

INTRACELLULAR PATTERN RECOGNITION RECEPTORS UNDERLIE
INFLAMMATORY RESPONSES OF GLIAL CELLS TO CENTRAL NERVOUS
SYSTEM PATHOGENS

by

David George Sterka Jr.

A dissertation submitted to the faculty of
The University of North Carolina at Charlotte
in partial fulfillment of the requirements
for the degree of Doctor of Philosophy
in Biology

Charlotte

2009

Approved by:

Dr. Ian Marriott

Dr. Kenneth L. Bost

Dr. Valery Grdzlishvili

Dr. Daniel Nelson

Dr. Michael Turner

© 2009
David G. Sterka Jr.
ALL RIGHTS RESERVED

ABSTRACT

DAVID G. STERKA JR. Intracellular pattern recognition receptors underlie inflammatory responses of glial cells to central nervous system pathogens. (Under the direction of DR. IAN MARRIOTT)

There is growing appreciation that the resident glial cells of the CNS, in particular microglia and astrocytes, are important participants in the generation of inflammation during brain infection. However, the mechanisms by which these cell types perceive and respond to microbial pathogens is only recently becoming apparent with the discovery of highly conserved families of pattern recognition receptors. In the current study we demonstrate that microglia and astrocytes express members of the NOD-like family of intracellular receptors. We demonstrate that the NOD2 pathway represents a functional mechanism by which these cells can augment the responses mediated by other families of pattern recognition receptors, specifically members of the Toll-like receptor family. Furthermore, we show that the NOD2 pathway contributes to the generation of potentially damaging inflammation in response to *N. meningitidis* and *B. burgdorferi*, both in vitro and in vivo, and that the elimination of this pathway results in a decrease in the production of important inflammatory mediators. Our additional studies involving viral infection of microglia and astrocytes highlight the potential of these cell types to respond to a variety of microbial types. Additionally, this work also demonstrated the replication-dependent nature of glial responses to vesicular stomatitis virus, a model of rabies, which points to the use of replication-dependent intracellular receptors such as Rig-I. Taken as a whole, this study implicates intracellular pattern recognition receptors as potentially important contributors to the glial immune responses within the CNS.

DEDICATION

This dissertation is dedicated to those who have supported me through all the tough times. For my mother Linda, my father Dave, my brother Mike, my sister Jen, daughter Mackezie, and Robin; thank you!

ACKNOWLEDGEMENTS

I would like to thank everyone who has helped me during my career as a student at UNC Charlotte. I would especially like to thank my advisor, Dr. Ian Marriott, for his neverending patience and support. I would like to thank Dr. Ken Bost, Dr. Dan Nelson, Dr. Valery Grdzlishvili, and Dr. Michael Turner for serving on my committee and providing me with much needed feedback. I would also like to thank Dr. Vinita Chauhan as well as the rest of the Marriott lab for all of their help and input.

TABLE OF CONTENTS

CHAPTER 1: INTRODUCTION	1
CHAPTER 2: MATERIALS AND METHODS	28
CHAPTER 3: EXPRESSION OF NOD2 IN PRIMARY MURINE ASTROCYTES	42
3.1 Rationale	42
3.2 Results	45
3.3 Conclusions	50
3.4 Figures	55
CHAPTER 4: EXPRESSION OF NOD2 IN PRIMARY MURINE MICROGLIA	61
4.1 Rationale	61
4.2 Results	64
4.3 Conclusions	69
4.4 Figures	73
CHAPTER 5: FUNCTIONAL ROLE OF NOD2 IN MICROGLIA AND ASTROCYTES	79
5.1 Rationale	79
5.2 Results	82
5.3 Conclusions	85
5.4 Figures	89

CHAPTER 6: REPLICATION-DEPENDENT IMMUNE RESPONSE OF MICROGLIA AND ASTROCYTES TO VESICULAR STOMATITIS VIRUS	95
6.1 Rationale	95
6.2 Results	97
6.3 Conclusions	104
6.4 Figures	108
CHAPTER 7: DISSERTATION SUMMARY	115
REFERENCES	128
APPENDIX: AUTHOR PUBLICATIONS	150

CHAPTER 1: INTRODUCTION

Bacterial infection can cause damaging inflammation within the central nervous system (CNS)

Traditionally the central nervous system is considered an area of the body that is largely devoid of immune response, a state referred to as “immune privileged”. Such an outlook is supported by observations of poor immune response generation in allograft tissue implantation experiments as compared to other possible sites (Cserr and Knopf 1992). This concept is further supported by the presence of the selective blood-brain barrier, relatively low expression of immune molecules, and absence of conventional lymphatic drainage (Barker and Billingham 1977; Nathanson and Chun 1989). The benefits of immune privilege within the CNS are quite obvious in that an immunological response in this area has the potential to be more devastating than the agent causing the response (Brent 1990). As such, it was classically believed that the CNS is isolated from the immune system. In this model, innate immune responses are severely impaired as the afferent arm of the adaptive immune response is disrupted by the lack of conventional lymph drainage, preventing the movement of antigens to the lymph nodes, while the efferent arm is disrupted by the blood-brain barrier which prevents the movement of effector cells into the CNS (Barker and Billingham 1977; Leibowitz and Hughes 1983).

Recent studies suggest that previous assumptions concerning CNS immune responses were not entirely accurate. While the CNS can be considered immune

privileged, it is still under constant immune surveillance (Hickey 2001). Immune activity observed in resident cells provides strong evidence that innate immune responses are generated within the CNS. Indeed, studies have demonstrated that some resident cell types can be induced to express important inflammatory mediators (Dong and Benveniste 2001; Kielian 2004b). Rapid responses by these cells may set the stage for potent adaptive immune response (Schwartz et al. 1999). While the blood-brain barrier does present a formidable obstacle to effector cell migration into the CNS, it is far from impenetrable. Indeed, very low levels of adhesion molecules are constitutively expressed by the endothelial cells of the blood-brain barrier and leukocytes are able to utilize these molecules to traverse the barrier (Bart et al. 2000). Likewise there is an inherent level of immunoglobulin G (IgG) present in cerebrospinal fluid as a result of molecule migration (Bart et al. 2000). During a disease state the blood-brain barrier changes markedly. These changes are believed to be a result, in part, of rising levels of tumor necrosis factor alpha (TNF- α), an important pro-inflammatory cytokine. Following exposure to TNF- α , the permeability of the blood-brain barrier increases dramatically, resulting in increased leukocyte migration as well as movement of molecules into and out of the CNS. Interestingly, the source of TNF- α need not be local, as rising levels within systemic circulation produce similar effects (Fabry et al. 1995; Mark and Miller 1999; Dickstein et al. 2000). As such, the blood-brain barrier does not impede the efferent arm of the immune response, but instead closely regulates the movement of effector cells into the CNS. Likewise, the afferent arm of the immune response is not impeded as much as previously supposed. While the CNS does lack conventional lymphatics, the role of these passages is accomplished via other means. Specifically, the movement of

cerebrospinal fluid in the brain and the Virchow-Robins spaces allows for the drainage into typical lymphatics, which are located along the cranial and spinal nerves (Cserr et al. 1992; Kida et al. 1995). Therefore, these observations of cell trafficking, a lymph-like system, and immune activity in endogenous glial cells have provided evidence that the CNS is more immunocompetent than originally believed.

Interestingly, the immunocompetent nature of the CNS is not as beneficial in some disease states as one would suppose. The immune response, while at times protective, can also cause collateral damage in areas of infection. In the case of inflammation in the CNS, it has been documented that the inflammatory response mediates damage in a variety of disease states. The initiating agents of this inflammation are variable and can be of both bacterial, such as brain abscess, Lyme disease, and bacterial meningitis, or non-bacterial in origin as observed in Alzheimer's disease, multiple sclerosis, allergic encephalomyelitis, and HIV-associated dementia. However, in all of these situations the major source of CNS damage is more likely to be the inflammatory response than the source of antigen directly (Benveniste 1997b; Gonzalez-Scarano and Baltuch 1999; Stoll and Jander 1999; Kielian 2004b; Kielian 2004a; Streit 2004). The presence of bacteria within the CNS is especially problematic and in most cases, if left untreated, results in the death of the host (Rajnik and Ottolini 2000). Luckily, the blood brain barrier provides protection against most bacterial types (Nathanson and Chun 1989). However, some neurotropic bacteria are specially adapted to cross this barrier and establish infection (Kim 2006). The nutrient-rich cerebrospinal fluid provides an ideal growth medium for bacterial proliferation. The detection of bacterial antigens by resident cells causes the generation of an innate immune response.

This results in the production of pro-inflammatory molecules including cytokines and chemokines which serve to both amplify the immune response and draw in additional immune cells from the periphery (Van Wagoner and Benveniste 1999; Ambrosini and Aloisi 2004; John et al. 2005). While these responses serve to help control the magnitude of infection, there is also collateral damage to the delicate cell types within the CNS directly through the production of cytotoxic effects by immune cells as well as indirectly through pressure caused by brain swelling (Gasque et al. 1995; Medana et al. 2000; Nau and Bruck 2002). This, coupled with the limited regeneration of CNS cells, can result in permanent neurologic deficit (Bailey et al. 2006).

***Borrelia burgdorferi* and *Neisseria meningitidis* are important Gram-negative bacterial pathogens of the CNS**

Borrelia burgdorferi, the causative agent of Lyme disease, is a Gram-negative spirochetal bacterium transmitted by Ixodes ticks (Magnarelli and Anderson 1988). Infection with this bacterium is the most recognizable arthropod-borne infection in the United States (Kaiser 1998). Approximately 15% of untreated exposures result in a crossing of the blood-brain barrier leading to neuroborreliosis, a degenerative condition of the central nervous system (Steere 2001). This infiltration, along with other evasion strategies such as antigenic variation, regulation of antigen expression, and suppression of immune action, provides a means by which to circumvent the immune responses of the infected host (Embers et al. 2004). Furthermore, *B. burgdorferi* can associate and invade neuronal and glial cells which further contributes to the survival of this bacteria in the CNS (Livengood and Gilmore 2006). Neuroborreliosis manifests itself clinically through encephalitis, cranial neuropathy, and meningitis. Although the neurological symptoms are variable, patients commonly develop cognitive and memory impairment during the

course of infection, which may or may not resolve with clearance of the bacteria (Halperin 1997). This is because the inflammation associated with this condition results in debilitating effects including cell damage and death of neurons within the central and peripheral nervous systems (Steere 2001). Studies have shown that *B. burgdorferi* can cause robust innate immune responses within the CNS as evidenced by rapid local increases in important pro-inflammatory mediators such as IL-1, IL-6, TNF- α , and nitric oxide (NO) and chemokines such as MCP-1, MIP-1 α , and MIP-1 β (Habicht et al. 1985; Defosse et al. 1992; Tatro et al. 1994; Isogai et al. 1996). Additionally, increases in glial fibrillary acidic protein and TNF- α in cerebral spinal fluid are observed during infection (Dotevall et al., 1996; Widhe et al., 2002). These important innate immune responses serve to direct adaptive immunity as well as amplify the overall inflammatory response through the migration, proliferation, and maturation of innate immune cells.

Neisseria meningitidis, another bacterial pathogen of the CNS, is one of the three most common causes of bacterial meningitis which, despite antimicrobial treatment, is one of the top 10 infectious causes of death worldwide (Scheld et al. 2002). This Gram-negative diplococcal bacterium exists within the nasopharynx of close to 40% of the adult population as a member of the normal flora and is spread via respiratory secretions. In order to cause disease this bacterium must colonize the nasopharynx, traverse into the bloodstream, evade the host immune mechanisms of the intravascular space, cross the blood-brain barrier, and replicate in the subarachnoid space (Tzeng and Stephens 2000). *N. meningitidis* is able to cross the epithelial barrier in the nasopharynx as well as the blood-brain barrier through pili-mediated adhesion to CD46 molecules (Johansson et al. 2003). After penetration this pathogen has been shown to proliferate both extracellularly

as well as within resident cells of the CNS (Nikulin et al. 2006). This infection of the CNS can result in the impairment of cerebrospinal fluid dynamics, formation of brain edema, increased intracranial pressure, arterial and venous cerebral vascular defect, seizure activity, other neurologic sequelae, and death (Nathan and Scheld 2000).

Damage to the CNS is manifested predominantly as necrotic cortical injury and apoptotic hippocampal injury (Pfister et al. 1994; Braun et al. 1999; Nau et al. 1999). In spite of bacterial clearance, 30-50% of survivors will retain some type neurologic deficit (Grimwood et al. 2000). Obviously, the host immune response is not able to control the infection within the CNS and it is believed that the immune response is responsible for many of the damaging events during this disease state (Tunkel and Scheld 1995; Pfister and Scheld 1997). Indeed, as with *B. burgdorferi*, robust innate immune responses are generated within the CNS. Copious amounts of pro-inflammatory mediators, such as IL-1, IL-6, TNF- α , and NO, and chemokines, such as IL-8, MCP-1, MIP-1 α , MIP-2, and MIP-1 β are produced by resident cell types (Leib et al. 1996; Spanaus et al. 1997; Lahrtz et al. 1998; Winkler et al. 2001). The chemokines serve to stimulate the immigration of leukocytes to the location of CNS infection while the cytokines amplify the inflammatory responses of both resident and infiltrating cells. The effector functions of these cells, such as the production of reactive oxygen species, have been implicated as a major source of damage during bacterial meningitis (Tunkel and Scheld 1995; Leib et al. 1996; Pfister and Scheld 1997). However, these responses lack the ability to clear the pathogen from the CNS. This is likely due to the immune evasion mechanisms of this pathogen including immunomodulation, resistance to phagocytosis, antibody cleavage, and intracellular invasion (Dehio et al. 2000).

While *Borrelia burgdorferi* and *Neisseria meningitidis* are highly disparate organisms, they are both significant pathogens of the CNS which result in high risk of morbidity and mortality regardless of the available treatment options (Halperin 1997; Scheld et al. 2002). The damage resulting from infection by these organisms is mediated, in large part, by the host immune responses. Indeed, while the immune responses serve to limit bacterial proliferation they also result in damage to the delicate cell types of the CNS (Tunkel and Scheld 1995; Pfister and Scheld 1997; Steere 2001). As such, the study of these pathogens and the immune responses generated against them is an important undertaking. Beyond this, both of these pathogens have the unique ability to invade and survive within the resident cells of the CNS, including microglia and astrocytes. This behavior is particularly interesting in that it limits the perception of these pathogens by immune cells as well as limits their exposure to mechanisms of immune-mediated clearance (Dehio et al. 2000; Livengood and Gilmore 2006).

Resident CNS cells contribute to the generation of potentially damaging inflammation

Microglia are considered to be the facultative macrophages of the central nervous system (Jordan and Thomas 1988; Aloisi 2001). The specific phenotype of these resident cells is indicative of specialized adaptation to the neural environment, as they exhibit a “down-regulated” phenotype in their normal state unlike that of other macrophage populations, this phenotype is characterized by low expression of CD45 and other surface molecules coupled with lack of phagocytic and endocytic properties (Perry and Gordon 1988; Kreutzberg 1996). The role of this cell type in the normal brain is largely unknown although evidence suggests that they may have homeostatic and reparative functions (Kreutzberg 1996; Batchelor et al. 1999). In response to trauma or infection, Microglia quickly activate and undergo rapid cell proliferation known as reactive microgliosis (Streit et al. 1999; Wirenfeldt et al. 2005). This rapid proliferation is in stark contrast to the normal slow turnover of microglia usually occurring in the CNS (Lawson et al. 1992). In addition, microglia become activated at the site of challenge, enlarge, and assume many of the immune effector functions typically associated with macrophages. In this respect, they are able to contribute to the establishment of non-specific inflammation as well as adaptive immune responses. Microglia gain endocytic and phagocytic activity, facilitated by expression of Fc receptors, and the ability to present antigen in the context of MHC class II molecules (Hickey and Kimura 1988; Ulvestad et al. 1994; Streit et al. 1999). This latter function is supported by the expression of other molecules important in antigen presentation, namely CD11a, CD40, CD54, CD58, CD80 (B7-1), and CD86 (B7-2), which are expressed upon microglia activation (Williams et al. 1994; Cannella and Raine 1995; De Simone et al. 1995; Satoh et al. 1995; Gerritse et al. 1996; Tran et al.

1998). These molecules, in combination with MHC class II, allow microglia to function as professional antigen presenting cells for both naïve and memory T-cells. Indeed, although inferior to other types of macrophages, microglia can be considered to be the most effective antigen presenting cells within the brain parenchyma (Shrikant and Benveniste 1996). Microglia can be also induced to produce a variety of cytokines and chemokines including key pro-inflammatory molecules such as TNF- α , IL-6, IL-12, IL-1 β , MIP-1 α , MCP-1, and IL-8 (Kiefer et al. 1993; Meda et al. 1995; Walker et al. 1995; Lorton et al. 1996; Meda et al. 1996; Liu et al. 1998; Aloisi et al. 1999; Meda et al. 1999; Prinz et al. 1999; Streit et al. 1999; Gregersen et al. 2000; Nadeau and Rivest 2000; Owens et al. 2005). This is of particular importance because chemokines facilitate the recruitment of leukocytes into the CNS and cytokines contribute to their subsequent activation. This further highlights the importance of microglia in immune response generation since these events are integral to the development and amplification of host immune responses. Additionally, microglia can directly mediate damage to other CNS cells through production of reactive oxygen species as well as complement components (Ulvestad et al. 1994; Akundi et al. 2005).

Astrocytes, the major glial cell type in the central nervous system, are important cells in CNS homeostasis. These cells influence neuronal function through the release of neurotropic factors, assist synaptic formation and maintenance, help guide neuronal development, contribute to neurotransmitter metabolism, regulate the extracellular environment, and contribute to the integrity of the blood-brain barrier (Bush et al. 1999; Rubin and Staddon 1999; Sofroniew et al. 1999; Haydon 2000; Dong and Benveniste 2001; Ullian et al. 2001). Astrocytes have also been recognized as potentially important

contributors to inflammatory immune responses within the brain. Upon activation astrocytes undergo astrogliosis; a rapid proliferation followed by morphological changes and increased expression of glial fibrillary acidic protein (GFAP). This event can be beneficial through the production of neuronal growth factors or it can be damaging, resulting in the production of glial scarring and functional impairment (Hatten et al. 1991). As with microglia, astrocytes can be induced to express MHC class II molecules and can, importantly, process and present antigen in its context (Soos et al. 1998). However, the role of astrocytes as a professional antigen presenting cell is still in question. Some studies have reported that astrocytes can be induced to express B7-1 (CD80), B7-2 (CD86), and CD40 (Nikceovich et al. 1997; Issazadeh et al. 1998; Tan et al. 1998; Abdel-Haq et al. 1999; Soos et al. 1999). In contrast, others have reported that these cells lack expression of these molecules both constitutively as well as following activation (Williams et al. 1994; Satoh et al. 1995; Windhagen et al. 1995; Aloisi et al. 1998; Cross and Ku 2000; Nguyen and Benveniste 2000; Togo et al. 2000). As such, it is possible that these cells may act as nonprofessional antigen presenting cells, stimulating memory T-cells, but not naive T-cells. Obviously additional research would be required in order to better describe the role of astrocytes as antigen presenting cells. The role of astrocytes in the production of inflammatory mediators, however, is well established. Astrocytes have been shown to produce a variety of pro and anti-inflammatory cytokines, including IL-1, IL-6, IL-10, GM-CSF, G-CSF, M-CSF, TNF- α , and TGF- β , and important chemokines, such as RANTES, IL-8, MCP-1, and IP-10 (Benveniste 1997a; Owens et al. 2005). As a potent source of both of these molecule classes, which are

important mediators of the inflammatory process, astrocytes are integral contributors to the development of CNS immune responses.

These resident glial cells have been implicated as major contributors to damage-causing inflammation in disease states including, but not limited to, bacterial infection (Boje and Arora 1992; Ulvestad et al. 1994). They have the capacity to detect and respond to pathogens in circumstances lacking infiltrating immune cells and established inflammation. The innate immune actions of these cells represent some of the earliest responses to CNS infection and help set the stage for subsequent inflammatory and immune responses (Schwartz et al. 1999; Owens et al. 2005). These responses, while at times protective, can also be damaging to the delicate cells of the CNS. The ability of these two cell types to contribute in damaging inflammation is well illustrated in studies of CNS disease. Indeed, studies in HIV-1-associated dementia, Alzheimer's disease, and Multiple Sclerosis highlight the potential of microglia and astrocytes to elicit damage to the nervous system (Minagar et al. 2002). As part of these disease states, microglia and astrocytes become activated, proliferate, and assume their effector functions including antigen presentation, cytokine and chemokine excretion, and the production of cytotoxic molecules (Wisniewski et al. 1989; Tyor et al. 1992; Wesselingh et al. 1993; Giulian et al. 1995; Conant et al. 1998). These actions lead to changes in blood-brain barrier permeability as well as the recruitment and activation of peripheral immune cells, ultimately amplifying the immune response and causing increased inflammation within the CNS (Minagar et al. 2002; Bailey et al. 2006). This inflammation, although required for pathogen/antigen clearance and damage repair, can also result in collateral damage to

the delicate cells present in the CNS such as neurons. Damage to these cells is particularly devastating due to limited regenerative abilities.

Resident CNS cells perceive bacterial and viral pathogens

Recent studies by our group, as well as others, have demonstrated that microglia and astrocytes have the ability to perceive and respond to microbial pathogens. These resident glial cells have been shown to respond to a variety of bacterial species of both Gram-negative and Gram-positive types including *Borrelia burgdorferi*, *Neisseria meningitidis*, and *Staphylococcus aureus* (Kielian et al. 2002; Rasley et al. 2002a; Esen et al. 2004; Kielian et al. 2004; Rasley et al. 2006; Chauhan et al. 2008). The activation of microglia and astrocytes, however, is not limited to bacterial infections. Studies have demonstrated the ability of these cells to respond to multiple viral species and types including Borna virus, West Nile virus, vesicular stomatitis virus, Japanese encephalitis virus, HIV, Theiler's, Measles, and rabies (Christian et al. 1996; Marquette et al. 1996; Noe et al. 1999; D'Aversa et al. 2004; Cheeran et al. 2005; Ovanesov et al. 2006; So et al. 2006; Jin et al. 2007; Alvarez et al. 2008; Das et al. 2008; Kang et al. 2008; Lehrmann et al. 2008; Ovanesov et al. 2008). Interestingly, bacterial and viral components have been shown to be a sufficient stimulus to result in the activation of microglia and astrocytes. Investigations of this phenomenon have demonstrated that lipopolysaccharides, flagellin, unmethylated CPG motifs, synthetic ssRNA, synthetic dsRNA, and lipoteichoic acids are able to elicit the effector responses of these cells, notably cytokine production (Dalpke et al. 2002; Jack et al. 2005; Kinsner et al. 2006; Lund et al. 2006; Suuronen et al. 2006; Gurley et al. 2008). However, the mechanisms by which these cell types perceive these pathogens and pathogen associated molecules are not fully understood.

Innate immune cells utilize pattern recognition receptors to perceive microbial pathogens

The function of the innate immune response is to identify and respond to invading pathogens in an effort to limit proliferation, control their spread, and assist in microbial clearance. These responses are rapid and not specific to particular pathogens. The mechanisms by which immune cells perceive a pathogen and subsequently generate inflammation have long been unknown. However, the recent discovery of receptors for molecules produced by microorganisms has shed light on how this occurs. These receptors, known as pattern recognition receptors (PRRs), interact with highly conserved microbial structures known as pathogen-associated molecular patterns (PAMPS). The result is the initiation of the innate immune system leading, ultimately, to the development of an adaptive immune response. The presence of these receptors on many cell types confers a selective advantage by allowing for rapid development of the local immune response to pathogens, a fact demonstrated by the highly conserved nature of these receptors (Medzhitov and Janeway 1997; Beutler 2004; Beutler et al. 2004; Lemaitre 2004).

The Toll family of PRRs was originally identified in *Drosophila*, but studies have demonstrated that humans and other organisms express receptors of a similar nature termed the Toll-like family of PRRs (Anderson et al. 1985; Lemaitre et al. 1996; Lemaitre et al. 1997; Rock et al. 1998; Lemaitre 2004). To date, the Toll-like receptor family is the most highly studied of all PRRs and consist of receptors that recognize specific PAMPs of microbial pathogens. Currently 10 Toll-like receptors (TLRs) (TLR1-10) in humans and 12 TLRs (TLR 1-9 and 10-13) in mice have been identified (Medzhitov and Janeway 1997; Akira 2003). Structurally, these are type 1

transmembrane glycoprotein receptors which consist of an intracellular and extracellular domain. The intracellular domain, consisting of a highly conserved Toll-interleukin-1 receptor (TIR) domain, mediates the interaction between the receptor and downstream effector molecules. The extracellular domain, consisting of a leucine rich repeat region, is responsible for ligand binding (Beutler 2004; Beutler et al. 2004; Hoebe and Beutler 2004). These molecules can be located on the cell surface, such as TLRs 1, 2, 4, 5, 6, and 10, or intracellularly, such as TLRs 3, 7, 8, and 9 (Bowie and O'Neill 2000; Ozinsky et al. 2000; Hornef et al. 2003; Latz et al. 2004). TLRs are expressed on many immune cell types including macrophages, B cells, dendritic cells, and even specific types of T cells. Aside from this, there is also expression on nonimmune cells including epithelial, endothelial, and smooth muscle cell types. Expression of these molecules can be constitutive or modulated by the activation, maturation, or differentiation of the specific cell types (Visintin et al. 2001; Rehli 2002; Heinz et al. 2003).

There are many PAMPs which are recognized by members of the TLR family including lipopeptides (TLR2), double stranded RNA (TLR3), Lipopolysaccharides (TLR4), bacterial flagellin (TLR5), single stranded RNA (TLR7 and TLR8), and unmethylated DNA CPG motifs (TLR9) (Poltorak et al. 1998; Qureshi et al. 1999; Hemmi et al. 2000; Alexopoulou et al. 2001; Hayashi et al. 2001; Barton and Medzhitov 2002; Akira 2003; Barton and Medzhitov 2003; Girardin et al. 2003d; Takeda et al. 2003; Underhill 2003; Travassos et al. 2004). It is important to note that there may be other PAMPs recognized by TLRs that have not yet been described (Akira 2003; Kawai and Akira 2006). Upon binding of the ligand to the extracellular domain, TLRs dimerize and undergo conformational changes to associate with important downstream adapter

molecules (Visintin et al. 2003; Akira and Takeda 2004; Hoebe and Beutler 2004). There are a variety of possible adapters including myeloid differentiation primary response gene 88 (MyD88), MyD88-adaptor-like (Mal), (Toll-interleukin 1 receptor (TIR) domain-containing adapter protein) TIRAP, Toll-receptor-associated activator of interferon (TRIF), Toll-receptor-associated-molecule (TRAM), and Sterile-alpha and Armadillo motif containing protein (SARM) (O'Neill et al. 2003). The varying responses exhibited by the different TLRs are dependent upon the combination of adapters recruited upon ligation which allows for a tailored response by the cell through the activation of specialized inflammatory genes including those controlling the NF κ B and MAP kinase pathways (Hirschfeld et al. 2001; Gao et al. 2002; Doyle et al. 2003; Nau et al. 2003).

Microglia and astrocytes express pattern recognition receptors

Studies have shown that microglia and astrocytes, resident glial cells of the CNS, express pattern recognition receptors, namely members of the Toll-like family of receptors. Indeed, recent studies conducted by our group as well as others have demonstrated that microglia and astrocytes express TLR2, TLR3, TLR4, TLR5, TLR7, TLR8, and TLR9, receptors for lipoproteins, double stranded RNA, lipopolysaccharide, bacterial flagellin, single stranded RNA, and unmethylated DNA CpG motifs, respectively (Laflamme and Rivest 2001; Bsibsi et al. 2002; Rasley et al. 2002a; Bowman et al. 2003; Esen et al. 2004; Olson and Miller 2004; Carpentier et al. 2005; Esen and Kielian 2005; Jack et al. 2005; Kielian et al. 2005a). These receptor types are constitutively expressed by microglia and astrocytes, which would indicate their use as a constant mechanism for immune surveillance. Importantly, the levels of these receptors are increased upon activation of microglia and astrocytes. The induction of higher pattern

recognition receptor levels has been shown to occur following exposure to their specific ligands, as well as the ligands associated with other pattern recognition receptors. This effect also occurs in response to more complex stimuli including the clinically relevant bacteria *N. meningitidis* and *B. burgdorferi*. The presence of these receptor types within these resident glial cells is consistent with the profile of microbial component responses observed in these cell types, which provides an important explanation for the mechanism of how these responses are mediated. Evidence suggests that these molecules are important in the immune activation of these cells types and generation of subsequent effector functions, in particular by the induction of cytokine and chemokine production (Jack et al. 2005).

Members of the NOD-like receptor family of cytosolic proteins function as intracellular pattern recognition receptors

Recent studies have identified a new family of novel intracellular pattern recognition receptors. Nucleotide binding and oligomerization domain receptors or NODs are part of a family of cytosolic protein receptors known as NOD-like receptors (NLRs). This family of receptors contains some members that appear to play a role in the recognition of bacteria and induction of inflammatory responses (Girardin et al. 2001; Carneiro et al. 2004). The members of this family possess what are known as amino-terminal effector binding domains, which include caspase recruitment domains (CARDs), pyrin domains (PYD), or baculovirus inhibitor of apoptosis domains (BIR). They also contain a central nucleotide-binding oligomerization domain (NOD) and a carboxyl-terminal ligand sensing domain containing leucine-rich repeats or WD40 repeats (Tanabe et al. 2004). These proteins are structurally related to the nucleotide binding site-leucine-rich repeat class of plant R gene products that mediate pathogen resistance in

plants. The plant proteins both recognize and elicit a defensive response following exposure to molecules from pathogenic bacteria (Girardin et al. 2002; Chamaillard et al. 2003a; Athman and Philpott 2004) Intracellular signaling is accomplished by interactions between the effector binding domains and signaling molecules after the oligomerization of NOD proteins. To date ligands consisting of components of peptidoglycan have been identified for several of the members of the NOD family, including NOD1/CARD4, NOD2/CARD15, and Cryopyrin (Chamaillard et al. 2003b; Girardin et al. 2003a; Girardin et al. 2003b; Inohara et al. 2003). NOD1, also known as CARD4, has been shown to be an important intracellular receptor of bacterial peptidoglycan components in specific subsets of bacteria (Girardin et al. 2003a; McDonald et al. 2005).

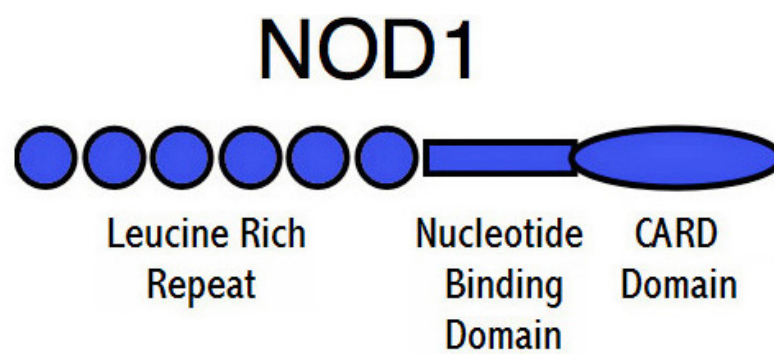

Figure 1: Schematic representation of NOD1 protein structure

As shown in Figure 1, NOD1 contains a single amino-terminal CARD domain, a nucleotide binding site, and a leucine-rich carboxyterminal region (Inohara et al. 1999). Lipopolysaccharide was originally thought to be the ligand for NOD1, but further study revealed that this finding could be attributed to peptidoglycan contamination of the lipopolysaccharide preparation (Inohara and Nunez 2001; Inohara et al. 2001; Yoo et al. 2002). Additional studies have also demonstrated the actual ligand to be peptidoglycan fragments that contain a specific dipeptide. This dipeptide is the D- γ -glutamyl-meso-

DAP (iE-DAP) motif of GM-Tri-DAP and is generated by either degradation of peptidoglycan or secretion by the bacteria itself during the process of replication. The iE-DAP dipeptide is found in Gram-negative bacteria and select subsets of Gram-positive bacteria (Chamaillard et al. 2003b; Girardin et al. 2003a; Girardin and Philpott 2004; Girardin et al. 2005). This would suggest that the presence of the NOD1 receptor would confer an advantage to the host in areas of high exposure to Gram-negative bacteria, such as the lining of the intestinal mucosa (Chamaillard et al. 2003b; Girardin et al. 2003a; Carneiro et al. 2004; Travassos et al. 2005).

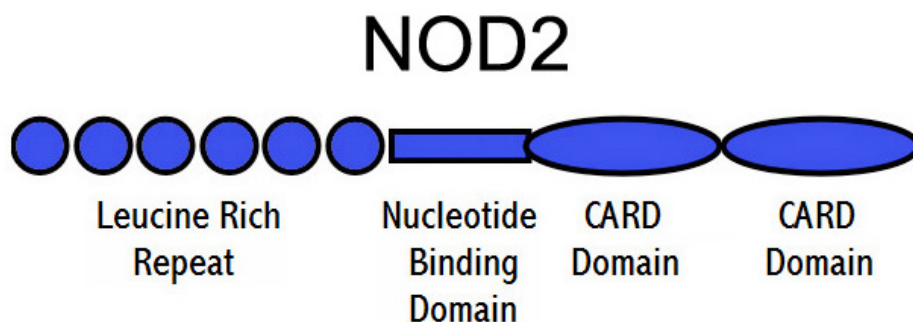

Figure 2: Schematic representation of the NOD2 protein structure

NOD2/CARD15 is also an intracellular receptor, but for a range of bacterial peptidoglycan types (Girardin et al. 2003b; Inohara et al. 2003). As shown in Figure 2, there are slight differences in the structural composition between NOD1 and NOD2, as NOD2 has two CARD domains (Ogura et al. 2001b; Carneiro et al. 2004). Defects in the gene coding for NOD2 have been implicated in Crohn's disease, Blau syndrome, and sarcoidosis (Hugot et al. 2001; Miceli-Richard et al. 2001; Ogura et al. 2001a). The mutation associated with Crohn's disease is a result of a frame shift mutation affecting the terminal leucine rich repeats and manifests itself as an inability to detect peptidoglycan (Ogura et al. 2001a; Girardin and Philpott 2004). This lack of sensing may

result in the lack of a local response to infection leading to systemic responses and inflammation (Girardin et al. 2003c; Carneiro et al. 2004). NOD2 expression has been shown to be present in a wide range of cell types including granulocytes, neutrophils, dendritic cells, epithelial cells, and myofibroblasts (Gutierrez et al. 2002; Hisamatsu et al. 2003; Otte et al. 2003). Like in the studies of NOD1, the stimulation of NOD2 was also found to be due to exposure to lipopolysaccharide. Yet, also as with NOD1, the observed stimulation was a result of peptidoglycan persisting through the purification process. The actual ligand that initiates activation through NOD2 is muramyl dipeptide (MDP), a minimal motif of the peptidoglycan found in both Gram-negative and Gram-positive bacteria (Girardin et al. 2003b; Girardin et al. 2003e; Inohara et al. 2003; Travassos et al. 2004). In addition studies have shown NOD2 receptors can respond to other structural components of peptidoglycan such as muramyl-tri-lys. However it cannot respond to the similar muramyl-tri-DAP (Girardin et al. 2003e; Girardin and Philpott 2004). Since MDP is found in the peptidoglycan expressed on almost all bacterial types it can be suggested that this molecule serves as a more general receptor than NOD1 for peptidoglycan and confers a selective advantage to a host against all bacteria (Girardin et al. 2003b; Girardin et al. 2003d; Inohara et al. 2003).

Since both NOD1 and NOD2 are intracellular receptors, the highly conserved peptidoglycan structures in the cell bacterial walls that they recognize must be internalized. It is possible that the phagocytic mechanisms of some cell types, such as macrophages, are involved. Within the phagosome, bacteria and bacterial structures are degraded using a number of lysosomal enzymes. Following degradation, the bacterial products, including those recognized by NOD1 and NOD2, may be allowed to come into

contact with the cytoplasmic environment of the cell and stimulate these pathways. Some of the cell types expressing NOD1 and NOD2, including, but not limited to, intestinal epithelial cells, do not undergo active phagocytosis. In such cell types it is possible that active invasion of the cell by intracellular pathogens which enter the cytosol results in the exposure to the required bacterial products. Another possibility could be that fragments of peptidoglycan, released from the replication of extracellular bacteria, are taken up by host cells. While these are all viable options for entry of NOD-specific ligands into intracellular space, recent studies propose another mechanism. Indeed, studies have demonstrated that the molecule hPepT1 has the ability to specifically transport muramyl dipeptide (Ismair et al. 2006). While the exact mechanisms of NOD ligand translocation are poorly understood, this opens the possibility that there may be other specific transporters to fulfill this role.

NOD-like receptors can mediate inflammatory responses

Members of the NOD-like family of pattern recognition receptors can contribute to the generation of inflammatory responses, in particular those involved with the production of inflammatory cytokines. Studies have demonstrated that the ligands for NOD1 and NOD2 can elicit, independently of other stimuli, the production of the inflammatory cytokines IL-6, TNF- α , IL-1 β , and IL-12 (Adam et al. 1978; Heinzlmann et al. 2000; Nau et al. 2002). Beyond this, NOD ligands have been used as adjuvants for antigen-specific T-cell mediated responses and antibody production in that they can influence the expression of membrane-bound co-stimulatory molecules important for the activation of T-cells (Heinzlmann et al. 2000; Nau et al. 2002). Regardless of their differences, both NOD1 and NOD2 utilize the same adapter protein resulting in identical

downstream signaling as well as immune response. Yet this does not eliminate the possibility that there may be additional specific responses for each receptor, a feature which occurs in the members of the Toll-like receptor family. Both NOD1 and NOD2 interact with Rip2 kinase, which is also known as RICK (Rip-like CARD-containing kinase) or CARDIAK (CARD-containing interleukin-1 β -converting enzyme-associated kinase) (Inohara et al. 1999; Ogura et al. 2001b).

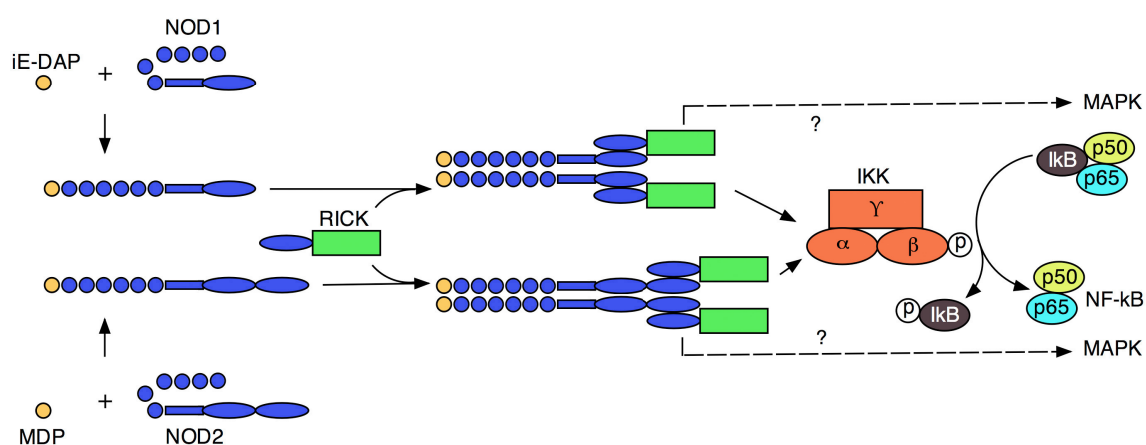

Figure 3: Schematic representation of the NOD1 and NOD2 signaling pathway

As shown in Figure 3, in the resting state the NOD1 and NOD2 proteins are negatively regulated by their leucine-rich regions. While in this state, the leucine-rich region is folded to prevent the oligomerization and activation of the receptor pathway. However, once a ligand is recognized by the receptor the NOD proteins undergo conformational change and become unfolded. This allows the receptors to become oligomerized, which results in the recruitment of Rip2 kinase. Rip2 kinase contains a CARD domain which enables it to physically associate with the oligomerized NOD proteins through homophilic CARD-CARD interaction and Rip2 kinase is then able to interact with IKK γ , which is a regulatory subunit of the IKK complex, linking these

proteins to the IKK complex ultimately results in the activation of NF κ B (Inohara et al. 1999; Ogura et al. 2001b; Kobayashi et al. 2002). The regulation of NF κ B is controlled by the binding of inhibitory proteins known as I κ B proteins. The phosphorylation of the IKK complex results in the activation of that complex. This causes the degradation of the I κ B proteins and results in transcription of the NF κ B gene products. The activation of IKK in response to NOD1 or NOD2 activation is best explained by an induced proximity model in which the oligomer interacts with the IKK α and IKK β dimer, thereby increasing their proximity and resulting in mutual trans-autophosphorylation (Ali and Mann 2004). After activation the IKK complex subunits phosphorylate the I κ B proteins. This phosphorylation tags the I κ B proteins for ubiquitination and subsequent degradation, thus freeing NF κ B dimers. These dimers translocate to the nucleus where they regulate the expression of a wide variety of genes, and hence their gene products (Lucas et al. 2004). This activation of NF κ B is independent of MyD88, which is the key adaptor molecule involved in signaling via Toll-like receptors (Kobayashi et al. 2002). There is also data to suggest that NODs can activate c-JUN N-terminal kinase in response to bacteria, however the mechanism is not fully understood (Girardin et al. 2001). It is important to note that there may be other, alternative, adaptor molecules for the NOD2 pathway including the recently described GRIM-19. The pathway for the action of this molecule has not been described to date. However, evidence suggests that this adaptor may also lead to the activation of the NF κ B pathway (Barnich et al. 2005).

Studies have shown that the induced expression of NF κ B products is a critical component in the control of microbial infection and the lack of proper activation results in host susceptibility to infection (Ali and Mann 2004). Liberation and nuclear

translocation of the NF κ B genes results in the production of important cellular signaling proteins. Important pro-inflammatory cytokines such as TNF α , IL-1, IL-2, IL-6, IL-12, TNF α , TNF β , and GM-CSF are all controlled by NF κ B expression. In addition NF κ B controls production of chemokines (IL-8, RANTES, MIP-1 α , MCP1, and eotaxin) and adhesion molecules (ICAM-1, VCAM, E-selectin) (Ali and Mann 2004). NF κ B is essential for the production of effector molecules which directly affect pathogens and the enzymes which generate reactive intermediates. Also, NF κ B has a role in the upregulation of MHC molecules and CD80/86 receptors on the surface of antigen-presenting cells. This provides a link between the innate and adaptive immune responses facilitating the activation of the adaptive immune response (Lucas et al. 2004).

Hypothesis and Present Study

In the present study we have tested the hypothesis that the immune activation of microglia and astrocytes is mediated, at least in part, by novel intracellular pattern recognition receptors of the NOD-like and Rig-like helicase families. This course of study is based upon previous observations that microglia and astrocytes, as resident glial cells of the CNS, are immunocompetent and the activation of these cell types contributes to the potentially damaging inflammation associated with microbial infection. We demonstrate that microglia and astrocytes constitutively express members of the NOD-like family of intracellular pattern recognition receptors, namely NOD1 and NOD2, and that the expression of these molecules is increased at both the mRNA and protein level following exposure of these cells to *N. meningitidis* and *B. burgdorferi*, two disparate and clinically relevant pathogens of the CNS. Likewise, this expression is also increased following exposure to known Toll-like receptor ligands. However, the expression of

NOD1 was markedly lower than that of the NOD2 receptor. This led us to the conclusion that NOD2 is potentially a more important receptor in the identification of pathogens by glial cells and we focused further studies exclusively on the NOD2 receptor. Importantly, both microglia and astrocytes express critical downstream effector molecules for the NOD pathways, including RIP2-kinase in astrocytes as well as both RIP2-kinase and GRIM19 in microglia. In order to begin to address the functional contributions of this pathway in these resident glial cells we demonstrated the ability of NOD2 ligation with MDP to significantly augment the production of important pro-inflammatory cytokines, namely IL-6, TNF- α , and IL-1 β in microglia and IL-6 and TNF- α in astrocytes, following Toll-like receptor stimulation. The investigations up to this point provided exciting and compelling circumstantial evidence that there is functional expression of the NOD2 pathway in microglia and astrocytes.

In order to confirm our hypothesis and definitively show functional NOD2 expression, we conducted additional studies. First we demonstrated that there is increased association between NOD2 and the downstream effector molecule RIP2-kinase using co-immunoprecipitation. Following this we performed additional studies utilizing transgenic mice deficient in the NOD2 receptor. Experiments mirroring our previous work confirmed that wild-type microglia and astrocytes have augmented TLR-mediated cytokine production, namely IL-6 and TNF- α , in the presence of MDP. This effect is eliminated in cells derived from NOD2-deficient mice. This phenomenon was also observed in experiments involving *N. meningitidis* and *B. burgdorferi* in which microglia and astrocytes derived from NOD2-deficient had significantly lower IL-6 and TNF- α production than that observed in wild-type. In-vivo infection studies resulted in similar

observations in which the production of pro-inflammatory cytokines was attenuated in NOD2-deficient mice. These data provide strong evidence that there is functional expression of the NOD2 pathway in microglia and astrocytes and that this pathway may be an important contributor to the generation of inflammatory responses by these resident glial cells.

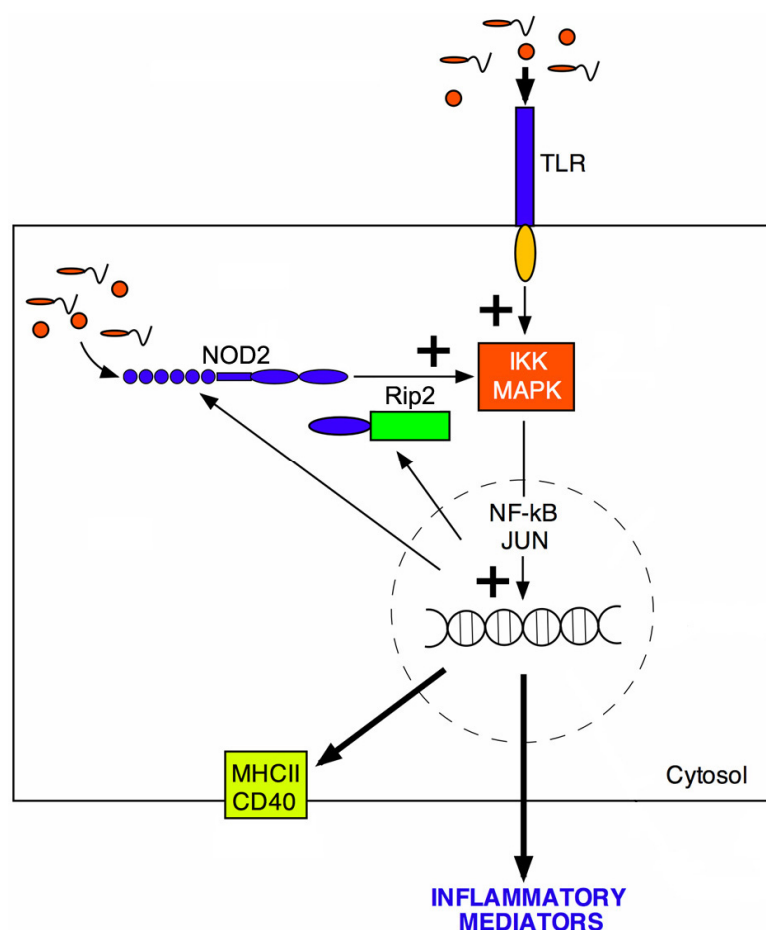

Figure 4: Proposed pathway of TLR and NOD2 cooperation in microglia and astrocytes

Taken as a whole, our data proposes the pathway shown in Figure 4 for glial cells. In this model TLR ligands interact with their receptors on microglia and astrocytes resulting in the activation of NFκB and the MAP kinase pathways which, in turn, result in the production of inflammatory mediators and the upregulation of NOD2 and Rip2

kinase expression. The upregulation of members of the NOD2 pathway makes microglia and astrocytes more sensitive to levels of MDP and, as the pathway is activated, causes further activation of the NF κ B and MAP kinase pathways. This ultimately leads to augmentation of inflammatory mediator production beyond that observed with TLR ligands alone.

Our additional studies concerning viral pathogens in microglia and astrocytes are based upon research conducted by other members of our group and published in Furr et al., 2008. Those studies demonstrated that microglia and astrocytes express members of the RIG-like helicase family of pattern recognition receptors. Of particular interest is the constitutive expression of RIG-I by these resident glial cells which is upregulated following exposure vesicular stomatitis virus (VSV), which is commonly used as a model for rabies infection. However, the ability of VSV to infect and replicate within these glial cells has not been established. In the present study, we demonstrate that primary murine microglia and astrocytes are permissive for VSV infection both in vitro and in vivo. Furthermore, we show that active replication of this virus appears to be required for robust inflammatory mediator production by these resident CNS cell types. These data suggest that viral replication within resident glial cells plays a key role in the development of lethal CNS inflammation following neurotropic Mononegavirus infection. Since the RIG-I pathway is only activated during the replication of these viruses, this provides evidence that stimulation of this pathway may contribute to the generation of inflammation by microglia and astrocytes during viral infection.

Taken in concert, the demonstration of functional NOD2 expression along with evidence supporting RIG-I as a mechanism for viral detection provide for a compelling

argument that intracellular pattern recognition receptors such as these may play an important role in the generation of immune responses by microglia and astrocytes.

CHAPTER 2: MATERIALS AND METHODS

Wild-Type and NOD2-Deficient Mice

B6.129S1-Nod2tm1Flv/J mice that are NOD2-deficient (NOD2^{-/-}) and bred for >10 generations onto a C57BL/6 background, as well as wild-type C57BL/6j mice, were purchased from Jackson Laboratory (Bar Harbour, Maine). All studies were performed in accordance with relevant federal guidelines and institutional policies regarding the use of animals for research purposes

Reagents and Solutions

Lipopolysaccharide (LPS; from *E. coli*, 0.5 and 5 EU/ml) and the muramyl dipeptide, MurNAc-L-Ala-D-isoGln (MDP), were purchased from Sigma Chemical Company (St. Louis, MO). The TLR2 ligand, S-(2,3-bis(palmitoyloxy)-(2-RS)-propyl)-N-palmitoyl-(R)-Cys(S)-Ser-(S)-Lys⁴-OH, trihydrochloride (Pam(3)Cys), was purchased from Calbiochem (San Diego, CA). An activating oligonucleotide, GCTCATGACGTTCCCTGATGCTG, previously described as a specific agonist for TLR9 (Sweet et al. 2002), was synthesized by Integrated DNA Technologies (Coralville, IN). Endotoxin-free flagellin protein preparations were isolated from *Salmonella typhimurium* serotype 12023 as previously described (Ibrahim et al. 1985; Bowman et al. 2003). Briefly, *Salmonella typhimurium* serotype 12023 were cultured in a modified medium as previously described (Ibrahim et al. 1985). *Salmonella* were cultured at 37°C in an orbital shaker for 24 h at 200 rpm. Flagellins were isolated according to the method of

Bowman et al. (2003). Briefly, 500 ml of bacterial culture was centrifuged at 5,000 g for 30 min and resuspended in 50 ml phosphate-buffered saline. The suspension was then adjusted with 1 M HCl to pH 2.0 and incubated at room temperature with constant stirring for 30 min in order to detach flagella. Bacterial cells were separated from free flagella by centrifugation at 5,000 g for 30 min. Flagellin-containing supernatant was then further centrifuged at 100,000 g for 90 min at 4°C to remove pH 2.0 insoluble components. The supernatant was adjusted with 1 M NaOH to pH 7.2 and flagellins were precipitated through slow addition of ammonium sulfate to 2/3 saturation (2.67 M) with vigorous stirring. Precipitated flagellins were collected by centrifugation at 15,000 g at 4°C for 60 min. Pelleted flagellins were resuspended in 5 ml distilled water and dialyzed against running tap water for 2 h and then against 1 L distilled water with 10 g of activated charcoal for 24 h in Spectrapor dialysis tubing with a molecular weight cutoff of 50,000 (Spectrum Medical Industries, Los Angeles, CA). Flagellin proteins were analyzed by 0.1% sodium dodecylsulfate (SDS)-polyacrylamide gel electrophoresis and protein visualized by Coomassie blue staining. The flagellin isolation procedure yielded a single major product with a molecular weight of approximately 48 kDa, a size that is within the previously described size range for flagellins from *Salmonella* serotypes (Ibrahim et al., 1985). Endotoxin was removed from flagellin preparations using a Detoxi- Gel endotoxin removing gel column (Pierce, Rockford, IL) according to the manufacturer's instructions. Residual endotoxin content was determined to be negligible according to the Pyrogen Limulus amoebocyte lysate assay (BioWhittaker, Walkersville, MD). Doses selected represent those that were empirically determined to elicit optimal responses.

Isolation of Primary Murine Microglia

Murine neonatal brain microglia were isolated and cultured ostensibly as described previously (Harry et al. 1998; Rasley et al. 2002a; Rasley et al. 2002b). Briefly, six to eight neonatal C57BL/6 mouse brains per preparation were dissected free of meninges and large blood vessels and finely minced with sterile surgical scissors. The minced tissue was then forced through a wire screen and briefly incubated with 0.01% trypsin–0.005% EDTA for 5 min. The cell suspension was then washed and this mixed glial culture was maintained in RPMI 1640 containing 10% FBS and gentamicin for 2 weeks. A microglia culture was obtained from this mixed glial culture by shaking flasks for 2 h at 200 rpm in an orbital shaker and allowing the transferred dislodged cells to adhere to new tissue culture vessels for 1 h. The media were then removed and fresh RPMI 1640 with 10% FBS and 20% conditioned medium from LADMAC (ATCC number CRL-2420) cells as a source of CSF-1 was added to maintain microglia cultures for 1 week, as described previously (O'Keefe et al. 2001). Cells isolated in this manner were >95% authentic microglia as assessed by their characteristic morphology and by the expression of CD11b and F4/80 as determined by immunofluorescent microscopy (Rasley et al. 2002a).

Isolation of Primary Murine Astrocytes

Brain astrocytes were isolated and cultured as described previously (Bowman et al. 2003; Rasley et al. 2004a; Rasley et al. 2006). Briefly, six to eight neonatal C57BL/6 mouse brains per preparation were dissected free of meninges and large blood vessels and finely minced with sterile surgical scissors. The minced tissue was then forced through a wire screen and briefly incubated with 0.01% trypsin–0.005% EDTA for 5 min. The cell suspension was then washed and this mixed glial culture was maintained in RPMI 1640 containing 10% FBS and gentamicin for 2 weeks. Astrocyte culture was obtained from the mixed glial culture by shaking flasks for 1 h at 210 rpm in an orbital shaker to dislodge weakly adherent microglia and these cells were cultured separately as described above. The remaining astrocytes were mechanically dissociated, transferred to new tissue culture vessels, and cultured for 1 week prior to use. Cells isolated in the above manner were demonstrated to be greater than 97% authentic astrocytes due to their characteristic morphology and the presence of the astrocyte marker, glial fibrillary acidic protein (GFAP), and the absence of the microglia cell surface marker, CD11b as determined by confocal microscopy (Bowman et al. 2003).

Culture of *Borrelia burgdorferi* and *Neisseria meningitidis* and Preparation of Antigen Lysates

We have utilized *B. burgdorferi* strain N40 and *N. meningitidis* strain MC58 in these studies. While these organisms are not associated with CNS disease in mice, both represent clinically relevant gram-negative bacteria responsible for Lyme neuroborreliosis and bacterial meningitis, respectively. We have previously demonstrated that antigens from these organisms elicit robust inflammatory responses by both murine microglia and astrocytes (Rasley et al. 2002a; Rasley et al. 2004b; Rasley et

al. 2006). Importantly, both of these organisms express peptidoglycan motifs that can be recognized by NOD2, but *B. burgdorferi* lacks the expression of the TLR4 ligand, LPS, and has been shown to initiate TLR2- and TLR5-mediated innate immune responses (Shin et al. 2008) whereas *N. meningitidis* expresses LPS and can elicit TLR2- and TLR4-mediated responses (Zughaier et al. 2005; Hellerud et al. 2008).

A clonal low passage of *B. burgdorferi* strain N40 was used throughout these studies (Barthold et al. 1993). Spirochetes were grown for a period of two weeks in Barbour-Stoener-Kelly (BSK) II medium at 34°C (Barbour et al., 1984). *N. meningitidis* strain MC58 was grown overnight (16 hours) in 5 ml of GC medium plus hemoglobin with Isovitalax enrichment solution in a shaking water bath at 37°C. Bacteria were harvested by centrifugation and washed twice in PBS. Confluent cell layers of microglia or astrocytes were washed 3 times with 4 ml of PBS to remove growth media and then infected with log growth *N. meningitidis* or *B. burgdorferi* at multiplicities of infection (m.o.i) of between 3:1 and 30:1 bacteria to cells in media without antibiotics for 60 min at 37°C. Following the infection period, cell cultures were washed and incubated in media with 10% fetal bovine serum (FBS) supplemented with 25 µg/ml gentamicin to kill remaining extracellular bacteria. At 4-24 hours following this procedure, RNA, protein isolates, or culture supernatants were collected.

To prepare lysates, log growth *B. burgdorferi*, *N. meningitidis*, or *S. aureus* UAMS-1 (ATCC 49230) bacterial cultures were centrifuged at 10,000 X g and washed three times with PBS. Bacteria were then resuspended in PBS and pulsed three times with a cell sonicator for 20 seconds at 25 second intervals. Levels of endotoxin in *B. burgdorferi* antigen isolates were below detectable levels as determined by Limulus

amebocyte lysate assay (Cambrex Bio Science, Walkersville, MD) consistent with previous reports (Anguita et al., 2002). The maximum concentration of *N. meningitidis* antigens used (5 µg/ml) contained 1 EU/ml endotoxin as determined by Limulus amebocyte lysate assay (Cambrex Bio Science, Walkersville, MD). Isolated microglia and astrocytes were exposed to 1-5 µg/ml *B. burgdorferi*, *N. meningitidis*, or *S. aureus* cell lysate as indicated. Dose ranges used represent those previously determined by our laboratory to elicit low to maximal glial responses (Rasley et al. 2002a; Bowman et al. 2003; Rasley et al. 2006). At 4-24 hours following this procedure, RNA, protein isolates, or culture supernatants were collected.

Intracerebral Administration of Bacteria

Viable *N. meningitidis* or *B. burgdorferi* (1×10^6 bacteria) were administered via intracerebral (i.c.) injection as previously described by our laboratory (Rasley et al. 2006) into NOD2^{-/-} or wild-type mice. Anesthetized animals were secured in a stereotaxic platform and stand and received an i.c. injection containing pathogens resuspended in Ringer's solution (final volume of 1 µL), or vehicle only, 1 mm lateral and 1 mm posterior to the bregma using a Hamilton positive displacement syringe (7001 series) with a 25-gauge needle and a tubing guard to ensure constant depth of administration (3–3.5 mm). Five animals per group were used and animals displaying signs such as seizures, abnormal gait/ataxia, failure to open eyes, or other physical disabilities were euthanized immediately. At 3 days post infection, animals were euthanized and all brain tissue removed and weighed. The brain tissue was mechanically disrupted in a glass homogenizer in 3 mL PBS and then centrifuged. Supernatants were analyzed for cytokine content by specific capture ELISA.

Isolation of RNA and PCR

Poly(A)+ RNA was isolated from microglia and reverse transcribed as previously described (Bowman et al. 2003; Rasley et al. 2004a). Real-time PCR was performed on the reverse transcribed cDNA product to determine the expression of mRNA encoding NOD1, NOD2, Rip2 kinase, and glyceraldehyde 3-phosphate dehydrogenase (G3PDH) essentially as described previously (Marriott et al. 2005). Positive and negative strand PCR primers used, respectively, were GTCCTCAACGAGCATGGCGAGACT and AGTCATCCAGGCCGTCAA to amplify mRNA encoding murine NOD1 (299 bp fragment), GCTGCCAATCTTCACGTCGTC and TAAGTACTGAGGAAGCGAGACTGA to amplify mRNA encoding murine NOD2 (273 bp fragment), CTGCACCCGAAGGAGGAACAATCA and GCGCCCATCCACTCTGTATTAGA to amplify mRNA encoding murine Rip2 kinase (276 bp fragment), and CCATCACCATCTTCCAGGAGCGAG and CACAGTCTTCTGGGTGGCAGTGAT to amplify mRNA encoding G3PDH (340 bp fragment). PCR primers were derived from the published sequences of NOD1 (Strausberg et al. 2002), NOD2 (Iwanaga et al. 2003), Rip2 kinase (Inohara et al. 1998), and G3PDH (Tso et al. 1985). All primers were designed by using Oligo 4.0 primer analysis software (National Biosciences Inc., Plymouth, MA) based on their location in different exons of the genomic sequences in addition to their lack of significant homology to sequences present in GenBank (MacVector Sequence analysis software, IBI, New Haven, CT). The identity of the PCR amplified fragments were verified by size comparison with DNA standards (Promega) and by direct DNA sequencing of representative fragments (Davis Sequencing, Davis, CA).

Co-immunoprecipitation of NOD2 with Rip2 kinase

Co-immunoprecipitation was performed essentially as described previously by (Clark et al. 2001). Briefly, cells (1×10^6) stimulated with bacterial lysates were washed with ice-cold PBS and lysed at 4°C for 2 h in Tris-buffered saline with EDTA (150 mM NaCl, 5 mM EDTA, 20 mM Tris, pH 7.5) plus 1% Brij-97 (Sigma-Aldrich) and 10 units/mL aprotinin (Calbiochem, San Diego, CA), 1 mM PMSF, and 1 µg/mL pepstatin A. The lysates were incubated with protein A agarose beads (Pierce Endogen) conjugated with antibodies directed against NOD2 or Rip2 kinase for 18 h at 4°C. The immunoprecipitated material was subsequently subjected to immunoblot analysis for the presence of NOD2 or Rip2 kinase.

Western blot analysis for NOD1, NOD2, and Rip2-kinase

Western blot analyses for the presence of NOD1, NOD2, or Rip2 kinase in astrocytes and microglia were performed as described previously by our laboratory (Marriott et al. 2005). Whole protein samples were obtained from microglia, astrocytes, and brain tissue in a buffer containing 125 mM Tris base, 20% glycerol, 2% SDS, 1% bromophenol blue and 2% 2-mercaptoethanol. Samples were separated using 10% SDS PAGE and transferred to Immobilon-P membranes (Millipore, Bedford, MA). Membranes were blocked for 18 hours with 5% skimmed milk at 4°C. After incubation with a rabbit primary antibodies against NOD1, NOD2, or Rip2-kinase for 24 hours at 4°C, blots were washed and incubated in the presence of an HRP-conjugated donkey anti-rabbit antibody (Cell Signaling, Danvers, MA) or an HRP-conjugated goat anti-mouse IgG antibody (Sigma-Aldrich, St. Louis, MO). Bound enzyme was detected with the Super Signal system (Thermo Scientific, Rockford, IL). The primary antibodies used

were an affinity purified rabbit polyclonal antibody directed against human NOD1 (Alpha Diagnostics International Inc., San Antonio, TX), mouse monoclonal antibody reactive against mouse NOD2 (Clone 2D9; Novus Biologicals, Littleton, CO), a rabbit polyclonal antiserum against human NOD2 (Cayman Chemical, Ann Harbor, MI), and a mouse reactive affinity purified rabbit polyclonal antibody directed against Rip2 kinase (Cell Sciences Inc., Canton, MA).

Quantification of IL-6, TNF- α , IL1 β , and IL-10 secretion

Specific capture ELISAs were performed to quantify IL-6, TNF- α , IL1 β , and IL-10 secretion by glial cells as described previously by our laboratory (Anguita et al. 2001; Rasley et al. 2004b; Rasley et al. 2006). TNF- α , IL1 β , and IL-10 secretion were measured using commercially available ELISA kits (R&D Systems, Minneapolis, MN and BD Pharmingen, San Diego, CA). IL-6 secretion was measured using a rat anti-mouse IL-6 capture antibody (Clone MP5-20F3) and a biotinylated rat anti-mouse IL-6 detection antibody (Clone MP5-C2311) (BD Pharmingen, San Diego, CA). Briefly, 96-well ELISA plates (ICN Pharmaceuticals, Costa Mesa, CA) were coated with the capture antibody (2 μ g/ml) overnight at 4°C. After blocking with PBS plus 10% FBS for 2 h at room temperature, samples were applied and incubated for 1 hour at 37°C. The biotinylated detection antibody (1 μ g/ml) was added after washing the plates with PBS plus 0.5% v/v Tween 20 (PBS/Tween 20). HRP-conjugated streptavidin was then added prior to addition of tetramethylbenzidine substrate (Kirkegaard & Perry Laboratories, Gaithersburg, MD) and stop solution (25% v/v sulfuric acid in distilled water). Quantification of cytokine levels was achieved by comparison with standard concentrations of recombinant mouse IL-6, IL1 β , IL-10, and TNF- α (R&D Systems,

Minneapolis, MN). Cytokine levels in brain homogenates were normalized to total brain weight and reported as pg/g of brain tissue.

Viral Strains

Figure 23 shows viral maps of the three recombinant viruses used in this study. Recombinant VSV wt (Indiana serotype) and its derivative VSV rHR1-1 with a single aa substitution D1671V in the L protein have been previously described (Grzelishvili et al. 2005; Grzelishvili et al. 2006). To generate heat-inactivated wt-VSV, live virus was heated in a water bath at 65°C for 15 minutes. This procedure was determined empirically to eliminate virus replication as determined by plaque assay. VSV-GFP is a VSV wt (Indiana serotype) encoding GFP as an extra gene between G and L genes (Das et al. 2006) and was kindly provided by Dr. Asit K. Pattnaik (University of Nebraska). Recombinant wt SeV (Fushimi strain) (Leyrer et al. 1998) and SeV-GFP-Fmut (SeV-GFP) with an enhanced green fluorescent protein (GFP) upstream of the NP gene (Wiegand et al. 2007) were kindly provided by Dr. Wolfgang J. Neubert (Max-Planck-Institute of Biochemistry, Germany). Monolayer cultures of Vero or BHK-21 cell lines were maintained in Dulbecco's modified Eagle's medium (DMEM, Cellgro) supplemented with 9% fetal bovine serum (FBS, Gibco). To produce VSV or SeV, BHK or Vero cells, respectively, were infected with wt or mutant viruses at a multiplicity of infection (MOI) of 0.05 plaque-forming units (PFU) per cell in MegaVir HyQSFM4 serum-free medium (Hyclone) and incubated for 24-48 hr at 34°C. SeV-GFP virus was grown without acetylated trypsin in the medium as they have a wt monobasic trypsin-dependent cleavage site in the F protein mutated to an oligobasic cleavage site allowing F activation in any cell type through a ubiquitous furin-like protease (Wiegand et al. 2007).

It should be noted that the MOI values are relative and calculated based on the VSV titer determined on BHK cells or SeV titer on Vero cells supporting robust virus replication. It is therefore likely that the actual MOI values for microglia and/or astrocytes were actually lower than indicated.

In vitro viral infection

Isolated primary microglia and astrocytes were infected with VSV or SeV at MOI of 0.001, 0.01, 0.1, 1, and 10 PFU per cell and the virus was allowed to adsorb for 1 hour. Non-adherent viral particles were removed by washing with PBS followed by the addition of RPMI 1640 media supplemented with 10% FBS (for astrocytes) or 10% FBS and 20% LADMAC (for microglia). Cultures were maintained for 12 and 24 hours prior to collection of culture supernatants and preparation of whole cell protein isolates.

Immunoblot analyses for GFP and VSV products

Immunoblot analyses for the presence of GFP and VSV proteins in microglia, astrocytes, and whole brain samples were performed as described previously by our laboratory (Bowman et al. 2003; Rasley et al. 2006). Whole protein samples were obtained from microglia, astrocytes, and brain tissue in a buffer containing 125 mM Tris base, 20% glycerol, 2% SDS, 1% bromophenol blue and 2% 2-mercaptoethanol. Samples were separated using 10% SDS PAGE and transferred to Immobilon-P membranes (Millipore, Bedford, MA). Membranes were blocked for 18 hours with 5% skimmed milk at 4°C. After incubation with a rabbit polyclonal antibodies against VSV or GFP (Thermo Scientific Affinity BioReagents) for 24 hours at 4°C, blots were washed and incubated in the presence of an HRP-conjugated donkey anti-rabbit antibody (Cell Signaling, Danvers, MA) or an HRP-conjugated goat anti-mouse IgG antibody (Sigma-

Aldrich, St. Louis, MO). Bound enzyme was detected with the Super Signal system (Thermo Scientific, Rockford, IL).

In-vivo viral infection

VSV wt or VSV-GFP were administered to 3-4 week old male wt C57BL/6 mice (Jackson Laboratories) via intranasal (i.n.) infection essentially as previously described by our laboratory (Gasper-Smith et al. 2006). Anesthetized animals were untreated or received i.n. administration of VSV (1×10^7 PFU) in PBS (final volume of 20 μ l). At 5 days post infection (d.p.i.), protein isolates were prepared from whole brain tissue homogenates or mixed glial cells acutely isolated from infected and uninfected animals using a modified protocol (Campanella et al. 2002). All studies were performed in accordance with relevant federal guidelines and institutional policies regarding the use of animals for research purposes. Infected and uninfected animals were scored 5 d.p.i for disease severity using protocols previously described by our group (Rettew et al. 2008). A score of 1 was given to mice with percolated fur but no detectable behavioral differences compared to untreated mice, a score of 2 was given to mice with percolated fur and a huddle reflex but were still active, a score of 3 was given to mice that were less active and were relatively passive when handled, a score 4 was assigned to inactive mice that exhibited only limited response when handled, and a score of 5 was applied to moribund mice. Severity was scored from 1 (no detectable behavioral differences) to 5 (moribund). Animals were then euthanized and protein isolates were prepared from whole brain tissue homogenates or mixed glial cells acutely isolated from infected and uninfected animals as described above. All studies were performed in accordance with

relevant federal guidelines and institutional policies regarding the use of animals for research purposes.

Acute isolation and cytometric analysis of CNS cells

Mixed CNS cells were acutely isolated from infected and uninfected animals using a modified protocol (Campanella et al. 2002). Briefly, brains were rapidly removed and mechanically disrupted in a glass homogenizer, washed, and resuspended in PBS/30% Percoll (Fluka, Sigma Aldrich, St Louis, MO) solution. This was overlaid on a gradient containing 37% and 70% Percoll solutions and centrifuged at 600 X G for 20 min at room temperature. Glial cells were then collected from the interface and washed with PBS. For VSV-wt infected animals, protein isolates were prepared from the purified cells and analyzed for the presence of VSV products by immunoblotting using a polyclonal antibody directed against this virus. For VSV-GFP infected animals, cells were stained with an R-phycoerythrin conjugated monoclonal anti-mouse CD11b antibody (BD Pharmingen clone #M1-70). These cells were analyzed using a FACSCalibur flow cytometer (Becton Dickson, San Jose, CA) to determine the percentage of GFP and CD11b dual positive cells. A minimum of 50,000 cells were counted and data are reported as the percentage of the cell population.

Fluorescence microscopy

Fluorescence microscopy pictures were taken using an Olympus DP70 digital camera on an Olympus IX71 inverted fluorescent microscope under 10X objective using Olympus DP Controller software.

Densitometric analyses

Densitometric analyses of Western blots were performed using NIH Image (obtained from the NIH Web site: <http://rsb.info.nih.gov/nih-image>). Results are presented as mean values of arbitrary densitometric units corrected for background intensity or as fold increases over levels in unstimulated cells.

Statistical Analyses

All results are presented as the mean \pm SEM and were tested statistically by Student's t test, one-way analysis of variance (ANOVA) with Tukey's post hoc test, or repeated measures ANOVA with Tukey's post hoc test, as appropriate, using commercially available software (Sigma Stat; Systat Software, San Jose, CA). Results were considered to be statistically significant at a probability of <0.05 .

CHAPTER 3: EXPRESSION OF NOD2 IN PRIMARY MURINE ASTROCYTES

3.1 Rationale

Bacterial invasion of the CNS is well known to result in devastating disease, associated with high rates of mortality and morbidity, despite marked advances in antimicrobial treatments. Evidence suggests that the often irreversible damage associated with CNS infection is mediated in large part not by the pathogen itself, but by the immune responses initiated in response to the foreign antigens (Boje and Arora 1992; Ulvestad et al. 1994). While the inflammation generated may be protective by limiting bacterial proliferation and assisting with pathogen clearance, it also causes collateral damage to the delicate cell types within the CNS (Benveniste 1997b; Gonzalez-Scarano and Baltuch 1999; Stoll and Jander 1999; Kielian 2004b; Kielian 2004a; Streit 2004). This, coupled with limited generation potential, can lead to permanent neurological injury (Gasque et al. 1995; Medana et al. 2000; Nau and Bruck 2002).

There is growing appreciation that astrocytes, the major glial cell type in the CNS, are important contributors to the inflammatory immune responses in the brain. Upon exposure to inflammatory mediators, bacteria, or bacterial components these cells assume effector functions such as the production of cytokines and expression of MHC class II molecules which contribute to the recruitment and activation of leukocytes (Hatten et al. 1991; Benveniste 1997a; Soos et al. 1998; Owens et al. 2005). The mechanisms by which these cells perceive and subsequently respond to these stimuli are only recently becoming

apparent with the demonstration of pattern recognition receptor expression, namely those of the Toll-like family of pattern recognition receptors. Indeed, a number of different receptors in this family have been shown in astrocytes (Laflamme and Rivest 2001; Rasley et al. 2002a; Bowman et al. 2003; Esen et al. 2004; Carpentier et al. 2005). However, the presence of these molecules does not preclude the possibility of other pathways for the identification of pathogens.

The recent discovery of members of the NOD-like family of cytosolic pattern recognition receptors may provide another means by which effector responses of astrocytes are generated against bacterial infection. Studies have demonstrated that members of this family, in particular NOD1 and NOD2, have the ability to interact with minimal motifs of peptidoglycan and, using the adapter molecule Rip2 kinase, result in the activation of the NF κ B (Chamaillard et al. 2003b; Girardin et al. 2003a; Girardin et al. 2003b; Girardin and Philpott 2004). NF κ B, as a pivotal transcription factor in the production of pro-inflammatory molecules, can contribute to the generation of effector functions in astrocytes. Additionally, astrocytes have been shown to respond functionally to commercial preparations of peptidoglycan with cytokine and chemokine production, which lends support to this possibility (Esen et al. 2004).

In the present study, we demonstrate that isolated murine astrocytes constitutively express robust levels of NOD2 and that such expression is significantly upregulated following exposure to two disparate and clinically relevant bacterial pathogens of the CNS, *Borrelia burgdorferi* and *Neisseria meningitidis*. Similarly, NOD2 protein expression is elevated following exposure to specific bacterial ligands for TLRs. Importantly, astrocytes express Rip2 kinase, an essential downstream effector molecule

for NOD-mediated cell responses, and this expression is upregulated following microbial challenge. Furthermore, we provide strong evidence for the functional nature of NOD2 in astrocytes by demonstrating that a specific ligand for this cytosolic pattern recognition receptor can induce significant inflammatory cytokine production and can augment immune responses induced by TLR ligation. The demonstration that astrocytes express functional NOD2 proteins may represent a potentially important mechanism by which this glial cell type can respond to bacterial infections of the CNS.

3.2 Results

Induction of mRNA encoding NOD1 and NOD2 in murine astrocytes following bacterial exposure

To begin to determine whether astrocytes express these novel pattern recognition receptors, we have determined the level of expression of mRNA encoding NOD1 and NOD2 in isolated cultures of murine astrocytes either at rest or following challenge with clinically relevant gram-negative bacterial pathogens of the CNS. Murine astrocytes were untreated or exposed to live *N. meningitidis* or bacterial lysates. At 4 and 8 hours post-infection, RNA was isolated and real time PCR was performed for the presence of mRNA encoding NOD1 or NOD2. As shown in Figure 5, there is very low constitutive expression of mRNA encoding NOD1 in resting cultures of astrocytes. However, exposure of cells to either viable *N. meningitidis* or *N. meningitidis* antigens elicits modest but significant ($p < 0.05$) increases in the level of expression of mRNA encoding NOD1 (Figure 5). The high level of variability in the data obtained at 30:1 *N. meningitidis* to each glial cell is most likely due to astrocyte cell death at this multiplicity of infection (data not shown). In addition, we have also exposed primary astrocytes to *B. burgdorferi* antigens, a preparation that has previously been shown to be free of LPS (Anguita et al. 2002). Challenge with this disparate gram-negative bacterium similarly elicited modest but significant elevations in NOD1 mRNA expression (Figure 5).

In contrast, resting astrocytes constitutively express mRNA encoding NOD2 at levels that are approximately three orders of magnitude greater than that seen for NOD1 (Figure 6). Furthermore, both *N. meningitidis* and *B. burgdorferi* antigens elicit significant increases in NOD2 mRNA expression in astrocytes (Figure 6A). In addition, cells were exposed to LPS, flagellin, or an activating oligonucleotide to test whether

bacterial stimuli for TLR4, TLR5, or TLR9, respectively, can induce NOD protein expression in astrocytes. As shown in Figure 6B, purified bacterial TLR ligands elicited significant increases in NOD2 mRNA levels and these increases occurred more rapidly than that seen for bacterial lysates.

Induction of NOD1 and NOD2 protein expression in astrocytes following bacterial challenge

To determine whether the expression of mRNA encoding NOD1 or NOD2 in resting or bacterially challenged astrocytes results in the expression of these protein products, immunoblot analyses were performed. Reagents for murine NOD proteins were not currently available and so polyclonal antibodies directed against human NOD1 and NOD2 proteins were utilized due to their 89% and 78% homology to murine NOD1 and NOD2, respectively (Girardin et al, 2003a; Strausberg et al, 2002). Murine astrocytes were exposed to *N. meningitidis* or *B. burgdorferi* antigens at the indicated concentrations and whole cell protein isolates were obtained at 12 or 24 hours prior to immunoblot analysis for NOD1 or NOD2. As shown in the representative experiment in Figure 7A, resting cultures of astrocytes showed very low levels of a protein that migrated close to the predicted size of the NOD1 protein (~130 kDa) and exposure to either bacterial species elicited only modest elevations in such expression as determined by densitometric analysis. These findings are in agreement with the levels of mRNA encoding NOD1 shown in Figure 5. In addition, cells were exposed to LPS, flagellin, or an activating oligonucleotide to test whether bacterial stimuli for TLRs can induce NOD protein expression in astrocytes. However, these purified bacterial components elicited only modest elevations in NOD1 protein expression even at relatively high concentrations (Figure 7B).

In contrast, murine astrocytes constitutively expressed robust levels of a protein that migrated close to the predicted size of NOD2 proteins (~115 kDa) (Figure 8A). Furthermore, NOD2 protein expression demonstrated a 2-fold induction following exposure to either *N. meningitidis* or *B. burgdorferi* antigens as determined by densitometric analysis (Figure 8A). Again, these data are in agreement with the levels of mRNA encoding NOD2 observed in astrocytes constitutively and the upregulation observed following bacterial challenge (Figure 6). In addition, levels of NOD2 protein expression were markedly increased following exposure to even low concentrations of TLR ligands (Figure 8B). Interestingly, muramyl dipeptide (MDP), a specific ligand for NOD2, failed to elicit significant elevations in NOD2 protein expression at either 12 hours (19.0 +/- 4.2 versus 18.4 +/- 4.9 arbitrary densitometric units for resting and MDP-stimulated astrocytes, respectively) or 24 hours (29.0 +/- 5.0 versus 33.6 +/- 6.7 arbitrary densitometric units for resting and MDP-stimulated astrocytes, respectively) following challenge.

Astrocytes express, Rip2 kinase, a pivotal downstream effector molecule for NOD signaling

To begin to determine whether astrocytes can express functional NOD pattern recognition receptors, we have investigated whether these cells express Rip2 kinase, a critical effector molecule in both NOD1 and NOD2-mediated cellular activation. Cells were untreated or exposed to *N. meningitidis* or *B. burgdorferi* antigens for 4 or 12 hours. As shown in the representative experiment in Figure 9A, mRNA encoding Rip2 kinase is expressed in murine astrocytes, constitutively. Importantly, exposure to either *N. meningitidis* or *B. burgdorferi* antigens elicit marked increases in levels of Rip2 kinase mRNA as rapidly as 4 hours post-treatment, with maximal increases of 4.6 and 4.8-fold,

respectively, over constitutive levels as determined by densitometric analysis (Figure 9A). Furthermore, these increases were maintained up to 12 hours following bacterial exposure (Figure 9A). On average, levels of mRNA encoding Rip2 kinase were significantly increased ($p < 0.05$) from 35 ± 13 arbitrary densitometric units in unstimulated cells to 128 ± 10 and 131 ± 7 arbitrary densitometric units following exposure to *B. burgdorferi* and *N. meningitidis*, respectively.

To determine whether mRNA levels are representative of Rip2 kinase protein expression, immunoblot analyses were performed. Murine astrocytes were untreated or exposed to *N. meningitidis* or *B. burgdorferi* antigens for 24 hours. As shown in the representative experiment in Figure 9B, unstimulated astrocytes expressed Rip2 kinase constitutively (60 kDa). Importantly, the level of expression of this protein was increased by approximately 2- and 3-fold at 24 hours following challenge with *N. meningitidis* or *B. burgdorferi* antigens, respectively, as determined by densitometric analysis (Figure 9B). On average, Rip2 kinase protein levels were significantly increased ($p < 0.05$) from 18 ± 4 arbitrary densitometric units in unstimulated cells to 70 ± 10 and 42 ± 7 arbitrary densitometric units following exposure to *B. burgdorferi* and *N. meningitidis*, respectively. As such, the constitutive expression of this critical downstream effector molecule and its sensitivity to bacterial challenge, provides circumstantial evidence for the functionality of NOD proteins in astrocytes.

Astrocyte immune responses are augmented by a specific NOD2 agonist

To test whether astrocytes express functional NOD molecules we have investigated the ability of MDP, a well characterized and specific ligand for NOD2 (Girardin et al. 2003b; Girardin et al. 2003c; Inohara et al. 2003), to induce cytokine production by these cells or augment immune responses induced by specific bacterial ligands for other pattern recognition receptors. Astrocytes were untreated or exposed to MDP (1 and 5 $\mu\text{g/ml}$), in the presence or absence of LPS, flagellin, or an activating oligonucleotide at concentrations that elicit suboptimal cytokine responses by these cells. At 12 or 24 hours following treatment, culture supernatants were isolated and assayed for IL-1 β , IL-6, and TNF- α content by specific capture ELISAs. As shown in Figure 10, MDP elicited modest but significant elevations in both IL-6 and TNF- α production by astrocytes. Importantly, MDP significantly increased ($p < 0.05$) IL-6 and TNF- α secretion by cells stimulated with LPS, flagellin or CpG (Figure 10). Interestingly, combined exposure of cells to 5 $\mu\text{g/ml}$ MDP and flagellin or LPS elicited significantly greater than additive ($p < 0.05$) elevations in TNF- α production at 24 hours post-treatment (Figure 10B). In contrast, MDP failed to augment IL-1 β production by astrocytes either when used alone or in combination with TLR ligands (data not shown). Taken together, these data suggest that astrocytes express functional NOD2 receptors and that such molecules can act in a cooperative manner with TLRs to augment production of specific inflammatory cytokines.

3.3 Conclusions

Astrocytes are well known to play essential roles in the development, survival and functioning of CNS neurons. However, it has become increasingly apparent that astrocytes may also be important contributors to inflammatory immune responses within the brain. Stimulated astrocytes have been demonstrated to express an array of inflammatory cytokines and chemokines (Dong and Benveniste 2001) that could initiate leukocyte migration through the blood brain barrier (Persidsky 1999). Furthermore, it has been suggested that astrocytes express, or may be induced to express, antigen presenting class II MHC molecules and co-stimulatory molecules (Dong and Benveniste 2001). Importantly, astrocytes have been shown to mount such responses following exposure to microbial challenges (Krueger et al. 1995; Wesselingh and Thompson 2001). To date, the mechanisms by which these resident CNS cells perceive bacterial pathogens remain unclear. While our group (Bowman et al. 2003), as well as others (Bsibsi et al. 2002; Esen et al. 2004; Carpentier et al. 2005), have recently described the presence of members of the Toll-like family of receptors on murine astrocytes, such expression does not prevent the possible involvement of other pattern recognition receptors in astrocyte activation. Indeed, recent studies have suggested that disparate pattern recognition receptor types may act in a synergistic manner to promote inflammatory immune responses (Uehara et al. 2005).

NOD1 and NOD2 are members of a family of proteins whose members appear to serve as pattern recognition receptors (Ting and Davis 2005). In the present study, we provide evidence for the expression of these novel pathogen-associated molecular pattern recognition receptors in murine astrocytes. We demonstrate that these cells constitutively

express robust levels of NOD2 mRNA and show that expression is elevated following challenge with two clinically relevant bacterial pathogens of the CNS, *N. meningitidis* and *B. burgdorferi*. In addition, NOD2 mRNA levels are rapidly upregulated following exposure to bacterial ligands for TLRs. Such a finding is consistent with the previously documented ability of LPS to induce NOD2 mRNA expression in a monocytic cell line (Iwanaga et al. 2003). Our current experiments have enabled us to confirm that isolated astrocytes express NOD2 protein constitutively and have elevated levels following bacterial challenge. In contrast, resting astrocytes express little or no NOD1 and only modest expression was observed following bacterial challenge.

While both NOD1 and NOD2 detect bacterial peptidoglycans, differences exist between the specific motifs recognized by each in that NOD1 interacts with the naturally occurring peptidoglycan degradation product, GlcNAc-MurNAC-L-Ala- γ -D-Glu-*meso*-DAP, that is found in peptidoglycans from gram-negative bacteria while NOD2 recognizes a minimal muramyl dipeptide motif, MurNAC-L-Ala-D-IsoGln (MDP), present in all peptidoglycans (Chamaillard et al. 2003b; Girardin et al. 2003a; Girardin et al. 2003b; Girardin et al. 2003c; Inohara et al. 2003; Girardin et al. 2005). As such, it has been suggested that NOD1 represents a specific receptor for gram-negative bacteria while NOD2 is a more general sensor of bacteria (Girardin et al. 2003a; Girardin et al. 2003b).

Borrelia burgdorferi is the causative agent of Lyme neuroborreliosis and can elicit astrocyte immune responses (Ramesh et al. 2003) while *Neisseria meningitidis* is an important cause of bacterial meningitis (Kolb-Maurer et al. 2003) and induces elevated levels of inflammatory cytokine production in the cerebral spinal fluid of infected patients (Waage et al. 1989; Sharief et al. 1992; Kornelisse et al. 1997). More

importantly, these organisms are gram-negative bacterial species possessing peptidoglycan motifs that can be recognized by both NOD homologues. In the present study we show that exposure of astrocytes to either *B. burgdorferi* or *N. meningitidis* elevates the expression of both NOD1 and NOD2 in astrocytes (Figures 5-8), with NOD2 being the predominant homologue as assessed at both the level of mRNA and protein expression. However, it is possible that induction of NOD molecules occurs secondary to signaling via other pattern recognition receptors, rather than a direct consequence of bacterial ligands interacting with NOD receptors. Support for this notion comes from the finding that ligands for TLRs can elicit elevations in NOD expression in astrocytes (Figures 6 and 8B) and a monocytic cell line (Iwanaga et al. 2003). Furthermore, the NOD2 specific ligand, MDP, fails to augment NOD2 expression. It is, therefore, likely that *B. burgdorferi* and *N. meningitidis* indirectly induce NOD expression following engagement of other pattern recognition receptors.

Both NOD1 and NOD2 have been reported to associate with Rip2 kinase (Ogura et al. 2001b; Chin et al. 2002; Kobayashi et al. 2002; Yoo et al. 2002) and the present demonstration of the inducible expression of Rip2 kinase in astrocytes lends credence to the notion that NOD proteins are functional in this cell type. Activation of this adaptor molecule results in the activation of NF- κ B, a pivotal transcription factor in the production of cytokines such as IL-6 and TNF- α , and the induction of co-stimulatory molecules. Hence, activation of astrocytes via NOD receptors could underlie, at least in part, the bacterially-induced immune molecule production previously reported in this cell type (Dong and Benveniste 2001).

More direct evidence for the functional presence of NOD molecules in astrocytes comes from the demonstration that extracellular application of MDP, an apparent ligand for NOD2, can elicit modest but significant production of IL-6 and TNF- α (Figure 10). These findings are consistent with previous studies employing MDP that show that this molecule is a relatively poor stimulus in macrophages (Pauleau and Murray 2003). Importantly, we demonstrate that this NOD2 ligand can significantly augment cytokine production elicited by TLR agonists. Furthermore, the presence of this NOD ligand can elicit inflammatory mediator production that is greater than the sum of each stimulus alone. Such a finding is in agreement with previous studies in other cell types demonstrating that MDP can act in a synergistic manner with LPS to elicit inflammatory cytokines production. It must be noted that extracellular application of specific ligands for NOD proteins can initiate cellular responses (Pauleau and Murray, 2003; Wolfert et al, 2002; Yang et al, 2001) despite the predicted inability of these molecules to cross the plasma membrane. To date, the precise mechanisms responsible for this uptake have yet to be determined, although it is possible that phagocytosis and/or pinocytosis/macropinocytosis underlie such uptake.

While it is presently unclear why MDP alone elicits only modest cytokine production by astrocytes, it is possible an initial stimulus is required to induce NOD2 expression, thereby rendering astrocytes more sensitive to the presence of MDP. Alternatively, these findings may indicate that multiple signals, via dissimilar pattern recognition receptors, act in a synergistic manner to promote inflammatory astrocyte responses. Regardless of which scenario is correct, the present study demonstrates that disparate bacterial pattern recognition receptors can act in a co-operative manner to

initiate immune responses in astrocytes. As such, the functional presence of NOD proteins in primary astrocytes may represent an important mechanism by which this cell type responds to bacterial CNS pathogens.

3.4 Figures

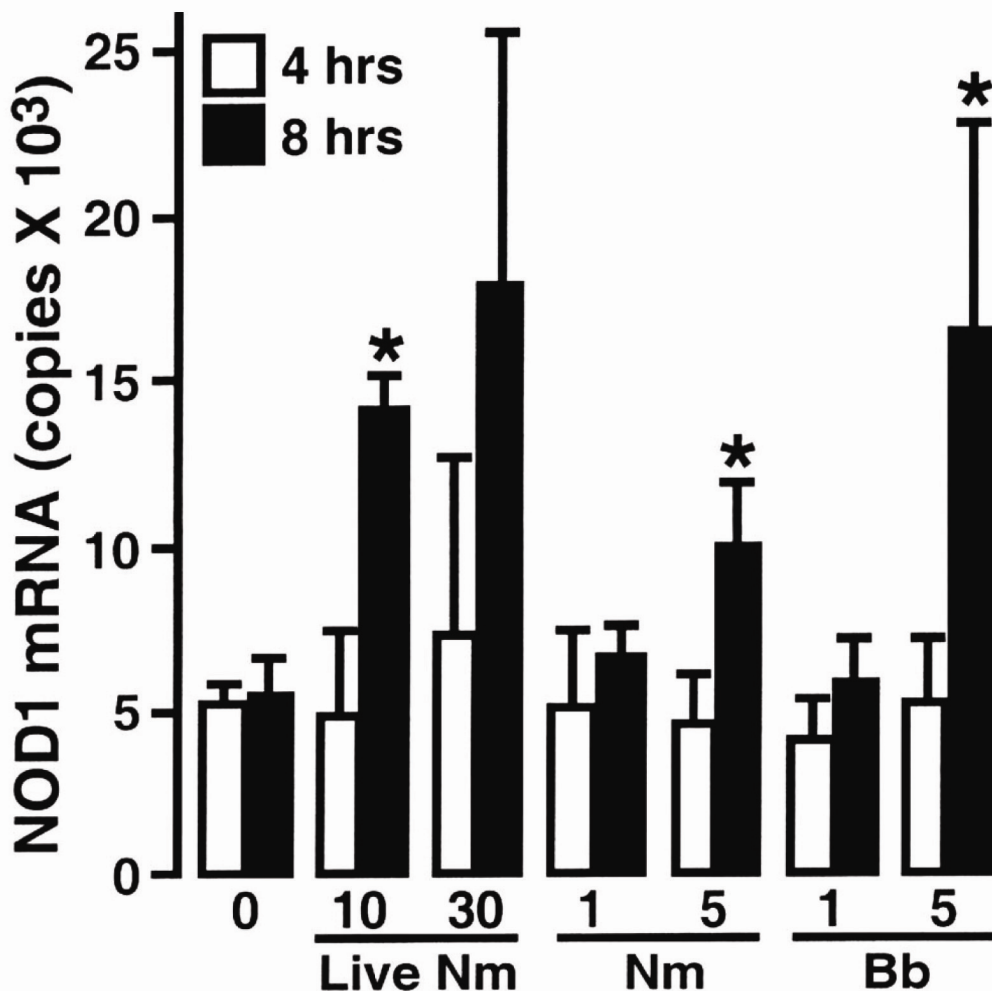

Figure 5: Expression of mRNA encoding NOD1 in isolated murine astrocytes. Cells (2×10^6) were untreated (0) or exposed to whole viable *N. meningitidis* (Nm Live) (10 and 30 bacteria to each astrocyte) or *N. meningitidis* antigens (Nm) (1 and 5 $\mu\text{g/ml}$) or *B. burgdorferi* antigens (Bb) (1 and 5 $\mu\text{g/ml}$). At 4 and 8 hours post-treatment, RNA was isolated and real time PCR performed to determine the level of expression of mRNA encoding NOD1. Data are presented as the mean \pm SEM of four experiments normalized to the expression of G3PDH. Asterisk indicates a statistically significant difference from untreated astrocytes.

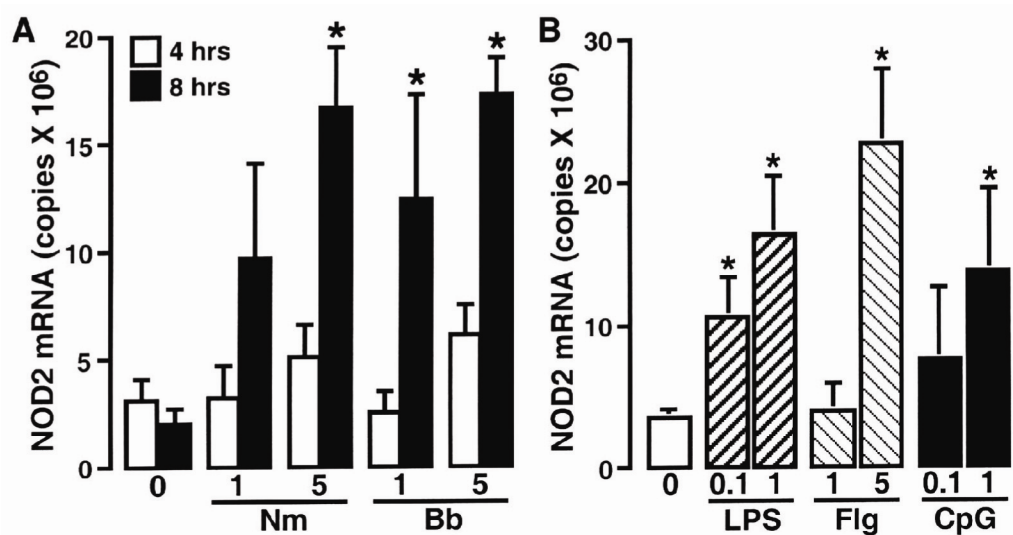

Figure 6: Expression of mRNA encoding NOD2 in isolated murine astrocytes. Panel A: Cells (2×10^6) were untreated (0) or exposed to *N. meningitidis* antigens (Nm) (1 and 5 $\mu\text{g/ml}$) or *B. burgdorferi* antigens (Bb) (1 and 5 $\mu\text{g/ml}$) for 4 and 8 hours. Panel B: Cells were untreated (0) or exposed to lipopolysaccharide (LPS) (0.1 and 1 ng/ml), purified flagellin (Flg) (1 and 5 ng/ml), or an activating oligonucleotide (CpG) (0.1 and 1 $\mu\text{g/ml}$) for 4 hours. At the indicated times RNA was isolated and real time PCR performed to determine the level of expression of mRNA encoding NOD2. Data are presented as the mean \pm SEM of four experiments normalized to the expression of G3PDH. Asterisk indicates a statistically significant difference from untreated astrocytes.

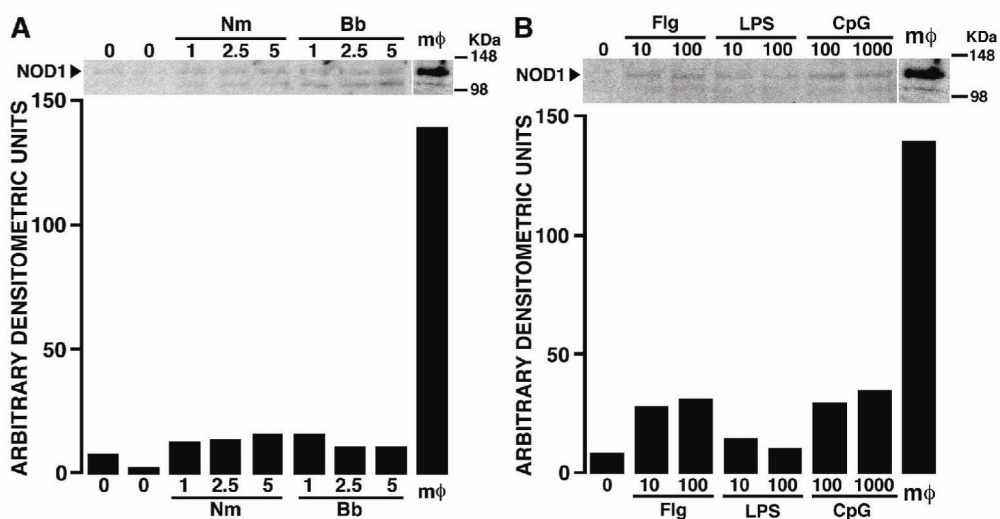

Figure 7: Astrocytes express only low levels of NOD1 protein following bacterial challenge. Panel A: Isolated murine astrocytes (2×10^6) were untreated (0) or exposed to *N. meningitidis* antigens (Nm) (1, 2.5, and 5 $\mu\text{g/ml}$) or *B. burgdorferi* antigens (Bb) (1, 2.5, and 5 $\mu\text{g/ml}$) for 12 hours. Panel B: Cells were untreated (0) or treated with lipopolysaccharide (LPS) (10 and 100 ng/ml), purified flagellin (Flg) (10 and 100 ng/ml), or an activating oligonucleotide (CpG) (100 and 1000 ng/ml) for 24 hours. After treatment, whole cell protein isolates were prepared and NOD1 protein expression was determined by immunoblot and quantified by densitometric analysis. Representative results are shown for one of three separate experiments with densitometric analyses normalized to β -actin expression. For comparison purposes, immunoblots and densitometric analyses for NOD1 expression in the same number of LPS-activated murine peritoneal macrophages is shown (m ϕ).

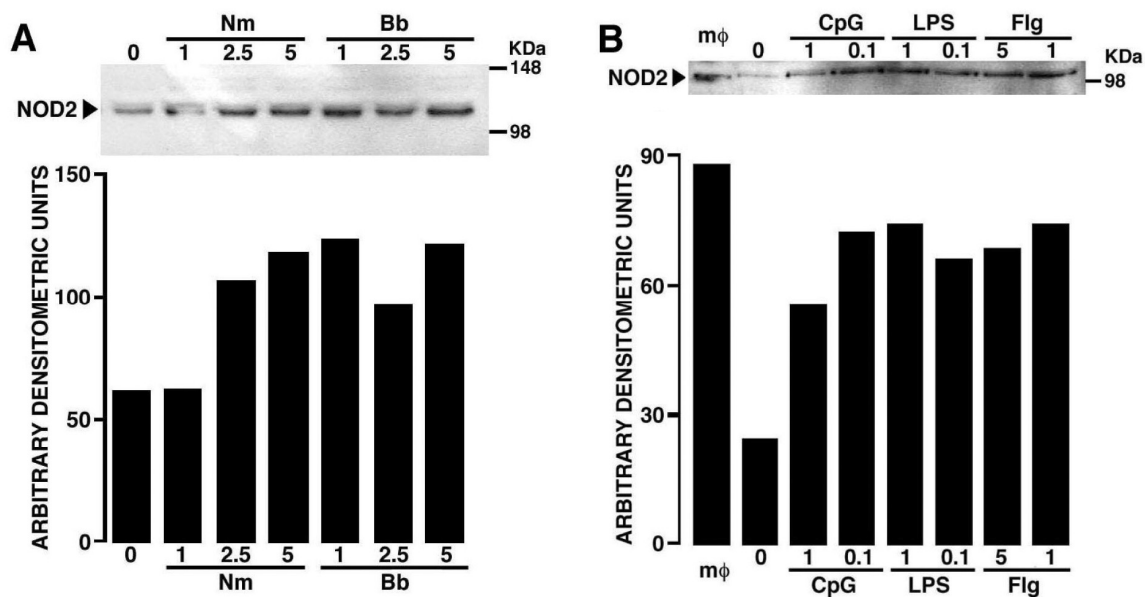

Figure 8: Astrocytes constitutively express NOD2 protein and levels are elevated following challenge with bacterial pathogens or known ligands for Toll-like pattern recognition receptors. Panel A: Astrocytes (2×10^6) were untreated (0) or exposed to *N. meningitidis* antigens (Nm) (1, 2.5, and 5 $\mu\text{g/ml}$) or *B. burgdorferi* antigens (Bb) (1, 2.5, and 5 $\mu\text{g/ml}$) antigens for 24 hours. Panel B: Cells were untreated (0) or exposed to lipopolysaccharide (LPS) (10 and 100 ng/ml), purified flagellin (Flg) (10 and 100 ng/ml), or an activating oligonucleotide (CpG) (0.1 and 1 $\mu\text{g/ml}$) for 24 hours. After treatment, whole cell protein isolates were prepared and NOD2 protein expression was determined by immunoblot and quantified by densitometric analysis. Representative results are shown of one of three separate experiments with densitometric analyses normalized to β -actin expression.

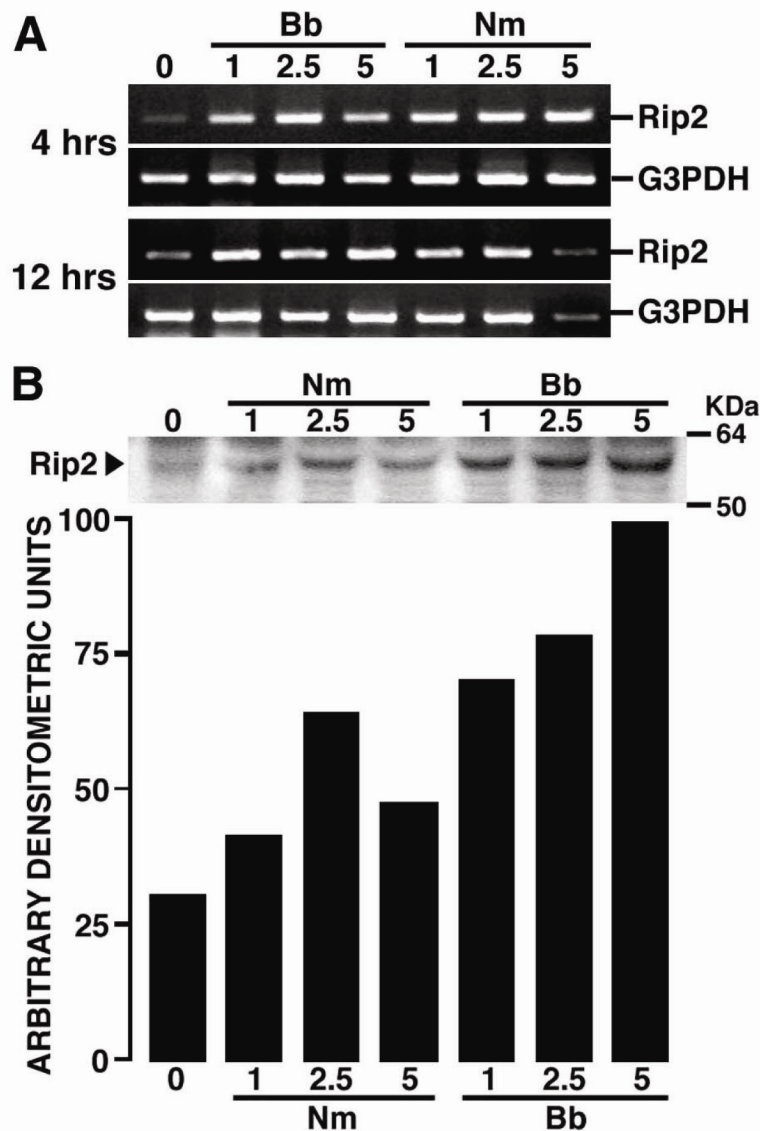

Figure 9: Astrocytes express Rip2 kinase, a critical downstream effector molecule of NOD signaling. Panel A: Cells (2×10^6) were untreated (0) or exposed to *N. meningitidis* antigens (Nm) (1 and 5 $\mu\text{g/ml}$) or *B. burgdorferi* antigens (Bb) (1 and 5 $\mu\text{g/ml}$). At 4 and 12 hours post-treatment, RNA was isolated and semi-quantitative RT-PCR performed to determine expression of mRNA encoding Rip2 kinase. PCR amplification of G3PDH was performed to ensure similar amounts of input RNA and similar efficiencies of reverse transcription. These studies were performed 3 times with similar results. Panel B: Cells were untreated (0) or exposed to *N. meningitidis* antigens (Nm) (1, 2.5, and 5 $\mu\text{g/ml}$) or *B. burgdorferi* antigens (Bb) (1, 2.5, and 5 $\mu\text{g/ml}$) antigens for 24 hours. After treatment, whole cell protein isolates were prepared and Rip2 kinase protein expression was determined by immunoblot and quantified by densitometric analysis. Representative results from one of three separate experiments are shown with densitometric analyses normalized to β -actin expression.

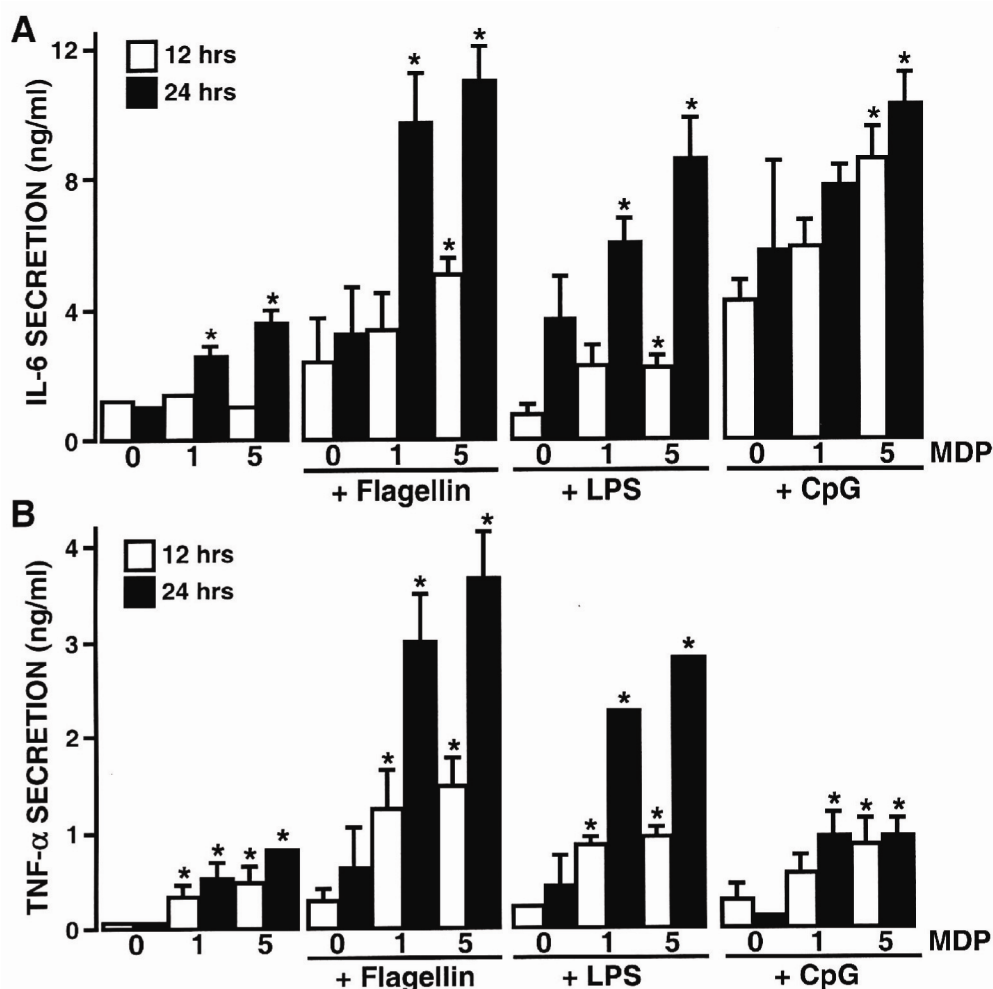

Figure 10: A NOD2 specific ligand, MDP, augments inflammatory cytokine production by murine astrocytes. Cells (2×10^6) were untreated (0) or exposed to muramyl dipeptide (MDP) (1 and 5 $\mu\text{g/ml}$) in the presence or absence of lipopolysaccharide (LPS) (1 ng/ml), purified flagellin (Flg) (1 ng/ml), or an activating oligonucleotide (CpG) (100 ng/ml). At 24 hours post treatment, culture supernatants were assayed for the presence of IL-6 (Panel A) or TNF- α (Panel B) by specific capture ELISAs. Data are presented as the mean of triplicate determinations \pm SEM. Asterisks indicate statistically significant difference between cytokine levels detected in the absence and presence of MDP within each bacterial stimuli group.

CHAPTER 4: EXPRESSION OF NOD2 IN PRIMARY MURINE MICROGLIA

4.1 Rationale

Microglia are resident immune cells of the CNS and, like macrophages and dendritic cells, are of myeloid lineage. This important glial cell type responds to traumatic injury or the presence of infectious organisms by migrating to the site of injury and undergoing rapid proliferation. These cells then become activated at the site of challenge, assuming many of the immune effector functions typically associated with macrophages. Microglia are capable of serving as facultative phagocytes and express antigen presenting MHC class II molecules. These effector functions, combined with the expression of co-stimulatory molecules, allow microglia to act as professional antigen presenting cells (Hickey and Kimura 1988). Additionally, microglia can be induced to produce key pro-inflammatory molecules such as TNF- α and IL-6 (Kiefer et al. 1993; Streit et al. 1999). As such, these cells are ideally suited to detect and respond to pathogens that infiltrate the CNS. Our group has recently demonstrated that microglia can respond to *Borrelia burgdorferi* and *Neisseria meningitidis*, two clinically relevant Gram-negative bacterial pathogens of the CNS (Rasley et al. 2002a; Rasley et al. 2006). Other groups have demonstrated that the Gram-positive organism, *S. aureus*, similarly elicits pro-inflammatory responses by purified cultures of microglia (Kielian et al. 2002; Kielian et al. 2004).

However, the mechanisms by which these cells identify bacterial pathogens are poorly understood. Recent studies have demonstrated that microglia express members of the Toll-like family of receptors (TLR) that recognize conserved bacterial motifs. Microglia express TLR2, TLR4, TLR5, and TLR9, which are known receptors for lipoproteins/peptidoglycan, lipopolysaccharide (LPS), bacterial flagellin, and unmethylated CpG motifs, respectively (Bsibsi et al. 2002; Rasley et al. 2002a; Olson and Miller 2004; Esen and Kielian 2005; Kielian et al. 2005a). However, the expression of these molecules does not eliminate the possible involvement of other pattern recognition receptors in the perception of bacterial pathogens by these cells.

A recent study has suggested that peptidoglycan perception is mediated by members of the novel nucleotide-binding oligomerization domain (NOD) family of proteins rather than by TLR2 (Travassos et al. 2004). NOD proteins have been identified in both immune and non-immune cell types and at least two members of this family of proteins appear to serve as cytosolic pattern recognition receptors (Ting and Davis 2005; Strober et al. 2006). NOD1 (also designated CARD4) appears to interact with motifs found in peptidoglycans from Gram-negative bacteria (Chamaillard et al. 2003b; Girardin et al. 2003a; Girardin et al. 2003e). In contrast, NOD2 (also designated CARD15) has been suggested to be a more general sensor of bacterial peptidoglycans as it recognizes a minimal motif present in all peptidoglycans (Girardin et al. 2003b; Girardin et al. 2003c; Girardin et al. 2003e; Inohara and Nunez 2003). Both NOD1 and NOD2 have been reported to associate with Rip2 kinase (also designated RICK and CARDIAK) (Ogura et al. 2001b; Chin et al. 2002; Kobayashi et al. 2002; Yoo et al. 2002), the activation of which ultimately results in the activation of NF- κ B, a pivotal transcription factor in the

production of pro-inflammatory mediators. As such, NOD molecules could play an important role in the detection of bacterial CNS pathogens and the initiation of inflammation within the brain. To date, the expression of these novel bacterial pattern recognition receptors has not been investigated in microglia.

In the present study, we demonstrate that isolated murine microglia constitutively express robust levels of NOD2 and show that such expression is upregulated following exposure to two disparate bacterial pathogens of the CNS, *Borrelia burgdorferi*, and *Neisseria meningitidis*. Similarly, NOD2 protein expression is elevated following exposure to specific bacterial ligands for TLRs. The notion that NOD2 is functional in these cells is supported by the observation that muramyl dipeptide (MDP), a specific ligand for NOD2, can also elevate levels of this receptor and by the demonstration that microglia express Rip2 kinase, an essential downstream effector molecule for NOD-mediated cell responses. Finally, compelling evidence for the functional nature of NOD2 expression in microglia is provided by the demonstration that MDP can augment inflammatory cytokine production induced by TLR ligation in a synergistic/non-additive manner. Taken as a whole, the demonstration that microglia express functional NOD2 proteins may represent a potentially important mechanism by which this glial cell type can respond to bacterial infections of the CNS.

4.2 Results

Microglia express mRNA encoding NOD molecules

To begin to determine whether microglia express these novel pattern recognition receptors we have assessed the level of mRNA expression encoding NOD1 and NOD2 in isolated cultures of murine microglia either at rest or following challenge with clinically relevant Gram-negative bacterial pathogens of the CNS. Murine microglia were untreated or exposed to live *N. meningitidis*. At 4 hours post infection, RNA was isolated and real time PCR was performed for the presence of mRNA encoding NOD1 or NOD2. As shown in Figure 11A, microglia constitutively express very low levels of mRNA encoding NOD1. Exposure of microglia to viable *N. meningitidis* fails to elicit significant increases in such expression (Figure 11A). In contrast, resting microglia constitutively express mRNA encoding NOD2 at levels that are approximately two orders of magnitude greater than those seen for NOD1 (Figure 11B). Furthermore, exposure of microglia to viable *N. meningitidis* significantly increases NOD2 mRNA expression (Figure 11B). Similarly, mixed *N. meningitidis* antigen isolates elicit marked elevations in expression of mRNA encoding NOD2, but not NOD1 (Figures 11B and 11A, respectively). Finally, we have investigated the effects of a disparate bacterial pathogen, *B. burgdorferi*, on NOD mRNA expression. As shown in Figure 11, *B. burgdorferi* antigens also significantly elevate NOD2 mRNA expression.

The ability of whole cell bacterial lysates to induce NOD2 mRNA expression indicates that a dynamic interaction between viable bacteria and murine cells is not required for this effect. Rather, it suggests that bacterial motifs are a full and sufficient stimulus to induce NOD2 mRNA expression in microglia. To further investigate this

possibility, we have assessed the ability of purified microbial components to induce NOD2 mRNA expression. Microglia were exposed to the minimal peptidoglycan motif, muramyl dipeptide (MDP), a known ligand for NOD2 (Girardin et al. 2003b; Girardin et al. 2003e; Inohara et al. 2003). As shown in Figure 12A, MDP elicits modest but significant increases in levels of mRNA encoding NOD2. This effect was specific for NOD2, as MDP failed to elicit significant increases in the expression of mRNA encoding NOD1 (Figure 12A). Furthermore, we have investigated the effect of known bacterial ligands for members of the Toll-like family of pattern recognition receptors on NOD2 mRNA expression. As shown in Figure 12B, bacterial LPS and flagellin, ligands for TLR4 and TLR5, respectively, elicit marked and rapid increases in NOD2 mRNA levels. In contrast, specific ligands for TLR2 and TLR9 (Pam(3)Cys and an activating oligonucleotide, respectively) fail to significantly alter NOD2 mRNA expression (Figure 12B).

Microglia express elevated levels of NOD proteins following bacterial challenge

To determine whether expression of mRNA encoding NOD molecules in microglia translates into expression of these proteins, immunoblot analyses were performed. Reagents for murine NOD proteins were not currently available, so we employed polyclonal antibodies directed against human NOD molecules to detect the presence of murine NOD1 and NOD2 due to their 89% and 78% homology to human NOD1 and NOD2, respectively (Strausberg et al. 2002; Girardin et al. 2003a). As shown in Figure 13, murine microglia constitutively express low levels of NOD2 protein. Importantly, exposure of these cells to *N. meningitidis* or *B. burgdorferi* antigens results in marked increases in NOD2 protein expression of approximately 8- and 5-fold,

respectively. However, antigens derived from the Gram-positive bacterial pathogen, *S. aureus*, previously shown to elicit microglial responses in part via TLR2 (Kielian et al. 2005b), fail to elicit significant increases in such expression (Figure 13A). This finding is consistent with the ability of LPS and flagellin to markedly elevate NOD2 protein expression while the TLR2 ligand, Pam(3)Cys, does not (Figure 13B).

In contrast, microglia constitutively express little or no NOD1 protein (Figure 14). Exposure of microglia to bacteria or bacterial components elicited only modest elevations in NOD1 expression (Figure 14). It is noteworthy that such expression was inconsistently observed and was only detectable on immunoblots loaded with three times the input protein used for NOD2 assays.

Microglia express Rip2 kinase, a pivotal downstream effector molecule for NOD signaling

To begin to determine if NOD proteins are functional in microglia, we have investigated whether these cells express Rip2 kinase, a critical downstream effector molecule in both NOD1 and NOD2-mediated cellular activation. As shown in Figure 15A, microglia constitutively express low levels of mRNA encoding Rip2 kinase. However, such expression is rapidly and markedly upregulated following exposure to either *N. meningitidis* or *B. burgdorferi* antigens (Figure 15A). Interestingly, bacterial ligands for TLR2, TLR4, and TLR5 similarly elevate Rip2 kinase mRNA levels, while ligands for TLR9 and NOD2 do not. This indicates a measure of specificity in the regulation of this important signaling component.

To confirm that microglia express Rip2 kinase, whole cell protein isolates were probed for the presence of this molecule by immunoblot analysis. As shown in Figures 15B and C, resting microglia express robust levels of this protein. While microglia

exposed to *N. meningitidis* or *B. burgdorferi* antigens tended to have higher Rip2 kinase protein levels, these differences were not statistically significant (Figure 15B). However, purified bacterial components elicited an approximately 2-fold induction in Rip2 kinase protein expression (Figure 15C). Curiously, the ligand for TLR9 significantly elevated levels of Rip2 kinase protein despite failing to elicit demonstrable changes in mRNA levels. Taken together, the constitutive expression of this critical downstream effector molecule and its sensitivity to bacterial challenge provide circumstantial evidence for the functionality of NOD proteins in microglia.

MDP augments TLR ligand-induced inflammatory cytokine production by microglia

To more directly assess the functionality of NOD2 protein expression in microglia, we have investigated the effects of MDP on production of key inflammatory mediators by these cells. As shown in Figure 16, MDP treatment alone elicited modest but significant increases in IL-1 β at the highest dose used (Figure 16B). In contrast, MDP failed to induce significant secretion of IL-6 (Figure 16A) or TNF- α (Figure 16C). However, this NOD2 ligand markedly augmented the expression of all of these important inflammatory cytokines when used in combination with specific bacterial ligands for TLRs. MDP significantly increased the production of IL-1 β , IL-6 and TNF- α following exposure to LPS or flagellin. Interestingly, increases were greater than additive for flagellin-induced IL-1 β , IL-6 and TNF- α , and LPS-induced IL-6 and TNF- α . The ability of this NOD2 ligand to augment TLR-mediated immune responses appears to show specificity as MDP increased Pam(3)Cys-induced IL-6 and TNF- α but not IL-1 β . Furthermore, MDP fails to significantly elevate cytokine production by microglia exposed to activating oligonucleotides (CpG). Taken together, these data demonstrate

that microglia express functional NOD2 receptors and suggest that these molecules can act in a cooperative manner with specific TLRs to augment production of pivotal inflammatory cytokines.

4.3 Conclusions

Traumatic injury and infectious agents can elicit marked inflammatory responses within the CNS. While such responses may represent protective immunity against certain pathogens, inflammation elicited by infectious agents often results in progressive damage to the CNS. An accumulating body of evidence suggests that resident glial cells play a major role in host responses to microbial infection. Microglia are of the same cellular lineage as macrophages and are, therefore, likely to play a key role in host defense against invading pathogens (Benveniste 1997b; Benveniste 1997a; Gonzalez-Scarano and Baltuch 1999; Stoll and Jander 1999). Our group has previously demonstrated that microglia can respond to *B. burgdorferi* and *N. meningitidis* through the production of key inflammatory mediators, namely IL-6 and TNF- α (Rasley et al. 2002a; Rasley et al. 2006). *B. burgdorferi* is the causative agent of Lyme neuroborreliosis while *N. meningitidis* is an important cause of bacterial meningitis making them clinically relevant pathogens of the CNS (Kolb-Maurer et al. 2003). To date, the mechanisms by which these resident CNS cells perceive bacterial challenges remain unclear. Our groups, as well as others, have recently described the presence of members of the Toll-like family of receptors on murine microglia. However, such expression does not preclude the involvement of other pattern recognition receptors in microglial activation (Bsibsi et al. 2002; Rasley et al. 2002a; Olson and Miller 2004; Esen and Kielian 2005). Indeed, there is a growing perception that disparate pattern recognition receptor types act in a synergistic manner to promote maximal inflammatory immune responses (Uehara et al. 2005).

NOD1 and NOD2 are members of a family of proteins whose members are thought to serve as pattern recognition receptors for bacterial peptidoglycans (Ting and Davis 2005; Strober et al. 2006). In the present study, we provide evidence for the expression of such novel pathogen-associated molecular pattern receptors in primary microglia. We demonstrate that these cells constitutively express robust levels of mRNA encoding NOD2 and detectable amounts of this cytosolic protein. NOD2 mRNA expression is markedly elevated following exposure to the Gram-negative pathogen of the CNS, *N. meningitidis*. Interestingly, this effect appears to be independent of bacterial viability, as whole cell lysates are at least as effective as live bacteria in augmenting NOD2 expression. Mixed antigen preparations from a disparate Gram-negative bacterial CNS pathogen, *B. burgdorferi*, similarly induced NOD2 levels in microglia. However, this effect shows pathogen specificity as lysates of Gram-positive *S. aureus* fail to induce increases in NOD2 protein levels. These data suggest that certain bacterial components are a full and sufficient stimulus for NOD2 expression. Surprisingly, a specific ligand for NOD2 induced relatively modest increases in NOD2 expression. In contrast, agonists for TLR4 and TLR5 proved to be potent stimuli for NOD2 levels suggesting that cross-regulation may occur between disparate pattern recognition receptors. Such a finding is consistent with the previously documented ability of LPS to induce NOD2 mRNA expression in a monocytic cell line (Iwanaga et al. 2003). It is noteworthy that a specific ligand for TLR2 does not augment NOD2 expression in microglia. This observation is consistent with the inability of *S. aureus* antigens to induce NOD2 protein levels (Figure 13) because microglial responses to this pathogen appear to be mediated, in part, by TLR2 (Kielian et al. 2005a).

In contrast to NOD2, our data indicated that resting microglia express little or no NOD1 and only modest expression was observed following bacterial challenge. While this finding might be considered surprising because NOD1 has been reported to interact with the naturally occurring peptidoglycan degradation product GlcNAc-MurNAC-L-Ala-gamma-D-Glu-meso-DAP that is found in peptidoglycans from Gram-negative bacteria (Chamaillard et al. 2003b; Girardin et al. 2003a; Girardin et al. 2003e), our data is consistent with previous studies showing that other myeloid cell types including macrophages preferentially express NOD2 (Strober et al. 2006). In contrast, intestinal epithelial cells have been demonstrated to express NOD1 almost exclusively (Strober et al. 2006), as evidenced by the robust NOD1 protein levels in protein isolates from small intestine tissue (Figure 14).

Both NOD1 and NOD2 have been reported to associate with Rip2 kinase (Ogura et al. 2001b; Chin et al. 2002; Kobayashi et al. 2002; Yoo et al. 2002) and the present demonstration of inducible Rip2 kinase expression in microglia lends credence to the notion that NOD proteins are functional in this cell type. Activation of this adaptor molecule results in the activation of NF- κ B, a pivotal transcription factor in the production of cytokines including IL-1 β , IL-6, and TNF- α , and the induction of co-stimulatory molecules. Hence, activation of microglia via NOD receptors could underlie, at least in part, the bacterially-induced immune molecule production previously reported in this cell type.

More direct evidence for the functional presence of NOD molecules in microglia comes from the observation that extracellular application of MDP, an apparent ligand for NOD2, can elicit modest but significant production of IL-1 β (Figure 16). These findings

are consistent with previous studies employing MDP showing that this molecule is a relatively poor stimulus in macrophages (Pauleau and Murray 2003). However, we demonstrate that this NOD2 ligand can significantly augment cytokine production elicited by TLR agonists. Importantly, co-treatment of microglia with MDP and TLR ligands elicits inflammatory mediator production that is greater than the sum of each stimulus alone. This finding is in agreement with studies in other cell types showing that MDP can act in synergy with LPS to elicit inflammatory cytokine production (Ribi et al. 1979; Yang et al. 2001; Wolfert et al. 2002; Li et al. 2004). It must be noted that extracellular application of specific ligands for NOD proteins can initiate cellular responses despite the predicted inability of these molecules to cross the plasma membrane (Yang et al. 2001; Wolfert et al. 2002; Pauleau and Murray 2003). To date, the precise mechanisms responsible for this uptake have yet to be determined, although it is possible that phagocytosis and/or pinocytosis/macropinocytosis underlie such uptake.

While it is presently unclear why MDP alone elicits only modest cytokine production by microglia, it is possible an initial stimulus is required to induce NOD2 expression, thereby rendering microglia more sensitive to the presence of MDP. Alternatively, these findings may indicate that multiple signals, via dissimilar pattern recognition receptors, act in a synergistic manner to promote inflammatory microglial responses. Regardless of which scenario is correct, the present study demonstrates that disparate bacterial pattern recognition receptors can act in a co-operative manner to initiate immune responses in this resident CNS cell type. As such, the functional presence of NOD proteins in primary microglia may represent an important mechanism by which this cell type responds to bacterial CNS pathogens.

4.4 Figures

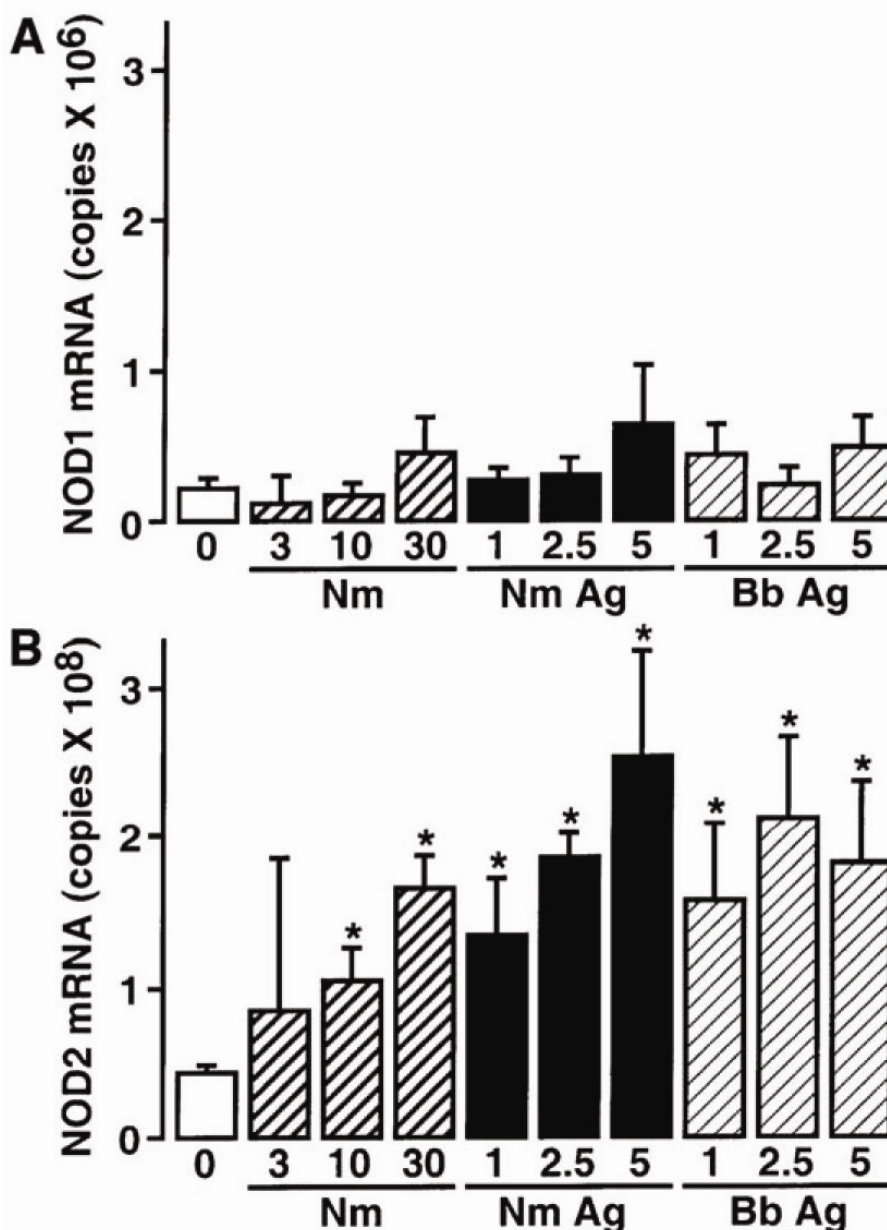

Figure 11: Primary murine microglia constitutively express mRNA encoding members of the NOD family of cytosolic pattern recognition receptors and such expression is elevated following bacterial challenge. Cells (2×10^6) were untreated (0) or exposed to live *N. meningitidis* (Nm) (3:1, 10:1, and 30:1 ratios of bacteria to cells), *N. meningitidis* antigens (Nm Ag) (1, 2.5, and 5 $\mu\text{g/ml}$), or *B. burgdorferi* antigens (Bb Ag) (1, 2.5, 5 $\mu\text{g/ml}$). At 4 hours following treatment, mRNA was isolated and real time PCR performed to determine the level of expression of mRNA encoding NOD1 (Panel A) or NOD2 (Panel B). Data are presented as the mean \pm SEM of five experiments normalized to the expression of G3PDH. Asterisk indicates a statistically significant difference from untreated microglia.

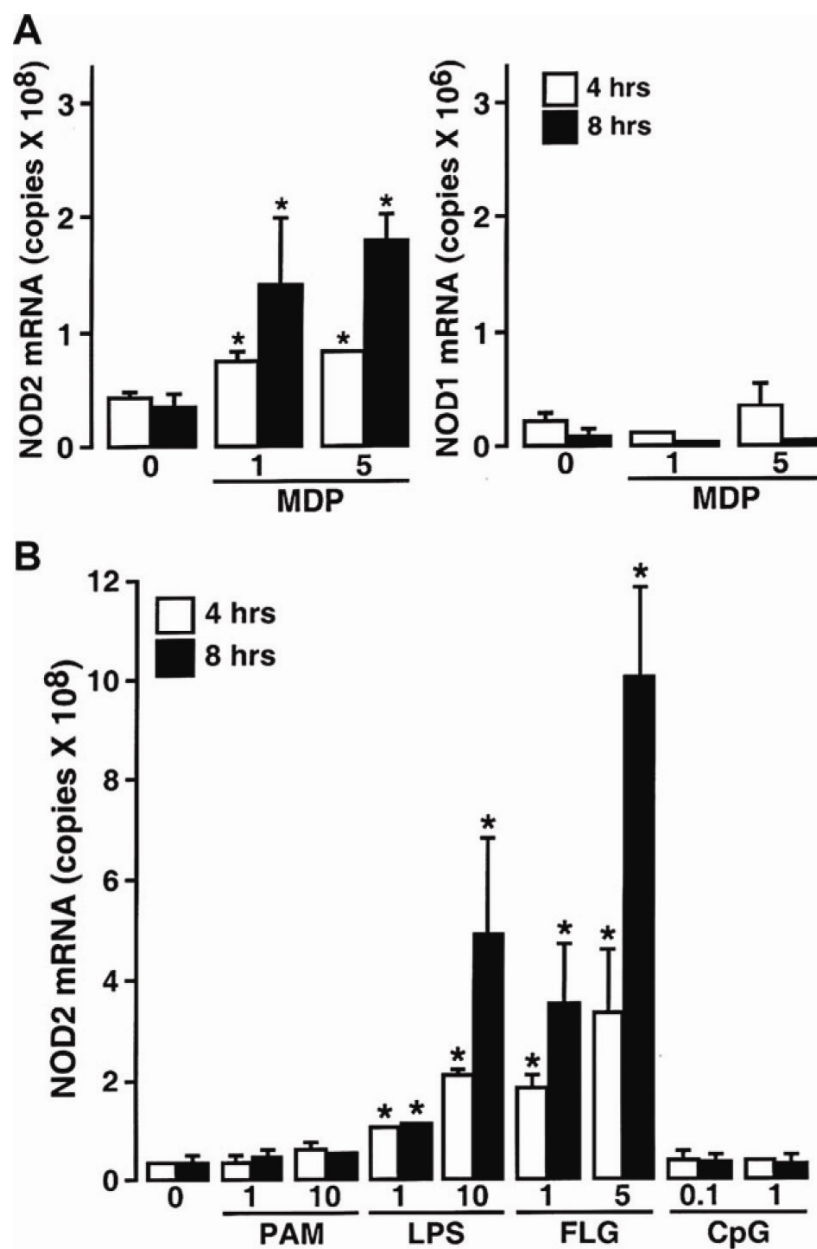

Figure 12: Expression of mRNA encoding NOD2 is elevated following exposure to the NOD2 specific ligand, MDP, or known ligands for Toll-like pattern recognition receptors. Panel A: Cells (2×10^6) were untreated (0) or exposed to MDP (1 and 5 $\mu\text{g/ml}$) for 4 and 8 hours prior to mRNA isolation and real time PCR for NOD1 or NOD2 expression. Panel B: Cells (2×10^6) were untreated (0) or exposed to Pam(3)Cys (PAM) (1 and 5 ng/ml), lipopolysaccharide (LPS) (1 and 10 ng/ml), purified flagellin (FLG) (1 and 5 ng/ml), or an activating oligonucleotide (CpG) (0.1 and 1 $\mu\text{g/ml}$) for 4 and 8 hours prior to mRNA isolation and real time PCR for NOD2 expression. Data are presented as the mean \pm SEM of three experiments normalized to the expression of G3PDH. Asterisk indicates a statistically significant difference from untreated microglia.

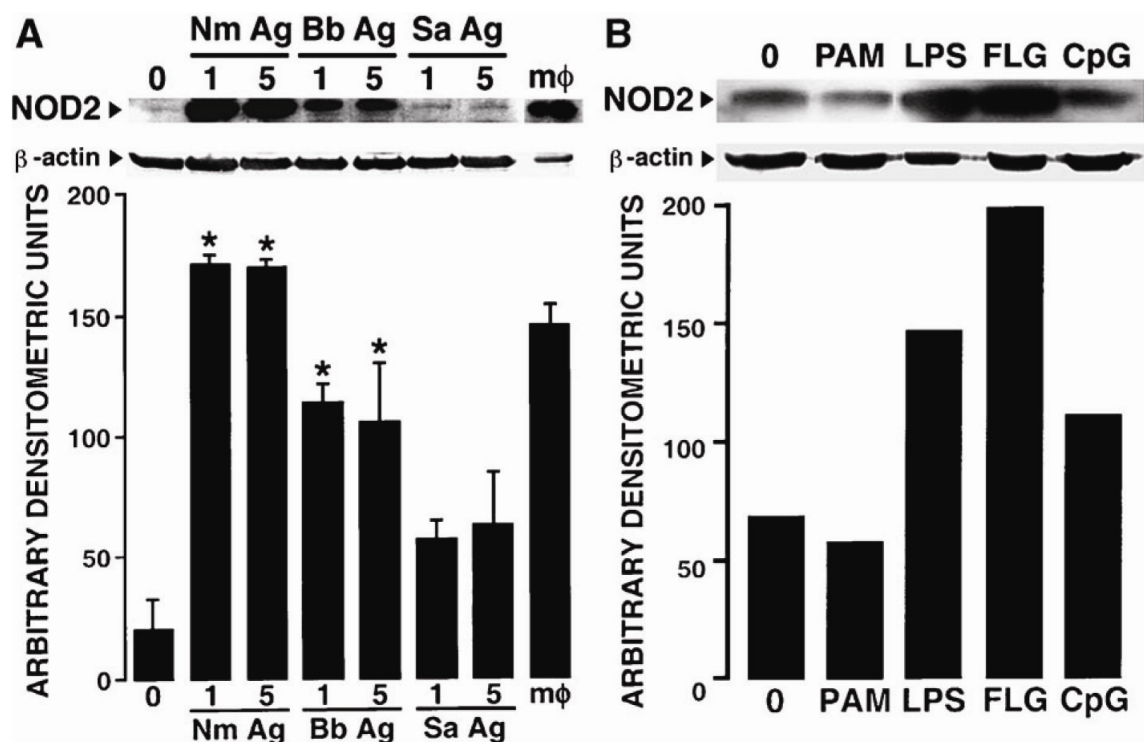

Figure 13: Microglia constitutively express low levels of NOD2 protein and such expression is elevated following bacterial challenge or exposure to Toll-like receptor ligands. Panel A: Cells (2×10^6) were untreated (0) or exposed to *N. meningitidis* antigens (Nm Ag) (1 and 5 $\mu\text{g/ml}$), *B. burgdorferi* antigens (Bb Ag) (1 and 5 $\mu\text{g/ml}$), or *S. aureus* antigens (1 and 5 $\mu\text{g/ml}$). Panel B: Cells (2×10^6) were untreated (0) or exposed to Pam(3)Cys (PAM) (10 ng/ml), lipopolysaccharide (LPS) (100 ng/ml), purified flagellin (FLG) (10 ng/ml), or an activating oligonucleotide (CpG) (1 $\mu\text{g/ml}$). At 24 hours post-treatment, whole cell protein isolates were prepared and NOD2 protein expression was determined by immunoblot. Bands were quantified by densitometric analyses normalized to β -actin expression. Bar graph in panel A depicts average values \pm SD for three experiments. Bar graph in Panel B depicts normalized densitometric values for immunoblot shown which is representative of four separate experiments. For comparison purposes NOD2 protein expression in a similar number of LPS and IFN- γ stimulated macrophages is shown (m ϕ).

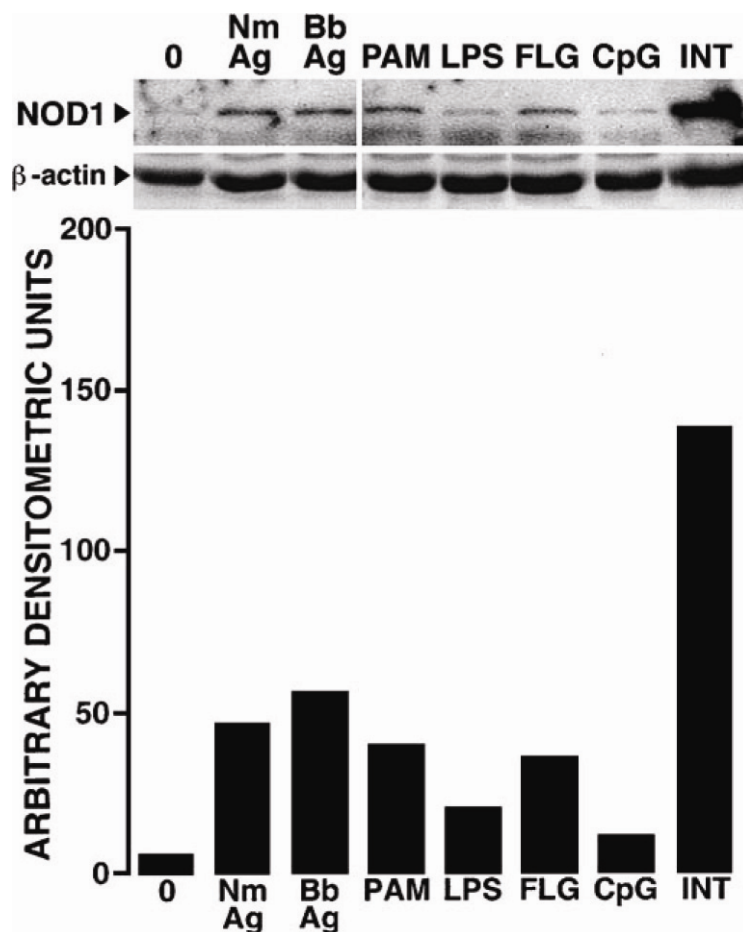

Figure 14: Microglia express little or no NOD1 protein constitutively, and only modest levels following bacterial antigen challenge. Cells (2×10^6) were untreated (0) or exposed to *N. meningitidis* antigens (Nm Ag) ($5 \mu\text{g/ml}$), *B. burgdorferi* antigens (Bb Ag) ($5 \mu\text{g/ml}$), Pam(3)Cys (PAM) (10 ng/ml), lipopolysaccharide (LPS) (100 ng/ml), purified flagellin (FLG) (10 ng/ml), or an activating oligonucleotide (CpG) ($1 \mu\text{g/ml}$). At 24 hours post-treatment, whole cell protein isolates were prepared and NOD1 protein expression was determined by immunoblot. Bar graph depicts results of densitometric analyses normalized to β -actin expression for immunoblot shown, and this experiment was performed twice with similar results. For comparison purposes NOD1 expression in protein samples from small intestine tissue is also shown (INT).

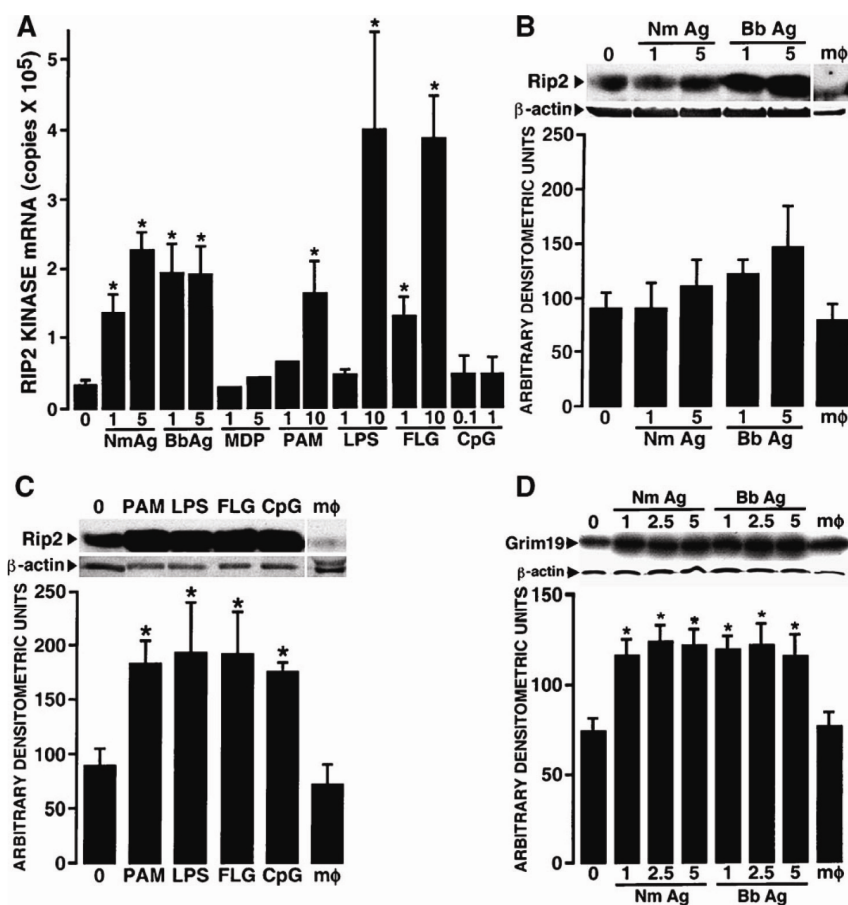

Figure 15: Microglia constitutively express Rip2 kinase, a critical downstream effector molecule of NOD signaling, and such expression is elevated following bacterial challenge. Panel A: Cells (2×10^6) were untreated (0) or exposed to *N. meningitidis* antigens (Nm Ag) (1 and 5 $\mu\text{g/ml}$), *B. burgdorferi* antigens (Bb Ag) (1 and 5 $\mu\text{g/ml}$), muramyl dipeptide (MDP) (1 and 5 $\mu\text{g/ml}$), Pam(3)Cys (PAM) (1 and 10 ng/ml), lipopolysaccharide (LPS) (10 and 100 ng/ml), purified flagellin (FLG) (1 and 10 ng/ml), or an activating oligonucleotide (CpG) (0.1 and 1 $\mu\text{g/ml}$). At 4 hours post treatment, RNA was isolated and real time RT-PCR performed to determine expression of mRNA encoding Rip2 kinase. Data are presented as the mean \pm SEM of three experiments normalized to the expression of G3PDH. Asterisk indicates a statistically significant difference from untreated microglia. Panels B and C: Cells (2×10^6) were untreated (0) or exposed to *N. meningitidis* antigens (Nm Ag) (1 and 5 $\mu\text{g/ml}$), *B. burgdorferi* antigens (Bb Ag) (1 and 5 $\mu\text{g/ml}$) (Panel B), or Pam(3)Cys (PAM) (10 ng/ml), lipopolysaccharide (LPS) (100 ng/ml), purified flagellin (FLG) (10 ng/ml), or an activating oligonucleotide (CpG) (1 $\mu\text{g/ml}$) (Panel C). At 24 hours post-treatment, whole cell protein isolates were prepared and Rip2 kinase protein expression was determined by immunoblot. Bands were quantified by densitometric analyses normalized to β -actin expression and bar graphs depict average values \pm SD for three experiments. For comparison purposes Rip2 kinase protein expression in a similar number of LPS and IFN- γ stimulated macrophages is shown (m ϕ).

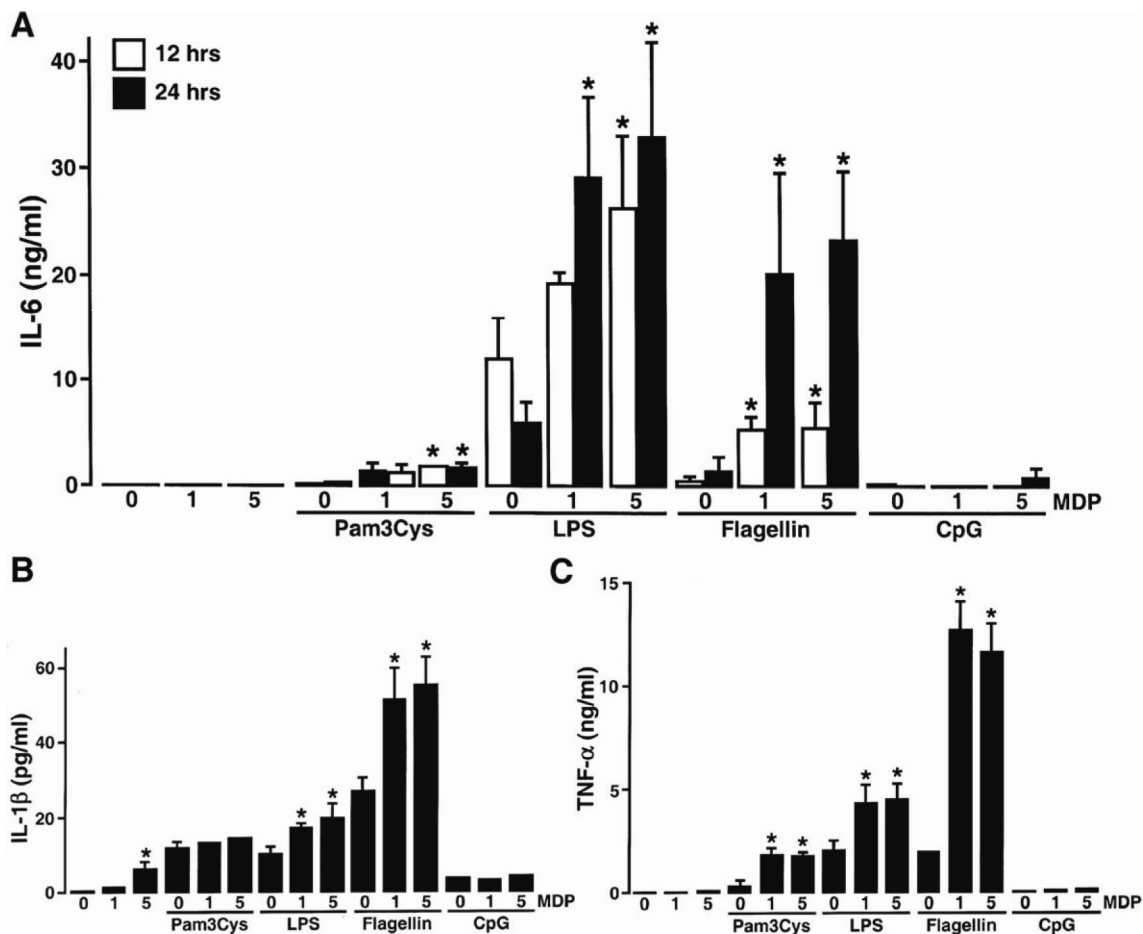

Figure 16: MDP, a NOD2 specific ligand, augments inflammatory cytokine production by murine microglia. Cells (2×10^6) were untreated (0) or exposed to muramyl dipeptide (MDP) (1 and 5 $\mu\text{g/ml}$) in the presence or absence of Pam(3)Cys (PAM) (10 ng/ml), lipopolysaccharide (LPS) (10 ng/ml), purified flagellin (FLG) (1 ng/ml), or an activating oligonucleotide (CpG) (1 $\mu\text{g/ml}$). At 12 and/or 24 hours post treatment, culture supernatants were assayed for the presence of IL-6 (Panel A), IL-1 β (Panel B), or TNF- α (Panel C) by specific capture ELISAs. Data are presented as the mean of duplicate measurements of samples from three separate experiments \pm SEM. Asterisks indicate statistically significant difference between cytokine levels detected in the absence and presence of MDP within each stimuli group.

CHAPTER 5: FUNCTIONAL ROLE OF NOD2 IN MICROGLIA AND ASTROCYTES

5.1 Rationale

Microglia and astrocytes are major glial cell types within the CNS. Studies conducted by our group, as well as others, have highlighted these cell types as important contributors to the generation of inflammation during infection of the brain. It has been demonstrated that these resident glial cells, upon exposure to pathogens of the CNS, are able to assume effector functions such as cytokine production and the expression of MHC class II molecules. The production of inflammatory mediators may serve to recruit leukocytes to the site of challenge and, in combination with antigen presentation in the context of MHC class II molecules, activate those cells upon their arrival (Hickey and Kimura 1988; Hatten et al. 1991; Kiefer et al. 1993; Benveniste 1997a; Soos et al. 1998; Streit et al. 1999; Owens et al. 2005). Our group has already demonstrated that microglia and astrocytes have the ability to detect and respond to clinically relevant bacterial pathogens of the CNS, including *Borrelia burgdorferi* and *Neisseria meningitidis* (Rasley et al. 2002a; Bowman et al. 2003; Rasley et al. 2004b; Rasley et al. 2006). However, the mechanisms by which these important resident glial cells perceive bacterial pathogens are only recently being described.

Studies have demonstrated that microglia and astrocytes utilize pattern recognition receptors as a means by which to identify and respond to microbial

pathogens. Studies conducted by our group as well as others have reported the expression of Toll-like receptor family members known to be important in the perception of extracellular bacterial pathogens (Laflamme and Rivest 2001; Bsibsi et al. 2002; Rasley et al. 2002a; Bowman et al. 2003; Esen et al. 2004; Olson and Miller 2004; Carpentier et al. 2005; Esen and Kielian 2005; Kielian et al. 2005a). However, *Borrelia burgdorferi* and *Neisseria meningitidis* are known to be internalized by eukaryotic cells and the mechanisms by which intracellular bacteria are identified in microglia and astrocytes have not yet been established (Dehio et al. 2000; Livengood and Gilmore 2006).

We have already demonstrated that microglia and astrocytes constitutively express NOD2, a member of the novel nucleotide-binding domain leucine-rich repeat region containing family of proteins (NLR) (See Chapter 3 and 4). This molecule functions as an intracellular receptor for a minimal motif present in all types of bacterial peptidoglycans. Those studies have provided circumstantial evidence that this pattern recognition receptor is functional within microglia and astrocytes. Indeed, functionality can be inferred from the ability of TLR ligands and *Borrelia burgdorferi* and *Neisseria meningitidis* antigens to significantly upregulate expression of NOD2 within these cell types. Further evidence exists in the inducibility of Rip2 kinase, a critical downstream effector molecule of this pathway. Finally, we have also demonstrated that muramyl dipeptide, a known ligand for NOD2, can significantly augment TLR-mediated inflammatory cytokine production in both microglia and astrocytes.

In the current study, we have confirmed the functional nature of NOD2 pathway expression in microglia and astrocytes. Additionally, we have taken steps to investigate

the relative contribution of this pathway in the generation of inflammatory responses to clinically relevant bacterial CNS pathogens. We demonstrate increased association of NOD2 with its downstream adaptor molecule Rip2 kinase in primary cultures of murine microglia and astrocytes following exposure to bacterial antigens. Furthermore, we demonstrate that NOD2 underlies the ability of muramyl dipeptide to augment glial immune responses. Finally, we also show that NOD2 represents an important component in the generation of inflammatory immune responses of resident glia to *Borrelia burgdorferi* and *Neisseria meningitidis*.

5.2 Results

Increased association of NOD2 with Rip2 kinase in murine microglia and astrocytes following bacterial challenge

To establish the functional relevance of NOD2 expression in resident CNS cells, we investigated the ability of NOD2 to associate with its downstream effector molecule, Rip2 kinase, in isolated cultures of primary murine microglia and astrocytes using co-immunoprecipitation techniques. As shown in Figure 17, protein isolates from resting cultures of microglia and astrocytes exhibit constitutive association between NOD2 with Rip2 kinase. Importantly, the level of association between NOD2 and Rip2 kinase is elevated in both microglia and astrocytes following exposure to lysates prepared from *N. meningitidis* or *B. burgdorferi*, two clinically relevant bacterial pathogens of the CNS that have been demonstrated to be internalized by glial cells (Livengood and Gilmore, 2006). As such, the increased association of these molecules provides circumstantial evidence supporting a functional role for NOD2 in the immune responses of resident CNS cell types following bacterial challenge.

MDP augmentation of inflammatory cytokine production by stimulated microglia and astrocytes is mediated by NOD2

In this study we have confirmed our previous findings in microglia and astrocytes derived from BALB/c mice using those derived from C57BL/6 mice. As shown in Figure 18A, C, MDP alone fails to elicit significant production of IL-6 or TNF- α . However, this NOD2 ligand significantly augments the production of both of these inflammatory cytokines by microglia following exposure to the TLR4 and TLR5 specific ligands, LPS and flagellin, respectively. Similarly, MDP augments LPS and flagellin induced IL-6 and TNF- α production by isolated astrocytes (Fig. 19A, C). Importantly, we have confirmed

that the effects of MDP are mediated by NOD2 by performing parallel experiments using microglia and astrocytes derived from animals genetically deficient in the expression of NOD2 (NOD2^{-/-}). As shown in Figure, 18B, D, MDP fails to augment inflammatory cytokine production by NOD2^{-/-} derived microglia challenged with LPS or flagellin. Similarly, MDP does not elevate TLR-induced IL-6 or TNF- α production by astrocytes derived from NOD2^{-/-} mice (Fig. 19B, D). These data confirm that MDP acts via NOD2 and can augment TLR-induced inflammatory cytokine production by both microglia and astrocytes.

NOD2 is required for maximal in vitro responses of microglia and astrocytes to *N. meningitidis* and *B. burgdorferi*

To begin to determine the relative importance of the NOD2 receptor in inflammatory glial responses to bacterial pathogens, we have compared the responses of *N. meningitidis* and *B. burgdorferi* challenged cells derived from wild-type animals (NOD2^{+/+}) with those of cells derived from NOD2^{-/-} animals. As shown in Figure 20, microglia produce IL-6 and TNF- α in response to exposure to *N. meningitidis* or *B. burgdorferi* antigens. Importantly, cells derived from NOD2^{-/-} mice exhibited significantly lower responses than their NOD2^{+/+} derived counterparts (see Figure 20). Similarly, NOD2^{-/-} derived astrocytes produce significantly lower amounts of IL-6 and TNF- α than wild-type derived cells following bacterial challenge (see Figure 21). Taken together, these data indicate that NOD2 is an important contributor to the in vitro inflammatory immune responses of resident CNS cell types to these two clinically relevant bacterial pathogens.

CNS Inflammation Following In Vivo Bacterial Administration are reduced in the Absence of NOD2

To establish the in vivo role of NOD2 in bacterially induced inflammatory glial responses, we have investigated the generation of inflammation associated with in vivo administration of *N. meningitidis* in the presence or absence of NOD2. As shown in Figure 22, the infection of the CNS with *N. meningitidis* results in the production of statistically significant levels of the pro-inflammatory cytokine TNF- α . This significant increase was not apparent in NOD2^{-/-} mice. We extended our in vivo studies to include the disparate CNS pathogen, *B. burgdorferi*. As shown in Figure 22, i.c. administration of *B. burgdorferi* (1×10^6 organisms) is associated with a significant increase in TNF- α levels in whole brain homogenates. Importantly, *B. burgdorferi* administration failed to elicit significant elevations in TNF- α levels in NOD2^{-/-} animals. These results indicate that NOD2 plays an important role in the generation of in vivo inflammatory responses to these bacterial pathogens.

5.3 Conclusions

A number of studies, conducted by our group as well as others, suggest that resident glial cells play an important role in the initiation and progression of inflammation following infection or trauma. Microglia and astrocytes are major glial cell types present within the CNS and, upon exposure to microbial pathogens, assume important effector functions. Studies have demonstrated that both microglia and astrocytes have the ability to produce key inflammatory cytokines including TNF- α and IL-6 (Kiefer et al. 1993; Streit et al. 1999; Kielian et al. 2002; Rasley et al. 2002a; Kielian 2004b; Rasley et al. 2004b). In order to accomplish this role, microglia and astrocytes utilize microbial pattern recognition receptors to perceive bacterial pathogens and to initiate protective, as well as damaging, CNS inflammation. Indeed, these cell types have been shown to functionally express members of the Toll-like family of pattern recognition receptors (Lieberman et al. 1989; Dong and Benveniste 2001; Bsibsi et al. 2002; Bowman et al. 2003; Esen et al. 2004; Olson and Miller 2004; Carpentier et al. 2005; Esen and Kielian 2005; Kielian et al. 2005a; Oh et al. 2005). Additionally, we have demonstrated that microglia and astrocytes express members of the NOD-like family of pattern recognition receptors (see Chapter 3 and 4).

NLR proteins such as NOD2 have been identified as cytosolic pattern recognition receptors that play a role in the initiation of inflammatory host immune responses to bacterial challenge (Girardin et al. 2003a; Girardin et al. 2003b; Girardin et al. 2003e; Ting and Davis 2005; Strober et al. 2006). NOD2 appears to function as an intracellular receptor for a minimal motif common to all bacterial peptidoglycans (Girardin et al. 2003b; Girardin et al. 2003e; Takada and Uehara 2006). We have characterized the

expression of NOD2 in primary cultures of murine glial cells and demonstrated that microglia and astrocytes not only express NOD2 and its downstream effector molecule Rip2 kinase constitutively, but that expression of these molecules is upregulated in glial cells following bacterial challenge (See Chapter 3 and 4). However, the importance of NLR proteins in the generation of inflammatory host responses to bacterial pathogens within the brain has not been established.

In this study, we demonstrate that exposure of microglia and astrocytes to bacterial lysates increases the association between NOD2 and Rip2 kinase. In addition, we have confirmed our previous findings using BALB/c derived cells, by demonstrating that MDP augments the TLR-induced inflammatory responses of microglia and astrocytes derived from C57BL/6 mice. Importantly, we have confirmed that these effects are mediated by NOD2, rather than other putative receptors for MDP such as NLRP3 (Martinon et al., 2004), by demonstrating that the ability of MDP to exacerbate responses to TLR ligands is abolished in cells derived from NOD2^{-/-} animals (Martinon et al. 2004). Perhaps more importantly, we have assessed the relative importance of NOD2 in the immune responses of isolated cultures of primary glia cells to bacterial antigens from two disparate and clinically relevant bacterial pathogens of the CNS, *N. meningitidis* and *B. burgdorferi*. We show that the inflammatory responses of both astrocytes and microglia are significantly reduced in the absence of NOD2 expression. Finally, we have established the in vivo relevancy of our in vitro studies by studying the CNS inflammation associated with direct i.c. bacterial administration in wild-type animals and mice genetically deficient in the expression of NOD2. Our data indicate that increases in inflammatory cytokine levels within the CNS associated with bacterial infection are

reduced in the absence of NOD2 expression. These studies indicate that NOD2 represents an important component in the generation of damaging CNS inflammation following bacterial infection.

Interestingly, there does not appear to be marked differences between the responses of microglia to *N. meningitidis* or *B. burgdorferi* antigens in the presence or absence of NOD2. However, astrocytes challenged with *B. burgdorferi* exhibit more NOD2/Rip2 kinase association and higher production of both IL-6 and TNF- α than cells exposed to *N. meningitidis*. As *B. burgdorferi* has been shown to initiate TLR2- and TLR5-mediated innate immune responses (Shin et al. 2008), while *N. meningitidis* can elicit TLR2 and TLR4-mediated responses (Zughaier et al. 2005; Hellerud et al. 2008), it is tempting to suggest that the TLR5/NOD2 interaction might elicit a more robust response in astrocytes than that associated with TLR4/NOD2 signaling. While verification of such a hypothesis will require further study, it is interesting to note that the TLR5 ligand, flagellin, elicits higher inflammatory cytokine production by astrocytes when co-administered with MDP than a combination of LPS and MDP (see Figure 19).

To date, the mechanisms underlying TLR and NOD2 interaction/synergy have yet to be determined, but it is probable that crosstalk exists between these disparate pattern recognition receptors and recent studies have focused on this issue (Kim et al. 2008). We have demonstrated that ligands such as Pam3Cys (TLR2), LPS (TLR4), flagellin (TLR5), and a TLR9-activating CpG oligonucleotide can all augment NOD2 and Rip2 kinase protein expression in both microglia (Chapter 4) and astrocytes (Chapter 3). Clearly, the interaction between these pattern recognition receptor families requires additional study

and experiments to determine the mechanisms underlying TLR and NOD2 interaction/synergy in glial cells are ongoing in our laboratory.

While it is readily apparent that the MDP-associated exacerbation of glial responses to TLR ligands are absent in NOD2^{-/-} derived cells and the responses of these cells to bacterial lysates are lower than those seen in wild-type-derived cells, it is interesting to note that NOD2^{-/-} glial cells demonstrated greater cytokine responses to TLR ligands than wild-type-derived cells. Similarly, we observed that uninfected NOD2^{-/-} mice exhibited higher basal cytokine levels than their wild-type counterparts. At present we cannot explain these findings, but it is conceivable that an endogenous ligand for NOD2 might exist that serves to limit TLR-mediated inflammatory responses rather than exacerbate them. Further studies will be required to resolve this issue. Taken together, the present studies indicate that NOD2 acts in a co-operative manner with disparate TLR homologues in the induction of inflammatory cytokine responses of primary microglia and astrocytes. In addition, we have shown that NOD2 is required for maximal *in vitro* inflammatory responses of resident CNS cells to bacterial lysates. As such, we have identified NOD2 as an important component in the generation of damaging CNS inflammation following bacterial infection.

5.4 Figures

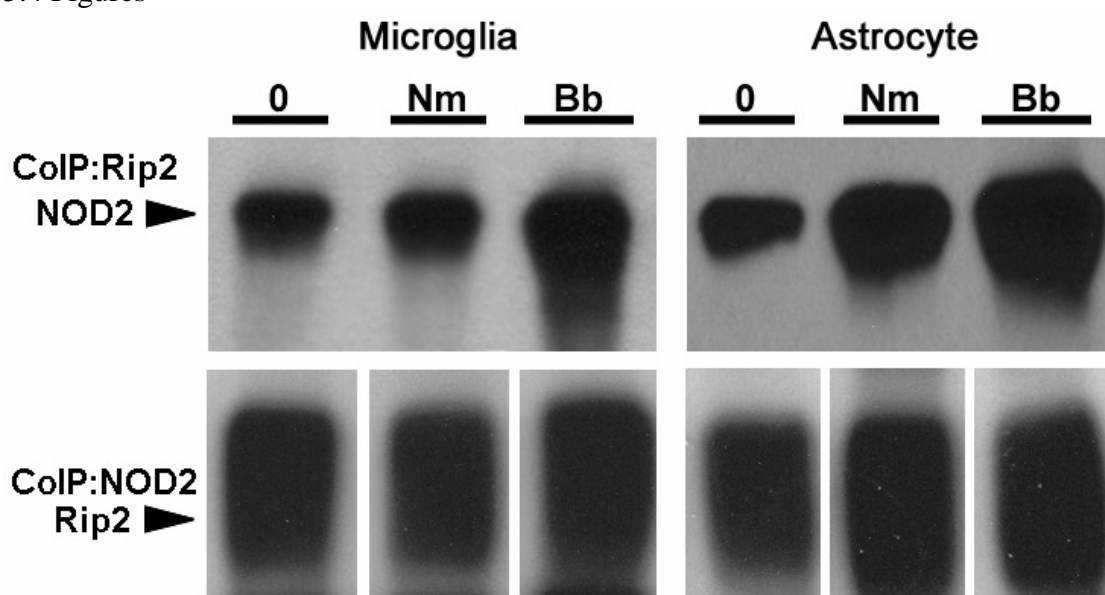

Figure 17: Association of NOD2 with Rip2 kinase in murine microglia and astrocytes increases following challenge with bacterial antigens. Primary murine microglia and astrocytes (2×10^6 per well) were untreated (0) or exposed to *N. meningitidis* (Nm: 1 and 5 $\mu\text{g}/\text{mL}$) or *B. burgdorferi* (Bb: 1, 5, and 10 $\mu\text{g}/\text{mL}$) antigens. At 2 h following bacterial challenge, protein isolates were immunoprecipitated with antibodies directed against Rip2 kinase or NOD2 and subsequently analyzed by denaturing immunoblot for the presence of NOD2 (upper panel) or Rip2 kinase (lower panel), respectively. These experiments were performed three times with similar results.

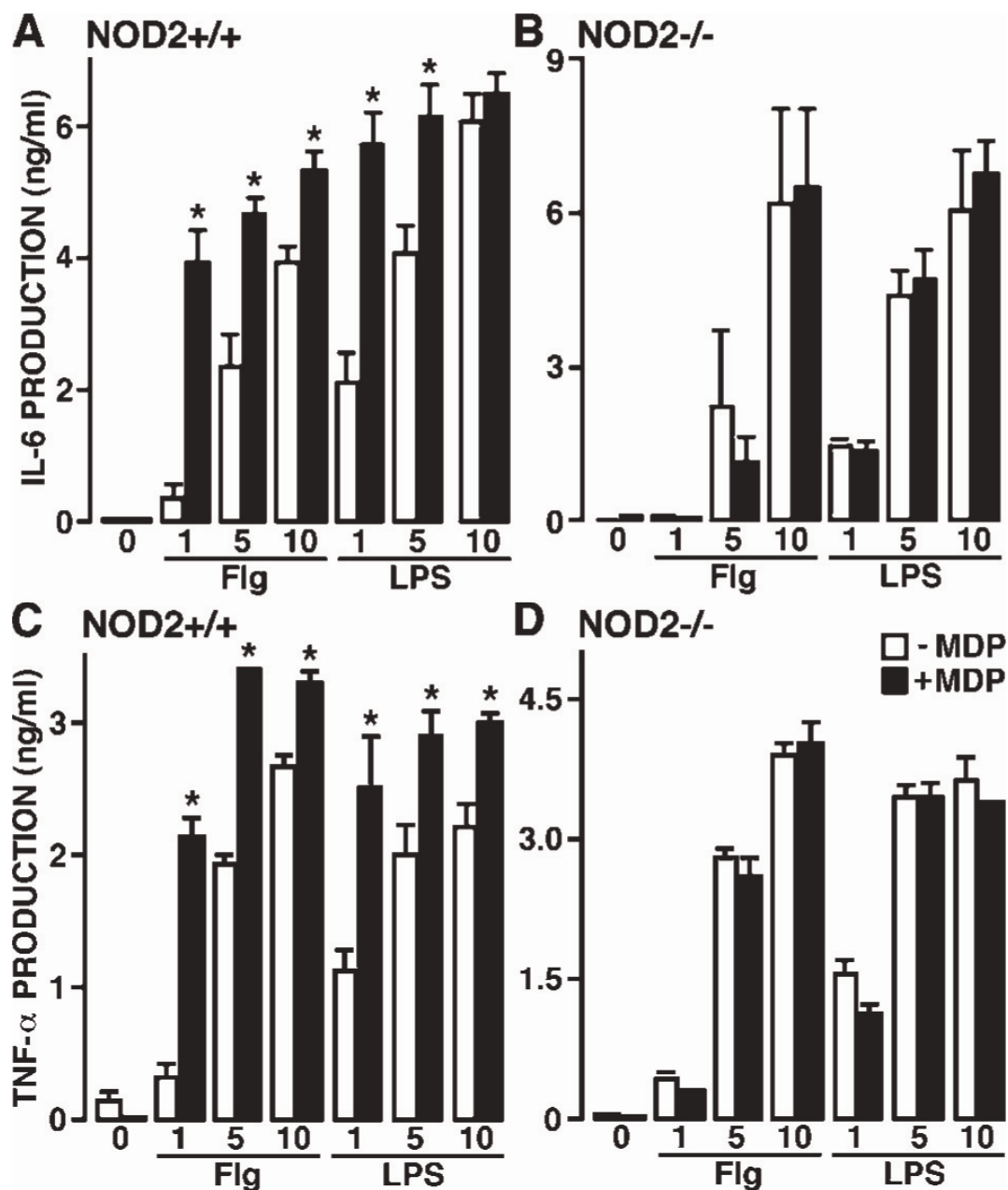

Figure 18: MDP augmentation of inflammatory cytokine production by stimulated microglia is mediated by NOD2. Cells (2×10^6) from wild-type (NOD2^{+/+}) and NOD2-knockout (NOD2^{-/-}) animals were untreated (0) or exposed to bacterial flagellin (Flg) or LPS (1, 5, and 10 ng/mL in the presence or absence of MDP (5 μ g/mL). At 12 h following bacterial challenge, culture supernatants were assayed for the presence of IL-6 (A and B) and TNF- α (C and D) by specific capture ELISA. Data are presented as the mean of triplicate determinations of samples from three separate experiments \pm SEM. Asterisks indicate statistically significant differences between cytokine levels in the absence or presence of MDP.

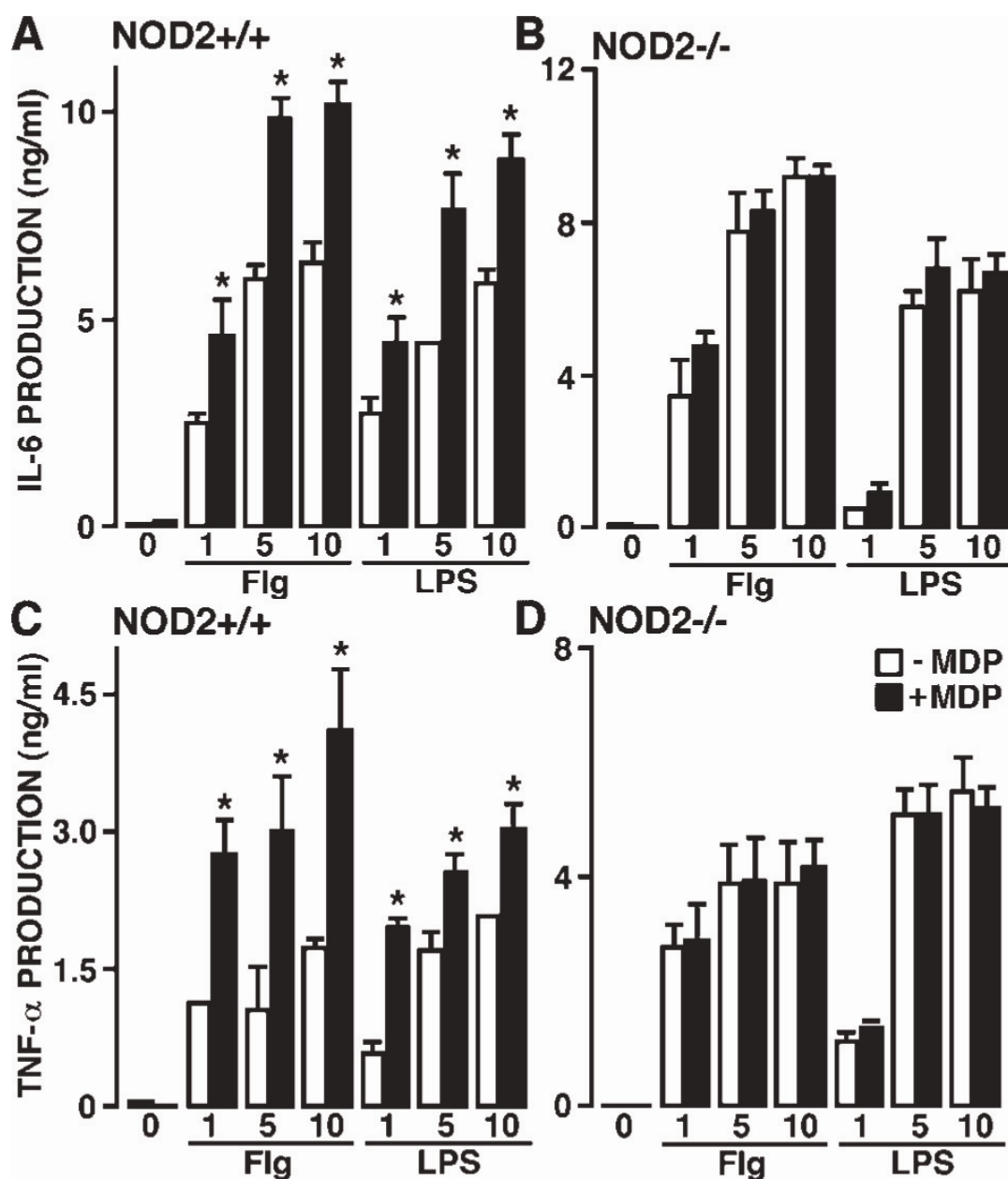

Figure 19: MDP augmentation of inflammatory cytokine production by stimulated astrocytes is mediated by NOD2. Cells (2×10^6) from wild-type (NOD2^{+/+}) and NOD2-knockout (NOD2^{-/-}) animals were untreated (0) or exposed to bacterial flagellin (Flg) or LPS (1, 5, and 10 ng/mL in the presence or absence of MDP (5 μ g/mL). At 12 h following bacterial challenge, culture supernatants were assayed for the presence of IL-6 (A and B) and TNF- α (C and D) by specific capture ELISA. Data are presented as the mean of triplicate determinations of samples from three separate experiments \pm SEM. Asterisks indicate statistically significant differences between cytokine levels in the absence or presence of MDP.

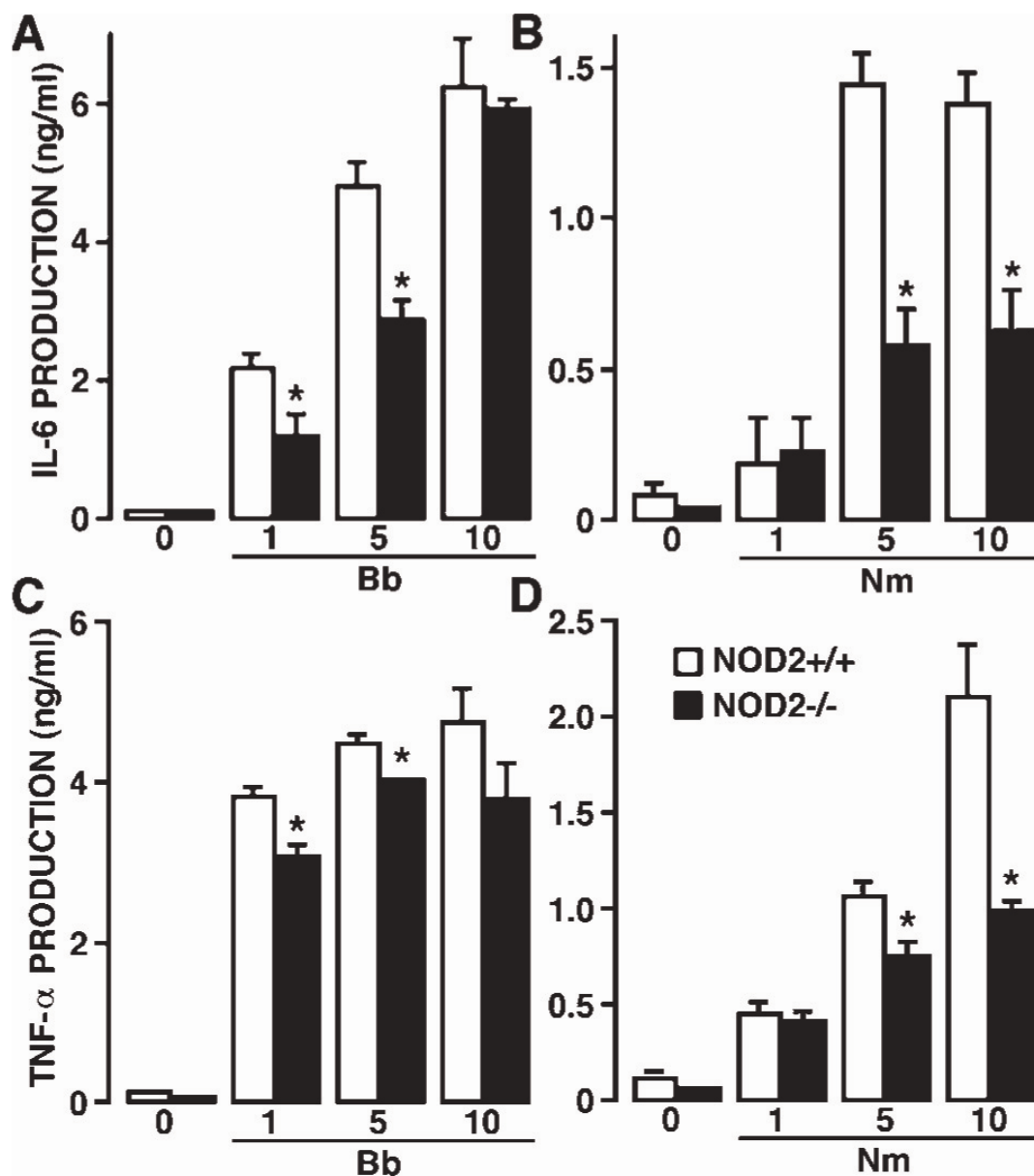

Figure 20: Inflammatory cytokine responses of microglia to *N. meningitidis* and *B. burgdorferi* are significantly lower in the absence of NOD2 expression. Cells (2×10^6) from wild-type (NOD2^{+/+}) and NOD2- knockout (NOD2^{-/-}) animals were untreated or exposed to either *B. burgdorferi* antigens (Bb: 1, 5, and 10 μg/mL) or *N. meningitidis* antigens (Nm: 1, 5, and 10 μg/mL). At 12 h following bacterial challenge culture supernatants were isolated and assayed for the presence of IL-6 (A and B) or TNF-α (C and D) by specific capture ELISA. Data are presented as the mean of triplicate determinations of samples from three separate experiments \pm SEM. Asterisks indicate statistically significant differences in cytokine production between cells derived from wild-type and NOD2-deficient animals.

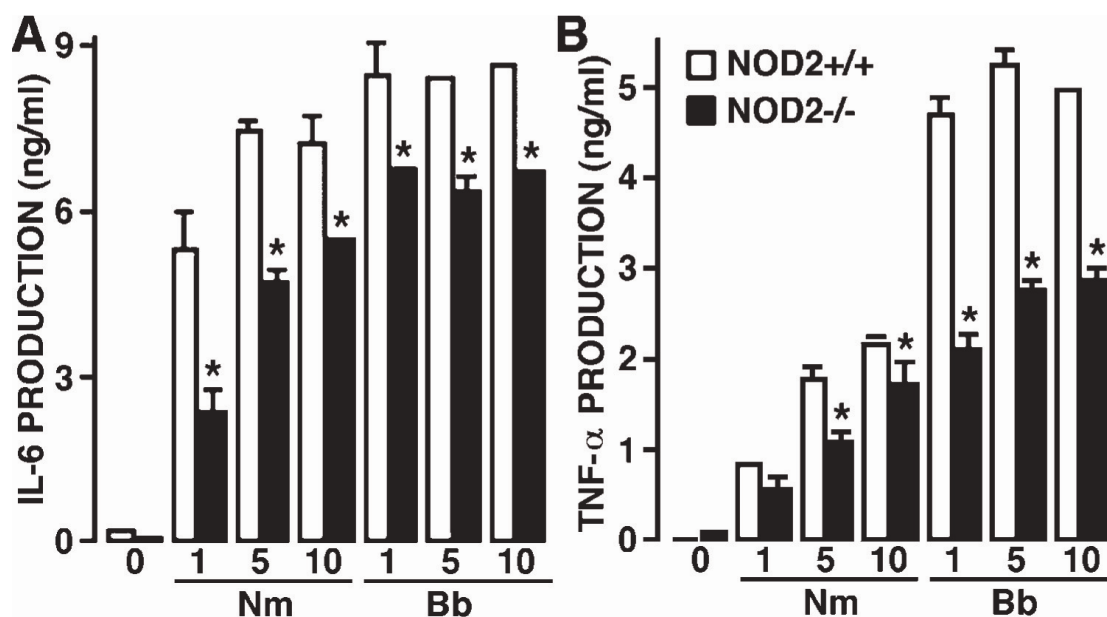

Figure 21: Inflammatory cytokine responses of astrocytes to *N. meningitidis* and *B. burgdorferi* are significantly lower in the absence of NOD2 expression. Cells (2×10^6) from wild-type (NOD2^{+/+}) and NOD2- knockout (NOD2^{-/-}) animals were untreated or exposed to either *B. burgdorferi* antigens (Bb: 1, 5, and 10 $\mu\text{g}/\text{mL}$) or *N. meningitidis* antigens (Nm: 1, 5, and 10 $\mu\text{g}/\text{mL}$). At 12 h following bacterial challenge culture supernatants were isolated and assayed for the presence of IL-6 (Panel A) or TNF- α (Panel B) by specific capture ELISA. Data are presented as the mean of triplicate determinations of samples from three separate experiments \pm SEM. Asterisks indicate statistically significant differences in cytokine production between cells derived from wild-type and NOD2-deficient animals.

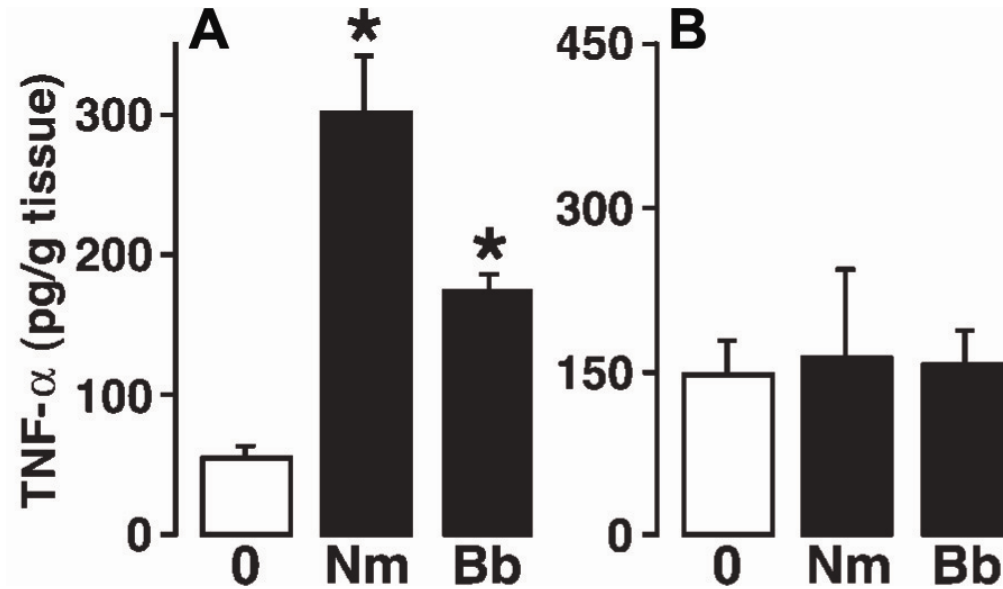

Figure 22: Inflammatory cytokine production is markedly reduced in the absence of NOD2. Panel A: Wild-type C57BL/6 mice were given vehicle (0) or were infected with *N. meningitidis* (Nm) or *B. burgdorferi* (Bb) (1×10^6) via intracerebral injection. Panel B: NOD2^{-/-} C57BL/6 mice were given vehicle (0) or were infected with *N. meningitidis* (Nm) or *B. burgdorferi* (Bb) (1×10^6) via intracerebral injection. At 72 h post infection tissue homogenates were isolated for measurement of TNF- α protein expression by specific capture ELISA. Asterisk indicates significant difference from uninfected animals.

CHAPTER 6: REPLICATION-DEPENDENT IMMUNE RESPONSE OF MICROGLIA AND ASTROCYTES TO VESICULAR STOMATITIS VIRUS

6.1 Rationale

Vesicular stomatitis virus (VSV) is a nonsegmented negative-strand RNA virus of the family *Rhabdoviridae*, order *Mononegavirales*. Members of this order include many medically important pathogens including the lethal rabies, Ebola, Marburg, Nipah and Hendra viruses. VSV has limited human pathogenicity, despite similarities to other *Mononegavirales*, making it an attractive model for the study of other viruses in this order. As described in work by Dr. Carol Reiss and others (Miyoshi et al. 1971; Lundh et al. 1987; Lundh 1990; Bi et al. 1995), intranasal inoculation of VSV leads to infection of the olfactory bulb via the olfactory neurons and subsequently leads to infection throughout the central nervous system (CNS). This infection is associated with acute encephalitis, breakdown of the blood-brain barrier, and a high degree of mortality similar to that seen with rabies infections (Huneycutt et al. 1993). Interestingly, VSV-associated encephalitis appears to be T-cell independent (Frei et al. 1989). This observation and the rapidity of the response suggest a role for resident CNS cells in the initiation and/or progression of this deadly CNS inflammation. While previous studies have demonstrated that neurons are readily infected by VSV (Bi et al. 1995), the susceptibility of other glial cell types to infection with this virus remains unclear.

Microglia and astrocytes are resident glial cells of the CNS and are ideally situated to detect and respond to viral pathogens. Upon activation, these cells assume

immune effector functions that include inflammatory mediator production and MHC class II molecule expression (Hickey and Kimura 1988; Hatten et al. 1991; Kiefer et al. 1993; Benveniste 1997a; Soos et al. 1998; Streit et al. 1999; Owens et al. 2005). Importantly, microglia and astrocytes appear to respond to VSV as the encephalitis caused by this virus is associated with proliferation of these cell types and increased MHC class II molecule expression on their surfaces (Bi et al. 1995). Recent studies from our laboratory have shown that microglia and astrocytes express retinoic acid-inducible gene-I (RIG-I) and melanoma differentiation-associated gene-5 (MDA5) (Furr et al. 2008), two members of the (RIG-I)-like receptor (RLR) family of cytosolic proteins that can serve as intracellular pattern recognition receptors for replicative RNA virus motifs (Meylan and Tschopp 2006; Takeuchi and Akira 2007). Interestingly, the level of expression of these receptors was upregulated in microglia and astrocytes following exposure to VSV, consistent with a functional role for RLRs in virally-induced immune responses by these resident CNS cells (Furr et al. 2008). However, the ability of VSV to infect and replicate within these glial cells has not been established.

In the present study, we demonstrate that primary murine microglia and astrocytes are permissive for VSV infection both in vitro and in vivo. Furthermore, we show that active replication of this virus appears to be required for robust inflammatory mediator production by these resident CNS cell types. These data suggest that viral replication within resident glial cells plays a key role in the development of lethal CNS inflammation following neurotropic *Mononegavirales* infection.

6.2 Results

***Mononegavirales* infect and replicate within primary murine microglia and astrocytes**

To directly examine the ability of VSV to infect and replicate in astrocytes and microglia, we isolated primary glial cells from neonatal C57BL/6 mice using protocols established in our laboratory (Harry et al. 1998; Rasley et al. 2002a; Rasley et al. 2002b). After two weeks in culture, astrocytes and microglia were isolated from these mixed glial preparations and the purity of the cell populations were confirmed by immunofluorescence microscopy as described in the Materials and Methods section. To directly assess the ability of VSV to infect and replicate within these isolated glial cells we have employed a recombinant VSV containing the GFP gene (VSV-GFP) incorporated between the viral G and L genes (Figure 23B). Due to the negative-sense polarity of the VSV RNA genome and the distant position of the GFP gene from the 3'-end of the genomic RNA, GFP expression is only detectable following successful VSV-GFP replication within target cells. As shown in the fluorescence micrographs in Figure 24A, GFP-associated fluorescence attributable to VSV-GFP replication was readily detectable in both astrocyte and microglia cultures at 24 hours following viral challenge. The maximal GFP-associated fluorescence intensity was observed in astrocytes infected with VSV-GFP at an MOI of 10 (Figure 24A). Interestingly, maximal GFP-associated fluorescence intensity was observed in microglia at an MOI of only 1. While the reason for this difference is unclear, it is most likely attributable to decreased microglia viability as evidenced by morphological changes (data not shown) and our previous demonstration that cellular protein expression is decreased when these cells are exposed to high VSV titers (Furr et al. 2008). We have verified these findings by immunoblot analysis for the

presence of GFP in infected glial cells. As shown in Figure 24B, the levels of VSV-directed GFP expression in both astrocytes and microglia mirrored the results obtained using fluorescence microscopy with maximal expression of GFP in astrocytes infected with an MOI of 10 and a maximal expression of GFP in microglia infected at an MOI of 1. In addition, we performed parallel studies utilizing wild type VSV in which astrocytes and microglia were infected in vitro and the presence of viral products were determined in whole cell protein isolates by immunoblot analysis. We report that both microglia and astrocytes demonstrated cellular accumulation of VSV N and P-proteins at 24 hours p.i. (data not shown).

To determine whether the ability of VSV to replicate within resident CNS cells is specific for this neurotropic RNA virus, microglia and astrocytes were exposed to the paramyxovirus, Sendai virus (SeV), a *Mononegavirales* that is distantly related to VSV and lacks the ability to cross the blood-brain barrier (Lundh et al. 1987). Primary murine glial cells were exposed to recombinant SeV containing the GFP gene (SeV-GFP, Fig. 23D) and viral infection and replication was again assessed by fluorescence microscopy and immunoblot analysis. As shown in Figure 24C, SeV-associated GFP fluorescence was readily detectable in both astrocytes and microglia at 24 hours post infection (p.i.). Fluorescence intensity increased according to the initial number of infectious viral particles introduced (Figure 24C) and this observation was confirmed by immunoblot analysis for cellular GFP expression (Figure 24D). These data demonstrate the ability of SeV to infect murine glial cells and suggest that astrocytes and microglia are permissive for infection by both neurotropic and non-neurotropic *Mononegavirales*.

Primary murine microglia and astrocytes respond to Mononegavirales infection by secreting key inflammatory mediators

Previous studies have indicated that resident CNS cell types respond to the presence of VSV by the expression of MHC class II molecules and production of NO (Bi et al. 1995). However, it is not clear whether these effects occur as a consequence of viral recognition by glial cells or as a secondary response to inflammatory mediators and/or damage-associated molecules released by infected neurons. To directly assess the ability of glial cells to respond to VSV we have utilized specific capture ELISAs to quantify the production of key inflammatory cytokines by isolated cultures of primary murine microglia and astrocytes following infection with VSV. As shown in Figure 25A, microglia produce significant levels of both IL-6 and TNF- α , cytokines known to be produced at high levels during viral encephalitis (Nuovo et al. 2005; Rempel et al. 2005), in response to wild type VSV at 12 and 24 hours p.i.. Maximal cytokine responses in microglia were observed at viral MOI of 0.1 and 1 at 12 and 24 hours p.i., respectively (Figure 25A), with higher viral titers resulting in lower production consistent with cell death at these MOIs. Similarly, astrocytes also produced significant levels of IL-6 and TNF- α at 12 and 24 h following infection with VSV (Figure 25B).

To determine whether these responses were specific for the neurotropic virus VSV, we have performed similar experiments to determine the cytokine responses of microglia and astrocytes to SeV infection. As shown in Figure 26, both microglia and astrocytes produced significant levels of IL-6 and TNF- α in response to SeV-GFP at both 12 and 24 hours p.i.. These responses increased according to the numbers of infectious viral particles introduced to the glial cultures (Figure 26). Interestingly, while SeV also elicited significant cytokine responses, the levels of IL-6 and TNF- α produced by SeV-

infected glial cells were substantially lower than those observed for comparable numbers of infectious VSV particles (Figure 25).

Viral replication is required for robust microglia and astrocyte immune responses to VSV

While it is apparent that glial cells can directly respond to VSV infection, it is unclear whether these cells respond to external/internalized viral particles or if viral replication is a prerequisite for microglia and astrocyte immune responses. To begin to address this question, we have performed experiments employing heat-inactivated VSV. While exposure of microglia or astrocytes to heat-inactivated wild type VSV resulted in production of detectable levels of both IL-6 and TNF- α (Figure 27), it is important to note that such inflammatory cytokine production was approximately 10-fold lower than that observed following infection with viable VSV (Figure 25).

To further address the question of whether viral replication is required for robust inflammatory mediator production by infected glial cells we have performed parallel experiments utilizing a host-range VSV mutant, HR1-1 (Figure 23C), developed by our laboratory (Grzelishvili et al. 2005; Grzelishvili et al. 2006) that can infect cells but demonstrates severely impaired replication in most cell types. The VSV HR1-1 mutant has a single nucleotide substitution resulting in a mutant L protein with a D to V substitution at position 1671. We have shown that the D1671V L mutation completely eliminates viral mRNA cap methylation at both the guanine-*N*7 and 2'-*O*-adenosine positions (Grzelishvili et al. 2005; Grzelishvili et al. 2006) and results in subsequent non-translatability of primary VSV transcripts (Horikami and Moyer 1982; Hercyk et al. 1988; Horikami et al. 1992; Grzelishvili et al. 2005; Grzelishvili et al. 2006). As a result, VSV HR1-1 displays a host-range (hr) phenotype characterized by severely

restricted growth in most cell types lines but normal replication in a very limited number of “permissive” cells including BHK-21 cell line, which was used to produce this mutant virus (Grzelishvili et al. 2005; Grzelishvili et al. 2006). As shown in Figure 28, exposure of microglia or astrocytes to VSV HR1-1 results in detectable production of inflammatory cytokines but such production was again 10-fold lower than that observed following exposure to comparable numbers of infectious wild type VSV particles (Figure 25). Taken together, these data demonstrate that active viral replication is required for robust immune responses of infected glial cells.

Intranasal administration of VSV results in murine glial cell infection in situ

To confirm the ability of VSV to infect glial cells in situ we have employed an established murine model of virally-induced encephalitis (Bi et al. 1995). Wild type VSV was introduced via intranasal administration to 3-4 week old male C57BL/6 mice. As shown in Figure 29A, VSV inoculated animals rapidly developed symptoms associated with CNS infection as assessed by disease severity scoring in contrast to mice that received inoculation with vehicle alone. Animals were sacrificed at 4 days p.i. and whole brains were isolated in such a way as to avoid possible contamination with any residual viral particles that might be present in the olfactory canal. Brain tissue was homogenized and viral product expression and infectious viral particle content was quantified by immunoblot analysis and plaque assay, respectively. As shown in Figure 29B, the N, P, M and G proteins of VSV were detectable in whole brain protein isolates as determined by immunoblot analysis using a polyclonal antibody directed against VSV. In addition, we have performed plaque assays using BHK cells to confirm the presence of infectious particles in the CNS at 4 days p.i. (data not shown). Finally, we have

confirmed the development of infection within the CNS following intranasal VSV administration by direct quantification of pro- and anti-inflammatory mediators in whole brain homogenates by specific capture ELISAs. As shown in Figure 29C, VSV infection resulted in marked increases in levels of the pro-inflammatory cytokine, IL-6. Interestingly, this elevation was associated with a concomitant decrease in levels of the immunosuppressive cytokine, IL-10, in infected brain tissue (Figure 29C). Together, these data confirm that intranasal VSV administration leads to establishment of brain tissue infection and results in CNS inflammation.

Importantly, we have performed experiments to determine whether resident glial cells are infected in situ following intranasal VSV administration. To accomplish this goal, glial cells were purified from infected whole brain tissue homogenates by Percoll gradient and the presence of VSV structural proteins was determined by immunoblot analysis. As shown in Figure 29B, N, P, M and G proteins of VSV were readily detectable in glial cell protein isolates. To independently confirm this result we have again utilized our recombinant VSV-GFP virus (Figure 23). Mice received intranasal viral inoculations and at 5 days p.i. enriched microglia cell populations were prepared by density gradient purification. The identity of these myeloid cells was verified by the cell surface expression of CD11b by flow cytometry. Importantly, we have been able to simultaneously analyze these cells for the presence of GFP fluorescence associated with replicating VSV. As shown in Figure 29D, we have determined that 12% of the total cell population was dual positive for the microglia marker CD11b and viral GFP, and this corresponds to 20% of the total CD11b-positive population. Taken together, these in vivo studies support the results obtained in isolated glial cultures and indicate that

resident non-neuronal CNS cells can be infected by VSV in situ following intranasal infection and, importantly, can support viral replication.

6.3 Conclusions

The order *Mononegavirales* consists of viruses containing a non-segmented, negative-sense RNA genome and includes the causative agents for a number of established (rabies, measles, mumps) and emerging (Ebola, Borna, Hendra, Nipah) human diseases (Pringle 1997). Some members of this order, such as rabies and Newcastle disease virus, have the ability to circumvent the blood-brain barrier to establish CNS infection resulting in a severe and often fatal inflammation of brain tissue (Seal et al. 2000; Leung et al. 2007). VSV has the ability to infect neurons and generate acute encephalitis in mice in a manner that closely resembles rabies (Huneycutt et al. 1993) and has therefore proved to be a useful model for *Mononegavirales* that cause lethal human CNS infections. Like rabies virus, VSV-associated CNS inflammation is rapid, occurring within days of intranasal inoculation (Huneycutt et al. 1993). This rapid onset is indicative of an innate immune response and is likely to involve the activation of resident CNS cells that have immune functions. Such a hypothesis is supported by the observation that VSV-associated encephalitis is unaltered in athymic mice suggesting that this inflammatory immune response is T-cell independent (Frei et al. 1989). Furthermore, several studies have indicated that resident CNS cells exhibit immune functions in situ following VSV infection (Huneycutt et al. 1993; Bi et al. 1995; Christian et al. 1996).

There is growing appreciation that microglia and astrocytes play an important role in the generation of protective immune responses or progressive inflammatory damage following CNS infection. These cells are activated by a variety of microbial pathogens including viruses and assume immune effector functions such as the production of

inflammatory mediators and the expression of MHC class II molecules (Bi et al. 1995; Taylor et al. 2003; Rasley et al. 2004a). Studies conducted in the laboratory of Dr. Carol Reiss (Bi et al. 1995) have demonstrated that microglia and astrocytes respond to VSV infection by proliferation, production of iNOS, and the induction of cell surface MHC class II molecule expression. Such responses are likely to set the stage for subsequent inflammatory damage (Schwartz et al. 1999). While it is possible that these glial cells can directly recognize viral motifs via cell surface pattern recognition receptors or may respond to inflammatory mediators or other "danger signals" released from infected neurons following lytic damage, the mechanisms underlying *Mononegavirales* activation of resident CNS cells have not been determined.

In the present study, we demonstrate that VSV replication products can be detected in isolated cultures of primary murine microglia and astrocytes following in vitro viral challenge. In addition, we have shown that these products can be detected in glial cells isolated from the brains of mice inoculated with VSV intranasally. We have utilized recombinant GFP gene containing VSV to establish that the presence of viral products within glia is not attributable to adhesion of viral particles to the plasma membrane or their internalization by phagocytosis. Finally, we have demonstrated that VSV replication in microglia or astrocytes precipitates inflammatory cytokine production by these resident CNS cell types. These findings are consistent with the previously documented in situ activation of glial cell following in vivo VSV infection (Bi et al. 1995; Christian et al. 1996). The relevancy of these findings to human *Mononegavirales* CNS infections is supported by the ability of rabies virus to infect cultured microglia and astrocytes (Ray et al. 1997). In addition, we have shown that the susceptibility of murine

microglia and astrocytes to infection is not restricted to rhabdoviruses as these cells can be infected with and support the replication of SeV, a paramyxovirus, (Lundh et al. 1987). Furthermore, we show that glial cells respond to SeV infection by inflammatory cytokine production, albeit with smaller responses to those seen with VSV. As such, these data suggest that glial cells have a broad susceptibility to *Mononegavirales* and can respond to members of this order by changes in the production of immune molecules that can promote damaging CNS inflammation.

Interestingly, we have also demonstrated that viral replication is required to elicit robust immune responses by microglia and astrocytes. We show that heat inactivated wild type VSV elicits glial immune responses that are an order of magnitude lower than that induced by infectious viral particles. These results suggest that VSV-associated inflammatory responses are not predominantly mediated by cell surface and/or endosomal microbial pattern recognition receptors such as TLR3 or TLR7. Such a hypothesis is further supported by our experiments employing the host-range VSV HR1-1 mutant which is replication impaired in glial cells (Grzelishvili et al. 2005; Grzelishvili et al. 2006) and fails to elicit marked inflammatory cytokine production by microglia or astrocytes. This result indicates that active viral replication is a critical requirement for the generation of glial immune responses to this *Mononegavirales*. While this effect cannot be adequately explained by the perception of viral particles by TLRs present on glial cells (Konat et al. 2006), the recent demonstration that microglia and astrocytes express members of the newly described RLR family may provide a mechanism underlying the replication-dependent nature of these responses (Furr et al. 2008). RLRs are present in the cytosol of many cell types and have been shown to

function as intracellular sensors for replicative viral RNA motifs (Meylan and Tschopp 2006; Takeuchi and Akira 2007). Interestingly, recent studies suggest that the RLR, RIG-I, demonstrates specificity for VSV and SeV RNA (Yoneyama et al. 2004; Yoneyama et al. 2005; Kato et al. 2006; Hiscott 2007) and we have demonstrated that both microglia and astrocytes constitutively express this intracellular receptor (Furr et al. 2008). Furthermore, we have shown that such expression is rapidly elevated in murine glial cells following infection with either VSV or SeV (Furr et al. 2008). As such, the replication-dependent nature of microglia and astrocyte responses to VSV described in the present study provides circumstantial evidence for the importance of RIG-I in the generation of inflammatory cytokine production by glial cells.

Taken in concert, these studies support a scenario in which neurotropic *Mononegavirales* can invade the CNS and infect both neuronal and non-neuronal cell types. While neurons are well known to support viral replication, our data indicates that microglia and astrocytes are also permissive for *Mononegavirales* replication. Importantly, the generation of replicative viral RNA can subsequently be perceived by intracellular pattern recognition receptors such as RIG-I, known to be expressed by both astrocytes and microglia. The resulting activation of RIG-I-dependent signaling pathways could then initiate glial cell immune functions, precipitating the lethal inflammation associated with *Mononegavirales* CNS infections.

6.4 Figures

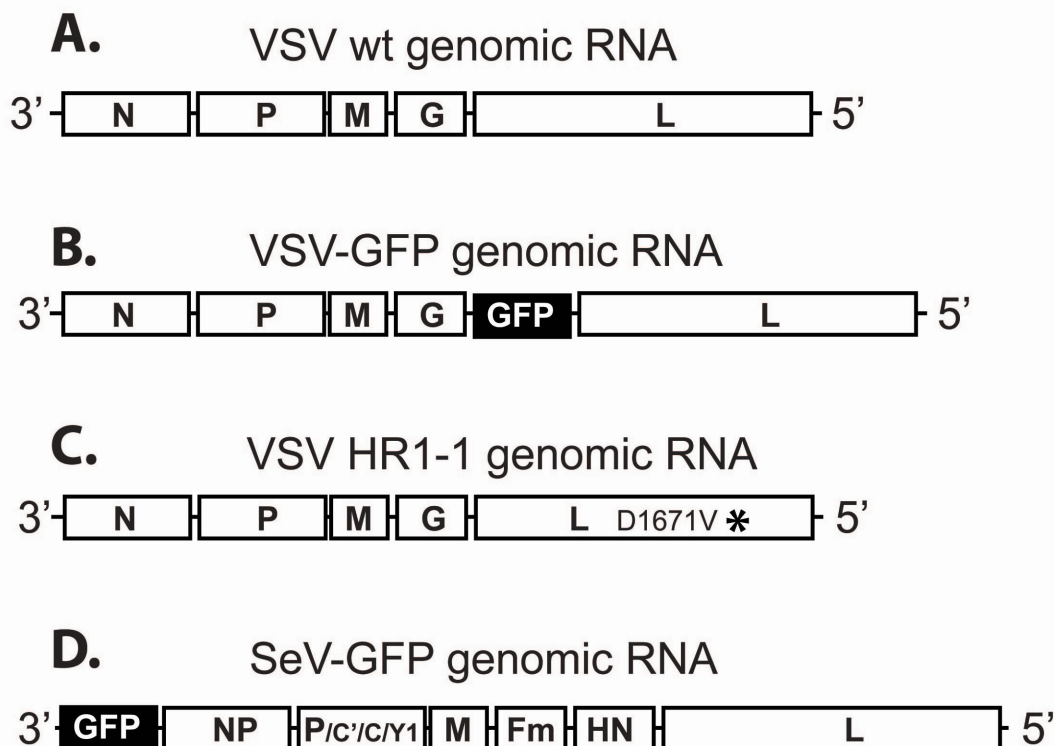

Figure 23: The organization of negative-sense RNA genomes of the recombinant viruses used in the present study. The viral RNA dependent RNA polymerase (consisting of L and P proteins) sequentially synthesizes mRNAs in the order that they appear from the 3' end of the genome. Initiation of each downstream gene occurs sequentially as the polymerase pauses at the intergenic junction and then reinitiates synthesis of the next gene. Panel A: Recombinant wt VSV (Indiana serotype) genomic RNA. Panel B: Recombinant wt VSV (Indiana serotype) encoding GFP as an extra gene between G and L genes Panel C: Recombinant VSV (Indiana serotype) HR1-1 mutant with a mutation resulting in an L protein with a single substitution D to V at L amino acid position 1671. Panel D: Recombinant SeV (Fushimi strain) with GFP as an extra gene upstream of the NP gene. SeV-GFP does not require trypsin in the medium as it has a wt monobasic trypsin-dependent cleavage site in the F protein mutated to an oligobasic cleavage site, allowing F activation in any cell type through a ubiquitous furin-like protease. (Designed by Dr. Valery Grdzlishvili)

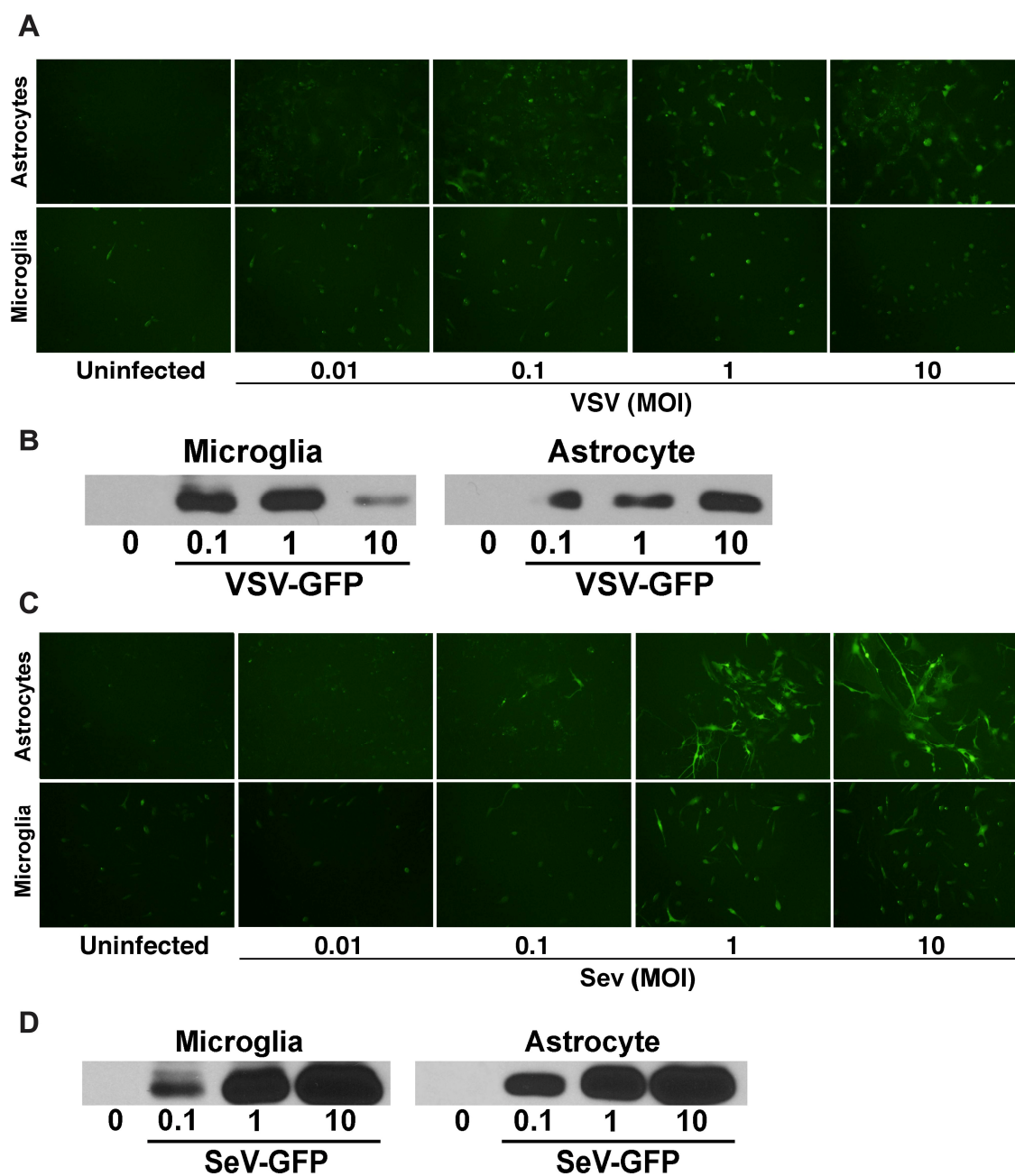

Figure 24: VSV and SeV infect and replicate within primary murine microglia and astrocytes. Cells (1×10^6) were untreated or infected with VSV-GFP (Panels A and B) or SeV-GFP (Panels C and D) and cultured for a period of 24 hours. Panels A and C: Cells were imaged for the expression of GFP by fluorescence microscopy. Panels B and D: Whole cell protein lysates were prepared and GFP expression determined by Western blot analysis. One representative blot from three separate experiments is shown.

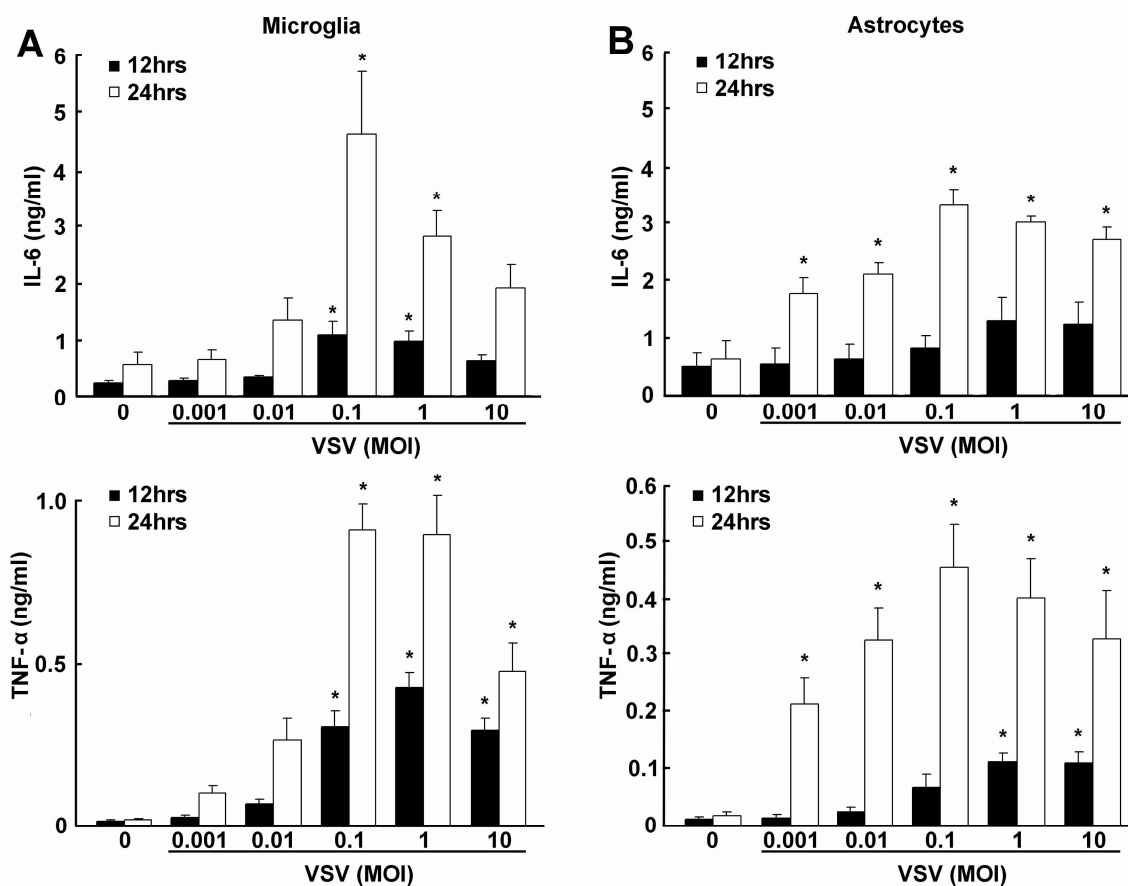

Figure 25: Primary murine microglia and astrocytes produce inflammatory mediators following infection with wt VSV. Microglia (Panel A) and astrocytes (Panel B) were uninfected or exposed to wt VSV. At 12 and 24 hours p.i., culture supernatants were assayed for the presence of IL-6 or TNF- α by specific capture ELISA. Data are presented as the mean of duplicate measurements of samples from at least three separate experiments \pm SEM. Asterisks indicate a statistically significant difference from uninfected cells.

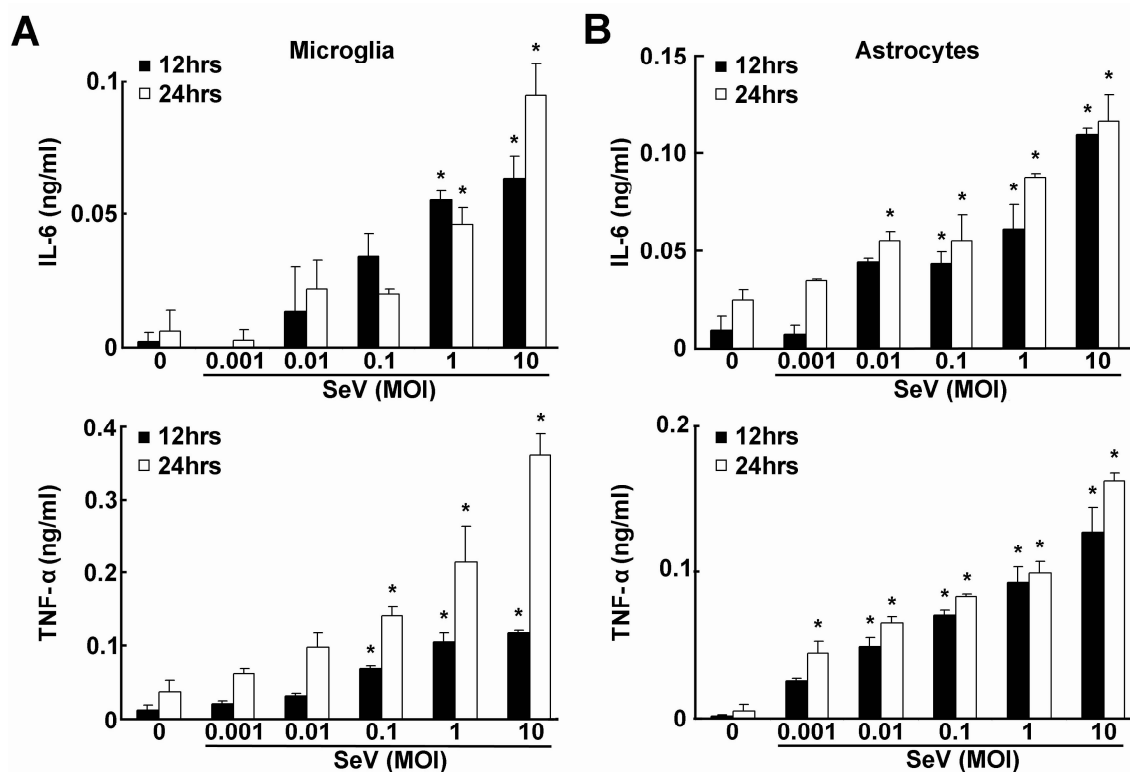

Figure 26: Primary murine microglia and astrocytes produce inflammatory mediators following exposure to SeV-GFP. Microglia (Panel A) and astrocytes (Panel B) were uninfected or exposed to SeV-GFP. At 12 and 24 hours p.i. culture supernatants were assayed for the presence of IL-6 or TNF- α by specific capture ELISA. Data are presented as the mean of duplicate measurements of samples from at least three separate experiments \pm SEM. Asterisks indicate a statistically significant difference from uninfected cells.

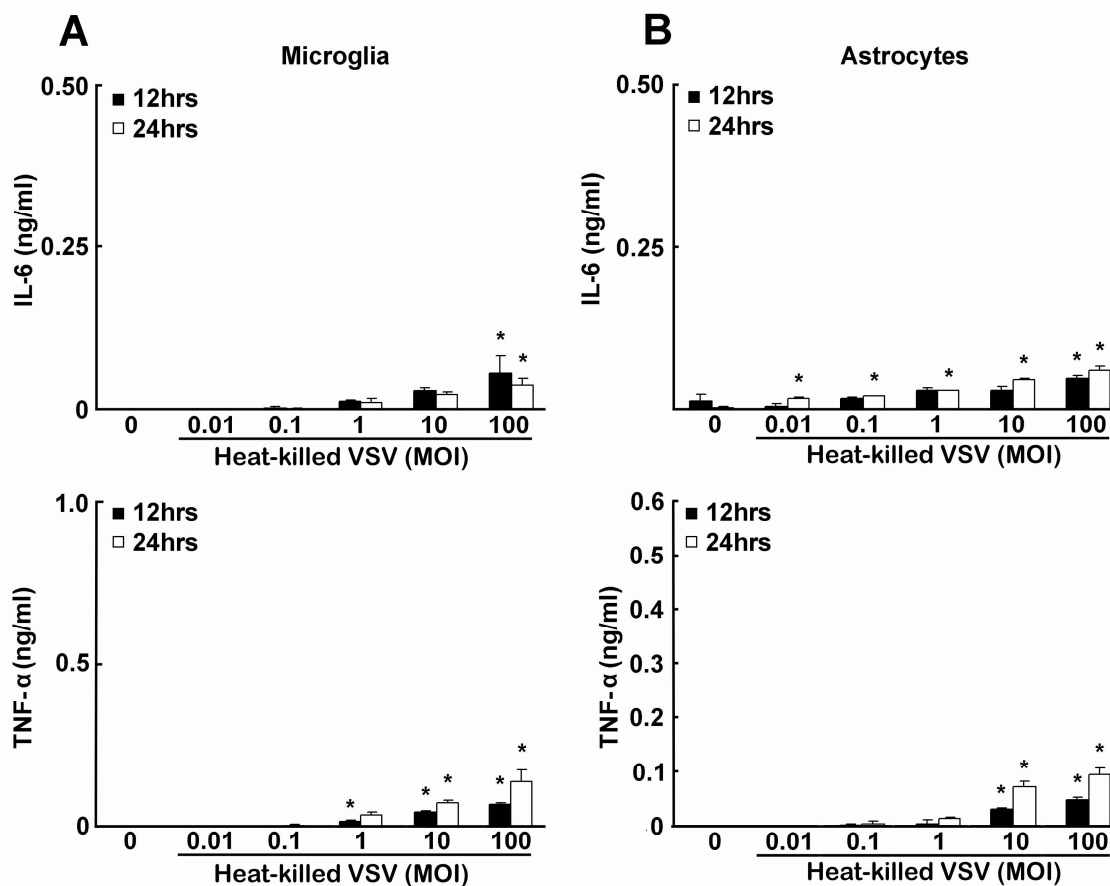

Figure 27: Heat inactivation attenuates VSV-induced inflammatory mediator production by primary murine microglia and astrocytes. Microglia (Panel A) and astrocytes (Panel B) were untreated or exposed to heat-inactivated wt VSV. At 12 and 24 hours p.i., culture supernatants were assayed for the presence of IL-6 or TNF- α by specific capture ELISA. Data are presented as the mean of duplicate measurements of samples from at least three separate experiments \pm SEM. Asterisks indicate a statistically significant difference from uninfected cells.

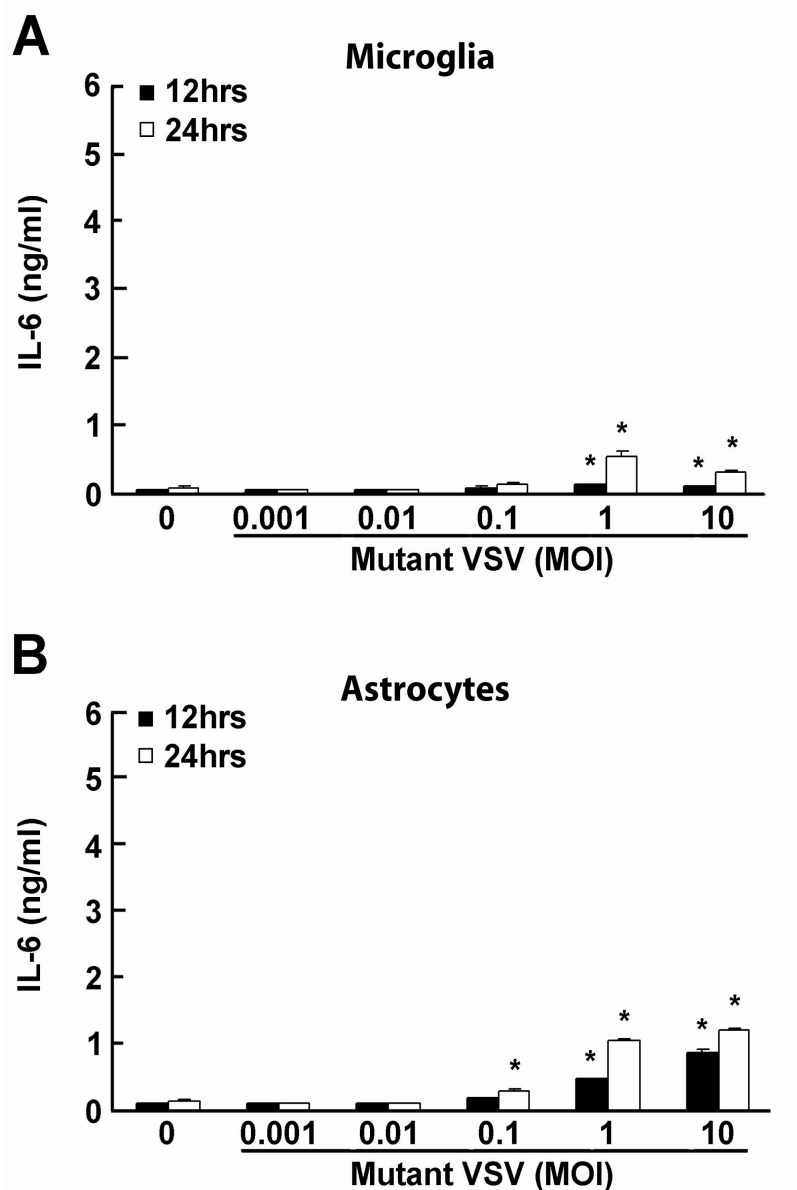

Figure 28: Exposure of primary murine microglia and astrocytes to a replication-impaired VSV HR1-1 mutant elicits only modest inflammatory mediator production. Microglia (Panel A) and astrocytes (Panel B) were uninfected or infected with VSV HR1-1 mutant. At 12 and 24 hours p.i. culture supernatants were assayed for the presence of IL-6 or TNF- α by specific capture ELISA. Data are presented as the mean of duplicate measurements of samples from at least three separate experiments \pm SEM. Asterisks indicate statistically significant difference from uninfected cells.

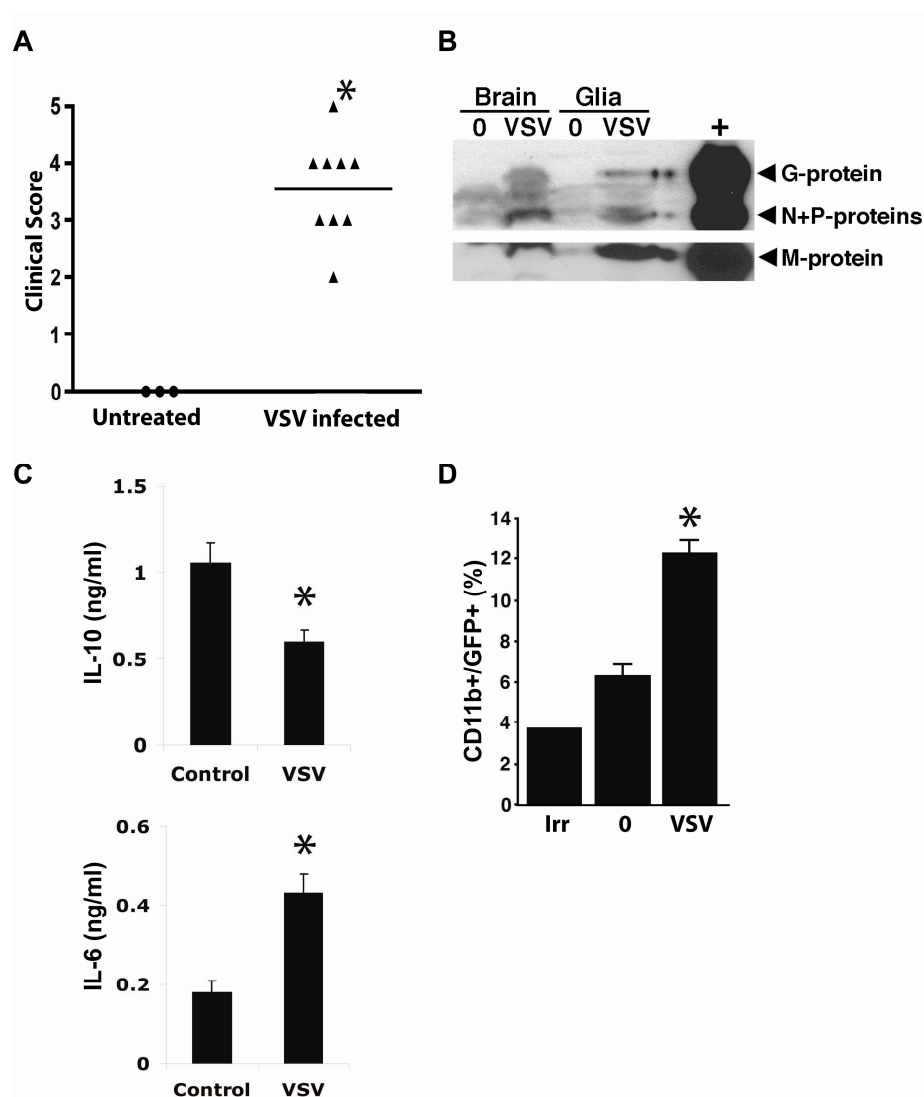

Figure 29: VSV infects microglia and astrocytes in situ following intranasal administration. C57BL/6 mice were inoculated intranasally with 2×10^7 PFUs of wt VSV (Panels A to C) or VSV-GFP (Panel D). At 5 days post-infection, disease severity was assessed according to appearance and behavior and is reported as a severity score for each animal (Panel A). Severity was scored from 1 (no detectable behavioral differences) to 5 (moribund). Asterisk indicates a moribund animal that was euthanized prior to day 5. Panel B: Protein isolates from whole brain (Brain) or density gradient purified glial cells (Glia) were analyzed for the presence of VSV products by immunoblot analysis. Plus sign represents a positive control with protein isolates prepared from purified VSV virions. Panel C: Levels of IL-6 and IL-10 were quantified in whole brain homogenates by specific capture ELISA. Panel D: Density gradient purified glial cells were analyzed for the percentage of cells co-expressing the microglia/macrophage cell marker CD11b and VSV-associated GFP by flow cytometry. Asterisk indicates statistically significant difference from uninfected cells (0). Non-specific staining was determined using antibodies directed against irrelevant antigens and is indicated (Irr).

CHAPTER 7: DISSERTATION SUMMARY

There is growing appreciation for the role of resident glial cell in the generation of inflammation, both damaging and protective, during central nervous system infection. Studies have demonstrated that microglia and astrocytes, major glial cell types within the brain, have the ability to perceive microbial pathogens and subsequently assume effector functions to recruit and activate infiltrating leukocytes (Hickey and Kimura 1988; Hatten et al. 1991; Kiefer et al. 1993; Benveniste 1997a; Soos et al. 1998; Streit et al. 1999; Owens et al. 2005). In order to accomplish these tasks, microglia and astrocytes utilize pattern recognition receptors to identify and respond to highly conserved pathogen associated molecular patterns. Previous studies have demonstrated that these resident glial cells functionally express members of the Toll-like family of pattern recognition receptors. However, the expression of these molecules does not eliminate the possibility that other families of pattern recognition receptors may contribute to the activation of these cell types. Furthermore, the expression of TLRs fails to adequately explain responses of these cell types to intracellular pathogens within the cytosolic space (Laflamme and Rivest 2001; Bsibsi et al. 2002; Rasley et al. 2002a; Bowman et al. 2003; Esen et al. 2004; Olson and Miller 2004; Carpentier et al. 2005; Esen and Kielian 2005; Kielian et al. 2005a).

In the present study, we have employed methods to demonstrate that members of the NLR family of pattern recognition receptors, specifically NOD1 and NOD2, are

present within murine microglia and astrocytes. The NOD1 and NOD2 molecules are cytosolic receptors that have been shown to perceive minimal motifs of bacterial peptidoglycans, specifically iE-DAP and muramyl dipeptide, respectively (Chamaillard et al. 2003b; Girardin et al. 2003a; Girardin et al. 2003b; Girardin and Philpott 2004). Our investigations have determined that robust levels of NOD2 mRNA and protein are expressed constitutively by both microglia (Figures 11B and 13) and astrocytes (Figures 6 and 8). There is marked upregulation of NOD2 molecules following exposure to antigen preparations of *N. meningitidis* or *B. burgdorferi*, two clinically relevant pathogens of the CNS (Figures 5, 8A, 11B, and 13A). Interestingly, viability of the bacterium was not a requirement for the upregulation of this molecule. As such it can be inferred that intracellular infection of microglia and astrocytes by *N. meningitidis* or *B. burgdorferi* was also not required. This argues against the maintenance of NOD2 levels via an autoregulatory mechanism. Such a hypothesis is supported by the observation that MDP, a known ligand for NOD2 was a relatively poor stimulus in microglia as compared to TLR ligands for the upregulation of NOD2 molecules (Figure 12A and 12C). Certain TLR ligands proved to be potent inducers of NOD2 expression (Figures 8B, 12C, and 3B). There were, however, differences between microglia and astrocytes in that TLR9 ligation was unable to induce upregulation in microglia, yet proved to be a sufficient stimulus in astrocytes. Since TLR receptors are found on the cell membrane or within endosomal compartments the lack of intracellular bacterial infection would be irrelevant in their action. This is suggestive of TLR-mediated upregulation of the NOD2 receptor, an observation which is consistent with other studies highlighting possible cooperation between different families of pattern recognition receptors. To confirm this hypothesis

additional studies examining the interactions between TLRs and NOD2 are being undertaken by other members of our group.

Our investigations have also demonstrated constitutive expression of NOD1 mRNA as well as protein (Figures 5, 7, 11A, and 14). However, marked differences in the levels of these molecules were observed when comparing NOD1 and NOD2 with NOD2 being expressed at multiple log scales higher than NOD1 in both microglia and astrocytes. Like NOD2, NOD1 expression was increased following exposure to antigen preparations of *N. meningitidis* and *B. burgdorferi*, as well as known TLR ligands (Figures 5, 7, 11, and 14). However, the final levels of the NOD1 expression paled in comparison to those of NOD2. This finding is not altogether unexpected as other studies have reported a cell-specific preference of expression for the NOD1 and NOD2 molecules. Indeed, studies have demonstrated that macrophages preferentially express NOD2 while intestinal epithelial cells express NOD1 almost exclusively (Strober et al. 2006). Our finding is suggestive of NOD2 serving a potentially more important role than NOD1 in the perception of bacterial pathogens by these resident glial cell types. Therefore, we elected to focus our investigation specifically on the role of the NOD2 pathway in the generation of inflammation by microglia and astrocytes. Although it is likely that later studies by our group will investigate the possible role of NOD1 in these resident glial cells.

The activation of the NOD2 pathway begins with the interaction between muramyl dipeptide and the leucine-rich repeat region of the NOD2 receptor. In a resting state the protein is negatively regulated by this leucine rich region and, upon ligand binding, undergoes a conformational change allowing oligomerization and interaction

with the downstream effector molecule Rip2 kinase. Rip2 kinase contains a CARD domain which allows it to physically associate with oligomerized NOD proteins through homophilic CARD-CARD interactions. Rip2 kinase is then able to interact with the IKK complex ultimately leading to the activation of the NF κ B complex. There is also evidence to suggest that the MAP kinase cascade is activated although the mechanism is not currently understood. It is obvious from a brief examination of this pathway that Rip2 kinase is integral to the action of the NOD2 receptor and it is also equally important in the NOD1 pathway (Inohara et al. 1999; Ogura et al. 2001b; Kobayashi et al. 2002). Due to this fact our study has also investigated the expression of Rip2 kinase mRNA and protein within microglia and astrocytes. We have demonstrated that there is constitutive expression of Rip2 kinase mRNA and protein within both glial cell types. These levels are markedly upregulated following exposure to antigen preparations from *N. meningitidis* and *B. burgdorferi* (Figures 9 and 15). This indicates that microglia and astrocytes possess, constitutively, the critical molecular participants in the NOD2 pathway. It is important to note that levels of Rip2 kinase expression were markedly higher in microglia in comparison to astrocytes, representing a cell-specific difference in the expression of this protein. The observation that Rip2 kinase is upregulated by similar stimuli to those observed in NOD2 is an interesting result and may constitute an additional mechanism for signal magnification to complement increased receptor expression. Late in our investigation another group of researchers identified GRIM-19 as a possible alternative adapter molecule for the NOD2 receptor and, therefore, we took steps to investigate this molecule as part of our microglia study. As with Rip2 kinase, robust GRIM-19 expression was observed in microglia and, in a similar manner, antigen

preparations were a sufficient stimulus to elicit marked upregulation of this molecule (Figure 15). It is possible that microglia may use this molecule during NOD2 pathway activation. The identification of this molecule occurred subsequently to the conclusion of our astrocyte study and was not included as part of that investigation.

The demonstration that the NOD2 receptor, as well as the downstream effector molecule Rip2 kinase, is present and can be upregulated following stimulation suggests of a functional pathway. However, this evidence is far from conclusive in this matter. Additional experiments examining pathway functionality were conducted beginning with the investigation of the influence that NOD2 ligation has upon pro-inflammatory cytokine production. Interestingly, exposure of microglia and astrocytes to MDP alone failed to elicit statistically significant production of IL-6 and TNF- α , important cytokines that have been associated with inflammatory processes within the CNS (Figures 10 and 16). This finding was not considered overly surprising in that previous studies have reported that MDP is a relatively poor stimulus, even in dedicated immune cell types such as macrophages (Pauleau and Murray 2003). Additional experiments were conducted to evaluate the ability of the NOD2 pathway to augment TLR mediated responses. Microglia and astrocytes were exposed to known ligands for TLR2 (Poly I:C), TLR4 (lipopolysaccharide), TLR5 (flagellin), and TLR9 (unmethylated CpG motifs) alone and in combination with MDP. These ligands were chosen based upon previous studies indicating the expression of their corresponding receptors in microglia and astrocytes. The results of this experiments indicated that the NOD2 pathway is able to augment TLR-mediated production of pro-inflammatory cytokines in a greater than additive manner. This is indicative of a synergistic relationship between the TLR

receptors and the NOD2 pathway. Additionally, this finding is in agreement with studies in other cell types (Pauleau and Murray, 2003) and is consistent with the recent findings of Chen et al. showing that NOD2 functions in conjunction with TLR2 to upregulate the expression of formyl peptide receptor 2 (mFPR2) (Chen et al. 2008), a G-protein coupled receptor that mediates the chemotactic activity of pathogen and host-derived peptides including amyloid beta 42, the key causative factor in Alzheimer's disease. Similarly, another recent study has demonstrated that NOD2 acts in concert with TLRs to induce nitric oxide and TNF- α production and to upregulate the expression of P2X4R, an ATP-regulated ion channel associated with CNS inflammation (Guo et al., 2006).

Interestingly, this relationship demonstrates a degree of cell specificity. In astrocytes MDP was able to augment TLR4, TLR5, and TLR9-mediated production of IL-6 and TNF- α in a statistically significant manner (TLR2 was not tested). In microglia, MDP was able to augment TLR2, TLR4, and TLR5-mediated production of IL-6 and TNF- α , yet failed to augment TLR9-mediated production. IL-1 β was also examined in microglia and displayed some surprising results. In microglia MDP alone was able to elicit cytokine production along with an ability to augment TLR4 and TLR5-mediated IL-1 β production. These data serve to highlight important differences between microglia and astrocytes in terms of NOD2 and are consistent with some of our previous observations. First, the augmentation of TLR-mediated responses in microglia is greater in magnitude than those observed in astrocytes. This is consistent with higher NOD2 mRNA and protein, as well as higher Rip2 kinase expression, observed in microglia relative to astrocytes. Second, unmethylated CpG motifs were able to elevate NOD2 expression in astrocytes, but not in microglia. This is consistent with the inability of

NOD2 to augment TLR9-mediated cytokine production in microglia. Finally, MDP is able to elicit a modest, yet statistically significant, production of IL-1 β which represents a cell-specific difference in NOD2 mediated responses between these two cell types.

While there are marked differences between the responses in microglia and astrocytes, the observation that NOD2 ligation can augment TLR-mediated cytokine production provides important evidence of functional NOD2 expression.

Our further experiments focused on providing even more definitive evidence of functional NOD2 pathway expression. To this end we revisited the critical role of Rip2 kinase in this pathway, in particular to examine the interaction between Rip2 kinase and the NOD2 molecule. If activation of this pathway is occurring then there must be interaction between the NOD2 receptor molecule and the downstream effector Rip2 kinase. We utilized co-immunoprecipitation to evaluate if, following exposure to antigen preparations from *N. meningitidis* and *B. burgdorferi*, there were increases in this interaction. Our results indicated that exposure to either these bacterial preparations resulted in increased association between NOD2 and Rip2 kinase (Figure 17). These results were independently confirmed in additional experiments conducted by Samantha Furr, another member of our research group (Chauhan et al. 2009).

It has been suggested that there may be other receptors for muramyl dipeptide, such as NLRP3 (Martinon et al. 2004). Therefore, in order to determine if the effects we have observed can directly be attributed to the NOD2 pathway, we decided to utilize siRNA technology to knock down NOD2 protein production. This course of experimentation also allows us to examine the relative contribution of the NOD2 pathway to the generation of inflammatory cytokines by microglia and astrocytes. Unfortunately,

this approach proved to be technically challenging and ultimately ineffective for our purposes and, as such, was abandoned for the use of commercially available mice deficient in the NOD2 protein. Our initial studies examining the augmentation of TLR-mediated responses by MDP were conducted in microglia and astrocytes derived from the Balb/c mouse strain while the NOD2-deficient mice were bred onto a C57Bl/6 background. Therefore, in order to insure the appropriate control groups, the initial experiments using TLR ligands in combination with MDP were repeated using cells derived from the new mouse strain. In these repeat experiments we utilized the ligands for TLR4 and TLR5 due to the demonstrated cooperativity with MDP effects in both microglia and astrocytes. At the same time parallel experiments were conducted in the NOD2 deficient mice. As expected, MDP significantly augmented the TLR4 and TLR5-mediated production of IL-6 and TNF- α in the wild-type C57Bl/6 microglia and astrocytes. The NOD2 deficient microglia and astrocytes, however, displayed no such augmentation (Figures 18 and 19). This piece of evidence definitively demonstrates that the MDP-mediated effects observed in combination with the TLR ligands are due to interaction with the NOD2 pathway. Furthermore, this experiment proves that there is functional NOD2 pathway expression in murine microglia and astrocytes.

The demonstration of functional NOD2 pathway expression leads to the question of to what degree that this particular pathway contributes to the generation of inflammatory responses in microglia and astrocytes to pathogens. Therefore, we utilized cells derived from NOD2-deficient mice to address this issue. Our experiments utilizing antigen preparations from *N. meningitidis* and *B. burgdorferi* demonstrate that, in the absence of NOD2 expression, the production of the pro-inflammatory cytokines IL-6 and

TNF- α are significantly attenuated (Figures 20 and 21). This result is consistent between microglia and astrocytes and indicates that the NOD2 pathway may represent an important mechanism for the generation of inflammatory responses by these cell types.

In order to translate these results into an in-vivo setting, experiments were conducted using an established model of *N. meningitidis* and *B. burgdorferi* infection. Wild-type or NOD2 deficient mice were uninfected or injected intracerebrally with live *N. meningitidis* or *B. burgdorferi*. After 72 hour incubation the animals were sacrificed and levels of TNF- α were quantified. The wild-type mice had statistically significant increases in TNF- α upon infection, whereas the NOD2 deficient mice did not (Figure 21). These results are consistent with studies conducted by Dr. Vinita Chauhan which demonstrate that there are decreased levels of astrogliosis following CNS infection of NOD2 deficient mice compared to wild-type (Chauhan et al. 2009). Taken together our studies provide strong evidence that the NOD2 pathway may be an important contributor to the generation of inflammation during infection with these pathogens. Further work by Dr. Chauhan and Amy Young, demonstrating decreased demyelination and neurological deficit in NOD2-deficient mice as compared to wild-type, indicates that this attenuation in inflammation also corresponds to a similar reduction in behavioral and pathological manifestations of CNS damage (Chauhan et al. 2009).

These findings are consistent with the known role for NOD2 in the initiation and/or progression of bacterially induced inflammation. NOD2 mutations have been associated with the development of chronic inflammatory bowel diseases and monocytes/macrophages derived from humans or mice with such mutations demonstrate

altered NF- κ B activity and inflammatory cytokine production (Hugot et al. 2001; Ogura et al. 2001a; Maeda et al. 2005; Beynon et al. 2008).

The final section of this study represents a departure from investigations of bacterial infections with an examination of the interactions between glial cells and viruses. Vesicular stomatitis virus is a well established model of other neurotropic viruses present in the order *Mononegavirales*. Infection with this virus results in acute t-cell independent encephalitis, breakdown of the blood-brain barrier, and a high mortality rate similar to that observed during rabies (Frei et al. 1989; Huneycutt et al. 1993). The nature of this infection suggests a possible role for resident CNS cells in the initiation and/or progression of the disease state. Studies have demonstrated that microglia and astrocytes can perceive and respond to VSV of the CNS (Bi et al. 1995). These cell types utilize pattern recognition receptors as a means by which to accomplish this. Previous work by members of our research group has demonstrated that microglia and astrocytes constitutively express members of the Rig-like helicase receptor family, specifically Rig-I and MDA5. Studies have implicated Rig-I as being potentially important in the inflammatory responses to VSV infection (Furr et al. 2008). Studies in our lab have shown this receptor to be upregulated following exposure to VSV, suggesting that it may play a role in the perception of this virus by microglia and astrocytes (Furr et al. 2008). Rig-I serves as an intracellular receptor for replicative RNA virus motifs and is only activated following infection of the cell with an actively replicating virus (Meylan and Tschopp 2006; Takeuchi and Akira 2007). Therefore, in order for the Rig-I pathway to be utilized by microglia and astrocytes during CNS infection, these cells must be actively infected by the virus. While studies have demonstrated that neurons are readily infected

by VSV, the susceptibility of microglia and astrocytes has not yet been evaluated (Bi et al. 1995).

In the current study we examined the permissibility of microglia and astrocytes to infection and replication by VSV. In order to do this we have employed a recombinant strain of VSV containing the GFP gene. Due to the negative-sense polarity of the VSV RNA genome and the distant position of the GFP gene from the 3'-end of the genomic RNA, GFP expression is only detectable following successful VSV-GFP replication within target cells. Following incubation with the VSV-GFP, GFP expression was readily observed in both microglia and astrocytes. This expression was confirmed using immunoblot analysis against GFP and VSV structural proteins. Since GFP can only be produced by successful viral replication, it can be concluded that murine microglia and astrocytes are permissive to VSV infection. Additional studies were conducted utilizing a GFP expressing Sendai virus, a non-neurotropic member of the order *Mononegavirales* to examine if this permissibility can be extended to other viruses of this order. Once again GFP expression was readily observed and was confirmed using immunoblot against GFP. Thus we were able to conclude that not only are microglia and astrocytes permissive to VSV infection and replication, but that this observation can be extended to other members of this order. This is consistent with the observation that microglia and astrocytes are permissive to rabies virus, which is also a member of order *Mononegavirales*. We also evaluated the permissibility of microglia and astrocytes using an established in-vivo model of VSV infection. As shown in Figure 27B, VSV structural proteins were observed both in whole brain isolates as well as purified glial isolations.

Additional analysis of the purified glial isolation using FACS demonstrated the presence of dual-positive CD11b/GFP cells, indicative of infected microglia.

We continued our study by characterizing the cytokine responses of microglia and astrocytes to VSV infection. As expected, infection with VSV resulted in the production of significant levels of the pro-inflammatory cytokines IL-6 and TNF- α . In response to SeV microglia and astrocytes also produced significant levels of IL-6 and TNF- α , although these levels were approximately 10-fold lower than those observed in response to VSV. This is likely due to species specific differences between VSV and SeV, which is expected due to the non-neurotropic nature of SeV. If indeed the Rig-I pathway is responsible, at least in part, for the inflammatory actions of microglia and astrocytes following viral infection we would expect these responses to be dependent upon the active replication of the virus. In order to test this hypothesis we exposed microglia and astrocytes to heat-inactivated VSV, which are unable to infect or replicate within these cells. The result of this experiment was a 10-fold reduction in the levels of IL-6 and TNF- α production. This is suggestive that active replication is required for optimal immune response by microglia and astrocytes. In order to confirm this, we infected our cells with a replication impaired VSV strain (Grzelishvili et al. 2005; Grzelishvili et al. 2006). Once again a 10-fold reduction in cytokine production was observed. This provides important supporting evidence of possible Rig-I involvement in the anti-viral responses of microglia and astrocytes. It is important to note that this evidence is far from definitive and additional experimentation is required in order to demonstrate the role of Rig-I in microglia and astrocytes.

In summary, the current study provides definitive evidence of functional NOD2 pathway expression in murine microglia and astrocytes. Additionally we also provide strong evidence that this pathway may serve an important role in the generation of potentially damaging inflammation by resident glial cells within the CNS in response to bacterial infection. Our viral study demonstrated the permissibility of microglia and astrocytes to VSV infection. Additionally, our study highlights the possible replication dependent nature of glial responses to VSV, which may indicate a role for receptors such as Rig-I. Taken as a whole, this research strongly suggests a role for intracellular pattern recognition receptors as an underlying mechanism for the generation of inflammatory responses by glial cells to CNS pathogens.

REFERENCES

- Abdel-Haq, N., H. N. Hao, et al. (1999). "Cytokine regulation of CD40 expression in fetal human astrocyte cultures." J Neuroimmunol **101**(1): 7-14.
- Adam, A., V. Souvannavong, et al. (1978). "Non-specific MIF-like activity induced by the synthetic immunoadjuvant: N-acetyl muramyl-L-alanyl-D-isoglutamine (MDP)." Biochem Biophys Res Commun **85**(2): 684-90.
- Akira, S. (2003). "Mammalian Toll-like receptors." Curr Opin Immunol **15**(1): 5-11.
- Akira, S. and K. Takeda (2004). "Toll-like receptor signalling." Nat Rev Immunol **4**(7): 499-511.
- Akundi, R. S., E. Candelario-Jalil, et al. (2005). "Signal transduction pathways regulating cyclooxygenase-2 in lipopolysaccharide-activated primary rat microglia." Glia **51**(3): 199-208.
- Alexopoulou, L., A. C. Holt, et al. (2001). "Recognition of double-stranded RNA and activation of NF-kappaB by Toll-like receptor 3." Nature **413**(6857): 732-8.
- Ali, S. and D. A. Mann (2004). "Signal transduction via the NF-kappaB pathway: a targeted treatment modality for infection, inflammation and repair." Cell Biochem Funct **22**(2): 67-79.
- Aloisi, F. (2001). "Immune function of microglia." Glia **36**(2): 165-79.
- Aloisi, F., G. Penna, et al. (1999). "CD40-CD154 interaction and IFN-gamma are required for IL-12 but not prostaglandin E2 secretion by microglia during antigen presentation to Th1 cells." J Immunol **162**(3): 1384-91.
- Aloisi, F., F. Ria, et al. (1998). "Microglia are more efficient than astrocytes in antigen processing and in Th1 but not Th2 cell activation." J Immunol **160**(10): 4671-80.
- Alvarez, S., A. Blanco, et al. (2008). "HIV-2 induces NF-kappaB activation and cyclooxygenase-2 expression in human astroglial cells." Virology **380**(1): 144-51.
- Ambrosini, E. and F. Aloisi (2004). "Chemokines and glial cells: a complex network in the central nervous system." Neurochem Res **29**(5): 1017-38.
- Anderson, K. V., L. Bokla, et al. (1985). "Establishment of dorsal-ventral polarity in the Drosophila embryo: the induction of polarity by the Toll gene product." Cell **42**(3): 791-8.

- Anguita, J., S. Samanta, et al. (2002). "Cyclooxygenase 2 activity modulates the severity of murine Lyme arthritis." FEMS Immunol Med Microbiol **34**(3): 187-91.
- Anguita, J., V. Thomas, et al. (2001). "Borrelia burgdorferi-induced inflammation facilitates spirochete adaptation and variable major protein-like sequence locus recombination." J Immunol **167**(6): 3383-90.
- Athman, R. and D. Philpott (2004). "Innate immunity via Toll-like receptors and Nod proteins." Curr Opin Microbiol **7**(1): 25-32.
- Bailey, S. L., P. A. Carpentier, et al. (2006). "Innate and adaptive immune responses of the central nervous system." Crit Rev Immunol **26**(2): 149-88.
- Barker, C. F. and R. E. Billingham (1977). "Immunologically privileged sites." Adv Immunol **25**: 1-54.
- Barnich, N., T. Hisamatsu, et al. (2005). "GRIM-19 interacts with nucleotide oligomerization domain 2 and serves as downstream effector of anti-bacterial function in intestinal epithelial cells." J Biol Chem **280**(19): 19021-6.
- Bart, J., H. J. Groen, et al. (2000). "The blood-brain barrier and oncology: new insights into function and modulation." Cancer Treat Rev **26**(6): 449-62.
- Barthold, S. W., M. S. de Souza, et al. (1993). "Chronic Lyme borreliosis in the laboratory mouse." Am J Pathol **143**(3): 959-71.
- Barton, G. M. and R. Medzhitov (2002). "Toll-like receptors and their ligands." Curr Top Microbiol Immunol **270**: 81-92.
- Barton, G. M. and R. Medzhitov (2003). "Toll-like receptor signaling pathways." Science **300**(5625): 1524-5.
- Batchelor, P. E., G. T. Liberatore, et al. (1999). "Activated macrophages and microglia induce dopaminergic sprouting in the injured striatum and express brain-derived neurotrophic factor and glial cell line-derived neurotrophic factor." J Neurosci **19**(5): 1708-16.
- Benveniste, E. N. (1997a). "Cytokines: influence on glial cell gene expression and function." Chem Immunol **69**: 31-75.
- Benveniste, E. N. (1997b). "Role of macrophages/microglia in multiple sclerosis and experimental allergic encephalomyelitis." J Mol Med **75**(3): 165-73.
- Beutler, B. (2004). "Inferences, questions and possibilities in Toll-like receptor signalling." Nature **430**(6996): 257-63.

- Beutler, B., K. Hoebe, et al. (2004). "Genetic analysis of innate immunity: TIR adapter proteins in innate and adaptive immune responses." Microbes Infect **6**(15): 1374-81.
- Beynon, V., S. Cotofana, et al. (2008). "NOD2/CARD15 genotype influences MDP-induced cytokine release and basal IL-12p40 levels in primary isolated peripheral blood monocytes." Inflamm Bowel Dis **14**(8): 1033-40.
- Bi, Z., M. Barna, et al. (1995). "Vesicular stomatitis virus infection of the central nervous system activates both innate and acquired immunity." J Virol **69**(10): 6466-72.
- Boje, K. M. and P. K. Arora (1992). "Microglial-produced nitric oxide and reactive nitrogen oxides mediate neuronal cell death." Brain Res **587**(2): 250-6.
- Bowie, A. and L. A. O'Neill (2000). "The interleukin-1 receptor/Toll-like receptor superfamily: signal generators for pro-inflammatory interleukins and microbial products." J Leukoc Biol **67**(4): 508-14.
- Bowman, C. C., A. Rasley, et al. (2003). "Cultured astrocytes express toll-like receptors for bacterial products." Glia **43**(3): 281-91.
- Braun, J. S., R. Novak, et al. (1999). "Neuroprotection by a caspase inhibitor in acute bacterial meningitis." Nat Med **5**(3): 298-302.
- Brent, L. (1990). Pathophysiology of the Blood-Brain Barrier: Long Term Consequences of Barrier Dysfunction for the Brain. Amsterdam, The Netherlands, Elsevier Science Publishers.
- Bsibsi, M., R. Ravid, et al. (2002). "Broad expression of Toll-like receptors in the human central nervous system." J Neuropathol Exp Neurol **61**(11): 1013-21.
- Bush, T. G., N. Puvanachandra, et al. (1999). "Leukocyte infiltration, neuronal degeneration, and neurite outgrowth after ablation of scar-forming, reactive astrocytes in adult transgenic mice." Neuron **23**(2): 297-308.
- Campanella, M., C. Sciorati, et al. (2002). "Flow cytometric analysis of inflammatory cells in ischemic rat brain." Stroke **33**(2): 586-92.
- Cannella, B. and C. S. Raine (1995). "The adhesion molecule and cytokine profile of multiple sclerosis lesions." Ann Neurol **37**(4): 424-35.
- Carneiro, L. A., L. H. Travassos, et al. (2004). "Innate immune recognition of microbes through Nod1 and Nod2: implications for disease." Microbes Infect **6**(6): 609-16.
- Carpentier, P. A., W. S. Begolka, et al. (2005). "Differential activation of astrocytes by innate and adaptive immune stimuli." Glia **49**(3): 360-74.

- Chamaillard, M., S. E. Girardin, et al. (2003a). "Nods, Nalps and Naip: intracellular regulators of bacterial-induced inflammation." Cell Microbiol **5**(9): 581-92.
- Chamaillard, M., M. Hashimoto, et al. (2003b). "An essential role for NOD1 in host recognition of bacterial peptidoglycan containing diaminopimelic acid." Nat Immunol **4**(7): 702-7.
- Chauhan, V. S., D. G. Sterka, Jr., et al. (2009). "NOD2 plays an important role in the inflammatory responses of microglia and astrocytes to bacterial CNS pathogens." Glia **57**(4): 414-23.
- Chauhan, V. S., D. G. Sterka, Jr., et al. (2008). "Neurogenic exacerbation of microglial and astrocyte responses to *Neisseria meningitidis* and *Borrelia burgdorferi*." J Immunol **180**(12): 8241-9.
- Cheeran, M. C., S. Hu, et al. (2005). "Differential responses of human brain cells to West Nile virus infection." J Neurovirol **11**(6): 512-24.
- Chen, K., L. Zhang, et al. (2008). "Cooperation between NOD2 and Toll-like receptor 2 ligands in the up-regulation of mouse mFPR2, a G-protein-coupled Abeta42 peptide receptor, in microglial cells." J Leukoc Biol **83**(6): 1467-75.
- Chin, A. I., P. W. Dempsey, et al. (2002). "Involvement of receptor-interacting protein 2 in innate and adaptive immune responses." Nature **416**(6877): 190-4.
- Christian, A. Y., M. Barna, et al. (1996). "Host immune response to vesicular stomatitis virus infection of the central nervous system in C57BL/6 mice." Viral Immunol **9**(3): 195-205.
- Clark, K. L., Z. Zeng, et al. (2001). "PGRL is a major CD81-associated protein on lymphocytes and distinguishes a new family of cell surface proteins." J Immunol **167**(9): 5115-21.
- Conant, K., A. Garzino-Demo, et al. (1998). "Induction of monocyte chemoattractant protein-1 in HIV-1 Tat-stimulated astrocytes and elevation in AIDS dementia." Proc Natl Acad Sci U S A **95**(6): 3117-21.
- Cross, A. H. and G. Ku (2000). "Astrocytes and central nervous system endothelial cells do not express B7-1 (CD80) or B7-2 (CD86) immunoreactivity during experimental autoimmune encephalomyelitis." J Neuroimmunol **110**(1-2): 76-82.
- Cserr, H. F., C. J. Harling-Berg, et al. (1992). "Drainage of brain extracellular fluid into blood and deep cervical lymph and its immunological significance." Brain Pathol **2**(4): 269-76.

Cserr, H. F. and P. M. Knopf (1992). "Cervical lymphatics, the blood-brain barrier and the immunoreactivity of the brain: a new view." Immunol Today **13**(12): 507-12.

D'Aversa, T. G., K. O. Yu, et al. (2004). "Expression of chemokines by human fetal microglia after treatment with the human immunodeficiency virus type 1 protein Tat." J Neurovirol **10**(2): 86-97.

Dalpke, A. H., M. K. Schafer, et al. (2002). "Immunostimulatory CpG-DNA activates murine microglia." J Immunol **168**(10): 4854-63.

Das, S., M. K. Mishra, et al. (2008). "Japanese Encephalitis Virus infection induces IL-18 and IL-1beta in microglia and astrocytes: correlation with in vitro cytokine responsiveness of glial cells and subsequent neuronal death." J Neuroimmunol **195**(1-2): 60-72.

Das, S. C., D. Nayak, et al. (2006). "Visualization of intracellular transport of vesicular stomatitis virus nucleocapsids in living cells." J Virol **80**(13): 6368-77.

De Simone, R., A. Giampaolo, et al. (1995). "The costimulatory molecule B7 is expressed on human microglia in culture and in multiple sclerosis acute lesions." Journal of neuropathology and experimental neurology **54**(2): 175-87.

Defosse, D. L., P. H. Duray, et al. (1992). "The NIH-3 immunodeficient mouse is a model for Lyme borreliosis myositis and carditis." Am J Pathol **141**(1): 3-10.

Dehio, C., S. D. Gray-Owen, et al. (2000). "Host cell invasion by pathogenic Neisseriae." Subcell Biochem **33**: 61-96.

Dickstein, J. B., H. Moldofsky, et al. (2000). "Brain-blood permeability: TNF-alpha promotes escape of protein tracer from CSF to blood." Am J Physiol Regul Integr Comp Physiol **279**(1): R148-51.

Dong, Y. and E. N. Benveniste (2001). "Immune function of astrocytes." Glia **36**(2): 180-90.

Doyle, S. E., R. O'Connell, et al. (2003). "Toll-like receptor 3 mediates a more potent antiviral response than Toll-like receptor 4." J Immunol **170**(7): 3565-71.

Embers, M. E., R. Ramamoorthy, et al. (2004). "Survival strategies of *Borrelia burgdorferi*, the etiologic agent of Lyme disease." Microbes Infect **6**(3): 312-8.

Esen, N. and T. Kielian (2005). "Recognition of *Staphylococcus aureus*-derived peptidoglycan (PGN) but not intact bacteria is mediated by CD14 in microglia." J Neuroimmunol **170**(1-2): 93-104.

- Esen, N., F. Y. Tanga, et al. (2004). "Toll-like receptor 2 (TLR2) mediates astrocyte activation in response to the Gram-positive bacterium *Staphylococcus aureus*." J Neurochem **88**(3): 746-58.
- Fabry, Z., D. J. Topham, et al. (1995). "TGF-beta 2 decreases migration of lymphocytes in vitro and homing of cells into the central nervous system in vivo." J Immunol **155**(1): 325-32.
- Frei, K., U. V. Malipiero, et al. (1989). "On the cellular source and function of interleukin 6 produced in the central nervous system in viral diseases." Eur J Immunol **19**(4): 689-94.
- Furr, S. R., V. S. Chauhan, et al. (2008). "Characterization of retinoic acid-inducible gene-I expression in primary murine glia following exposure to vesicular stomatitis virus." J Neurovirol: 1-11.
- Gao, J. J., V. Diesl, et al. (2002). "Regulation of gene expression in mouse macrophages stimulated with bacterial CpG-DNA and lipopolysaccharide." J Leukoc Biol **72**(6): 1234-45.
- Gasper-Smith, N., I. Marriott, et al. (2006). "Murine gamma-herpesvirus 68 limits naturally occurring CD4+CD25+ T regulatory cell activity following infection." J Immunol **177**(7): 4670-8.
- Gasque, P., M. Fontaine, et al. (1995). "Complement expression in human brain. Biosynthesis of terminal pathway components and regulators in human glial cells and cell lines." J Immunol **154**(9): 4726-33.
- Gerritse, K., J. D. Laman, et al. (1996). "CD40-CD40 ligand interactions in experimental allergic encephalomyelitis and multiple sclerosis." Proc Natl Acad Sci U S A **93**(6): 2499-504.
- Girardin, S. E., I. G. Boneca, et al. (2003a). "Nod1 detects a unique muropeptide from gram-negative bacterial peptidoglycan." Science **300**(5625): 1584-7.
- Girardin, S. E., I. G. Boneca, et al. (2003b). "Nod2 is a general sensor of peptidoglycan through muramyl dipeptide (MDP) detection." J Biol Chem **278**(11): 8869-72.
- Girardin, S. E., J. P. Hugot, et al. (2003c). "Lessons from Nod2 studies: towards a link between Crohn's disease and bacterial sensing." Trends Immunol **24**(12): 652-8.
- Girardin, S. E., M. Jehanno, et al. (2005). "Identification of the critical residues involved in peptidoglycan detection by Nod1." J Biol Chem **280**(46): 38648-56.
- Girardin, S. E. and D. J. Philpott (2004). "Mini-review: the role of peptidoglycan recognition in innate immunity." Eur J Immunol **34**(7): 1777-82.

- Girardin, S. E., D. J. Philpott, et al. (2003d). "Sensing microbes by diverse hosts. Workshop on pattern recognition proteins and receptors." EMBO Rep **4**(10): 932-6.
- Girardin, S. E., P. J. Sansonetti, et al. (2002). "Intracellular vs extracellular recognition of pathogens--common concepts in mammals and flies." Trends Microbiol **10**(4): 193-9.
- Girardin, S. E., R. Tournebize, et al. (2001). "CARD4/Nod1 mediates NF-kappaB and JNK activation by invasive *Shigella flexneri*." EMBO Rep **2**(8): 736-42.
- Girardin, S. E., L. H. Travassos, et al. (2003e). "Peptidoglycan molecular requirements allowing detection by Nod1 and Nod2." J Biol Chem **278**(43): 41702-8.
- Giulian, D., L. J. Haverkamp, et al. (1995). "Senile plaques stimulate microglia to release a neurotoxin found in Alzheimer brain." Neurochem Int **27**(1): 119-37.
- Gonzalez-Scarano, F. and G. Baltuch (1999). "Microglia as mediators of inflammatory and degenerative diseases." Annu Rev Neurosci **22**: 219-40.
- Grdzlishvili, V. Z., S. Smallwood, et al. (2005). "A single amino acid change in the L-polymerase protein of vesicular stomatitis virus completely abolishes viral mRNA cap methylation." J Virol **79**(12): 7327-37.
- Grdzlishvili, V. Z., S. Smallwood, et al. (2006). "Identification of a new region in the vesicular stomatitis virus L polymerase protein which is essential for mRNA cap methylation." Virology **350**(2): 394-405.
- Gregersen, R., K. Lambertsen, et al. (2000). "Microglia and macrophages are the major source of tumor necrosis factor in permanent middle cerebral artery occlusion in mice." J Cereb Blood Flow Metab **20**(1): 53-65.
- Grimwood, K., P. Anderson, et al. (2000). "Twelve year outcomes following bacterial meningitis: further evidence for persisting effects." Arch Dis Child **83**(2): 111-6.
- Gurley, C., J. Nichols, et al. (2008). "Microglia and Astrocyte Activation by Toll-Like Receptor Ligands: Modulation by PPAR-gamma Agonists." PPAR Res **2008**: 453120.
- Gutierrez, O., C. Pipaon, et al. (2002). "Induction of Nod2 in myelomonocytic and intestinal epithelial cells via nuclear factor-kappa B activation." J Biol Chem **277**(44): 41701-5.
- Habicht, G. S., G. Beck, et al. (1985). "Lyme disease spirochetes induce human and murine interleukin 1 production." J Immunol **134**(5): 3147-54.
- Halperin, J. J. (1997). "Neuroborreliosis: central nervous system involvement." Semin Neurol **17**(1): 19-24.

- Harry, G. J., M. Billingsley, et al. (1998). "In vitro techniques for the assessment of neurotoxicity." Environ Health Perspect **106 Suppl 1**: 131-58.
- Hatten, M. E., R. K. Liem, et al. (1991). "Astroglia in CNS injury." Glia **4**(2): 233-43.
- Hayashi, F., K. D. Smith, et al. (2001). "The innate immune response to bacterial flagellin is mediated by Toll-like receptor 5." Nature **410**(6832): 1099-103.
- Haydon, P. G. (2000). "Neuroglial networks: neurons and glia talk to each other." Curr Biol **10**(19): R712-4.
- Heinz, S., V. Haehnel, et al. (2003). "Species-specific regulation of Toll-like receptor 3 genes in men and mice." J Biol Chem **278**(24): 21502-9.
- Heinzelmann, M., H. C. Polk, Jr., et al. (2000). "Endotoxin and muramyl dipeptide modulate surface receptor expression on human mononuclear cells." Immunopharmacology **48**(2): 117-28.
- Hellerud, B. C., J. Stenvik, et al. (2008). "Stages of meningococcal sepsis simulated in vitro, with emphasis on complement and Toll-like receptor activation." Infect Immun **76**(9): 4183-9.
- Hemmi, H., O. Takeuchi, et al. (2000). "A Toll-like receptor recognizes bacterial DNA." Nature **408**(6813): 740-5.
- Hercyk, N., S. M. Horikami, et al. (1988). "The vesicular stomatitis virus L protein possesses the mRNA methyltransferase activities." Virology **163**(1): 222-5.
- Hickey, W. F. (2001). "Basic principles of immunological surveillance of the normal central nervous system." Glia **36**(2): 118-24.
- Hickey, W. F. and H. Kimura (1988). "Perivascular microglial cells of the CNS are bone marrow-derived and present antigen in vivo." Science **239**(4837): 290-2.
- Hirschfeld, M., J. J. Weis, et al. (2001). "Signaling by toll-like receptor 2 and 4 agonists results in differential gene expression in murine macrophages." Infect Immun **69**(3): 1477-82.
- Hisamatsu, T., M. Suzuki, et al. (2003). "CARD15/NOD2 functions as an antibacterial factor in human intestinal epithelial cells." Gastroenterology **124**(4): 993-1000.
- Hiscott, J. (2007). "Triggering the innate antiviral response through IRF-3 activation." J Biol Chem **282**(21): 15325-9.

- Hoebe, K. and B. Beutler (2004). "LPS, dsRNA and the interferon bridge to adaptive immune responses: Trif, Tram, and other TIR adaptor proteins." J Endotoxin Res **10**(2): 130-6.
- Horikami, S. M., J. Curran, et al. (1992). "Complexes of Sendai virus NP-P and P-L proteins are required for defective interfering particle genome replication in vitro." J Virol **66**(8): 4901-8.
- Horikami, S. M. and S. A. Moyer (1982). "Host range mutants of vesicular stomatitis virus defective in in vitro RNA methylation." Proc Natl Acad Sci U S A **79**(24): 7694-8.
- Hornef, M. W., B. H. Normark, et al. (2003). "Intracellular recognition of lipopolysaccharide by toll-like receptor 4 in intestinal epithelial cells." J Exp Med **198**(8): 1225-35.
- Hugot, J. P., M. Chamaillard, et al. (2001). "Association of NOD2 leucine-rich repeat variants with susceptibility to Crohn's disease." Nature **411**(6837): 599-603.
- Huneycutt, B. S., Z. Bi, et al. (1993). "Central neuropathogenesis of vesicular stomatitis virus infection of immunodeficient mice." J Virol **67**(11): 6698-706.
- Ibrahim, G. F., G. H. Fleet, et al. (1985). "Method for the isolation of highly purified Salmonella flagellins." J Clin Microbiol **22**(6): 1040-4.
- Inohara, N., L. del Peso, et al. (1998). "RICK, a novel protein kinase containing a caspase recruitment domain, interacts with CLARP and regulates CD95-mediated apoptosis." J Biol Chem **273**(20): 12296-300.
- Inohara, N., T. Koseki, et al. (1999). "Nod1, an Apaf-1-like activator of caspase-9 and nuclear factor-kappaB." J Biol Chem **274**(21): 14560-7.
- Inohara, N. and G. Nunez (2001). "The NOD: a signaling module that regulates apoptosis and host defense against pathogens." Oncogene **20**(44): 6473-81.
- Inohara, N. and G. Nunez (2003). "NODs: intracellular proteins involved in inflammation and apoptosis." Nat Rev Immunol **3**(5): 371-82.
- Inohara, N., Y. Ogura, et al. (2001). "Human Nod1 confers responsiveness to bacterial lipopolysaccharides." J Biol Chem **276**(4): 2551-4.
- Inohara, N., Y. Ogura, et al. (2003). "Host recognition of bacterial muramyl dipeptide mediated through NOD2. Implications for Crohn's disease." J Biol Chem **278**(8): 5509-12.

- Ismair, M. G., S. R. Vavricka, et al. (2006). "hPepT1 selectively transports muramyl dipeptide but not Nod1-activating muramyl peptides." Can J Physiol Pharmacol **84**(12): 1313-9.
- Isogai, E., H. Isogai, et al. (1996). "Cytokines in the serum and brain in mice infected with distinct species of Lyme disease *Borrelia*." Microb Pathog **21**(6): 413-9.
- Issazadeh, S., V. Navikas, et al. (1998). "Kinetics of expression of costimulatory molecules and their ligands in murine relapsing experimental autoimmune encephalomyelitis in vivo." J Immunol **161**(3): 1104-12.
- Iwanaga, Y., M. P. Davey, et al. (2003). "Cloning, sequencing and expression analysis of the mouse NOD2/CARD15 gene." Inflamm Res **52**(6): 272-6.
- Jack, C. S., N. Arbour, et al. (2005). "TLR signaling tailors innate immune responses in human microglia and astrocytes." J Immunol **175**(7): 4320-30.
- Jin, Y. H., M. Mohindru, et al. (2007). "Differential virus replication, cytokine production, and antigen-presenting function by microglia from susceptible and resistant mice infected with Theiler's virus." J Virol **81**(21): 11690-702.
- Johansson, L., A. Rytönen, et al. (2003). "CD46 in meningococcal disease." Science **301**(5631): 373-5.
- John, G. R., S. C. Lee, et al. (2005). "IL-1-regulated responses in astrocytes: relevance to injury and recovery." Glia **49**(2): 161-76.
- Jordan, F. L. and W. E. Thomas (1988). "Brain macrophages: questions of origin and interrelationship." Brain Res **472**(2): 165-78.
- Kaiser, R. (1998). "Neuroborreliosis." J Neurol **245**(5): 247-55.
- Kang, M. H., E. Y. So, et al. (2008). "Replication of Theiler's virus requires NF-kappa B-activation: higher viral replication and spreading in astrocytes from susceptible mice." Glia **56**(9): 942-53.
- Kato, H., O. Takeuchi, et al. (2006). "Differential roles of MDA5 and RIG-I helicases in the recognition of RNA viruses." Nature **441**(7089): 101-5.
- Kawai, T. and S. Akira (2006). "TLR signaling." Cell Death Differ **13**(5): 816-25.
- Kida, S., R. O. Weller, et al. (1995). "Anatomical pathways for lymphatic drainage of the brain and their pathological significance." Neuropathol Appl Neurobiol **21**(3): 181-4.

- Kiefer, R., R. Gold, et al. (1993). "Transforming growth factor beta expression in reactive spinal cord microglia and meningeal inflammatory cells during experimental allergic neuritis." J Neurosci Res **36**(4): 391-8.
- Kielian, T. (2004a). "Immunopathogenesis of brain abscess." J Neuroinflammation **1**(1): 16.
- Kielian, T. (2004b). "Microglia and chemokines in infectious diseases of the nervous system: views and reviews." Front Biosci **9**: 732-50.
- Kielian, T., N. Esen, et al. (2005a). "Toll-like receptor 2 (TLR2) is pivotal for recognition of *S. aureus* peptidoglycan but not intact bacteria by microglia." Glia **49**(4): 567-76.
- Kielian, T., A. Haney, et al. (2005b). "Toll-like receptor 2 modulates the proinflammatory milieu in *Staphylococcus aureus*-induced brain abscess." Infect Immun **73**(11): 7428-35.
- Kielian, T., P. Mayes, et al. (2002). "Characterization of microglial responses to *Staphylococcus aureus*: effects on cytokine, costimulatory molecule, and Toll-like receptor expression." J Neuroimmunol **130**(1-2): 86-99.
- Kielian, T., M. McMahon, et al. (2004). "*S. aureus*-dependent microglial activation is selectively attenuated by the cyclopentenone prostaglandin 15-deoxy-Delta12,14-prostaglandin J2 (15d-PGJ2)." J Neurochem **90**(5): 1163-72.
- Kim, K. S. (2006). "Microbial translocation of the blood-brain barrier." Int J Parasitol **36**(5): 607-14.
- Kim, Y. G., J. H. Park, et al. (2008). "The cytosolic sensors Nod1 and Nod2 are critical for bacterial recognition and host defense after exposure to Toll-like receptor ligands." Immunity **28**(2): 246-57.
- Kinsner, A., M. Boveri, et al. (2006). "Highly purified lipoteichoic acid induced pro-inflammatory signalling in primary culture of rat microglia through Toll-like receptor 2: selective potentiation of nitric oxide production by muramyl dipeptide." J Neurochem **99**(2): 596-607.
- Kobayashi, K., N. Inohara, et al. (2002). "RICK/Rip2/CARDIAK mediates signalling for receptors of the innate and adaptive immune systems." Nature **416**(6877): 194-9.
- Kolb-Maurer, A., O. Kurzai, et al. (2003). "The role of human dendritic cells in meningococcal and listerial meningitis." Int J Med Microbiol **293**(4): 241-9.
- Konat, G. W., T. Kielian, et al. (2006). "The role of Toll-like receptors in CNS response to microbial challenge." J Neurochem **99**(1): 1-12.

- Kornelisse, R. F., J. A. Hazelzet, et al. (1997). "Meningococcal septic shock in children: clinical and laboratory features, outcome, and development of a prognostic score." Clin Infect Dis **25**(3): 640-6.
- Kreutzberg, G. W. (1996). "Microglia: a sensor for pathological events in the CNS." Trends Neurosci **19**(8): 312-8.
- Krueger, N., C. Low, et al. (1995). "Phenotypic characterization of the cells of the inflammatory response in ovine encephalitic listeriosis." J Comp Pathol **113**(3): 263-75.
- Laflamme, N. and S. Rivest (2001). "Toll-like receptor 4: the missing link of the cerebral innate immune response triggered by circulating gram-negative bacterial cell wall components." Faseb J **15**(1): 155-163.
- Lahrtz, F., L. Piali, et al. (1998). "Chemokines and chemotaxis of leukocytes in infectious meningitis." J Neuroimmunol **85**(1): 33-43.
- Latz, E., A. Schoenemeyer, et al. (2004). "TLR9 signals after translocating from the ER to CpG DNA in the lysosome." Nat Immunol **5**(2): 190-8.
- Lawson, L. J., V. H. Perry, et al. (1992). "Turnover of resident microglia in the normal adult mouse brain." Neuroscience **48**(2): 405-15.
- Lehrmann, E., P. Guidetti, et al. (2008). "Glial activation precedes seizures and hippocampal neurodegeneration in measles virus-infected mice." Epilepsia **49 Suppl 2**: 13-23.
- Leib, S. L., Y. S. Kim, et al. (1996). "Detrimental effect of nitric oxide inhibition in experimental bacterial meningitis." Ann Neurol **39**(4): 555-6.
- Leibowitz, S. and R. A. C. Hughes (1983). Immunology of the nervous system London, Edward Arnold.
- Lemaitre, B. (2004). "The road to Toll." Nat Rev Immunol **4**(7): 521-7.
- Lemaitre, B., E. Nicolas, et al. (1996). "The dorsoventral regulatory gene cassette spatzle/Toll/cactus controls the potent antifungal response in *Drosophila* adults." Cell **86**(6): 973-83.
- Lemaitre, B., J. M. Reichhart, et al. (1997). "*Drosophila* host defense: differential induction of antimicrobial peptide genes after infection by various classes of microorganisms." Proc Natl Acad Sci U S A **94**(26): 14614-9.
- Leung, A. K., H. D. Davies, et al. (2007). "Rabies: epidemiology, pathogenesis, and prophylaxis." Adv Ther **24**(6): 1340-7.

- Leyrer, S., W. J. Neubert, et al. (1998). "Rapid and efficient recovery of Sendai virus from cDNA: factors influencing recombinant virus rescue." J Virol Methods **75**(1): 47-58.
- Li, J., T. Moran, et al. (2004). "Regulation of IL-8 and IL-1beta expression in Crohn's disease associated NOD2/CARD15 mutations." Hum Mol Genet **13**(16): 1715-25.
- Lieberman, A. P., P. M. Pitha, et al. (1989). "Production of tumor necrosis factor and other cytokines by astrocytes stimulated with lipopolysaccharide or a neurotropic virus." Proc Natl Acad Sci U S A **86**(16): 6348-52.
- Liu, J. S., T. D. Amaral, et al. (1998). "IFNs are critical regulators of IL-1 receptor antagonist and IL-1 expression in human microglia." J Immunol **161**(4): 1989-96.
- Livengood, J. A. and R. D. Gilmore, Jr. (2006). "Invasion of human neuronal and glial cells by an infectious strain of *Borrelia burgdorferi*." Microbes Infect **8**(14-15): 2832-40.
- Lorton, D., J. M. Kocsis, et al. (1996). "beta-Amyloid induces increased release of interleukin-1 beta from lipopolysaccharide-activated human monocytes." J Neuroimmunol **67**(1): 21-9.
- Lucas, P. C., L. M. McAllister-Lucas, et al. (2004). "NF-kappaB signaling in lymphocytes: a new cast of characters." J Cell Sci **117**(Pt 1): 31-9.
- Lund, S., K. V. Christensen, et al. (2006). "The dynamics of the LPS triggered inflammatory response of murine microglia under different culture and in vivo conditions." J Neuroimmunol **180**(1-2): 71-87.
- Lundh, B. (1990). "Spread of vesicular stomatitis virus along the visual pathways after retinal infection in the mouse." Acta Neuropathol **79**(4): 395-401.
- Lundh, B., K. Kristensson, et al. (1987). "Selective infections of olfactory and respiratory epithelium by vesicular stomatitis and Sendai viruses." Neuropathol Appl Neurobiol **13**(2): 111-22.
- Maeda, S., L. C. Hsu, et al. (2005). "Nod2 mutation in Crohn's disease potentiates NF-kappaB activity and IL-1beta processing." Science **307**(5710): 734-8.
- Magnarelli, L. A. and J. F. Anderson (1988). "Ticks and biting insects infected with the etiologic agent of Lyme disease, *Borrelia burgdorferi*." J Clin Microbiol **26**(8): 1482-6.
- Mark, K. S. and D. W. Miller (1999). "Increased permeability of primary cultured brain microvessel endothelial cell monolayers following TNF-alpha exposure." Life Sci **64**(21): 1941-53.

- Marquette, C., A. M. Van Dam, et al. (1996). "Induction of immunoreactive interleukin-1 beta and tumor necrosis factor-alpha in the brains of rabies virus infected rats." J Neuroimmunol **68**(1-2): 45-51.
- Marriott, I., D. M. Rati, et al. (2005). "Induction of Nod1 and Nod2 intracellular pattern recognition receptors in murine osteoblasts following bacterial challenge." Infect Immun **73**(5): 2967-73.
- Martinon, F., L. Agostini, et al. (2004). "Identification of bacterial muramyl dipeptide as activator of the NALP3/cryopyrin inflammasome." Curr Biol **14**(21): 1929-34.
- McDonald, C., N. Inohara, et al. (2005). "Peptidoglycan signaling in innate immunity and inflammatory disease." J Biol Chem **280**(21): 20177-80.
- Meda, L., P. Baron, et al. (1999). "Proinflammatory profile of cytokine production by human monocytes and murine microglia stimulated with beta-amyloid[25-35]." J Neuroimmunol **93**(1-2): 45-52.
- Meda, L., S. Bernasconi, et al. (1996). "Beta-amyloid (25-35) peptide and IFN-gamma synergistically induce the production of the chemotactic cytokine MCP-1/JE in monocytes and microglial cells." J Immunol **157**(3): 1213-8.
- Meda, L., M. A. Cassatella, et al. (1995). "Activation of microglial cells by beta-amyloid protein and interferon-gamma." Nature **374**(6523): 647-50.
- Medana, I. M., A. Gallimore, et al. (2000). "MHC class I-restricted killing of neurons by virus-specific CD8+ T lymphocytes is effected through the Fas/FasL, but not the perforin pathway." Eur J Immunol **30**(12): 3623-33.
- Medzhitov, R. and C. A. Janeway, Jr. (1997). "Innate immunity: impact on the adaptive immune response." Curr Opin Immunol **9**(1): 4-9.
- Meylan, E. and J. Tschopp (2006). "Toll-like receptors and RNA helicases: two parallel ways to trigger antiviral responses." Mol Cell **22**(5): 561-9.
- Miceli-Richard, C., S. Lesage, et al. (2001). "CARD15 mutations in Blau syndrome." Nat Genet **29**(1): 19-20.
- Minagar, A., P. Shapshak, et al. (2002). "The role of macrophage/microglia and astrocytes in the pathogenesis of three neurologic disorders: HIV-associated dementia, Alzheimer disease, and multiple sclerosis." J Neurol Sci **202**(1-2): 13-23.
- Miyoshi, K., D. H. Harter, et al. (1971). "Neuropathological and immunofluorescence studies of experimental vesicular stomatitis virus encephalitis in mice." J Neuropathol Exp Neurol **30**(2): 266-77.

Nadeau, S. and S. Rivest (2000). "Role of microglial-derived tumor necrosis factor in mediating CD14 transcription and nuclear factor kappa B activity in the brain during endotoxemia." J Neurosci **20**(9): 3456-68.

Nathan, B. R. and W. M. Scheld (2000). "New Advances in the Pathogenesis and Pathophysiology of Bacterial Meningitis." Curr Infect Dis Rep **2**(4): 332-336.

Nathanson, J. A. and L. L. Chun (1989). "Immunological function of the blood-cerebrospinal fluid barrier." Proc Natl Acad Sci U S A **86**(5): 1684-8.

Nau, G. J., J. F. Richmond, et al. (2002). "Human macrophage activation programs induced by bacterial pathogens." Proc Natl Acad Sci U S A **99**(3): 1503-8.

Nau, G. J., A. Schlesinger, et al. (2003). "Cumulative Toll-like receptor activation in human macrophages treated with whole bacteria." J Immunol **170**(10): 5203-9.

Nau, R. and W. Bruck (2002). "Neuronal injury in bacterial meningitis: mechanisms and implications for therapy." Trends Neurosci **25**(1): 38-45.

Nau, R., A. Soto, et al. (1999). "Apoptosis of neurons in the dentate gyrus in humans suffering from bacterial meningitis." J Neuropathol Exp Neurol **58**(3): 265-74.

Nguyen, V. T. and E. N. Benveniste (2000). "Involvement of STAT-1 and its family members in interferon-gamma induction of CD40 transcription in microglia/macrophages." J Biol Chem **275**(31): 23674-84.

Nikceovich, K. M., K. B. Gordon, et al. (1997). "IFN-gamma-activated primary murine astrocytes express B7 costimulatory molecules and prime naive antigen-specific T cells." J Immunol **158**(2): 614-21.

Nikulin, J., U. Panzner, et al. (2006). "Intracellular survival and replication of *Neisseria meningitidis* in human brain microvascular endothelial cells." Int J Med Microbiol **296**(8): 553-8.

Noe, K. H., C. Cenciarelli, et al. (1999). "Requirements for measles virus induction of RANTES chemokine in human astrocytoma-derived U373 cells." J Virol **73**(4): 3117-24.

Nuovo, G. J., D. L. Defaria, et al. (2005). "Molecular detection of rabies encephalitis and correlation with cytokine expression." Mod Pathol **18**(1): 62-7.

O'Keefe, G. M., V. T. Nguyen, et al. (2001). "IFN-gamma regulation of class II transactivator promoter IV in macrophages and microglia: involvement of the suppressors of cytokine signaling-1 protein." J Immunol **166**(4): 2260-9.

O'Neill, L. A., K. A. Fitzgerald, et al. (2003). "The Toll-IL-1 receptor adaptor family grows to five members." Trends Immunol **24**(6): 286-90.

- Ogura, Y., D. K. Bonen, et al. (2001a). "A frameshift mutation in NOD2 associated with susceptibility to Crohn's disease." Nature **411**(6837): 603-6.
- Ogura, Y., N. Inohara, et al. (2001b). "Nod2, a Nod1/Apaf-1 family member that is restricted to monocytes and activates NF-kappaB." J Biol Chem **276**(7): 4812-8.
- Oh, H. M., H. J. Lee, et al. (2005). "Induction and localization of NOD2 protein in human endothelial cells." Cell Immunol **237**(1): 37-44.
- Olson, J. K. and S. D. Miller (2004). "Microglia initiate central nervous system innate and adaptive immune responses through multiple TLRs." J Immunol **173**(6): 3916-24.
- Otte, J. M., I. M. Rosenberg, et al. (2003). "Intestinal myofibroblasts in innate immune responses of the intestine." Gastroenterology **124**(7): 1866-78.
- Ovanesov, M. V., Y. Ayhan, et al. (2008). "Astrocytes play a key role in activation of microglia by persistent Borna disease virus infection." J Neuroinflammation **5**: 50.
- Ovanesov, M. V., C. Sauder, et al. (2006). "Activation of microglia by borna disease virus infection: in vitro study." J Virol **80**(24): 12141-8.
- Owens, T., A. A. Babcock, et al. (2005). "Cytokine and chemokine inter-regulation in the inflamed or injured CNS." Brain Res Brain Res Rev **48**(2): 178-84.
- Ozinsky, A., D. M. Underhill, et al. (2000). "The repertoire for pattern recognition of pathogens by the innate immune system is defined by cooperation between toll-like receptors." Proc Natl Acad Sci U S A **97**(25): 13766-71.
- Pauleau, A. L. and P. J. Murray (2003). "Role of nod2 in the response of macrophages to toll-like receptor agonists." Mol Cell Biol **23**(21): 7531-9.
- Perry, V. H. and S. Gordon (1988). "Macrophages and microglia in the nervous system." Trends Neurosci **11**(6): 273-7.
- Persidsky, Y. (1999). "Model systems for studies of leukocyte migration across the blood - brain barrier." J Neurovirol **5**(6): 579-90.
- Pfister, H. W., A. Fontana, et al. (1994). "Mechanisms of brain injury in bacterial meningitis: workshop summary." Clin Infect Dis **19**(3): 463-79.
- Pfister, H. W. and W. M. Scheld (1997). "Brain injury in bacterial meningitis: therapeutic implications." Curr Opin Neurol **10**(3): 254-9.
- Poltorak, A., X. He, et al. (1998). "Defective LPS signaling in C3H/HeJ and C57BL/10ScCr mice: mutations in Tlr4 gene." Science **282**(5396): 2085-8.

Pringle, C. R. (1997). "The order Mononegavirales--current status." Arch Virol **142**(11): 2321-6.

Prinz, M., O. Kann, et al. (1999). "Microglial activation by components of gram-positive and -negative bacteria: distinct and common routes to the induction of ion channels and cytokines." J Neuropathol Exp Neurol **58**(10): 1078-89.

Qureshi, S. T., L. Lariviere, et al. (1999). "Endotoxin-tolerant mice have mutations in Toll-like receptor 4 (Tlr4)." J Exp Med **189**(4): 615-25.

Rajnik, M. and M. G. Ottolini (2000). "Serious infections of the central nervous system: encephalitis, meningitis, and brain abscess." Adolesc Med **11**(2): 401-25.

Ramesh, G., A. L. Alvarez, et al. (2003). "Pathogenesis of Lyme neuroborreliosis: *Borrelia burgdorferi* lipoproteins induce both proliferation and apoptosis in rhesus monkey astrocytes." Eur J Immunol **33**(9): 2539-50.

Rasley, A., J. Anguita, et al. (2002a). "*Borrelia burgdorferi* induces inflammatory mediator production by murine microglia." J Neuroimmunol **130**(1-2): 22-31.

Rasley, A., K. L. Bost, et al. (2004a). "Murine gammaherpesvirus-68 elicits robust levels of interleukin-12 p40, but not interleukin-12 p70 production, by murine microglia and astrocytes." J Neurovirol **10**(3): 171-80.

Rasley, A., K. L. Bost, et al. (2002b). "Expression of functional NK-1 receptors in murine microglia." Glia **37**(3): 258-67.

Rasley, A., I. Marriott, et al. (2004b). "Substance P augments *Borrelia burgdorferi*-induced prostaglandin E2 production by murine microglia." J Immunol **172**(9): 5707-13.

Rasley, A., S. L. Tranguch, et al. (2006). "Murine glia express the immunosuppressive cytokine, interleukin-10, following exposure to *Borrelia burgdorferi* or *Neisseria meningitidis*." Glia **53**(6): 583-92.

Ray, N. B., C. Power, et al. (1997). "Rabies viruses infect primary cultures of murine, feline, and human microglia and astrocytes." Arch Virol **142**(5): 1011-9.

Rehli, M. (2002). "Of mice and men: species variations of Toll-like receptor expression." Trends Immunol **23**(8): 375-8.

Rempel, J. D., L. A. Quina, et al. (2005). "Viral induction of central nervous system innate immune responses." J Virol **79**(7): 4369-81.

- Rettew, J. A., Y. M. Huet-Hudson, et al. (2008). "Testosterone reduces macrophage expression in the mouse of toll-like receptor 4, a trigger for inflammation and innate immunity." Biol Reprod **78**(3): 432-7.
- Ribi, E. E., J. L. Cantrell, et al. (1979). "Enhancement of endotoxic shock by N-acetylmuramyl-L-alanyl-(L-seryl)-D-isoglutamine (muramyl dipeptide)." Cancer Res **39**(11): 4756-9.
- Rock, F. L., G. Hardiman, et al. (1998). "A family of human receptors structurally related to *Drosophila* Toll." Proc Natl Acad Sci U S A **95**(2): 588-93.
- Rubin, L. L. and J. M. Staddon (1999). "The cell biology of the blood-brain barrier." Annu Rev Neurosci **22**: 11-28.
- Satoh, J., Y. B. Lee, et al. (1995). "T-cell costimulatory molecules B7-1 (CD80) and B7-2 (CD86) are expressed in human microglia but not in astrocytes in culture." Brain Res **704**(1): 92-6.
- Scheld, W. M., U. Koedel, et al. (2002). "Pathophysiology of bacterial meningitis: mechanism(s) of neuronal injury." J Infect Dis **186 Suppl 2**: S225-33.
- Schwartz, M., G. Moalem, et al. (1999). "Innate and adaptive immune responses can be beneficial for CNS repair." Trends Neurosci **22**(7): 295-9.
- Seal, B. S., D. J. King, et al. (2000). "The avian response to Newcastle disease virus." Dev Comp Immunol **24**(2-3): 257-68.
- Sharief, M. K., M. Ciardi, et al. (1992). "Blood-brain barrier damage in patients with bacterial meningitis: association with tumor necrosis factor-alpha but not interleukin-1 beta." J Infect Dis **166**(2): 350-8.
- Shin, O. S., R. R. Isberg, et al. (2008). "Distinct roles for MyD88 and Toll-like receptors 2, 5, and 9 in phagocytosis of *Borrelia burgdorferi* and cytokine induction." Infect Immun **76**(6): 2341-51.
- Shrikant, P. and E. N. Benveniste (1996). "The central nervous system as an immunocompetent organ: role of glial cells in antigen presentation." J Immunol **157**(5): 1819-22.
- So, E. Y., M. H. Kang, et al. (2006). "Induction of chemokine and cytokine genes in astrocytes following infection with Theiler's murine encephalomyelitis virus is mediated by the Toll-like receptor 3." Glia **53**(8): 858-67.
- Sofroniew, M. V., T. G. Bush, et al. (1999). "Genetically-targeted and conditionally-regulated ablation of astroglial cells in the central, enteric and peripheral nervous systems in adult transgenic mice." Brain Res **835**(1): 91-5.

- Soos, J. M., T. A. Ashley, et al. (1999). "Differential expression of B7 co-stimulatory molecules by astrocytes correlates with T cell activation and cytokine production." Int Immunol **11**(7): 1169-79.
- Soos, J. M., J. Morrow, et al. (1998). "Astrocytes express elements of the class II endocytic pathway and process central nervous system autoantigen for presentation to encephalitogenic T cells." J Immunol **161**(11): 5959-66.
- Spanaus, K. S., D. Nadal, et al. (1997). "C-X-C and C-C chemokines are expressed in the cerebrospinal fluid in bacterial meningitis and mediate chemotactic activity on peripheral blood-derived polymorphonuclear and mononuclear cells in vitro." J Immunol **158**(4): 1956-64.
- Steere, A. C. (2001). "Lyme disease." N Engl J Med **345**(2): 115-25.
- Stoll, G. and S. Jander (1999). "The role of microglia and macrophages in the pathophysiology of the CNS." Prog Neurobiol **58**(3): 233-47.
- Strausberg, R. L., E. A. Feingold, et al. (2002). "Generation and initial analysis of more than 15,000 full-length human and mouse cDNA sequences." Proc Natl Acad Sci U S A **99**(26): 16899-903.
- Streit, W. J. (2004). "Microglia and Alzheimer's disease pathogenesis." J Neurosci Res **77**(1): 1-8.
- Streit, W. J., S. A. Walter, et al. (1999). "Reactive microgliosis." Prog Neurobiol **57**(6): 563-81.
- Strober, W., P. J. Murray, et al. (2006). "Signalling pathways and molecular interactions of NOD1 and NOD2." Nat Rev Immunol **6**(1): 9-20.
- Suuronen, T., J. Huuskonen, et al. (2006). "Characterization of the pro-inflammatory signaling induced by protein acetylation in microglia." Neurochem Int **49**(6): 610-8.
- Sweet, M. J., C. C. Campbell, et al. (2002). "Colony-stimulating factor-1 suppresses responses to CpG DNA and expression of toll-like receptor 9 but enhances responses to lipopolysaccharide in murine macrophages." J Immunol **168**(1): 392-9.
- Takada, H. and A. Uehara (2006). "Enhancement of TLR-mediated innate immune responses by peptidoglycans through NOD signaling." Curr Pharm Des **12**(32): 4163-72.
- Takeda, K., T. Kaisho, et al. (2003). "Toll-like receptors." Annu Rev Immunol **21**: 335-76.

- Takeuchi, O. and S. Akira (2007). "Recognition of viruses by innate immunity." Immunol Rev **220**: 214-24.
- Tan, L., K. B. Gordon, et al. (1998). "Presentation of proteolipid protein epitopes and B7-1-dependent activation of encephalitogenic T cells by IFN-gamma-activated SJL/J astrocytes." J Immunol **160**(9): 4271-9.
- Tanabe, T., M. Chamaillard, et al. (2004). "Regulatory regions and critical residues of NOD2 involved in muramyl dipeptide recognition." Embo J **23**(7): 1587-97.
- Tatro, J. B., L. I. Romero, et al. (1994). "Borrelia burgdorferi and Escherichia coli lipopolysaccharides induce nitric oxide and interleukin-6 production in cultured rat brain cells." J Infect Dis **169**(5): 1014-22.
- Taylor, W. R., A. Rasley, et al. (2003). "Murine gammaherpesvirus-68 infects microglia and induces high levels of pro-inflammatory cytokine production." J Neuroimmunol **136**(1-2): 75-83.
- Ting, J. P. and B. K. Davis (2005). "CATERPILLER: a novel gene family important in immunity, cell death, and diseases." Annu Rev Immunol **23**: 387-414.
- Togo, T., H. Akiyama, et al. (2000). "Expression of CD40 in the brain of Alzheimer's disease and other neurological diseases." Brain Res **885**(1): 117-21.
- Tran, C. T., P. Wolz, et al. (1998). "Differential expression of MHC class II molecules by microglia and neoplastic astroglia: relevance for the escape of astrocytoma cells from immune surveillance." Neuropathol Appl Neurobiol **24**(4): 293-301.
- Travassos, L. H., L. A. Carneiro, et al. (2005). "Nod1 participates in the innate immune response to Pseudomonas aeruginosa." J Biol Chem **280**(44): 36714-8.
- Travassos, L. H., S. E. Girardin, et al. (2004). "Toll-like receptor 2-dependent bacterial sensing does not occur via peptidoglycan recognition." EMBO Rep **5**(10): 1000-6.
- Tso, J. Y., X. H. Sun, et al. (1985). "Isolation and characterization of rat and human glyceraldehyde-3-phosphate dehydrogenase cDNAs: genomic complexity and molecular evolution of the gene." Nucleic Acids Res **13**(7): 2485-502.
- Tunkel, A. R. and W. M. Scheld (1995). "Acute bacterial meningitis." Lancet **346**(8991-8992): 1675-80.
- Tyor, W. R., J. D. Glass, et al. (1992). "Cytokine expression in the brain during the acquired immunodeficiency syndrome." Ann Neurol **31**(4): 349-60.
- Tzeng, Y. L. and D. S. Stephens (2000). "Epidemiology and pathogenesis of Neisseria meningitidis." Microbes Infect **2**(6): 687-700.

- Uehara, A., Y. Sugawara, et al. (2005). "Chemically synthesized pathogen-associated molecular patterns increase the expression of peptidoglycan recognition proteins via toll-like receptors, NOD1 and NOD2 in human oral epithelial cells." Cell Microbiol **7**(5): 675-86.
- Ullian, E. M., S. K. Sapperstein, et al. (2001). "Control of synapse number by glia." Science **291**(5504): 657-61.
- Ulvestad, E., K. Williams, et al. (1994). "Fc receptors for IgG on cultured human microglia mediate cytotoxicity and phagocytosis of antibody-coated targets." J Neuropathol Exp Neurol **53**(1): 27-36.
- Underhill, D. M. (2003). "Toll-like receptors: networking for success." Eur J Immunol **33**(7): 1767-75.
- Van Wagoner, N. J. and E. N. Benveniste (1999). "Interleukin-6 expression and regulation in astrocytes." J Neuroimmunol **100**(1-2): 124-39.
- Visintin, A., E. Latz, et al. (2003). "Lysines 128 and 132 enable lipopolysaccharide binding to MD-2, leading to Toll-like receptor-4 aggregation and signal transduction." J Biol Chem **278**(48): 48313-20.
- Visintin, A., A. Mazzoni, et al. (2001). "Regulation of Toll-like receptors in human monocytes and dendritic cells." J Immunol **166**(1): 249-55.
- Waage, A., A. Halstensen, et al. (1989). "Local production of tumor necrosis factor alpha, interleukin 1, and interleukin 6 in meningococcal meningitis. Relation to the inflammatory response." J Exp Med **170**(6): 1859-67.
- Walker, W. S., J. Gatewood, et al. (1995). "Mouse microglial cell lines differing in constitutive and interferon-gamma-inducible antigen-presenting activities for naive and memory CD4+ and CD8+ T cells." J Neuroimmunol **63**(2): 163-74.
- Wesselingh, S. L., C. Power, et al. (1993). "Intracerebral cytokine messenger RNA expression in acquired immunodeficiency syndrome dementia." Ann Neurol **33**(6): 576-82.
- Wesselingh, S. L. and K. A. Thompson (2001). "Immunopathogenesis of HIV-associated dementia." Curr Opin Neurol **14**(3): 375-9.
- Wiegand, M. A., S. Bossow, et al. (2007). "De novo synthesis of N and P proteins as a key step in Sendai virus gene expression." J Virol **81**(24): 13835-44.
- Williams, K., E. Ulvestad, et al. (1994). "B7/BB-1 antigen expression on adult human microglia studied in vitro and in situ." Eur J Immunol **24**(12): 3031-7.

Windhagen, A., J. Newcombe, et al. (1995). "Expression of costimulatory molecules B7-1 (CD80), B7-2 (CD86), and interleukin 12 cytokine in multiple sclerosis lesions." J Exp Med **182**(6): 1985-96.

Winkler, F., U. Koedel, et al. (2001). "Differential expression of nitric oxide synthases in bacterial meningitis: role of the inducible isoform for blood-brain barrier breakdown." J Infect Dis **183**(12): 1749-59.

Wirenfeldt, M., A. A. Babcock, et al. (2005). "Reactive microgliosis engages distinct responses by microglial subpopulations after minor central nervous system injury." J Neurosci Res **82**(4): 507-14.

Wisniewski, H. M., J. Wegiel, et al. (1989). "Ultrastructural studies of the cells forming amyloid fibers in classical plaques." Can J Neurol Sci **16**(4 Suppl): 535-42.

Wolfert, M. A., T. F. Murray, et al. (2002). "The origin of the synergistic effect of muramyl dipeptide with endotoxin and peptidoglycan." J Biol Chem **277**(42): 39179-86.

Yang, S., R. Tamai, et al. (2001). "Synergistic effect of muramyl dipeptide with lipopolysaccharide or lipoteichoic acid to induce inflammatory cytokines in human monocytic cells in culture." Infect Immun **69**(4): 2045-53.

Yoneyama, M., M. Kikuchi, et al. (2005). "Shared and unique functions of the DExD/H-box helicases RIG-I, MDA5, and LGP2 in antiviral innate immunity." J Immunol **175**(5): 2851-8.

Yoneyama, M., M. Kikuchi, et al. (2004). "The RNA helicase RIG-I has an essential function in double-stranded RNA-induced innate antiviral responses." Nat Immunol **5**(7): 730-7.

Yoo, N. J., W. S. Park, et al. (2002). "Nod1, a CARD protein, enhances pro-interleukin-1beta processing through the interaction with pro-caspase-1." Biochem Biophys Res Commun **299**(4): 652-8.

Zughaier, S. M., S. M. Zimmer, et al. (2005). "Differential induction of the toll-like receptor 4-MyD88-dependent and -independent signaling pathways by endotoxins." Infect Immun **73**(5): 2940-50.

APPENDIX: AUTHOR PUBLICATIONS

Chalermkulrat, W., K. P. McKinnon, et al. (2006). "Combined donor specific transfusion and anti-CD154 therapy achieves airway allograft tolerance." Thorax **61**(1): 61-7.

Chauhan, V. S., D. G. Sterka, Jr., et al. (2009). "NOD2 plays an important role in the inflammatory responses of microglia and astrocytes to bacterial CNS pathogens." Glia **57**(4): 414-23.

Chauhan, V. S., D. G. Sterka, Jr., et al. (2008). "Neurogenic exacerbation of microglial and astrocyte responses to *Neisseria meningitidis* and *Borrelia burgdorferi*." J Immunol **180**(12): 8241-9.

Furr, S. R., V. S. Chauhan, et al. (2008). "Characterization of retinoic acid-inducible gene-I expression in primary murine glia following exposure to vesicular stomatitis virus." J Neurovirol: 1-11.

Sterka, D., Jr. and I. Marriott (2006). "Characterization of nucleotide-binding oligomerization domain (NOD) protein expression in primary murine microglia." J Neuroimmunol **179**(1-2): 65-75.

Sterka, D., Jr., D. M. Rati, et al. (2006). "Functional expression of NOD2, a novel pattern recognition receptor for bacterial motifs, in primary murine astrocytes." Glia **53**(3): 322-30.

Sterka, D., Jr., V. S. Chauhan, et al. (2009). Vesicular stomatitis virus and Sendai virus infect and induce immune responses in murine resident glial cells. Submitted for publication