Prompt gamma imaging based on Compton camera detector systems for range verification in proton therapy treatments

Ingrid Isabel Valencia Lozano



München 2018

Prompt gamma imaging based on Compton camera detector systems for range verification in proton therapy treatments

Ingrid Isabel Valencia Lozano

Dissertation
an der Fakultät für Physik
der Ludwig-Maximilians-Universität
München

vorgelegt von
Ingrid Isabel Valencia Lozano
aus Kolumbien

München, den 20. August 2018

Erstgutachter: Prof. Dr. Katia Parodi
Zweitgutachter: PD Dr. Peter G. Thirolf
Tag der mündlichen Prüfung: 16.10.2018

Contents

Abbreviations and Acronyms	ix
List of Figures	xi
List of Tables	xv
Zusammenfassung	xvii
Abstract	xxi
I Rationale & Background	1
1 Introduction	3
2 Physics background and sources of range uncertainties	7
2.1 Proton interaction mechanisms	7
2.1.1 Energy loss rate	7
2.1.2 Range	9
2.1.3 Multiple Coulomb scattering	10
2.1.4 Nuclear interactions	10
2.2 Clinical implementation of proton beams	13
2.2.1 External beam therapy treatment delivery	13
2.2.2 Treatment planning	14
2.3 Range uncertainty	15
2.3.1 Sources from treatment planning	16
2.3.2 Sources from treatment delivery	17
2.3.3 Uncertainties management	18
2.4 Methods for <i>in vivo</i> range verification	19
2.4.1 Direct relative stopping power assessment	19
2.4.2 Indirect methods	20
3 Prompt Gamma monitoring	27
3.1 Rationale of prompt gamma imaging	27

3.2	Interactions of radiation with matter	31
3.2.1	Interactions of photons with matter	31
3.2.2	Interactions of electrons with matter	36
3.3	Prompt gamma detection devices	38
3.3.1	Integrated yields counting systems	38
3.3.2	Collimated systems	41
3.4	Compton camera detectors	43
3.4.1	Investigated detector configurations	45
II	Analysis techniques for Compton camera detectors	49
4	Data acquisition & Image reconstruction	51
4.1	Monte Carlo simulations of Compton camera detection set-ups	52
4.2	From hits to Compton events	53
4.2.1	Compton sequence reconstruction	54
4.2.2	Event statistics	57
4.3	Image reconstruction algorithms	59
4.3.1	Maximum-likelihood reconstruction algorithm	61
4.3.2	Stochastic origin ensembles algorithm	64
III	LMU Compton camera performance	67
5	LMU prototype performance and imaging properties	69
5.1	Spectral response	69
5.2	Angular resolution measurement	72
5.3	Compton sequence reconstruction performance	74
5.4	Detector imaging capabilities	79
IV	Proton range verification through prompt gamma imaging	83
6	Prompt gamma imaging using CCs detection systems	85
6.1	Imaging of prompt gamma distributions	86
6.1.1	Water phantom irradiation	86
6.1.2	Heterogeneous phantom	92
6.2	Range shifts evaluation	98
6.3	Prompt gamma imaging for small animals	103
V	Outlook for Compton camera detectors in proton therapy	109
7	Outlook for Compton camera detectors	111

Table of content	vii
7.1 Alternatives for the LMU Compton camera prototype	111
7.2 Set-up for low gamma energies using a two-stage design	118
8 Conclusions and perspective	129
Acknowledgements	137
Bibliography	143

Abbreviations and Acronyms

- 1D** One-dimensional. [xiii](#), [6](#), [24](#), [30](#), [87](#), [91](#), [94](#), [98–100](#), [104](#), [107](#)
- 2D** Two-dimensional. [5](#), [6](#), [22](#), [79](#), [80](#), [85](#), [87](#), [88](#), [90](#), [100](#), [104](#), [121](#), [124](#), [129](#), [132](#), [134](#)
- 3D** three-dimensional. [4](#), [24](#), [25](#), [42](#), [51](#), [60](#), [65](#), [133](#)
- ARM** Angular Resolution Measurement. [6](#), [72](#), [73](#), [119–121](#), [123](#), [124](#), [126](#), [127](#), [130](#), [134](#)
- CC** Compton camera. [vi](#), [xii](#), [xiii](#), [xvi](#), [xxi](#), [xxii](#), [5](#), [6](#), [25](#), [27](#), [35](#), [42–46](#), [51–62](#), [64](#), [69](#), [70](#), [72](#), [74](#), [77](#), [79](#), [80](#), [85](#), [86](#), [88](#), [90–94](#), [96](#), [98–100](#), [102–107](#), [113–119](#), [126](#), [129](#), [131–135](#)
- CSR** Compton sequence reconstruction. [xiii](#), [xvii](#), [xxi](#), [53](#), [54](#), [73](#), [74](#), [76](#), [77](#), [79](#), [86](#), [94–96](#), [98](#), [99](#), [104](#), [107](#), [111–116](#), [130–133](#)
- CT** computed tomography. [xiii](#), [xxii](#), [16](#), [17](#), [19](#), [21–25](#), [41](#), [105](#), [107](#), [133](#)
- CZT** cadmium zinc telluride. [46](#), [47](#), [52](#), [59](#)
- DSSSD** double-sided silicon strip detector. [xii](#), [45](#), [46](#), [52](#), [55](#), [69](#), [71](#), [74](#), [77](#), [111–113](#), [115](#), [116](#), [130](#), [131](#)
- FWHM** full width at half maximum. [xii](#), [xvi](#), [11](#), [24](#), [25](#), [45](#), [46](#), [52](#), [70](#), [72](#), [73](#), [79](#), [121](#), [123](#), [124](#), [127](#), [130](#), [134](#)
- HDPE** high density polyethylene. [xiii](#), [xv](#), [xxii](#), [98](#), [100–103](#), [133](#)
- kNN** k-Nearest-Neighbor. [45](#), [120](#), [127](#), [134](#)
- MC** Monte Carlo. [xii](#), [xxi](#), [xxii](#), [6](#), [9](#), [10](#), [14](#), [17](#), [21](#), [22](#), [24](#), [27](#), [29](#), [30](#), [38–40](#), [51](#), [52](#), [57](#), [64](#), [72–74](#), [77](#), [87–90](#), [92](#), [94–101](#), [104](#), [105](#), [111](#), [113–116](#), [119](#), [123](#), [130–133](#)
- MCS** multiple Coulomb scattering. [10](#), [17](#), [19](#)
- MLEM** Maximum-Likelihood Expectation-Maximization. [xii](#), [xiv](#), [xv](#), [xvii](#), [xviii](#), [xxi](#), [xxii](#), [5](#), [6](#), [51](#), [61](#), [65](#), [79](#), [80](#), [85–89](#), [91](#), [92](#), [94](#), [96–98](#), [101–104](#), [121–124](#), [126](#), [131–134](#)

OAR organ at risk. 18

pCT proton computed tomography. xi, 19, 20

PET positron emission tomography. 20–23, 25, 27

PG prompt gamma. xi–xiii, xv–xviii, xxi, xxii, 4–6, 25, 27–32, 38–45, 51, 57–60, 69, 77, 78, 80, 81, 85–87, 89, 91–107, 112, 115, 129–133, 135

SOBP spread-out Bragg peak. 5, 15, 30

SOE Stochastic Origin Ensemble. xii, xv, xviii, xxii, 5, 6, 51, 64, 85, 87, 89–92, 94, 96–98, 131–133

TOF time-of-flight. 39, 42

Z atomic number. 12, 34–36, 38, 43, 45

List of Figures

1.1	Comparison of the depth dose curves for high energy photons and protons.	5
2.1	Stopping power as function of kinetic energy for protons in water	8
2.2	Range of a proton beam in water based on the continuous slow down approximation as function of the proton energy	9
2.3	Lateral dose profile as function of the distance from the exit window	11
2.4	Operating principles of the passive scattering beam delivery for proton therapy	13
2.5	Principle of an active proton beam scanning system	14
2.6	Impact of range uncertainties for conventional X-ray radiotherapy and proton therapy	15
2.7	Range uncertainties in proton radiotherapy	16
2.8	Passively scattered proton therapy dose distributions for a non-small cell lung cancer patient	17
2.9	Typical range margins in proton therapy	19
2.10	Scheme of a modern pCT scanner system	20
2.11	Work-flow for PET monitoring for proton therapy	22
2.12	Depth dose and PET activity profiles for the orthogonal fields of a proton beam irradiation for a cranial-base tumour	23
2.13	Three-dimensional ionoacoustic tomography of the Bragg peak	25
3.1	Total non-elastic cross sections of the proton-induced reactions with ^{16}O , ^{12}C and ^{14}N	29
3.2	Distribution of emission vertices of prompt secondary radiation during proton beam irradiation of a homogeneous water cylinder target	30
3.3	Proof of principle of PG detection for proton range verification	31
3.4	Measured PG spectra for four different sample solutions	32
3.5	Schematic drawing of Compton scattering	33
3.6	Differential electronic cross section for Compton effect	34
3.7	Attenuation coefficient for different photon interactions	37
3.8	Experimental set-up for measurements of the absolute target shift by means of prompt gamma timing (PGT) spectra	39
3.9	Proton range verification through prompt gamma ray spectroscopy	40
3.10	First clinical application of PG imaging using a knife-edge shaped slit camera	42
3.11	Multi-slit detector configuration and measured gamma distributions	43

3.12	Comparison of the different Compton camera configurations	44
3.13	Components of the LMU CC detector prototype	46
3.14	Polaris-J detector prototype system	47
4.1	Implemented <i>in silico</i> detector geometry for the LMU prototype in Geant4	53
4.2	Implemented <i>in silico</i> detector geometry for the Polaris-J CC in Geant4 . .	53
4.3	Event type distribution as a function of the incident gamma energy for the different Compton camera configurations	57
4.4	Perfect event retrieval as a function of the incident gamma energy	58
4.5	Event retrieval for the virtually measured PG emission during a proton beam irradiation (150 MeV)	60
4.6	Measurement modelling of the response matrix for CC image reconstruction	64
4.7	Pseudocode for the stochastic origin ensembles reconstruction implementation	66
5.1	LMU prototype spectral response for a 4.44 MeV point-like source	70
5.2	Calibration for the energy deposition in the DSSSD layers based on experi- mental data	71
5.3	Angular resolution measurement distributions at 2 MeV to 6 MeV for the LMU CC prototype	73
5.4	Angular resolution (FWHM) as a function of the energy for reconstructed events obtained via MC simulations	74
5.5	Comparison of the absolute error distributions of the estimated kinematic parameters for a 4.44 MeV point-like gamma source	75
5.6	Comparison of the absolute error distributions of the estimated kinematic parameters for a 4.44 MeV point-like gamma source applying an energy selection filter	76
5.7	Comparison of the absolute error distributions of the estimated kinematic parameters for the PG emission during a proton beam irradiation	78
5.8	Images of reconstructed on-axis point sources using the Compton events for the simulations of the LMU CC prototype	80
5.9	Images of reconstructed on-axis beam sources using the Compton events virtually detected by the LMU CC prototype	81
6.1	Schematic of the simulation set-up for the imaging of PG emissions during the irradiation of a water phantom	86
6.2	Reconstructed PG emission for the simulation scenario with a proton beam energy of 150 MeV (MLEM algorithm)	88
6.3	Reconstructed PG emission for the simulation scenario with a proton beam energy of 180 MeV (MLEM algorithm)	89
6.4	Reconstructed PG emission for the simulation scenario with a proton beam energy of 150 MeV (SOE reconstruction)	90
6.5	Reconstructed PG emission for the simulation scenario with a proton beam energy of 180 MeV (SOE reconstruction)	90

6.6	Experimental set-up using the Polaris-J CC	91
6.7	Reconstructed PG emission for experimental data with the Polaris-J CC for a water target proton beam irradiation	92
6.8	Schematic of the simulation set-up for the imaging of PG emissions during the irradiation of a water phantom including a bone insert and an air gap	93
6.9	Reconstructed PG emission for the LMU CC simulations scenario with a proton beam of 180 MeV impinging on a heterogeneous phantom	95
6.10	Reconstructed PG emission for the Polaris-J CC simulation scenario with a proton beam of 180 MeV impinging on a heterogeneous phantom (CSR retrieval)	96
6.11	Reconstructed PG emission for the Polaris-J CC simulation scenario with a proton beam of 180 MeV impinging on a heterogeneous phantom (perfect retrieval)	97
6.12	Reconstructed PG emission for emulated range shifts in a water phantom	99
6.13	1D extracted from the PG images for emulated range shifts in a water phantom	100
6.14	Comparison of PG emission for range shifts in an HDPE phantom (LMU detector simulation)	101
6.15	Comparison of PG emission for range shifts in an HDPE phantom (Polaris-J experimental data)	103
6.16	XZ projection images of the PG emission for a 100, 50 and 35 MeV proton beam irradiation of a water target using the LMU and Polaris-J CCs	105
6.17	Comparison of the PG profiles and depth-dose curves for low energy proton beam irradiation	106
6.18	First study for small animal CT data comparing the 35 MeV proton pencil beam and the corresponding PG emission	107
7.1	Trigger efficiency for the different configurations of the LMU CC prototype design	113
7.2	Fraction of Compton events among the triggered events for the LMU CC prototype with different configurations	113
7.3	Event retrieval for different configurations of the LMU CC design	114
7.4	Classification of events obtained by the CSR algorithm for different configurations of the LMU CC design	115
7.5	Missing information of events not retrieved by the CSR algorithm for different configurations of the LMU CC	116
7.6	Absolute error distributions of the estimated kinematic parameters for different configurations of the LMU CC design	117
7.7	Sketch of the two-stage Compton camera set-up for low energy gammas	119
7.8	Detector response for each of the detector components for ^{137}Cs source	120
7.9	Hit position maps of the GAGG and the LaBr_3 detectors for the ^{137}Cs acquisition	121
7.10	Comparison of the Compton scatter angle calculated via kinematics and via interactions geometry for the ^{60}Co acquisition	122

7.11 Reconstructed images for the experimental data of the ^{137}Cs source using the MLEM algorithm	122
7.12 Reconstructed images for the simulated data of the ^{137}Cs source using the MLEM algorithm	123
7.13 Spectral response for each of the detector components for ^{60}Co source acquisitions	124
7.14 Hit position maps of the GAGG and the LaBr_3 detectors for the ^{60}Co acquisition	125
7.15 Comparison of the Compton scatter angle calculated via kinematics and via interactions geometry for the ^{60}Co acquisition	126
7.16 Reconstructed images for the experimental data of the ^{60}Co source using the MLEM algorithm	126
7.17 Reconstructed images for the simulated data of the ^{60}Co source using the MLEM algorithm	127

List of Tables

2.1	Main nuclear reaction channels for proton induced positron emitter production	21
3.1	Prompt gamma emission for reaction channels with ^{12}C , ^{16}O and ^{14}N	28
5.1	Absolute error of kinematic parameters for a 4.44 MeV point-like source . .	75
5.2	Absolute error of kinematic parameters for a 4.44 MeV point-like source applying an energy selection criteria	77
5.3	Absolute error of kinematic parameters for a proton beam induced PG emission	78
5.4	Bivariate Gaussian fitting parameters for images of mono-energetic point sources	79
6.1	Proton beam range in water for 150 MeV and 180 MeV in comparison with the fall-off position of the corresponding reconstructed PG profile (MLEM algorithm)	88
6.2	Proton beam range in water for 150 MeV and 180 MeV in comparison with the fall-off position of the corresponding reconstructed PG profile (SOE algorithm)	89
6.3	Measured proton beam range in water for the experimental 150 MeV irradiation set-up compared with the fall-off position of the corresponding reconstructed PG profiles	93
6.4	Distal dose fall-off position compared with the PG range for the LMU prototype using a proton beam of 180 MeV and impinging on an heterogeneous phantom	95
6.5	Distal dose fall-off position compared to the PG range obtained from the Polaris-J during irradiation with proton beam of 180 MeV and impinging on an heterogeneous phantom	97
6.6	Reference distal dose fall-off position compared to the PG range for different energies to emulate 3 mm and 6 mm shifts in the position of the Bragg peak.	100
6.7	Reference distal dose fall-off position compared with the PG ranges for three different energies to emulate 3 mm and 6 mm shifts in the position of the Bragg peak inside of an HDPE phantom for the LMU prototype	102
6.8	Reference distal dose fall-off position compared with the PG ranges for the range shifts evaluation using an HDPE phantom (experimental data)	102

6.9	Distal dose fall-off position compared to the PG ranges for 100, 50 and 35 MeV proton beams	105
7.1	Projected range values of electrons in silicon	112
7.2	Absolute error of kinematic parameters for alternative tracker configurations of the LMU CC detector	118
7.3	Experimental and simulated source position and position resolution (FWHM) for the reconstructed images of the ^{137}Cs source	123
7.4	Experimental and simulated position resolution (FWHM) and source position for the reconstructed images of the ^{60}Co source	127

Bildgebung mit prompt emittierten Photonen und Compton-Kamera Detektoren zur Reichweitenverifikation in der Protonenbestrahlung

Zusammenfassung

Die potenziellen Vorteile der Protonenbestrahlungen aufgrund der vorteilhaften Tiefendosiskurve und der überlegenen Dosiskonformation müssen durch Kontrolle der Bestrahlung gewährleistet werden, um die Gefahr von Unsicherheiten in der Protonenreichweite zu minimieren. *In-vivo* Reichweitenverifikation ist hochgradig wünschenswert, um die Qualität der Bestrahlung zu garantieren und eine zuverlässige Angabe der Protonenreichweite im Patienten oder anderen biologischen Zielen (z. B. Kleintieren) zu erhalten. Die entwickelten Methoden beruhen hauptsächlich auf der Detektion von Sekundärstrahlung, welche während der Bestrahlung aus Kernreaktionen im Gewebe hervorgeht. Es wurde gezeigt, dass von dieser Strahlung besonders prompt emittierte Photonen eine starke Korrelation mit dem distalen Ende der Tiefendosiskurve aufweisen. In dieser Arbeit wird eine ausführliche und detaillierte Untersuchung der Bildgebung mittels prompter Gammaquanten (PG) durchgeführt. Die verwendeten Compton-Kamera Detektoren befinden sich derzeit in der Entwicklung für die Reichweitenverifikation in der Protonenbestrahlung. Zusätzlich werden auch mögliche Verbesserungen der an der LMU entwickelten Compton-Kamera diskutiert, um die Effizienz und Bildgebung in biomedizinischen Anwendungen zu verbessern.

Im ersten Kapitel werden Monte-Carlo Simulationen durchgeführt, um die Leistungsfähigkeit der LMU Compton-Kamera zu evaluieren. Die spektrale Auflösung für experimentelle und simulierte Daten einer monoenergetischen 4.44 MeV Punktquelle wurde verglichen. Basierend auf Monte Carlo Simulationen wurde die Winkel-Auflösung und das Potenzial für Bildgebung mittels des „Maximum-Likelihood Expectation-Maximization“ (MLEM) Algorithmus charakterisiert. Bei Anwendung einer Energie-Selektion von $\pm 5\%$ um den bekannten Wert der Quelle verschlechterte sich die Winkel-Auflösung von 2.9° bei 2 MeV zu 6.2° bei 6 MeV, obwohl sich die Orts- und Energieauflösung der Detektoren leicht verbesserte. Die Ergebnisse lassen sich auf die unvollständige Absorption der gestreuten Elektronen zurückführen. Punktquellen konnten mit Submillimeter-Genauigkeit rekonstruiert werden und durch die Energie-Selektion wurde die Ortsauflösung um $\sim 60\%$ verbessert. Die Leistungsfähigkeit in realistischeren und komplexeren Szenarien wurde anhand der Bestrahlung mit 150 MeV Protonen untersucht. Es zeigte sich, dass die „Compton Sequence Reconstruction“ (CSR) fünfmal mehr Events ermittelt als theoretisch möglich, d. h. viele fehlerhafte Events sind enthalten. Dies spiegelt sich in einem erheblichen Hintergrundrauschen in den Bildern wieder, da die fehlerhaften Events von der CSR nicht erkannt werden. Abschließend hat eine Optimierungs-Studie ergeben, dass Anpassungen des derzeitigen Detektor-Designs, z. B. durch dickere Siliziumschichten, die Leistungsfähigkeit des Detektors verbessern können. Dies würde die Effizienz verbessern und es ermöglichen potentiell bis zu 10% der registrierten Events als Compton-Streuung zu erhalten.

Der zweite Teil dieser Arbeit war darauf fokussiert, den Rahmen für die quantitative Machbarkeitsstudie von Bildgebung mit prompt emittierten Photonen zur Protonen-Reichweitenverifikation zu schaffen. Dazu wurden experimentelle und simulierte Daten von Bestrahlungen homogener und heterogener Phantome mit einzelnen Protonen-Nadelstrahlen verwendet. Der Vergleich zwischen dem LMU-Detektor und der Polaris-J Compton-Kamera sowie des MLEM und des „Stochastic Origin Ensemble“ (SOE) Algorithmus bestätigte eine konsistente Korrelation von Protonen-Reichweite (R_D) und PG Verteilung (R_{PG}). Für die Bestrahlung eines Wasserphantoms war die Abweichung von R_D und R_{PG} kleiner als 3.0 mm für Simulationen und kleiner als 5.0 mm für experimentelle Daten. Aufgrund von fehlerhaften Compton-Events hat die Bildrekonstruktion für heterogene Phantome unscharfe PG Emissions-Verteilungen ergeben. Dies erzeugt Mehrdeutigkeiten in der Reichweitenbestimmung, welche für den LMU Prototypen nicht vernachlässigt werden können. Falls nur perfekte Compton-Events berücksichtigt werden, ergeben sich verlässliche PG Profile die eine gute Übereinstimmung mit der ursprünglichen Emission aufweisen. In diesem Fall waren die Reichweitenunterschiede ($R_D - R_{PG}$) zwischen 2.0 mm und 4.0 mm. Weiterhin wurde untersucht ob es die Methode ermöglicht Abweichungen in der Protonenreichweite zu erkennen. Dazu wurden Simulationen (LMU-Prototyp) und experimentelle Daten (Polaris-J) von homogenen Phantomen genutzt. Veränderungen in der Reichweite des Protonenstrahls von 3.0 mm, 5.0 mm und 6.0 mm konnten in Wasser und Polyethylen nachgewiesen werden, indem die relativen Differenzen zwischen den R_{PG} Werten berechnet wurden. Um die Möglichkeit von PG Bildgebung für Kleintiere zu untersuchen, wurde eine „Proof of Concept“ Studie durchgeführt, bei der die Bestrahlung eines Wasserphantoms mit niederenergetischen Protonenstrahlen (100 MeV, 50 MeV und 35 MeV) simuliert wurde. Die Ergebnisse bestätigen die weiterhin bestehende Korrelation zwischen Protonenreichweite und Wendepunkt einer Sigmoidfunktion, mit der die wahre PG-Abfall gefittet wird. Die festgestellten Reichweitenunterschiede waren im Submillimeter-Bereich. Die Ergebnisse weisen allerdings auch auf Einschränkungen aufgrund der intrinsischen Fähigkeiten des Detektors hin, da die rekonstruierten PG-Profile (trotz Benutzung perfekter Daten) kaum der ursprünglichen PG-Verteilung entsprechen. Eine erste Monte-Carlo Simulation basierend auf den Daten einer Kleintier-Computertomographie wurde durchgeführt, um die möglichen Grenzen für vorklinische Anwendungen zu veranschaulichen. Dafür wurde versucht das PG Signal einer 35 MeV Protonenbestrahlung zu rekonstruieren. Ein erheblicher Einfluss der geringen Reichweite und der Heterogenitäten entlang des Strahlwegs wurde beobachtet. Dies legt die Einschränkungen der Anwendbarkeit dieser Methode nahe, unter Berücksichtigung der Leistungsfähigkeit derzeitiger Detektorkonfigurationen.

Abschließend wurde die Leistungsfähigkeit einer zweiteiligen Compton-Kamera untersucht, die zur Bildgebung für Radioisotope entwickelt wurde. Eine Ortsauflösung von 3.0 mm wurde für ^{137}Cs (662 keV) und ^{60}Co (1.173 MeV und 1.332 MeV) Punktquellen nachgewiesen. Diese Ergebnisse bestätigen die Umsetzbarkeit des Systems, welches eine verbesserte Winkel-Auflösung bei höheren Energien aufweist. Dies ist in Übereinstimmung mit der experimentell bestimmten Orts- und Energieauflösung für den Streuer- und den Absorber-Detektor. Außerdem wurde gezeigt, dass Submillimeter-Genauigkeit bei der

Bestimmung der Position von Quellen erreicht werden kann, falls Ungenauigkeiten in der Bestimmung des Wechselwirkungspunktes mittels des Algorithmus für den LaBr_3 -Detektor verringert werden können.

Prompt gamma imaging based on Compton camera detector systems for range verification in proton therapy treatments

Abstract

The potential advantages offered by proton therapy due to the favourable depth-dose distribution and the resulting superior dose conformity must be ensured by controlling and monitoring the beam delivery to overcome the peril of range uncertainty. *In vivo* range verification is highly desired in order to guarantee the treatment quality by having a reliable estimation of the proton beam range inside the patient or other biological targets (e.g. small animals). Mainly, the proposed methods rely on the detection of secondary particles and photons originated from nuclear interactions inside the target during the irradiation. Among this secondary radiation, [prompt gamma \(PG\)](#) emission has been demonstrated to be well correlated with the distal dose fall-off of the depth-dose distribution. In this thesis, an extensive and dedicated investigation of the [PG](#) imaging performance based on [Compton camera \(CC\)](#) detectors, which are currently under development for proton beam range monitoring, is presented. The study includes possible design upgrades for the LMU [CC](#) prototype envisaging an improved efficiency and imaging capability for biomedical applications.

In the first part, a [Monte Carlo \(MC\)](#) simulation study was performed in order to assess the performance of the LMU [CC](#) prototype. Experimental and simulated spectral response were compared using a 4.44 MeV mono-energetic point-like source. In addition, by means of [MC](#) simulations, the angular resolution and the imaging capabilities using the [Maximum-Likelihood Expectation-Maximization \(MLEM\)](#) reconstruction algorithm were characterised. Applying an energy selection of $\pm 5\%$ around the known source value, the angular resolution was degraded from 2.9° at 2 MeV to 6.2° at 6 MeV due to the incomplete absorption of recoil electrons despite the slightly better position and energy resolution of the detector component. Point sources could be reconstructed with submillimetre accuracy and the spatial resolution of the image was improved by $\sim 60\%$, when the energy window is applied for the selection of Compton events. The performance in more realistic and complex scenarios was evaluated using a reference 150 MeV proton beam irradiation. Assessing the [MC](#) simulation information, it was found that the fraction of events retrieved by the [Compton sequence reconstruction \(CSR\)](#) is five times larger than the amount of correct Compton events that could be theoretically retrieved, i.e., many incorrect events are obtained. This is translated into considerable background noise in the images because of non-valid events, which cannot be rejected by the [CSR](#). Finally, a detector optimisation study suggested that changes in the current design such as considering thicker silicon layers for the tracker component could improve the performance of the detector configuration enhancing the efficiency, while the potential Compton event retrieval would reach 10% of the total number of registered triggers.

The second part of this work was focused on providing a framework for the quantitative evaluation of the feasibility of [PG](#) imaging for proton beam range monitoring using single

pencil beams in homogeneous and heterogeneous phantoms exploiting simulated and experimental data. The comparison of the aforementioned LMU prototype and the Polaris-J (University of Maryland, USA) CC detectors in addition to the MLEM and the Stochastic Origin Ensemble (SOE) algorithms underlines a consistent correlation of the proton beam range (R_D) and the obtained PG distribution (R_{PG}). For the baseline water phantom study, the distance between R_D and R_{PG} was within 3.0 mm and 5.0 mm for the simulated and experimental data, respectively. In heterogeneous targets, the image reconstruction yields blurred PG emissions due to incorrect Compton events, causing ambiguities in the PG/proton range estimation, which are not negligible with the LMU prototype. By making use of perfect event retrieval, reliable PG profiles that correspond better to the ground truth emission are retrieved. In this case, range differences ($R_D - R_{PG}$) were between 2.0 mm and 4.0 mm. Moreover, the ability of the method for resolving shifts in the proton beam range was evaluated in homogeneous targets exploiting simulated (LMU) and experimental (Polaris-J) data. Shifts of 3.0 mm, 5.0 mm and 6.0 mm have been resolved in water and high density polyethylene (HDPE) targets by calculating the relative difference between the estimated R_{PG} values. In order to evaluate the feasibility of PG imaging for small animal irradiation, a proof of concept study was conducted by simulating three different low energy proton beams (100, 50, 35 MeV) impinging on a water phantom. The results have indicated a still valid correlation within submillimetre range difference between the proton beam range and the inflection point of the sigmoidal fit in the true PG fall-off region. However, the findings also have suggested limitations of the intrinsic capabilities of the detector configurations, since reconstructed PG profiles (employing perfect data) barely resemble the ground truth PG distribution. With the aim of exemplifying the possible constraints for a potential pre-clinical application, a first MC simulation study using small animal computed tomography (CT) data was performed attempting to retrieve the PG signal due to a 35 MeV proton beam irradiation. A noticeable impact of the very short range combined with the heterogeneities along the beam path has been observed. It could be translated into drawbacks in the applicability of the method accounting for the current capabilities of the detector configurations.

Finally, the performance of a two-stage CC detector designed for radioisotope imaging was investigated. A spatial resolution of 3.0 mm was demonstrated for the imaging of ^{137}Cs (662 keV) and ^{60}Co (1.173 MeV and 1.332 MeV) point-like sources. The findings have revealed the feasibility of the system with an improved angular resolution for increasing energies according to the experimentally determined energy and position resolution of the scatterer and absorber detector components. Furthermore, submillimetre precision in the source position estimation can be achieved if ambiguities in the interaction position determination by means of the algorithm for position retrieval of the monolithic LaBr_3 detector can be solved.

****Now, the special interest of radium is in the intensity of its rays which several million times greater than the uranium rays. And the effects of the rays make the radium so important. If we take a practical point of view, then the most important property of the rays is the production of physiological effects on the cells of the human organism. These effects may be used for the cure of several diseases. Good results have been obtained in many cases. What is considered particularly important is the treatment of cancer. [...] But we must not forget that when radium was discovered no one knew that it would prove useful in hospitals. The work was one of pure science. And this is a proof that scientific work must not be considered from the point of view of the direct usefulness of it. It must be done for itself, for the beauty of science, and then there is always the chance that a scientific discovery may become like the radium a benefit for humanity.****

The Discovery of Radium, Address by Madame Marie Sklodowska Curie at Vassar
College, 1921

Part I

Rationale & Background

“ On the other hand, if we are successful, we shall have the largest electron accelerator in the world and new areas of research will be opened to us.”

Robert R. Wilson

1

Introduction

Cancer, the second leading cause of death after heart failure, is a generic term for a group of diseases characterised by the growth of abnormal cells, which can invade adjoining parts of the body and/or spread to other organs. External factors, such as tobacco or infections, and internal factors, such as genetic mutations or also predisposition, may act together or in sequence causing cancer in almost any part of the body. By 2012, 8.8 million people died from cancer being nearly 16% of all worldwide deaths and 32.6 million were living with the disease (within five years of diagnosis). New cases are expected to increase by 70% in the next 20 years [Ferlay et al., 2013].

Social and economic impacts of cancer have attracted more efforts in order to have a better understanding of the disease and most effective manners to treat it. According to the World Health Organization, the correct diagnosis is essential for an adequate and effective treatment that depends on the type of cancer. A tailored patient treatment should encompass one or more modalities among surgery, chemotherapy, immunotherapy and/or radiotherapy. About 50% of the diagnosed population receives radiotherapy in localized tumours during the course of the illness with an estimation that the radiation contributes to around 40% towards curative treatment [Begg et al., 2011].

The discovery of X-rays by W.C. Röntgen in 1895, quickly followed by the discovery of natural radioactivity and the isolation of radium in 1898 by M. Curie, were the basis for the most spread radiotherapy techniques nowadays [Thariat et al., 2012]. Teleradiotherapy or external-beam radiotherapy is delivered with a radiation source at a certain distance from the patient surface, whereas in brachytherapy the radiation source is placed inside the patient targeting the organ with a tumour. Conventional radiotherapy is delivered mainly with linear accelerators (LINACs), which are able to produce high energy photons (X-ray beams) with energies between 6 MV and 20 MV for deep-seated targets. Furthermore, electrons can also be produced by the accelerator being suitable for superficial lesions. More

recently, technological improvements gave rise to the adaptation of the beam delivery to a 3D conformal approach in more complex scenarios and the optimization of the image-guidance during the treatments [Thariat et al., 2012].

The therapeutic potential of protons arose as a novel proposal with Robert R. Wilson. He suggested the use of protons due to their finite range in tissue, as the increasing energy loss with decreasing energy results in the so-called Bragg peak. Ten years later in 1954, the first patient was irradiated with a 340 MeV proton beam generated by the 184-inch synchrocyclotron in Lawrence Berkeley Laboratory [Tobias et al., 1958]. In the subsequent years, nuclear physics laboratories were adapted to treat cancer patients, and the community was very active in research for treatment planning regardless of the limitations faced during the clinical practice due to the lack of dedicated centres. The situation changed when the first hospital-based proton therapy facility started at Loma Linda University Medical Centre in 1990. It was the milestone motivating the expansion of facilities and patients around the world and gather the attention of the radiation oncology community [Das and Paganetti, 2015]. By November 2017, around 70 active facilities worldwide are treating patients with protons, 11 also with carbon ions, and 40 more are under construction [PTCOG, 2017].

The use of ionizing radiation in cancer treatment relies on the accuracy to deliver therapeutic dose to the target volume, while the exposure of adjacent healthy structures is minimized. For photons, the radiation dose as a function of depth in the patient rises rapidly, building up a maximum due to the contribution of secondary electrons ejected by the photons, then it decreases exponentially as photons are attenuated. By contrast, the energy deposition of charged particles increases with depth and then abruptly drops forming a sharp, narrow and characteristic peak close to the end of their range (cf. figure 1.1).

The finite range of protons and the ability to stop the beam just at the boundary of the target allow treating cancer with a high dose conformity. Nevertheless, advantages of proton therapy are still not completely exploited due to the high sensitivity to uncertainties in any prediction of the beam range. This lack of accuracy could result in either margin underestimations with portions of the tumour not receiving any dose or a shift in the sharp distal dose fall-off causing an undesirable dose deposition in adjacent healthy tissues. Those uncertainties in the beam range estimation can be divided in two main categories: the treatment planning and the treatment delivery (cf. chapter 2). Despite the complexity of the uncertainties, their effects should be mitigated to overcome limitations of proton therapy in clinical practice. This field of research has been investigated over the last two decades and different approaches to measure and assess proton beam ranges *in-vivo* have been proposed [Polf and Parodi, 2015]. Those methods are mainly based on the detection of secondary particles originated from nuclear interactions inside the patient. Regarding produced gammas, two kinds can be detected: (1) annihilation gammas from the production of positron emitters and (2) PGs from excitations of the tissue nuclei.

PG detection for range verification was first proposed by Min et al. [2006]. Inelastic interactions of protons occur along the penetration path of the beam until 2-3 mm before the Bragg peak, therefore the emission has been found to be well correlated with the distal dose fall-off [Knopf and Lomax, 2013]. An additional advantage is the feasibility

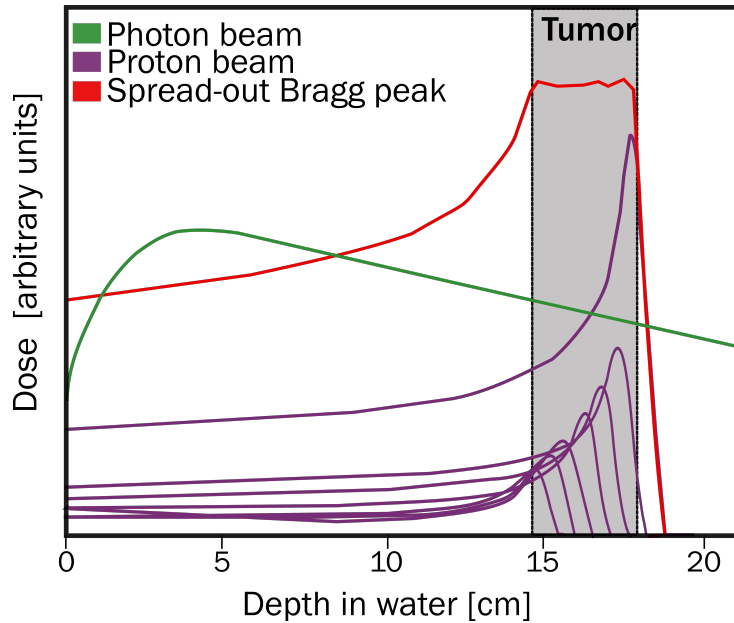

Figure 1.1: Depth-dose distributions for a mono-energetic photon beam (green) and mono-energetic proton beams (purple). The photon dose shows a maximum close to the entrance and afterwards decreases with depth. For protons, the absorbed dose increases with depth and reaches a narrow 'Bragg peak' near the maximum range. This dose peak must be broadened by overlapping different beam energies and the resulting [spread-out Bragg peak \(SOBP\)](#) (red) aims to cover the extended tumour target volume. Adapted from [Durante and Loeffler, 2010] and [Bortfeld and Wolfgang, 1996].

to perform real-time verification of the proton beam during the treatment. However, the accuracy of this method strongly depends on the detector performance and the way in which the measured spectrum is translated into an image of the beam range.

This thesis aims to perform an extensive and dedicated study of [PG](#) imaging based on [Compton camera \(CC\)](#) detectors as a range verification tool during proton therapy treatments, assessing the design and performance of two different prototype configurations. This work also includes an optimisation of the current LMU [CC](#) detector investigating possible upgrades of the design. Furthermore, the image reconstruction tasks in this thesis are addressed by using the iterative [MLEM](#) and [SOE](#) algorithms. [Two-dimensional \(2D\)](#) images of the [PG](#) distributions are employed to quantitatively verify the correlation between the reconstructed [PG](#) range and the proton beam range.

This thesis is divided into five parts set out as follows: the first part, *Rationale & Background (I)* reviews the fundamental aspects of the physics of proton therapy underlying the peril of range uncertainty. A brief overview on the state-of-the-art *in-vivo* range verification methods, which have been proposed, investigated or already clinically implemented is presented. Chapter 3 is primarily dedicated to establish the relevance of [PG](#) detection as a range verification tool, studying the rationale of the emission during proton irradiation. This chapter also includes a summary of the different detection modalities and concludes

with the theory behind **CC** devices, which paves the way to introduce the main topic of this thesis. Furthermore, a description of the two investigated detector systems is given.

The employed materials and methods are fully addressed in part (II): *Analysis techniques for Compton camera detectors*. Chapter 4 presents simulation models of the **CC** detector configurations in the Geant4 Monte Carlo simulation toolkit [Agostinelli et al., 2003]. The methods for converting the detector acquisition into Compton events using the MEGALib software package [Zoglauer et al., 2006] are explained in detail. Furthermore, the reconstruction performance is evaluated in terms of event statistics using the data obtained by two different detector configurations. The image reconstruction algorithms are introduced in the second part of the chapter. A comprehensive description of the **MLEM** method that includes the modelling of the system matrix is given. This response matrix takes into account the intrinsic uncertainties of the measurement process and the physics of the interactions. Lastly, the context of application of the **SOE** implementation developed by Mackin et al. [2012] is presented.

In part III (*LMU Compton camera prototype performance*), the benchmarking of the LMU **CC** prototype is presented. The spectral response obtained using **Monte Carlo (MC)** simulations is compared to experimental data from mono-energetic point-like sources. The **Angular Resolution Measurement (ARM)** is characterised by simulating radioactive point sources with energies ranging from 2 MeV to 6 MeV. A study of the Compton sequence reconstruction performance in terms of kinematic parameter estimation is carried out for two different irradiation set-ups. Additionally, the influence of the energy selection window is analysed. Finally, chapter 5 evaluates the imaging capabilities of the LMU prototype.

The feasibility of **PG** imaging for single proton pencil beams is studied exploiting simulated and experimental data from the LMU and Polaris-J **CCs** in part IV (*Proton range verification through prompt gamma imaging*). Different target scenarios were considered for various proton beam energies. **One-dimensional (1D) PG** profiles were extracted from the obtained **2D** distribution and compared with the known depth-dose curve and the reference **PG** emission. A quantitative correlation between the reconstructed **PGs** and the proton beam range is investigated using the **PG** range value estimation method from Tian et al. [2018]. In addition, low energy irradiation simulations were performed as a proof of concept study for small animal **PG** imaging.

In the last part (V, *Outlook for Compton camera detectors in proton therapy*), a summary of the closing remarks of this thesis is presented. Chapter 7 explores the potential of different detector modifications based on the limitations faced with the LMU prototype. The first section involves simulation studies for an upgraded detector with thicker silicon trackers. Moreover, the second section includes experimental and simulated data with a two-stage **CC** set-up for low energy gamma detection. The main conclusions of the research in **PG** imaging based on **CC** detectors conducted in this thesis are outlined in chapter 8. Guidelines for future work envisaging the clinical and pre-clinical development and implementation are also given.

‘I have approximate answers and possible beliefs in different degrees of certainty about different things, but I’m not absolutely sure of anything.’

Richard Feynman

2

Physics background and sources of range uncertainties

Range uncertainties are probably the main factor limiting the ability of proton therapy to spare healthy tissue and therefore exploit its full potential to treat patients. Since the effects appear as part of the daily treatment routine, range margins are typically defined to mitigate the peril of under-dosage ensuring the coverage of the clinical target volume under all possible sources of uncertainties. Additionally, cautious beam directions are chosen, trading tumour dose conformity for safer delivery. Thus, the treatment volumes become bigger and the Bragg peak advantage partially vanishes.

This chapter introduces the basic physics of proton interactions with matter along with a brief explanation of treatment delivery and treatment planning. Later, the range uncertainty issue is defined and its causes described. Finally, the different *in-vivo* approaches that have been developed over the last years to tackle range uncertainties in proton therapy are presented.

2.1 Proton interaction mechanisms

2.1.1 Energy loss rate

Protons release their energy in different interactions with the traversed material. Each one of those interactions can change the direction and the energy of the original particle. The average rate at which protons lose energy δE per unit path length δz due to Coulomb interactions is given by the *linear stopping power* S :

$$S(E) = -\frac{\delta E}{\delta z} \quad [\text{MeV cm}^{-1}] \quad (2.1)$$

The stopping power can be expressed in units of mass thickness. Equation 2.1 has to be divided by the density of the medium ρ resulting in the *mass stopping power* [MeV cm²/g].

The dominant effect for proton energy loss in the therapeutical energy regime results from inelastic interactions with electrons via electromagnetic Coulomb forces, known as electronic stopping power, over the nuclear and radiative contributions. The following analytical expression describes the electronic mass stopping power of ions, as derived by [Bethe \[1930\]](#) and [Bloch \[1933\]](#) (so-called Bethe-Bloch equation):

$$\frac{S}{\rho} = -4\pi N_A r_e^2 m_e c^2 \frac{Z z^2}{A \beta^2} \left[\ln \frac{2m_e c^2 \gamma^2 \beta^2}{I} - \beta^2 - \frac{\delta}{2} - \frac{C}{Z} \right] \quad (2.2)$$

where N_A is the Avogadro number, r_e is the classical electron radius, m_e is the electron mass, z is the charge of the particle, Z is the atomic number of the medium, A is the atomic mass number, c is the speed of light, $\beta = v/c$ where v is the velocity of the particle, $\gamma = (1 - \beta^2)^{-1/2}$ is the Lorentz factor and I is the mean excitation energy of the medium. Furthermore, δ is the density correction, relevant for ultra-relativistic particles and C is the shell correction term, which becomes relevant when the velocity of the charged particle reaches the velocity of atomic electrons.

For very low energies, β becomes comparable to the velocity of the orbital electrons and equation 2.2 is no longer valid. For this so-called Lindhard region [[Lindhard et al., 1963](#)], the energy loss is proportional to β . For intermediate energies preceding the Bethe-Bloch region (> 1 MeV), energy losses can be described by the model of Anderson and Ziegler [[Ziegler et al., 1985](#)]. The electronic stopping power as a function of the kinetic energy of protons impinging on a water target is depicted in figure 2.1. The Bethe-Bloch equation

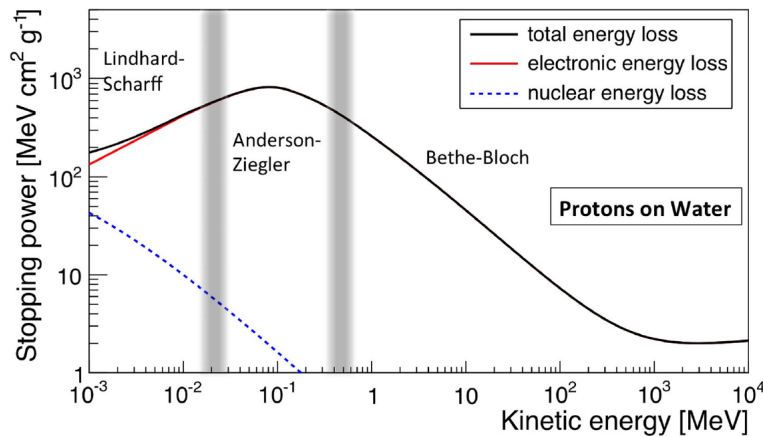

Figure 2.1: For protons in water the total energy loss is plotted as function of the kinetic energy using NIST 2005 data. The different energy regions and the contributions from the electronic (red line) and nuclear (blue line) energy loss are also shown [[Kraan, 2015](#)].

mainly describes the finite range and the characteristic depth-dose along the beam direction with a low entrance plateau ending with a steep Bragg peak (cf. figure 2.2a) [Bragg and Kleeman, 1904].

2.1.2 Range

The range R is an empirical concept providing the thickness of an absorber that the proton can just penetrate. The *projected range* R_{mf} , on the other hand, is the sum of individual path lengths projected onto the incident particle direction. A similar quantity R_{CSDA} , called continuous slow-down approximation (CSDA) range [Seltzer and Berger, 1982], represents the average path length travelled by a proton when it slows down from an initial energy E_o down to a final energy $E_f=0$. In terms of the total mass stopping power, R_{CSDA} is defined as:

$$R_{CSDA} = \int_{E_o}^0 \left(-\frac{dE}{S_{tot}(E)} \right) \quad (2.3)$$

where E_o is the initial kinetic energy of the charged particle, the total mass stopping power $S_{tot}(E)$ is a function of the kinetic energy of the protons and R_{CSDA} is typically in cm^2g^{-1} .

The R_{CSDA} does not necessarily represent the depth of penetration in a defined direction in the absorbing medium, because the definition refers only to interactions which result in energy loss. The ratio R_{mf}/R_{CSDA} is called the *detour factor* and accounts for the scattering effects responsible for the difference between R_{mf} and R_{CSDA} . Figure 2.2a depicts the projected range of a proton beam in water as a function of the initial beam energy. The region of interest in proton therapy is extended in the interval from few centimetres to around 30 cm (mid-line of a large adult male's pelvis), which corresponds to energies between 50 MeV and 230 MeV.

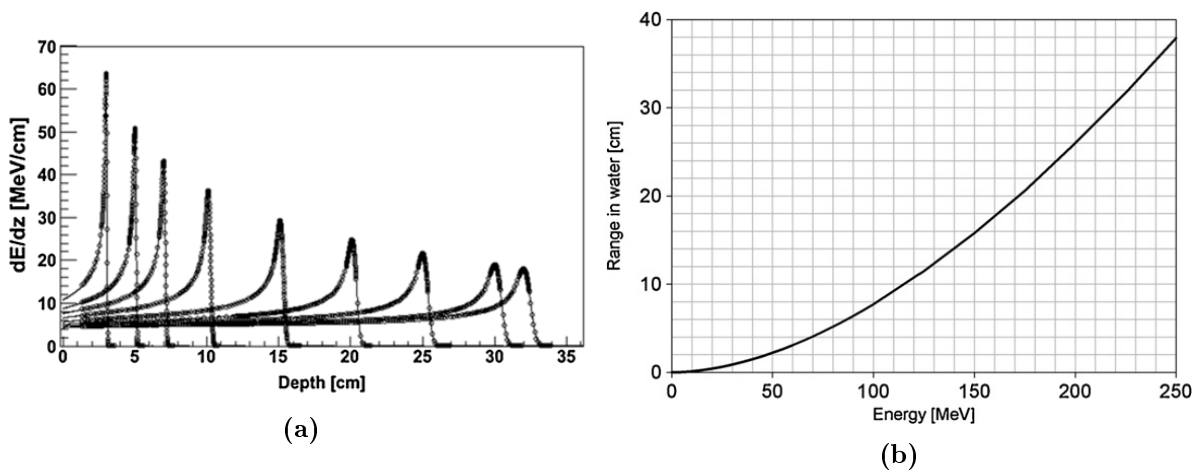

Figure 2.2: MC calculated depth-dose curves for different proton beam energies in water (2.2a). The range of protons in water based on the projected mean range is depicted in 2.2b as a function of the beam energy. Taken from [Molinelli et al., 2013] and [Paganetti, 2012].

The Bragg peak has a finite longitudinal width. The stochastic nature of the interactions gives the actual range for each proton, which has small variations from the corresponding mean value. This effect is termed *range straggling* and it determines the longitudinal widening of the proton dose distribution peak that becomes broader for high beam energies.

2.1.3 Multiple Coulomb scattering

When penetrating matter, protons are laterally scattered through: 1) deflection by Coulomb interactions with electrons (a small effect due to the mass ratio between protons and electrons), and 2) Coulomb interactions with atomic nuclei known as **multiple Coulomb scattering (MCS)**. This latter effect is described by the Molière theory, as the probability distribution function of the scattering angle θ [Durante and Paganetti, 2016]:

$$f(\theta) = \frac{1}{4\pi \theta_M^2} \sum_k \frac{f^k(\theta')}{B^k} \quad (2.4)$$

where θ_M is the characteristic **MCS** angle, θ' is the reduced scattering angle and B is the logarithm of the effective number of collisions in the target. Even though, due to the central limit theorem, the probability distribution of the deflection angle in a thick material is nearly Gaussian as the result of numerous small random deflections with a width given by [Highland, 1975]:

$$\sigma_\theta = \frac{14.1\text{MeV}}{\beta pc} Z_p \sqrt{\frac{L}{L_{rad}}} \left[1 + 0.038 \ln \left(\frac{L}{L_{rad}} \right) \right] \quad (2.5)$$

The lateral scattering described by equation 2.5 increases for thick targets (L is the total mass thickness) and target materials with high atomic number Z . $L_{rad} \sim Z^{-2}$ is the radiation length. In addition, the scattering decreases while increasing the energy due to the βpc factor.

Nevertheless, the Gaussian description is not perfect. The presence of large-angle tails that are originated from electromagnetic interactions is described by the Molière theory, and nuclear interactions, which are not negligible and typically calculated by **MC** approaches [Durante and Paganetti, 2016]. Figure 2.3 shows the effect of beam broadening by multiple scattering including exit window, beam monitors and a water phantom for proton and carbon ion projectiles. Broadening is about 3.5 times larger for proton than for carbons ions considering the same range.

2.1.4 Nuclear interactions

Protons having sufficient kinetic energy to overcome the Coulomb barrier may interact inelastically with atomic nuclei. The target can break up, be excited, or yield a particle transfer reaction; however, the contribution to energy losses is substantially less than electromagnetic processes. Modelling approaches of nuclear interactions are based on the

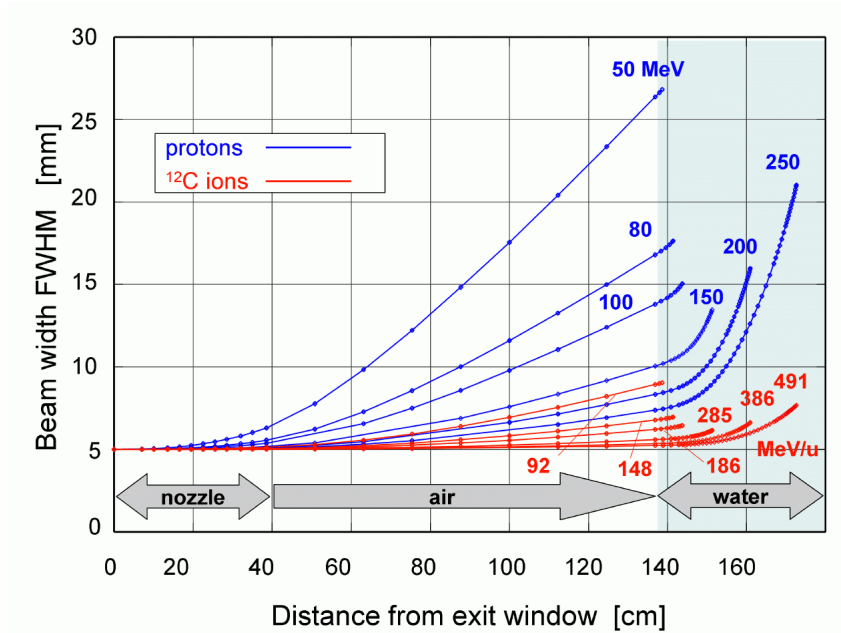

Figure 2.3: Lateral scattering full width at half maximum (FWHM) is calculated for protons and carbon ions in the GSI facility. Initial beam width of 5.0 mm is assumed. At a distance of 140 cm from the exit window, the beam enters the water phantom and is considerably scattered [Weber and Kraft, 2009].

two-step picture called cascade-evaporation to describe the collision interaction [Durante and Paganetti, 2016]. This model includes the abrasion (particle removal during ion-ion interaction) and ablation (nuclear de-excitation) steps.

The probability of not having a nuclear interaction after travelling a certain distance x is given by [Kraan, 2015]:

$$P(x) = e^{-\frac{x}{\lambda_{int}}} \quad \text{and} \quad \lambda_{int} = \frac{A}{N_A \sigma \rho} \quad (2.6)$$

where λ_{int} is the mean free path or interaction length and σ the total cross section. For proton-nucleus inelastic interactions, the threshold value is around few MeV.

The general modelling approach samples the probability that a nuclear event happens by means of cross sections from databases and parametrised physics models. In proton therapy, when the incident particle hits a nucleus, a series of nucleon-nucleon collisions are prompted. Individually, the aforementioned events can be described as a three-stage process:

- Intra-nuclear cascade: This model implemented by Bertini et al. [1974] is based on the assumption that the incident particle interacts with quasi-free nucleons within the nucleus and this is one of the possible models for the dynamic part the reaction. Protons and neutrons have momentum and binding energy following the Fermi gas

model and the semi-empirical mass formula [Battistoni et al., 2016]. The path-length for the projectile is computed with its total cross section and the nucleon density. Once the nuclear interaction occurs, the type and momentum of the striking particle and the target are determined. If the energy is above the cut-off threshold and the assertion of the Pauli exclusion principle is fulfilled, the final state particles (secondaries) are treated as the primary and transported through the nucleus producing the cascade [Ferrari and Sala, 1998]. The production time-scale corresponds to strong interactions at around 10^{-22} - 10^{-23} s. Depending on the energy, secondary particles can scatter or escape and through the *coalescence mechanism* not only protons and neutrons, but also light nuclear fragments can be emitted [Ribanský et al., 1973] [Blann, 1983]. Among other possible models, the binary cascade model [Folger et al., 2004] is similar to the intra-nuclear cascade. By contrast, the quantum molecular dynamics model [Sorge et al., 1989] is the most comprehensive hadronic inelastic model, which does not simulate nucleon-nucleon collisions, but a more collective effect.

- Pre-equilibrium: This stage corresponds to the moment when particles of the cascade are below the energy threshold (few tens of MeV), but the nucleus is not in thermal equilibrium. The interactions are modelled using a semi-classical approach, where nuclear collisions originate holes in the Fermi sea that represent the excited nucleons [Griffin, 1966]. For each step, there is a different probability for the emission of particles; however, the residual nucleus stays in equilibrium with some excitation energy, which is shared among the remaining nucleons [Battistoni et al., 2016].
- De-excitation: The de-excitation process undergoes in different ways depending on the mass of the target nucleus [Battistoni et al., 2016]. Light particles with kinetic energies of few MeV can be emitted from the excited nucleus according to the nuclear evaporation approach [Weisskopf, 1937]. In the so-called Fermi-breakup model [Fermi, 1950], the excitation energy may be larger than the binding energy of some fragmentation channels; therefore, the nucleus splits into smaller fragments. This mechanism plays a significant role in human-body interactions because of the relevance for low- Z nuclei. By contrast, for heavy nuclei ($Z \geq 65$), which apart from metallic implants are not relevant in proton therapy, the fission of the excited nucleus into two fragments becomes the main mechanism to dissipate the residual energy. Finally, after the aforementioned processes, the remaining excited nuclei release energy through the emission of gamma (γ) rays.

Nuclear interactions directly affect the absorbed dose curve. There is a considerable energy dependent reduction in the primary proton fluence and secondary particles can have a relevant contribution to the total energy deposition in the build-up region. The contribution for proton beams in water is about 10% for 150 MeV and up to 20% for 250 MeV [ICRU, 2000]. Furthermore, secondary particles of different types may be produced. High-energetic ones are originated mostly in the intra-nuclear cascade and pre-equilibrium stage and are emitted in the forward direction in the laboratory frame, whereas low-energy secondaries are emitted more or less isotropically in the centre-of-mass frame of the mother

nucleus [Kraan, 2015]. Most importantly, secondary particles are highly relevant to infer the proton beam range *in vivo* (cf. section 2.4).

2.2 Clinical implementation of proton beams

2.2.1 External beam therapy treatment delivery

The beam characteristics are highly dependent on the dose delivery technique that is used. There are two different ways in which the protons can be delivered for treatment. Passive scattering technology is named in this way since the field-specific hardware is required [Koehler et al., 1977]. The mono-energetic pencil beam generated from the accelerator is broadened laterally and longitudinally in order to produce a homogeneous dose distribution throughout the solid angle covering the tumour (cf. figure 2.4). Lateral spreading is achieved by a system of scatterers with different degree of complexity. Range modulation is accomplished either using a rotating absorber of an appropriately tailored profile (range modulator wheels) or by plates of variable thickness or, for small modulation, a stationary absorber (ridge filter) [Schippers, 2015]. A tumour specific combination of collimators and compensators conforms the dose to the lateral and distal shape of the target region keeping a constant energy width modulation. The neutron production due to the additional materials along the beam path and the poor conformation in the proximal part of the target are disadvantages of this technique.

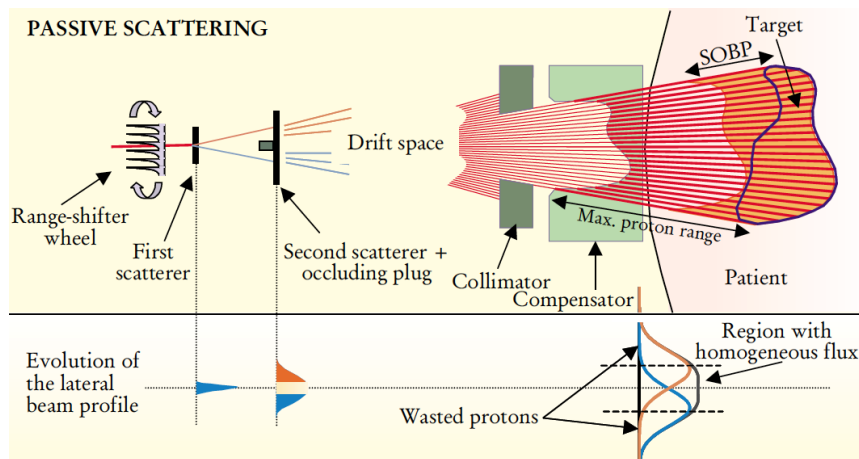

Figure 2.4: Scheme of a passive scattering proton beam delivery system. The range shifter wheel is used to vary the range while the first and second scatterers spread out the beam laterally. Tailored collimators and compensators ensure an improved target conformality [Goitein et al., 2002].

Active scanning is a much more modern technique. In this approach, the depth and direction of the proton pencil beams are dynamically changed to cover the target volume following an optimal pattern. Among the advantages can be mentioned the proximal and

distal dose conformity, the absence of patient-specific hardware and the more efficient use of the protons. A scheme illustrating such a system is shown in figure 2.5. The proton pencil beam is deflected and steered by a magnetic field, and the range is adjusted either by changing the energy of the beam at the accelerator level or by dynamically adding material in front of the patient with a range shifter [Lomax, 1999]. The scan can be performed in two ways: spot (discrete steps) or raster (continuous) scanning. In the raster scanning, the intensity is varied while the beam is moving and in the spot scanning the dose delivered is controlled at each point [Goitein et al., 2002]. Technical challenges include overcoming the interplay effects of the tumour motion and the scanning sequence [Schippers and Lomax, 2011].

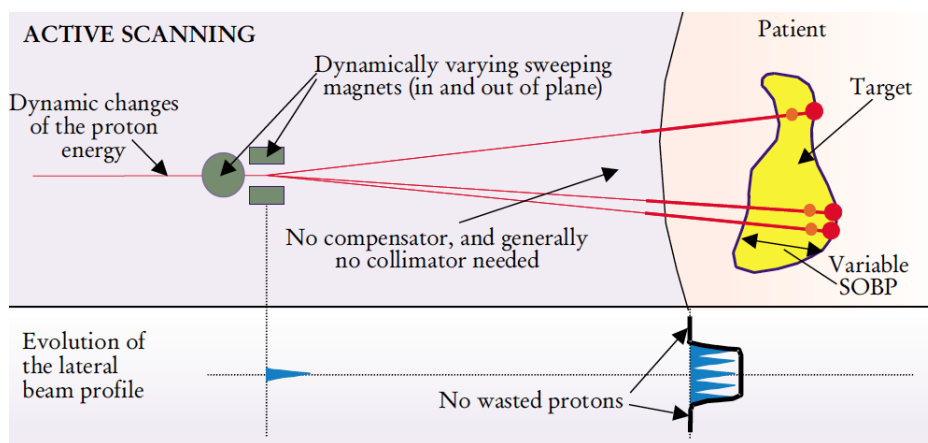

Figure 2.5: Basic principles of an active proton beam scanning system: A narrow pencil beam is deflected by a magnetic field, which allows to scan the target volume. The intensity can be varied from spot to spot or continuously along the path [Goitein et al., 2002].

2.2.2 Treatment planning

Regardless of the delivery technique, the use of radiation requires a plan that based on the patient anatomy model can generate steps for the treatment delivery and compute the expected dose distribution within the patient. The ultimate goal is the delivery of a dose distribution, which gives the best trade-off between tumour coverage and avoidance of healthy surrounding tissue.

Proton therapy treatment planning mostly adopts semi-empirical analytical formalisms and algorithms to calculate the dose in the patient [Mohan and Grosshans, 2017]. Ray-tracing models use generic functions to describe the proximal build-up as well as the distal fall-off of the depth-dose curves, while lateral penumbra functions are used to form the lateral profiles [Paganetti and Bortfeld, 2006]. On the other hand, pencil-beam algorithms rely on pencil kernels, derived from physical data in order to model the dose contribution of each individual pencil beam in which a broad field is decomposed, or being directly delivered with a beam scanning delivery system [Lomax, 1999]. However, MC simulations

are considered the gold standard for dose calculations despite the extensive computational time and the demands that an implementation implies in the clinical routine.

Three different planning strategies can be distinguished for proton therapy. In single field uniform dose plans each treatment field contributes a uniform dose within the target. For the so-called ‘field patching’, two or more fields are combined in such a way that the first field treats a segment of the target avoiding nearby critical organs with its lateral penumbra, while the subsequent fields cover the remaining target matching their distal dose fall-off with the lateral penumbra of the first field. The weight of the low- and high-dose regions is ensured by using a combination of patch fields with different junctions [Bussi ere and Adams, 2003]. By contrast, intensity modulated proton therapy, analogous to intensity modulated radiotherapy and only possible with beam scanning delivery is a technique that delivers non-uniform dose distributions for each treatment field. The desired uniform dose distribution in a tumour is obtained by superimposing the dose contribution of all the fields. A non-uniform dose in each of the directions causes additional degrees of freedom used for the optimisation of the plans, i.e., improved dose conformality and steeper dose gradients sparing the critical structures around the tumour [Paganetti and Bortfeld, 2006].

2.3 Range uncertainty

The depth-dose distribution depicted in figure 1.1 gives an idea of how much cancer treatments can be improved with the use of protons. The sharp distal dose fall-off is the most relevant strength but also causes the peril of high sensitivity to uncertainties. Any inaccuracy in the range may lead to either an inadequate coverage of the target or a considerable over-dosage in critical structures. Knowledge of the penetration depth is part of the clinical practice for both X-rays and protons; however, the dose distributions delivered with protons are much more sensitive to uncertainties (see figure 2.6 for a schematic explanation).

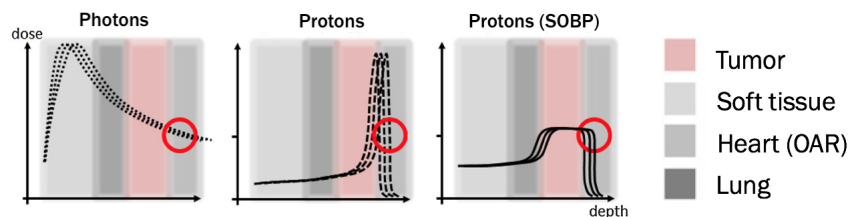

Figure 2.6: The potential dose benefit of proton therapy is hampered by the high sensitivity to range uncertainties. The different scenarios in the figure compare changes in the delivered dose distributions of photon and proton irradiation in the case of heterogeneous media. For photons, the dose beyond the target is a few percent compared with the 100% dose contribution in the same scenario for the SOBP field [Knopf and Lomax, 2013].

The potential sources of beam-range prediction uncertainties can be divided into two main categories [McGowan et al., 2013], depicted with the chart in figure 2.7: treatment

planning (calculations within the treatment planning system) and treatment delivery (discrepancies between planned and delivered dose).

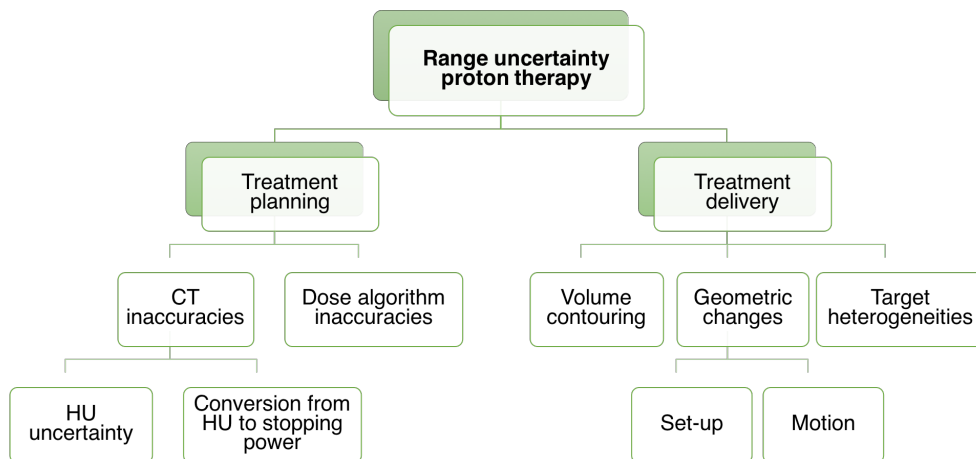

Figure 2.7: Sources of range uncertainties in proton therapy can be classified in two main categories. Adapted from [McGowan et al., 2013].

2.3.1 Sources from treatment planning

CT inaccuracies

Patient image data for treatment planning is acquired based on an X-ray **computed tomography (CT)** scan, whose information is expressed in terms of linear photon attenuation coefficients in the Hounsfield unit scale. Inaccuracies in those values are caused by noise, **CT** artefacts and beam hardening [Paganetti, 2012]. Moreover, this information has to be translated into relative (to water) stopping power via semi-empirical calibration curves introducing inaccuracies of about 1-3% of the proton beam range [Schaffner and Pedroni, 1998].

Dose algorithm inaccuracies

The algorithms used to compute the dose distributions have intrinsic approximations and assumptions, which result in additional uncertainties. Analytical dose calculation algorithms mostly project the range based on the water equivalent length in the patient neglecting the position of inhomogeneities relative to the Bragg peak [Paganetti, 2012], being less sensitive to complex geometries and density variations. Therefore, those algorithms have limitations predicting the range degradation caused by **MCS**. Sawakuchi et al. [2008] studied this effect as a function of the proton energy and geometric complexity finding a

difference in the 80% to 20% distal fall-off position in the order of ~ 2 mm for a 220 MeV proton beam.

In contrast to analytical mathematical methods, **MC** models (gold standard in dose calculations) use random sampling from probability distribution functions for interactions of the primary beam as well as the production and corresponding transport of secondary particles in a medium. Since differences between analytical dose calculation engines and **MC** simulations (cf. figure 2.8) have been demonstrated, implementation of **MC** dose algorithms could overcome the limitations from range degradation due to inhomogeneities [Paganetti, 2012].

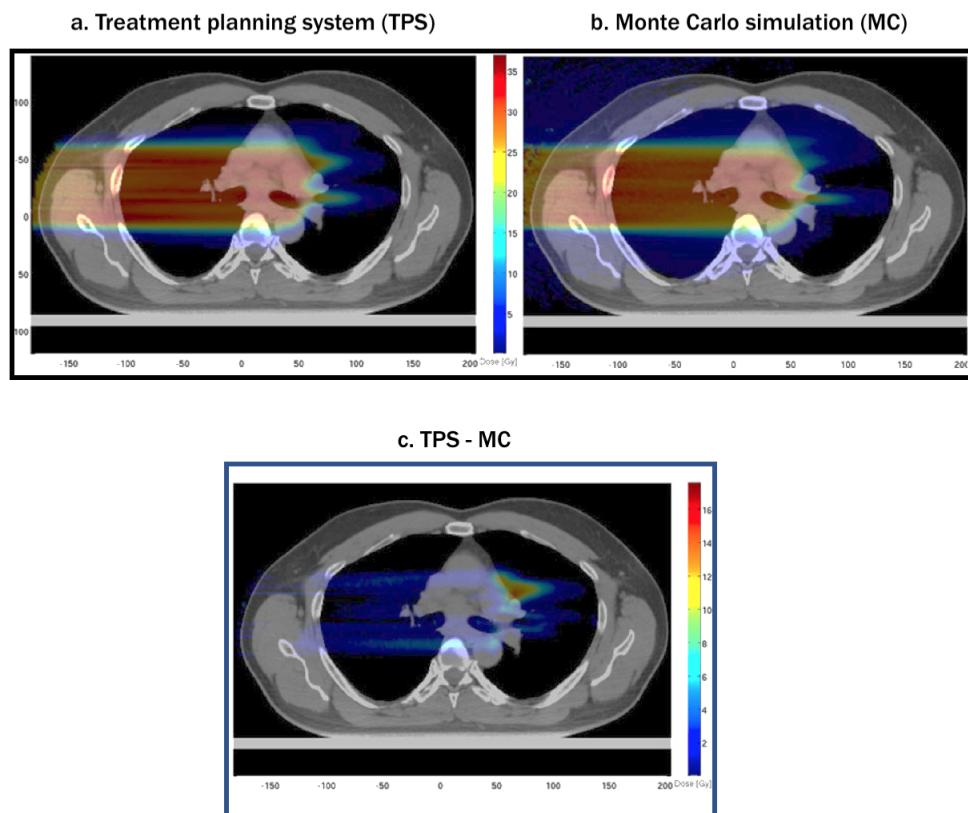

Figure 2.8: Dose distributions for passively scattered proton therapy computed with (a) a commercial treatment planning system and (b) a **MC** simulation. In (c) the difference (a)- (b) illustrates the under dosage due to conventional model predictions. Adapted from [Mohan and Grosshans, 2017].

2.3.2 Sources from treatment delivery

The success of a proton therapy treatment depends, among other factors, on how accurate the position of the patient during irradiation is matching with the planning **CT**. However, the exact alignment can never be reproduced. Conventionally, treatments are performed

with fractionated schemes, i.e., the total dose is delivered in the course of treatment over weeks, which can come along with patient anatomy changes: weight loss, tumour shrinkage or normal tissue swelling [Polf and Parodi, 2015]. Besides the aforementioned changes, a human-being has bowel movements, respiration and heartbeats that cause position shifts during the delivery of a single fraction. Geometric variations in proton therapy can also result in density changes, thereby modifying the radiological path length, which at the end can translate into considerable under-dosage of the target and over-dosage of healthy tissue or even worse **organ at risk (OAR)**s. These effects appear for both passive and active delivery techniques.

2.3.3 Uncertainties management

A treatment plan should be robust enough against uncertainties. Robustness for conventional radiotherapy (high energy X-rays) is achieved with proper safety margins around the clinical target volume, thus ensuring the correct dose delivery despite possible set-up and anatomy variations during the irradiation. The scenario for protons is much more complex, since the range uncertainty depends on the radiological depth where the tumour is located, and the assumptions behind the planning target volume are not necessarily always valid. Margins for **OARs** have similar issues.

In proton therapy, the range uncertainty is incorporated into the treatment plan by ensuring confidence in the calculated dose distribution [Verburg, 2015]. Increasing the safety margins to the distal surface of the target, the robustness of the plan can be achieved. However, this will lead to a reduction in the dose conformity or distorted distributions when density changes in the beam path affect the proton range. Beam-specific proximal and distal margins must be assigned to the clinical target volume, but there is no universally accepted standard. Figure 2.9 shows a schematic representation of a target, an **OAR**, the position of the proton range and the standard margins which made individual beams robust against a -1.5σ variation of the end-of-range.

Anatomical changes in the beam path give rise to perturbations in the dose distribution. For passive scattering, these relative shifts can be compensated by ‘smearing’ the proton range with a compensator. Nevertheless, this technique reduces the conformity of the dose distribution [McGowan et al., 2013]. On the other hand, intensity modulated proton therapy treatments are more sensitive to uncertainties in patient positioning and anatomical motion, requiring ‘robust optimisation’ techniques. This process considers multiple uncertainty scenarios defining an objective function for optimisation of the dose distribution. For instance, it may consider the nominal dose distribution, six dose distributions obtained by shifting the patient **CT** along three orthogonal directions and two additional dose distributions incorporating uncertainties in the range [Mohan and Grosshans, 2017].

Regardless of the selected technique to make plans more robust against uncertainties, a quantification of the delivered beam range is still not addressed. Thus, a real-time monitoring device can overcome the limitations originated by uncertainties, providing more precise information about the protons inside a patient during the treatment.

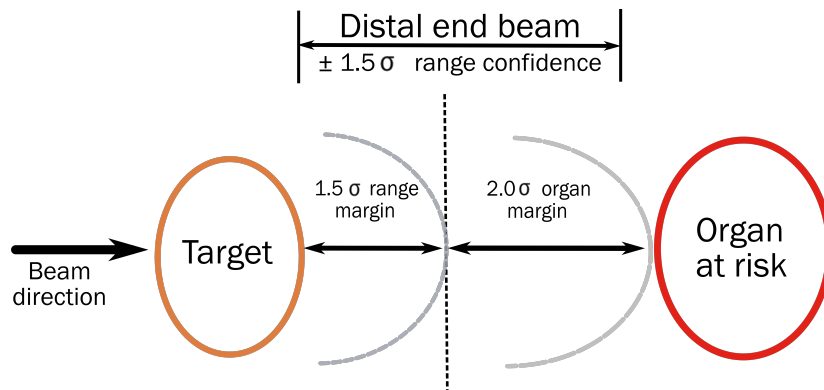

Figure 2.9: Range margins for a uniform dose distribution robust against a $\pm 1.5\sigma$ variation of the range. The distal dose surface is positioned at a distance from the target of 1.5σ of the expected range distribution. A separation of 2σ between the mean position of the end-of-range and the edge of the OAR provides a 98% confidence level. If this margin is bigger than the distance between the target and the OAR, the beam direction is forbidden in the clinical practice. Adapted from [Verburg, 2015].

2.4 Methods for *in vivo* range verification

2.4.1 Direct relative stopping power assessment

Proton radiography and tomography

Previously in section 2.3.1, an explanation about the errors related to the conversion of X-ray images Hounsfield units to proton stopping power was introduced. Differences in the proton range up to 3% [Paganetti, 2012] could be reduced if the stopping power (relative to water) of protons is measured directly, i.e., by using them for imaging, hereafter referred as **proton computed tomography (pCT)**. To this end, proton beams must completely penetrate the patient requiring energies much higher than those used in the therapeutic regime [Parodi, 2014]. For the thickest parts of the body, it becomes a challenge because the available energies at existing proton therapy centres are not sufficient to traverse the patient. Nonetheless, a reduced angular coverage may be sufficient to perform imaging for prostate and sacral cases skipping thick and bony structures [Rinaldi et al., 2011].

The pioneering idea of pCT was outlined in the 60s by Cormack [1963] (Nobel laureate for the invention of X-ray CT) including the energy loss of charged particles in his method to reconstruct radiological images. Five years later Koehler [1968] demonstrated the high density contrast but poor spatial resolution of proton radiography for an aluminium absorber. First experimental pCT acquisition was performed by Cormack and Koehler [1976] using a 158 MeV proton beam; they succeeded in the reconstruction of density differences of less than 1% in a phantom consisting of lucite and a sugar solution. For a long time pCT remained in its infancy as a result of the technological and instrumentation limitations, but a breakout conceptual design specifically for proton irradiation treatments was proposed

within the US pCT collaboration project [Schulte et al., 2004].

The main drawback of proton computed tomography is the limited spatial resolution as a consequence of MCS. Small angle deflections in the proton trajectories are translated in uncertainties in the reconstructed images. Despite different system proposals and research efforts, an optimal set-up must include tracking and measurement of individual particles together with their residual energy [Langen et al., 2015] as is illustrated in figure 2.10. Furthermore, the beam is either broadened or scanned by magnets and the phantom must be able to rotate (for a patient by rotating the gantry) within the detectors by at least 180° . Finally, for each particle, the geometrical path together with the integrated energy loss (in terms of the water equivalent path length) should be provided.

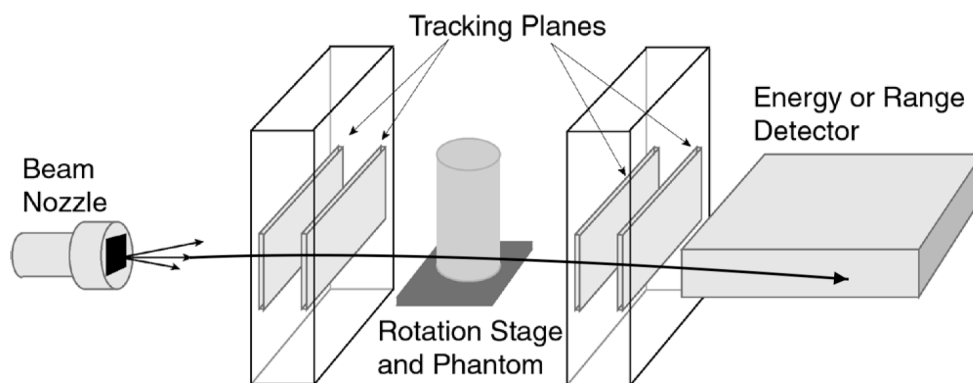

Figure 2.10: The pCT scanner has two tracking detectors before and two behind the phantom in order to enable the reconstruction of trajectories for single particles. Protons are stopped in a multi-stage scintillating detector measuring their residual energy/range. Adapted from [Johnson, 2018].

Proton tomography can provide an upper limit on the range error (as measurement done before treatment), which occurs during the treatment [Knopf and Lomax, 2013]. However, at the moment, most efforts in pCT are aiming to get more accurate stopping power ratio values for treatment planning purposes.

2.4.2 Indirect methods

These methods are based on the detection of nuclear reactions or the ultrasonic signals accompanying proton irradiation of tissue. The beam range is assessed from the measurement of another signal.

Positron emission tomography

Nuclear interactions between protons and the irradiated tissue along the beam path induce transient β^+ activation. Target fragmentation originates a footprint of radio-tracers that decay via positron emission. The emitted positron travels a small distance (\sim mm) before

annihilating with an electron in the medium producing two almost anti-parallel coincident gammas of 511 keV, which can be detected with a [positron emission tomography \(PET\)](#) detector [[Parodi, 2012](#)]. Most frequent β^+ emitters produced in the human body are listed in the table 2.1. In soft tissues, the prominent radionuclide species are ^{11}C , ^{13}N and ^{15}O .

β^+ emitter	Half-life [min]	Reaction channel	Threshold energy [MeV]
^{15}O	2.037	$^{16}\text{O}(\text{p},\text{pn})$	16.79
^{11}C	20.385	$^{12}\text{C}(\text{p},\text{pn})^{11}\text{C}$	20.61
		$^{14}\text{N}(\text{p},2\text{p}2\text{n})^{11}\text{C}$	3.22
		$^{16}\text{O}(\text{p},3\text{p}3\text{n})^{11}\text{C}$	59.64
		$^{16}\text{O}(\text{p},\alpha\text{d})^{11}\text{C}$	27.50
^{13}N	9.965	$^{16}\text{O}(\text{p},2\text{p}2\text{n})^{13}\text{N}$	5.66
		$^{14}\text{N}(\text{p},\text{pn})^{13}\text{N}$	11.44
^{30}P	2.498	$^{31}\text{P}(\text{p},\text{pn})^{30}\text{P}$	19.7
^{38}K	7.636	$^{40}\text{Ca}(\text{p},2\text{p}2\text{n})^{38}\text{K}$	21.2

Table 2.1: Most frequent nuclear reactions in the human body for positron emitter production in proton therapy. Adapted from [[Beebe-Wang et al., 2003](#)]

For proton irradiation, dose monitoring by means of [PET](#) techniques was developed by different groups during the 90s and to-date it is the only established method in the clinical practice [[Knopf and Lomax, 2013](#)]. However, dose distributions cannot be directly correlated with the β^+ emitters activity due to differences in the physical processes involved.

[PET](#)-based treatment verification is performed as follows (cf. figure 2.11): a reconstructed image of the positron emission in the patient is retrieved from the information of the detector, but since a direct comparison is not possible, a reference must be created. [MC](#) simulations typically are performed in order to create a [PET](#) measurement estimation on the basis of the treatment plan, the time-course of irradiation, patient [CT](#), detector geometry and imaging procedure. This approach was first deployed by [Parodi et al. \[2007a\]](#) in proton therapy. The simulated proton fluence is convolved with the cross sections for the main reaction channels and then scaled with the target nuclei densities. Corrections for biological washout and radioactive decay are applied to those distributions and finally, the expected [PET](#) distribution is obtained applying a convolution kernel to model the resolution of the scanner. This reference distribution is compared with the measured [PET](#) data, which allows estimating whether the dose was delivered favourably [[Parodi et al., 2007a](#)].

Range verification accuracy of 1-2 mm was demonstrated in patients with skull base tumours (depth profiles shown in figure 2.12) due to the good immobilization and registration between treatment and imaging CT along with reduced washout in bony structures [Parodi et al., 2007b]. Nevertheless, in other anatomical sites, the accuracy is typically around 3-5 mm, indicating a lack of millimetre range accuracy for every tumour indication [Knopf and Lomax, 2013].

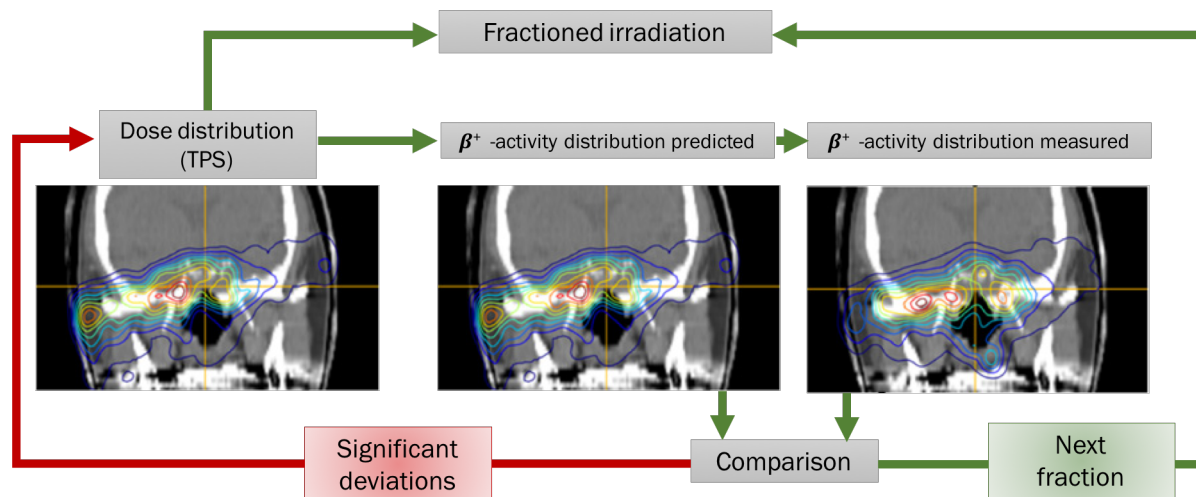

Figure 2.11: For a dose delivery scheme, the β^+ – activity distribution is computed via Monte Carlo simulations (predicted). Afterwards, a comparison with the measured activity is performed. If significant deviations are found corrections must be applied, otherwise the next fraction is delivered. Dose and β^+ activity are depicted as isolines superimposed onto the patient planning CT. Adapted from [Shakirin et al., 2011].

PET data acquisition is categorized in three different operational modalities:

- **In-beam PET:** The detector is integrated into the proton therapy delivery system enabling the acquisition during (for synchrotron-based facilities) or immediately after (for cyclotron-based facilities) irradiation. The strength of this technique is the time course of the acquisitions providing high β^+ activity levels for both long (e.g. ^{11}C and ^{13}N) and short (e.g. ^{15}O and ^{10}C) half-life components, which also reduce the effect of biological signal washout. Furthermore, the treatment position is preserved and uncertainties associated with patient repositioning or anatomical changes are minimised [Zhu and El Fakhri, 2013]. By contrast, among the disadvantages of in-beam PET systems are the expensive integration into the beam delivery and the demanding technical challenges that have to be faced during the implementation. Since geometrical limitations of the detector are one of the major obstacles, time-of-flight techniques have been proposed to reverse the effects of limited angle information [Crespo et al., 2007]. In addition, Tashima et al. [2016] developed a transformable PET system that can be placed around the patient table offering a visualisation of a physically opened space with an extended axial field-of-view [Yoshida et al., 2017].

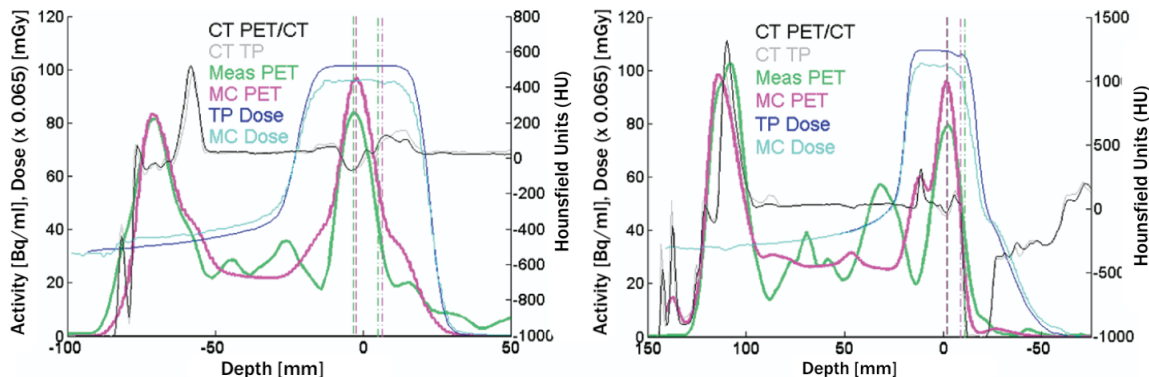

Figure 2.12: Measured (green) and calculated (magenta) activity depth profiles for the lateral (left) and posterior-anterior (right) fields taken along the center and at 5 mm offset of the 2D distributions for a patient with pituitary adenoma. Dashed and dashed-dotted lines mark the positions of the distal maximum and 50% fall-off, respectively. Planned (blue) and MC (cyan) dose are also depicted. The corresponding positions of the measured and predicted activity distal maximum and 50% distal fall-off agree within 0.6-1.9 mm. Adapted from [Parodi et al., 2007b].

Finally, an important aspect to take into account during the beam-on acquisition is the considerable prompt radiation background, which can saturate the signal of the detectors [Parodi, 2012].

- **In-room PET:** A stand-alone PET scanner is placed in the treatment room and the image is acquired immediately after the irradiation has finished. The first implementation was carried out by Zhu et al. [2011] in the proton therapy centre of the Massachusetts General Hospital. The use of a conventional full-ring detector eliminates the limited angle issue of the in-beam technique producing better quality images. Biological washout and uncertainties related to repositioning and anatomical changes are considerably reduced. However, the major drawback is the co-registration accuracy between the PET acquisition and the planning CT, since the comparison is made with CT-based simulated predictions, along with the limited field-of-view of the small-bore system [Parodi, 2012].
- **Off-line PET:** The image is acquired with a commercial PET device outside of the treatment area [Parodi et al., 2007b]; thus, the acquisition has a delay that depends on the distance to the imaging facility and related time for patient transfer and repositioning. As a consequence, there is a significant loss of counting statistics, because the contribution of short-live radionuclei species such as ^{15}O has vanished and the biological washout processes degrade the performance. These effects must be included in the simulation process in order to have a reliable comparison with the measured activity. Additional issues related to repositioning errors and anatomical changes should also be considered even though this can be compensated when using a combined PET/CT device.

As mentioned before, PET is the only imaging technique already clinically implemented for proton range verification in few centres that provides indirect, though relevant information about the dose deposition in the patient. However, technological and methodological improvements may be implemented for a more reliable correlation between the induced β_{\pm}^+ activity and the dose delivery. A better knowledge of the cross section values for the dominant emitters along with improved CT [Bauer et al., 2013; Berndt et al., 2017] and a better modelling of the biological washout could give a more accurate prediction of the simulated activity. Additionally, dedicated instrumentation and high-sensitivity detectors could improve the resolution of the images [Bisogni et al., 2016].

Ionoacoustics

Thermoacoustic detection of the Bragg peak is a consequence of the conversion of localized energy deposition to a mechanical pressure wave (ionoacoustic signal). Therefore, the correlation between both phenomena can be used to determine the proton beam range [Parodi and Assmann, 2015]. The feasibility of ionoacoustics was first investigated for beam diagnostics by Sulak et al. [1979] using 200 MeV and 158 MeV protons impinging onto a water phantom and measuring the signal of hydrophones placed at variables distances from the beam. They were successful in demonstrating how the thermal expansion produces the observed signals. However, the first clinical investigation was performed in the 90s by Hayakawa et al. [1995] during the proton irradiation of a liver cancer patient. At this time, the proof-of-principle was limited by the lack of tailored instrumentation and proton delivery systems, which produced complex ionoacoustic signals. Nowadays, ionoacoustics has raised a revived interest due to improved ion beam therapy systems and ultrasound technology along with the commercial establishment of intrinsically pulsed proton accelerators (synchrocyclotrons). The ability of this promising technique to characterise the dose distribution derives from the dominant mechanisms of energy transfer (electromagnetic interactions), and the monitoring of the beam range in the patient could be performed by overlapping ionoacoustic images of the Bragg peak with conventional ultrasound anatomy images [Lehrack et al., 2017].

By detecting and mathematically inverting the ultrasound waves produced upon the stopping of protons in water, as proposed by Kellnberger et al. [2016], the deposited dose profile could be reconstructed. It provides a direct measure of the energy deposition and enables ultrasound-diffraction limited imaging resolution (100-300 micrometers) within several centimetres penetration depth. The experimental set-up for the 3D ionoacoustic imaging for 20 MeV protons hitting a water target is shown in figure 2.13. The three-dimensional reconstructions of the Bragg peak are also depicted, including the effect on the proton range when a 0.5 mm thick aluminium absorber is introduced along the beam path. Bragg peak positions and FWHM of the lateral distribution are in good agreement with Geant4 MC simulations and previous 1D experimental measurements [Assmann et al., 2015]. Ionoacoustic imaging for range verification has demonstrated an accuracy better than 1.5 mm for homogeneous target irradiations although at still prohibitively high doses [Patch et al., 2016]. The feasibility of proton range assessment using a synchrocyclotron at clinical ener-

gies [Lehrack et al., 2017] has been proven, even though also in this case the required dose is exceeding the standard treatment regimes. Further detector developments and signal processing optimisation must be implemented to enable *in vivo* verification. A more challenging situation is encountered for heterogeneous scenarios, because different materials produce different pressure waves for the same energy deposition. Some simulation studies have been performed in order to model the generation and propagation of ionoacoustic signals based on CT data, but experimental validation still has to be done [Jones et al., 2018].

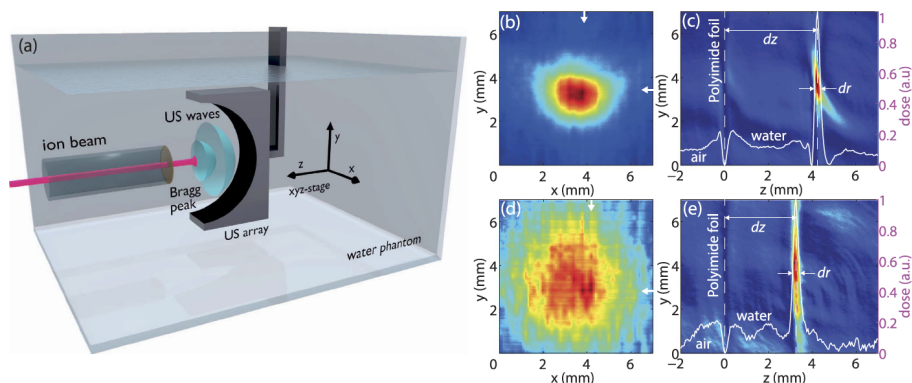

Figure 2.13: Experimental set-up (a) for 3D imaging of a 20 MeV proton beam. The ultrasound array was moved in lateral steps along the beam to record the data. Maximum intensity projection in the xy (b) and yz (c) -planes are reconstructed, range ($dz = 4.3 \pm 0.2$ mm) and FWHM ($dr = 0.28 \pm 0.05$ mm) agree well with previous measurements and Monte Carlo simulations. Range shifts (e) and changes in the lateral spread distribution (d) can be resolved by the 3D reconstruction [Kellnberger et al., 2016].

Prompt gamma monitoring

PGs are emitted during proton irradiation as consequence of nuclei de-excitation from nuclear interactions along the beam path (cf. section 2.1.4) with typical energies from 2 MeV to 15 MeV. These gammas were first identified as noisy events that are not straightforward to disentangle from the signal of β^\pm emitters in in-beam PET by Parodi et al. [2005] and the direct measurement of this signal for proton range verification was proposed one year later by Min et al. [2006].

This method has the advantage to enable real-time verification, since the PG emission is isotropic and can be detected within few nanoseconds after the nuclear interaction occurs. Theoretically, clinical doses are high enough to produce an acceptable rate of gammas in order to retrieve the information of the proton beam delivery. Theoretical aspects of prompt gamma imaging as well as a discussion about the detection methods including CC systems are presented in chapter 3.

“The language of science is universal, and is a powerful force in bringing the peoples of the world closer together.”

Arthur H. Compton

3

Prompt Gamma monitoring

Prompt gamma (PG) monitoring techniques for range verification are based on the detection of energetic photons (in the range of MeV) promptly emitted in the de-excitation stage of nuclei, which have undergone inelastic nuclear interactions during proton or ion therapy treatments. The feasibility of this method was first investigated using MC simulations by Jongen and Stichelbaut [2003] and experimentally verified by Min et al. [2006]. Potential application in clinical routine is justified because compared to PET monitoring, PGs are not affected by washout effects and their production cross section is much more favourable [Polf and Parodi, 2015]. Therefore, different groups worldwide have studied the correlation between the deposited dose and the PG emission as well as different detector modalities have been explored.

In this chapter, a complete overview of the state-of-the-art in PG detection as a range verification tool in proton therapy is presented. First, the rationale of PG emission is explained followed by the description of the different detection modalities that have been proposed during the last years. Finally, the CC systems which are investigated in this thesis are fully introduced.

3.1 Rationale of prompt gamma imaging

Nuclear excitations due to inelastic interactions of protons and target nuclei occur along the penetration path until some millimetres before the Bragg peak, where the energy of the primary protons drops below the reaction threshold, resulting in a distal fall-off correlated with the proton beam range [Knopf and Lomax, 2013]. A subsequent excited nucleus decays into lower energy states emitting photons. Above the particle emission and evaporation energies, this process competes with the emission of other secondaries as

protons, neutrons and alpha particles, originating residual nuclei that can be in an excited state [Verburg et al., 2012]. Thus, the gammas emitted from nuclear emission are either due to the target nuclei or any fusion/fission production and the resulting nucleus can decay through different channels.

Nuclei have quantised energy states with well-established properties and as long as the cross sections of the transitions are high enough, discrete gamma emissions can be extracted from the standard measurements [Verburg et al., 2012]. For lower incident proton beam energies, only some excitation levels can be reached and few discrete lines are distinguishable in the energy spectrum. At higher proton energies, many reaction channels are feasible and the spectrum is called the *quasi-continuum* [Murphy et al., 2009]. PG emission during proton irradiation depends strongly on the energy of the incident protons and the tissue composition of the target [Polf et al., 2009a]. The gamma lines from proton interaction with ^{12}C , ^{16}O and ^{14}N , the most abundant elements in the human body, are listed in table 3.1. The transitions indicate inelastic reactions from the first excited state to the ground state.

Target	Reaction channel	E_γ (MeV)	Transition $I_i^\pi, E_i^* \rightarrow I_f^\pi, E_f^*$	Mean life (s)
^{16}O	$^{16}\text{O}(p,p')^{16}\text{O}^*$	2.74	$2^- 8.87 \rightarrow 3^- 6.13$	1.8×10^{-13}
		6.13	$3^- 6.13 \rightarrow 0^+ \text{ g.s.}$	2.7×10^{-11}
		6.92	$2^+ 6.92 \rightarrow 0^+ \text{ g.s.}$	6.8×10^{-14}
		7.12	$1^- 7.12 \rightarrow 0^+ \text{ g.s.}$	1.2×10^{-19}
	$^{16}\text{O}(p,x)^{12}\text{C}^*$	4.44	$2^+ 4.44 \rightarrow 0^+ \text{ g.s.}$	6.1×10^{-14}
		$^{16}\text{O}(p,x)^{15}\text{N}^*$	5.27	$\frac{5}{2}^+ 5.27 \rightarrow \frac{1}{2}^- \text{ g.s.}$
^{12}C	$^{12}\text{C}(p,x)^{11}\text{C}^*$	2.00	$\frac{1}{2}^- 2.00 \rightarrow \frac{3}{2}^- \text{ g.s.}$	1.0×10^{-14}
	$^{12}\text{C}(p,p')^{12}\text{C}^*$	4.44	$2^+ \rightarrow 4.44 0^+ \text{ g.s.}$	6.1×10^{-14}
^{14}N	$^{14}\text{N}(p,p')^{14}\text{N}^*$	1.64	$1^+ 3.95 \rightarrow 0^+ 2.31$	6.9×10^{-15}
		2.31	$0^+ 2.31 \rightarrow 1^+ \text{ g.s.}$	6.9×10^{-15}
		5.11	$2^- 5.11 \rightarrow 1^+ \text{ g.s.}$	6.3×10^{-12}

Table 3.1: Relevant reaction channels for prompt gamma emission in proton therapy (g.s. ground state). Data available from [Kozlovsky et al., 2002] and [Verburg et al., 2012].

For ^{16}O the discrete lines at 6.13, 6.92 and 7.12 MeV are the most dominant gamma emissions for low incident proton beam energies [Tilley et al., 1993]. For proton energies above 15 MeV, the reactions $^{16}\text{O}(p,x)^{12}\text{C}^*$ result in a notable increment of 4.44 MeV PGs from the residual $^{12}\text{C}^*$. The dominant gamma emission contribution for proton reactions with ^{12}C is the 4.44 MeV line, which apart from the $^{12}\text{C}(p,p')^{12}\text{C}^*$ reaction includes also small contributions from $^{12}\text{C}(p,2p)^{11}\text{B}^*$. Levels above the 4.44 MeV line, coming from ^{12}C

reactions, mostly decay through alpha emission [Ajzenberg-Selove, 1990]. On the other hand, the role of ^{14}N is less significant, because the abundance in tissues is lower compared to oxygen and carbon. Its more important gamma emissions are at 2.31, 1.64 and 5.11 MeV. Figure 3.1 depicts the cross sections of the relevant components of tissue for proton irradiation.

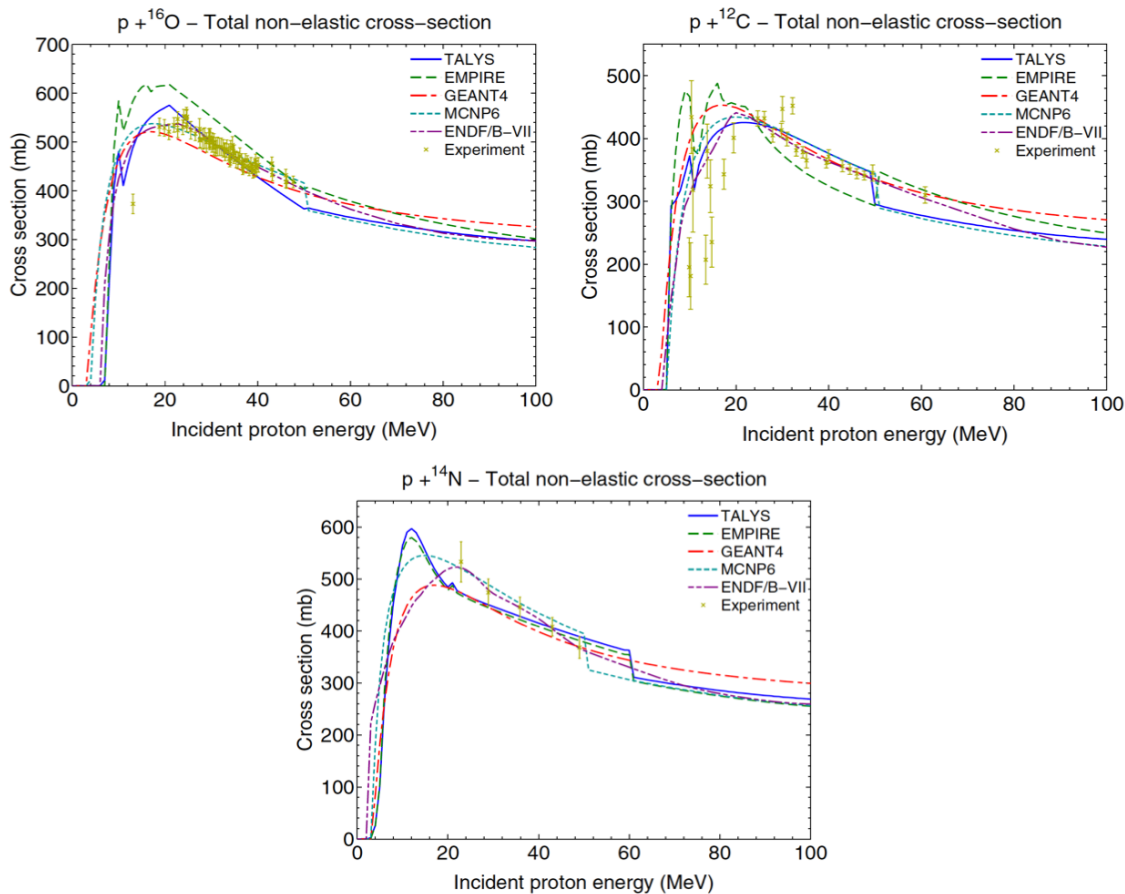

Figure 3.1: Total cross sections for proton induced reactions with carbon, oxygen and nitrogen calculated by nuclear reaction models of different MC codes and dedicated simulation models [Verburg et al., 2012]. Experimental data were plotted from Bauhoff [1986].

The isotropic emission of PGs is much more favourable than PET as a range verification tool. Prompt gammas can be detected within few nanoseconds after the nuclear interaction and have theoretically high production rates for a typical therapeutic dose rate of 2 Gy/min [Moteabbed et al., 2011]. Moreover, if the longitudinal dose profile is compared with the emission distribution of prompt secondary particles (as shown in figure 3.2), PGs are well-correlated with the primary range, preserving the information of their initial direction while traversing the target [Krimmer et al., 2018].

The first experimental attempt to measure the correlation between the PG emission and

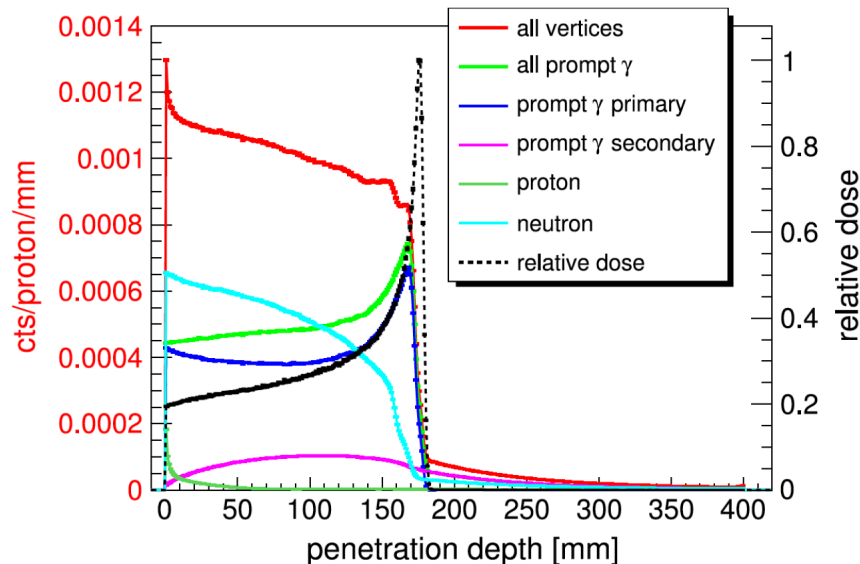

Figure 3.2: 1D distributions of secondary prompt radiation with energies above 1 MeV emerging from the simulation (Geant4) of a cylindrical water phantom irradiated by a 160 MeV proton beam [Krimmer et al., 2018]. The correlation between the PGs and the dose profile justifies the development of a tool to retrieve the proton range based on these physical quantities.

the distal fall-off of the dose profile was performed by Min et al. [2006]. A shielded detector was used in order to mitigate the signal from fast neutrons and measure only the gammas passing through a collimator hole emitted perpendicular to the beam direction. Three layers are depicted in the schematic drawing of figure 3.3a: the paraffin layer and the B_4C powder moderating and then capturing high energy neutrons together with products of the $B(n,\gamma)$ reaction and at the end a lead layer to stop unwanted gammas. The measurements, choosing a lower threshold of 4 MeV for the gamma detection, proved a clear correlation between the maximum of the prompt gamma distribution and the Bragg peak location, for example the agreement was within 1-2 mm at 100 MeV (cf. figure 3.3b). For high energy (150 MeV and 200 MeV) proton beams the distal fall-off of the gammas is reduced due to the background of high energy neutrons and broader due to the increased range straggling.

In the subsequent years, different groups demonstrated the feasibility of range verification by means of PG distributions for clinical mono-energetic proton pencil beams. Dedicated detector systems were successful in measuring PG signals from plastic phantom irradiation scenarios (Polf et al. [2009a,b]). MC simulations for homogeneous irradiation scenarios carried out using custom-built prototype systems showed a reasonable correlation between the retrieved signal and the depth-dose profile (Kang and Kim [2009]; Frandes et al. [2010]; Richard et al. [2011]). Furthermore, the viability of PG verification for passively scattered SOBP fields has been theoretically demonstrated (Polf et al. [2009a]; Moteabbed et al. [2011]; Testa et al. [2014]).

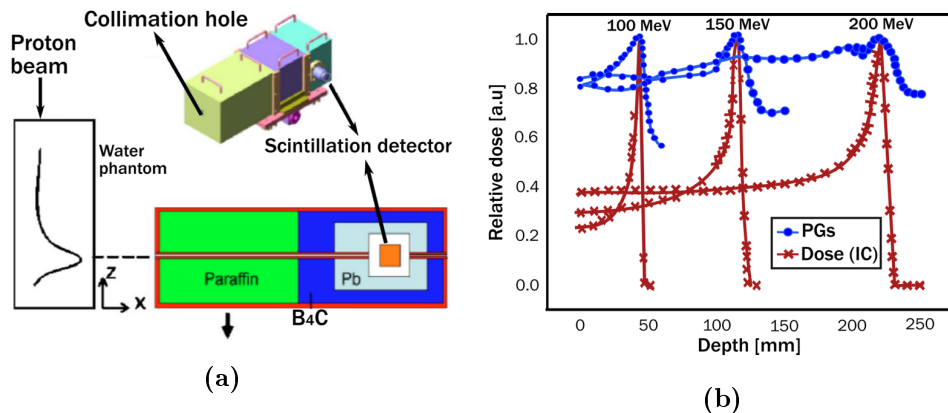

Figure 3.3: Scanning system set-up (figure 3.3a) used to detect PGs near to the dose fall-off region. For three different beam energies (100, 150 and 200 MeV) the measured depth-dose is correlated with the PG distribution as depicted in figure 3.3b. Adapted from [Min et al., 2006].

The prompt emission of gammas within the tissue is dependent on the proton beam energy as well as the elemental composition of the irradiated material [Polf et al., 2009b]. Those differences enable methods to determine the elemental composition of the target by measuring the spectral information of the PGs. Polf et al. [2013] measured the PG emission spectra for different tissue-equivalent solutions with a high-purity germanium detector. The results showed a linear relationship between the weight of the ^{16}O emission line and the amount of oxygen within the irradiated target (cf. figure 3.4). This information is valuable, for instance when the level of tumour hypoxia is monitored during the treatment. Furthermore, spectroscopy measurements on an active-scanning proton beam-line have been performed by Verburg et al. [2013], who was able to clearly resolve the discrete lines at 4.44, 5.2 and 6.13 MeV in terms of energy and time.

Clinical application of PG range verification requires an optimised detector capable of measuring high energy gammas at high count rates. The neutron background rejection also plays an important role as well as the adaptation of the system to the beam time structure. Dedicated groups have developed several approaches in order to build a suitable prototype, which can be used in treatment scenarios.

3.2 Interactions of radiation with matter

3.2.1 Interactions of photons with matter

Compton effect

The Compton effect (Compton scattering) describes the interaction between a photon of certain initial energy with a loosely bound orbital electron. The first measurements of this effect were made by Compton [1923], who demonstrated a relation between the scatter

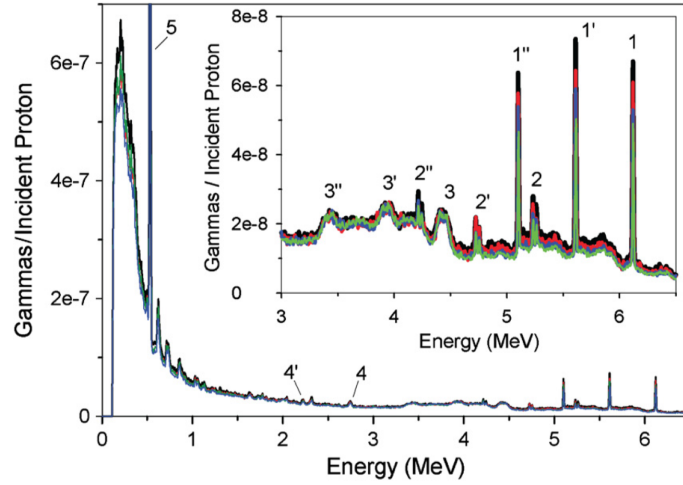

Figure 3.4: Spectrum of PGs emitted during the irradiation with a 48 MeV proton pencil beam for four different samples: H_2O (black line), $\text{H}_2\text{O} + 25$ g of $\text{C}_{12}\text{H}_{12}\text{O}_{11}$ (red), $\text{H}_2\text{O} + 75$ g of $\text{C}_{12}\text{H}_{12}\text{O}_{11}$ (blue) and $\text{H}_2\text{O} + 130$ g of $\text{C}_{12}\text{H}_{12}\text{O}_{11}$ (green). The prompt gamma emission, single and double escape peaks for ^{16}O (1, 1', 1''), ^{15}O (2, 2', 2'') and ^{12}C (3, 3', 3'') are depicted. The line for the positron annihilation gamma peak is labelled as 5 [Polf et al., 2013].

angle and the initial and final wavelength of the photon. The theory assumes that the photon interacts with a free and stationary electron. A scheme of a typical Compton scattering interaction is shown in figure 3.5. The scattering angle θ is defined as the angle between the incident photon direction \vec{r}_i and the scattered photon direction \vec{r}_g , taking values in the range $[0 \leq \theta \leq 180]$. The recoil electron angle ϕ is the angle between the incident photon direction \vec{r}_i and the direction of the recoil Compton electron \vec{r}_e ranging between $[0 \leq \phi \leq 90]$.

The kinematics of Compton scattering are derived by using the relativistic relationships for the total energy and momentum conservation (assuming a “free electron” at rest):

$$\begin{aligned} E_i + m_e c^2 &= E_g + E_e \\ \vec{p}_i &= \vec{p}_g + \vec{p}_e \end{aligned} \quad (3.1)$$

where E_i and E_g are the energy of the incident and scattered photon, respectively. $m_e c^2$ is the rest energy and E_e is the total energy of the recoil electron. \vec{p}_i , \vec{p}_g and \vec{p}_e are the momentum of the incident photon, scattered photon and recoil electron, respectively.

The total energy of the recoil electron is given by $E_e = \sqrt{(m_e c^2)^2 + p_e^2 c^2}$, applying the relativistic energy-momentum relation; the energy of the scattered photon is correlated with its momentum by $E_g = p_g c$. The well-known *Compton equation* results after combining the different relations:

$$\cos \theta = 1 + m_e c^2 \left(\frac{1}{E_g + E_e} - \frac{1}{E_e} \right) \quad (3.2)$$

Compton was awarded with the Nobel Prize in Physics for his discovery in 1927.

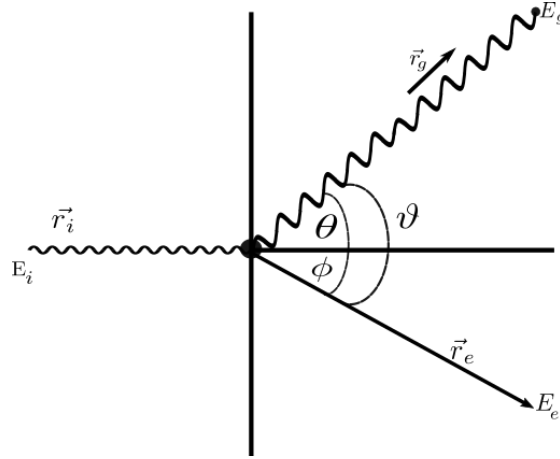

Figure 3.5: Schematic representation of the Compton effect and notation of the different quantities being used throughout this work. An incident photon with energy E_i is scattered in a certain material along its path with a scattering angle θ . Due to energy conservation, the difference between the incident and the scattered photon energy is given by the kinetic energy of the recoil electron E_e . The recoil electron ϕ and the total scattering ϑ angles are also shown.

Equation 3.2 puts some restrictions to the energy of the scattered gamma and the recoil electron to get physically meaningful scattering angles (the domain of arccos is $[-1, 1]$):

$$\begin{aligned} \frac{m_e c^2 E_i}{2E_i + m_e c^2} < E_g < E_i \\ 0 < E_e < \frac{2E_i^2}{2E_i + m_e c^2} \end{aligned} \quad (3.3)$$

The limits of equation 3.3 correspond to forward scattering, i.e., scattering angle $\theta = 0$ and electron recoil angle $\phi = 90^\circ$ and photon backscattering i.e., scattering angle $\theta = 180^\circ$ and electron recoil angle $\phi = 0^\circ$. Likewise, expressions for the recoil scatter angle and the total scattering angle can be obtained:

$$\cos \phi = \frac{E_e(E_i + m_e c^2)}{E_i \sqrt{E_e^2 + 2E_e m_e c^2}} \quad (3.4)$$

$$\cos \vartheta = \frac{E_e(E_g - m_e c^2)}{E_g \sqrt{E_e^2 + 2E_e m_e c^2}} \quad (3.5)$$

Klein and Nishina [1929] derived an expression for the electronic cross section of Compton interaction per unit solid angle given in $[(\text{cm}^2/\text{electron})/\text{steradians}]$:

$$\frac{d_e \sigma_c^{KN}}{d\Omega} = \frac{r_e^2}{2} \left(\frac{E_g}{E_i} \right)^2 \left\{ \frac{E_g}{E_i} + \frac{E_i}{E_g} - \sin^2 \theta \right\} \quad (3.6)$$

where R_e is the classical radius of the electron (2.82 fm). For most materials, the aforementioned equation 3.6 remains an approximation because it assumes unbound electrons at rest.

The differential Compton electronic cross section versus the scattering angle in polar coordinates is plotted in figure 3.6a for different incident photon energies. For low energies, the probabilities for forward ($\theta = 0$) and backscattering ($\theta = \pi$) are equal. When the incident energy increases, the scattering becomes more forward peaked and backscattering drops off even though the forward scattering probability remains constant.

The directional distribution of the scattered photons and the recoil electrons provides practical information about the overall Compton scattering behaviour in terms of the cross section per unit scattering angle (eq. 3.7) and per unit recoil angle (eq. 3.8):

$$\frac{d_e\sigma_c^{KN}}{d\theta} = \frac{d_e\sigma_c^{KN}}{d\Omega} \frac{d\Omega}{d\theta} \quad (3.7)$$

$$\frac{d_e\sigma_c^{KN}}{d\phi} = \frac{d_e\sigma_c^{KN}}{d\Omega} \frac{d\Omega}{d\phi} \quad (3.8)$$

Figure 3.6b shows how these cross sections are varying with the angles for four different incident energies. $\frac{d_e\sigma_c^{KN}}{d\theta}$ and $\frac{d_e\sigma_c^{KN}}{d\phi}$ for low energies exhibit curves with two maxima: $\theta = 55^\circ$ and $\theta = 125^\circ$, which correspond to $\phi = 62.5^\circ$ and $\phi = 27.5^\circ$ in the electron curve, respectively. The curves become asymmetrical with increasing energy and the maximum is pushed to smaller angles in both cases.

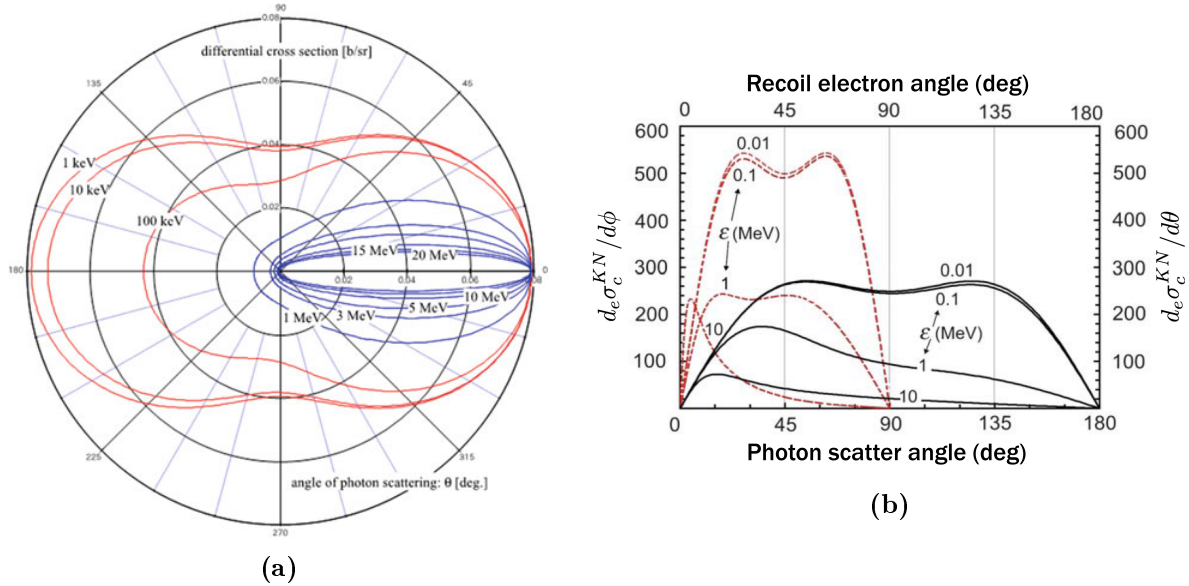

Figure 3.6: Differential electronic cross section given by the Klein-Nishina equation as a function of the incident energy (3.6a) displayed in the polar coordinate system [Nishio, 2015]. The differential cross section can be expressed in terms of the scattering angle θ and the recoil electron angle ϕ as depicted in the Cartesian representation in figure 3.6b for different values of $\epsilon = h\nu/m_e c^2$. $\frac{d_e\sigma_c^{KN}}{d\theta}$ vs. θ (black solid line) and $\frac{d_e\sigma_c^{KN}}{d\phi}$ vs. ϕ (red line) are plotted for four values of ϵ [Podgorsak, 2010].

The Compton effect becomes slightly less likely in high Z materials, because as the atomic number rises, the density of electrons falls slowly. Additionally, incoherent scattering decreases with energy making this interaction more relevant as photon energies rise above the K-shell binding energies of the orbital electrons [Podgorsak, 2010].

Doppler broadening in the measured Compton spectra due to the velocity distribution of the orbital electrons was introduced by Mond [1929]. A modification of the Klein-Nishina cross section was introduced by Ribberfors [1975] to take into account this effect by including an additional function S_i^I that depends on the scattering material and the incident energy of the photons:

$$\left(\frac{d_e\sigma_c}{d\Omega}\right)_{bound} = \left(\frac{d_e\sigma_c^{KN}}{d\Omega}\right)_{unbound} S_i^I(E_i, \theta, Z) \quad (3.9)$$

Several aspects have to be considered when the assumption of the free-electron at rest is no longer valid [Zoglauer and Kanbach, 2003]. For low energy photons, the event distribution and the detector sensitivity change because the cross sections are slightly higher than the values predicted by the Klein-Nishina equation (cf. equation 3.6). Furthermore, small variations in the scattering angle distribution can appear. The significant impact on the performance of CC detectors (because photons of several MeV are affected) is due to the disagreement between the measured scattering angle and the computation of equation 3.2, which causes a broadening of the lines in the energy spectra and decreases the image resolution.

Photoelectric effect (Photoelectric absorption)

In this interaction the energy of the incident photon E_i is transferred entirely to a bound electron of an absorber atom followed by its ejection with kinetic energy E_k . In contrast to Compton scattering, the photoelectric effect occurs when the electron is tightly bound having a binding energy E_B . Subsequently, the vacancy in the K-shell (85% of the times) is filled with a higher orbit electron and the transition energy is emitted either in form of characteristic photons (fluorescence) or Auger electrons. The kinetic energy E_k of the ejected photo electron is the incident photon energy minus the binding energy of the orbital electron:

$$E_K = h\nu - E_B \quad (3.10)$$

This energy may be insufficient to eject the photo electron from the atom, so-called atomic ionization process, although it may be sufficient to raise it into a higher orbit by atomic excitation.

The atomic cross section for the photoelectric effect is a function of both the incident photon energy and the atomic number of the target material. The energy dependence is approximately proportional to $1/(h\nu)^3$ at low energies and to $1/(h\nu)$ at higher photon energies. On the other hand, the atomic cross section changes as Z^n , where n ranges approximately from 4 to 5. Figure 3.7 depicts the attenuation coefficient for the photoelectric

absorption of the different materials used for the CC detectors in this thesis. The particular sharp discontinuities, called absorption edges, arise when the photon energy coincides with the binding energy of a particular electron shell.

Pair production

Pair production describes the conversion of an incoming photon with an energy exceeding $2m_e c^2$ (twice the rest energy of the electron) into an electron-positron pair. The effect has to fulfil energy, charge and momentum conservation simultaneously. Since the production in free space does not satisfy the momentum conservation, the interaction can only occur in the presence of the Coulomb field of an atomic nucleus or an orbital electron.

In the standard pair production, the excess of momentum is taken by the nucleus. $2m_e c^2$ of the initial photon energy is spent in the electron-positron pair production; the rest is shared as kinetic energy between the two particles leaving the interaction site. The positron releases all of its kinetic energy and quickly recombines with a nearby electron. The annihilation typically results in two photons of energy $m_e c^2 = 0.511$ MeV moving in opposite directions (at nearly 180°) ensuring energy, momentum and charge conservation. The probability of pair production (cf. figure 3.7) is evidently zero at very low photon energies. Above the threshold, it increases rapidly with the incident photon energy but then saturates. Furthermore, the pair creation cross section varies roughly with Z^2 of the absorber material.

Triplet production is a special case of pair production which occurs in the electric field of an atomic electron, therefore recoiling with sufficient energy to be ejected from the atomic shell. Three electrons appear as result of the interaction. Triple production has an energy threshold at $4m_e c^2$ (2.04 MeV) and approximately varies as Z although the Z dependence becomes weaker with higher atomic numbers due to screening of the electric fields of the target entities by the surrounding atomic electrons [Mayles et al., 2007].

3.2.2 Interactions of electrons with matter

Molière multiple elastic scattering

Molière scattering [Moliere, 1955] refers to the process experienced by an electron moving through an absorber material that results in many small-angle scattering events. The interactions are characterized by their random nature being roughly Gaussian for small deflection angles but at larger angles those events can be described by Rutherford-type Coulomb interactions.

An approximation (generally used for experimental purposes) for the standard deviation δ_o of the angular distribution projected on a scattering plane is given by [Beringer et al., 2012]:

$$\delta_o = \frac{13.6 \text{ MeV}}{\beta c p} z \sqrt{x/X_0} [1 + 0.038 \ln(x/X_0)] \quad (3.11)$$

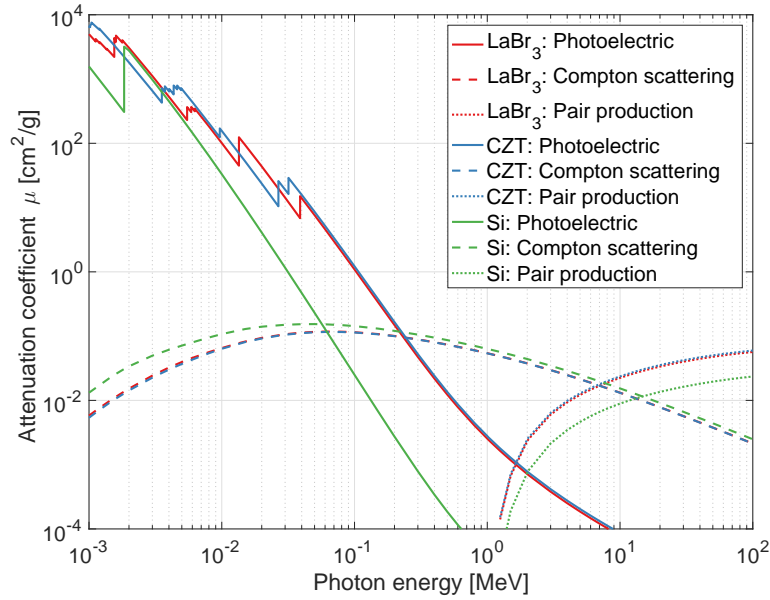

Figure 3.7: Attenuation coefficients as a function of photon energy for the materials used in this work. Data were plotted from NIST 2010.

Here βc , p and z are the velocity, the momentum and the charge of the incident electron, respectively. x/X_0 is the thickness of the scattering medium in radiation lengths (i.e., the mean distance over which a high-energy electron loses all but $1/e$ of its energy by bremsstrahlung). The value of δ_o according to equation 3.11 is accurate to 11% or better for $10^{-3} < x/X_0 < 100$ [Beringer et al., 2012].

Multiple scatter interactions have additional consequences for measuring the tracks. Since the electron loses energy along the track and consequently δ_o increases with decreasing energy, the average recoil angle becomes larger along the path. Furthermore, the angular distribution approximation assumes that the electron will pass the material layer completely. This is not thoroughly accurate for the interaction in the layer where the Compton scattering occurs. Consequently, the effect of the Molière scattering is reduced by up to 50% for the electron emerging from the conversion layer [Zoglauer, 2005].

Inelastic collisions

Inelastic interactions deflect electrons from their original path transferring energy to an orbital electron mostly at low energies or emitting radiation in form of bremsstrahlung that dominates above a few tens of MeV in most materials. When an electron undergoes a collision with an orbital electron, the Coulomb interactions result in ionisation and excitation of the absorber atoms. The incident electrons can transfer a considerable amount of energy to an inner-shell electron. Subsequently, the electron is ejected. The mass collision stopping power can describe the energy losses due to these inelastic interactions:

$$\frac{S_{col}}{\rho} = \frac{1}{\rho} \left(\frac{dE_k}{dx} \right)_{col} \quad (3.12)$$

here, $\frac{dE_k}{dx}$ represents the kinetic energy lost by the electron per unit path length.

Bremsstrahlung is emitted due to the acceleration caused by the electrostatic field of the atoms. The electron, while passing near a nucleus, may suffer deflection and acceleration, which result in velocity changes. Therefore, the electron may lose all or part of its kinetic energy in the form of X-rays with a continuous spectrum from zero to the maximum kinetic energy of the incident electron. The acceleration is proportional to Z/m , where m is the mass of the moving particle, while the intensity of the produced radiation is proportional to $(Z/m)^2$. The direction of photon emission depends on the energy of the incident electron. As the kinetic energy increases, the direction becomes increasingly forward peaked.

3.3 Prompt gamma detection devices

PG detection systems can be divided in PG collimated and integrated yields counting devices [Krimmer et al., 2018].

3.3.1 Integrated yields counting systems

Prompt gamma timing

PG timing is based on the physical fact that particles traversing tissue require a finite transit time (about 1-2 ns) until stopping in the target. This time is range dependent causing a measurable effect, which can be used for range assessment. The idea was originally proposed by Golnik et al. [2014] being experimentally tested in the irradiation of a graphite target with a 150 MeV proton beam. Shifts in the PG timing spectra were visible using a cylindrical GAGG:Ce (cerium-doped $Gd_3Al_2Ga_3O_{12}$) scintillator for different target positions (c.f. figure 3.8). Similar results were obtained for varying the proton beam range from 2.0 to 17.0 cm. Based on MC studies, the feasibility of PG timing in inhomogeneous targets was also confirmed [Golnik et al., 2014].

Range differences of 2.0 mm were resolved in the first experimental test with heterogeneous phantoms based on the timing distributions of 10^{10} protons. For less statistics the minimum detected range shift was not exceeding 5.0 mm [Hueso-González et al., 2015]. Regardless of these promising results, PG timing encountered some considerable limitations. First, the radio frequency signal (used as a time reference) was found to be unstable on a long-term time scale causing drifts in the same order of magnitude as the proton range shift. Moreover, the detector must be capable of handling the high acquisition rates expected in a clinical treatment fraction and accurate models should be implemented to obtain a quantitative measurement of the particle range [Pausch et al., 2016]. Nevertheless, many of these obstacles can be overcome and several efforts are ongoing to improve the method and translate it to clinical scenarios.

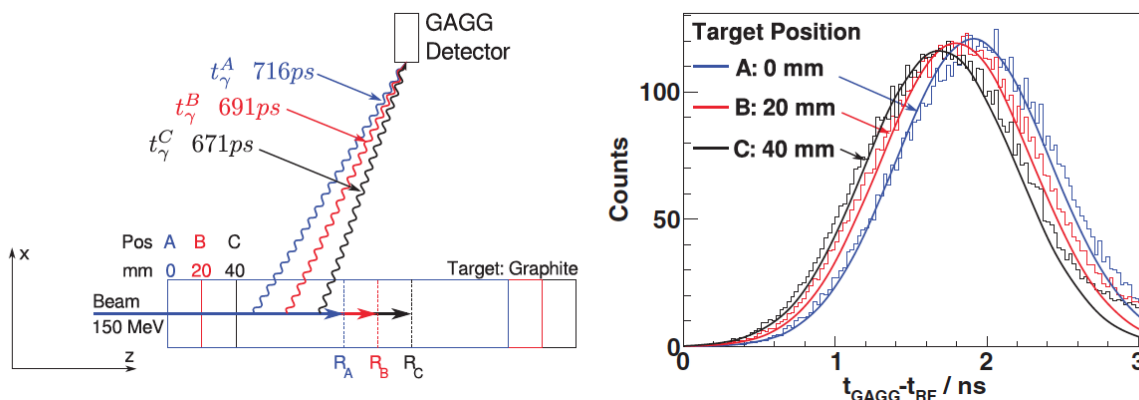

Figure 3.8: A graphite target ($\rho = 1.7 \text{ g/cm}^3$) was irradiated with a 150 MeV proton beam at three different positions as depicted on the left. The measured PG timing spectra at A, B and C are shown together with the corresponding modelled data (solid line) on the right [Golnik et al., 2014].

Prompt gamma peak integral

The peak integrals of PG time-of-flight (TOF) distributions were exploited by Krimmer et al. [2017] to detect deviations in proton therapy treatments. An affordable and independent monitoring system was implemented in order to retrieve the TOF information providing a reliable way to discriminate the PGs produced in the beam line from those generated in the target [Krimmer et al., 2017].

Test experiments were performed by irradiating a homogeneous PMMA phantom with 65 MeV protons at a clinical cyclotron. Cerium-doped LaBr₃ and BaF₂ scintillator detectors measured the PG rays using a dedicated data acquisition readout. External signals (as the accelerator radio frequency or a beam monitor) were established as the time reference for the TOF determination and the modulator wheel was used to modify the proton range inside the target [Krimmer et al., 2018]. Measurements showed that PG peak integrals are sensitive to variations in the registered prompt gamma ray counts. This fact can be translated in the detection of 3.0 mm range shifts in PMMA for 10^8 incident protons with detectors covering a solid angle of 25 msr. However, the prediction of the expected PG signal must be integrated into the treatment planning system and improved and fast MC techniques able to calculate the distributions for real patient data are required [Krimmer et al., 2017].

Prompt gamma spectroscopy (PGS)

The PG spectroscopy technique verifies the proton beam range by comparing the measurements of discrete PG emission lines with a model, which uses experimental nuclear reaction cross sections [Verburg et al., 2012]. Differential cross section measurements were performed by Verburg and Seco [2014] using a cerium-doped LaBr₃ crystal actively shielded

with BGO crystals. Additionally, the scintillator detector is placed behind a lead shielding. Different phantoms were irradiated at a clinical cyclotron and shifts in the range were introduced by adding plastic slabs in the beam path. The detection system is capable of performing energy- and time-resolved PG ray measurements as depicted by the histogram in figure 3.9a [Verburg and Seco, 2014]. In addition, fifteen different PG emissions from proton-nuclear interactions with ^{12}C and ^{16}O were measured and fitted to modelled yields from optimized cross sections (cf. figure 3.9b). With this information, the target composition can be retrieved. A proper correlation between the measured gamma counts and the proton beam range enables an accurate method for the detection of relative range shifts [Verburg and Seco, 2014].

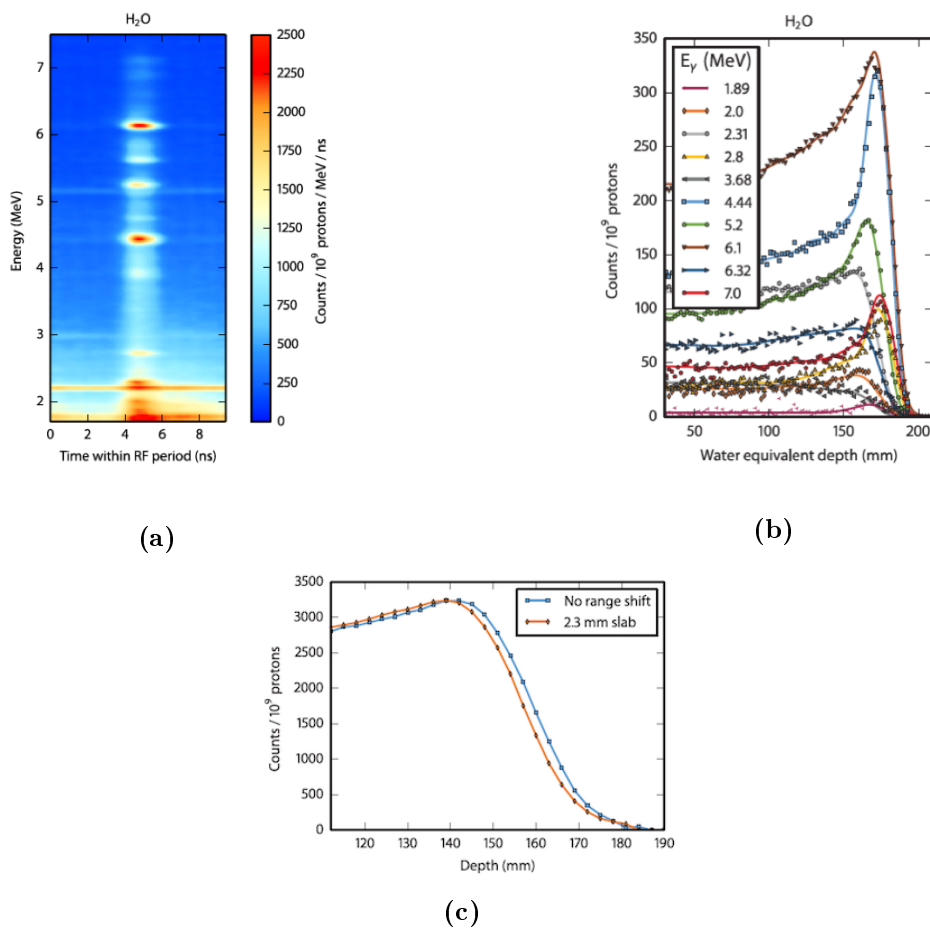

Figure 3.9: Measured energy- and time- resolved PG emission histogram for a H₂O phantom irradiation (figure 3.9a). Data measured for the cross section optimization is depicted in figure 3.9b for the same scenario and the lines represent the fitting to model calculations. For the detection of relative range shifts, the total PG counts around the position of the Bragg peak are measured with and without plastic slabs along the beam path. The range difference is identified as the shift between the two curves (figure 3.9c) [Verburg and Seco, 2014].

3.3.2 Collimated systems

Pinhole/knife edge cameras

High energy PGs can be detected applying the same principle as an optical pinhole camera. A proof of principle study was performed by Jong-Won [2009] using a CsI(Tl) scintillation detector behind a pinhole aperture located at the end of the range of a 50 MeV proton beam hitting a water target. Since for range monitoring the meaningful information is contained in the PG distribution profile, a relatively simple detector combining a gamma camera and a knife-edge-shaped slit placed perpendicular to the beam direction might provide one- or two-dimensional information about the PG production inside the target [Bom et al., 2012]. The first knife-edge camera prototype consisted of the HiCam gamma camera and a 1.0 cm thick LYSO crystal with a slit collimator [Smeets et al., 2012]. The system was built by the company IBA in collaboration with Politecnico di Milano. The geometry was optimised by performing an extensive MC study. The first test for homogeneous targets established the feasibility to detect 1.0-2.0 mm range deviations with doses around 25 cGy for 100 and 160 MeV protons [Smeets et al., 2012]. In order to improve the counting statistics and the photon-detection efficiency, a second generation of the prototype was built using LYSO scintillator slabs read by silicon photomultipliers. For PG profiles measured for homogeneous targets, a precision of 4.0 mm (2σ) was achieved applying an energy window of 3-6 MeV [Perali et al., 2014]. In contrast, low-density regions inside inhomogeneous tissue-equivalent targets required at least 7.0 mm penetration depth beyond the air cavity for reliable detection [Priegnitz et al., 2015]. The knife-edge shaped slit camera operation is based on a spot by spot range measurement and the feasibility for detecting range mixing whilst traversing lateral inhomogeneities was demonstrated in high weighted spots ($\sim 10^8$ protons) by analysing the distal edge slope of the PG profiles [Priegnitz et al., 2016].

The first clinical implementation of this PG monitoring technique was using a prototype of the knife-edge shaped slit camera during a proton treatment of a head and neck tumour at OncoRay in Dresden, Germany [Richter et al., 2016]. Although the camera was originally designed for pencil beam scanning, the measurements were performed using passively scattered proton therapy. PG profiles were measured during the course of the treatment, i.e., seven consecutive fractions, detecting inter-fractional global range variations in the order of ± 2.0 mm, which was in agreement with the information of control CTs [Richter et al., 2016]. Figure 3.10 shows a picture of the camera trolley during the proton treatment along with the (smoothed) measured PG profiles for each one of the fractions after background subtraction. A second clinical implementation was conducted by Xie et al. [2017] in pencil beam scanning proton therapy for a brain cancer patient at the University of Pennsylvania. The average shift was 1.0 to 2.0 mm, which is below the clinical fixed distal margin of 5.0 mm. However, the retrieved measurement is sensitive to the camera positioning, which means that the alignment should be performed with respect to the patient along the beam direction rather than the beam isocenter. Clinical application for more complex targets, which increases the difficulty of the spot by spot analysis and the neighbouring pencil beam aggregation, remains to be explored. On the other hand, the

technique still faces challenges, for instance device positioning, strength of the measured signal and the data post-processing, which need to be overcome in order to acquire a key role during the clinical treatment work-flow [Xie et al., 2017].

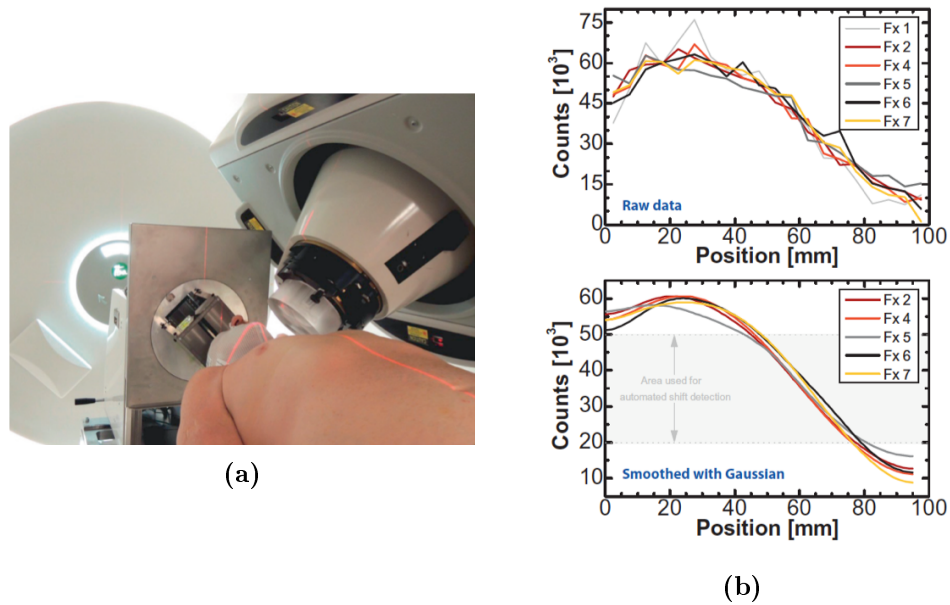

Figure 3.10: Placement of the slit camera trolley during patient treatment (figure 3.10a). The net sum PG profiles before (upper panel) and after (lower panel) background subtraction and smoothing are depicted in figure 3.10b. The grey area was used for automated shift detection and fraction one was excluded due to the high grade of non-uniformity in the region of maximum count rate [Richter et al., 2016].

Multi-slit camera

The multi-slit configuration (cf. figure 3.11) is based on detectors behind parallel slit collimators placed perpendicular to the proton beam direction. Gammas produced in the target should pass through the corresponding collimator slit for the counts to be registered. The acquired PG distribution is correlated with the distal dose fall-off location and knowing the entrance position the proton range is obtained [Min et al., 2012; Krimmer et al., 2015]. Measurements of PG yields as a function of depth in the target have been conducted by Pinto et al. [2015] using crystal scintillators and by Kelleter et al. [2017] using semiconductor detectors. Among the advantages of multi-slit cameras are the possibility to enlarge the field of view to encompass the complete beam path in the target, good spatial resolution (allowing to retrieve the sharp distal fall-off) compared with other detection systems and no need of a reconstruction algorithm. However, inter-detector scattering might occur causing blurred signals [Pinto et al., 2014].

Optimization techniques have been proposed in order to reduce the neutron background and the effect of scattered prompt gammas in the detector system. The use of TOF

[Biegun et al., 2012] enhances the performance of the technique by increasing the signal-to-background ratio, which translates into an improved precision to resolve range shifts by a factor equal to the square root of the background reduction [Roellinghoff et al., 2014].

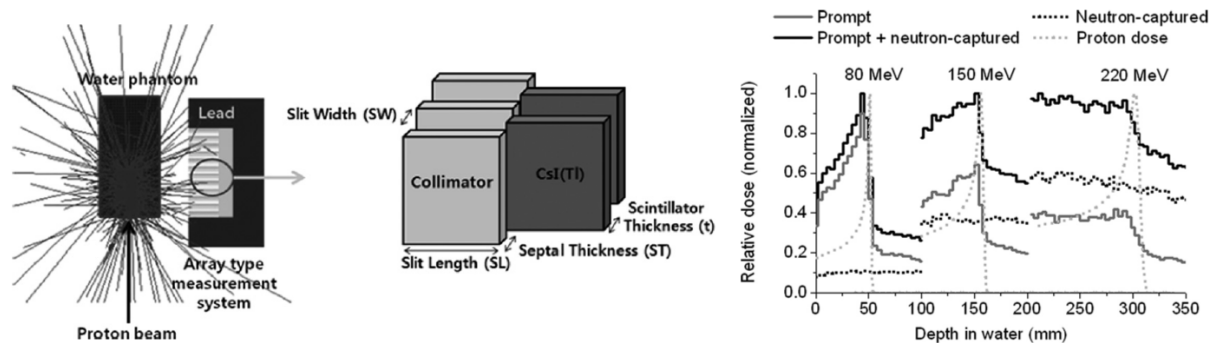

Figure 3.11: Schematic set-up of an array-type PG detection system using CsI(Tl) scintillation detectors. The measured gamma distributions for proton beams of 80, 150 and 220 MeV are shown on the right. The probability of neutron production increases with the energy of the protons. However, the good correlation between the PG distribution and the proton dose is confirmed [Min et al., 2012].

3.4 Compton camera detectors

A Compton camera (CC) system is an assembly of two or more detectors capable of measuring position and energy deposition for each interaction. By means of the Compton kinematics, the direction of an incident gamma is restricted to the surface of a cone with an aperture equal to the Compton scattering angle. The vertex of the generation is obtained by intersecting multiple cones from the detector acquisition. A CC for medical imaging was first proposed by Todd et al. [1974] and later investigated by Everett et al. [1977] using a simplified detector prototype with two segmented semiconductor layers. Simulations were performed to study the sensitivity and resolution effects. CCs have emerged as a suitable alternative for PG *in vivo* range verification. In principle, 3D photon emission information can be retrieved and the detection of gammas in the MeV range is favourable, because Compton scattering is the dominant interaction process. Compared to collimated detectors, the interaction probability is potentially improved by two orders of magnitude [Knopf and Lomax, 2013] whilst the design can be much more simplified due to the omission of bulky collimators. The three basic configurations of CC detectors are presented in figure 3.12.

A two-stage system is built with a low Z scatterer detector (cf. figure 3.12a), where the Compton scattering is intended to take place, and a high Z absorber detector, where the gamma should be fully absorbed. Events can be discriminated by a coincidence time measurement due to the clear separation of the individual interactions. However, ambiguities

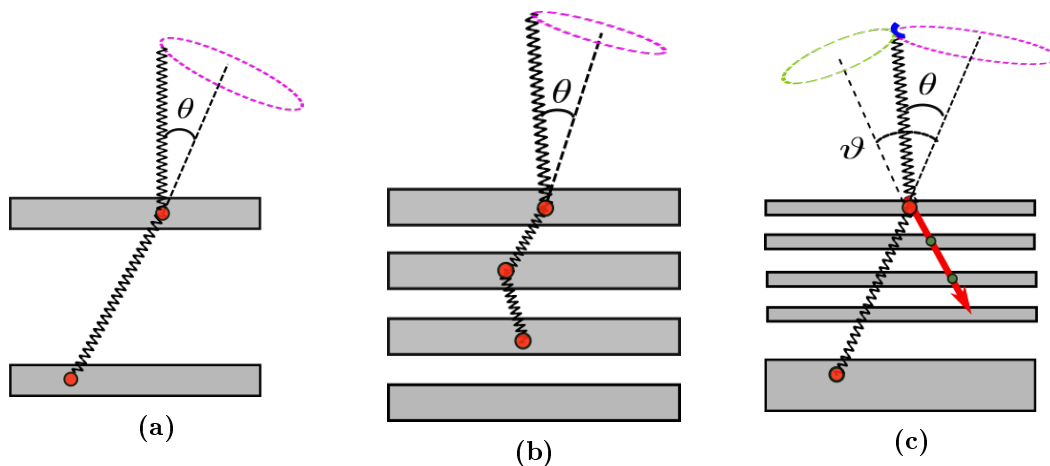

Figure 3.12: Basic configurations of CC detectors. A classic two-stage CC configuration (figure 3.12a): a scatterer and an absorber component. Full absorption of events is required in order to retrieve the complete information of the Compton interaction. An extension of this classical concept (figure 3.12b), where different layers register multiple Compton scattering interactions for one single gamma. On the other hand, the electron tracking configuration (figure 3.12c) consists of several thin layers able to register the path of the recoil electron. Ideally, the original gamma interacts in a thicker detector component and its initial direction may be completely determined (θ represents the photon scattering angle, ϑ represents the total scattering angle).

in the calculation of the incident direction arise from the unknown initial gamma energy. These limitations can be overcome using high photo-absorption cross section materials, high statistics measurements and applying image reconstruction techniques. Two-stage devices rely on the complete absorption of the gamma to determine its initial energy. This lack of additional information to retrieve Compton events is translated in a poor intrinsic measurement performance for gamma rays above 2 MeV [Takada et al., 2005] reducing the applicability in range monitoring for proton therapy treatments. Therefore, medical applications of two-stage CCs are limited to the localization of radioisotopes.

A second group of CC detectors consists of at least three stages, which may detect more than one Compton interaction per incident gamma (cf. figure 3.12b). Redundant information can be used and full absorption is no longer required for the image reconstruction. A detailed explanation of how the events are retrieved with this approach is given in chapter 4. Different research groups have proposed three-stage CCs to measure secondary PG radiation during proton therapy treatments, for example Richard et al. [2009] and Solevi et al. [2016].

In contrast, detectors designed as depicted in figure 3.12c are additionally capable of measuring the direction of the recoil electron. This provides information about the total scattering angle that, combined with the photon scattering angle, restricts the origin of the incoming gamma to an arc segment (details on the calculation are presented in chapter 4). The segment length is going to be determined by the accuracy of the track reconstruction. For proton range verification, gaseous detectors developed for the detection of cosmic and

atmospheric gamma rays have been tested [Takada et al., 2005] with 140 MeV protons impinging on a water target. Despite the good correlation of the measured PGs with the Bragg peak [Kurosawa et al., 2012], this approach is limited by the low efficiency. Among other alternatives, tracking detectors combining semiconductor and scintillation materials have also been investigated.

3.4.1 Investigated detector configurations

Two different CC configurations are studied and discussed in this thesis. The LMU prototype, a project pursued within the MAP (Munich-Centre for Advanced Photonics) Cluster of Excellence, was designed as electron tracking configuration in order to build a tool for proton range verification. The detector is still in a development stage; therefore, aspects related to a better understanding of the design, the involved physical processes and the potential imaging capabilities are assessed in the next chapters. In contrast, the Polaris-J CC, which has been developed by H3D Inc. for the group of Prof. Polf at University of Maryland, retrieves events by means of the gamma tracking configuration. The detector includes four different stages allowing the detection of double and triple scatter events. Different experimental scenarios have been tested ([McCleskey et al., 2015; Polf et al., 2015; Draeger et al., 2018]) proving the feasibility to detect secondary PGs for proton range verification in potential clinical scenarios. The patent of the detector is currently pending [Polf et al., 2017] and clinical implementation is envisaged in the near future. A quantitative comparison study involving the two CC configurations is presented in chapter 6 including also different image reconstruction algorithms in order to evaluate the proton range verification capabilities in different irradiation scenarios.

LMU prototype

The CC prototype was designed based on previous simulation studies [Lang, 2015] in order to achieve a configuration that allows electron tracking capabilities. The tracker consists of a stack of six double-sided silicon strip detector (DSSSD) (cf. figure 3.13 left) with each layer having an active area of $5.0 \times 5.0 \text{ cm}^2$ and a thickness of 0.05 cm. Individual layers are separated by 1.0 cm. In addition to the suitability of low Z materials for Compton scattering and reduced Doppler-broadening, good energy and position resolution of the detector components are required. Each layer has 128 orthogonal strips corresponding to p- and n- side (0.39 mm pitch size), which determines the interaction position. Furthermore, the detector is characterized by a high resistivity ($>10 \text{ k}\Omega$) maximising the detection of low-energy depositions due to the small leakage current. A detailed explanation of the experimental characterisation and performance of the strip detectors is presented in Liprandi [2018]. In the standard configuration a monolithic $\text{LaBr}_3:\text{Ce}$ scintillator with an active area of $5.0 \times 5.0 \text{ cm}^2$ and 3.0 cm thickness acts as the absorber component of the CC (cf. figure 3.13 right). The signal is read out by a 256-fold segmented multi-anode photomultiplier tube (H9500 PMT, Hamamatsu 16×16 segments, each one $3.0 \times 3.0 \text{ mm}^2$) providing a sum signal, extracted via the “sum dynode” output. $\text{LaBr}_3:\text{Ce}$ exhibits advantageous proper-

ties with respect to other commonly used scintillators in terms of energy resolution and timing with a decay time of $\tau = 17$ ns and a light yield of $LY=63000$ ph/MeV. The time resolution was determined as 273 ps (FWHM) and 536 ps (FWHM) with reflective and absorptive coating, respectively, using a ^{60}Co source and the relative energy resolution is $\Delta E/E \sim 3.8\%$ (FWHM) at 662 keV [Aldawood et al., 2015]. The possibility to file several modules increasing the field-of-view at larger sizes is an additional justification for future implementations at a real clinical scale. Intrinsic radioactivity of the lanthanum halide scintillator family is *a priori* one of the major drawbacks of the detector. In this case, the measured activity was 1.6 Bq/cm³ becoming a limiting factor in low background measurements; even though the effect can be exploited for energy calibration purposes. The interaction positions within the detector and the overall spatial resolution is determined through the *k-Nearest-Neighbor* (kNN) algorithm, which uses previous calibration measurements to derive the coordinate of an interaction. The good performance achieved in monolithic crystals is hampered by the high computational cost and the need of extensive calibration measurements. The complete description and commissioning of the absorber component for our CC can be found in Aldawood [2017].

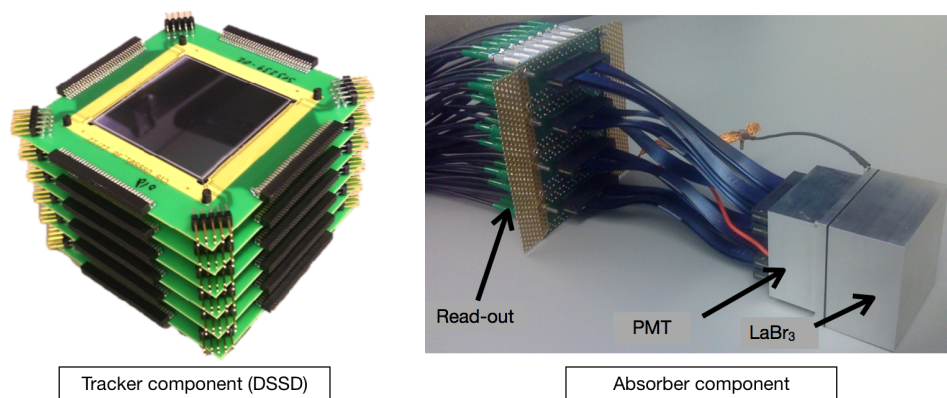

Figure 3.13: Components of the LMU CC detector prototype. The left side shows the scatterer array consisting of six DSSDs separated by a distance of 1.0 cm with the connectors attached to the side in order to read out the electrical signals of the p and n sides. The LaBr_3 scintillator attached to a 256-fold multi-anode photomultiplier (PMT) is shown on the right side, four neighbouring segments are combined to form 64 output signals. Courtesy of Silvia Liprandi, LMU.

Polaris-J

Four cadmium zinc telluride (CZT) detector stages make up the CC prototype Polaris-J (cf. figure 3.14 left). The material was selected due to its high cross section for Compton scattering and photo-absorption in the first and second interaction, respectively [McCleskey et al., 2015]. Each detector module contains four pixelated (11×11) CZT blocks (cf. figure 3.14 right): two stages have an active volume of $2.0 \times 2.0 \times 1.5$ cm³ and the other two $2.0 \times 2.0 \times 1.0$ cm³. The achievable spatial resolution is 1.5 mm in the xy plane and less

than 1.0 mm in depth using a pulse height and shape analysis of the anode signals [Polf et al., 2015]. The detector configuration is coupled by a synchronization coincidence timing module and the events are registered within a fixed time window of $1.5 \mu\text{s}$ [McCleskey et al., 2015]. Triggering all the read-out and resetting all stages of the CC takes about $100 \mu\text{s}$. However, since the read-out does not discriminate between single and multiple pixel events, an acceptance filtering is applied to the measured data. First experimental studies [McCleskey et al., 2015] showed a relative energy resolution of $\Delta E/E \sim 1.5 \%$ (FWHM) for the 662 keV line from ^{137}Cs and the position resolution for the reconstructed point source was about 2.0 mm. The raw efficiency (interaction registered in the measurement) was 2.2×10^{-5} for double and 5.8×10^{-7} for triple scatter events, using measurements of gammas from a ^{60}Co source.

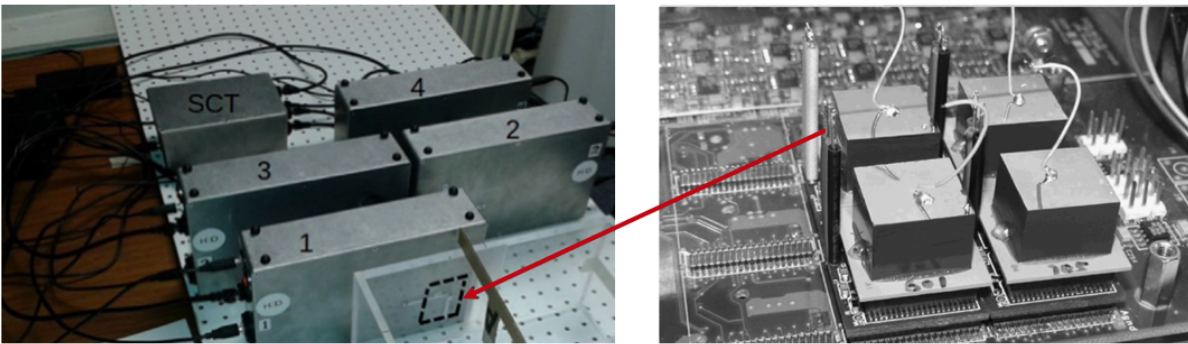

Figure 3.14: Polaris-J set-up. Modules are labelled from 1 to 4 and the coincidence module appears as SCT. The black square indicates the position of the CZT crystals inside the aluminium housing. On the right, a close up of the interior of one detector module attached to the motherboard by fine pitch connectors is shown. The total sensitive area is $4.0 \times 4.0 \text{ cm}^2$. Adapted from McCleskey et al. [2015] and [Zhang et al., 2007].

Part II

Analysis techniques for Compton camera detectors

“The nature of the human mind is such that unless it is stimulated by images of things acting upon it from without, all remembrance of them passes easily away.”

Galileo Galilei

4

Data acquisition & Image reconstruction

The **CC** measurement acquisition is just the first step of the **PG** imaging work-flow. Since most **PG** detectors are still in development stage facing different challenges, the amount of available experimental data is limited. In order to study and optimize the design as well as to evaluate the imaging capabilities of a specific configuration extensive **MC** simulations are required. In this work, Geant4 [Agostinelli et al., 2003] (standing for GEometry ANd Tracking) was used to simulate not only the **PG** generation but also the detection process due to the capabilities of the algorithms within the platform to model the passage of particles and photons through matter. Moreover, information from the detection process (either measurements or simulations) requires methods to convert initial raw data (energy depositions and positions) into physical Compton event representations. Data analysis and filtering have been performed with the software package MEGAlib [Zoglauer et al., 2006], which facilitates the use of a variety of independent routines in each step of the **PG** image generation chain.

This first part of this chapter includes the description of the computational tools used for the **MC** studies of the two different **CC** configurations. Furthermore, a detailed explanation of the reconstruction methods implemented to retrieve Compton events from the raw data registered with the detectors is given. The second part is dedicated to the image reconstruction algorithms, which are needed in **PG** imaging to invert the detection process (experimental measurements or **MC** simulations) in order to determine the **3D** distribution of the **PG** emission. The state-of-the-art **MLEM** algorithm for **CCs** (section 4.3.1) is presented. Besides, an overview of a novel approach [Mackin et al., 2012] based on the **SOE** method is reviewed in section 4.3.2.

4.1 Monte Carlo simulations of Compton camera detection set-ups

Simulations were carried out using the object-oriented tool-kit Geant4 [Agostinelli et al., 2003]. The code is written in C++ and the algorithms are based on the MC approach consisting of the repetition of processes with randomised starting conditions or events. Geant4 is characterised by the flexibility to work with various materials, geometries, physics lists, event generators, visualisation and analysis. For the different irradiation scenarios presented in this study, the simulations were conducted with the version 10.02.p01 using the QGSP-BIC-HP and Livermore physics lists for hadronic and electromagnetic processes, respectively. For hadrons, this includes the use of the Geant4 Binary cascade for primary protons of energies below ~ 10 GeV, which better describes the production of secondary particles in interactions of protons and neutrons with nuclei [Geant4, 2018]. On the other hand, the electromagnetic physics list covers the low-energy gamma and electron interaction processes including Doppler-broadening effects [Geant4, 2018]. The LMU prototype and the Polaris-J CCs were modelled in Geant4 including the experimentally determined spatial and energy resolutions.

The implemented *in silico* LMU detector geometry shown in figure 4.1 consists of the monolithic LaBr₃(Ce) scintillation absorber crystal preceded by the array of DSSSDs, which have a separation of 1.0 cm. The distance between the first layer of the tracker and the centre of the absorber crystal is 10.0 cm. Each silicon layer has an active area of 5.0×5.0 cm² and 0.05 cm thickness. The strip pitch size is 390 μ m for a total of 128 strips per side allowing for the determination of the x-y position for any interaction on the detector. The relative energy resolution is set as $\Delta E/E = 5\%$ (FWHM) at 140 keV for all layers as a conservative value, since no experimental measurement was available. Trigger and noise threshold are both 50 keV. For the LaBr₃(Ce), on average, the position resolution is 0.30 cm for energy depositions of few MeVs (experimentally determined) and the energy resolution was set as $\Delta E/E = 3.5\%$ (FWHM) at 662 keV and $\Delta E/E \sim 2\%$ (FWHM) at 1.5 MeV [Aldawood, 2017]. Furthermore, the multi-anode PMT was not included in the MC simulation; instead, an Anger system model was used to retrieve the position of the interaction within the absorber detector module.

The Polaris-J geometry definition in Geant4 is depicted in figure 4.2. Four aluminium boxes containing the detector modules are aligned along the direction of the irradiation. Each one includes an array of 2×2 CZT crystals. Two stages have crystal sizes of $2.0 \times 2.0 \times 1.5$ cm³, while the other two have $2.0 \times 2.0 \times 1.0$ cm³, that are pixelated 11 x 11 on the anode side with a planar cathode. The position resolution is 0.15 cm for the x- and y- directions and 0.10 cm in depth [McCleskey et al., 2015]. A Gaussian smearing with $\sigma = (0.006 + 0.15 \sqrt{E_{dep}})/2.3548$ is applied to the energy depositions [Mackin et al., 2013] in order to model the energy resolution of the CZT crystals.

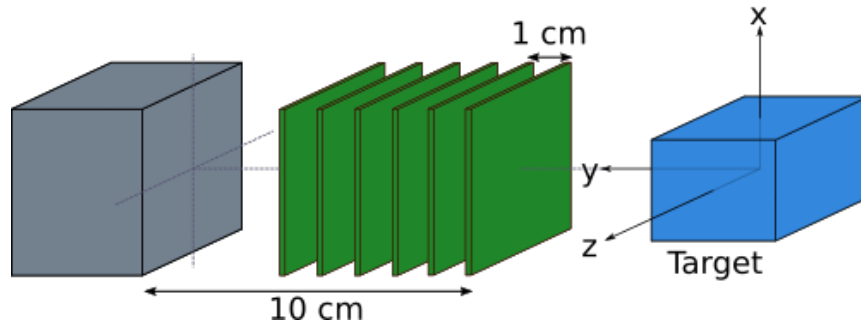

Figure 4.1: Implemented *in silico* detector geometry for the LMU prototype in Geant4. A water tank is depicted in the target position as a reference. The beam direction is z .

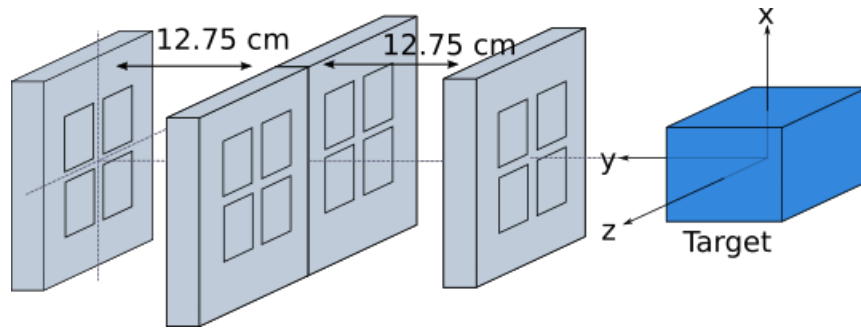

Figure 4.2: Implemented *in silico* detector geometry for the Polaris-J CC in Geant4. A water tank is depicted in the target position as a reference. The beam direction is z .

4.2 From hits to Compton events

Processed measured raw data are represented by hits, which contain the position and energy deposition in the detector world coordinate system. Using the [Compton sequence reconstruction \(CSR\)](#) algorithm implementation included within the MEGALib software package (version 2.31) [Zoglauer et al., 2006], data is combined into Compton events in order to obtain meaningful data for the image reconstruction phase.

MEGALib (“Medium-Energy Gamma-ray Astronomy library”) was developed as a tool for the simulation and data analysis of low-to-medium gamma-ray Compton telescopes used in astrophysics. The code was built in a very flexible way and designed as a set of libraries written in C++ providing full functionality of the different data-analysis classes, separately. The Revan (“Real event analyser”) library [Zoglauer et al., 2008] includes algorithms for the identification of the original interaction process such as Compton scattering using information of the individual hits. As a result, events with the associated kinematic parameters are obtained, i.e., energies and directions of the scattered photon and recoil electron. Additionally, the probability that the event actually happened is calculated.

4.2.1 Compton sequence reconstruction

The classical approach of the [CSR](#) algorithm retrieves the true origin of the initial photon by analysing all possible permutations of the recorded detector interactions. A quality factor (probability) is assigned to each permutation, and the best one is chosen as the event sequence; afterwards, the kinematic parameters are computed. Measurements registered by [CCs](#) are distinguished in three event types:

Two site interactions -single photoabsorption-

Two hits in two separated detector planes due to a single Compton scattering are registered with their corresponding energy deposition and position. The available information only allows the retrieval of fully absorbed events, where $E_i = E_1 + E_2$ being E_1 and E_2 the energy losses in the detectors. From the positions, the direction of the scattered gamma can be obtained, and the Compton angle is computed according to equation [3.2](#).

Multiple Compton scattering events -Gamma tracking-

Gamma tracking takes advantage of the redundant information measured in the [CC](#) detector during a single event to determine the most likely sequence and total energy of the interaction. A photon with initial energy E_i interacts at N different sites of the detector depositing energy at each position \vec{r}_i . In general, $N-1$ interactions assumed to be Compton events followed by an N^{th} final photo-absorption cause $N!$ possible paths, which have to be evaluated. In principle the photo-absorption is not required, because three or more interactions are enough to compute the energy of incompletely absorbed events.

For the triple Compton scatter events in the Polaris-J, six permutations of interactions must be evaluated to identify the correct sequence. The incident energy of the photon must be determined [[S.E Boggs and P. Jean, 2000](#)]:

$$E_i = E_1 + E_2 \frac{\sqrt{(E_2)^2 + \frac{4E_2m_e c^2}{1-\cos\theta_2}}}{2} \quad (4.1)$$

where E_1 and E_2 are the energy depositions for the first and the second interactions, respectively. θ_2 is the scattering angle of the second Compton event, which can be calculated via geometry (θ_2^{geo}) or energies (θ_2^{kin}):

$$\cos\theta_2^{kin} = 1 + m_e c^2 \left(\frac{1}{E_2} - \frac{1}{E_2 + E_3} \right) \quad (4.2)$$

$$\cos\theta_2^{geo} = \frac{\vec{r}_{g1} \cdot \vec{r}_{g2}}{|\vec{r}_{g1}| |\vec{r}_{g2}|} \quad (4.3)$$

here E_2 and E_3 are the energy depositions for the second and the third interaction, \vec{r}_{g1} is the vector between the position of first and the second interaction and \vec{r}_{g2} is the vector between the position of the second and the third interaction.

Using the Compton equation 3.2, the expression for the photon scatter angle (via kinematics and geometry) is as follows:

$$\cos \theta = 1 + m_e c^2 \left(\frac{1}{E_i} - \frac{1}{E_i - E_1} \right) \quad (4.4)$$

A correct permutation, in an ideal scenario, exhibits identical values of θ^{geo} and θ^{kin} . However, uncertainties due to the finite energy and spatial resolution of the detectors as well as Doppler broadening determine the effective width of the event annulus [S.E Boggs and P. Jean, 2000]:

$$\delta\theta = \theta^{kin} - \theta^{geo} \quad (4.5)$$

The value of $\delta\theta$ establishes a selection criteria for the determination of the correct sequence using the redundant Compton scatter information.

A generalised χ^2 approach was applied in order to find the correct order of the sequences [Zoglauer, 2005]. Thus, the calculated quality factor $Q_{c,classic}$ (figure-of-merit) describes the plausibility of a particular sequence as an accurate and ordered Compton event:

$$Q_{c,classic} = \frac{(\cos \theta^{kin} - \cos \theta^{geo})^2}{\Delta \cos^2 \theta^{kin} + \Delta \cos^2 \theta^{geo}} \quad (4.6)$$

where $\Delta \cos \theta^{kin}$ and $\Delta \cos \theta^{geo}$ are the measurement uncertainties modelled using a Gaussian error propagation. Small values of $Q_{c,classic}$ represent sequences which are more likely corresponding to actual Compton events for completely absorbed photons, although the incomplete absorption arises the quality factor. A good event selection accepts events below a certain $Q_{c,classic}$ value, providing a method for effective discrimination between the real events and background measurements.

Two site events with track -electron tracking-

Electron tracking events rely on the measured path of the recoil electron to calculate the incident direction of the original photon exploiting the redundant information given by the total scatter angle. A desired downward tracked event in the LMU CC prototype consists of at least two interactions in the tracker stack (DSSSD layers) (by the recoil electron) and a subsequent interaction in the absorber component (by the scattered gamma). The total scatter angle, which is the angle between the direction of the scattered gamma and the direction of the recoil electron is determined by kinematics:

$$\cos \nu^{kin} = \frac{(\sum_{i=1}^6 E_i)(E_{AB} - m_e c^2)}{E_{AB} \sqrt{(\sum_{i=1}^6 E_i)^2 + 2(\sum_{i=1}^6 E_i)m_e c^2}} \quad (4.7)$$

where E_i is the energy deposited in layer i and E_{AB} the energy deposition in the LaBr₃. The geometrical computation of the total scatter angle is given by the electron track \vec{r}_e and the direction of the scattered gamma \vec{r}_g :

$$\cos \vartheta^{geo} = \frac{\vec{r}_g \cdot \vec{r}_e}{|\vec{r}_g| |\vec{r}_e|} \quad (4.8)$$

The calculation of \vec{r}_e is not straightforward and involves a two-step process: first, the identification of all possible tracks and second, a selection of the one that is most likely. A detector-independent figure-of-merit approach developed by Zoglauer [2005] was implemented for the retrieval of the LMU CC tracking events. The method suggests the use of the covariances for E_{dep} (first energy deposition by the recoil electron) and $\Delta\alpha$ (angular deviation from layer to layer) with the hit ID i along the track [Zoglauer, 2005]:

$$cov(E_{dep}, i) = \overline{E_{dep} \cdot i} - \overline{E_{dep}} \overline{i} \quad (4.9)$$

$$cov(\Delta\alpha, i) = \overline{\Delta\alpha \cdot i} - \overline{\Delta\alpha} \overline{i} \quad (4.10)$$

The correct sequence corresponds to positive values of both covariances indicating that an increase in the hit number is correlated with an increase of the scatter angle α or the energy deposition E_{dep} . The figure-of-merit used in this work for combining the covariances into a dimensionless quantity is the Spearman-Rank correlation, which assumes a monotone association between the variables [Zoglauer, 2005]. The Spearman-Rank correlation coefficient is defined as follows:

$$r_{rank} = 1 - \frac{6D}{N^3 - N} \quad (4.11)$$

where D is the sum of the squared differences of the ranks of E_{dep} and $\Delta\alpha$ with i respectively:

$$D(E_{dep}, i) = \sum_{n=1}^N (\text{Rank}(E_{dep}) - \text{Rank}(i_n))^2 \quad (4.12)$$

$$D(\Delta\alpha, i) = \sum_{n=1}^N (\text{Rank}(\Delta\alpha) - \text{Rank}(i_n))^2 \quad (4.13)$$

When r_{rank} has a value of 1, the relation between associated values is valid. In contrast, zero describes a very weak correlation. The quality factor based on the probability of a particular track sequence is given by [Zoglauer, 2005]:

$$Q_{e,Rank} = 1 - \frac{2 + r_{Rank}(E_{dep}, i) + r_{Rank}(\Delta\alpha, i)}{4} \quad (4.14)$$

Good tracks have quality factors around zero due to the normalization of the values. The difference between the total scatter angle ϑ as calculated by kinematics and geometry can establish a selection criterion in order to discriminate badly reconstructed events:

$$\delta\vartheta = \vartheta^{kin} - \vartheta^{geo} \quad (4.15)$$

Since $\delta\vartheta > 0$ even for correct sequences due to the effects of Molière scattering, a reasonably large tolerance in this value may be allowed.

4.2.2 Event statistics

Simulations give access to information about statistics of the real interactions, which are undergone in the detectors. The trigger conditions for true events are defined by at least one recorded hit in the tracker and the absorber (LMU prototype) or at least two hits in different detector stages (Polaris-J). Point-like gamma sources within the expected energy range of PGs emitted during a proton beam irradiation were considered and placed at the origin of the coordinate system. Figure 4.3 depicts the distribution of interactions in the detectors as a function of the incident photon energy.

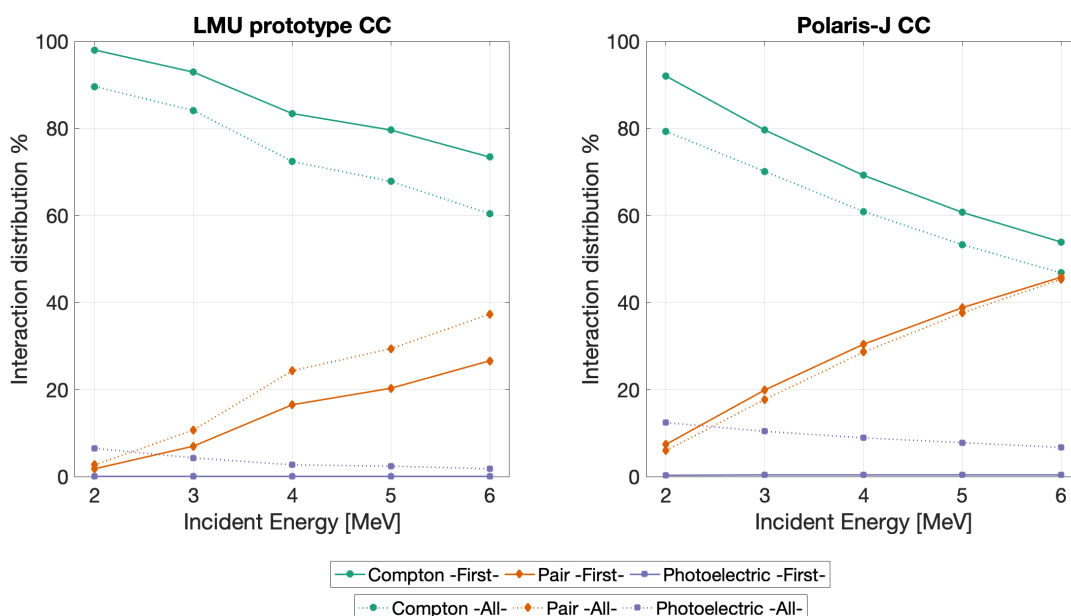

Figure 4.3: Event type distribution as a function of the incident gamma energy for the interactions where the primary particle is involved for the LMU CC (left) and the Polaris-J CC (right). The label -First- refers to the first interaction of the incident gamma and the label -All- includes all the interactions occurring in the detectors.

Most detector interactions are Compton scattering even though the fraction decreases with increasing incident photon energy. In contrast, the pair production cross section increases (cf. figure 3.7). The contribution of gammas undergoing photo-effect as first interaction is negligible. For the studied energy range, the probability that original gammas experiencing a Compton scattering event will eventually deposit all their energy within the detector configurations is considerably low as shown by the fraction of all photoelectric interactions (Photoelectric -All-). This could lead to ambiguities in the determination of the total energy of those events. Perfect event retrieval was considered by using the interaction information provided by the MC simulation and keeping the same trigger conditions as previously introduced. Figure 4.4 shows the statistics of events relative to the total number of triggers registered with the CCs presented in section 3.4.

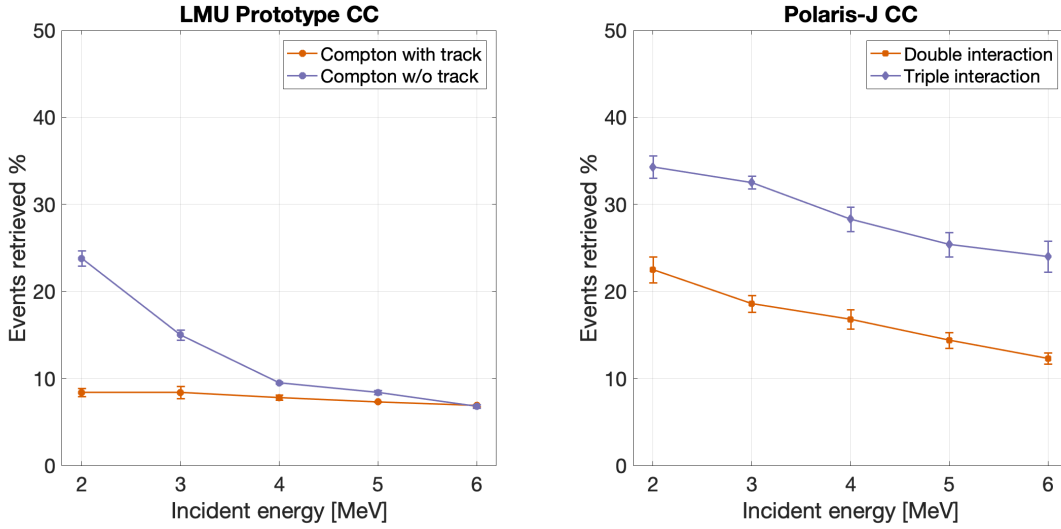

Figure 4.4: Distribution of perfect retrieved events with the LMU (left) and Polaris-J (right) CCs. For the LMU prototype, *Compton with track* refers to events whose first and last interaction in the tracker module belong to the recoil electron. On the contrary, for *Compton w/o track* events, the electron track may not be retrieved. Double and triples interactions with the Polaris-J CC are counted in different detector stages. The percentages are calculated relative to the valid number of triggers registered.

LMU prototype events are valid when the first hit (of the at least two hits fulfilling the trigger condition) is within the tracker module. For energies from 2 to 6 MeV, around 35% of the registered triggers correspond to interactions starting in one of the scatterer layers, while the remaining fraction is due to gammas impinging first on the absorber module. A breakdown of information relative to Compton interactions in the tracker exhibits a fraction of untracked electrons that falls off whilst increasing the energy of the initial gammas (from 24% at 2 MeV to 7% at 6 MeV). In contrast, the number of events with electron tracking remains around 8% within the exploited energy range. This number was expected to be higher, since the fraction of energy that is transferred to the recoil electron is increasing with the photon energy and then most likely two hits in different layers of the tracker are registered. However, this effect is compensated by an overall decrease of the Compton scattering probability. Valid events registered with the Polaris-J CC can be discriminated as either two or three energy depositions, which correspond to a single mother particle. The fraction of ideal double interactions, defined as a Compton scattering followed by a full photo-absorption, is around 20%, while the fraction of triple interactions is higher but decreasing for increasing energies.

In order to assess the performance of the CCs detector configurations in more complex PG emission scenarios, a set-up using a reference proton beam irradiation was assumed. It includes a water target irradiated by a 150 MeV proton pencil beam. A single spot of

1×10^9 primaries was considered. The field-of-view of both detection devices was enlarged for acquiring more data along the beam axis. The LMU modules and the individual stages of the Polaris-J were simulated considering an increased field-of-view (three measurements at different camera locations along the beam axis) with a total area of $5 \times 15 \text{ cm}^2$ and $4 \times 12 \text{ cm}^2$, respectively. The detector devices were placed parallel to the proton beam and centred at the isocenter, which is defined along the beam axis at the position of 5.0 mm proximal to the 80% distal dose fall-off. The relative distances correspond to the arrangements depicted in figures 4.1 and 4.2. The absolute trigger efficiency for the LMU prototype was 5×10^{-4} and for the Polaris-J 3×10^{-3} .

The bar plots shown in figure 4.5 depict the statistics of a perfect event retrieval. For the LMU prototype, Compton interactions are classified into the tracked (electron) and untracked categories and the fractions observed in figure 4.5a are relative to the total number of triggers. For the PG emission derived from the proton irradiation, the ideal scenario indicates that mostly Compton interactions without electron track are measured. Two effects can explain this. First, the triggered events consist of only two hits (one in any of the layers of the tracker and one in the absorber component), which results in a lack of information to generate electron tracks. Secondly, high energy gammas undergoing Compton interaction result in high energy recoil electrons, because the fraction of energy transferred from the photons to the Compton recoil electrons increases with the incident energy. For instance, the mean energy of the recoil electron for an incident photon with $E_i = 4.44 \text{ MeV}$ is $\overline{E}_e \sim 0.6E_i$. Consequently, a significant fraction of electrons have sufficient energy to pass through all the scatterer layers and interact with the LaBr₃ crystal. These interactions may cause ambiguities in the reconstruction of the electron track and a lack of information to correctly retrieve not fully photo-absorbed events.

On the other hand, the events retrieved with the Polaris-J CC correspond to double (Compton-Photoelectric) or triple (Compton-Compton-Anything) interactions originated by the original gamma as observed in figure 4.5b. The significant fraction of two-interaction Compton events might be explained by the low energy gammas ($< 2 \text{ MeV}$) being detected. Since the thick CZT detectors have depth resolution, the probability of photoelectric absorption in this energy regime is enhanced [Kroeger et al., 2002]. The fraction of three-interactions events is around half of the double interactions due to the size of the detector and the capability to produce three or more detectable interactions. If those events are correctly identified, the total energy absorption is not required and the associated kinematic parameters may be correctly computed.

4.3 Image reconstruction algorithms

Image reconstruction has been a considerable challenge since CCs were proposed for medical applications. First attempts consisted solely of back-projecting event cones into a binned image space with no additional considerations or data processing. While point-like sources can be well located with back-projection methods, PG imaging for proton range verification requires a more sophisticated approach, which accounts for variations in the response of the

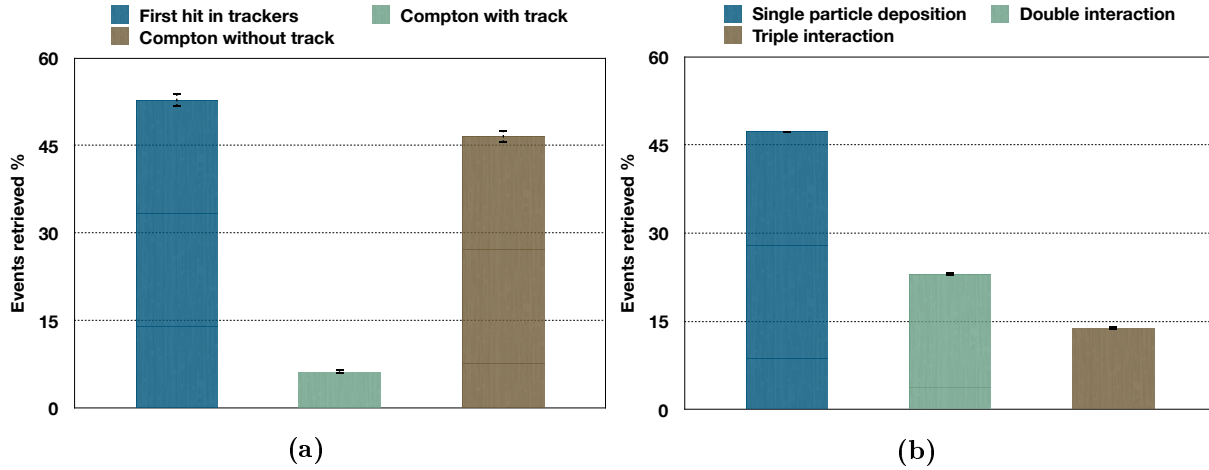

Figure 4.5: Fraction of perfectly retrieved events for the virtually measured PG emission during a proton beam irradiation of a water target with the LMU prototype in figure 4.5a and the Polaris-J in figure 4.5b. The percentages are relative to the valid number of triggers in each of the configurations and the error bars are estimated at 3σ around the mean value.

imaging system to more complex emission patterns and the uncertainty of the scattering angle from event to event. Therefore, analytical or iterative algorithms have been proposed for CC imaging.

Analytical methods mainly involve data projected onto spherical virtual detectors. Cree and Bones [1994] developed an inversion formula which shows that by collecting all scattering angles, the 3D source distribution can be recovered as the spatial extent of the detector tends to infinity. When using detectors of finite extent, only limited-angle tomography is achievable. The methods described by Parra [2000] and Basko et al. [1998] consider each element of the first detector to be at the centre of a spherical second detector. The back-projected data is later expressed as spherical harmonics and the image can be reconstructed using the inverse 3D transform. Despite the development of analytical inversion methods, they faced significant limitations during the implementation, e.g. drawbacks dealing with incomplete data. The photon attenuation cannot be incorporated within the image. Furthermore, the existence of an analytical inverse does not guarantee computational efficiency, and the existence of a fast transform is mandatory. Finally, some approaches encountered difficulties in constrain the reconstruction to lie within a function space, which is appropriate to point-source distributions. Since realistic cases are characterised by low counting statistics, extended sources of signal and incomplete angular sampling, the analytic methods will perform deficiently; therefore, the image reconstruction algorithms used in this work are restricted to iterative methods based on statistical models of image formation.

Data space storage uses the list-mode representation [Barrett et al., 1997], i.e., the measured attributes (for CCs: positions and energy depositions) are saved as a simple list of individual events. This reduces the number of bins for each attribute making post-processing of the data much more efficient without any loss of information. However, the

disadvantage is that the complexity and storage increases with the number of collected data. Nevertheless, it currently represents the more advantageous approach for representing CC data, hence the algorithms hereafter mentioned have list-mode capabilities.

4.3.1 Maximum-likelihood reconstruction algorithm

The application of the MLEM algorithm for the reconstruction of CC scattering images was first proposed by Wilderman et al. [1998]. The goal of the method is the estimation of the origin f_j of the photons given the measurement y_i from the CC detector.

Maximum-likelihood step

Since random coincidences (i.e., sequences in the same time window but corresponding to more than one event) are ignored, the events are presumed to be independent and the time between them is exponentially distributed. Thus, the detection process follows Poisson statistics and the probability of observing y_i for a given event index i is given by:

$$y_i \sim \text{Poisson}(\bar{y}_i) \Rightarrow p(y_i | \mathbf{f}) = \frac{\bar{y}_i^{y_i}}{y_i!} e^{-\bar{y}_i} \quad (4.16)$$

where \bar{y}_i is the mean value of coincidence events. By simplicity \bar{y}_i can be expressed as the mean number of photons emitted from the pixels j of the image times the probability that this emission is measured with the parameters of the event i (the so-called response matrix t_{ij}):

$$\bar{y}_i = \sum_{j=1}^J f_j t_{ij} \quad (4.17)$$

Assuming that every combination of measurements is independent, the likelihood function is described by:

$$\mathcal{L}(y | \mathbf{f}) = \prod_{i=1}^N p(y_i | \mathbf{f}) = \prod_{i=1}^N \frac{\bar{y}_i^{y_i}}{y_i!} e^{-\bar{y}_i} \quad (4.18)$$

and the log-likelihood is given by:

$$\ln \mathcal{L}(y | \mathbf{f}) = \sum_{i=1}^N \left(y_i \ln \left(\sum_{j=1}^J t_{ij} f_j \right) - \sum_{j=1}^J t_{ij} f_j - \ln(y_i!) \right) \quad (4.19)$$

The maximization of the likelihood is equivalent to finding the maximum of the log-likelihood function, which is obtained by setting the partial derivative (with respect to f_j) to zero:

$$\frac{\partial \ln \mathcal{L}}{\partial f_j} = - \sum_{i=1}^N t_{ij} + \sum_{i=1}^N \frac{y_i t_{ij}}{\sum_{j=1}^J t_{ij} f_j} \quad (4.20)$$

The sensitivity $s_j = \sum_{i=1}^N t_{ij}$ is the probability that a photon emitted from pixel j would be detected. For the sake of simplicity, sensitivity values were assumed equal to 1 $\forall j$ in this work.

Expectation maximization step

The expectation maximization step is an iterative procedure to compute the maximum likelihood of \mathbf{f} . The formulation of the expectation of the likelihood function is obtained in terms of complete data, given the measurements y_i and the image estimation $\mathbf{f}^{(l)}$ from the previous iteration l . Then, the likelihood is maximized with respect to \mathbf{f} to obtain $\mathbf{f}^{(l+1)}$. The iterative procedure is performed until the algorithm converges.

A random variable z_{ij} , representing the emission at voxel j detected by the list-mode entry i , is introduced in order to fulfill the requirement of a complete data set for the expectation maximization step. The z_i elements contain a single non-zero element, since one emission can be detected by no more than one event. The relation between the detection and the completed data is given by the response matrix t_{ij} .

Substituting the complete data in the log-likelihood expression 4.19, the expectation of the likelihood is given in terms of the actual measurements and the current estimate of the image $\mathbf{f}^{(l)}$:

$$E [z_{ij}|y_i, \mathbf{f}^{(l)}] = y_i \frac{t_{ij} f_j^{(l)}}{\sum_{j=1}^J t_{ij} f_j^{(l)}} \quad (4.21)$$

Finally, the maximization step estimates the image $\mathbf{f}^{(l+1)}$ and the reconstruction algorithm results in the following iterative equation [Wilderman et al., 1998]:

$$f_j^{(l+1)} = \frac{f_j^l}{s_j} \sum_i \frac{t_{ij} v_i}{\sum_k t_{ik} f_k} \quad (4.22)$$

The initial guess $\mathbf{f}^{(0)}$ is the back-projection of the acquired events. Compared to the original formulation, equation 4.22 includes a visibility term v_i , which represents the probability that an event comes from the selected image space. For example, for small image spaces and large cone sections, the only fraction of an event seen in the image is v_i [Zoglauer, 2005].

Response matrix for Compton camera imaging reconstruction

The response matrix t_{ij} (or system matrix) must model the detector geometry, the intrinsic uncertainties of the measurement process as well as the physical phenomena of the interactions. As described by Wilderman et al. [1998], the probabilistic description of the process includes the following variables:

- \mathcal{E} : Event detected by the CC

- $\tilde{\mathcal{E}}$: Real event (energy and position of interactions)
- M : Emission point of the photon

Thus, t_{ij} can be expressed as:

$$t_{ij} = p(y_i|f_j) = \int_{\mathcal{V}} p(y_i|M)p(M)\chi_f(M)d\mathcal{V} \quad (4.23)$$

where $p(M)$ is the probability of emission in the point M , $\chi_f = \delta(M - M')$ is a delta function which indicates if M is contained in the voxel f_j and \mathcal{V} is the defined image volume.

If the resolution of the detector or intrinsic effects as Doppler-broadening were previously taken into account, $p(y_i|M)$ can be expressed as the sum of the probabilities of all real events that can result in the measurement y_i :

$$p(y_i|M) = \int_{\tilde{\mathcal{E}}} p(y_i|\tilde{e}_i)p(\tilde{e}_i, |M)d\tilde{\mathcal{E}} \quad (4.24)$$

where $p(y_i|\tilde{e}_i)$ is the probability that the measured y_i corresponds to the real event \tilde{e}_i .

Errors in the energy measurements, Doppler-broadening and spatial resolution of the detectors lead to uncertainties in the Compton scatter angle θ . Furthermore, errors in the electron path and recoil electron energy measurements are correlated with uncertainties in the total scatter angle ϑ . Consequently, the probability $p(y_i|\tilde{e}_i)$ was formulated as:

$$p(y_i|\tilde{e}_i) = p(\Delta\theta)l(\Delta\vartheta) \quad (4.25)$$

here the probability density functions $p(\Delta\theta)$ and $l(\Delta\vartheta)$ follow a Gaussian distribution as presented by Zoglauer [2005]:

$$p(\theta_{kin}^{meas}, E_i^{meas}) = \frac{1}{\sqrt{2\pi}\sigma_\theta} e^{-\left(\frac{1}{\sqrt{2}\sigma_\theta}\right)^2} \quad (4.26)$$

$$l(\vartheta_{kin}^{meas}, E_e^{meas}) = \frac{1}{\sqrt{2\pi}\sigma_\vartheta} e^{-\left(\frac{1}{\sqrt{2}\sigma_\vartheta}\right)^2} \quad (4.27)$$

The standard deviations σ_θ and σ_ϑ were calculated using the energy depositions (E_g , E_i) and the actual resolution of the detectors (ΔE_g , ΔE_i):

$$\sigma_\theta = \frac{mc^2}{\sin\theta} \sqrt{\left(\frac{1}{E_g^2} - \frac{1}{(E_e + E_g)^2}\right)^2 (\Delta E_g)^2 + \frac{1}{(E_e + E_g)^4} (\Delta E_e)^2} \quad (4.28)$$

$$\sigma_\vartheta = \cos^{-1}((\vec{r}_g \times \vec{r}_i) \circ (\vec{r}_g \times \vec{r}_e)) \quad (4.29)$$

A visual representation of the image response is depicted in the figure 4.6. The profile of the cone section (shown in figure 4.6a) and for electron tracked events the length of

the arc segment (shown in figure 4.6b) represent the distribution of all possible true cones and scatter planes for the measured event and/or electron track. The conical shapes were normalized in such a way that the sum of all intensities contained in the image volume is one.

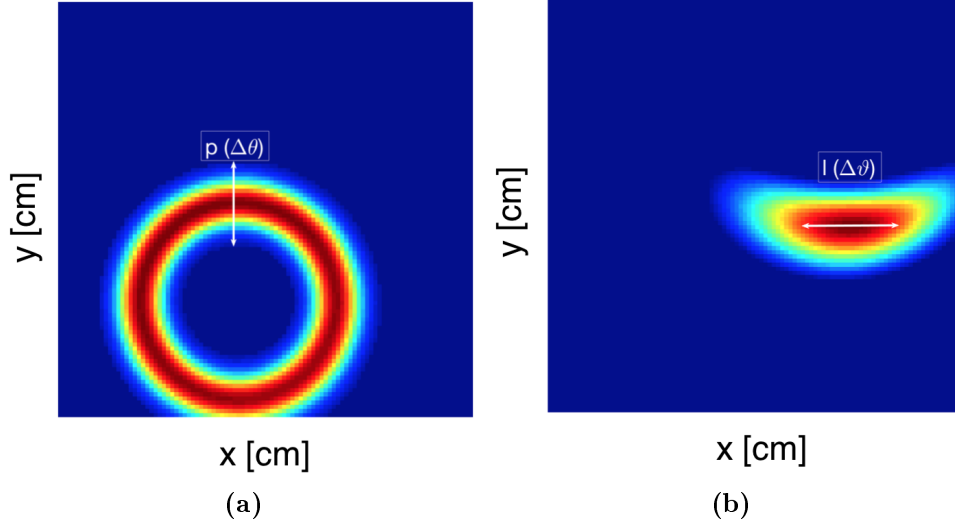

Figure 4.6: Measurement process modelling for the response matrix for CC image reconstruction. The ring shape of the cone depends mainly on the energy measurements and the arc segment shape on Molière scattering of electrons.

Computation of the second part of equation 4.24 has to consider the variables that describe the complete photon path through the detector configuration. A simplification of the model proposed by Wilderman et al. [1998] was implemented following the expression:

$$p(\tilde{e}_i, |M) = K(\theta, E_i) \frac{\cos(\theta_g)\cos(\theta_M)}{|\vec{r}_g|^2|\vec{r}_i|^2} \delta\left(\arccos\left(\frac{\vec{r}_g \cdot \vec{r}_i}{|\vec{r}_i||\vec{r}_g|}\right) - \theta\right) \quad (4.30)$$

where $K(\theta, E_i)$ is the Klein-Nishina coefficient accounting for Compton scattering cross section given by the equation 3.6, θ_M is the incident angle of the photon emitted at M , θ_g is the polar angle of the Compton cone axis and the Dirac function takes into account that the emission point M lies on the surface of the Compton cone defined by the event \mathcal{E} .

4.3.2 Stochastic origin ensembles algorithm

The SOE algorithm is a MC Markov chain method that uses the Metropolis-Hastings algorithm, which was first implemented for CC imaging by Andreyev et al. [2011]. The method uses a set of origins of detected events, and the image is reconstructed considering only a single representative point of the cone surface that is initially randomly selected within the volume where the emission is produced.

Following the implementation of Mackin et al. [2012], every state s in the ensemble Y is generated as a set of origins \vec{r}_i (representative points) of photons detected during

the acquisition process. Those points are randomly selected on the surface of the cones generating for each iteration an ensemble transition $Y_s \rightarrow Y_{s+1}$ governed by the acceptance probability, where Y_s and Y_{s+1} are subsequent states in the Markov chains. The algorithm work-flow is schematically described by the pseudo-code of figure 4.7. This implementation differs from the original algorithm of [Andreyev et al. \[2011\]](#), because the contribution of the current representative point is removed from the probability density estimate for the computation of $p(\vec{r}_i)$. Final images are generated by binning the 3D coordinates according to the desired image resolution providing a way of ensuring a reliable comparison with the reconstructions performed using the [MLEM](#) algorithm. Therefore, the resolution of the final images was determined by the size of the voxels in the image volume.

The performance of the [MLEM](#) and [SOE](#) algorithms in the context of prompt gamma imaging for range verification is demonstrated through the reconstructions obtained for a variety of irradiation scenarios in Chapter 6.

```

Data: List-mode measured data
Result: 3D coordinates of expected prompt gamma emission
/* initialization arbitrary starting state  $Y_o$  */
for  $i = 1$  to  $N$  do
    Picks a random origin  $\mathbf{r}_i$  on the surface of backprojected cones within the
    image volume;
    Fill 3D histogram to compute the probability density estimate  $\mathcal{H}_j = p(x)$ ;
end
for  $n = 0$  to max Iterations do
    /* generate state  $Y_{s+1}$  */
    for  $i = 1$  to  $N$  do
        event  $k =$  random event  $i$  in the list;
        while event is equal to  $k$  do
            new locations for state  $Y_{s+1}$  ;
            random position within its own cone surface =  $\beta_i$  ;
            /* estimation of density probabilities */
             $p(\beta_i) \leftarrow \mathcal{H}$ ;
             $p(\mathbf{r}_i) \leftarrow \mathcal{H}$ ;
            /* acceptance probability */
             $A(Y_s \rightarrow Y_{s+1}) \approx \min \left( 1, \left( \frac{p(\beta_i)+1}{p(\mathbf{r}_i)} \right) \right)$  ;
            if event density increases then
                /* new position is accepted */
                 $\mathbf{r}_i = \beta_i$  ;
                /* probability density is updated */
                 $p(\mathbf{r}_i) - 1/N \leftarrow \mathcal{H}$ ;
            else
                /* new position is rejected */
                 $\mathbf{r}_i = \mathbf{r}_i$  ;
                event  $k == 0$ ;
            end
        end
    end
end
    /* save representative points and produce the image */
     $\mathcal{H}$  is discarded;
    image generation;

```

Figure 4.7: Pseudocode for the stochastic origin ensembles reconstruction implementation [Mackin et al., 2012].

Part III

LMU Compton camera performance

“There are two possible outcomes: if the result confirms the hypothesis, then you’ve made a measurement. If the result is contrary to the hypothesis, then you’ve made a discovery.”

Enrico Fermi

5

LMU prototype performance and imaging properties

5.1 Spectral response

Energy or spectral response defines the capability of **CCs** to detect and identify photons in the energy regime of interest. The detector prototype in our department was developed in order to detect multi-MeV **PG**; in consequence, a benchmarking scenario in this energy region was generated taking into account the available experimental data. The measurements were taken at the Tandetron accelerator of the Helmholtz-Zentrum Dresden-Rossendorf, which allows for the generation of point-like emissions of mono-energetic gammas via the proton capture reaction $^{15}\text{N}(p, \alpha\gamma_{4.439})^{12}\text{C}$ by irradiating a TiN target with a low energy (~ 0.9 MeV) proton beam. Details of the measurement campaign and the description of the experimental set-up are given in [Aldawood \[2017\]](#).

As in the experimental scenario, the detector acquisition for a mono-energetic point-like gamma source of 4.44 MeV was simulated. For the LaBr_3 absorber component, energy resolution values were chosen in agreement to the extrapolation model obtained by measurements at low photon energies (calibration sources) [[Aldawood, 2017](#)]. On the other hand, the tracker module readout electronics were not able to provide a trigger signal at the time of this measurement; thus, the simulation recorded as valid events those with at least a deposition of energy in the absorber. Furthermore, these limitations made it difficult to establish a calibration of the deposited energy in the **DSSSD** layers [[Liprandi, 2018](#)]. Therefore, the simulation results were used to provide a correlation between the channel information and the actual energy deposition for the different tracker layers. The experimental detector response (energy deposition in the scatterers and the absorber component)

is compared to the simulation results in figure 5.1. Overall the measured spectral response of the CC components was consistent with the simulation results. Well-distinguished high energy peaks in the LaBr₃ spectra (cf. figure 5.1a) are associated with the 4.44 MeV photo-peak of the ¹²C and the corresponding single and double escape peaks having a relative energy resolution between 2.4% and 2.2% (FWHM), respectively.

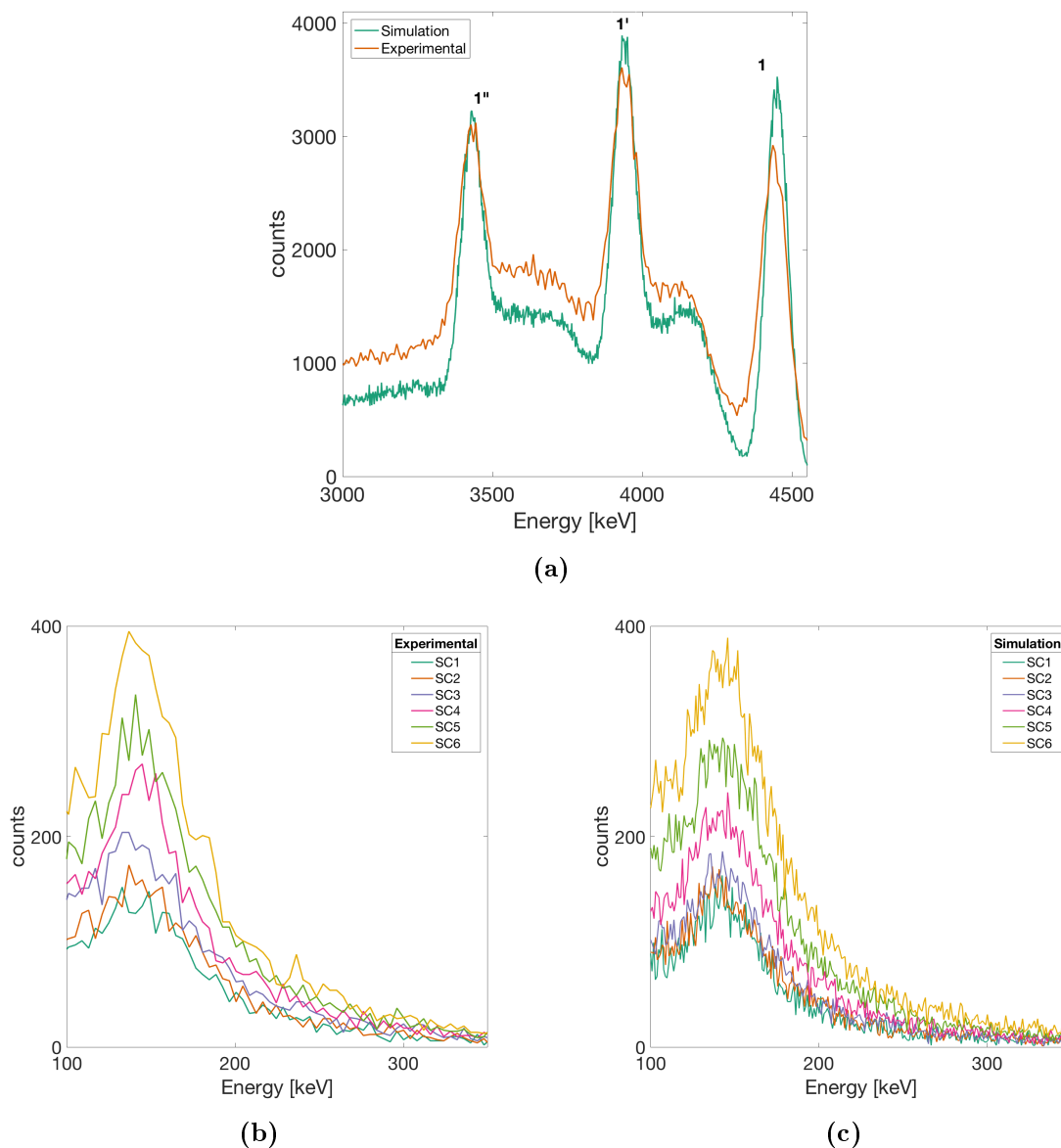

Figure 5.1: Spectral response of the LMU CC prototype for a 4.44 MeV point-like photon source. The simulated and measured data are depicted together for the absorber component in figure 5.1a: photo-peak, single and double escape peaks are labelled as 1, 1' and 1'', respectively. For improved visibility, the measured calibrated (figure 5.1b) and the simulated energy deposition (figure 5.1c) in each layer of the tracker module are plotted separately.

The calibrated measurements for the DSSSDs are depicted in figure 5.1b. These values were computed assuming a linear relation between the energy deposition E given by the simulation and the channel number CH of the minimum and maximum value in the peak region of the measured spectra:

$$E = m \cdot CH + E_o \quad (5.1)$$

with $m=0.25$ keV/channel and $E_o= 86.1$ keV. The comparison of simulated and calibrated experimental data for the different layers of the tracker component is shown in figure 5.2. The proposed calibration based on the spectral response of the first and the last layer is consistent with the simulation results for all layers. However, a more sophisticated model, which includes the measurement of calibration sources and considers the experimentally determined energy resolution of the DSSSDs is required.

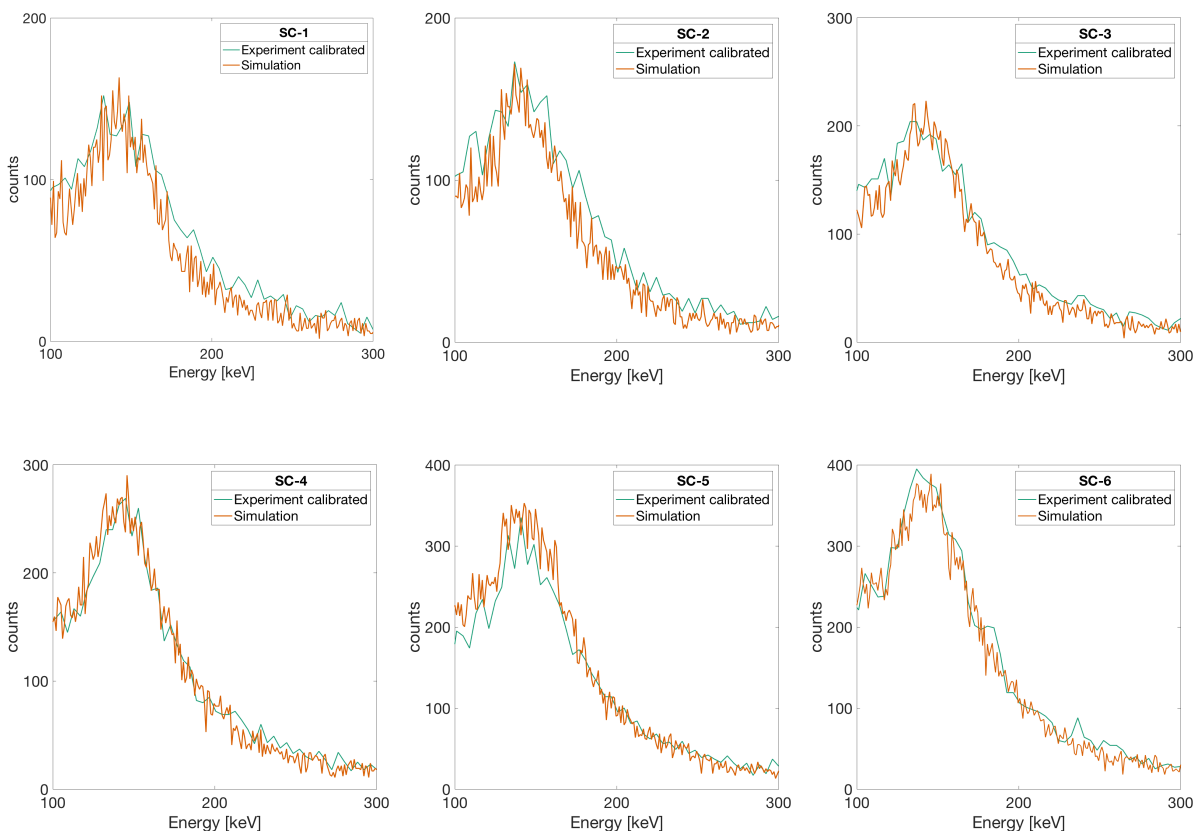

Figure 5.2: Energy deposition distributions for each layer of the tracker module for an incident gamma energy of 4.44 MeV.

The energy deposition in the tracker shown in figures 5.1b and 5.1c exhibits an increment of intensity towards the last layers due to the sequential chain of energy deposition after the scattering of the primary photon. Nevertheless, the most likely deposition of

energy per incident electron in each layer is around 140 keV. This behaviour is related to the dependence of the energy deposition in the silicon layer on the energy of the recoil electron. Most of the low energy electrons (below 500 keV) are stopped within the silicon layers depositing all their energy. At medium energies (0.5-2 MeV), a notable increment in the energy deposition is observed; however, at higher energies the minimum ionising character of the electrons begins to appear and the ionisation losses are becoming weakly dependent of the momentum. Bremsstrahlung also contributes to the energy loss of electrons. The so-called critical energy is the energy for which the loss rates (ionisation and bremsstrahlung) are equal and it is approximated 53 MeV for electrons in silicon [Berger and Seltzer, 1964].

5.2 Angular resolution measurement

The angular resolution measurement (**ARM**) of a **CC** detector is given by the difference between the geometrical scattering angle (angle between the initial direction and the scattered gamma) and the Compton scattering angle computed via kinematics (equation 3.2):

$$ARM = \arccos(\vec{r}_i \circ \vec{r}_g) - \theta^{kin} \quad (5.2)$$

The calculation is based on the actual direction of the incident photon \vec{r}_i and the direction of the scattered gamma \vec{r}_g that is determined from the position of first and second interaction in the detectors. In other words, the **ARM** is considered as the smallest angular distance between the known origin of the gamma and the Compton cone. If the real origin lies inside the cone, the **ARM** value is negative, meaning that the photon was not fully absorbed, while positive values are an indication of incompletely absorbed recoil electrons [Zoglauer, 2005].

A large data sample of Compton events is statistically required to obtain a meaningful distribution of **ARM** values in order to characterise the directional accuracy of the reconstructed events. The **FWHM** of this distribution determines the average uncertainty in the opening angle of the cone for retrieved Compton events.

In order to characterise the angular resolution of the LMU **CC** prototype, the **ARM** distributions of five different point-like sources with energies between 2 and 6 MeV were obtained using **MC** simulations. For the computation, kinematically correct Compton events were selected assuming a known source energy E_i , i.e., the initial energy of reconstructed events must correspond to an energy window of $\pm 5\%$ around the known source value. Additionally, at least 50000 events were included in the calculation of the distribution in order to guarantee statistically significant results. A Voigt fit [Takeda et al., 2007] was used to determine the **FWHM** of the distribution. This consists of a convolution of a Gaussian and a Lorentzian profile. The corresponding **ARM** distributions are shown in figure 5.3.

In general, the obtained **ARM** distributions tend towards positive values and the peak is slightly moved by $\sim 0.2^\circ$ out of the centre, which may be caused by the inherent detector position resolution. A strong background contribution beyond 10° becomes visible for increasing energy due to incorrectly reconstructed events. Incomplete absorption of recoil

electrons could explain this effect in events retrieved by the [CSR](#) approach. At higher energies the fraction of energy transferred to the recoil electron increases from $\sim 0.5E_i$ for 2 MeV to $\sim 0.65E_i$ for 6 MeV and as the electron is not completely stopped inside the tracker, the event reconstruction has limitations recovering the correct kinematic parameters. Therefore, the [ARM](#) values (FWHM of the Voigt fit) summarised in [table 5.4](#) are degraded for high energy photons despite the slightly better position and energy resolution of the detector. In contrast, considering the perfect event retrieval, the [ARM](#) value is $2.8^\circ \pm 0.2^\circ$ and it is almost independent of the incident energy, since the determined position and energy resolution are roughly constant.

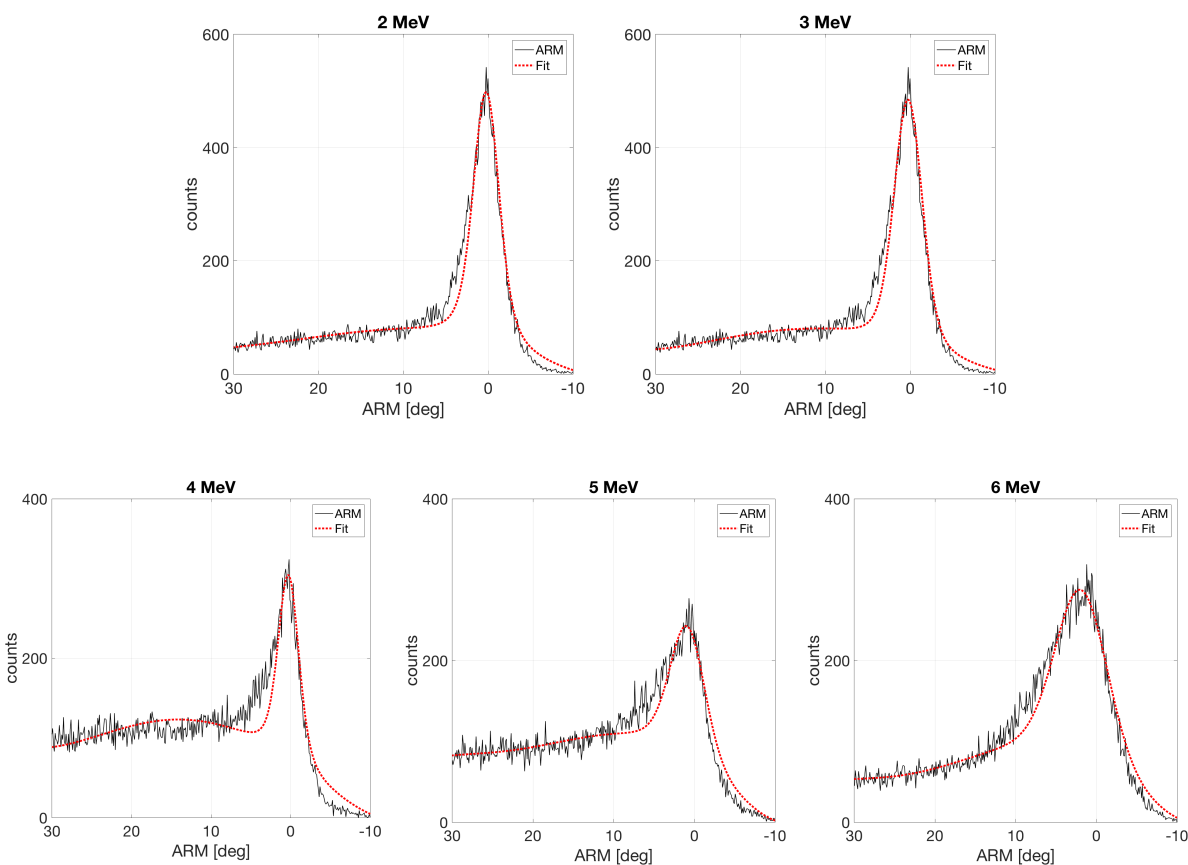

Figure 5.3: [ARM](#) distributions of reconstructed events for point-like sources from 2 MeV to 6 MeV obtained from [MC](#) simulations of the LMU prototype detector. Knowing the position of the initial source, the [ARM](#) values are mainly determined by the performance of the [CSR](#) algorithm.

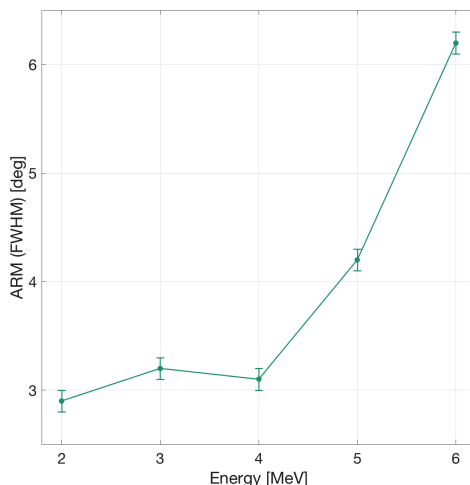

Figure 5.4: Angular resolution measurement as function of the photon source energy obtained via the MC simulation framework.

5.3 Compton sequence reconstruction performance

Data obtained from the simulation model of the LMU CC prototype, which includes the experimentally determined detector energy and position resolutions, were evaluated using the event reconstruction approach previously introduced in section 4.2.1. Interactions from the MC simulation were compared with the events retrieved by the CSR in order to quantify the error in the estimation of the initial photon energy and the Compton (scattering) angle. Therefore, two different set-ups were investigated.

Point-like source reference set-up

A mono-energetic gamma source of 4.44 MeV is placed 5.0 cm from the surface of the first DSSSD layer. Gamma rays were isotropically emitted. The detection efficiency was 2×10^{-2} without any selection other than the trigger condition, i.e., at least one deposition of energy in the tracker and one in the absorber. The CSR algorithm retrieved 64% of events of the total number of Compton interactions. However, 20% of the retrieved events were false positive. The analysis of the quality of reconstructed (real) Compton events was performed by computing the difference between the estimated kinematic parameters and the actual interaction values. The obtained absolute error distributions are shown in figure 5.5. It seems that most kinematic parameters are underestimated by the reconstruction method. In fact, only a small portion of events is retrieved with the corresponding known source energy. The difference is caused by an underestimation of the recoil electron energy while the energy of the scattered gamma is mostly overestimated. Table 5.1 summarises the mean and median values of the absolute error distributions depicted in figure 5.5. The recovered energy of the recoil electron is visibly smaller than the actual value, thus a notable

impact on the calculation of the scattering angle can be observed. This suggests that high energy electrons are not stopped inside the tracker, causing an incorrect energy prediction. A closer look at the particle trajectories of real interactions reveals that a considerable fraction of recoil electrons reaches the LaBr₃ detector and the algorithm associates this energy deposition with the corresponding scattered gamma.

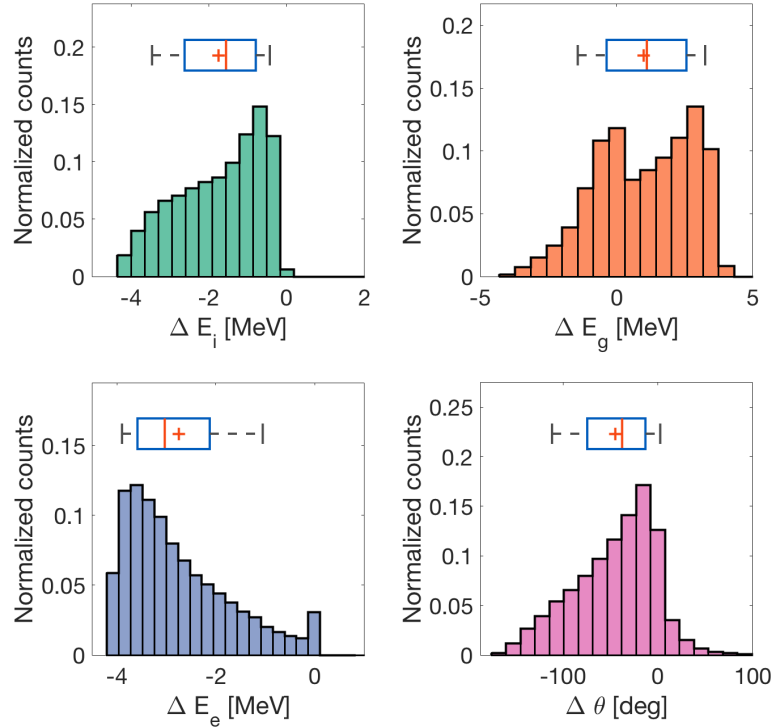

Figure 5.5: Comparison of the absolute error distributions of the estimated kinematic parameters for a 4.44 MeV point-like gamma source. The scattering angle (θ) was computed via the Compton kinematics using the corresponding energies. For normalization, the area under the histogram is equal to one. Median and mean values are marked by a vertical line and the cross inside the box, respectively. The box encloses the first and the third quartile.

Parameter	μ	\bar{x}
ΔE_i	-1.75 MeV	-1.55 MeV
ΔE_g	+0.99 MeV	+1.12 MeV
ΔE_e	-2.75 MeV	-3.03 MeV
$\Delta \theta$	-45.0 deg	-38.0 deg

Table 5.1: Mean (μ) and median (\bar{x}) values of the absolute error distributions for a 4.44 MeV point-like gamma source.

Nevertheless, prior information can be included in the CSR in order to optimize the performance. An energy window filtering was applied by selecting retrieved events, which have initial energy within $\pm 5\%$ of the known source energy. The absolute error distributions when applying the aforementioned selection criteria can be found in figure 5.6 and table 5.2 summarises the corresponding mean and median values. The retrieval of the Compton kinematic parameters was noticeably improved in comparison with the values reported in table 5.1, despite the limited amount of events for the image reconstruction. Furthermore, 80% of the events within the selected energy window correspond to electrons, which were stopped before reaching the scintillator crystal.

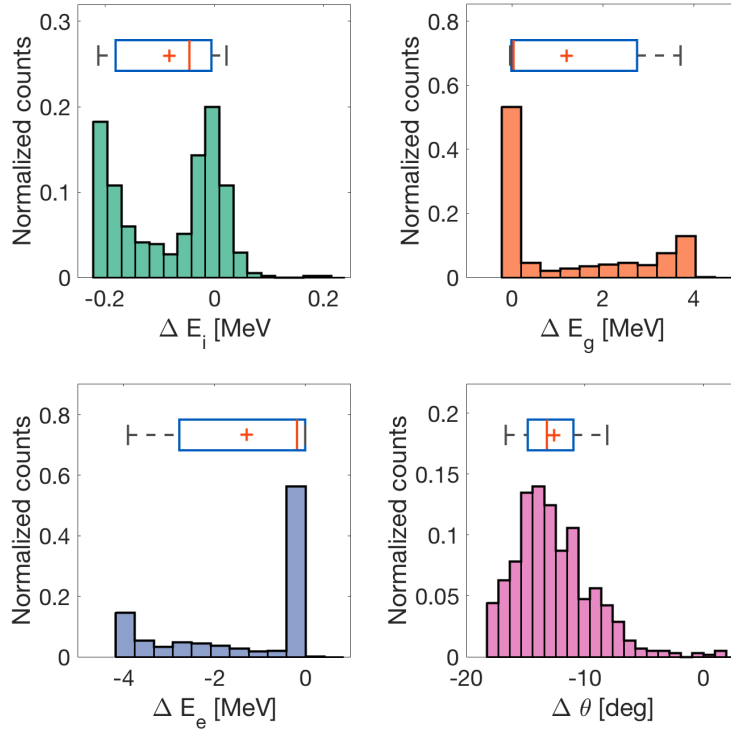

Figure 5.6: Comparison of the absolute error distributions of the estimated kinematic parameters for 4.44 MeV point-like gamma source applying an energy selection filter of $\pm 5\%$. For normalization, the area under the histogram is equal to one. Median and mean values are marked by a vertical line and the cross inside the box, respectively. The box encloses the first and the third quartile.

H₂O phantom reference set-up

The CSR reconstruction analysis was performed on the data virtually acquired by the LMU detector for the reference proton beam irradiation set-up introduced in section 4.2.2. The detection efficiency was 1.8×10^{-3} assuming the same trigger condition as for the

Parameter	μ	\bar{x}
ΔE_i	-0.11 MeV	-0.05 MeV
ΔE_g	+1.21 MeV	+0.04 MeV
ΔE_e	-1.29 MeV	-0.18 MeV
$\Delta \theta$	-13.0 deg	-13.2 deg

Table 5.2: Mean (μ) and median values (\bar{x}) of the absolute error distributions for a 4.44 MeV point-like gamma source applying an energy selection filter of $\pm 5\%$.

mono-energetic point-like source. An additional energy window of [2.0 MeV, 6.5 MeV] was applied to the reconstructed events. This selection has been shown to provide a good correlation between the distal dose fall-off and the PG profile by rejecting 511 keV photons and secondary neutron interactions in the CC [Polf et al., 2015]. The fraction of triggers identified and retrieved as Compton events by the CSR was around 10% even though one third of them did not correspond to real Compton interactions.

Absolute error distributions depicted in figure 5.7 suggest that to some extent the inferred events do not correspond to the correct kinematic parameters. Consistent with the mono-energetic point-like scenario, E_g (energy of the scattered gamma) is overestimated while the initial E_i and recoil electron energy E_e are underestimated with respect to the real interactions. Compton scattering angle error estimations are appreciably high (in some cases up to 100°), which can be associated to poor quality image reconstructions due to errors in the aperture of conical sections. Table 5.3 lists the mean and median values of the absolute error distributions. As anticipated by the results of the mono-energetic source (without energy selection), the energy of the recoil electron is noticeably smaller for the reconstructed Compton events. The mean absolute error $\mu_{\Delta E_e} = -2.76$ MeV is nearly equal to the mean energy transferred to recoil electrons (as deduced from MC simulation). It is evident that in this scenario many electrons may have sufficient energy to escape the DSSSD stack and interact with the LaBr₃. Indeed, around 40% of the reconstructed events correspond to interactions where recoil electrons deposit a fraction of their energy in the absorber module. For these events, the kinematics are consistent and the CSR algorithm tends to associate the corresponding energy depositions with the scattered gamma; consequently, the energy deposition in the tracker (around 140 keV per layer) is assigned to the recoil electron.

Those results indicate that modifications of the trackers as well as in the electron tracking retrieval algorithm must be considered in order to correctly identify high-energy electron tracks. Moreover, the fraction of Compton interactions among the triggers has to be increased by improving the detector efficiency. A potential upgrade must demand a high Compton scattering probability for the tracker component; furthermore, it should guarantee that electrons will be capable of passing through enough layers to measure the direction, but eventually being stopped before further interactions with the absorber module. An investigation and discussion about possible modifications of the current LMU CC design can be found in chapter 7. Additionally, a comparison of the CSR algorithm

performance for the different configuration designs is presented.

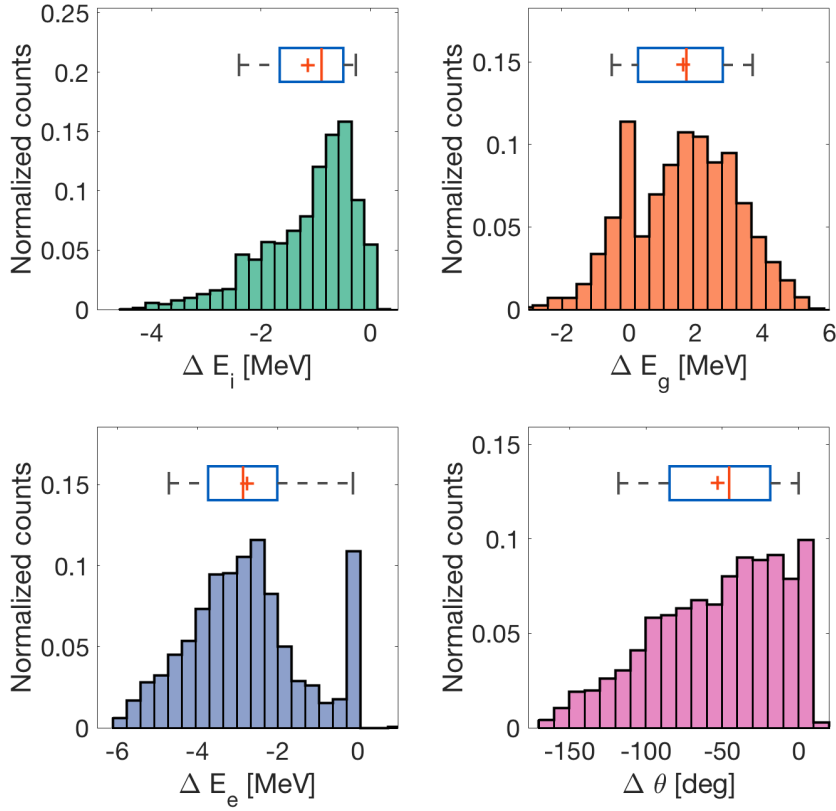

Figure 5.7: Comparison of the absolute error distributions of the estimated kinematic parameters for the PG emission during a proton beam irradiation (150 MeV). Median and mean values are marked by a vertical line and the cross inside the box, respectively. The box encloses the first and the third quartile.

Parameter	μ	\bar{x}
ΔE_i	-1.09 MeV	-0.87 MeV
ΔE_g	+1.62 MeV	+1.70 MeV
ΔE_e	-2.71 MeV	-2.72 MeV
$\Delta \theta$	-53.0 deg	-46.0 deg

Table 5.3: Mean (μ) and median (\bar{x}) values of the absolute error distributions for the PG emission during proton beam irradiation.

5.4 Detector imaging capabilities

Point-like sources

Reconstructed events obtained for the point source scenarios presented in section 5.2 were sorted as list-mode data to assess the imaging capabilities of the LMU detector prototype. The image reconstruction was performed with the **MLEM** algorithm introduced in section 4.3. The final 2D images after the 50th iteration, which ensure a good trade-off between convergence and noise can be observed in figure 5.8. The number of valid events included in the reconstruction was ~ 100000 and at least 30000 with energy window (i.e., an initial energy within $\pm 5\%$ of the known source energy) in order to ensure statistically significant results. The image volume was set from -2.0 cm to $+2.0$ cm for the lateral extension (x- and y- directions) and -1.0 cm to 1.0 cm along the z-axis. For all energies, the voxel size was defined as $0.04 \times 0.04 \times 2.0$ cm³ (i.e., one voxel in the direction perpendicular to the **CC** surface). The quantitative analysis was performed by calculating the position resolution for the xy-plane by fitting the normalized intensity profile using a 2D Gaussian. From the fit, the **FWHM** can be computed as the spatial resolution of the reconstructed position. Table 5.4 presents the obtained parameters for the images shown in figure 5.8.

A strong impact of the energy selection is observed in the reconstructed images, due to the rejection of incorrectly retrieved low energy Compton events that leads to sharper point sources. The spatial resolution is improved by 70% and 50% for the 2 and 6 MeV sources, respectively. However, the measured source location, in both scenarios, is resolved with submillimetre accuracy. Since the angular resolution is highly dependent on the incident energy due to the performance of the **CSR** algorithm (cf. figure 5.4), the spatial resolution of the reconstructed image is also degraded for increasing energy.

Energy [MeV]	Energy window [MeV]	FWHM (no window) [mm]	FWHM (window) [mm]
2	[1.90-2.10]	(13.0, 12.6)	(2.9, 2.9)
3	[2.85-3.15]	(12.9, 12.9)	(3.2, 3.2)
4	[3.80-4.20]	(13.4, 13.3)	(3.8, 3.8)
5	[4.75-5.25]	(13.5, 13.5)	(4.7, 4.7)
6	[5.70-6.30]	(13.4, 13.1)	(5.8, 5.8)

Table 5.4: Fitting parameters of the 2D Gaussian model for images shown in figure 5.8 of mono-energetic point-like sources. The position resolution is computed as $\text{FWHM} = 2\sqrt{2 \ln 2} \sigma$.

Extended sources

Reconstructed events obtained for the water phantom irradiation scenario introduced in section 5.3 were used to evaluate the imaging capabilities of the LMU prototype in a more

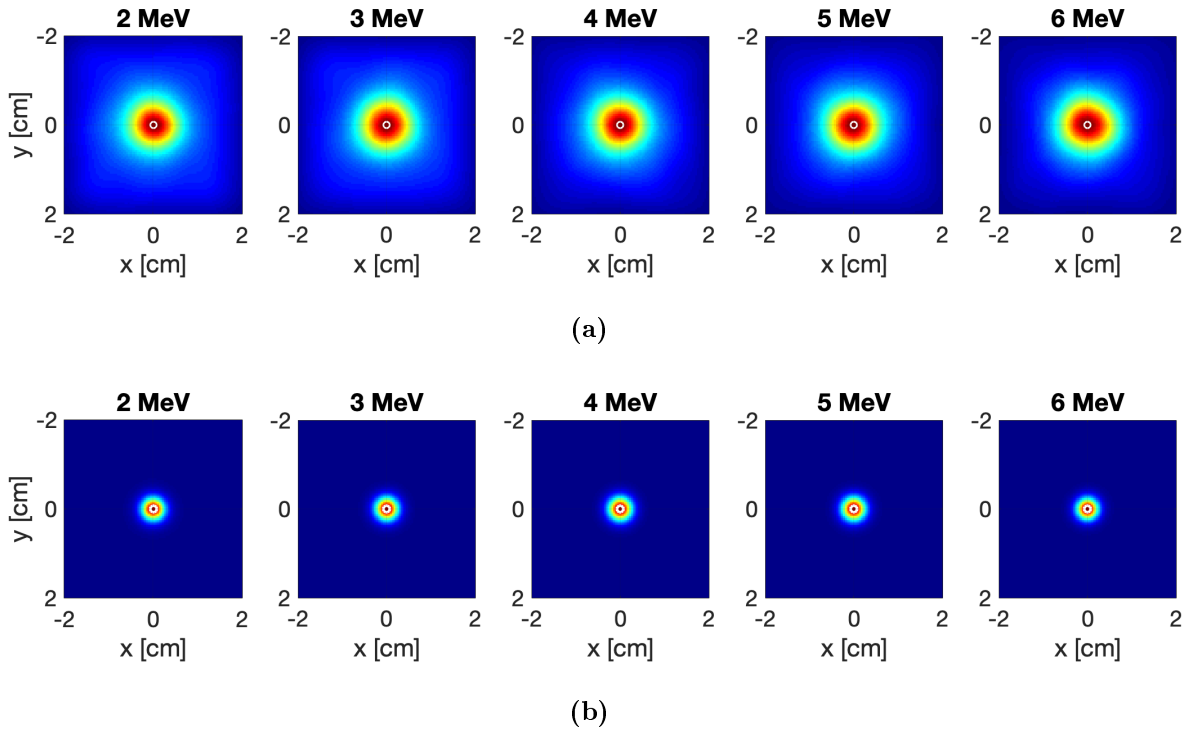

Figure 5.8: Images of reconstructed point sources without (figure 5.8a) and with (figure 5.8b) energy selection for the simulations with the LMU CC prototype. The true origin (0.0, 0.0, 0.0) is indicated by the white circle. The intensity is normalised to have 1 as a maximum.

complex and realistic scenario. The image reconstruction was performed with the MLEM algorithm. Around ~ 100000 valid events were used for the reconstruction and the number decreases to ~ 20000 applying an energy window of 2.0 to 6.5 MeV. 2D images obtained for the 20th iteration are shown in figure 5.9. In this case, fewer number of iterations were required comparing to the point source scenario to obtain a reconstruction closer to the true beam emission shape. Moreover, MLEM algorithm tends to become noisy as the number of iterations increases therefore the reconstructed image quality for more complex irradiation scenarios may be degraded after the 30th iteration. For both images, the image volume had a lateral extension (x- and y- directions) from -5.0 cm to $+5.0$ cm and the range along the beam axis (z-direction) was from -25.0 cm to $+25.0$ cm and the voxel size was defined as $0.2 \times 10 \times 0.05$ cm³. The camera was placed along the y-axis and the z-axis corresponds to the proton beam direction (cf. figure 4.1). The number of events and iterations are sufficient to reproduce the beam emission shape. Qualitatively, the image exhibits a higher contribution of background noise without the energy selection. This effect broadens the lateral distribution of the emission and blurs the fall-off region. Furthermore, the selection reduces the negative influence of low energy photons and enhances the proper reconstruction of the line-like emission. The following chapter (6) aims at quantifying the performance of PG imaging in range verification.

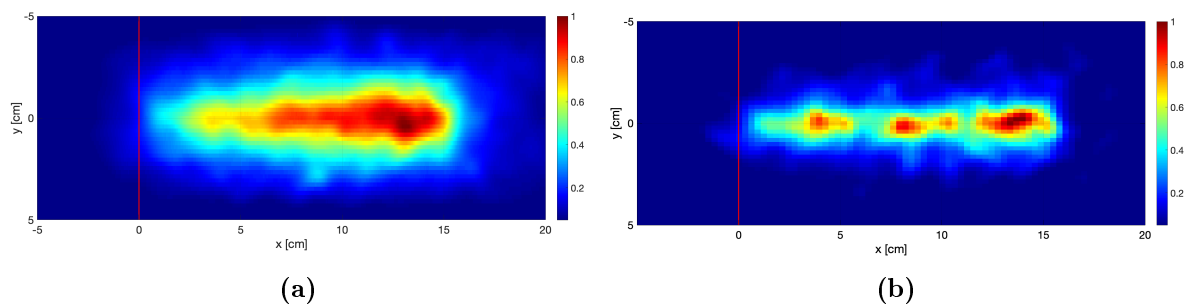

Figure 5.9: Images of the reconstructed PG emission without (figure 5.9a) and with an energy selection (figure 5.9b) for the irradiation of 150 MeV proton pencil beam in water with the LMU prototype. The red line depicts the entrance of the phantom. The intensity is normalised to have 1 as a maximum.

Part IV

Proton range verification through prompt gamma imaging

“One never notices what has been done; one can only see what remains to be done.”

Marie Curie -Letter to her brother (1894)-

6

Quantitative comparison of reconstructed prompt gamma emissions using two different Compton camera detection systems and image reconstruction algorithms

In this chapter, the ability of two **CC** devices to measure **PGs** emitted during proton pencil beam irradiation in different scenarios is evaluated. Additionally, a comparison between the **MLEM** and **SOE** reconstruction algorithms is presented.

2D images were reconstructed with events obtained from combining the interactions by means of Compton kinematics. Subsequently, one-dimensional profiles were extracted in order to be compared with the known depth-dose curves. The proton beam range is defined as the position of the 80% distal dose fall-off, because it coincides with the mean projected range and is thus independent of the beam's energy spread [Paganetti, 2012]. Then, the **PG** range obtained by fitting the distal end of the reconstructed profile with a sigmoidal function [Tian et al., 2018] can be correlated with the proton beam range. Detection of shifts in the position of the Bragg peak as small as 3 mm were also studied. Relative differences between the calculated **PG** ranges were compared with the expected range shifts, which were introduced by slightly changing the beam energy or adding material in the beam path.

Additionally, a proof of concept study for small animal **PG** imaging was conducted by simulating low energy proton beams impinging on water phantoms in order to qualitatively evaluate the range monitoring capabilities in preparation of future applications in pre-clinical research.

6.1 Imaging of prompt gamma distributions

6.1.1 Water phantom irradiation

The PG emissions during the irradiation of a water phantom with a proton pencil beam of 150 MeV and 180 MeV were simulated for the LMU prototype and the Polaris-J CCs (cf. figure 6.1). Acquisition of the PG emission was simulated at three different camera locations along the beam axis in order to cover a larger field-of-view. The total number of primary protons was 1×10^9 in both cases. The interactions in the detector were combined into events using the CSR presented in chapter 4 by means of the Compton kinematics. Additionally, an energy cut was applied to only keep Compton events with total energy in the relevant range of 2.0 to 6.5 MeV. Subsequently, the data were incorporated into the image reconstruction algorithms. The orientation of the coordinate system is as shown in figure 4.1. In both cases, the voxelized ($0.2 \times 1.0 \times 0.1 \text{ cm}^3$) image volume had a lateral extension (x- and y- directions) from -5.0 cm to $+5.0 \text{ cm}$ and the range along the beam axis (z-direction) was from -25.0 cm to $+25.0 \text{ cm}$.

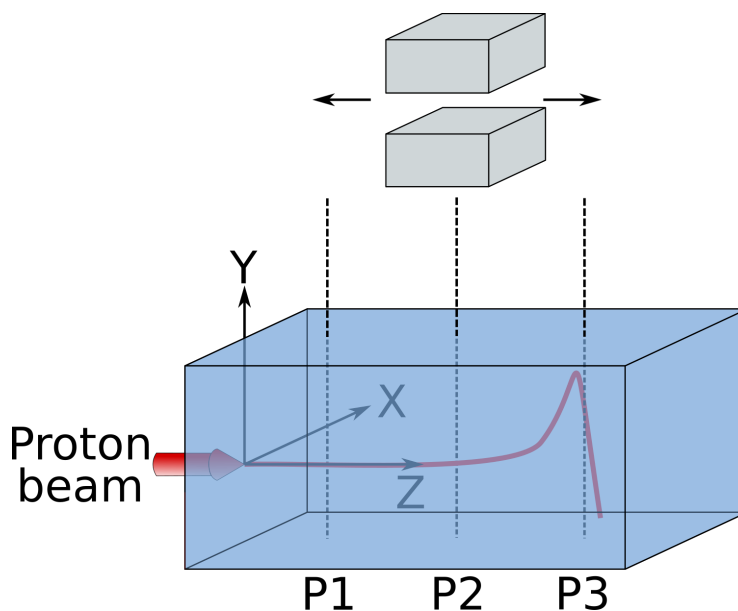

Figure 6.1: Schematic of the simulation set-up for the imaging of PG emissions during the irradiation of a water phantom showing the proton beam (red arrow) incident on the phantom from the negative z-direction. The grey boxes schematically represent the two different CC configurations. Acquisitions were registered in three different positions (P1, P2, P3) along the beam path.

Displayed in figure 6.2a and figure 6.3a are the PG emissions obtained for the 20th iteration with the MLEM algorithm for the irradiation of 150 MeV and 180 MeV proton pencil beams, respectively. For the 150 MeV irradiation scenario, the PG reconstructions were performed using two-site events (no electron tracking, two energy measurements and one angle) as well as including electron tracking events in order to evaluate the impact

of the redundant information in the retrieval of the total scatter angle. For the two cameras, a similar number of valid events is used for the image reconstruction in order to investigate the imaging performance independently from the efficiency. The LMU prototype image contains 7100 events without electron tracking whereas the electron tracking and the Polaris-J images contain 20000 valid events. For the 180 MeV case, the LMU electron tracking image contains 20000 and the Polaris-J 37900 valid events. In general, a marked decrement in the PG emission can be correlated with the finite proton beam range; even though, some background signal may be caused by an incorrect retrieval of Compton events around the downstream and off-axis beam regions in the image volume. 1D PG profiles were extracted from the reconstructed 2D images by integrating over a central region ($\Delta x = 1$ cm). The reconstructed PG profile, the corresponding depth-dose profile and the PG reference emission obtained from the MC simulations are shown in figures 6.2b and 6.3b. As expected, the PG profiles follow the trend of the depth-dose curve. Especially, the PG fall-off is lined up very well with the distal dose fall-off and there is a good agreement with the reference emission, which leads to a possible correlation between the detectable emission and the proton beam range in the target.

As mentioned previously in the introductory section, the proton beam range R_D is defined as the position of the 80% distal dose fall-off. The PG range (R_{PG}) is obtained by fitting the reconstructed fall-off region with a sigmoidal function using the two-step method of Tian et al. [2018]. First, the fall-off region is identified within the reconstructed signal; afterwards, the fit is applied following the function:

$$f(z) = a + (1 - a) \operatorname{erf}[b(z - c)] \quad (6.1)$$

where z is the depth in the target and a , b and c are fitting parameters. The parameter c , which corresponds to the inflection point of the sigmoidal fit, is defined as R_{PG} . The steepness of the fit given by b (expressed in cm^{-1}) [Schmid et al., 2015] is used to provide an error estimation of R_{PG} due to variations of the PG signal. Therefore, the reported error values hereafter assumed changes of 2% and 5% in the PG signal at the position of the inflection point. This fitting method provides a reliable and robust quantification of R_D using the reconstructed PG due to the strong correlation between the aforementioned inflection point and the proton range determined from the depth-dose curve [Janssen et al., 2014]. Table 6.1 summarizes the PG range values deduced from the reconstructed 1D profiles in comparison to the proton beam range. For both energies, the correlation was consistent and independent of the detector configuration, the distances between R_D and R_{PG} are within 3.0 mm.

PG emissions and the corresponding 1D profiles reconstructed by using the SOE algorithm are shown in figures 6.4 and 6.5 for 150 MeV and 180 MeV, respectively. Consistent with the MLEM results, the distal fall-off of the PG profiles aligns well with the distal dose fall-off in both cases. Reconstructed images are noticeably different in the entrance region of the phantom. The LMU signal arises just ~ 2 cm after the front face, whereas for the Polaris-J a sharp increase of the signal can be seen before the phantom entrance. This may be due to an increased amount of overlapping cones in this region for the Polaris-J,

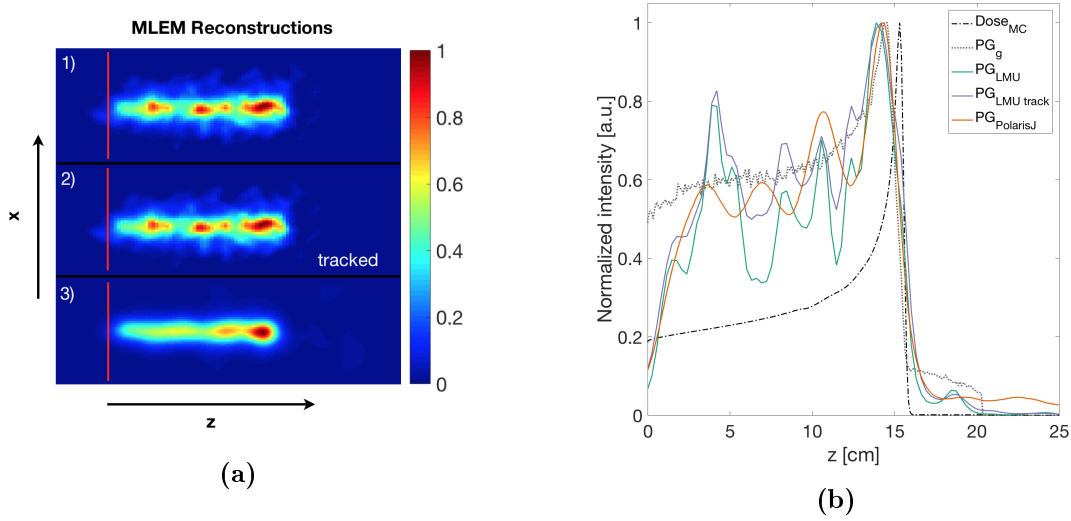

Figure 6.2: Reconstructed 2D images for the LMU (figure 6.2a, panel 1-2 without and with electron tracking) and Polaris-J (figure 6.2a, panel 3) detectors using the MLEM algorithm for the simulation scenario with a proton beam energy of 150 MeV. The red line indicates the entrance of the phantom and the z-axis depicts the beam direction. Intensity units are normalised. One-dimensional profiles (figure 6.2b) were extracted from the reconstructed 2D images integrating over a central region with $\Delta x = 1$ cm and compared to the depth-dose profile given by the MC simulation.

Energy [MeV]	R_D [cm]	R_{PG-g} [cm]	$R_D - R_{PG-g}$ [cm]	R_{PG} [cm]		$R_D - R_{PG}$ [cm]
150	15.67	$15.33^{+0.00*}_{\pm 0.01}$	+0.34	LMU	$15.48^{+0.02}_{\pm 0.05}$	+0.19
				LMU (tracked)	$15.67^{+0.02}_{\pm 0.05}$	0.00
				Polaris-J	$15.46^{+0.02}_{\pm 0.05}$	+0.21
180	21.60	$21.25^{+0.01}_{\pm 0.03}$	+0.35	LMU	$21.42^{+0.02}_{\pm 0.04}$	+0.18
				Polaris-J	$21.32^{+0.02}_{\pm 0.04}$	+0.28

* Error estimation < 0.01 cm.

Table 6.1: Proton beam range for 150 MeV and 180 MeV in comparison with the fall-off position of the corresponding reconstructed PG profile (MLEM algorithm), determined by the sigmoidal fitting method. As reference R_{PG-g} (MC) is also listed. The reported error values correspond to 2% (superscript) and 5% (subscript) changes in the PG signal at the position of the inflection point.

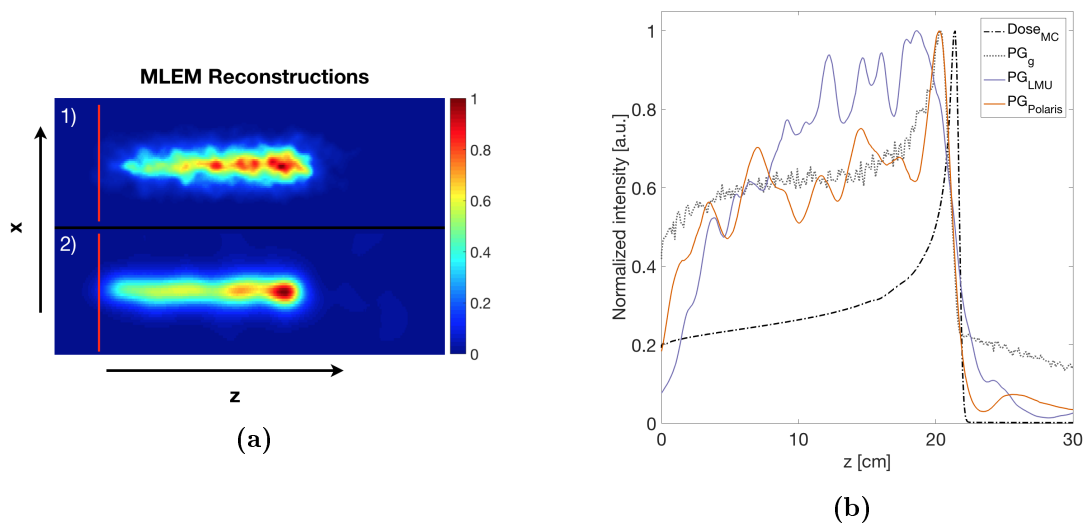

Figure 6.3: Reconstructed 2D images for the LMU (figure 6.3a, panel 1 with electron tracking) and Polaris-J (figure 6.3a panel 2) detectors using the MLEM algorithm for the simulation scenario with a proton beam energy of 180 MeV. The red line indicates the entrance of the phantom and the z-axis depicts the beam direction. The extracted one-dimensional profiles (figure 6.3b) are compared to the depth-dose profile given by the MC simulation.

originating from the larger field-of-view given by the lateral offset between stage 2 and 3 (cf. figure 4.2). Table 6.2 presents the proton beam range values in comparison with the obtained R_{PG} values. The correlation between the R_D and R_{PG} was within 2 mm using the SOE reconstruction. Moreover, the obtained PG profiles are shallower compared to the MLEM reconstruction, which is also reflected by the increased estimated fitting errors.

Energy [MeV]	R_D [cm]	R_{PG-g} [cm]	$R_D - R_{PG-g}$ [cm]	R_{PG} [cm]		$R_D - R_{PG}$ [cm]
150	15.67	$15.33^{+0.00*}_{\pm 0.01}$	+0.34	LMU	$15.50^{+0.02}_{\pm 0.05}$	+0.17
				Polaris-J	$15.50^{+0.05}_{\pm 0.12}$	+0.17
180	21.60	$21.25^{+0.01}_{\pm 0.03}$	+0.35	LMU	$21.30^{+0.04}_{\pm 0.10}$	+0.30
				Polaris-J	$21.40^{+0.04}_{\pm 0.11}$	+0.20

* Error estimation < 0.01 cm.

Table 6.2: Proton beam range for 150 MeV and 180 MeV in comparison with the fall-off position of the corresponding reconstructed PG profile (SOE algorithm) determined by the sigmoidal fitting method. As reference R_{PG-g} (MC) is also listed. The reported error values correspond to 2% (superscript) and 5% (subscript) changes in the PG signal at the position of the inflection point.

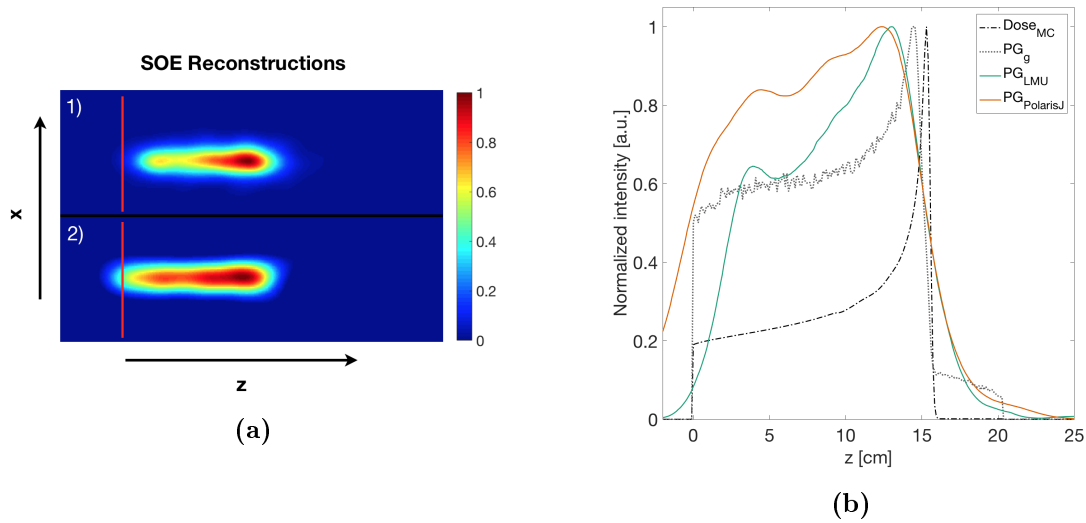

Figure 6.4: Reconstructed 2D images for the LMU (figure 6.4a, panel 1 without electron tracking) and Polaris-J (figure 6.4a, panel 2) detectors using the SOE algorithm for the simulation scenario with a proton beam energy of 150 MeV. The red line indicates the entrance of the phantom and the z-axis depicts the beam direction. The extracted one-dimensional profiles (figure 6.4b) are compared to the depth-dose profile given by the MC simulation.

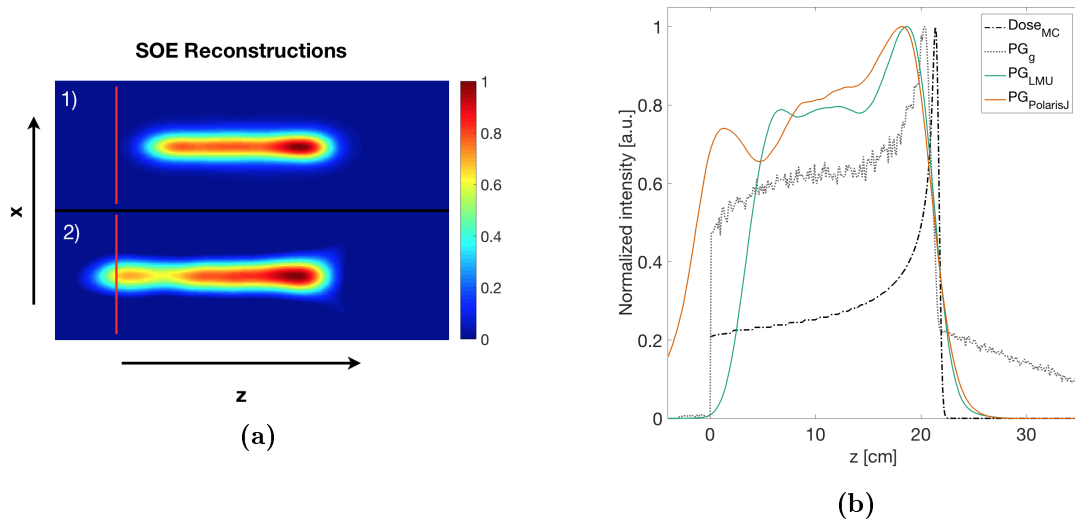

Figure 6.5: Reconstructed 2D images for the LMU (figure 6.5a, panel 1 without electron tracking) and Polaris-J (figure 6.5a, panel 2) detectors using the SOE reconstruction for the simulation scenario with a proton beam energy of 180 MeV. The red line indicates the entrance of the phantom and the z-axis depicts the beam direction. The extracted one-dimensional profiles (figure 6.5b) are compared to the depth-dose profile given by the MC simulation.

Experimental data

Experimental proton beam irradiation data were exploited in order to compare the performance of the different reconstruction approaches using the Polaris-J **CC** detector. The experiment was conducted at the University of Pennsylvania Roberts Proton Therapy Center, irradiating under real conditions a water target with a proton pencil beam of 150 MeV delivered at clinical dose rates. The estimated dose was 5 Gy at the position of the Bragg peak, which corresponds to 8.9×10^8 primary protons. The **CC** stages were aligned parallel to the beam axis and measurements in three different locations were performed to mimic a larger field-of-view. The experimental set-up can be found in figure 6.6 and more details on the measurement campaign are reported in [Polf et al. \[2015\]](#).

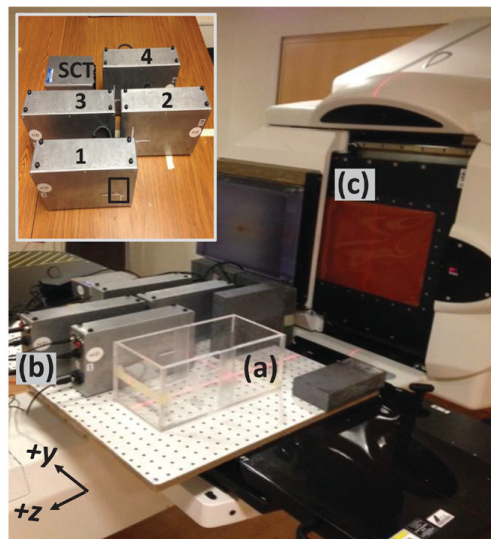

Figure 6.6: Experimental set-up for the **PG** measurement during the water phantom (a) irradiation using the Polaris-J (b) with respect to the treatment nozzle (c). The inset shows the four **CC** stages and the synchronization coincidence time (SCT) module [[Polf et al., 2015](#)].

Reconstructions of the **PG** image were performed by using the **MLEM** and **SOE** algorithms following an identical definition of the image volume (lateral extension from -1.5 cm to $+1.5$ cm and -25.0 cm to $+25$ cm along the beam direction). The reconstructed images shown in figure 6.7a were obtained by using 56000 valid events for the **MLEM** and 51300 for the **SOE** algorithm in the 2.0 - 6.5 MeV energy range. A smoother distribution of the events is obtained for the **MLEM** image. This can be explained by the way in which each algorithm samples the Compton cone within the image volume. Whereas the **MLEM** approach backprojects the whole cone with a finite width determined by the angular resolution of the detector, the **SOE** method evaluates one representative point on the surface of the cone. As a result, fairly coarse images are obtained when the number of origins (events) is limited. However, the retrieved **PG** emission for both algorithms are comparable regarding the range and the position of the maximum intensity. The measured depth-dose profile (ionisation chamber measurements) and the **1D PG** profiles extracted by

integrating over a central region with $\Delta x = 1$ cm are compared in figure 6.7b. Consistent with the previously presented simulation results, the distal dose fall-off lines up accurately with the fall-off of the PG profile for both reconstruction algorithms. The measured R_D and the calculated R_{PG} (sigmoidal fitting method) values are listed in table 6.3.

Differences between the positions of the PG fall-off position and R_D are within 5 mm. As for the previously presented simulation results, the MLEM reconstruction is slightly steeper than the SOE one. Overall, the reconstructed profiles exhibit slightly broader fall-off regions (compared to MC simulations of the PG under similar conditions), which causes a small misalignment with the distal dose fall-off. The signal background may be caused by gammas created beyond the beam range due to neutron interactions. Furthermore, incorrectly reconstructed events either originating from other interactions or having an incorrectly retrieved initial energy can cause an overall worsening of the image quality. In addition, the correlation between R_D and R_{PG} might not be strictly the same for each set-up, but can have variations depending on the detection process, the irradiated target medium and the energy of the proton beam [Janssen et al., 2014].

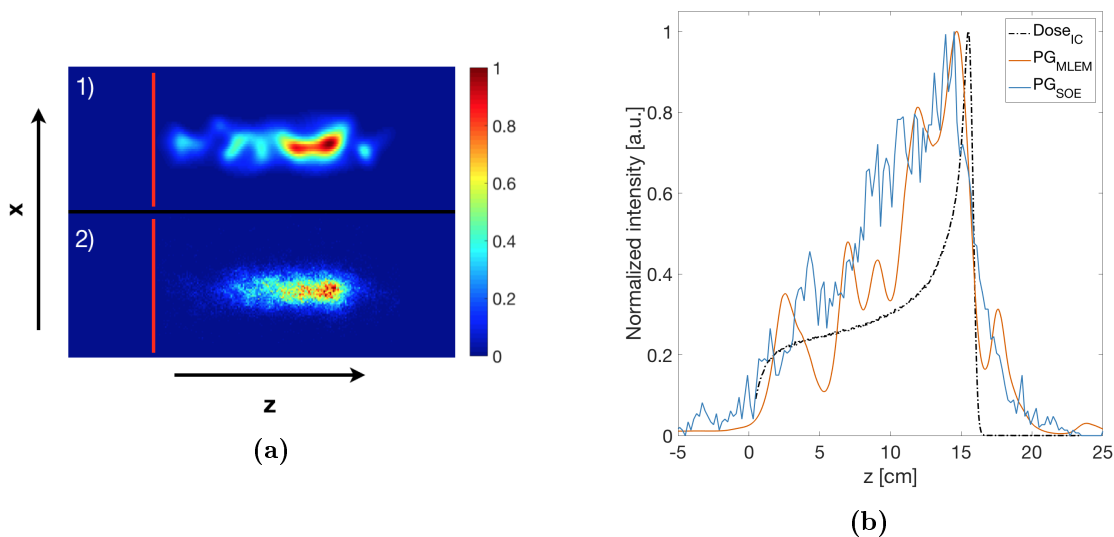

Figure 6.7: Reconstructed PG emission for a 150 MeV proton beam irradiation measured with the Polaris-J CC for a H₂O phantom. XZ projection images (figure 6.7a) are obtained by MLEM (panel 1) and SOE (panel 2) algorithms. The red line indicates the entrance of the phantom and the z-direction corresponds to the beam direction. The one dimensional profiles (figure 6.7b) are compared to the depth-dose profile measured with an ionization chamber (IC) [Polf et al., 2015].

6.1.2 Heterogeneous phantom

In order to evaluate the performance of PG imaging with the considered CC prototypes in more complex irradiation scenarios, MC simulations were performed for a proton beam

R_D [cm]	Algorithm	R_{PG} [cm]	$R_D - R_{PG}$ [cm]
15.73	MLEM	$16.06^{+0.03}_{\pm 0.09}$	-0.33
	SOE	$16.24^{+0.04}_{\pm 0.11}$	-0.51

Table 6.3: Measured proton beam range for the 150 MeV experimental irradiation set-up compared with the fall-off position of the corresponding reconstructed PG profiles for the Polaris-J CC . The reported error values correspond to 2% (superscript) and 5% (subscript) changes in the PG signal at the position of the inflection point.

irradiation (180 MeV) of a water phantom including a bone insert and an air gap (cf. figure 6.8).

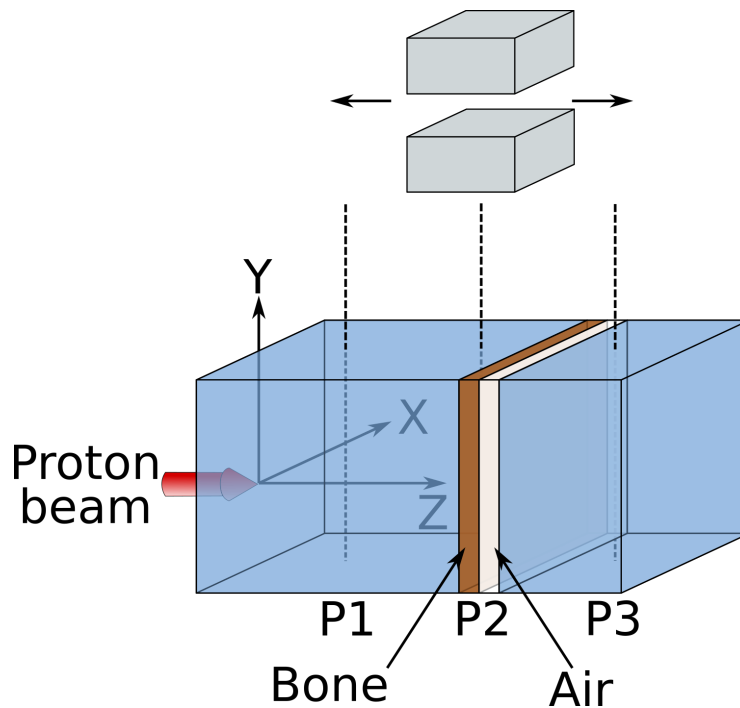

Figure 6.8: Schematic of the simulation set-up for the imaging of PG emissions during the irradiation of a water phantom with a bone insert and an air region showing the proton beam (red arrow) incident on the phantom from the negative z -direction. The grey boxes schematically represent the two different CC configurations. Acquisitions were registered in three different positions (P1, P2, P3) along the beam path.

LMU prototype

The simulated scenario for the LMU CC prototype considered 3×10^{10} primary protons. The cut in the total energy (2.0 - 6.5 MeV) of the reconstructed Compton events for the water phantom scenario was also applied in this case. Around 70000 Compton events were retrieved by the CSR and the image reconstruction was performed using a voxel size of $0.2 \times 1.0 \times 0.05$ cm³. The image obtained by the MLEM algorithm after the 20th iteration is shown in figure 6.9a. As it can be observed, changes in the PG emission due to the target composition are imperceptible. The maximum intensity coincides with the position of the bone slab, whereas the air region is blurred by wrongly reconstructed events. Therefore, variations in the ground truth emission cannot be distinguished. Besides, the pencil beam shape of the source emission is not retrieved because of missing gammas in the front face region of the phantom due to the limited field-of-view of the detector configuration. Assessing the information of the MC simulation, perfect retrieval of the events was considered in order to understand the impact of limitations in the CSR method. A perfect Compton event ensures that for every triggered interaction, first and second hit are originated from the initial gamma ray. As a result, 13900 valid events were found among the interactions. The reconstructed image using these events as input is shown in figure 6.9b. Clearly, the source distribution is better retrieved despite the reduced amount of valid events and changes in the PG emission intensity are visible at the end of the beam range. The level of background noise (80% of the CSR events were wrongly retrieved) was decreased. Visually, the blurring of the signal due to heterogeneities along the proton beam path is reduced. The amount of valid events in each of the images (~ 70000 and ~ 14000 for figures 6.9a and 6.9b), respectively, indicates the large amount of incorrect events that cannot be rejected by applying the CSR method.

The 1D profiles are compared in figure 6.9c. As reference, the true PG_g origin distribution given by the MC simulations is plotted. A poor PG profile reconstruction is obtained by applying the CSR method despite the considerable amount of presumed valid events within the image volume. Background signal caused by either incorrect or false Compton interactions tends to have a non negligible impact on more sophisticated irradiation scenarios. Limitations faced during the event retrieval using the information of the detector (explained in chapter 5) are assumed to cause the degraded image quality. The profile obtained from the perfect retrieval more closely follows the true PG origin distribution. Distances between the R_{PG} and R_D are listed in table 6.4. The relation given by the reconstructed PG profile (perfect retrieval) is within 2.0 mm, while the result using CSR events leads to ambiguities in the correct R_{PG} estimation (the positions were identical), since the relation between R_D and the PG_g range value (R_{PG-g}) (inflection point of the fall-off region of the reference PG) is actually 3.0 mm.

Polaris-J detector

The simulated scenario for the Polaris-J CC considered 1×10^9 protons. The images were reconstructed by the MLEM and SOE algorithms using comparable parameters. Valid

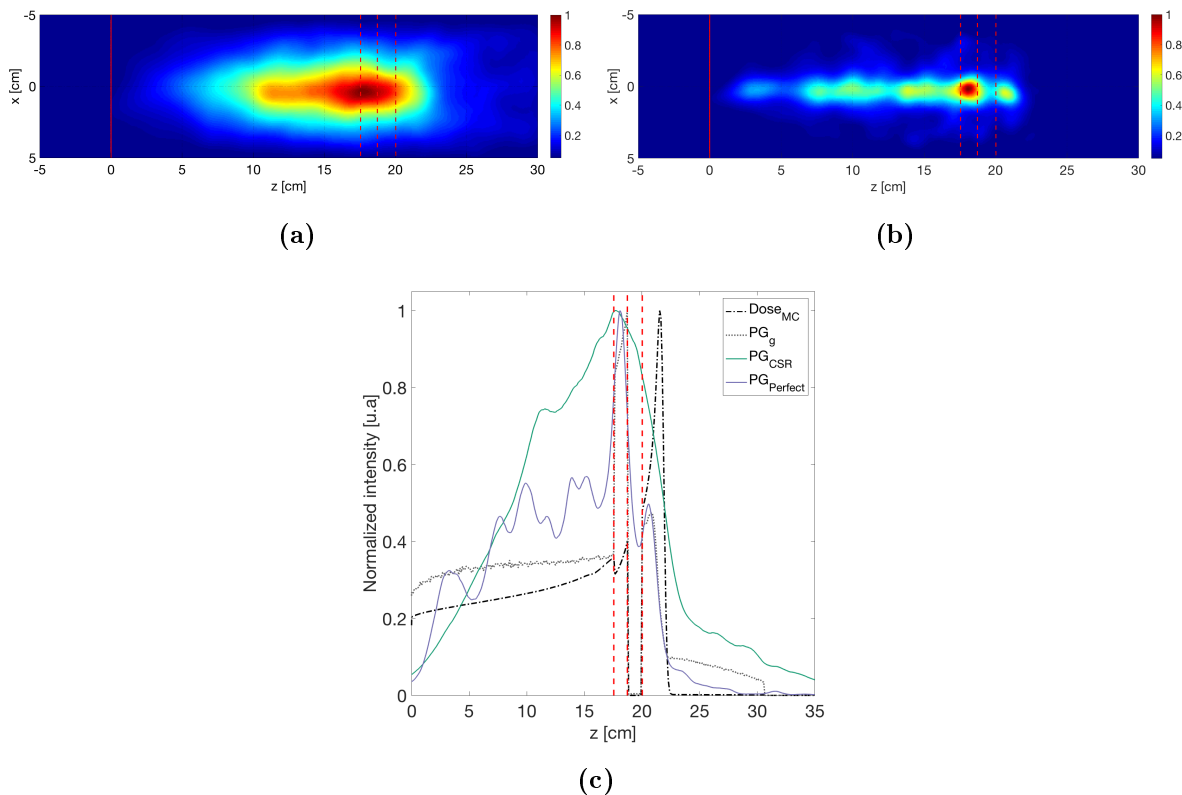

Figure 6.9: XZ projection images using the CSR algorithm (figure 6.9a) and considering perfect event retrieval (figure 6.9b) for the LMU camera. Solid red lines depict the entrance of the phantom and the dashed red lines mark the boundaries of the bone and air regions. One-dimensional profiles given in 6.9c were plotted relative to the entrance point. The PG_g distribution and the dose correspond to the information given by MC simulation.

R_D [cm]	R_{PG-g} [cm]	$R_D - R_{PG-g}$ [cm]	R_{PG} [cm]		$R_D - R_{PG}$ [cm]
21.78	$21.53^{±0.01}_{±0.03}$	+0.25	CSR	$21.84^{±0.06}_{±0.15}$	-0.06
			Perfect	$21.57^{±0.02}_{±0.05}$	+0.21

Table 6.4: Distal dose fall-off position compared to the PG range for the LMU prototype for a proton beam of 180 MeV impinging on an heterogeneous phantom. As reference R_{PG-g} (MC) is also reported. The reported error values correspond to 2% (superscript) and 5% (subscript) changes in the PG signal at the position of the inflection point.

events within the image volume were 50000 exploiting the CSR method (cf. figure 6.10), whilst the perfect retrieval found among the interactions 35000 events (cf. figure 6.11). For the CSR scenarios, both image reconstruction algorithms showed similar performance

in the PG fall-off region. This can be confirmed by comparing the R_{PG} estimations in table 6.5. Nevertheless, changes in the emission due to the phantom heterogeneities are not distinguishable in the reconstructions by neither of the algorithms. For the perfect retrieval, consistent with the previous results for the LMU prototype, the PG profiles obtained by both reconstructions visually line up better with the true PG origin. Furthermore, the bone insert and air gap close to the Bragg peak can be clearly identified although the $MLEM$ reconstruction is overestimating the signal in the region upstream of the bone insert. Compared to the LMU prototype, the improved efficiency of the Polaris-J detector is reflected in the increase amount of valid events contained in the final image. The perfect retrieval found 3 times more valid events for this detector even when the number of primary protons is by one order of magnitude lower. This can be explained by ambiguities in the electron track retrieval due to the large fraction of high energy electrons being not stopped in the tracker module and the worse angular resolution of tracked events compared with the non tracked ones. The correspondence between the R_D and R_{PG} (cf. table 6.5) varies between +2.0 mm ($MLEM$) and +4.0 mm (SOE).

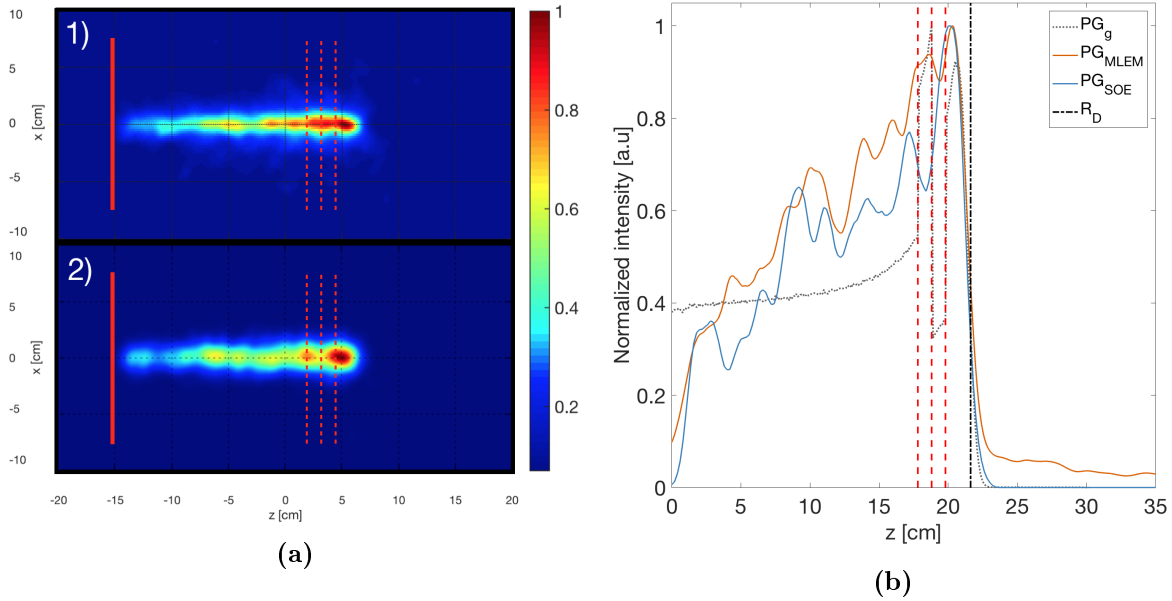

Figure 6.10: XZ projection images (CSR retrieval) obtained with the $MLEM$ (1) and SOE (2) algorithms (6.10a) for 180 MeV proton irradiation of an inhomogeneous target with the Polaris-J camera. Solid red lines depict the entrance of the phantom and the dashed red lines mark the boundaries of the bone and air region. One-dimensional profiles given in 6.10b were plotted relative to this point. The PG_g distribution correspond to the information given by the MC simulation.

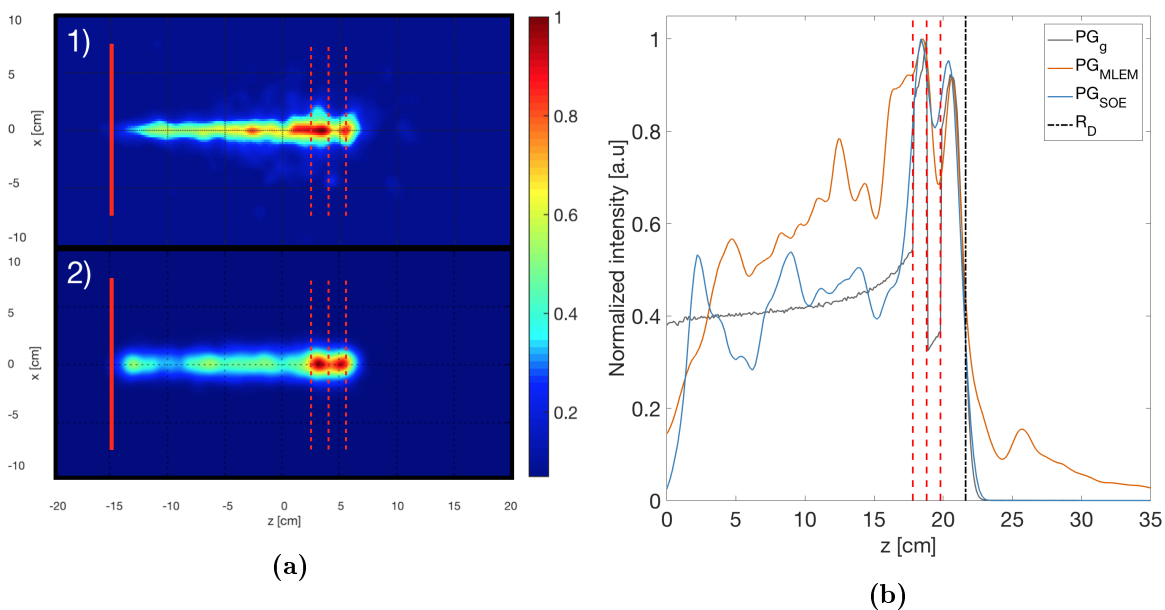

Figure 6.11: XZ projection images (*perfect retrieval*) obtained with the MLEM (1) and SOE (2) algorithms (figure 6.11a) for 180 MeV proton irradiation of an inhomogeneous target with the Polaris-J camera. Red lines depict the entrance of the phantom and the red dashed line marks the boundaries of the bone and air region. One-dimensional profiles given in figure 6.10b were plotted relative to this point. The PG_g distribution correspond to the information given by the MC simulation.

R_D [cm]	R_{PG-g} [cm]	$R_D - R_{PG-g}$ [cm]	Events	R_{PG} [cm]		$R_D - R_{PG}$ [cm]
21.78	$21.53^{+0.01}_{\pm 0.03}$	+0.25	CSR	MLEM	$21.67^{+0.02}_{\pm 0.05}$	-0.11
				SOE	$21.35^{+0.02}_{\pm 0.04}$	+0.43
			Perfect	MLEM	$21.55^{+0.02}_{\pm 0.06}$	+0.23
				SOE	$21.43^{+0.02}_{\pm 0.04}$	+0.35

Table 6.5: Distal dose fall-off position compared with the PG range obtained from the Polaris-J during irradiation with a proton beam of 180 MeV impinging on a heterogeneous phantom. As reference R_{PG-g} (MC) is also listed. The reported error values correspond to 2% (superscript) and 5% (subscript) changes in the PG signal at the position of the inflection point.

6.2 Range shifts evaluation

As a range verification tool, the reconstructed PG emissions must allow for resolving relative shifts in the proton beam range during treatment delivery using a consistent and quantitative correlation between the measurement and the depth-dose profile. Following, these capabilities are evaluated for both CC configurations.

Water phantom

For the water target scenario, taking 120 MeV as reference, shifts of 3 mm and 6 mm were emulated in the MC simulations by slightly increasing the energy of the proton beam (122 MeV and 124 MeV). The number of primary protons in each case was 7×10^9 and the acquisition was simulated in three different locations along the beam axis. As in previous studies, interactions in each of the CC detector configurations were combined to Compton events based on the CSR algorithm. Images were reconstructed using an image volume which ranges along the beam axis (z-direction) from -15 cm to $+15$ cm. The voxel size was set to $0.2 \times 1.0 \times 0.05$ cm³. Shown in figure 6.12 are the XZ projection images reconstructed with the MLEM algorithm after the 20th iteration. Independent of efficiency, 25000 valid events were selected to be contained in the reconstructed images for both detector configurations. It can be recognised, that the PG emission is shifted with respect to the reference as the beam energy is increased. Incorrectly reconstructed events contribute to a broadening of the pencil beam source emission as previously encountered for the inhomogeneous target scenarios in section 6.1.2. On the other hand, the Polaris-J acquisition yields a steeper fall-off with a marked high-intensity value close to the position of the Bragg peak. The noise background in the images is also reduced. The corresponding 1D profiles are depicted in figure 6.13. The proton beam range (R_D), the ground truth PG range (R_{PG-g}), the estimated PG range (R_{PG}) and the calculated and predicted shifts relative to the 120 MeV reference are summarised in table 6.6. Consistent with previous results, the distance between the proton beam range and R_{PG} at the reference beam energy (120 MeV) is within 5 mm in all cases. Furthermore, by using the inflection point of the sigmoidal fitting in the fall-off region of the reconstructed PG profiles, shifts in the proton range as small as 3.0 mm could be resolved calculating the relative difference between the obtained R_{PG} values in each case. These variations in the proton pencil beam range were quantified with 2.0 mm accuracy for the LMU and Polaris-J CC simulations. The aforementioned findings are consistent with the studies conducted by Polf et al. [2015] for the SOE reconstruction using experimental data.

High density polyethylene phantom

The ability to detect shifts in the proton beam range during the irradiation of a tissue-equivalent plastic phantom (HDPE, (C₂H₄, $\rho = 0.96$ g cm⁻³)) with a proton pencil beam of 120 MeV was tested exploiting MC simulations for the LMU prototype and experimental data for the Polaris-J detector.

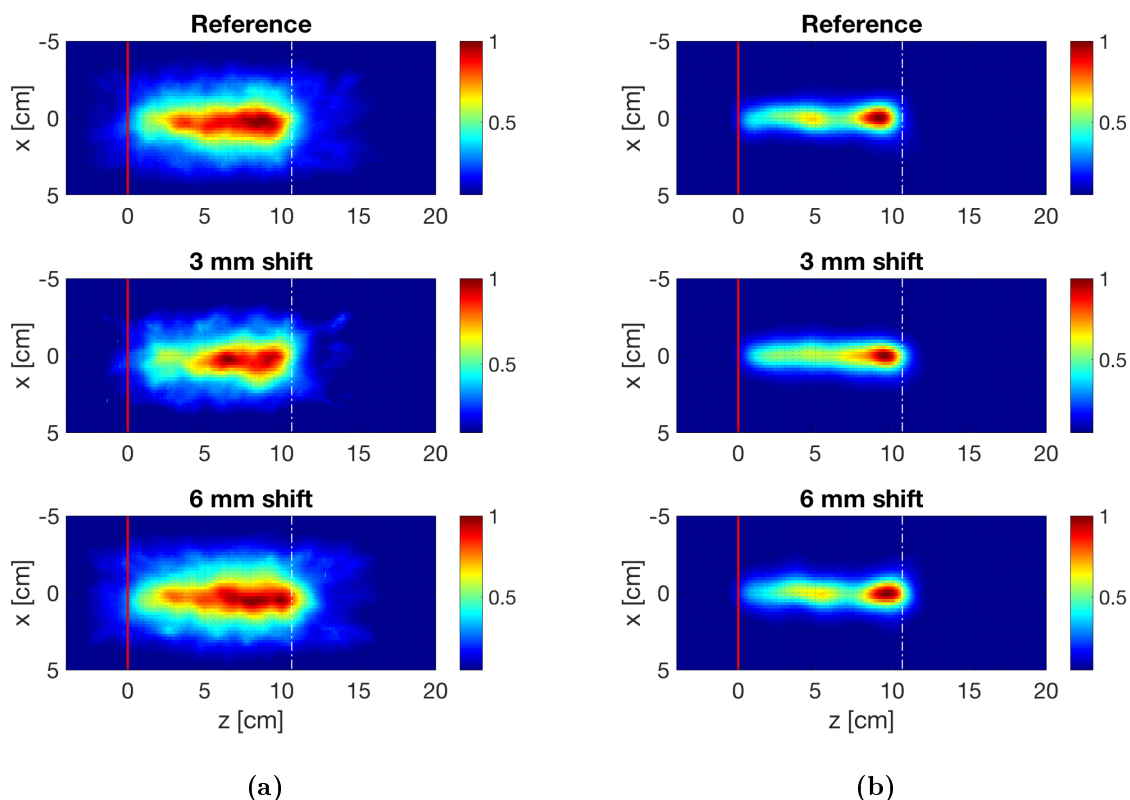

Figure 6.12: Comparison of the XZ projection images reconstructed for the LMU (figure 6.12a) and the Polaris-J (figure 6.12b) detectors using CSR. The PG images for the beam range shifted by 3 mm and 6 mm are also shown. The dashed white line represents the position of R_D for the reference and the dashed red line depicts the entrance of the phantom.

As for the water phantom evaluation, the LMU CC simulation scenario emulated range shifts by varying the proton beam energy. Acquisition of the PG emission was obtained at three different camera locations along the beam-axis in order to cover a larger field-of-view. The number of primary protons was set to 1.5×10^{12} in order to ensure 15000 valid events in the image after applying a selection in the initial energy of the gammas around 4.44 MeV, which is the most intense PG emission from $^{12}\text{C}^*$ [Draeger et al., 2018]. Due to this selection combined with the efficiency shortcoming of the LMU prototype and the computational limitations, the reconstructed 2D projection images shown in figure 6.14a contain 60% less valid events than for the subsequent experimental scenario with the Polaris-J CC. Since the aforementioned energy selection reduces the number of events, the overall image quality is much noisier than for previously studied scenarios. This likely leads to an increased number of incorrect Compton events causing artefacts in the final image. However, compared with the water phantom range shift scenario (cf. figure 6.12a), the applied energy window seems to improve the lateral broadening of the pencil beam emission. 1D central axis profiles are depicted in figure 6.14b. Qualitatively, the distal end

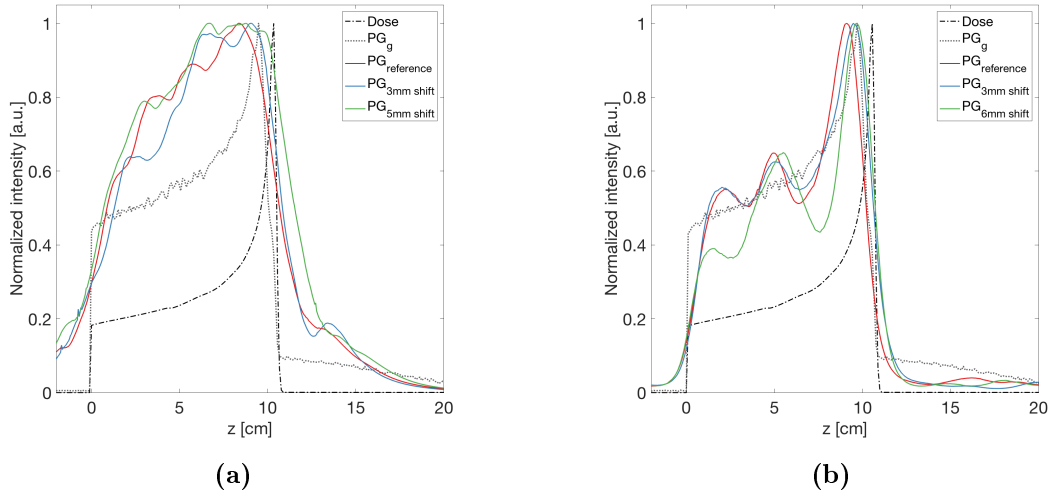

Figure 6.13: 1D profiles extracted from the PG images for the 120 MeV (reference), 122 MeV (3 mm shift) and 124 MeV (6 mm shift) proton beam. The depth-dose profile (for 120 MeV) in the water phantom is obtained from MC simulation for the LMU (figure 6.13a) and the Polaris-J (figure 6.13b) CCs.

R_D (120 MeV) [cm]	R_{PG-g} (120 MeV) [cm]	$R_D - R_{PG-g}$ (120 MeV) [cm]	R_{PG} [cm]		$R_D - R_{PG}$ [cm]	Expected shift [cm]	Calculated shift [cm]
10.65	$10.34^{+0.01}_{\pm 0.02}$	+0.31	LMU (120 MeV)	$10.48^{+0.04}_{\pm 0.11}$	+0.17	-	-
			Polaris-J (120 MeV)	$10.27^{+0.02}_{\pm 0.04}$	+0.38		
			LMU (122 MeV)	$10.72^{+0.05}_{\pm 0.11}$	-0.07	+0.30	+0.24
			Polaris-J (122 MeV)	$10.70^{+0.02}_{\pm 0.05}$	-0.05		+0.43
			LMU (124 MeV)	$11.28^{+0.03}_{\pm 0.08}$	-0.63	+0.60	+0.80
			Polaris-J (124 MeV)	$10.93^{+0.02}_{\pm 0.05}$	-0.28		+0.66

Table 6.6: Reference distal dose fall-off position compared to the PG range for different energies to emulate 3 mm and 6 mm shifts in the position of the Bragg peak in a water target. A positive sign of the range shift value corresponds to a longer range compared to the reference. The value R_{PG-g} (MC) is reported in order to compare the accuracy of the correlation that has been found using the reconstructed profiles. The reported error values correspond to 2% (superscript) and 5% (subscript) changes in the PG signal at the position of the inflection point.

of the PG profiles shifts to larger depths as the energy of the protons increases, even though the reconstructed PG profiles are wider than the true PG distribution. The accuracy in resolving the correlation between R_D and R_{PG} for the reference energy is within 3.0 mm (compared with the value given by the ground truth PG emission). Additionally, range values listed in table 6.7 demonstrate the feasibility of range shift detection as little as 3.0

mm with the LMU prototype for homogeneous targets different from water.

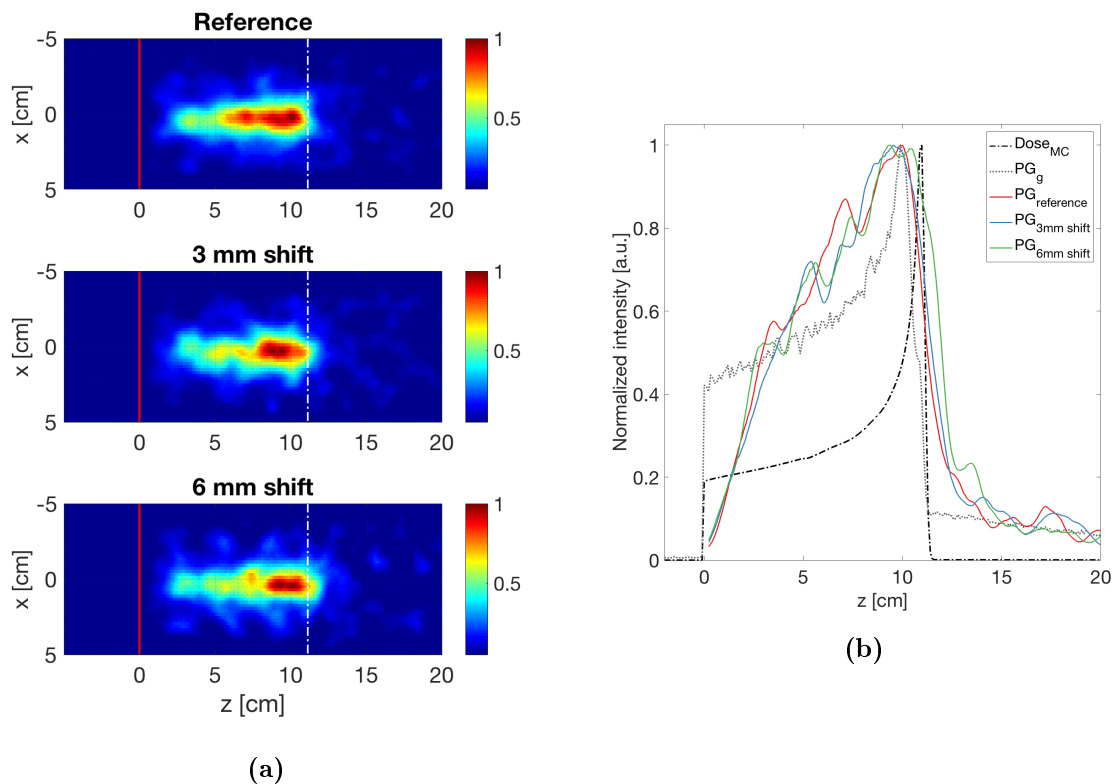

Figure 6.14: Comparison of PG emissions for the reference, 3 mm and 6 mm shifts for the HDPE target irradiation (6.14a) with the LMU prototype and using the MLEM reconstruction. Solid red lines indicate the entrance of the phantom and the dashed white lines represent the position of R_D for the reference (120 MeV) scenario. The central axis profiles in 6.14b are compared to the depth-dose profile and the PG ground truth obtained via MC simulations.

Experimental measurements were made with the Polaris-J CC placed at three different locations along the proton beam path. A single pencil beam of 120 MeV was delivered under clinical-like conditions to an HDPE phantom. The number of protons for the delivery of 2 Gy was determined as 6.29×10^8 . Measurements were conducted for the full beam range and introducing shifts of 3 mm and 5 mm by placing plastic slabs in front of the phantom. More details of the set-up and the experimental campaign can be found in [Draeger et al., 2018]. Images in figure 6.15a were reconstructed using the MLEM algorithm for an image volume of 10.0 cm in the x and y dimensions and 30.0 cm in the z dimension being the beam direction. Around 40000 Compton events are contained in each of the images. In general, the PG emission can be clearly visualized and the lateral profile is not severely smeared by the background noise. However, a considerable signal can be observed in the entrance of the phantom and beyond the Bragg peak. The background contribution may have been due to gammas scattered inside the phantom and gammas created by secondary neutron

R_D (120 MeV) [cm]	R_{PG-g} (120 MeV) [cm]	$R_D - R_{PG-g}$ (120 MeV) [cm]	R_{PG} [cm]	$R_D - R_{PG}$ [cm]	Expected shift [cm]	Calculated shift [cm]
11.06	$10.66^{±0.01}_{±0.03}$	+0.40	$11.19^{±0.03}_{±0.07}$	-0.13	-	
			$11.39^{±0.03}_{±0.07}$	-0.33	+0.30	+0.20
			$11.91^{±0.03}_{±0.07}$	-0.85	+0.60	+0.72

Table 6.7: Reference distal dose fall-off position compared with the PG ranges for three different energies to emulate 3 mm and 6 mm shifts in the position of the Bragg peak inside of an HDPE phantom for the LMU prototype. The reported error values correspond to 2% (superscript) and 5% (subscript) changes in the PG signal at the position of the inflection point.

interactions. Additionally, the statistical nature of the reconstruction process can cause a misidentification of the correct origin of some PGs. Those effects can be also observed in figure 6.15b, where the depth-dose curve is inaccurately resembled by the PG profiles. Shifts in the proton beam range are clearly affecting the distal end of the PG profiles and the relation between R_D and R_{PG} is strongly influenced by the intense background signal in the downstream region of the phantom, which challenges the evaluation based on a sigmoidal fit. The quantification of the predicted ranges obtained by manually selecting the peak region is listed in table 6.8. For this set of data, the smallest correctly retrieved shift is around 5.0 mm, since the 3.0 mm profile yields a shift of 1.0 mm, which is within the error estimation of the R_{PG} value. This is most likely due to the very strong signal at the entrance of the phantom that is not compensated in the Bragg peak region causing also problems with the signal intensity normalization.

R_D (120 MeV) [cm]	R_{PG} [cm]	$R_D - R_{PG}$ [cm]	Expected shift [cm]	Calculated shift [cm]
10.57	$11.02^{±0.05}_{±0.13}$	-0.45	-	
	$10.90^{±0.07}_{±0.18}$	-0.33	-0.30	-0.12
	$10.61^{±0.04}_{±0.11}$	-0.04	-0.50	-0.41

Table 6.8: Reference distal dose fall-off position compared with the PG ranges for the range shifts evaluation using an HDPE phantom. Experimental campaign reported in Draeger et al. [2018]. A negative shift of the range shift value corresponds to a shorter range compared to the reference. The reported error values correspond to 2% (superscript) and 5% (subscript) changes in the PG signal at the position of the inflection point.

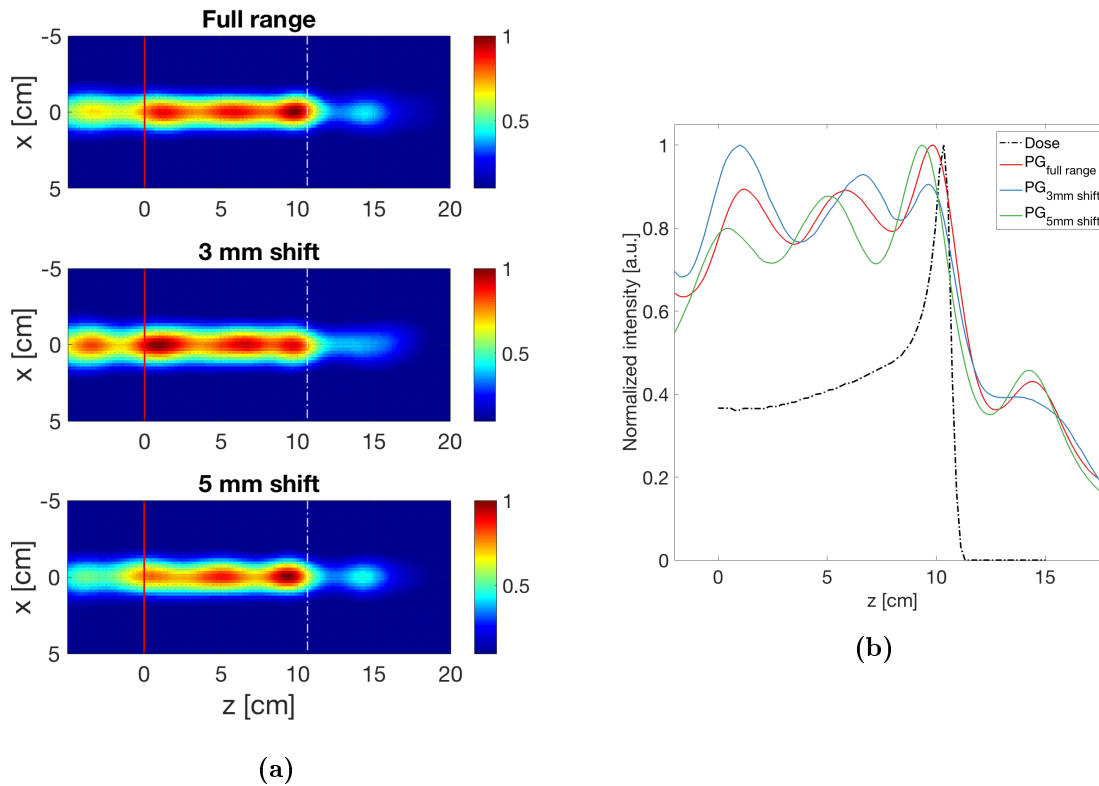

Figure 6.15: Comparison of PG emissions for the full range, 3.0 mm and 5.0 mm shifts for the Polaris-J during the experimental irradiation of an HDPE target (figure 6.15a) reconstructed with the MLEM algorithm. The solid red line depicts the entrance of the phantom and the dashed white line represents the position of R_D for the full range (120 MeV) measurement. The profiles depicted in figure 6.15b are compared to the depth-dose profile obtained via calculations within the treatment planning system.

6.3 Prompt gamma imaging for small animals: a proof of concept study

Small animal imaging plays a crucial role in the modelling of human diseases being an important component of pre-clinical and translational biomedical research. Investigations in this field do not only lead to a better understanding of the disease mechanisms, but findings in different imaging modalities can be translated to technologies used in clinical scenarios. It is foreseen that the LMU CC will be used for pre-clinical research with laser driven proton irradiation at the Centre of Advanced Laser Application (CALA) [CALA, 2018]. Regarding PG imaging, detection and image reconstruction are challenging because of the limited emission yields during low energy proton irradiation. Since the cross section for PG emission due to ^{16}O and ^{12}C (most relevant emission lines) increases to a maximum between 10-20 MeV and then drops off sharply as the protons completely lose their energy,

the detection rate can be considerably reduced compared to conventional clinical beam energies [Polf et al., 2014].

This proof of concept study for the use of PG imaging in small animals was performed by simulating 100, 50 and 35 MeV proton pencil beams irradiating a water phantom for both CCs configurations. The MC simulations were conducted with the Geant4 version 10.02.p01 using the QGSP-BERT-HP physics list for hadronic processes. Simulations using the BIC (Binary Cascade) model for this energy regime resulted in discontinuities in the PG profile that may come either from transitions in the simulation models, resonances or disagreement in the employed cross sections as encountered in Verburg et al. [2013] and Jeyasugiththan and Peterson [2015]. The number of primaries (1×10^{10} for the LMU CC simulation and 1×10^9 for the Polaris-J) was selected independently of the efficiency in order to ensure the reconstruction of images with at least 20000 events with initial energies between 2 and 6.5 MeV. Perfect event retrieval was considered in order to evaluate and compare solely the imaging capabilities for low energy proton beams (ranges between 1.2 and 7.7 cm). The image reconstruction was performed by using the MLEM algorithm. The voxel size was set as $0.1 \times 1.0 \times 0.02$ cm³ and the final image was obtained after 20 iterations in order to ensure a proper convergence that is still not strongly affected by the intrinsic noise of the data.

Qualitatively, the 2D images shown in figure 6.16 illustrate the variation of the PG emission due to changes in the proton beam range for the three different simulated scenarios. The pencil-like source distribution is visible for 100 and 50 MeV, whereas the retrieved PG emissions for 35 MeV protons result in a point-like source due to the narrow Bragg peak ($\sigma_{RS}=0.03$ cm) and the short range inside the phantom. The 1D profiles of the reconstructed PG emissions in figure 6.17 were extracted from the 2D images by integrating over a central region with $\Delta x = 1$ cm. The profiles obtained by both CC configurations resemble to some extent the depth-dose curves for the considered low energy scenarios. For ranges of 1.2 cm (cf. figure 6.17c), the PG emission that evokes a Gaussian distribution could be still correlated with the steep true PG emission. The reliability of the sigmoidal fitting previously employed to quantify the correlation between R_{PG} and R_D was investigated. The results summarised in table 6.9 demonstrated a ground truth correspondence between R_D and R_{PG-g} of better than 1.0 mm for proton beam energies even as low as 35 MeV.

The correlation between R_D and R_{PG} appears still valid despite the very sharp Bragg peak due to reduced straggling. However, broader fall-off regions of the reconstructed PG profiles mostly give rise to a ~ 0.1 cm overestimation of the correlation. Bearing in mind that the presented results were obtained using the perfect event retrieval, the achieved accuracy can be affected by the background noise due to the non-valid events, which is translated into broader fall-off regions if the CSR is used. Indeed, PG profiles depicted in figures 6.17b and 6.17c poorly resemble the ground truth distribution as a result of the intrinsic angular resolution limitations of the different detector configurations. Although this proof of concept study was limited to evaluate the validity of the correlation between R_D and the reconstructed R_{PG} given by the inflection point of the sigmoidal fit (cf. section 6.1.1) without the impact of the uncertainty introduced by the CSR method,

the preliminary findings might offer an understanding of the challenges for the envisaged pre-clinical application.

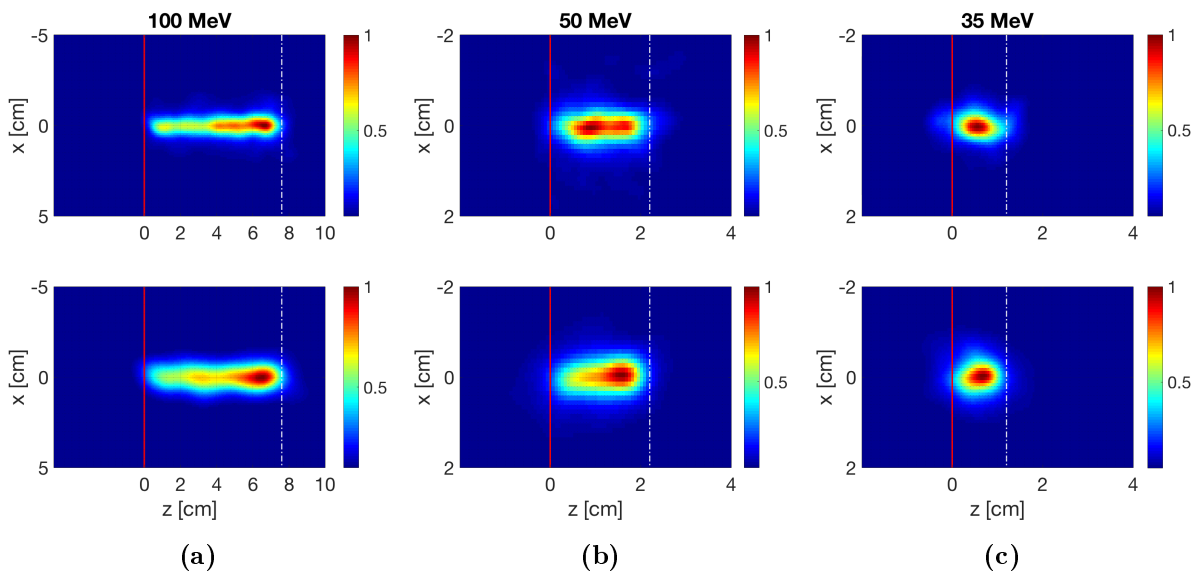

Figure 6.16: XZ projection images of the PG emission for a 100 (figure 6.16a), 50 (figure 6.16b) and 35 MeV (figure 6.16c) proton beam irradiation of a water target for the LMU (upper panel) and Polaris-J (lower panel) CCs considering perfect event retrieval. The white dashed line depicts the position of R_D and the images are shown relative to the phantom entrance.

Energy [MeV]	R_D [cm]	R_{PG-g} [cm]	$R_D - R_{PG-g}$ [cm]	R_{PG} [cm]		$R_D - R_{PG}$ [cm]
				LMU	Polaris-J	
100	7.70	$7.64^{+0.00*}_{\pm 0.00}$	+0.06	LMU	$7.50^{+0.01}_{\pm 0.02}$	+0.20
				Polaris-J	$7.61^{+0.01}_{\pm 0.02}$	+0.09
50	2.29	$2.21^{+0.00*}_{\pm 0.00}$	+0.08	LMU	$2.21^{+0.01}_{\pm 0.02}$	+0.08
				Polaris-J	$2.06^{+0.01}_{\pm 0.23}$	+0.23
35	1.16	$1.08^{+0.00*}_{\pm 0.00}$	+0.08	LMU	$1.21^{+0.01}_{\pm 0.02}$	-0.05
				Polaris-J	$1.04^{+0.01}_{\pm 0.02}$	+0.12

* Error estimation < 0.01 cm.

Table 6.9: Distal dose fall-off position compared to the PG ranges for 100, 50 and 35 MeV proton beams in a water target. The reported error values correspond to 2% (superscript) and 5% (subscript) changes in the PG signal at the position of the inflection point.

In order to illustrate the more complex scenario encountered for small animal irradiation, MC simulations were performed using a real mouse CT obtained from the cone beam acquisition of a SARRP machine (Small Animal Radiation Research Platform, Xstrahl

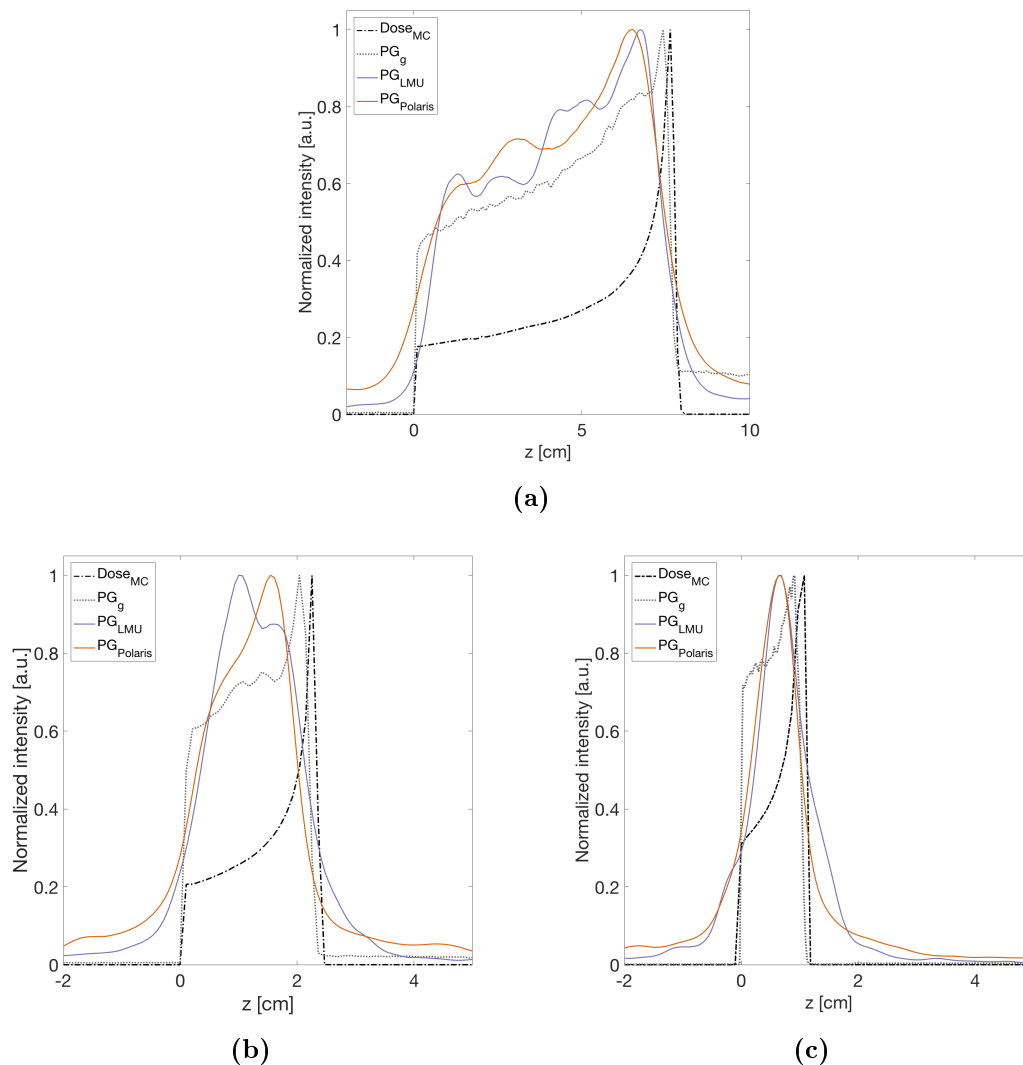

Figure 6.17: Comparison of the acquired PG profiles for 100 MeV (figure 6.17a), 50 MeV (figure 6.17b), 35 MeV (figure 6.17c) proton beams in water and the corresponding depth-dose curves. The profiles were plotted relative to the phantom entrance.

Limited, Surrey, UK). The voxelized data ($0.03 \times 0.03 \times 0.03 \text{ cm}^3$) of the mouse anatomy was imported into Geant4 and the irradiation with a 35 MeV proton beam was simulated. The number of primaries was set to 1×10^{10} . Figures 6.18a and 6.18b depict the computed dose as well as the true PG origin distributions. A strong impact of the very short range (limited amount of gammas) and the target heterogeneities along the beam path can be clearly observed. The detection process for the foreseen pre-clinical application is tested by simulating the acquisition with the LMU CC prototype. Even for the perfect event retrieval assumption, the reliability of the comparison between R_D and R_{PG} is limited by the intrinsic capabilities of the detector configuration. The current spatial resolution

is similar to the range in the target, which makes it more difficult to resemble the correct beam emission from the reconstructed **PG** profile. The spatial variations in the **PG** emission, due to target heterogeneities, can cause additional implications when extracting the **1D** profile by integrating over a central region. This effect seems to cause a further broadening of the reconstructed Gaussian-like **PG** profile compared to the water phantom scenario (cf. figure 6.17c). Additionally, as it was also observed for the heterogeneous phantom set-up (cf. section 6.1.2), the heterogeneities seem to have a negative impact on the reconstruction when using the **CSR**, hence changes in the emission cannot be obtained from the reconstructed images.

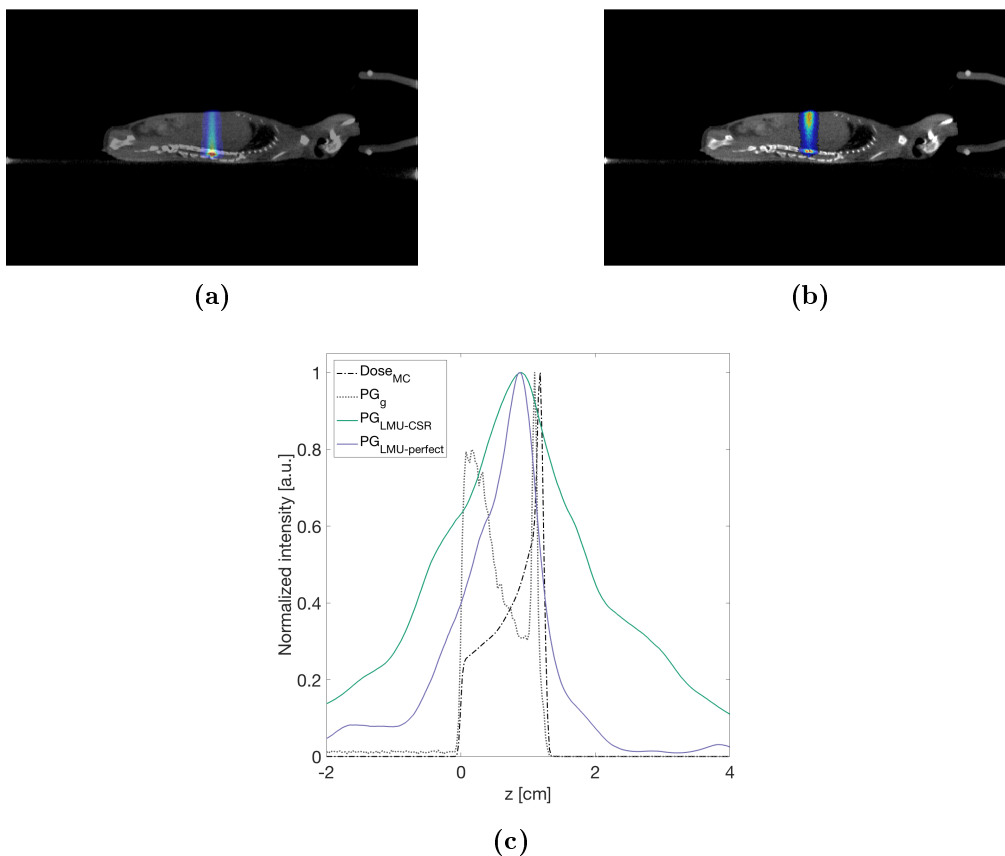

Figure 6.18: First study for small animal **CT** data comparing the simulated 35 MeV proton pencil beam (figure 6.18a) and the corresponding **PG** emission (figure 6.18b). The reconstructed **PG** profiles with the LMU **CC** (**CSR** and *perfect retrieval*) are compared to the depth-dose profile and the **PG** ground truth in figure 6.18c. The profiles were plotted relative to the mouse surface.

Concluding, the application and feasibility of **PG** imaging for small animal irradiation is currently restricted by implications due to limited emission from the short beam range and ambiguities introduced from the tissue heterogeneities. Both effects cannot be compensated by the exploited reconstruction strategies. The detector capabilities (i.e., spatial and angular resolution) might be an additional limiting factor at the investigated small

scale scenario. Therefore, a further optimization of the detector design is required as it will be investigated in chapter 7.

Part V

Outlook for Compton camera detectors in proton therapy

“It is common sense to take a method and try it. If it fails, admit it frankly and try another. But above all, try something”

Franklin D. Roosevelt

7

Towards an improved performance of the LMU prototype in clinical practice and alternative detector configurations

7.1 Alternatives for the LMU Compton camera prototype

The results presented in chapters 5 and 6 suggest that the design of the LMU prototype detector must undergo modifications in order to improve the efficiency and performance. These changes should yield interactions in the detectors that the CSR algorithm will be able to distinguish among gammas of a broad initial energy spectrum.

Thicker silicon detectors may be the most intuitive solution to the efficiency shortcoming of the scatterer component. The interaction probability of high energy gammas will rise, and likely much more correct events can be retrieved because the recoil electrons are stopped inside the tracker. Even though, this solution has limitations. Silicon detectors cannot be thicker than few millimetres and conventional manufacturers reach only around 300 - 500 μm [Sadrozinski, 2001]. Furthermore, those thicker detectors would require higher voltage and the effect of scattering and electronic noise should be carefully taken into consideration. However, even having the possibility to employ the desired thickness, the recoil electron must interact in more than one layer of the tracker without further interactions in the absorber component in order to enable the electron tracking capability.

For finding a good compromise between the detector availability and the electron tracking requirements, MC simulations were performed using an increased thickness of 1 mm for the DSSSD layers for a H₂O phantom irradiation with 150 MeV protons. The number

of primary protons for each simulation run was 1×10^8 . Relative distances between the detectors of the current configuration depicted in 4.1 were preserved. Besides, the number of layers was increased by two and four. Recoil electrons can be very energetic (e.g. the average electron energy is $\bar{E}_{e^-} \sim 2.4$ MeV for the broad emission spectra encountered in proton therapy), which translates in large ranges. For electrons with energies between 2 MeV and 6 MeV, the projected ranges (R_{mf}) obtained from the NIST 2010 CSDA range values and the detour factors using the semi-empirical formula given by Fernández-Varea et al. [1996] are summarised in table 7.1. Currently, the silicon material within the tracker module is able to stop roughly 2.5 MeV electrons i.e., around 40% of the electrons produced by the broad PG emission during a proton beam irradiation. Therefore, six, eight and ten layers of thicker DSSSDs were investigated in the simulation study.

Energy [MeV]	R_{mf} [cm]
1	0.10
2	0.23
3	0.38
4	0.53
5	0.68
6	0.84

Table 7.1: Projected range of electrons in silicon using the detour factors given by the semi-empirical formula of Fernández-Varea et al. [1996] and the CSDA range obtained from the NIST ESTAR database [Berger et al., 2005].

The average efficiency for the design with the thicker detectors was improved by almost 100% based on the total number of triggers (i.e., at least one hit in the scatterer and one hit in the absorber) based on the number of triggers as it can be seen in figure 7.1. The statistics of interactions occurring in the detector relative to the total number of triggers are depicted in figure 7.2, comparing the current LMU prototype with alternative configurations of 1 mm DSSSD thickness. Electron tracking is also improved by the thicker silicon layers and in principle a track can be associated to around 10% of the Compton interactions for the ten layers, while it is only 6% for the current configuration. An evaluation of the track quality will be presented later on.

Bearing in mind the defined trigger condition, the performance of the CSR algorithm is evaluated applying comparable parameters for each data set for the different detector configurations. Additionally, hereafter only retrieved events with an initial energy between 2 MeV and 6.5 MeV are considered. As shown in figure 7.3, the fraction of gammas undergoing Compton interaction in the tracker component is only slightly varying while the layer thickness is increased or more layers are introduced. The fraction of events retrieved by the CSR algorithm decreases for the thicker silicon detectors, whereas it stays roughly constant when more layers are added. It is important to notice that a reduced amount of obtained events must not necessarily correspond to a degraded CSR or detector

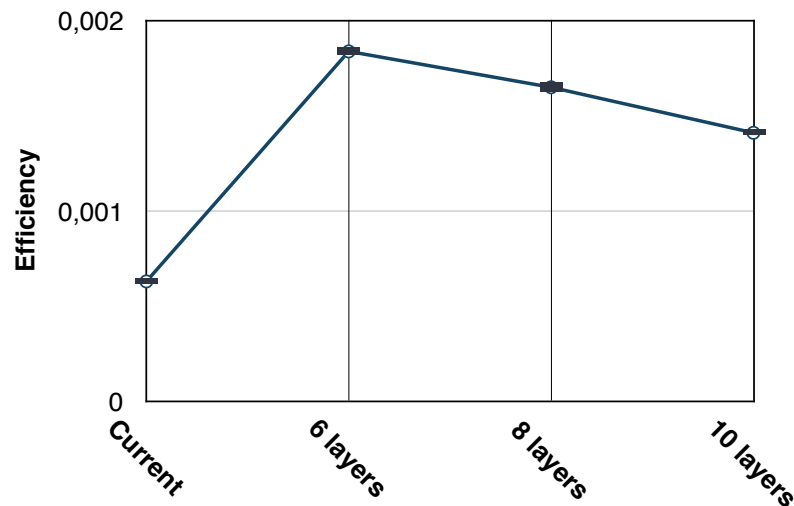

Figure 7.1: Trigger efficiency for the different configurations of the LMU CC prototype design. The current configuration contains six layers but with 0.05 cm DSSSD thickness.

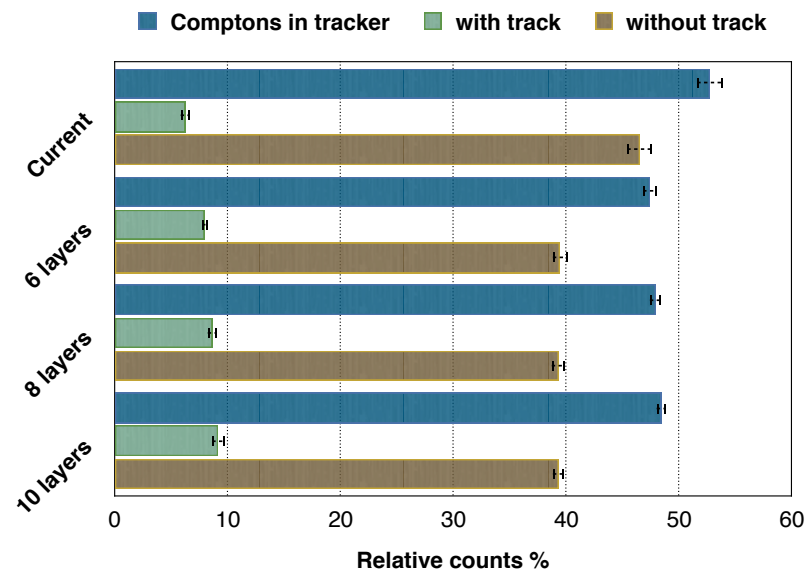

Figure 7.2: Fraction of Compton events among the triggers for the current LMU CC prototype and alternative configurations using 1 mm thick DSSSD layers. Error bars represent the 3σ interval obtained from five independent MC simulation runs.

performance, since the quality of those events is not yet considered. On the contrary, exploiting the information of the MC simulations, the fraction of Compton interactions that could be theoretically retrieved, named as perfect retrieval (i.e., first and second hit are originated from the initial gamma ray), appreciably increases from 3% for the current design up to almost 9% for the thicker configuration with ten layers. It can be noticed that this fraction is lower than the retrieved events by the CSR to perform the image

reconstruction step. The additional events might cause the considerable background noise in the images shown in chapter 6.

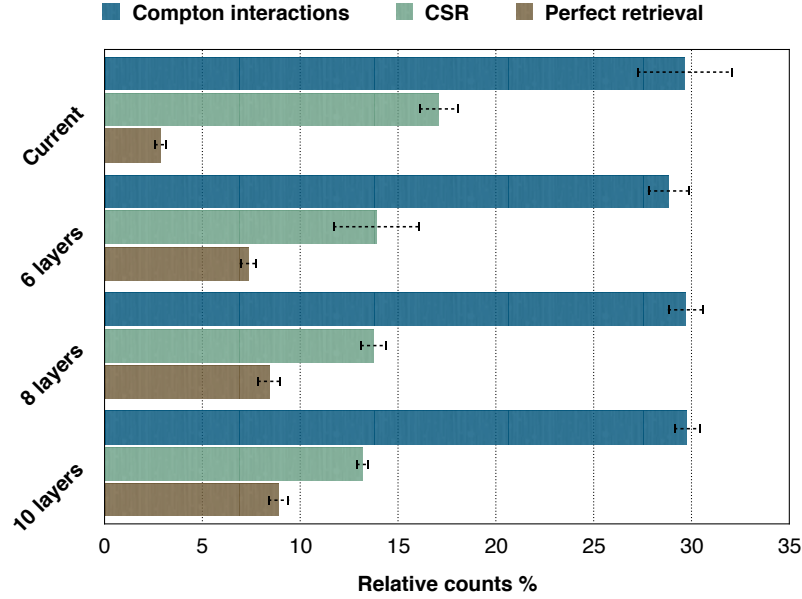

Figure 7.3: Event retrieval for different configurations of the LMU CC design applying an energy window from 2 MeV to 6.5 MeV. The number of Compton interactions in the detector is expressed relative to the total amount of triggers recorded during the acquisition. Error bars represent the 3σ interval obtained from five independent MC simulation runs.

A detailed analysis of the information retrieved by the CSR is shown in figure 7.4 in order to identify the quality of the events contained in a reconstructed image for the different detector configurations. The presented fractions are relative to the total number of triggered events (i.e., they correspond to the green bar in figure 7.3). The number of correctly reconstructed events is around 2% for the current detector design being improved up to 5% when expanding the tracker module. This is because more high-energetic recoil electrons are completely stopped within the tracker and their energy is accurately retrieved. False positive events correspond to around 7% of the triggers independent of the detector configuration. Mainly those events result from pair production or backscattering from the absorber. The quality factor (cf. section 4.2.1) derived by the CSR provides a straightforward tool to reject false positive events. For instance, using $Q_{c,classic} \leq 0.8$ rejects 18% of these events in the current configuration and around 25% in the upgraded design. However, this selection also compromises the amount of correctly retrieved events. In all cases, around 10% of the valid and correctly retrieved source gammas would be rejected. The third category of obtained events are Compton events retrieved with incorrect kinematic parameters (i.e., they do not correspond to perfect events). Those events are most likely associated with very energetic recoil electrons reaching the absorber module. The CSR algorithm fails in rejecting this type of events causing errors in the determination of the opening angle of the Compton cone. As the probability of stopping electrons is increased

due to the thicker trackers, the amount of incorrectly retrieved events is reduced by 5% for the thicker layer configurations.

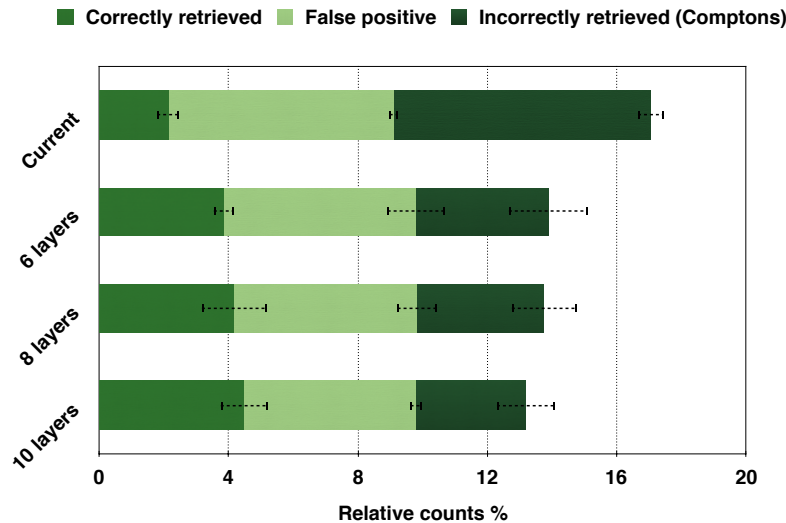

Figure 7.4: Classification of the events obtained by the [CSR](#) algorithm for different configurations of the LMU [CC](#) design. The fractions are relative to the total number of triggered events. *Correctly retrieved* refers to events matching with Compton interactions as known from the underlying data of the [MC](#) simulation. The *incorrectly retrieved* events are divided in Compton interactions with incorrect kinematic parameters and false positives. Error bars represent the 3σ interval obtained from five independent [MC](#) simulation runs.

A comparison of the perfect events with the [CSR](#) results reveals that not all of them are retrieved (i.e., events which are contained in the brown bar in figure 7.3 but not in the correctly retrieved bar in 7.4) and therefore this information is lost for the image reconstruction. Three different types of interactions can be distinguished among the data of missing Compton events as it can be seen in figure 7.5. Mainly, the [CSR](#) algorithm is not capable of assigning a track despite having associated hits of the same electron in different layers. This is a consequence of scattered electrons leaving the detector configuration, additional triggered hits due to bremsstrahlung or Compton interactions in the LaBr_3 detector. Future work could be done in the identification of these tracks. This becomes even more important if the detector is upgraded with thicker [DSSSD](#) layers due to marked improvement of the track measurements. Therefore, the track retrieval will be improved but is limited by the performance of the current [CSR](#) algorithm implementation. Finally, *two hit events* and *others* in which the algorithm fails in identifying the correct Compton interactions correspond to less than 0.5% of the triggers registered by the detector. All the aforementioned effects impact the overall performance of the [PG](#) imaging workflow.

Findings suggest that more Compton interactions could be potentially retrieved by an upgraded configuration design. Furthermore, the performance of the [CSR](#) retrieval would be enhanced: the fraction of correct Compton events increases, whereas the false positive and incorrectly retrieved events are reduced. This will be favourable in terms of the final

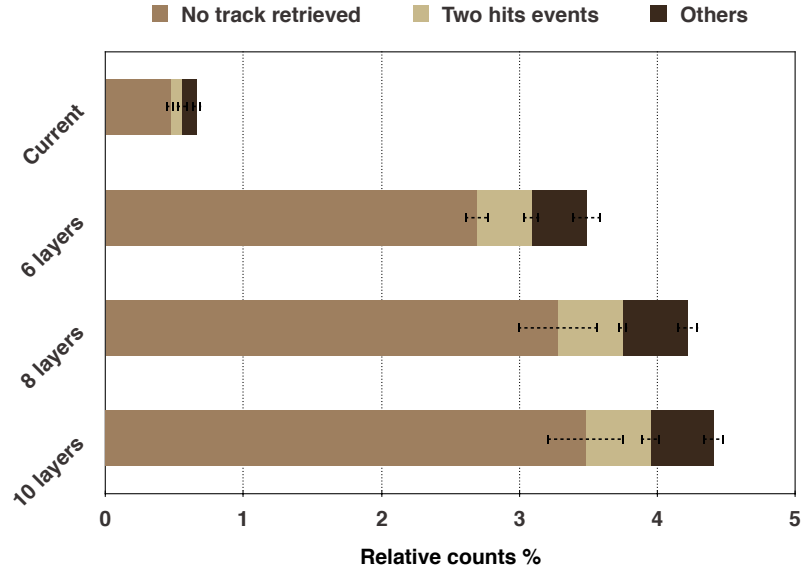

Figure 7.5: Missing information of events not retrieved by the CSR algorithm although they could be theoretically obtained. The results are shown for different LMU CC configurations. The fraction is relative to the total number of triggers. Error bars represent the 3σ interval obtained from five independent MC simulation runs.

image quality. However, an unexpected but small rise in the fraction of perfect events that are not retrieved by the CSR is observed for the thicker DSSD layers. Therefore, future work could be done in the electron tracking algorithm in order to guarantee the reliability of the event reconstruction method.

An analysis of the quality of the reconstructed (real) Compton interactions was performed by comparing the estimated kinematic parameters with the corresponding interaction values from the MC simulation. This also quantifies the discrepancies in the determination of the opening angle of the Compton cone due to incorrectly retrieved events. The absolute error distributions (difference between estimated and interaction value) for different configurations of the LMU design are shown in figure 7.6. An improvement in the accuracy of the mean recoil electron energy and the mean Compton angle of ~ 1 MeV and $\sim 20^\circ$ is observed, respectively. In contrast, for the other kinematic parameters changes are relatively small (< 0.3 MeV). All mean and median values of the absolute error distributions are summarised in table 7.2.

As mentioned above, a thicker tracker will provide improved efficiency and track probability for retrieving Compton interactions in the proton beam irradiation scenario. However, the potential tracks acquired using alternative configurations may not be retrieved by the current CSR implementation. Thus, a trade-off between the desired number of tracks and the quantity of missing information for the image reconstruction should be considered in order to improve the overall performance of the LMU prototype. The presented results demonstrated the importance of upgrading the tracker component and how this could improve the quality of the events retrieved by employing the CSR approach. For this

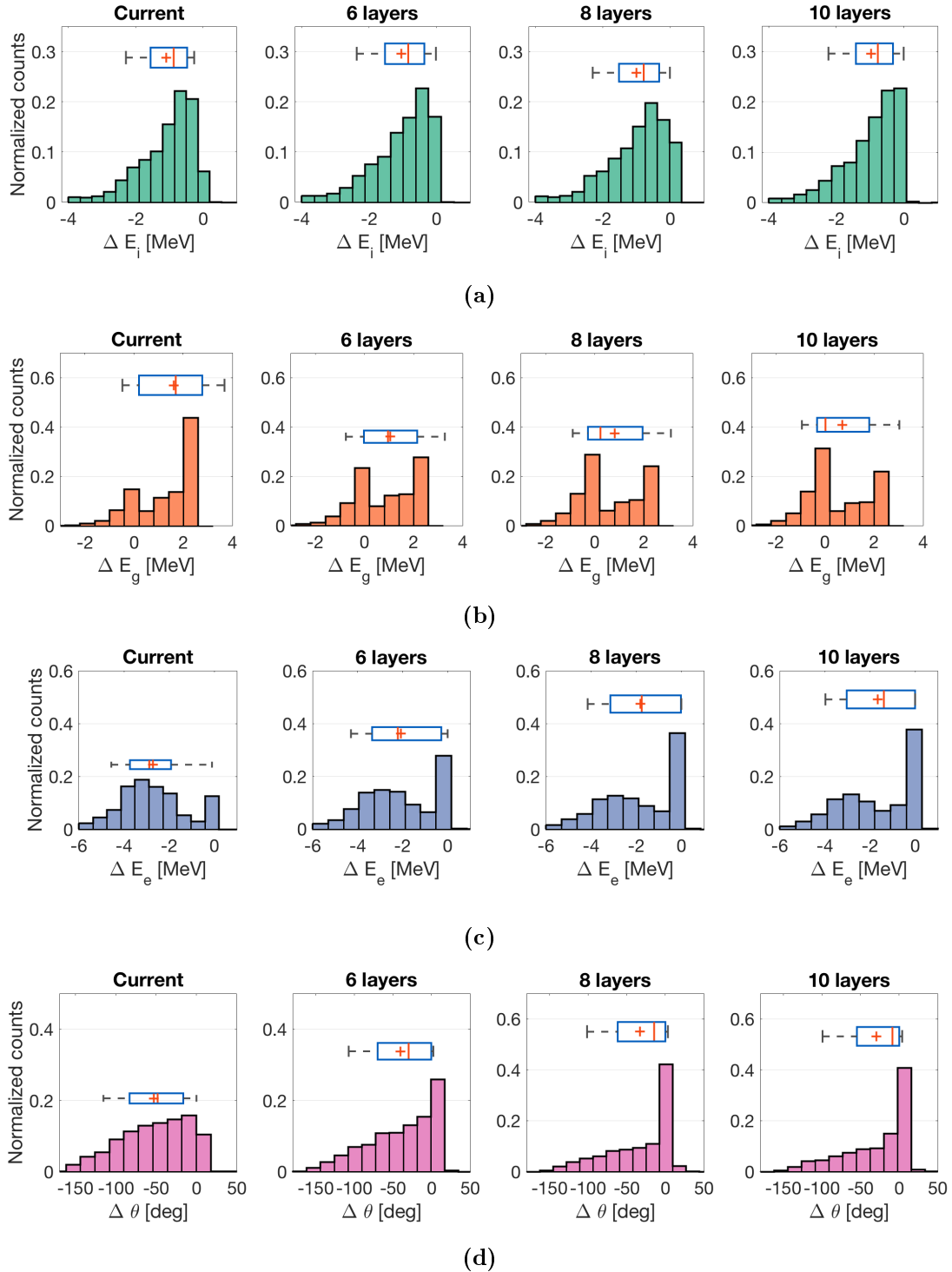

Figure 7.6: Comparison of the absolute error distributions of the estimated kinematic parameters for different tracker configurations of the LMU CC design (label “current” refers to 6 DSSSD layers of 0.05 cm thick while for the other configurations the thickness is 0.1 cm). For normalization, the area under the histogram is equal to one. Median and mean values are marked by a vertical line and the cross inside the box, respectively. The box encloses the first and the third quartile.

scenario, the electron tracking must be further studied and optimised. Possible sources of errors in the electron track estimation such as U-turns influenced by Molière scattering, the identification of the start point and the need of having a tracker with excellent spatial resolution, high efficiency and capable of stopping the high energy recoil electrons must be considered but are beyond the scope of this thesis.

Configuration	Parameter	μ	\bar{x}
Current	ΔE_i	-1.09 MeV	-0.88 MeV
	ΔE_g	+1.62 MeV	+1.70 MeV
	ΔE_e	-2.71 MeV	-2.72 MeV
	θ	-53.0 deg	-46.0 deg
6 layers	ΔE_i	-1.04 MeV	-0.84 MeV
	ΔE_g	+1.06 MeV	+0.96 MeV
	ΔE_e	-2.08 MeV	-2.21 MeV
	θ	-40.0 deg	-30.0 deg
8 layers	ΔE_i	-1.00 MeV	-0.79 MeV
	ΔE_g	+0.81 MeV	+0.23 MeV
	ΔE_e	-1.80 MeV	-1.75 MeV
	θ	-33.0 deg	-15.0 deg
10 layers	ΔE_i	-0.97 MeV	-0.77 MeV
	ΔE_g	+0.71 MeV	0.01 MeV
	ΔE_e	-1.66 MeV	-1.39 MeV
	θ	-30.0 deg	-9.0 deg

Table 7.2: Mean (μ) and median (\bar{x}) values of the absolute error distributions for alternative tracker configurations of the LMU **CC** detector of figure 7.6.

7.2 Compton camera set-up for low gamma energies using a two-stage design

For investigating the performance of different **CC** detector designs more tailored to radioisotope imaging, a two-stage (cf. figure 3.12a) configuration was investigated. It is assembled as the combination of a segmented array of GAGG ($\text{Gd}_3\text{Al}_2\text{Ga}_3\text{O}_{12}$) scintillator crystals acting as a scatterer and the $\text{LaBr}_3(\text{Ce})$ scintillator of the LMU prototype as an absorber component. A scheme of the **CC** set-up is shown in figure 7.7. The scatterer module consists of 22×22 individual crystals ($0.9 \times 0.9 \times 6.0 \text{ mm}^3$) read out by a MPPC (Multi-Pixel Photon Counter) SiPM (Silicon Photomultiplier) 64 channels array. The detector was developed by collaborators at the National Institute of Radiological Sciences in Chiba, Japan [Takyu et al., 2017]. Customized electronics provides four outputs and a sum signal enabling the processing by Anger logic calculation for the position determination of the interactions.

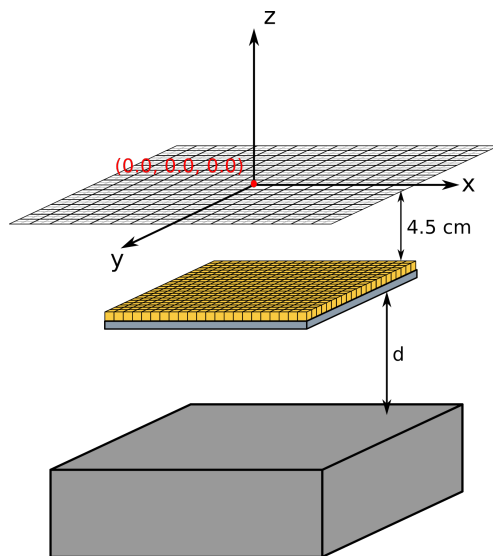

Figure 7.7: Schematic representation of the two-stage **CC** configuration. The source distance from the GAGG module was 4.5 cm. The distance d is varied between 5.0 and 20.0 cm in order to evaluate its effect on the performance. Adapted from [Liprandi et al. \[2018\]](#).

Experimental data from a ^{137}Cs and a ^{60}Co calibration sources were acquired in order to investigate the performance and imaging capabilities of this two-stage **CC** device in different energy regimes [[Liprandi et al., 2017, 2018](#)]. The source distance from the scatterer module was 4.5 cm. Results of the experimental campaigns were benchmarked in this work with **MC** simulations, using a comparable geometrical configuration and the experimentally determined spatial and energy resolution.

Caesium-137 source

Three different distances ($d= 5, 10$ and 20 cm) between the two detector stages were evaluated in terms of angular resolution. The spatial resolution for the LaBr_3 was calculated as 0.5 cm (for a collimated source) and the energy resolution was found to be 9% and 5% at $E_\gamma= 662$ keV for the GAGG and LaBr_3 , respectively [[Liprandi, 2018](#)]. The reconstructed events for simulated and experimental data were selected within an energy window of $\pm 5\%$ around 662 keV. Using around 21000 valid events, the computed **ARM** (cf. section 5.2) varied from 5° to 7° for the simulated data and from 11° to 22° for the experimental measurements. In both cases, the best performance corresponds to $d= 20.0$ cm. The increased distance between the photon interactions is translated into a decreased uncertainty in the cone axis determination. Hereafter, the studies are based on the $d= 20.0$ cm set-up configuration.

Since the **ARM** value differs by more than 5° for the simulated (5°) and experimental data (11°), the comparison of the corresponding energy depositions and interaction positions may provide information about their impact on the detector resolution and the resulting image quality. Energy deposition in the **CC** components and the Compton scatter

angle calculated via kinematics (θ_{kin}) are depicted in figure 7.8. Ensuring a proper comparison of the data, the simulated number of events was equal to the amount of measured decays. Overall the simulated and experimental spectral response agree well. Differences are appreciable for very low energy (E_e) recoil electrons (energy in the GAGG), which correspond to high energy (E_g) scattered gammas (energy in LaBr₃). Figure 7.8c shows the high degree of similarity between the computed opening angle of the Compton cone (θ_{kin}).

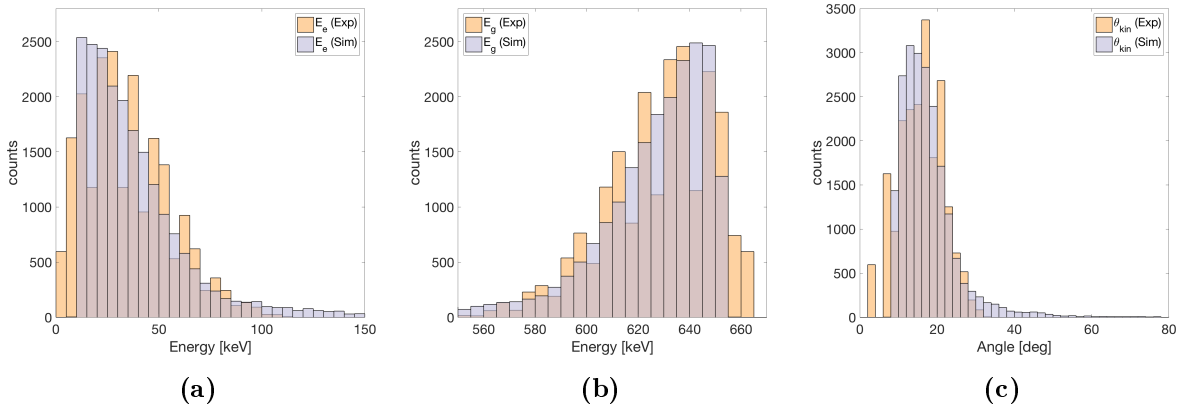

Figure 7.8: Energy deposition in the GAGG (figure 7.8a) and the LaBr₃ (figure 7.8b) crystals with a relative separation distance of 20 cm for the ¹³⁷Cs source. Compton scatter angles (figure 7.8c) are calculated according to equation 3.2 assuming full absorption of the events.

On the other hand, the interaction positions are represented by the measured hit maps in figure 7.9. The spatial distributions on the GAGG detector are somewhat consistent except for few hot spots towards the central region, whilst the results for the LaBr₃ are markedly different. The hit pattern of the measurements, which is obtained by the kNN algorithm [Liprandi, 2018] is pushed towards the outer region of the detector where the area exceeds the projected dimensions of the GAGG. The pattern observed in the LaBr₃ for the simulation data coincides with the smaller area of the GAGG scatterer, which is expected due to the obtained Compton scatter distribution (cf. figure 7.8c).

From the known origin of the gammas, the Compton scatter angle can be calculated via the interaction positions (θ_{geo}). This computation provides information regarding the Compton cone direction which can be compared to the angle derived via Compton kinematics in order to evaluate the impact of aforementioned uncertainties in position and energy determination. The experimental data in figure 7.10a exhibit a shift between the angular distributions along with a considerable contribution of small angles compared to the simulated scenario shown in figure 7.10b. It seems likely that the high peaks in the θ_{kin} distribution (cf. figure 7.8c) also contribute as background noise to the final image. The discrepancies might explain the difference in the ARM value between the measurements and the simulations.

Since events corresponding to large ARM values result in a significantly degraded image quality, the measured events were restricted to those with ARM values between 0° and 5° for

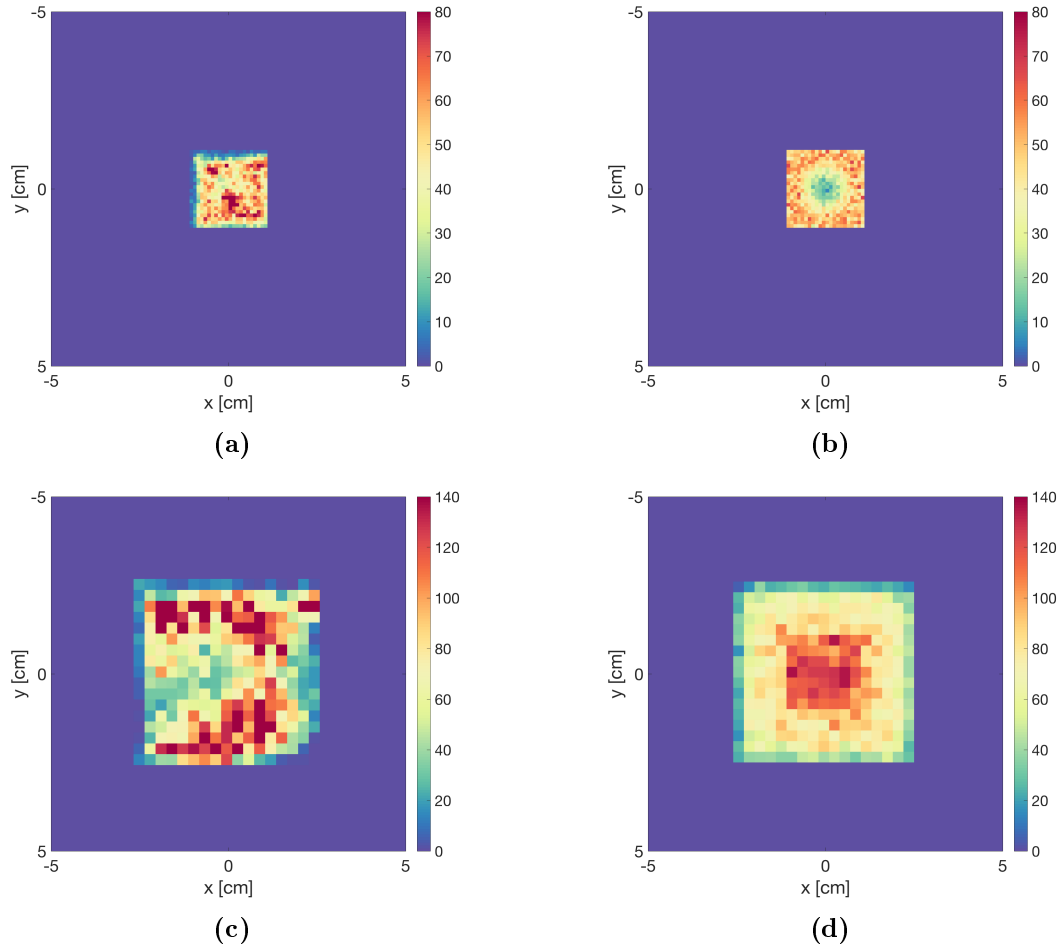

Figure 7.9: Measured hit position maps of the GAGG and the LaBr_3 crystal detectors (figures 7.14a and 7.14c) in comparison to the simulation results (figures 7.14b and 7.14d) for the ^{137}Cs source. The GAGG data is binned using the center of each individual crystal (size of $0.9 \times 0.9 \text{ cm}^2$) and for the LaBr_3 the bin size is given by the experimentally determined position resolution of 0.5 cm.

the image reconstruction, according to the [ARM](#) value obtained for the simulated data. The selection was based on the known source position in order to purely evaluate the imaging performance of the detector device. Nevertheless, such a selection is meaningless when the position of the source is intended to be determined. Figures 7.11 (experimental) and 7.12 (simulation) present the reconstructed images of the ^{137}Cs source placed at different locations in the xy plane. The images were obtained after the 30th iteration of the [MLEM](#) algorithm. Compared to the point source images in chapter 5, the convergence of the spatial resolution value is reached earlier because of the applied angular selection. Each image contains ~ 10500 events and the size of the image volume was $20 \times 20 \times 1.0 \text{ mm}^3$ divided in $100 \times 100 \times 1$ voxels. Table 7.3 summarises the [FWHM](#) values of the 2D Gaussian fittings and the estimated location of the source given by the mean position of the fit. For the

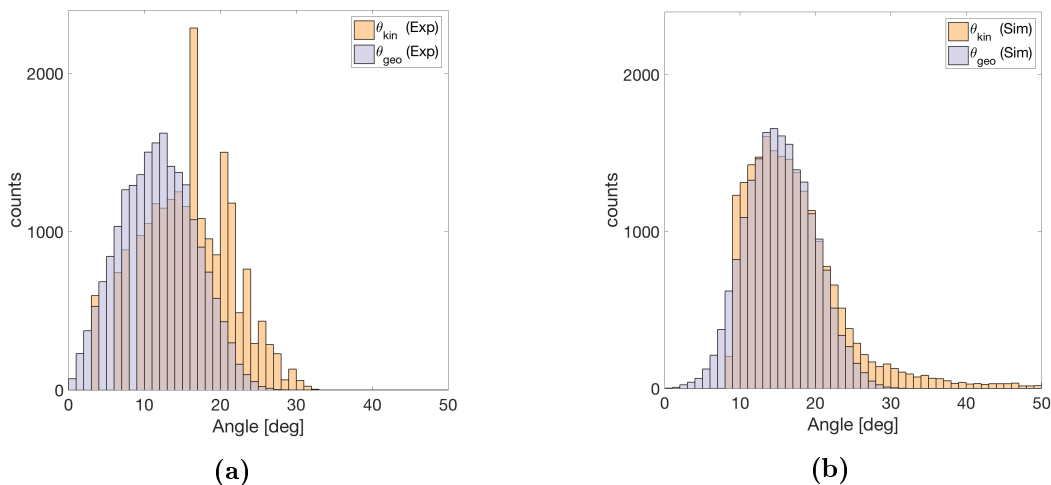

Figure 7.10: Comparison of the Compton scatter angle calculated via kinematics (θ_{kin}) and via interactions geometry (θ_{geo}) for the ^{137}Cs acquisition with experimental (figure 7.10a) and simulated (figure 7.10b) data.

experimental data, the same angular selection was applied in all data sets, which results in 50% of the triggered events used by the reconstruction algorithm. In contrast, the images for the simulated scenario were reconstructed without the ARM assumption. Despite the sub-millimetre accuracy of the position retrieval, the source distribution becomes distorted in both scenarios as the lateral offset with respect to the origin increases. The image becomes angularly non-uniform and scatter events in specific directions increase, which may be a combined effect of the projected position (xy plane) of the source with respect to the border of the GAGG detector and the source-detector distance. This creates an artefact due to the geometrical distortion in the final image.

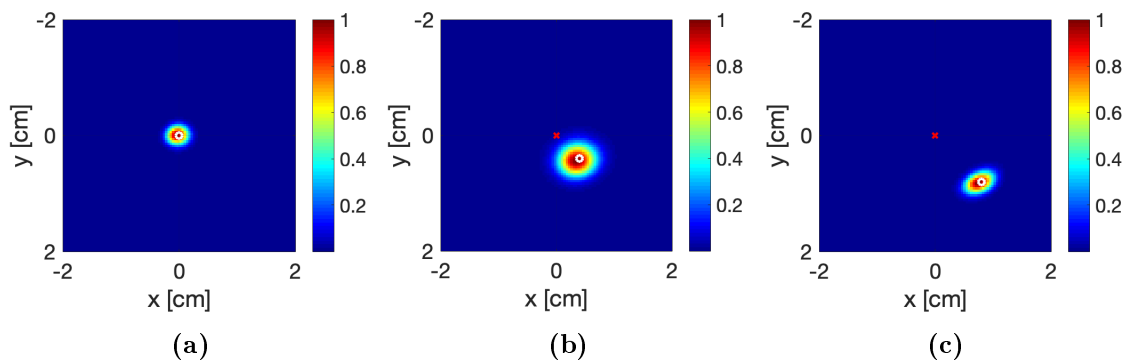

Figure 7.11: Reconstructed images for the experimental data of the ^{137}Cs source using the MLEM algorithm. The true source position is (0.0 mm, 0.0 mm) (figure 7.11a), (4.0 mm, 4.0 mm) (figure 7.11b) and (8.0 mm, 8.0 mm) (figure 7.11c) and indicated with the white circle. As a reference a red cross indicates the origin for the shifted position.

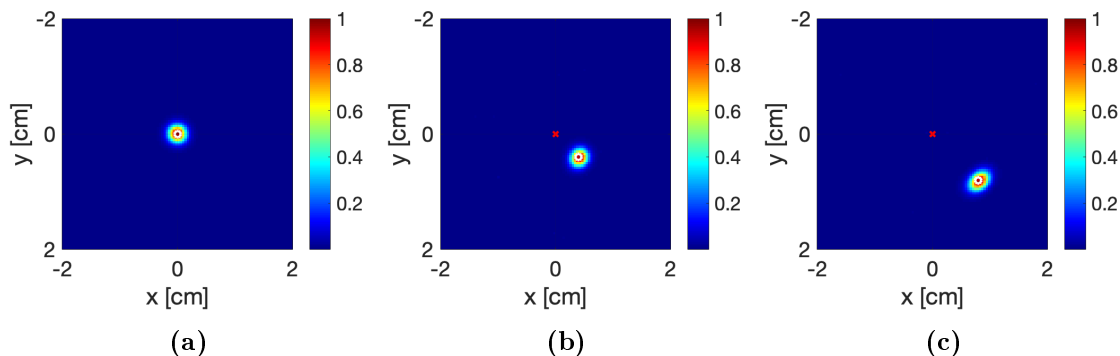

Figure 7.12: Reconstructed images for the simulated data of the ^{137}Cs source using the MLEM algorithm. The true source position is (0.0 mm, 0.0 mm) (figure 7.12a), (4.0 mm, 4.0 mm) (figure 7.12b) and (8.0 mm, 8.0 mm) (figure 7.12c) and indicated with the white circle. As reference the red cross indicates the origin coordinates for the shifted positions.

Original position [mm]	Reconstructed position [mm]		FWHM [mm]
(0.0, 0.0)	Experimental	(0.0, 0.0)	(3.0, 2.6)
	Simulation	(0.0, 0.1)	(2.5, 2.5)
(4.0, 4.0)	Experimental	(3.6, 4.2)	(3.5, 3.0)
	Simulation	(4.2, 4.1)	(2.4, 2.5)
(8.0, 8.0)	Experimental	(7.4, 8.0)	(3.8, 2.9)
	Simulation	(8.2, 8.1)	(2.7, 2.6)

Table 7.3: Experimental and simulated source position and position resolution (FWHM) for the reconstructed images of the ^{137}Cs source in comparison to the true source position.

Cobalt-60 source

In this scenario, the two detector components were placed at a relative distance of 5.0 cm. The spatial resolution for the LaBr_3 was measured as 0.3 cm and the energy resolution was 6.9% and 3.5% at 1.17 and 1.32 MeV for the GAGG and the LaBr_3 , respectively [Liprandi, 2018]. MC simulations were performed to benchmark the overall detector response. Since the incident photon energies (1.1715 and 1.336 MeV) are known, the reconstructed events were selected within an energy window of $\pm 5\%$ around each of the mentioned values. Using ~ 27000 events, the obtained ARM value is 7° for the simulated data and 13° for the experimental measurements. As expected, the angular resolution is improved compared with the identical scenario for the ^{137}Cs source (being 22° for $d=5.0$ cm) due to the better position and energy resolution of the detectors for higher energies [Aldawood, 2017; Liprandi, 2018]. In order to identify the cause of the difference between the simulated and experimental ARM value, the experimental energy deposition and the Compton scatter angle calculated via kinematics (θ_{kin}) are compared with the MC simulations. The distributions can be seen in figure 7.13. As for the ^{137}Cs source, the simulation results for the recoil electron

(E_e , energy in the GAGG) and the scattered gamma (E_g , energy in the LaBr₃) energies are generally in good agreement with the experimental measurements. A small portion of events corresponding to energetic electrons (>400 keV) and low energy photons (<800 keV) observed in the simulation were not measured. Since the Compton scatter angle computation directly depends on the energy measurements, the angular distributions agree well except for a small fraction of events with very small and large angles.

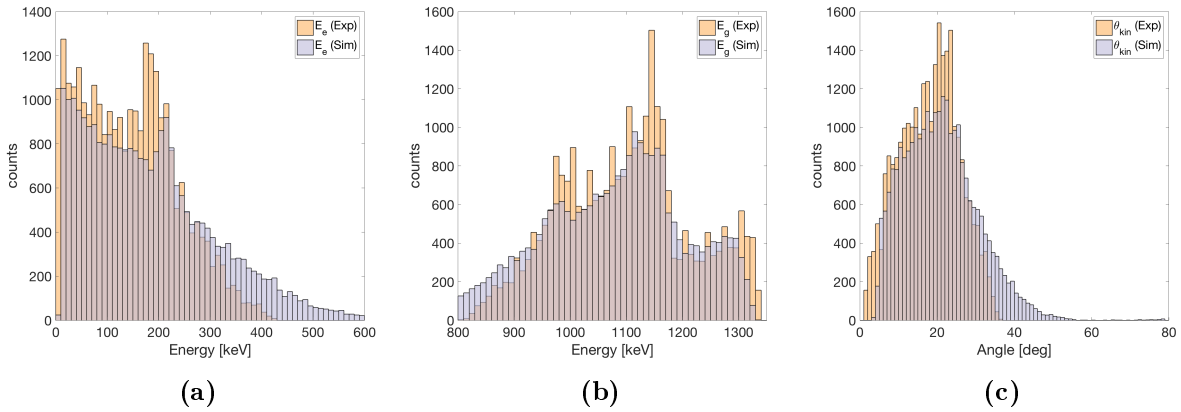

Figure 7.13: Energy deposition in the GAGG (figure 7.13a) and the LaBr₃ (figure 7.13b) crystals of a configuration with a relative separation distance of 5 cm for the ^{60}Co source. The Compton scatter angle (figure 7.13c) is calculated using equation 3.2 assuming full absorption of the events. As reference the red cross indicates the origin coordinates for the shifted positions.

The ARM also depends on the interaction positions. Hit position maps of both detector components can be found in figure 7.14 for simulated and experimental data. The agreement in the position information of the GAGG detector is generally good, while for the LaBr₃ considerable discrepancies are observed. For the GAGG detector, the changes in the hit distribution compared to the ^{137}Cs scenario are due to the closer source location (cf. figure 7.9). As shown in figure 7.14d the gammas are scattered towards the centre of the absorber, which produces the high intensity region in the area covered by the scatterer module. In contrast, the experimental hit distribution for the monolithic LaBr₃ crystal exhibits clusters with a significant portion of hits at the upper border of the crystal.

Errors in the interaction positions influence the direction of the Compton cone and consequently the quality of the image. Compton scatter angles derived via kinematics and via interaction geometry are compared in figure 7.15. A similar trend as for the ^{137}Cs source is observed suggesting the presence of a systematic error in the interaction position retrieval of the LaBr₃. The angular distribution (experimental) is slightly shifted towards larger angles, which might explain the differences in the angular resolution between experimental and simulated data.

For the image reconstruction, the measured events were again restricted to those having $0^\circ \leq \text{ARM} \leq 7^\circ$. In contrast, no selection was applied for the simulated data. Reconstructed images of the ^{60}Co source shown in figures 7.16 and 7.17 were obtained by the MLEM

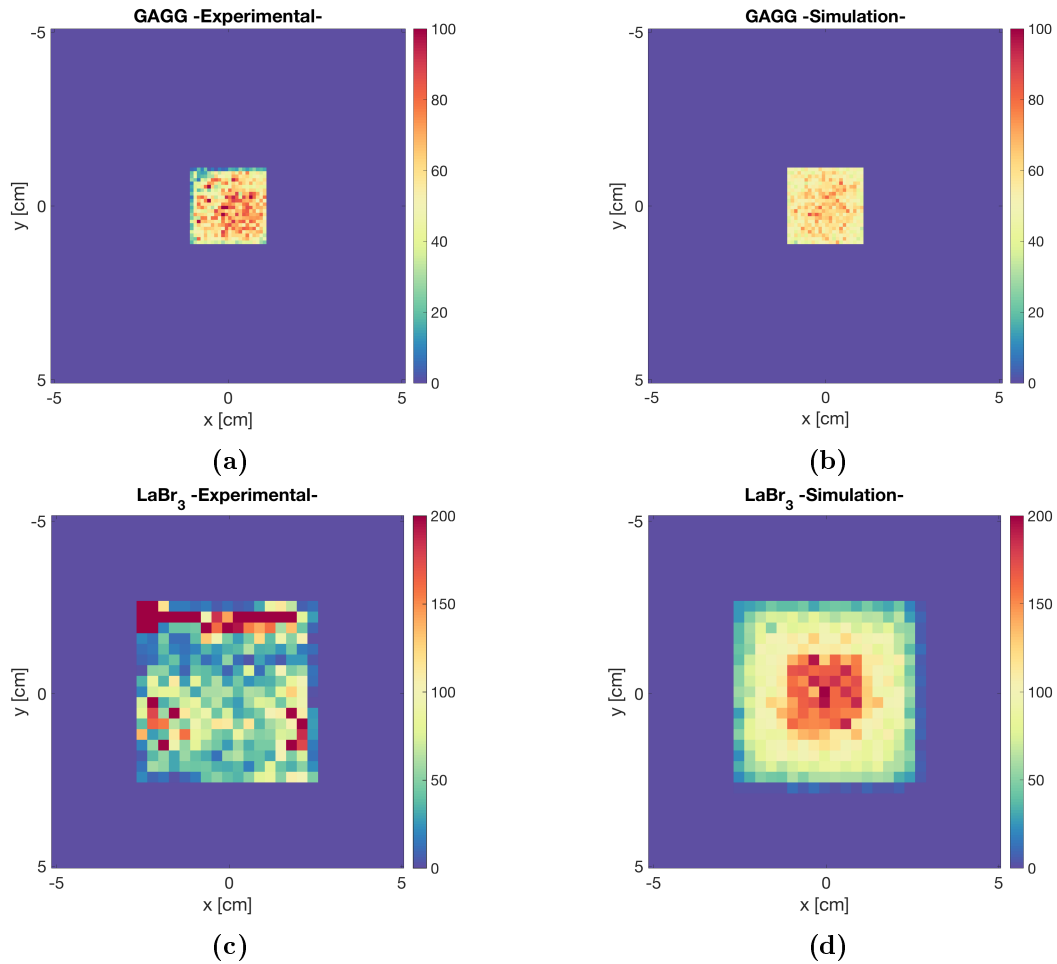

Figure 7.14: Measured hit position maps of the GAGG and the LaBr₃ crystal detectors (figures 7.14a and 7.14c) in comparison to the simulation results (figures 7.14b and 7.14d) for the ⁶⁰Co source. The GAGG data is binned using the center of each individual crystal (size of 0.1 cm) and for the LaBr₃ the bin size is given by the experimentally determined position resolution of 0.3 cm. As reference the red cross indicates the origin coordinates for the shifted positions.

algorithm for 30 iterations. The image volume was defined in the same way as for the ¹³⁷Cs reconstruction. Table 7.4 summarises the estimated source location and the spatial resolution given by the FWHM values of the 2D Gaussian fitting. The image performance is enhanced compared with the ¹³⁷Cs measurements, which is in agreement with an improved ARM value. Additionally, the uniformity of the reconstructed sources (experimental and simulated scenario) is preserved for the 8 mm offset image due to the proximity between scatterer and absorber modules. Even though, the overall accuracy remains unchanged.

Summarising, the feasibility of a two-stage CC consisting of a segmented array of GAGG acting as scatterer and a monolithic LaBr₃ crystal as absorber component was

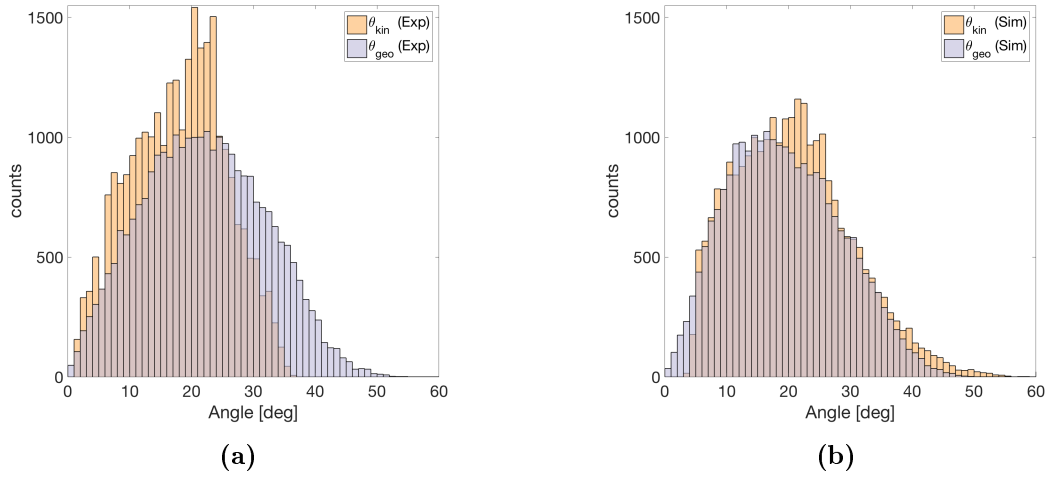

Figure 7.15: Comparison of the Compton scatter angle calculated via kinematics and via interactions geometry for the ^{60}Co acquisition with experimental (7.15a) and simulated (7.15b) data. As reference the red cross indicates the origin coordinates for the shifted positions.

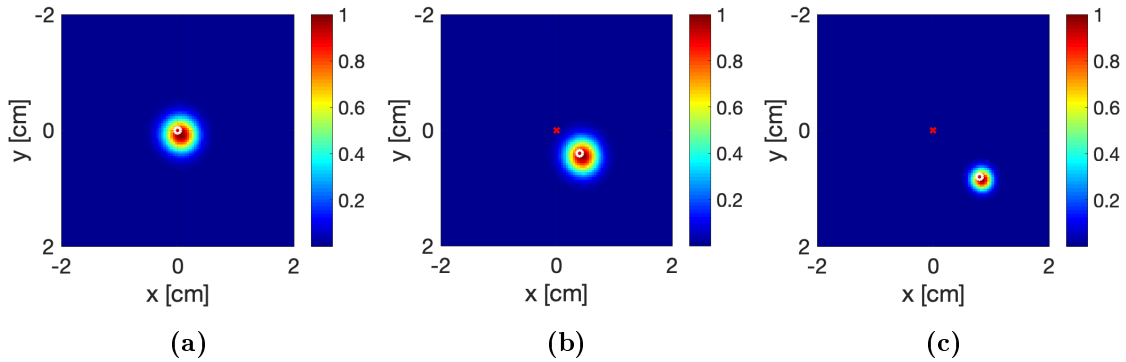

Figure 7.16: Reconstructed images for the experimental data of the ^{60}Co source using the MLEM algorithm. The true source position is (0.0 mm, 0.0 mm) (7.16a), (4.0 mm, 4.0 mm) (7.16b) and (8.0 mm, 8.0 mm) (7.16c) and indicated with the white circle. As reference the red cross indicates the origin coordinates for the shifted positions.

demonstrated¹. The imaging capabilities were investigated for point-like sources of different incident energies such as ^{137}Cs (662 keV) and ^{60}Co (1.173 MeV and 1.332 MeV). The dedicated simulation benchmarking study conducted in this thesis revealed a generally good agreement in the spectral response of the detectors, whereas some differences in the interaction position distributions were encountered. In order to overcome the shortcomings in the experimental data, reconstructed images were obtained by applying an angular selection based on the ARM value calculated from the simulated scenarios. All reconstructed sources (i.e., experimental and simulated data) correctly retrieved the true source positions

¹Thanks to Silvia Liprandi for providing the experimental data-set used for this study

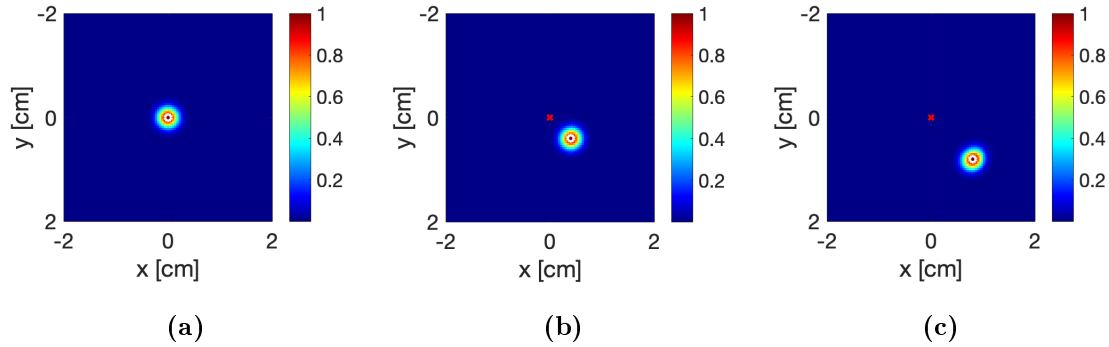

Figure 7.17: Reconstructed images for the simulated data of the ^{60}Co source using the MLEM algorithm. The true source position is (0.0 mm, 0.0 mm) (7.17a), (4.0 mm, 4.0 mm) (7.17b) and (8.0 mm, 8.0 mm) (7.17c) and indicated with the white circle. As reference the red cross indicates the origin coordinates for the shifted positions.

Original position [mm]	Reconstructed position [mm]		FWHM [mm]
(0.0, 0.0)	Experimental	(0.5, 0.7)	(3.2, 3.2)
	Simulation	(0.0, 0.0)	(2.8, 2.9)
(4.0, 4.0)	Experimental	(4.5, 4.5)	(3.1, 3.1)
	Simulation	(4.1, 4.0)	(2.8, 3.0)
(8.0, 8.0)	Experimental	(8.3, 8.5)	(3.2, 3.2)
	Simulation	(8.1, 8.1)	(2.9, 2.6)

Table 7.4: Experimental and simulated position resolution (FWHM) and source position for the reconstructed images of the ^{60}Co source in comparison to the true source position.

with submillimetre accuracy. As expected, the spatial resolution is slightly better for the simulated images. Improvements in the performance of the kNN algorithm for position determination of the monolithic LaBr_3 detector are expected to reduce uncertainties in the position estimation and further enhance the spatial resolution (without angular selection) in future experimental campaigns.

“Let the future tell the truth, and evaluate each one according to his work and accomplishments. The present is theirs; the future, for which I have really worked, is mine.”

Nikola Tesla

8

Conclusions and perspective

The clinical potential of hadron therapy mainly relies on the high dose delivery precision, longitudinally and transversally, which can be achieved due to the characteristic relation between initial energy and energy deposition of protons inside matter. However, nowadays there are still challenges to face in order to exploit the full clinical potential and overcome the economical burden. The control and monitoring of the beam delivery is one of the research areas receiving currently increased interest. The high ballistic precision of protons makes the treatment more prone to any source of deviation with respect to the treatment planning. As protons stop inside the patient, an intuitive way to access the range information is by means of secondary radiation produced by nuclear interactions along the proton path. Henceforth, *in vivo* range verification plays a key role in order to overcome the peril of range uncertainty in proton therapy treatments.

Positron emission tomography is the most thoroughly investigated technique in clinical practice for range verification. Since the method still faces different limitations, this thesis explores the feasibility of monitoring the proton beam range by measuring the high-energy photons promptly emitted in the de-excitation stage of nuclei following nuclear interactions. Theoretically, those gammas may provide a more direct measurement of the proton range without being affected by washout effects and having a much more favourable production cross section. The accomplished investigations in this work studied the use of two different **CC** detector configurations to produce **2D** images of **PGs** emitted during proton irradiation.

The studies carried out can be divided between the performance evaluation and optimization of the LMU **CC** prototype, the quantification of the correlation between the **PG** profile and the depth-dose curve for two different reconstruction approaches and the study of a two-stage **CC** tailored to radioisotope imaging.

LMU Compton camera performance

An extensive MC simulation study was performed in order to benchmark the spectral response of the detector using experimental data from a point-like emission of 4.44 MeV gammas. For both components (scatterer and absorber) good agreement between the simulated and experimental data was found; however, a more sophisticated energy calibration for the DSSSD layers must be implemented based on experimental data. In order to characterise the imaging performance of the detector prototype, the angular resolution was computed using MC simulations for energies between 2 MeV and 6 MeV for point sources placed in the centre of the field-of-view. The ARM determined by the FWHM of the distribution was between 2.9° and 6.2° , being the worst for the 6 MeV source. Since the determined energy and position resolution for these energies are comparable, the obtained ARM values are dominated by tails in the ARM distribution as a result of incompletely absorbed gammas and incorrect Compton events from the CSR method. Theoretically, the ARM value could be improved to 2.8° by enhancing the performance of the CSR algorithm to retrieve Compton events with highly energetic recoil electrons or by preventing those electrons to reach the absorber. The imaging capability study was concluded with the characterization of the spatial resolution by computing the width of the point spread function of the reconstructed sources. The images demonstrated an excellent submillimetre accuracy for the source location, while the spatial resolution was 2.9 mm and 5.8 mm for 2 MeV and 6 MeV, respectively. As expected, the trend of the ARM is translated in a degraded spatial resolution at higher energies. A qualitative evaluation of the PG imaging of extended sources was performed using a reconstructed PG emission for the simulated irradiation of a 150 MeV proton pencil beam.

Since the imaging resolution is particularly influenced by incorrectly retrieved Compton events, the performance of the CSR algorithm was evaluated for two different simulation set-ups by quantifying the error of the estimated kinematic parameters. Predominantly, the values are underestimated except for the energy of the scattered gamma, which was overestimated in all studied cases. The point-like source ($E_\gamma=4.44$ MeV) set-up clearly revealed the impact of applying a selection window around the known source energy for improving the image quality. The greatest improvement was observed for the Compton scatter angle (θ) showing error reductions by around 30%. Among the other kinematic parameters, the absolute error of the recoil electron energy was reduced by almost 1.5 MeV. For the PG emission during a proton beam irradiation, the influence of applying an energy selection filter [2-6.5 MeV] was not as noticeable as for the aforementioned scenario, considering that the rationale of the selection is to improve the correlation with the proton beam range [Polf et al., 2009a; Verburg et al., 2013]. However, a closer look at the event statistics allowed to conclude that the disagreement in the kinematic parameters estimation must be caused by high energy recoil electrons interacting with the absorber module. Expanding prior work, an extensive MC simulation study was developed in order to provide a framework to assess the detector performance together with the event retrieval method. While 50% of the triggered events (i.e., at least one hit in the tracker and in the absorber module) correspond to Compton interactions within the tracker component,

only a small fraction of them ($<5\%$) could be theoretically correctly retrieved with the information gathered by the detector. Therefore, it is not surprising that the 18% of the triggers retrieved as Compton events by the CSR mainly contribute to background noise in the final image ($\sim 80\%$). Additionally, limitations of the method were corroborated by an analysis of the correct events not being retrieved, hence missing important information for the image reconstruction step. These findings revealed the need for an improved prototype design, which is able to yield a better overall efficiency by finding a good trade-off between the detector capabilities and the event retrieval method. MC simulations were performed using an increased thickness of 1.0 mm for the DSSSD layers for a water phantom proton irradiation (150 MeV) in order to find a good compromise between an improved detector efficiency and the electron tracking capability. The findings suggested that the theoretical fraction of events retrieved by the detector could be improved up to 10% compared to the current 3%. Furthermore, the quality of events retrieved with the CSR method would be also enhanced due to a 2% and 5% reduction of false positive and incorrectly retrieved events, respectively. Despite the considerable improvements, missing information for the image reconstruction step was slightly increased by 3% compared to the current detector configuration. The potential tracks that theoretically could be retrieved using alternative detector configurations will require future work in the CSR implementation for electron tracking.

In summary, the simulations of the LMU CC prototype demonstrated the potential and capabilities of the detector to image point-like and beam source emissions. However, the data analysis and the CSR algorithm performance revealed limitations especially in terms of the detection efficiency and the retrieval of events, which correspond to high energy electrons. For the current detector design, trade-off considerations between the sensitivity and the electron tracking capability should be foreseen in order to enhance the applicability for proton range verification. This includes an optimized thickness of the DSSSD layers and an improved background rejection by the event reconstruction method.

Quantitative comparison of image reconstruction algorithms using Compton camera detectors

A quantitative comparison of the PG distributions reconstructed by an MLEM and a SOE algorithm, exploiting simulated and experimental data from the LMU and the Polaris-J CC, is presented.

For the investigated detectors, a similar quantity of valid events was used for the image reconstruction. This ensures a reliable comparison of the range monitoring capabilities independent of the detector efficiency. Enlarging the field-of-view by virtually measuring at three different locations along the beam path allows not only to register more events but also to account for a broader scattering angle distribution sufficient to reproduce the beam induced emission. The reconstructed PG images resulted from the definition of tailored image volumes, whose extension in the x- and y- direction corresponds to the dimension of the target and the extension along the beam axis (z-axis) was set to 10 cm larger. Since data from CCs are inherently noisy, the number of iterations for a beam source emission

has to be limited in order to avoid artefacts from the noise break-up. Therefore, the MLEM images for the 20th and the SOE images for the 1000th iteration were used, respectively. Throughout this work, a strong impact of invalid events not being rejected by the CSR has been observed. This has been previously reported by Rohling et al. [2017], indicating an influence on the convergence of the implemented MLEM algorithm. Improvements in the efficiency and event retrieval could enhance the quality of the images allowing a more reliable determination of an appropriate number of iterations, e.g. stopping the reconstruction when the variance between neighbouring pixels does not change by more than a predefined value.

In order to gradually approach the real patient anatomy, homogeneous and heterogeneous phantoms were considered and the feasibility of measuring and imaging the PG emission during proton pencil beam irradiation has been shown. The PG profiles were evaluated using a sigmoid fit applying the two-step method of Tian et al. [2018]. A strong correlation between the inflection point of the curve fit in the fall-off region of the reconstructed profiles (R_{PG}) and the proton beam range (R_D) was observed. For the baseline water phantom study, the distance between R_D and R_{PG} was within 3.0 mm for the 150 MeV and 180 MeV proton beams. These results are consistent with the ground truth distance (3.5 mm) calculated by using the real PG emission information from the MC simulation. For the experimental scenario (150 MeV), the distance between the proton range and the inflection point was 3.0 mm and 5.0 mm using the MLEM and SOE reconstruction algorithms, respectively. In inhomogeneous targets, including a bone insert and an air gap close to the Bragg peak region, the spatial changes in the PG emission due to the different materials cannot be resolved from the reconstructed profiles by neither of the cameras nor the algorithms due to the background caused by incorrect Compton events that the CSR method is not capable of rejecting. For the LMU CC, establishing an accurate proton beam/PG range correlation using aforementioned profiles led to ambiguities because of the degraded fall-off retrieval. Consequently, the image reconstruction was performed using only perfect events in order to evaluate the impact of non-valid events in the reconstructed image. As comparison, the same scenarios were considered for the Polaris-J simulations. Heterogeneities are better visible when perfect retrieval was used for both detector configurations. Furthermore, the reconstructed PG profiles qualitatively resemble better the ground truth emission (MC information). The difference between R_D and R_{PG} varies from 0.0 mm to 4.0 mm for the reconstructed images using the CSR and from 2.0 mm to 4.0 mm for the perfect retrieval, which is closer to the ground truth correlation (3.0 mm). The findings have suggested a comparable performance of the two image reconstruction algorithms.

Range monitoring capabilities were evaluated for both detector configurations in homogeneous targets. The baseline simulation study in water used a 120 MeV proton beam irradiation as reference and shifts of 3 mm and 6 mm were emulated by increasing the beam energy. Small variations with respect to the reference Bragg peak position were noticeable in the reconstructed 2D images. Since the LMU CC data is more affected by incorrect events within the image volume, the acquisition yielded a laterally broadened pencil beam emission and a slightly blurred fall-off region. Shifts as small as 3.0 mm in

the proton beam range could be resolved by calculating the relative difference between the R_{PG} values for each scenario, even though the absolute shift differs by ~ 1.5 mm respect to the expected value. The proton beam range correlation with R_{PG} was found within ± 1.0 mm for the reference beam energy. Moreover, range assessment was also investigated for the irradiation of a tissue-equivalent plastic phantom (HDPE) with a 120 MeV pencil beam exploiting simulated (LMU) and experimental (Polaris-J) data. The energy selection around the most intense PG emission considerably reduced the number of valid events having an unwanted effect on the overall quality of the reconstructed images. Since a clear maximum of intensity cannot be retrieved, changes in the Bragg peak position could be barely noticed especially for the experimental data. Shifts of 3.0 mm and 5.0 mm in the proton beam range could be resolved by calculating the relative difference between the estimated R_{PG} values. The absolute value of the shifts are underestimated by 1.0 mm with the Polaris-J CC while the 6.0 mm shift is overestimated by 2.0 mm with the LMU prototype.

Finally, a proof of concept study of PG imaging for small animal irradiation is presented. MC simulations were performed for three different low energy proton beams (100, 50 and 35 MeV) irradiating a water phantom using both CC configurations. Reconstructed images corresponding to 100 MeV and 50 MeV protons somewhat resembled the pencil beam shape of the PG emission whereas the 35 MeV resulted in a narrow Gaussian-like distribution due to the limited range of the proton beam in the target. A correlation of better than 3.0 mm between R_D and the reconstructed R_{PG} has been demonstrated by using perfect events for the image reconstruction. However, this relationship appears to be slightly overestimated (by ~ 1.0 mm) when the values are compared to the true R_{PG-g} obtained from MC calculations. In order to assess more complex scenarios, a first MC simulation study attempt was performed using a real mouse CT. The irradiation with a 35 MeV proton pencil beam yielded an imprecise correlation between R_D and R_{PG} for perfect events as well as for the CSR. Results suggest that further work should be done to overcome the intrinsic limitations of the detector capabilities and the event retrieval method envisaging the applicability of PG imaging in preclinical irradiations.

The summarised studies have shown that acquiring the PG emission by means of CC devices in order to correlate the proton beam range with the PG range is feasible. The functionality of the MLEM and the SOE image reconstruction algorithms was verified for two different CC configurations showing a comparable performance for homogeneous and heterogeneous targets. The CSR is not able to properly reject the non-valid Compton events, which seems to have a considerable impact on the overall image quality. Therefore, the event reconstruction should be further improved to enhance the 3D imaging capabilities. Currently, the large parallax error along the CC axis (i.e., the y-axis) results in a distorted 3D image pushed towards the front face of the detector. Further investigations could include an additional CC positioned at different angles around the target [Draeger et al., 2018; Rohling et al., 2017] or filtering the data in order to include prior information regarding the beam axis location [Draeger et al., 2017]. Moreover, the energy window selection is another important aspect, which modifies the spatial distribution of the reconstructed PGs ensuring a correct correlation with the depth-dose curve. The PG emissions

presented throughout this thesis were reconstructed using valid events with initial energies from 2 MeV to 6.5 MeV [Polf et al., 2015]; however, this selection is currently debated. Further, studies should investigate the impact of the energy window on the distance between R_D and R_{PG} , for instance avoiding the 2.2 MeV line from the neutron-capture at hydrogen, which is not suitable for the correlation with the depth-dose distribution [Rohling et al., 2017].

Compton camera set-up for radioisotope imaging using a two-stage design

The feasibility of imaging point-like sources with energies lower than 1.5 MeV using a CC detector assembled from an array of GAGG crystals [Takyu et al., 2017] and a monolithic LaBr₃ crystal was demonstrated. Experimental data [Liprandi, 2018] for different incident gamma source energies corresponding to ¹³⁷Cs (662 keV) and ⁶⁰Co (1.173 MeV and 1.332 MeV) were acquired in order to investigate the detector performance. A benchmark simulation study, which includes the experimentally determined energy and spatial resolution of the detector components was also performed. The measured ARM for ¹³⁷Cs was 11.0° and 13.4° for ⁶⁰Co using a relative distance between the detector components of 20.0 cm and 5.0 cm, respectively. Notwithstanding, the simulated data indicated better ARM results. The values differed by more than 5° in both cases; therefore, a comprehensive comparison of the corresponding energy depositions and interaction positions for the experimental and simulated data was conducted. Appreciably, the major disagreements were encountered in the hit position maps of the LaBr₃ leading to discrepancies between the Compton scatter angle calculated via kinematics (θ_{kin}) and the geometrically derived angle (θ_{geo}). These effects translated into uncertainties in the estimated source position that result in a degraded image quality. Hence, an angular selection based on the simulation ARM values (<5.0° for ¹³⁷Cs and <7.0° for ⁶⁰Co) was applied to the experimentally measured data. Reconstructed images were obtained using the MLEM algorithm. The source positions given by the mean value of a 2D Gaussian fit were correctly retrieved with submillimetre accuracy for both cases. The observed spatial resolution (FWHM) is ~3.0 mm at both energies and becomes slightly better (by 0.3 mm) for the images reconstructed using simulation data (without angular selection). The ability to measure shifts in the true source position as small as 4.0 mm has been tested and demonstrated for both energies. Artefacts in the image started to appear when the off-axis distances were bigger than 8.0 mm due to a combined effect of the smaller effective area of the GAGG detector (compared with the LaBr₃) and the increased distance (20.0 cm) between the scatterer and absorber modules.

Overall, promising results have been obtained for the two-stage configuration, using a detector combination of GAGG and LaBr₃ crystals. The angular resolution is expected to improve for increasing energies according to the experimentally determined energy and position resolution in this regime (>1 MeV) [Aldawood, 2017; Liprandi, 2018]. Currently, shortcomings in the kNN algorithm implementation [Liprandi, 2018] cause uncertainties in the position estimation of the gamma ray interaction, resulting in a deteriorated angular resolution, where 50% of the events have major discrepancies (>5°) between θ_{kin} and θ_{geo} . Future work in the refinement of the aforementioned method could result in a feasible CC

configuration with acceptable sensitivity for the low energy gamma regime.

Overall, this thesis has contributed to a deeper understanding of the promising potential but also remaining challenges of PG imaging with CC detection systems for *in vivo* range verification in proton therapy. The simulation and image reconstruction framework here presented will provide guidance for future developments towards a suitable system overcoming the complexity concerning data acquisition and image reconstruction.

Acknowledgements

The PhD journey is shrouded by expectations, difficulties and from time to time some accolades; however, this is not a solo adventure. There will not be enough words to extend my gratitude for the people who have been around me, for their enormous support during these almost four years to help me for the accomplishment of this thesis.

Firstly and foremost, I would like to express my deepest gratitude and admiration for my advisor Professor Katia Parodi. Thank you for giving me the opportunity to conduct the research to pursue my PhD thesis in the Medical Physics Department at the LMU, being a member of your group meant a lot to me. Your encouragement and support gave me the motivation to take a step further even during the tough times. There is always room for me to improve but your insights and guidance allowed me to grow as a becoming-scientist. It was a privilege to have you as my supervisor, your commitment is an example I take for my future career.

I also thank my second supervisor Dr. George Dedes for all your support and advice throughout my PhD journey. Nothing is perfect, human relations are complex but the difficulties are meant to rouse, not discourage.

The LMU Compton camera would not exist without the work and effort of the group of PD Dr. Peter G. Thirolf. I appreciated the most all good discussions during the group meetings. Your endless efforts towards an improved detector have allowed me to work from the computational side on this topic and have the possibility to explore it in different ways. Many discussions brought us to strive for the cause of the encountered detector shortcomings and the result can be appreciated in this thesis. Last but not least, thanks for accepting my invitation to be part of my dissertation committee as the second referee.

I express my gratitude to Professor Jerimy Polf and his group at the University of Maryland. A fruitful collaboration led to the studies here presented for the Polaris-J Compton camera. A special mention goes to Dr. Steve Peterson, who developed and provided us with the Geant4 simulation environment for the Polaris-J as well as to Dr. Dennis Mackin, the main developer of the SOE algorithm implementation. I appreciate your collaboration and the time you were always willing to spend to share the different data or to perform specific reconstructions. The insightful discussions have significantly enriched my knowledge regarding Compton cameras and prompt gamma imaging.

I am particularly indebted to Dr. Andreas Zoglauer. The apparent reason is that without his MEGALib software the investigations and reported findings in this thesis would not have been a reality. In addition, your support and expertise have been invaluable. Thanks for the interest you put in our project and your patient answering to my numerous

emails about the code. I appreciate the opportunity the scientific career gave me to get to know you.

I would like to thank Professor Kirsten Lauber for providing the mouse CT data, which was used to conduct the first simulation attempt for the feasibility of prompt gamma imaging in pre-clinical scenarios.

Dear Professor Jochen Weller, Professor Otmar Biebel, Professor Joachim Rädler and Professor Thomas Kuhr, thank you for accepting to be members of my dissertation committee.

The quantification of the correlation between the proton beam range and the reconstructed prompt gamma profiles would not have been possible without the contribution of Liheng Tian. Thanks Liheng for the time you spent taking a look at my crazy profiles (most of the time flipped), fitting the curves, but foremost your positive attitude and the desire to help me every time I was approaching you with questions. I wish you the best for the completion of the PhD.

Basti there are no words to express how much you have meant for me. You are the love of my life. We have been sharing and trying to manage together the roller-coaster life of a PhD student (even sharing the office) and all the experienced feelings I have been through affected you as much as they did to me. But you brought me the light in the darkest moments, endured the after-work complains and encouraged me in every possible way to keep me on the track towards the main goal. You are the reason why this thesis is a reality. Furthermore, the last months, you have painstakingly been reading the entire document over and over, helping me with insightful comments to improve it considerably. I cannot forget to mention your Ink-scape master skills and certainly your dedicated work with the German translation of the abstract. PhD experiences take us where something incredible is waiting to be known. Something became someone: YOU, and every day I feel how we are together making each other a whole. Looking forward to seeing our dreams become true.

My time at Munich was made enjoyable due to friends at the department. Juliana, Thomas, Matthias and Chiara you always created a friendly working environment, and I am very grateful for the very nice time we spent together. All the best for your future. Silvia and Franz, your genuine friendship has filled my life with happiness but also given me strength throughout the difficulties in the last years. Thank you for putting always a smile on my face and offering your unconditional support. You both are welcome in Colombia to celebrate a combined PhD party!

Finally, I acknowledge the financial support of the DFG Cluster of Excellence Munich Center for Advanced Photonics (MAP) through a stipend from the International Max Planck Research School (IMPRS) of Advanced Photon Science (APS) at the Max-Planck-Institut für Quantenoptik.

My thoughts, my feelings, my spirit, they are all in Spanish... Los agradecimientos cruzan el Atlántico y llegan a Colombia. Más que un gracias quisiera dedicarle esta tesis a mi mamá. Su apoyo incondicional ha sido siempre fundamental para cumplir mis sueños, incluso cuando eso ha significado que estemos lejos en los buenos y malos ratos. En especial,

los últimos meses su valentía y fortaleza han sido el motor para alcanzar la meta y aunque las circunstancias no han sido favorables, estoy segura que la vida nos recompensará con abrazos y tiempo compartido. A Nataly y Karen, su amor siempre me motiva a dar lo mejor y seguir adelante en medio de las dificultades. La admiración que me tienen es una gran responsabilidad, espero no defraudarlas. A mi papá y todos los demás miembros de mi familia, gracias por estar siempre presentes y brindarme en la distancia su apoyo incondicional. Esta tesis también va dedicada a ustedes que han estado con mi mamá cuando más lo ha necesitado. Gracias!

Mi infinita gratitud a esas personas que te encuentras en el camino y se vuelven como parte de tu familia. Carlos, siempre podré contar contigo a pesar de la distancia (y la residencia!). David, Olga y Daniel con ustedes los lazos de unión siempre se han fortalecido sin importar que la vida nos lleve por latitudes diferentes, gracias por todos estos años de amistad incondicional. Juan Felipe, no puedo quedarme sin expresar todo el cariño que te tengo, las casualidades nos ha hecho coincidir geográficamente en muchas ocasiones, gracias por tantos momentos compartidos. A mis amigas y amigos (cuyos nombres no están escritos), ustedes que han estado siempre presentes, dispuestos a escucharme los tengo en un lugar muy especial de mi corazón. Gracias a aquellos a quien tuve la fortuna de recibir en Múnich y/o visitarlos en diferentes lugares en Europa; su amistad y sus buenos deseos siempre me han llenado de la mejor energía. A veces tenemos que estar alejados de aquellos a los que queremos, pero eso no significa que no los queramos, muchas veces eso nos hace quererlos aún más. Nos veremos pronto!

Por último agradezco al departamento Administrativo de Ciencia, Tecnología e Innovación (Colciencias) por el financiamiento recibido a través del programa Beca Colciencias Doctorado en el exterior, beca que obtuve en 2015 y facilitó la satisfactoria culminación de mi programa doctoral.

We are going to very distant lands... It is Adventure Time!

Bibliography

- S. Agostinelli, J. Allison, K. Amako, et al. Geant4—a simulation toolkit. *Nuclear Instruments and Methods in Physics Research Section A: Accelerators, Spectrometers, Detectors and Associated Equipment*, 506(3):250 – 303, 2003. ISSN 0168-9002. doi: [https://doi.org/10.1016/S0168-9002\(03\)01368-8](https://doi.org/10.1016/S0168-9002(03)01368-8). URL <http://www.sciencedirect.com/science/article/pii/S0168900203013688>.
- F. Ajzenberg-Selove. Energy levels of light nuclei $A = 11-12$. *Nuclear Physics A*, 506(1): 1–158, 1990. ISSN 0375-9474. doi: 10.1016/0375-9474(90)90271-M.
- S. Aldawood. *Commissioning of a Compton camera for medical imaging*. PhD dissertation, Ludwig-Maximilians-Universität München, 2017. URL https://edoc.uni-muenchen.de/20304/13/Aldawood_Saad.pdf.
- S. Aldawood, I. Castelhana, G. Roman, H. Van Der Kolff, C. Lang, S. Liprandi, R. Lutter, L. Maier, T. Marinšek, D. Schaart, K. Parodi, and P.G. Thirolf. Comparative characterization study of a $\text{labr}_3(\text{ce})$ scintillation crystal in two surface wrapping scenarios: Absorptive and reflective. *Frontiers in Oncology*, 5:270, 2015. ISSN 2234-943X. doi: 10.3389/fonc.2015.00270. URL <https://www.frontiersin.org/article/10.3389/fonc.2015.00270>.
- A. Andreyev, A. Sitek, and A. Celler. Fast image reconstruction for Compton camera using stochastic origin ensemble approach. *Medical Physics*, 38(1):429–438, 2011. doi: 10.1118/1.3528170. URL <https://aapm.onlinelibrary.wiley.com/doi/abs/10.1118/1.3528170>.
- W. Assmann, S. Kellnberger, S. Reinhardt, S. Lehrack, A. Edlich, P.G. Thirolf, M. Moser, G. Dollinger, M. Omar, V. Ntziachristos, and K. Parodi. Ionoacoustic characterization of the proton Bragg peak with submillimeter accuracy. *Medical Physics*, 42(2):567–574, 2015. ISSN 2473-4209. doi: 10.1118/1.4905047. URL <http://dx.doi.org/10.1118/1.4905047>.
- H.H. Barrett, T. White, and L.C. Parra. List-mode likelihood. *J. Opt. Soc. Am. A*, 14(11):2914–2923, Nov 1997. doi: 10.1364/JOSAA.14.002914. URL <http://josaa.osa.org/abstract.cfm?URI=josaa-14-11-2914>.

- R. Basko, G.L. Zeng, and G.T. Gullberg. Application of spherical harmonics to image reconstruction for the Compton camera. *Physics in Medicine & Biology*, 43(4):887, 1998. URL <http://stacks.iop.org/0031-9155/43/i=4/a=016>.
- G. Battistoni, I. Mattei, and S. Muraro. Nuclear physics and particle therapy. *Advances in Physics: X*, 1(4):661–686, 2016. doi: 10.1080/23746149.2016.1237310. URL <https://doi.org/10.1080/23746149.2016.1237310>.
- J. Bauer, D. Unholtz, F. Sommerer, C. Kurz, T. Haberer, K. Herfarth, T. Welzel, S.E. Combs, J. Debus, and K. Parodi. Implementation and initial clinical experience of offline pet/ct-based verification of scanned carbon ion treatment. *Radiotherapy and Oncology*, 107(2):218 – 226, 2013. ISSN 0167-8140. doi: <https://doi.org/10.1016/j.radonc.2013.02.018>.
- W. Bauhoff. Tables of reaction and total cross sections for proton-nucleus scattering below 1 GeV. *Atomic Data and Nuclear Data Tables*, 35(3):429 – 447, 1986. ISSN 0092-640X. doi: 10.1016/0092-640X(86)90016-1. URL <http://www.sciencedirect.com/science/article/pii/0092640X86900161>.
- J. Beebe-Wang, P. Vaska, F. A. Dilmanian, S. G. Peggs, and D. J. Schlyer. Simulation of proton therapy treatment verification via PET imaging of induced positron-emitters. In *2003 IEEE Nuclear Science Symposium. Conference Record (IEEE Cat. No.03CH37515)*, volume 4, pages 2496–2500, Oct 2003. doi: 10.1109/NSSMIC.2003.1352399.
- A.C. Begg, F.A. Fiona, and C. Vens. Strategies to improve radiotherapy with targeted drugs. *Nature Reviews Cancer*, 11(4):239–253, 2011. ISSN 1474-175X. doi: 10.1038/nrc3007. URL <http://www.nature.com/doifinder/10.1038/nrc3007>.
- M.J. Berger and S.M. Seltzer. Tables of energy losses and ranges of electrons and positrons. Technical report, NTIS, 1964.
- M.J. Berger, J.H. Hubbell, S.M. Seltzer, J. Chang, J.S. Coursey, R. Sukumar, D.S. Zucker, and K. Olsen. *XCOM: Photon Cross Section Database (version 1.5)*, 2010. <http://physics.nist.gov/xcom> [Accessed: March, 2018].
- M.J. Berger et al. *ESTAR, PSTAR, and ASTAR: Computer Programs for Calculating Stopping-Power and Range Tables for Electrons, Protons, and Helium Ions (version 1.2.3)*, 2005. <http://physics.nist.gov/Star> [Accessed: January, 2018].
- J. Beringer, J. F. Arguin, R. M. Barnett, K. Copic, et al. Review of particle physics. *Phys. Rev. D*, 86:010001, Jul 2012. doi: 10.1103/PhysRevD.86.010001. URL <https://link.aps.org/doi/10.1103/PhysRevD.86.010001>.
- B. Berndt, G. Landry, F. Schwarz, T. Tessonier, F. Kamp, G. Dedes, C. Thieke, M. Würfl, C. Kurz, U. Ganswindt, F. Verhaegen, J. Debus, C. Belka, W. Sommer, M. Reiser,

-
- J. Bauer, and K. Parodi. Application of single- and dual-energy ct brain tissue segmentation to pet monitoring of proton therapy. *Physics in Medicine & Biology*, 62(6):2427, 2017. URL <http://stacks.iop.org/0031-9155/62/i=6/a=2427>.
- H.W. Bertini, T.A. Gabriel, R.T. Santoro, O.W. Hermann, N.M. Larson, and J.M. Hunt. HIC-1: a first approach to the calculation of heavy-ion reactions at energies greater than or equal to 50 MeV/nucleon. Technical report, Oak Ridge National Laboratory, Oak Ridge, Tennessee, January 1974.
- H. Bethe. Zur theorie des durchgangs schneller korpuskularstrahlen durch materie. *Annalen der Physik*, 397(3):325–400, 1930. ISSN 1521-3889. doi: 10.1002/andp.19303970303. URL <http://dx.doi.org/10.1002/andp.19303970303>.
- A.K. Biegun, E. Seravalli, P.C Lopes, I. Rinaldi, M. Pinto, D.C. Oxley, P. Dendooven, F. Verhaegen, K. Parodi, P. Crespo, and D.R. Schaart. Time-of-flight neutron rejection to improve prompt gamma imaging for proton range verification: a simulation study. *Physics in Medicine & Biology*, 57(20):6429, 2012. URL <http://stacks.iop.org/0031-9155/57/i=20/a=6429>.
- M.G. Bisogni, A. Attili, G. Battistoni, N. Belcari, N. Camarlinghi, P. Cerello, S. Coli, A. Del Guerra, A. Ferrari, V. Ferrero, E. Fiorina, G. Giraudo, E. Kostara, M. Morrocchi, F. Pennazio, C. Peroni, M.A. Piliero, G. Pirrone, A. Rivetti, M.D. Rolo, V. Rosso, P. Sala, G. Sportelli, and R. Wheadon. Inside in-beam positron emission tomography system for particle range monitoring in hadrontherapy. *Journal of Medical Imaging*, 4:4 – 4 – 12, 2016. doi: 10.1117/1.JMI.4.1.011005.
- M. Blann. Precompound analyses of spectra and yields following nuclear capture of stopped π^- . *Phys. Rev. C*, 28:1648–1662, Oct 1983. doi: 10.1103/PhysRevC.28.1648.
- F. Bloch. Zur bremsung rasch bewegter teilchen beim durchgang durch materie. *Annalen der Physik*, 408(3):285–320, 1933. ISSN 1521-3889. doi: 10.1002/andp.19334080303. URL <http://dx.doi.org/10.1002/andp.19334080303>.
- V. Bom, L. Joulaeizadeh, and F. Beekman. Real-time prompt gamma monitoring in spot-scanning proton therapy using imaging through a knife-edge-shaped slit. *Physics in Medicine & Biology*, 57(2):297, 2012. URL <http://stacks.iop.org/0031-9155/57/i=2/a=297>.
- T. Bortfeld and S. Wolfgang. An analytical approximation of depth-dose distributions for therapeutic proton beams. *Physics in Medicine & Biology*, 41(8):1331, 1996. URL <http://stacks.iop.org/0031-9155/41/i=8/a=006>.
- W.H. Bragg and R. Kleeman. Lxxiv. on the ionization curves of radium. *The London, Edinburgh, and Dublin Philosophical Magazine and Journal of Science*, 8(48): 726–738, 1904. doi: 10.1080/14786440409463246. URL <https://doi.org/10.1080/14786440409463246>.

- M.R. Bussi ere and J.A. Adams. Treatment planning for conformal proton radiation therapy. *Technology in cancer research & treatment*, 2(5):389–399, 2003.
- CALA. *Centre for Advanced Laser Applications*, 2018. <https://www.cala-laser.de> [Accessed: July, 2018].
- A.H. Compton. A quantum theory of the scattering of x-rays by light elements. *Phys. Rev.*, 21:483–502, May 1923. doi: 10.1103/PhysRev.21.483. URL <https://link.aps.org/doi/10.1103/PhysRev.21.483>.
- A.M. Cormack. Representation of a Function by Its Line Integrals, with Some Radiological Applications. *Journal of Applied Physics*, 34(9):2722–2727, 1963. doi: 10.1063/1.1729798. URL <https://doi.org/10.1063/1.1729798>.
- A.M. Cormack and A.M. Koehler. Quantitative proton tomography: preliminary experiments. *Physics in Medicine & Biology*, 21(4):560, 1976. URL <http://stacks.iop.org/0031-9155/21/i=4/a=007>.
- M.J. Cree and P.J. Bones. Towards direct reconstruction from a gamma camera based on Compton scattering. *IEEE Transactions on Medical Imaging*, 13(2):398–407, Jun 1994. ISSN 0278-0062. doi: 10.1109/42.293932.
- P. Crespo, G. Shakirin, F. Fiedler, W. Enghardt, and A. Wagner. Direct time-of-flight for quantitative, real-time in-beam pet: a concept and feasibility study. *Physics in Medicine & Biology*, 52(23):6795, 2007. URL <http://stacks.iop.org/0031-9155/52/i=23/a=002>.
- I.J. Das and H. Paganetti. Introduction and history of proton therapy. In I.J. Das and H. Paganetti, editors, *Principles and Practice of Proton Beam Therapy, AAPM Monograph 2015, Summer School*, chapter 1, pages 1–15. American Association on Physicists in Medicine AAPM, 2015. ISBN 978-3-540-00321-2. doi: 10.1007/3-540-29999-8.
- E. Draeger, S. Peterson, D. Mackin, H. Chen, S. Beddar, and J. C. Polf. Feasibility studies of a new event selection method to improve spatial resolution of Compton imaging for medical applications. *IEEE Transactions on Radiation and Plasma Medical Sciences*, 1(4):358–367, July 2017. ISSN 2469-7311. doi: 10.1109/TRPMS.2017.2703095.
- E. Draeger, D. Mackin, S. Peterson, H. Chen, S. Avery, S. Beddar, and J.C. Polf. 3d prompt gamma imaging for proton beam range verification. *Physics in Medicine & Biology*, 63(3):035019, 2018. URL <http://stacks.iop.org/0031-9155/63/i=3/a=035019>.
- M. Durante and J.S. Loeffler. Charged particles in radiation oncology. *Nature Reviews Clinical Oncology*, 7:37–43, January 2010. ISSN 1759-4774. doi: doi:10.1038/nrclinonc.2009.183. URL <http://dx.doi.org/10.1038/nrclinonc.2009.183>.

-
- M. Durante and H. Paganetti. Nuclear physics in particle therapy: a review. *Reports on Progress in Physics*, 79(9):096702, 2016. URL <http://stacks.iop.org/0034-4885/79/i=9/a=096702>.
- D.B. Everett, J.S. Fleming, R.W. Todd, and J.M. Nightingale. Gamma-radiation imaging system based on the Compton effect. *Electrical Engineers, Proceedings of the Institution of*, 124(11):995–, November 1977. ISSN 0020-3270. doi: 10.1049/piee.1977.0203.
- J. Ferlay, I. Soerjomataram, M. Ervik, R. Dikshit, S. Eser, C. Mathers, M. Rebelo, DM Parkin, and D. Forman an F. Bray. GLOBOCAN 2012 V1.0, Cancer Incidence and Mortality Worldwide: IARC CancerBase No. 11 [Internet]. Technical report, International Agency for Research on Cancer, Lyon, 2013. URL <http://globocan.iarc.fr>.
- E. Fermi. High Energy Nuclear Events. *Progress of Theoretical Physics*, 5(4):570–583, 1950. doi: 10.1143/ptp/5.4.570. URL <http://dx.doi.org/10.1143/ptp/5.4.570>.
- J.M. Fernández-Varea, P. Andreo, and T. Tabata. Detour factors in water and plastic phantoms and their use for range and depth scaling in electron-beam dosimetry. *Physics in Medicine & Biology*, 41(7):1119, 1996. URL <http://stacks.iop.org/0031-9155/41/i=7/a=004>.
- A. Ferrari and P.R Sala. The physics of high energy reactions. In ICTP, editor, *Workshop on Nuclear Reaction Data and Nuclear Reactor Physics, Design and Safety*, pages 424–532, Trieste, April 1998.
- G. Folger, VN. Ivanchenko, and J. Wellisch. The binary cascade: Nucleon nuclear reactions. *The European Physical Journal A - Hadrons and Nuclei*, 21:407–417, 09 2004.
- M. Frandes, A. Zoglauer, V. Maxim, and R. Prost. A Tracking Compton-Scattering Imaging System for Hadron Therapy Monitoring. *IEEE Transactions on Nuclear Science*, 57(1):144–150, 2010. ISSN 0018-9499. doi: 10.1109/TNS.2009.2031679.
- Geant4. *Physics Reference Manual*, 2018. <http://geant4-userdoc.web.cern.ch/geant4-userdoc/UsersGuides/PhysicsReferenceManual/html/index.html> [Accessed: March, 2018].
- M. Goitein, A.J. Lomax, and E.S. Pedroni. Treating cancer with protons. *Physics Today*, 55(9):45–51, 2002.
- C. Golnik, F. Hueso-González, A. Müller, P. Dendooven, W. Enghardt, F. Fiedler, T. Kormoll, K.E Römer, J. Petzoldt, A. Wagner, and G. Pausch. Range assessment in particle therapy based on prompt γ -ray timing measurements. *Physics in Medicine & Biology*, 59(18):5399, 2014. URL <http://stacks.iop.org/0031-9155/59/i=18/a=5399>.
- J.J. Griffin. Statistical model of intermediate structure. *Phys. Rev. Lett.*, 17:478–481, Aug 1966. doi: 10.1103/PhysRevLett.17.478. URL <https://link.aps.org/doi/10.1103/PhysRevLett.17.478>.

- Y. Hayakawa, J. Tada, N. Arai, K. Hosono, M. Sato, T. Wagai, H. Tsuji, and H. Tsujii. Acoustic pulse generated in a patient during treatment by pulsed proton radiation beam. *Radiation Oncology Investigations*, 3(1):42–45, 1995. ISSN 1520-6823. doi: 10.1002/roi.2970030107. URL <http://dx.doi.org/10.1002/roi.2970030107>.
- V.L. Highland. Some practical remarks on multiple scattering. *Nuclear Instruments and Methods*, 129(2):497 – 499, 1975. ISSN 0029-554X. doi: [https://doi.org/10.1016/0029-554X\(75\)90743-0](https://doi.org/10.1016/0029-554X(75)90743-0).
- F. Hueso-González, W. Enghardt, F. Fiedler, C. Golnik, G. Janssens, J. Petzoldt, D. Prieels, M. Priegnitz, K.E. Römer, J. Smeets, F.V. Stappen, A. Wagner, and G. Pausch. First test of the prompt gamma ray timing method with heterogeneous targets at a clinical proton therapy facility. *Physics in Medicine & Biology*, 60(16):6247, 2015. URL <http://stacks.iop.org/0031-9155/60/i=16/a=6247>.
- ICRU. *International Commission on Radiation Units and Measurements (ICRU) Report 63. Nuclear Data for Neutron and Proton Radiotherapy and for Radiation Protection*. ICRU report. International Commission on Radiation Units and Measurements, 2000.
- FMFC Janssen, G. Landry, P. Cambraia Lopes, G. Dedes, J. Smeets, D.R. Schaart, K. Parodi, and F. Verhaegen. Factors influencing the accuracy of beam range estimation in proton therapy using prompt gamma emission. *Physics in Medicine & Biology*, 59(15):4427, 2014. URL <http://stacks.iop.org/0031-9155/59/i=15/a=4427>.
- J. Jeyasugiththan and S.W. Peterson. Evaluation of proton inelastic reaction models in geant4 for prompt gamma production during proton radiotherapy. *Physics in Medicine & Biology*, 60(19):7617, 2015. URL <http://stacks.iop.org/0031-9155/60/i=19/a=7617>.
- R.P. Johnson. Review of medical radiography and tomography with proton beams. *Reports on Progress in Physics*, 81(1):016701, 2018. URL <http://stacks.iop.org/0034-4885/81/i=1/a=016701>.
- K.C. Jones, W. Nie, J. C H Chu, J.V. Turian, A. Kassaei, C.M. Sehgal, and S. Avery. Acoustic-based proton range verification in heterogeneous tissue: simulation studies. *Physics in Medicine & Biology*, 63(2):025018, 2018. URL <http://stacks.iop.org/0031-9155/63/i=2/a=025018>.
- K. Jong-Won. Pinhole camera measurements of prompt gamma-rays for detection of beam range variation in proton therapy. *Journal of Korean Physical Society*, 55:1673, 2009.
- Y. Jongen and F. Stichelbaut. Verification of the proton beam position in the patient by the detection of prompt gamma-rays emission. In *39th Meeting of the Particle Therapy Co-Operative Group*, San Francisco, CA, Oct. 26-29 2003.

- B.H. Kang and J.W. Kim. Monte Carlo Design Study of a Gamma Detector System to Locate Distal Dose Falloff in Proton Therapy. *IEEE Transactions on Nuclear Science*, 56(1):46–50, 2009. ISSN 0018-9499.
- L. Kelleter, A. Wrońska, J. Besuglow, A. Konefał, K. Laihem, J. Leidner, A. Magiera, K. Parodi, K. Rusiecka, A. Stahl, and T. Tessonnier. Spectroscopic study of prompt-gamma emission for range verification in proton therapy. *Physica Medica*, 34:7 – 17, 2017. ISSN 1120-1797. doi: <https://doi.org/10.1016/j.ejmp.2017.01.003>.
- S. Kellnberger, W. Assmann, S. Lehrack, S. Reinhardt, P. Thierolf, D. Queirós, G. Sergiadis, G. Dollinger, K. Parodi, and V. Ntziachristos. Ionoacoustic tomography of the proton bragg peak in combination with ultrasound and optoacoustic imaging. *Scientific Reports*, 6:29305 EP –, 07 2016. URL <http://dx.doi.org/10.1038/srep29305>.
- O. Klein and T. Nishina. Über die streuung von strahlung durch freie elektronen nach der neuen relativistischen quantendynamik von dirac. *Zeitschrift fur Physik*, 52:853–868, Nov 1929. doi: 10.1007/BF01366453. URL <http://adsabs.harvard.edu/abs/1929ZPhy...52..853K>.
- A-C. Knopf and A. Lomax. In vivo proton range verification: a review. *Physics in Medicine & Biology*, 58(15):R131, 2013. URL <http://stacks.iop.org/0031-9155/58/i=15/a=R131>.
- A.M. Koehler. Proton Radiography. *Science*, 160(3825):303–304, 1968. ISSN 0036-8075. doi: 10.1126/science.160.3825.303. URL <http://science.sciencemag.org/content/160/3825/303>.
- A.M. Koehler, R.J. Schneider, and J.M. Sisterson. Flattening of proton dose distributions for large-field radiotherapy. *Medical Physics*, 4(4):297–301, 1977. ISSN 2473-4209. doi: 10.1118/1.594317. URL <http://dx.doi.org/10.1118/1.594317>.
- B. Kozlovsky, R.J. Murphy, and R. Ramaty. Nuclear Deexcitation Gamma-Ray Lines from Accelerated Particle Interactions. *The Astrophysical Journal Supplement Series*, 141(2): 523, 2002. URL <http://stacks.iop.org/0067-0049/141/i=2/a=523>.
- A.C. Kraan. Range verification methods in particle therapy: Underlying physics and monte carlo modeling. *Frontiers in Oncology*, 5:150, 2015. ISSN 2234-943X. doi: 10.3389/fonc.2015.00150. URL <https://www.frontiersin.org/article/10.3389/fonc.2015.00150>.
- J. Krimmer, M. Chevallier, J. Constanzo, D. Dauvergne, M. De Rydt, G. Dedes, N. Freud, P. Henriquet, C. La Tessa, J.M. Létang, R. Pleská, M. Pinto, C. Ray, V. Reithinger, M.H. Richard, I. Rinaldi, F. Roellinghoff, C. Schuy, E. Testa, and M. Testa. Collimated prompt gamma tof measurements with multi-slit multi-detector configurations. *Journal of Instrumentation*, 10(01):P01011, 2015. URL <http://stacks.iop.org/1748-0221/10/i=01/a=P01011>.

- J. Krimmer, G. Angellier, L. Balleyguier, D. Dauvergne, N. Freud, J. Héroult, J. M. Létang, H. Mathez, M. Pinto, E. Testa, and Y. Zoccarato. A cost-effective monitoring technique in particle therapy via uncollimated prompt gamma peak integration. *Applied Physics Letters*, 110(15):154102, 2017. doi: 10.1063/1.4980103. URL <https://doi.org/10.1063/1.4980103>.
- J. Krimmer, D. Dauvergne, J.M. Létang, and Á. Testa. Prompt-gamma monitoring in hadrontherapy: A review. *Nuclear Instruments and Methods in Physics Research Section A: Accelerators, Spectrometers, Detectors and Associated Equipment*, 878:58 – 73, 2018. ISSN 0168-9002. doi: 10.1016/j.nima.2017.07.063. URL <http://www.sciencedirect.com/science/article/pii/S0168900217308380>. Radiation Imaging Techniques and Applications.
- R.A. Kroeger, W.N. Johnson, J.D. Kurfess, B.F. Philips, and E.A. Wulf. Three-Compton telescope: theory, simulations, and performance. *IEEE Transactions on Nuclear Science*, 49(4):1887–1892, Aug 2002. ISSN 0018-9499. doi: 10.1109/TNS.2002.801539.
- S. Kurosawa, H. Kubo, K. Ueno, S. Kabuki, S. Iwaki, M. Takahashi, K. Taniue, N. Higashi, K. Miuchi, T. Tanimori, D. Kim, and J. Kim. Prompt gamma detection for range verification in proton therapy. *Current Applied Physics*, 12(2):364 – 368, 2012. ISSN 1567-1739. doi: <https://doi.org/10.1016/j.cap.2011.07.027>. URL <http://www.sciencedirect.com/science/article/pii/S1567173911004123>.
- C. Lang. *Design of a Compton camera for medical imaging and characterization of its components*. PhD dissertation, Ludwig-Maximilians-Universität München, 2015. URL https://edoc.ub.uni-muenchen.de/18918/1/Lang_Christian.pdf.
- K. Langen, J. Polf, and R. Schulte. Imaging for Proton Therapy. In I.J. Das and H. Paganetti, editors, *Principles and Practice of Proton Beam Therapy, AAPM Monograph 2015, Summer School*, chapter 7, pages 165–186. American Association on Physicists in Medicine AAPM, 2015. ISBN 978-3-540-00321-2. doi: 10.1007/3-540-29999-8.
- S. Lehrack, W. Assmann, D. Bertrand, S. Henrotin, J. Herault, V. Heymans, F.V. Stappen, P.G. Thirolf, M. Vidal, J. Van de Walle, and K. Parodi. Submillimeter ionoacoustic range determination for protons in water at a clinical synchrocyclotron. *Physics in Medicine & Biology*, 62(17):L20, 2017. URL <http://stacks.iop.org/0031-9155/62/i=17/a=L20>.
- J. Lindhard, V. Nielsen, M. Scharff, and P.V. Thomsen. Integral equations governing radiation effects. (Notes on atomic collisions, III). *Kgl. Danske Videnskab. Selskab Mat.-fys. Medd.*, 33(10):1–42, 1963.
- S. Liprandi. *Development and performance evaluation of detectors in a Compton camera arrangement for ion beam range monitoring in particle therapy (PhD in preparation)*. PhD dissertation, Ludwig-Maximilians-Universität München, 2018.

-
- S. Liprandi, S. Takyu, S. Aldawood, T. Binder, G. Dedes, K. Kamada, R. Lutter, M. Mayerhofer, A. Miani, A. Mohammadi, F. Nishikido, D.R. Schaart, I.I. Valencia-Lozano, E. Yoshida, T. Yamaya, K. Parodi, and P.G. Thirolf. Characterization of a Compton camera setup with monolithic $\text{LaBr}_3(\text{Ce})$ absorber and segmented GAGG scatter detectors. In *2017 IEEE Nuclear Science Symposium, Medical Imaging Conference and Room-Temperature Semiconductor Detector Workshop (NSS/MIC/RTSD)*, pages 424–532, Atlanta, GE, Oct-Nov 2017.
- S. Liprandi, S. Takyu, T. Binder, G. Dedes, K. Kamada, M. Kawula, R. Lutter, F. Nishikido, I.I. Valencia-Lozano, R. Viegas, T. Yamaya, K. Parodi, and P.G. Thirolf. Monolithic $\text{LaBr}_3(\text{Ce})$ absorber and segmented GAGG scatter detectors in a Compton camera arrangement for medical imaging. In *2018 IEEE Nuclear Science Symposium, Medical Imaging Conference and Room-Temperature Semiconductor Detector Workshop (NSS/MIC/RTSD)*, Sidney, Nov. 10-17 2018.
- A. Lomax. Intensity modulation methods for proton radiotherapy. *Physics in Medicine & Biology*, 44(1):185, 1999. URL <http://stacks.iop.org/0031-9155/44/i=1/a=014>.
- D. Mackin, S. Peterson, S. Beddar, and J. Polf. Evaluation of a stochastic reconstruction algorithm for use in Compton camera imaging and beam range verification from secondary gamma emission during proton therapy. *Physics in Medicine & Biology*, 57(11):3537, 2012. URL <http://stacks.iop.org/0031-9155/57/i=11/a=3537>.
- D. Mackin, J. Polf, S. Peterson, and S. Beddar. The effects of doppler broadening and detector resolution on the performance of three-stage Compton cameras. *Medical Physics*, 40(1):012402, 2013. doi: 10.1118/1.4767756. URL <https://aapm.onlinelibrary.wiley.com/doi/abs/10.1118/1.4767756>.
- P. Mayles, A. Nahum, and J.C. Rosenwald. *Handbook of Radiotherapy Physics- Theory and Practice*. Taylor & Francis, United States of America, 2007. ISBN 13-978-0-7503-0860-1.
- M. McCleskey, W. Kaye, D.S. Mackin, S. Beddar, Z. He, and J.C. Polf. Evaluation of a multistage CdZnTe Compton camera for prompt γ imaging for proton therapy. *Nuclear Instruments and Methods in Physics Research Section A: Accelerators, Spectrometers, Detectors and Associated Equipment*, 785:163 – 169, 2015. ISSN 0168-9002. doi: <https://doi.org/10.1016/j.nima.2015.02.030>. URL <http://www.sciencedirect.com/science/article/pii/S0168900215002193>.
- S.E. McGowan, N.G. Burnet, and A. Lomax. Treatment planning optimisation in proton therapy. *The British Journal of Radiology*, 86(1021):20120288–20120288, 2013. doi: 10.1259/bjr.20120288. URL <https://doi.org/10.1259/bjr.20120288>. PMID: 23255545.
- CH. Min, C.H. Kim, M-Y. Youn, and J-W. Kim. Prompt gamma measurements for locating the dose falloff region in the proton therapy. *Applied Physics Letters*, 89(18):183517, 2006. doi: 10.1063/1.2378561. URL <https://doi.org/10.1063/1.2378561>.

- CH. Min, H.M Lee, C.H. Kim, and S.B.Lee. Development of array-type prompt gamma measurement system for in vivo range verification in proton therapy. *Medical Physics*, 39(4):2100–2107, 2012. ISSN 2473-4209. doi: 10.1118/1.3694098. URL <http://dx.doi.org/10.1118/1.3694098>.
- R. Mohan and D. Grosshans. Proton therapy: Present and future. *Advanced Drug Delivery Reviews*, 109(Supplement C):26 – 44, 2017. ISSN 0169-409X. doi: <https://doi.org/10.1016/j.addr.2016.11.006>. URL <http://www.sciencedirect.com/science/article/pii/S0169409X16303192>. Radiotherapy for cancer: present and future.
- G. Moliere. *Theory of Scattering of Fast Charged Particles*. Number pt. 1 in A. T. S. Translation. Associated Technical Services, 1955.
- S. Molinelli, A. Mairani, A. Mirandola, G. Vilches Freixas, T. Tessonier, S. Giordanengo, K. Parodi, M. Ciocca, and R. Orecchia. Dosimetric accuracy assessment of a treatment plan verification system for scanned proton beam radiotherapy: one-year experimental results and monte carlo analysis of the involved uncertainties. *Physics in Medicine & Biology*, 58(11):3837, 2013. URL <http://stacks.iop.org/0031-9155/58/i=11/a=3837>.
- J.W.M Du Mond. Compton modified line structure and its relation to the electron theory of solid bodies. *Phys. Rev.*, 33:643–658, May 1929. doi: 10.1103/PhysRev.33.643. URL <https://link.aps.org/doi/10.1103/PhysRev.33.643>.
- M. Moteabbed, S. Espana, and H. Paganetti. Monte Carlo patient study on the comparison of prompt gamma and PET imaging for range verification in proton therapy. *Physics in Medicine & Biology*, 56(4):1063, 2011. URL <http://stacks.iop.org/0031-9155/56/i=4/a=012>.
- R.J. Murphy, B. Kozlovsky, J. Kiener, and G.H. Share. Nuclear Gamma-Ray De-Excitation Lines and Continuum from Accelerated-Particle Interactions in Solar Flares. *The Astrophysical Journal Supplement Series*, 183(1):142, 2009. URL <http://stacks.iop.org/0067-0049/183/i=1/a=142>.
- T. Nishio. *Physics*, pages 27–43. Springer Japan, 2015. ISBN 978-4-431-54883-6. doi: 10.1007/978-4-431-54883-6_3.
- H. Paganetti. Range uncertainties in proton therapy and the role of Monte Carlo simulations. *Physics in Medicine & Biology*, 57(11):R99–R117, June 2012. ISSN 0031-9155. doi: 10.1088/0031-9155/57/11/R99. URL <http://www.ncbi.nlm.nih.gov/pmc/articles/PMC3374500/>.
- H. Paganetti and T. Bortfeld. Proton therapy. In W.C. Schlegel, T. Bortfeld, and A.L. Grosu, editors, *New Technologies in Radiation Oncology*, chapter 27, pages 345–365. Springer-Verlag Berlin Heidelberg, 2006. ISBN 978-3-540-00321-2. doi: 10.1007/3-540-29999-8.

-
- K. Parodi. PET monitoring of hadrontherapy. *Nuclear Medicine Review*, 15(C):37–42, 2012. ISSN 1506-9680. URL https://journals.viamedica.pl/nuclear_medicine_review/article/view/28472.
- K. Parodi. Heavy ion radiography and tomography. *Physica Medica*, 30(5):539 – 543, 2014. ISSN 1120-1797. doi: <https://doi.org/10.1016/j.ejmp.2014.02.004>. URL <http://www.sciencedirect.com/science/article/pii/S1120179714000271>. Particle Radiosurgery Conference.
- K. Parodi and W. Assmann. Ionoacoustics: A new direct method for range verification. *Modern Physics Letters A*, 30(17):1540025, 2015. doi: 10.1142/S0217732315400258. URL <http://www.worldscientific.com/doi/abs/10.1142/S0217732315400258>.
- K. Parodi, P. Crespo, H. Eickhoff, T. Haberer, J. Pawelke, D. Schardt, and W. Enghardt. Random coincidences during in-beam PET measurements at microbunched therapeutic ion beams. *Nuclear Instruments and Methods in Physics Research Section A: Accelerators, Spectrometers, Detectors and Associated Equipment*, 545(1):446 – 458, 2005. ISSN 0168-9002. doi: <https://doi.org/10.1016/j.nima.2005.02.002>. URL <http://www.sciencedirect.com/science/article/pii/S0168900205005759>.
- K. Parodi, A. Ferrari, F. Sommerer, and H. Paganetti. Clinical ct-based calculations of dose and positron emitter distributions in proton therapy using the fluka monte carlo code. *Physics in Medicine & Biology*, 52(12):3369, 2007a. URL <http://stacks.iop.org/0031-9155/52/i=12/a=004>.
- K. Parodi, H. Paganetti, A. Helen H. Shih, S. Michaud, J.S. Loeffler, T.F. DeLaney, N.J. Liebsch, J.E. Munzenrider, A.J. Fischman, A. Knopf, and T. Bortfeld. Patient study of *In Vivo* verification of beam delivery and range, using positron emission tomography and computed tomography imaging after proton therapy. *International Journal of Radiation Oncology *Biology *Physics*, 68(3):920–934, 2007b. doi: 10.1016/j.ijrobp.2007.01.063. URL <http://dx.doi.org/10.1016/j.ijrobp.2007.01.063>.
- L.C. Parra. Reconstruction of cone-beam projections from Compton scattered data. *IEEE Transactions on Nuclear Science*, 47(4):1543–1550, Aug 2000. ISSN 0018-9499. doi: 10.1109/23.873014.
- S.K. Patch, M. Kireeff Covo, A. Jackson, Y.M. Qadadha, K.S. Campbell, R.A. Albright, P. Bloemhard, A.P. Donoghue, C.R. Siero, T.L. Gimpel, S.M. Small, B.F. Ninemire, M.B. Johnson, and L. Phair. Thermoacoustic range verification using a clinical ultrasound array provides perfectly co-registered overlay of the Bragg peak onto an ultrasound image. *Physics in Medicine & Biology*, 61(15):5621, 2016. URL <http://stacks.iop.org/0031-9155/61/i=15/a=5621>.
- G. Pausch, J. Petzoldt, M. Berthel, W. Enghardt, F. Fiedler, C. Golnik, F. Hueso-González, R. Lentering, K. Römer, K. Ruhnuau, J. Stein, A. Wolf, and T. Kormoll. Scintillator-Based High-Throughput Fast Timing Spectroscopy for Real-Time Range Verification in

- Particle Therapy. *IEEE Transactions on Nuclear Science*, 63(2):664–672, 2016. ISSN 0018-9499. doi: 10.1109/TNS.2016.2527822.
- I. Perali, A. Celani, L. Bombelli, C. Fiorini, F. Camera, E. Clementel, S. Henrotin, G. Janssens, D. Prieels, F. Roellinghoff, J. Smeets, F. Stichelbaut, and F. Vander Stappen. Prompt gamma imaging of proton pencil beams at clinical dose rate. *Physics in Medicine & Biology*, 59(19):5849, 2014. URL <http://stacks.iop.org/0031-9155/59/i=19/a=5849>.
- M. Pinto, D. Dauvergne, N. Freud, J. Krimmer, J.M. Letang, C. Ray, F. Roellinghoff, and E. Testa. Design optimisation of a TOF-based collimated camera prototype for online hadrontherapy monitoring. *Physics in Medicine & Biology*, 59(24):7653, 2014. URL <http://stacks.iop.org/0031-9155/59/i=24/a=7653>.
- M. Pinto, M. Bajard, S. Brons, M. Chevallier, D. Dauvergne, G. Dedes, M. De Rydt, N. Freud, J. Krimmer, C. La Tessa, J.M. Létang, K. Parodi, R. Pleskač, D. Prieels, C. Ray, I. Rinaldi, F. Roellinghoff, D. Schardt, E. Testa, and M. Testa. Absolute prompt-gamma yield measurements for ion beam therapy monitoring. *Physics in Medicine & Biology*, 60(2):565, 2015. URL <http://stacks.iop.org/0031-9155/60/i=2/a=565>.
- E.B. Podgorsak. *Radiation Physics for Medical Physicists*. Biological and Medical Physics, Biomedical Engineering. Springer Berlin Heidelberg, 2010. ISBN 9783642008757.
- J. Polf, E. Draeger, S. Peterson, D. Mackin, and S. Beddar. Techniques for producing an image of radioactive emissions using a compton camera and compton lines, September 2017. URL <http://www.google.it/patents/US4741207>. Application Patent WO/2017/156113.
- J.C. Polf and K. Parodi. Imaging particle beams for cancer treatment. *Physics Today*, 68(10):28–33, 2015. doi: 10.1063/PT.3.2945. URL <https://doi.org/10.1063/PT.3.2945>.
- J.C. Polf, S. Peterson, G. Ciangaru, M. Gillin, and S. Beddar. Prompt gamma-ray emission from biological tissues during proton irradiation: a preliminary study. *Physics in Medicine & Biology*, 54(3):731, 2009a. URL <http://stacks.iop.org/0031-9155/54/i=3/a=017>.
- J.C. Polf, S. Peterson, M. McCleskey, B.T. Roeder, A. Spiridon, S. Beddar, and L. Trache. Measurement and calculation of characteristic prompt gamma ray spectra emitted during proton irradiation. *Physics in Medicine & Biology*, 54(22):N519, 2009b. URL <http://stacks.iop.org/0031-9155/54/i=22/a=N02>.
- J.C. Polf, R. Panthi, D.S. Mackin, M. McCleskey, A. Saastamoinen, B.T. Roeder, and S. Beddar. Measurement of characteristic prompt gamma rays emitted from oxygen and carbon in tissue-equivalent samples during proton beam irradiation. *Physics in Medicine*

-
- Phys. Med. Biol.*, 58(17):5821, 2013. URL <http://stacks.iop.org/0031-9155/58/i=17/a=5821>.
- J.C. Polf, D. Mackin, E. Lee, S. Avery, and S. Beddar. Detecting prompt gamma emission during proton therapy: the effects of detector size and distance from the patient. *Physics in Medicine & Biology*, 59(9):2325, 2014. URL <http://stacks.iop.org/0031-9155/59/i=9/a=2325>.
- J.C. Polf, S. Avery, D.S. Mackin, and S. Beddar. Imaging of prompt gamma rays emitted during delivery of clinical proton beams with a Compton camera: feasibility studies for range verification. *Physics in Medicine & Biology*, 60(18):7085, 2015. URL <http://stacks.iop.org/0031-9155/60/i=18/a=7085>.
- M. Priegnitz, S. Helmbrecht, G. Janssens, I. Perali, J. Smeets, F. Vander Stappen, E. Sterpin, and F. Fiedler. Measurement of prompt gamma profiles in inhomogeneous targets with a knife-edge slit camera during proton irradiation. *Physics in Medicine & Biology*, 60(12):4849, 2015. URL <http://stacks.iop.org/0031-9155/60/i=12/a=4849>.
- M. Priegnitz, S. Helmbrecht, G. Janssens, I. Perali, J. Smeets, F. Vander Stappen, E. Sterpin, and F. Fiedler. Detection of mixed-range proton pencil beams with a prompt gamma slit camera. *Physics in Medicine & Biology*, 61(2):855, 2016. URL <http://stacks.iop.org/0031-9155/61/i=2/a=855>.
- PTCOG. *Particle therapy facilities in operation*, 2017. <https://www.ptcog.ch> [Accessed: November, 2017].
- I. Ribanský, P. Obložinský, and E. Běták. Pre-equilibrium decay and the exciton model. *Nuclear Physics A*, 205(3):545 – 560, 1973. ISSN 0375-9474. doi: [https://doi.org/10.1016/0375-9474\(73\)90705-7](https://doi.org/10.1016/0375-9474(73)90705-7).
- R. Ribberfors. Relationship of the relativistic Compton cross section to the momentum distribution of bound electron states. ii. effects of anisotropy and polarization. *Phys. Rev. B*, 12:3136–3141, Oct 1975. doi: 10.1103/PhysRevB.12.3136. URL <https://link.aps.org/doi/10.1103/PhysRevB.12.3136>.
- M.H. Richard, M. Chevallier, D. Dauvergne, N. Freud, P. Henriquet, F. Le Foulher, J.M. Létang, G. Montarou, C. Ray, F. Roellinghoff, E. Testa, M. Testa, and A.H. Walenta. Design study of a Compton camera for prompt γ imaging during ion beam therapy. In *2009 IEEE Nuclear Science Symposium Conference Record (NSS/MIC)*, pages 4172–4175, Oct 2009. doi: 10.1109/NSSMIC.2009.5402293.
- M.H. Richard, M. Chevallier, D. Dauvergne, N. Freud, P. Henriquet, F. Le Foulher, J.M. Letang, G. Montarou, C. Ray, F. Roellinghoff, E. Testa, M. Testa, and A.H. Walenta. Design Guidelines for a Double Scattering Compton Camera for Prompt- γ Imaging During Ion Beam Therapy: A Monte Carlo Simulation Study. *IEEE Transactions on Nuclear Science*, 58(1):87–94, 2011. ISSN 0018-9499. doi: 10.1109/TNS.2010.2076303.

- C. Richter, G. Pausch, S. Barczyk, M. Priegnitz, I. Keitz, J. Thiele, J. Smeets, F. Vander Stappen, L. Bombelli, C. Fiorini, L. Hotoiu, I. Perali, D. Prieels, W. Enghardt, and M. Baumann. First clinical application of a prompt gamma based *in vivo* proton range verification system. *Radiotherapy & Oncology*, 118(2):232–237, 2016. doi: 10.1016/j.radonc.2016.01.004. URL <http://dx.doi.org/10.1016/j.radonc.2016.01.004>.
- I. Rinaldi, S. Brons, O. Jäkel, A. Mairani, R. Panse, B. Voss, and K. Parodi. Investigations on novel imaging techniques for ion beam therapy: Carbon ion radiography and tomography. In *2011 IEEE Nuclear Science Symposium Conference Record*, pages 2805–2810, Oct 2011. doi: 10.1109/NSSMIC.2011.6153643.
- F. Roellinghoff, A. Benilov, D. Dauvergne, G. Dedes, N. Freud, G. Janssens, J. Krimmer, J.M. Létang, M. Pinto, D. Prieels, C. Ray, J. Smeets, F. Stichelbaut, and E. Testa. Real-time proton beam range monitoring by means of prompt-gamma detection with a collimated camera. *Physics in Medicine & Biology*, 59(5):1327, 2014. URL <http://stacks.iop.org/0031-9155/59/i=5/a=1327>.
- H. Rohling, M. Priegnitz, S. Schoene, A. Schumann, W. Enghardt, F. Hueso-González, G. Pausch, and F. Fiedler. Requirements for a Compton camera for *in vivo* range verification of proton therapy. *Physics in Medicine & Biology*, 62(7):2795, 2017. URL <http://stacks.iop.org/0031-9155/62/i=7/a=2795>.
- H.F.W. Sadrozinski. Applications of silicon detectors. *IEEE Transactions on Nuclear Science*, 48(4):933–940, Aug 2001. ISSN 0018-9499. doi: 10.1109/23.958703.
- G.O. Sawakuchi, U. Titt, D. Mirkovic, and R. Mohan. Density heterogeneities and the influence of multiple coulomb and nuclear scatterings on the bragg peak distal edge of proton therapy beams. *Physics in Medicine & Biology*, 53(17):4605, 2008. URL <http://stacks.iop.org/0031-9155/53/i=17/a=010>.
- B. Schaffner and E. Pedroni. The precision of proton range calculations in proton radiotherapy treatment planning: experimental verification of the relation between ct-hu and proton stopping power. *Physics in Medicine & Biology*, 43(6):1579, 1998. URL <http://stacks.iop.org/0031-9155/43/i=6/a=016>.
- J.M. Schippers and A.J. Lomax. Emerging technologies in proton therapy. *Acta Oncologica*, 50(6):838–850, 2011. doi: 10.3109/0284186X.2011.582513.
- M. Schippers. Proton beam production and dose delivery techniques. In I.J. Das and H. Paganetti, editors, *Principles and Practice of Proton Beam Therapy, AAPM Monograph 2015, Summer School*, chapter 6, pages 129–161. American Association on Physicists in Medicine AAPM, 2015. ISBN 978-3-540-00321-2. doi: 10.1007/3-540-29999-8.
- S. Schmid, G. Landry, C. Thieke, F. Verhaegen, U. Ganswindt, C. Belka, K. Parodi, and G. Dedes. Monte carlo study on the sensitivity of prompt gamma imaging to proton range variations due to inter-fractional changes in prostate cancer patients. *Physics in*

-
- Medicine & Biology*, 60(24):9329, 2015. URL <http://stacks.iop.org/0031-9155/60/i=24/a=9329>.
- R. Schulte, V. Bashkirov, Tianfang Li, Zhengrong Liang, K. Mueller, J. Heimann, L. R. Johnson, B. Keeney, H. F. W. Sadrozinski, A. Seiden, D. C. Williams, Lan Zhang, Zhang Li, S. Peggs, T. Satogata, and C. Woody. Conceptual design of a proton computed tomography system for applications in proton radiation therapy. *IEEE Transactions on Nuclear Science*, 51(3):866–872, June 2004. ISSN 0018-9499. doi: 10.1109/TNS.2004.829392.
- S.E Boggs and P. Jean. Event reconstruction in high resolution Compton telescopes. *Astron. Astrophys. Suppl. Ser.*, 145(2):311–321, 2000. doi: 10.1051/aas:2000107. URL <https://doi.org/10.1051/aas:2000107>.
- S.M. Seltzer and M.J. Berger. Procedure for calculating the radiation stopping power for electrons. *The International Journal of Applied Radiation and Isotopes*, 33(11):1219–1226, 1982. ISSN 0020-708X. doi: [https://doi.org/10.1016/0020-708X\(82\)90245-9](https://doi.org/10.1016/0020-708X(82)90245-9). URL <http://www.sciencedirect.com/science/article/pii/0020708X82902459>.
- G. Shakirin, H. Braess, F. Fiedler, D. Kunath, K. Laube, K. Parodi, M. Priegnitz, and W. Enghardt. Implementation and workflow for pet monitoring of therapeutic ion irradiation: a comparison of in-beam, in-room, and off-line techniques. *Physics in Medicine & Biology*, 56(5):1281, 2011. URL <http://stacks.iop.org/0031-9155/56/i=5/a=004>.
- J. Smeets, F. Roellinghoff, D. Prieels, F. Stichelbaut, A. Benilov, P. Busca, C. Fiorini, R. Peloso, M. Basilavecchia, T. Frizzi, J.C. Dehaes, and A. Dubus. Prompt gamma imaging with a slit camera for real-time range control in proton therapy. *Physics in Medicine & Biology*, 57(11):3371, 2012. URL <http://stacks.iop.org/0031-9155/57/i=11/a=3371>.
- P. Solevi, E. Muñoz, C. Solaz, M. Trovato, P. Dendooven, J.E. Gillam, C. Lacasta, J.F. Oliver, M. Rafecas, I. Torres-Espallardo, and G. Llosá. Performance of MACACO Compton telescope for ion-beam therapy monitoring: first test with proton beams. *Physics in Medicine & Biology*, 61(14):5149, 2016. URL <http://stacks.iop.org/0031-9155/61/i=14/a=5149>.
- H. Sorge, H. Stöker, and W. Greiner. Relativistic quantum molecular dynamics approach to nuclear collisions at ultrarelativistic energies. *Nuclear Physics A*, 498:567 – 576, 1989. ISSN 0375-9474. doi: [https://doi.org/10.1016/0375-9474\(89\)90641-6](https://doi.org/10.1016/0375-9474(89)90641-6).
- L. Sulak, T. Armstrong, H. Baranger, M. Bregman, M. Levi, D. Mael, J. Strait, T. Bowen, A.E. Pifer, P.A. Polakos, H. Bradner, A. Parvulescu, W.V. Jones, and J. Learned. Experimental studies of the acoustic signature of proton beams traversing fluid media. *Nuclear Instruments and Methods*, 161(2):203 – 217, 1979. ISSN 0029-554X. doi: [https://doi.org/10.1016/0029-554X\(79\)90386-0](https://doi.org/10.1016/0029-554X(79)90386-0). URL <http://www.sciencedirect.com/science/article/pii/0029554X79903860>.

- A. Takada, K. Hattori, H. Kubo, K. Miuchi, T. Nagayoshi, H. Nishimura, Y. Okada, R. Orito, H. Sekiya, A. Tada, and T. Tanimori. Development of an advanced Compton camera with gaseous TPC and scintillator. *Nuclear Instruments and Methods in Physics Research Section A: Accelerators, Spectrometers, Detectors and Associated Equipment*, 546(1):258 – 262, 2005. ISSN 0168-9002. doi: <https://doi.org/10.1016/j.nima.2005.03.050>. Proceedings of the 6th International Workshop on Radiation Imaging Detectors.
- S. Takeda, S. Ishikawa, H. Odaka, S. Watanabe, T. Takahashi, K. Nakazawa, H. Tajima, Y. Kuroda, M. Onishi, Y. Fukazawa, and H. Yasuda. A new si/cdte semiconductor Compton camera developed for high-angular resolution. In *Hard X-Ray and Gamma-Ray Detector Physics IX*, volume 6706, pages 6706 – 6706 – 11, 2007. doi: 10.1117/12.733840. URL <https://doi.org/10.1117/12.733840>.
- S. Takyu, S. Liprandi, F. Nishikido, A. Mohammadi, E. Yoshida, S. Aldawood, T. Binder, M. Mayerhofer, R. Lutter, I. Valencia-Lozano, G. Dedes, K. Kamada, K. Parodi, P. Thirolf, and T. Yamaya. Development of a Doi-based Compton camera for nuclear medicine application. In *Poster presented at the IEEE 2017 Nuclear Science Symposium and Medical Imaging Conference Atlanta, USA*, 2017.
- H. Tashima, E. Yoshida, N. Inadama, F. Nishikido, Y. Nakajima, H. Wakizaka, T. Shinaji, M. Nitta, S. Kinouchi, M. Suga, H. Haneishi, T. Inaniwa, and T. Yamaya. Development of a small single-ring OpenPET prototype with a novel transformable architecture. *Physics in Medicine & Biology*, 61(4):1795, 2016. URL <http://stacks.iop.org/0031-9155/61/i=4/a=1795>.
- M. Testa, CH. Min, J.M. Verburg, J. Schümann, H-M. Lu, and H. Paganetti. Range verification of passively scattered proton beams based on prompt gamma time patterns. *Physics in Medicine & Biology*, 59(15):4181, 2014. URL <http://stacks.iop.org/0031-9155/59/i=15/a=4181>.
- J. Thariat, JM Hannoun-Levi, A. Sun Myint, T. Vuong, and JP Gérard. Past, present, and future of radiotherapy for the benefit of patients. *Nature Reviews Clinical Oncology*, 10(1):52–60, 2012. doi: 10.1038/nrclinonc.2012.203. URL <http://www.nature.com/doifinder/10.1038/nrclinonc.2012.203>.
- L. Tian, G. Landry, G. Dedes, F. Kamp, M. Pinto, K. Niepel, C. Belka, and K. Parodi. Toward a new treatment planning approach accounting for in vivo proton range verification. *Physics in Medicine & Biology*, 63(21):215025, 2018. URL <http://stacks.iop.org/0031-9155/63/i=21/a=21502>.
- D.R. Tilley, H.R. Weller, and C.M. Cheves. Energy levels of light nuclei $A = 16-17$. *Nuclear Physics A*, 564:1–183, 1993. doi: 10.1016/0375-9474(93)90073-7.
- C.A. Tobias, J.H. Lawrence, J.L. Born, R.K. McCombs, J.E. Roberts, H.O. Anger, B.V.A. Low-Beer B.V.A., and C.B. Huggins. Pituitary Irradiation with High-Energy Proton

-
- Beams A Preliminary Report Pituitary Irradiation with High-Energy Proton Beams A Preliminary Report. *Cancer Research*, 18(2):121–134, 1958.
- R.W. Todd, J.M. Nightingale, and D.B. Everett. A proposed γ camera. *Nature*, 251:132, 09 1974. URL <http://dx.doi.org/10.1038/251132a0>.
- J.M. Verburg. *Reducing Range Uncertainty in Proton Therapy*. PhD dissertation, Technische Universiteit Eindhoven, 2015. URL https://gray.mgh.harvard.edu/images/documents/PhDThesis_JMVerburg_Web_20150912.pdf.
- J.M. Verburg and J. Seco. Proton range verification through prompt gamma-ray spectroscopy. *Physics in Medicine & Biology*, 59(23):7089, 2014. URL <http://stacks.iop.org/0031-9155/59/i=23/a=7089>.
- J.M. Verburg, H.A. Shih, and J. Seco. Simulation of prompt gamma-ray emission during proton radiotherapy. *Physics in Medicine & Biology*, 57(17):5459, 2012. URL <http://stacks.iop.org/0031-9155/57/i=17/a=5459>.
- J.M. Verburg, K. Riley, T. Bortfeld, and J. Seco. Energy- and time-resolved detection of prompt gamma-rays for proton range verification. *Physics in Medicine & Biology*, 58(20):L37, 2013. URL <http://stacks.iop.org/0031-9155/58/i=20/a=L37>.
- U. Weber and G. Kraft. Comparison of carbon ions versus protons. *Cancer Journal*, 15(4):325–332, 2009. ISSN 15289117. doi: 10.1097/PPO.0b013e3181b01935.
- V. Weisskopf. Statistics and nuclear reactions. *Phys. Rev.*, 52:295–303, Aug 1937. doi: 10.1103/PhysRev.52.295.
- S.J. Wilderman, N.H. Clinthorne, J.A. Fessler, and W.L. Rogers. List-mode maximum likelihood reconstruction of Compton scatter camera images in nuclear medicine. In *1998 IEEE Nuclear Science Symposium Conference Record. 1998 IEEE Nuclear Science Symposium and Medical Imaging Conference (Cat. No.98CH36255)*, volume 3, pages 1716–1720 vol.3, 1998.
- R.R. Wilson. Radiological use of fast protons. *Radiology*, 47(5):487–491, 1946. doi: 10.1148/47.5.487. URL <https://doi.org/10.1148/47.5.487>. PMID: 20274616.
- Y. Xie, E.H. Bentefour, G. Janssens, J. Smeets, F. Vander Stappen, L. Hotoiu, L. Yin, D. Dolney, S. Avery, F. O’Grady, D. Prieels, J. McDonough, T.D. Solberg, R.A. Lustig, A. Lin, and B-K. Teo. Prompt Gamma Imaging for In Vivo Range Verification of Pencil Beam Scanning Proton Therapy. *International Journal of Radiation Oncology*Biophysics*Physics*, 99(1):210 – 218, 2017. ISSN 0360-3016. URL <https://doi.org/10.1016/j.ijrobp.2017.04.027>.
- E. Yoshida, H. Tashima, T. Shinaji, K. Shimizu, H. Wakizaka, A. Mohammadi, F. Nishikido, and T. Yamaya. Development of a Whole-Body Dual Ring OpenPET

- for in-Beam PET. *IEEE Transactions on Radiation and Plasma Medical Sciences*, 1(4): 293–300, July 2017. ISSN 2469-7311.
- F. Zhang, Z. He, and C.E. Seifert. A prototype three-dimensional position sensitive cdznte detector array. *IEEE Transactions on Nuclear Science*, 54(4):843–848, Aug 2007. ISSN 0018-9499.
- X. Zhu and G. El Fakhri. Proton therapy verification with PET imaging. *Theranostics*, 3(10):731–740, 2013. ISSN 18387640. doi: 10.7150/thno.5162.
- X. Zhu, S. España, J. Daartz, N. Liebsch, J. Ouyang, H. Paganetti, T.R. Bortfeld, and G. El Fakhri. Monitoring proton radiation therapy with in-room pet imaging. *Physics in Medicine & Biology*, 56(13):4041, 2011. URL <http://stacks.iop.org/0031-9155/56/i=13/a=019>.
- J.F. Ziegler, U. Littmark, and J.P. Biersack. *The stopping and range of ions in solids*. Pergamon New York, 1985. ISBN 008021603.
- A. Zoglauer and G. Kanbach. Doppler broadening as a lower limit to the angular resolution of next-generation Compton telescopes. In *X-Ray and Gamma-Ray Telescopes and Instruments for Astronomy*, volume 4851, pages 4851 – 4851 – 8, 2003. doi: 10.1117/12.461177. URL <https://doi.org/10.1117/12.461177>.
- A. Zoglauer, R. Andritschke, and F. Schopper. Megalib—the medium energy gamma-ray astronomy library. *New Astronomy Reviews*, 50(7):629 – 632, 2006. ISSN 1387-6473. doi: <https://doi.org/10.1016/j.newar.2006.06.049>. URL <http://www.sciencedirect.com/science/article/pii/S1387647306000972>. Astronomy with Radioactivities. V.
- A. Zoglauer, R. Andritschke, S.E. Boggs, F. Schopper, G. Weidenspointner, and C.B. Wunderer. Megalib: simulation and data analysis for low-to-medium-energy gamma-ray telescopes. In *Space Telescopes and Instrumentation 2008: Ultraviolet to Gamma Ray*, volume 7011, pages 7011 – 7011 – 10, 2008. doi: 10.1117/12.789537. URL <https://doi.org/10.1117/12.789537>.
- A.C. Zoglauer. *First light for the next generation of Compton and pair telescopes*. PhD dissertation, Technische Universität München, Garching: Max-Planck-Institut für Extraterrestrische Physik, 2006, MPE Report, No. 289, 2005. URL http://megalibtoolkit.com/documents/Zoglauer_PhD.pdf.