

8-2020

A Visible Light Communications Framework for Intelligent Transportation Systems

Hovannes Kulhandjian
California State University, Fresno

Follow this and additional works at: https://scholarworks.sjsu.edu/mti_publications



Part of the [Public Policy Commons](#), and the [Transportation Commons](#)

Recommended Citation

Hovannes Kulhandjian. "A Visible Light Communications Framework for Intelligent Transportation Systems" *Mineta Transportation Institute Publications* (2020). doi:<https://doi.org/10.31979/mti.2020.1911>

This Report is brought to you for free and open access by SJSU ScholarWorks. It has been accepted for inclusion in Mineta Transportation Institute Publications by an authorized administrator of SJSU ScholarWorks. For more information, please contact scholarworks@sjsu.edu.

A Visible Light Communications Framework for Intelligent Transportation Systems

Hovannes Kulhandjian, PhD

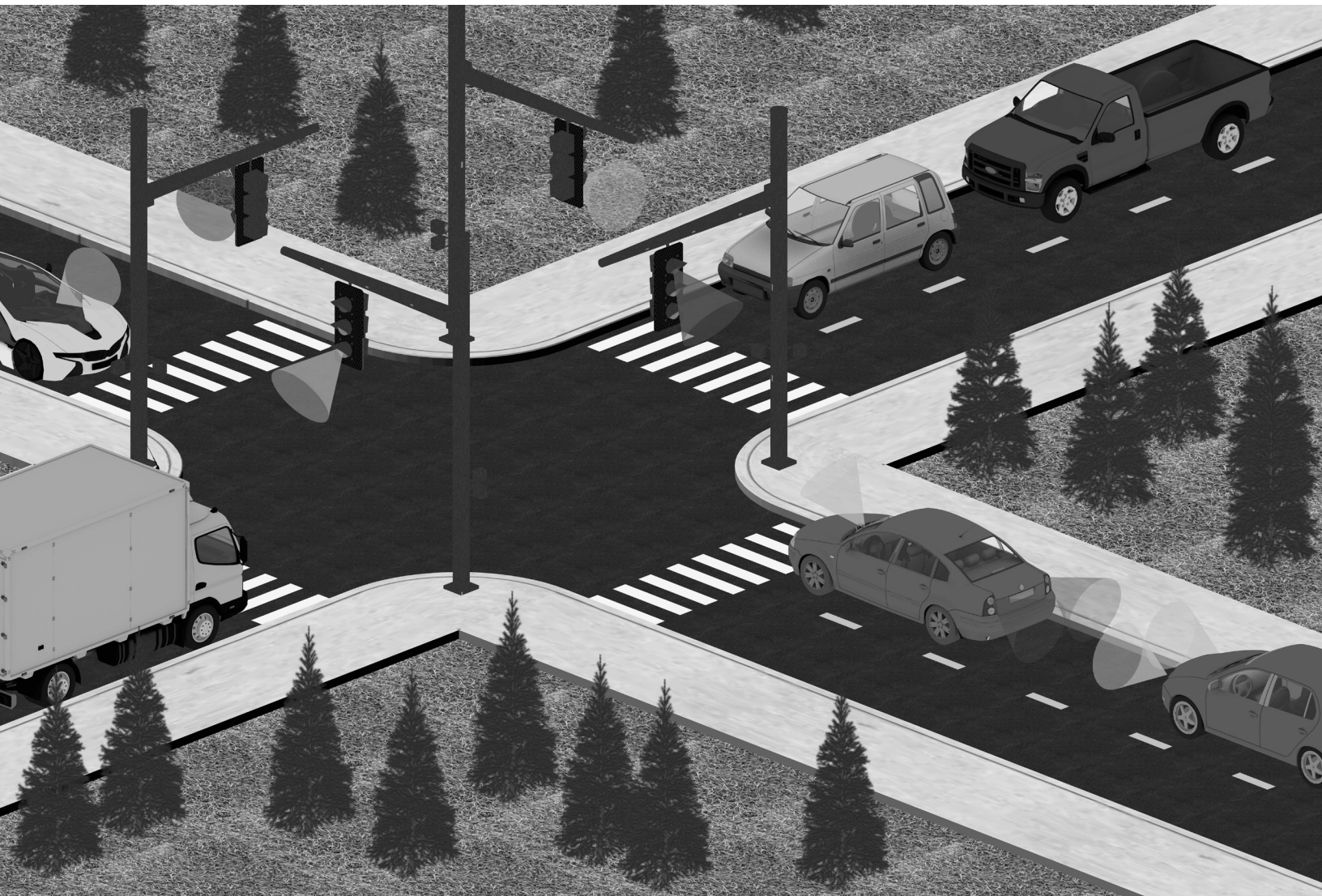

MINETA TRANSPORTATION INSTITUTE

Founded in 1991, the Mineta Transportation Institute (MTI), an organized research and training unit in partnership with the Lucas College and Graduate School of Business at San José State University (SJSU), increases mobility for all by improving the safety, efficiency, accessibility, and convenience of our nation's transportation system. Through research, education, workforce development, and technology transfer, we help create a connected world. MTI leads the four-university, MTI leads the four-university California State University Transportation Consortium funded by the State of California through Senate Bill 1.

MTI's transportation policy work is centered on three primary responsibilities:

Research

MTI works to provide policy-oriented research for all levels of government and the private sector to foster the development of optimum surface transportation systems. Research areas include: bicycle and pedestrian issues; financing public and private sector transportation improvements; intermodal connectivity and integration; safety and security of transportation systems; sustainability of transportation systems; transportation / land use / environment; and transportation planning and policy development. Certified Research Associates conduct the research. Certification requires an advanced degree, generally a Ph.D., a record of academic publications, and professional references. Research projects culminate in a peer-reviewed publication, available on TransWeb, the MTI website (<http://transweb.sjsu.edu>).

Education

The Institute supports education programs for students seeking a career in the development and operation of surface transportation systems. MTI, through San José State University, offers an AACSB-accredited Master of Science in Transportation Management and graduate certificates in Transportation Management, Transportation Security, and High-Speed Rail Management that serve to prepare the nation's transportation managers for the 21st century. With the

active assistance of the California Department of Transportation (Caltrans), MTI delivers its classes over a state-of-the-art videoconference network throughout the state of California and via webcasting beyond, allowing working transportation professionals to pursue an advanced degree regardless of their location. To meet the needs of employers seeking a diverse workforce, MTI's education program promotes enrollment to under-represented groups.

Information and Technology Transfer

MTI utilizes a diverse array of dissemination methods and media to ensure research results reach those responsible for managing change. These methods include publication, seminars, workshops, websites, social media, webinars, and other technology transfer mechanisms. Additionally, MTI promotes the availability of completed research to professional organizations and journals and works to integrate the research findings into the graduate education program. MTI's extensive collection of transportation-related publications is integrated into San José State University's world-class Martin Luther King, Jr. Library.

Disclaimer

The contents of this report reflect the views of the authors, who are responsible for the facts and accuracy of the information presented herein. This document is disseminated in the interest of information exchange. The report is funded, partially or entirely, by a grant from the State of California. This report does not necessarily reflect the official views or policies of the State of California or the Mineta Transportation Institute, who assume no liability for the contents or use thereof. This report does not constitute a standard specification, design standard, or regulation.

REPORT 20-38

A VISIBLE LIGHT COMMUNICATIONS FRAMEWORK FOR INTELLIGENT TRANSPORTATION SYSTEMS

Hovannes Kulhandjian, PhD

August 2020

A publication of

Mineta Transportation Institute

Created by Congress in 1991

College of Business
San José State University
San José, CA 95192-0219

TECHNICAL REPORT DOCUMENTATION PAGE

1. Report No. 20-38	2. Government Accession No.	3. Recipient's Catalog No.	
4. Title and Subtitle A Visible Light Communications Framework for Intelligent Transportation Systems		5. Report Date August 2020	
		6. Performing Organization Code	
7. Authors Hovannes Kulhandjian, PhD http://orcid.org/0000-0002-8983-6757		8. Performing Organization Report CA-MTI-1911	
9. Performing Organization Name and Address Mineta Transportation Institute College of Business San José State University San José, CA 95192-0219		10. Work Unit No.	
		11. Contract or Grant No. ZSB12017-SJAUX	
12. Sponsoring Agency Name and Address State of California SB1 2017/2018 Trustees of the California State University Sponsored Programs Administration 401 Golden Shore, 5th Floor Long Beach, CA 90802		13. Type of Report and Period Covered Final Report	
		14. Sponsoring Agency Code	
15. Supplemental Notes DOI: 10.31979/mti.2020.1911			
16. Abstract <p>In this work, we developed a visible light communication (VLC) framework that can be used for Intelligent Transportation Systems (ITS). ITS has been motivated by the need for reducing traffic congestion and offering better user experience in navigation and location-specific services. Recently, VLC has drawn a great deal of attention in the research community, including the development of new applications for ITS. It would be of great use to enable the traffic lights to be able to talk to the vehicles in their proximity and convey important information about the traffic condition. In this project, we developed a framework that can potentially support infrastructure-to-vehicle (I2V) and vehicle-to-infrastructure (V2I) communication. (In our context the infrastructure refers to traffic lights using VLC.) Specifically, traffic lights will be used to not only to order traffic flow, but also to share some important information to the cars. The developed smart traffic light system can provide information about the traffic conditions several blocks down the road and, in case of accidents, this information would be useful for the driver to detour their original route to help reduce congestion and save time. In order to do that we have developed a transmitter circuitry that is composed of an embedded system and optical electronics. In addition, we have developed the receiver circuitry in which the photodiode along with other circuitry is used for detecting and decoding the VLC signal coming from the traffic lights. We have also developed and experimented in a laboratory with a novel optical code-division multiple-access (CDMA) scheme for overloaded optical CDMA transmission in which the optical codes are uniquely decodable. This new coding system could potentially provide higher data rate in the VLC protocol establishment.</p>			
17. Key Words Intelligent transportation systems (ITS), traffic signal control systems, traffic lights USE, traffic signal networks	18. Distribution Statement No restrictions. This document is available to the public through The National Technical Information Service, Springfield, VA 22161		
19. Security Classif. (of this report) Unclassified	20. Security Classif. (of this page) Unclassified	21. No. of Pages 25	22. Price

Copyright © 2020
by **Mineta Transportation Institute**
All rights reserved

DOI: 10.31979/mti.2020.1911

Mineta Transportation Institute
College of Business
San José State University
San José, CA 95192-0219

Tel: (408) 924-7560
Fax: (408) 924-7565
Email: mineta-institute@sjsu.edu

transweb.sjsu.edu

ACKNOWLEDGMENTS

This study was supported by both the CSU Transportation Consortium and the Fresno State Transportation Institute. Any opinions, findings, conclusions, and recommendations expressed in this material are those of the author and do not necessarily reflect the views of these institutes. The author would like to thank his student assistants, Wyatt Greives undergraduate student and Rojin Zandi, graduate student in the Electrical and Computer Engineering (ECE) department at California State University, Fresno for working on this interesting research project and implementing and testing the final proposed prototype. The author would also like to thank Editing Press, for editorial services, as well as MTI staff, including Executive Director Karen Philbrick, PhD; Deputy Executive Director Hilary Nixon, PhD; Graphic Designer Alverina Eka Weinardy; and Executive Administrative Assistant Jill Carter.

TABLE OF CONTENTS

Executive Summary	1
I. Introduction	2
II. Overloaded Optical Code-Division Multiple-Access Modulation for VLC	6
III. LED Driver Circuit for Transmitter	7
IV. Photodiode Receiver Circuit	8
V. Simulation Results	12
VI. Hardware Implementation	14
VII. Conclusion	21
Abbreviations and Acronyms	22
Bibliography	23
About the Author	24
Peer Review	25

LIST OF FIGURES

1. Intelligent Transportation System Using VLC Framework	3
2. Block Diagram of VLC System	4
3. LED Driver Circuit	7
4. Photodiode Receiver Circuit	8
5. BPX61 Photodiode Relative Spectral Sensitivity as a Function of Wavelength	9
6. BPX61 Photodiode Junction Capacitance as a Function of Reverse Bias Voltage	10
7. BPX61 Photodiode Photocurrent and Open-circuit Voltage as a Function of Luminosity	10
8. UD Code Set C with $L = 4$ and $K = 5$	12
9. UD Code Set C with $L = 8$ and $K = 13$	12
10. UD Code Set C4x5	13
11. UD Code Set C8x13	13
12. Raspberry Pi 3 Model B+	14
13. ThorLabs PDA 100A2	14
14. BPX61 Photodiode	14
15. High-power Red LED	15
16. OPA2810 Operational Amplifier	15
17. Red Green Traffic Light Signal Display	15
18. Arduino Uno R3 Board	16
19. Transmitter Circuit Design on Breadboard	16
20. High-power Red LED with Heat Sink and Focusing Lens	17
21. Receiver Circuit Design on Breadboard	17
22. Transmitter and Receiver Circuitry Experimentation	18

23. Transmitter and Receiver Voltage Analysis on the Oscilloscope	18
24. Transmitter and Receiver Voltage Captured On the Oscilloscope: A) Transmitted Information Bits Are Displayed on Top in Yellow, B) Received Information Bits Are Displayed at the Bottom In Cyan	19
25. A Screenshot of the Transmitted Message	19
26. A Screenshot of the Received Message	20

LIST OF TABLES

- | | |
|---|----|
| 1. Resistor Component Values for LED Driver Circuit | 7 |
| 2. Component Values for Receiver Circuit | 11 |

EXECUTIVE SUMMARY

In this research work, the author develop a visible light communication (VLC) framework that can be used for intelligent transportation systems (ITSs). ITS has been motivated by the need to reduce traffic congestion and offer better user experience in navigation and location-specific services. Recently, VLC has drawn a lot of attention by the research community in the areas of high data rate transmission, secure communications, and indoor localization systems as well in ITS. The use of VLC in ITS could lead to potential new useful applications. Traffic lights have been used to control traffic flow and are often located at a particular place, and they are rarely moved. It would be of great use to enable the traffic lights to be able to talk to the vehicles in their proximity and convey important information about the traffic conditions. In this project, the aim is to develop a framework that can support infrastructure-to-vehicle (I2V) and vehicle-to-infrastructure (V2I) communication: in this context the infrastructure refers to traffic lights using VLC. Specifically, traffic lights are used to not only to orderly provide traffic flow, but also to share some important information to the cars. The developed smart traffic light can provide information about the traffic conditions several blocks down the road, and in case of accidents this information would be useful for the passenger to take a detour from their original driving route to help reduce congestion and save time. The infrastructure of the ITS is composed of a central station that controls the traffic flow and when new information is provided to the traffic lights they are routed to the central station for analysis and to provide smarter traffic control. The focus is on the development of VLC infrastructure to establish communications between the traffic lights and vehicles for better traffic management.

To begin with, the researchers establish a visible light communication link between a traffic light and a vehicle which is capable of receiving the information. To do that, the research team first develops transmitter circuitry that is composed of an embedded system and optical electronics fast-switching network. The traffic lights not only will be performing its functionalities i.e., providing traffic light signals to pedestrians, drivers, but also sending out pertinent coded information to the vehicles through light pulses. After presenting the transmitter side circuitry, the authors will then present the receiver circuitry that is composed of optical electronics circuitry in which the photodiode along with other circuitry is used for detecting and decoding the VLC signal coming from the traffic lights. The received signal is passed through an analog-to-digital (ADC) interface before sending them to the embedded system to receive and decode the transmitted signals. The authors have also developed and experimented a novel optical code-division multiple-access (CDMA) scheme for overloaded optical CDMA transmission in which the optical codes will be uniquely decoded. This new coding system could potentially provide higher data rates and can support larger numbers of users in the visible light communication protocol establishment. After developing the system, the researchers conducted actual experimentation using a traffic light model/prototype and experimented with the VLC framework to test its functionality and have been working on improving its performance.

I. INTRODUCTION

In this research work, the researchers develop a visible light communication (VLC) framework that can be used for intelligent transportation systems (ITSs). The development of ITS has been motivated by the need to reduce traffic congestion and offer better user experience in navigation and location-specific services. Recently, VLC has drawn a lot of attention from the research community in the areas of high data rate transmission, secure communications, and indoor localization systems as well in ITS. The use of VLC in ITS will lead to potential new and useful applications.

Traffic lights have been used to control traffic flow, are often located at a particular place, and are rarely moved. It would be of great use to enable the traffic lights to talk to the vehicles in their proximity and convey important information about the traffic conditions. In this project, the aim is to develop a framework that can potentially support infrastructure-to-vehicle (I2V) and vehicle-to-infrastructure (V2I) communication; in the present context the infrastructure refers to traffic lights using VLC. Specifically, traffic lights are used not only to provide orderly traffic flow, but also to share some important information with the cars. The traffic light can provide information about the traffic conditions several blocks down the road, and in case of accidents this information would be useful to enable the passenger to divert from their original driving route to help reduce congestion and save time. The infrastructure of the ITS is composed of a central station that controls the traffic flow, and when new information is provided to the traffic lights it is first routed to the central station to undergo analysis to make sure it is a legitimate information and in addition to that provide smarter traffic control. The focus in this work is on the development of VLC infrastructure to establish communications between the traffic lights and vehicles for better traffic management.

To begin with, the researchers establish a visible light communication link between traffic lights and a vehicle which is capable of receiving the information. To do that, the researchers first develop transmitter circuitry that is composed of an embedded system and an optical electronics fast-switching network. The traffic lights will not only be performing their standard functionalities, i.e., providing traffic light signals to pedestrians and drivers, but they will also be sending out pertinent coded information to the vehicles through light pulses. After presenting the transmitter circuitry, this report will then present the receiver circuitry that is composed of optical electronics circuitry in which the photodiode along with other circuit components is used for detecting and decoding the VLC signal coming from the traffic lights. The received signal is passed through an analog-to-digital converter (ADC) before being sent to the embedded system to receive and decode the transmitted signals. The researchers also developed and tested a novel optical code-division multiple-access (CDMA) scheme for overloaded optical CDMA transmission in which the optical codes will be uniquely decoded. This new coding system could potentially provide a higher data rate and can support larger numbers of users in the visible light communication protocol establishment. After developing the system, the authors conducted actual experimentation using a traffic light model/prototype and experimented with the VLC framework to test its functionality and improve its performance.

A demonstration of the ITS traffic light controller using the VLC framework is shown in Fig. 1. As shown, the traffic lights can transmit digital pulse coded information to the vehicles for navigation or to convey important information.

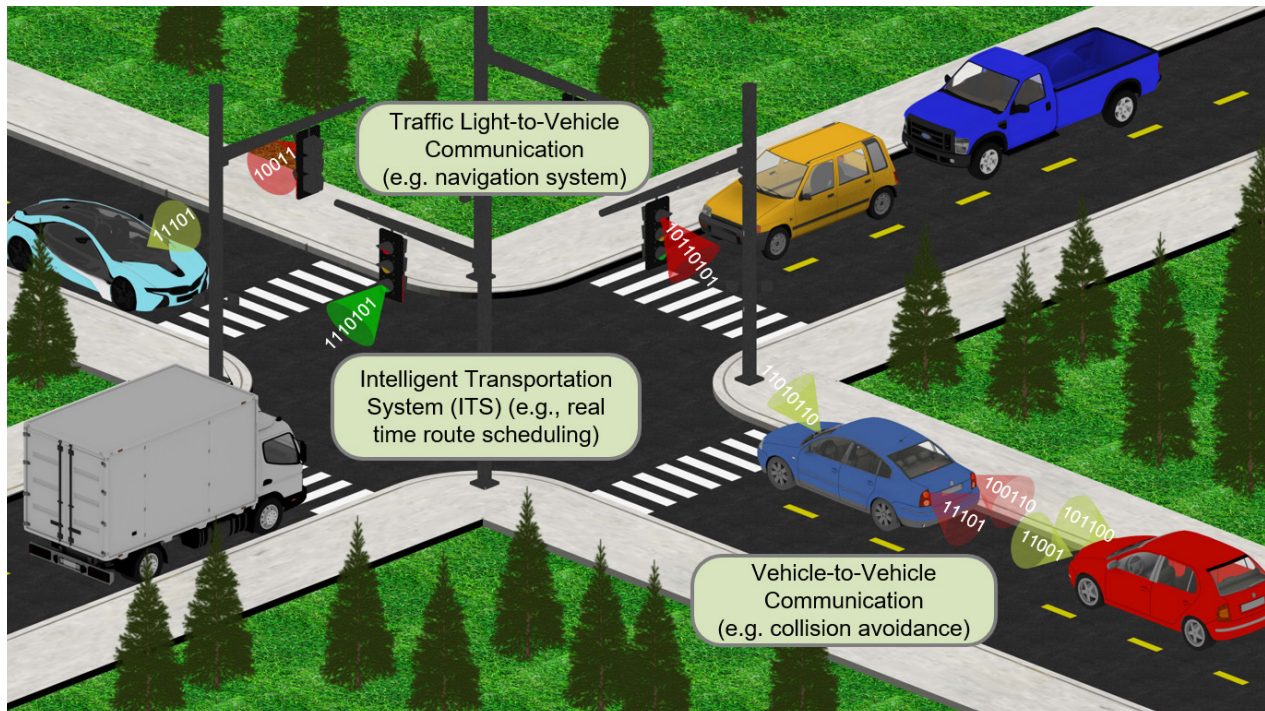

Figure 1. Intelligent Transportation System Using VLC Framework

In this project, a transmitter and receiver circuitry is developed that communicates pertinent information using modulated light pulses. It is meant to improve upon the existing infrastructure of LEDs by adapting their driver circuitry for high-speed VLC. The project also serves to test the capabilities of photodiodes as viable receiver devices used in the developed VLC network. The main component of the project is a transmitter/receiver pair design that can send and receive modulated light data. The transmitter system is designed for high-frequency operation in order to modulate the data at optimal rates. The system's microcontroller outputs a modulated bit stream to an amplifier, whose output drives the base of a transistor controlling the current flow to a high-power red LED. The binary data are encoded into the pulses of light through the quickly switching behavior of the transistor. On-Off-Keying (OOK) modulation is used for data transmission, which is simply switching on and off the LED light, i.e., the traffic light, at a very high rate. To transmit the digital information, a binary "1" information bit is represented by a square pulse and is generated by turning the LED on, while the binary "0" is generated by turning the LED off, i.e., no light transmission. The modulated light is projected into the medium where it can be detected by the receiver system's optical sensor. The optical sensor is composed of a photodiode, which converts the modulated light data sent from the transmitter into a current. This current is converted into a voltage using a transimpedance amplifier (TIA), and the output voltage is then filtered and amplified using a band-pass filter and inverting amplifier. The voltage is sampled by the ADC connected to the receiver system's microcontroller, where the received signal can be processed and decoded.

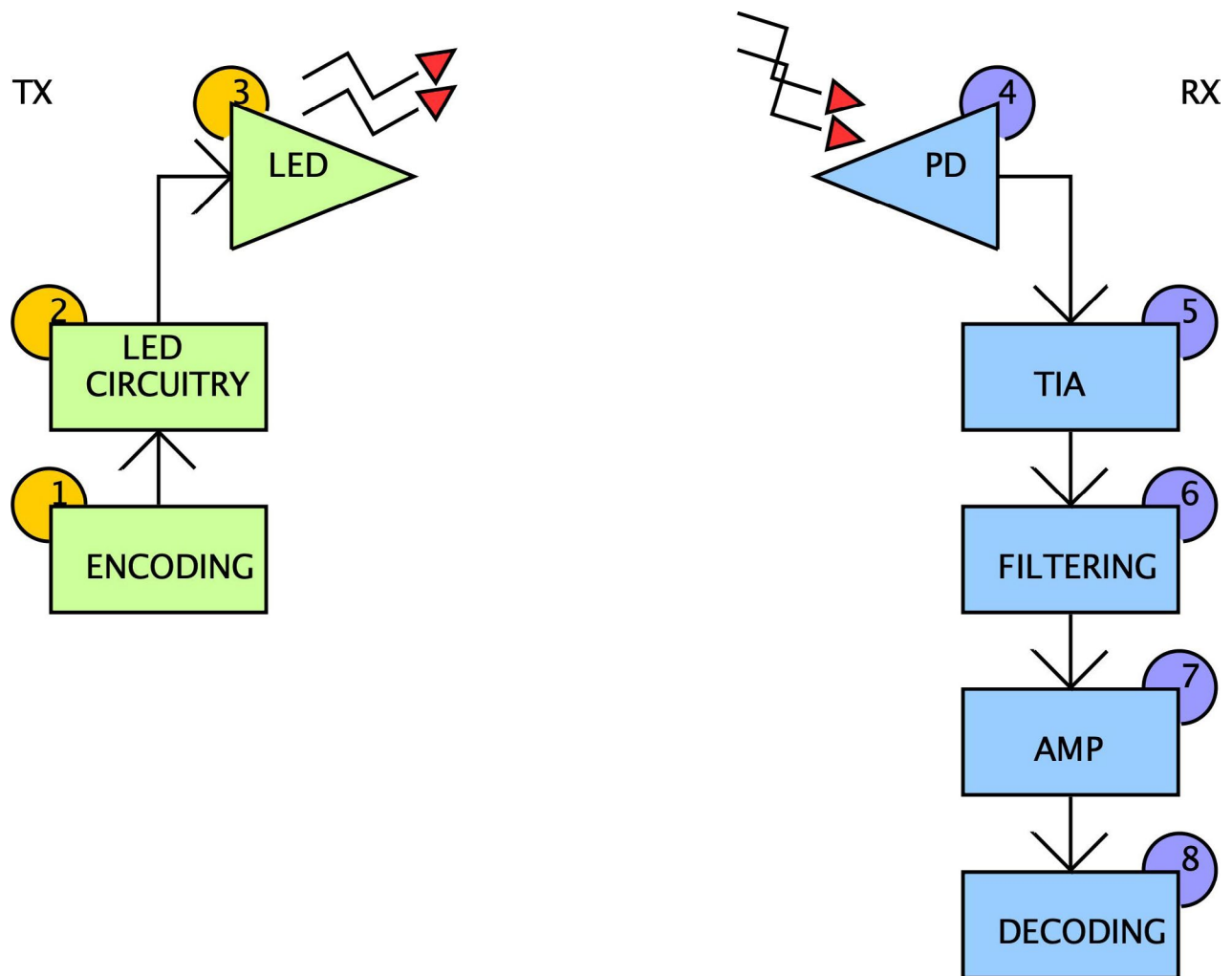

Figure 2. Block Diagram of VLC System

Figure 2 shows an overview of how the complete system operates. All of the main components are indicated by numbers and are described below.

1. The encoding is performed by the Raspberry Pi board scripted in Python. The general-purpose input/output (GPIO) ports on the Pi board are output to the encoded data.
2. The light-emitting diode (LED) circuitry consists of amplifiers and transistors to drive the LED with the proper amount of current.
3. The high-power LED is used to convert the modulated data into light pulses that is projected through the physical medium.
4. The photodiode collects the incident light pulses sent from the transmitter and converts the information to a current signal.
5. The current is converted into a voltage utilizing the TIA, which is optimized for fast response.

6. The voltage signal from the TIA is filtered using a combination of a high-pass and a low-pass filter.
7. The signal is amplified for increased reception reliability.
8. The signal is sampled by an ADC and decoded using the Raspberry Pi board.

II. OVERLOADED OPTICAL CODE-DIVISION MULTIPLE-ACCESS MODULATION FOR VLC

The authors have recently developed a fast decoder algorithm for uniquely decodable (errorless) code sets for overloaded synchronous optical code-division multiple-access (O-CDMA) system in Kulhandjian et al. (2019), which is then utilized to improve the proposed VLC system developed for ITS. The proposed decoder is designed in such a way that the users can uniquely recover the information bits with a very simple decoder, which uses only a few comparisons. Compared to maximum-likelihood (ML) decoder, which has a high computational complexity for even moderate code lengths, the proposed decoder has much lower computational complexity. Simulation results in terms of bit error rate (BER) demonstrate that the performance of the proposed decoder for a given BER requires only a 1–2 dB higher signal-to-noise ratio (SNR) than the ML decoder. The Fast Decoder Algorithm (FDA) is presented below. The details of the algorithm can be found in Kulhandjian et al.

Fast Decoder Algorithm (FDA)

Input: y

- 1: $z_1 \leftarrow Q(y_1, 0, K)$
- 2: **if** $|z_1| = K$, $\hat{x} \leftarrow \mathbf{1}_K$
- 3: **else**
- 4: $\mathbf{m} \leftarrow -\mathbf{1}_K$, $r_c \leftarrow 1$, $n \leftarrow z_1$
- 5: $m_{LR}(r_c, 3) \leftarrow n$
- 6: $dP(r_c) \leftarrow [n, K, m_{LR}(r_c, 1), m_{LR}(r_c, 2), mP(r_c)]$
- 7: $\mathbf{c}_{AL} \leftarrow \mathbf{0}$, $\mathbf{z} \leftarrow \mathbf{0}$, $s_I \leftarrow 1$, $c_T \leftarrow 1$
- 8: **while** ($s_I = 1$ AND $c_T < N_c$)
- 9: $s_I \leftarrow 0$
- 10: **while** ($r_c < L$, $r_c \leftarrow r_c + 1$)
- 11: $[dP(r_c), m] \leftarrow m_eP(dP(r_c - 1), \mathbf{m}, n, K, r_c, m_{LR}, mP)$
- 12: $A_{min} \leftarrow \min T(dP(r_c))$, $A_{max} \leftarrow \max T(dP(r_c))$
- 13: $\mathbf{z}(r_c) \leftarrow Q(y', A_{min}, A_{max}, 1)$
- 14: $\mathbf{c}_{AL}(r_c, 2) \leftarrow (A_{min} - A_{max}) + 1$
- 15: $m_{LR}(r_c, 3) \leftarrow \mathbf{z}(r_c)$
- 16: $m_{LR}(r_c, 4) \leftarrow n - m_{LR}(r_c, 3)$
- 17: $\mathbf{m} \leftarrow uM(\mathbf{m}, m_{LR}, r_c, mP)$
- 18: $\mathbf{m} \leftarrow f_c(\mathbf{m}, m_{LR})$, $\mathbf{t}_D \leftarrow \mathbf{z} - \mathbf{Cm}$
- 19: **if** $\mathbf{t}_D \notin \mathbf{0}$, $s_I \leftarrow 1$, $r_c \leftarrow i_d$
- 20: $\mathbf{c}_{AL}(r_c + 1, 1) \leftarrow \mathbf{c}_{AL}(r_c + 1, 1) + 1$
- 21: $c_T \leftarrow c_T + 1$
- 22: $\hat{x} \leftarrow \mathbf{m}$

Output: \hat{x}

The researchers evaluated the performance of the proposed antipodal UD code sequences generated in the simulation results section.

III. LED DRIVER CIRCUIT FOR TRANSMITTER

Traffic lights are composed of high-power LEDs that require driver circuitry capable of supplying enough current to the LED. Figure 3 below shows the driver circuit designed for simulation purposes using National Instruments (NI) Multisim software package.

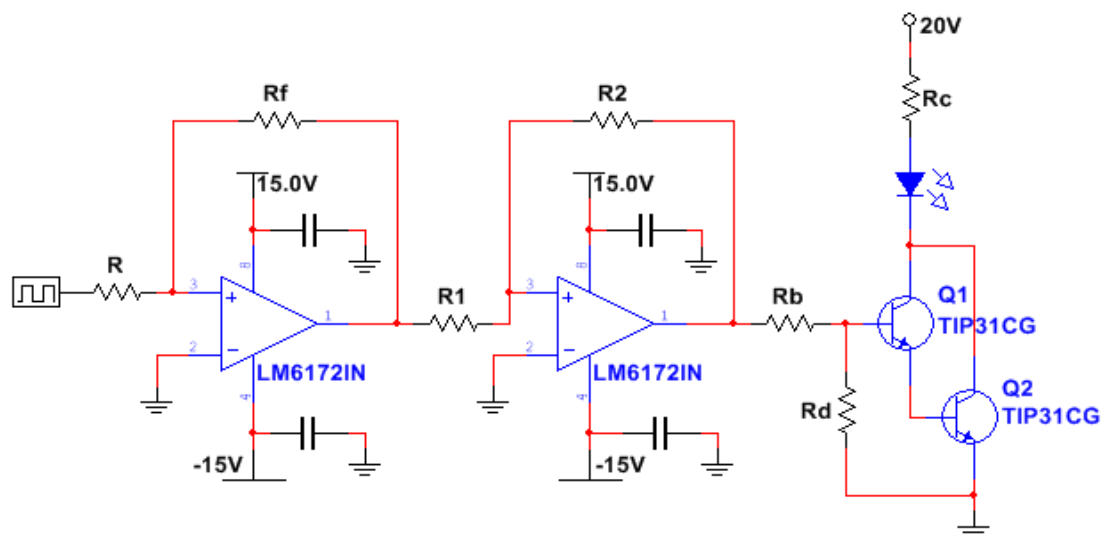

Figure 3. LED Driver Circuit

The encoded binary information is applied as a voltage signal to the input of an operational amplifier (op-amp) in an inverting amplifier configuration. Resistors R and R_f are used to amplify the voltage signal, where $V_o = -V_{in} * R_f / R$. The output voltage from the first amplifier is returned to a positive voltage using another inverting amplifier configuration with R_1 and R_2 having the same resistance value of 1 k Ω .

The amplified voltage output from the op-amp is used to drive a transistor switch. Two BJTs are used in a Darlington pair configuration for heat dissipation and high current gain. R_b and R_d are used to set the base current, with R_d also serving as a sink for the turn-off period. R_c is used as a current-limiting resistor for the LED. Table 1 below shows the resistor component values used for the LED driver circuit.

Table 1. Resistor Component Values for LED Driver Circuit

R (k Ω)	R_f (k Ω)	R_1 (k Ω)	R_2 (k Ω)	R_b (k Ω)	R_d (k Ω)	R_c (Ω)
1	3.3	1	1	10	17	330

The capacitors on the op-amp power supplies are used to prevent oscillations from the power supplies by shunting AC components to ground. All capacitors are 0.01 μ F.

IV. PHOTODIODE RECEIVER CIRCUIT

There are two main ways to receive a visible light signal: an image sensor or a photodiode. A photodiode is used for this design to improve the response time. A photodiode is a type of semiconductor device that converts absorbed photons of light into current. Figure 4 shows the receiver design used for the simulation.

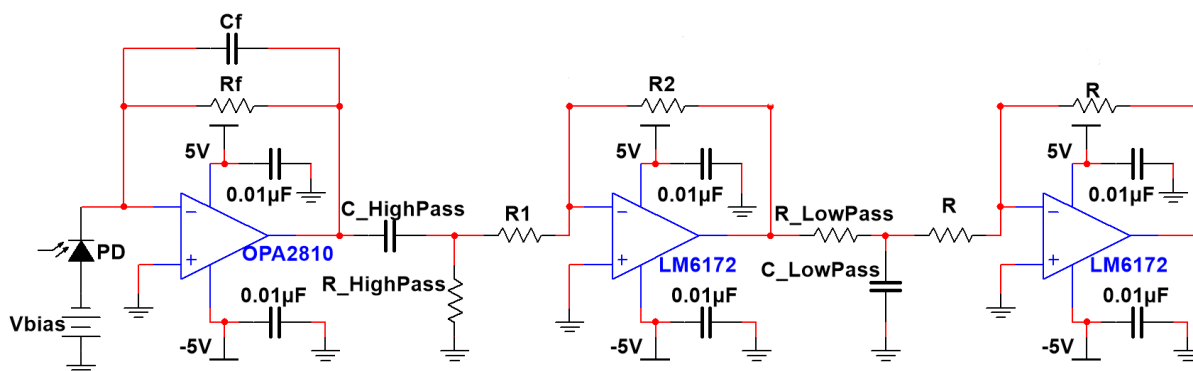

Figure 4. Photodiode Receiver Circuit

As can be seen in Fig. 4 (left side), the photodiode receives the encoded light signal sent through line-of-sight (LOS) and converts the pulses of light into a current waveform. The photodiode is operated in reverse bias with V_{bias} being used to decrease the junction capacitance, thereby increasing the responsiveness and decreasing the rise time. The current is converted into a voltage using a TIA configuration. The feedback capacitor (C_f) offsets the effects of the photodiode's junction capacitance. The current generated by the photodiode runs through the feedback resistor (R_f) and generates a voltage at the output.

The TIA maximum output voltage is set by the maximum generated photodiode current and the R_f . The relative spectral sensitivity of the BPX61 photodiode used in the system is shown below in Fig. 5. Due to red light being approximately 70% of the peak spectral sensitivity for the BPX61, the maximum photodiode current is $49\mu\text{A}$. The equation for determining the value of the feedback resistor in the transimpedance amplifier circuit for a maximum output voltage of 1V is shown below.

$$R_f = \frac{V_{out,max} - V_{out,min}}{I_{PD,max}} = \frac{1V - 0V}{49\mu A} = 20.4k\Omega \approx 20k\Omega$$

Relative Spectral Sensitivity

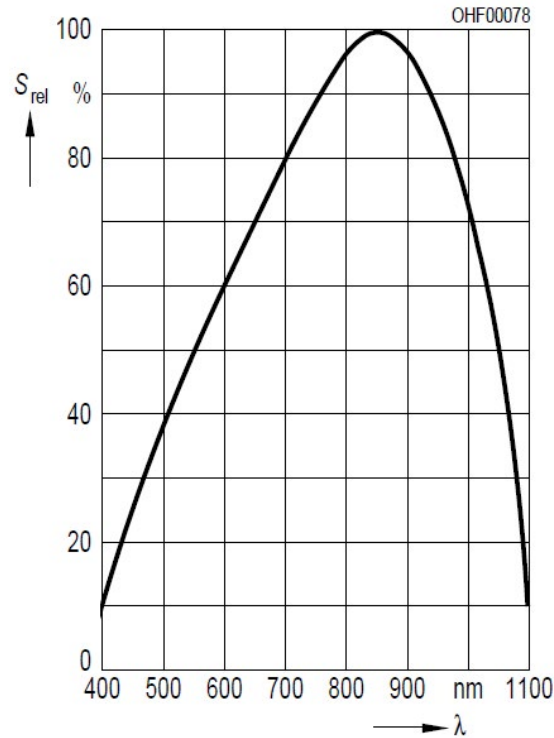

$$S_{rel} = f(\lambda)$$

Figure 5. BPX61 Photodiode Relative Spectral Sensitivity as a Function of Wavelength

Junction capacitance of the photodiode with a reverse bias voltage of 10V is determined from the BPX61 datasheet, as shown in Figure 6. Total input capacitance is determined from the junction capacitance of the photodiode and the differential and common-mode input capacitance of the operational amplifier, according to the following equation.

$$C_{in} = C_J + C_{diff} + C_{CM} = 18pF$$

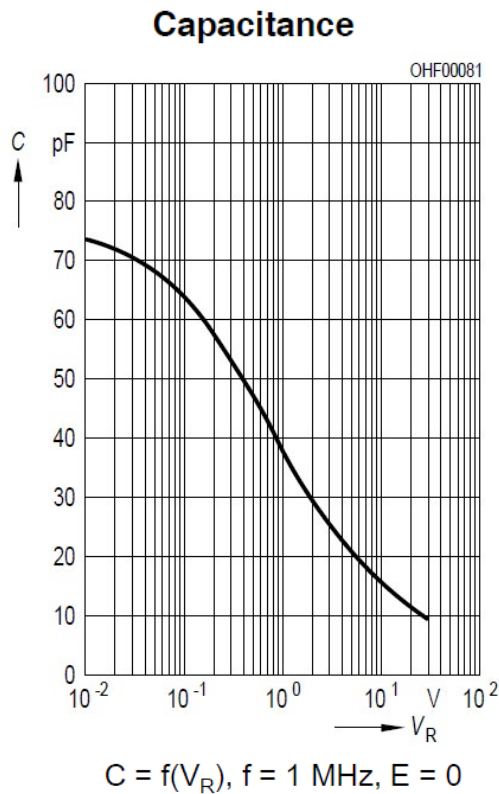

Figure 6. BPX61 Photodiode Junction Capacitance as a Function of Reverse Bias Voltage

The BPX61 photodiode photocurrent and open-circuit voltage as a function of luminosity is depicted in Fig. 7.

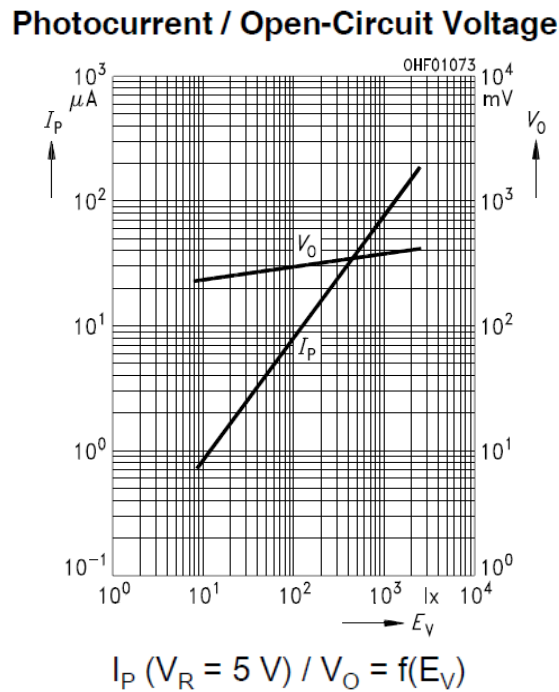

Figure 7. BPX61 Photodiode Photocurrent and Open-circuit Voltage as a Function of Luminosity

The gain-bandwidth product (GBWP) for the OPA2810 op-amp is 70 MHz. For stability, the GBWP is set to 60% of that value, 42 MHz. The equation for determining the value of the feedback capacitor for the TIA is shown below.

$$C_f = \frac{1 + \sqrt{1 + (8\pi * R_f * C_{in} * GBWP)}}{4\pi * R_f * GBWP} \approx 2pF$$

The output voltage from the TIA is filtered using a combination of a high-pass filter and low-pass filter to produce a bandpass filter as shown in Fig. 4. The high-pass filter blocks any DC interference and therefore is set to a lower cut-off frequency of about 3000 Hz. The two filters are separated by an inverting op-amp buffer that amplifies the voltage output from the high-pass filter, where $V_o = -V_{in} * R_2 / R_1$. The output from the amplifier is put through a low-pass filter to eliminate high-frequency oscillations present at the maximum and minimum light levels. The upper cut-off frequency is set to 20 MHz. The voltage output is inverted to a positive voltage using an inverting amplifier with a gain of 1. The output is sampled by an analog- ADC and the binary information is processed. Table 2 shows the component values for the receiver circuit.

Table 2. Component Values for Receiver Circuit

V_{bias} (V)	R_f (k Ω)	C_f (pF)	R_{HP} (k Ω)	C_{HP} (nF)	R_1 (k Ω)	R_2 (k Ω)	R_{LP} (k Ω)	C_{LP} (pF)	R (k Ω)
10	20	2	20	16	1	2	5	10	1

V. SIMULATION RESULTS

The next step was to evaluate the performance of the proposed antipodal UD code sequences generated to be utilized in the developed VLC system for ITS. Two of the code sets are shown in Figs. 8 and 9.

$$\mathbf{C}_{4 \times 5} = \begin{bmatrix} 1 & 1 & 1 & 1 & 1 \\ 1 & 0 & 1 & 0 & 0 \\ 1 & 1 & 0 & 0 & 1 \\ 1 & 0 & 0 & 1 & 1 \end{bmatrix}$$

Figure 8. UD Code Set C with L = 4 and K = 5

$$\mathbf{C}_{8 \times 13} = \begin{bmatrix} 1 & 1 & 1 & 1 & 1 & 1 & 1 & 1 & 1 & 1 & 1 & 1 & 1 \\ 1 & 0 & 1 & 0 & 1 & 0 & 1 & 0 & 0 & 1 & 0 & 0 & 0 \\ 1 & 1 & 0 & 0 & 1 & 1 & 0 & 0 & 0 & 0 & 1 & 1 & 1 \\ 1 & 0 & 0 & 1 & 1 & 0 & 0 & 1 & 0 & 0 & 0 & 1 & 1 \\ 1 & 1 & 1 & 1 & 0 & 0 & 0 & 0 & 1 & 1 & 1 & 1 & 0 \\ 1 & 0 & 1 & 0 & 0 & 1 & 0 & 1 & 1 & 1 & 1 & 0 & 1 \\ 1 & 1 & 0 & 0 & 0 & 0 & 1 & 1 & 1 & 1 & 1 & 1 & 0 \\ 1 & 0 & 0 & 1 & 0 & 1 & 1 & 0 & 1 & 1 & 1 & 1 & 0 \end{bmatrix}$$

Figure 9. UD Code Set C with L = 8 and K = 13

In the simulations conducted, the researchers compare the proposed decoder with the maximum likelihood (ML) decoder and a probabilistic data association (PDA) decoder to decipher the proposed code set sequences. The comparison in the simulation is performed with the PDA algorithm alone as it has the best performance compared to other decoding algorithms (e.g., matched filter (MF), minimum-mean-square-error (MMSE), and so on). Figures 10 and 11 plot the BER performance averaged over the different users for $\mathbf{C}_{4 \times 5}$ and $\mathbf{C}_{8 \times 13}$, respectively. As can be seen from Figs. 10 and 11 for a BER of 10^3 the performance of the proposed detector is only about 0.2 dB and 1 dB inferior compared to the ML decoder for UD code sets $\mathbf{C}_{4 \times 5}$ and $\mathbf{C}_{8 \times 13}$, respectively. In other words, using the proposed overloaded O-CDMA code design along with the developed detector, it would require additional powers of 0.2 dB and 1 dB to decode the UD code sets $\mathbf{C}_{4 \times 5}$ and $\mathbf{C}_{8 \times 13}$, respectively, compared to the ML decoder. The performance of the PDA suffers significantly compared to the proposed decoder developed in Kulhandjian et al. Although the BER performance of the proposed decoder is slightly higher than that of the ML detector, it is much less complex and less costly to implement compared to the ML decoder.

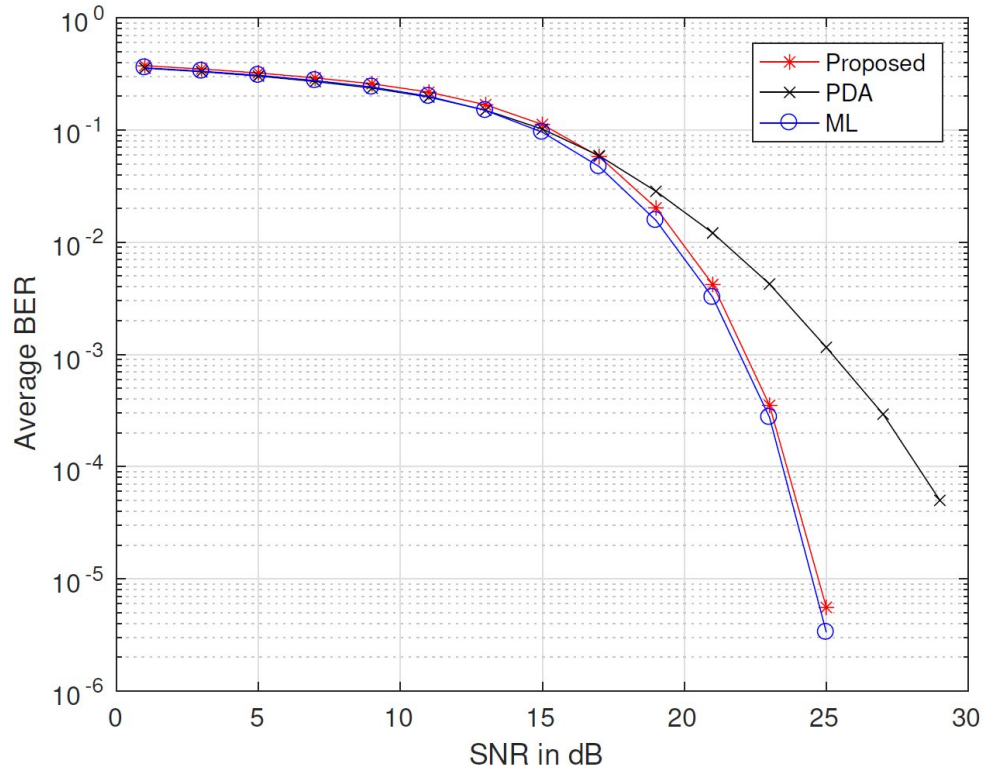

Figure 10. UD Code Set C4x5

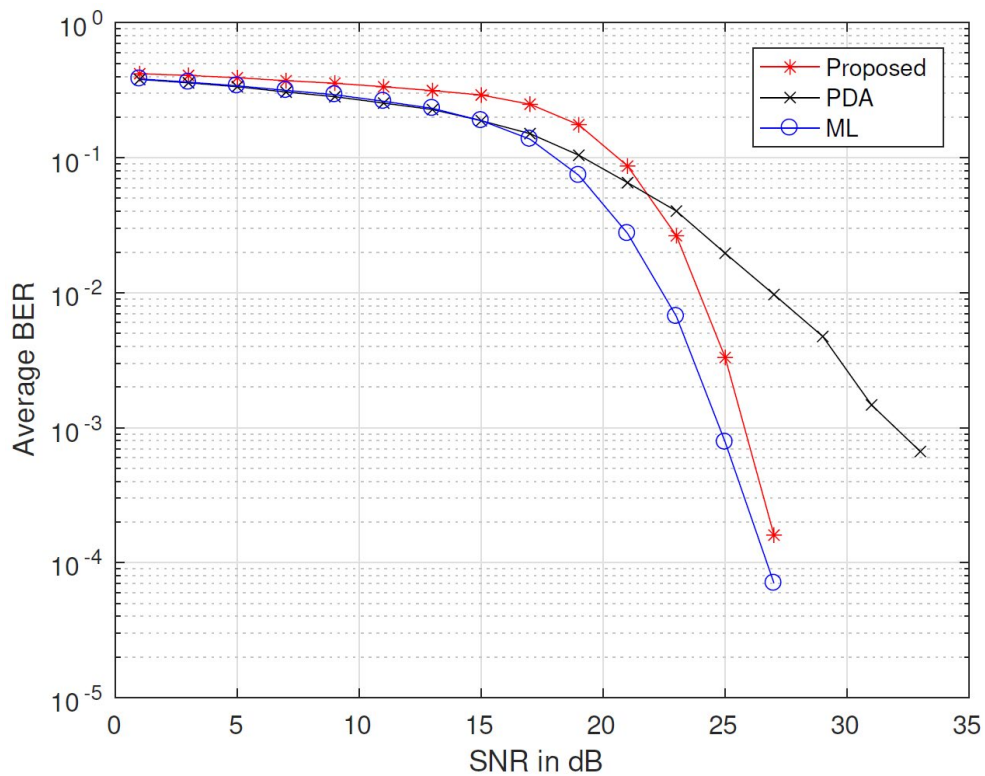

Figure 11. UD Code Set C8x13

VI. HARDWARE IMPLEMENTATION

The proposed visible light communication framework for ITS was developed and tested in a laboratory. A description of some of the hardware used in developing the VLC system follows.



Figure 12. Raspberry Pi 3 Model B+

Figure 12 shows the Raspberry Pi 3 Model B+. The board is used for transmitting the CDMA-encoded information.



Figure 13. ThorLabs PDA 100A2

Figure 13 shows the photodetector from ThorLabs used for running tests. The PDA 100A2 is a switchable gain detector with a large active area and bandwidth used for high-speed applications.



Figure 14. BPX61 Photodiode

Figure 14 shows the BPX61 photodiode that is used for receiving the light signals sent by the transmitter. The BPX61 is a fast-response, highly sensitive photodiode that works well with bias voltages.

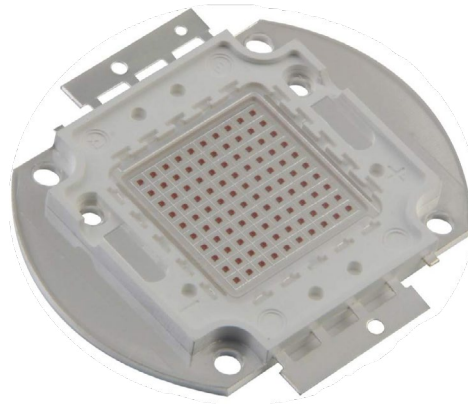

Figure 15. High-power Red LED

Figure 15 shows the high-power red LED that is used in the project. This LED is driven by the LED driver circuitry to modulate light data and send through the medium.



Figure 16. OPA2810 Operational Amplifier

Figure 16 shows the OPA2810 operational amplifier that is used in the transimpedance amplifier for the receiver. The OPA2810 is a rail-to-rail operational amplifier that has a large small-signal bandwidth, dynamic AC/DC performance, large GBWP, low noise, and a fast slew rate.



Figure 17. Red Green Traffic Light Signal Display

Figure 17 shows the traffic light signal display that is used to simulate a real traffic light signal lens. The light from the high-power LED is partially scattered by the red covering but this causes no significant degradations in the quality of the light at the receiver side.

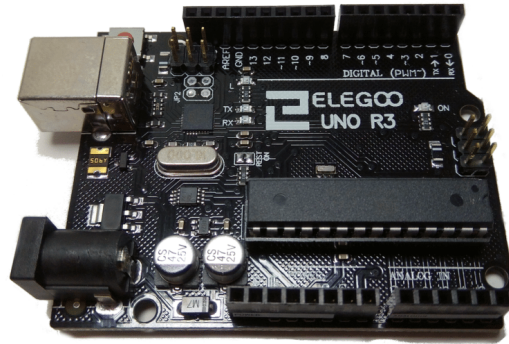

Figure 18. Arduino Uno R3 Board

Figure 18 shows the Arduino Uno R3 board that is used for sampling the output voltage of the receiver circuit and decoding the information.

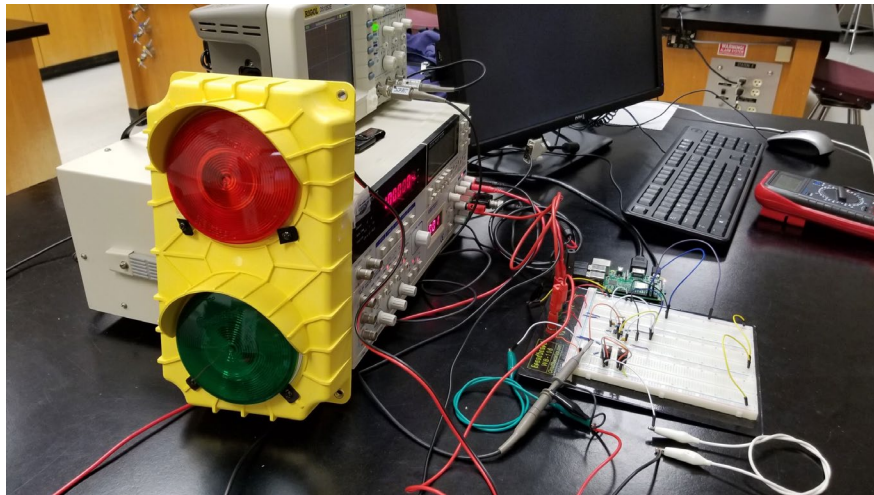

Figure 19. Transmitter Circuit Design on Breadboard

Figure 19 shows the transmitter side of the VLC system. The LED driver circuit is shown on the breadboard connected to the Raspberry Pi board. The traffic light signal display is shown with the high-power LED behind the red lens. The Raspberry Pi board outputs modulated data to the driver circuit and pulses the LED on and off corresponding to the binary information.

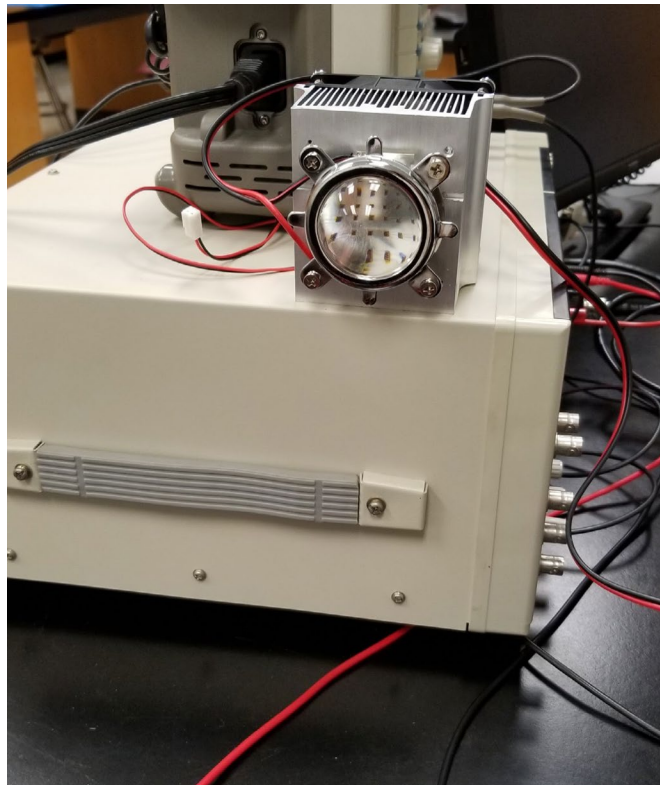

Figure 20. High-power Red LED with Heat Sink and Focusing Lens

Figure 20 shows the high-power red LED assembled with the heat sink and focusing lens. The LED receives modulated current pulses from the driver circuit.

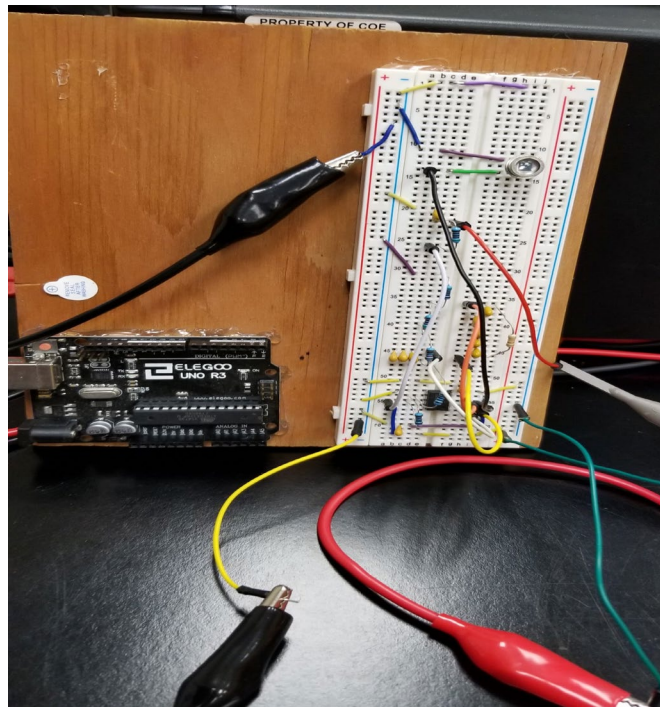

Figure 21. Receiver Circuit Design on Breadboard

Figure 21 shows the receiver circuit on the breadboard. The photodiode receives optical signals sent from the LED and converts them to current pulses. The current is converted

to a voltage and is then filtered and amplified to be sampled by the ADC.

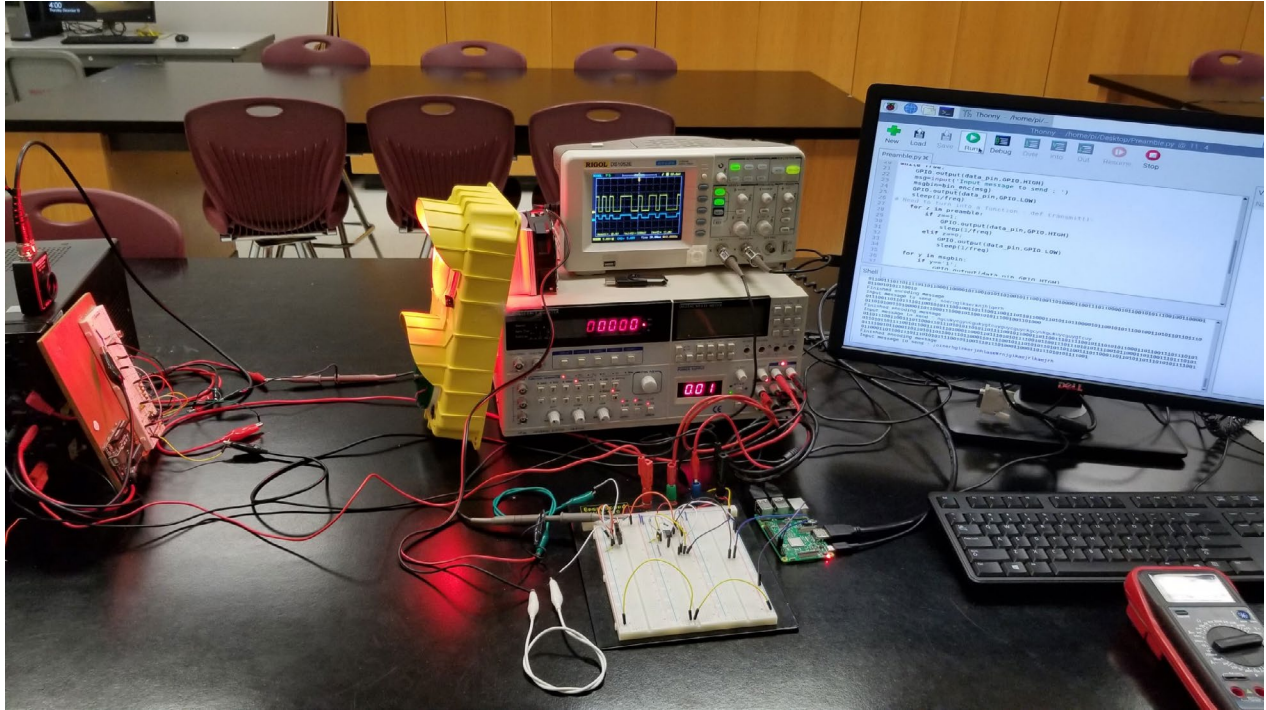

Figure 22. Transmitter and Receiver Circuitry Experimentation

Figure 22 shows the VLC system as a whole. The data are modulated and sent from the transmitter side through the medium and received by the optical sensor.

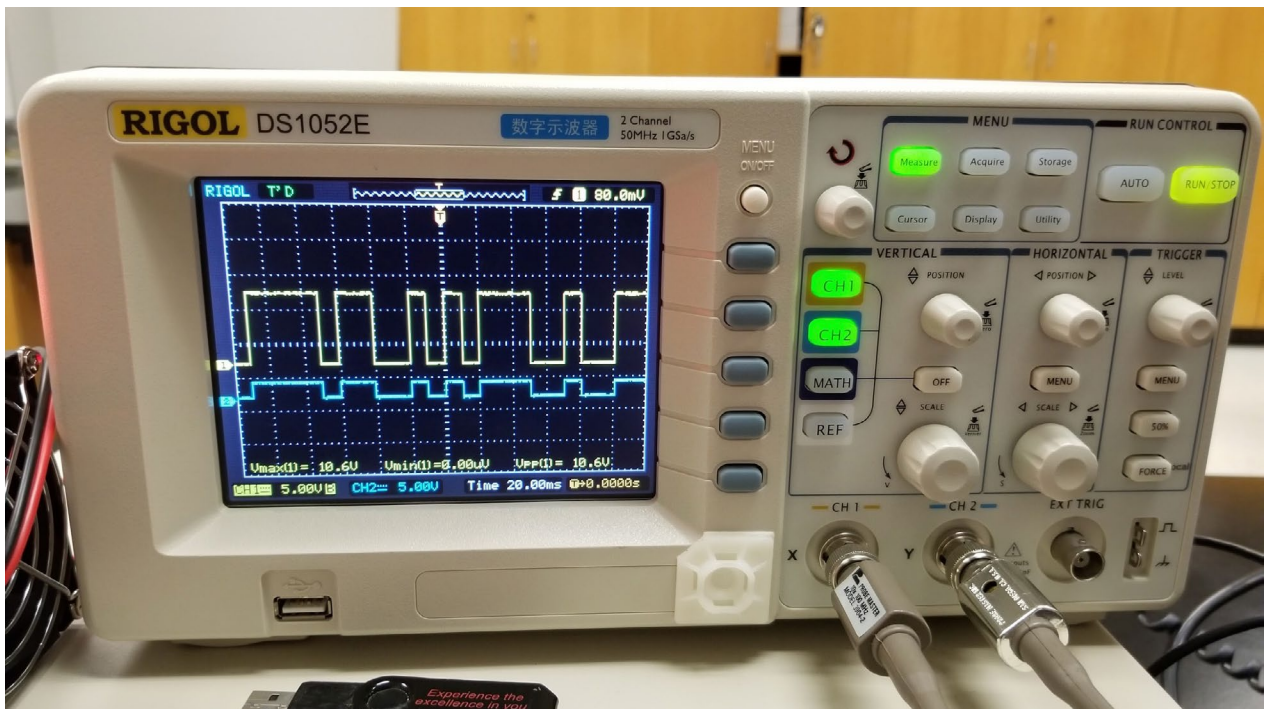
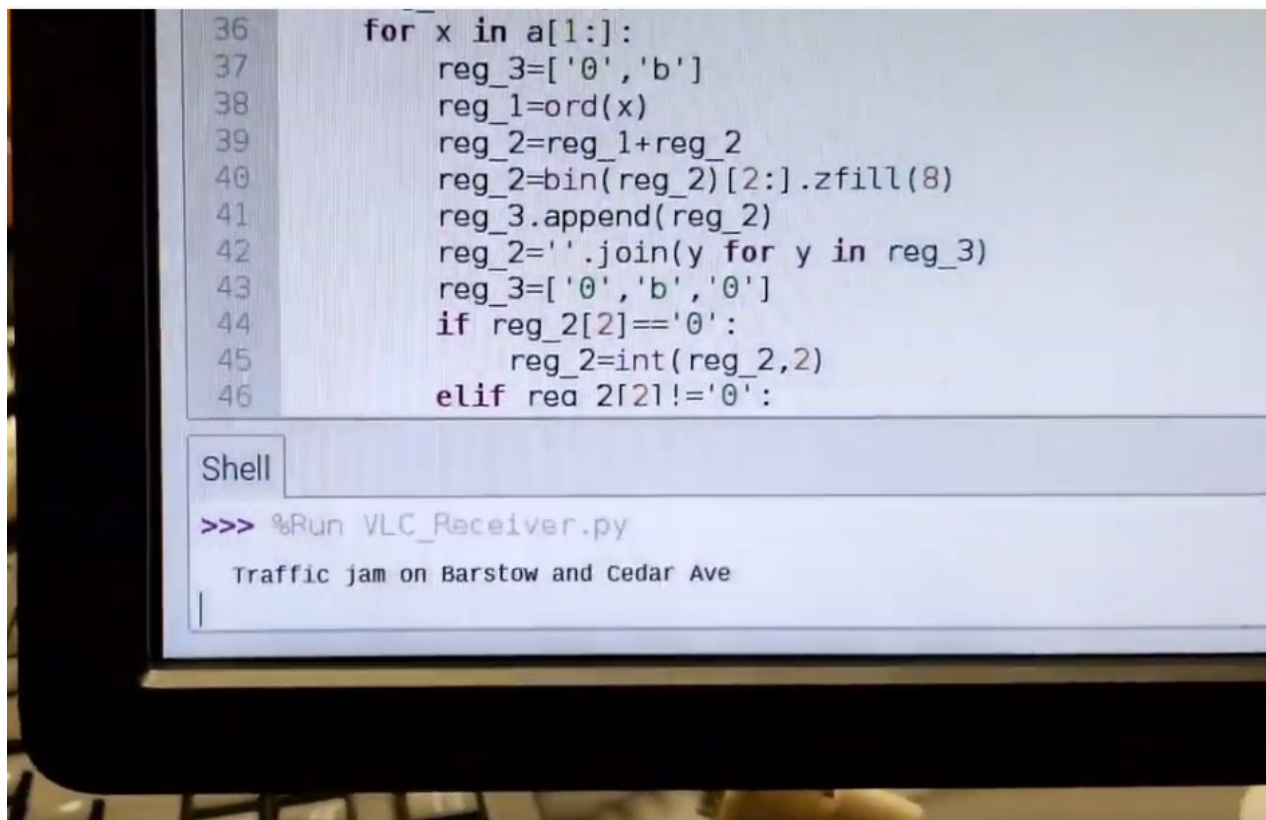

Figure 23. Transmitter and Receiver Voltage Analysis on the Oscilloscope

Figure 23 shows the signal that is sent by the transmitter (yellow) and the signal that is received by the sensor (blue), as observed on the oscilloscope.

Figure 25 shows the screenshot of the transmitted message which was encoded and sent by the red traffic light stating that there is a “Traffic jam on Barstow and Cedar Ave.”

A screenshot of a terminal window. The top part shows Python code for encoding a message. The code iterates over a list 'a', converts each character to its ASCII value, and then to a binary string. It then concatenates these binary strings and checks for a specific bit pattern. The bottom part shows the execution of a script named 'VLC_Receiver.py', which outputs the decoded message: 'Traffic jam on Barstow and Cedar Ave'.

```
36     for x in a[1:]:
37         reg_3=['0','b']
38         reg_1=ord(x)
39         reg_2=reg_1+reg_2
40         reg_2=bin(reg_2)[2:].zfill(8)
41         reg_3.append(reg_2)
42         reg_2=''
43         reg_3=['0','b','0']
44         if reg_2[2]=='0':
45             reg_2=int(reg_2,2)
46         elif reg_2[2]!='0':

Shell

>>> %Run VLC_Receiver.py

Traffic jam on Barstow and Cedar Ave
```

Figure 26. A Screenshot of the Received Message

Figure 26 shows the screenshot of the decoded received message that was originally sent by the red traffic light stating that there is a “Traffic jam on Barstow and Cedar Ave.”

VII. CONCLUSION

In this research project, a visible light communication (VLC) framework has been developed that can be used for intelligent transportation systems (ITSs). Not only can the traffic light control the flow of traffic: it can also provide information about the traffic conditions several blocks down the road, and in case of accidents this information would be useful to enable the passenger to take a detour from their original driving route to help reduce congestion and save time. In order to do that, the researchers have developed a transmitter circuitry that is composed of an embedded system and an optical electronics fast-switching network. In addition to that, the researchers have developed the receiver circuitry composed of optical electronics circuitry in which the photodiode along with other circuitry is used for detecting and decoding the VLC signal coming from the traffic lights. The received signal is passed through an analog-to-digital converter (ADC) before sending it to the embedded system to receive and decode the transmitted signals. The researchers have also developed and tested a novel optical code-division multiple-access (CDMA) scheme for overloaded optical CDMA transmission in which the optical codes will be uniquely decodable. This new coding system can provide higher data rates, and it promises to support larger numbers of users in the visible light communication protocol establishment. After developing the system, the researchers conducted actual experimentation in a laboratory using a traffic light model/prototype and studied the VLC framework to test its functionality and improve its performance.

ABBREVIATIONS AND ACRONYMS

ADC	Analog-to-Digital
BER	Bit Error Rate
CDMA	Code-Division Multiple-Access
Cf	Feedback Capacitor
FDA	Fast Decoder Algorithm
GBWP	Gain-Bandwidth Product
GPIO	General-Purpose Input/Output
ITS	Intelligent Transportation Systems
I2V	Infrastructure-to-Vehicle
LED	Light-Emitting Diode
LOS	Line-of-Sight
MF	Matched Filter
ML	Maximum-Likelihood
MMSE	Minimum-Mean-Square-Error
NI	National Instruments
O-CDMA	Optical Code-Division Multiple-Access
OOK	On-Off-Keying
Rf	Feedback Resistor
SNR	Signal-to-Noise Ratio
TIA	Transimpedance Amplifier
VLC	Visible Light Communication
V2I	Vehicle-to-Infrastructure

BIBLIOGRAPHY

Bhat, Akshay. "Stabilize Your Transimpedance Amplifier." APPLICATION NOTE 5129, February 3, 2012.

Fuada, Syifaul, Angga Pratama Putra, Yulian Aska, and Trio Adiono. "Trans-impedance amplifier (HA) design for Visible Light Communication (VLC) using commercially available OP-AMP." 2016 3rd International Conference on Information Technology, Computer, and Electrical Engineering (ICITACEE), Semarang, 2016, pp. 31–36. doi: 10.1109/ICITACEE.2016.7892405

Dang, Quang-Hien, and Myungsik Yoo. "Handover Procedure and Algorithm in Vehicle to Infrastructure Visible Light Communication." In *IEEE Access* 5 (2017): 26466–26475. doi: 10.1109/ACCESS.2017.2771199

Kulhandjian, Michel, Hovannes Kulhandjian, Claude D'Amours, Halim Yanikomeroğlu, and Gurgun Khachatryan. "Fast Decoder for Overloaded Uniquely Decodable Synchronous Optical CDMA." In *Proc. of IEEE Wireless Comm. and Networking Conf. (WCNC)*, Marrakech, Morocco, April 2019. doi: 10.1109/WCNC.2019.8885608

ABOUT THE AUTHOR

HOVANNES KULHANDJIAN, PHD

Dr. Hovannes Kulhandjian is an Assistant Professor in the Department of Electrical and Computer Engineering at California State University, Fresno (Fresno State). He joined Fresno State in Fall 2015 as a tenure-track faculty member. Before that, he was an Associate Research Engineer in the Department of Electrical and Computer Engineering at Northeastern University. He received his B.S. degree in Electronics Engineering with high honors from the American University in Cairo (AUC) in 2008, and his M.S. and Ph.D. degrees in Electrical Engineering from the State University of New York at Buffalo in 2010 and 2014, respectively. His current research interests are in digital signal processing, wireless communications, and networking, with applications to underwater and visible light communications and networking geared towards Intelligent Transpiration Systems (ITS).

Dr. Kulhandjian has received research grants from Fresno State Transportation Institute (FSTI) and he also received the 2020 Claude C. Laval Award for Innovative Technology and Research at Fresno State.

Dr. Kulhandjian is an active member of the Association for Computing Machinery (ACM) and the Institute of Electrical and Electronics Engineers (IEEE). He is a Senior Member of IEEE. He has served as a Guest Editor for IEEE Access Special Section Journal, Session Co-Chair for IEEE UComms'18 Conference, Session Chair for ACM WUWNet'19 Conference, Publicity Chair for ACM WUWNet'17 Conference. He also serves as a member of the Technical Program Committee (TCP) for ACM and IEEE Conferences such as GLOBECOM 2019, IPCCC 2017, WiMob 2018, WD 2018, ICC 2018, WUWNet 2018, and VTC Fall 2017. He is a recipient of the Outstanding Reviewer Award from ELSEVIER Ad Hoc Networks and ELSEVIER Computer Networks.

PEER REVIEW

San José State University, of the California State University system, and the Mineta Transportation Institute (MTI) Board of Trustees have agreed upon a peer review process required for all research published by MTI. The purpose of the review process is to ensure that the results presented are based upon a professionally acceptable research protocol.

MTI FOUNDER

Hon. Norman Y. Mineta

MTI BOARD OF TRUSTEES

Founder, Honorable Norman Mineta*
Secretary (ret.),
US Department of Transportation

Chair, Abbas Mohaddes
President & COO
Econolite Group Inc.

Vice Chair, Will Kempton
Executive Director
Sacramento Transportation Authority

Executive Director, Karen Philbrick, PhD*
Mineta Transportation Institute
San José State University

Winsome Bowen
Chief Regional Transportation
Strategy
Facebook

David Castagnetti
Co-Founder
Mehlman Castagnetti
Rosen & Thomas

Maria Cino
Vice President
America & U.S. Government
Relations Hewlett-Packard Enterprise

Grace Crunican**
Owner
Crunican LLC

Donna DeMartino
Managing Director
Los Angeles-San Diego-San Luis
Obispo Rail Corridor Agency

Nuria Fernandez**
General Manager & CEO
Santa Clara Valley
Transportation Authority (VTA)

John Flaherty
Senior Fellow
Silicon Valley American
Leadership Forum

William Flynn *
President & CEO
Amtrak

Rose Guilbault
Board Member
Peninsula Corridor
Joint Powers Board

Ian Jefferies*
President & CEO
Association of American Railroads

Diane Woodend Jones
Principal & Chair of Board
Lea + Elliott, Inc.

David S. Kim*
Secretary
California State Transportation
Agency (CALSTA)

Therese McMillan
Executive Director
Metropolitan Transportation
Commission (MTC)

Bradley Mims
President & CEO
Conference of Minority
Transportation Officials (COMTO)

Jeff Morales
Managing Principal
InfraStrategies, LLC

Dan Moshavi, PhD*
Dean, Lucas College and
Graduate School of Business
San José State University

Toks Omishakin*
Director
California Department of
Transportation (Caltrans)

Takayoshi Oshima
Chairman & CEO
Allied Telesis, Inc.

Paul Skoutelas*
President & CEO
American Public Transportation
Association (APTA)

Beverly Swaim-Staley
President
Union Station Redevelopment
Corporation

Jim Tymon*
Executive Director
American Association of
State Highway and Transportation
Officials (AASHTO)

Larry Willis*
President
Transportation Trades
Dept., AFL-CIO

* = Ex-Officio

** = Past Chair, Board of Trustees

Directors

Karen Philbrick, PhD
Executive Director

Hilary Nixon, PhD
Deputy Executive Director

Asha Weinstein Agrawal, PhD
Education Director
National Transportation Finance
Center Director

Brian Michael Jenkins
National Transportation Security
Center Director

