

UNIDA 1,2 Y 3
EVALUACION DE LA RED NGN
FASE 6

ENTREGADO POR:
JUAN CAMILO CARRILLO HERNANDEZ

GRUPO:
215005_3

TUTOR:
OMAR ALBEIRO TREJO

UNIVERSIDAD NACIONAL ABIERTA Y A DISTANCIA
VICERRECTORÍA ACADÉMICA Y DE INVESTIGACIÓN
14 DE DICIEMBRE 2019

Tabla de contenido

INTRODUCCIÓN	3
ACTIVIDADES A DESARROLLAR	4
INDIVIDUAL.....	4
1. Explique mediante un diagrama de bloques el funcionamiento de un servidor de VoIP.....	4
2. Que elementos y consideraciones se requieren para la implementación del servicio IPTV.....	5
COLABORATIVO.....	6
1. Un Call Center para comunicar las ciudades de la red, con los siguientes requerimientos.....	6
CONCLUSIONES.....	27
BIBLIOGRAFIA	28

INTRODUCCIÓN

El presente trabajo, contiene conceptos relevantes sobre servicios de redes NGN tales como VoIP y IPTV. También se encuentra plasmados los protocolos de distintos niveles involucrados, como lo son: UDP, IGMP, RSVP, RTP y SIP. Y al final un ejemplo de los servicios mencionados anteriormente.

Como primera parte del trabajo veremos un diagrama de bloques el cual explica el funcionamiento de un servidor VoIP, desde su primer nivel, hasta el nivel de red. En un segundo lugar se tratará todo lo relacionado a la IPTV y sus ventajas como una nueva alternativa de entretenimiento, aprovechando las ventajas que nos brindan las nuevas tecnologías. Y por último se realiza la implementación del servidor de VoIP Elastix, así mismo, se configura una red VPN con protocolo MPLS y se implementa el servicio de IPTV sobre esta red.

ACTIVIDADES A DESARROLLAR

INDIVIDUAL

1. Explique mediante un diagrama de bloques el funcionamiento de un servidor de VoIP.



Figura 1. Funcionamiento de un servidor VoIP. (Carrillo, 2019)



Figura 2. Funcionamiento de un servidor VoIP. (prosciencas, 2019)

2. Que elementos y consideraciones se requieren para la implementación del servicio IPTV.

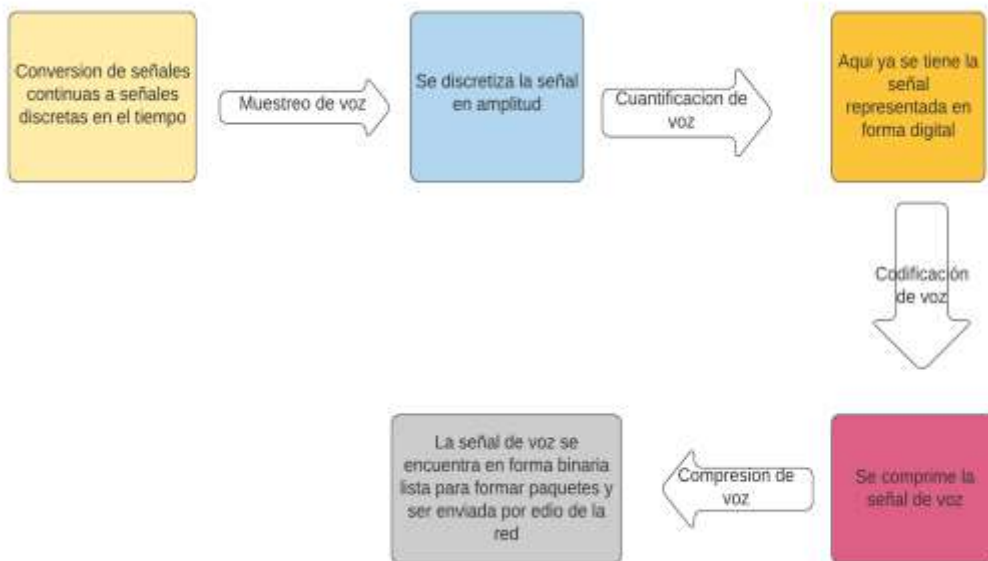
Para presentar el escenario completo de protocolos Utilizados en la red IPTV se requiere detallar las técnicas Para la transmisión de video sobre IP. Por lo general se Utilizan protocolos de Streaming de video, como RTP y Multicast, para la difusión de los contenidos.

Real-time Transport Protocol [RTP]. Fue diseñado por el Audio-Video Transport Working Group del IETF, planteado para soportar aplicaciones de tiempo real como el flujo multimedia en Internet. RTP es un protocolo ligero el cual por sí solo no proporciona reserva de recursos, ni mecanismos de control de flujo y calidad de servicio. Generalmente viaja sobre los paquetes UDP puesto que ellos poseen un menor retardo que TCP; pero a cambio, sacrifica la confiabilidad que ofrece TCP. Por esta razón, RTP no garantiza la entrega confiable y ordenada de paquetes, por lo que, para esta tarea, es necesario que sea acompañado por otros protocolos de control de los cuales, a continuación, se explicarán algunos de los protocolos que soportan Multicast, pero desde el enfoque de una red IPTV, y como estos hacen posible el correcto despliegue de los servicios ofrecidos por IPTV.

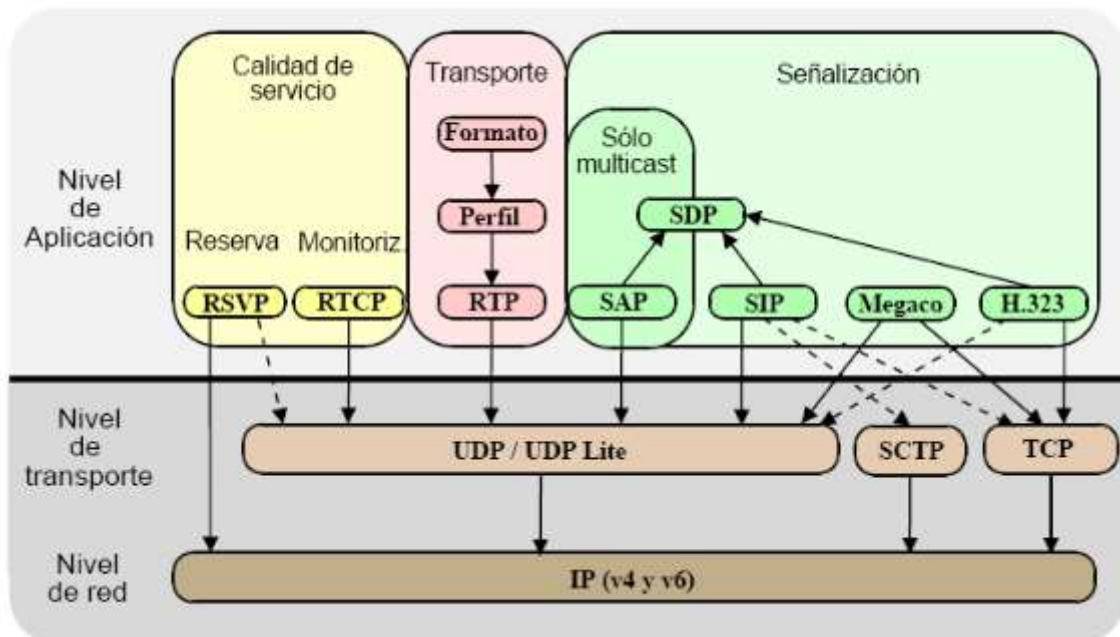
1) Internet Group Multicast Protocol [IGMP]: Es el protocolo usado por las redes de IPTV para unirse a los grupos multicast, cuando hay un flujo multicast disponible en la red; los STB tendrán que unirse a dicho grupo para Poder recibir el trafico multicast; de igual manera, cuando el usuario no desea recibir más datos de ese flujo, el STB mandará un mensaje de leave para notificar que no quiere recibir más contenidos de ese grupo. En la Figura se puede visualizar el funcionamiento de IGMP en redes IPTV con red de acceso DSL (Amir, 2010).



Figura 4. (VIVI, 2011)

2) Multicast e IGMP para el cambio de canal. Cuando un usuario desea cambiar de canal, el tiempo que demora desde que es presionado el botón del control, hasta que el contenido del canal escogido se despliega en la pantalla, es conocido como tiempo de zapping de canal o cambio de canal. La señalización durante el cambio de canal se muestra en la Figura 6 (Internet Society, 2006). Cuando el usuario cambia de canal, manda dos mensajes, un leave asociado al canal que estaba visualizando, y un join para asociarse al nuevo canal que desea ver.

Existen una serie de áreas interrelacionadas para poder ofrecer IPTV. Estas son:

1. Adquisición de la señal de video
2. Almacenamiento y servidores de video
3. Distribución de contenido
4. Equipo de acceso y suscriptor
5. Software

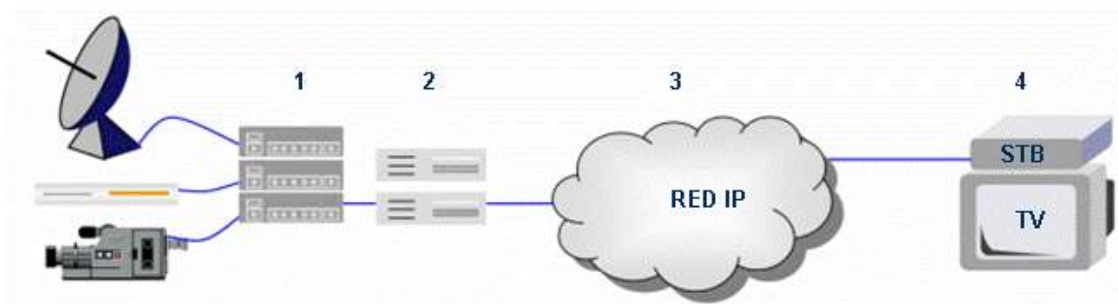
Colaborativa

Sobre la conexión MPLS implementada en la Fase 4, configurar los siguientes servicios basados en el servidor de VoIP Asterisk o Elastix:

3. Un Call Center para comunicar las ciudades de la red, con los siguientes requerimientos:

Basados en la topología de la fase 4 reutilizamos el mismo servidor de VoIP con el sistema operativo Elastix en el cual fueron creadas 3 extensiones para simular la conexión de cada ciudad teniendo en cuenta que los recursos de la maquina son limitados no se configuraron las 80 extensiones.

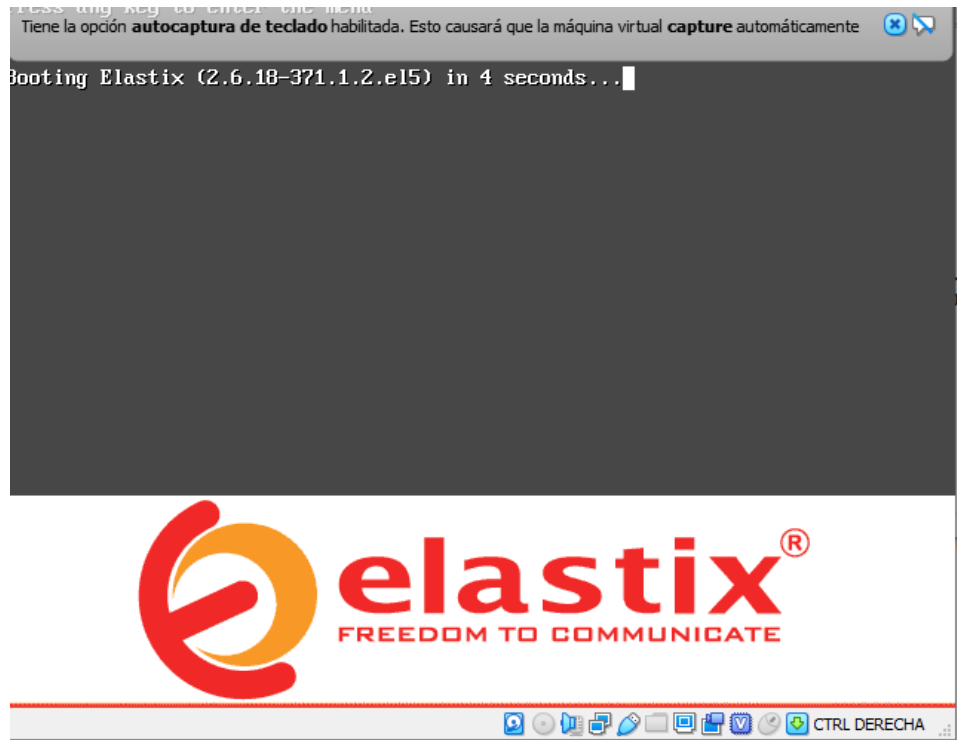

```
No suspend signature on swap, not resuming.
Creating root device.
Mounting root filesystem.
EXT3-fs: INFO: recovery required on readonly filesystem.
EXT3-fs: write access will be enabled during recovery.
kjournald starting. Commit interval 5 seconds
EXT3-fs: dm-0: orphan cleanup on readonly fs
EXT3-fs: dm-0: 5 orphan inodes deleted
EXT3-fs: recovery complete.
EXT3-fs: mounted filesystem with ordered data mode.
Setting up other filesystems.
Setting up new root fs
no fstab.sys, mounting internal defaults
Switching to new root and running init.
unmounting old /dev
unmounting old /proc
unmounting old /sys
SELinux: Disabled at runtime.
type=1404 audit(1575428480.618:2): selinux=0 auid=4294967295 ses=4294967295
INIT: version 2.86 booting
      Welcome to CentOS release 5.10 (Final)
      Press 'I' to enter interactive startup.
Configuración del reloj (localtime): mié dic  4 03:01:12 C [ OK ]
Iniciando udev: [ OK ]
```

```

Running dahdi_cfg: [ OK ]
[ OK ]
Iniciando el demonio HAL: [ OK ]
Starting monitoring for VG VolGroup00: 2 logical volume(s) in volume group "Uo
lGroup00" monitored
[ OK ]
Iniciando sshd: [ OK ]
Iniciando xinetd: [ OK ]
Iniciando ntpd: [ OK ]
Iniciando mysqld: [ OK ]
Importando la base de datos cyrus-imapd : [ OK ]
Iniciando cyrus-imapd: [ OK ]
Password configuration already present.
Iniciando postfix: [ OK ]
Iniciando httpd: httpd: apr_sockaddr_info_get() failed for IPBX
httpd: Could not reliably determine the server's fully qualified domain name, us
ing 127.0.0.1 for ServerName
[ OK ]
SETTING FILE PERMISSIONS Asterisk
Permissions Asterisk OK
Starting asterisk: [ OK ]
Iniciando crond: [ OK ]
Starting xfs: [ OK ]
Starting Elastix Port Knocking: [ OK ]
Starting Elastix Update Helper:

```

```

Elastix (GNS3 Linked Base for clones) [Corriendo] - Oracle VM VirtualBox
Archivo Máquina Ver Entrada Dispositivos Ayuda
To access your Elastix System, using a separate workstation (PC/MAC/Linux)
Open the Internet Browser using the following URL:
http://<YOUR-IP-HERE>
If you could not get a DHCP IP address please type setup and select "Network con
figuration" to set up a static IP.

[root@IPBX ~]# ifconfig
lo          Link encap:Local Loopback
            inet addr:127.0.0.1  Mask:255.0.0.0
            UP LOOPBACK RUNNING MTU:16436 Metric:1
            RX packets:97 errors:0 dropped:0 overruns:0 frame:0
            TX packets:97 errors:0 dropped:0 overruns:0 carrier:0
            collisions:0 txqueuelen:0
            RX bytes:10756 (10.5 KiB)  TX bytes:10756 (10.5 KiB)

eth0       Link encap:Ethernet  HWaddr 08:00:27:74:30:FE
            inet addr:192.168.1.4  Bcast:192.168.1.255 Mask:255.255.255.0
            UP BROADCAST RUNNING MULTICAST MTU:1500 Metric:1
            RX packets:153 errors:0 dropped:0 overruns:0 frame:0
            TX packets:103 errors:0 dropped:0 overruns:0 carrier:0
            collisions:0 txqueuelen:1000
            RX bytes:12727 (12.4 KiB)  TX bytes:7489 (7.3 KiB)
            Interrupt:177 Base address:0xd020

[root@IPBX ~]# _

```

En las anteriores imágenes se puede ver el inicio de la máquina virtual de virtualbox, con sistema operativo Linux centos corriendo la IPBX Elastix importada en GNS3 y conectada directamente a la red LAN de Bogotá.

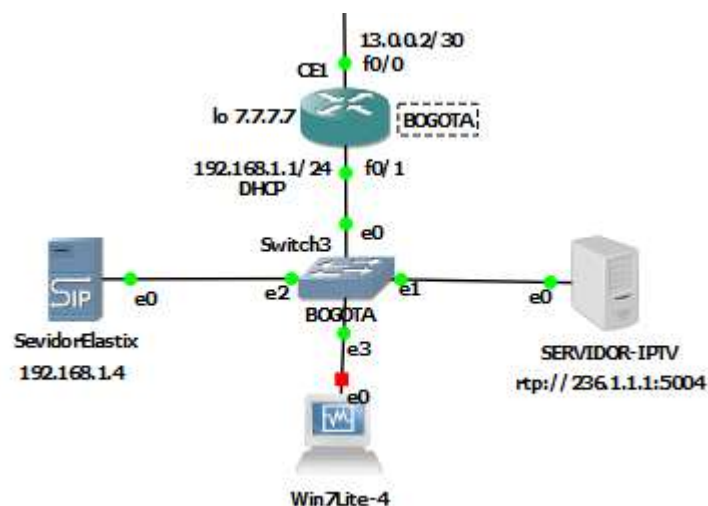

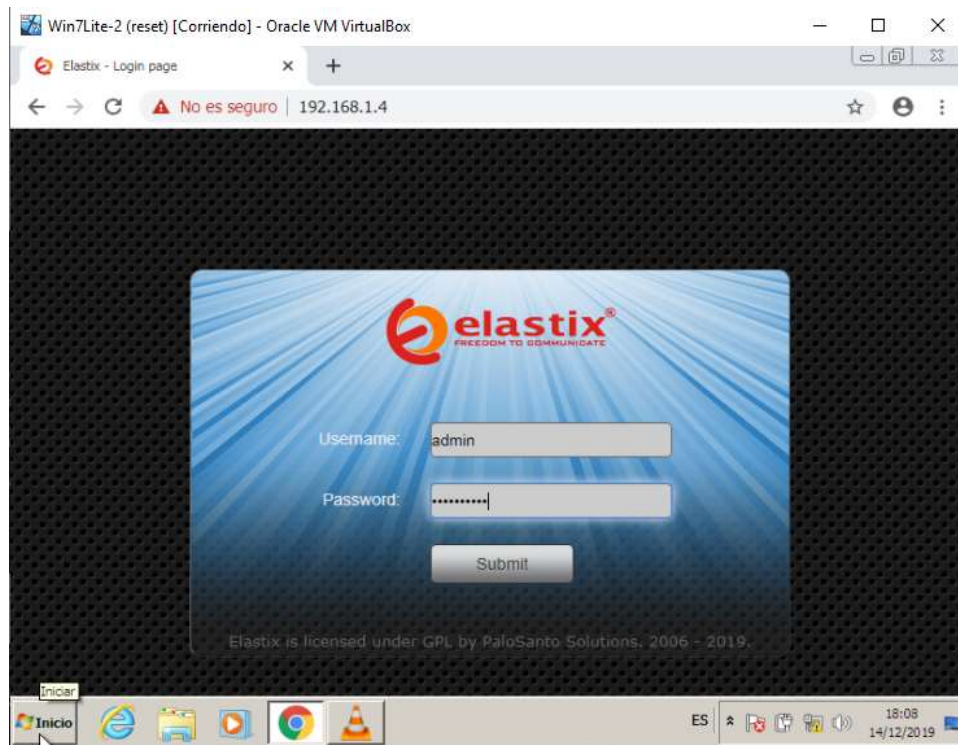

Accediendo al panel de administración desde la máquina virtual 2 en la ciudad de barranquilla con Windows 7 y corriendo en GNS3.

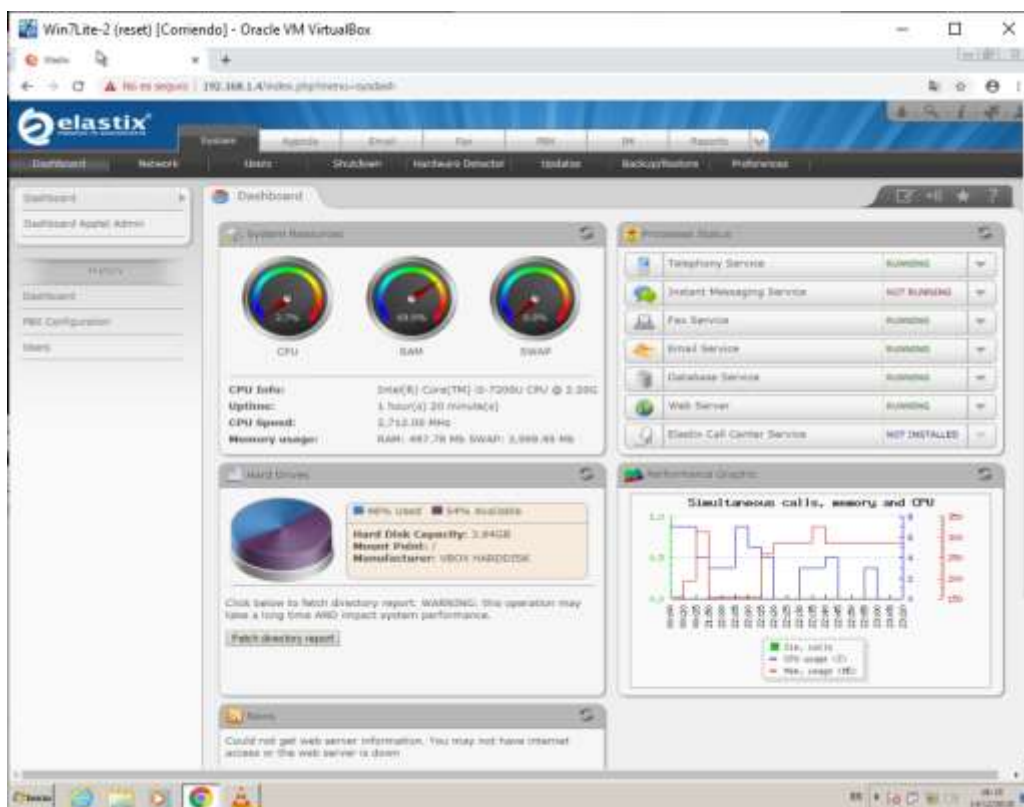

IPBX con los servicios básicos activos

➤ **Soporte para 80 llamadas simultaneas entre las sedes de la entidad.**

Luego realizamos la creación de las extensiones 1010 para Bogotá 1111Barranquillay 1212 para Medellín para configurarlas en las aplicaciones Xlite instaladas en cada pc virtualizado-correspondientes a cada ciudad.



Barranquilla

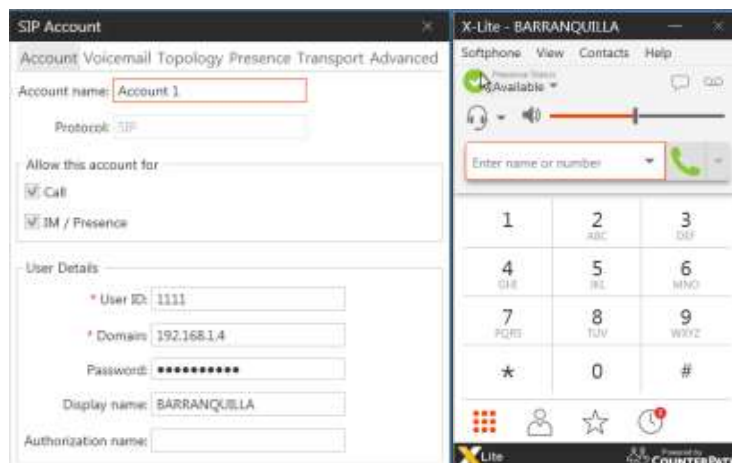

Bogotá

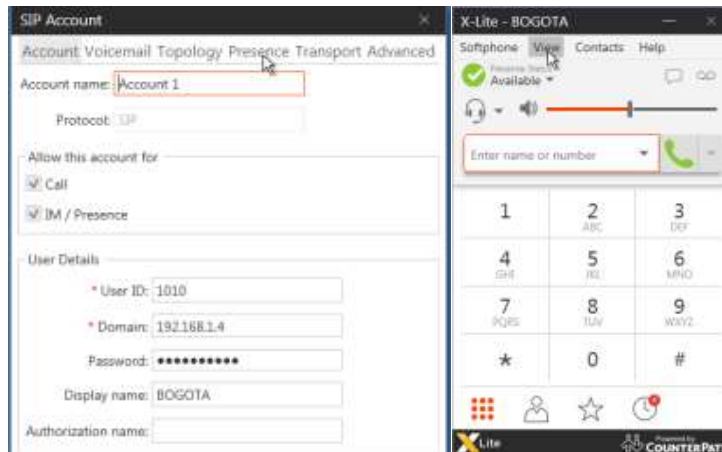

Medellín

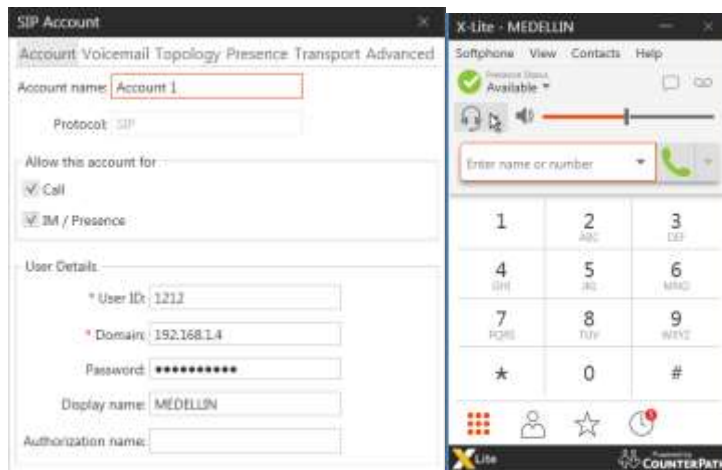

- El transporte de datos entre las sedes de la empresa tiene un ancho de banda de 100 Mbps.

Para la interconexión de sedes en esta topología usamos el router C2691 el cual cuenta con interfaces fast ethernet cumpliendo con el requerimiento de conexiones a 100 Mbps como se muestra en la siguiente imagen.

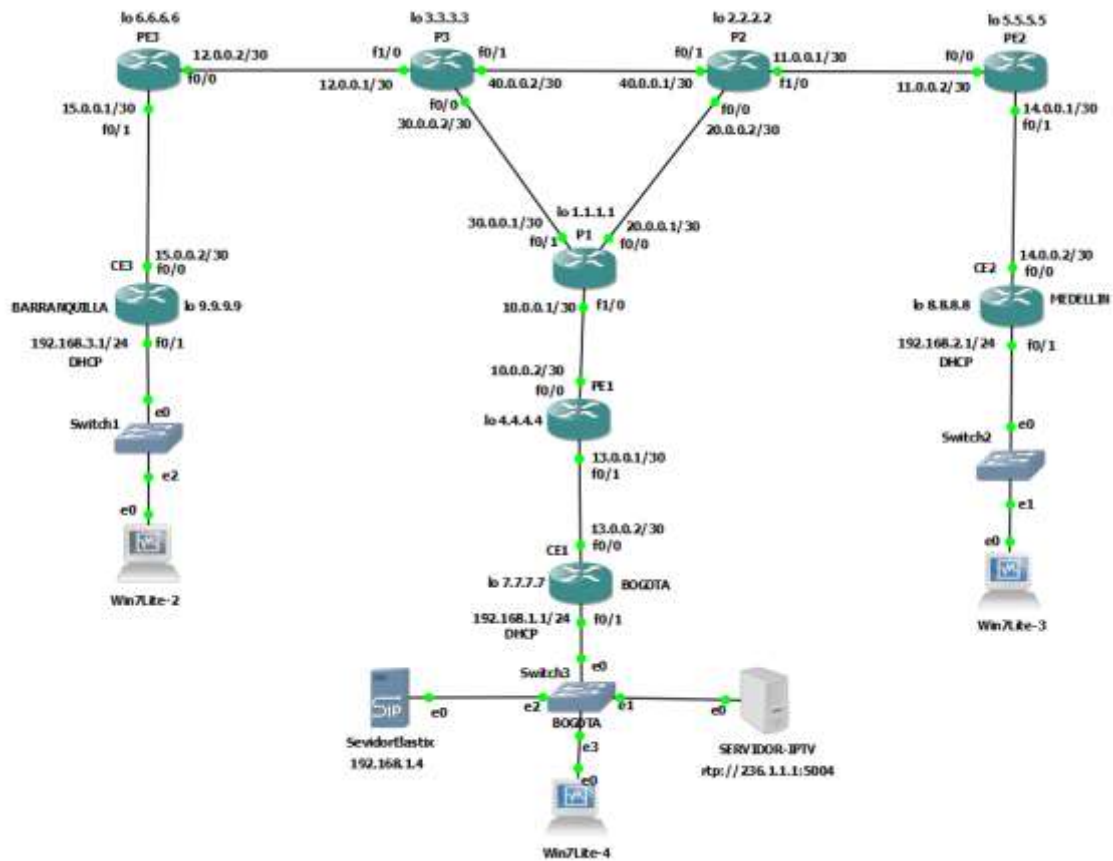

La asignación de direcciones IP se realizó basada en la siguiente tabla de redes

DIRECCIONAMIENTO FASE 6

TIPO DE RED	SEGMENTO	DIRECCION DE RED
CORE MPLS	P1 - P2	20.0.0.0/30
	P1 - P3	30.0.0.0/30
	P2 - P3	40.0.0.0/30
PERIMETRO MPLS	P1 - PE1	10.0.0.0/30
	P2 - PE2	11.0.0.0/30
	P3 - PE3	12.0.0.0/30
CONEXIÓN ULTIMA MILLA	PE1 - CE1	13.0.0.0/30
	PE2 - CE2	14.0.0.0/30
	PE3 - CE3	15.0.0.0/30
RED LAN	CE1	192.168.1.0/24
	CE2	192.168.2.0/24
	CE3	192.168.3.0/24

Servicio IPTV entre las sedes, el cual permitirá transferir contenidos multimedia.

Para la implementación del servicio de video IP se realizaron las siguientes configuraciones en la red

- Configuración del protocolo de enrutamiento OSPF para el intercambio de tablas de enrutamiento entre sedes.
- Configuración del protocolo MPLS en cada router pertenecientes al core y y perímetro MPLS para brindar mayor velocidad de rutas y procesamiento entre router mediante etiquetas MPLS.

```

router ospf 1
mpls ldp autoconfig
router-id 1.1.1.1
log-adjacency-changes
network 1.1.1.1 0.0.0.0 area 0
network 10.0.0.0 0.0.0.3 area 0
network 20.0.0.0 0.0.0.3 area 0
network 30.0.0.0 0.0.0.3 area 0

no ip http server
no ip http secure-server
ip pim rp-address 1.1.1.1

no cdp log mismatch duplex

mpls ldp router-id Loopback0
  
```

```

router ospf 1
mpls ldp autoconfig
router-id 3.3.3.3
log-adjacency-changes
network 3.3.3.3 0.0.0.0 area 0
network 12.0.0.0 0.0.0.3 area 0
network 30.0.0.0 0.0.0.3 area 0
network 40.0.0.0 0.0.0.3 area 0

no ip http server
no ip http secure-server
ip pim rp-address 1.1.1.1

no cdp log mismatch duplex

mpls ldp router-id Loopback0
  
```

```

router ospf 1
mpls ldp autoconfig
router-id 2.2.2.2
log-adjacency-changes
network 2.2.2.2 0.0.0.0 area 0
network 11.0.0.0 0.0.0.3 area 0
network 20.0.0.0 0.0.0.3 area 0
network 40.0.0.0 0.0.0.3 area 0

no ip http server
no ip http secure-server
ip pim rp-address 1.1.1.1

no cdp log mismatch duplex

mpls ldp router-id Loopback0
  
```

Configuración de OSPF y MPLS en los routers del core P1, P2 y P3

Tabla de enrutamiento en P1, P2 y P3

```

1.0.0.0/32 is subnetted, 1 subnets
C 1.1.1.1 is directly connected, Loopback0
2.0.0.0/32 is subnetted, 1 subnets
O 2.2.2.2 [110/11] via 20.0.0.2, 02:14:29, FastEthernet0/0
3.0.0.0/32 is subnetted, 1 subnets
O 3.3.3.3 [110/11] via 20.0.0.1, 02:16:33, FastEthernet0/0
4.0.0.0/32 is subnetted, 1 subnets
O 4.4.4.4 [110/11] via 20.0.0.1, 02:16:33, FastEthernet0/0
20.0.0.0/30 is subnetted, 1 subnets
C 20.0.0.0 is directly connected, FastEthernet0/0
5.0.0.0/32 is subnetted, 1 subnets
O 5.5.5.5 [110/11] via 30.0.0.2, 02:14:30, FastEthernet0/0
6.0.0.0/32 is subnetted, 1 subnets
O 6.0.0.0 [110/11] via 30.0.0.2, 02:14:31, FastEthernet0/1
40.0.0.0/8 is variably subnetted, 2 subnets, 2 masks
O 40.0.0.0/30 [110/20] via 20.0.0.2, 02:14:35, FastEthernet0/0
O 40.0.0.0/22 [110/20] via 30.0.0.2, 02:14:30, FastEthernet0/1
10.0.0.0/30 is subnetted, 1 subnets
C 10.0.0.0 is directly connected, FastEthernet1/0
11.0.0.0/30 is subnetted, 1 subnets
O 11.0.0.0 [110/11] via 20.0.0.2, 02:14:37, FastEthernet0/0
12.0.0.0/30 is subnetted, 1 subnets
O 12.0.0.0 [110/11] via 30.0.0.2, 02:14:30, FastEthernet0/1
192.168.1.0/24 [110/21] via 10.0.0.2, 02:14:30, FastEthernet1/0
13.0.0.0/30 is subnetted, 1 subnets
O 13.0.0.0 [110/11] via 10.0.0.2, 02:14:30, FastEthernet1/0
192.168.2.0/24 [110/21] via 20.0.0.2, 02:14:40, FastEthernet0/0
14.0.0.0/30 is subnetted, 1 subnets
O 14.0.0.0 [110/11] via 20.0.0.2, 02:14:40, FastEthernet0/0
192.168.3.0/24 [110/21] via 30.0.0.2, 02:14:41, FastEthernet0/1
30.0.0.0/30 is subnetted, 1 subnets
C 30.0.0.0 is directly connected, FastEthernet0/1
15.0.0.0/30 is subnetted, 1 subnets
O 15.0.0.0 [110/11] via 30.0.0.2, 02:14:42, FastEthernet0/1
  
```

```

1.0.0.0/32 is subnetted, 1 subnets
O 1.1.1.1 [110/11] via 30.0.0.1, 02:16:35, FastEthernet0/0
2.0.0.0/32 is subnetted, 1 subnets
C 2.2.2.2 is directly connected, Loopback0
3.0.0.0/32 is subnetted, 1 subnets
O 3.3.3.3 [110/11] via 20.0.0.1, 02:16:33, FastEthernet0/0
4.0.0.0/32 is subnetted, 1 subnets
O 4.4.4.4 [110/11] via 20.0.0.1, 02:16:33, FastEthernet0/0
20.0.0.0/30 is subnetted, 1 subnets
C 20.0.0.0 is directly connected, FastEthernet0/0
5.0.0.0/32 is subnetted, 1 subnets
O 5.5.5.5 [110/11] via 11.0.0.2, 02:16:34, FastEthernet1/0
6.0.0.0/32 is subnetted, 1 subnets
O 6.0.0.0 [110/22] via 20.0.0.1, 02:16:36, FastEthernet0/0
40.0.0.0/8 is variably subnetted, 2 subnets, 2 masks
C 40.0.0.0/30 is directly connected, FastEthernet0/1
O 40.0.0.0/22 [110/30] via 20.0.0.1, 02:16:39, FastEthernet0/0
10.0.0.0/30 is subnetted, 1 subnets
O 10.0.0.0 [110/11] via 20.0.0.1, 02:16:39, FastEthernet0/0
11.0.0.0/30 is subnetted, 1 subnets
O 11.0.0.0 [110/11] via 20.0.0.1, 02:16:39, FastEthernet1/0
12.0.0.0/30 is subnetted, 1 subnets
O 12.0.0.0 [110/21] via 20.0.0.1, 02:16:39, FastEthernet0/0
192.168.1.0/24 [110/31] via 20.0.0.1, 02:16:39, FastEthernet0/0
13.0.0.0/30 is subnetted, 1 subnets
O 13.0.0.0 [110/21] via 20.0.0.1, 02:16:39, FastEthernet0/0
192.168.2.0/24 [110/21] via 11.0.0.2, 02:16:39, FastEthernet1/0
14.0.0.0/30 is subnetted, 1 subnets
O 14.0.0.0 [110/11] via 11.0.0.2, 02:16:41, FastEthernet1/0
192.168.3.0/24 [110/41] via 20.0.0.1, 02:16:41, FastEthernet0/0
30.0.0.0/30 is subnetted, 1 subnets
C 30.0.0.0 [110/20] via 20.0.0.1, 02:16:41, FastEthernet0/0
15.0.0.0/30 is subnetted, 1 subnets
O 15.0.0.0 [110/11] via 30.0.0.1, 02:16:41, FastEthernet0/0
  
```

```

P1# show ip forwarding-table
1.0.0.0/32 is subnetted, 1 subnets
D 1.1.1.1 [110/11] via 30.0.0.1, 02:18:52, FastEthernet0/0
D 2.0.0.0/32 is subnetted, 1 subnets
D 2.2.2.2 [110/21] via 30.0.0.1, 02:18:52, FastEthernet0/0
D 3.0.0.0/32 is subnetted, 1 subnets
C 3.3.3.3 is directly connected, Loopback0
D 4.0.0.0/32 is subnetted, 1 subnets
D 4.4.4.4 [110/12] via 30.0.0.1, 02:18:52, FastEthernet0/0
D 20.0.0.0/30 is subnetted, 1 subnets
D 20.0.0.0 [110/20] via 30.0.0.1, 02:18:52, FastEthernet0/0
D 5.0.0.0/32 is subnetted, 1 subnets
D 5.5.5.5 [110/22] via 30.0.0.1, 02:18:53, FastEthernet0/0
D 6.0.0.0/32 is subnetted, 1 subnets
D 6.6.6.6 [118/2] via 12.0.0.2, 02:18:54, FastEthernet1/0
D 40.0.0.0/8 is variably subnetted, 2 subnets, 2 masks
D 40.0.0.0/30 [110/30] via 30.0.0.1, 02:18:55, FastEthernet0/0
D 40.0.0.0/22 is directly connected, FastEthernet0/1
D 10.0.0.0/30 is subnetted, 1 subnets
D 10.0.0.0 [110/11] via 30.0.0.1, 02:18:55, FastEthernet0/0
D 11.0.0.0/30 is subnetted, 1 subnets
D 11.0.0.0 [110/21] via 30.0.0.1, 02:18:55, FastEthernet0/0
D 12.0.0.0/30 is subnetted, 1 subnets
C 12.0.0.0 is directly connected, FastEthernet1/0
D 192.168.1.0/24 [110/31] via 30.0.0.1, 02:18:55, FastEthernet0/0
D 13.0.0.0/30 is subnetted, 1 subnets
D 13.0.0.0 [110/21] via 30.0.0.1, 02:18:55, FastEthernet0/0
D 192.168.2.0/24 [110/41] via 30.0.0.1, 02:18:55, FastEthernet0/0
D 14.0.0.0/30 is subnetted, 1 subnets
D 14.0.0.0 [110/31] via 30.0.0.1, 02:18:57, FastEthernet0/0
D 192.168.3.0/24 [110/21] via 12.0.0.2, 02:18:57, FastEthernet1/0
D 30.0.0.0/30 is subnetted, 1 subnets
C 30.0.0.0 is directly connected, FastEthernet0/0
D 15.0.0.0/30 is subnetted, 1 subnets
D 15.0.0.0 [110/11] via 12.0.0.2, 02:18:57, FastEthernet1/0

```

Tabla LFIB en router P1, P2 y P3

Local	Outgoing	Prefix	Bytes	tag	Outgoing	Next Hop
tag	tag or VC	or Tunnel Id	switched	switched	interface	interface
16	Pop tag	13.0.0.0/30	0	0	Fa1/0	10.0.0.2
17	Pop tag	2.2.2.2/32	22460	0	Fa0/0	20.0.0.2
18	Pop tag	4.4.4.4/32	0	0	Fa1/0	10.0.0.2
19	Pop tag	11.0.0.0/30	0	0	Fa0/0	20.0.0.2
20	Pop tag	40.0.0.0/30	0	0	Fa0/0	20.0.0.2
21	16	192.168.1.0/24	2251446	0	Fa1/0	10.0.0.2
22	Pop tag	12.0.0.0/30	0	0	Fa0/1	30.0.0.2
23	16	15.0.0.0/30	0	0	Fa0/1	30.0.0.2
24	19	14.0.0.0/30	0	0	Fa0/0	20.0.0.2
25	Pop tag	3.3.3.3/32	21276	0	Fa0/1	30.0.0.2
26	25	5.5.5.5/32	0	0	Fa0/0	20.0.0.2
27	17	6.6.6.6/32	0	0	Fa0/1	30.0.0.2
28	Pop tag	40.0.0.0/22	3185832	0	Fa0/1	30.0.0.2
29	29	192.168.2.0/24	3185832	0	Fa0/0	20.0.0.2
30	18	192.168.3.0/24	2935459	0	Fa0/1	30.0.0.2

Local	Outgoing	Prefix	Bytes	tag	Outgoing	Next Hop
tag	tag or VC	or Tunnel Id	switched	switched	interface	interface
16	Pop tag	10.0.0.0/30	0	0	Fa0/0	20.0.0.1
17	Pop tag	1.1.1.1/32	0	0	Fa0/0	20.0.0.1
18	Pop tag	30.0.0.0/30	0	0	Fa0/0	20.0.0.1
19	Pop tag	14.0.0.0/30	0	0	Fa1/0	11.0.0.2
20	16	13.0.0.0/30	0	0	Fa0/0	20.0.0.1
21	22	12.0.0.0/30	0	0	Fa0/0	20.0.0.1
22	23	15.0.0.0/30	0	0	Fa0/0	20.0.0.1
23	25	3.3.3.3/32	0	0	Fa0/0	20.0.0.1
24	18	4.4.4.4/32	0	0	Fa0/0	20.0.0.1
25	Pop tag	5.5.5.5/32	0	0	Fa1/0	11.0.0.2
26	27	6.6.6.6/32	0	0	Fa0/0	20.0.0.1
27	28	40.0.0.0/22	0	0	Fa0/0	20.0.0.1
28	21	192.168.1.0/24	786026	0	Fa0/0	20.0.0.1
29	16	192.168.2.0/24	3185832	0	Fa1/0	11.0.0.2
30	30	192.168.3.0/24	590	0	Fa0/0	20.0.0.1

Local	Outgoing	Prefix	Bytes	tag	Outgoing	Next Hop
tag	tag or VC	or Tunnel Id	switched	switched	interface	interface
16	Pop tag	15.0.0.0/30	0	0	Fa1/0	12.0.0.2
17	Pop tag	0.0.0.0/30	0	0	Fa1/0	12.0.0.2
18	16	192.168.3.0/24	2935459	0	Fa1/0	12.0.0.2
19	Pop tag	10.0.0.0/30	0	0	Fa0/0	30.0.0.1
20	Pop tag	20.0.0.0/30	0	0	Fa0/0	30.0.0.1
21	18	13.0.0.0/30	0	0	Fa0/0	30.0.0.1
22	19	11.0.0.0/30	0	0	Fa0/0	30.0.0.1
23	24	14.0.0.0/30	590	0	Fa0/0	30.0.0.1
24	Pop tag	1.1.1.1/32	0	0	Fa0/0	30.0.0.1
25	17	2.2.2.2/32	0	0	Fa0/0	30.0.0.1
26	18	4.4.4.4/32	0	0	Fa0/0	30.0.0.1
27	26	5.5.5.5/32	0	0	Fa0/0	30.0.0.1
28	20	40.0.0.0/30	0	0	Fa0/0	30.0.0.1
29	21	192.168.1.0/24	1466079	0	Fa0/0	30.0.0.1
30	29	192.168.2.0/24	0	0	Fa0/0	30.0.0.1

Confirmación de configuraciones en los Routers PE1, PE2 y PE3

Tabla LIB

```

PE1#sh mpls ldp bindings
t1h entry: 1.1.1.1/32, rev 12
  local binding: tag: 14
  remote binding: tar: 1.1.1.1:0, tag: ldp-null
t1h entry: 2.2.2.2/32, rev 14
  local binding: tag: 19
  remote binding: tar: 1.1.1.1:0, tag: 17
t1h entry: 3.3.3.3/32, rev 25
  local binding: tag: 25
  remote binding: tar: 1.1.1.1:0, tag: 25
t1h entry: 4.4.4.4/32, rev 4
  local binding: tag: ldp-null
  remote binding: tar: 1.1.1.1:0, tag: 18
t1h entry: 5.5.5.5/32, rev 26
  local binding: tag: 27
  remote binding: tar: 1.1.1.1:0, tag: 26
t1h entry: 6.6.6.6/32, rev 32
  local binding: tag: 28
  remote binding: tar: 1.1.1.1:0, tag: 27
t1h entry: 10.0.0.0/30, rev 5
  local binding: tag: ldp-null
  remote binding: tar: 1.1.1.1:0, tag: ldp-null
t1h entry: 11.0.0.0/30, rev 16
  local binding: tag: 20
  remote binding: tar: 1.1.1.1:0, tag: 19
t1h entry: 12.0.0.0/30, rev 22
  local binding: tag: 23
  remote binding: tar: 1.1.1.1:0, tag: 22
t1h entry: 13.0.0.0/30, rev 6
  local binding: tag: ldp-null
  remote binding: tar: 1.1.1.1:0, tag: 16
t1h entry: 14.0.0.0/30, rev 28
  local binding: tag: 25
  remote binding: tar: 1.1.1.1:0, tag: 24
t1h entry: 15.0.0.0/30, rev 34
  local binding: tag: 24
  remote binding: tar: 1.1.1.1:0, tag: 23
t1h entry: 20.0.0.0/30, rev 10
  local binding: tag: 17
  remote binding: tar: 1.1.1.1:0, tag: ldp-null
t1h entry: 30.0.0.0/30, rev 18
  local binding: tag: 21
  remote binding: tar: 1.1.1.1:0, tag: ldp-null
t1h entry: 40.0.0.0/30, rev 24
  local binding: tag: 22
  remote binding: tar: 1.1.1.1:0, tag: 20
t1h entry: 40.0.0.0/22, rev 34
  local binding: tag: 29
  remote binding: tar: 1.1.1.1:0, tag: 28
t1h entry: 192.168.1.0/24, rev 8
  local binding: tag: 16
  remote binding: tar: 1.1.1.1:0, tag: 21
t1h entry: 192.168.2.0/24, rev 16
  local binding: tag: 26
  remote binding: tar: 1.1.1.1:0, tag: 29
t1h entry: 192.168.3.0/24, rev 38
  local binding: tag: 31
  remote binding: tar: 1.1.1.1:0, tag: 30

PE2#sh mpls ldp bindings
t1h entry: 1.1.1.1/32, rev 18
  local binding: tag: 23
  remote binding: tar: 2.2.2.2:0, tag: 17
t1h entry: 2.2.2.2/32, rev 29
  local binding: tag: 22
  remote binding: tar: 2.2.2.2:0, tag: ldp-null
t1h entry: 3.3.3.3/32, rev 35
  local binding: tag: 25
  remote binding: tar: 2.2.2.2:0, tag: 24
t1h entry: 4.4.4.4/32, rev 22
  local binding: tag: 23
  remote binding: tar: 2.2.2.2:0, tag: 24
t1h entry: 5.5.5.5/32, rev 4
  local binding: tag: ldp-null
  remote binding: tar: 2.2.2.2:0, tag: 23
t1h entry: 6.6.6.6/32, rev 36
  local binding: tag: 26
  remote binding: tar: 2.2.2.2:0, tag: 28
t1h entry: 10.0.0.0/30, rev 12
  local binding: tag: 18
  remote binding: tar: 2.2.2.2:0, tag: 16
t1h entry: 11.0.0.0/30, rev 5
  local binding: tag: ldp-null
  remote binding: tar: 2.2.2.2:0, tag: ldp-null
t1h entry: 12.0.0.0/30, rev 13
  local binding: tag: 20
  remote binding: tar: 2.2.2.2:0, tag: 21
t1h entry: 13.0.0.0/30, rev 15
  local binding: tag: 20
  remote binding: tar: 2.2.2.2:0, tag: 20
t1h entry: 14.0.0.0/30, rev 6
  local binding: tag: ldp-null
  remote binding: tar: 2.2.2.2:0, tag: 19
t1h entry: 15.0.0.0/30, rev 34
  local binding: tag: 27
  remote binding: tar: 2.2.2.2:0, tag: 22
t1h entry: 20.0.0.0/30, rev 10
  local binding: tag: 17
  remote binding: tar: 2.2.2.2:0, tag: ldp-null
t1h entry: 30.0.0.0/30, rev 18
  local binding: tag: 19
  remote binding: tar: 2.2.2.2:0, tag: 18
t1h entry: 40.0.0.0/30, rev 24
  local binding: tag: 24
  remote binding: tar: 2.2.2.2:0, tag: ldp-null
t1h entry: 40.0.0.0/22, rev 37
  local binding: tag: 30
  remote binding: tar: 2.2.2.2:0, tag: 27
t1h entry: 192.168.1.0/24, rev 25
  local binding: tag: 25
  remote binding: tar: 2.2.2.2:0, tag: 28
t1h entry: 192.168.2.0/24, rev 8
  local binding: tag: 16
  remote binding: tar: 1.1.1.1:0, tag: 25
t1h entry: 192.168.3.0/24, rev 10
  local binding: tag: 31
  remote binding: tar: 2.2.2.2:0, tag: 30

PE3#sh mpls ldp bindings
t1h entry: 1.1.1.1/32, rev 26
  local binding: tag: 23
  remote binding: tar: 3.3.3.3:0, tag: 24
t1h entry: 2.2.2.2/32, rev 28
  local binding: tag: 26
  remote binding: tar: 3.3.3.3:0, tag: 25
t1h entry: 3.3.3.3/32, rev 10
  local binding: tag: 17
  remote binding: tar: 3.3.3.3:0, tag: ldp-null
t1h entry: 4.4.4.4/32, rev 30
  local binding: tag: 27
  remote binding: tar: 3.3.3.3:0, tag: 27
t1h entry: 5.5.5.5/32, rev 32
  local binding: tag: 18
  remote binding: tar: 3.3.3.3:0, tag: 27
t1h entry: 6.6.6.6/32, rev 4
  local binding: tag: ldp-null
  remote binding: tar: 3.3.3.3:0, tag: 17
t1h entry: 10.0.0.0/30, rev 17
  local binding: tag: 20
  remote binding: tar: 3.3.3.3:0, tag: 19
t1h entry: 11.0.0.0/30, rev 22
  local binding: tag: 23
  remote binding: tar: 3.3.3.3:0, tag: 22
t1h entry: 12.0.0.0/30, rev 5
  local binding: tag: ldp-null
  remote binding: tar: 3.3.3.3:0, tag: ldp-null
t1h entry: 13.0.0.0/30, rev 20
  local binding: tag: 22
  remote binding: tar: 3.3.3.3:0, tag: 21
t1h entry: 14.0.0.0/30, rev 24
  local binding: tag: 24
  remote binding: tar: 3.3.3.3:0, tag: 23
t1h entry: 15.0.0.0/30, rev 6
  local binding: tag: ldp-null
  remote binding: tar: 3.3.3.3:0, tag: 16
t1h entry: 20.0.0.0/30, rev 18
  local binding: tag: 21
  remote binding: tar: 3.3.3.3:0, tag: 20
t1h entry: 30.0.0.0/30, rev 32
  local binding: tag: 18
  remote binding: tar: 3.3.3.3:0, tag: ldp-null
t1h entry: 40.0.0.0/30, rev 34
  local binding: tag: 29
  remote binding: tar: 3.3.3.3:0, tag: 28
t1h entry: 40.0.0.0/22, rev 14
  local binding: tag: 19
  remote binding: tar: 3.3.3.3:0, tag: ldp-null
t1h entry: 192.168.1.0/24, rev 36
  local binding: tag: 30
  remote binding: tar: 3.3.3.3:0, tag: 29
t1h entry: 192.168.2.0/24, rev 8
  local binding: tag: 16
  remote binding: tar: 3.3.3.3:0, tag: 18

```

Interfaces habilitadas con MPLS en routers PE1, PE2 y PE3

```

PE3#sh mpls int
Interface      IP      Tunnel  Operational
FastEthernet0/0  Yes (ldp) No      Yes

PE2#sh mpls int
Interface      IP      Tunnel  Operational
FastEthernet0/0  Yes (ldp) No      Yes

PE3#sh mpls int
Interface      IP      Tunnel  Operational
FastEthernet0/0  Yes (ldp) No      Yes

```

Configuraciones en router CE1, CE2 y CE3

Tabla de ruta OSPF

```

Overview
CE1
1.0.0.0/32 is subnetted, 1 subnets
  1.1.1.1 [110/21] via 13.0.0.1, 04:39:33, FastEthernet0/0
2.0.0.0/32 is subnetted, 1 subnets
  2.2.2.2 [110/31] via 13.0.0.1, 04:39:33, FastEthernet0/0
3.0.0.0/32 is subnetted, 1 subnets
  3.3.3.3 [110/31] via 13.0.0.1, 04:39:33, FastEthernet0/0
4.0.0.0/32 is subnetted, 1 subnets
  4.4.4.4 [110/11] via 13.0.0.1, 04:39:33, FastEthernet0/0
20.0.0.0/30 is subnetted, 1 subnets
  20.0.0.0 [110/30] via 13.0.0.1, 04:39:33, FastEthernet0/0
5.0.0.0/32 is subnetted, 1 subnets
  5.5.5.5 [110/32] via 13.0.0.1, 04:39:32, FastEthernet0/0
6.0.0.0/32 is subnetted, 1 subnets
  6.6.6.6 [110/32] via 13.0.0.1, 04:39:34, FastEthernet0/0
7.0.0.0/32 is subnetted, 1 subnets
  7.7.7.7 is directly connected, Loopback0
40.0.0.0/8 is variably subnetted, 2 subnets, 2 masks
  40.0.0.0/30 [110/40] via 13.0.0.1, 04:39:35, FastEthernet0/0
  40.0.0.0/22 [110/40] via 13.0.0.1, 04:39:35, FastEthernet0/0
10.0.0.0/30 is subnetted, 1 subnets
  10.0.0.0 [110/30] via 13.0.0.1, 04:39:36, FastEthernet0/0
11.0.0.0/30 is subnetted, 1 subnets
  11.0.0.0 [110/31] via 13.0.0.1, 04:39:36, FastEthernet0/0
12.0.0.0/30 is subnetted, 1 subnets
  12.0.0.0 [110/31] via 13.0.0.1, 04:39:37, FastEthernet0/0
192.168.1.0/24 is directly connected, FastEthernet0/1
13.0.0.0/30 is subnetted, 1 subnets
  13.0.0.0 is directly connected, FastEthernet0/0
192.168.2.0/24 [110/51] via 13.0.0.1, 04:39:37, FastEthernet0/0
14.0.0.0/30 is subnetted, 1 subnets
  14.0.0.0 [110/41] via 13.0.0.1, 04:39:38, FastEthernet0/0
192.168.3.0/24 [110/51] via 13.0.0.1, 04:39:40, FastEthernet0/0
30.0.0.0/30 is subnetted, 1 subnets
  30.0.0.0 [110/30] via 13.0.0.1, 04:39:41, FastEthernet0/0
15.0.0.0/30 is subnetted, 1 subnets
  15.0.0.0 [110/41] via 13.0.0.1, 04:39:42, FastEthernet0/0

```

```

Overview
CE1
1.0.0.0/32 is subnetted, 1 subnets
  1.1.1.1 [110/51] via 14.0.0.1, 04:40:43, FastEthernet0/0
2.0.0.0/32 is subnetted, 1 subnets
  2.2.2.2 [110/21] via 14.0.0.1, 04:40:43, FastEthernet0/0
3.0.0.0/32 is subnetted, 1 subnets
  3.3.3.3 [110/41] via 14.0.0.1, 04:40:43, FastEthernet0/0
4.0.0.0/32 is subnetted, 1 subnets
  4.4.4.4 [110/32] via 14.0.0.1, 04:40:43, FastEthernet0/0
20.0.0.0/30 is subnetted, 1 subnets
  20.0.0.0 [110/30] via 14.0.0.1, 04:40:44, FastEthernet0/0
5.0.0.0/32 is subnetted, 1 subnets
  5.5.5.5 [110/11] via 14.0.0.1, 04:40:44, FastEthernet0/0
6.0.0.0/32 is subnetted, 1 subnets
  6.6.6.6 [110/42] via 14.0.0.1, 04:40:45, FastEthernet0/0
8.0.0.0/32 is subnetted, 1 subnets
  8.8.8.8 is directly connected, Loopback0
40.0.0.0/8 is variably subnetted, 2 subnets, 2 masks
  40.0.0.0/30 [110/30] via 14.0.0.1, 04:40:45, FastEthernet0/0
  40.0.0.0/22 [110/50] via 14.0.0.1, 04:40:45, FastEthernet0/0
10.0.0.0/30 is subnetted, 1 subnets
  10.0.0.0 [110/31] via 14.0.0.1, 04:40:45, FastEthernet0/0
11.0.0.0/30 is subnetted, 1 subnets
  11.0.0.0 [110/30] via 14.0.0.1, 04:40:45, FastEthernet0/0
12.0.0.0/30 is subnetted, 1 subnets
  12.0.0.0 [110/41] via 14.0.0.1, 04:40:45, FastEthernet0/0
192.168.1.0/24 [110/51] via 14.0.0.1, 04:40:45, FastEthernet0/0
13.0.0.0/30 is subnetted, 1 subnets
  13.0.0.0 [110/41] via 14.0.0.1, 04:40:46, FastEthernet0/0
192.168.2.0/24 is directly connected, FastEthernet0/1
14.0.0.0/30 is subnetted, 1 subnets
  14.0.0.0 is directly connected, FastEthernet0/0
192.168.3.0/24 [110/51] via 14.0.0.1, 04:40:47, FastEthernet0/0
30.0.0.0/30 is subnetted, 1 subnets
  30.0.0.0 [110/40] via 14.0.0.1, 04:40:47, FastEthernet0/0
15.0.0.0/30 is subnetted, 1 subnets
  15.0.0.0 [110/51] via 14.0.0.1, 04:40:47, FastEthernet0/0

```

```

Overview
CE2
1.0.0.0/32 is subnetted, 1 subnets
  1.1.1.1 [110/31] via 15.0.0.1, 04:41:57, FastEthernet0/0
2.0.0.0/32 is subnetted, 1 subnets
  2.2.2.2 [110/41] via 15.0.0.1, 04:41:57, FastEthernet0/0
3.0.0.0/32 is subnetted, 1 subnets
  3.3.3.3 [110/21] via 15.0.0.1, 04:41:57, FastEthernet0/0
4.0.0.0/32 is subnetted, 1 subnets
  4.4.4.4 [110/32] via 15.0.0.1, 04:41:57, FastEthernet0/0
20.0.0.0/30 is subnetted, 1 subnets
  20.0.0.0 [110/40] via 15.0.0.1, 04:41:59, FastEthernet0/0
5.0.0.0/32 is subnetted, 1 subnets
  5.5.5.5 [110/42] via 15.0.0.1, 04:41:59, FastEthernet0/0
6.0.0.0/32 is subnetted, 1 subnets
  6.6.6.6 [110/11] via 15.0.0.1, 04:41:59, FastEthernet0/0
9.0.0.0/32 is subnetted, 1 subnets
  9.9.9.9 is directly connected, Loopback0
40.0.0.0/8 is variably subnetted, 2 subnets, 2 masks
  40.0.0.0/30 [110/50] via 15.0.0.1, 04:42:00, FastEthernet0/0
  40.0.0.0/22 [110/30] via 15.0.0.1, 04:42:00, FastEthernet0/0
10.0.0.0/30 is subnetted, 1 subnets
  10.0.0.0 [110/31] via 15.0.0.1, 04:42:00, FastEthernet0/0
11.0.0.0/30 is subnetted, 1 subnets
  11.0.0.0 [110/41] via 15.0.0.1, 04:42:00, FastEthernet0/0
12.0.0.0/30 is subnetted, 1 subnets
  12.0.0.0 [110/20] via 15.0.0.1, 04:42:00, FastEthernet0/0
192.168.1.0/24 [110/51] via 15.0.0.1, 04:42:00, FastEthernet0/0
13.0.0.0/30 is subnetted, 1 subnets
  13.0.0.0 [110/41] via 15.0.0.1, 04:42:00, FastEthernet0/0
192.168.2.0/24 [110/51] via 15.0.0.1, 04:42:02, FastEthernet0/0
14.0.0.0/30 is subnetted, 1 subnets
  14.0.0.0 [110/51] via 15.0.0.1, 04:42:02, FastEthernet0/0
192.168.3.0/24 is directly connected, FastEthernet0/1
30.0.0.0/30 is subnetted, 1 subnets
  30.0.0.0 [110/30] via 15.0.0.1, 04:42:02, FastEthernet0/0
15.0.0.0/30 is subnetted, 1 subnets
  15.0.0.0 is directly connected, FastEthernet0/0

```

Configuración de la red para la transmisión multicast de video en roters CE1, CE2 y CE3. Tabla de rutas multicast en CE3 sin transmisión de video donde se identifica que el router P1 con interfaz lo 1.1.1.1 es el punto de encuentro.

```

CE3#sh ip mroute
IP Multicast Routing Table
Flags: D - Dense, S - Sparse, B - Bidir Group, s - SSM Group, C - Connected,
      L - Local, P - Pruned, R - RP-bit set, F - Register flag,
      T - SPT-bit set, J - Join SPT, M - MSDP created entry,
      X - Proxy Join Timer Running, A - Candidate for MSDP Advertisement,
      U - URD, I - Received Source Specific Host Report,
      Z - Multicast Tunnel, z - MDT-data group sender,
      Y - Joined MDT-data group, y - Sending to MDT-data group
Outgoing interface flags: H - Hardware switched, A - Assert winner
Timers: Uptime/Expires
Interface state: Interface, Next-Hop or VCD, State/Mode

(*, 239.255.255.250), 04:33:58/00:02:02, RP 1.1.1.1, flags: SJC
  Incoming interface: FastEthernet0/0, RPF nbr 15.0.0.1
  Outgoing interface list:
    FastEthernet0/1, Forward/Sparse, 04:33:58/00:02:02

(*, 224.0.1.40), 05:10:08/00:02:58, RP 1.1.1.1, flags: SJCL
  Incoming interface: FastEthernet0/0, RPF nbr 15.0.0.1
  Outgoing interface list:
    Loopback0, Forward/Sparse, 05:10:08/00:02:58

```

La misma tabla Mroute pero con la trasmisión de video

```

PE1  CE2  CE3
CE3#sh ip mroute
IP Multicast Routing Table
Flags: D - Dense, S - Sparse, B - Bidir Group, s - SSM Group, C - Connected,
      L - Local, P - Pruned, R - RP-bit set, F - Register flag,
      T - SPT-bit set, J - Join SPT, M - MSDP created entry,
      X - Proxy Join Timer Running, A - Candidate for MSDP Advertisement,
      U - URD, I - Received Source Specific Host Report,
      Z - Multicast Tunnel, z - MDT-data group sender,
      Y - Joined MDT-data group, y - Sending to MDT-data group
Outgoing interface flags: H - Hardware switched, A - Assert winner
Timers: Uptime/Expires
Interface state: Interface, Next-Hop or VCD, State/Mode

(*, 239.255.255.250), 00:33:42/00:02:01, RP 1.1.1.1, flags: SJC
  Incoming interface: FastEthernet0/0, RPF nbr 15.0.0.1
  Outgoing interface list:
    FastEthernet0/1, Forward/Sparse, 00:33:42/00:02:01

(*, 236.1.1.1), 00:00:15/stopped, RP 1.1.1.1, flags: SJC
  Incoming interface: FastEthernet0/0, RPF nbr 15.0.0.1
  Outgoing interface list:
    FastEthernet0/1, Forward/Sparse, 00:00:15/00:02:44

(192.168.1.2, 236.1.1.1), 00:00:17/00:02:50, flags: JT
  Incoming interface: FastEthernet0/0, RPF nbr 15.0.0.1
  Outgoing interface list:
    FastEthernet0/1, Forward/Sparse, 00:00:17/00:02:42

(*, 224.0.1.40), 00:36:03/00:02:52, RP 1.1.1.1, flags: SJCL
  Incoming interface: FastEthernet0/0, RPF nbr 15.0.0.1
  Outgoing interface list:
    Loopback0, Forward/Sparse, 00:36:03/00:02:52

```

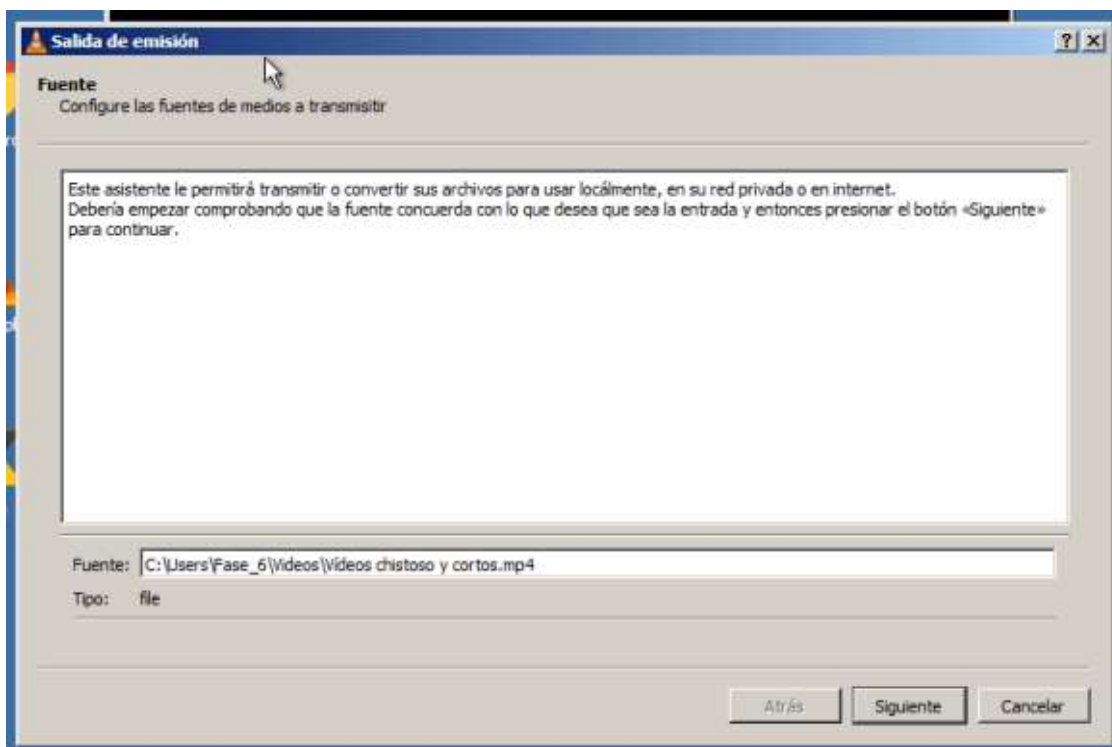
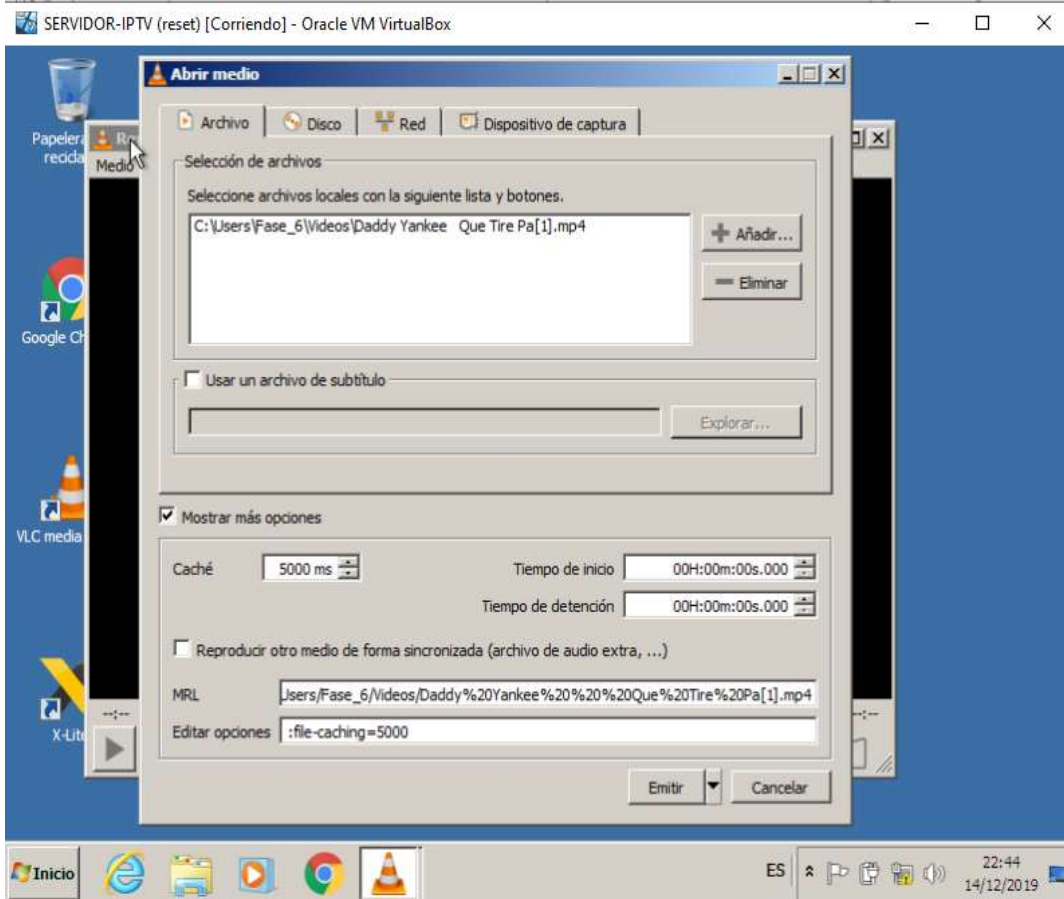

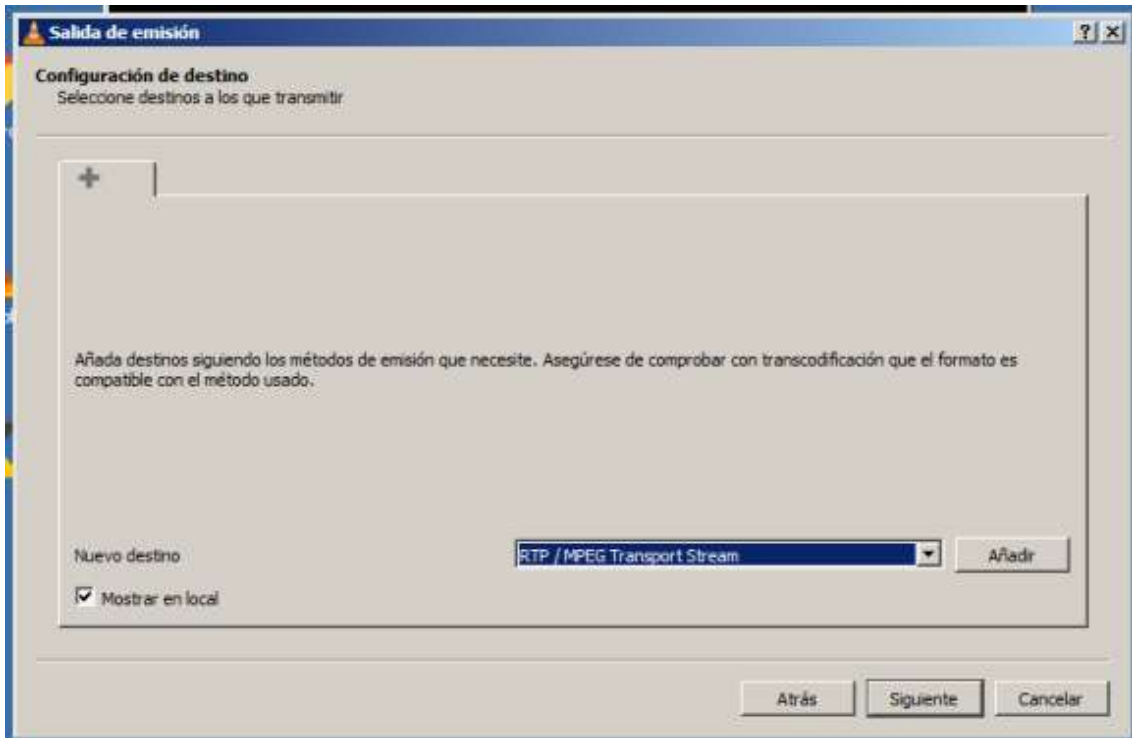

Seleccionando la dirección de multicast RTP

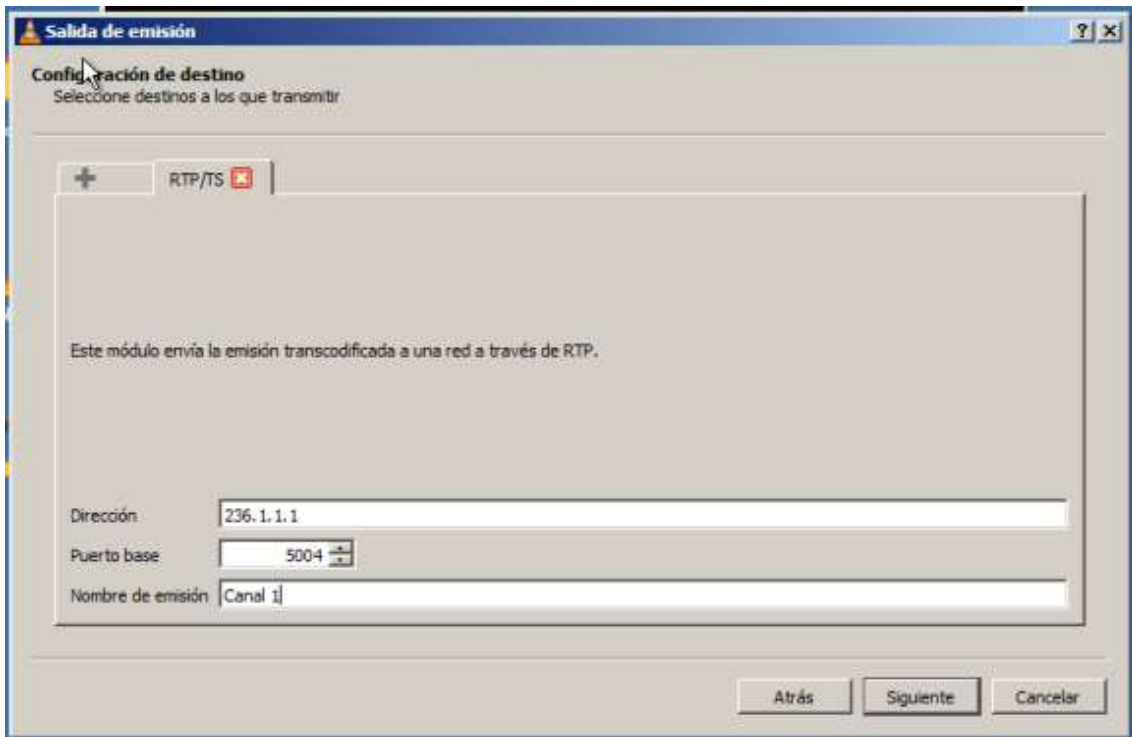

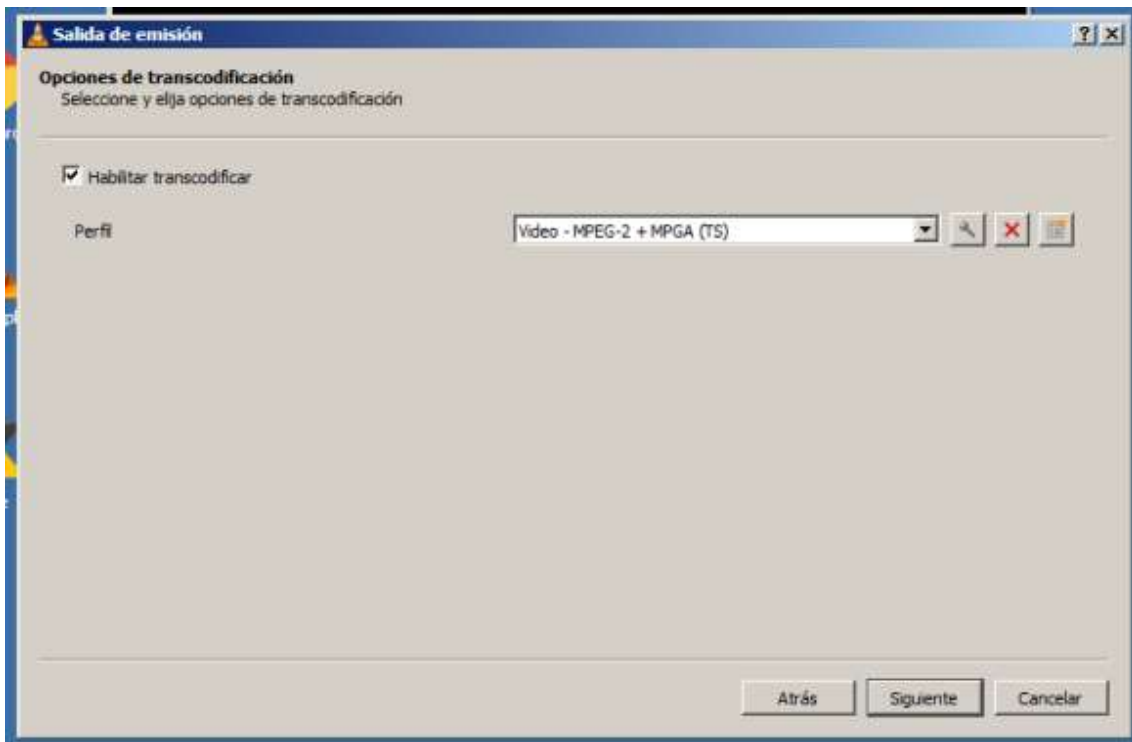

En las preferencias se ajustó el TTL=10 dado que viene por defecto en 1 y de esta forma no al cansaría los routers de las sedes remotas

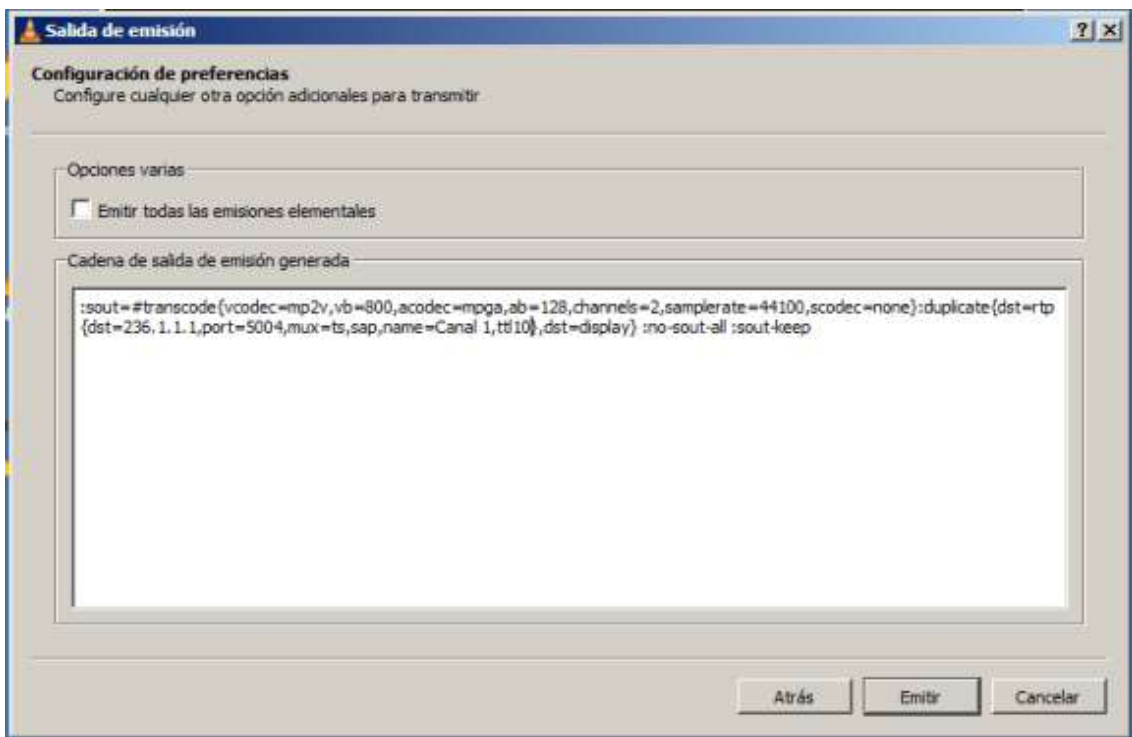

Reproducción del streaming en el servidor

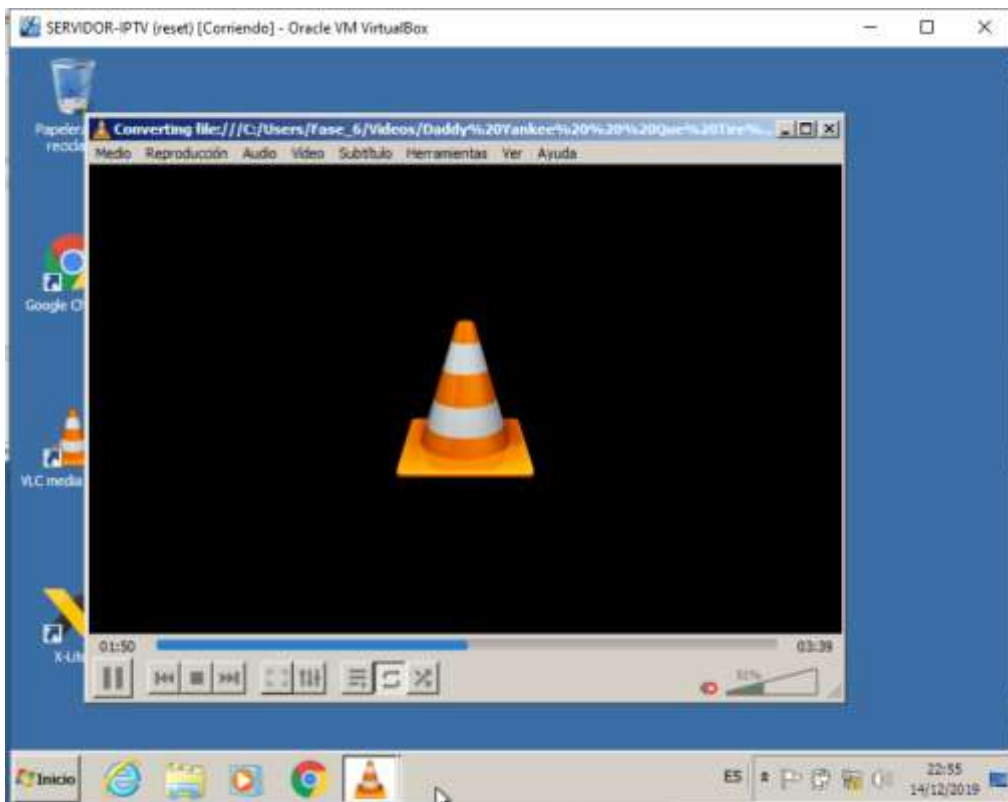

Configuración de los clientes para el caso se eligió la terminal de barranquilla

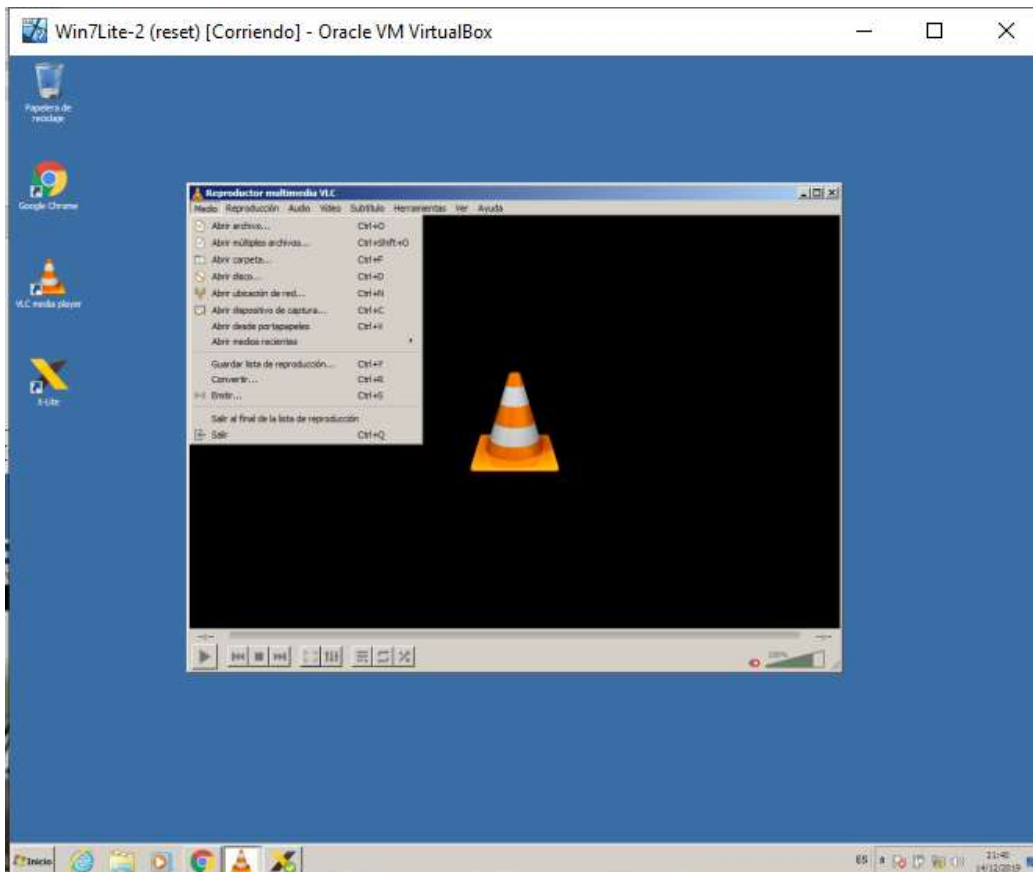

Configuración del RTP del servidor

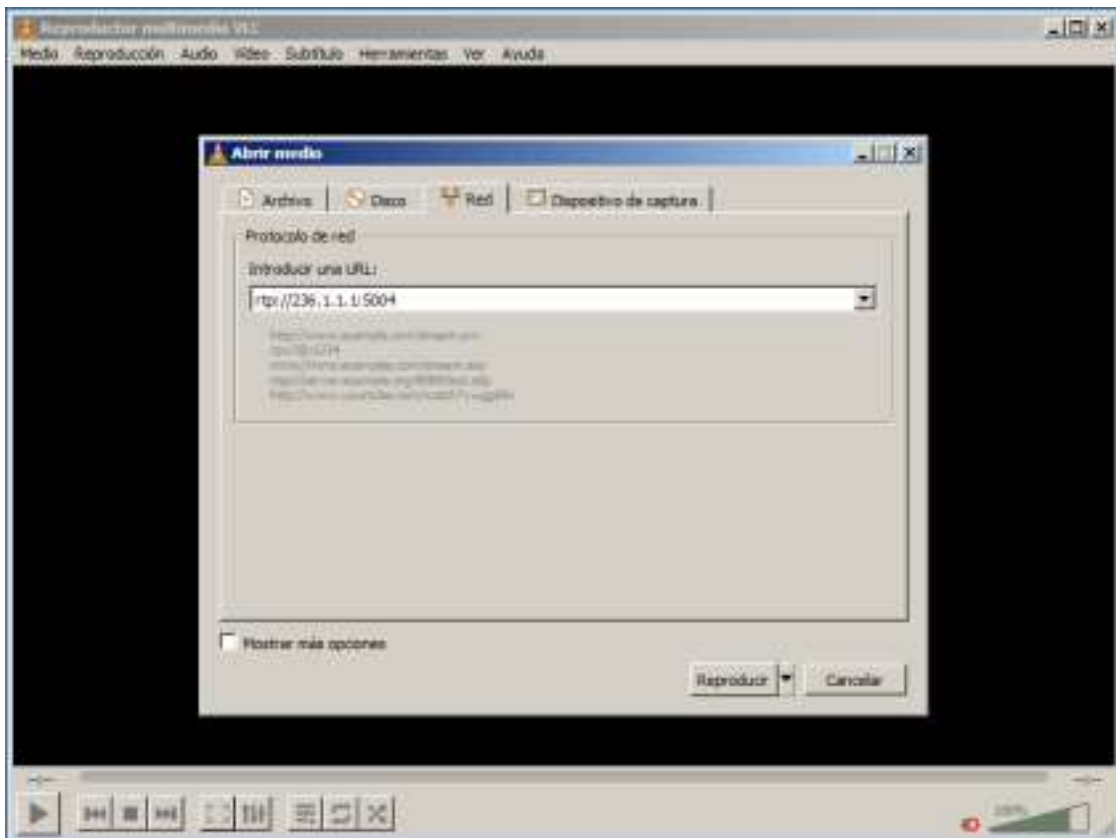

Captura del video multicast rtp desde el cliente



➤ **Un plan de calidad de servicios QoS que defina los siguientes porcentajes sobre el ancho de banda total (separar tráfico mediante definición de clases):**

- 10% del ancho de banda total para tráfico web
- 15% para tráfico de voz
- 20% para tráfico de streaming de video.

Para aplicar el plan de QoS, se aplicó las siguientes configuraciones en cada Reuter cliente (CE1, CE2 y CE3) con el fin de distribuir la carga de procesamiento y análisis de paquetes, por ultimo se aplicó la política a la interface de salida de dichos Reuters fa0/0 para garantizar los anchos de banda y prioridades requeridas

Listas de acceso

```
access-list 100 permit udp any any range 16384 32000
access-list 101 permit tcp any any eq www
access-list 101 permit tcp any any eq 443
access-list 102 permit udp any any eq 5004
access-list 103 permit icmp any any
no cdp log mismatch duplex
!
```

Clases y políticas ajustadas por % teniendo en cuenta que los enlaces son de 100 Mbps

```
!
class-map match-all VOIP
 match access-group 100
class-map match-all PING
 match access-group 103
class-map match-all IPTV
 match access-group 102
class-map match-all WEB
 match access-group 101
!
!
policy-map QoS1
 class VOIP
  priority percent 15
 class WEB
  bandwidth percent 10
 class IPTV
  bandwidth percent 20
 class PING
  bandwidth percent 2
 class class-default
  fair-queue
!
```

Aplicación de política QoS en las interfaces fa0/0 de todos los CE

```
!
interface FastEthernet0/0
ip address 13.0.0.2 255.255.255.252
ip pim sparse-mode
duplex auto
speed auto
service-policy output QoS1
!
```

```
!
interface Loopback0
ip address 8.8.8.8 255.255.255.255
ip pim sparse-mode
!
interface FastEthernet0/0
ip address 14.0.0.2 255.255.255.252
ip pim sparse-mode
duplex auto
speed auto
service-policy output QoS1
!
```

```
!
interface Loopback0
ip address 9.9.9.9 255.255.255.255
ip pim sparse-mode
!
interface FastEthernet0/0
ip address 15.0.0.2 255.255.255.252
ip pim sparse-mode
duplex auto
speed auto
service-policy output QoS1
!
```

Nota:

Erros de exportación archivo fuente GNS3, al intentar exportar el proyecto o topología para compartir la simulación, el programa GNS3 arroja un error indicando que no puede exportar la topología por tener imágenes virtuales clonadas por lo que compartimos archivo previo de la simulación y archivos .txt con la configuración final de cada Reuter al igual que las imágenes de las maquinas virtuales utilizadas en la actividad

Adjunto imagen del error entregado por GNS3

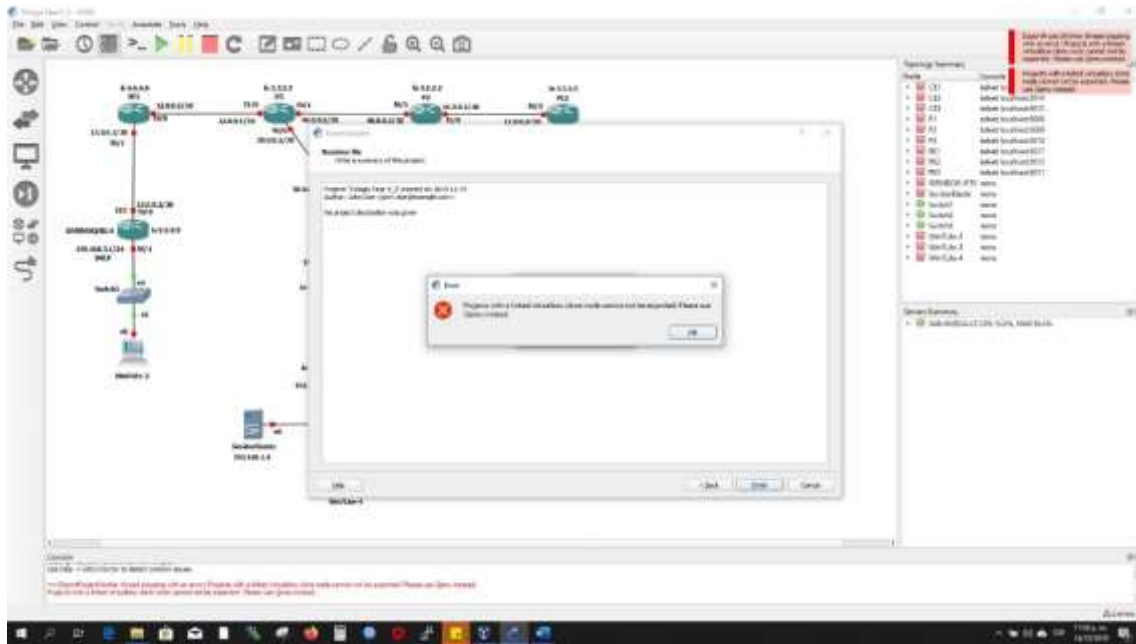

Link para consultar los archivos de configuración

https://drive.google.com/drive/folders/1kY8XuC6afHXZTXuNhVxHSrzmGh_2wQra?usp=sharing

CONCLUSIONES

Mediante la elaboración de actividades como las observadas anteriormente, se logra poner en práctica todo lo visto durante el transcurso del diplomado en redes de nueva generación, logrando así establecer un aprendizaje más efectivo ya que se evoca lo realizado en actividades anteriores, y se pasa a un concepto más práctico que si lo tenemos en cuenta la práctica es la que hace al maestro.

BIBLIOGRAFÍA

- Gallon, A. R. (01 de 2012). Obtenido de <http://dtm.unicauca.edu.co/pregrado/conmutacion/transp/8-MPLS.pdf>
- Lavado, G. (29 de 01 de 2015). *Slideshare*. Obtenido de Calidad de Servicio IP-MPLS v2.2: <https://es.slideshare.net/GianpietroLavado/calidad-de-servicio-ip-mpls-v22>
- Movil, E. (04 de 2012). *Edad Movil*. Obtenido de <https://edadmovil.wordpress.com/casos-de-desarrollo/implementacion-ims/arquitectura-ims/>