

Review

# Electronics and Its Worldwide Research

Rosa M. García Salvador , Nuria Novas , Alfredo Alcayde , Dalia El Khaled  and Francisco G. Montoya \* 

Department of Engineering, ceiA3, University of Almeria, 04120 Almeria, Spain; rgarciasalvador@ual.es (R.M.G.S.); nnovas@ual.es (N.N.); aalcayde@ual.es (A.A.); dalia.elkhaled@gmail.com (D.E.K.)

\* Correspondence: pagilm@ual.es

Received: 3 May 2020; Accepted: 8 June 2020; Published: 11 June 2020



**Abstract:** The contributions of researchers at a global level in the journal *Electronics* in the period 2012–2020 are analyzed. The objective of this work is to establish a global vision of the issues published in the *Electronic* magazine and their importance, advances and developments that have been particularly relevant for subsequent research. The magazine has 15 thematic sections and a general one, with the programming of 385 special issues for 2020–2021. Using the Scopus database and bibliometric techniques, 2310 documents are obtained and distributed in 14 thematic communities. The communities that contribute to the greatest number of works are Power Electronics (20.13%), Embedded Computer Systems (13.59%) and Internet of Things and Machine Learning Systems (8.11%). A study of the publications by authors, affiliations, countries as well as the H index was undertaken. The 7561 authors analyzed are distributed in 87 countries, with China being the country of the majority (2407 authors), followed by South Korea (763 authors). The H-index of most authors (75.89%) ranges from 0 to 9, where the authors with the highest H-Index are from the United States, Denmark, Italy and India. The main publication format is the article (92.16%) and the review (5.84%). The magazine publishes topics in continuous development that will be further investigated and published in the near future in fields as varied as the transport sector, energy systems, the development of new broadband semiconductors, new modulation and control techniques, and more.

**Keywords:** Internet of Things; field programmable gate array; Raspberry Pi; 5G; deep learning; convolutional neural network; wireless sensor network

## 1. Introduction

The *Electronics* magazine publishes topics of special interest that cover different areas, such as power electronics [1], the design of photovoltaic systems integrated by optimal control mechanisms [2], the development of new energy converters [3], the development of electric vehicles [4], as well as the study of new semiconductors that allow for devices with higher performance [5]. Other widely developed lines of research are those related to optoelectronics [6], biomedical applications [7] and wireless communications [8]. In these areas, numerous investigations have been established that seek to establish more efficient, safe and ecological communication systems allowing for the extension of the concept of the “Internet of Things” to a greater number of smart devices and applications. Devices such as GPUs, DPSs and microcontrollers, along with other powerful computing tools, have also been used in several of these publications. These devices are not studied in depth in this work as they are not part of the most important publications according to the relationships they present. However, they contribute in the achievement of the objectives set in the publications based on digital processing, embedded computing systems, new methods or automatic learning. The importance and variability of the published topics is amply reflected in this work, with the “*Electronics*” magazine representing a

world reference for quality research, and future works that cover the existing challenges so far, or open new lines of research.

The Electronics magazine is embedded in the profile of Computers and Electrical Engineering in the Engineering, Electrical and Electronic category. This category covers resources dealing with applications of electricity, image and signal processing, electromagnetization, electronic components and materials, microwave technology, and microelectronics. Electronics belongs to the Computer Science subareas: Hardware and Architecture (position 35 of 150 in 2018), Computer Networks and Communications (position 73 of 272 in 2018), and Signal Processing (position 33 of 97 in 2018) and the Engineering subareas: Electrical and Electronic Engineering (position 162 of 658 in 2018), and Control and Systems Engineering (position 71 of 233 in 2018). Figure 1 shows the evolution in the Engineering, Electrical and Electronic category and the outstanding position of Electronics upon its incorporation in 2017 to the category in position 107. It has been represented since its inception in 1997 with 193 magazines up to 266 magazines registered in 2018 in this category. It also joined the second quartile (2017) and dropped to the third quartile in the following year.

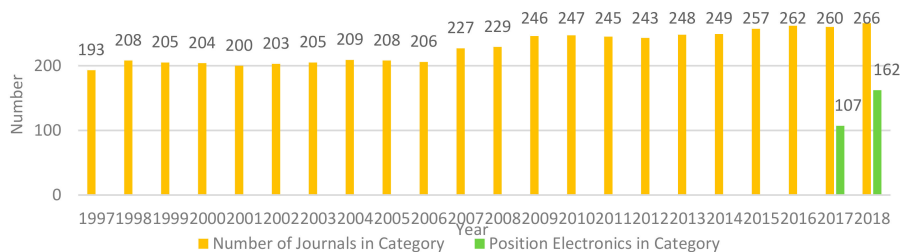

Figure 1. Evolution of the Engineering, Electrical and Electronic category and relationship with the journal Electronics.

Until 2001, there were no data on the number of articles published. In 2001 and 2003, 25,659 and 30,277 documents were published, respectively. From 2005 (30,366 articles, 4.47% of the registered total) to 2018 (70,247 articles, 10.34% of the registered total) 679,516 articles were published, producing a gradual increase of 10.15% with respect to the first value registered in 2001 (Figure 2). The number of citations has followed a similar relationship to the number of articles, the more documents published, the greater the number of citations. The annual percentage was somewhat lower until 2013 with 6.82% in citations (930,393 citations) and 6.77% in documents (46,030 documents), as of 2014 the increase in citations in percentage is greater than the increase in published documents reaching 14.14%, with 1,942,589 citations in 2018. If we relate the number of articles and number of citations obtained at the beginning, there is a 0.07 relationship that remains until 2007 and then falls to 0.05, in 2008 it follows an evolution in gradually decreasing until it reached 0.04 in 2018. This implies that each time the relationship between the percentage increases in documents, a similar proportion in citations contributions is not incorporated.

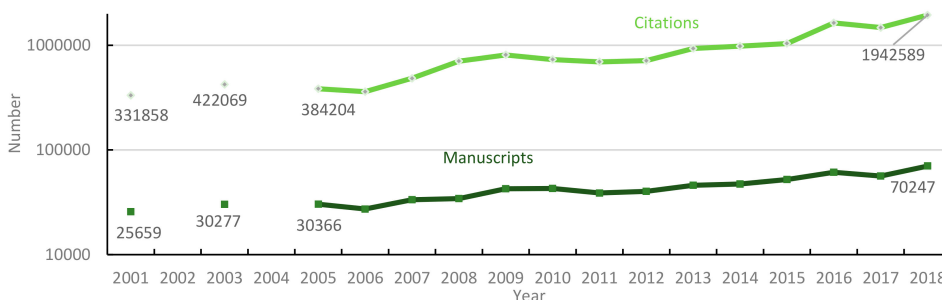

Figure 2. Evolution of citations and articles in the category Engineering, Electrical and Electronic.

In Figure 3, the most significant milestones since the foundation of the journal and their relation to the number of articles published are shown. Electronics was founded in 2012, and three years later it was added to the Scopus indexed database (2015), and later in 2017, it joined the Science Citation Index Expanded (SCIE) in the second quartile. In the same year, it began with the Outstanding Reviewer Award and Travel Award. In 2018, it obtained Journal Citation Reports (JCR 2017) of 2.110, positioning it in the second quartile, at position 113 of 260 journals in the Engineering, Electrical and Electronic category, although the figure marked this event in 2017, as it is known one year late. In 2018, Electronics was divided into eleven topical sections: Microelectronics and Optoelectronics, Power Electronics, Bioelectronics, Microwave and Wireless Communications, Computer Sciences and Engineering, Networks, Systems and Control Engineering, Circuit and Signal Processing, Semiconductors and Quantum, Artificial Intelligence, Electrical and Autonomous Vehicles. In 2019, it reached 2000 papers and received the Impact Factor 2018 of 1.764 (154/265 (Q3)) in “Engineering, Electrical and Electronic” and the Cite Score 2018 of 2.49. Electronics divided Semiconductors and Quantum Section into Semiconductor Devices Section and Quantum Electronics Section. Now, there are fifteen sections within the scope of the journal. Electronics sponsored, had the exhibition booth, and met their editorial board members, guest editors, authors, reviewers and readers at the conferences ELECTRIMACS 2019 and IEDM 2019.

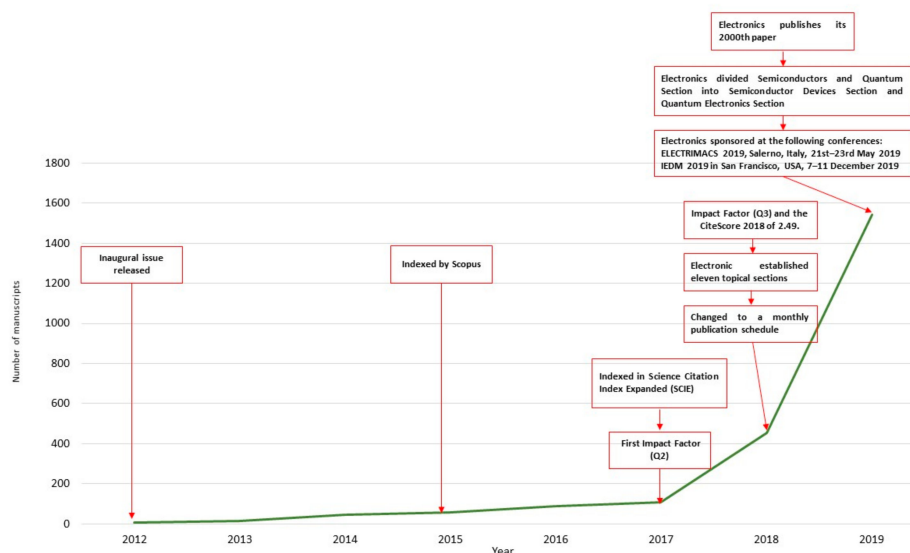

Figure 3. Journal history.

Electronics is a journal that promotes publication in 15 thematic areas and a general one as shown:

1. Microelectronics and Optoelectronics
2. Power Electronics
3. Bioelectronics
4. Microwave and Wireless Communications
5. Computer Science and Engineering
6. Networks
7. Systems and Control Engineering
8. Circuit and Signal Processing
9. Semiconductor Devices
10. Artificial Intelligence
11. Electrical and Autonomous Vehicles
12. Quantum Electronics

13. Organic Electronics
14. Artificial Intelligence Circuits and Systems (AICAS)
15. Industrial Electronics
16. General

Each thematic area includes different topics. Based on the thematic areas, the journal managed 385 Special Issues between 2020 and 2021 and 2772 documents published until April 2020. In Figure 4, the distribution by percentage of the articles according to sections is represented. The three sections with the most publications are the most generic, such as Microwave and Wireless Communications with 550 documents (19.80%), Power Electronics with 466 published documents (16.80%) and Computer Science and Engineering with 459 documents (16.57%), and the rest of sections have contributions of less than 231 documents. In Figure 5, the distribution of special issues is represented according to section. The three sections with the highest special issues are the same with the highest published documents, but the position of the second changes with the third: Microwave and Wireless Communications with 550 special issues (16.36%), Computer Science and Engineering with 79 special issues (16.56%) and Power Electronics with 55 special issues (14.29%), the rest of the sections have contributions of less than 43 special issues.

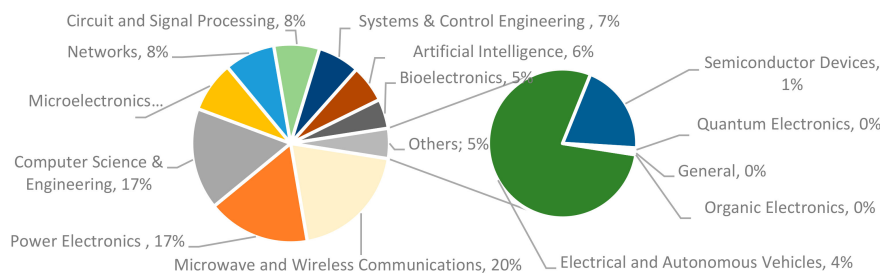

Figure 4. Distribution of manuscripts by section.

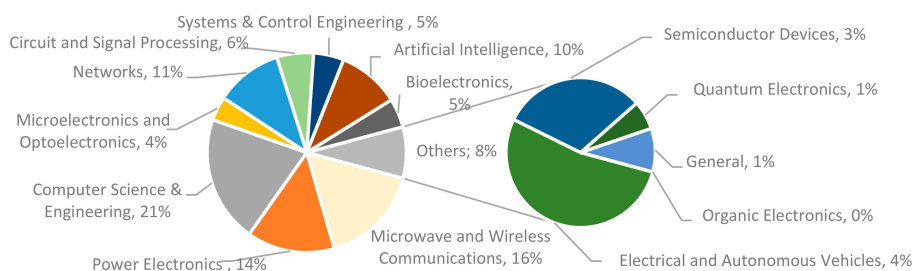

Figure 5. Distribution of special issues by section.

In Figure 6, the relationship between the documents published and the number of citations received on a logarithmic scale is observed to highlight the low values with respect to the maximums that, on a linear scale, would not be appreciated. Both documents and citations maintain different distributions, the number of citations has a potential relationship adjusting to the  $R^2$  trend of 0.99, and the distribution of publications maintains an exponential relationship with the years, adjusting  $R^2$  to 0.95. There is also a relationship in regards to citations/published documents: the greater the number of published documents, the greater the number of citations, and the relationship between the two is not uniform, as it increased to a maximum of 6.77 in 2017 and then decreased to 2.37 in 2019. The decrease coincides with the incorporation of the journal in the Journal Citation Reports.

The objective of this work is to establish a global vision of the issues published in the Electronic magazine and their importance, advances and developments that have been particularly relevant for subsequent research.

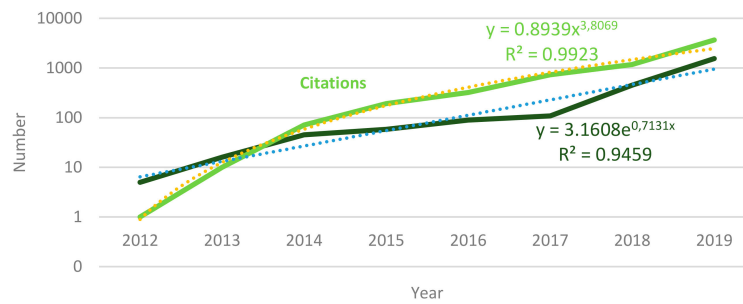

Figure 6. Distribution of published documents and citations per year on a logarithmic scale.

## 2. Materials and Methods

This work studies all the scientific publications published in the Electronics journal, which have been indexed in the Scopus database. Elsevier’s Scopus is selected from the existing databases, since it is the scientific database with the greatest contributions to publications worldwide [9]. To obtain automatic bibliographic data, an API interface is used in top of the crawler *rasNetBot*, developed by the research group of the Department of Electrical Engineering at the University of Almería (Spain) [10]. The word used in the search is the ISSN of the Electronics magazine. “ISSN (20799292)”, obtaining a large number of documents and relationships, which are analyzed using community detection algorithms and are represented graphically, using *Gephi* open source software [11].

## 3. Results and Discussion

### 3.1. Community Establishment

Figure 7a shows the result of the search established by the string “ISSN (20799292)”, obtaining a total of 2310 documents with a total of 1463 relationships, comprising publications established in the journal from 2012 to 2019. Each publication is represented by a node whose size is proportional to the cites received. A link between two nodes indicates that one of them cited the other and the distance between them represents the existing collaboration. A filtering process was applied to the total number of documents, which made it possible to eliminate those that were not cited by any other paper, due to the lack of collaboration ties between the authors. After this process, the documents that were located on the periphery were filtered from the Figure 7a,b were obtained.

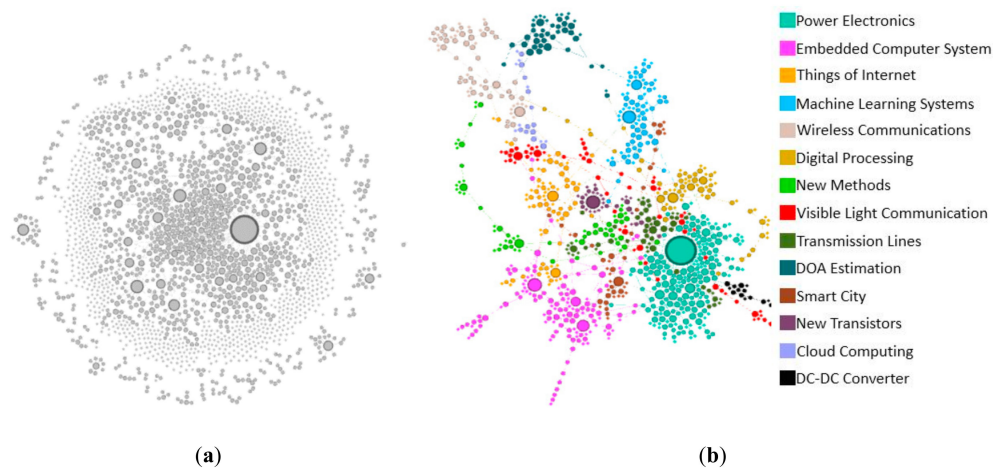

Figure 7. Representations for the node relationships. (a) Total node graph. (b) Node without citations filtered and colored communities.



keywords of the communities to which they are named, as is the case of “DC-DC Converter” in the smallest community, as well as words that are predominant due to their use in different communities such as “Raspberry Pi” in the “Embedded Computer system” community, or “Deep Learning” and “Convolutional Neural Network” in the “Machine Learning Systems” community.

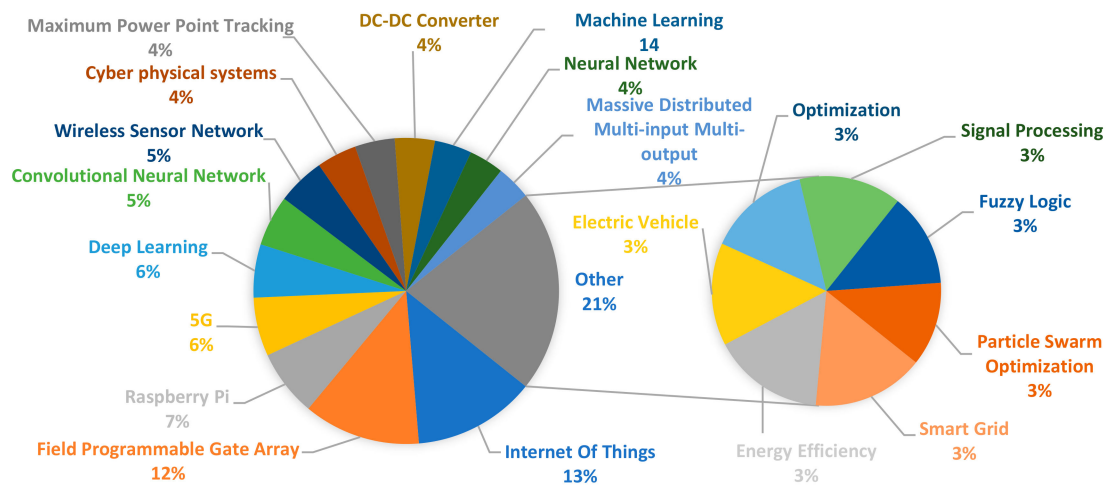

Figure 10. Representation of the 20 most repeated global keywords.

### 3.2. Community Analysis

Each community maintains a common theme, although it is closely interrelated with the rest of the communities. The main nodes of each community and their most significant contributions, according to their size, were analyzed in order to understand their research field in depth.

Power Electronics Community is formed by research that studies the latest applications developed in the field of Power Electronics, such as motor control, energy converters, or photovoltaic systems. The spatial distribution of this community is shown in Figure 11a, where the size of the nodes is related to the importance of the publication. It is the largest community with 20.13% of the total number of works and with a very compact distribution, with numerous relationships between the works that comprise it. In Figure 11b, the 10 most repeated keywords in this community are represented, the most repeated being “Maximum Power Point Tracking”, followed by “DC-DC Converter” and “Field Programmable Gate Array”, all these words constitute the main lines of research developed in power electronics.

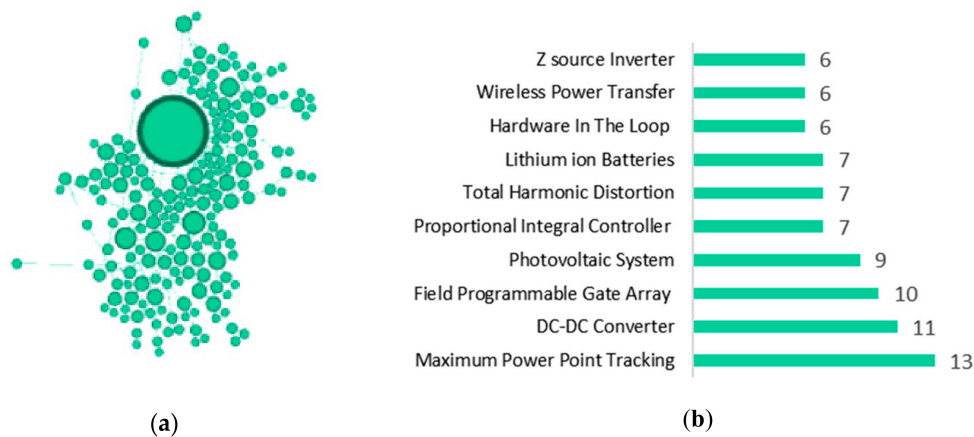

Figure 11. Representation of the Power Electronics community: (a) Isolated distribution of publications. (b) Keywords of the community.

In this community, the main node stands out with a size considerably larger than the rest, with which it establishes relationships to a greater or lesser extent. This main node is [12], a special issue that addresses the latest advancements in power electronics. It includes areas such as fault diagnosis and reliability, a topic widely studied in order to extend the life of power systems. Work has been carried out on open-circuit fault diagnosis and fault tolerance control of three-phase active rectifiers, strategies for fault-tolerant control of induction motors of different phases [2] and reviews on the status of lithium ion batteries for electric vehicles [13].

Nowadays, more and more devices are equipped with power electronics systems for their activation. This is one of the reasons why an approach is being developed to improve the performance and stability of motor drive systems through control systems. Some of the work carried out in this field aims to improve performance of dual three-phase permanent magnet synchronous motors (PMSM), or use active vector modulation to improve the control scheme [14]. Bypass power filter design methodologies have been developed, or cycle controllers. The performance of dual active converters for isolated power converters is also evaluated, as well as the use of digital control techniques for inverters that can be used in renewable energy applications. Power electronics are widely used in photovoltaic applications, for which a three-level step-up converter using FPGAs can be used, or photovoltaic inverter controllers can be developed, that improve the quality of the solar energy supply. An example of this is the design of a Bi-reflector solar photovoltaics system (BRPVS) for building integrated photovoltaics (BIPV). Effective power conditioning for BIPV is crucial, using a booster DC-DC converter that boosts the voltage and tracks the peak of the output power in real time [15].

Energy management involves the application of different power systems, from the modeling of electrical circuits to double-layer capacitors for energy storage, introducing enhancements to the State of charge (SoC) estimation using optimization and appropriate filtering methods in [16]. The development of a hybrid energy source is also a topic of special interest in this community [17]. This source is made up of a system consisting of a supercapacitor (SC) and a lithium ion battery bank. The system consists of a quick charging circuit with fuzzy logic controller (FLC) and fuzzy logic-based intelligent energy management system (FLIEMS). This device allows a user to decrease the loading time of systems such as the electric powered wheelchair (EPW), regulating the energy profile of the battery to be able to use it when a fast charge or discharge is needed. The FLC control system allows a user to reduce existing voltage differences, avoid overcharging and improve battery efficiency. The objective of this area is to achieve a safer operation of the batteries, with an efficient management of their charge and discharge.

One of the applications receiving increasing interest in recent times is the development of innovative control strategies for hybrid AC-DC and AC-DC microgrids. In this area, harmonic linearization techniques have been implemented to analyze the stability of an AC microgrid in the sequence domain, as well as mechanisms for microgrids based on renewable energy [18].

The dead time in the activation signal in power converters has also been a growing line of research in recent times. This is the main theme of the second most important publication of this community [19], where negative effects of presence in the system are studied, such as current distortion, or voltage reduction at the fundamental output frequency. To mitigate these effects, different control strategies have been developed with state-of-the-art dead time compensation algorithms. This compensation affects the output performance, stability, and reliability of the control system, so further investigation is required [20].

Embedded Computer System Community includes publications with a theme related to Embedded Computing Systems (ECS), its general considerations, applications, as well as the open source systems that can be used. The treated subject covers diverse disciplines, which is the reason why the spatial distribution of this community is wide, as observed in Figure 12a. It is the second largest community, in relation to the rest of the communities, made up of 13.59% of the total papers. In Figure 12b, the 10 most repeated keywords in this community are represented, the most frequent word being Internet of Things (IoT), being the main application of ECS. The next most popular word is Raspberry Pi, the main



ECS system used in most research. The rest of the words reflect the variability of the applications developed with these systems.

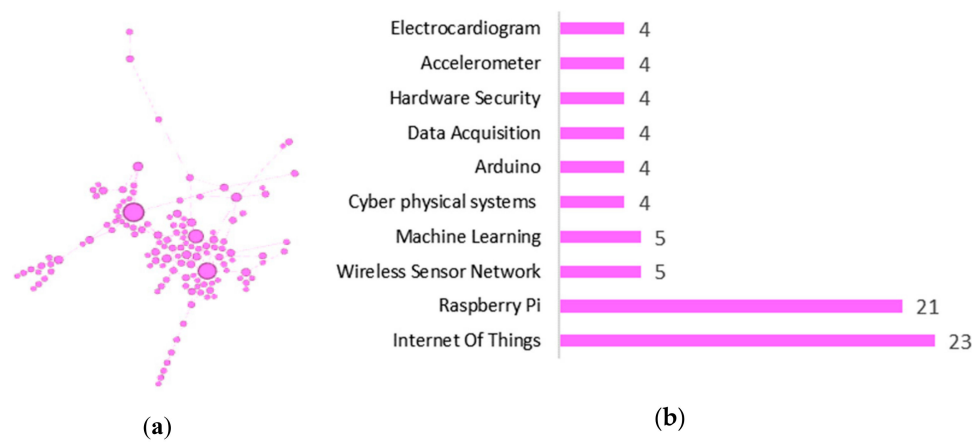

**Figure 12.** Representation of the Embedded Computer System community: (a) Isolated distribution of publications. (b) Keywords of the community.

In the spatial distribution of this community, three publications can be seen with a node of a size considerably larger than the rest. One of these reference nodes is [21], a publication presenting the capabilities of one of the most researched ECS in recent years, the Raspberry Pi. This device is known as a single-board computer (SBC), it runs a full operating system, and it has enough peripherals to start running without additional hardware. The Raspberry Pi can support multiple operating systems and can connect to various electronic components. All these features along with low-cost hardware and easy availability have fueled its increasing development and popularity. The predominant use of the Raspberry Pi is in the educational field, so it is included in numerous schools [22], universities and research facilities [23]. Other reference node is [24], it exposes different applications of these systems in the field of biomedicine. Innovative sensors, detection platforms and adequate data mining have been developed in this area, focusing on the integration and conditioning of physiological signals [25]. There are many different investigations, such as those focused on monitoring cardiac signals using a portable system of a sensor shirt capable of acquiring the multichannel electrocardiogram (ECG) [26], a wireless sensor system for the long-term monitoring of cardiac arrhythmias [27], or a portable system for monitoring heart rate variability (HRV) in humans and animals [28]. A portable system has also been developed to monitor electrodermal activity (EDA) signals during emotional stimulation [29]. A non-intrusive method of tracking hydration rates in the body that can aid in the diagnosis of fluid disorders such as lymphedema has also been developed [30], as well as algorithms for portable surgical navigation [31]. The domestic applications have also undergone a notable development, with the ECS proposing new structures for the Smart Home, which allow for the analysis of the behavior of various sensors through Wi-Fi connectivity, or other protocols [32].

The growth in open source software platforms at ECS has also contributed to the growth and development of these systems [33]. There are studies that establish the impact of the presence of open source through the diversity of research developed with these systems [34]. Some of these investigations include the development of a platform or the transmission of data in real time, and the analysis of livestock [35], the implementation of smart converters for real-time current and voltage of renewable energy systems, or a method of creating and detecting hardware Trojans using FPGA [36]. The great variety of applications developed shows that there are no restrictions or limitations in the use of these products and that they constitute a constant research topic.

Internet of Things (IoT) Community constituted by publications aim to extend the use of everyday devices to the internet space, known as the Internet of Things (IoT). This community is the third in size and is made up of 8.11% of the total number of filtered works. In Figure 13a, its isolated spatial

distribution is represented, in which two larger nodes are observed around which smaller publications are located, there being a great dispersion due to the great variety of applications developed in this community. In Figure 13b the 10 most repeated keywords are represented, among which the keyword that marks the theme of this community “Internet of Things” stands out, with 10 repetitions. The rest of the words have a very small frequency and mark the variety of subtopics covered, such as “Deep Learning” or “Vehicle to Everything”.

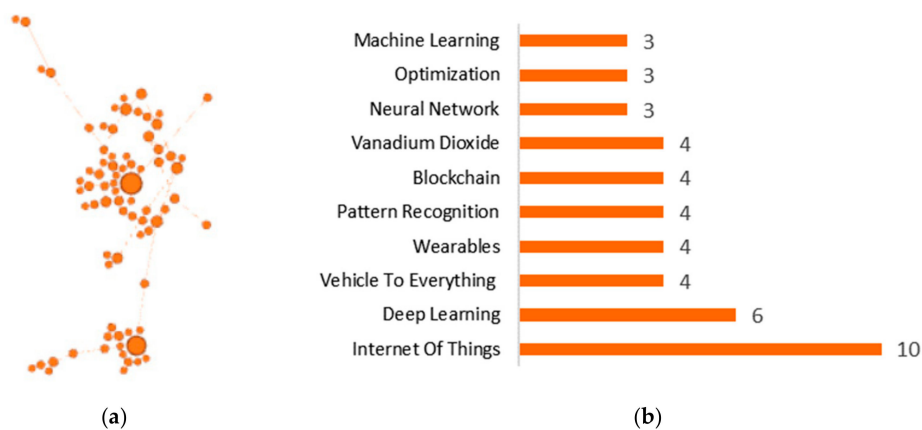

**Figure 13.** Representation of the Internet of Things community: (a) Isolated distribution of publications. (b) Keywords of the community.

IoT allows multiple devices to communicate and share information, without human intervention, creating a global network and applying to different scenarios. One of the most researched fields in IoT is transportation, as indicated by the largest publication in this community [37]. This paper presents different considerations related to vehicle networks and the promotion of the Internet of Vehicles (IoV) [38]. The main research in this area has focused on traffic management, developing applications capable of managing and balancing traffic flows according to current and future congestion conditions, methodologies capable of allowing coordination of vehicle congestion according to protocols [39], match control, or by encoding road junction vectors and recursive bidirectional neural networks. Vehicle energy management is another issue to consider for efficient devices [40]. With this objective, publications are developed that present a model of optimization of charging stations, maximizing the efficiency and stability of vehicles [41]. Cybersecurity is very important in these systems due to the multiple threats to which vehicles are exposed, for which reason implicit authentication mechanisms have been evaluated through the added delay in communication and processing tasks [42]. The integration of these systems within the new 5G architecture opens a wide field of research [43], which will allow for the establishment of greater capabilities in these systems.

The IoT in medical care present another relevant publications in this community [44]. A line of research is the monitoring of physiological signals [45], among which the processing of electrocardiograms (ECG) stands out, developing finite response models (FIR) to correct discretely acquired ECGs and methods that allow for recording by Smartphone [46], for the discrimination of possible atrial fibrillations in patients. The subject’s behavior, position and movement represent a relevant source of information, which allows for the development of joint models for medical study, or the sports activity of an athlete by monitoring their physiological parameters [47]. In this line, systems have been implemented to help elderly people at risk of falling, by estimating human orientation in three dimensions by monitoring the signals from different sensors [48]. Research has also been carried out on portable systems for the disabled, an example of which is a system that allows the characteristics of sounds to be estimated in real time and to create a fingerprint for people with hearing disabilities [49]. The IoT is becoming very popular even outside of its original home automation scenario, with music related apps popping up [50], along with rural development and smart farming [51].

The relationship of the IoT with the development of smart cities is very close, highlighting the concept of the home area network (HAN) that allows for the connection of sensors and household appliances making up smart homes or residences. One of the biggest challenges in the development of these networks is the reduction of energy consumption, focusing the search for energy efficiency initially on the development of hardware [52]. Nowadays, this search has also become a concern for software developers, and there is an intense area of research with this objective. An example is a hybrid method, developed to optimize the load scheduling problem [53]. It is a hybrid model with a multi-objective optimization differential evolution (MODE) algorithm, that allows a user to obtain a set of optimal solutions, minimizing the cost and the peak load, with energy and cost savings of 47% and 46% respectively. Programmers are increasingly aware of the impact of energy consumption, so new energy efficiency techniques are applied, with which savings of up to 99.56% can be achieved.

The IoT is characterized by multi-object connectivity anytime, anywhere, so security threats increase and methods to increase device security must be explored [54]. A method that restricts the extension of vulnerable devices to security risks by imposing sanctions has been developed. It only allows highly secure devices to be authenticated and extended securely and quickly without user intervention.

Machine Learning Systems Community is made up of investigations regarding automated machine learning. Topics related to advanced driver assistance systems, image or trajectory detection using convolutional neural networks and other machine learning methods are considered. In Figure 14a, the isolated distribution of this community is represented, where its dispersion is observed due to the variability of the topics covered. The representation of the 10 most repeated keywords in this community is observed in Figure 14b, and “Convolutional Neural Network” is the most repeated word, presenting itself as the most-used method to carry out the learning method. The rest of the keywords are related to this learning and the devices +used in the systems such as the “Faithful Programmable Gate Array” case.

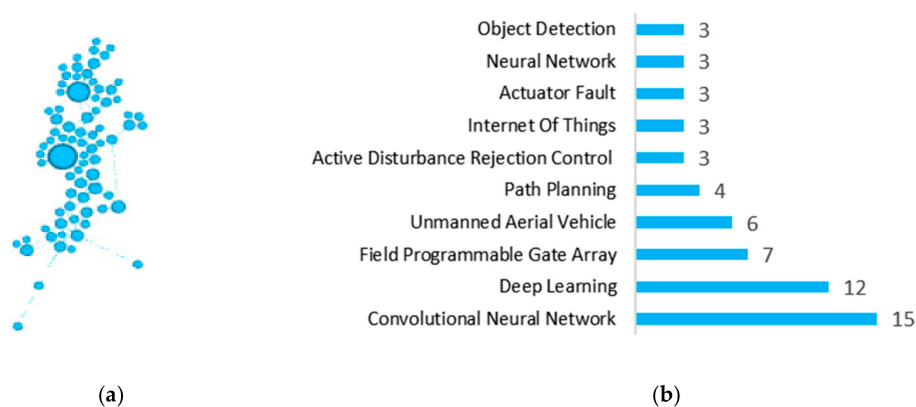

**Figure 14.** Representation of the Machine Learning Systems Community: (a) Isolated distribution of publications. (b) Keywords of the community.

The two most important nodes in this community are similar in size and both are special issues released in 2019. The main one is [55], with the largest number of publications associated. This work considers Advanced Driver Assistance Systems (ADAS) and its development for autonomous vehicles. Advanced machine learning algorithms allow for the ADAS system to detect objects, obstacles, other vehicles, pedestrians, and lanes, and allow for the estimation of object trajectories and intentions. Aspects related to communications between ADAS are considered, which allow for the improvement of vehicle safety and alerting the autonomous system to potentially dangerous situations. Detection is a critical component in ADAS applications. Objects must be detected and tracked to avoid obstacles, collisions and plan possible routes [56]. The 3D point cloud of a Light Detection and Ranging (LiDAR) sensor can be used to classify the manageable and unmanageable regions, establishing a method that

allows for the detection of passive beacons and the implementation of models that prevent the vehicle from entering a restricted space [57]. The LiDaR methodology can also be used to detect pedestrians with clouds of points, or for real-time models in densely vegetated environments.

Many modern machine learning algorithms require significant amounts of training data, making the availability of this data critical to their development and testing. There are studies where these data are used to train learning algorithms to detect objects in panoramic images or to speed up the process of detecting urban objects in real time. To address the challenges and problems that arise in aspects related to machine learning, some techniques that are based on the use of convolutional neural networks are proposed. There are publications that present the detection of land vehicles in infrared aerial images based on a convolutional, a novel approach so far [58]. It has the unique ability to detect both stationary and moving vehicles in real urban environments. The importance of establishing systems with these networks leads to the development of methods to accelerate deep networks and establish greater precision. In addition, new hardware methods for the implementation of convolutional networks using FPGA are considered [59].

Among autonomous learning methods, approaches derived from computational intelligence processes, reinforcement learning, and the use of neural networks are increasingly important in flight systems. In the second most relevant work of this community [60], the main challenges and basic considerations of the Unmanned Aerial Vehicles (UAVs). These vehicles have both military and civil applications [61], these applications include from surveillance, reconnaissance, remote sensing, target acquisition, border patrol, infrastructure surveillance, aerial imaging, industrial inspection and medical aid to emergency [62]. A vehicle is considered autonomous when it can make decisions and reacting to events without the direct intervention of human beings. It must have the ability to detect and perceive the environment, analyze the information detected, communicate, plan and make decisions, as well as act using control algorithms and actuators. In order for UAVs to be fully autonomous, aspects such as stability and waypoint flight, 3D trajectory planning with obstacle avoidance using efficient computational methods and visual control of maneuvers in the vicinity of the earth [63]. Furthermore, they must be able to reject disturbances in a robust manner and establish efficient communication links. To refine these considerations, different techniques have recently been established, including single carrier frequency division multiplex modulation, which achieves great efficiency in the communication link between the unmanned aerial vehicle and the present control station on earth [64].

Wireless Communications Community is made up of publications whose subject matter includes issues related to wireless communications, from the evolution of wireless networks, the development of antennas for these communications and their main applications. In Figure 15a, the isolated distribution of this community is represented, observing that it has a concentrated distribution, despite dealing with quite varied topics. It is a community with an intermediate size, considering that it is made up of 7.38% of the publications. In Figure 15b, the 10 most repeated keywords in this community are represented, with 5G being the word with the highest number of repetitions as it is the latest technology developed for all communications. The next most repeated word is Massive Multiple-Input-Multiple-Output (MIMO), one of the most researched and used technologies in wireless communications. The rest of the keywords have a lower frequency of appearance, such as the Reconfigurable Antenna, one of the last proposed antennas for these communications.

Two nodes larger than the rest are observed in this community, representing two of the works that serve as a reference to the rest. One of these publications is [8], where a review of the most researched wireless communication technology in recent years is established, the MIMO technology. This technology promises true broadband wireless networks, employing hundreds of base station (BS) antennas to simultaneously serve dozens of active terminals (users), with the same time and frequency resources. Massive MIMO systems have higher selectivity in data transmission and reception, improving interference cancellation. Furthermore, increasing the number of BS antennas above the number of active users produces a higher performance and an improvement in the quality of the channel estimate. Due to the advantages and popularity of the massive MIMO system, the number of

posts in this area has increased markedly in recent years [65]. New algorithms, methods for estimating the direction of arrival with low complexity, as well as studies on the optimization of energy efficiency in systems of this type have been developed to increase the addition rate [66].

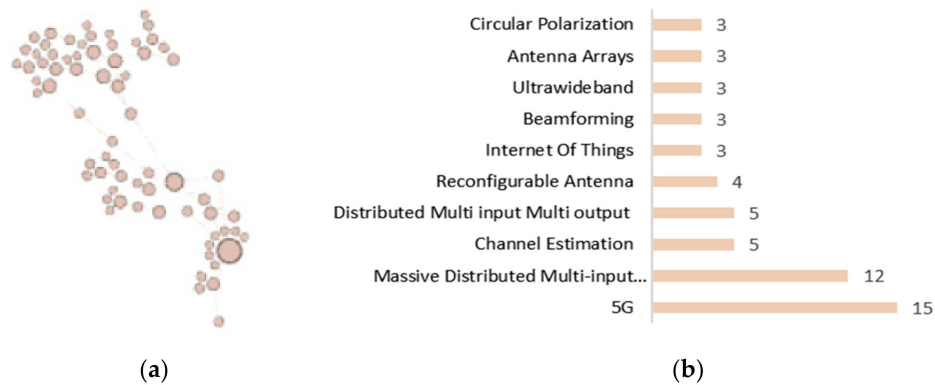
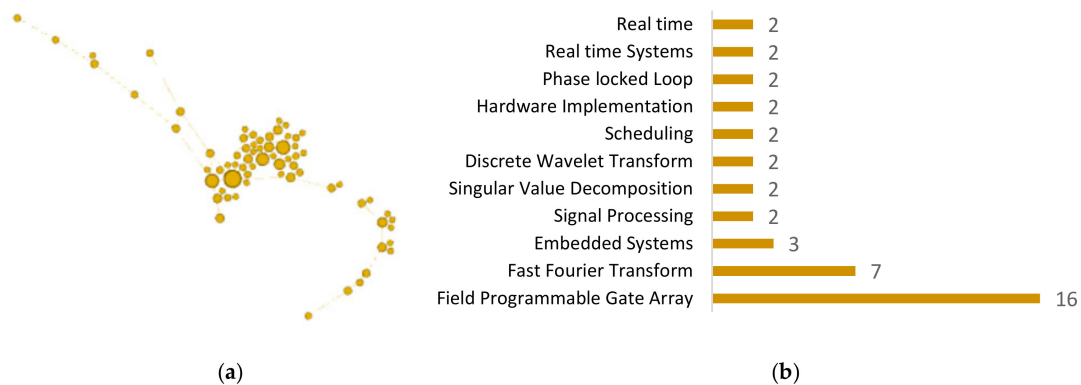

**Figure 15.** Representation of the Wireless Communications community: (a) Isolated distribution of publications. (b) Keywords of the community.

The most important publication of this community is [67], as it establishes different aspects of ecological communications in smart buildings, considering massive MIMO technology. One of the main aspects to be dealt with for the development of this type of communications is the communication infrastructure, with 5G communication being the one that offers the greatest benefits due to the wide variety of frequency bands it has [68]. The implementation of high-precision and energy-efficient location algorithms is of special interest for the development of these communications, which need to reduce general infrastructure requirements and computational complexity.

Within wireless communications, there is a widely developed research area, the study of new antennas. The most widely-used types of antennas in wireless communications are reconfigurable antennas [69]. These are antennas whose properties can be adjusted to achieve a specific frequency band, direction and polarization. These tunable antennas offer several advantages, such as multifunctional capabilities, lower volume, low front processing efforts without the need for a filter element, good insulation and enough out-of-band rejection. For the configuration of the possible states, different techniques are usually used with active elements such as switches or capacitors. There are numerous publications where different antennas of this type are presented, such as [70], where a printed antenna of small size is exposed, and a frequency displacement occurs and the reconfiguration of its patterns, by means of three switches. Other publications propose reconfigurable antennas powered by coplanar waveguide, shaped like a cedar, or circularly polarized antennas with a semicircular groove [71]. There are also other investigations where non-reconfigurable antennas are developed. These antennas are also of interest to wireless communications because of their large bandwidth, small size, good phase linearity, low cost, and radiation pattern [72].

Digital Processing (DP) Community consisting of publications that focus on digital data processing generally in real time. For this processing, a key device is usually used, such as Field-Programmable Gate Arrays (FPGAs). The number of works that comprise it constitute 7.27% of the total and its spatial distribution and is shown in Figure 16a. This figure shows a great spatial dispersion, due to the diversity of applications that can be related to this topic, although there is also a central area with a greater concentration of publications. In Figure 16b, the 10 most repeated keywords in this community are represented, the word Field-Programmable Gate Arrays (FPGA) being the most repeated, being the most used device to carry out digital processing, the next word is Fast Fourier Transform (FFT), a mathematical technique widely used in this process. The following words have very little repetition, as they are a small community, where words from the digital processing theme such as Embedded System or Real Time occur.

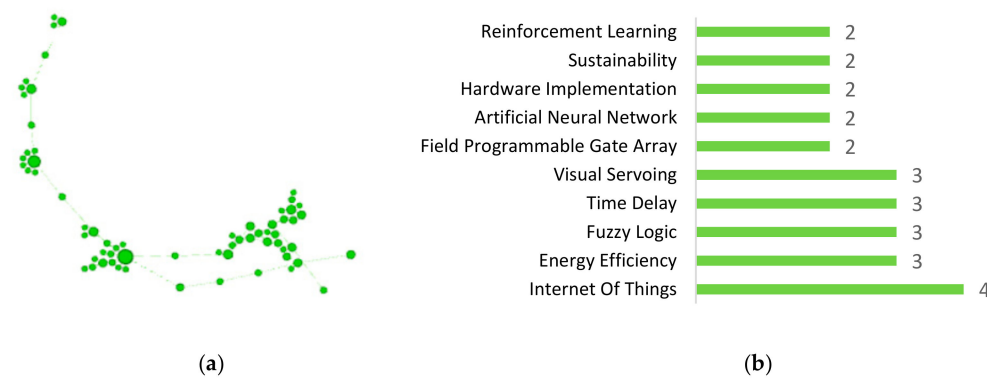

**Figure 16.** Representation of the Digital Processing community: (a) Isolated distribution of publications. (b) Keywords of the community.

In the spatial distribution of this community, there are three nodes, or publications, with a size greater than the rest, around which connections are established with the rest of the works. One of these posts is slightly larger [73], considered the most important work of the community. This is a special issue where solutions related to the efficient digital processing of signals in real time using FPGAs are presented. These devices have performance, consumption and cost characteristics that allow their use in the development of sensors, in control systems, or robotics, its key application being signal processing. In addition, the detection, processing, communication and action on human activities in real time has involved a wide area of research, focused on these devices. Numerous applications have been developed for health monitoring, such as generalized microcontroller environments for detecting ventricular fibrillation in real time [74] and systems where alerts can be sent without the need for external processing. An application with this theme, where there has been a breakthrough, is [75], another of the three reference publications in this community. This work presents an adaptive demodulator for high dynamics efficiently integrated with FPGA, which allows for the establishment of the velocity profile of a fluid. The detection of this profile is carried out using a Pulse-Wave Doppler (PWD) ultrasound system, which detects pulses of energy that are periodically transmitted through the medium due to changes in the Doppler frequencies of moving particles. This system allows the rheological characterization of fluids such as blood, or industrial fluids [76].

One of the most developed lines of research currently focused on image processing using FPGAs [77]. There are some works where novel topics in this area are exposed, such as the implementation of a real-time motion detection system for automated video surveillance [78], or systems for the recognition of traffic signs by color segmentation and the Functions Invariance Feature (SIFT) [79], Speeded-up Robust Feature (SURF) and Histogram of Oriented Gradients (HOG). Advanced motion control applications require high sampling rates to achieve good control system performance with high precision. A possible solution to this requirement is proposed with an improved speed estimation algorithm, which consumes the minimum FPGA resources [80]. This fact is in accordance with the new existing trends in the development of these types of devices, aimed at establishing smaller designs and with lower energy consumption [81].

New Methods Community is formed by research that considers the most recent developments in topics of interest in industrial applications. Publications based on visual service, temporary challenge or image processing are considered. In this community, very diverse topics are discussed, which are not strongly related to each other, so the dispersion in the spatial distribution of the community is notable. Figure 17a. The representation of the 10 most repeated keywords is shown in Figure 17b, where the most frequent word is “Internet of Things”, considering that most of the methods developed aim to increase the amplitude of IoT devices. Other trends are focused on “time delay” or “visual servoing”, as indicated by the frequency of the keywords present.



**Figure 17.** Representation of the New Methods community: (a) Isolated distribution of publications. (b) Keywords of the community.

In recent decades, research in networked control systems has been very relevant, considering the determination and study of the influence of delays as of special interest, since they can degrade the performance of the system. Reference [82] is the article represented by the largest node in the community, and it shows the latest developments in delayed systems and their applications. Research has been conducted that addresses the impact of delays on network-based systems for the droop-controlled AC microgrid; systems that allow the detection of failures triggered by cyber-physical events with non-linear sensors [83], as well as methods to analyze the stability of sampled-data systems [84]. Attempts have been made to determine the criteria for the finite time stabilization of systems with delay, in its application for image encryption using delayed non-linear modulation, or in energy storage circuits.

Another field of research with new advances is visual serving, also called visual service, and some of these advances are exposed in [85], another one of the most important publications in the community. In this discipline, image processing, robotics and control theory are combined to control the movement of robots using images captured by one or more cameras. Issues such as the development of an improved image-based visual servo system for a 6-degree-of-freedom industrial robot are currently being investigated, along with algorithms for image reconstruction using Kalman filters, or mobile manipulators [86]. The use of new control schemes allows for the system to behave in a more robust, efficient and less time-consuming manner, and monitoring control is also of interest for robotic cloud systems with delayed measurements [87]. The fields of application of visual servo systems are very wide and include navigation, the location of mobile robots, the guide of humanoid robots, robot control, etc. Among the new applications, it is worth highlighting the use of this theme for deep learning, or intelligent systems, is focused on application in buildings.

Image processing is a topic that has been extensively investigated in recent decades. Such processing is being applied in a wide variety of fields [88]. By means of image processing, the first theoretical model of the load induced on a bar electrode is developed, which until now did not exist, providing a basis for more complex future studies. Rod electrodes are based on an electrostatic induction mechanism, which are widely used in various industrial applications for their easy installation and precision [89].

Within image processing, restoration is one of the topics that is generating the most interest, as it is used in a wide variety of fields. Degraded images and certain background information are used to restore and rebuild images, improving their quality. A publication that represents a breakthrough on this topic is [90], as it proposes two new models to solve the problem of erasing images in the presence of impulsive noise. Both models improve the visual quality of the images and their signal-to-noise ratio (SNR), at the cost of a small increase in calculation time.

Visible Light Communication (VLC) Community is made up of a series of investigations that consider the characteristics of wireless communication in the visible spectrum, the development of

efficient algorithms and their different applications. It is made up of 6.53% of the publications, and due to the variability of the topics covered, it has a dispersed spatial distribution, without the existence of areas of high density, as can be seen in Figure 18a. In the representation of the 10 most repeated keywords (Figure 18b), Visible Light Communication (VLC) is the most frequent, being the main theme of the community. It is followed by words that relate to the main applications of this technology, such as Motor Control, Wireless Sensors Network, Field Programmable Gate Array (FPGA) or Hybrid Electric Vehicle.

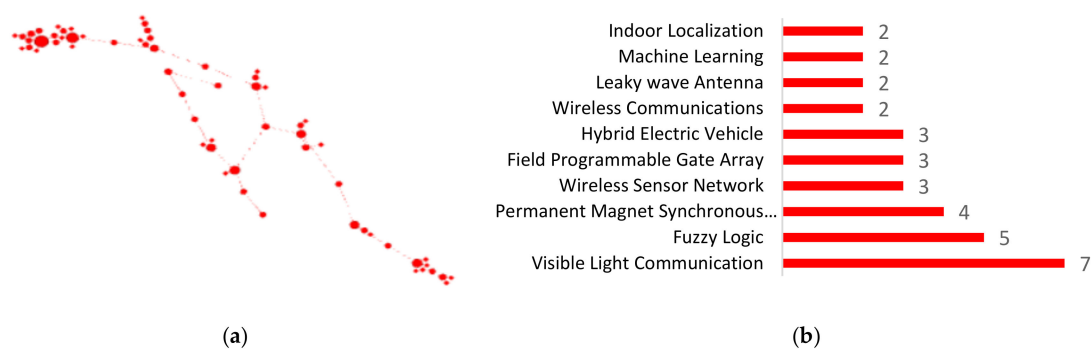

**Figure 18.** Representation of the Visible Light Communication community: (a) Isolated distribution of publications. (b) Keywords of the community.

Wireless communication in the visible spectrum (380 to 780 nm) uses a visible light source as the signal transmitter, a free space as the transmission medium, and a photodiode or photodetector as the receiver [91]. The field of research in VLC is very extensive, considering the special interest around the development of high-speed communication systems such as that set forth in [92]. It is one of the most important publications of this community, and it presents a good solution for high-speed wireless transmission by microwave transmission over an optical fiber or radio over fiber (RoF). Some of the characteristics of the developed system are a low cost, a simple architecture, possible anti-interference, high bandwidth, low transmission loss and low power consumption. The importance of this work lies in being the first to attempt simultaneous multimode wireless operation on a single optical medium. Single sideband signals are used to improve the spectral efficiency of the system and reduce chromatic dispersion. This publication lays the foundation for further research, considering the developed technique an effective candidate for mobile communications, low cost, low complexity and easy to implement.

The next largest node size post is [93], which establishes different aspects related to the positioning of visible light. The limited transmission range of the visible spectrum requires high precision positioning, being of special interest for indoor Visible Light Positioning (VLP). Therefore, positioning models based on machine learning have been established, as well as investigations based on the influence of the inclination of LEDs on positioning systems [94].

The increasing development in wireless communications in the visible light spectrum is increasingly being used to increase the reach of the Internet of Things (IoT), seemingly being a technology capable of short-range communications and soon long scope. To this end, investigations have been carried out that aim to connect intelligent vehicles or transport systems. With this sub-theme, it is worth staking the establishment of route planning systems where trajectories are coordinated using learning algorithms [95], trajectory planning algorithms for overtaking maneuvers [96], models that allow for the establishment of the dynamics of a vehicle due to its rocking while driving on the road, or evolutionary algorithms that can mimic the learning stage of a professional driver [97]. All of this research aims to achieve more efficient algorithms, which increasingly resemble human behavior.

Transmission Lines Community constituted by works where aspects related to transmission lines are studied, in high or low voltage, as well as safety considerations, impedance, etc. In Figure 19a,



the isolated distribution of this community is represented, where the dispersion is observed when dealing with very diverse topics. In Figure 19b, the 10 most repeated keywords are represented, the small size of the community is reflected in the low frequency of repetition of these words. The most repeated is “Power Line Communication”, followed by “Cyber Physical System” and “Electromagnetic Compatibility”, all of which make direct reference to power lines, and words from the main applications such as “Electric Vehicle” or “Smart Home” also appear.

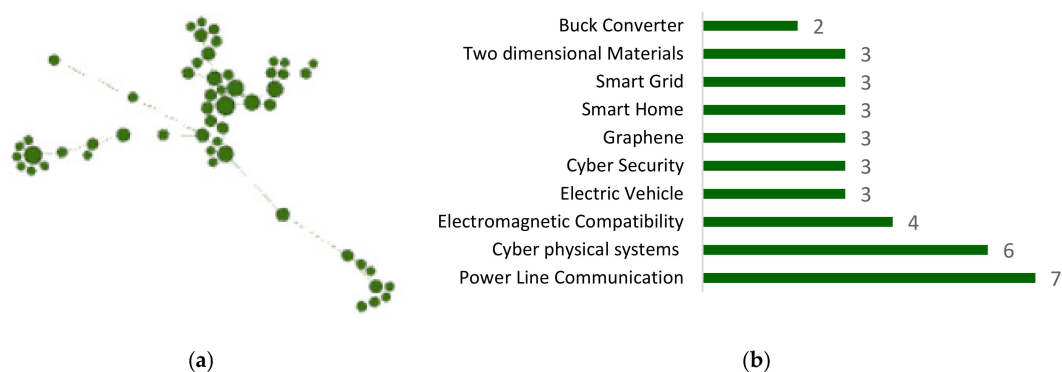

**Figure 19.** Representation of the Transmission Lines community: (a) Isolated distribution of publications. (b) Keywords of the community.

The most important publication of this community is [98], comparing three methods of measurement of the impedance of a network low voltage (LV) in the range Narrow Band-Power Line Communications (NB-PLC), which ranges from 9 kHz to 500 kHz. The three models studied are based on injecting a reference signal into the network, although with different methodologies. Although there is not yet a commonly accepted measurement method, validated with laboratory measurements and supported by standardization agents, the methods presented show a very good correlation with the simulations and the results obtained with a precision impedance meter. The previous publication is strongly related to others that attempt to complete the characterization of these low-voltage transmission lines in the same frequency range, such as [99]. This work is among the five most important in the community, and it describes the results of a measurement campaign to characterize non-intentional emissions (NIE). They are present in the low voltage section of the electrical network, within the NB-PLC frequency range.

Another publication, related to the largest node, presents an analysis of the Flexible Gas Insulated Transmission Lines (FGILs) [100]. The synergistic impact of aging is compared according to time and temperature, the effect of external and internal loads, as well as the dead weight existing in a FGIL with the results established in one form of Gas Insulated Lines (GILs). A GIL is made up of a rigid metal enclosure and its application prospects are limited to metropolitan neighborhoods due to its large intrinsic radius of curvature, its laying length and the need for trenches. FGIL consists of a flexible stranded conductor, a flexible thermoplastic enclosure, open cell foam of significant structural strength for alignment of the concentric conductor, and a compressed mixture of dielectric gases. The results and characteristics of the FGIL allow them to be considered as perfect candidates to solve the difficulties existing in metropolitan applications, since they facilitate the laying of the underground cable without ditches, providing a less expensive laying in the project and duration.

In this community, there are also publications that present energy conversion filters for these transmission lines. These works describe the design of an Electromagnetic Interference (EMI) filter for the High-Frequency Link Matrix Converter (HFLMC) [101].

The second most important job in this community is [102], as it shows a global perspective of two-dimensional electronics and optoelectronics. Materials studied in two-dimensional (2D) layers, beyond graphene, offer the opportunity to create many heterostructures without limitations of atomic

commensurability. The use of these materials supposes the development of new electronic devices, being of special interest in the establishment of Field Effect Transistors (FET), Photovoltaic Cells, Light Emitting Diodes (LEDs), photodetectors, lasers and Integrated Circuits (IC).

DOA Estimation Community formed by investigations that study the concepts of radar signal processing, among which the different methods of Direction of Arrivals (DOA) estimation. This community is one of the smallest, it is in the tenth position according to its size with 4.64% of all jobs. This community is quite compact and presents an area with a high density of works as indicated in the Figure 20a. In Figure 20b, the 10 most repeated keywords are represented with very little frequency due to the size of the community. The most frequently repeated word is “DOA estimation”, a fundamental theme of the community, followed by “Radar” or “Compressed sensing”, terms which are typical of radar signal processing.

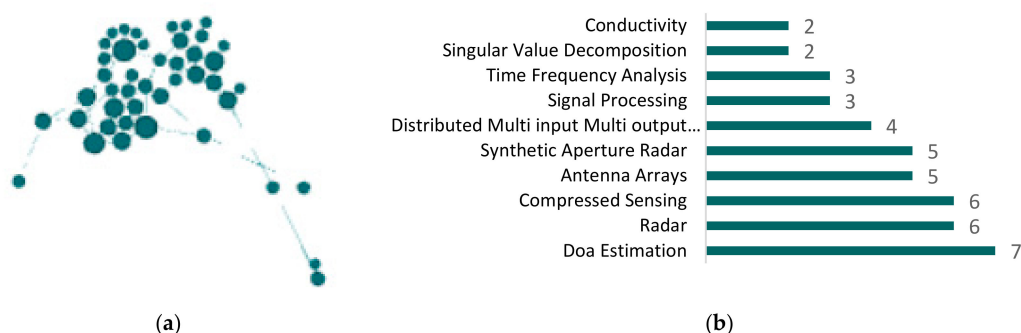

**Figure 20.** Representation of Direction of Arrivals (DOA) Estimation community: (a) Isolated distribution of publications. (b) Keywords of the community.

In this community, there is no main node, but two publications appear with nodes of the same size, followed by others with a somewhat smaller size. One of these works is [103], a special issue where different radar signal processing techniques and questions about the design of radar systems are considered. Even though radar technology was developed in the early 1900s, today it still has civil and military applications. Radar signal processing is the most active area of research, with most publications focusing on Synthetic Aperture Radar (SAR) technology, for its high spatial resolution in adverse climatic conditions. The use of SAR remote sensing data can be used for a wide variety of applications, such as mapping levees to find landslides [104], for obtaining images of targets on moving ships [105], or the characterization of materials [106].

Research related to the compressed sensing (CS) theory is of interest, as it allows for the recovering of signals with fewer samples, being able to sample a signal uniformly at or above Nyquist speed. It includes aspects such as the poor representation of the signal, the design of the observation matrix and the use of a reconstruction algorithm [107]. In another publications, research on DOA estimation in a system is investigated ULA with the unknown Mutual Coupling (MC) effect [108]. A novel CS-based method is proposed for DOA estimation using iteratively determined unknown MC coefficients, turning the DOA estimation problem into an inverse reconstruction. The simulation results show that the proposed method significantly improves the performance of DOA estimation, beating other methods and reducing the MC effect by approximately 4 dB.

One issue to be highlighted is an offline method called a Grid Reconfiguration Direction of Arrival (GRDOA) estimation method based on sparse Bayesian learning [109]. This method is characterized by having less computational complexity, reasonable precision, greater robustness and great efficiency when compared to other methods.

Smart City Community is made up of research that develops different smart devices that may constitute the concept of a smart city. For this, aspects related to buildings, communications or different services such as transport are considered. These publications represent 4.53% of the total, it is a

small community compared to the rest, as indicated by its isolated spatial distribution (Figure 21a). In Figure 21b, the most repeated keywords in this community are represented, where “Smart Grid” and “Quality of Experience” are the most repeated for the importance and quality of communications in this type of environment, followed by “Internet of Things” or “Smart home”. These are concepts necessary for the development of smart devices and buildings within a Smart City.

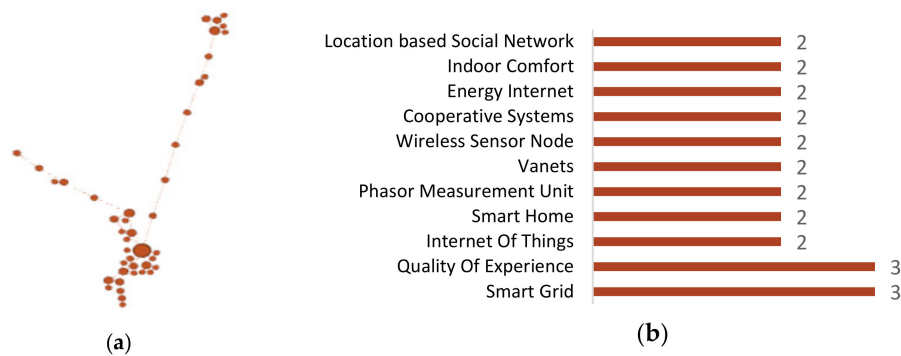
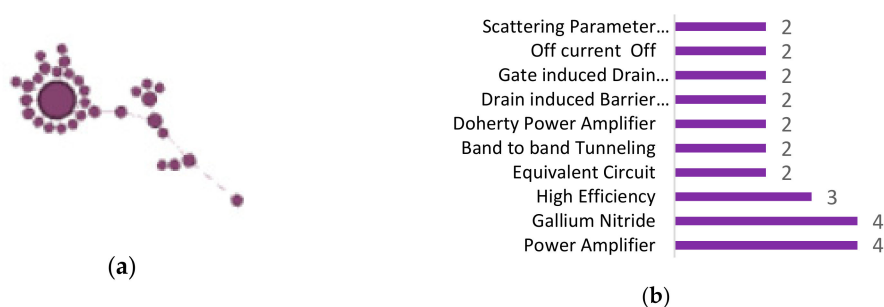

**Figure 21.** Representation of the Smart City community: (a) Isolated distribution of publications. (b) Keywords of the community.

In the spatial distribution, it is observed that the publications are quite scattered, divided by the diversity of applications that can be developed, despite this, around the largest node there is a greater concentration of works. This node represents the most important work in this community [110], where some of the latest technologies and services developed for smart cities are exposed, considering multidisciplinary aspects and in continuous evolution. Intelligent sensor systems are presented to determine in real time and with great sensitivity fundamental parameters such as water quality [111], or air quality [112].

The development of a hybrid communication network that serves as a communication infrastructure is key to the development of these devices, making it a widely researched area. Some of the systems developed show several advantages over conventional fiber optic communication systems, in terms of placement and installation costs, with simple infrastructures such as the system exposed in [113]. Another service that is established intelligently is tourism, through the concept of RoomFort, an application for managing the comfort or convenience of hotel guests [114]. By exploiting the automatic reasoning capabilities provided by semantic web technologies and the collection of data through a network of sensors, personalized comfort profiles are sent to guests. This customization is also intended to be extrapolated to other areas such as tourist information [115], or for the development of domestic environment [116].

New Transistors Community formed by the investigations that propose the development of new transistors, considering these devices as one of the precursors of current power electronics. For this, new materials of different sizes and different techniques are used. It is one of the smallest communities, made up of 3.37% of works, as well as quite dispersed when dealing with very varied topics. The isolated distribution of this community is shown in Figure 22a, where one can see the relationships between the publications. Being a small community, the number of repetitions of the keywords is low. In Figure 22b, the 10 most repeated keywords in the community are represented, “Power Amplifier” stands out, as it is the main application for which new transistors are used, or “Gallium Nitride”, the most used material in new devices developed in recent years.



**Figure 22.** Representation of the New Transistors community: (a) Isolated distribution of publications. (b) Keywords of the community.

In this community, a node of a larger size than the rest is observed [117], surrounded by other works to which the node serves as a reference. This paper presents the research trends related to new nanoelectronics materials, devices and models. The decrease in the size of the semiconductors that make up the transistors involves challenges such as low mobility of the carriers, degradation of the lower threshold slope and heat dissipation, although it produces an increase in the integration density. Carrier mobility is sought to be improved by developing Field Effect Transistors (FET) verticals with new broadband semiconductors (Gallium Nitride (GaN)), to which an additional current blocking layer is added [118].

To improve the performance of a transistor, the steep Subthreshold Slope (SS) should be considered [119]. A pronounced SS can be achieved by two methods, one of them involves using a vanadium dioxide (VO<sub>2</sub>) FET switch as an Insulating-metal Transition Material (IMT), which allows a user to establish slopes of current below threshold at 42 mV/decB [120]. The other method is based on using an L-shaped tunnel FET, to improve the SS [121]. Additionally, it has been extensively investigated in the Drain-induced Barrier Lowering (DIBL) and in the characteristics of the leakage current of a Partial Isolation Field-effect Transistor (PiFET), for sub-0.1  $\mu\text{m}$  [122]. PiFET is a type of transistor in which the buried insulator is penetrated to a certain depth in the direction of the channel below the drain region, whereby the fold effect due to the floating body effect is structurally blocked.

The use of new materials in data storage devices, memory and solar cells is another area of current research. Studies that present the characteristics of new analog memories using gold/zinc dioxide/indium tin oxide (Au/ZnO/ITO) [123] devices, or the analysis of the electron affinity optimization and the band gap of a ZnO/Si [124] heterojunction solar cell. Even though all the devices in development have a higher cost, they are attracting great technological interest [125]. Through its empirical analysis, the aim is to obtain information to optimize its performance and reduce unwanted defects such as deformation [126], considering that all these characteristics depend on temperature.

Cloud Computing Community formed by research that addresses the main pillars of modern computing systems, such as computing and data storage. Different tasks of massive data processing and optimization, as well as storage methodologies, are studied in order to establish efficient and reliable systems. Only 2.11% of all jobs make up this community, making it the second smallest of all those studied in this study.

In Figure 23a, its isolated distribution is represented, considering very varied and relatively recent aspects. Areas of high population density are not observed, they are quite dispersed and with weak relationships. In Figure 23b, the 10 most repeated keywords in this community are represented, showing the most repeated words “Cloud Computing” and “Data Centers”, both related to data storage systems. In this community there are numerous investigations based on “Virtual Machine Placement”, hence it is another example of the most repeated words. The variety of the keywords observed indicates the multidisciplinary of the applications that can be developed with this theme.

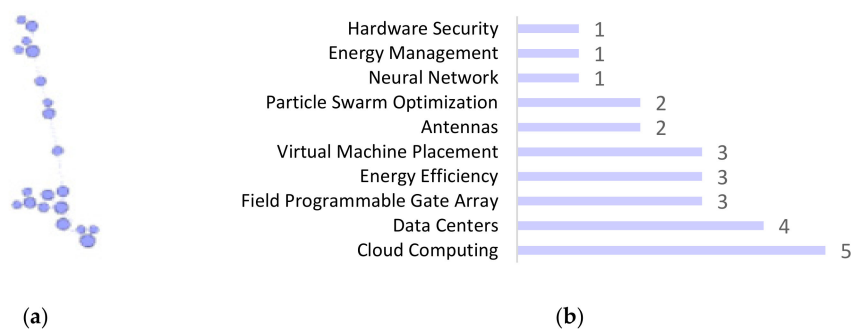
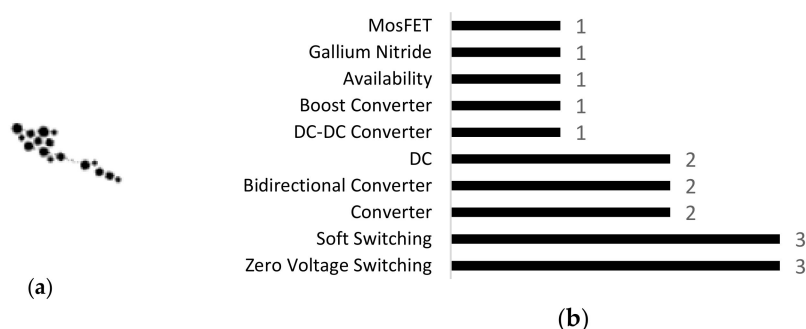

**Figure 23.** Community representation Cloud Computing: (a) Isolated distribution of publications. (b) Keywords of the community.

In this community, there are no publications with an importance much higher than the rest, depending on the size of the nodes that represent it, almost all the works have the same size or importance. A publication slightly larger than the rest is [127], a paper that covers some concepts of computing and storage. Among the computational techniques, the most studied are those based on Oscillatory Neural Networks (ONN), inspired by the oscillatory behavior of the brain [128], or those that seek to improve their efficiency for pattern recognition tasks [129].

A topic of special interest in this field is the optimization of Virtual Machine Placement (VMP). Cloud computing offers an unlimited amount of heterogeneous resources through virtualization [130] multiple virtual machines share resources on the same Physical Machine (PM). Therefore, as many can be placed Virtual Machine (VM) as possible in the minimum number of PM, with the necessity of the optimization of the minimum amount of PM that can supply the necessary resources to host a specific quantity of VM with the lowest possible energy consumption. To minimize the placement of PM in the system, the Particle Swarm Optimization (PSO) algorithm, or an improved particle swarm optimization algorithm, is used [131]. An issue of special interest in this community is the optimal virtual machine placement based on gray wolf optimization [132]. Optimal virtual machine placement based on gray wolf optimization, where a gray wolf optimization (GWO)-based optimization method is applied for VMP optimization as a highly efficient discrete combinatorial problem. This work supposes the support of others like [133], which proposes a Levy-based Multi-objective Gray Wolf Optimization (LMOGWO) algorithm, for efficient VM placement resolution. The proposed algorithm mimics the leadership and hunting behavior of the Grey Wolf (GW) in the multiple target search space. The said algorithm was tested with different reference functions, achieving PM minimization rates of 30%, higher than those achieved with other methods. Research related to efficient data storage in the cloud should also be considered, for which different coding theories were developed [134], as well as programming these data centers efficiently using renewable energy [135].

DC-DC Converter Community consisting of publications studying converters that allow for the transition from one DC value to another of a different level, the different types that have been recently developed or issues related to control strategies for these devices. This community is strongly related to the community that deals with power applications, with these converters being one of the most relevant applications or developments in power electronics. The isolated distribution of this community is observed in Figure 24a, publications are represented by nodes whose size is related to their importance or relationships to other jobs. In Figure 24b, the 10 most repeated keywords in this community are represented, the smallest with 1.69% of the jobs. This fact is reflected in the low frequency of the keywords, among which “Zero Voltage Switching” and “Soft Switching” stand out the main techniques present in the new converters currently developed. Other trends are the “Bidirectional Converter” or “Boost Converter”, as seen in the rest of the keywords.



**Figure 24.** Representation of the DC-DC Converter community: (a) Isolated distribution of publications. (b) Keywords of the community.

In this community, a publication of a much larger size than the rest does not appear, as almost all publications are of a similar size or importance. One of the works has the largest possible node size and is considered the most relevant in the community, in which different high-efficiency DC-DC converters are developed for application in renewable energy systems [136]. Three isolated converter topologies are developed by combining CUK converters, with the concepts of Switched-Inductor (SL) and Switched-Capacitor (SC). In this type of DC-DC converters the output voltage may be higher or lower than the input voltage. Conventional DC-DC converters cannot be used in these systems, since an extremely high ratio is required to achieve a high voltage gain, which would degrade the conversion efficiency due to conduction losses [137]. These drawbacks are also not solved with transformer-less converters, so the use of converters with coupled inductors and/or switched capacitors is proposed. These converters must use two different inputs [138], so they must be Dual-input Converters (DIC) and for high voltages to be applied and power to be produced even when the input source is turned off, it is considered a Dual-input High Step-up Isolated Converter (DHSIC). In [139], one of the most relevant publications, a DHSIC with a switched boost capacitor and an extra circuit that allows for an increase in the voltage gain is analyzed. This converter can control the dual inputs independently and individually and allows a user to suppress the voltage peak in the power switch, improving its efficiency, which can be as high as 91.40%. In the other publications, an uninsulated converter is considered, with less loss, weight and volume than isolated converters [140].

In order to increase the efficiency of conversion systems, numerous investigations based on high-efficiency systems are carried out [141]. In their works, a new Zero Voltage Transition (ZVT) resonant boost converter is developed. Typical converters generate switching losses during startup and shutdown, which can cause decreased efficiency. These losses can be reduced by using smooth switching, using an auxiliary circuit with a resonant inductor, a capacitor and two auxiliary switches, or with coupled inductors [142].

One possibility within the study of DC-DC converters is the development of control strategies to obtain higher performance systems. This is established a control strategy appropriate to the topology of a three-level DC-DC converter connected to a Proton Exchange Membrane Electrolyze (PEM EL) [143]. The experimental results obtained validate the performance of the converter and guarantee the correct energy consumption of the system [144]. Research that coordinates development of DC-DC converter improvements and implementation of control strategies leads to more efficient dynamic systems [145].

### 3.3. Author Analysis, Affiliations and Countries of Publication in Journal Electronics

In this section, the authors are studied from different perspectives. In this work, 7561 authors who have contributed to their research in the journal Electronics are analyzed and are distributed in 87 different countries. In Figure 25, the top 20 author-countries with global percentages have been represented, the percentages shown in Figure 25 correspond to the totals with respect to the 87 countries, although only 20 countries are shown. The highest country number that authors correspond to is

China with 2407 authors and a global percentage of 31.83%, followed by South Korea with 763 authors (10.09%) and Italy with 613 authors (8.11%). The rest of the countries contribute with less than 600 authors and with a participation below 8.00%. The rest of the countries not represented in the top 20 contribute 12.71% of the authors. This indicates that there are many countries that have contributed to publications in the Electronics journal.

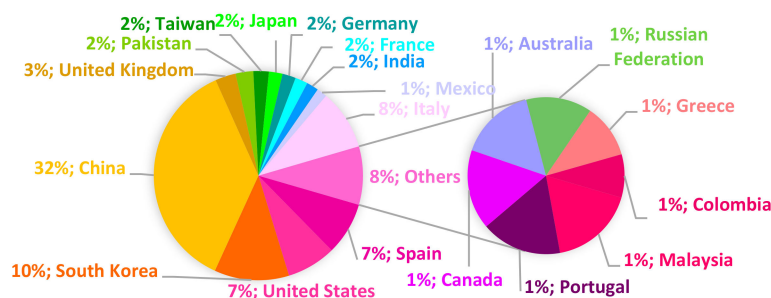

**Figure 25.** Distribution of authors for the 20 countries that show the highest participation (87.29% of the global) in the journal Electronics. Data referenced to global data from 87 countries.

Figure 26 represents the 87 countries with researchers who publish on topics included in the Electronics journal topics. It is observed that the Asian continent and North America are the ones that publish the most in this magazine, and the low participation of the African continent stands out.

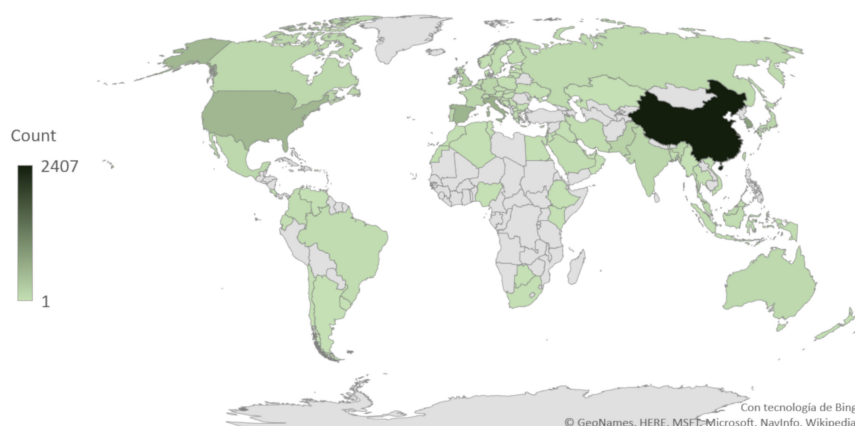

**Figure 26.** Representation of the 87 countries with contributions from authors.

If we analyze the authors’ H-index, it is found that most of these authors have a value that ranges from [0–9] with 75.89% of the total (Figure 27), although the total range reaches 157. The second rank is formed by 16.19% of the total and the third by 5.36%. Among the first three ranges collecting [0–29], they constitute 97.43% of the total, leaving the authors with the highest index in a minority of 2.57%. This is common in most of the studies, and this is due to the fact that there are few authors with a high H-Index, since it requires close relation in their research topics and many contributions that are very innovative to serve as a reference to other researchers in their field or nearby fields.

Table 1 shows the 20 authors with the highest H-index, collecting values from 58 to 157. From the H-Index values, those that are  $\geq 70$  are a minority. If we analyze the origin of the authors, they are concentrated in 10 countries, with four of them not included among the top 20 author-countries (Denmark, Brazil, Turkey and Belgium). In addition, the order does not coincide with the top 20 author-countries, with the United States being the one that provides five authors, which is in the fifth position of 87, followed by Denmark, Italy, and Germany, with three authors, and the rest with one

author. The Chinese author is in the position 17/7561 authors, as the country with the highest number of authors contributing to the analyzed publications.

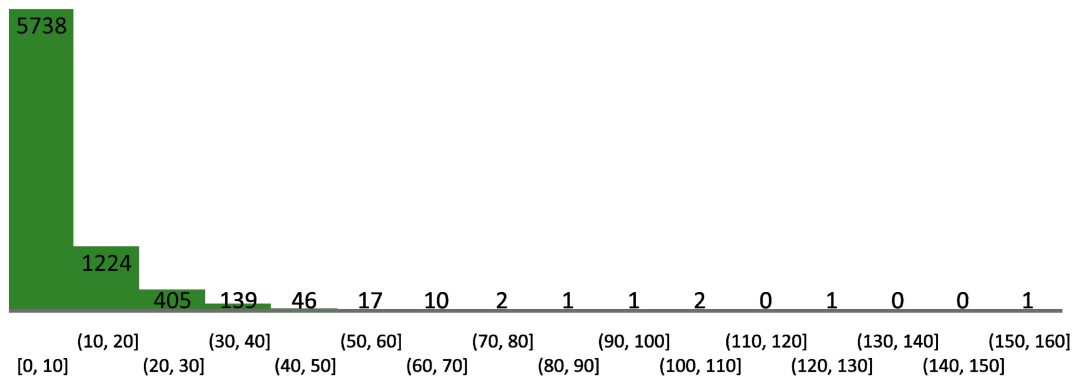

Figure 27. Authors’ H-index histogram.

Table 1. Top 20 of the authors with the highest H-index published in journal Electronics.

Scopus ID	Indexed Name	H-Index	Citation_Count	Country	University
35492852400	Ajayan P.	157	107,372	United States	Rice University
7004992352	Blaabjerg F.	121	72,921	Denmark	Aalborg Universitet
55667348900	Aloisio A.	101	59,497	Italy	Università degli Studi di Napoli Federico II
57191607340	Vaidyanathan S.	101	20,414	India	Vel Tech Rangarajan Dr.Sagunthala R&D Institute of Science and Technology
7006009729	Leo K.	93	36,140	Germany	Technische Universität Dresden
35588010400	Guerrero J.	83	35,519	Denmark	Aalborg Universitet
7003388970	Vajtai R.	77	25,863	United States	Rice University
24433472700	Bell J.	74	17,846	United States	Arizona State University
7003748060	Teodorescu R.	69	26,165	Denmark	Aalborg Universitet
55777593400	Heine T.	68	15,993	Germany	Universität Leipzig
57202521319	Engel A.	66	23,522	Germany	Universitätsklinikum Hamburg-Eppendorf und Medizinische Fakultät
55887046200	Andreotti M.	64	16,444	Italy	Istituto Nazionale di Fisica Nucleare, Sezione di Ferrara
14630220200	Gregorio A.	63	25,729	Italy	Università degli Studi di Trieste
16686333000	Cerqueira A.	62	16,423	Brazil	Universidade Federal de Juiz de Fora
7102777145	Pecht M.	62	17,909	United States	A. James Clark School of Engineering
7405458795	Wang P.	62	18,661	China	Nanjing University
35563614300	Grigoropoulos C.	62	14,742	United States	University of California, Berkeley
7005872966	Baleanu D.	61	20,595	Turkey	Çankaya Üniversitesi
7006613644	Plaza A.	59	16,852	Spain	Universidad de Extremadura
34572758100	Steyaert M.	58	12,119	Belgium	KU Leuven



### 3.4. Analysis by Document Format Published in Journal Electronics

The Electronics journal publishes in five different formats in English. Figure 28 represents the distribution according to format of the 2310 documents analyzed in the search for Scopus. Of the total documents, 92.16% are found as an article (2129 documents), 5.84% as a review (135 documents), the rest have a contribution of less than 2%. These results are like those found in other work [11].

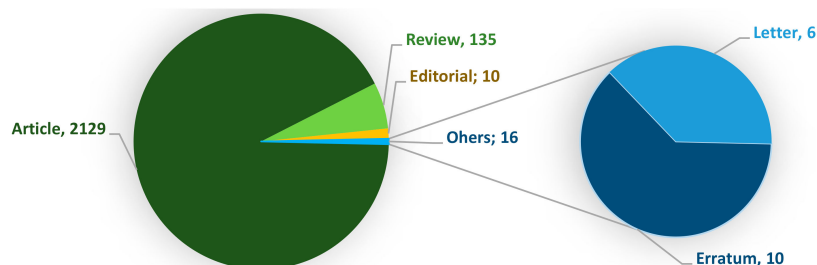

Figure 28. Distribution of journal Electronics publications according to document formats.

## 4. Conclusions

This work analyzed the research collected in the publications of the Electronics journal, in any of its 14 Subject Areas from 2012 to January 2020. Scopus was used as a database, collecting all the information related to each publication and a search was performed for the keyword “ISSN (20799292)”. The search found 2310 documents with a total of 1463 unrelated relationships. A total of 949 publications and 1239 relationships between nodes were studied. After analyzing the publications, it was established that, due to the topics covered and their relationships, there are 14 research communities: Power Electronics, Embedded Computer System, Internet of Things, Machine Learning Systems, Wireless Communications, Digital Processing, New Methods, Visible Light Communication, Transmission Lines, DOA Estimation, Smart City, New Transistors, Cloud Computing and DC-DC Converter. The Power Electronics Community has the highest concentration of documents with 20.13% of the total number of works analyzed, followed by Embedded Computer Systems Community (13.59%) and Internet of Things (IoT) and Machine Learning Systems Community with 8.11% both, while the rest have lower contributions at 8.00%. In the spatial distribution of the communities, 12 regions are observed, leaving two of them, the smallest, immersed in the center of the communities. Almost all the communities have one or several central nodes, around which are several minor works that were studied as a sample of the research carried out in each community. The study of the keywords used both globally and by the community shows that there are a huge number of them that are only used once, the largest number of them being acronyms. This indicates that the use of acronyms in the keywords does not complete its job of giving visibility to the document in the indexing of the databases. A main conclusion after carefully analyzing the keywords in detail is that authors should select them more efficiently and limit themselves to avoid using acronyms in order to increase visibility, and thus citations to published documents.

The trend of the research collected in the journal Electronics is directed to subjects in continuous development, as it occurs in the transport sector and its electric power system [146]. Academic research of general interest has been published, as well as industrial research that is being applied or may soon be applied. It should be noted that most research developments have, as their ultimate goal, the maturity of knowledge for possible application in the industrial field. An example of this can be seen in the transport sector, where a wide range of products have been developed with the aim of establishing an industrially competitive end product. In this field, research is continuing to achieve the full integration of vehicles into the 5G and IoT ecosystems, improving the communication capabilities of autonomous vehicles, remote control applications, vehicle monitoring or safety systems. Other topics of industrial interest include engine improvement, or the development of wireless biomedical

sensors [24]. General research or research with no industrial application so far are those that are in the start-up phase and cannot yet be safely applied in industry. An example of this is the work developing improved fuzzy logic control models for parameter optimization based on learning functions applied to the indoor environment, the development of new optimization algorithms for energy consumption, data processing [127] and flow pattern prediction. All of these topics have been developed recently, so many of them are in an initial phase, where their behavior must be studied and simulated to be applied reliably in the near future. This fact is reflected in works that address the simulation of the behavior of new devices such as small field effect transistors [147], high mobility transistors [148] and new energy converters, among others.

In addition, new Artificial Intelligence (AI)-based schemes are needed to make quick and smart decisions that will enhance driving experiences [60]. The development of new broadband semiconductors together with new modulation and control techniques leads to improved miniaturization of the efficiency of electronic power converters, a device widely studied due to its wide variety of applications [149]. Another device of special interest is the FPGAs where smaller designs are needed, with lower power consumption, low cost and that maintain a solid level of performance [117]. The development of FPGA with these characteristics allows to develop new cutting-edge solutions, for example, in the area of sensors and smart devices [12].

Most of the publications that constitute the smaller communities, where the number of works that are related to each other is lower, comprise new fields of research. These communities are considered emerging communities, encompassing great progress. Most have appeared and fully developed in the last two years. An example of this is research studying the behavior of new devices, including the appearance of small-sized transistors (nonmetric scale) or using new, hitherto unknown semiconductor materials, such as gallium nitride. New fields of research are also considered, such as those related to cloud computing and the development of new optimization and control algorithms [127]. All these concepts are currently being widely developed and aim to achieve systems with higher computing performance, which can be applied to different areas. Future research will focus on determining the negative and positive effects of time delay on control systems, such as network systems, smart grids and wireless robotics [82]. More effective control schemes should be designed, along with the DOA estimation in the scenario of mobile platforms [103], as well as the development of new strategies to filter or mitigate the effect of movements on the quality of the recorded data. Another topic to study is the impact of LED design on communication performance and positioning accuracy, as well as related joint optimization for both communication and positioning [93], considering the great alternatives in the Visible Light Communication (VLC) field that will allow for this development.

**Author Contributions:** R.M.G.S., N.N. and A.A. formed the manuscript; A.A. and M.F.R. developed the figures and tables; A.A. and D.E.K. contributed to the search of date and the realized of the maps; R.M.G.S. and N.N. redacted the paper. F.G.M. checked the whole manuscript. All authors have read and agreed to the published version of the manuscript.

**Funding:** Under I+D+I Project UAL18-TIC-A025-A, University of Almeria, the Ministry of Economy, Knowledge, Business and University and the European Regional Development Fund (FEDER).

**Acknowledgments:** Under I+D+I Project UAL18-TIC-A025-A, University of Almeria, the Ministry of Economy, Knowledge, Business and University and the European Regional Development Fund (FEDER), Andalusian Regional Government through the Electronics, Communications and Telemedicine TIC019 Research Group of the University of Almeria, Spain and in part by the European Union FEDER Program and CIAMBITAL Group.

**Conflicts of Interest:** The authors declare no conflict of interest.

## References

1. Dragicevic, T.; Waheeler, P.; Blaabjerg, F. Artificial Intelligence Aided Automated Design for Reliability of Power Electronic Systems. *IEEE Trans. Power Electron.* **2019**, *34*, 7161–7171. [[CrossRef](#)]
2. Baneira, F.; Doval-Gandoy, J.; Yepes, A.G.; López, Ó. Control Strategy for Multiphase Drives With Minimum Losses in the Full Torque Operation Range Under Single Open-Phase Fault. *IEEE Trans. Power Electron.* **2017**, *32*, 6275–6285. [[CrossRef](#)]

3. Liu, H.; Pu, S.; Cao, J.; Yang, X.; Wang, Z. Torque Ripple Mitigation of T-3L Inverter Fed Open-End Doubly-Salient Permanent-Magnet Motor Drives Using Current Hysteresis Control. *Energies* **2019**, *12*, 3109. [[CrossRef](#)]
4. Dubarry, M.; Baure, G.; Pastor-Fernández, C.; Fai, T.; Widanage, W.D.; Marco, J. Battery energy storage system modeling: A combined comprehensive approach. *J. Energy Storage* **2019**, *21*, 172–185. [[CrossRef](#)]
5. Chen, K.; Häberlen, O.; Lidow, A.; Tsai, C.; Ueda, T.; Uemoto, Y.; Wu, Y. GaN-on-Si Power Technology: Devices and Applications. *IEEE Trans. Electron Devices* **2017**, *64*, 779–795. [[CrossRef](#)]
6. Rahmani, S.; Mendalek, N.; Al-haddad, K. Experimental Design of a Nonlinear Control Technique for Three-Phase Shunt Active Power Filter. *IEEE Trans. Ind. Electron.* **2010**, *57*, 3364–3375. [[CrossRef](#)]
7. Van Laerhoven, K.; Lo, B.P.L.; Ng, J.W.P. Medical Healthcare Monitoring with Wearable and Implantable Sensors. In Proceedings of the 3rd International Workshop on Ubiquitous Computing for Healthcare Applications, Nottingham, UK, 6–7 September 2004.
8. Hassan, N.; Fernando, X. Massive MIMO wireless networks: An overview. *Electronics* **2017**, *6*, 63. [[CrossRef](#)]
9. Montoya, F.G.; Alcayde, A.; Baños, R.; Manzano-Agugliaro, F. A fast method for identifying worldwide scientific collaborations using the Scopus database. *Telemat. Inform.* **2018**, *35*, 168–185. [[CrossRef](#)]
10. Novas, N.; Alcayde, A.; El Khaled, D.; Manzano-agugliaro, F. Coatings in Photovoltaic Solar Energy Worldwide Research. *Coatings* **2019**, *9*, 797. [[CrossRef](#)]
11. Bastian, M.; Heymann, S.; Jacomy, M. Gephi: An Open Source Software for Exploring and Manipulating Networks. In Proceedings of the Third International ICWSM Conference, San Jose, CA, USA, 17–20 May 2009; pp. 361–362.
12. Blaabjerg, F.; Dragicevic, T.; Davari, P. Applications of power electronics. *Electronics* **2019**, *8*, 465. [[CrossRef](#)]
13. Andwari, A.M.; Pesiridis, A.; Rajoo, S.; Martinez-Botas, R. A review of Battery Electric Vehicle technology and readiness levels. *Renew. Sustain. Energy Rev.* **2017**, *78*, 414–430. [[CrossRef](#)]
14. Wei, Q.; Shi, G.; Song, R.; Liu, Y. Adaptive Dynamic Programming-Based Optimal Control Scheme for Energy Storage Systems. *IEEE Trans. Ind. Electron.* **2017**, *64*, 5468–5478. [[CrossRef](#)]
15. Hafez, A.Z.; Yousef, A.M.; Harag, N.M. Solar tracking systems: Technologies and trackers drive types—A review. *Renew. Sustain. Energy Rev.* **2018**, *91*, 754–782. [[CrossRef](#)]
16. Rivera-Barrera, J.P.; Muñoz-Galeano, N.; Sarmiento-Maldonado, H.O. Soc Estimation for Lithium-ion Batteries: Review and Future Challenges. *Electronics* **2017**, *6*, 102. [[CrossRef](#)]
17. Masih-tehrani, M.; Ha, M.; Esfahanian, V.; Safaei, A. Optimum sizing and optimum energy management of a hybrid energy storage system for lithium battery life improvement. *J. Power Sources* **2013**, *244*, 2–10. [[CrossRef](#)]
18. Umair, M.; Mansoor, M.; Hashmi, K.; Boudina, R.; Khan, A.; Yuning, J.; Tang, H. Electrical Power and Energy Systems Renewable energy source (RES) based islanded DC microgrid with enhanced resilient control. *Electr. Power Energy Syst.* **2019**, *113*, 461–471.
19. Ji, Y.; Yang, Y.; Zhou, J.; Ding, H.; Guo, X.; Padmanaban, S. Control strategies of mitigating dead-time effect on power converters: An overview. *Electronics* **2019**, *8*, 196. [[CrossRef](#)]
20. Iqbal, S.; Xin, A.; Jan, M.U.; Abdelbaky, M.A. Applied sciences Improvement of Power Converters Performance by an Efficient Use of Dead Time Compensation Technique. *Appl. Sci.* **2020**, *10*, 3121. [[CrossRef](#)]
21. Johnston, S.J.; Cox, S.J. The raspberry Pi: A technology disrupter, and the enabler of dreams. *Electronics* **2017**, *6*, 51. [[CrossRef](#)]
22. Burd, B.; Divitini, M.; Armando, F.; Perez, F.; Russell, I.; Tudor, L. Courses, Content, and Tools for Internet of Things in Computer Science Education. In Proceedings of the ITiCSE-WGR'17, Bologna, Italy, 3–5 July 2017; pp. 125–139.
23. Kurkovsky, S.; Williams, C. Raspberry Pi as a Platform for the Internet of Things Projects: Experiences and Lessons. In Proceedings of the ITiCSE'17, Bologna, Italy, 3–5 July 2017; pp. 64–69.
24. Scilingo, E.P.; Valenza, G. Recent advances on wearable electronics and embedded computing systems for biomedical applications. *Electronics* **2017**, *6*, 12. [[CrossRef](#)]
25. Sun, Y.; Yu, X.B. Capacitive Biopotential Measurement for Electrophysiological Signal Acquisition: A Review. *IEEE Sens. J.* **2016**, *16*, 2832–2853. [[CrossRef](#)]

26. Linz, T.; Kallmayer, C.; Aschenbrenner, R.; Reichl, H. Fully Integrated EKG Shirt based on Embroidered Electrical Interconnections with Conductive Yarn and Miniaturized Flexible Electronics. In Proceedings of the International Workshop on Wearable and Implantable Body Sensor Network (BSN'06), Cambridge, UK, 3–5 April 2006; pp. 20–23.
27. Greco, A.; Valenza, G.; Citi, L.; Scilingo, E.P. Arousal and Valence Recognition of Affective Sounds Based on Electrodermal Activity. *IEEE Sens. J.* **2017**, *17*, 716–725. [[CrossRef](#)]
28. Von Borell, E.; Langbein, J.; Després, G.; Hansen, S.; Letierrier, C.; Marchant-forde, J.; Marchant-forde, R.; Minero, M.; Mohr, E.; Prunier, A.; et al. Heart rate variability as a measure of autonomic regulation of cardiac activity for assessing stress and welfare in farm animals—A review. *Physiol. Behav.* **2007**, *92*, 293–316. [[CrossRef](#)] [[PubMed](#)]
29. Haddad, P.; Servati, A.; Soltaninan, S.; Ko, F.; Servanti, P. Breathable Dry Silver/Silver Chloride Electronic Textile Electrodes for Electrodermal Activity Monitoring. *Biosensors* **2018**, *8*, 79. [[CrossRef](#)]
30. Garrett, D.C.; Rae, N.; Fletcher, J.R.; Zarnke, S.; Thorson, S.; Hogan, D.B.; Fear, E.C.; Member, S. Engineering Approaches to Assessing Hydration Status. *IEEE Rev. Biomed. Eng.* **2018**, *11*, 233–248. [[CrossRef](#)] [[PubMed](#)]
31. Naranjo-hernández, D.; Callejón-leblic, A.; Seyedi, M.; Gao, Y.; Lu, C.; Vasi, I. Past Results, Present Trends, and Future Challenges in Intrabody Communication. *Wirel. Commun. Mob. Comput.* **2018**. [[CrossRef](#)]
32. Bassoli, M.; Bianchi, V.; De Munari, I. A plug and play IoT Wi-Fi smart home system for human monitoring. *Electronics* **2018**, *7*, 200. [[CrossRef](#)]
33. Scacchi, W. Understanding the requirements for developing open source software systems. *IEE Proc. Softw.* **2002**, *149*, 24–39. [[CrossRef](#)]
34. Saqlain, M.; Piao, M.; Shim, Y.; Lee, J.Y. Framework of an IoT-based Industrial Data Management for Smart Manufacturing. *Sens. Actuator Netw.* **2019**, *8*, 25. [[CrossRef](#)]
35. Quang, H.; Ngo, T.; Nguyen, T.P.; Nguyen, H. Monitoring Data Collector to Predict Livestock's Habits Based on Location and Auditory Information: A Case Study from Vietnam. *Agriculture* **2020**, *10*, 180.
36. Abdul-ghani, H.A.; Konstantas, D. A Comprehensive Study of Security and Privacy Guidelines, Threats, and Countermeasures: An IoT Perspective. *Sens. Actuator Netw.* **2019**, *8*, 22. [[CrossRef](#)]
37. Santa, J.; Sanchez-Iborra, R. Vehicular systems technologies: Challenges and trends across transportation means. *Electronics* **2019**, *8*, 1214. [[CrossRef](#)]
38. Talavera, E.; Díaz Alvarez, A.; Naranjo, J.E. A Review of Security Aspects in Vehicular Ad-Hoc Networks. *IEEE Access* **2019**, *7*, 41981–41988. [[CrossRef](#)]
39. Contreras-Castillo, J.; Guerrero-ibañez, J.A. Internet of Vehicles: Architecture, Protocols, and Security. *IEEE Internet Things J.* **2017**, *5*, 3701–3709. [[CrossRef](#)]
40. Kessels, J.T.B.A.; Koot, M.W.T.; Van den Bosch, P.P.J.; Kok, D.B. Online Energy Management for Hybrid Electric Vehicles. *IEEE Trans. Veh. Technol.* **2008**, *57*, 3428–3440. [[CrossRef](#)]
41. Rostami, A.; Member, S.; Cheng, B.; Member, S.; Bansal, G.; Sjöberg, K.; Gruteser, M.; Kenney, J.B. Stability Challenges and Enhancements por Vehicular Channel Congestion Control Approaches. *IEEE Trans. Intell. Transp. Syst.* **2016**, *17*, 2935–2948. [[CrossRef](#)]
42. De Souza, A.M.; Pedrosa, L.L.C.; Botega, L.C.; Villas, L. itsSAFE: An Intelligent Transportation System for Improving Safety and Traffic Efficiency. In Proceedings of the 2018 IEEE 87th Vehicular Technology Conference (VTC Spring), Porto, Portugal, 3–6 June 2018; pp. 1–7.
43. Ge, X.; Li, Z.; Li, S. 5G Software Defined Vehicular Networks. *IEEE Commun. Mag.* **2017**, *55*, 87–93. [[CrossRef](#)]
44. Greco, A.; Lanata, A.; Vanello, N. Data processing and wearable systems for effective human monitoring. *Electronics* **2019**, *8*, 1003. [[CrossRef](#)]
45. Vargas-Lopez, O.; Amezcua-Sanchez, J.P.; De-Santiago-Perez, J.J.; Rivera-Guillen, J.R.; Valtierra-Rodriguez, M.; Toledano-Ayala, M. A New Methodology Based on EMD and Nonlinear Measurements for Sudden Cardiac Death Detection. *Sensors* **2019**, *20*, 9. [[CrossRef](#)]
46. Babaeizadeh, S.; Gregg, R.E.; Helfenbein, E.D.; Lindauer, J.M.; Zhou, S.H. Improvements in atrial fibrillation detection for real-time monitoring. *J. Electrocardiol.* **2009**, *42*, 522–526. [[CrossRef](#)]
47. Llosa, J.; Vilajosana, I.; Vilajosana, X.; Navarro, N.; Suriñach, E.; Marquès, J.M. REMOTE, a Wireless Sensor Network Based System to Monitor Rowing Performance. *Sensors* **2009**, *9*, 7069–7082. [[CrossRef](#)] [[PubMed](#)]
48. Fiore, L.; Fehr, D.; Bodor, R.; Drenner, A.; Somasundaram, G. Multi-Camera Human Activity Monitoring. *J. Intell. Robot. Syst.* **2008**, *52*, 5–43. [[CrossRef](#)]

49. Padhy, S.; Tiwari, J.; Rathore, S. Emergency Signal Classification for the Hearing Impaired using Multi-channel Convolutional Neural Network Architecture. In Proceedings of the IEEE Conference on Information and Communication Technology (CICT), Allahabad, India, 6–8 December 2019; pp. 1–6.
50. Okanoya, K. Sad music induces pleasant emotion. *Front. Psychol.* **2013**, *4*, 311.
51. Ojha, T.; Misra, S.; Singh, N. Wireless sensor networks for agriculture: The state-of-the-art in practice and future challenges. *Comput. Electron. Agric.* **2015**, *118*, 66–84. [[CrossRef](#)]
52. Soares, A.; Gomes, Á.; Antunes, C.H. Categorization of residential electricity consumption as a basis for the assessment of the impacts of demand response actions. *Renew. Sustain. Energy Rev.* **2014**, *30*, 490–503. [[CrossRef](#)]
53. Shakouri, H.; Kazemi, A. Multi-objective cost-load optimization for demand side management of a residential area in smart grids. *Sustain. Cities Soc.* **2017**, *32*, 171–180. [[CrossRef](#)]
54. Khan, P.W.; Byun, Y. A Blockchain-Based Secure Image Encryption Scheme for the Industrial Internet of Things. *Entropy* **2020**, *22*, 175. [[CrossRef](#)]
55. Ball, J.E.; Tang, B. Machine learning and embedded computing in advanced driver assistance systems (ADAS). *Electronics* **2019**, *8*, 748. [[CrossRef](#)]
56. Liu, K.; Wang, J. Fast Dynamic Vehicle Detection in Road Scenarios Based on Pose Estimation with Convex-Hull Model. *Sensors* **2019**, *19*, 3136. [[CrossRef](#)]
57. Park, Y.; Yun, S.; Won, C.S.; Cho, K.; Um, K.; Sim, S. Calibration between Color Camera and 3D LIDAR Instruments with a Polygonal Planar Board. *Sensors* **2014**, *14*, 5333–5353. [[CrossRef](#)]
58. Li, J.; Dai, Y.; Li, C.; Shu, J.; Li, D.; Yang, T. Visual Detail Augmented Mapping for Small Aerial Target Detection. *Remote Sens.* **2019**, *11*, 14. [[CrossRef](#)]
59. Wang, C.; Gong, L.; Yu, Q.; Li, X.; Xie, Y.; Zhou, X. DLAU: A Scalable Deep Learning Accelerator Unit on FPGA. *IEEE Trans. Comput. Des. Integr. Circuits Syst.* **2017**, *36*, 513–517. [[CrossRef](#)]
60. Becerra, V.M. Autonomous control of unmanned aerial vehicles. *Electronics* **2019**, *8*, 452. [[CrossRef](#)]
61. Haibin, D.; Shan, S.; Bingwei, S.U.; Lei, Z. New development thoughts on the bio-inspired intelligence based control for unmanned combat aerial vehicle. *Sci. China Technol. Sci.* **2010**, *53*, 2025–2031.
62. Mebarki, R.; Lippiello, V.; Siciliano, B. Nonlinear Visual Control of Unmanned Aerial Vehicles in GPS-Denied Environments. *IEEE Trans. Robot.* **2015**, *31*, 1004–1017. [[CrossRef](#)]
63. Kurnaz, S.; Cetin, O.; Kaynak, O. Expert Systems with Applications Adaptive neuro-fuzzy inference system based autonomous flight control of unmanned air vehicles. *Expert Syst. Appl.* **2010**, *37*, 1229–1234. [[CrossRef](#)]
64. Özbek, N.S.; Önkol, M.; Efe, M.O. Feedback control strategies for quadrotor-type aerial robots: A survey. *Trans. Inst. Meas. Control* **2016**, *38*, 529–554. [[CrossRef](#)]
65. Lu, L.; Member, S.; Li, G.Y.; Swindlehurst, A.L. An Overview of Massive MIMO: Benefits and Challenges. *IEEE J. Sel. Signal Process.* **2014**, *8*, 742–758. [[CrossRef](#)]
66. Larsson, E.G.; Edfors, O.; Tufvesson, F.; Marzetta, T.L. Massive MIMO for next generation Wireless Systems. *IEEE Commun. Mag.* **2014**, *52*, 186–195. [[CrossRef](#)]
67. Hassan, N.U.; Yuen, C. Green communications in smart cities. *Electronics* **2019**, *8*, 773. [[CrossRef](#)]
68. Shafi, M.; Fellow, L.; Molisch, A.F.; Smith, P.J.; Haustein, T.; Zhu, P.; Member, S.; De Silva, P.; Tufvesson, F.; Benjebbour, A.; et al. 5G: A Tutorial Overview of Standards, Trials, Challenges, Deployment, and Practice. *IEEE J. Sel. Areas Commun.* **2017**, *35*, 1201–1221. [[CrossRef](#)]
69. Christodoulou, C.G.; Tawk, Y.; Lane, S.A.; Erwin, S.R. Reconfigurable Antennas for Wireless and Space Applications. *Proc. IEEE* **2012**, *100*, 2250–2261. [[CrossRef](#)]
70. Peroulis, D.; Sarabandi, K.; Katehi, L.P.B. Design of reconfigurable slot antennas. *IEEE Trans. Antennas Propag.* **2005**, *53*, 645–654. [[CrossRef](#)]
71. Ghaffar, A.; Li, X.J.; Hussain, N.; Awan, W.A. Flexible Frequency and Radiation Pattern Reconfigurable Antenna for Multi-band Applications. In Proceedings of the 4th Australian Microwave Symposium, Sydney, Australia, 13–14 February 2020; pp. 13–14.
72. Zaidi, A.; Awan, W.A.; Hussain, N.; Baghdad, A. A Wide and Tri-band Flexible Antennas with Independently Controllable Notch Bands for Sub-6-GHz Communication System. *Radioengineering* **2020**, *29*, 44–51. [[CrossRef](#)]
73. Koulamas, C.; Lazarescu, M.T. Real-time embedded systems: Present and future. *Electronics* **2018**, *7*, 205. [[CrossRef](#)]

74. De la Piedra, A.; Braeken, A.; Touhafi, A. Sensor systems based on FPGAs and their applications: A survey. *Sensors* **2012**, *12*, 12235–12264. [[CrossRef](#)]
75. Ricci, S.; Meacci, V. Data-adaptive coherent demodulator for high dynamics pulse-wave ultrasound applications. *Electronics* **2018**, *7*, 434. [[CrossRef](#)]
76. Ricci, S.; Meacci, V.; Birkhofer, B.; Wiklund, J. FPGA-based system for in-line measurement of velocity profiles of fluids in industrial pipe flow. *IEEE Trans. Ind. Electron.* **2017**, *64*, 3997–4005. [[CrossRef](#)]
77. Daniel, M.J.; Kumar, K.S. Recent Trends and Improvisations in FPGA. *IOSR J. Electr. Electron. Eng.* **2017**, *12*, 71–77. [[CrossRef](#)]
78. Singh, S.; Saurav, S.; Saini, R.; Mandal, A.S.; Chaudhury, S. FPGA-based Smart Camera System for Real-time Automated Video Surveillance. In Proceedings of the International Symposium on VLSI Design and Test, Roorkee, India, 29 June–2 July 2017; pp. 533–544.
79. Singh, S.; Mandal, A.S.; Shekhar, C.; Vohra, A. Memory Efficient VLSI Implementation of Real-Time Motion Detection System Using FPGA Platform. *J. Imaging* **2017**, *3*, 20. [[CrossRef](#)]
80. Lee, S.; Lee, E.; Hwang, Y.; Jang, S.; Korea, S. Low-Complexity Hardware Architecture of Traffic Sign Recognition with IHSL color space for Advanced Driver Assistance Systems. In Proceedings of the IEEE International Conference on Consumer Electronics-Asia (ICCE-Asia) Low-Complexity, Seoul, Korea, 26–28 October 2016; pp. 1–2.
81. Rodríguez-andina, J.J.; Member, S.; Valdés-peña, M.D.; Moure, M.J. Advanced Features and Industrial Applications of FPGAs—A Review. *IEEE Trans. Ind. Inform.* **2015**, *11*, 853–864. [[CrossRef](#)]
82. Zhang, X.M. Recent developments in time-delay systems and their applications. *Electronics* **2019**, *8*, 552. [[CrossRef](#)]
83. Zhang, R.; Zhang, J.; Yu, H. Review of modeling and control in UAV autonomous maneuvering flight. In Proceedings of the 2018 IEEE International Conference on Mechatronics and Automation (ICMA), Changchun, China, 5–8 August 2018; pp. 1920–1925.
84. Li, M.; Naessens, F.; Debacker, P.; Raghavan, P.; Desset, C.; Li, M.; Dejonghe, A.; Perre, L.V.D. An area and energy efficient half-row-paralleled layer LDPC decoder for the 802.11AD standard. In Proceedings of the IEEE Workshop on Signal Processing Systems, Taipei City, Taiwan, 16–18 October 2013; pp. 112–117.
85. Pomares, J. Visual Servoing in Robotics. *Electronics* **2019**, *8*, 1298. [[CrossRef](#)]
86. Kim, J.; Lee, J.; Lee, J.; Park, G. Motion-based Identification of Multiple Mobile Robots using Trajectory Analysis in a Well-configured Environment with Distributed Vision Sensors. *Int. J. Control Autom. Syst.* **2012**, *10*, 787–796. [[CrossRef](#)]
87. Banlue, T.; Sooraksa, P.; Noppanakeepong, S. A Practical Position-based Visual Servo Design and Implementation for Automated Fault Insertion Test. *Int. J. Control Autom. Syst.* **2014**, *12*, 1090–1101. [[CrossRef](#)]
88. Mia, M.; Królczyk, G.; Maruda, R.; Wojciechowski, S. Intelligent Optimization of Hard-Turning Parameters Using Evolutionary Algorithms for Smart Manufacturing. *Materials* **2019**, *12*, 879. [[CrossRef](#)]
89. Lebecki, K.; Ma, M.; So, T. Continuous dust monitoring in headings in underground coal mines. *J. Sustain. Minig* **2017**, *15*, 125–132. [[CrossRef](#)]
90. Krabicka, J.; Yan, Y. Finite-Element Modeling of Electrostatic Sensors for the Flow Measurement of Particles in Pneumatic Pipelines. *IEEE Trans. Instrum. Meas.* **2009**, *58*, 2730–2736. [[CrossRef](#)]
91. Reyes-vera, E.; Senior, D.E.; Luna-Rivera, J.M.; Lopez, F. Advances in electromagnetic applications and communications. *TecnoLógicas* **2018**, *21*, 9–13. [[CrossRef](#)]
92. Li, G.; Lin, Z.; Huang, X.; Li, J. A radio over fiber system with simultaneous wireless multi-mode operation based on a multi-wavelength optical comb and pulse-shaped 4QAM-OFDM. *Electronics* **2019**, *8*, 1064. [[CrossRef](#)]
93. Gong, C. Visible light communication and positioning: Present and future. *Electronics* **2019**, *8*, 788. [[CrossRef](#)]
94. Tran, H.Q. applied sciences Improved Visible Light-Based Indoor Positioning System Using Machine Learning Classification and Regression. *Appl. Sci.* **2019**, *9*, 1048. [[CrossRef](#)]
95. Werfli, K.; Chvojka, P.; Ghassemlooy, Z.; Hassan, N.B.; Zvanovec, S.; Burton, A.; Haigh, P.A.; Bhatnagar, M.R. Experimental Demonstration of High-Speed 4x4 Multi-CAP MIMO visible Light communications. *IEEE J. Light. Technol.* **2018**, *16*, 1944–1951. [[CrossRef](#)]
96. Lee, S.H.; Jung, S.; Kwon, J.K. Modulation and Coding for Dimmable Visible Light Communication. *Opt. Commun.* **2015**, *27*, 136–143. [[CrossRef](#)]

97. Cailean, A.M.; Dimian, M. Current Challenges for Visible Light Communications Usage in Vehicle Applications: A Survey. *IEEE Commun. Surv. Tutor.* **2017**, *19*, 2681–2703. [[CrossRef](#)]
98. Fernández, I.; de la Vega, D.; Roggo, D.; Stiegler, R.; Capponi, L.; Angulo, I.; Meyer, J.; Arrinda, A. Comparison of measurement methods of LV grid access impedance in the frequency range assigned to NB-PLC technologies. *Electronics* **2019**, *8*, 1155. [[CrossRef](#)]
99. Fernández, I.; de la Vega, D.; Arrinda, A.; Angulo, I.; Uribe-Pérez, N.; Llano, A. Field trials for the characterization of non-intentional emissions at low-voltage grid in the frequency range assigned to NB-PLC technologies. *Electronics* **2019**, *8*, 1044. [[CrossRef](#)]
100. Alvi, M.J.; Izhar, T.; Qaiser, A.A.; Kharal, H.S. Field Optimization and Electrostatic Stress Reduction of Proposed Conductor Scheme for Pliable Gas-Insulated Transmission Lines. *Appl. Sci.* **2019**, *9*, 2988. [[CrossRef](#)]
101. Khelladi, S.; Saci, K.; Hadjadj, A.; Ales, A. Design And Behavioral Study Of EMI Filter Intended For Aeronautical Application. In Proceedings of the International Conference on Advanced Electrical Engineering (ICAEE), Algiers, Algeria, 19–21 November 2019; pp. 1–5.
102. Zhou, Z.; Yap, Y.K. Two-dimensional electronics and optoelectronics: Present and future. *Electronics* **2017**, *6*, 53. [[CrossRef](#)]
103. Ball, J.E.; Younan, N.H. Radar and radio signal processing. *Electronics* **2017**, *6*, 64. [[CrossRef](#)]
104. Qian, Y.; Zhu, D. High-resolution spotlight spaceborne SAR focusing via modified-SVDS and deramping-based approach. *IET Radar Sonar Navig.* **2019**, *13*, 1826–1835. [[CrossRef](#)]
105. Lombardini, F.; Member, S. Multibaseline ATI-SAR for Robust Ocean Surface Velocity Estimation. *IEEE Trans. Aerosp. Electron. Syst.* **2004**, *40*, 417–433. [[CrossRef](#)]
106. Deng, Y.; Liu, X. Electromagnetic Imaging Methods for Nondestructive Evaluation Methods. *Sensors* **2011**, *11*, 11774–11808. [[CrossRef](#)] [[PubMed](#)]
107. Liu, L.; Zhang, X.; Chen, P. Compressed sensing-based DOA estimation with antenna phase errors. *Electronics* **2019**, *8*, 294. [[CrossRef](#)]
108. Zheng, Z.; Zhang, J.; Zhang, J. Joint DOD and DOA estimation of bistatic MIMO radar in the presence of unknown mutual coupling. *Signal Process.* **2012**, *92*, 3039–3048. [[CrossRef](#)]
109. Wang, H.; Wang, X.; Huang, M. Robust Sparse Bayesian Learning for Off-Grid DOA Estimation With Non-Uniform Noise. *IEEE Access* **2018**, *6*, 64688–64697. [[CrossRef](#)]
110. Mukhopadhyay, S.C.; Islam, T. Innovative technologies and services for smart cities. *Electronics* **2019**, *8*, 376. [[CrossRef](#)]
111. Zhang, K.; Member, S.; Amineh, R.K.; Member, S. Microwave Sensing of Water Quality. *IEEE Access* **2019**, *7*, 69481–69493. [[CrossRef](#)]
112. Yi, W.Y.; Lo, K.M.; Mak, T.; Leung, K.S.; Leung, Y.; Meng, M.L. A Survey of Wireless Sensor Network Based Air Pollution Monitoring Systems. *Sensors* **2015**, *25*, 31392–31427. [[CrossRef](#)]
113. Bashian, A.; Assili, M.; Anvari-Moghaddam, A.; Catalão, J.P.S. Optimal design of a wide area measurement system using hybrid wireless sensors and phasor measurement units. *Electronics* **2019**, *8*, 1085. [[CrossRef](#)]
114. Nolich, M.; Spoladore, D.; Carciotti, S.; Buqi, R.; Sacco, M. Cabin as a Home: A Novel Comfort Optimization Framework for IoT Equipped Smart Environments and Applications on Cruise Ships. *Sensors* **2019**, *19*, 1060. [[CrossRef](#)] [[PubMed](#)]
115. Kleinlein, R.; García-Faura, Á.; Jiménez, C.L.; Montero, J.M.; Díaz-De-maría, F.; Fernández-Martínez, F. Predicting image aesthetics for intelligent tourism information systems. *Electronics* **2019**, *8*, 671. [[CrossRef](#)]
116. Arlati, S.; Colombo, V.; Spoladore, D.; Greci, L.; Pedroli, E.; Serino, S.; Cipresso, P.; Goulene, K.; Stramba-badiale, M.; Riva, G.; et al. A Social Virtual Reality-Based Application for the Physical and Cognitive Training of the Elderly at Home. *Sensors* **2019**, *19*, 261. [[CrossRef](#)] [[PubMed](#)]
117. Zhu, H.; Li, Q. Nanoelectronic materials, devices and modeling: Current research trends. *Electronics* **2019**, *8*, 564. [[CrossRef](#)]
118. Najam, F.; Yu, S. Impact of Quantum Confinement on Band- to-Band Tunneling of Line-Tunneling Type L-Shaped Tunnel Field-Effect Transistor. *IEEE Trans. Electron. Devices* **2019**, *66*, 2010–2016. [[CrossRef](#)]
119. Crupi, G.; Schreurs, D.M.M.; Raskin, J.; Caddemi, A. Solid-State Electronics A comprehensive review on microwave FinFET modeling for progressing beyond the state of art. *Solid State Electron.* **2013**, *80*, 81–95. [[CrossRef](#)]

120. Chung, S.; Lee, S.; Jang, S.; Yoo, M.; Kim, K.; Chung, C.; Cho, S.Y.; Cho, H.; Hwang, S.; Kim, J.; et al. Highly Scalable Saddle-Fin (S-Fin) Transistor for Sub-50 nm DRAM Technology. In Proceedings of the VLSI Symposium, Honolulu, HI, USA, 13–15 June 2006; pp. 147–148.
121. Suligoj, T.; Poljak, M.; Jovanovic, V. Improving bulk FinFET DC performance in comparison to SOI FinFET. *Microelectron. Eng.* **2009**, *86*, 2078–2085.
122. Kim, Y.K.; Lee, J.S.; Kim, G.; Park, T.; Kim, H.J.; Cho, Y.P.; Park, Y.J.; Lee, M.J. The Optimized Partial Insulator Isolation MOSFET (PiFET). *J. Semicond. Technol. Sci.* **2017**, *17*, 729–732. [[CrossRef](#)]
123. Cheng, T.; Rao, J.; Tang, X.; Yang, L.; Liu, N. Analog Memristive Characteristics and Conditioned Reflex Study Based on Au/ZnO/ITO Devices. *Electronics* **2018**, *7*, 141. [[CrossRef](#)]
124. Xiong, C.; Xiao, J.; Chen, L.; Du, W.; Xu, W.; Hou, D. Interfacial passivation of n-ZnO/p-Si heterojunction by CuI thin layer. *J. Semicond.* **2018**, *39*. [[CrossRef](#)]
125. Lv, F.; Yang, R.; Guo, X. Analog and digital Reset processes observed in Pt/CuO/Pt memristive devices. *Solid State Ionics* **2017**, *303*, 161–166. [[CrossRef](#)]
126. Górecki, K.; Górecki, P. Compact electrothermal model of laboratory made GaN Schottky diodes. *Microelectron. Int.* **2020**, *37*, 95–102. [[CrossRef](#)]
127. Kim, Y. Editorial of energy-efficient and reliable information processing: Computing and storage. *Electronics* **2019**, *8*, 914. [[CrossRef](#)]
128. Kuzmina, M.; Manykin, E.; Surina, I. Oscillatory network with self-organized dynamical connections for synchronization-based image segmentation. *BioSystems* **2004**, *76*, 43–53. [[CrossRef](#)] [[PubMed](#)]
129. Yin, J.; Lai, Z.; Zeng, W.; Wei, L. Local sparsity preserving projection and its application to biometric recognition. *Multimed. Tools Appl.* **2018**, *77*, 1069–1092. [[CrossRef](#)]
130. Ruqia, B.; Javaid, N.; Husain, A.; Hassan, N.M. Influential Reasonable Robust Virtual Machine Placement for Utilization and Saving Energy. In *International Conference on Innovative Mobile and Internet Services in Ubiquitous Computing*; Springer: Cham, Switzerland, 2019; pp. 549–561.
131. Liu, B. Improved particle swarm optimization combined with chaos. *Chaos Solitons Fractals* **2005**, *25*, 1261–1271. [[CrossRef](#)]
132. Mirjalili, S.; Mohammad, S.; Lewis, A. Advances in Engineering Software Grey Wolf Optimizer. *Adv. Eng. Softw.* **2014**, *69*, 46–61. [[CrossRef](#)]
133. Mirjalili, S.; Saremi, S.; Mohammad, S. Multi-objective grey wolf optimizer: A novel algorithm for multi-criterion optimization. *Expert Syst. Appl.* **2016**, *47*, 106–119. [[CrossRef](#)]
134. Gopalan, P.; Huang, C.; Simitci, H.; Yekhanin, S. On the Locality of Codeword Symbols. *IEEE Trans. Inf. Theory* **2012**, *8*, 6925–6934. [[CrossRef](#)]
135. Thi, M.; Pierson, J.; Da, G.; Stolf, P.; Nicod, J.; Rostirolla, G.; Haddad, M. Negotiation game for joint IT and energy management in green datacenters. *Future Gener. Comput. Syst.* **2019**. [[CrossRef](#)]
136. Almalaq, Y.; Matin, M. Three topologies of a non-isolated high gain switched-inductor switched-capacitor step-up cuk converter for renewable energy applications. *Electronics* **2018**, *7*, 94. [[CrossRef](#)]
137. Siwakoti, Y.P.; Blaabjerg, F.; Loh, P.C.; Town, G.E. High-voltage boost quasi-Z-source isolated DC/DC converter. *IET Power Electron.* **2014**, 2387–2395. [[CrossRef](#)]
138. Applications, G.; Li, W.; He, X. Review of Nonisolated High-Step-Up DC/DC Converters in Photovoltaic. *IEEE Trans. Ind. Electron.* **2011**, *58*, 1239–1250.
139. Shen, C.L.; Chen, L.Z.; Chen, H.Y. Dual-input isolated DC-DC converter with ultra-high step-up ability based on sheppard taylor circuit. *Electronics* **2019**, *8*, 1125. [[CrossRef](#)]
140. Almalaq, Y.; Alateeq, A.; Matin, M. A Non-Isolated High Gain Switched-Inductor Switched-Capacitor Step-Up Converter for Renewable Energy Applications. In Proceedings of the 2018 IEEE International Conference on Electro/Information Technology (EIT), Rochester, MI, USA, 3–5 May 2018; pp. 134–138.
141. Khorasani, R.R.; Member, S.; Adib, E. ZVT Resonant Core Reset Forward Converter With a Simple Auxiliary Circuit. *IEEE Trans. Ind. Electron.* **2018**, *65*, 242–250. [[CrossRef](#)]
142. Wang, C. Novel Zero-Voltage-Transition PWM DC—DC Converters. *IEEE Trans. Ind. Electron.* **2006**, *53*, 254–262. [[CrossRef](#)]
143. Zhou, T.; Francois, B. Modeling and control design of hydrogen production process for an active hydrogen/wind hybrid power system. *Int. J. Hydrogen Energy* **2009**, *34*, 21–30. [[CrossRef](#)]
144. Guilbert, D.; Maria, S.; Scipioni, A.; Lorraine, D. DC/DC converter topologies for electrolyzers: State-of-the-art and remaining key issues. *Int. J. Hydrogen Energy* **2017**, *42*, 23966–23985. [[CrossRef](#)]



145. Tang, J.; Lee, J.; Roh, J. Low-Power Fast-Transient Capacitor-Less LDO Regulator With High Slew-Rate Class-AB Amplifier. *IEEE Trans. Circuits Syst.* **2019**, *66*, 462–466. [[CrossRef](#)]
146. Strasser, T.; Member, S.; Andrén, F.; Kathan, J.; Cecati, C.; Buccella, C.; Member, S.; Siano, P.; Member, S.; Leitão, P.; et al. A Review of Architectures and Concepts for Intelligence in Future Electric Energy Systems. *IEEE Trans. Ind. Electron.* **2015**, *62*, 2424–2438. [[CrossRef](#)]
147. Model, N.R.; Simulation, D.; Tunneling, I. New Recombination Model for Device Simulation Including Tunneling. *IEEE Trans. Electron Devices* **1992**, *39*, 331–338.
148. Wang, H.; Wang, N.; Jiang, L.; Zhao, H.; Lin, X.; Yu, H. Solid-State Electronics Study of the enhancement-mode AlGaIn/GaN high electron mobility transistor with split floating gates. *Solid State Electron.* **2017**, *137*, 52–57. [[CrossRef](#)]
149. Viswamohan, K.; Jayakrishna, G. Soft-Switching Techniques for DC-to-DC Converters in Electrolyzer Application. *Int. J. Adv. Technol. Innov. Res.* **2014**, *6*, 1021–1026.



© 2020 by the authors. Licensee MDPI, Basel, Switzerland. This article is an open access article distributed under the terms and conditions of the Creative Commons Attribution (CC BY) license (<http://creativecommons.org/licenses/by/4.0/>).