



*Alliance for Batteries Technology, Training and Skills*

*2019-2023*

**Intelligence in Mobile Battery  
Applications  
Desk Research Report**



Deliverable D5.1 Desk Research & Data Analysis IMBA –

Release 1



Co-funded by the  
Erasmus+ Programme  
of the European Union

Report Title:	Intelligence in Mobile Battery Applications (D5.1 Desk Research & Data Analysis IMBA – Release 1)		
Author(s):	WP5 and other partners: AIA, Merinova, ACEA, APIA, Corvus, EFACEC, FEUP, HE3DA, Northvolt, Realizeit, SKEA, SPIN360, VSB-TUO		
Responsible Project Partner:	AIA (Czech Automotive Industry Association)	Contributing Project Partners:	AIA, Merinova, ACEA, APIA, Corvus, EFACEC, FEUP, HE3DA, Northvolt, Realizeit, SKEA, SPIN360, VSB-TUO

Document data:	File name:	Intelligence in Mobile Battery Applications (D5.1 Desk Research & Data Analysis IMBA – Release 1)		
	Pages:	236	No. of annexes:	0
	Status:	Final	Dissemination level:	Public
Project title:	ALBATTTS (Alliance for Batteries, Training and Skills)		GA No.:	2019-612675
WP title:	WP5 - Intelligence in Mobile Applications		Project No.:	612675-EPP-1-2019-1-SE-EPPKA2-SSA-B
			Deliverable No:	D5.1
Date:	Due date:	31. 8. 2020	Submission date:	31. 8. 2020
Keywords:	Battery value chain, EU, battery technologies, job roles, skills, electric passenger cars, electric vessels			
Reviewed by:	Václav Janda, ACEA		Review date:	30. 8. 2020
			Review date:	
Approved by:	Zdeněk Petzl, AIA		Approval date:	31. 8. 2020

## TABLE OF CONTENTS

<b>Table of Contents</b> .....	<b>2</b>
<b>Introduction</b> .....	<b>3</b>
<b>List of Abbreviations</b> .....	<b>4</b>
<b>1 Methodology</b> .....	<b>7</b>
1.1 Preview of the Methodology .....	7
1.2 Scope .....	8
1.3 Defined Battery Value Chain .....	10
1.4 Topics of Sectoral Intelligence .....	11
1.5 Desk Research Excel File .....	13
1.6 Goals .....	14
<b>2 Overview of the subsector</b> .....	<b>15</b>
2.1 Drivers of change .....	15
2.2 Stakeholders .....	31
2.3 Technologies .....	55
2.4 Job, Roles and Skills .....	61
2.5 Education .....	67
<b>3 Value chain</b> .....	<b>68</b>
3.1 Raw Materials and Processing .....	68
3.2 Components and cell manufacturing .....	87
3.3 Module and Pack Manufacturing .....	111
3.4 Battery Integration .....	115
3.5 Operation, Repair and Maintenance .....	132
3.6 Second Life .....	176
3.7 Recycling .....	196
<b>4 Training &amp; Education Methods and Approaches</b> .....	<b>228</b>
4.1 Education Offerings .....	233

## INTRODUCTION

---

The first iteration of the report Intelligence in Mobile Battery Applications mostly covers state of the art of the traction battery use in the automotive sector with the focus on **passenger cars**, particularly on Battery Electric Vehicles (BEVs) and Plug-in Hybrid vehicles (PHEVs). Driven mainly by the EU CO<sub>2</sub> emission legislation, sales volumes of these vehicles are expected to boom. They require a significant battery capacity and thus have the biggest importance and the highest economic potential for Europe. **Lithium-ion battery technology** is currently the mainstream technology used in these vehicle types. The report also covers battery use in **vessels**, where a very interesting emission reduction potential can be exploited, and specific know-how of partners associated in the project (Corvus) used.

In the following versions of the report, the information gathered will be **deepened and focused** based on the received feedback and further analysis. The intention of the authors is also to **extend the scope of the next report iterations** to e.g. vans, heavy duty vehicles and other mobile battery applications, such as rail, aviation, non-road machinery or devices for city/ micro mobility - electric bikes, scooters, one/two wheelers.

**Emerging concepts** concerning battery technology and relevant impact on job roles, skills and qualifications will also be explored in the following deliverables in more detail.

The authors of the report are aware of its **limitations** when it comes to scope and content. Some chapters provide very detailed technical information, while other provide more general overview. Following the feedback received, these issues will be addressed through further desk research activities as well as via workshops and surveys with the focus on identification of **skills and competences** needed in the future.



## LIST OF ABBREVIATIONS

---

AC	...	Alternating current
ACEA	...	European Automobile Manufacturers' Association
Ah/kg	...	Ampere-hour per kilogram
ALBATTTS	...	Alliance for Batteries Technology, Training and Skills
B2G	...	Battery to Grid
BEV	...	Battery electric vehicle
BMS	...	Battery management system
CAGR	...	Compound annual growth rate
CAN	...	Controller area network
CNG	...	Compressed natural gas
CO	...	Carbon monoxide
CO <sub>2</sub>	...	Carbon dioxide
DC	...	Direct current
DEG	...	Digitally Enabled Grid
ECU	...	Electronic Control Unit
EEA	...	European Economic Area
EGD	...	European Green Deal
EIB	...	European Investment Bank
ELV	...	End of Life Vehicles
EoL	...	End of Life
EPC	...	Engineering, Procurement and Construction
EPR	...	Extended Producer Responsibility
EQF	...	European Qualifications Framework
ESCO	...	European Skills/Competences, Qualifications and Occupations
ESOI	...	European Society of Oncologic Imaging
ESS	...	Energy Storage Systems
EV	...	Electric vehicle
FCEV	...	Fuel cell electric vehicle
GDP	...	Gross Domestic Product
GHG	...	Greenhouse gas

GPS	...	Global positioning system
GST	...	Grid Storage Technologies
HEV	...	Hybrid electric vehicle
ICE	...	Internal combustion engine
ICT	...	Information and Communication Technologies
IMBA	...	Intelligence in Mobile Battery Applications
IoT	...	Internet of Things
ISCO	...	International Standard Classification of Occupations
ISIBA	...	Intelligence in Stationary and other Industrial Battery Applications
ISIC	...	International Standard Industrial Classification
kW	...	Kilowatt
kWh	...	Kilowatt-hour
kWh/100 km	...	Kilowatt-hour per 100 kilometres
LCO	...	Lithium cobalt oxide
LFP	...	Lithium iron phosphate
LIB	...	Lithium-ion battery
LiCoO <sub>2</sub>	...	Lithium Cobalt Oxide
LMO	...	Lithium ion manganese oxide
LTO	...	Lithium titanate oxide
NACE	...	Nomenclature of Economic Activities
NCA	...	Lithium Nickel Cobalt Aluminium Oxide
NiCd	...	Nickel-cadmium
NiMH	...	Nickel–metal hydride
NMC	...	Lithium nickel manganese cobalt oxides
NMHC	...	Non-methane volatile organic compound
NO <sub>x</sub>	...	Nitrogen oxide
O&M	....	Operations and Maintenance
OEM	...	Original equipment manufacturer
PHEV	...	Plug-in hybrid electric vehicle
PM	...	Particulate matter
SEI	...	Solid-Electrolyte Interphase

SMEs	...	Small and medium-sized enterprises
SoC	...	State of Charge
SoH	...	State of Health
SRM	...	Secondary Raw Materials
THC	...	Hydrocarbons
V2G	...	Vehicle to Grid
Wh/kg	...	Watt-hour per kilogram

## 1 Methodology

This section of the report describes role of the desk research in the ALBATTTS project context, how it was executed and which methods and tools were used in order to gather all the necessary information about the sub-sectoral Intelligence in Mobile Battery Applications (IMBA). After the methodology methods are declared it is important to define the goals of the report, these must be aligned with the defined scope, topics of the sub sectoral intelligence and overall approach to the execution of the desk research. Project **Deliverable 3.1 Methodology Methods for Sectoral Intelligence** is solely focused on the methodology

### 1.1 PREVIEW OF THE METHODOLOGY

This sub section describes the relation of the IMBA to the overall battery sector and the defined scope and how the data about sub-sectoral intelligence are going to be gathered.

#### 1.1.1 Work Package Structure and Relation

As defined in project application and **D3.1**, the overall battery sector was divided into 3 work packages in ALBATTTS project as seen in **Figure 1**.

#### Work packages (Figure 1):

- ◆ **WP3 – Sectoral Intelligence**
  - Definition of methodology and overall approach.
  - Provision of summarisation for overall sector and comparison between applications in sub-sectors.
- ◆ **WP4 – Intelligence in Stationary and other Industrial Battery Applications (ISIBA)**
  - Follows the same structure of work and methodology.
  - Provision of detailed insights and summarisation of ISIBA.
- ◆ **WP5 – Intelligence in Mobile Battery Applications (IMBA)**
  - Follows the same structure of work and methodology.
  - Provision of detailed insights and summarisation of IMBA.

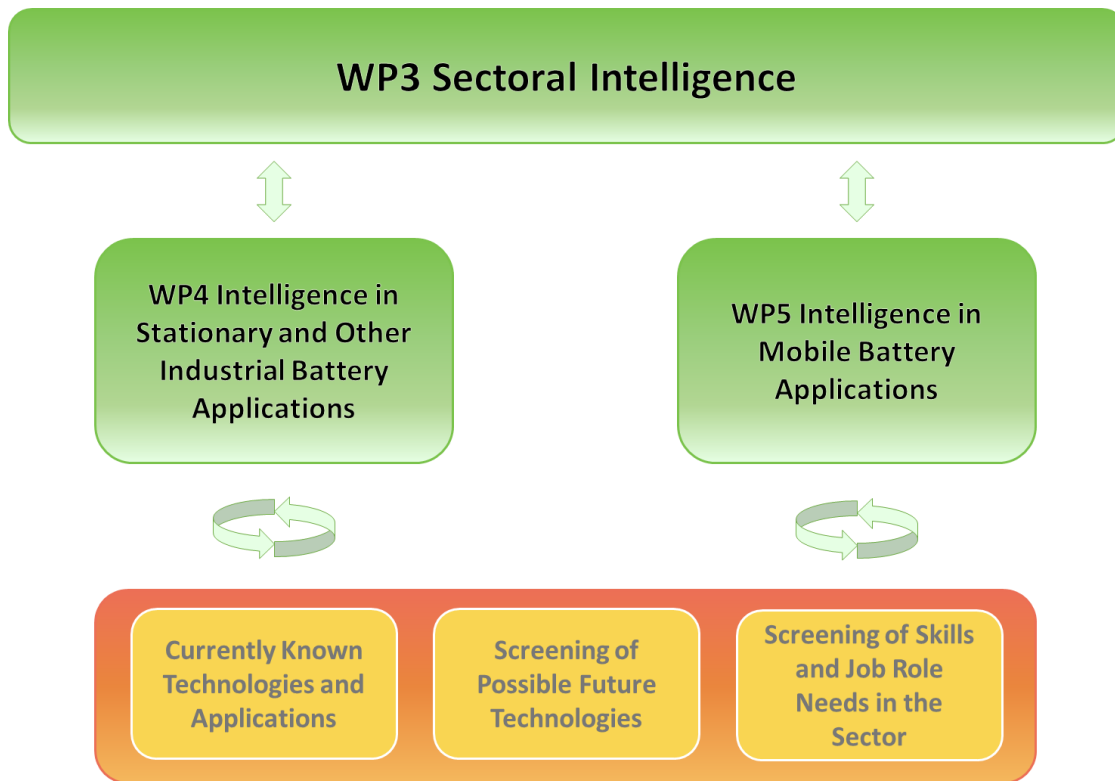

Figure 1 Depiction of WP3 and WP4-5 Relation

## 1.2 SCOPE

As mentioned above, whole sectoral intelligence will be composed from the findings of the WP4 and WP5. Therefore, the scope of the desk research needs to be defined for both sub-sectors.

### 1.2.1 Geographical Scope

The geographical scope of the sub-sector is focused on **Europe, especially on the EU** and other **EEA countries**. However, inputs to the project are not restricted by this geographical scope.

### 1.2.2 Educational Scope

Educational scope of the sub-sector was declared to be from EQF level 4 to 7. In this report we do not include pre-upper-secondary education (EQF 1-3) and PhD education (EQF 8). The report also covers the informal reskilling and lifelong education for the workforce throughout the whole battery life cycle.

### 1.2.3 IMBA Scope

The scope of the IMBA:

- ◆ **1<sup>st</sup> iteration** of the desk research report is mainly focused on Li-ion traction battery topics relevant to:
  - Passenger cars
  - Vessels

### 1.2.4 Overlaps

Overlaps occurred between ISIBA and IMBA when executing the research since some of the battery **early and late value chain stages** are very similar for both stationary and mobile applications. That is why the following chapters were prepared in **close cooperation** between WP4 and WP5:

- ◆ Raw Materials and Processing
- ◆ Components and Cell Manufacturing
- ◆ Module and Pack Manufacturing
- ◆ Battery integration (partly)
- ◆ Second Use of Batteries
- ◆ Recycling
- ◆ Education

### 1.3 DEFINED BATTERY VALUE CHAIN

The whole sectoral intelligence as well as each sub-sector follows the battery value chain structure which was defined in **D3.1**. This sub-section will briefly touch on the battery value chain steps with more detailed description to be found in **Chapter 3**. These steps of battery value chain are important when it comes to categorisation of the information which is going to be researched throughout the project. Of course, there is always possibility of making changes to the battery value chain in the later stages of the ALBATTTS project.

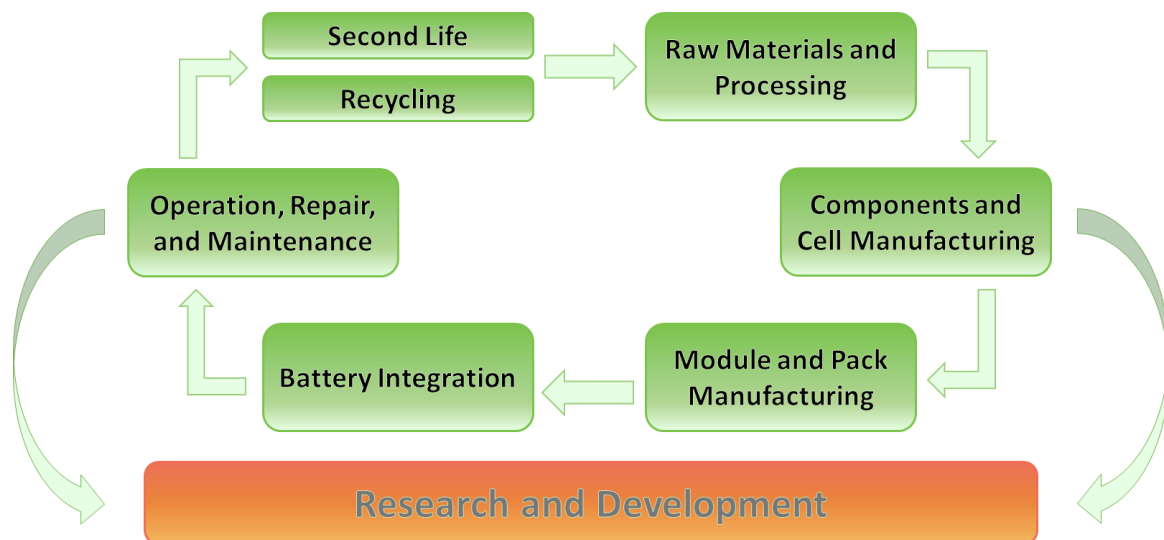

Figure 2 Battery Value Chain

#### Defined battery value chain (Figure 2):

- ◆ **Raw materials and processing**
  - Primary material sourcing with emphasis on rare earths and scarce metals. In the future, also integration of the recycled materials coming from end-of-life EV batteries into the production stream.
- ◆ **Components and cell manufacturing**
  - Battery components, cell manufacturing methods.
- ◆ **Module and pack manufacturing**
  - Creation of larger systems from battery cells and modules.
- ◆ **Battery integration**
  - Integration of assembled battery modules together with Battery Management System into the specific use cases such as passenger cars.

- ◆ **Operation, repair, and maintenance**
  - Topics related to passenger cars and vessel technology, operation, repair, and maintenance topics including safety issues, charging and new emerging services.
- ◆ **Second life**
  - “Life after life” of the batteries used e. g. as an energy storage.
- ◆ **Recycling**
  - Re-use of the scarce materials taken from used batteries, in line with “circular economy” principles. Important to ensure compliance with current and upcoming legislation and to avoid harming the environment.

## 1.4 TOPICS OF SECTORAL INTELLIGENCE

Topics of sectoral intelligence which are going to be mapped within the battery value chain steps need to be defined to ensure systematic work and comparability of the results of both sub-sectors. This structure will also ensure adaptation of the field research and mapping its results to the same structure. This report covers adapted structure of topics of sectoral intelligence based on the **D3.1** as seen below.

### Topics of the sectoral intelligence:

- ◆ Drivers of change
- ◆ Major stakeholders
- ◆ Technologies
- ◆ Sector Attractiveness
- ◆ Job roles and skills needs
- ◆ Existing training and education
- ◆ Training methods

#### 1.4.1 Sectoral Intelligence Topics Association with the Battery Value Chain

The sectoral intelligence topics listed above are associated with the battery value chain in two different manners. Some topics have different associations with the battery value chain than others. This can be separated into two different categories:



◆ **Individual battery value chain step related topics (Figure 3)**

- Major stakeholders
- Technologies
- Job roles and skills needs
- Drivers of change

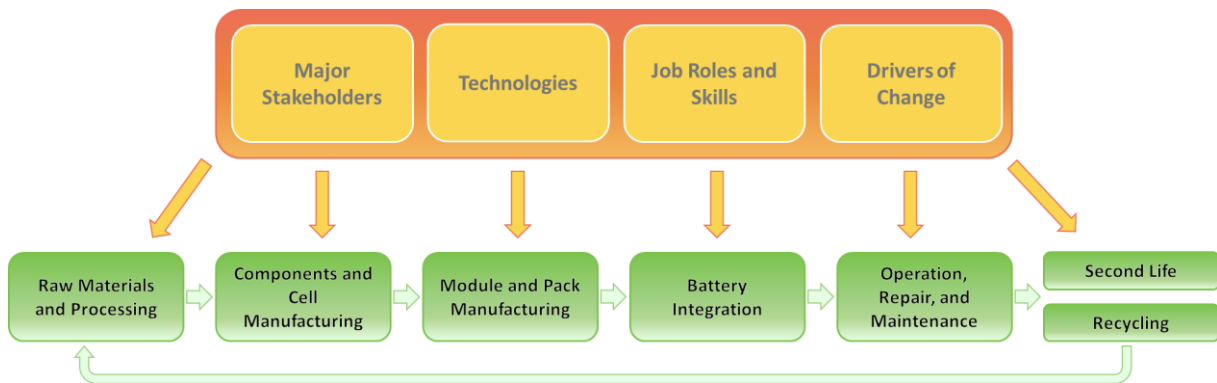

Figure 3 Individual Battery Chain Step Related Topics

◆ **Overall battery value chain related topics (Figure 4)**

- Sector attractiveness
  - In some cases, this can be also mapped to the individual steps
- Existing trainings, qualification, and education
- Training methods and approaches

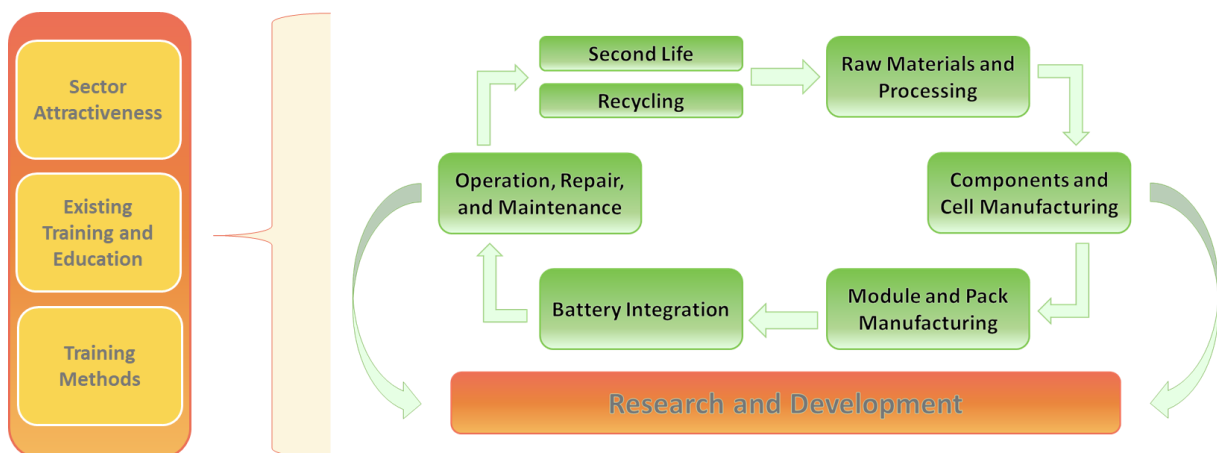

Figure 4 Overall Battery Chain Related Topics

## 1.5 DESK RESEARCH EXCEL FILE

An Excel file was created based on desk research methodology to classify and map information into the declared structure of the corresponding topics. This will allow the statistical analysis of the data, which will help with the choice of which data will be inputted into the final reports. This structured Excel file also allows data to be searched, sorted, and worked with collaboratively via the online NextCloud application, which is used to store and share materials between the project partners.

### 1.5.1 Desk Research File Structure

As mentioned previously, this Excel file is structured into worksheets based on the declared topics of sectoral intelligence. Each topic is represented by a separate worksheet with a unique structure.

### 1.5.2 Virtual Library

The desk research Excel file also includes Virtual Library, which is essentially one of the worksheets of the Excel file used to collect all the sources and material that might be used for analysis.

### 1.5.3 Competence List

A competence list was shared between the partners to classify their skills and competence. Based on their expertise and preference, they were assigned to the corresponding topics of the sectoral intelligence for further analysis. This allowed a very flexible division of work between the partners.

### 1.5.4 Desk Research Strategy

Strategy of execution of the desk research activity was defined to deliver good quality sectoral intelligence.

### Desk research process:

- ◆ Assessment of partners' skills
- ◆ Population of the Virtual Library
- ◆ Declaration of index of the final report
- ◆ Division of the sections between the partners based on the assessed skills
- ◆ Research activity based on the defined methodology
  - Mapping selected information to the Desk Research Excel file
  - Writing the report
- ◆ Continuous report revision and finalisation
- ◆ Report delivery

## 1.6 GOALS

To have a clear vision and understanding where the project is heading, as well as the various reports, we need to define understandable goals to guide the work of the project partners.

### 1.6.1 Basis for Gap Analysis

As defined in **D3.1**, desk research is the opposite of field research. This does not mean that there will not be any interaction between those two. Field research is a key part of the research since it will enable us to close the gaps which will be encountered in the desk research. One of the goals of the desk research is to map the current state of the art of the sub-sector which will be then used for the gap analysis. This will further lead to declaration and creation of the online survey and workshop events which are going to close as many gaps as possible.

### 1.6.2 Understanding the State-of-the-Art

As mentioned previously, this first iteration of several desk research reports should serve as an overview of the state-of-the-art of the sub-sector. This will help partners and the public to understand the current situation and help us to establish next steps in the project and for the next iteration.

## 2 Overview of the subsector

### 2.1 DRIVERS OF CHANGE

#### 2.1.1 Methodology

Drivers of change are those factors which are key to transforming an industry. Specifically, a literature review of available reports was undertaken to create an overview of current Drivers of Change and their relevance in the sector.

The process started from an internal project partners' analysis where 4 macro areas have been identified to concentrate the possible changing within: (i) the rise of new technologies, (ii) climate goals, (iii) societal and structural changes and (iv) globalisation and the rise of new players.

The literature review enabled the mapping of each initial macro area of the Drivers of Change against wider research evidence and following the desk-research process, the initial categories with several more specific Drivers of Change identified as relevant to be validated were:

- ◆ **New technologies and business models**
  - Cybersecurity
  - Global technical harmonisation, standardisations, and Plug & Play
  - Smart Grid (B2X)
- ◆ **Climate goals, environmental and health challenges**
  - Circular value chain of the manufacturing process
  - Electrification and green energy
  - Improved charging/refuelling infrastructure
- ◆ **Structural changes**
  - Acquisition of new skills / Continuous training
  - Restructuring
- ◆ **Globalisation**
  - Access to raw materials
  - Global regulatory dialogue

During the desk-research process the 4 macro areas with the initial 10 Drivers of Change have been evaluated and compared with the analysed literature; this resulted in **3 main areas**: **(i)** Climate goals, regulation and environmental challenges, **(ii)** Globalisation and **(iii)** New technologies with a total of 9 specific Drivers of Change (see next chapter for details).

**The desk research activity focused on 3 main aspects for each Driver of Change:**

- ◆ **Occurrence:** indicating whether a Driver of Change was cited in analysed reports reviewed (if a specific Driver of Change is cited multiple times in the same report, the occurrence is, in any case, 1; if in a report different Drivers of Change are cited, all of them are counted and the occurrence per each of them is 1).
- ◆ **Importance:** an evaluation by the ALBATTIS project partners, based on the context in which the specific Driver of Change is discussed, focused on its possible status in the future and on its direct implications on changes in the sector, using a ranking from 0 to 5 (0 = not possible to evaluate, 1= not important, 5 very important).
- ◆ **Urgency:** a specific time frame (year), which can be noticed from the text of the analysed document, in which the Driver of Change will become particularly necessary or will make its consequence felt overwhelmingly.

### 2.1.2 Introduction to the Drivers of Change

In the European Green Deal<sup>1</sup> (EGD), the European Commission stated that a 90% reduction in transport emissions is needed by 2050 (compared to 1990) and that road transport needs to move to zero emissions beyond 2025. To reach this objective, Europe will have to significantly increase the uptake of zero emission technologies with a strong emphasis on battery electric vehicles. Gradually, these will be accompanied by hydrogen powered vehicles.<sup>2</sup> According to the EGD, the power sector will be based much more on renewable sources of energy. Batteries can help with integrating renewables into the electricity grid. Development in other technological areas, such as 5G (5G base stations have higher energy consumption and require higher density than earlier generations<sup>3</sup>) also brings big opportunities for (Li-ion) batteries.

<sup>1</sup> European Green Deal, [https://ec.europa.eu/info/strategy/priorities-2019-2024/european-green-deal\\_en](https://ec.europa.eu/info/strategy/priorities-2019-2024/european-green-deal_en), 2019

<sup>2</sup> [https://ec.europa.eu/energy/sites/ener/files/hydrogen\\_strategy.pdf](https://ec.europa.eu/energy/sites/ener/files/hydrogen_strategy.pdf)

<sup>3</sup> <https://www.spglobal.com/marketintelligence/en/news-insights/latest-news-headlines/china-8217-s-5g-construction-turns-to-lithium-ion-batteries-for-energy-storage-58474880> (last accessed on 28.08.2020)

This will require large amounts of batteries on the European market. According to the 3 GHG scopes emissions<sup>4;5</sup>:

1. batteries could enable 30% of the required reductions in carbon emissions in the transport and power sectors, provide access to electricity to 600 million people who currently have no access, and create 10 million safe and sustainable jobs around the world.
2. a circular, responsible, and just battery value chain is one of the major near-term drivers to realize the 2°C Paris Agreement goal in the transport and power sectors, setting course.
3. batteries directly avoid 0.4 Gt CO<sub>2</sub> emissions in transport and contribute to enabling renewables as a reliable source of energy to displace carbon-based energy production, which will avoid 2.2 Gt CO<sub>2</sub> emissions – together roughly 30% of required emission reductions in these sectors until 2030.

Based on a World Economic Forum report, the battery value chain will halve its GHG intensity by 2030 at a net economic gain, reducing 0.1 Gt emissions within the battery value chain itself and putting it on track to achieving net-zero emissions in 2050<sup>6</sup>.

Within this context, the European Commission prioritises zero emission technologies also in the recently published EU Industrial Strategy and the Circular Economy Action Plan<sup>7</sup> to support the domestic production of sustainable batteries.

According to Bloomberg Electric Vehicle Outlook, EVs and fuel cell vehicles will reduce road CO<sub>2</sub> emissions by 2.57Gt a year by 2040 - and are set for much larger reductions thereafter. Lithium-ion battery pack prices fell 87% from 2010 to 2019, with the volume-weighted average hitting \$156/kWh. Underlying material prices will play a larger role in the future, but the introduction of new chemistries, new manufacturing techniques and simplified pack designs will keep prices falling<sup>8</sup>.

<sup>4</sup> Greenhouse gas protocol, <https://ghgprotocol.org/>, 2020 and „Word Economic Forum“ Report [http://www3.weforum.org/docs/WEF\\_A\\_Vision\\_for\\_a\\_Sustainable\\_Battery\\_Value\\_Chain\\_in\\_2030\\_Report.pdf](http://www3.weforum.org/docs/WEF_A_Vision_for_a_Sustainable_Battery_Value_Chain_in_2030_Report.pdf), 2019

<sup>5</sup> <https://www.carbontrust.com/resources/briefing-what-are-scope-3-emissions> last accessed on 28.08.2020

<sup>6</sup> A Vision for a Sustainable Battery Value Chain in 2030, Global Battery Alliance, WEF, 2019; accessed from: [http://www3.weforum.org/docs/WEF\\_A\\_Vision\\_for\\_a\\_Sustainable\\_Battery\\_Value\\_Chain\\_in\\_2030\\_Report.pdf](http://www3.weforum.org/docs/WEF_A_Vision_for_a_Sustainable_Battery_Value_Chain_in_2030_Report.pdf)

<sup>7</sup> [https://ec.europa.eu/environment/circular-economy/pdf/new\\_circular\\_economy\\_action\\_plan.pdf](https://ec.europa.eu/environment/circular-economy/pdf/new_circular_economy_action_plan.pdf), 2020

<sup>8</sup> Electric Vehicle Outlook 2020, Bloomberg, 2020 (<https://about.bnef.com/electric-vehicle-outlook/>) and EUROBAT „Battery Innovation Roadmap 2030“, <https://www.eurobat.org/news-publications/press->

In preparation for the upcoming EU Battery Strategy, the Commission is planning to revise still by the end of 2020 the Directive (2006/66/EC) on Batteries to prioritise a circular economy approach when it comes to addressing the recycling of batteries. This includes ensuring the security of supply of raw materials, the reuse (where adequate) and recycling of batteries, as well as the high environmental and social values in the manufacturing process as ways to promote a sustainable EU battery industry. Moreover, it will be extremely important to take note of the emerging new jobs related to the dismantling and recycling sector overall, as well as the processing and the reincorporation of used active materials within new batteries (i.e. when repurposing is economically proven to be better than recycling). The Commission is currently also evaluating the End of Life Vehicles Directive. As a follow up to this evaluation one can assume that a revision of the ELV Directive is likely to have an impact also on the batteries used for vehicles as it sets obligatory targets for reuse and recycling. This should, according to the Commission, be the path to build a sustainable battery industry in Europe. The sourcing of certain raw materials such as cobalt and lithium that are crucial to the battery value chain is impaired by human rights abuses, environmental legislation infringement and business ethics violation. With a demand that is deemed to soar seven-fold by 2024 and in the absence of early and stringent countermeasures, the issues stated above need to be taken into consideration<sup>9</sup>. Moreover, the battery recycling process could lead to new economy and jobs in the EU: it is important to distinguish the recycling of the whole battery pack and its critical components. Dismantling and recycling can be two separate business models where the dismantling might be handled at local level, creating new businesses opportunities, while it would be better if the active materials were shipped for recycling by high-tech industries. The automotive sector is a major European employer<sup>10</sup> and the conversion to EVs production will have a strong impact on the workforce in the battery sector. The European Battery Alliance has paved the way for building a sustainable battery industry that could create up to 4 million

<sup>9</sup> [https://www.greencarcongress.com/2020/07/20200704-un.html?utm\\_source=feedburner&utm\\_medium=feed&utm\\_campaign=Feed%3A+greencarcongress%2FTrBK+%28Green+Car+Congress%29](https://www.greencarcongress.com/2020/07/20200704-un.html?utm_source=feedburner&utm_medium=feed&utm_campaign=Feed%3A+greencarcongress%2FTrBK+%28Green+Car+Congress%29) (last accessed on 28.08.2020)

<sup>10</sup> According to ACEA, 2.7 million direct manufacturing jobs and 14.6 million indirect jobs are provided by the EU automotive sector; <https://www.acea.be/statistics/article/direct-automotive-manufacturing-jobs-in-eu-by-country>, [https://www.acea.be/uploads/publications/ACEA\\_Pocket\\_Guide\\_2020-2021.pdf](https://www.acea.be/uploads/publications/ACEA_Pocket_Guide_2020-2021.pdf)



jobs in the EU<sup>11</sup>. While going through restructuring, European industry can benefit from an increased demand for the production, installation, operation & maintenance of charging points, public transport systems, batteries and other related infrastructure, resulting in a net increase in employment in the construction, electricity, services and most manufacturing sectors<sup>12</sup>. With the right enabling policies, e-mobility can also gradually replace the decreasing jobs in manufacturing of diesel and petrol engines with new jobs and new skills required in electric powertrain manufacturing and key supply chains such as batteries. Recent analysis by the Platform for Electro-mobility<sup>13</sup> (to update the existing job estimates in the e-mobility ecosystem) shows that an additional 1.1 million jobs will be created in Europe by 2030.

Overall, with a strong focus on e-mobility more than 200,000 net additional jobs by 2030 can be created in the European economy<sup>14</sup>. The demand for new skills and experience will equally result in a fall in demand for other more traditional skills. This implies a need for skills restructuring that balances out existing skills mismatches which in turn, will require significant investment in new technologies, production processes and in the reskilling and training of the workforce.

Apart from environmental concerns, also the aspect of novelty in mobility represents an important factor for the attractiveness of the sector. As social media play an increasing role, the reason why a buyer of a car wants to have an electric vehicle may have more to do with the coolness factor, sleek looks, high performance, and innovative features in terms of user interface and experience etc. Other attractive elements might include easier operation and maintenance of EVs<sup>15</sup>.

In a disruptive scenario<sup>16</sup> (the next years will bring such significant changes as electrification,

<sup>11</sup> EIT InnoEnergy assessed that the European Battery Alliance have a potential of 400GWh of battery production per year by 2025. EBA, InnoEnergy 2019 Battery Materials Europe (Amsterdam presentation) <https://www.metalbulletin.com/events/presentations/E001854/battery-materials-europe-2019/a011t00000I5R1IEAV/day-2-0900-diego-pavia-kic-innovaenergy-fe.html>

<sup>12</sup> EuropeOn, Powering a new value chain in the automotive sector, 2018 [https://download.dalicloud.com/fis/download/66a8abe211271fa0ec3e2b07/c572c686-f52f-4c0d-88fc-51f9061126c5/Powering\\_a\\_new\\_value\\_chain\\_in\\_the\\_automotive\\_sector\\_-\\_the\\_job\\_potential\\_of\\_transport\\_electrification.pdf](https://download.dalicloud.com/fis/download/66a8abe211271fa0ec3e2b07/c572c686-f52f-4c0d-88fc-51f9061126c5/Powering_a_new_value_chain_in_the_automotive_sector_-_the_job_potential_of_transport_electrification.pdf)

<sup>13</sup> <https://www.platformelectromobility.eu/2020/06/17/event-how-can-zero-emission-mobility-become-the-motor-of-european-green-recovery/> (last accessed on 03.07.2020)

<sup>14</sup> Harrison P. 2018, Fueling Europe's Future : How the transition from oil strengthens the economy

<sup>15</sup> <https://newmotion.com/en/how-to-maintain-an-ev/> (last accessed on 04.08.2020)

<sup>16</sup> Electric Vehicle Outlook 2020, Bloomberg, 2020 and EUROBAT „Battery Innovation Roadmap 2030“, <https://www.eurobat.org/news-publications/press-releases/442-eurobat-launches-the-battery-innovation->



shared mobility, vehicle connectivity, autonomous vehicles and the massive use of removable energies) the changes and innovations create possible new markets and design new value chains and eventually disrupt an existing market and value network, displacing established market-leading firms, products, and alliances. It is necessary to analyse the Drivers of Change to support the market into this business transition<sup>17</sup>.

Continuous education and training are part of lifelong learning and may encompass any kind of education (general, specialised, or vocational, formal, or non-formal, etc.) and are important for the employability of individuals. During a disruptive period, continuous training becomes crucial not only as part of the regular lifelong learning process but also to align skills and competences to the new emerging needs. These activities also need to be supported by actions to improve mobility and transferability of skills, linked to the development of an efficient apprenticeship market and encouragement of informal learning. As batteries are a systemic enabler of a major shift to bring transportation and power to greenhouse gas neutrality, this transformation will have a significant impact on the industry's workforce and the acquisition of new skills will be a key factor enabling employees to be equipped to deal with these changes.

As previously mentioned, before the desk research analysis, the ALBATTTS consortium identified 4 macro areas to concentrate on: (i) the rise of new technologies, (ii) climate goals, (iii) societal and structural changes and (iv) globalisation and the rise of new players. Later, during the analysis of the available literature sources, **3 macro areas** of Drivers of Change with an assessment on current availability intelligence related to the Battery sector were identified and confirmed:

- ◆ Climate goals, regulation, and environmental challenges
- ◆ Globalisation
- ◆ New technologies

The following **Figure 5** outlines the occurrence of the highlighted Drivers of Change (i.e.

---

[roadmap-2030-in-the-presence-of-european-commission-evp-frans-timmermans-and-mep-claudia-gamon](#),  
(last accessed on 08.07.2020)

<sup>17</sup> The innovator's solution: creating and sustaining successful growth, Christensen, Clayton M Raynor, Michael E, Harvard Business School Press, 2003

number of times they have been mentioned in the analysed reports). “CLIMATE GOALS, REGULATION AND ENVIRONMENTAL CHALLENGES” is the most cited Driver of Change in terms of occurrence, with 40,28% followed by “GLOBALISATION” at 34,72%; third one is “NEW TECHNOLOGIES” with 25,00%.

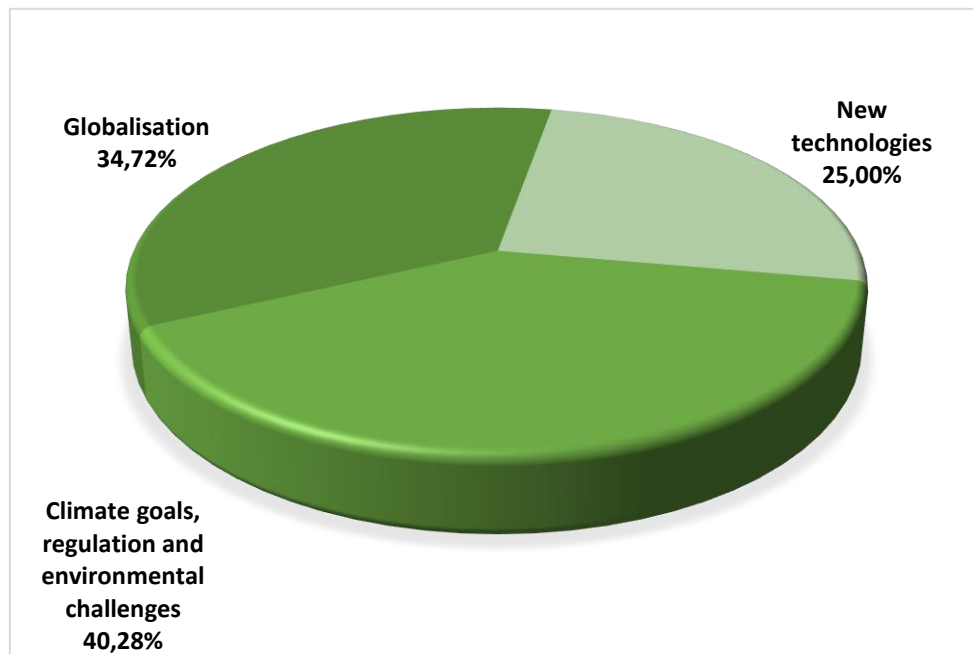

Figure 5: Occurrence- how much macro Drivers of Change are quoted related to all reports analysed

Each of the 3 macro areas then has different items for a total of 9 detailed Drivers of Change emerged and mapped:

- ◆ **Climate goals, regulation, and environmental challenges**
  - Reducing CO<sub>2</sub> emissions from battery manufacturing
  - Electrification and green energy
  - Widespread charging/refuelling infrastructure
- ◆ **Globalisation**
  - Access to raw materials
  - Global regulatory dialogue
  - Restructuring
- ◆ **New technologies**

- Cybersecurity
- Global technical harmonisation and standardisations
- Smart Grid

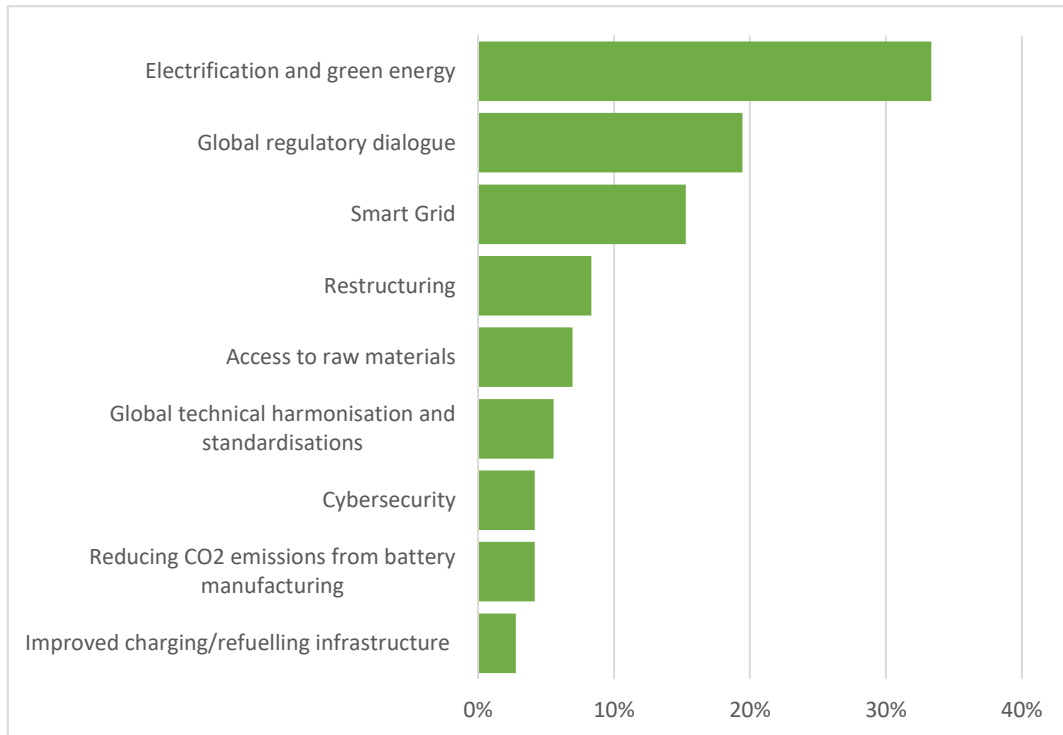

Figure 6: Occurrence - how much each Driver of Change is quoted related to all reports analysed

**Figure 6** outlines the ranking of all 9 detailed Drivers of Change based on the occurrence point of view. „ELECTRIFICATION AND GREEN ENERGY“ is the most cited Driver of Change, with 33%, followed by „GLOBAL REGULATORY DIALOGUE“ WITH 19% and „SMART GRID“ with 15%. These 3 Drivers of Change represent over 67% of the total.

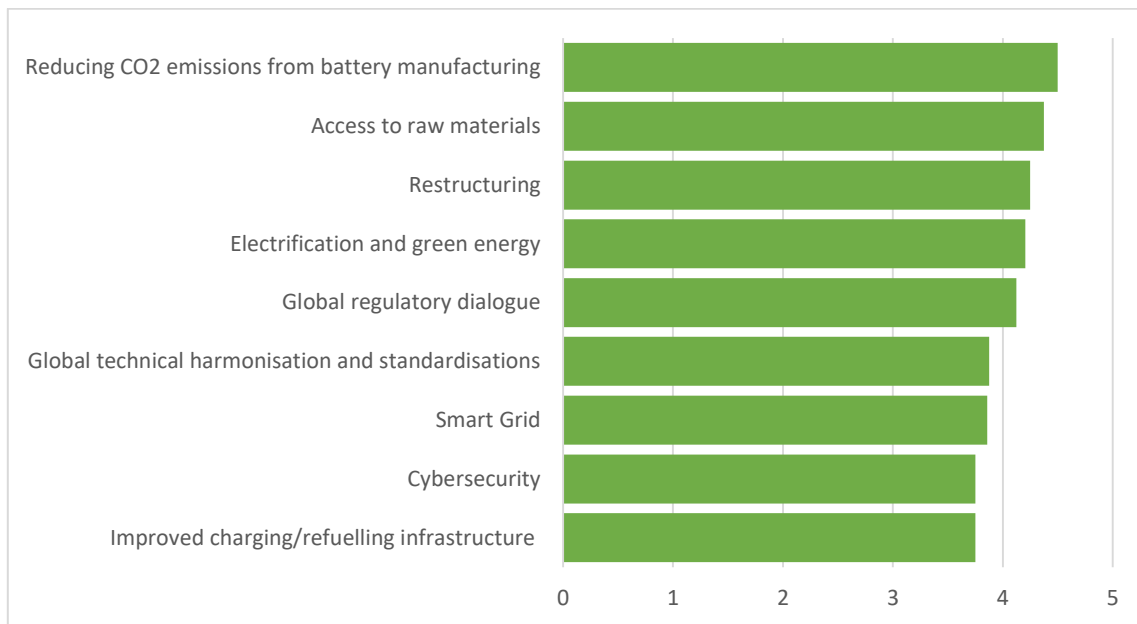

Figure 7: Importance - how much each Driver of Change is evaluated important related to all reports analysed

The importance of point of view of the 9 detailed Drivers of Change is highlighted in **Figure 7**. All of them are similar and the difference between the first („REDUCING CO2 EMISSIONS FROM BATTERY MANUFACTURING“ at 4,50) and the last („IMPROVED CHARGING/REFUELLING INFRASTRUCTURE“ and „CYBERSECURITY“ at 3,75) on a scale 0-5 is only 0,75. Therefore, this aspect could be a suitable topic to be evaluated in direct interaction with stakeholders through a workshop and/or a survey.

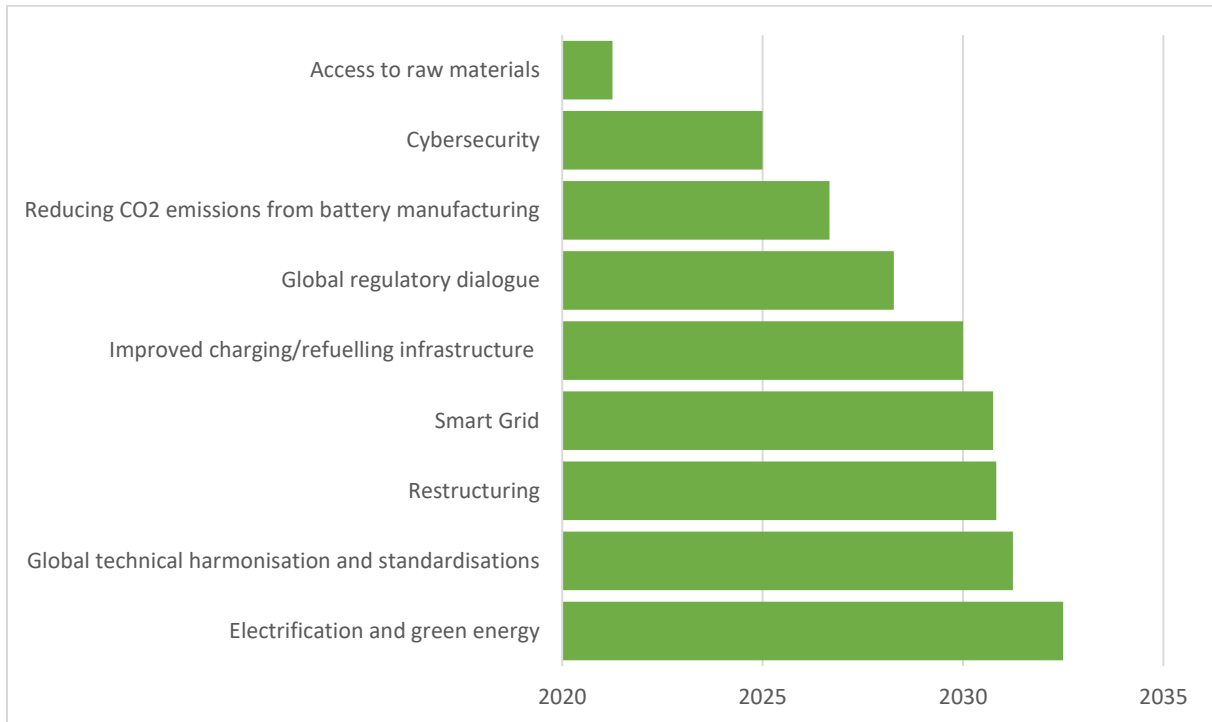

Figure 8: Urgency - how much each Driver of Change is evaluated urgent related to all reports analysed

The urgency of the analysed Drivers of Change is showed in **Figure 8**. „ACCESS TO RAW MATERIALS“ has been outlined as the most urgent as into 2021 it will be particularly crucial (according to the adopted desk-research methodology to map the “urgency” of a Driver of Change); into 2025 the problems related to “CYBERSECURITY” and 2027 for the “REDUCING CO2 EMISSIONS FROM BATTERY MANUFACTURING” will be crucial too.

### 2.1.3 Drivers of Change detailed description

Based on the methodology approach, this chapter presents the detailed description for each macro area and related Drivers of Change; the reports used for the wider literature review were selected through an expert group, comprising partners of the ALBATTs project involved in this task. Selection was based on practical experience and usage of particular reports by the partners. This approach was supplemented with manual searches, further iterative improvements in searches using keywords from selected papers, and further discussion to validate the final set of reports. The reports are, for the most part, those representing the whole battery value chain and compiled by respected consultancy organisation or projects; each Driver of Change title has a reference with the specific reports / documents where it has been mentioned in the desk-research analysis cited.

### 2.1.3.1 Climate goals, regulation, and environmental challenges

Global and EU level commitments to decrease GHG emissions, stricter EU CO<sub>2</sub> emissions regulation, legislation and standards concerning recharging infrastructure and incentives at EU, national, and regional level encourage EU industry to step-up efforts to find viable alternatives to current technologies that can reduce the CO<sub>2</sub> emissions in the run up to 2030 and beyond and facilitate the uptake of intermittent renewable energy sources by acting as a flexibility solution. Batteries are one of the most important climate targets driver to decarbonize road transportation and support the transition to a renewable power system. The process of managing the complete lifecycle of a product from concept to design, manufacture, service and disposal of manufactured products supports a reduction in waste and pollution, whilst at the same time providing opportunities for significant cost reductions and a need for new skills in different areas.

- ◆ **Reducing CO<sub>2</sub> emissions from battery manufacturing**<sup>18, 19,20</sup>

Since the production of batteries requires significant amounts of energy, increase in the share of renewable energies and energy efficiency in the battery value chain would be a major step for decreasing CO<sub>2</sub> emissions from battery production. Also, moving from a linear to a circular value chain can improve both the environmental and the economic footprint of batteries by getting more out of batteries in use, and by harvesting end-of-life value from batteries.

Carbon footprint criteria could be a useful tool to increase transparency and provide the relevant information about the battery's environmental impacts. It specifically should be based on where the battery and its key components such as cathodes are produced, as well as by CO<sub>2</sub> per kWh.

<sup>18</sup> UN report highlights urgent need to tackle impact of EV battery production boom, [https://www.greencarcongress.com/2020/07/20200704-un.html?utm\\_source=feedburner&utm\\_medium=feed&utm\\_campaign=Feed%3A+greencarcongress%2FTrBK+%28Green+Car+Congress%29](https://www.greencarcongress.com/2020/07/20200704-un.html?utm_source=feedburner&utm_medium=feed&utm_campaign=Feed%3A+greencarcongress%2FTrBK+%28Green+Car+Congress%29), 2020

<sup>19</sup> Batteries and hydrogen technology: keys for a clean energy future, IEA, <https://www.iea.org/articles/batteries-and-hydrogen-technology-keys-for-a-clean-energy-future>, 2020

<sup>20</sup> A Vision for a Sustainable Battery Value Chain in 2030 (McKinsey World Economic Forum, 2019)

◆ **Electrification and green energy**<sup>21,22,23,24,25,26,27,28,29,30, 31, 32, 33, 34, 35, 36, 37, 38, 39</sup>

Batteries can fundamentally reduce GHG emissions in the transport and power sectors as they are a systemic enabler of a major shift to bring transportation and power to greenhouse gas neutrality playing an increasingly important role in three areas: (i) electrification, (ii) renewables as a reliable source of energy and (iii) a circular, responsible and just battery value chain. For vehicle manufacturers, one of the most important drivers for electrification of their production fleet is EU regulation (particularly Regulation (EU) 2019/631 setting CO<sub>2</sub> emission performance standards for new passenger cars and for new light commercial vehicles for 2020/21 and 2025, 2030), as electrified vehicles can significantly help the car manufacturers to meet their respective CO<sub>2</sub> reduction targets.

◆ **Widespread charging/refuelling infrastructure**<sup>40, 41</sup>

Demand for a widespread charging infrastructure is a key driver to boost the commercialisation of a technology based on batteries. The easier the access to a reliable and suitable (also in terms of charging speed needs) charging infrastructure is, the quicker will be the development of such new technologies. Regulation can play an important role here as well, for instance the planned revision of the Directive 2014/94/EU on the

<sup>21</sup> Transformation-in-energy-utilities-and-resources (PricewaterhouseCoopers, 2019)

<sup>22</sup> Three ways batteries could power change in the world (WEF 2019)

<sup>23</sup> Three surprising resource implications from the rise of electric vehicles (McKinsey, 2018)

<sup>24</sup> Second-life-EV-batteries-The-newest-value-pool-in-energy-storage (McKinsey, 2019)

<sup>25</sup> Renewable Energy and Jobs – Annual Review 2019 (IRENA 2019)

<sup>26</sup> Ready for inspection – the automotive aftermarket in 2030 (McKinsey, 2018)

<sup>27</sup> Powering an innovative battery value chain in Europe (EUROBAT 2018)

<sup>28</sup> Policy Recommendations German EU Presidency (EUROBAT 2020)

<sup>29</sup> New markets. New entrants. New challenges. Battery electric vehicles (Deloitte, 2019)

<sup>30</sup> Making the future of mobility work (Deloitte, 2017)

<sup>31</sup> Interactive map: Electric vehicle incentives per country in Europe,

<https://www.acea.be/statistics/article/interactive-map-electric-vehicle-incentives-per-country-in-europe>, 2017

<sup>32</sup> Greenhouse gas protocol, <https://ghgprotocol.org>, 2020

<sup>33</sup> Five trends transforming the Automotive Industry (PwC, 2018)

<sup>34</sup> EBA, InnoEnergy 2019 Battery Materials Europe (Amsterdam presentation)

<sup>35</sup> Decarbonisation Pathways (Eurelectric, 2018)

<sup>36</sup> Carbon Neutrality in the Automotive Sector and its Effects for the Supply Chain

(<https://www.thinkstep.com/blog/carbon-neutrality-automotive-sector-and-its-effects-supply-chain>, 2019)

<sup>37</sup> Battery storage: The next disruptive technology in the power sector (McKinsey, 2017)

<sup>38</sup> Battery innovation roadmap 2030 (EUROBAT, 2020)

<sup>39</sup> A Vision for a Sustainable Battery Value Chain in 2030 (McKinsey World Economic Forum, 2019)

<sup>40</sup> EV charging infrastructure: a growing part of the electricity system (EBA250 2020)

<sup>41</sup> Automotive revolution – perspective towards 2030 (McKinsey, 2016)

deployment of alternative fuels infrastructure. To increase the comfort for customers, innovative ways of vehicle charging (such as wireless charging or battery pack swapping) are being investigated as well.

### 2.1.3.2 Globalisation

In 2018, only approximately 1% of the total global demand for EV batteries was supplied by European companies. Over the next years, production in global markets is expected to grow strongly and the EU production must completely change its position to create a competitive advantage. This market represents a substantial—but so far untapped—potential opportunity for European battery makers and carmakers, as well as for the European economy in general. Currently, the EV-battery market is dominated by players from only three countries, all of them in Asia: China, Japan, and Korea. Stimulating the European mining and refining industry will be essential to provide the growing battery industry with sustainable raw materials<sup>42</sup>.

---

<sup>42</sup> Platform for Electromobility, March 2020; <https://www.platformelectromobility.eu/wp-content/uploads/2018/02/Platform-recommendations-on-European-Battery-Package.pdf> (last accessed on 28.08.2020)



◆ **Access to raw materials**<sup>43, 44, 45, 46, 47</sup>

In a disruptive scenario (with rapid increase in numbers of EVs, the regulatory push across different European countries and the key role in complementing generation of renewable energy), activities linked to raw materials become critical, especially if some resources (limited in terms of quantity or geographical presence) are necessary to produce key components. From this point of view, the battery sector needs to come up with new chemistries of batteries (e. g. lithium-sulphur<sup>48</sup>), develop sourcing strategies to ensure a stable supply of critical and key raw material (e.g. lithium, cobalt), also via recycling, to insulate them from the risk of shortages and potential price spikes.

◆ **Global regulatory dialogue**<sup>49, 50, 51, 52, 53, 54, 55, 56, 57, 58, 59, 60, 61</sup>

The EU Single Market is a key element for the maintenance and increase of the EU competitiveness and it is evident that such process cannot be put in place by social partners or industry alone; the Commission and in general, Governments and public administrations will need to play a fundamental role in the elaboration of policies and strategies, from which the battery sector could benefit. The process could be enabled by timely policies, including the review of the Alternative Fuels Infrastructure Directive, the

<sup>43</sup> Lithium and cobalt: A tale of two commodities (McKinsey, 2018)

<sup>44</sup> Policy Recommendations German EU Presidency (EUROBAT 2020)

<sup>45</sup> Three surprising resource implications from the rise of electric vehicles (McKinsey, 2018)

<sup>46</sup> Transformation-in-energy-utilities-and-resources (PricewaterhouseCoopers, 2019)

<sup>47</sup> UN report highlights urgent need to tackle impact of EV battery production boom, [https://www.greencarcongress.com/2020/07/20200704-un.html?utm\\_source=feedburner&utm\\_medium=feed&utm\\_campaign=Feed%3A+greencarcongress%2FTrBK+%28Green+Car+Congress%29](https://www.greencarcongress.com/2020/07/20200704-un.html?utm_source=feedburner&utm_medium=feed&utm_campaign=Feed%3A+greencarcongress%2FTrBK+%28Green+Car+Congress%29), 2020

<sup>48</sup> Example of a project: <https://www.vutbr.cz/en/rad/projects/detail/26436> (last accessed on 28.08.2020)

<sup>49</sup> A new regulatory framework on batteries to reach Europe's sustainability goals (EBA 2020)

<sup>50</sup> A Vision for a Sustainable Battery Value Chain in 2030 (McKinsey World Economic Forum, 2019)

<sup>51</sup> Battery innovation roadmap 2030 (EUROBAT, 2020)

<sup>52</sup> Battery storage: The next disruptive technology in the power sector (McKinsey, 2017)

<sup>53</sup> Decarbonisation Pathways (Eurelectric, 2018)

<sup>54</sup> Driving CO2 emissions to zero (and beyond) with carbon capture, use, and storage (McKinsey, 2020)

<sup>55</sup> EBA, InnoEnergy 2019 Battery Materials Europe (Amsterdam presentation)

<sup>56</sup> Policy Recommendations German EU Presidency (EUROBAT 2020)

<sup>57</sup> Powering an innovative battery value chain in Europe (EUROBAT 2018)

<sup>58</sup> Ready for inspection – the automotive aftermarket in 2030 (McKinsey, 2018)

<sup>59</sup> Second-life-EV-batteries-The-newest-value-pool-in-energy-storage (McKinsey, 2019)

<sup>60</sup> The future of distributed generation (PricewaterhouseCoopers, 2019)

<sup>61</sup> Cleaner Cars from Cradle to Grave, <https://www.ucsusa.org/sites/default/files/attach/2015/11/Cleaner-Cars-from-Cradle-to-Grave-full-report.pdf>, 2015

Sustainable Battery package and the revision of the Energy Taxation Directive.

◆ **Restructuring**<sup>62, 63, 64, 65</sup>

The European battery sector is expected to undergo structural changes due to the development of a zero-emission mobility and as a flexible facilitator of the intermittent renewable energy sources. The industry, in particular SMEs, will need to assess and, if necessary, redefine their position in the value chain as well as increase their capacity to integrate digital technologies and circular economy concepts in their production processes.

2.1.3.3 *New technologies*

The need for urgent and intense actions against climate change is widely recognized and batteries are an essential system for storing energy in electric vehicles and making renewable energy a reliable alternative source. Although batteries are therefore needed to help tackle climate change, this cannot be achieved without a fundamental change in the way materials are purchased and this technology is produced and used; these challenges can only be addressed through collaborative efforts throughout the value chain, with important investments in R&D<sup>66</sup> and with profound changes in the current business model.

◆ **Cybersecurity**<sup>67, 68, 69</sup>

By 2024, the number of connected devices will exceed 4 times that of the world population<sup>70</sup>. Exponential growth of IoT devices connected to a network, cloud infrastructures and the navigation and location information can compromise customer

<sup>62</sup> Transformation-in-energy-utilities-and-resources (PricewaterhouseCoopers, 2019)

<sup>63</sup> New markets. New entrants. New challenges. Battery electric vehicles (Deloitte, 2019)

<sup>64</sup> Motor vehicles generate €413 billion in taxes for EU-15, new data shows, <https://www.acea.be/press-releases/article/motor-vehicles-generate-413-billion-in-taxes-for-eu-15-new-data-shows>, 2018

<sup>65</sup> Automakers are cutting 80,000 jobs globally as EV shift upends industry, <https://europe.autonews.com/automakers/automakers-are-cutting-80000-jobs-globally-ev-shift-upends-industry>, 2019

<sup>66</sup> <https://battery2030.eu/research/>, (last accessed on 28.08.2020)

<sup>67</sup> The future of the Automotive Value Chain – 2025 and beyond (Deloitte, 2017)

<sup>68</sup> Securing the future of mobility: Addressing cyber risk in self-driving cars and beyond (Deloitte, 2017)

<sup>69</sup> Forces of change: the future of mobility (Deloitte, 2017)

<sup>70</sup> AgendaDigitale.eu, <https://www.agendadigitale.eu/sicurezza/cybersecurity-per-iot-e-5g-il-ruolo-strategico-degli-standard/>, (last accessed on 06.08.2020)

privacy and security, requiring providers to keep communications secure. This threat landscape requires the industry to modify the security approach, aimed at guaranteeing the internal one linked to the resilience of the infrastructures to cyber-attacks. IoT are expected to advance the battery management systems (BMS) by fully utilizing wireless network and cloud support, resulting in providing significant value in cost reduction, extended scalability, and greater visibility in the lithium-ion battery energy storage systems<sup>71</sup>.

◆ **Global technical harmonisation and standardisations**<sup>72, 73, 74</sup>

The supply chain structure within the sector will need to meet the challenges posed by the introduction of new technology but also meet changing market conditions. Common online platforms might connect supply and demand globally to increase the efficiency of players across the supply chain; new standards and product harmonisations will also be necessary to create scale economies and to satisfy a possible increasing request of white label components and unbranded vehicles with also a standardisation of the dimension of the product. Future advantages are likely to be linked to increased standardisation between Member States and to achieving a leading role in regulation at the global level.

<sup>71</sup> S. Kumbhar, T. Faika, D. Makwana, T. Kim and Y. Lee, "Cybersecurity for Battery Management Systems in Cyber-Physical Environments", 2018

<sup>72</sup> Second-life-EV-batteries-The-newest-value-pool-in-energy-storage (McKinsey, 2019)

<sup>73</sup> Ready for inspection – the automotive aftermarket in 2030 (McKinsey, 2018)

<sup>74</sup> EUROBAT proposal for a notification, verification and validation system of batteries that become waste (EUROBAT 2020)

♦ **Smart Grid**<sup>75, 76, 77, 78, 79, 80, 81, 82, 83, 84, 85, 86</sup>

Storage is one of the most important smart grid components due to its key role in complementing renewable energy generation. With the proper amount and type of storage broadly deployed and optimally controlled, renewable generation can be transformed from an energy source into a dispatchable generation source. The smart grid, with its many advanced communications and control features, will make it possible to integrate the application of widely dispersed battery storage systems. Vehicles (vehicle-to-grid applications), houses and electrical devices will be connected, with digital technologies changing the way data is transferred and utilised. These new communication technologies have a key strategic importance in relation to changes in the sector.

## 2.2 STAKEHOLDERS

*More details about stakeholders are provided in the respective chapters of the report in Section 3.*

### Raw materials and processing

The activities of the stakeholders involved in the process of mining and processing of raw materials have an impact on the whole value chain and affect other stakeholders who need batteries for their own products. Companies who need batteries in their products consider mining and supply of raw materials as a reason for concern due to public scrutiny and potential subsequent negative impact on the company's reputation.

The environmental impact, the working conditions, as well as political factors related to

<sup>75</sup> Transformation-in-energy-utilities-and-resources (PricewaterhouseCoopers, 2019)

<sup>76</sup> The future of distributed generation (PricewaterhouseCoopers, 2019)

<sup>77</sup> Powering an innovative battery value chain in Europe (EUROBAT 2018)

<sup>78</sup> POV-Energy-Storage-DEG (Accenture, 2016)

<sup>79</sup> Here's How Ioney Prices Stack Up Against Tesla's Supercharger in Europe, <https://www.autoevolution.com/news/here-s-how-ionity-prices-stack-up-against-teslas-supercharger-in-europe-140457.html>, 2020

<sup>80</sup> Energy Storage - A key enabler of the Smart Grid (U.S. Department of Energy, Office of Electricity Delivery and Energy Reliability by the National Energy Technology Laboratory, 2009)

<sup>81</sup> Decarbonisation Pathways (Eurelectric, 2018)

<sup>82</sup> Capturing-Value-Managing-Energy-Flexibility (Accenture, 2017)

<sup>83</sup> Battery storage: The next disruptive technology in the power sector (McKinsey, 2017)

<sup>84</sup> Battery innovation roadmap 2030 (EUROBAT, 2020)

<sup>85</sup> Battery Energy Storage in the EU (EUROBAT 2020)

<sup>86</sup> A Vision for a Sustainable Battery Value Chain in 2030 (McKinsey World Economic Forum, 2019)

mining and processing the materials needed in battery manufacturing, are often considered as challenges. This includes not only companies but also public organizations and authorities responsible for ecological and economical sustainability and human rights. Consequently, these challenges related to certain raw materials encourage companies to take a more active role in raw material extraction and affect their research and development on batteries and enhance the recycling.

### **Components and cell manufacturing**

A mass battery production in Europe is only starting to develop. The driving force behind that is the need to satisfy rising demand from electric vehicles manufacturers combined with intensified efforts to store energy coming from conventional, but increasingly also renewable sources. Big battery players are starting to build their mass battery production facilities with outputs exceeding 1GWh in Europe, the so-called “Gigafactories.” Many of these manufacturers currently come from Asia. There are also smaller companies starting to appear in Europe, which do not want to compete with large manufacturers, but focus instead on “niche markets” and adapt batteries to sometimes very specific customer needs. Battery factories can bring many jobs, not only directly in the factories themselves, but also within subcontractors.

### **Module and pack manufacturing**

As for the mobile applications/automotive industry, the car manufacturers often opt for in-house module and pack assembly trying to maximise the value they add to the vehicle. Modules and packs are critical to determining an EV’s key performance indicator, such as range and charging speed. Vehicle manufacturers want to control the way in which the battery pack space is being used and also how the battery optimal working temperature is achieved, because it has strong implications regarding the safety of the battery and of the vehicle as such.

### **Battery integration**

Stakeholders that are active at this stage of the value chain specialize in production of battery embedded systems like battery management system, battery thermal regulation systems and

other components that are associated with battery intelligence which also cover the implementation of software needed. Since this is a crucial part of the whole battery system, many companies that produce energy storage solutions want to manufacture their own systems and components. The car manufacturers in Europe are a good example of this tendency.

### **Operation, repair, and maintenance**

Vehicle electrification affects a wide range of stakeholders. This includes, in the first place, vehicle manufacturers who need to prepare EV production to be able to meet EU CO<sub>2</sub> emission standards. Suppliers must update their portfolio to include new parts or components. Home, as well as public or corporate charging infrastructure, will require massive investments in charging stations, electricity infrastructure, as well as qualified personnel. It also brings about opportunities to introduce brand new business concepts and services. Vehicle repair shops must get ready for the new procedures and risks related to repairing the EVs. Emergency/rescue services must be made aware of new safety procedures.

Electrification of vessels brings new challenges to producers and operators of the vessels, including companies providing servicing and maintenance.

### **Second life**

The list of interested parties is quite long and diverse. It ranges from battery and vehicle manufacturers (alternative to direct recycling, also potential way to reduce electric vehicles' cost, design of batteries with second life/use in mind), through repair and maintenance shops to entities involved in stationary applications and recycling companies. As for stationary/storage applications, second life of batteries could be an interesting area for industrial plant operators, solar panel / wind farm developers, energy production and distribution companies, charging infrastructure operators or real estate owners and households. In the future, refurbished batteries could be used in mobile applications, covering for example non-road mobile machinery or micro mobility vehicles (e-scooters, e-bikes etc.), thus important to manufacturers of these vehicles, repair shops or battery swapping services. As second life of batteries is still in its infancy, there are, therefore, huge opportunities for research and education institutions, standardisation bodies or different public bodies and

authorities (providing incentives and altering the legislation).

## Recycling

The stakeholders for battery recycling involve all elements of the battery value chain. This is important for the sustainability of the battery ecosystem but, also, for batteries to become part of the circular economy. Only through the engagement of all current actors and business newcomers, as well as through the creation of new business models, will such actors tackle the challenge and opportunity that recycling brings about.

As there is a need for increased battery recycling capacity and new business models, new players, completely focused on the recycling of the batteries, are coming to the market. Their main goal is to maximize the recovery of critical battery material from Li-ion batteries in a sustainable, economically sound, and safe manner. Technologically, they may differ in the applied processes and the level of the reclaimed material, but their goal is to achieve the right balance between environmental performance and resource efficiency.

### 2.2.1 EUROSTAT statistics

The project **ALBATTs - Alliance for Batteries Technology, Training and Skills** - aims at enabling and guiding both industrial and educational stakeholders in the emerging European Batteries ecosystem, towards the future competence needs and supply.

As a result, the **ALBATTs project needs stakeholders' involvement** from a wide range of partners across the entire battery value chain (from raw materials to advanced materials, cells, packs, systems, and end-of-life management).

### *Who are the Stakeholders?*

**Battery cell manufacturing** sector will play a central role in the project since cell manufacturing is at the core of the strategic battery value chain and major breakthroughs are necessary to curb current downsides.

**End users in the automotive sector** will also have a very important role in the project given the fact that road transport will remain the largest battery market<sup>87</sup> by far in the foreseeable

<sup>87</sup> <https://about.bnef.com/electric-vehicle-outlook/>, (last accessed on 28.08.2020)



future. By 2030, passenger cars will account for the largest share (60 %) of global battery demand, followed by the commercial vehicle segment with 23 %.<sup>88</sup>

According to Deloitte study<sup>89</sup>, total EV sales growing from 2.5 million in 2020 to 11.2 million in 2025, then reaching 31.1 million by 2030. EVs would secure approximately 32 per cent of the total market share for new car sales (**Figure 9**)

### Outlook for annual global passenger-car and light-duty vehicle sales, to 2030

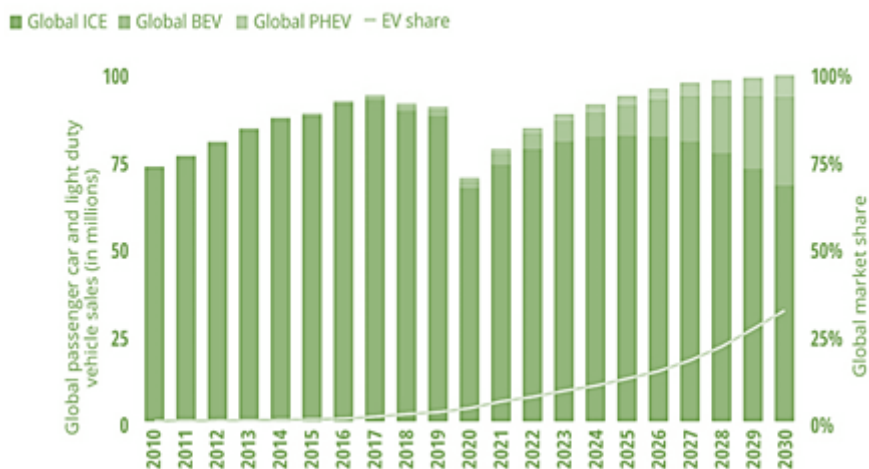

Figure 9 EV Projections by 2030<sup>90</sup>

Other **relevant application sectors**: mobile road and non-road applications, other than automotive (sightseeing trackless trains<sup>91</sup>, airport buses<sup>92</sup>, forklifts, front loaders, Automatic Guided Vehicles-AGVs in automated container ports<sup>93</sup>), stationary applications, waterborne, airborne and rail transport.

**Battery recycling sector** will help key players to establish a closed-loop and sustainable value chain.

Finally, active involvement is needed from different sectors, backgrounds, and fields of

<sup>88</sup>[http://www3.weforum.org/docs/WEF\\_A\\_Vision\\_for\\_a\\_Sustainable\\_Battery\\_Value\\_Chain\\_in\\_2030\\_Report.pdf](http://www3.weforum.org/docs/WEF_A_Vision_for_a_Sustainable_Battery_Value_Chain_in_2030_Report.pdf) (last accessed on 28.08.2020)

<sup>89</sup><https://www2.deloitte.com/us/en/insights/focus/future-of-mobility/electric-vehicle-trends-2030.html>, (last accessed on 28.08.2020)

<sup>90</sup> <https://www2.deloitte.com/uk/en/insights/focus/future-of-mobility/electric-vehicle-trends-2030.html> (last accessed on 28.08.2020)

<sup>91</sup> <https://www.visiter-bordeaux.com/en/discovering-bordeaux/bordeaux-visit-electric-touristic-train.html>, (last accessed on 28.08.2020)

<sup>92</sup> <https://www.buslife.de/en/2015/10/german-airport-electric-bus>, (last accessed on 28.08.2020)

<sup>93</sup> <https://e.huawei.com/topic/leading-new-ict-en/yangshan-port-case.html>, (last accessed on 28.08.2020)



expertise, including academic partners (**Universities and research organizations**).

The analysis of the sector has been compiled based on the most relevant EUROSTAT indicators relating to the economic structure, market dynamics and workforce within the 27 EU countries in terms of:

- ◆ V11110 Enterprises – number
- ◆ V12110 Turnover or gross premiums written - million Euro
- ◆ V16110 Persons employed - number

The analysis uses **EUROSTAT data from 2017**, the last year with full data available.

NACE<sup>94</sup> (Nomenclature of Economic Activities) is the European statistical classification of economic activities. Statistics produced based on NACE are comparable at European level and, in general, at world level in line with the United Nations' International Standard Industrial Classification (ISIC).

The ALBATTTS partners agreed disclaimer to define the scope of the project based on the following NACE rev. 2 codes:

- ◆ C2720 Manufacture of batteries and accumulators
- ◆ C2910 Manufacture of motor vehicles
- ◆ C2920 Manufacture of bodies (coachwork) for motor vehicles; manufacture of trailers and semi-trailers
- ◆ C2931 Manufacture of electrical and electronic equipment for motor vehicles
- ◆ C2932 Manufacture of other parts and accessories for motor vehicles
- ◆ C3011 Building of ships and floating structures
- ◆ C3012 Building of pleasure and sporting boats
- ◆ C3091 Manufacture of motorcycles
- ◆ E3812 Collection of hazardous waste (collection of hazardous waste, such as used

---

<sup>94</sup> <https://ec.europa.eu/eurostat/web/nace-rev2/overview> (last accessed on 28.08.2020)

batteries)

- ◆ E3832 Recovery of sorted materials (recovery of materials from waste streams... or the separating and sorting of commingled recoverable materials.... shredding of metal waste, end-of-life vehicles)
- ◆ G4511 Sale of cars and light motor vehicles
- ◆ G4519 Sale of other motor vehicles
- ◆ G4520 Maintenance and repair of motor vehicles (electrical repairs, repair of motor vehicle parts – battery)
- ◆ G4531 Wholesale trade of motor vehicle parts and accessories
- ◆ G4532 Retail trade of motor vehicle parts and accessories
- ◆ G4540 Sale, maintenance and repair of motorcycles and related parts and accessories
- ◆ G4764 Retail sale of sporting equipment in specialised stores (ships, boats...)

As some categories listed above have particular business-related specificities (large number of operators, low traceability of the business objects, insufficient policing), on top of the collected numbers, there are important additions that are not known but should somehow be accounted for. In the case of some of the NACE codes (**G4520**: Maintenance and repair of motor vehicles - electrical repairs, repair of motor vehicle parts – battery; **G4540**: Sale, maintenance and repair of motorcycles and related parts and accessories; **E3812**: Collection of hazardous waste and **E3832**: Recovery of sorted materials (recovery of materials from waste streams... or the separating and sorting of commonly recoverable materials.... shredding of metal waste, end-of-life vehicles), the figures presented are probably lower due to some unlawful activities, as suggested by several sources.<sup>95;96;97;98</sup>

<sup>95</sup> <https://www.autoactu.com/actualites/prison-ferme-et-fortes-amendes-pour-une-fraude-a-la-tva-sur-la-vente-de-voitures-d-occasion>, accessed on 06.08.2020

<sup>96</sup> <https://www.midilibre.fr/2019/10/10/nimes-fraude-a-la-tva-dans-le-milieu-automobile-suspects-deferes-a-marseille,8470759.php>, accessed on 06.08.2020

<sup>97</sup> [https://www.lecese.fr/sites/default/files/pdf/Avis/2016/2016\\_14\\_evitement\\_fiscal.pdfm](https://www.lecese.fr/sites/default/files/pdf/Avis/2016/2016_14_evitement_fiscal.pdfm) accessed on 06.08.2020

<sup>98</sup> <https://www.letelegramme.fr/morbihan/plumelec-operation-anti-fraude-dans-une-casse-auto-21-05-2015-10635922.php>, accessed on 06.08.2020

Country	Enterprises - number	Persons employed - number	Turnover or gross premiums written - million euro
EU27	887,904	6,456,071	2,241,981

Figure 10 Sector Dimension

Based on EUROSTAT<sup>99</sup> data, the sector size is shown in **Figure 10**

According to the EUROSTAT database, the total number of companies (**Figure 11**) carrying out activities stipulated by the above mentioned NACE codes is over 880,000. Almost two thirds of them are involved in maintenance and repair of motor vehicles (G4520) – 444,212.

In 2017, only 429 companies were involved in the production of batteries.

<sup>99</sup> Source Eurostat, date of extraction 24.07.2020

NACE code	V11110 - Enterprises - number	V12110 - Turnover or gross premiums written - million euro	V16110 - Persons employed - number
C2720	429	10,304.7	28,160
C2910	1,688	746,897.0	1,044,571
C2920	5,911	31,371.1	145,219
C2931	1,487	40,422.7	260,996
C2932	7,454	231,064.1	980,770
C3011	3,417	22,245.6	101,329
C3012	3,718	6,961.8	41,125
C3091	777	3,362.2	14,489
E3812	1,302	2,274.8	14,202
E3832	14,016	35,660.8	134,963
G4511	186,135	710,852.0	1,222,481
G4519	14,118	57,489.4	111,147
G4520	444,212	124,131.4	1,376,809
G4531	39,729	115,492.3	324,881
G4532	67,777	32,129.1	251,788
G4540	36,659	22,737.4	92,968
G4764	59,075	48,584.3	310,173
<b>Total EU27</b>	<b>887,904</b>	<b>2,241,980.7</b>	<b>6,456,071</b>

Figure 11 Sector Dimension Split by NACE Codes

In terms of people employed (**Figure 12**), the activities analysed in this chapter includes over 6.4 million persons. The motor vehicle (C29) sector, together with ships and boats manufacturing (C301), account for over 2.4 million, whereas an important part of the supplier`s output (providing jobs to one and a quarter million people) goes towards the assembly of new vehicles.

Together with the people working in the distribution, production of motor vehicles, ships, and boats, it reaches 4.7 million jobs.

The **maintenance and repair of motor vehicles** sector accounts for another 1.37 million jobs that are divided between authorized dealerships and independent repairers.

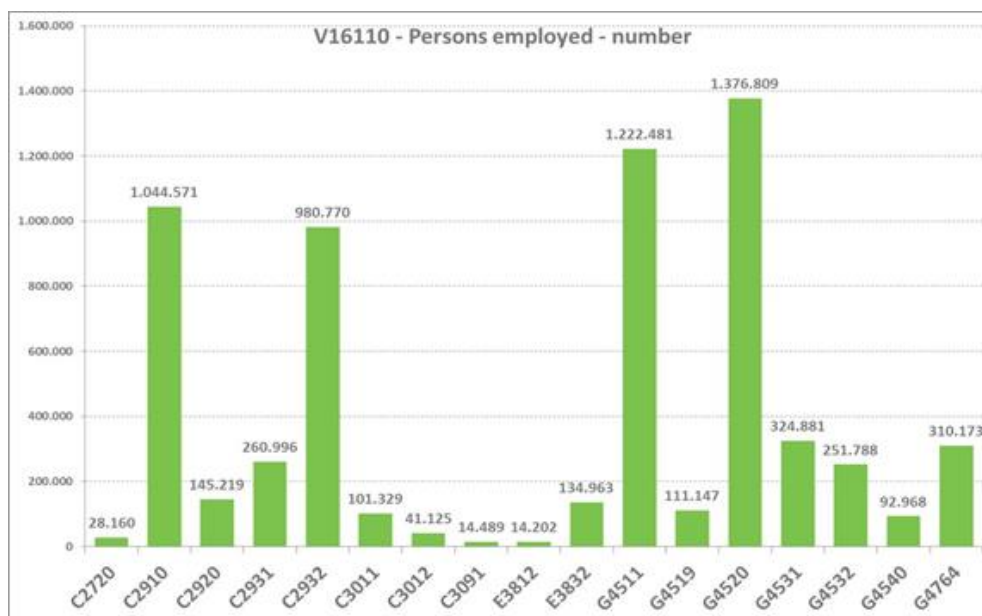

Figure 12 NACE Sectors by Number of Persons Employed

As expected, the highest turnover (**Figure 13**) is achieved by the **manufacturing of motor vehicles** sector with 778,3 billion EUR, followed by the **sales of motor vehicles** sector with 769,3 billion EUR.

The **battery manufacturing** sector only yielded a little over 10 billion EUR.

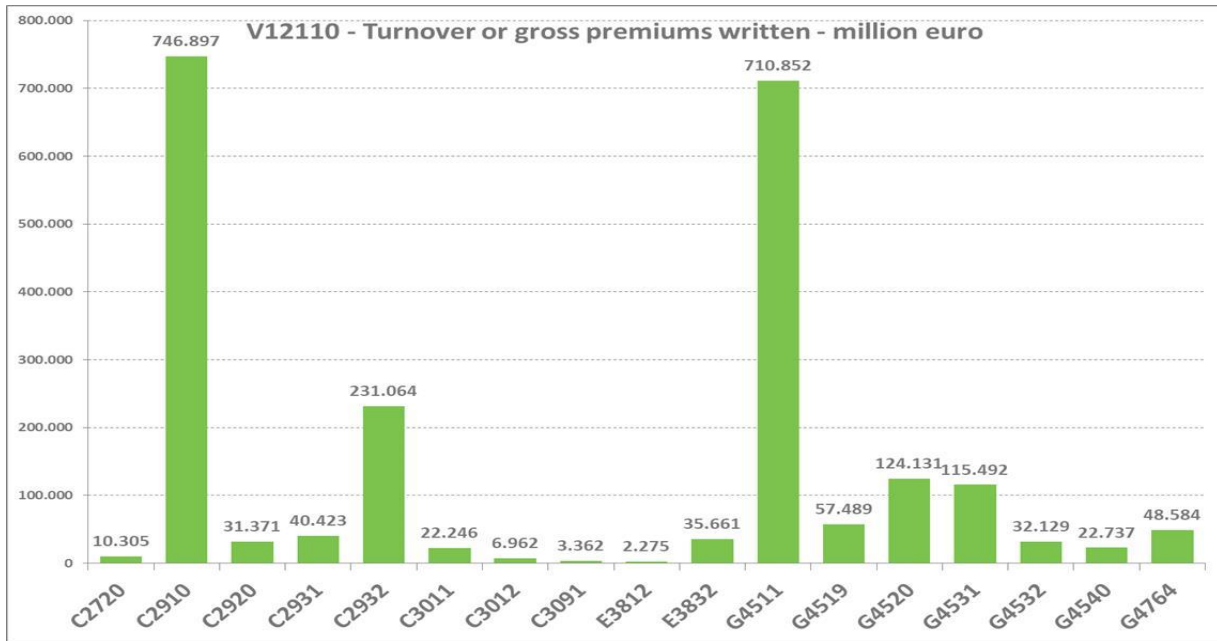

Figure 13 NACE Sectors by Turnover

In terms of gross **vehicle production**<sup>100</sup>, the EU leader is undoubtedly Germany with an output of around 5.2 million units (**Figure 14**).

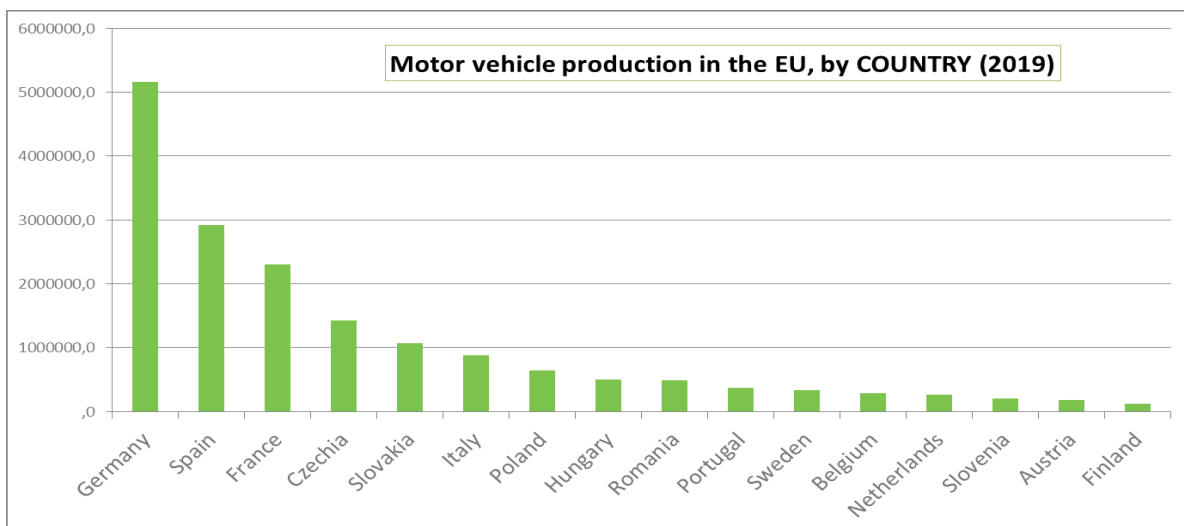

Figure 14 Motor Vehicle Production

The runner-up is Spain with almost 3 million units manufactured, followed by France (around 2.3 million units), Czechia (more than 1.4 million units) and Slovakia (slightly above 1 million

<sup>100</sup> [https://www.acea.be/uploads/publications/ACEA\\_Pocket\\_Guide\\_2020-2021.pdf](https://www.acea.be/uploads/publications/ACEA_Pocket_Guide_2020-2021.pdf)

units).

From a **productivity<sup>101</sup> perspective**, things are radically different from the previous graphic, with Slovakia in the first place with 190 vehicles/1.000 inhabitants, followed by Czechia with 127, Slovenia with 100, Germany with 62 and Spain with 49 (**Figure 15**).

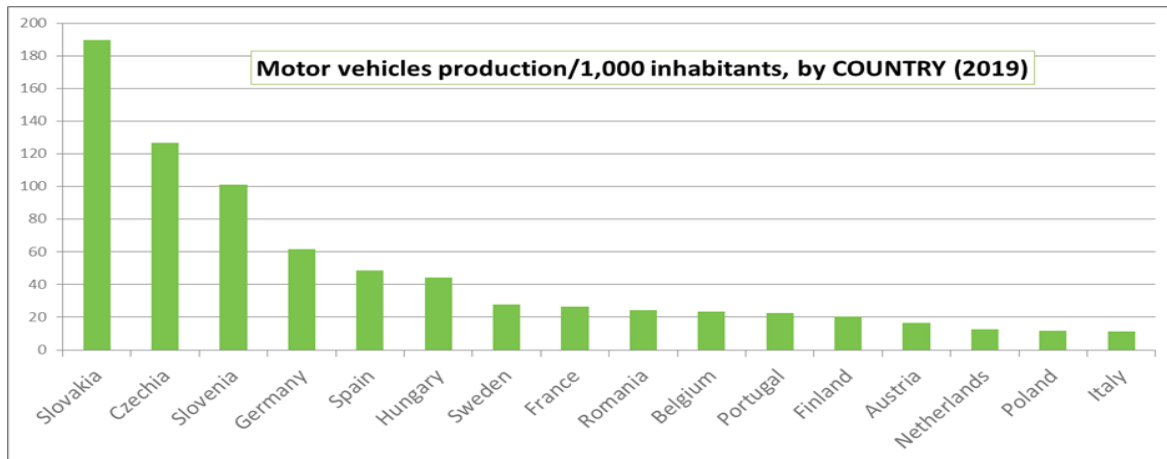

Figure 15 Motor vehicle production/1000 inhabitants

In terms of the **number of companies**, their geographical distribution (**Figure 16**) and their activity type, Germany leads in **battery production** with around 80 companies, followed by Italy and Poland.

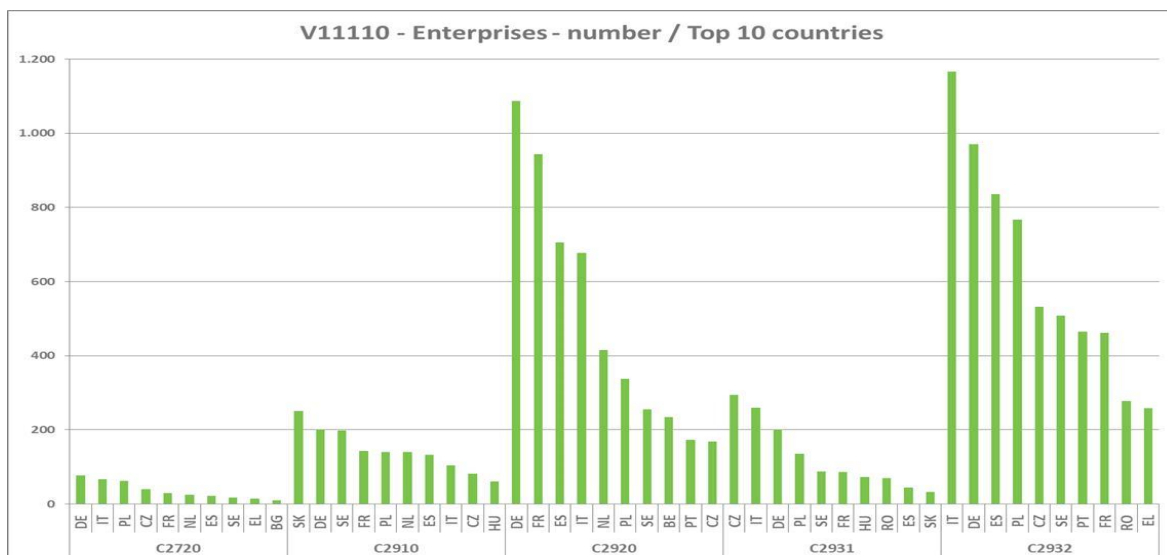

Figure 16 Top 10 countries by number of enterprises

<sup>101</sup> [https://www.acea.be/uploads/publications/ACEA\\_Pocket\\_Guide\\_2020-2021.pdf](https://www.acea.be/uploads/publications/ACEA_Pocket_Guide_2020-2021.pdf)

Slovakia is the home for most companies **manufacturing motor vehicles** in Europe, followed by Germany and Sweden.

With over 1400 companies, Italy is on top regarding the number of economic operators involved in **the manufacture of parts and accessories for motor vehicles**, followed by Germany and Poland.

In terms of net **employment (Figure 17)**, according to activity type, Germany is the biggest player in **battery manufacturing, vehicle manufacturing** (556,000 people) and **parts and accessories manufacturing** (280,000 jobs).

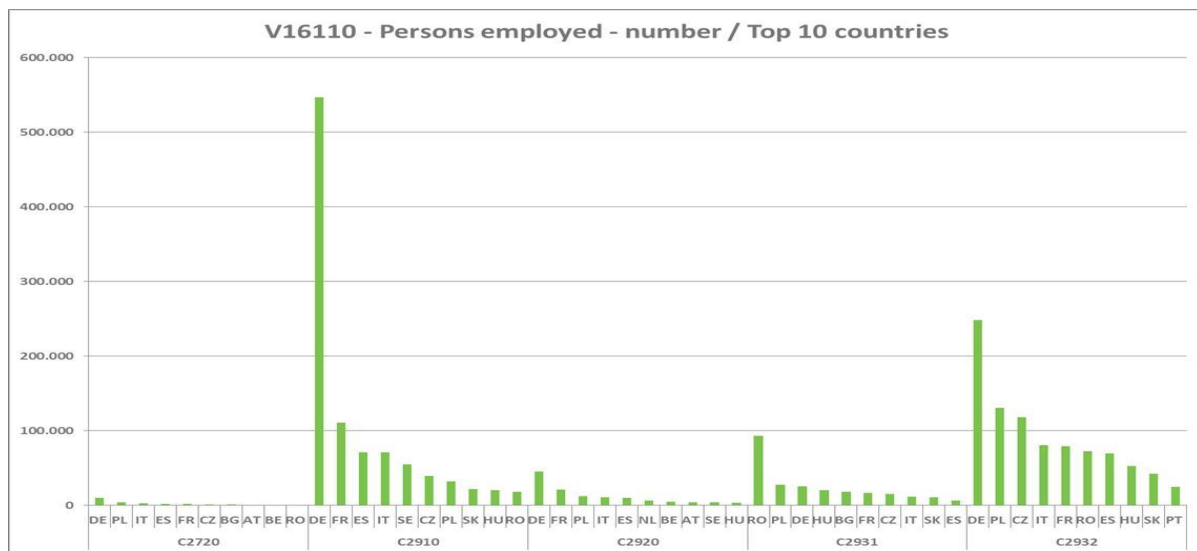

Figure 17 Top 10 countries by persons employed

With a steeply declining position (110,000 jobs), France is the runner up in motor vehicle manufacturing whereas Romania is in the second position in parts and accessories for motor vehicles with around 170,000 jobs.

Germany is once again leading the European economic environment in terms of **turnover (Figure 18)**, at least in **battery manufacturing, motor vehicle manufacturing** (EUR 400 billion) and **parts and accessories manufacturing** (around EUR 80 billion). France is runner up again in motor vehicle manufacturing (EUR 100 billion) and parts and accessories manufacturing (around EUR 30 billion).



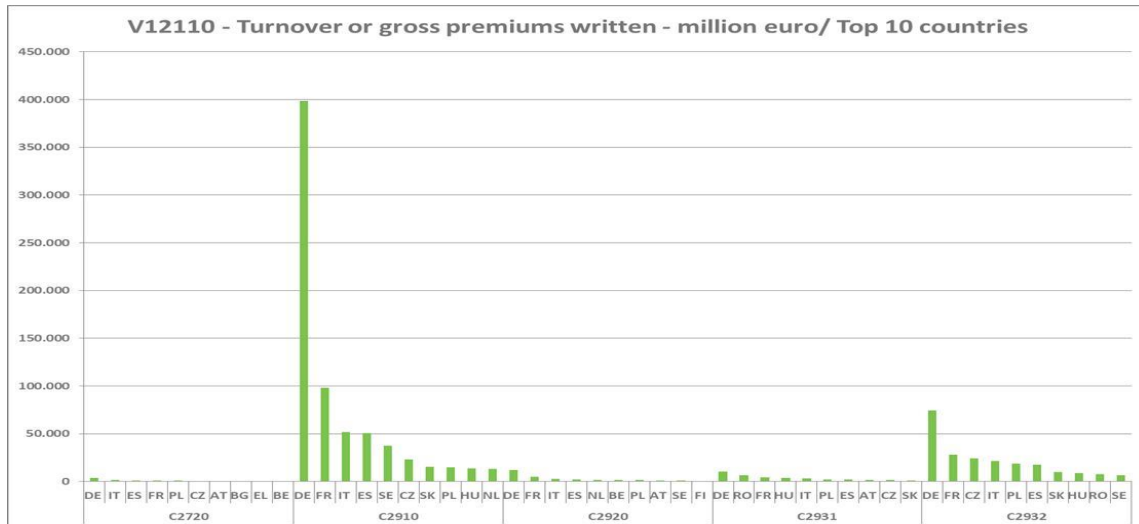

Figure 18 Top 10 countries by turnover

In terms of **number of companies**, Italy leads in **ships and boats production (Figure 19)** with around 1,550 companies, followed by the Netherlands (1,100) and Poland (1,060).

Italy leads in **motorcycle manufacturing**, followed by Spain and the Netherlands.

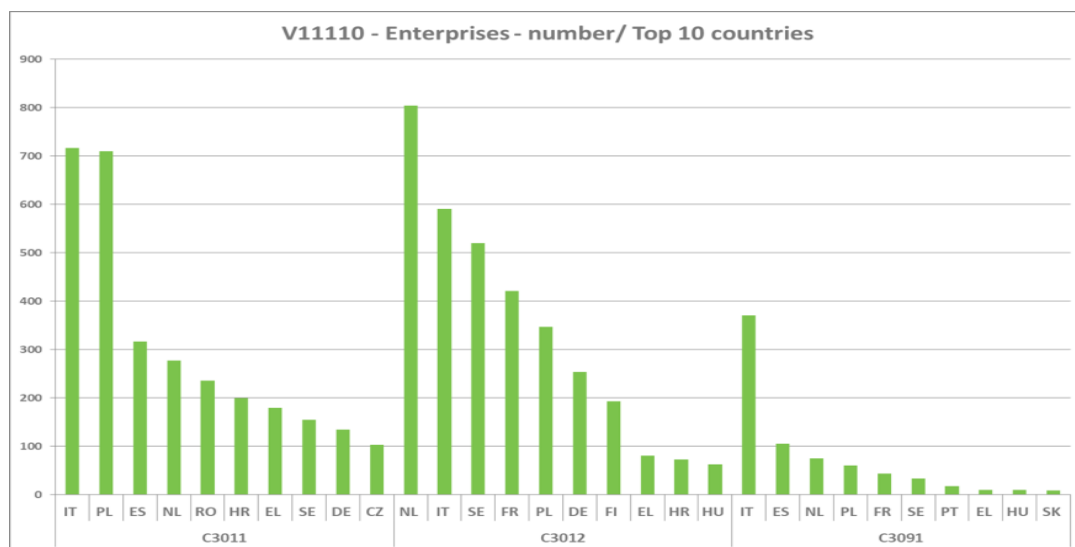

Figure 19 Top 10 Countries by Number of Enterprises

In terms of **net employment (Figure 20)**, Italy is the biggest player with 25,500 people followed by Poland and the Netherlands with 11,500 each.

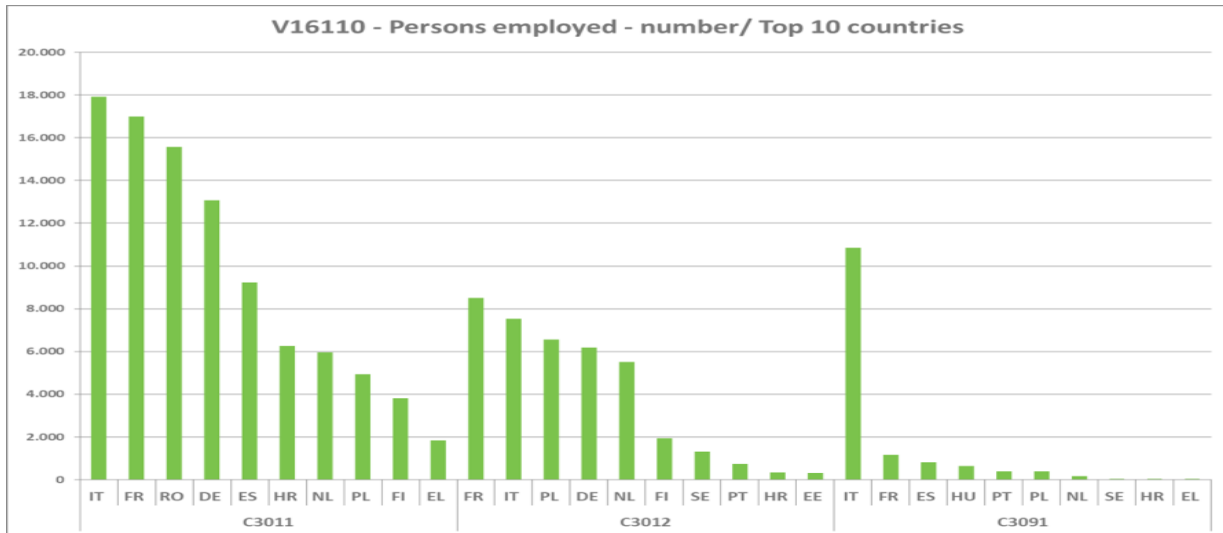

Figure 20 Top 10 countries by persons employed

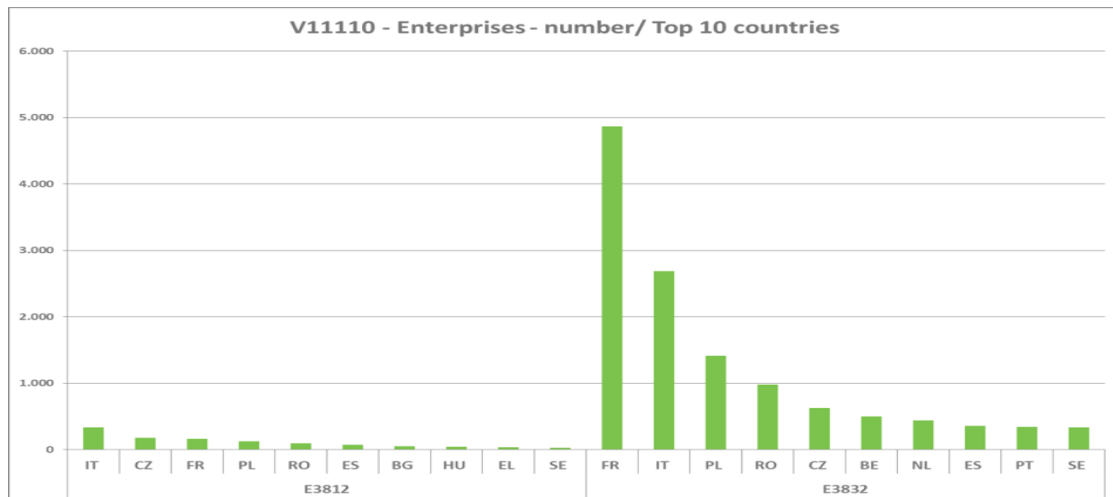

Figure 21 Top 10 Countries by Enterprises

Regarding **recycling activities** in Europe, in terms of registered companies (Chyba! Nenalezen droj odkazů.), the leaders are almost the same as above, in a slightly different configuration: Italy is in 1<sup>st</sup> position in **collection of hazardous waste** – 350 companies and #2 in recovery of sorted materials – 2,800 economic operators whereas France is 1<sup>st</sup> in **recovery of sorted materials** – around 4,800 economic operators and Czechia is 2<sup>nd</sup> in collection of hazardous waste – 200 companies).



Figure 22 Top 10 countries by number of employees

Also in the **recycling sector** but in terms of people hired (**Figure 22**), Italy and France share the first 2 positions: Italy is in 1<sup>st</sup> position in **collection of hazardous waste** – around 3,000 jobs and #2 in recovery of sorted materials – 25,000 people whereas France is 2<sup>nd</sup> in collection of hazardous waste – around 2,000 jobs and #1 in **recovery of sorted materials** – around 53,000 people).

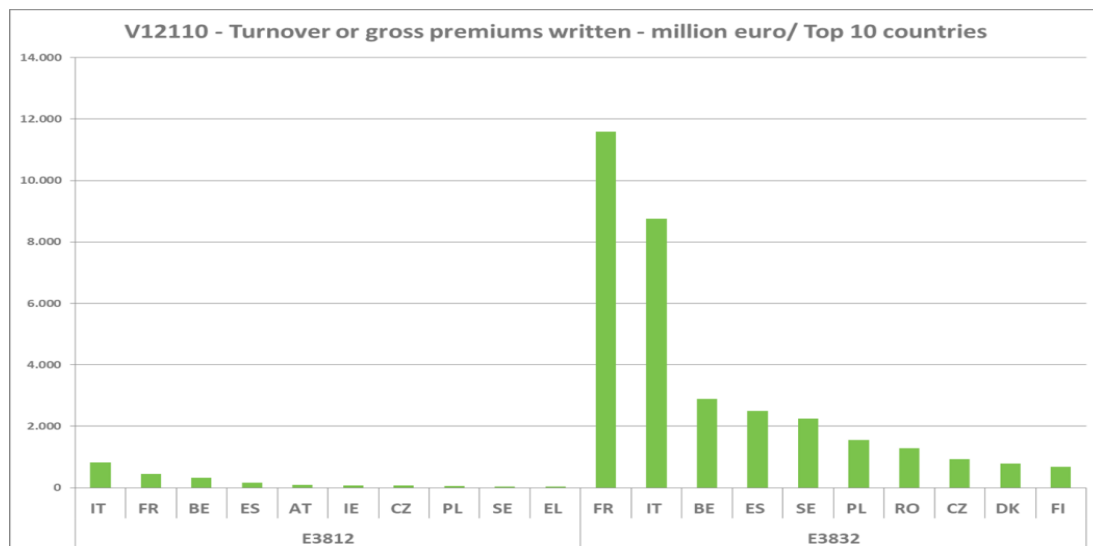

Figure 23 Top 10 countries by turnover

At national level, the highest performing countries in terms of **turnover** (**Figure 23**) on **recycling** activities were Italy (#1 in collection of hazardous waste – around EUR 800 million and #2 in recovery of sorted materials – EUR 8,4 billion) and France (#2 in collection of

hazardous waste – around EUR 500 million and #1 in recovery of sorted materials – around EUR 11.7 billion).

As presented in **Figure 24**, the **sale, maintenance and repair of motor vehicles** represents an important turnover generator, hence the attention granted to it in the current analysis. Regarding the **number of enterprises** involved at national level, it is noteworthy that Germany is in 1<sup>st</sup> position in terms of sales of motor vehicles (40,000 companies), followed by France (25,000), and the Netherlands (23,000). In terms of maintenance and repair of motor vehicles, Italy takes the lead with 70,000 companies, followed by Poland (58,000) and France (52,000).

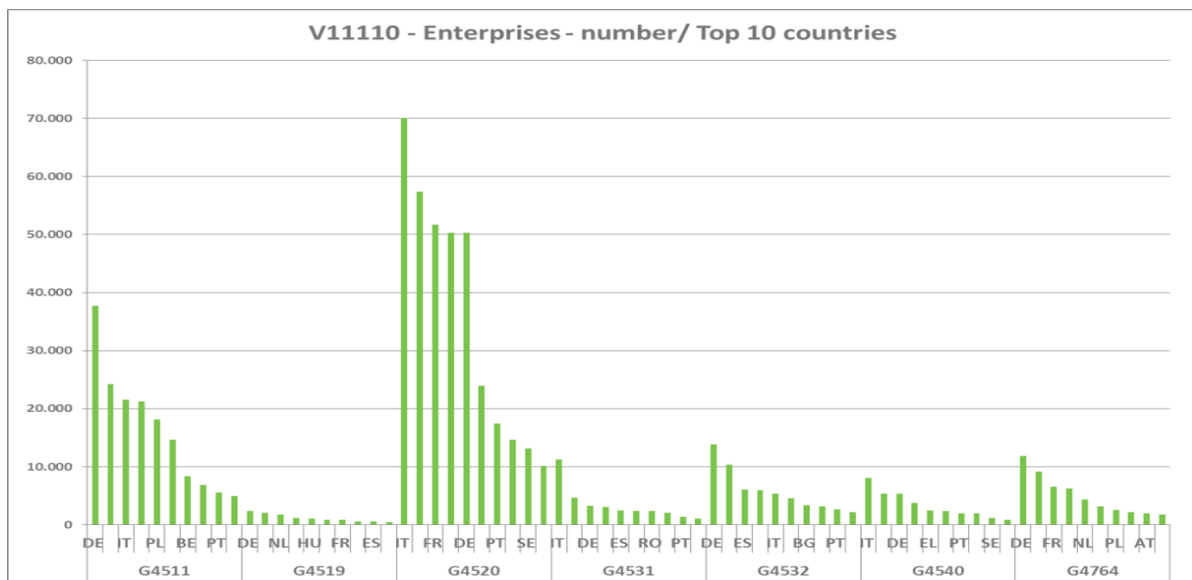

Figure 24 Top 10 countries by number of enterprises

Italy leads again in sale, maintenance, and repair of motorcycles, followed by France and Germany.

In the same three categories (sales of motor vehicles, maintenance and repair of motor vehicles and sale, maintenance and repair of motorcycles), but in **terms of personnel (Figure 25)**, the absolute leader is Germany (435,000 people in G451 / 300,000 in G4520 / 25,000 in G4540).

In 2<sup>nd</sup> and 3<sup>rd</sup> place, France and Italy are taking turns in the three categories: France is 2<sup>nd</sup> in G451 with 190,000 people and 3<sup>rd</sup> in both G4520 (170,000) and G4540 (15,000). Italy takes 3<sup>rd</sup> position in G451 with 100,000 jobs and the 2<sup>nd</sup> place twice (G4520 – 195,000 jobs) and G4540 – 20,000 jobs).

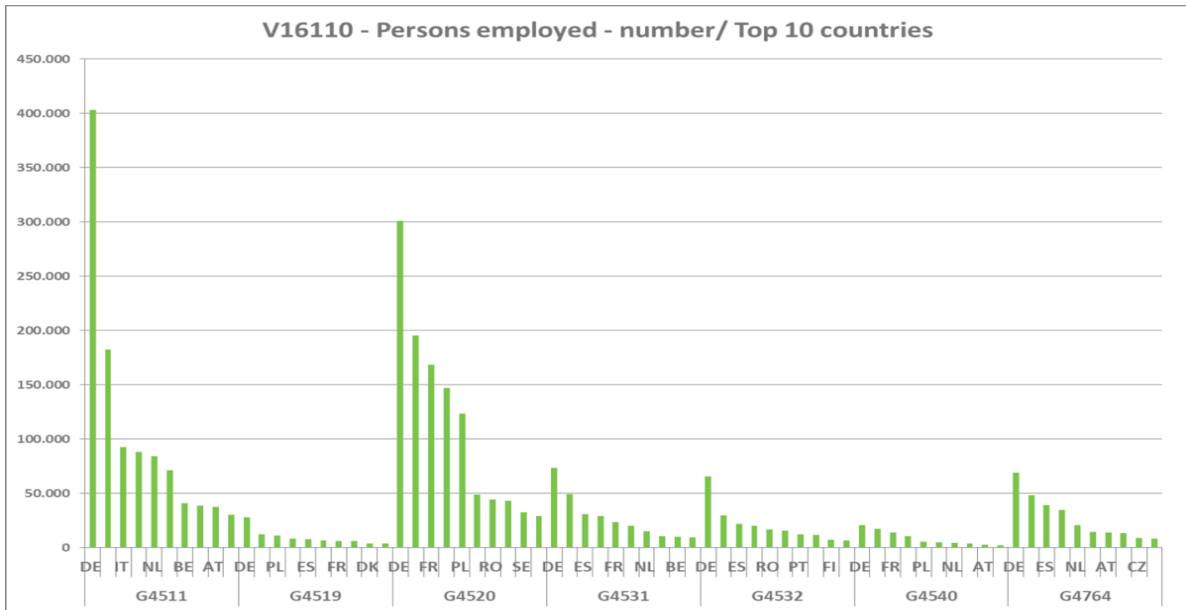

Figure 25 Top 10 countries by persons employed

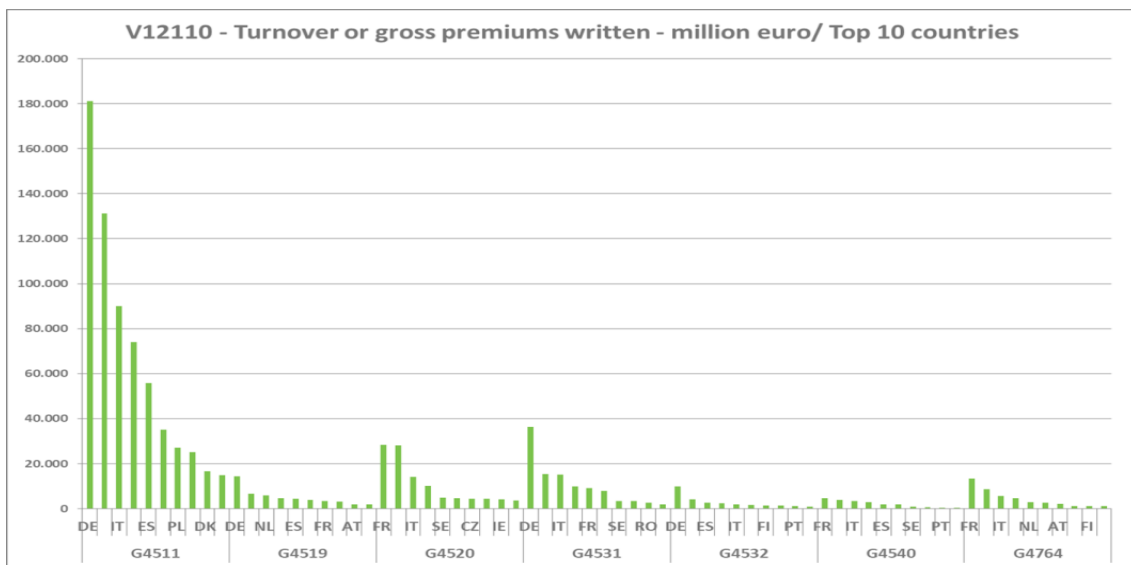

Figure 26 Top 10 countries by turnover

Germany and France also take turns in terms of the same three categories, this time between the first two positions regarding the **turnover** (Figure 26).

Germany takes the cake in **sales of motor vehicles** with close to EUR 200 billion and settles for runner up position in **maintenance and repair of motor vehicles** (EUR 25 billion) and sale, **maintenance and repair of motorcycles** (EUR 5 billion).

France gets the 2<sup>nd</sup> position in G451 with EUR 135 billion and leads the other 2 categories with around EUR 28 billion (maintenance and repair of motor vehicles) and EUR 6 billion (sale, maintenance, and repair of motorcycle).

If we analyse the share of **SMEs**, their consistent presence in the total number is noteworthy, as they are the backbone of Europe's economy. As could be seen in the (Figure 26), most of the companies are from the SME area, having less than 250 employees.

NACE_R2	Indicator	SME (0 - 249 pers), in EU27	>250 persons employed, in EU27	% SME in total
C272	V11110 - Enterprises - number	281	17	94.3%
	V12110 - Turnover or gross premiums written - million euro	708.4	1,547.9	31.4%
	V16110 - Persons employed - number	2,893	4,232	40.6%
C291	V11110 - Enterprises - number	1,444	125	92.0%
	V12110 - Turnover or gross premiums written - million euro	3,125.9	581,315.2	0.5%
	V16110 - Persons employed - number	16,446	921,153	1.8%
C292	V11110 - Enterprises - number	5,323	82	98.5%
	V12110 - Turnover or gross premiums written - million euro	15,200.5	12,117.5	55.6%
	V16110 - Persons employed - number	85,317	37,617	69.4%
C293	V11110 - Enterprises - number	7,120	877	89.0%
	V12110 - Turnover or gross premiums written - million euro	45,347.5	160,885.0	22.0%
	V16110 - Persons employed - number	197,547	867,621	18.5%
C301	V11110 - Enterprises - number	6,229	65	99.0%
	V12110 - Turnover or gross premiums written - million euro	8,337.4	16,226.1	33.9%
	V16110 - Persons employed - number	48,508	56,073	46.4%
C309	V11110 - Enterprises - number	2,677.0	29.0	98.9%
	V12110 - Turnover or gross premiums written - million euro	4,466.7	2,870.2	60.9%
	V16110 - Persons employed - number	24,164.0	12,144.0	66.6%
E381	V11110 - Enterprises - number	12,945	240	98.2%
	V12110 - Turnover or gross premiums written - million euro	18,234.4	14,281.8	56.1%
	V16110 - Persons employed - number	182,910	194,250	48.5%
E383	V11110 - Enterprises - number	16,501	34	99.8%
	V12110 - Turnover or gross premiums written - million euro	32,302.2	7,040.4	82.1%
	V16110 - Persons employed - number	115,766	38,586	75.0%
G45	V11110 - Enterprises - number	795,359	728	99.9%
	V12110 - Turnover or gross premiums written - million euro	807,750.0	313,797.8	72.0%
	V16110 - Persons employed - number	2,924,166	457,141	86.5%

Figure 27 Companies split by SMEs

In the field of **battery manufacturers**, the first position is taken by Italy (64 companies), followed by Poland (57) and Germany (44).

A large disparity can be observed in the **number of small-medium enterprises (Figure 28)** manufacturing batteries and accumulators (around 200 overall with 60 in Italy and 50 in Poland), the ones manufacturing motor vehicles (around 1,500 overall with 240 in Slovakia, 190 in Sweden and 180 in Germany), the ones manufacturing trailers, semi-trailers and bodies for motor vehicles (around 5,000 overall with 1,050 in Germany, 950 in France and 750 in Spain) and the ones manufacturing parts and electronic equipment for motor vehicles (more than 6,000 overall with 1,360 in Italy, 950 in Germany and 800 in Spain).

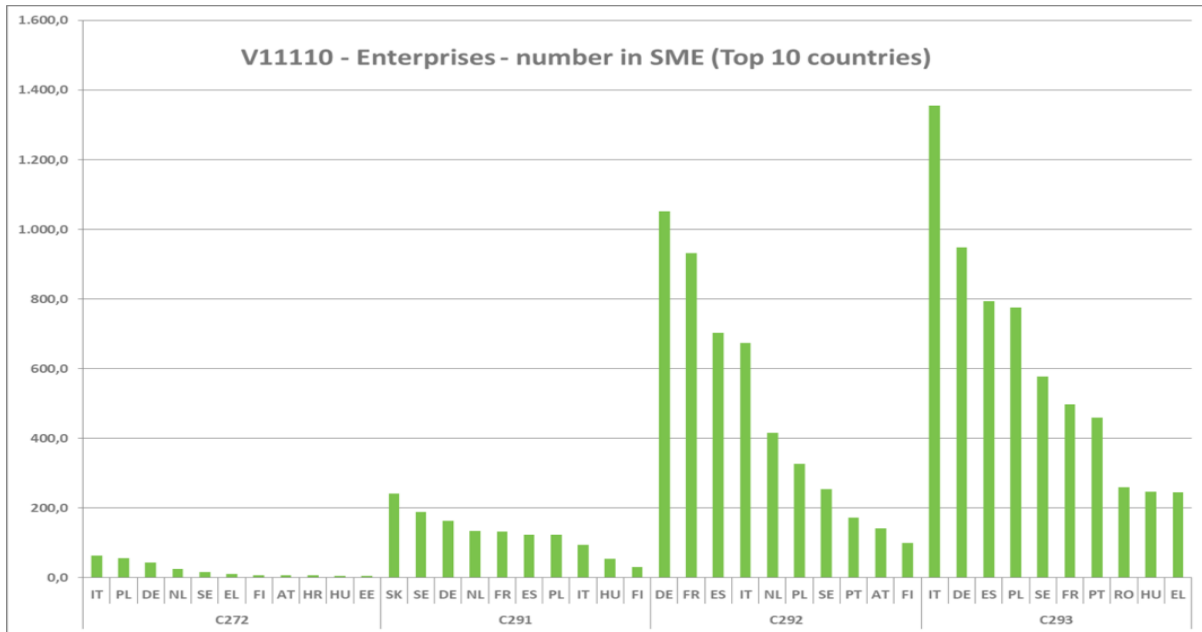

Figure 28 Top 10 countries by SMEs number

In terms of **employment (Figure 29)**, the disparity is similar to the previous figure on number of SMEs. A mere 2,500 people work in the battery manufacturing SMEs in Europe whereas the SMEs manufacturing motor vehicles keep more than 15,000 people busy.

The SMEs manufacturing trailers, semi-trailers and bodies for motor vehicles provide a living to around 80,000 people across Europe. The SMEs manufacturing parts and electronic equipment for motor vehicles are leading in terms of employment with around 200,000 jobs.

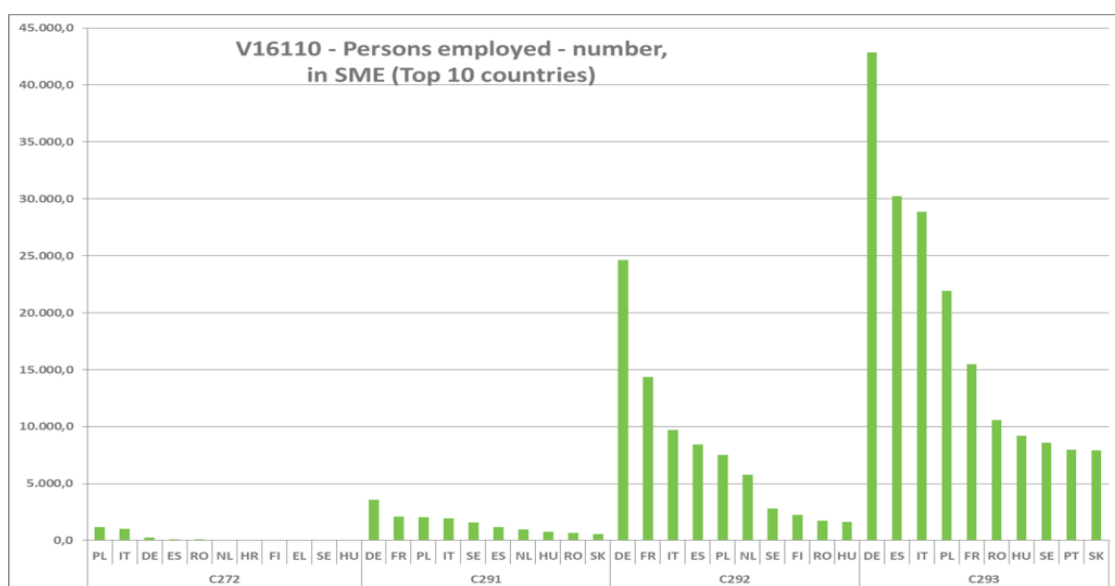

Figure 29 Top 10 countries by SMEs number of persons employed

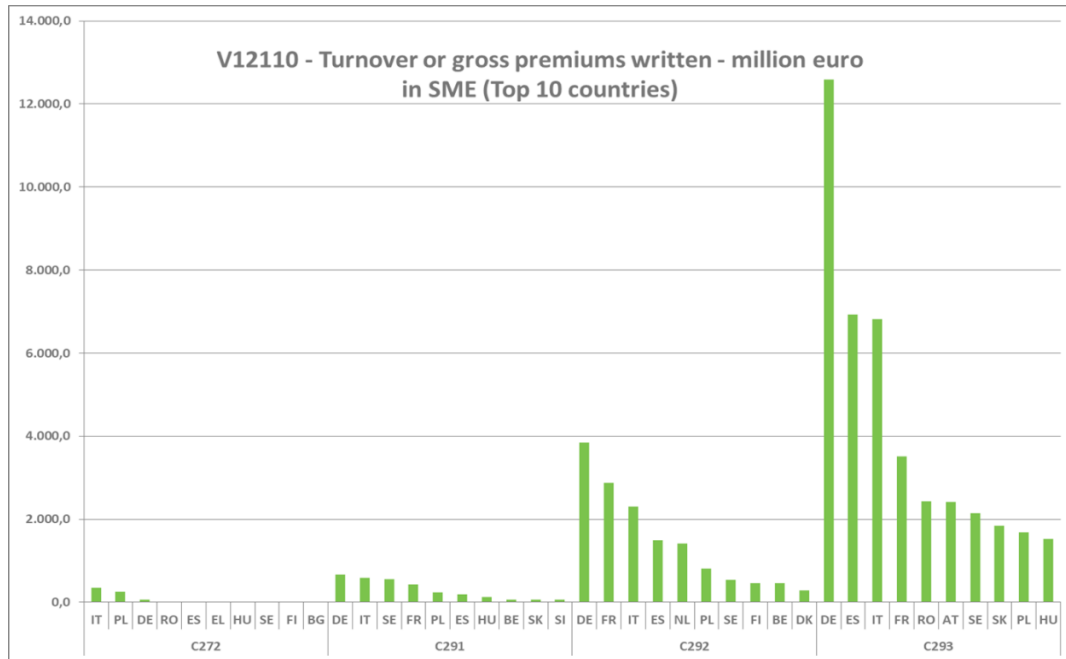

Figure 30 Top 10 countries by SMEs turnover

In terms of the **economic impact of SMEs** (Figure 30), the disparity between the abovementioned sectors can again be observed. Battery manufacturing, with Italy in top position, yields a sheer turnover of less than EUR 500 million whereas the remaining sectors, with Germany in top position, generates an overall turnover of around EUR 60 billion (EUR 2.4 billion in motor vehicle manufacturing, EUR 15 billion in trailers, semi-trailers and bodies for motor vehicles manufacturing and a hefty EUR 42 billion in parts and electronic equipment for motor vehicles manufacturing).

Regarding the **number of SMEs** (Figure 31) involved in **manufacturing ships**, floating structures and pleasure/sporting boats, in comparison with SMEs building **motorcycles**, the statistics show Italy is number one in both sectors with 1,300 SMEs in boating (out of a total of around 6,000) and 820 in motorcycling (out of more than 2,500).



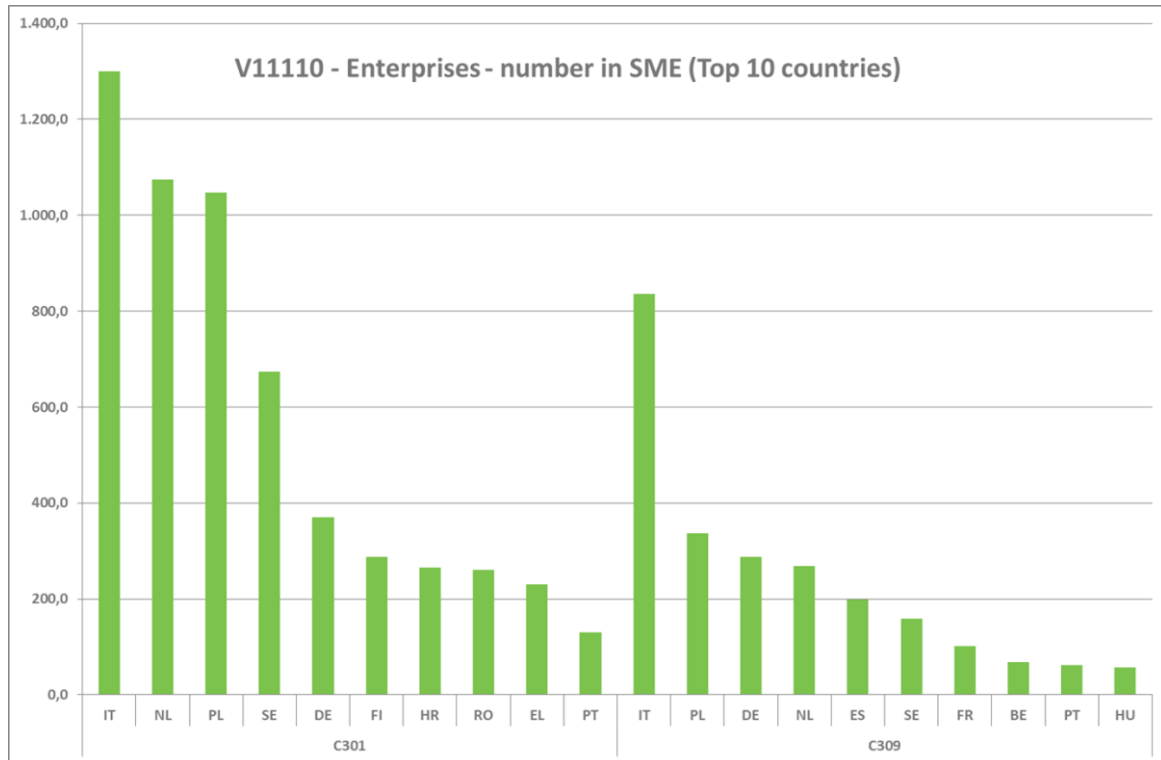

Figure 31 Top 10 countries by SMEs numbers

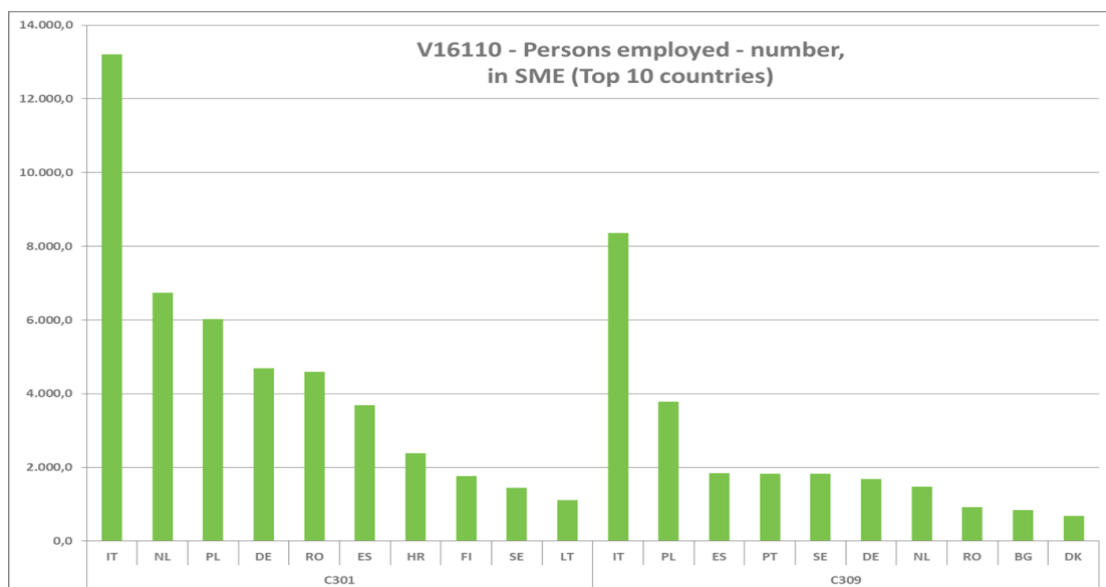

Figure 32 Top 10 countries by SMEs number of persons employed

Italy is also leading in terms of jobs (**Figure 32**) in SMEs involved in manufacturing of ships, floating structures and pleasure/sporting boats, as well as the SMEs building motorcycles. With more than 13,000 jobs in ships and boats manufacturing, Italy provides almost twice as many jobs in the sector as the runner up – the Netherlands with around 6,700 jobs, and the

third placed country – Poland with 6,000 workplaces. In motorcycling manufacturing, Italian SMEs offer more than twice as many jobs as the runner up – Poland (8,400 vs. 3,800).

Things change slightly in terms of turnover (**Figure 33**) of the SMEs involved in ships/boats manufacturing where the Netherlands takes the lead over Italy (runner up) with a little bit above EUR 2.5 billion.

Italy keeps its lead in motorcycle manufacturing turnover with a hefty EUR 1.8 billion, more than three times as much compared to the runner up – Sweden, with slightly less than EUR 500 million.

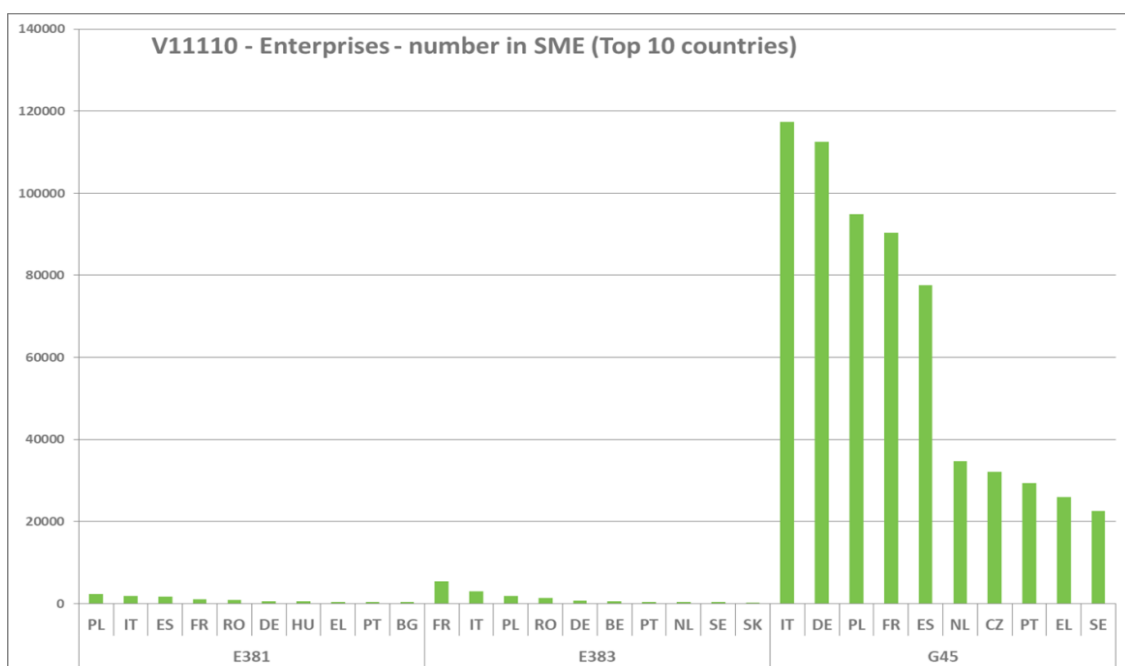

Figure 33 Top 10 countries by SMEs numbers

Just to have a very good look over the situation in the recycling industry, the following graphs (Figure 34 Top 10 countries by SMEs turnover, Figure 35, Figure 36) compare the spread and the strength of the SMEs involved in motor vehicle and motorcycle sale, maintenance and repair sectors with the SMEs involved in collection of hazardous waste and recycling.

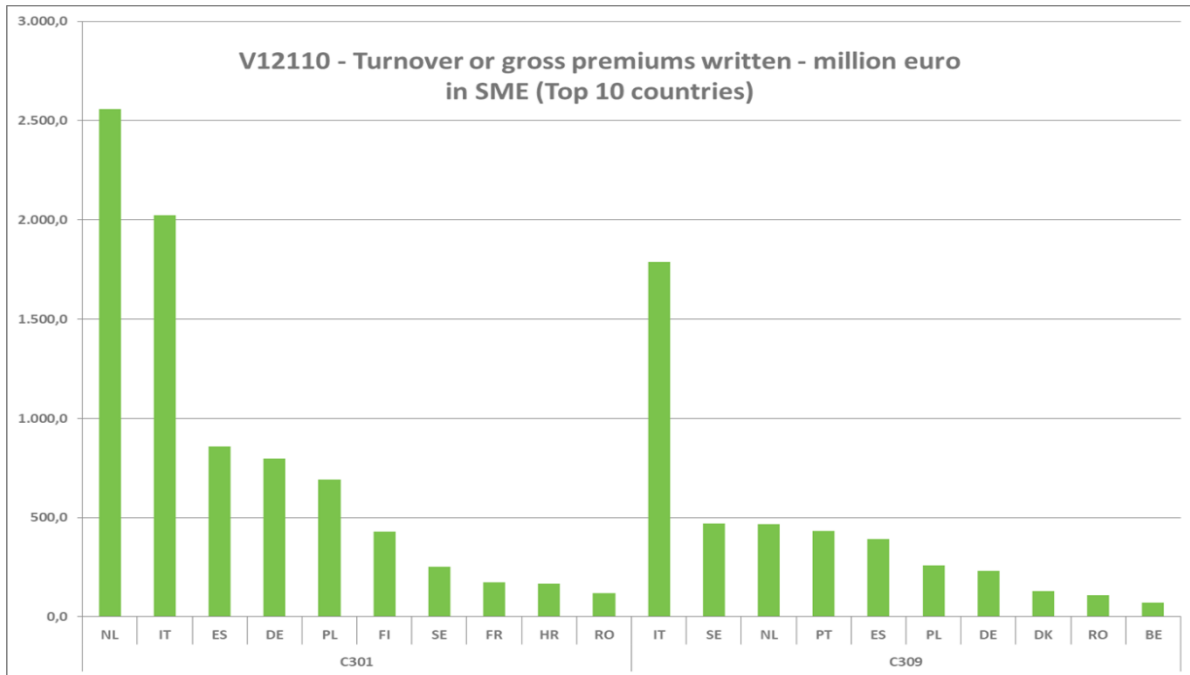

Figure 34 Top 10 countries by SMEs turnover

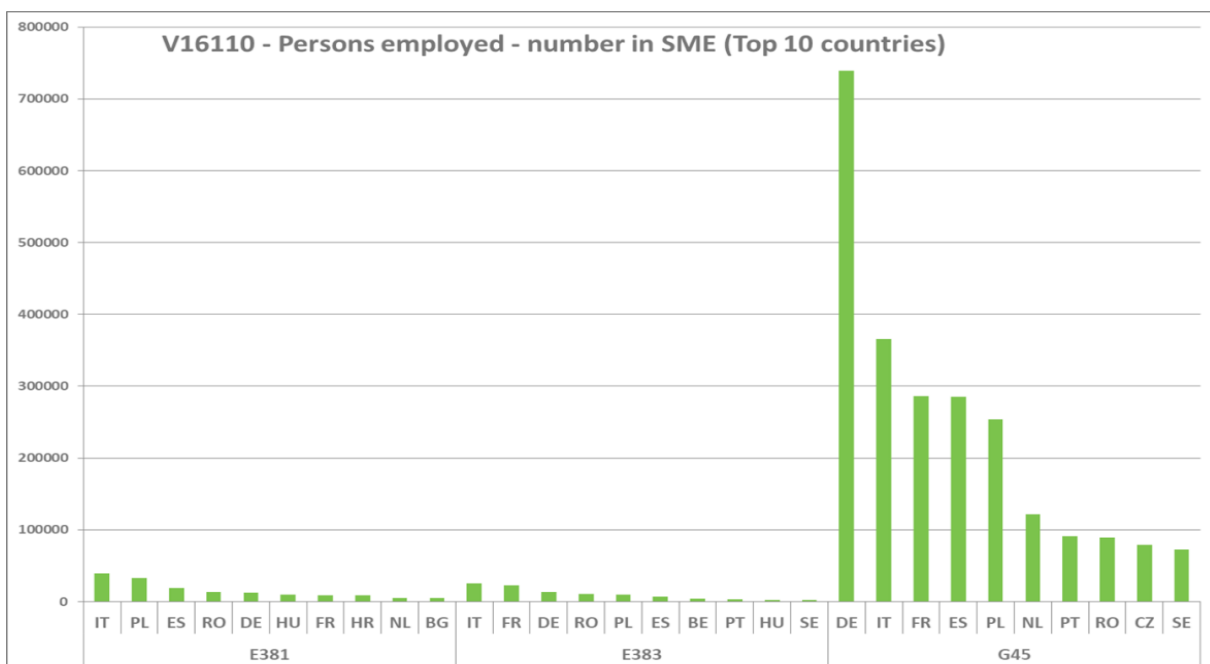

Figure 35 Top 10 countries by SMEs number of persons employed

In terms of people employed, the best performing country, which is once again Italy, counts a mere 70,000 jobs in collection of hazardous waste and recycling whereas the SMEs involved in motor vehicle and motorcycle sale, maintenance and repair sectors provide around 750,000 jobs in Germany alone (the #1).

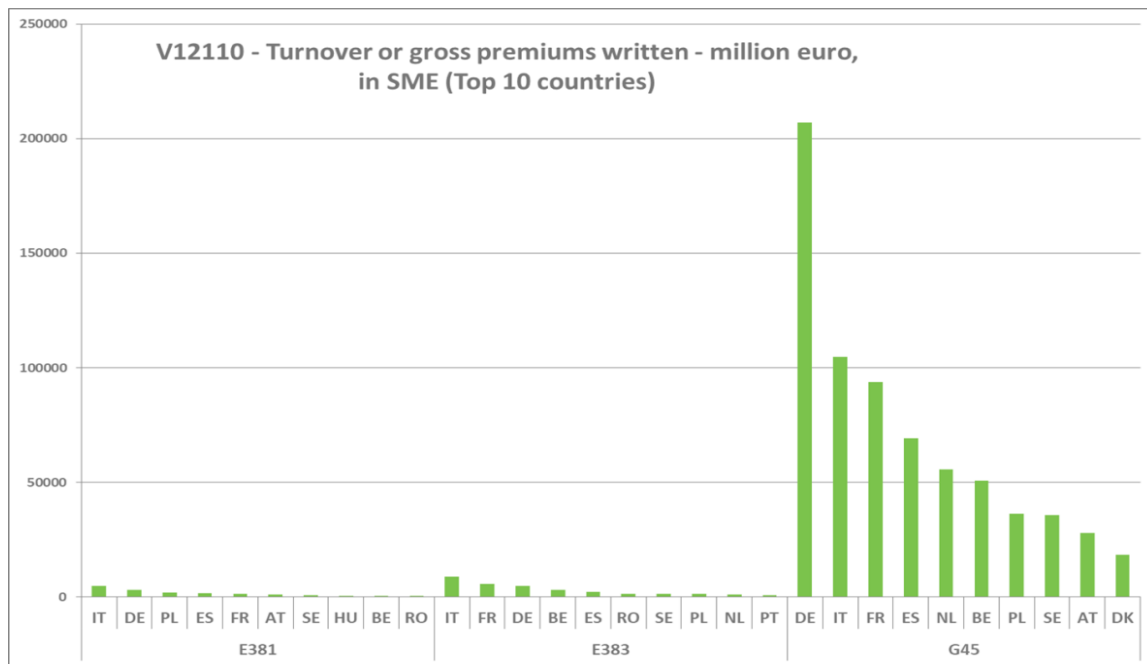

Figure 36 Top 10 countries by SMEs turnover

## 2.3 TECHNOLOGIES\*

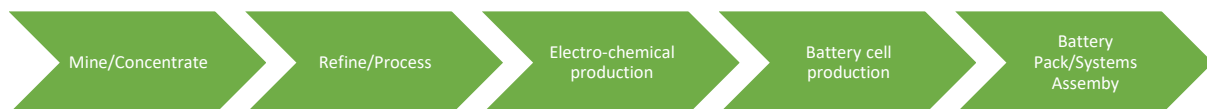

Figure 37: LIB value chain

### 2.3.1 Raw Materials and Processing

The chapter focuses on the raw materials needed for Lithium-ion Batteries (LIB) with NCA or NMC cathodes as these are the most important technologies currently being used. Cobalt, Natural Graphite and Silicon are classified as critical by the European Commission. Lithium, Nickel and Manganese are essential as well, also considering the demand is increasing.

**Lithium** is the most electropositive element in nature; it is relatively lightweight compared to other metals such as Nickel and Cadmium. Lithium is extracted by mining from brine or through hard rock Lithium processing. Lithium Carbonate is mostly used by the EV industry, mainly in cathodes. With NMC cathodes having higher Nickel proportions, the production of Lithium hydroxide is expected to exceed that of Lithium Carbonate.

**Cobalt** provides LIBs chemical and thermal stability with high energy density. It is recovered

through different processes involving ore concentrate by roasting, solvent extraction, electrolysis, or bioleaching. Producers seek to substitute Cobalt, as it is a costly mineral and is sourced mainly from conflict-ridden parts of the world.

**Nickel** conducts heat and electricity and delivers high energy density with low costs. This potential Cobalt replacement is mined as lateritic and Ni-sulfidic ores. Lateritic ores are processed in electric reduction furnaces followed by hydrometallurgical treatment. With sulfidic ores, flash smelting is common, followed by metallurgical processes.

**Manganese** can improve a cathode in LIBs in various ways and can be a cheap alternative to Cobalt and Nickel. Manganese is commonly found as oxide and hydroxide in soils. Its mining is frequently an open pit operation. Pure manganese is produced through hydrometallurgy and electrolysis.

**Graphite**, both natural and synthetic, is used for anodes due to being safe and reliable as an active material. It has sufficient energy density for mobile applications. Natural graphite is mined in open-cast quarries where it can exist as flakes, veins and crystal formations. When refined, graphite flakes are rounded to spherical units followed by thermal or acid purification.

**Silicon** is an alternative to graphite as an active material in an anode. It is preferably mined from pure quartz. After mining and sorting, reduction of quartz with carbon is conducted in a reduction furnace followed by oxidative refining, casting, crystallization and crushing.

### 2.3.2 Component and Cell Manufacturing

Several types of LIBs are used today. These are divided according to the composition of the cathode material. Each composition differs slightly in parameters such as voltage, operation life, capacity, etc.

Presently, batteries account for up to 50% of the total cost of an EV. Moreover, out of all cost associated with LIBs, material costs are the most significant: considering only the separator (3%), the electrolyte (1%), the current collectors (3%), the anode materials (8%) and the cathode materials (26%), 41% of total battery cost is reached already, with the most significant contribution owing to the cathode material.

The manufacturing process includes the preparation of active materials, the production of electrodes and the assembly of batteries. The positive electrode is formed by depositing a cathode material on an aluminium foil and the negative electrode is formed by depositing

an anode material on a copper foil (for Graphite). A separator is inserted between these foils and at the edges. The separator is a plastic, porous film that separates the anode from the cathode but allows electrolyte to flow. The structure is filled with electrolyte. Electrolyte is a solution of lithium salts and is used in a battery to enable the flow of electrons from the anode to the cathode. Then the battery is assembled into the desired shape.

Three shapes are used: cylindrical, prismatic and pouch cells. These variations in shape of the cells bring about differences in terms of capacity, thermal management, integration, etc.

### 2.3.3 Module and Pack Manufacturing

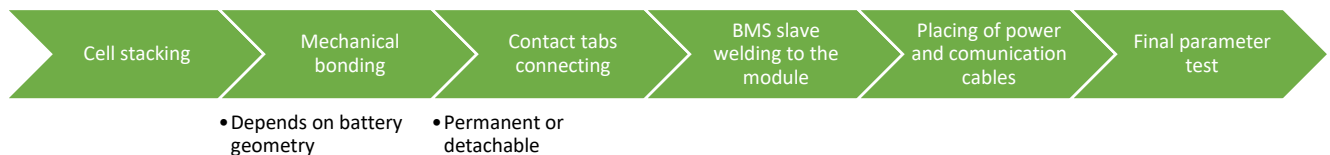

Figure 38 Battery module assembly process

For stationary and mobile applications such as EVs, LIBs are used in the form of a pack. This pack consists of several blocks of battery modules, battery management system (BMS) master, and thermal regulation system. Design possibilities of the pack arrangement include series and parallel stacking of modules.

One of the main concerns regarding the incorporation of LIBs is its inherent risk of thermal runaway and explosion. This leads to the important role the BMS and thermal regulation system have for the module and pack assembly, together accounting for 24% of the total battery cost. Each battery module requires the simultaneous installation of a BMS master and its thermal regulation system, significantly increasing the total volume occupied by the pack.

### 2.3.4 Battery Integration

This step covers the stage between the module and pack manufacturing and operation, repair, and maintenance phases of the battery value chain. Integration process varies mostly based on the application type: either stationary (base stations, power grid, industrial applications,

etc.) or mobile (cars, ships, etc.).

Generic integration process covers the configuration of cells and battery pack and its integration with embedded systems like battery management systems and thermal regulation system which prolong the battery life. This integration step also covers the hardware needed (wiring, sensors, etc.) and the proper enclosure. The last step, before the battery goes into service, is the check for compliance with the safety standards which requires proper testing.

### 2.3.5 Operation, Repair and Maintenance

The first iteration of the report focuses on battery applications in passenger cars and vessels.

#### 2.3.5.1 Passenger Cars

Mass market uptake of electric vehicles (EVs) is strongly driven by the EU CO<sub>2</sub> emission legislation (Regulation (EU) 2019/631), with targets in 2020/21 and 2025/2030. This means that, now, the number of EVs in operation in the EU let alone the ones needing repair and maintenance is rather limited, hence the relevant market is in its infancy.

The mainstream technology today is Lithium Nickel Manganese Cobalt Oxide (NMC) or Lithium Iron Phosphate (LFP), while NMC and solid-state technologies are among the most promising for the future.

Electrification of the vehicle fleet brings about several challenges and opportunities, including new possible services and thus also the need for new job roles and qualifications. These are related, for example, to EV charging, monitoring and managing battery state of charge and health or to safety issues aiming at reducing or eliminating hazards that an electric vehicle equipped with a large high-voltage battery, could wreak on its environment while parked or in motion.

Repair workshops need to get ready for the challenges ahead. Electric vehicles are easier to maintain compared to ICEs as they do not require for example regular engine/gearbox oil change or oil/air/fuel filter replacement. This means a loss of business turnover for the repair workshops. On the other hand, some works on EVs require extra skills and education, including a combination of car mechanic and high voltage qualifications.

#### 2.3.5.2 Vessels

Maritime sector also needs to reduce its CO<sub>2</sub> and air pollutants emissions such as NO<sub>x</sub>. This,

together with the technological development and other drivers, leads to a progressive hybridisation and electrification of the vessel fleet.

The dominant technology today is lead, both flooded and sealed, but Li-ion technologies (NMC and LFP) are penetrating this market. Solid-state electrolyte batteries are a new technology with great potential.

Also, in the case of vessels, attention must be paid to safety issues and potential negative thermal events.

Servicing of the electrified vessels by qualified personnel can be done in docks, by the crew at the sea or, since vessels travel at distant locations, remotely. To carry out any repair or maintenance operation, the personnel must have at least a basic understanding of high voltage maritime applications. As for new skills, data analytics, remote guidance and support, digital tools and software for remote operations are among the highly demanded ones when talking about service engineers.

### 2.3.6 Second Life

Battery second use dissemination enables to mitigate CO<sub>2</sub> emissions and decrease an overall demand for brand-new batteries production, thus decrease the impact on environment by the extraction of minerals and the whole battery production chain. Repurposing retired electric vehicle (EV) batteries provides a potential way to also reduce EV cost. Embedded in stationary energy storage systems, second life EV batteries could unlock the energy storage market and generate synergic value for the energy sector.

EV batteries can be re-used in stationary applications to facilitate integration of renewable sources of energy to grid, off-grid stationary to back-up power for remote consumers etc. or for single households to manage demand peaks and regulate power flow. In the future, second life batteries can be used also in mobile applications, for instance in non-road machinery or micro mobility devices.

Currently, there are still significant challenges in exploiting the expected volume of decommissioned batteries. These include a lack of standardization generally, and specifically in communication protocols. There are also technical barriers associated with the variations of battery cells, shapes, chemistries, capacities, and sizes used by different vehicle manufacturers, in addition to data accessibility related challenges.

Furthermore, before proceeding to the integration phase, a decision on either direct



redeployment or reconfiguration of batteries is to be made. Cell quality selection process is to be scrutinized, considering a battery's SoH, a higher quality output is expected within the latter option. Overall, a greater degree of certification would help to allow a complete assessment of the residual energy capacity of a battery pack at the end of the first life; to allow a more optimized design of the full battery system for a stationary application; to enable developers and integrators of second-life batteries to provide product warranties to their customers etc. Challenges might also reside in the final integration of second life batteries, the replacement, or the capacity expansion that prompt for cooling, safety, hence BMS perfect compliance.

### 2.3.7 Recycling

According to the Strategic Action Plan on Batteries, the whole cycle of sustainable battery production has been revised, although recycling and re-use phases are still to be developed. Even though the EU has been lacking substantial regulations on sustainable battery recycling, a systematic vision is on the way to be integrated to reduce LIBs' (Lithium-ion Battery) net production and leverage EoL (End of Life) batteries' materials.

The recycling technologies of Li-ion batteries can be divided into two types, Direct and Indirect methods. Depending on whether a cathode is broken down to different elements, the former one appears to be more cost effective and energy conservative. There are different techniques to metals reclamation in the LIBs' recycling process for valuable metals (e.g. Co, Ni, Mn, Li etc.) recovery.

The most innovative recycling technologies have been elaborated in this report: Retrieval Technologies, Recupyl Valibat, Akkuser and Umicore Valéas™. Significant leaps can be attained through bringing higher automation degree of the recycling processes and avoiding cathode/anode materials mixing. There is a special attention drawn to Akkuser process, which shows the lowest energy consumption and fire risks with a high level of recycling efficiency, but a "black mass" is to be obtained by a third party. Furthermore, Recupyl Valibat also provides clear advantages, as it uses mechanical processing coupled with hydrometallurgical operations, which renders low losses and embraces strong circular economy principles.

## 2.4 JOB, ROLLES AND SKILLS

As stated in the project application: *“partners will design roadmap or blueprint for the synchronization of the demand; the new needs for competence, on the enterprise side, with the supply of education and training services, customised to meet the demands.”*<sup>102</sup>

The desk research report is a first part of the basis for the above-mentioned roadmap/blueprint and it will deliver important data on which the other two parts (survey and workshops) will be based, as mentioned in the methodology **section 1**.

This section will further describe the focus and approach to this research topic along with the main findings.

### 2.4.1 Focus of the Topic

The focus of this topic of sectoral intelligence is to gather valuable data on current and future job roles, competencies, skills, and knowledge needs, and the so-called state-of-the-art, to better understand the current situation of the fast-emerging battery sector.

### 2.4.2 Attractiveness of the Battery Sector

To better understand the current situation of the sector, the ALBATTTS partnership carried out a desk research study analysing the attractiveness of the battery sector by focusing on target groups which include primarily **potential newcomers** to the sector (i.e. students or young people at the beginning of their professional career); but also workers from other sectors who are eventually **considering** entering this growing sector. Through this research, the aim was to answer the following questions:

- a) Is the battery sector attractive for the above-mentioned target groups?
- b) Are they aware of the battery sector’s potential and its applications?

The numbers from the World Economic Forum, as reported by the Global Battery Alliance’s 2019 Report, are encouraging. If the growing global battery demand is matched with sound collaborative actions, the battery sector could create 10 million safe and sustainable jobs and

---

<sup>102</sup> Project application

\$150 billion of economic value in a fair value chain by 2030<sup>103</sup>. In the umbrella of such collaborative actions, the full exploiting the battery sector potential, increasing its attractiveness, and helping to create relevant competencies and training schemes that match new job roles and requirements are key.

As reported by the European Battery Alliance (EBA250), one of the top priority actions for the future is developing and strengthening a **skilled workforce** in all parts of the battery value chain and making Europe **attractive** for world class experts. To do this, it is imperative to attract talents with lighthouse projects for cell manufacturing and other relevant activities. Sufficient human capital with key skills are missing in Europe, especially in the field of applied process design<sup>104</sup>.



Figure 39: the battery "ecosystem"

From the results of the desk research (published papers, reports, and articles), there is no evidence about a proper and specific battery energy sector *“attraction effect”*. Therefore, in order to better understand the attractiveness of the battery sector, the ALBATTs project has taken a much broader perspective through the analysis and consideration of its main areas of application as per **Figure 39**.

<sup>103</sup> WEF 2019 “Three ways batteries could power change in the world”, <https://www.weforum.org/agenda/2019/09/three-ways-batteries-could-power-the-world/>

<sup>104</sup> EBA250 Priority Actions, <https://www.eba250.com/actions-projects/priority-actions/>

Electric vehicles are considered as an important step for clean energy transition, boosting innovation, digitalization and decarbonization. The general trend is year-on-year increase in first registrations, as shown for example by ACEA statistics.<sup>105</sup> Such interest in EVs requires a skilled workforce and ability to attract talents towards this growing sector. There is no doubt that electric vehicles and their potential are today an object of interest for many people, especially the youth. Young people are in fact attracted by the driving force behind the electrification of transport, namely, the concept of sustainability<sup>106</sup>.

However, the shift to EV manufacturing<sup>107</sup> requires a substantial investment in new talents both from OEMs and new entrants (start-ups in particular). OEMs must look for a workforce that is broader and deeper in terms of knowledge. Multi-skilled engineers, who are as comfortable with **chemistry** as they are with **electrical and mechanical engineering** are required, but this is a challenge since now they are scarce (and they demand higher wages). In addition, another challenge in the difficulty to attract such multi-skilled engineers or graduates in science, technology, engineering, and mathematics altogether is the fact that such people are increasingly attracted to start-ups. To address this issue, OEMs invest in talents capable of designing, building, and integrating battery cells. Various platforms and business models are being set up to find new ideas and talents, and not only in the production part of the value chain<sup>108</sup>. The demand for skilled workforce concerns not only university educated people, but also those with EQF level education (EQF 4-5). The ability to keep the current employees will be of great importance as well. Therefore, vast requalification programs are carried out by OEMs<sup>109</sup> and other stakeholders such as vehicle dealerships.

Another application of the battery sector representing an object of interest that is attracting many talents is “green energy,” where batteries represent a fundamental component in terms of green energy storage. **Young people** are increasingly concerned about environmental

<sup>105</sup> [https://www.acea.be/uploads/publications/ACEA\\_Pocket\\_Guide\\_2020-2021.pdf](https://www.acea.be/uploads/publications/ACEA_Pocket_Guide_2020-2021.pdf) accessed 28.08.2020

<sup>106</sup> PWC, 2017 “Five trends transforming the Automotive Industry”, <https://eu-smartcities.eu/sites/default/files/2018-03/pwc-five-trends-transforming-the-automotive-industry.compressed.pdf>

<sup>107</sup> Deloitte, 2019 “New markets. New entrants. New challenges. Battery electric vehicles”, <https://www2.deloitte.com/content/dam/Deloitte/uk/Documents/manufacturing/deloitte-uk-battery-electric-vehicles.pdf>

<sup>108</sup> For example <https://skodaautodigilab.com/>

<sup>109</sup> <https://www.volkswagen-newsroom.com/en/press-releases/transformation-continuing-apace-zwickau-car-factory-to-produce-only-electric-models-in-future-6154> accessed 28.08.2020

issues. Gen Z and Millennials see the industry’s careers in oil and gas as unstable, blue-collar, difficult, dangerous, and harmful to society, while considering jobs in green energy more appealing<sup>110</sup>. The green energy sector employed 11 million people at the end of 2018 (with solar photovoltaic panels being the top employer)<sup>111</sup>. Although many young people are interested in pursuing studies and making a career in the green energy sector, the main issue here is that, at EU level especially, more work should be done on providing a more systemic skills base. In fact, managing skills and technical job-specific skills are a greater concern than shortages of “new” green skills.

To conclude, when taken in isolation, it is still not possible to clearly outline if and to what extent the battery energy sector is attractive. However, findings from our desk research show that when taking a broader perspective by analysing its main areas of application, it is possible to measure as well as to boost the battery sector’s attractiveness. People and especially the youth are increasingly attracted to new ways of generating and using energy to tackle the biggest climate challenges and contribute to achieving sustainability goals. Therefore, it is imperative to show that batteries are the key enablers and accelerators to achieve such goals, through their impact on areas such as smart mobility; secure, green, and affordable energy; as well as circular economy. Therefore, young people should be aware that pursuing a career in such sector will allow them to contribute and make a direct impact on sustainability issues. Moreover, a more in-depth analysis of the sector attractiveness will be provided through the next steps of the project interactions with stakeholders.

### 2.4.3 Methodology and Classification Framework

All the job roles found were mapped to the battery value chain steps for further identification of the gaps. A spreadsheet template was used to achieve trackable work for all involved partners. This approach resulted in structured data collection.

#### ◆ Job Role (current or future)

<sup>110</sup> EY, 2017 “How do we regenerate this generation’s view of oil and gas?”, [https://assets.ey.com/content/dam/ey-sites/ey-com/en\\_gl/topics/oil-and-gas/ey-how-do-we-regenerate-this-generations-view-of-oil-and-gas.pdf](https://assets.ey.com/content/dam/ey-sites/ey-com/en_gl/topics/oil-and-gas/ey-how-do-we-regenerate-this-generations-view-of-oil-and-gas.pdf)

<sup>111</sup>IRENA, 2019 “Renewable Energy and Jobs – Annual Review 2019”, <https://www.irena.org/publications/2019/Jun/Renewable-Energy-and-Jobs-Annual-Review-2019>

- Name
- Application (stationary or mobile)
- Category (corresponding with the ISCO classification level I & II<sup>112</sup>)
- Description
- Mapping<sup>113</sup> to the battery value chain
  - Job role was assigned to the corresponding battery value chain.
- Responsibilities
- Qualification needed with EQF<sup>114</sup> mapping
- Actively offered or demanded
  - Information about demand or offer of the job role.
- Competences
  - Skills and knowledge required.
- Other relevant information
- ESCO mapping
- Information source

This generic template is very well suited for partners who can easily map the job advertisements, or any other data found in the various reports. It enables structured approach to the research and systematic work as well as backtracking to the source of information.

This structured data collection can then be easily mapped to the job role classification framework described below.

### Job Role Classification Framework:

- ◆ Name (Mandatory)

---

<sup>112</sup> Glossary:International standard classification of occupations (ISCO). (n.d.). Retrieved August 04, 2020, from [https://ec.europa.eu/eurostat/statistics-explained/index.php/Glossary:International\\_standard\\_classification\\_of\\_occupations\\_\(ISCO\)](https://ec.europa.eu/eurostat/statistics-explained/index.php/Glossary:International_standard_classification_of_occupations_(ISCO))

<sup>113</sup> An operation that associates each element of a given set (the domain) with one or more elements of a second set (the range).

<sup>114</sup> European qualifications framework (EQF). (2020, April 27). Retrieved August 04, 2020, from <https://www.cedefop.europa.eu/en/events-and-projects/projects/european-qualifications-framework-eqf>

- ◆ Description (Mandatory)
- ◆ Work Context<sup>115</sup> (Optional)
- ◆ ESCO Mapping (Mandatory)
  - Mapping to existing ESCO occupations
  - **M: N mapping**<sup>116</sup>: One job role to more occupations in ESCO and vice versa, one or more job roles to one occupation in ESCO.
- ◆ ISCO Mapping (Optional)
  - Level I ISCO Mapping
  - Level II ISCO Mapping
- ◆ Competencies (Mandatory)
  - List of competencies/skills on desired level
    - Mapped to ESCO existing competence/skill
  - List of knowledge necessary
    - Mapped to ESCO existing competence/skill
- ◆ EQF Level (Mandatory)
- ◆ Other Parameters (Optional)
  - Battery value chain mapping

Classification framework described above coheres well with the ESCO and enables identification among the different European skill agendas.

#### 2.4.4 Main Findings

For this desk research report, project partners decided to look for various job advertisements available on the internet relevant to the battery sector. The deliverable 6.1 which was done in WP6 was also used as a reference to better understand what are the possible job roles that could be described in more detail. Some of the information also comes from the reports which are publicly available on the internet. Synthesis of this data leads to the list of job roles, skills, and knowledge for each value chain step. Occurrence of required skills and knowledge is depicted in charts.

<sup>115</sup> Work Context. (2020, March 07). Retrieved August 04, 2020, from

[https://ec.europa.eu/esco/portal/escopedia/Work\\_context](https://ec.europa.eu/esco/portal/escopedia/Work_context)

<sup>116</sup> [https://en.wikipedia.org/wiki/Many-to-many\\_\(data\\_model\)](https://en.wikipedia.org/wiki/Many-to-many_(data_model)) last accessed on 28.08.2020



Main findings are described in more detail in the sections that relate to the specific value chain steps. Each section contains list of the found job roles and statistics about the skills and knowledge that were found.

## 2.5 EDUCATION

Although the EU countries have national education systems, the European Commission has high ambitions concerning their responsiveness to economic development needs, and continuously works with soft policy, such as the Bologna process, or in this case, the education blueprint for the development of education and training methods and approaches, for the fast development of the batteries and e-mobility sector in Europe.

The education and training methods and approaches used vary between the academic university sector and vocational education; methods also vary within these sectors. However, many of the same methods and approaches are used, but with varying blends, emphasis patterns and objectives. Universities work with advanced generalist education, and vocational institutes closer to actual application and work market. ICTs (Information and Communication Technologies) no longer constitute new methods by themselves, but they refresh the old and develop innovation in education, and training access and flexibility, so IT-integrated education has become the new normal. We present a time-based social perspective that can be used for analysis and classification when working further in desk research with analysing what is going on and what needs to be done.

ALBATTS deliverable 6.1 constituted a collection of European examples of existing education and training in the battery- and e-mobility sector, from EQF (European Qualification System) 4 (upper secondary school, gymnasium) to EQF 7 (master-level education), and found interesting examples all over, but with concentration on the masters level, which is important for development jobs in industry. For vocational education on EQF level 4-5 to start and thrive, job offers and opportunities in actual industries must be available close in time. This work will continue with desktop research, surveys and workshops in WP3, 4 and 5, but also by networking with other initiatives (such as the European Battery Alliance, BatteriesEurope, Battery2030+, EITInnoEnergy, EIT Raw Materials.) and educational institutions.



## 3 Value chain

### Introduction

Lithium-ion batteries (LIBs) currently dominate the battery market in mobile applications (mainly automotive) and are gaining increasing relevance in stationary (grid) applications. Lithium is relatively lightweight, compared to other metals such as Nickel and Cadmium. The couple  $\text{Li}^0/\text{Li}^+$  (3.05 V) has the highest possible voltage among the known raw materials, as Lithium is the most electropositive element found in nature<sup>117</sup>. Since Sony started using this type of battery in 1991, LIBs have been under the spotlight as the main researched topic of the energy storage systems (ESS) which has led to several significant improvements.

Presently, the main challenges to overcome are:

- (1)** reducing or, if possible, eliminating the use of Cobalt, which has the most critical supply chain of all the main constituents of LIB's positive electrode active materials, thus reducing cost and supply instability (Cobalt is  $\geq 80\%$  mined in the Democratic Republic of Congo);
- (2)** increasing LIB's overall life cycle and energy density<sup>118</sup> of LIBs.
- (3)** decreasing the inherent safety risks such as thermal runaway that may lead to fire and explosions.

The first and second challenges are closely related to tailoring chemistries for positive electrodes' active materials. Hereinafter, the positive electrodes active material will be referred to as "cathode" for simplification, although in the secondary batteries (rechargeable), the positive electrodes are cathodes while discharging, and anodes while charging.

### 3.1 RAW MATERIALS AND PROCESSING

#### 3.1.1 Stakeholders

Mining and supply of raw materials concern manufacturing companies, especially those involved in upstream battery cell. Furthermore, general consciousness about environmental impact, fair working conditions and political factors, associated with each raw material, create new avenues for developing new battery cell technologies, but also identifies current and future challenges such as recycling. These problems also concern public organizations and Global/European authorities, which are responsible for promoting ecological and economical

<sup>117</sup> Julien, C., et al., *Lithium Batteries: Science and Technology*. 2015: Springer International Publishing.

<sup>118</sup> Goodenough, J.B. and Y. Kim, *Challenges for Rechargeable Li Batteries*. *Chemistry of Materials*, 2010. **22**(3): p. 587-603.

sustainability, beside guaranteeing that working conditions in raw material supplying countries comply with fundamental human rights.

Major international companies selling end consumer products, such as well-known EVs manufacturers – Tesla, Nissan, and others – are subject of public scrutiny. This fact reinforces their active role in raw materials’ extraction, since severe environmental consequences, as well as unfair working conditions, may arise from these activities.

Thus, a list of stakeholders taking part in raw material mining, supply and processing may be identified as follows:

- ◆ Mining and mineral refining companies.
- ◆ Battery manufacturers.
- ◆ Vehicle manufacturers.
- ◆ Research institutions.
- ◆ Education institutions.
- ◆ Recycling companies.
- ◆ Energy/Natural resources regulation and fiscal authorities.
- ◆ Environmental non-profit organizations (NGOs).
- ◆ International organizations (UNESCO, UN, etc) and European Institutions.
- ◆ Local authorities/municipalities.

### 3.1.2 Drivers of Change

The European Commission (EC) list of Critical raw materials (CRM) from 2017 lists Cobalt, natural graphite, and Silicon as critical for battery production.<sup>119</sup> In this critical assessment, a balance between the economic importance and the supply risk is constantly analysed. The 2018 *Report on Raw Materials for Battery Applications* mentions Nickel and Lithium as “essential”.<sup>120</sup> In the 2018 EC communication “Europe on the move”, it is emphasized the need to increase the overview and knowledge on battery raw materials, which is the background of

<sup>119</sup> <https://eur-lex.europa.eu/legal-content/EN/TXT/?uri=CELEX:52017DC0490> last accessed on 28.08.2020

<sup>120</sup> <https://ec.europa.eu/transport/sites/transport/files/3rd-mobility-pack/swd20180245.pdf> last accessed on 28.08.2020

numerous reports, as the review of the 2017 list of CRMs<sup>121</sup> and JRC Science for policy reports.<sup>122 123</sup> Moreover, Nickel and Manganese are the most common metals employed to complement and decrease the amount of Cobalt which highlights both metals' importance for future cathode technologies.

### 3.1.3 Mining and supply

Limiting this study to the most important battery technologies currently being used, which are going to be identified in subsequent subchapters, the focus will be on critical raw materials needed for LIBs with NMC and NCA cathodes (lithiated compounds containing Nickel, Cobalt, Oxygen and Manganese or Aluminium, respectively). These compounds incorporate raw materials that are now in limited supply and extra demand due to the recent surge in battery production for EVs.

Based on *Drivers of Change* and the most relevant technologies, the short list for addressing raw materials includes: **Lithium, Cobalt, Nickel, Manganese, Graphite** and **Silicon**.

#### Lithium

Lithium is a highly reactive metal. It may ignite in the presence of moisture and/or air, and it is an electrical conductor ( $1.1 \times 10^7$  S/m). It is often transported in mineral oil to keep it protected from air and water. This metal's high reactivity leads to its absence in pure form. Instead, it is found in the composition of minerals, spodumene and petalite. There are two distinct techniques for extracting both minerals: mining from brine (salt lakes) and hard rock Lithium processing (pegmatite deposits).<sup>124125</sup> The EU import reliance thereof is 86%.<sup>126</sup>

<sup>121</sup><https://op.europa.eu/en/publication-detail/-/publication/08fdab5f-9766-11e7-b92d-01aa75ed71a1> last accessed on 28.08.2020

<sup>122</sup>[https://publications.jrc.ec.europa.eu/repository/bitstream/JRC112285/jrc112285\\_Cobalt.pdf](https://publications.jrc.ec.europa.eu/repository/bitstream/JRC112285/jrc112285_Cobalt.pdf) last accessed on 28.08.2020

<sup>123</sup><https://publications.jrc.ec.europa.eu/repository/bitstream/JRC105010/kj1a28534enn.pdf> last accessed on 28.08.2020

<sup>124</sup> <https://www.chemicool.com/elements/Lithium.html> last accessed on 28.08.2020

<sup>125</sup><https://www.sgs.com/~media/Global/Documents/Flyers%20and%20Leaflets/SGS-MIN-WA109-Hard-Rock-Lithium-Processing-EN-11.pdf> last accessed on 28.08.2020

<sup>126</sup><https://op.europa.eu/en/publication-detail/-/publication/08fdab5f-9766-11e7-b92d-01aa75ed71a1> last accessed on 28.08.2020

## Deposits

The biggest known global deposits for brine mining are located in the South American Lithium Triangle (Chile, Argentina, Bolivia) and Canada. Australia, China and USA have the biggest hard-rock deposits in the world<sup>127</sup> and smaller deposits of both mining sources are to be found in many countries, often in combination with hard rock copper mining. Seawater also contains Lithium in small concentrations (0.17 parts per million)<sup>128</sup> but presently, its extraction is not economically viable. Lithium is a common component of sea-bottom polymetallic nodules as well, for which harvesting is highly controversial, due to damage caused by current mining methods being employed.<sup>129</sup> In all, global Lithium deposits are considered enough in supply for at least this century, especially if efficient recycling technologies develop. In Europe, most of the additional prospecting for Lithium can be motivated by the lack of interest therefore. In the recent past, Lithium has simply not been so much in focus during explorations. So far, only about 1% of the world's total deposits have been depleted, so there will be Lithium access for many years. The big Bolivian deposits at the world's biggest salt flat, Salar de Uyuni<sup>130</sup> are interesting for both European and Chinese companies<sup>131 132</sup>, but it is more expensive to exploit than the reserves in other parts of the Lithium triangle, since they are chemically more complex and the high altitude with lower temperatures makes drying processes slower.<sup>133</sup> China encountered similar problems with its big Lithium deposits in Tibet.<sup>134</sup>

## Deposits in Europe

Portugal has the largest producing Lithium mines in Europe, in the Guarda area, Northern Portugal, near the border with Spain, run by Grupo Mota Felmica<sup>135</sup> and other deposits are

<sup>127</sup><https://www.statista.com/statistics/268790/countries-with-the-largest-Lithium-reserves-worldwide/> last accessed on 28.08.2020

<sup>128</sup><https://stockhead.com.au/resources/Lithium-from-seawater-its-possible-but-is-it-worth-pursuing/> last accessed on 28.08.2020

<sup>129</sup> <https://www.nature.com/articles/d41586-019-00757-y> last accessed on 28.08.2020

<sup>130</sup> <https://www.saltworkconsultants.com/salar-di-uyuni/> last accessed on 28.08.2020

<sup>131</sup> <https://www.mining.com/web/bolivia-picks-chinese-partner-2-3b-Lithium-project/> last accessed on 28.08.2020

<sup>132</sup> <https://www.dw.com/en/bolivia-scraps-joint-Lithium-project-with-german-company/a-51100873> last accessed on 28.08.2020

<sup>133</sup> <https://dialogochino.net/en/extractive-industries/35423-bolivia-rethinks-how-to-industrialize-its-Lithium-amid-political-transition/> last accessed on 28.08.2020

<sup>134</sup> <https://www.scmp.com/news/china/science/article/3010200/china-cracks-cheap-Lithium-production-electric-car-breakthrough> last accessed on 28.08.2020

<sup>135</sup> <http://Lithium.today/Lithium-supply-by-countries/Lithium-supply-portugal/> last accessed on 28.08.2020

under development.<sup>136</sup> Another promising deposit is located in the Krusne Hory mountains, Czech Republic, near the border with Germany.<sup>137</sup> Besides this, there are Lithium deposits in Mid-Finland (Ostrobothnia) which the company Keliber Oy plans to mine and then refine into Lithium hydroxide in Kokkola.<sup>138</sup> Lithium hydroxide is commonly found in LIBs electrolyte's composition, besides some more recently developed cathodes. These deposits, together with other smaller European deposits, are not considered enough for Europe's estimated needs of this metal.

## Production

The brine exploitation is done by pumping up salt from underground, drying this in enormous ponds and harvesting Lithium Carbonate which can be sold directly. In hard rock mining<sup>139</sup>, a Lithium concentrate is produced that must be refined into Lithium Carbonate or Lithium Hydroxide. Lithium Carbonate is the most widely used in the EV industry, mainly in cathodes, but recent market trends for Li- rich NMC cathodes containing higher proportions of Nickel is shifting Lithium's demand, with production of Lithium Hydroxide expected to overcome that of Lithium Carbonate by the second half of the 2020s decade.<sup>140</sup> The reason for this already observed increasing demand for Lithium Hydroxide is the need to enhance Nickel-rich active cathodes' chemical stability.

## Refining

The recovery of Lithium from brine is more expensive than mining of Lithium from hard rock, while refining from brine is less expensive, as Lithium Carbonate from dried-up brine is directly sellable. It is the other way around for hard rock mining: expensive refining processes are needed turn the concentrate to Lithium Carbonate and further to Carbon Hydroxide.

<sup>136</sup> <https://blog.energybrainpool.com/en/is-there-enough-Lithium-to-feed-the-need-for-batteries/> last accessed on 28.08.2020

<sup>137</sup> <https://www.mpo.cz/cz/rozcestnik/pro-media/tiskove-zpravy/tezba-lithia-na-cinovci-bude-v-ceskych-rukou-cez-ziska-51-procent-ve-spolecnosti-geomet--253714/> last accessed on 30.08.2020

<sup>138</sup> <https://www.keliber.fi/en/> last accessed on 28.08.2020

<sup>139</sup> <https://www.sgs.com/~media/Global/Documents/Flyers%20and%20Leaflets/SGS-MIN-WA109-Hard-Rock-Lithium-Processing-EN-11.pdf> last accessed on 28.08.2020

<sup>140</sup> Media, A. (2019). "Lithium hydroxide demand to overtake Carbonate: AABC." 2020, from <https://www.argusmedia.com/en/news/1836977-Lithium-hydroxide-demand-to-overtake-Carbonate-aabc>.

Considering total cost after refining, present day technologies render recovery of Lithium from brine the least expensive alternative.

### Trade and logistics

The price of Lithium is considered low at the present<sup>141</sup> and demand is weak, due to Covid 19 pandemic, reported by Albemarle and Livent in a Roskill report.<sup>142</sup> However, after the expected recovery from the pandemic, Lithium's cost will be on a steep rise as more battery factories resume (full capacity) production around 2022-2023. This will enable more investments – when the shortage becomes a fact. Nonetheless, a big problem for European battery value chain nowadays is that, although there are some deposits for mining in Europe's soil, the refining processes are cheaper in China, leading to mass transportation of ore concentrates into this country, for refining – and increasing this country's attractiveness for manufacturing Li-Ion cells. A big part of Australian Lithium concentrates is also refined in China, where there are both cheap labour and innovative technology available.<sup>143</sup>

### Politics and environment

The biggest three producers of Lithium are Albemarle<sup>144</sup>(extracting from Chile and Nevada, US), Sociedad Quimica y Minera de Chile and FMC (now renamed Livent<sup>145</sup> and extracting from Argentina). China is very strong in the market with companies as Lithium Tiangji, Lithium Ganfeng. The strength comes both directly via own mining (fifth in the world), and via refining companies importing ores and concentrates. Chinese companies are important shareholders in big Australian Lithium producers as well (as in Talisman).<sup>146</sup>

<sup>141</sup> US\$ 7,25 per kg Lithium Carbonate on London Stock Exchange Aug 6th, 2020 <https://www.lme.com/Metals/Minor-metals/Lithium-prices#tabIndex=0>

<sup>142</sup> <https://roskill.com/news/Lithium-albemarle-and-livent-highlight-continued-Lithium-market-weakness-in-q2-2020/> last accessed on 28.08.2020

<sup>143</sup> <https://www.scmp.com/news/china/science/article/3010200/china-cracks-cheap-Lithium-production-electric-car-breakthrough> last accessed on 28.08.2020

<sup>144</sup> <https://www.albemarle.com/businesses/Lithium> last accessed on 28.08.2020

<sup>145</sup> <https://www.prnewswire.com/news-releases/fmc-s-Lithium-business-to-be-named-livent-corporation-888859582.html> last accessed on 28.08.2020

<sup>146</sup> <https://investingnews.com/daily/resource-investing/battery-metals-investing/Lithium-investing/top-Lithium-producers/> last accessed on 28.08.2020

## Development and trends

Some new Lithium mining projects are in Mexico, Australia and the US.<sup>147</sup> There are plans to exploit Lithium from clay as well.<sup>148</sup>

## Recycling

Lithium is considered difficult and expensive to recycle and, at low market prices, it is not worthy to be done and that happens presently. Lithium from old batteries might end up as landfill in Europe while other parts of the batteries, that are more economically advantageous to recycle, would eventually re-join the value chain. It may be necessary to develop special processes for each cell chemistry to achieve viable recycling of Lithium. Northvolt intends to recycle substandard batteries from production directly at site and take the materials back in the process – besides using other recycled Lithium. The company American Manganese claims that their new ReCycLiCo process<sup>149</sup> “makes Lithium last forever”.

## Cobalt

Cobalt is a metal with high melting point but with low electrical and thermal conductivity. It is toxic by skin contact.<sup>150</sup> <sup>151</sup> This metal is mainly used for whitewares and technical applications, such as in the aircraft industry (superalloys), in tools (cemented carbides) and in electronics, as well as in cancer radioactive treatment. It is in high demand for high power and high-density batteries, namely LIBs, for which Cobalt enables chemical and thermal stability (so the cathode will not overheat or catch fire)<sup>152</sup>. The EC import reliance was 32%<sup>153</sup> in 2017 but has since then increased and will continue to do so with the boost of battery production.

<sup>147</sup> <https://www.mining-technology.com/features/top-ten-biggest-Lithium-mines/> last accessed on 28.08.2020

<sup>148</sup> <https://seekingalpha.com/article/4205681-look-Lithium-clay-projects> last accessed on 28.08.2020

<sup>149</sup> <https://americanmanganeseinc.com/> last accessed on 28.08.2020

<sup>150</sup> <https://www.chemicool.com/elements/Cobalt.html> last accessed on 28.08.2020

<sup>151</sup> <https://pubs.usgs.gov/of/2017/1155/ofr20171155.pdf>

<sup>152</sup> Li, M., & Lu, J. (2020). Cobalt in Lithium-ion batteries. *Science*, 367(6481), 979-980. <http://pibmub.com/pdf/979.full.pdf>

<sup>153</sup> <https://op.europa.eu/en/publication-detail/-/publication/08fdab5f-9766-11e7-b92d-01aa75ed71a1> last accessed on 28.08.2020



## Deposits

Cobalt findings are, to a high extent, geographically concentrated in the African Copper Belt and there, within the DRC, the Democratic Republic of Congo (Congo, capital city - Kinshasa) which owns about half of the world's known deposits.<sup>154</sup> Other big deposits are located in Australia, about 17% of all known deposits, with remaining sites shattered over the globe and often exploited as co-product of Copper and Nickel mining.<sup>155</sup>

## Deposits in Europe

In Europe, there are deposits of Cobalt in Finland (with four working mines and a large deposit in Talvivaara, currently unexploited but restarting<sup>156</sup> ) and some other (probably smaller<sup>157</sup>) deposits in an early stage of development or exploration in Poland, Germany, Italy, Cyprus, Slovakia, Austria and Czech Republic.<sup>158</sup> Other unquantified sources of Cobalt are old Copper and Nickel waste heaps that can be re-exploited by bioleaching processes like the one in Kasese, Uganda.

## Production

Cobalt is mined from several ores: Cobalt arsenic-, Nickel Cobalt sulphide-, Copper Cobalt sulphide-, Copper Cobalt oxide- and Nickel Cobalt laterite ores. This is done both in ordinary mines following each country's mining codes and rules, but also under more makeshift conditions. An estimated 35.000 children work in privately owned artisanal Cobalt mines, often without any protection, which indicates another kind of mining.<sup>159</sup> The biggest Cobalt-producing companies often also produce Nickel and Copper. The five largest companies producing Cobalt are Glencore PLC, China Molybdenum, The Fleurette Group, NYSE VALE and

<sup>154</sup> <https://www.statista.com/statistics/264930/global-Cobalt-reserves/> last accessed on 28.08.2020

<sup>155</sup> <https://pubs.usgs.gov/of/2017/1155/ofr20171155.pdf> last accessed on 28.08.2020

<sup>156</sup> <https://im-mining.com/2018/08/22/former-talvivaara-Nickel-mine-rebound-terrafame/> last accessed on 28.08.2020

<sup>157</sup> It is only possible to clearly evaluate the dimensions after exploitation works have started.

<sup>158</sup> Alves Dias P., Blagoeva D., Pavel C., Arvanitidis N., Cobalt: demand-supply balances in the transition to electric mobility, EUR 29381 EN, Publications Office of the European Union, Luxembourg, 2018, ISBN 978-92-79-94311-9, doi:10.2760/97710, JRC112285.

[https://publications.jrc.ec.europa.eu/repository/bitstream/JRC112285/jrc112285\\_Cobalt.pdf](https://publications.jrc.ec.europa.eu/repository/bitstream/JRC112285/jrc112285_Cobalt.pdf)

<sup>159</sup> <https://www.raconteur.net/business-innovation/responsible-business-2019/Cobalt-mining-human-rights> last accessed on 28.08.2020



Gecamines SA. Of these, all but VALE have their major operations or all operations, in the DRC. VALE also operates in Canada and New Caledonia.<sup>160</sup>

## Refining

Cobalt is recovered from these ores by different processes for each concentrate, including roasting, solvent extraction, electrolysis, among others. In the DRC, this is done in many ways that disregard environmental protection and health regulations. Cobalt can also be bioleached in a more environmentally friendly but slower way, as in the KCCL plant in Uganda, using copper mining waste heaps as resource.<sup>161</sup> <sup>162</sup> China is strong in the Cobalt refinery sector, but European projects are on the way. The Belgian metal recycler Umicore, with some Cobalt processing in Belgium, has bought the Kokkola plant in Finland from the Canadian Freeport Cobalt (who will continue to run the operations) and are about to start Cobalt processing and battery precursor production in Nysa, Poland, as well.<sup>163</sup>

## Trade and logistics

The price of Cobalt has soared 180% in two years and development is steep and volatile<sup>164</sup>. The price of Cobalt on London Metal Exchange (presently at \$33 per kilogram) was at a 10-month low in June 2020, due to pandemic-related factors. The supply of Cobalt is generally considered reliable than other metals. Shortages, together with reports of production conditions in the DRC stimulate innovation in cathodes' chemistry to limit the use or remove Cobalt from battery production altogether. A Roskill market report summary expresses hopes that "the Cobalt market is now entering a new phase of consolidation and rejuvenation".<sup>165</sup>

<sup>160</sup> <http://www.centuryCobalt.com/Cobalt> last accessed on 28.08.2020

<sup>161</sup> Brochot, S., Durance, M. V., Villeneuve, J., d'Hugues, P., & Mugabi, M. (2004). Modelling of the bioleaching of sulphide ores: application for the simulation of the bioleaching/gravity section of the Kasese Cobalt Company Ltd process plant. *Minerals Engineering*, 17(2), 253-260.

<sup>162</sup> <https://youtu.be/CCzDlv38qAA> a Youtube documentary from the FP6 Biomine research project, see from 22.30. last accessed on 28.08.2020

<sup>163</sup> <https://www.umicore.com/en/media/press/umicore-to-acquire-Cobalt-refinery-and-cathode-precursor-operations-in-finland/> last accessed on 28.08.2020

<sup>164</sup> <https://www.forbes.com/sites/greatspeculations/2018/02/27/the-worlds-Cobalt-supply-is-in-jeopardy/>

<sup>165</sup> <https://roskill.com/market-report/Cobalt/> last accessed on 28.08.2020

## Politics and environment

Cobalt has been called “blood metal” and “conflict metal” and some production conditions in the DRC are unquestionably highly unsatisfactory. Companies selling Cobalt often guarantee child-free labour under fair conditions, but the Cobalt produced in artisanal mines finds reliable distribution channels anyway. Apple, Google, Dell, Microsoft and Tesla have become involved in a lawsuit against Congolese families and human rights advocates concerning child labour with many casualties and serious injuries when mining Cobalt for the supply chains of US corporations became precarious and fatal.<sup>166</sup> This is something companies buying Cobalt desperately try to avoid.

## Development and trends

The version of Tesla’s Model 3 to be produced in its Gigafactory in China (Shanghai) has no Cobalt in its batteries – using Lithium iron phosphate (LFP) batteries from CATL instead<sup>167</sup> and Tesla’s new dry-electrode battery chemistry<sup>168</sup> (from Maxwell technologies) is expected to contain just a small quantity of Cobalt. In Li-Ion chemistries, the use of Cobalt has been reduced and limited to approximately 3% of a battery’s weight. In existing cell chemistries, it can be substituted (but not totally replaced) by Nickel, which is less expensive and is integrated in stable supply chains.

## Recycling

Cobalt can be recycled to a high degree, but these processes, often involving acids, bring about environmental hurdles. There is much optimism, though; some stakeholders hope that Cobalt will prove itself to be an “infinitely recyclable metal”.<sup>169</sup>

<sup>166</sup> <https://www.theguardian.com/global-development/2019/dec/16/apple-and-google-named-in-us-lawsuit-over-congolese-child-Cobalt-mining-deaths> last accessed on 28.08.2020

<sup>167</sup> <https://www.futurecar.com/3972/Tesla-Wins-Approval-to-Use-Cobalt-Free-Batteries-in-its-China-made-Model-3> last accessed on 28.08.2020

<sup>168</sup> <https://electrek.co/2020/05/05/tesla-million-mile-battery-less-Cobalt-higher-energy-density/> last accessed on 28.08.2020

<sup>169</sup> <https://globemetal.com/5-key-benefits-of-recycling-Cobalt/> last accessed on 28.08.2020

## Nickel

Nickel has considerable strengths, does not corrode easily and conducts heat and electricity<sup>170</sup>. It has been used in batteries for a long time, as in NiCd and NiMH batteries, and now in Li-Ion batteries. It helps delivering higher energy density and lowering the cost as it can be successfully used as a partial replacement for Cobalt.<sup>171</sup> The EU import reliance for Nickel 2017 was listed at 59%<sup>172</sup>, higher than for Cobalt.

## Deposits

Some of the global Nickel deposits are believed to have their origin in meteorites, as in Canada (11% of world reserves). The biggest deposits are in Australia (30%), followed by New Caledonia (15%), Canada (11%) and Russia (7%). The world's core is believed to have a high Nickel content, which is, of course, unavailable.

## Deposits in Europe

Finland, Greece, France (in New Caledonia, a French overseas territory) and Spain prospect for Nickel,<sup>173</sup> and exploration at scale is ongoing in Sweden. Europe's biggest deposit, in Talvivaara, Northern Finland, is a bioheap-leaching plant using natural bacteria. It is now run by Finnish Terafame, as the Talvivaara-Sotkamo corporation went bankrupt in 2013 after an environmental disaster, a bioleaching fluid leakage into a nearby lake system.<sup>174 175</sup>

## Production

Nickel is mined from lateritic ores as garnierite (in Australia and New Caledonia), and Ni-sulfidic ores as pentlandite (in Canada, Russia).<sup>176</sup> The biggest producers during 2018 were VALE (Headquarter in Brazil), Norilsk Nickel (Russia), Jinchuan Group Ltd (China-based),

<sup>170</sup> Habashi F. (2013) Nickel, Physical and Chemical Properties. In: Kretsinger R.H., Uversky V.N., Permyakov E.A. (eds) Encyclopedia of Metalloproteins. Springer, New York, NY. [https://doi.org/10.1007/978-1-4614-1533-6\\_338](https://doi.org/10.1007/978-1-4614-1533-6_338)

<sup>171</sup> <https://www.Nickelinstitute.org/about-Nickel/Nickel-in-batteries> last accessed on 28.08.2020

<sup>172</sup> <https://op.europa.eu/en/publication-detail/-/publication/08fdab5f-9766-11e7-b92d-01aa75ed71a1> last accessed on 28.08.2020

<sup>173</sup> <https://www.oma.on.ca/en/multimedialibrary/resources/NickelintheEuropeanUnionPDF.pdf> last accessed on 28.08.2020

<sup>174</sup> <https://www.mining.com/finland-inks-266-million-deal-revitalize-europes-largest-Nickel-mine/> last accessed on 28.08.2020

<sup>175</sup> [http://www.nuclear-heritage.net/index.php/Talvivaara\\_mine:\\_environmental\\_disaster\\_in\\_Finland](http://www.nuclear-heritage.net/index.php/Talvivaara_mine:_environmental_disaster_in_Finland) last accessed on 28.08.2020

<sup>176</sup> <https://mineralseducationcoalition.org/elements/Nickel/> last accessed on 28.08.2020

Glencore, BHP Billiton, Sumitomo Metal Mining (Japan), Sherrit International Corp (Canada), Framet (France), Anglo American and Minara Resources.<sup>177</sup>

### Refining

Lateric ores are processed in electric reduction furnaces (producing Nickel oxide), followed by hydrometallurgical treatment, often with ammonia. Sulfidic ores have a higher energy content and flash smelting from ore concentrates is common, producing Nickel matte (the principal metal extracted before a final pyrometallurgical reduction process).<sup>178</sup> Then different metallurgical processes follow to produce almost pure Nickel (with the Mond process) or to produce Nickel salts.<sup>179</sup>

### Trade and logistics

In August of 2020, Nickel had a spot price on London Metal Exchange of \$14,15 per kilogram. Roskill latest market report on Nickel forecasts that the use of this metal in batteries will grow from 3–4% of the total Nickel demand, to about 15–20% of the demand, which will affect prices.<sup>180</sup>

### Politics

The trade has been irregular due to US-China trade wars, but the price is on the way up due to increased demand from China. According to Amnesty International, Nickel mines in some developing countries, such as Guatemala and the Philippines, have very unsatisfactory working conditions yet states and corporations try to capitalise on the Nickel demand without scruples. Nickel is sometimes discussed as a ‘conflict’ metal. However, it is less critical than Cobalt because most of the mining of this metal is being done in appropriate working conditions.

### Development and trends

<sup>177</sup> <https://www.thebalance.com/the-10-biggest-Nickel-producers-2339731> last accessed on 28.08.2020

<sup>178</sup> [https://www.ifc.org/wps/wcm/connect/5cb00df9-e2c1-4b92-a585-6bef08d8a5de/Nickel\\_PPAH.pdf?MOD=AJPERES&CVID=iqeDjcl](https://www.ifc.org/wps/wcm/connect/5cb00df9-e2c1-4b92-a585-6bef08d8a5de/Nickel_PPAH.pdf?MOD=AJPERES&CVID=iqeDjcl) last accessed on 28.08.2020

<sup>179</sup> <http://metallpedia.asianmetal.com/metal/Nickel/extraction.shtml> last accessed on 28.08.2020

<sup>180</sup> <https://roskill.com/market-report/Nickel/> last accessed on 28.08.2020

According to the Nickel Institute, Nickel is the 5<sup>th</sup> most common element on earth, with about 600 million-ton deposits available for land and sea mining. So far, about 60 million tons were depleted. However, production capacity will be critical. EV production is rising the demand for Nickel considerably.

## Recycling

Nickel is recycled to a high extent; presently about 68% is recycled.<sup>181</sup>

## Manganese

Manganese is a metal, commonly found as oxide and hydroxide in soils.<sup>182</sup> In Li-Ion batteries, it can improve the cathode in different ways and can, at least to some extent, be a very cheap alternative to Cobalt and Nickel.<sup>183</sup> The EU import reliance in 2017 was listed at 89%.<sup>184</sup>

## Deposits

South Africa holds the biggest known reserves of manganese, followed by Ukraine, Brazil, Australia, and India.<sup>185</sup>

## Deposits in Europe

In the Czech Republic, the Chvaletice Manganese Project, developed by European Manganese Inc, is aiming at taking advantage from tailing piles originated from earlier mining, which maintain high manganese content.<sup>186</sup>

<sup>181</sup> <https://www.recyclingtoday.com/article/driving-Nickel-scrap-recovery/> last accessed on 28.08.2020

<sup>182</sup> <https://www.lenntech.com/periodic/elements/mn.htm#ixzz6Uz2fZR6F> last accessed on 28.08.2020

<sup>183</sup> <https://www.chemistryworld.com/news/manganese-makeover-for-Lithium-ion-batteries/3008886.article> last accessed on 28.08.2020

<sup>184</sup> <https://op.europa.eu/en/publication-detail/-/publication/08fdab5f-9766-11e7-b92d-01aa75ed71a1> last accessed on 28.08.2020

<sup>185</sup> <https://investingnews.com/daily/resource-investing/battery-metals-investing/manganese-investing/manganese-reserves/> last accessed on 28.08.2020

<sup>186</sup> <https://www.mn25.ca/chvaletice-project> last accessed on 28.08.2020

**Production.** Manganese mining is often an open pit soil operation with heavy earth machines. In Ukraine and in South Africa, there are also underground mines, often explored through the room-and-pillar method.<sup>187</sup>

### Refining

From a concentrate, the manganese in a pure form is retrieved by hydrometallurgy and electrolysis. Ferro- and silicomanganese are produced by smelting.<sup>188</sup>

### Trade and logistics

Manganese is sold and delivered in many forms, from ores and concentrates to oxides or pure metal. The price is considered low and stable.

Regarding the politics and the environment, presently Manganese is not a ‘conflict’ metal. Its mining and refining processes can have environmental consequences and too much manganese exposure has its risks.

### Recycling

Manganese is recycled from scrap and can also be bioleached.<sup>189</sup>

### Graphite

Carbon in the structural form of graphite is a mineral used in anodes in Li-Ion batteries, in its both natural and synthetic forms. It is safe and reliable as active material of anode, with sufficient energy density for high-density and mobile applications.<sup>190</sup> The EU import reliance for natural graphite was listed in 2017 as 99%.<sup>191</sup>

<sup>187</sup> <https://mineralseducationcoalition.org/minerals-database/manganese/> last accessed on 28.08.2020

<sup>188</sup> <https://www.britannica.com/technology/manganese-processing> last accessed on 28.08.2020

<sup>189</sup> Ghosh, S., Mohanty, S., Akcil, A., Sukla, L. B., & Das, A. P. (2016). A greener approach for resource recycling: Manganese bioleaching. *Chemosphere*, 154, 628-639.

<sup>190</sup> Lampe-Onnerud, C., Shi, J., Onnerud, P., Chamberlain, R., & Barnett, B. (2001). Benchmark study on high performing Carbon anode materials. *Journal of power sources*, 97, 133-136.

<sup>191</sup> <https://op.europa.eu/en/publication-detail/-/publication/08fdab5f-9766-11e7-b92d-01aa75ed71a1> last accessed on 28.08.2020

## Deposits

Turkey has the world's largest natural graphite reserves, followed by China, Brazil, Mozambique and Tanzania.<sup>192</sup> Turkey is increasing production, but owns, just as China does, a lot of the less attractive amorphous type of natural graphite.<sup>193</sup> Crystalline, vein and flake graphite has a higher price, but high-flake graphite can be too expensive for some applications. Battery producers seem to have different preferences.

## Deposits in Europe

Norway, Czech Republic, and Austria have some natural graphite reserves and exploration reported to be of high quality.<sup>194</sup>

## Production

Natural graphite is mostly mined in quarries where graphite in flakes, veins and crystal formations are found and less underground where lower quality amorphous lump graphite is common. China is, by far, the largest graphite producer in the world, with a reported production of 630 000 tons, in 2018, while the runner up, Brazil, produced 95 000 tons and Canada 40 000 tons.<sup>195</sup> The biggest companies are China Carbon Graphite Group in China and Syrah Resources in Brazil.

## Refining

Graphite flakes are rounded into spherical units and then go through a thermal or acid purification. China producers often use the acid method, which is considered less environmentally friendly.<sup>196</sup>

<sup>192</sup> <https://www.statista.com/statistics/267367/reserves-of-graphite-by-country/> last accessed on 28.08.2020

<sup>193</sup> <http://www.indmin.com/events/download.ashx/document/speaker/6517/a0ID000000X0jN5MAJ/Presentati on> last accessed on 28.08.2020

<sup>194</sup> <http://www.indmin.com/downloads/IM%20MAPS/GraphiteWallchart2018980x650PRINThighres.pdf> last accessed on 28.08.2020

<sup>195</sup> <https://investingnews.com/daily/resource-investing/battery-metals-investing/graphite-investing/top-graphite-producing-countries-china-india-brazil-canada/> last accessed on 28.08.2020

<sup>196</sup> <https://www.batteryminerals.com/our-business/spherical-graphite-process/> last accessed on 28.08.2020

## Politics and environment

China is the biggest producing country and dominates the market. Reports suggest the country is also interested in increasing imports from Africa and other locations and stockpile graphite, probably to secure supply for battery cell production and as a preparation for higher price levels.<sup>197</sup>

## Recycling

Presently, graphite is not significantly recycled<sup>198</sup>, but reliable methods seem to be under development.<sup>199 200</sup>

## Silicon

Silicon is a grey semi-conductive metalloid. Silicon is seldom found in the elementary form in nature but is the second most abundant element in the earth's crust (behind oxygen). In batteries, it is an alternative to graphite as active material in the anode.<sup>201</sup> The EU import reliance is 64%.<sup>202</sup>

## Deposits

Silicon is a widespread globally, but elementary silicon is very rare. It is preferably mined from very pure quartz. Additionally, silicon exists in minerals such as silica, feldspar and mica – major components of quartz and sandstone rocks.

<sup>197</sup> <https://stockhead.com.au/resources/chinas-graphite-imports-are-now-up-2000-over-the-last-18-months/> last accessed on 28.08.2020

<sup>198</sup> <https://www.semcoCarbon.com/blog/3-reasons-graphite-recycling-is-better-than-disposal> last accessed on 28.08.2020

<sup>199</sup> Moradi, B., & Botte, G. G. (2016). Recycling of graphite anodes for the next generation of Lithium ion batteries. *Journal of Applied Electrochemistry*, 46(2), 123-148.

<sup>200</sup> Rothermel, S., Evertz, M., Kasnatscheew, J., Qi, X., Grützke, M., Winter, M., & Nowak, S. (2016). Graphite recycling from spent Lithium-ion batteries. *ChemSusChem*, 9(24), 3473-3484.

<sup>201</sup> Ashuri, M., He, Q., & Shaw, L. L. (2016). Silicon as a potential anode material for Li-ion batteries: where size, geometry and structure matter. *Nanoscale*, 8(1), 74-103.

<sup>202</sup> <https://op.europa.eu/en/publication-detail/-/publication/08fdab5f-9766-11e7-b92d-01aa75ed71a1> last accessed on 28.08.2020



## Production

China stands presently for about 65% of global Silicon production, followed by Russia, Brazil and USA. In Europe, the Euroalliances Silicon-Metal Committee whose member companies are from Bosnia Hercegovina (B.S.I. d.o.o), Norway (Elkem), Spain (Ferroatlantica), Norway (Fesil), France (Ferropem), Germany (RW Silicium) and Northern Macedonia (Jugohrom),<sup>203</sup> declares a total production of about 330 000 tonnes/year. In Iceland, the PCC Bakki-Silicon company claims to have the world's most environmentally friendly silicon production.<sup>204</sup>

## Refining

After mining and sorting, reduction of quartz with Carbon takes place at high temperatures in a reduction furnace. The metal is further processed by oxidative refining, casting, crystallization and crushing. The biggest five companies selling refined products are Dow Corning, Wacker, Shin Etsu and Blue Star.<sup>205</sup>

<sup>203</sup> [http://www.euroalliances.com/web/silicon\\_metal%20committee/1011306087/list1187970111/f1.html](http://www.euroalliances.com/web/silicon_metal%20committee/1011306087/list1187970111/f1.html) last accessed on 28.08.2020

<sup>204</sup> <https://www.pcc.is/> last accessed on 28.08.2020

<sup>205</sup> <https://www.metalbulletin.com/events/download.ashx/document/speaker/7230/a0ID000000X0jzwMAB/Présentation> last accessed on 28.08.2020

## Politics and environment

According to sources, China has a history of increasing production and dumping prices of Silicon, making production in other countries more difficult.<sup>206</sup>

## Recycling

Silicon is usually not recycled and no technologies for recycling Silicon used in batteries have been successfully implemented, but there are methods for recycling silicon wafers from scrapped solar panels.<sup>207</sup>

### 3.1.4 Job Roles and Skills

Very few relevant job advertisements were found in the desk research in comparison with other value chain steps. This must be compensated by workshops and surveys in the future. Listed job roles are not specific to mobile or stationary application but to the whole battery sector.

For materials preparation, handling, and management, advertisements concerning **Supply Chain Managers, Manufacturing Engineers, Production Engineers and Battery Materials Engineers, High Density Anodes or Cathodes Material Engineers, Material Planners and Handlers** were found. **Operator** and **Machine Operator** jobs are associated with this value chain step. They operate machines and do all the procedures (material combining, slurry mixing, coating, etc.) to produce materials needed for next value chain steps.

These processes are accompanied and supported by **Calibration Technicians, Controls Engineers, Equipment Engineers, Maintenance Engineers and Metrologists** who calibrate the equipment and assure that all the machines are performing as expected. **Shift Leaders** are also present. **Quality and Compliance Engineers** verify and manage the quality of products and **Process Engineers** seek continuous process improvement.

**Safety Specialists and Managers** as well as **ISO Internal Auditors** assure the safety standards

<sup>206</sup> <https://www.crmalliance.eu/silicon-metal> last accessed on 28.08.2020

<sup>207</sup> <https://www.chemistryworld.com/news/a-bright-future-for-silicon-solar-cell-recycling/9160.article> last accessed on 28.08.2020

and requirements are met.

### Skills and knowledge required in relevant advertisements:

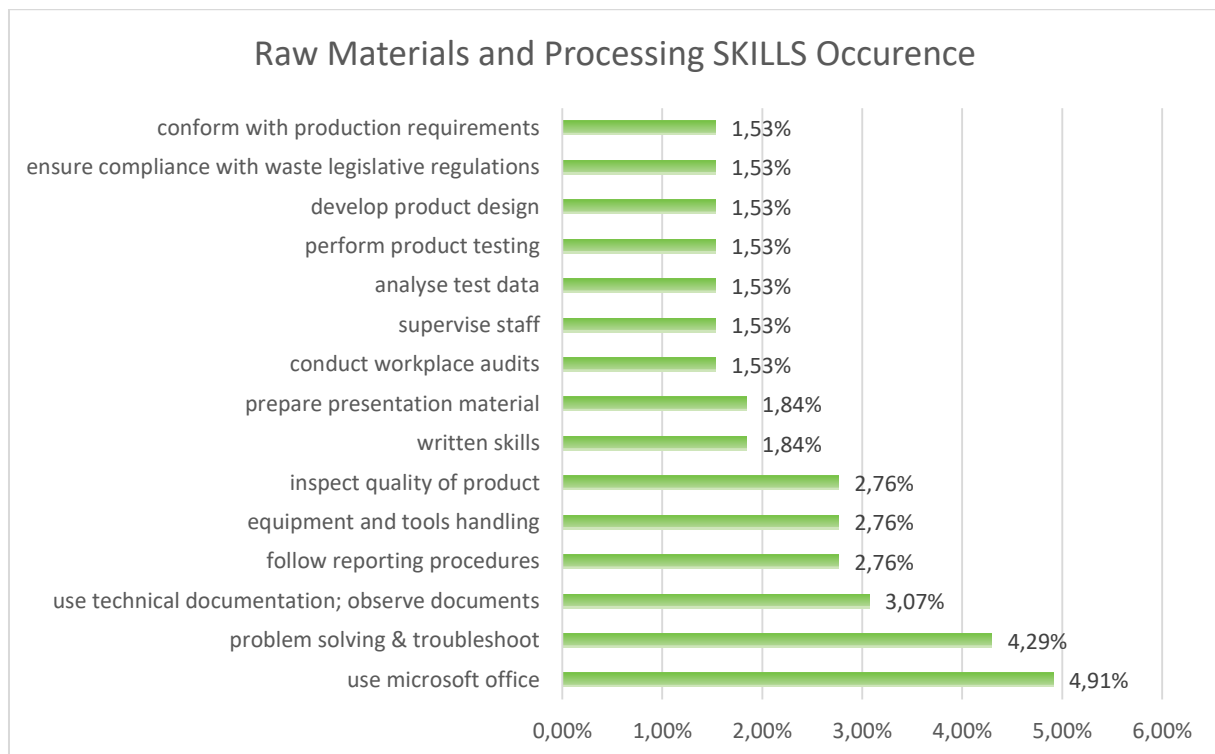

Figure 40 Raw Materials and Processing SKILLS Occurrence

### Skills

Skills occurrences for raw materials and processing, which are based on the researched job advertisements, are shown in **Figure 40**. Usage of Microsoft Office was the most frequent skill in the researched offers as well as problem solving and troubleshooting, document management and observation and follow up of reporting procedures. Inspection of product quality and equipment and tools handling are also being requested.

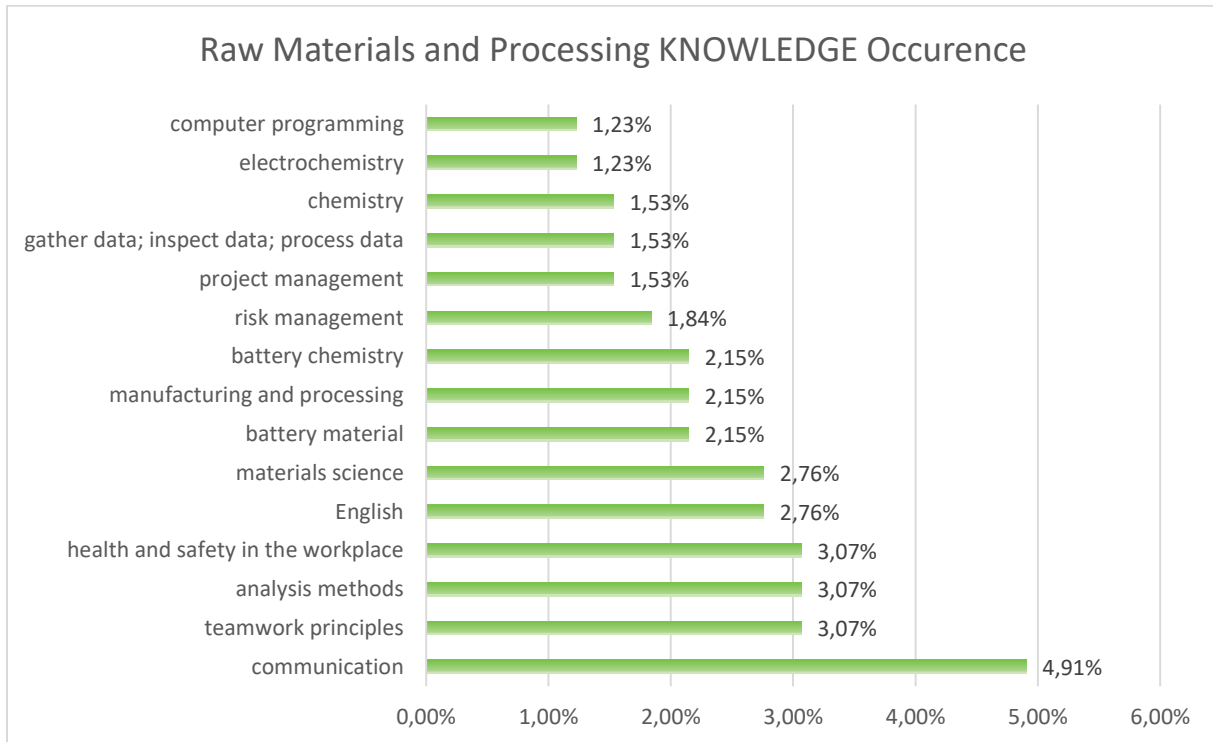

Figure 41 Raw Materials and Processing KNOWLEDGE Occurrence

## Knowledge

Knowledge occurrences for raw materials and processing are shown in **Figure 41**. Communication and teamwork principles are on the top positions as well as health and safety in the workplace and analysis methods. Materials science and battery material are required in this stage of the production as well as battery chemistry associated with general chemistry and electrochemistry knowledge.

## 3.2 COMPONENTS AND CELL MANUFACTURING

### 3.2.1 Stakeholders

Due to the high pressure to reduce greenhouse gases (GhG), fossil fuel combustion technology is being abandoned. EVs and battery storage for storing green energy are beginning to expand. Consequently, big players in the field of batteries are building their Gigafactories in Europe. Most of these producers come from Asia, which means that Europe is dependent on their production. Most of these projects are sponsored by the EIB.<sup>208, 209</sup>

<sup>208</sup><https://www.eib.org/en/press/all/2020-088-electric-vehicle-battery-production-in-europe-gets-boost-thanks-to-eib-loan-of-eur480-million-to-lg-chem-wroclaw-energy-in-poland> accessed 28.08.2020

<sup>209</sup><https://www.eib.org/en/press/all/2020-208-european-backing-for-northvolt-s-battery-gigafactory-in-sweden> accessed 28.08.2020

Most European manufacturers tend to focus on specialized production on a smaller scale. Because they cannot compete on price or production volume.<sup>210</sup>

### LG Chem

LG Chem is planning to open their Gigafactory in Wroclaw by 2022. It will be one of the biggest factories in Europe with production 70 GWh per year. The company wants to employ about 6000 full-time workers by the end of 2022.<sup>211, 212</sup>

### CATL

CATL is building the first European factory in Germany. The factory should start producing batteries in 2022 and the production capacity will be 14 GWh. It is planned to expand production up to 24 GWh in the future. The factory will offer about 2000 jobs. The factory produces batteries for BMW, VW, Daimler, and Volvo.<sup>213</sup>

### Northvolt

Northvolt owns a Gigafactory in Skellefteå Sweden, which will be in operation from the 2022. The aim of the factory is to produce 32 GWh per year by 2024 and increase the capacity to 40 GWh in the future. The factory is to provide about 2,500 jobs. Northvolt plans to build more LIB battery factories in the future. The condition for the location of each factory is the possibility of power supply by renewable energy sources. The factory produces batteries for BMW and VW.<sup>214, 215</sup>

### AMTE

AMTE in partnership with Britishvolt, plans to build a Gigafactory in Wales. The factory should

<sup>210</sup><https://www.reuters.com/article/us-climate-change-eu-batteries-insight/european-battery-makers-power-up-for-a-green-recovery-idUSKCN2590K3> accessed 28.08.2020

<sup>211</sup><https://www.ebrd.com/news/2019/lg-chem-battery-gigafactory-in-poland-to-be-powered-by-ebrd.html> accessed 28.08.2020

<sup>212</sup><https://www.electrive.com/2020/04/24/lg-chem-secures-e-half-a-billion-for-polish-factory-expansion/> accessed 28.08.2020

<sup>213</sup><https://www.electrive.com/2019/10/19/catl-starts-building-battery-plant-in-germany/> accessed 28.08.2020

<sup>214</sup><https://www.electrive.com/2019/02/26/northvolt-to-build-32-gwh-battery-plant-in-sweden/> accessed 28.08.2020

<sup>215</sup><https://northvolt.com/production> accessed 28.08.2020

be operational by the end of 2023. Total production should be between 30 and 35 GWh. The factory should employ about 3,500 employees. At the same time, another 10,000 to 15,000 jobs should be created by the suppliers.<sup>216</sup>

### **SAFT**

SAFT is building its first Gigafactory in the Hauts-de-France region and its second in Kaiserslautern, Germany. The French factory should be in operation in 2023 with a production of 8 GWh and an expansion to 24 GWh. The German factory will open in 2024 with the same production as the French factory. The overall goal is to reach 48 GWh in 2030. The main battery production will be for PSA.

### **FREYR**

The Norwegian company FREYR is starting to build a fast track facility for LIB production in Mo Industrial Park in Northern Norway (Mo-i-Rana) in autumn of 2020 to produce 2GWh energy storage annually. Partners are the Norwegian Technical University (NTNU) and SINTEF, a large Norwegian research Institute. EIT Innoenergy supports the project. The pilot plant will be followed by a scaled-up facility for 32GWh energy storage per annum by 2025, also in Northern Norway.<sup>217</sup>

### **Tesla**

Tesla is building its newest Gigafactory near Berlin. The Gigafactory will contain a giant line to produce EVs (first will be Model Y), but also a large line for the production of new Tesla batteries. Giga Berlin should be open in July 2021.<sup>218</sup>

### **VW**

The VW Group plans to produce more than 50 EV models, so they want to be partially independent of battery suppliers. They want to open the factory in Salzgitter at the turn of

<sup>216</sup> <https://www.electrive.com/2020/06/15/britishvolt-amte-planning-uk-battery-plant/> accessed 28.08.2020

<sup>217</sup> <https://news.cision.com/freyr/r/freyr-advances-the-development-of-its-initial-site-for-norway---s-first-battery-cell-facility,c3183404> (last accessed on 30.082020)

<sup>218</sup> <https://www.teslarati.com/tesla-gigafactory-berlin-2m-vehicles-per-year-media/> accessed 28.08.2020

2023/2024. Their target is production 16 GWh and then expand in the next years up to 24 GWh. The factory is being built in cooperation with Northvolt.<sup>219</sup>

### SK innovation

SK innovation is building two factories in Hungary. The first should be in operation this year (2020) and should produce 7,5 GWh of batteries. The second will be completed in 2022 and will produce 10 GWh. The factory produces batteries for Hyundai, Daimler, and VW.<sup>220</sup>

### Verkor

The French company Verkor plans to open its gigafactory in France. Their goal is to produce 16 GWh and then expand to 50 GWh in line with market growth. The factory will directly provide more than 2,000 jobs and thousands more in the supply chain.<sup>221</sup>

### Samsung SDI

Samsung built the first battery factory in 2018. It is located near Budapest in Hungary. Production is about 2,5 GWh. They are building the second Hungarian Gigafactory. The factory will be in operation in 2021 and will produce 7,5 GWh. The factory produces batteries for BMW, VW, and Volvo trucks.<sup>222</sup>

### InoBat

Slovak startup, which has the support of CEZ Group, Wildcat Discovery Technology and etc., built a factory in Voderady, Slovakia. Production should start in 2021 with a volume of 100 MWh per year. The company deals with specialized batteries according to the needs of individual customers. They also plan to build a factory with a production of 10 GWh. The factory should open in 2024.<sup>223</sup>

<sup>219</sup><https://www.electrive.com/2020/05/09/volkswagen-builds-battery-factory-in-salzgitter/> accessed 28.08.2020

<sup>220</sup><https://insideevs.com/news/392140/sk-innovation-new-battery-plants-us-hungary/> accessed 28.08.2020

<sup>221</sup><http://verkor.com/#partners> accessed 28.08.2020

<sup>222</sup><https://www.automotive-iq.com/electrics-electronics/articles/top-five-ev-battery-factories-in-europe> accessed 28.08.2020

<sup>223</sup><https://tech.eu/brief/inobat-funding/> accessed 28.08.2020

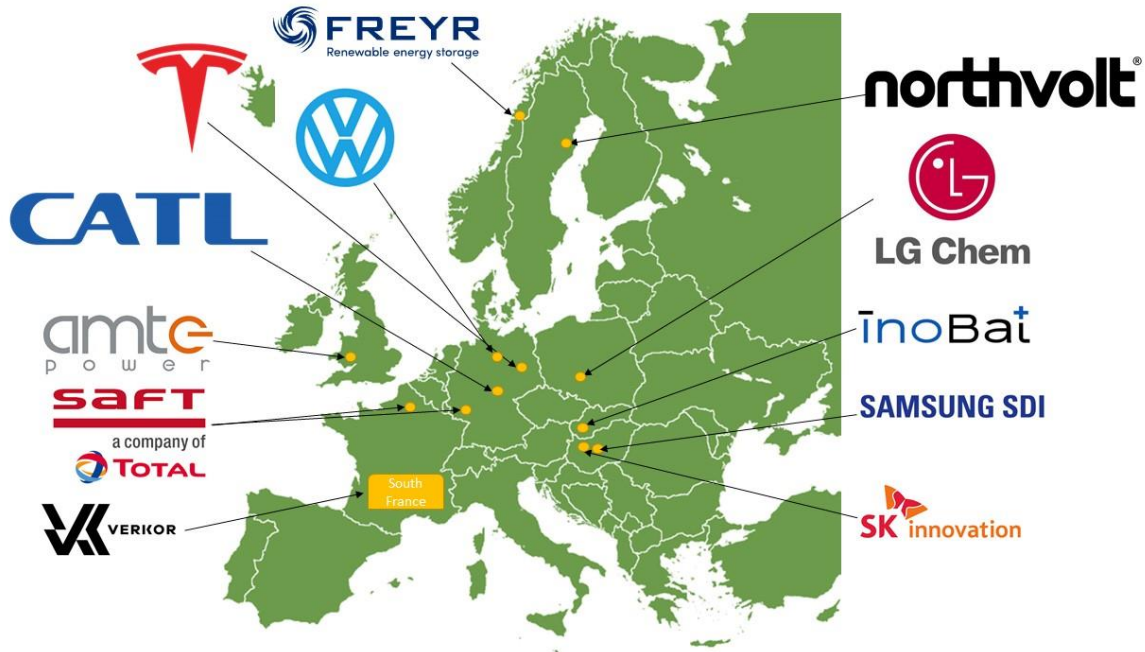

Figure 42: Location of stakeholders' factories

### 3.2.2 Cell Components

#### Drivers of Change for cathode and anode components

The different technologies that effectively allow for the full replacement of Cobalt without loss of performance are still to be adopted, and batteries using Lithium Cobalt oxide (NMC, NCA) dominate the EV battery industry with an increasing market share of nearly 96% in 2019, according to Figure 43. The same could be stated about LIB applications in Grid Storage Technologies (GSTs).

It is noteworthy that since the cathode typically limits LIBs' performance as it possesses a lower capacity than the graphitic anode and is the most expensive material of a LIB, it has been the target of intense research; the cathodes' enhancement the overall battery performance.



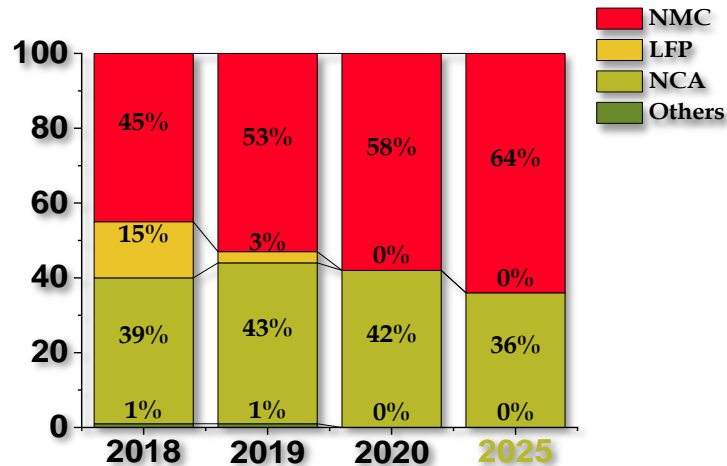

Figure 43 Adoption rate per Chemistry in EV battery Market.  
Adapted from the source: 224, 225

In recent years, scientific and technological progress in batteries has been largely motivated by the automotive industry and, specifically, by small vehicles for urban transportation. Nevertheless, electric mobility is also associated with recent trends of aerial and maritime applications as well as e-Bikes, electric motorcycles, and others.

According to the European Commission<sup>226</sup>, **shipping** accounts for 2 - 3% of global greenhouse gas (GHG) emissions, with a forecasted increase of 50 – 250% by 2050<sup>227</sup>. However, maritime applications have a market share of less than 1% of the total LIBs market, while Li-based batteries are the most widely used battery type for maritime applications<sup>228</sup>. The difficulty in implementing electric solutions on ships is mainly related to their higher power density and cycle and calendar life demands, as well as safety requirements. Nevertheless, the number of ships with batteries installed, or on order, more than doubled from 2018 (150 ships) to 2020 (314), which constitutes a major leap on the market, indicating that LIBs are reaching an interesting level of maturity.<sup>228</sup>

Airbus, Boeing, and NASA have targeted **aircraft** electrification as a crucial research and

<sup>224</sup> Jurgens, J., *This is why NCM is the preferable cathode material for li-ion batteries*. 2019.

<sup>225</sup> KrannichSolarGermany (2020). *LG Chem ESS cell*. Available at: [https://www.youtube.com/watch?v=CUORGpNwYYA&feature=emb\\_title](https://www.youtube.com/watch?v=CUORGpNwYYA&feature=emb_title) (accessed: 23 July 2020).

<sup>226</sup> Commission, E. *Commission publishes information on CO2 emissions from maritime transport*. 2019 [cited 2020; Available from: [https://ec.europa.eu/clima/news/commission-publishes-information-co2-emissions-maritime-transport\\_en](https://ec.europa.eu/clima/news/commission-publishes-information-co2-emissions-maritime-transport_en).

<sup>227</sup> Commission, E. *Reducing emissions from the shipping sector*. 2020 [cited 2020; Available from: [https://ec.europa.eu/clima/policies/transport/shipping\\_en](https://ec.europa.eu/clima/policies/transport/shipping_en).

<sup>228</sup> Helgesen, S.H., Sondre and A. Aarseth Langli, *Electrical Energy Storage for Ships*. 2020: Norway.

development topic to address. One thing all current aircraft-level projects have in common, as is the case of maritime and automobile applications, is the choice of Li-ion batteries for energy storage due to their unmatched energy density when compared with other batteries in the market.

### Overview and comparison with other batteries technologies

**Electric vehicles (EVs)** are becoming serious alternatives to internal combustion engine (ICE) vehicles. According to the International Energy Agency, electric vehicles account for 2.6% of global car sales in 2019, with an estimated increase to 3% in 2020<sup>229</sup>. LIBs represent a significant market share of the batteries for EV vehicles. The main reason for this is Li's high electroactivity, since this type of high-power vehicles have substantially high voltage requirements in the range of 400 – 800 V. Therefore, LIBs allow for less batteries to be associated in series to match the latter voltages, consequently reducing the internal resistance of the batteries leading to lower heat losses, and smaller size components, thus reducing weight and cost.

As for **Hybrid electric vehicles (HEV)**, more options are available, since Ni-MH batteries can power this type of vehicle, due to their reduced specific energy and power requirements when compared to EVs. With even less energy, power, and cycle life requirements, ICE vehicles still have **Pb-acid batteries** installed owing to this technology's low cost, safety, and facilitated substitution<sup>230</sup> given their recycling rate of practically 100%.

**Nickel Metal Hydride (Ni-MH) batteries** main advantages, considering their applicability in mobile applications such as HEVs, are:

- (1) the high energy density (50 – 75 Wh/kg) and power, compared to Ni-Cd batteries and Pb-acid;
- (2) relatively long cycle life (2000 – 2500 cycles);
- (3) wide-operation temperature range (-30 to 70 °C);

<sup>229</sup> Wheeler, E. *Electric vehicles to set new market share record in 2020*. Energy 2020 [cited 2020; Available from: <https://www.spglobal.com/marketintelligence/en/news-insights/latest-news-headlines/electric-vehicles-to-set-new-market-share-record-in-2020-59050766>].

<sup>230</sup> Energy, U.S.D.o. *Batteries for Hybrid and plug-In Electric Vehicles*. Alternative Fuels Data Center 2020 [cited 2020; Available from: [https://afdc.energy.gov/vehicles/electric\\_batteries.html](https://afdc.energy.gov/vehicles/electric_batteries.html)].

- (4) good charging properties, namely, good charge retention and rapid recharge capability<sup>232</sup>;
- (5) low maintenance requirements<sup>231,232</sup>; these batteries do not suffer from being fully discharged.

**The main disadvantages are:**

- (1) relatively low energy density when compared with LIBs;
- (2) increased cost, in comparison with Pb-acid batteries<sup>231,232</sup>.

The overall comparison between advantages and disadvantages places this battery type's performance between those of Pb-acid and Li-ion. In the past, its cost-effectiveness in respect of LIB technology led to its usage in **mild hybrid and full-hybrid** vehicles. However, the continuous improvement of LIBs has attenuated cost differences between both technologies, making LIBs the most attractive choice for HEVs,<sup>233,234</sup> having surpassed Ni-MH batteries' market share in this type of vehicles in the second half of the 2010s decade.

**The positive electrode (cathode)**

From what was previously mentioned, it can be stated that LIBs dominate the global market. The cathode exhibits some of the most determinant characteristics of batteries used in commercially available electric automobiles. Furthermore, **all passenger vehicles** sold in the European market use batteries with cathodes containing **Cobalt**. Tesla and Panasonic have developed battery cells with Lithium-**Nickel-Cobalt-Aluminium oxide (NCA)** as the cathode and all models sold by Tesla on the European market have batteries based on this system. On the other hand, the vast majority of car manufacturers incorporate batteries with **Nickel-Manganese-Cobalt** oxide as the cathode type, with a clear tendency for the NMC622 ratio ( $\text{LiNi}_{0.6}\text{Mn}_{0.2}\text{Co}_{0.2}\text{O}_2$ ) which reduces the Cobalt content. LG Chem, a world leader on the

<sup>231</sup> Abdin, Z. and K.R. Khalilpour, *Chapter 4 - Single and Polystorage Technologies for Renewable-Based Hybrid Energy Systems*, in *Polygeneration with Polystorage for Chemical and Energy Hubs*, K.R. Khalilpour, Editor. 2019, Academic Press. p. 77-131.

<sup>232</sup> Fan, X., et al., *Battery Technologies for Grid-Level Large-Scale Electrical Energy Storage*. Transactions of Tianjin University, 2020. **26**(2): p. 92-103.

<sup>233</sup> Oagana, A. *Hybrids, Plug-Ins and Electric Cars: Which Batteries Are Best?* 2016 [cited 2020; Available from: <https://www.autoevolution.com/news/hybrids-plug-ins-and-electric-cars-what-batteries-are-best-104634.html>].

<sup>234</sup> Halvorson, B. *Lithium-ion vs. nickel-metal hydride: Toyota still likes both for its hybrids*. 2018 [cited 2020; Available from: [https://www.greencarreports.com/news/1120320\\_lithium-ion-vs-nickel-metal-hydride-toyota-still-likes-both-for-its-hybrids](https://www.greencarreports.com/news/1120320_lithium-ion-vs-nickel-metal-hydride-toyota-still-likes-both-for-its-hybrids)].

number of NMC batteries sold<sup>235</sup>, shows a clear strategy for reducing cobalt content that consists of developing new cathodes with more favourable ratios (reducing the Cobalt content while maintaining or enhancing the performance). The company is focusing on developing NMC811 ( $\text{LiNi}_{0.8}\text{Mn}_{0.1}\text{Co}_{0.1}\text{O}_2$ ) and NMC712 ( $\text{LiNi}_{0.7}\text{Mn}_{0.1}\text{Co}_{0.2}\text{O}_2$ ) and NCA chemistries for the next generation of electric vehicles<sup>236</sup>.

**Lithium-Iron-Phosphate (LFP)** batteries exhibit several advantages that enable their application despite their low energy density, namely, mobile motorhomes<sup>237</sup> and vehicles with low range and performance requirements<sup>238</sup>, such as garbage trucks and electric road sweepers. These cells provide high cycle life and reduced risk of thermal runaway,<sup>237</sup> have no toxic components, low internal resistance, and high-load handling capability<sup>239</sup>. Chinese company CATL is the main responsible for developing this type of cathode, supplying several car manufacturers from its native country. In 2015, LFP batteries were the most popular for plug-in hybrid electric vehicles (PHEVs) and EVs<sup>117</sup>, but over the last five years, NMC has surpassed this type of cathode, both in market share and research interest.

In **Table 1**, LIBs' cathode types are compared. LFP exhibits the highest temperature above which thermal runaway occurs, as well as the highest number of cycles withstand before degradation. However, plateau voltage (optimum operational voltage) is significantly lower for this type of cathode, the main reason for NMC's recent increased interest. The latter presents the highest cycle life after the LFP's alternative, besides displaying good experimental capacity.

<sup>235</sup> Kane, M., *LG Chem Is Now The Biggest xEV Battery Maker By Capacity*. 2020.

<sup>236</sup> City, S., *THE STATE OF EV BATTERIES: LG CHEM, SK INNOVATION, & TESLA-PANASONIC IMPROVEMENTS*. 2020.

<sup>237</sup> Miao, Y., et al., *Current Li-Ion Battery Technologies in Electric Vehicles and Opportunities for Advancements*. Energies, 2019.

<sup>238</sup> Home, A., *Column: Tesla's reluctant commitment to cobalt a warning to others - Andy Home*. 2020, Reuters.

<sup>239</sup> MAHAMMAD A., H., et al., *State-of-the-Art and Energy Management System of Lithium-Ion Batteries in Electric Vehicle*. IEEE Access, 2018.

**Table 1 Capacity, thermal runaway temperature, and plateau voltage for different cathodes (reference values)<sup>236</sup>**

Cathode type	Formula (general)	Experimental Capacity (mAh.g <sup>-1</sup> ) Cut off@2 V <sup>240</sup>	Plateau voltage (V vs Li <sup>0</sup> /Li <sup>+</sup> )	Thermal runaway (°C)	Cycle life (No. of cycles) <sup>241</sup>
Lithium Nickel-Cobalt-Aluminum oxide (NCA)	LiNiCoAlO <sub>2</sub>	175	4.3-3.5	150	500
Lithium-Manganese-Oxide (LMO)	LiMn <sub>2</sub> O <sub>4</sub>	120-130	4.3-3.8	250	300 - 700
Lithium Nickel-Manganese-Cobalt oxide (NMC)	LiNiMnCoO <sub>2</sub>	150	4.3-3.7	210	1000 - 2000
Lithium Cobalt Oxide (LCO)	LiCoO <sub>2</sub>	150	4.3-3.8	150	500 - 1000
Lithium-Iron Phosphate (LFP)	LiFePO <sub>4</sub>	160-170	3.3	270	>2000

Other chemistries, such as Lithium-Manganese oxide (LMO), were more significant in the first generation of some EV vehicles, such as the Nissan Leaf and Chevy Bolt<sup>237,239</sup>, but it seems that their usage and representativity is decreasing, as these and other manufacturers currently opt for the cathodes mentioned before.

<sup>240</sup> Voltage at which the capacity is determined.

<sup>241</sup> Significantly dependent on specific application and environment. Some cathodes reach cycle lives far greater than the displayed values (e.g. Yuasa's LEV50 battery's LMO cathode retains 80% capacity after 5500 charge/discharge cycles)

**Table 2 Different cathodes used in EVs and their main characteristics**

Cathode type	Ratios (R) or Cell designation (S)	Manufacturer	No. of cells (series, parallel)	EV Model	Specific Energy (Wh/kg)	Energy (usable) (kWh)	Range, combined (WLTP values) (km)
Lithium Nickel-Cobalt-Aluminum oxide (NCA)	18650 (S)	Panasonic	8256 (s96p86)	Tesla Model S Tesla Model X	162	102.4 (98.4)	593, 487
	2170 (S)	Panasonic	4416 (s96p46)	Tesla Model 3	168	80.5 (76)	530
Lithium-Manganese Oxide (LMO)		Yuasa	80	Citroen Zero (LEV50 battery)	107	14.5	150
Lithium Nickel-Manganese-Cobalt oxide (NMC)	532 (R)	Nissan	288	Nissan Leaf e+		62	385
		CATL	216 (s108p2)	Peugeot e-208 Opel Corsa-e	140	50 (46)	349, 336
		ENVISION AESC	192 (s96p2)	Nissan Leaf	130	39.5 (36)	270
	333 (R)	Samsung SDI	264 (s88p3)	Volkswagen e-Golf	103	35.8 (32)	232
	721 (R)	LG Chem	192 (s96p2)	Renault ZOE	168	54.7 (52)	394
	622 (R)	Samsung SDI	96 (s96p1)	BMW i3	152	42.2 (37.9)	293 - 303
		SK Innovation	294 (s98p3)	Kia e-Soul Kia e-Niro	148	67.5 (64)	451, 454
		LG Chem	168 (s84p2)	Volkswagen e-Up, Seat Mii Electric, Skoda CITIGOe iV	148	36.8 (32.3)	256 - 273
			176 (s88p2)	Hyundai Ioniq Electric	112.4	40.4 (38.3)	310
			294 (s98p3)	Hyundai Kona Electric	149	67.5 (64)	447
			384 (s96p4)	Mercedes-Benz EQC	130	85 (80)	417
			396 (s198p2)	Porsche Taycan	148	93.4 (83.7)	333 - 407
			432 (s108p4)	Jaguar I-Pace	149	90 (84.7)	470
	Audi e-tron 55 quattro			136	95 (86.5)	402	
288(s96p3)	Chevrolet Bolt	143	68	417			
Lithium-Cobalt Oxide (LCO)		LG Chem	96	Smart Fortwo electric	150 - 200	17.6 (17.2)	120 - 135
Lithium-Iron Phosphate (LFP)		Elektrofahrzeuge Stuttgart		IRIDIUM E-MOBIL (electric mobile home)	90 - 120	106	400
		CATL		Tesla Model 3 (Chinese market)	125	106	400
		BYD Blade	102	BYD Han EV		65	506

## The negative electrode (anode)

Virtually every commercially available battery for mobile applications has batteries containing a graphitic anode<sup>242</sup>, which remains to be the most compatible with Li-ion cathodes. Julien et al.<sup>117</sup> thoroughly described the requirements for an ideal anode.

Limiting ourselves to the most relevant features, the abundance of graphite anodes owes to its:

- (1) low chemical potential  $\mu(\text{Li})-\mu(\text{LiC}_6) \approx 0.1 \text{ eV}$ , meaning that a lithiated graphite ( $\text{LiC}_6$ ) anode shows an equilibrium plateau discharge voltage that is 0.1 V lower than a Li-metal anode, for a cell containing a similar cathode and internal resistance;
- (2) significant worldwide reserves;
- (3) good electrochemical stability<sup>243</sup>;
- (4) safer than Lithium in case of fire.

Anode **technology has been reasonably stable** throughout the years, but with the continuous development of Li-ion cathodes, new materials, coatings, and manufacturing processes are being studied and commercialized. Since anode degradation is accountable for much of full **cell degradation**<sup>244</sup>, improvements at the anode component level will be important for developing **long-lasting batteries** for mobile applications<sup>245</sup>. Presently, **Carbon** (usually Carbon Black) coated graphite, **Li-metal**, and **Silicon**-based anodes are widely regarded as the major alternatives to **replace graphite** as the most important anode for LIBs.

The **main anode types** currently in use for mobile applications are summarized in

**Table 3.** Additionally, exhibited are the main properties of concern. It is demonstrated that graphite possesses the lowest voltage (V vs  $\text{Li}^0/\text{Li}^+$ ) among the alternatives (**Lithium-Titanium**

<sup>242</sup> Asenbauer, J., et al., *The success story of graphite as a lithium-ion anode material – fundamentals, remaining challenges, and recent developments including silicon (oxide) composites*. Sustainable Energy & Fuels, 2020.

<sup>243</sup> Kwon, H.J., et al., *Nano/Microstructured Silicon–Carbon Hybrid Composite Particles Fabricated with Corn Starch Biowaste as Anode Materials for Li-Ion Batteries*. Nano Letters, 2020. **20**(1): p. 625-635.

<sup>244</sup> Mao, C., et al., *Selecting the Best Graphite for Long-Life, High-Energy Li-Ion Batteries*. Journal of The Electrochemical Society, 2018.

<sup>245</sup> Scott, A., *In the battery materials world, the anode's time has come*. 2019, c&en.



**oxide**  $\text{Li}_4\text{Ti}_5\text{O}_{12}$  (LTO), and **silicon Nanowire** (SiNW)). However, graphite anodes not only possess relatively low specific capacity (theoretically,  $372 \text{ mA}\cdot\text{g}^{-1}$ ) but also have a typical cycle life of the same order as standard NMC cathodes, which means that graphite can limit the cycle life of the cell<sup>246</sup>. The decrease in cycle life is largely attributed to the chemical instability that occurs at the electrode/electrolyte interface<sup>247</sup>. This fact, besides motivating research for other materials, led to the development of Carbon coated graphitic anodes. The advantages thus obtained consist of:

- (1) a thinner solid electrolyte interphase (SEI), potentially leading to higher capacity<sup>248</sup>, as the SEI consumes  $\text{Li}^+$  – it is a mixture of insulating compounds mainly containing lithium;
- (2) a reduction of chemical instability between electrode and electrolyte leading to a great improvement in cycling performance<sup>249</sup>.

It is highlighted that the SEI is formed spontaneously when the anode and electrolyte align their chemical potentials and the Lower Unoccupied Molecular Orbital (LUMO) of the liquid electrolyte has lower energy than the chemical potential of  $\text{LiC}_6$ , leading to an electron current leak from the anode to the electrolyte. Those leaked electrons reduce  $\text{Li}^+$ -ions and subsequently  $\text{LiF}$ ,  $\text{Li}_2\text{O}$ , and  $\text{Li}_2\text{CO}_3$  are formed (if the electrolyte is the most common mixture of a carbonate solvent and  $\text{LiPF}_6$ ). The formation of these insulators inhibits the leakage of electrons to the electrolyte enabling the conduction of electrons throughout the external circuit.

Other types of Carbon-based anodes with higher capacities have been the subject of research efforts, namely, **Carbon nanotubes** and **graphene**. However, their use is limited due to the cost of the manufacturing process and discharge capacity degradation, respectively, although

<sup>246</sup> Wu, Z. and D. Kong, *Comparative life cycle assessment of lithium-ion batteries with lithium metal, silicon nanowire, and graphite anodes*. Clean Technologies and Environmental Policy, 2018. **20**(6): p. 1233-1244.

<sup>247</sup> Vetter, J., et al., *Ageing mechanisms in lithium-ion batteries*. Journal of Power Sources, 2005. **147**(1): p. 269-281.

<sup>248</sup> Julien, C., et al., *Lithium Batteries: Science and Technology*. 2015: Springer International Publishing.

<sup>249</sup> Zhang, H.-L., et al., *Electrochemical performance of pyrolytic carbon-coated natural graphite spheres*. Carbon, 2006. **44**(11): p. 2212-2218.



the latter has shown promising recent results, suggesting that this barrier may be overcome<sup>250</sup>.

**Table 3 Commercially available anodes and their main features**

Anode type	Application	Voltage (V vs Li <sup>0</sup> /Li <sup>+</sup> )	Capacity (mAh.g <sup>-1</sup> )	Specific Energy (Wh/kg)	Cycle life
Graphite (C)	Most of the commercially available batteries	0.15 – 0.25	375	100 – 156	2000
Lithium-Titanium Oxide Li <sub>4</sub> Ti <sub>5</sub> O <sub>12</sub> (LTO)	LFP batteries	2.40	175	50 - 80	3000 – 7000
Silicon	Nanowire (SiNW) Amprius Technologies: Airbus Zephyr S pseudosatellite HAPS Military vehicles	0.4	4200 (Silicon) 3579 (SiNW)	435 (Amprius)	>2000 (SiNW)

Compared with the typical values shown for graphite anodes the LTO and SiNW anodes show a significantly higher cycle life as well as specific capacity, which clearly explains why these anodes are viewed as the successors for graphite anodes. Both anode types have reached a technological stage that allowed their implementation on LIBs, as shown in

**Table 3.** Nevertheless, LTO presents itself as a more mature technology, as it is commercially available.<sup>251,252,253</sup>

According to Toshiba, their LTO based batteries are extremely safe, with little risk of thermal runaway<sup>253</sup>. Similar information is provided by other sources<sup>117</sup> stating that LFP/LTO cells perform especially well on safety tests. Besides safety reasons, this anode outperforms graphite on cycle life<sup>254</sup>. As such, it arises as an ideal technology for applications requiring a

<sup>250</sup> Al Hassan, M.R., et al., *Emergence of graphene as a promising anode material for rechargeable batteries: a review*. *Materials Today Chemistry*, 2019. **11**: p. 225-243.

<sup>251</sup> Altairnano. *Products*. 2020 [cited 2020; Available from: <https://altairnano.com/products/>].

<sup>252</sup> Leclanché. *Cells*. 2020 [cited 2020; Available from: <https://www.leclanche.com/our-technologies/cells/>].

<sup>253</sup> SCiB, T.R.b. *What is SCiB?* 2020 [cited 2020; Available from: <https://www.scib.jp/en/about/index.htm>].

<sup>254</sup> Toyohara, M., *Toshiba IR Day 2019 Battery Division*. 2019.

**high number of cycles**, such as industrial or military applications with no restrictions on total battery weight (thus, specific energy), or **public transportation vehicles**.

Silicon anodes have long been the subject of intensive research due to their relative inexpensiveness and very large specific capacity (theoretical capacity approximately 4200 mAh.g<sup>-1</sup> for the Li<sub>22</sub>Si<sub>5</sub> and 3579 mAh.g<sup>-1</sup> for the Li<sub>15</sub>Si<sub>4</sub> phases)<sup>117,255</sup>. However, due to high volumetric expansion associated with cycling (lithiation), materializations of this anode have suffered from performance degradation at an early stage<sup>256</sup>. One of the most promising solutions for overcoming this problem is nanocrystallization.<sup>257</sup> From several nanomaterials currently being studied, SiNW stands out as a successful implementation, with some applications at the battery level, such as Amprius Technologies' battery developed for Airbus' Zephyr S Pseudosatellite<sup>258,259</sup>. The main challenge that prevents its industrial development is high manufacturing cost.

<sup>255</sup> Phadatare, M., et al., *Silicon-Nanographite Aerogel-Based Anodes for High Performance Lithium Ion Batteries*. Scientific Reports, 2019. **9**(1): p. 14621.

<sup>256</sup> Jin, Y., et al., *Challenges and Recent Progress in the Development of Si Anodes for Lithium-Ion Battery*. Advanced Energy Materials, 2017. **7**(23): p. 1700715.

<sup>257</sup> Yang, Y., et al., *A review on silicon nanowire-based anodes for next-generation high-performance lithium-ion batteries from a material-based perspective*. Sustainable Energy & Fuels, 2020. **4**(4): p. 1577-1594.

<sup>258</sup> Scott, A. *In the battery materials world, the anode's time has come*. 2019 [cited 2020; Available from: <https://cen.acs.org/materials/energy-storage/battery-materials-world-anodes-time/97/i14>].

<sup>259</sup> Amprius. *100% Silicon Nanowire Batteries from Amprius Technologies*. 2020 [cited 2020; Available from: <https://www.amprius.com/technology/>].

**Table 4 Commercially available GES batteries and their main features.**

Cathode	Anode	Cell type	Plant	Power (kW)	Energy (kWh)	Operating Temperature (°C)	No. of cells (series, parallel)	Battery Manufacturer
NCA	Graphite	2170	Hornsedale powerplant (Tesla's Powerpacks)	150000	193500	-10 to 50		Tesla; Panasonic (Tesla's powerpack)
			Strata Oxnard, California (Tesla's Megapacks)	100000	400000			Tesla; Panasonic (Tesla's megapack)
			Tesla Moss Landing	182500	730000			
NMC	Graphite	Prismatic cells with Al exterior	Alamitos Energy Center, Long Beach, California (Fluence's Advancion 5 batteries)	100000	400000			Samsung SDI
LCO	LTO		Sendai Substation (Toshiba's SCiB)	40000	20000		24 (s12p2) per module	Toshiba
			Tohoku Minami-Soma (Toshiba's SCiB)	40000	40000			
LFP (BYD) LCO (Toshiba)	Graphite (BYD) LTO (Toshiba)		Zhangbei National Wind and Solar Energy Storage and Transmission Demo. Project	530000	36000			BYD; Toshiba
S	Na (liquid)		Abu Dhabi's main utility	108000	648000	300 to 350		NGK Insulators
			Transmission operator in Terna, Italy	35000	245000			
			Buzen Substation, Buzen, Fukuoka, Japan	50000	300000			
Ni-Cd			Golden valley Electric Association BESS	27000	25000	-52 to 32	13760	Saft Batteries
			Island of Bonaire	3000				

### 3.2.3 Cell Manufacturing

Due to LIBs dominant role in the battery's segment, we will be focusing on manufacturing processes for this type of battery.

#### Drivers of Change for cell manufacturing

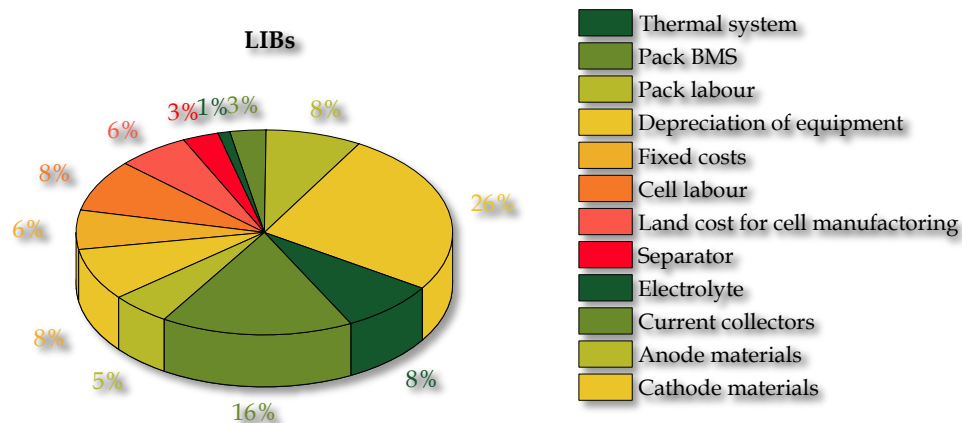

Figure 44 Relative costs for the fabrication of LIBs.

Presently, batteries account for up to 50% of the total cost of an EV. Moreover, out of all costs associated with LIBs, material costs are the most significant; based on **Figure 44** Relative costs for the fabrication of LIBs., considering only separator (3%), electrolyte (1%), current collectors (3%), anode materials (8%) and cathode materials (26%), 41% of total battery cost is reached, with the most significant contribution owed to the **cathode material**. The development of new manufacturing processes is paramount for reducing these costs, and the predicted increase in EV (and, thus, LIBs) sales for the next decade, will pave the way for larger scale production capacities in cell manufacturing, allowing for further investments and a reduction of overall costs.

In order to obtain a liquid electrolyte battery cell, cathode and anode are insulated by a separator and wetted by an electrolyte solution, while the flow of electrons is assured by current collectors. Liquid electrolytes, which are typically highly flammable, constitute one of the main safety concerns regarding LIBs. This has led to some major companies and research teams' efforts in developing all solid-state batteries, for which manufacturing and successfully incorporating solid electrolytes are key steps.

### Manufacturing process for electrodes

Li-based cathodes and graphite anodes are manufactured according to the stages presented in **Figure 45**.

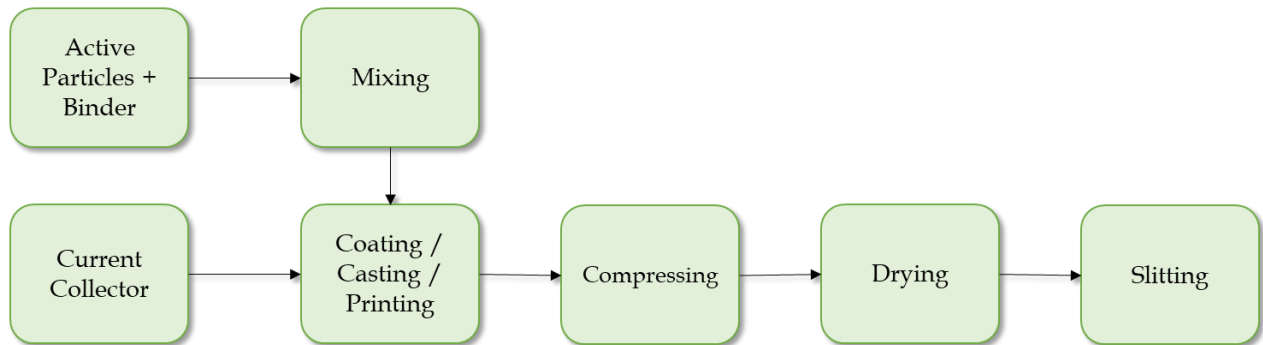

**Figure 45** Electrode manufacturing<sup>261</sup>. Flowchart adapted from the source.

The active materials are mixed with a binder to form a slurry, achieved by mechanically mixing the base metals in a reactor tank, carefully added until the desired proportions are obtained. Heat is supplied to aid mixing and control precipitation reactions. After mixing, the electrode is plasticized, allowing to handle the material and its deposition on the current collector<sup>117</sup>, typically as a continuous strip. Deposition can be achieved employing tape **casting, printing, and coating**, though the latter is the most used for LIBs current technologies. Coating speed is between 35 and 80 m/min. **Figure 45** depicts this type of manufacturing processes, often accompanied by a final measurement of total thickness. Next, the electrode is compressed by roll pressing. Thus, porosity is decreased, allowing for minimum electric contact resistance between the current collector and active particles. Finally, the strip is cut to the desired dimensions for cell assembly – **slitting**.

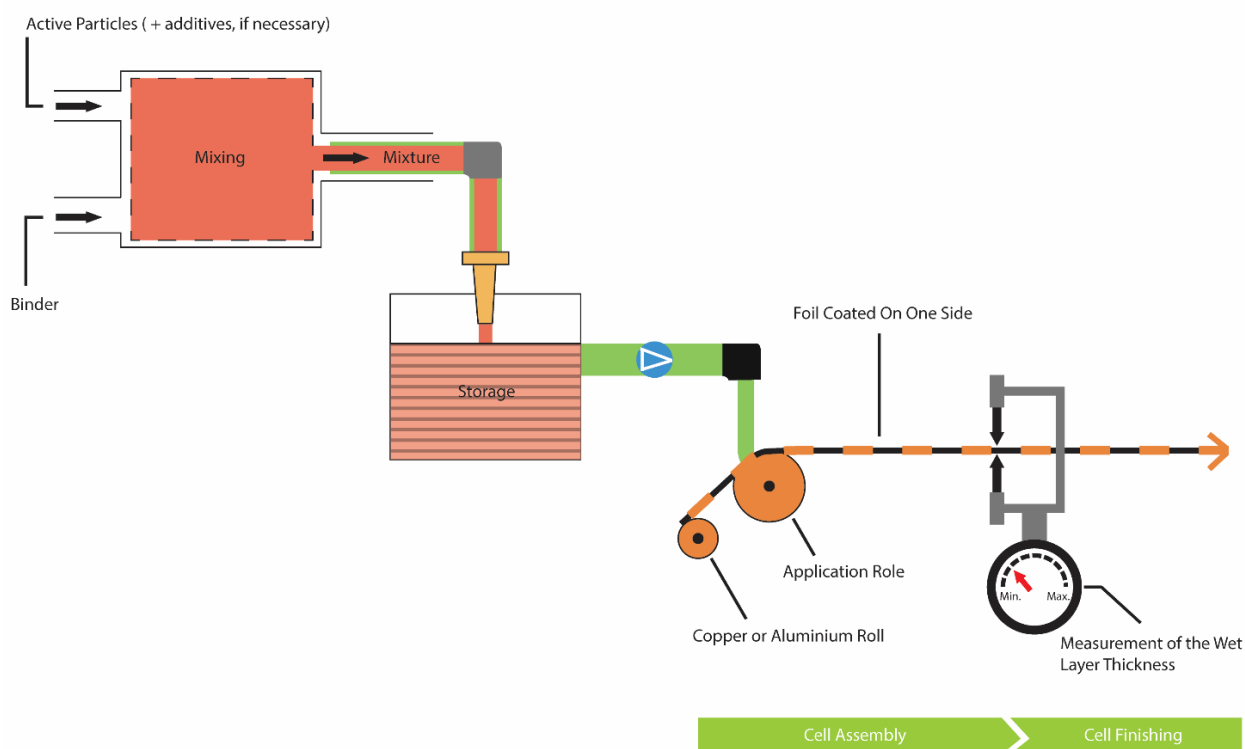

Figure 46 Main steps for electrode manufacturing using coating processes.

### Cathode manufacturing

For LIBs, the current collector used for cathodes is a 15 – 25  $\mu\text{m}$  thick aluminium foil. Active particles used are metal oxides which determine the cathode's designation as discussed previously. These compounds were mentioned and described in Table 1.

### Anode manufacturing

Graphite anodes are obtained from **graphitization** of soft Carbon (pitch coke). This process requires high temperatures (in the 2400 to 2800°C range<sup>260</sup>), with the mixture of pitch and coke forming a graphite structure in the form of graphite layers with the mixture of pitch and coke forming a graphite structure in the shape of graphite layers. Copper is the material of choice for a graphitic anode's current collector.

LTO anodes are processed in a similar way to cathodes. Moreover, current collectors used for this type of anodes consist of Aluminium foil.

<sup>260</sup> Chung, D.D.L., 1 - Carbon Fibers, Nanofibers, and Nanotubes, in Carbon Composites (Second Edition), D.D.L. Chung, Editor. 2017, Butterworth-Heinemann. p. 1-87.

### Electrolyte solution

The fundamental requirements for electrolyte selection are good ionic conductivity and electrical resistivity, besides its inertia towards chemical reactions with the electrodes' materials. From ceramics, gels, solid polymers, ionic liquids, and liquids, the latter dominates commercial applications, especially for EVs. Liquid electrolytes are solutions usually consisting of carbonate solvents and lithium salts, namely Lithium Hexafluorophosphate (LiPF<sub>6</sub>), the most used salt for liquid electrolytes. The salt provides the initial Li<sup>+</sup> content in the electrolyte.

### Battery module manufacturing

Popular commercially available formats include cylindrical, prismatic, and pouch-shaped cells. These geometries are all depicted in **Figure 47**.

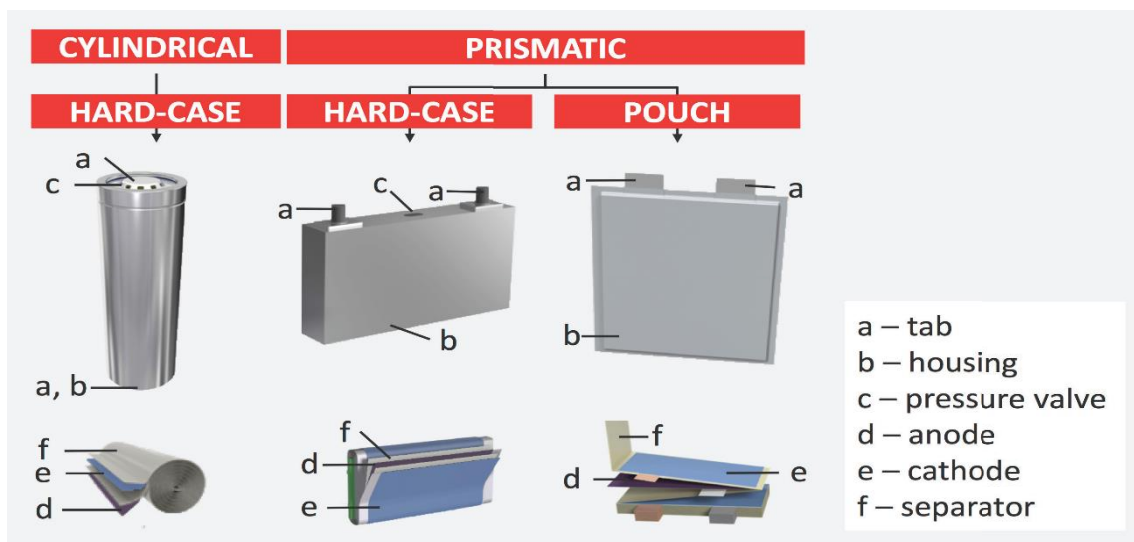

Figure 47 Different cell geometries for LIBs. According to the source 261

**Cylindrical cells** are among the earliest assembly designs for batteries. Nonetheless, they remain very popular on the market. The assembly is obtained by the cylindrical winding of three sheets: anode, separator, and cathode originating a jellyroll. The jellyroll is bonded by tab welding, using ultrasonic or laser welding techniques<sup>261</sup>. A cylindrical **housing** is necessary for allocating the electrical components since it should be capable of withstanding mechanical

<sup>261</sup> Schröder, R., M. Aydemir, and G. Seliger, *Comparatively Assessing different Shapes of Lithium-ion Battery Cells*. Procedia Manufacturing, 2017. **8**: p. 104-111.

loads and user handling. This housing is manufactured by deep drawing a metal sheet, a process that plastically deforms a metal sheet, typically made of Aluminium or stainless-steel<sup>262</sup>. To establish an electric current during charge and discharge, **current connectors** are necessary. They make the contact between the cell and the device being powered. Connection is, thus, obtained via tabs, identified in **Figure 47**. Positive and negative terminals are connected to the respective electrodes.

After **packaging** (at cell level), cell activation is initiated with **electrolyte filling, sealing** the housing, formation, and aging of the cell.

During the **formation stage**, the solid electrolyte interphase (SEI) is formed in the initial charges, a very important step for assuring no premature degradation of the electrolyte.<sup>117</sup> Batteries that meet the required standards after SEI formation are fully charged and stabilized. The final stage of cell manufacturing, the **aging**, consists of a month of storage under constant temperature and humidity. The objective is to detect short circuits and measure the performance – the battery is discharged to check for its capacity, which allows for its grading and commercialization.

**Prismatic cells**, very often installed in batteries for EVs, follow the same manufacturing procedure as cylindrical cells, except for the substitution of cylindrical winding by **flat winding and housing** shape. For prismatic geometry, the housing is also obtained by sheet metal stamping processes. However, both die and punch have rectangular geometries.

**Pouch cells** can be considered a type of prismatic cells. Their distinctive visual characteristic is the absence of a hard case. They are **sealed in a flexible foil** made of an Aluminium-Polymer electrical insulator compound, with raw materials being stacked, instead of using winding processes. **Stacking** is achieved either by single sheets of electrodes, or by z-folding the separator, and, then, insert the electrodes<sup>261</sup>. **Figure 48** is a schematic illustration of both stacking options.

<sup>262</sup> University, B. *BU-301a: Types of Battery Cells*. 2011 2019 [cited 2020; Available from: [https://batteryuniversity.com/index.php/learn/article/types\\_of\\_battery\\_cells](https://batteryuniversity.com/index.php/learn/article/types_of_battery_cells)].



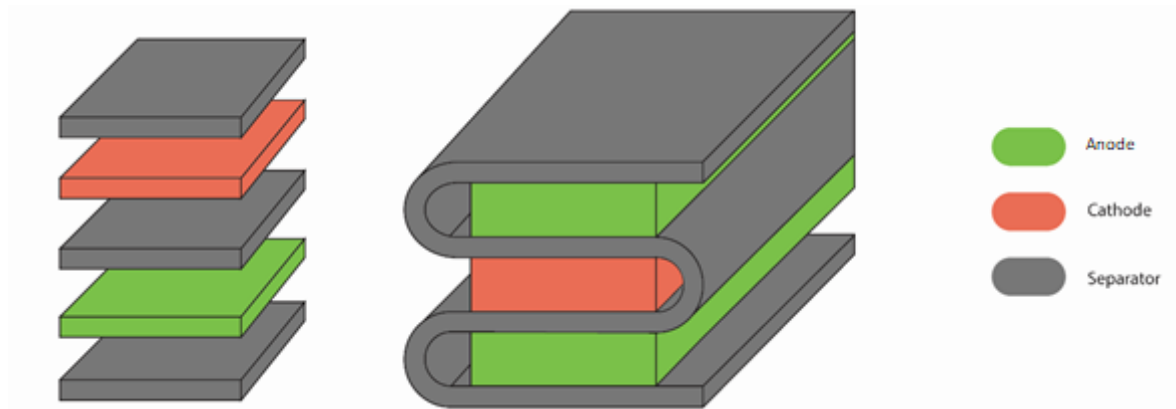

Figure 48 Stacking sequence of pouch cells, either by single sheets of electrode (to the left) or by z-folding the same component (to the right)

Electrolyte filling requires a vacuum, applied on the partially sealed cell, due to the stacked geometry. The final step before the formation is to complete the sealing of raw materials with flexible foil.

Once the formation process is completed, a pouch bag previously incorporated is filled with gas, which is absorbed during this step. The bag is removed, and the pouch cell permanently sealed. Aging of prismatic cells follows the same procedure as in the case of cylindrical cells. Even though the dimensions of cells vary between manufacturers, all commercialized cells must comply with standards ISO/PAS 16898:2012 and DIN 91252 - 2016-11.

### Market trends for cell geometry

The majority of NMC batteries installed in the EVs included in **Table 2** are **prismatic and pouch cells**.

LG Chem's NMC622 cells are being sold with the latter geometry. The company appreciates that this geometry is slimmer and lighter than prismatic cells, which leads to utilization cost and space savings. Other advantages include superior thermal management and improved aging of the cells, a result of its manufacturing process (stacking).<sup>261</sup>

Nissan is using pouch cells for its Leaf and Leaf+ models. Samsung's technologies for EVs are based on prismatic cells.

NCA batteries follow a distinct trend, as Panasonic uses cylindrical cells. This explains why cell designation is included in this chemistry in Table 2. The 18650 cells have a diameter of 18 mm and a length of 65 mm, while 2170 cells have a diameter of 21 mm and a length of 70 mm.

### 3.2.4 Job Roles and Skills

Considering the job advertisements for the components and cell manufacturing there were very few found in comparison with other value chain steps. This must be compensated by workshops and online surveys in the future. Listed job roles are not specific to mobile or stationary application but to the whole battery sector.

For the manufacturing of components and cells **Material Engineers for Cathodes and Anodes, Electrical Engineers/Battery Specialists, Manufacturing Engineers, Mechanical Battery Design Engineers** are being searched for as well as **Production Engineers** for specific components of the batteries and cells like **Top Cap<sup>263</sup> Engineers**.

**Operators and Machine Operators** who operate machines and do all the necessary procedures are also associated with this value chain step.

These processes are accompanied and supported by **Calibration Technicians, Controls Engineers, Equipment Engineers, Maintenance Engineers and Metrologists** who calibrate the equipment and assure that all the machines are performing as expected. **Shift Leaders** are also required. **Quality and Compliance Engineers** verify and manage the quality of products and **Process Engineers** seek continuous process improvement.

**Safety Specialists** and **Managers** as well as **ISO Internal Auditors** assure the safety standards and requirements are met.

---

<sup>263</sup> Battery top cap assembly that closes an upper end of an opening of a cylindrical secondary battery.

## Skills and knowledge required in relevant advertisements:

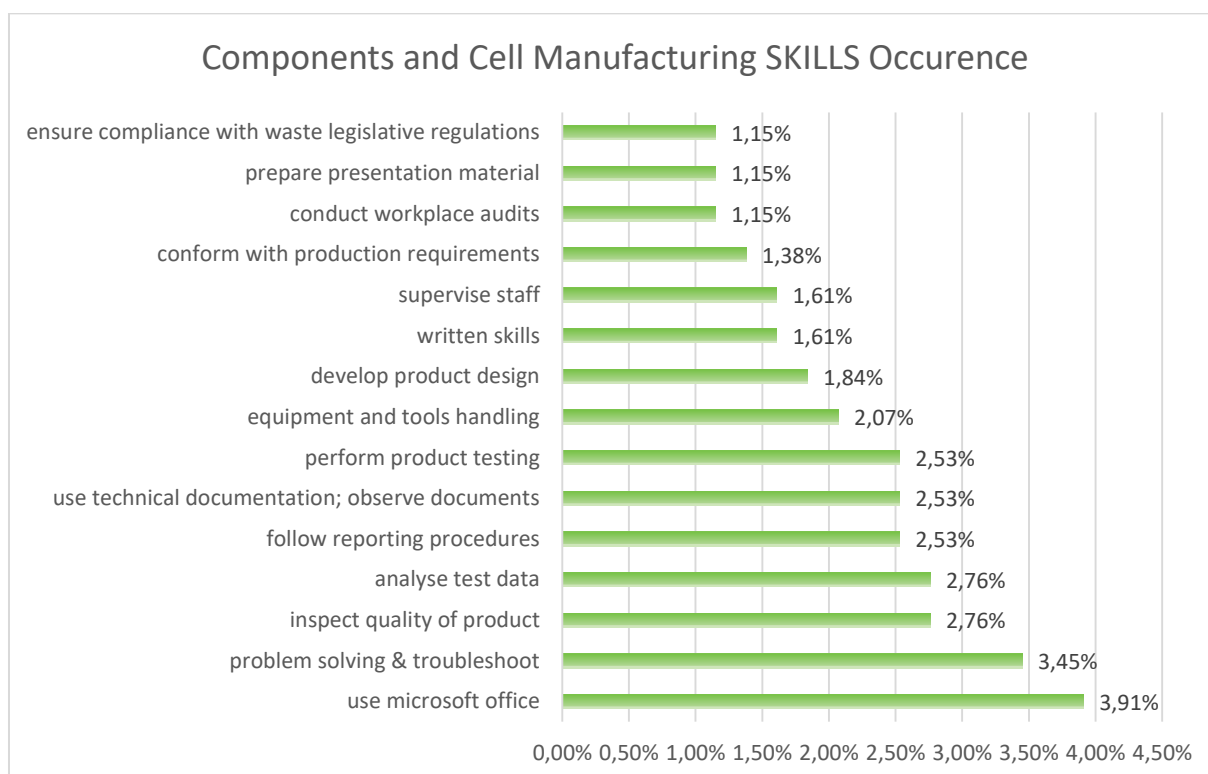

**Figure 49 Components and Cell Manufacturing SKILLS Occurrence**

### Skills

Skills occurrence for components and cell manufacturing are shown in **Figure 49**. Usage of Microsoft Office was the most frequent skill in the researched offers as well as problem solving and troubleshooting, document management and observation, and following of reporting procedures. Inspection of product quality, design and testing of a cell is, as expected, in the first half of the list.

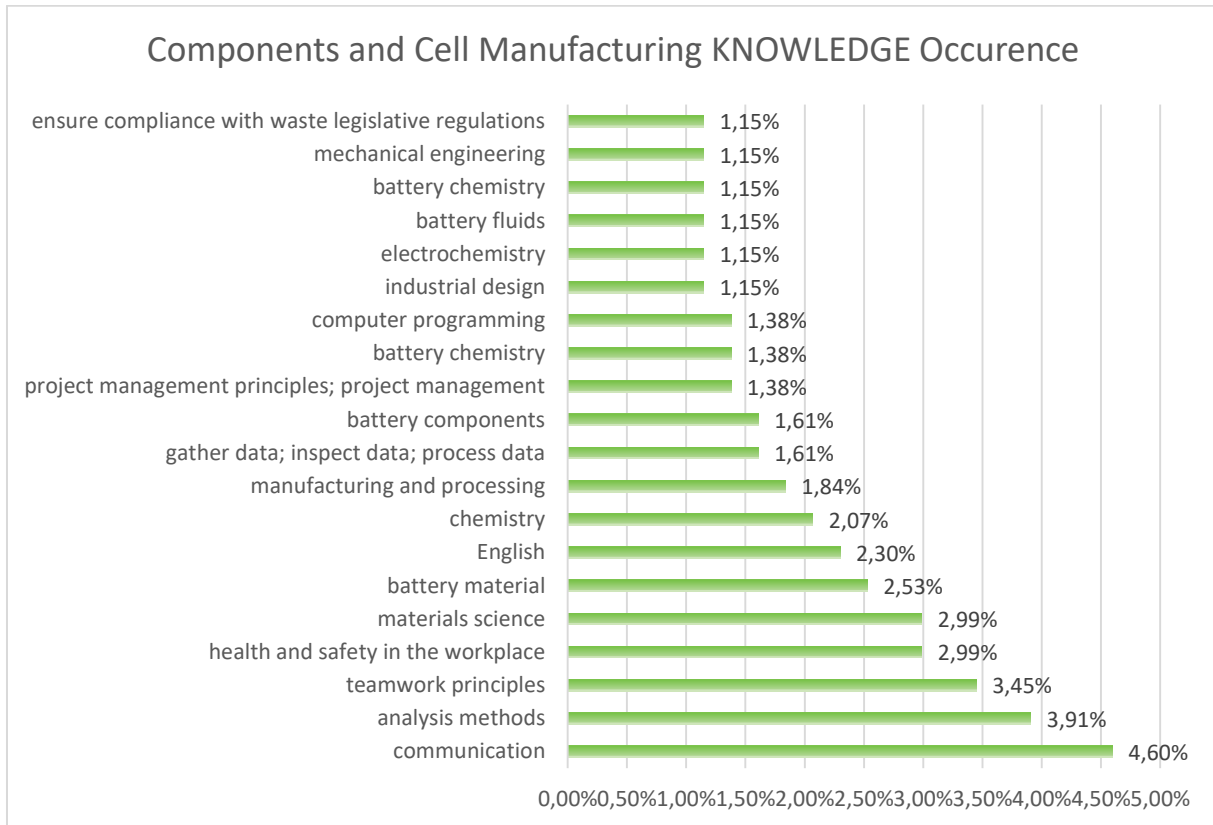

Figure 50 Components and Cell Manufacturing KNOWLEDGE Occurrence

## Knowledge

Knowledge occurrence for raw materials and processing are shown in **Figure 50**. Communication and teamwork principles are on the top positions as well as health and safety in the workplace and analysis methods. Materials science and battery material and components knowledge are required in this stage of the production, as well as battery chemistry associated with general chemistry and electrochemistry knowledge.

### 3.3 MODULE AND PACK MANUFACTURING

For stationary and mobile applications such as EVs, LIBs are used in the form of a pack. This pack consists of several blocks of battery modules, battery management system (BMS) master, and battery thermal management system (BTMS). Design possibilities on the pack arrangement, include series and parallel stacking of modules, as previously mentioned, and highlighted in **Table 2**.

Regardless of the cell's chemistry, the way the cells are combined into a **module** and modules combined into a **pack** has total influence on the usable energy and the total range because the number of cells in series defines the total voltage while the number of cells in parallel and

their shape/dimensions define(s) the capacity of the battery. Both voltage and capacity depend on the chemistry of each cell. Therefore, the same cell chemistry built by the same manufacturer leads to **very different values** due to the number of cells in series and parallel per module. This evidence can be easily comprehended by comparing values between EV models with NMC622 cells manufactured by LG Chem,<sup>262</sup> in **Table 2** .

As for the mobile applications/automotive industry, the car manufacturers often perform module and pack assembly in-house. Modules and packs are critical in determining an EV's range and charging rate, vehicle manufacturers want to control the way the battery pack space is used and cooled. Going forward, battery packs might become an even more essential aspect of vehicle design.<sup>264</sup>

### 3.3.1 Module and Pack Assembly

A battery module is obtained when cells are packed together with a BMS slave and sensors. These components are insulated by the module's housing. Presently, the most important module types for EVs are prismatic and pouch-shaped cells, with the increasing popularity of the latter.

**Cell stacking procedure** depends on whether prismatic, pouch or cylindrical cells are used for the battery module. Prismatic cells require an adhesive layer between them. Besides assuring the mechanical link, this layer must be electrically insulating, thus preventing short circuits. After being all glued together, the cells are pre-loaded to minimize swelling during charge and discharge, after which they are placed inside the insulation housing. As for pouch cells, each one is inserted into a frame, and the action of springs prevent high volumetric expansion/contraction, similarly to prismatic cells.

Following the mechanical bond, it is necessary to ensure the electrical functionality of the set. Contact tabs are electrically connected. This connection may either be **permanent** – guaranteed by welding processes - or **detachable**, using bolts and nuts. Although detachability is an advantage, connections with threaded fasteners typically bring about poorer electrical performance, with lower conductivity than permanent connections achieved by laser,

<sup>264</sup> <https://www.bcg.com/publications/2018/future-battery-production-electric-vehicles> (last accessed on 28.08.2020)

ultrasonic or other welding techniques.

As a next step, the BMS slave is welded to the module, typically on top of the cells, with the temperature sensors.

Finally, power and COM cables are placed and the lid fixed to the housing. In the end, a voltage test is performed and the compliant module is ready to be inserted into a pack. **Figure 51** shows a schematic of the assembly processes, clearly indicating that a module consists of a cluster of cells and a pack is a cluster of modules.

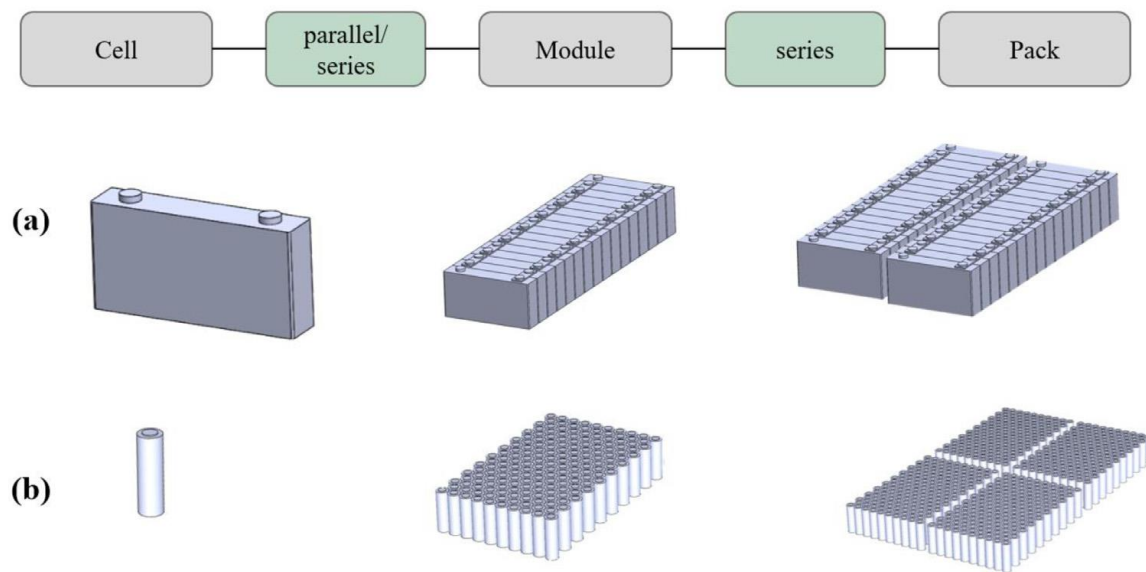

Figure 51 Overview of battery packs indicating two constructions with (a) cylindrical and (b) prismatic cells. Adapted from original source<sup>265</sup>

### 3.3.2 Job Roles and Skills

The differences based on the application are starting to be relevant at this stage.

As for the module and pack manufacturing, **Cell Module Engineers (Mechanical, Simulation, Electrical)** and **Manufacturing and Production Engineers** are working together with **Battery Design Engineers (Mechanical, Electrical)** on the development, design and functionality of a battery modules and packs. These are then assembled by **Battery Assemblers** as well as **Machine Operators**.

<sup>265</sup> Zwicker, M.F.R., et al., *Automotive battery pack manufacturing – a review of battery to tab joining*. Journal of Advanced Joining Processes, 2020. 1: p. 100017.

These processes are accompanied and supported by **Controls Engineers, Equipment Engineers, Maintenance Engineers and Metrologists** who calibrate the equipment and assure that all the machines are performing as expected. **Shift Leaders** are also present. **Quality and Compliance Engineers** verify and manage the quality of products and **Process Engineers** seek continuous process improvement.

**Battery System Engineers** and **Battery Test Engineers** and **Technicians** secure the preparation for further integration of the batteries into specific use cases (cars, vessels, etc. for mobile application and base stations, power grids, etc. for stationary applications).

**Safety Specialists** and **Managers** as well as **ISO Internal Auditors** assure the safety standards and requirements are met.

#### Skills and knowledge required in relevant advertisements:

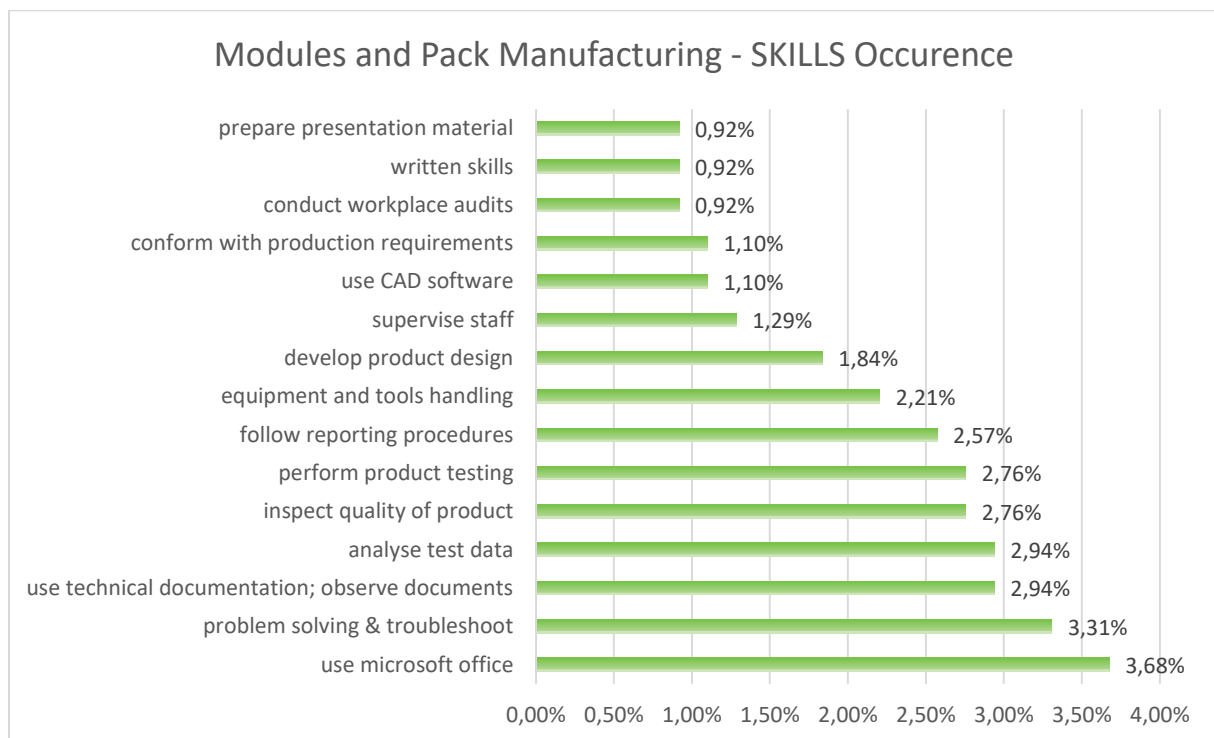

Figure 52 Module and Pack Manufacturing SKILLS Occurrence

#### Skills

Skills occurrence for module and pack manufacturing are shown in **Figure 52**. Usage of Microsoft Office was the most frequent skill in the researched offers as well as problem solving and troubleshooting, document management and observation and following of the reporting

procedures. Testing is starting to be more frequent in this stage as well as development of product design with usage of Computer Aided Design (CAD) software and other related tools.

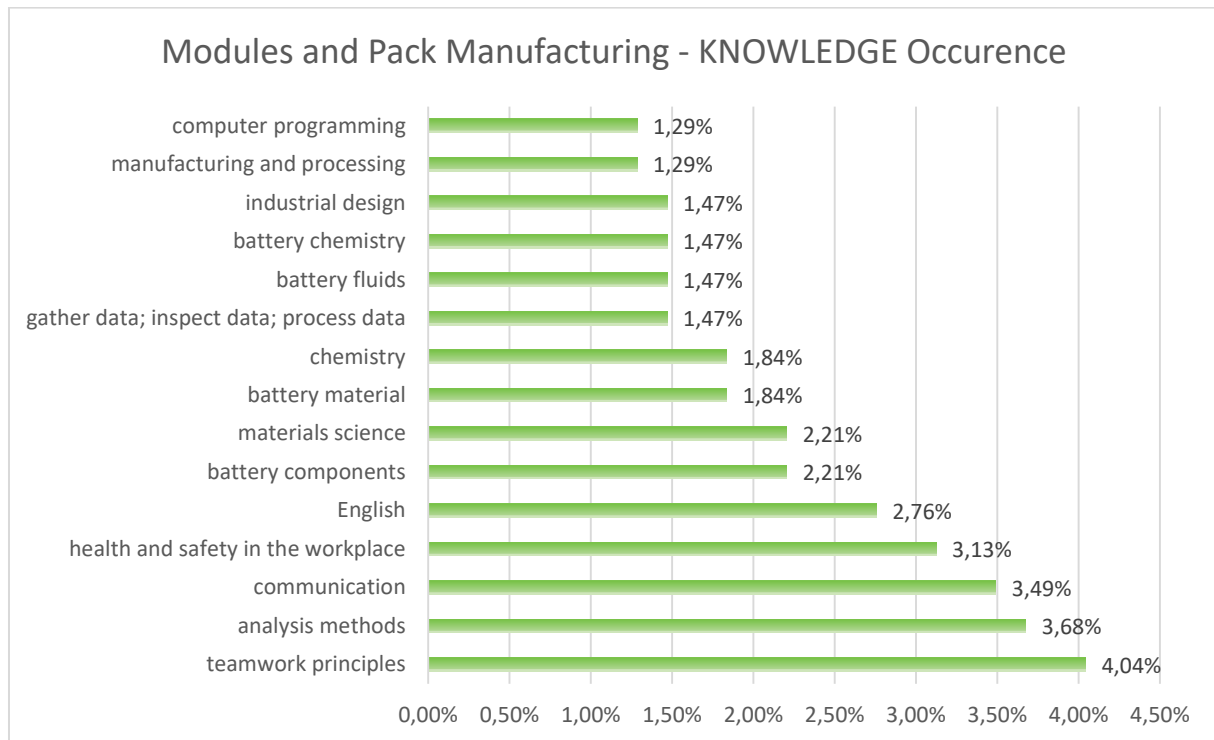

Figure 53 Module and Pack Manufacturing KNOWLEDGE Occurrence

## Knowledge

Knowledge occurrences for module and pack manufacturing are shown in **Figure 53**. Communication and teamwork principles ranked on the top positions as well as health and safety in the workplace and analysis methods. Materials science and battery material and components knowledge is being required as well as competences in battery chemistry and fluids associated with general chemistry. Computer programming is starting to occur.

## 3.4 BATTERY INTEGRATION

This section describes the battery value chain step of the battery integration process. This is the last step before the battery goes into the working environment/applications. This step covers mainly integration of modules, Battery Management Systems (BMS), safety installations, electronic intelligence (algorithms needed).



### 3.4.1 Main Terminology

This section gives basic terminology and explanation of battery systems for the battery integration processes that are described further in **3.4.4** and **3.4.5**.

Each battery pack requires simultaneous installation of a battery management system and battery thermal management system which together accounts for 24 % of total battery cost (excluding manufacturing labour costs related to the components).

#### 3.4.1.1 Battery Management System (BMS)

The BMS may fulfil a variety of functions depending on the particular application, as well as the type and size of the battery, but the overall goal of the BMS is to keep the battery within the safety operation region in terms of voltage, current, and temperature during charge, the discharge, and certain cases at open circuit<sup>266</sup>.

By achieving those goals, batteries will be efficient, with predictable behaviour and with no risk (inhabitants, staff, maintenance, etc.).

#### Topology of BMS

**Centralized:** One central pack controller that monitors, balances, and controls all the cells<sup>267</sup>.

**Modular:** BMS is divided into multiple, identical modules, each with its bundle of wires going to one of the batteries in the pack. Typically, one module is a master that manages the entire pack and other modules are just remote measurement units.

**Distributed:** Distributed BMS uses few communication wires between the cell boards and a BMS controller, which handles computation and communications.

<sup>266</sup> Angel Kirchev, Chapter 20 - Battery Management and Battery Diagnostics, Electrochemical Energy Storage for Renewable Sources and Grid Balancing, Elsevier, 2015, Pages 411-435, ISBN 9780444626165, <https://doi.org/10.1016/B978-0-444-62616-5.00020-6>.

<sup>267</sup> Shanbhag, K. (2020, March 14). How to best select Battery Management Systems (BMS) for High Voltage Li-Ion Batteries. Retrieved August 04, 2020, from <https://www.ionenergy.co/resources/blogs/hv-battery-management-systems/>

## General functions of the BMS:<sup>268, 269</sup>

### Cell voltage measurement and control

#### Monitoring of voltage across each series group of cells

Voltage excursions due to the overcharge, over discharge, or high-power pulses can lead to significantly reduced life and safety issues. Voltage is the critical input for the cell balancing algorithm, state of charge and state of health algorithms.

The main reason for the monitoring is to prevent overcharge which leads to the various chemical reaction and temperature rise which leads to the cell venting. Vented gases are highly flammable. The design of the battery must include a robust method for monitoring of the cells and for risk avoidance. The main response to this behaviour is that BMS request a change in power flow in/out of battery pack to bring voltage back within the limits; if some components might fail, the BMS has authority to open the contactors on the battery pack and stop all power flow.

#### Contactors control

BMS has the authority to control the contactors of the battery pack. This involves both the pre-charge contactor and main contactor(s). Contactors are managed by the contactor control algorithm which must confirm the state of the pre-charge process and the state of the different contactors. It must be assured that people do not get access to the high voltage system while it is energized.

#### Isolation monitoring

Isolation monitoring is another critical safety function which ensures that any fault of the system will not be exposed to the person in a dangerous way. It must be ensured that there is enough resistance between the high voltage system and the chassis (IEC 2007, ISO 2011). Monitoring and measurement are done by various methods and circuits.

<sup>268</sup> Gianfranco Pistoia, Chapter 5 - Vehicle Applications: Traction and Control Systems, Battery Operated Devices and Systems, Elsevier, 2009, Pages 321-378, ISBN 9780444532145, <https://doi.org/10.1016/B978-0-444-53214-5.00005-4>.

<sup>269</sup> N.M. Johnson, 19 - Battery technology for CO2 reduction, Alternative Fuels and Advanced Vehicle Technologies for Improved Environmental Performance, Woodhead Publishing, 2014, Pages 582-631, ISBN 9780857095220, <https://doi.org/10.1533/9780857097422.3.582>.

## Temperature measurement and control

BMS is responsible for battery pack and cell temperature control, strategy for monitoring and controlling is unique to each application. This data is needed to adjust heating, cooling, or pack power levels.

## State of charge (SoC), state of health (SoH) calculation

Possibly the most complex algorithm within the BMS.

- ◆ **SoC** is the percentage of electrons available to do work compared to a fully charged battery.
  - This is useful for cell balancing, indication of electrical power limits including charge rate of the battery, operation modes and ranges in case of usage in vehicles, etc.
- ◆ **SoH** is broader measure of overall performance capability of the battery compared to its initial performance when new.
  - Does not require as urgent time accuracy as SOC. SOH estimates the battery's overall performance over time, loss of capacity, increase in resistance, etc.

Both calculations will continue to develop along with the chemistry of batteries.

## Communications

BMS requires careful hardware and software design to assure maintenance of the safety goals of the system, as well as communication with the rest of the systems and the user interface if needed.

## Electronic Control Unit (ECU)

An ECU is a computer that performs a specific task, typically used in automotive and other branches of industry. Ultimately BMS as mentioned above could be considered an ECU since it is a separate computer system that performs a specific task; otherwise, the ECU could be considered as the logic part of the whole BMS.<sup>270</sup>

<sup>270</sup> Electronic Control Unit (ECU). (2015, September 22). Retrieved August 04, 2020, from [https://www.orionbms.com/manuals/utility\\_ir/acc\\_ecu.html](https://www.orionbms.com/manuals/utility_ir/acc_ecu.html)

## End of Line Testing

This term is related to the testing right after the battery modules are assembled. It includes quality and parameter control of the produced units with the related tests.<sup>271</sup>

- ◆ **Functional testing**
- ◆ **Performance testing**
- ◆ **Connection scanning**
- ◆ **Electrical testing including isolation tests**
  - Low voltages testing, sensor readings tests.
- ◆ **Testing and calibration of BMS**
- ◆ **Parts checks**

### 3.4.1.2 Battery Thermal Management System (BTMS)<sup>272</sup>

The BTMS is an important and integral part of the BMS.

The main goal of the BTMS is to manage temperature of the battery and overcome all challenges that are coupled with thermal effects including (capacity/power fade, thermal runaway, electricity imbalance among multiple cells in a battery pack, and low temperature performance). While designing the battery and battery systems, the rate of heat dissipation must be fast enough so the battery does not reach the thermal runaway temperature which would damage the electrolyte and electrodes and other battery components. The optimum range for most general batteries requires operating near room temperature (15-35 °C).

BTMS is comprised of a combination of hardware and software. It helps to enhance the lifetime of a battery while ensuring safe and secure operation of the battery pack. BTMS must be designed to suit application criteria either mobile or stationary (packing difficulty, costs, reliability, assembly difficulty, positioning, etc.).

## BMTS Methods (Figure 54)

Employed method inside of BTMS can be either for cooling, heating (electric), or insulating

<sup>271</sup> Quality Assurance within the Production. (n.d.). Retrieved August 04, 2020, from <https://www.horiba-fuelcon.com/en/battery-end-of-line>

<sup>272</sup> Khan, M.R.; Swierczynski, M.J.; Kær, S.K. Towards an Ultimate Battery Thermal Management System: A Review. *Batteries* **2017**, *3*, 9. Available from: <https://www.mdpi.com/2313-0105/3/1/9/pdf>

depending on the operating and ambient conditions. **Air** as the medium uses electric blowers or fans. **Liquid** BMTS include water, glycol, oil, acetone, **refrigerants**, and Phase Change Material (PCM) thermal management systems. Uniform and adequate cooling must be assured. Cooling or heating can be activated based on the rate of charge/discharge. This trigger is also dependent on altitude and geographical conditions. Proper insulation must be chosen based on these conditions as well.

Currently, most of LIBs are **liquid-cooled**, which brings complexity and potential leak issues related to the thermal regulation system. Some models use **passive or active air** thermal regulation, which is a much simpler and maintenance-friendly system. However, it requires a higher volumetric flow rate for equal cooling performance, owing to liquid's superior convective heat transfer coefficient, rendering its applications impractical for several EVs.



Figure 54 Battery Thermal Management System (BTMS)

### Aspects of BTMS

- ◆ **Safety:** Proper insulation of heater system components and sealing of control devices with proper positioning of all components to minimize and prevent electrical damage, gas ignition and thermal gradients.
- ◆ **Physical or Mechanical Performance:** Proper design of all the system modules and physical components. Proper ventilation must be assured.
- ◆ **Durability:** Components must endure shock effects of the desired application.
- ◆ **Ripple Current:** Charging current frequency restrictions to avoid overheating.
- ◆ **Accuracy of Measuring Instruments:** In the available sensors, the overall accuracy of

controlled or measured values must be assured with defined tolerance.

- ◆ **Materials for Fire Resistance:** Requirements for non-flammable or flammable-retardant materials to be used in accordance with applicable standards as well as BTMS is associated with many existing standards.<sup>273</sup>

### 3.4.2 Drivers of Change and Attractiveness

This section is based on information taken from The Global Management System market report from November 2019<sup>274</sup>.

This overview of the drivers of change and attractiveness of the battery integration is mainly based on the BMS. An overview of the BMS market is described in following section.

The global BMS market size is estimated to grow from USD 5.2 billion in 2019 to USD 12.6 billion by 2024, at a Compound Annual Growth Rate (CAGR) of 19.5%.



Figure 55 Attractive Opportunities in the Battery Management System Market

<sup>273</sup> Khan, M.R.; Swierczynski, M.J.; Kær, S.K. Towards an Ultimate Battery Thermal Management System: A Review. *Batteries* **2017**, *3*. Available from: <https://www.mdpi.com/2313-0105/3/1/9/pdf>

<sup>274</sup> Battery Management System Market. (2019, November). Retrieved August 04, 2020, from <https://www.marketsandmarkets.com/Market-Reports/battery-management-bms-market-234498189.html>

The growth of the global market (**Figure 55**) is expected to be driven by the growing trend of electric vehicles, increased requirement of battery monitoring in renewable energy systems, and need for effective electric grid management.

Regarding the topology (architecture of the BMS), the modular topology of BMS is preferred by most of the manufacturers as it offers significant computational power and is also safe as it does not require extensive wire harnesses. It is present in various applications such as:

- ◆ **Energy Storage Systems**
- ◆ **Industrial Uninterruptible Power Supply**
- ◆ **Medical Mobility Vehicles**
- ◆ **Parts of Electric Vehicles**
- ◆ **Drones**

Demand for this topology is expected to drive the market at the highest rate from 2019-2024.

### 3.4.3 Stakeholders

This section is based on the global management system market report from November 2019<sup>275</sup>.

The main global players for the BMS market are as follows:

- ◆ **Leclanche (Switzerland)**
  - Company largely involved in offering energy storage solutions, mainly dealing with lithium-ion cell technology aiming for cleaner energy. The company offers specialty battery systems, stationary solutions, e-transport solutions, and battery, and BMS. The company offers BMS technologies and suites of BMS software. Covering low or high voltage systems.

<sup>275</sup> Battery Management System Market. (2019, November). Retrieved August 04, 2020, from <https://www.marketsandmarkets.com/Market-Reports/battery-management-bms-market-234498189.html>



◆ **LITHIUM BALANCE (Denmark)**

- Founded in 2006 as an ambitious start-up at the Danish Technological Institute. The company develops and manufactures BMS for lithium ion battery technologies<sup>276</sup>.

◆ **Nuvation Engineering (US)**

- Company founded in 1997 which provides hardware design, software development, and Field-Programmable Gate Array (FPGA) services for electronic product development<sup>277</sup>.

◆ **Eberspaecher Vecture (Canada)**

- Corporation launched in 2001 and has been focused on providing its customers with reliable, innovative, and cost-effective BMS for portable power applications<sup>278</sup>.

◆ **Storage Battery Systems (US)**

- Established in 1915, Storage Battery Systems LLC has become renowned for providing DC Power Solutions for stationary and mobile power applications. From flooded battery cells, to sealed VRLA strings, from Ni-Cd jars to Li-ion rechargeable battery packs<sup>279</sup>.

◆ **STW Technic, LP (DE)**

- STW Technic, LP is a worldwide leader in the design, manufacture, and implementation of mobile electronics solutions. Founded in 1985 in Germany, STW provides sophisticated, highly reliable solutions for connectivity, automation, and electrification in the agricultural, mining, construction, municipal, military and oil/gas industries.<sup>280</sup>
- STW also specialises in development of battery management systems for HEV,

<sup>276</sup> About us. (n.d.). Retrieved August 04, 2020, from <https://lithiumbalance.com/about-us/>

<sup>277</sup> About Us. (n.d.). Retrieved August 04, 2020, from <https://www.nuvation.com/about-us>

<sup>278</sup> About us. (2016, November 28). Retrieved August 04, 2020, from <https://www.eberspaecher-venture.com/about-us.html>

<sup>279</sup> About Us: Storage Battery Systems. (n.d.). Retrieved August 04, 2020, from <https://www.sbsbattery.com/about-us>

<sup>280</sup> About STW Technic. (n.d.). Retrieved August 24, 2020, from <https://www.stw-technic.com/company/about-stw-technic/>



BEV and for storage power plants.<sup>281</sup>

◆ **Johnson Matthey (UK)**

- Johnson Matthey Battery Systems is one of Europe’s largest Lithium-ion battery systems supplier, processing over 70 million cells a year and supplying volume production of batteries for global markets.<sup>282</sup>

◆ **Saft (France)**

- Company which specialises in battery manufacturing and R&D<sup>283</sup>.

◆ **FIAMM (Italy)**

- Multinational company engaged in the production and distribution of batteries and accumulators for motor vehicles and for industrial use<sup>284</sup>.

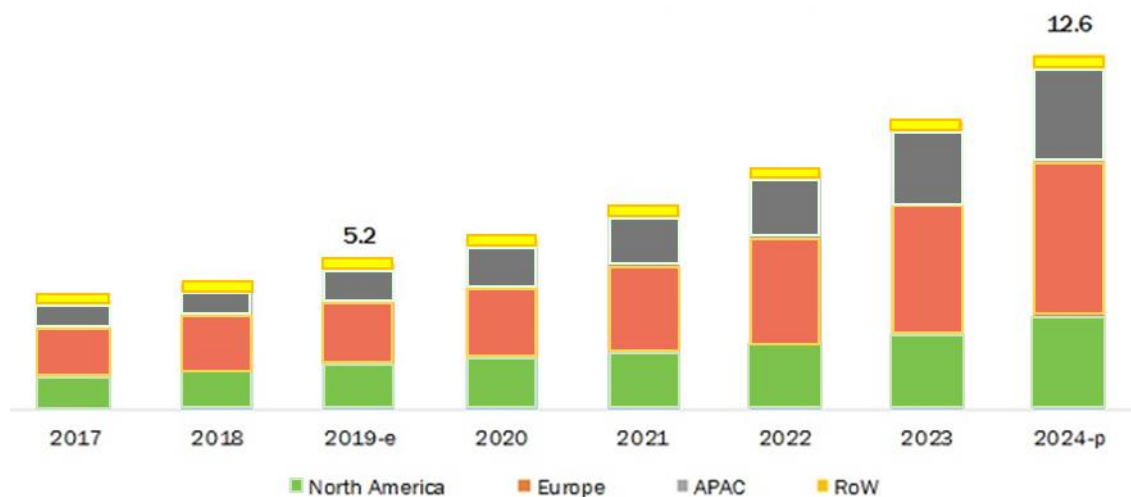

Source: Industry Expert, Secondary Research, and MarketsandMarkets Analysis

Figure 56 Battery Management System Market, by Region (USD Billion)

Europe dominated the battery management system market in 2018 as seen in **Figure 56**. Especially the automotive industry which is very pronounced in Europe with the leanest production processes where the use of water and energy is optimized. The demand for the

<sup>281</sup> MBMS – Battery Management System. (n.d.). Retrieved August 24, 2020, from <https://www.stw-technic.com/products/electrification-products/mbms-battery-management/>

<sup>282</sup> About Us. Johnson Matthey Battery Systems. (n.d.). Retrieved August 09, 2020, from <http://www.jmbatterysystems.com/company/about-us>

<sup>283</sup> Who is Saft. (2020, August 04). Retrieved August 04, 2020, from <https://www.saftbatteries.com/about-us/who-saft>

<sup>284</sup> About Us. (2020, April 10). Retrieved August 04, 2020, from <https://www.fiamm.com/en/north-america/company/about-us/>

battery management systems is attributed mainly because of major automotive manufacturers:

- ◆ BMW Group (Germany)
- ◆ Daimler (Germany)
- ◆ Volkswagen Group (Germany)
- ◆ Scania AB (Sweden)
- ◆ Volvo Group (Sweden)
- ◆ MAN SE (Germany)
- ◆ Renault (France)
- ◆ Fiat Automobiles S.p.A. (France)
- ◆ Jaguar Land Rover (United Kingdom)
- ◆ Other

#### 3.4.4 Generic Integration Process

This section provides generic skeleton for the battery integration process which was made by scanning through the processes that are relevant in the mobile applications scope.

##### Generic battery integration process

- ◆ **Assembly of battery module**
  - In this step the battery module is created. It consists of several integrated battery cells, as well electronics and sensors which measure the temperature and voltage. It may also contain circuits designed to switch the battery off and protect it from damage.
  - Cells are often between 2 – 4 volts each. Voltage for the whole module is dependent on the number of the battery cells. This number varies based on the application (car, vessel, stationary etc.).
  - Cells could be of a different type (cylindrical, prismatic, pouch, etc.).
- ◆ **Integration of the battery modules with the BMS**
  - Integrated modules are tested and stacked together

- Modules are connected via bus to the pack controller (which is essentially an ECU) to form the BMS.
- Proper enclosure must be granted
- Test checks might be executed throughout this stage
- End of line testing
- ◆ **Integration to the specific use case**
  - This means the integration of the BMS into the cars, vessels, etc.
  - Final integrated BMS must assure two-way communication between the battery and the rest of the system (information flow, commands, and error messages to be exchanged, state of health, state of charge).
  - Electrical connection within the BMS and the rest must be assured.

### 3.4.5 Battery Integration

This section provides description of the battery integration processes related to the mobile applications, namely the automotive and the maritime scope. It also considers and evaluates the differences and additions to the generic integration process described in.

#### **Automotive Applications Battery Integration Process:<sup>285</sup>**

##### **Integration of a cell into battery module**

A battery module contains electronics and sensors to measure temperature and voltage of cells. It also contains the circuits that allow the loading of cells to be switched off when maximum load is achieved. Typical case is that each cell has a capacity of 3 – 4 V and one module packages the cells e.g. 10 cells in one module with total 30 to 40 V in total.

##### **Integration of the battery modules with an electronic control unit**

The battery modules are connected via a bus system to the ECU and deliver the temperature and voltage data and have an interface to actuate the circuits to control the load. At this level, specific safety steps are being performed to further assure that temperature and voltage control works.

---

<sup>285</sup> Description based on ISCN experience

## Integration of the battery to the car

**Pilot hall:** Car makers have step wise development in samples which become more and more mature, based on the maturity different procedures can be executed (test drives of integrated batteries of vehicles, etc.)

**Car integration:** Standard production and integration procedures are accompanied by standardized set of tests. End of line testing is done to measure that all the diagnose functions work.

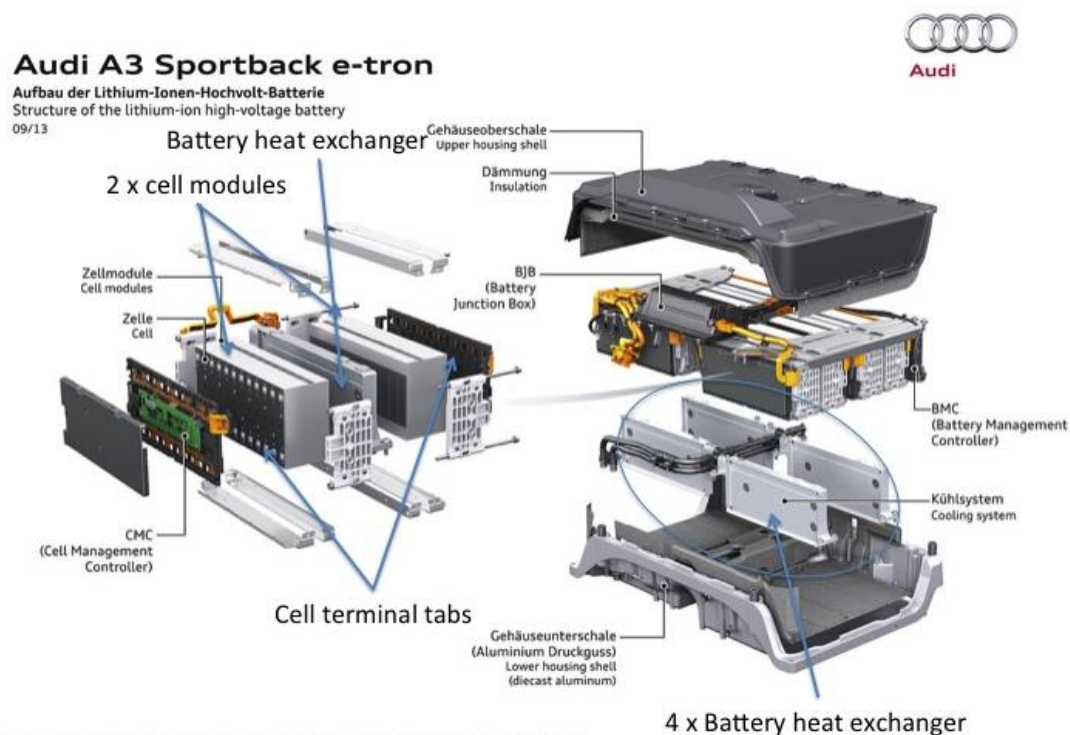

Image from Audi press release with additional annotation by AVID

Figure 57 Example of EV Battery<sup>286</sup>

In parallel to the process mentioned above there are software and electronics procedures that need to be executed:

- ◆ **ECU Software Component Integration:** This includes the software units.
- ◆ **ECU Software Integration:** Integration of all software components.
- ◆ **ECU Target System Integration:** Electronic and software, and interfaces.
- ◆ **ECU System Qualification:** Testing all ECU and software functions in a hardware and in the loop test, covering all diagnose functions.

<sup>286</sup> <https://avidtp.com/what-is-the-best-cooling-system-for-electric-vehicle-battery-packs/>

Car manufacturers do assessments on the ECU and software system and requests to cover Automotive SPICE<sup>287</sup>, Automotive SPICE 3.1<sup>288</sup>, and the ISO 26262<sup>289</sup>.

### Maritime Applications Battery Integration Process:<sup>290</sup>

#### Assembly of battery modules

A battery module contains electronics and sensors to measure temperature and voltage of cells. Typical case is that each cell has a capacity of 3 – 4 V and one module packages the cells. Module voltage can be in the range of 40 – 140V, depending on the type of battery system. Maritime batteries can contain cylindrical, pouch type or large-format prismatic battery cells. The production steps will vary depending on the cell format.

Product integration steps, example of an automated manufacturing for product containing cylindrical cells:

- ◆ **Logistics station:** The main task of this robotic station is to be able to take the cells from the cell shipping container, measure voltage and impedance, and deliver the cells to the cell stacking robot.
- ◆ **Cell stacking station:** The cell stacking takes the cells from logistics station and puts them into the cell carrier.
- ◆ **Welding station:** Placing the bus bars and welding the bus bars to the cells.
- ◆ **Cell module bank assembly station:** Puts number of cell carriers into a module.
- ◆ **Busbar assembly station:** Connects number of cells carries.
- ◆ **Final module assembly station:** Covers are put on.
- ◆ **End of line station:** At End of line the quality check is performed. The End of line must be able to detect missing welds, low voltages, errors in temperature readings etc.

<sup>287</sup> VDA QMC, (2018). Automotivespice.com. Retrieved August 04, 2020, from <http://www.automotivespice.com/>

<sup>288</sup> VDA QMC Working Group 13; Automotive SIG (2017-11-01). Automotive SPICE Process Assessment / Reference Model [PDF]. [www.automotivespice.com](http://www.automotivespice.com).

<sup>289</sup> Sasmita. (2020, May 14). ISO 26262 Guidelines for Functional Safety in Automotive. Retrieved August 04, 2020, from <https://www.embitel.com/blog/embedded-blog/iso-26262-compliant-safety-planning-for-functional-safety-automotive>

<sup>290</sup> Description based on CORVUS experience

### Assembly of pack controller

Electronic module that calculates state of charge and state of health. It also determines if the battery modules are used within the specification.

The pack controller contains power electronics and fuses to prevent abuse of the battery system. The logic within the pack controller controls the contactors that can turn off the battery pack. The pack controller often contains pre-charge that ensures a smooth connection of the battery to the DC/AC converter.

### Integration into the vessel

In the vessel integration step the batteries are integrated with the other parts of the vessel system. Details will vary depending on which company that has supplied the energy management system, the DC/AC converter, etc. Generally, the system must allow duplex communication between the battery and the rest of the system where commands and alarms must be allowed to be exchanged. Information about the battery state of charge and state of health is also sent from the battery to the bridge. This step also includes electrical connection between the battery system and the rest of the vessel creation.

### 3.4.6 Job Roles and Skills

This section provides an overview of the job roles and skills that have been found during the first iteration of the desk research and mapped according to a framework which is described in **section 2.4**.

Battery integration is heavily dependent on the BMS which is described and evaluated in the sections above. As for the first steps of the battery integration process the battery modules must be assembled. At this stage, the **Cell Module Engineers** are present, as well as **Battery Engineers** and **Battery Designers** who oversee the design of the parts of the battery other than the cells.

As for the second step of the integration process where assembled battery modules are integrated with the BMS there is a need for **Battery Management System Engineers, Thermal Engineer (BTMS)** and **Embedded System Engineers** who will develop and adjust the software needed and its coherency with the system hardware with expertise in automotive industry

like **Automotive Software Developers**. **Battery System Consultants** can be present when negotiating with the customers or third parties. Testing is performed by **Test Engineers** and **Battery Test Technicians**, specifically **Battery System Quality Assurance Engineers** who have the expertise in the BMS.

At the last step of the integration process the whole system is integrated into a specific use case where all job roles mentioned above might be present, as well as the **Application Engineers**. As for the specific applications, the **Automotive Battery Technicians**, **Car Mechanics** and **Electricians** with specialisation in vehicle battery assembly or other specific technicians might be present.

During this whole integration process, i.e. before the battery goes into the operational environment, compliance with the standards and the safety must be assured by **Compliance and Validation Engineers**, **Internal ISO Auditors**, **Safety Specialists**, **Functional Safety Engineers** and **Safety Managers** as well as the **Process Engineers** who actively seek the process improvement opportunities.



**Most notable skills and knowledge:**

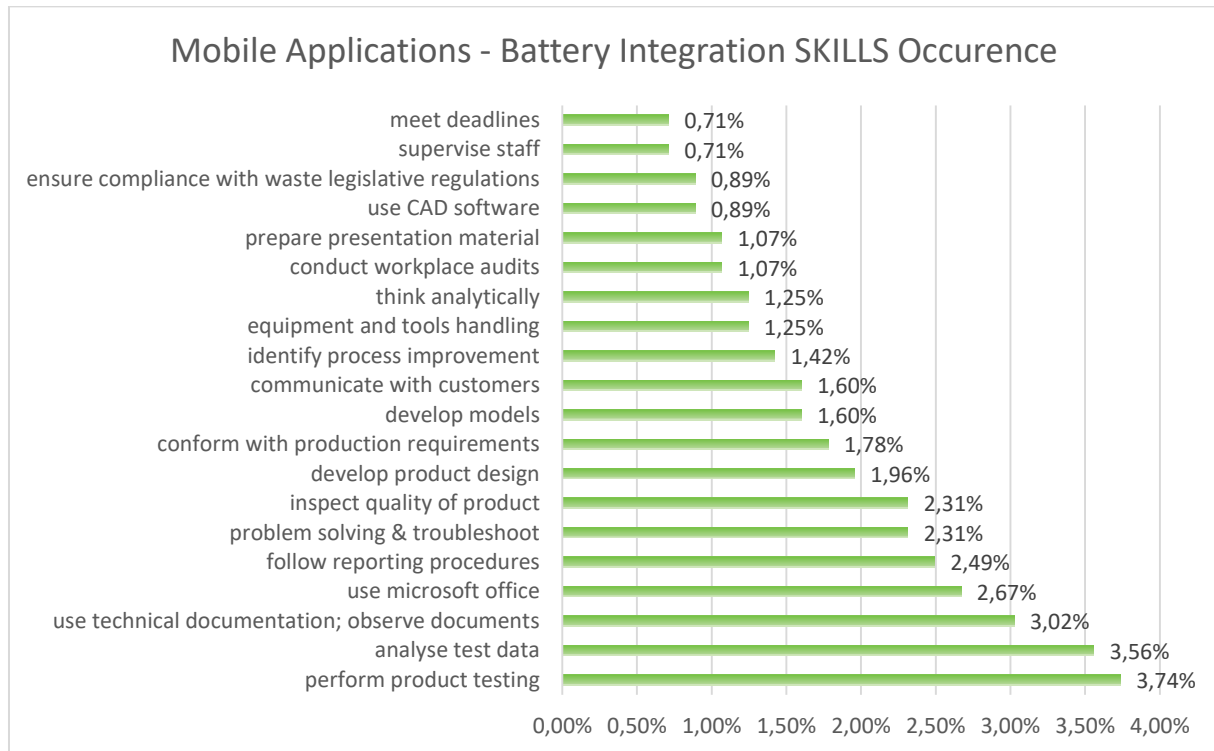

Figure 58 Skills Occurrence for Battery Integration

**Skills**

From the chart seen in (Figure 58) which is based on the researched job advertisements it is clearly visible that testing in general is a very important skill to have. Usage of Microsoft Office and being able to create and manage documentation is also important. Employees must also be able to negotiate with customers and conform with production requirements, follow reporting procedures, develop, and inspect the quality of product. Modelling and identification of process improvement are also important skills.



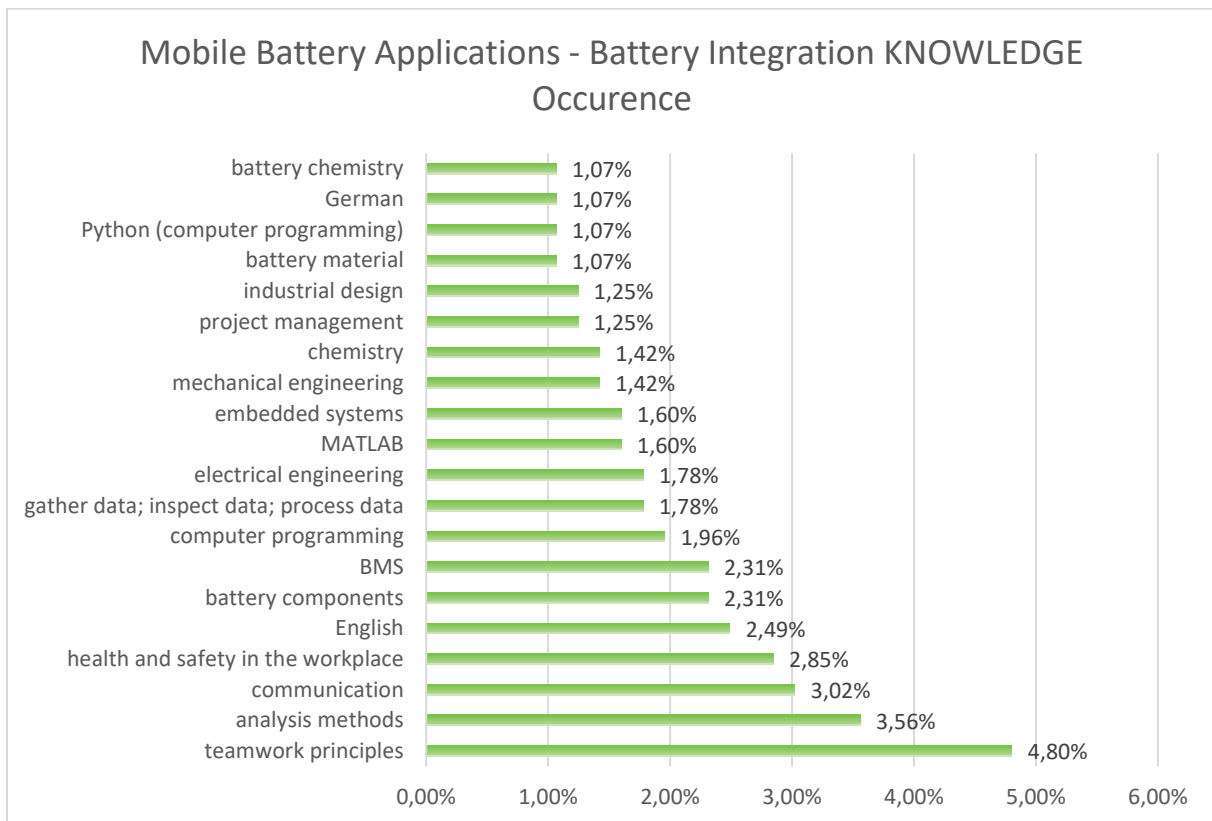

Figure 59 Knowledge Occurrence for Battery Integration

### Knowledge (Figure 59)

Teamwork principles are the most required pieces of knowledge, with communication also very important. English and German were frequently required. As for the technical knowledge, employees must have a good knowledge of BMS and embedded systems, analysis methods needed for specific tasks, computer programming, and data science, as well as a background in batteries as expected.

## 3.5 OPERATION, REPAIR AND MAINTENANCE

### 3.5.1 Passenger Cars

#### 3.5.1.1 Drivers of Change

The transition to electric vehicles in the EU (and similarly in some other parts of the world) has been mainly driven by the following factors:

#### 1) Regulations, incentives

**EU level** - The stricter legislation related to protection of the climate imposed on vehicle manufacturers, particularly the *Regulation (EU) 2019/631 setting CO<sub>2</sub> emission performance standards for new passenger cars and for new light commercial vehicles for 2020/21 and 2025*,

2030; the electrified vehicles can significantly help the car manufacturers to meet the targets and to avoid hefty fines. Another important piece of legislation is *Directive 2019/1161/EU on the promotion of clean and energy-efficient road transport vehicles* which introduces binding quotas concerning representation of clean vehicles, including electrified vehicles (EV), in fleets of public entities. Among the main drivers of electrification of the EU vehicle fleet are also *Directive 2014/94/EU on the deployment of alternative fuels infrastructure* supporting charging infrastructure deployment and standardisation, *Directive 2018/844/EU on the energy performance of buildings (Article 8)* supporting charging infrastructure in buildings and *Directive 2012/27/EU on energy efficiency*, where vehicle fleet electrification can help Member States to achieve the energy efficiency targets.

The regularly amended *Directive 70/220/EE on measures to be taken against air pollution by emissions from motor vehicles* setting exhaust emission limits (Euro 1 – 6 norms) requires installation of increasingly complicated and expensive devices in Internal Combustion Engine (ICE) vehicles and this, as a result, also supports future tipping the price parity in favour of electric vehicles.

National/Local level – To improve air quality and urban life, some cities have introduced restrictions on the entry of ICE vehicles into the city centres or incentives for EVs, such as free parking. Various other incentive schemes such as purchase subsidies, lower taxation, free or discounted highway fees and high-occupancy vehicle lanes, have been implemented by national Governments/local authorities.

## 2. The technological improvement

Other factors driving e-mobility (selection):

- ◆ Cheaper batteries with increased capacity, performance and endurance limiting the “range anxiety” of a driver.
- ◆ Availability and charging speed of public charging infrastructure.
- ◆ Innovative ways of payments such as mobile applications allowing to charge and pay at charging stations operated by various entities across the EU.

### 3. Changing consumer behaviour

Some of the private, public, and corporate entities have had preference for EVs due to climate and environmental concerns as well as increased attractiveness of the new technology. Other positive elements include easier operation / maintenance of EVs (lower running, servicing costs), positive customer experience (very good driving dynamics of the EVs, especially in cities) or no need of having a clutch / gearbox due to the high torque of the electric engine.

#### 3.5.1.2 Stakeholders

The stakeholders in the area of operation, repair and maintenance of EVs are quite diverse.

The non-exhaustive list may include the following activities and groups of relevant entities:

- ◆ Before placing a vehicle on the market, the **suppliers and car manufacturers** make sure vehicles comply with a complex set of quality, safety and environmental standards required by the type approval legislation introduced by the **EU and national regulatory authorities. Testing and certification companies** (e. g. TÜV SÜD/NORD, DEKRA) can also be involved in the process. **Standardisation bodies** are relevant to ensure safety and compatibility issues.
- ◆ **Dealerships and leasing companies** need to be trained to be able to provide the right information to **customers** concerning specifics of the electrified vehicle operation, although relevant information shall also be included in manuals provided by car manufacturers.
- ◆ **Car rental companies** should provide information on the use and charge of the electric vehicle, including instructions on how to behave in the event of car damage or accident.
- ◆ **(Professional) drivers and driving schoolteachers** need to be trained to be well aware of the specifics of the electric cars to ensure proper use, road safety and good maintenance of the vehicle and its battery.
- ◆ After being sold, EVs need to be regularly checked and/or, when needed, repaired by authorised or independent **car repair shops**.
- ◆ Mandatory periodical vehicle checks must be carried out by public or certified **entities responsible for periodical technical inspections**.

- ◆ Dense charging network for EVs is being installed across the EU in private, semi-public (shopping centre, hotel...), corporate or public places. This requires **personnel for charging infrastructure** design, installation, and maintenance.
- ◆ New business services and business models are being developed by **smart charging or EV fleet maintenance companies** with a specific know-how in IT and telematics.
- ◆ **Insurance companies** need to understand characteristics of EVs to be able to introduce relevant products
- ◆ In case an EV is not mobile due to damage or a collision, technical failure, the battery running out of electricity during the trip, **towing, on-road assistance and emergency charging services companies** qualified to be able to handle an EV should be able to step in.
- ◆ **Rescue services** need to be trained to be able to effectively assist in case of an accident. **Fire brigades and safety inspectors** need to be able to prevent and address emergency situations such as an accident or collision of an EV and to remove/tow away the car wreck, including possible intervention in difficult conditions such as underground garages.
- ◆ Innovative concepts relevant to operation, repair, and maintenance of EVs are being researched by **R&D organisations**.
- ◆ Educational institutions and relevant Government bodies (**Ministries of Labour, Ministries of Education...**), in close cooperation with relevant authorities at the EU level, should ensure relevant education and trainings are created and provided to the above-mentioned stakeholders.

### 3.5.1.3 Technologies

Currently, there are passenger cars with different degrees of electrification and battery technology in operation:

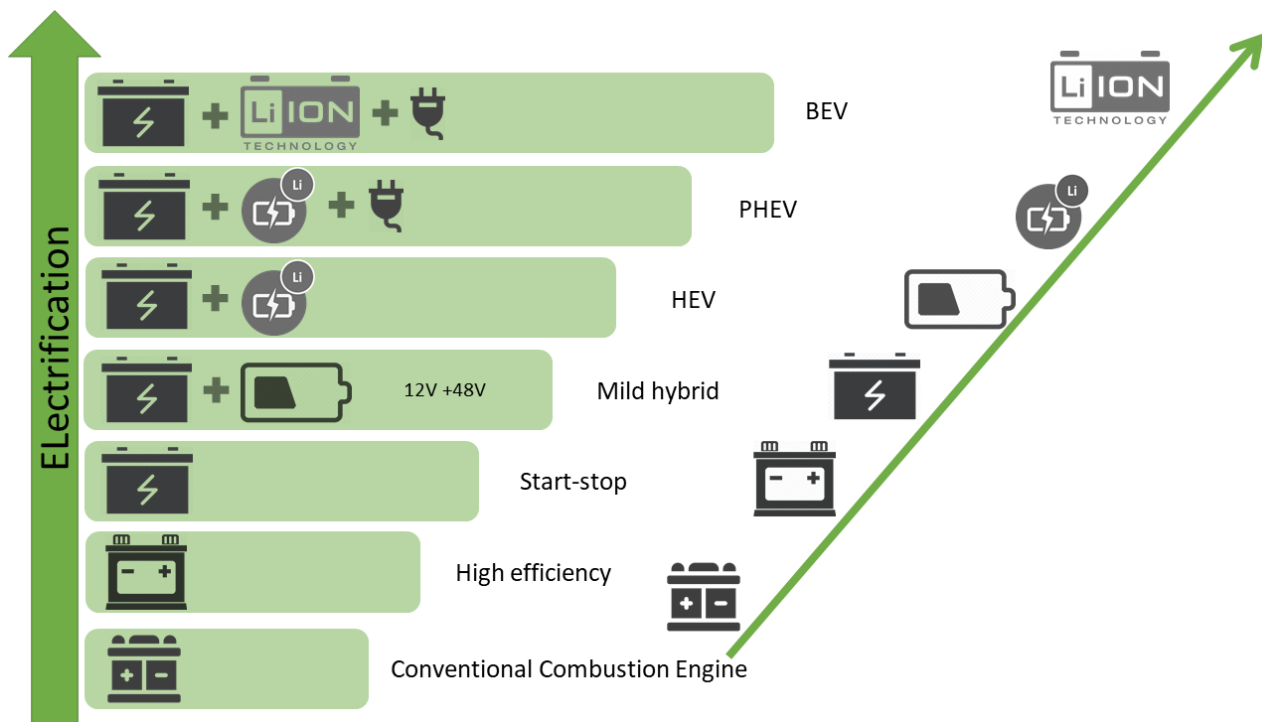

Figure 60: Degree of electrification of the vehicle<sup>291</sup>

- ◆ **Battery electric vehicle (BEV)** – uses electric drive only. It needs to be charged from an external electricity source; some energy may be recovered during braking. Despite further expected cost reduction, the high voltage battery with a value-added share of up to 50 percent is seen as the main core of an electric vehicle<sup>292</sup>.
  - The mainstream technology today is Lithium Nickel Manganese Oxide (NMC)/Lithium Iron Phosphate (LFP), while NMC and solid-state technologies will be targeted for development by 2030. Annual European production of EV lithium batteries today is between 5 and 15GWh and is estimated to reach 200-400GWh by 2030, depending on the market scenario used<sup>293</sup>.

There are two methods of electric vehicle charging from the power grid:

**Alternating Current (AC) charging** - electric current is produced and conveyed over long distances as alternating (AC). 230V and 50 Hz sockets are standard in most parts

<sup>291</sup> E-mobility Battery R&D Roadmap 2030 – Battery technology for Vehicle Applications, EUROBAT, June 2030 (edited)

<sup>292</sup> After Sales Service Strategies for HV Battery Diagnosis and Repair, N. Schreier, A. Einspiegel, L. Seibt, 2019

<sup>293</sup> White paper “Battery innovation roadmap 2030”, EUROBAT, June 2020

of Europe. However, batteries need direct current (DC) for their operation. Therefore, car's on-board charger is used which receives AC and converts it into DC, which is then sent to the car battery.

**Direct current (DC) charging** - or so-called fast charging, is done using a DC charging outlet, which can change AC to DC, it then "bypasses" the on-board charger of the electric car and sends this DC via BMS (Battery Management System) to the battery, as instructed by the vehicle's charging control system.<sup>294</sup>

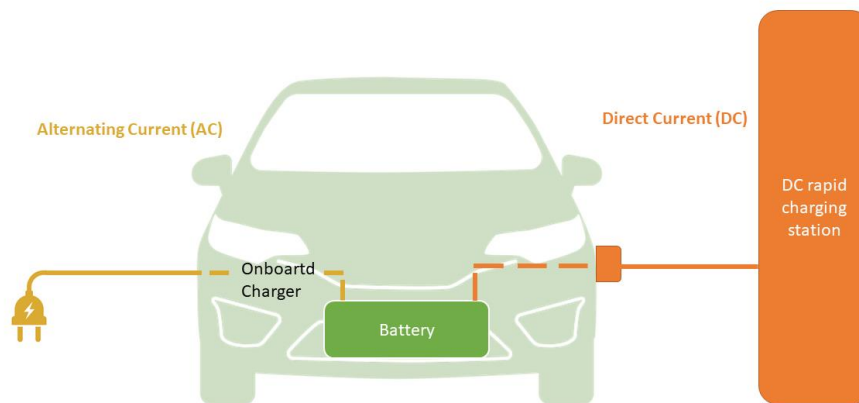

Figure 61: BEV charging options<sup>295</sup>

The maximum speed at which a car can receive energy using slow AC or rapid DC charging varies from model to model. In general, middle-class, and premium car models can achieve higher charging speeds than cheaper ones.

<sup>294</sup> <https://www.evexpert.eu/tips-advice-manual-curiosities-information-electromobility-evexpert/basics-of-electromobility-basic-abc/ac-dc-charging-electromobil-current-alternating-direct> last accessed on 28.08.2020

<sup>295</sup> [https://wallbox.com/en\\_uk/faqs-difference-ac-dc](https://wallbox.com/en_uk/faqs-difference-ac-dc) last accessed on 28.08.2020

Table 5 Examples of BEV models with main parameters

Car model	Battery technology	Voltage (V)	Capacity (kWh)*	AC charging (kW)	DC charging (kW)	Consumption (kWh/100 km)**
Tesla Model S	Cylindrical (18650), Li-ion NCA	402	85	17,2	200	19
BMW i3	Prismatic, Li-ion NMC	352	42,2	11	50	13,1
Škoda Citigo-e iV	Pouch, Li-ion NMC	307	36,8	7,2	40	14,8
VW eGolf	Prismatic, Li-ion NMC	323	35,8	7,2	50	13,2

\* Note: There is a difference between the **nominal** and **usable** battery capacity, due to the need to have some energy reserve a „buffer“ to prevent the battery from being either totally discharged or overcharged which could lead to damage of the battery and shortening of its lifespan. For example, the nominal battery capacity of Citigo-e iV is 36,8 kWh but the usable capacity is only 32,3 kWh

\*\*Note: Consumption depends on tyre width and structure, vehicle load and climatic conditions.

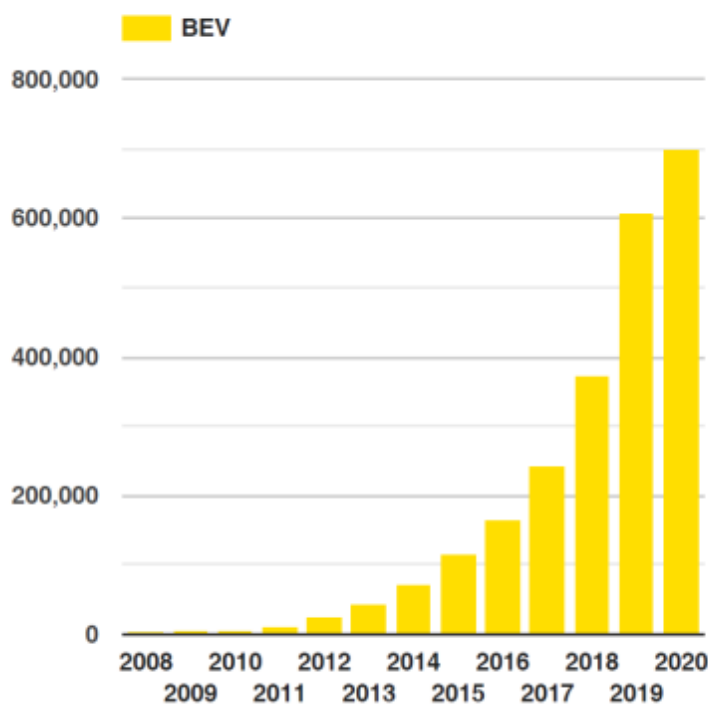
 Figure 62: BEV registrations in the EU (as of July 2020) <sup>296</sup>

- ◆ **Plug-in hybrid electric vehicle (PHEV)** – combines electric and internal combustion drive (mostly petrol). The battery can be recharged using external electric energy source, mostly using AC charging<sup>297</sup>.

<sup>296</sup> <https://www.eafo.eu/vehicle-statistics/m1> last accessed on 28.08.2020

<sup>297</sup> Mitsubishi Outlander is one of the few PHEV vehicle types with AC as well as DC charging possibility

Table 6 Examples of PHEV models with main parameters

Car model	Battery technology	Capacity (kWh)	AC charging (kW)	Fully electric range (km)
Škoda Superb iV	Prismatic, Li-ion	13	3,6	55
VW Passat GTE	Prismatic, Li-ion	13	3,6	60
BMW i8	Prismatic, Li-ion NMC	11,6	3,7	40
Toyota Prius	Cylindrical (18650), Li-ion NMC	9	3,3	55

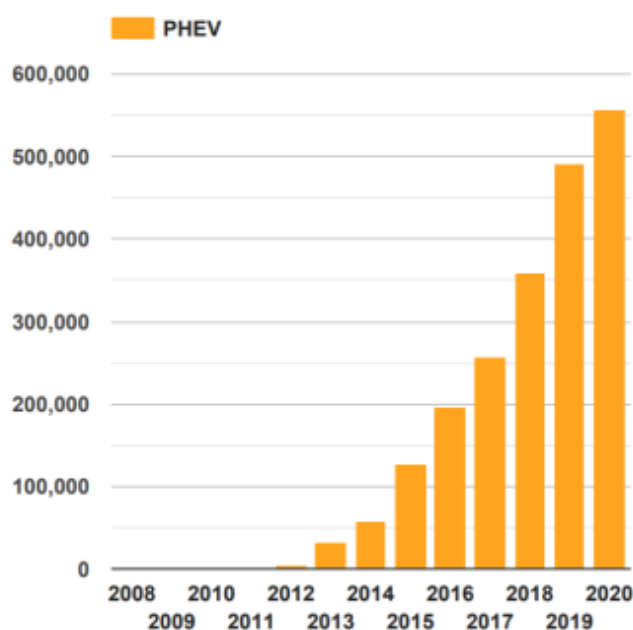
 Figure 63: PHEV registrations in the EU (as of July 2020)<sup>298</sup>

- ◆ **Hybrid electric vehicle (HEV)<sup>299</sup>** – combines electric and internal combustion engine (ICE). Its battery cannot be recharged using external electric energy source.

Table 7 Examples of HEV models with main parameters

Car model	Battery technology	Capacity (kWh)
Ford Mondeo	Li-ion	1,3
Toyota RAV4	NiMH, prismatic	1,6
Toyota Corolla	NiMH, prismatic	1,3
Lexus IS 300h	NiMH, prismatic	1,6

<sup>298</sup> <https://www.eafo.eu/vehicle-statistics/m1> last accessed on 28.08.2020

<sup>299</sup> European Alternative Fuels Observatory (EAFO) does not gather data on HEV vehicles sales



While a large part of the existing hybrid vehicle fleet has a nickel metal hydride (NiMH) battery, it is expected that the NiMH battery will disappear from the vehicle sector in the coming years<sup>300</sup>.

- ◆ **Mild hybrids<sup>301</sup>**– in Mild hybrids, the ICE is always used as the vehicle's propulsion device, and an auxiliary electric motor incorporated in the vehicle's alternator (combo) is also used during starts and acceleration. The car cannot run on electricity alone. The vehicle uses a 48 V power supply.<sup>302</sup>

The mild hybrid can “coast” - temporarily switch off the ICE combustion engine while in motion (as opposed to conventional ICEs with Start/Stop system) to save fuel and lower emissions. Vehicles use a 12 V lead-acid battery for auxiliary functions (such as control, safety and lighting). Its capacity depends on the combustion technology and engine parameters.<sup>303</sup>

Table 8 Examples of Mild-Hybrid models with main parameters

Car model	Battery technology	Voltage (V)	Capacity (kWh)
Volkswagen Golf 1.5 eTSI	Li-ion	48	1
Audi A8 3.0 TFSI	Li-ion	48	0,48
Mercedes Benz CLS 450	Li-ion	48	1

- ◆ **Conventional ICE vehicles / with a start stop system / with high efficiency battery<sup>304</sup>**  
These are vehicles with an ICE running on petrol, diesel, CNG etc. The stop / start system switches off the engine when vehicle is in standstill, thus reducing emissions when engine would otherwise be idling. Advanced charge management is used to

<sup>300</sup> Kowal Julia (2015): Grundlagen und Überblick über die Batterietechnik, in: Tschöke, Helmut (Hrsg.): Die Elektrifizierung des Antriebsstrangs: Basiswissen, Wiesbaden, Springer Vieweg, S. 52-60.

<sup>301</sup> European Alternative Fuels Observatory (EAFO) does not gather data on micro / mild hybrid vehicles sales last accessed on 28.08.2020

<sup>302</sup> <https://www.carbuyer.co.uk/tips-and-advice/159947/what-is-a-mild-hybrid> last accessed on 28.08.2020

<sup>303</sup> <https://x-engineer.org/automotive-engineering/vehicle/hybrid/micro-mild-full-hybrid-electric-vehicle/> last accessed on 28.08.2020

<sup>304</sup> European Alternative Fuels Observatory (EAFO) does not gather data on ICE vehicles sales

change the charging power of a 12V battery, which reduces fuel consumption and reduce emissions.<sup>305</sup>

Vehicles use a 12 V lead-acid battery for auxiliary functions (such as control, safety and lighting). Its capacity depends on the combustion technology and engine parameters.

### EV share increase in Europe 2010 - 2019

Global sales of passenger EVs jumped from 450,000 in 2015 to 2.1 million in 2019 and are expected to rise further.<sup>306</sup>

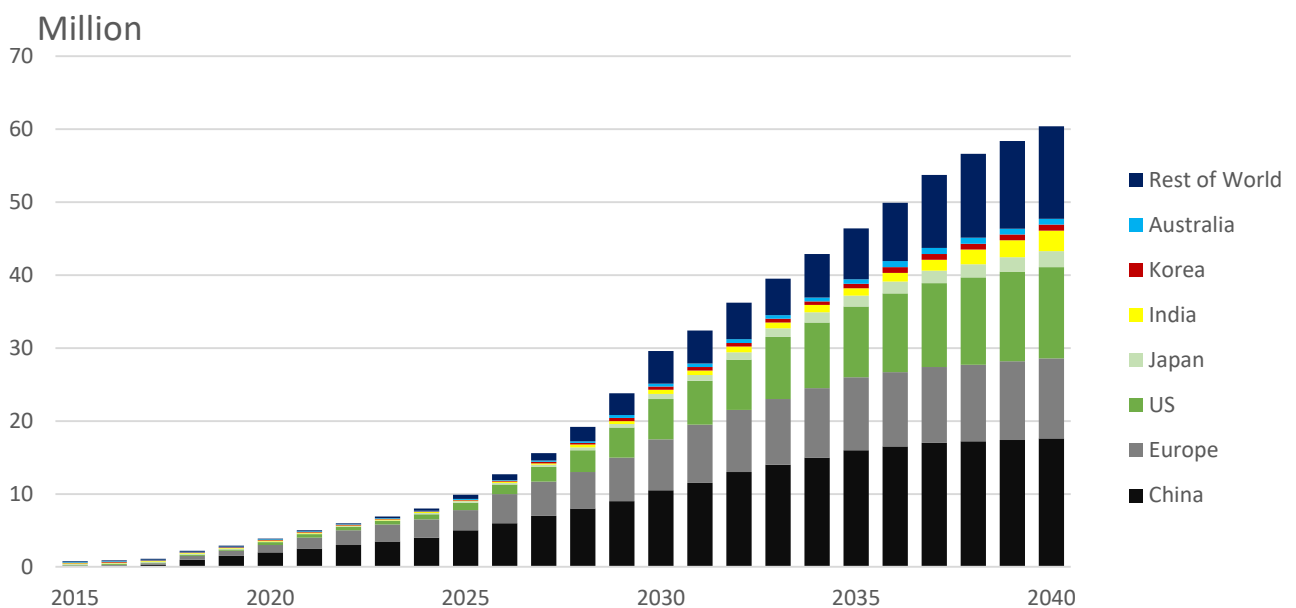

Figure 64: Global passenger EV sales

Demand for lithium-ion batteries for passenger EVs (in GWh/year) is also expected to increase significantly.<sup>306</sup>

<sup>305</sup> <https://www.canadianfuels.ca/Blog/2016/September-2016/ICE-HEV-PHEV-and-BEV-%E2%80%93-What-they-mean-and-what-s-under-the-hood/> last accessed on 28.08.2020

<sup>306</sup> <https://about.bnef.com/electric-vehicle-outlook/> last accessed on 28.08.2020

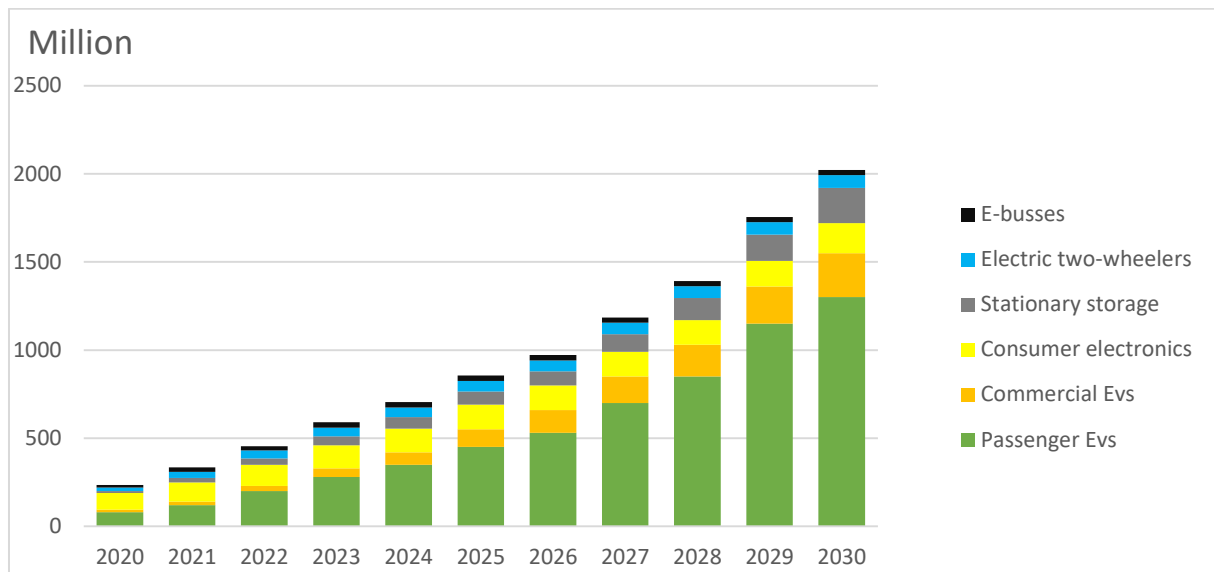

Figure 65: LIB demand outlook

The fuel cell (hydrogen) technology (Fuel Cell Electric Vehicle, FCEV) is expected to start gaining ground in global passenger vehicles sales starting from approx. 2030/2035<sup>307</sup>.

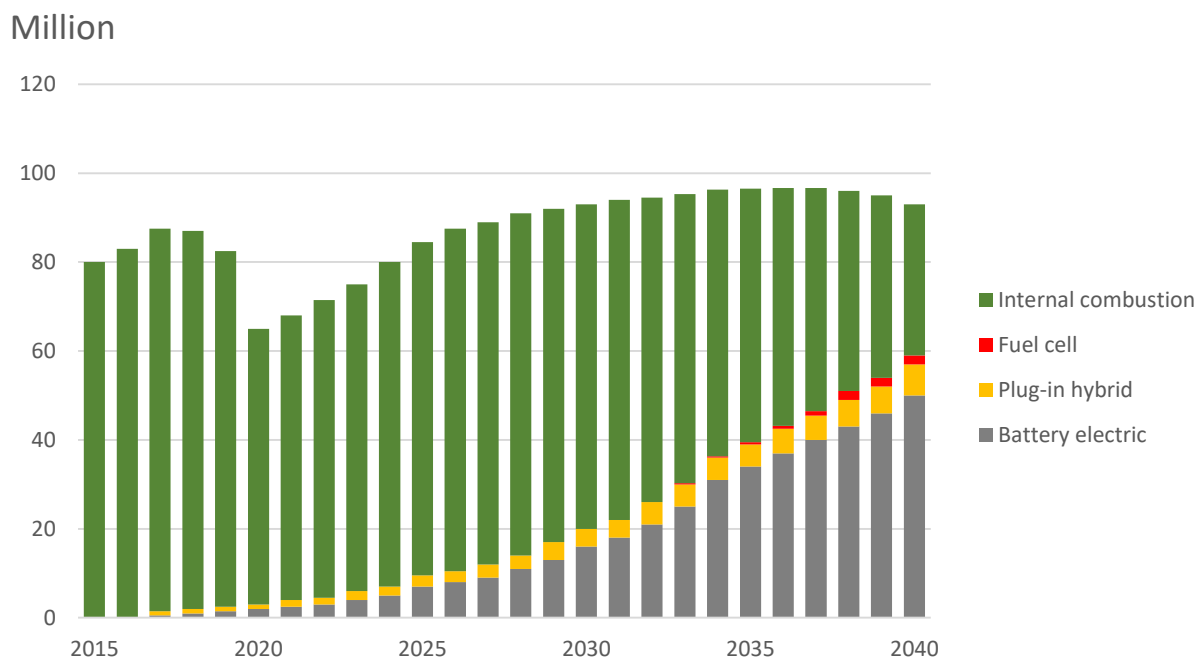

Figure 66: Global annual passenger vehicle sales by drivetrain

The battery capacity installed in fuel cell vehicles will be smaller compared to BEVs and PHEVs. Current fuel-cell model Hyundai Nexu, for example, has a 1.56kWh battery,<sup>308</sup> which serves primarily to support start-up performance before the chemical reactions in the cells

<sup>307</sup> <https://bnef.turtl.co/story/evo-2020/page/3/3?teaser=yes> last accessed on 28.08.2020

<sup>308</sup> <https://www.hyundai.co.uk/new-cars/nexo> last accessed on 28.08.2020

are fully started, and for recuperation.

### 3.5.1.4 Operation of Electric Vehicles

#### Aspects of electric vehicles testing<sup>309310</sup>

Before passenger cars can get to the road, they must be tested to ensure compliance with regulations addressing **safety, compatibility, and environmental** issues. EV testing goes beyond homologation testing for the vehicles and their components. It also covers the charging stations for EV – which can be based on either AC or DC technology – and the associated systems that enable EVs, charging stations and back-office systems to communicate with one another (interoperability or communication testing).

Additionally, EV testing covers battery packs and the modules they are made of, containing large numbers of battery cells. Battery cells and battery packs are each subject to different testing requirements.

Last but not least, it entails the conformity testing of all electrical components such as plugs, cables, connectors, wiring and switches. From a testing and certification perspective, EVs bring together two previously separate worlds: the automotive industry (ISO standards) and the electrical industry (IEC standards).

Services of **product testing and certification entities** with technical laboratories and testing facilities (such as DEKRA or TÜV SÜD/NORD) include:

- functional safety (type approval, IEC 26262);
- electrical safety (CB, EN 50604, ISO 18243, KEMA KEUR, IEC 62660);
- performance testing (ISO 12405, ISO 18243, ISO 15118, IEC 62660);
- environmental testing (ISO 12405, IEC 62660, ISO 16750, IEC 60068);
- development testing;
- validation testing or homologation testing (R100, UN 38.3 R10).

<sup>309</sup> <https://www.dekra-product-safety.com/en/electric-car-testing>; last accessed on 28.08.2020

<sup>310</sup> <https://www.tuv-sud.cz/cz-en/industry/automotive-transportation/e-mobility/e-mobility-battery-services>  
last accessed on 28.08.2020

## EV charging

EVs can be charged at

- ◆ home - 50-80%<sup>311</sup> of all charging sessions
- ◆ work place / corporate premises - 15-25%
- ◆ other locations - such as public slow charging locations or fast charging stations along distance travel corridors - less than 10%

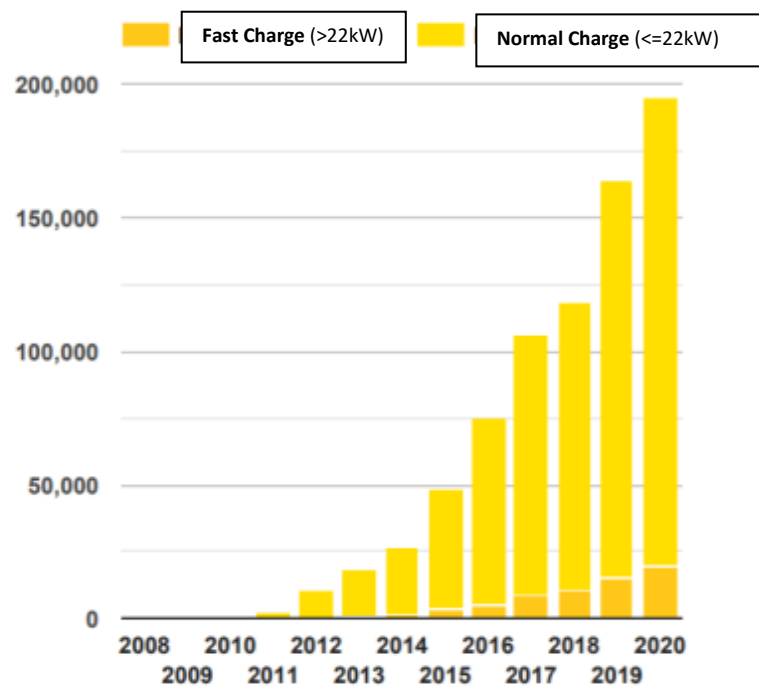

Figure 67: Total number of public charging points in the EU (as of July 2020)<sup>312</sup>

## Future technologies, new business models, services

- ◆ **Wireless charging** – stationary (while the vehicle is parked) or dynamic – using e. g. special installations in the highway surface.
  - During stationary charging, the vehicle stops at the parking space and (automatically) starts charging. Car uses coils in the chassis, other coils are in the parking floor. The vehicle is charged by the on-board charger.

<sup>311</sup> <https://www.sciencedirect.com/science/article/pii/S136192091930896X> last accessed on 28.08.2020

<sup>312</sup> [https://www.eafo.eu/uploads/temp\\_chart\\_/data-export-270720.pdf](https://www.eafo.eu/uploads/temp_chart_/data-export-270720.pdf) last accessed on 28.08.2020

- There are two **dynamic charging** options. One uses long coils in the shape of rails and the coils are installed on the road surface. The second uses small coils located in the roadway. The vehicle is charged by the on-board charger.<sup>313</sup>

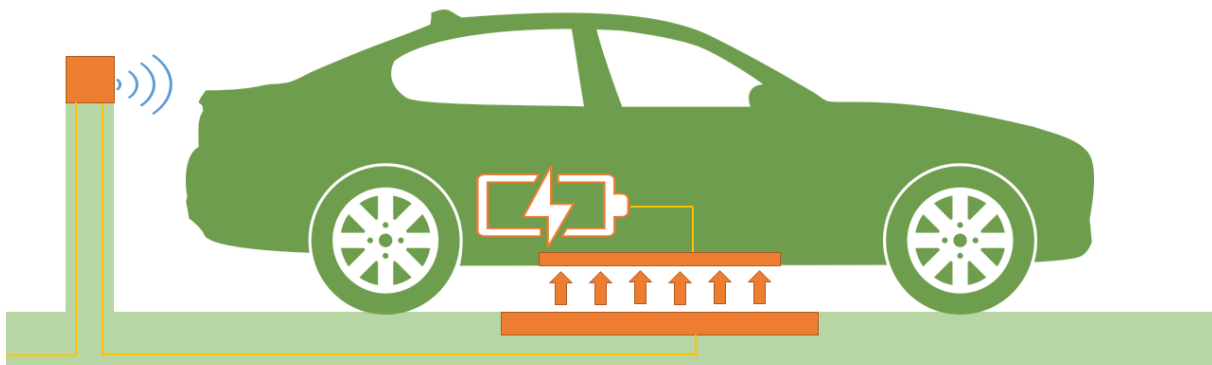

Figure 68: BEV wireless charging<sup>314</sup>

- ◆ **Battery pack swapping** – using mechanic devices able to replace a whole empty battery pack in a car with a charged one (such as the failed project “Better Place” in Israel)<sup>315 316</sup>.
- ◆ **Vehicle-to-grid applications (V2G)** – the EV can be used in the future as a storage of the energy able to both send and receive the energy from and to the grid and thus mitigate the stress on the grid. This would make it possible to take full advantage of the green sources of energy by storing most or all the green energy generated and shaving off power consumption peaks<sup>317</sup>.

Beyond the charging hardware (most of the current EV models can only accept energy from the power grid and are not able to deliver it back) inside and outside the vehicle, the V2G still faces several challenges such as the impact on the State of Health (SoH) of the battery or manufacturer`s warranty issues.

<sup>313</sup><https://www.sciencedirect.com/science/article/pii/S221509861830154X> last accessed on 28.08.2020

<sup>314</sup><https://www.intelligentliving.co/britains-streets-trial-wireless-electric-car-chargers/> last accessed on 28.08.2020

<sup>315</sup><https://qz.com/88871/better-place-shai-agassi-swappable-electric-car-batteries/> last accessed on 28.08.2020

<sup>316</sup><https://www.youtube.com/watch?v=H5V0vL3nnHY> last accessed on 28.08.2020

<sup>317</sup><https://www.smart-energy.com/industry-sectors/electric-vehicles/evs-on-the-grid-challenges-and-opportunities/> last accessed on 28.08.2020

- ◆ **Online battery status tracking services** - the specifics of electrified vehicles, such as still limited battery capacity and therefore limited range, longer charging time compared to refuelling of a conventional car and insufficient charging infrastructure, open up space for new business models and services. The need to monitor and manage the state of charge of the battery is especially relevant for the management of company fleets, in which there may be tens, hundreds or even thousands of vehicles.

To reduce the **complexity of management of such a fleet**, some companies have already been launching online tracking services where a (telematics) device installed in the car, GPS and mobile network may be used for real-time monitoring and administration of electric vehicle fleets including battery State of charge (SoC), State of health (SoH), charging information, maintenance alerts and other relevant and potentially valuable information.<sup>318 319</sup>

- ◆ **Rescue charging services** - In the case of countries with a limited number of charging points or even where the network is quite developed but not adjusted to the number of EVs (meaning that vehicles cannot recharge as the chargers are already in use), it will be necessary to envisage rescue charging services, not necessarily as companies dedicated solely to this purpose but probably as part of a company / service provider that already runs this kind of activities (tow-away, repair, rescue), especially for the situation where it is really difficult or dangerous to tow-away the stranded car<sup>320</sup>. There are already some pilot projects in the area of mobile charging.<sup>321</sup>
- ◆ Extreme weather - very hot or very cold - impacts range of EVs. The additional heating or cooling needed for passenger comfort requires more energy than more moderate temperatures would. Cold batteries also have greater resistance to charging and do not hold a charge as well. EV manufacturers and researchers are improving **temperature-control technology** to compensate for some of these issues. For

<sup>318</sup> <https://www.expertmarket.co.uk/vehicle-tracking/electric-vehicle-fleet-management> last accessed on 28.08.2020

<sup>319</sup> [https://www.eurowag.com/wp-content/uploads/EW\\_Position\\_Paper\\_Clean\\_Mobility.pdf](https://www.eurowag.com/wp-content/uploads/EW_Position_Paper_Clean_Mobility.pdf) last accessed on 28.08.2020

<sup>320</sup> <https://www.youtube.com/watch?v=hSWVx36OC8g> last accessed on 28.08.2020

<sup>321</sup> <https://skodaautodigilab.com/en/news/e-mona-now-charges-shared-car4way-evs> last accessed on 28.08.2020

instance, several models are now available with **battery heaters** or other technology to heat the battery and improve efficiency in cold climates. **Pre-heating or pre-cooling the cabin** of a BEV or PHEV while it is still plugged in can extend its electric range, especially in extreme weather.<sup>322</sup>

## EV design and safety issues

### Safety aspects related to EV batteries<sup>323</sup>

As more EVs become operational on the roads, the number of traffic accidents involving EVs is likely to rise. While the risks associated with conventional vehicles are well-defined and generally accepted by society, time and more awareness are needed to achieve a similar comfort level for EVs, as safety plays a prominent role in consumers' acceptance of new technologies.

When it comes to EVs, one of the most significant aspects is the risk that the LIB may ignite after a significant amount of time, after being damaged, or reignite after having been extinguished. This matter not only concerns firefighters, but also those involved in handling damaged EVs through towing, workshop, scrapyard or recycling activities or working in R&D, testing, and standardisation fields.

### Safety issues of battery cells and packs

In this part of the text, the **focus is on lithium-ion batteries (LIBs)**, as this technology represents the vast majority of passenger vehicles (BEVs and PHEVs) in operation and, therefore, testing, and real experience in traffic is most frequent.

The primary safety concern with LIBs originates from the individual battery cells that make up the battery pack; there is a risk of **thermal runaway** (triggered by a chain of chemical reactions inside the battery resulting in accelerated increase of internal temperature), where the

<sup>322</sup><https://www.energy.gov/eere/electricvehicles/maximizing-electric-cars-range-extreme-temperatures> last accessed on 28.08.2020

<sup>323</sup> Source of information primarily used in this subchapter: R. Bisschop, O. Willstrand, F. Amon, M. Rosengren Fire Safety of Lithium-Ion Batteries in Road Vehicles, RISE Report 2019:50



outcome can be complete combustion of the LIB accompanied by the release of gas, flying projectiles and jet flames.<sup>324</sup>

**Failure of a cell** may be the result of inadequate cell design or manufacturing flaws, external abuse (thermal, mechanical, electrical), poor battery assembly design or manufacture, battery electronics design or manufacture, or support equipment (i.e. battery charging/discharging equipment) design or manufacture. The **primary battery risks** are generally a result of external short circuits, internal short circuits, high or low temperatures, overcharge or over-discharge. These mechanisms can result in exothermic reactions within the battery.

There are many different **types of lithium-ion batteries**, with different packaging and chemistries but also variations in how they are integrated into vehicles. These characteristics have implications for their safety:

◆ **shape of the cells:**

- **cylindrical** (high mechanical stability, arrangement in a rectangular shape less efficient, but easier for air to flow freely resulting in a more efficient thermal management).
- **prismatic** (easier to integrate in a battery pack, but it is more challenging to regulate their temperatures).
- **pouch cells** (very high packaging efficiency of 90-95 %, temperature management is important as it is more difficult to dissipate heat, soft construction means more vulnerability to external mechanical damage)<sup>325</sup>.

- ◆ **chemistries of cathodes** - automotive industry opt for safer cathode materials (with higher thermal stability) such as Lithium Iron Phosphate (LFP) may be a preferred option from a fire and heat generation perspective, it may however not be as favourable when considering the release of toxic gases or the risk for explosion<sup>326</sup>), Lithium Nickel Manganese Cobalt Oxide (NMC), Lithium Manganese Oxide (LMO) or

<sup>324</sup> F. Larsson, Lithium-ion Battery Safety: Assessment by Abuse Testing, Fluoride Gas Emissions and Fire Propagation, Gothenburg: Chalmers University of Technology, 2017

<sup>325</sup> "Battery Packaging - Technology Review," E. Maiser, in AIP Conference Proceedings, 2015

<sup>326</sup> Ruiz, V. and Pfrang, A., "JRC exploratory research: Safer Li-ion batteries by preventing thermal propagation - Workshop report: summary & outcomes," Publications Office of the European Union, Luxembourg, 2018

## blends of different cathode materials

 Table 9 LIB cathode active materials' parameters<sup>327</sup>

Cathode	Capacity (Ah/kg)	Operating Voltage (V)	Energy Density (Wh/kg)	Life	Safety	Cost
LFP	160	3,4	544	High	High	Medium
LMO	100 - 120	4,1	410	Low	Medium	Low
LCO	160	3,9	624	Medium	Low	Medium
NCA	180 - 200	3,7	740	Medium	Low	High
NMC	160	3,8	592	High	Medium	High

- ◆ **anode materials** - commercially available are different carbon configurations and Lithium Titanate Oxide (LTO)<sup>328</sup>, LTO offers better thermal stability (but has some disadvantages like cost, cell capacity etc.)
- ◆ **electrolytes**<sup>329</sup> used for LIBs normally consist of Lithium Hexafluorophosphate (LiPF<sub>6</sub>) salts and organic carbonate solvents such as Ethylene Carbonate (EC), their components operating temperature is limited, and typically lies between -20 °C and +50 °C; another major issue is flammability (the most flammable solvent is Ethyl Acetate (EA)); alternative electrolytes are being developed (ex. nonaqueous fluoro-compounds, ionic liquids and polymeric electrolyte)
- ◆ **separator** plays an important role in terms of safety<sup>330</sup>, LIBs with organic electrolytes typically use microporous separator, fabricated from material such as polyethylene (PE) and polypropylene (PP); may also be ceramic or composite based (could offer improvement in terms of mechanical strength or thermal resistance)
- ◆ cells are connected in a **module**; as voltages greater than 30 VAC or 60 VDC are considered harmful for humans, restricting the voltage of battery modules is thus

<sup>327</sup> Adroit Market Research, 2019; Safety of Lithium-Ion Batteries in Road Vehicles, RISE Report 2019:50

<sup>328</sup> "Li-Ion Battery Materials: Present and Future," N. Nitta, F. Wu, T. Lee and G. Yushin, Materials Today, vol. 18, pp. 252-264, 2015

<sup>329</sup> Li, Q., Chen, J., Fan, L., Kong, X. and Lu, Y., "Progress in Electrolytes for Rechargeable Li-Based Batteries and Beyond," Green Energy and Environment, vol. 1, pp. 18-42, 2016; X. Kang, "Electrolytes and Interphases in Li-Ion Batteries and Beyond," Chemical Reviews, vol. 114, pp. 11503-11618, 2014.

<sup>330</sup> Arora, P. and Zhang, Z., "Battery Separators," Chemical Reviews, vol. 104, no. 10, pp. 4419-4462, 2004; F. Larsson and B.-E. Mellander, "Lithium-ion Batteries used in Electrified Vehicles – General Risk Assessment and Construction Guidelines from a Fire and Gas Release Perspective," RISE Research Institutes of Sweden, SP Rapport 2017:41, 2017

beneficial from a handling and shipping perspective

New technologies, like **solid-state batteries** having no liquid or flammable electrolytes, may reduce the risks of gassing/venting and fire in the future.

### Safety issues of the vehicle design

- ◆ Batteries are stored in a “**safe zone**” of a passenger car - most common are the “Floor” (larger target for damage by an object on the road) and “T” configurations (ensuring more protection of the battery pack against frontal collision and side impact), or “Rear” solution; different projects are carried out to find out post-crash risks and come up with recommendations for vehicle design (for example EVERSAFE project)<sup>331</sup>

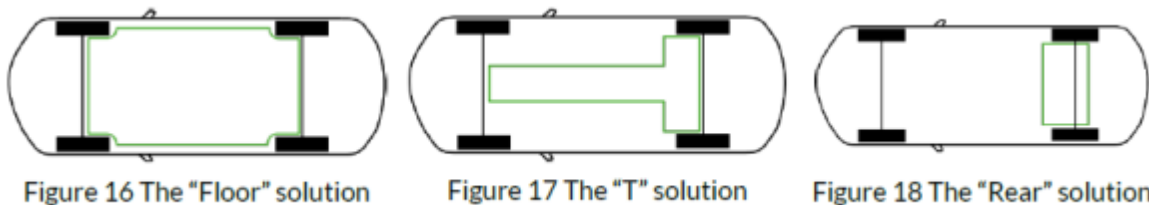

Figure 69: Battery placement in EV<sup>332</sup>

- ◆ An important role has **the Battery Management System (BMS)**, which monitors the cells and regulates the functions (charging, power release, heating, cooling) to optimize their energy output and ensure that the battery system is working within safe operating conditions. BMS, in general, automatically **disconnects** the battery system in response to the following situations: too high temperature, under-voltage, over-voltage, over-current, failure of the battery’s cooling system, damaged and/or falsely triggered crash sensor, the vehicle has begun to overturn (as detected by the sensor), insulation failure, and current fault, such as arcing.<sup>333</sup> An important factor affecting the severity of the safety hazard is the battery’s charge level (the energy release rate for charged cells is much higher than discharged cells) and cell capacity (generate more

<sup>331</sup> M. Wisch, J. Ott, R. Thomson, Y. Léost, M. Abert and J. Yao, “Recommendations and Guidelines for Battery Crash Safety and Post-Crash Handling,” EVERSAFE, 2014

<sup>332</sup> R. Bisschop, O. Willstrand, F. Amon, M. Rosengren Fire Safety of Lithium-Ion Batteries in Road Vehicles, RISE Report 2019

<sup>333</sup> J. Gehandler, P. Karlsson and L. Vylund, “Risks Associated with Alternative Fuels in Road Tunnels and Underground Garages,” SP Sveriges Tekniska Forskningsinstitut, Borås, 2017

heat when in use).<sup>334</sup>

To use LIBs safely means to keep the cells within a defined voltage and temperature window. These limits can be exceeded as a result of crash or fault conditions and thus damage the LIB causing them to vent and burn. Gases released in this process may be a threat to personnel and drivers.

**First responders and post-crash handlers** need to be aware of the possible risks posed by EVs and how to handle them. Among the main problem areas when handling damaged EVs in this case are<sup>335</sup>:

- ◆ Difficulty **identifying whether a vehicle is an EV or not** (different elements can be observed: missing tailpipe, high-voltage components identifiable from their orange colour, presence of warning stickers, charging port, two "fuel" flaps instead of a single one indicating a PHEV etc.; for newer vehicles, information sent by e-call are also useful).
- ◆ Knowledge of **how to turn off the electricity** in all car models and to **cut open an EV** safely (if the vehicle is rightly identified, fire rescue services can use information gathered from manufacturers' manuals and emergency response guides or applications developed for this matter<sup>336</sup>, for ex. Crash Recovery System by Moditech Rescue Solutions<sup>337</sup>).
- ◆ The kinds of gas and fluids that can **leak from batteries** and how to handle them (toxicity is of concern, gas emissions or fire water run-off can contain for ex. hydrogen fluoride, which is severely irritating to humans even at low concentrations, toxic, corrosive, can penetrate some types of protective gear<sup>338</sup>; efforts to suppress LIB fires

<sup>334</sup> A. W. Golubkov, S. Sheikl, R. Planteu, G. Voitic, H. Wiltsche, C. Stangl, G. Fauler, A. Thaler and V. Hacker, "Thermal Runaway of Commercial 18650 Li-Ion Batteries with LFP and NCA Cathodes - Impact of State of Charge and Overcharge," RSC Advances, vol. 5, pp. 57171-57186, 2015; S. Santhanagopalan, P. Ramadass and J. Zhang, "Analysis of Internal Short-Circuit in a Lithium Ion Cell," Journal of Power Sources, vol. 194, pp. 550-557, 2009

<sup>335</sup> C. Stave and A. Carlson, "A Case Study Exploring Firefighters' and Municipal Officials' Preparedness for Electrical Vehicles," Eur. Transp. Res. Rev. (2017) 9:25, <https://doi.org/10.1007/s12544-017-0240-1>, 2017

<sup>336</sup> Some examples can be found here: <https://www.hasici-vzdelavani.cz/content/prirucky-pro-zachranare-z-oblasti-vidn>

<sup>337</sup> <https://www.moditech.com/> last accessed on 28.08.2020

<sup>338</sup> MSB, "Nya risker för räddningspersonal vid bränder/ gasning av batteripack hos e-fordon," MSB, 2016

can result in a relatively large amounts of contaminated water or other foam/liquid run-off material that should be collected and disposed of in a responsible manner), light-weight composite materials used to build cars, such as carbon-fibre reinforced polymers (CFRPs), may, when exposed to fire, release inhalable fibres<sup>339</sup>

- ◆ **How to put out fires** in EVs (the biggest challenge is to supply water to the source of the fire, the amount of water used can be substantial and the fires can reignite multiple times; there are different projects looking at efficient cooling agents apart from water or approaches on how to easily access the inside of battery pack (for ex. using CCS COBRA).
- ◆ Risks associated with electricity if an EV comes into **contact with salt water** (submersion of an EV in salt or contaminated water may also be the cause for a fire to ignite in the battery pack), and whether this risk would remain after a rescue operation.

There are still very limited general statistics available on the occurrence of vehicle fires involving EVs, since the number of EVs on the roads have been statistically more significant only in the last couple of years, so more experience and information is still to be seen.

### Safety issues related to parking in garages

The changed fire developments in modern vehicles and the increased risk of multiple cars (with different propulsions) being involved in a fire can result in greater requirements for parking garages. These could include:

- ◆ **fire ventilation** in parking garages - adequate fire ventilation may prevent the accumulation of hot fumes that could contribute to escalating fire development.
- ◆ the **design of parking lots** (especially underground or multilevel parking lots) should consider the safest **placement of charging stations**; locating charging stations near ingress/egress points or other locations that have good ventilation and access to an adequate supply of extinguishing water may help to minimize hazards associated with

<sup>339</sup> T. Hertzberg, "Dangers Relating to Fires in Carbon-Fibre Based Composite Material," Fire and Materials, vol. 29, pp. 231-248, 2005

venting gases and fires<sup>340</sup>.

- ◆ installation of **automatic extinguishing systems** to reduce the risk of fire spreading, where this is practically and financially sound, even if there are no explicit requirements set down in regulations, could be recommended.

Based on the findings from statistics and a literature review, there were no indications that **charging of electric cars in parking garages** would result in an increased probability of fire.<sup>341</sup> However, this requires that the charging points are in accordance with the regulations and that the recommendations from the car manufacturers and the producers of the charging points are followed. It is important to avoid the use of power sockets not intended for the charging of vehicles and of extension leads.

There are still unknown factors regarding both the development of fire in parking garages in general and also regarding potential fire propagation to the battery pack specifically. More knowledge is needed to increase the accuracy of evaluations and recommendations. For the **fire service** to carry out effective extinguishing of fires in a parking basement, the fire service needs to be familiar with the new challenges relating to fire development and the risk of spreading. Additionally, tactics and techniques must be established to manage fire in battery packs in electric cars.

#### 3.5.1.5 Repair of Electric Vehicles

The car repair shops that we know today will gradually change due to lower service needs of EVs and, at the same time, higher qualification requirements.

- ◆ A special **service training** is required to allow employees to repair EVs, especially, when the car is damaged following a collision or signalling damage to the battery – **electro technical education** with certain years of **working experience** or a specific **professional training** in addition to **car mechanic** qualification is needed; it might require changes to the legislation in the area of occupational safety – information on the situation in different EU Member States must be gathered; a **common approach by EU Member States coordinated at the EU level could be beneficial**

<sup>340</sup> N. K. Reitan, A. G. Bøe and J. P. Stensaas, "Brannsikkerhet og alternative energibærere: El- og gasskjøretøy i innelukkede rom," SP Fire Research AS, SPFR-rapport A16 20096-1:1, Norway, 2016

<sup>341</sup> Charging of electric cars in parking garages, Are W. Brandt and K. Glansberg, RISE-report 2020:30

- ◆ In general, there seems to be a **lack of experts** qualified to repair EVs. According to a research<sup>342</sup> conducted in the UK as many as 97% of active auto mechanics are not qualified to work on electric cars. The vast majority of the 3% who are qualified are employed at manufacturer's dealerships.
- ◆ **Car manufacturers** have been introducing special trainings to get an authorised service network ready for EV servicing.<sup>343</sup>
- ◆ It will be necessary to use specialized **manuals** for each vehicle. An expanding **augmented reality** can be used to facilitate repairs.<sup>344</sup>
- ◆ The use of special tools and workshop equipment, such as **insulating** gloves, insulating floor, etc. will be necessary.
- ◆ **Towing** of a BEV & (P)HEV stuck on the road can be complicated as it can create dangerous voltages<sup>345</sup>.
- ◆ A very important thing to consider is the **risk of reignition**. As heat generation occurs inside the battery pack, it can be difficult to assess the risk by means of visual examination. If an EV has burned or sustained damage that might have affected the Lithium-ion batteries (LIB) it should be isolated from combustible material (for ex. stored at 10 – 15m from objects)<sup>346</sup>. Monitoring the LIB casing temperature using a thermal imaging camera / scanner is recommended if possible. The vehicle's windows/doors should be open for ventilation of potentially dangerous gases and the EV should not be exposed to rain or other precipitation if the LIB is ruptured/punctured.
- ◆ Other important parts to be repaired on a battery pack could be **safety fuses** destroyed after a car crash. When an EV crashes, safety fuses prevent occurrence of high voltage

<sup>342</sup> <https://enrg.io/new-report-says-97-of-auto-mechanics-cant-work-on-electric-cars/> last accessed on 28.08.2020

<sup>343</sup> <https://electrek.co/2018/03/26/tesla-start-automotive-training-program/> last accessed on 28.08.2020

<sup>344</sup> <https://www.youtube.com/watch?v=7fBPSjctbpk> last accessed on 28.08.2020

<sup>345</sup> <https://www.hse.gov.uk/mvr/topics/electric-hybrid.htm> last accessed on 28.08.2020

<sup>346</sup> EDUCAM, "Travailler en toute sécurité sur des véhicules hybrides et électriques (HEV)," [Online]. Available: <https://tinyurl.com/y3pg5fyw>. [Accessed 20 February 2019, National Fire Protection Association, "Hybrid and Electric Vehicle Emergency Field Guide," National Fire Protection Association, Quincy, MA, USA, 2014; SAE International, "Surface Vehicle Recommended Practice J2990, Hybrid and EV First and Second Responder Recommended Practice," Society of Automotive Engineers, 2012



on the car body by disconnecting the battery pack from the car frame. Safety fuses could be part of the BMS or work separately.

- ◆ Special attention must be paid to a possible **electrolyte spill** in case of punctured battery case - even though it may not be a common occurrence, there is still the possibility to encounter punctured battery cases in which case it is necessary to take the right measures in order to prevent serious injuries on people due mainly to the highly corrosive nature of the electrolyte that might spill.<sup>347</sup>
- ◆ Preparation in workshops and takeover of used yet still functional batteries for **second life** - once the battery is deemed unfit for the propulsion of the vehicle, it must be diagnosed with regard to its second life suitability and, if compliant, it must be stowed correctly and prepared for the safe shipment to its next assignment. The most important activity in this chain is the **check of the SoH** which may result in a decision to remove the battery from the vehicle due to a low remaining capacity.<sup>348</sup>

<sup>347</sup> <https://www.prevor.com/en/li-ion-batteries-chemical-hazard-inside-our-cars> last accessed on 28.08.2020

<sup>348</sup> [https://www.researchgate.net/publication/317256668\\_Electric\\_Vehicle\\_Battery\\_Reuse\\_Preparing\\_for\\_a\\_Second\\_Life](https://www.researchgate.net/publication/317256668_Electric_Vehicle_Battery_Reuse_Preparing_for_a_Second_Life) last accessed on 28.08.2020



## Occupational safety requirements in repair shops when working on electric vehicles<sup>349</sup>

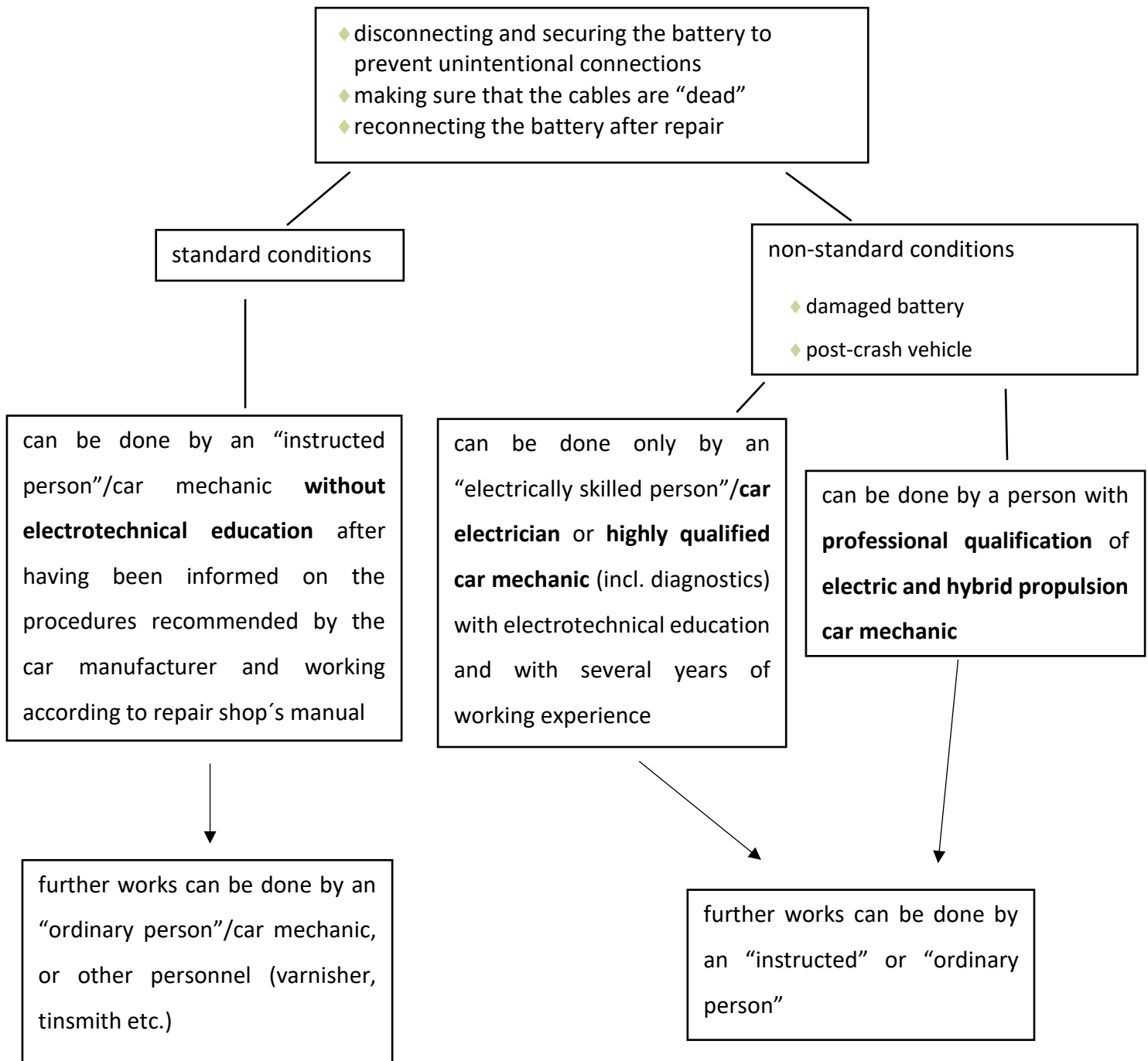

<sup>349</sup> According to the Czech legislation on occupational safety

## Battery replacement

- ◆ Due to a limited number of EVs at the end of life available, there is a very limited information on this topic as well as a limited number of authorised / independent workshops providing this service.
- ◆ In general, the time to change a battery cell or a battery pack may come when the **capacity decreases** significantly. It may happen that one battery cell dies much earlier than the others in the battery pack. Or the car is **damaged** (e. g. after a crash) and it is not safe or it does not make economic sense to repair the pack.
- ◆ Every worker who repairs a car battery needs to be qualified to work with high voltage.
- ◆ Procedure depends on **vehicle design** and how / where batteries are stored.
- ◆ There are differences between location and shape of the battery. In **BEV**, the battery is mostly part of the car skeleton and it is harder to open and repair the battery, so workers need suitable work equipment and instructions on how to work with the battery. The procedure is rather **complicated and costly**, leaving out the rather high price of a new battery cells/pack itself
- ◆ In **(P)HEV** the battery is generally stored in the trunk and it is much smaller than in BEV. Access to and repair of the (P)HEV battery is much easier than in case of BEVs.
- ◆ The battery repair procedure is to remove the cover, to diagnose individual battery packs/cells SoH, then replace **the weak or dead** cell or battery packs manually.
- ◆ Replacement of the battery pack can be done **manually or automatically** by a special machine. The automatic replacement of the battery pack requires that the car has been designed so that automatic replacement is possible (e.g., Tesla).
- ◆ For some vehicles, it is already possible to purchase either more expensive **OEM battery packs** or cheaper **after-market battery packs**.<sup>350</sup>

<sup>350</sup> <https://www.voltek.biz/hev-battery-replacement> last accessed on 28.08.2020

### 3.5.1.6 Maintenance of Electric Vehicles

**BEV** maintenance is much easier than maintenance of vehicles run on ICEs, because there are usually fewer fluids (like oil and transmission fluid) to change and far fewer moving parts. However, this is not the case of **(P)HEVs** that contain more components than ICEs and BEV.

**Routine** vehicle maintenance includes replacement of wipers, tires, cab filter, refill air condition, brakes and suspension parts.<sup>351 352</sup>

Also, both BEVs and PHEVs require minimal scheduled **maintenance of their electrical systems**, which can include the battery, electrical motor, and associated electronics.<sup>353</sup> The electric car engine, the inverter and the on-board charger are where the most of the investment in maintenance is required.<sup>354</sup>

Main **specifics of BEV** in terms of maintenance include:

- ◆ No need to **change** oil, belts, spark plugs and filter.
- ◆ Maintenance of brake parts is still needed; however, thanks to **recuperation**, the brakes wear less.
- ◆ **Fewer components** / moving parts than in ICE which are prone to wear / break.
- ◆ BEVs generally only have the following **kinds of fluids** that need to be topped up or changed regularly:
  - coolant fluid (cools the batteries as well as the oils in the electric motor gearbox)
  - brake fluid (must be changed every 2 years given its hygroscopic behaviour);
  - air conditioning refrigerant (used either to cool down the cabin or to cool down the cabin and the battery, according to the technical solution);
  - Transmission oil for the gearbox connected to the drive;
  - Windshield/headlight washer fluid.

<sup>351</sup> <https://newmotion.com/en/how-to-maintain-an-ev/> last accessed on 28.08.2020

<sup>352</sup> <https://www.motoringresearch.com/advice/servicing-an-electric-car/> accessed 28.08.2020

<sup>353</sup> U.S. Department of Energy's Office of Energy Efficiency and Renewable Energy, accessible online from <https://www.energy.gov/eere/electricvehicles/electric-car-safety-maintenance-and-battery-life>

<sup>354</sup> <https://newmotion.com/en/how-to-maintain-an-ev/>

- ◆ Possible repairs of high voltage cables in BEVs
- ◆ May need change of tyres more frequently (BEVs are usually heavier and create near-instant torque off the line)<sup>355</sup>
- ◆ Unlike ICEs, BEVs might need repair or replacement of the battery cells/ pack or the battery electronics

Apart from having the most complex propulsion system, **(P)HEVs'** batteries might need to be replaced more often than those of BEVs because they are smaller and drain more. On the other hand, (P)HEVs may possess some advantages over BEVs (for ex. brakes wear less).

### Periodical technical inspections of electric vehicles

According to, for instance, Czech legislation<sup>356</sup> and discussion with experts, technical inspections of electrified vehicles are carried out with **the same periodicity** and within **the same scope** as in the case of ICE vehicles. Of course, emission testing is not included when testing a BEV.

Specific **methodology** is used by the technical inspection services. It is created also based on information provided by vehicle manufactures. So far, specific education or professional qualification is not needed. If the voltage system had to be checked, then similar requirements as for repair shops' personnel would be required.

#### 3.5.1.7 Job Roles and Skills

This stage of the battery values chain offered the most advertisements.

At this stage the **Application Engineers, Battery System Engineers, Embedded Battery Systems Engineer, IT Experts, Telematics Experts, Charging Infrastructure Development** troubleshoot the systems.

In a case of automotive applications **Electrician Assemblers, Automotive Battery Technicians and Car Mechanics** are responsible for dismantling of the batteries and other components of

<sup>355</sup>[https://techcrunch.com/2020/03/06/electric-vehicles-are-changing-the-future-of-auto-maintenance/?guccounter=1&guce\\_referrer=aHR0cHM6Ly93d3cuZ29vZ2xlLmNvbS8&guce\\_referrer\\_sig=AQAAAFQHz8DihJ-1ce3teG-SCoEW5pDZRpnFXhZFI34DA313CSIB2si45txdXNshCOHgV2vfO2HQ06X-N79rOaXWK-c0QBUjcnUryuJzTNxJld0feAtOl8RW2EKO1-e\\_Nqkn9xpC2uZ7SRIU3wqViqbGVb8ifsYsp5OdPrLRulsVmiG](https://techcrunch.com/2020/03/06/electric-vehicles-are-changing-the-future-of-auto-maintenance/?guccounter=1&guce_referrer=aHR0cHM6Ly93d3cuZ29vZ2xlLmNvbS8&guce_referrer_sig=AQAAAFQHz8DihJ-1ce3teG-SCoEW5pDZRpnFXhZFI34DA313CSIB2si45txdXNshCOHgV2vfO2HQ06X-N79rOaXWK-c0QBUjcnUryuJzTNxJld0feAtOl8RW2EKO1-e_Nqkn9xpC2uZ7SRIU3wqViqbGVb8ifsYsp5OdPrLRulsVmiG)

<sup>356</sup> For ex. Decree 211/2018 - Czech Republic (available from <https://www.zakonyprolidi.cz/cs/2018-211>)

the car and other applications. All the processes must follow safety standards and procedures developed by **Quality Planners and Process Engineers**. Batteries are then evaluated and tested by **Battery Test Technicians, Cell Inspection Technicians** and **Technicians for Battery Analysis** under supervision of **Functional Safety Engineers and Managers, Validation and Compliance Engineers** and **ISO Auditors**. To support sales **Business Development**.

For the battery, repair, and maintenance, the **EV Battery Maintenance Technician, Automotive Battery Technicians and Engineers** and **Electric Battery Repairers** or the above-mentioned **Test Engineers** and **Technicians** are relevant.

The day-to-day operation of vehicles requires these jobs, such as **Towing / On Toad Services Personnel, Fleet Management Experts, Insurance Personnel, Car Rental and Dealership Personnel** and **Fire Brigades**.

## Skills and knowledge required in relevant advertisements:

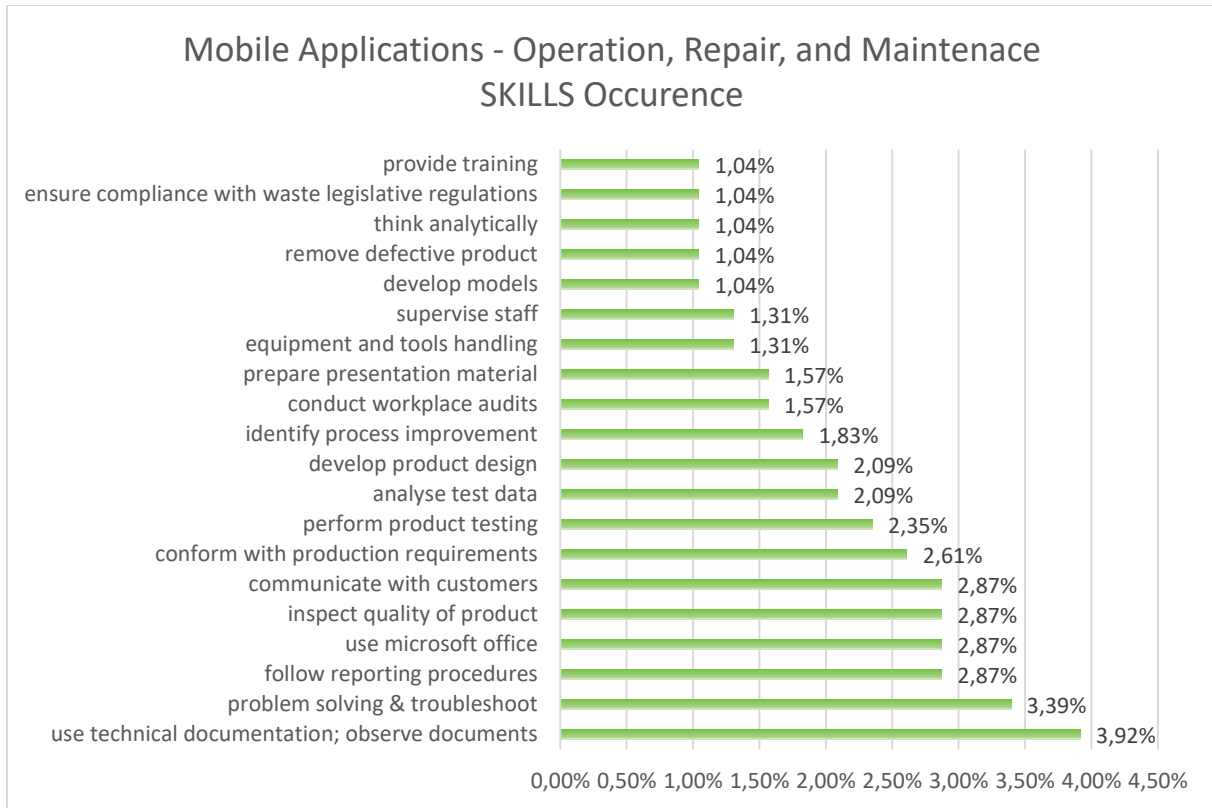

Figure 70 Operation, Repair, and Maintenance SKILLS Occurrence Mobile Applications

### Skills

From the information shown in **Figure 70** it is clear that testing in general is a very important skill to have. Technical documentation and problem solving are also at the top. Data science and product quality is needed. Reporting and communication with customers, usage of Microsoft Office, model development and conformation with requirements follows.

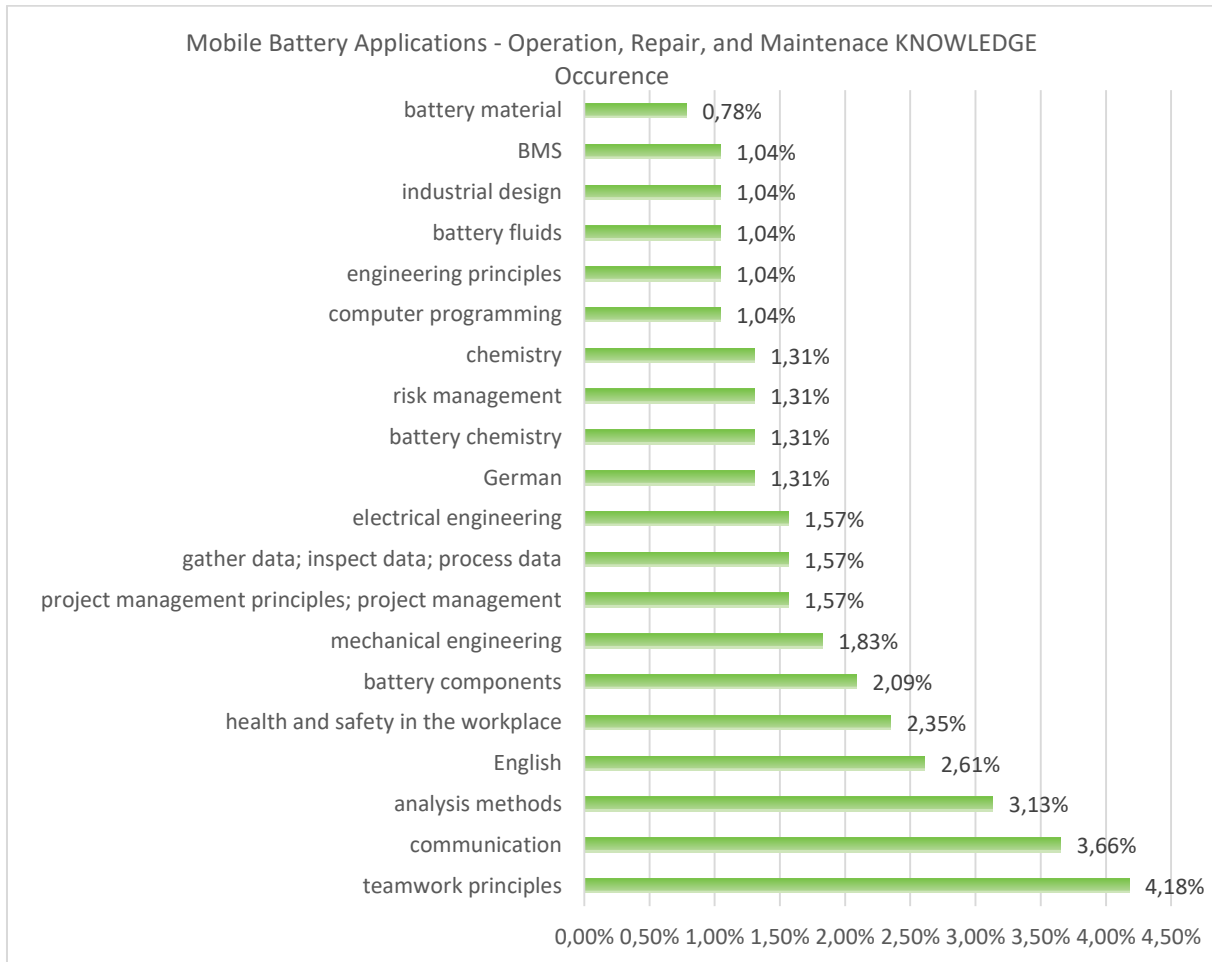

Figure 71 Operation, Repair, and Maintenance KNOWLEDGE Occurrence Mobile Applications

### Knowledge (Figure 71)

Amongst the knowledge needed the teamwork principles are most demanded as well as communication skills. English language was a frequently required language. As for technical knowledge, employees must have a good knowledge about battery components, health and safety standards, and data science.

## 3.5.2 Vessels

### 3.5.2.1 Drivers of Change

According to the Paris Agreement the target for global air temperature increase is below 2°C above pre-industrial level and is to be achieved through reducing greenhouse gas (GHG) emissions.

The European Commission has set out a strategy to cut the local emissions by at least 40% by 2050 (compared to 2005).<sup>357</sup> In April of 2018 United Nations International Maritime Organization (IMO) has adopted an initial strategy on the reduction of total annual GHG emissions from international shipping by at least 50% by 2050 compared to 2008 and phased out entirely as soon as possible in this century<sup>358</sup>.

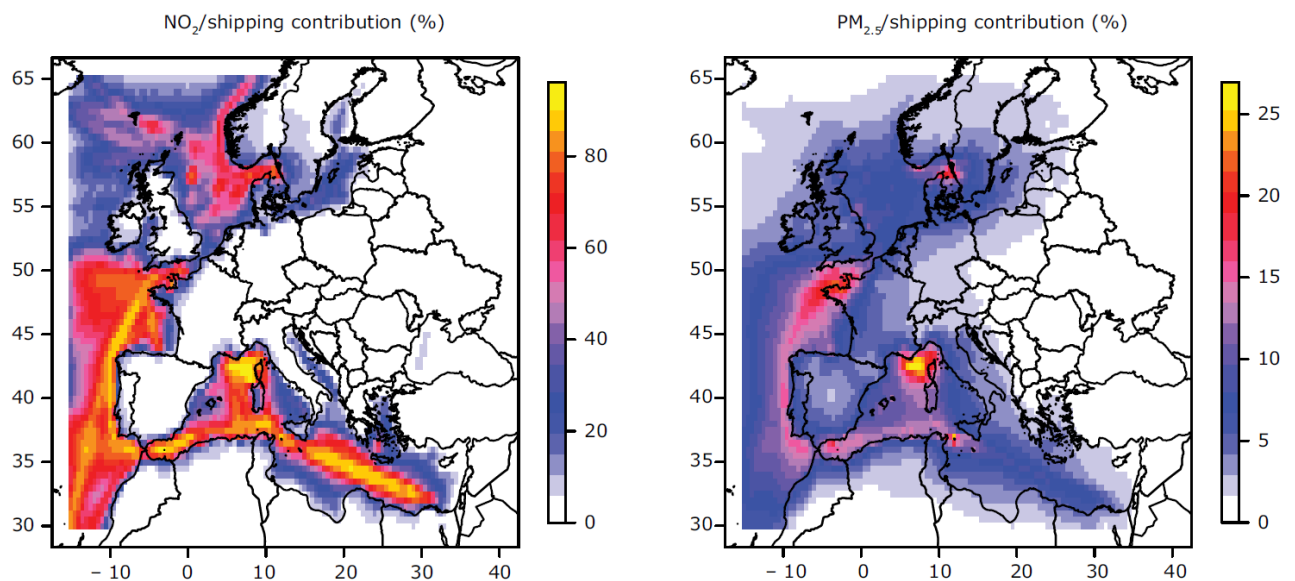

Figure 72: % of total emissions of NOx and PM from shipping in Europe<sup>359</sup>

In addition to greenhouse gas emissions, maritime transport accounts for substantial NOx and PM emissions as shown in **Figure 72**.

It is also of importance to reduce the EU dependency on oil and gas imports from unstable countries, thus reducing the related risks<sup>360</sup>, following the European Commission's 2014 Energy Security Strategy; as well as increasing the share of renewable energy as outlined in the 2030 Energy Strategy.

<sup>357</sup> [https://ec.europa.eu/clima/policies/transport/shipping\\_en#tab-0-0](https://ec.europa.eu/clima/policies/transport/shipping_en#tab-0-0) last accessed on 28.08.2020

<sup>358</sup> International Maritime Organization, Briefing 13/04/2018

<sup>359</sup> "The impact of international shipping on European air quality and climate forcing", EEA Technical report No 4/2013

<sup>360</sup> Programme Review Report 2016, Fuel Cells and Hydrogen Joint Undertaking, 2017



Battery solutions for maritime transportation, either through fully electric or hybrid solutions, are one of the important solutions that can contribute to the emission reduction goal<sup>361</sup>. The market introduction of maritime battery solutions is still in an early phase. The maritime battery market is growing at a current rate of approximately 40% CAGR as shown in **Figure 73** and according to Navigant, Western Europe stands out as a key market.

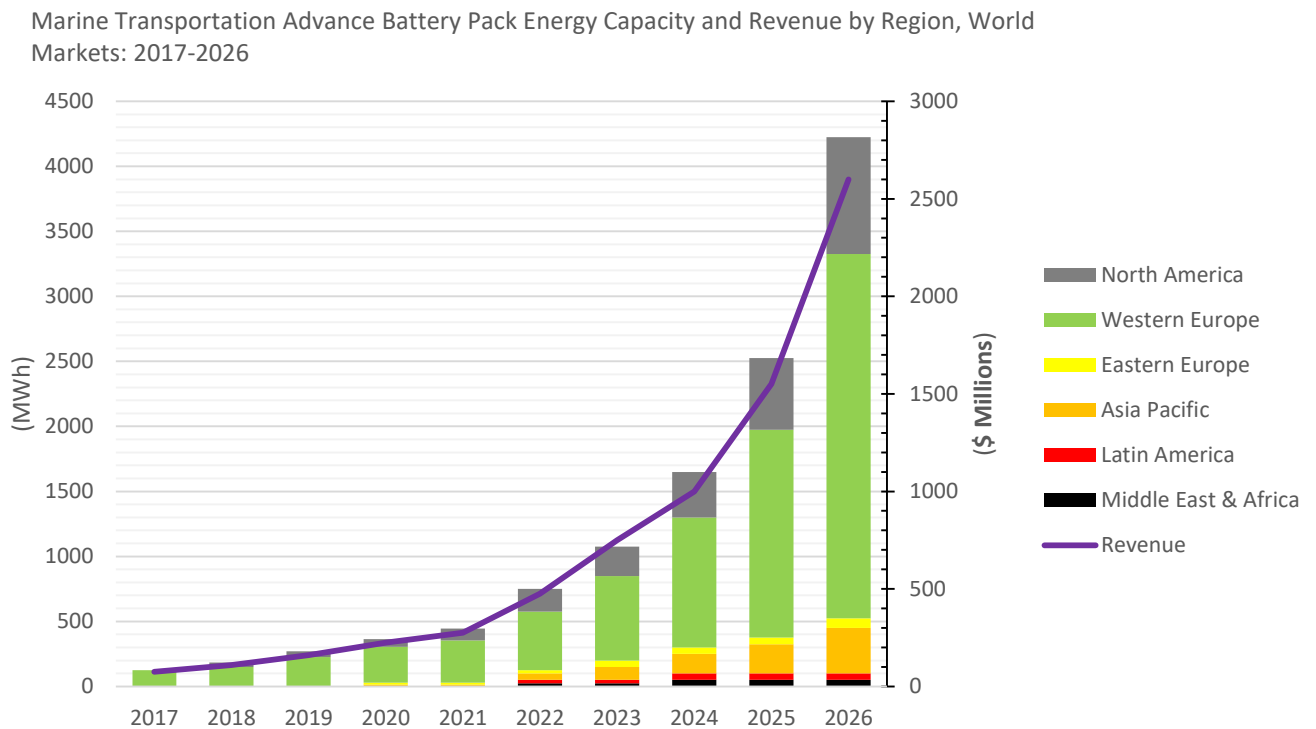

Figure 73: Market growth by region<sup>362</sup>

Many ferry and vessel builders are looking for either hybrid or fully electric solutions for new projects and to maximize the impact they need safe, robust and cost-effective battery systems.

<sup>361</sup> <https://www.dnvgl.com/article/battery-power-improves-performance-86095> last accessed on 28.08.2020

<sup>362</sup> <https://guidehouseinsights.com/reports/market-data-non-automotive-transportation-markets-for-advanced-batteries> last accessed on 28.08.2020

### 3.5.2.2 Stakeholders

The main purchasers of maritime battery systems are system integrators, but no orders are placed unless the end customers want to install battery systems. The end customers can be categorized in three main groups:

CUSTOMER GROUP	EXAMPLE
Customers that have identified that batteries are needed to satisfy operational requirements/costs/regulations or popular demand by customers.	<ul style="list-style-type: none"> <li>• Offshore supply vessel owners</li> <li>• Ferry operators</li> <li>• Cruise ship owners</li> <li>• Tourist boat operators</li> </ul>
Customers who have identified that battery solutions may give benefits for operational requirements/costs/regulations but lack knowledge to quantify the benefits and implement battery solutions.	<ul style="list-style-type: none"> <li>• Ferry operators</li> <li>• Fishing boat owners</li> <li>• Work boat owners</li> </ul>
Customers who have not yet gained enough knowledge to be able to evaluate whether implementing batteries can give benefits for operational requirements/costs/regulations.	<ul style="list-style-type: none"> <li>• Bulk ship owners</li> <li>• Ocean going ship owners</li> </ul>

To summarize, the main stakeholders are:

- ◆ Governments including local governments
- ◆ Ship-owners
- ◆ Integrators
- ◆ Battery system manufacturers

### 3.5.2.3 Technologies

## OPERATION OF THE VESSELS

There are vessels with different degrees of electrification and battery technology used.

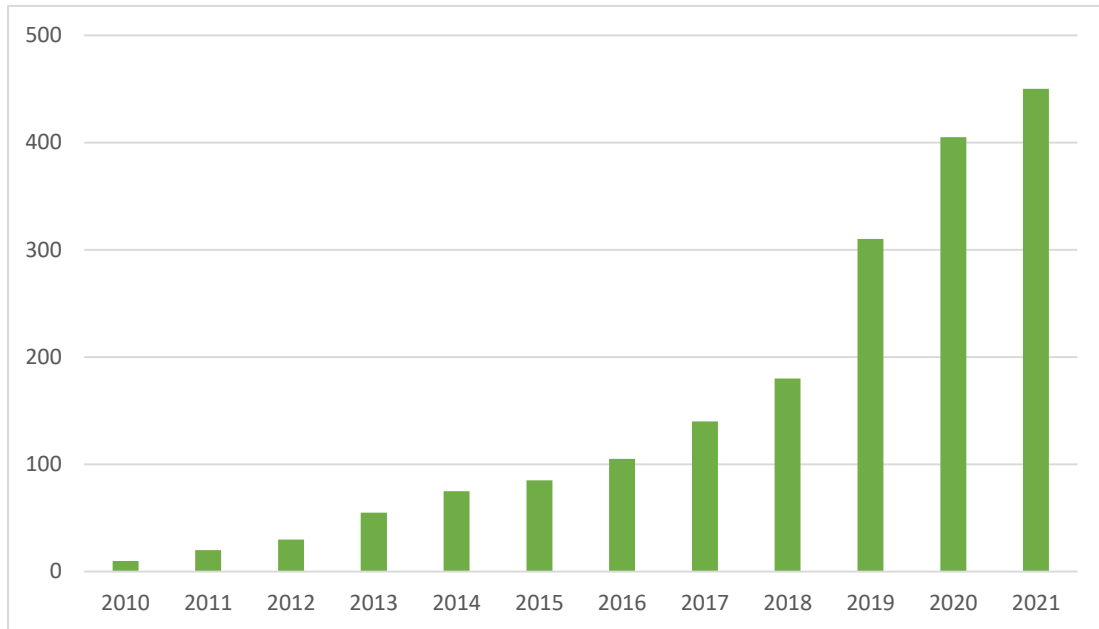

Figure 74: Total number of ships with batteries in operation and on order<sup>363</sup>

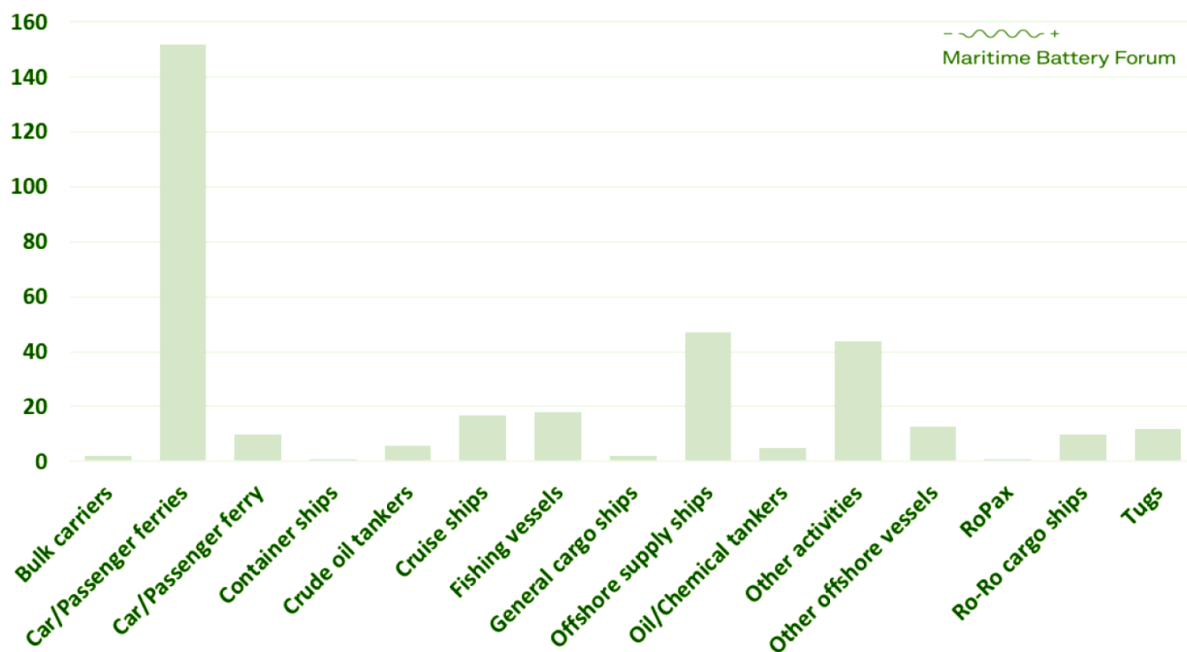

Figure 75: Number of ships with batteries by ship type<sup>365</sup>

<sup>363</sup> <https://www.maritimebatteryforum.com/ship-register> last accessed on 28.08.2020

## Large boats<sup>364</sup>

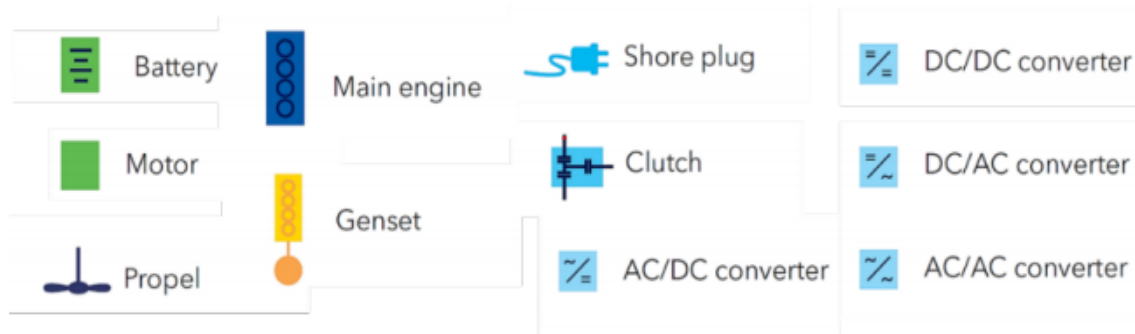

Figure 76: Legend for vessel propulsion

### ◆ Mechanical propulsion with battery hybrid electric power plant

In this case, the battery is used within the electrical network to balance the power peaks, and the ship is powered by a conventional engine.

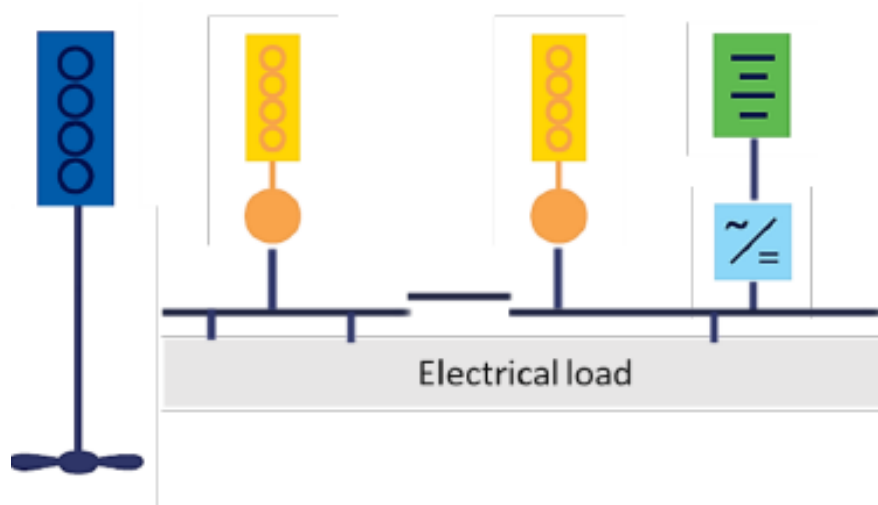

Figure 77: Mechanical propulsion with battery hybrid electric power plant

<sup>364</sup> EMSA MARITIME BATTERY STUDY, Electrical Energy Storage for Ships, 2019-0217, Rev. 04

◆ **Battery hybrid propulsion**

It is a drive in which the batteries are part of the power supply network and the drive is provided by electric motors. This design allows you to work only from generators, or only from batteries, or combinations thereof.

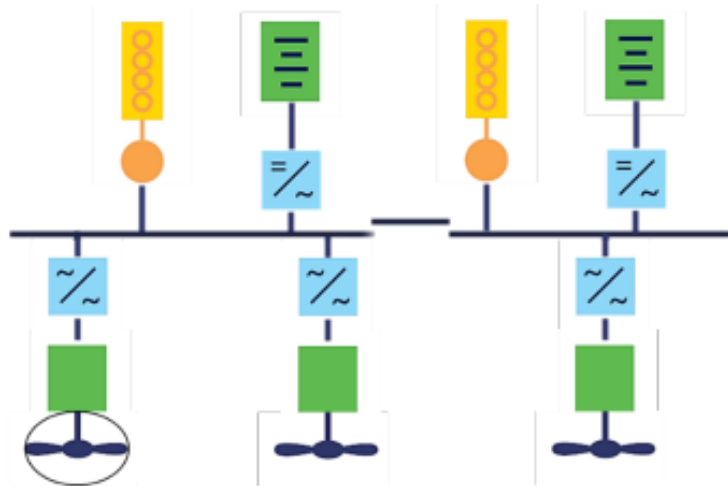

Figure 78: Battery hybrid propulsion

◆ **Battery hybrid propulsion with distributed batteries**

A variant of a hybrid drive that integrates batteries into motor inverters, thus enabling independent motor drive and increasing efficiency and reliability.

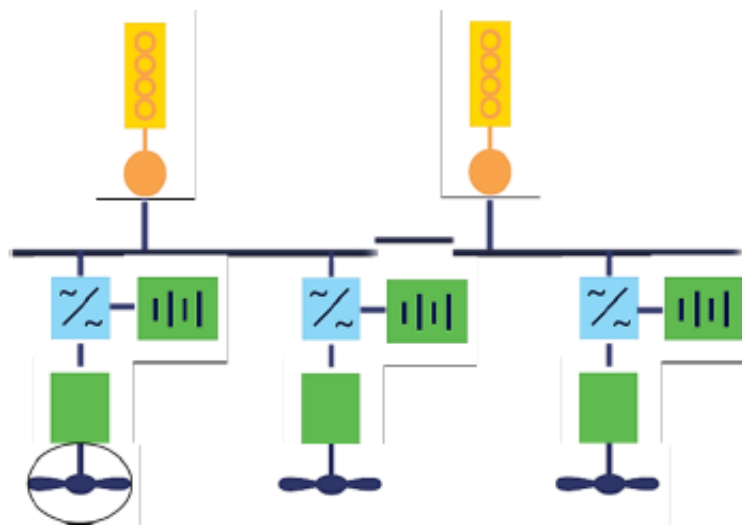

Figure 79: Battery hybrid propulsion with distributed batteries

◆ **Electrical/mechanical hybrid with DC power distribution**

The boat contains both a battery and an engine. The motor clutch switches between the ship's propulsion and the electric generator. The ship is also powered by an electric drive. The main combustion engine can operate as a drive alone, or in combination with electric motors, or it can produce energy for the electricity grid and electric drive. Another variant is a purely electric drive.

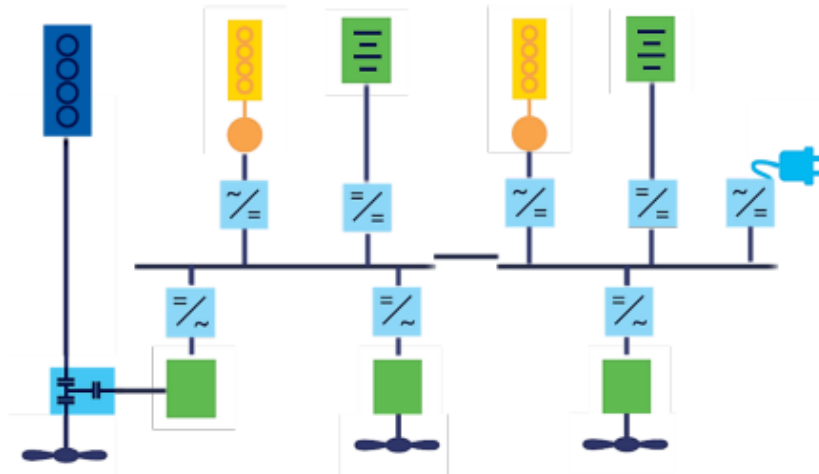

Figure 80: Electrical/mechanical hybrid with DC power distribution

◆ **All-electric propulsion**

It is a purely electric drive, where the battery is charged using an AC / DC converter in the port.<sup>365</sup>

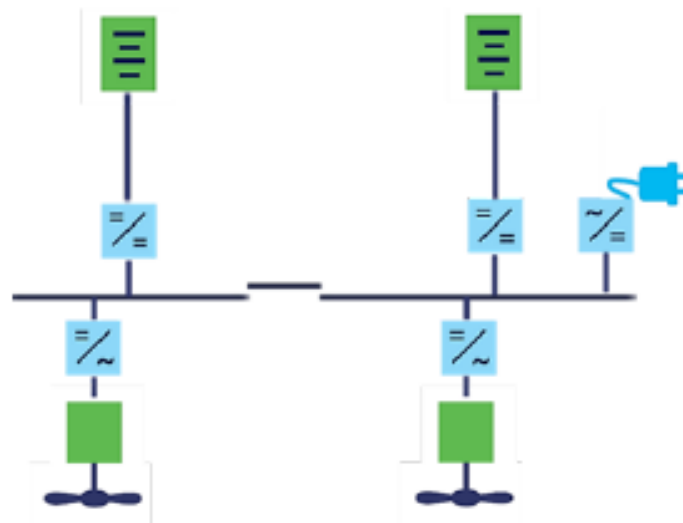

Figure 81: All-electric propulsion

<sup>365</sup> EMSA MARITIME BATTERY STUDY, Electrical Energy Storage for Ships, 2019-0217, Rev. 04

In achieving a higher level of market penetration for large modular battery systems, substantial savings can be achieved. Engine maintenance cost will be reduced because of two factors

- ◆ Fewer running hours
- ◆ Less variations in load; The engines can run at an optimal load rather than on partial load.

The fuel consumption and the CO<sub>2</sub> emissions will also decrease for the same reasons as the maintenance hours. The NO<sub>x</sub> emissions are not as easy to quantify as several factors influence the NO<sub>x</sub> emissions per liter of fuel used. With batteries in a hybrid configuration it will, however, be more possibilities to fine-tune the engine performance and thereby decreasing the NO<sub>x</sub> emissions. The savings for different vessel types are quantified below.<sup>366</sup>

Vessel savings	Electric car ferry	Hybrid passenger ferry	Hybrid fishing vessel	Hybrid work boat
Maintenance	80%	35-50%	50-75%	35-55%
Fuel consumption	100%	15-40%	20-25%	20-60%
CO <sub>2</sub> emissions	95%	15-40%	20-25%	20-60%
NO <sub>x</sub> emissions	95%	30-60%	30-40%	30-60%

The market drivers for maritime batteries are changing from regulation driven to financially driven. This has a huge impact on the global market size, particularly increasing the growth rate outside Europe while maintaining the strong growth within Europe.

### Small boats

Smaller battery electric boats, such as canal, river and lake vessels, are boats propelled by mechanical systems consisting of an electric motor turning a propeller to reduce noise and

<sup>366</sup> Corvus Energy estimates, 2019

operate with zero emissions. Battery electric boats are often integrated into a fleet of vessels which has an onshore charging infrastructure in place.

### **Mainstream battery technologies and key performance indicators**

The dominant technology today is lead, both flooded and sealed, but Lithium NMC is also breaking through in this market.

The payback time for installing large battery systems in large vessels in continuous operation is normally between 2-4 years whereas for smaller vessels not in continuous use, the payback time is very often too long to make the business case viable. As the cost of batteries is coming down and the packaging and system integration become more standardized, the market penetration is expected to rise substantially.

### **Used batteries**

Commonly used battery types are Li-ion batteries with NMC and LFP technology, which represent a suitable compromise between volumetric capacity, price and battery life.

Solid-state electrolyte batteries are a new technology with great potential. The anode and cathode of the battery are the same materials as in today's Li-ion batteries, but thanks to the solid-state electrolyte they have a significantly larger capacity with the same size.



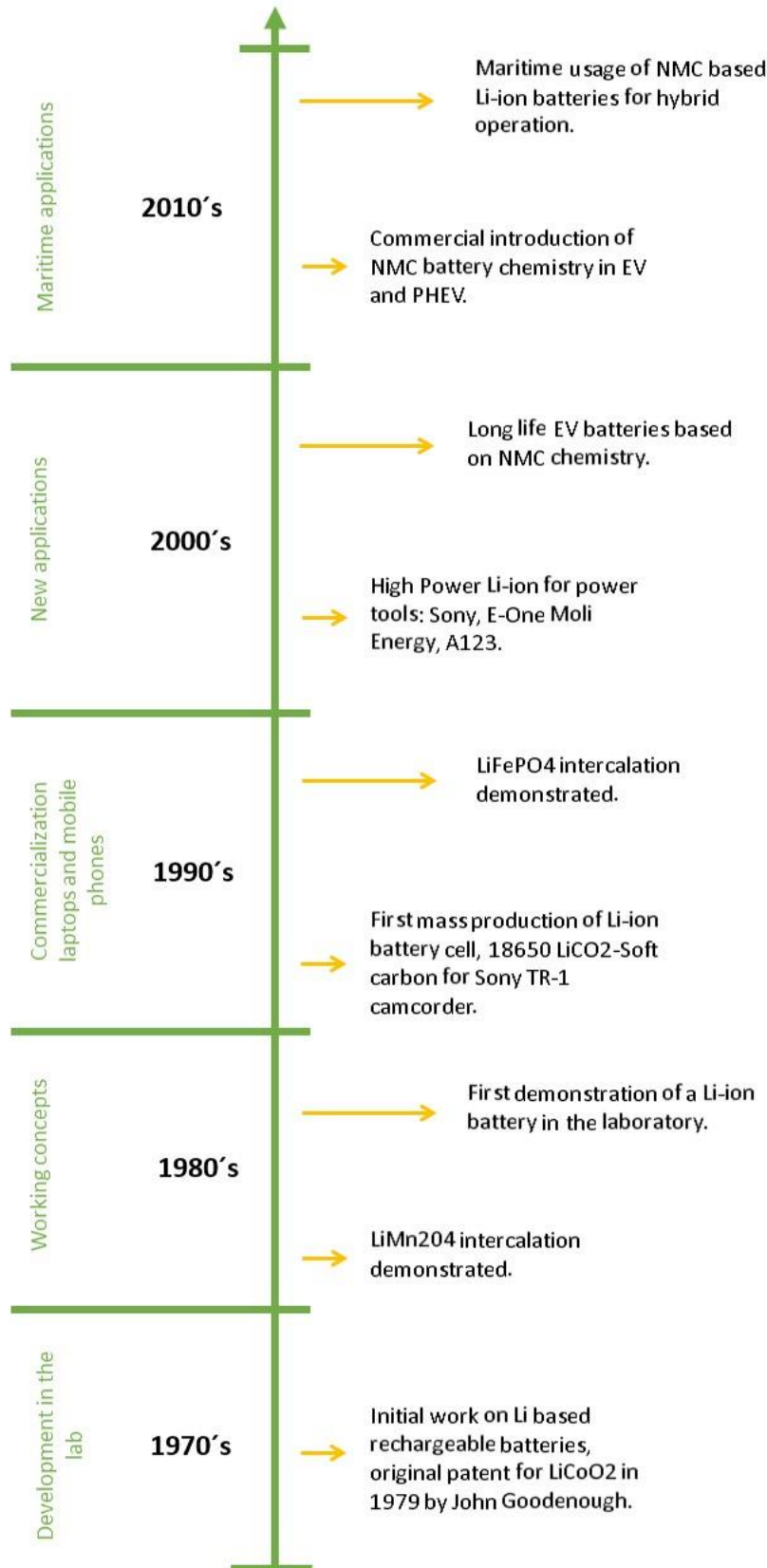

Figure 82: Li-ion history<sup>367</sup>

<sup>367</sup> The future is hybrid - A guide to use of batteries in shipping, DNVGL 201

Each step in the Li-ion battery history was built on the previous step. The power tool Li-ion battery effort was the catalyst for the automotive Li-ion battery development. The automotive Li-ion battery development was necessary for the maritime Li-ion battery system development.

Maritime additional safety requirements:

- ◆ Propagation of thermal events; if a battery thermal event occurs, it should not spread to neighbouring cells & modules
- ◆ Off-gas handling; In case of a thermal event, the potentially poisonous and explosive gases are dealt with in a way that minimizes the risk for passengers & crew.
- ◆ System level safety. Several additional system level safety features not common in automotive are mandatory for maritime use.
- ◆ Double faults are considered for risk evaluations
- ◆ Lifetime modelling and warranties are more comprehensive compared to automotive
- ◆ SOC window limitation and other usage restrictions are common to achieve the required lifetime.

### 3.5.2.4 Repair and Maintenance

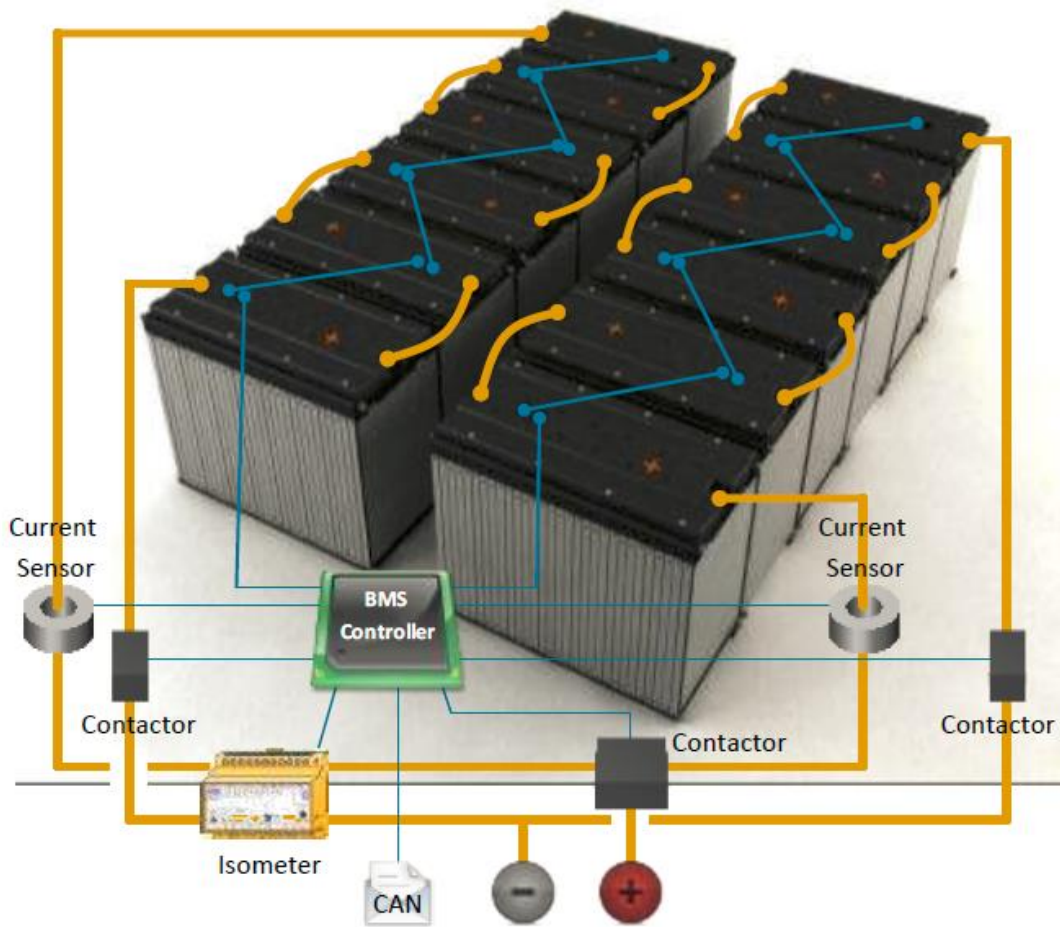

Figure 83: Conceptual illustration of a battery system <sup>368</sup>

Note: Controller Area Network (CAN) communication protocol shown. CAN is a bus for communication with sensors and control units. Other communication protocols may be used. Maritime battery systems are required to have redundancy in some of the functions and shutdown paths.

To fully understand the operation of a battery system, several basic skills are needed

- ◆ Electrical & fusing
- ◆ Mechanical
- ◆ Communication protocols
- ◆ Electronics
- ◆ Software

<sup>368</sup> L.O. Valøen, EV Battery Forum Europe 2012 Barcelona

To carry out any repair or maintenance operation the personnel must therefore have some knowledge on at least one of the skill sets listed above.

A basic understanding of high voltage will be needed for all operations. If a high voltage certification process could be developed, it could really help ensure an adequate level of safety for repair & maintenance operations.

It is necessary to first divide the repairs into three types:

### **Emergency repair while sailing**

These are minor emergency repairs that will be carried out by the ship's crew directly at sea, so that the ship can reach the docks.

### **Repair in docks**

Major repairs of damaged parts, which are carried out in, for example, dry docks. It may be the repair of defects that could not be repaired at sea, or defects that prevent further movement of the ship.

**Service:** The traditional service concept is Field service. OEM Service Engineers travel to vessel on-site and do scheduled or event driven service work. OEM Service Engineers have qualifications to deal with **high voltage**.

There are also periodical technical inspections of vessels, both remotely and in the field.

#### *3.5.2.5 Job Roles and Skills*

New skills needed for both OEM Service Engineers and System integrators Service Engineers will be data analytics, remote guidance and support, digital tools and SW for remote operations, proactive dialogue with end customer and intermediates.

More advanced new skills needed for Service Engineers will be legal and contractual understanding, basic maritime law and negotiation skills for handling warranty claims and service incidents. The role of a modern Service Engineer is very different and more challenging than for the traditional field service engineer.

## 3.6 SECOND LIFE

### 3.6.1 Drivers of Change

By 2030, up to half of the vehicles sold in Europe will be electric and will need batteries to power them<sup>369</sup>. At the same time, renewable energy sources will make up an increasing share of our electricity system. This increased demand will result in a need for batteries that are capable of efficiently storing power to smooth out peak demands.

#### 3.6.1.1 Environmental Impacts

The mobility of the future is tightly related to the electric propulsion, especially the electric vehicle (next to the Fuel Cell). These technologies imply the use of a propulsion battery whose life cycle is currently estimated between 10 and 20 years (best case scenario). If the donor EV is driven mostly in warm climate countries such as Portugal and Spain, the lifespan of the battery might reach 20 years whereas the batteries of cars driven mostly in temperate, cold climate countries (Belgium, Poland, Germany) is expected to go up to 10 years.<sup>370</sup> Future battery technologies promise longer lifespans and better resilience to frequent charging – discharging cycles, yet over the next couple of years, the most commonly used technology will remain the Li-ion.

Battery production is energy and resource intensive. To meet the growing demand, it is necessary to find solutions to make the entire battery life cycle more sustainable. To enable the transition to a circular economy, with emphasis on reuse and recycling, specific product designs and business models are required<sup>371</sup>.

According to the company Watt4Ever<sup>372</sup>, by reusing an electric vehicle battery for a stationary storage system one could avoid:

- ◆ Unnecessary CO<sub>2</sub> emissions:
  - To produce a battery with 1 kWh of energy, 70 to 110kg of CO<sub>2</sub>-eq are released into the environment. This means that, for a small electric vehicle with a 41 kWh battery, the resulting emissions reach levels of up to 4,5 tons of CO<sub>2</sub>-eq. Several additional tons of CO<sub>2</sub> by using the battery

<sup>369</sup> <https://about.bnef.com/electric-vehicle-outlook/> last accessed on 28.08.2020

<sup>370</sup> <https://pdfs.semanticscholar.org/49a1/d62cda83ed072ef77f169e71b8a0f0877f0a.pdf> accessed 06.08.2020

<sup>371</sup> Bocken, N.M.P.; de Pauw, I.; Bakker, C.; van der Grinten, B. Product design and business model strategies for a circular economy. *J. Ind. Prod. Eng.* 2016, 33, 308–320. [[Google Scholar](#)] [[CrossRef](#)].

<sup>372</sup> <https://watt4ever.be/technology> last accessed on 30.07.2020

to support renewable energy sources.

- ◆ Depleting rare minerals (Cobalt, Lithium, Nickel, and Yttrium), some of which have to be extracted using invasive and damaging mining techniques and must be imported from faraway countries, therefore carrying a massive carbon footprint.
- ◆ Up to 0,5 kg of Cobalt extraction per battery kWh.
- ◆ Avoid the impact of lithium extraction on local water resources.

These impacts will continue to grow along with the development of the electric vehicle and stationary battery markets. EU-based battery capacity is expected to jump from a mere dozen GWh today to several thousand GWh by 2049. This means that future battery production could be responsible for emitting hundreds of billions of tons of CO<sub>2</sub> into the atmosphere and for depleting rare mineral resources like Cobalt within a single generation.

There is a wave of investments in lithium-ion battery factories across Europe and the continent is expected to be the second largest battery producer after China. However, most investments are coming from Asian based companies such as LG Chem, Samsung, CATL, SK innovation or GS Yuasa. Majority of the lithium-ion battery factories that will be built in Europe will actually import battery cells from Asia and only the packing will be done in Europe (**Figure 84**).

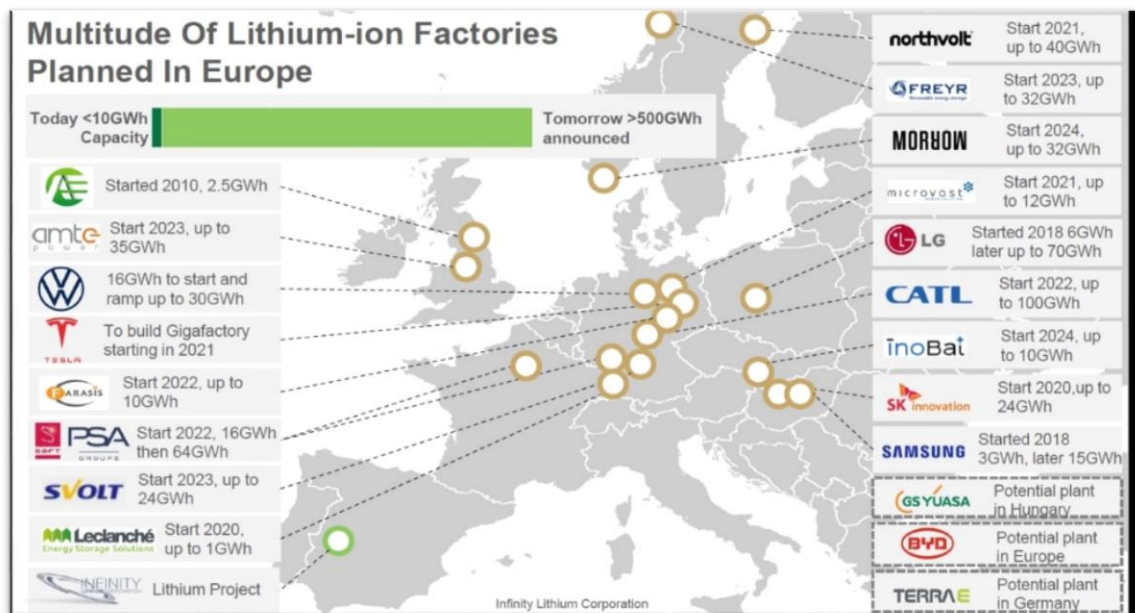

Figure 84: Factories planned in Europe <sup>373</sup>

<sup>373</sup> [www.infinitylithium.com](http://www.infinitylithium.com) accessed 6 August 2018



Also, the raw materials needed for battery production, such as lithium, nickel, manganese, and cobalt, are currently being extracted in limited quantities in Europe, though potential reserves are present. These European reserves will need to be exploited, although it currently seems that they will only be able to cover around 15 to 20% of the total demand<sup>374</sup>. The extension of the batteries lifetime through their second-use results in a decrease of quantity of secondary raw materials (SRM) available in the market. On the other hand, extending the lifetime also translates into an increase of materials productivity and a decrease of demand of batteries e.g. for stationary storage systems.

By 2025, 250,000 metric tons of EV lithium-ion batteries (LIBs) are expected to have reached end-of-life<sup>375</sup>. In this context, end-of-life means that the batteries are no longer considered useful in a vehicle, but they still retain 70–80% capacity. Being able to make use of that capacity, and only recycle the batteries, thereafter, might lead to big sustainability improvements. Capturing the value that is left in a product after the primary use is the cornerstone of circular economy. Through direct reuse, refurbishment, remanufacturing, and/or recycling, waste can be eliminated<sup>376</sup>. Remanufacturing and reuse slow down the resource cycle by extending products' life while recycling closes the resource loop<sup>377;378</sup>.

Second life may bring more benefits than just economic revenue, such as environmental and social consciousness-raising or circular economy enhancement. In fact, circular economy by means of second life batteries eliminates the environmental impact caused

<sup>374</sup> OPINION European Economic and Social Committee, Report from the Commission to the European Parliament, the Council, the European Economic and Social Committee, the Committee of the Regions and the European Investment Bank on the Implementation of the Strategic Action Plan on Batteries: Building a Strategic Battery Value Chain in Europe, [COM(2019) 176 final],

<https://webapi2016.eesc.europa.eu/v1/documents/EESC-2019-01700-00-00-AC-TRA-EN.docx/content>

<sup>375</sup> Winslow, K.M.; Laux, S.J.; Townsend, T.G. A review on the growing concern and potential management strategies of waste lithium-ion batteries. *Resour. Conserv. Recyc.* 2018, 129, 263–277. [[Google Scholar](#)]

[[CrossRef](#)]

<sup>376</sup> Ellen MacArthur Foundation. Towards a Circular Economy: Business Rationale for an Accelerated Transition. Available online: [https://www.ellenmacarthurfoundation.org/assets/downloads/TCE\\_Ellen-MacArthur-Foundation\\_9-Dec-2015.pdf](https://www.ellenmacarthurfoundation.org/assets/downloads/TCE_Ellen-MacArthur-Foundation_9-Dec-2015.pdf) accessed 6 August 2018

<sup>377</sup> Bocken, N.M.P.; de Pauw, I.; Bakker, C.; van der Grinten, B. Product design and business model strategies for a circular economy. *J. Ind. Prod. Eng.* 2016, 33, 308–320. [[Google Scholar](#)] [[CrossRef](#)]

<sup>378</sup> Stahel, W. The product-life factor. In *An Inquiry into the Nature of Sustainable Societies: The Role of the Private Sector*; Orr, S.G., Ed.; Houston Area Research Center: Houston, TX, USA, 1981; pp. 72–96. [[Google Scholar](#)]

by the manufacture of new batteries with an equivalent capacity, participating in the up/downstream circles of structural construction components.

The processes of reuse and recycling are complementary to each other, and the largest sustainability benefit can be reached if EV batteries are first reused and then recycled.

Globally, cumulative sales of fully electric and plug-in hybrid vehicles exceed five million units up to this date. As this market continues to grow and mature, the potential second-life battery storage capacity is huge. Several GWh of second-life batteries are expected to become available in the next 15 years (**Figure 85**). The fact that the major EV automakers active in the European market cover their batteries with warranties over eight years essentially guarantees that they will retain 70-80% of their original rated capacity at end-of-life. Therefore, they can continue to provide services in stationary storage applications for up to 30 years.<sup>379</sup>

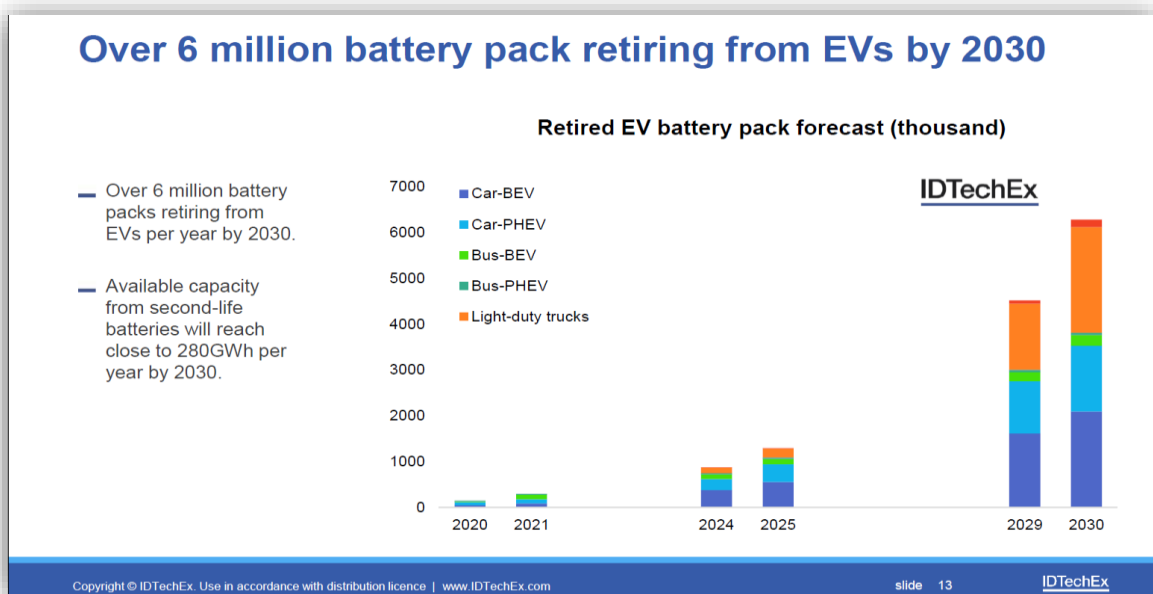

Figure 85: Retired EV battery pack forecast

Second-life batteries can be used in various energy storage applications to facilitate renewable grid integration, thereby increasing the renewable mix of electricity; to provide grid ancillary services that improve the efficiency of power plant operation and

<sup>379</sup> <https://www.pv-magazine.com/2020/02/20/new-markets-for-old-batteries/> last accessed on 5.07.2020



potentially delay or even avoid grid infrastructure upgrade and the demand for new peaker-plants, which are often gas or coal-fired<sup>380</sup>.

### 3.6.1.2 Financial and Social Aspects

The study performed by IDTechEx<sup>381</sup> shows that batteries are the most expensive component of an electric car. An electric vehicle (EV) battery is expected to last 8-10 years as with the battery warranties offered by most EV manufacturers, and the battery is retired from EVs when it cannot satisfy the requirements for use in EVs anymore, for example, when the loss of battery capacity limits the driving range of the electric car.

Repurposing retired electric vehicle (EV) batteries provides a potential way to also reduce EV cost. Embedded in stationary energy storage systems, second life EV batteries could unlock the energy storage market and generate synergic value for the energy sector.<sup>382</sup>

Regarding the social perspective, the major step represented by the shift to electric mobility is expected to provide not only an environmentally-friendly, affordable means of transportation for the masses but also jobs for those who will most likely lose them in the automotive industry and the connected sectors (repair shops, fuel extraction and distribution, lubricants production, etc). The second life applications have a strong employment potential for both people being laid off from vehicle manufacturing and newcomers in the workforce.

Speaking about the financial aspects, there are also several issues that need to be dealt with in order to prevent the slump in GDP, fiscal revenues and local taxes. The strong employment potential and the business opportunities in the battery sector could compensate the fiscal revenue losses envisaged by the shift towards mass electric mobility.

<sup>380</sup> <https://www.idtechex.com/users/action/dl.asp?documentid=22273> last accessed on 06.08.2020

<sup>381</sup> <https://www.idtechex.com/en/research-report/second-life-electric-vehicle-batteries-2020-2030/681> last accessed on 30.07.2020

<sup>382</sup> Jiao, Na & Evans, Steve. (2016). Market Diffusion of Second-life Electric Vehicle Batteries: Barriers and Enablers. World Electric Vehicle Journal. 8. 599-608. 10.3390/wevj8030599.

### 3.6.1.3 Legislation Compliance

As it is right now, the EU legislation on batteries and end-of-life vehicles might be a major drawback as it sets targets for recycling that are not yet technologically achievable: at least 50% by average weight of replaced batteries according to the directive 2006/66/EC and, considering the share of a battery in the overall vehicle's weight, around 75% of the weight of the battery according to the provisions of directive 2000/53/EC<sup>383</sup>.

The recyclability targets are not yet an issue as few EV have reached their end-of-life so far, except the crashed and damaged ones; that means the industry is enjoying some lead-time for research on performant recycling technologies, second-use applications and new battery technologies. Furthermore, most of the EVs that are approaching their end-of-life are prone to be exported to non-EU countries<sup>384, 385</sup>, thusly removing the legal compliance pressure away from the stakeholder's shoulders.

Also, the medium and long term decarbonization targets<sup>386</sup> call for a major switch from black and grey energy sources to green energy production; given that the green energy has some restrictive conditions and is mostly weather-dependent, it is absolutely necessary to develop performant storage technologies and solutions (e.g. accumulate energy during production peaks and shave off consumption peaks). One of the envisaged solutions, therefore, is the energy storage provided by second life batteries (e.g. in households equipped with solar panels) and even by the EVs themselves, through the smart charging and V2G applications, when the technology advances accordingly.

Development of ultra-long life of EV propulsion batteries that outlive the vehicles they are installed in on the assembly line would pave the way for solid and extensive second-life applications.<sup>387</sup>

<sup>383</sup> Directive 2000/53/EC [https://eur-lex.europa.eu/resource.html?uri=cellar:02fa83cf-bf28-4afc-8f9f-eb201bd61813.0005.02/DOC\\_1&format=PDF](https://eur-lex.europa.eu/resource.html?uri=cellar:02fa83cf-bf28-4afc-8f9f-eb201bd61813.0005.02/DOC_1&format=PDF) and Directive 2006/66/EC <https://eur-lex.europa.eu/legal-content/EN/TXT/PDF/?uri=CELEX:32006L0066&from=EN> (last accessed on 14.08.2020), calculations by ALBATTs partners

<sup>384</sup> <https://news.africa-business.com/post/export-used-cars-to-africa-importers-of-used-cars> last accessed on 07.08.2020

<sup>385</sup> <https://www.dw.com/en/world-in-progress-the-dirty-export-business-of-used-cars/av-44204306> last accessed on 07.08.2020

<sup>386</sup> [https://ec.europa.eu/clima/policies/strategies/2050\\_en](https://ec.europa.eu/clima/policies/strategies/2050_en) (last accessed on 14.08.2020)

<sup>387</sup> <https://singularityhub.com/2020/06/11/road-trip-new-record-crushing-battery-lasts-1-2-million-miles-in-electric-cars/> last accessed on 06.08.2020

Refusal of some vehicle owners to replace the battery once it reaches SoH 80% might be a challenge<sup>388</sup>. As the SoH of a battery is not a safety concern, the diminution thereof resulting in the technical requirement to replace it cannot be enforced on owners of electric vehicles, thus unnaturally expanding the battery first life and depriving the second life market of the necessary stream. This phenomenon may be probably more intense in certain parts of the EU (e.g. Central and Eastern European countries) where many second-hand vehicles, including electric ones could end up.

### 3.6.2 Stakeholders

Vehicle manufacturers are not the only companies paying attention to second-life batteries. A growing number of project developers are also starting to see second-life battery storage to bring down the capital costs of commercial- and grid-scale battery installations. This marks a shift away from the smaller residential and off-grid battery applications where initially repurposed batteries were tested.<sup>389</sup>

Based on the perspective of potential operators, a broad range of second-life applications has been systemized. The resulting **Figure 86** illustrates a variety of application scenarios which may be currently of particular interest from both the provider's and the user's perspective<sup>390</sup>.

<sup>388</sup><https://pdfs.semanticscholar.org/49a1/d62cda83ed072ef77f169e71b8a0f0877f0a.pdf>, page 269 last accessed on 06.08.2020

<sup>389</sup><https://www.greentechmedia.com/articles/read/car-makers-and-startups-get-serious-about-reusing-batteries> last accessed on 14.08.2020

<sup>390</sup> Rehme, Marco & Richter, Stefan & Temmler, Aniko & Götze, Uwe. (2016). CoFAT 2016 - Second-Life Battery Applications - Market potentials and contribution to the cost effectiveness of electric vehicles.





Second-Life Applications						
Stationary application scenarios	<i>On-grid solutions (network-connected)</i> 					
	<i>Perspective of the operator</i>	(Industrial) plant operators	Storage operators		Charging infrastructure operators	Residential and commercial real estate owners
	<i>Applications</i>	Short-term storage systems for renewable energy production plants (wind power and photovoltaics)	Stationary storage systems for participating in electricity balancing markets	Short-term storage systems for grid stabilization and regulation	Storage buffers for DC-quick charging stations	Storage systems for load shifting energy-intensive consumers (load management)
	<i>Off-grid solutions (without network connection)</i> 					
Quasi-stationary application scenarios	<i>Perspective of the operator</i>	(Small) plant operators/private households		Operators of critical infrastructure	Storage/charging infrastructure operators	
	<i>Applications</i>	Storage systems for optimizing the own consumption of electrical energy from photovoltaics	Storage systems for uninterruptible power supply of private households	Emergency power systems for ensuring security of supply	Autarkic storage systems for micro mobility (e.g. charging e-bikes in non-grid-connected areas)	
Mobile application scenarios	<i>Off-grid solutions (without network connection)</i> 					
	<i>Applications</i>	Decentralized energy supply of major events		Decentralized energy supply of construction sites		
	<i>Industrial solutions</i> 					
Mobile application scenarios	<i>Applications</i>	Re-use in industrial trucks (e.g. forklifts, lift trucks, tractors, transport trolleys), sweepers etc.		Re-use in driverless transport vehicles for the internal transport		
	<i>Private and commercial solutions</i> 					
<i>Applications</i>	Re-use in e-bikes, e-scooters, golf carts etc.	Battery swapping systems for e-bikes, e-scooters	Re-use in driverless transport vehicles			

Figure 86: Second life applications

The actors along the battery value chain should set up new collaborations with other actors to be able to benefit from creating new business opportunities and developing new business models together.

The list may refer to the following groups of stakeholders:

- ◆ Vehicle manufacturers
- ◆ Battery manufacturers
- ◆ Automotive repair and maintenance workshops
- ◆ Energy production companies with focus on green energy production
- ◆ Energy distribution companies including owners and operators of EV charging stations
- ◆ Solar panel manufacturers and distributors
- ◆ Electric component manufacturers
- ◆ Automation solutions developers and manufacturers
- ◆ High level and secondary level education institutions
- ◆ Research institutes
- ◆ Recycling companies
- ◆ Real estate developers
- ◆ Road construction and maintenance companies

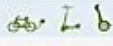
- ◆ Energy regulation and taxation authorities
- ◆ Local authorities/municipalities
- ◆ Regular citizens/flat owners associations

### 3.6.3 Technologies

#### 3.6.3.1 Current Technologies

The model of the value chain of EV batteries and the batteries flows in Europe according to the stakeholders' information and the performed literature review<sup>391</sup> is presented in **Figure 87**.

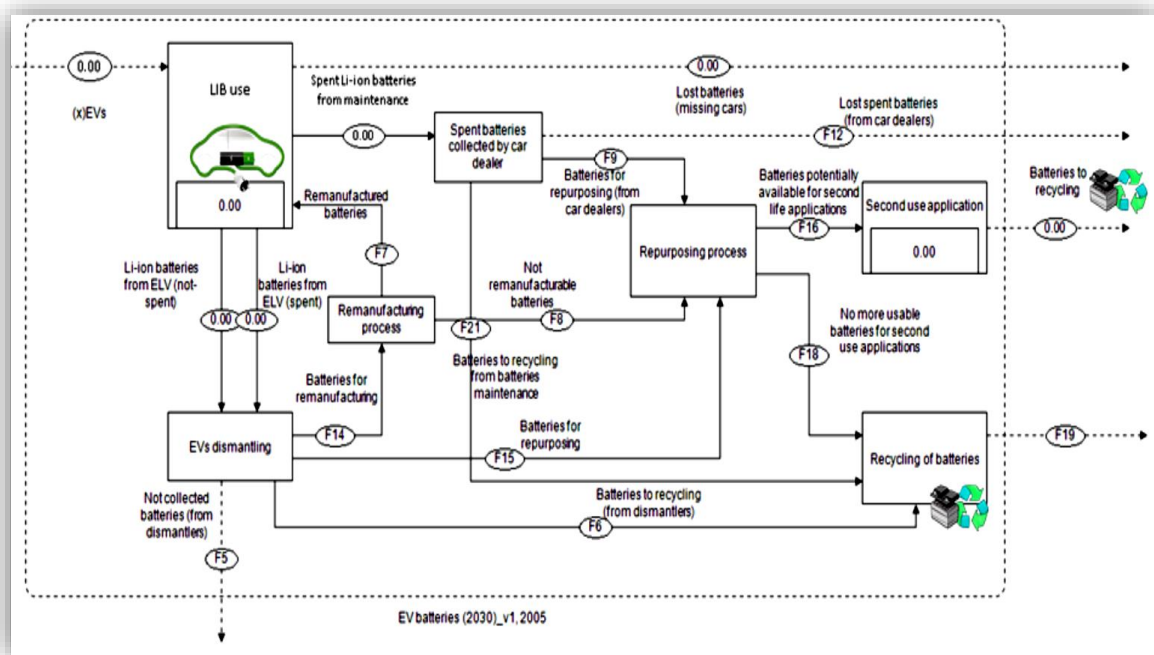

Figure 87: Value chain of EV batteries

<sup>391</sup> Bobba S., Podias A., Di Persio F., Messagie M., Tecchio P., Cusenza M.A., Eynard U., Mathieux F., Pfrang A.; Sustainability Assessment of Second Life Application of Automotive Batteries (SASLAB): JRC Exploratory Research (2016-2017): Final technical report: August 2018; EUR 29321 EN, Publications Office of the European Union, Luxembourg, 2018, ISBN 978-92-79-92835-2; doi:10.2760/53624, JRC112543

A simpler illustration of the value chain is provided in **Figure 88**. The value chain starts with design and manufacturing. After first life, the battery's health and capacity are checked to see if it can be used in a different vehicle or in a stationary application or if it needs to be recycled directly. If a second life is possible, the battery is refurbished according to the specific standards<sup>392</sup>. Depending on the battery and the application, refurbishment can include different processes<sup>393</sup>.

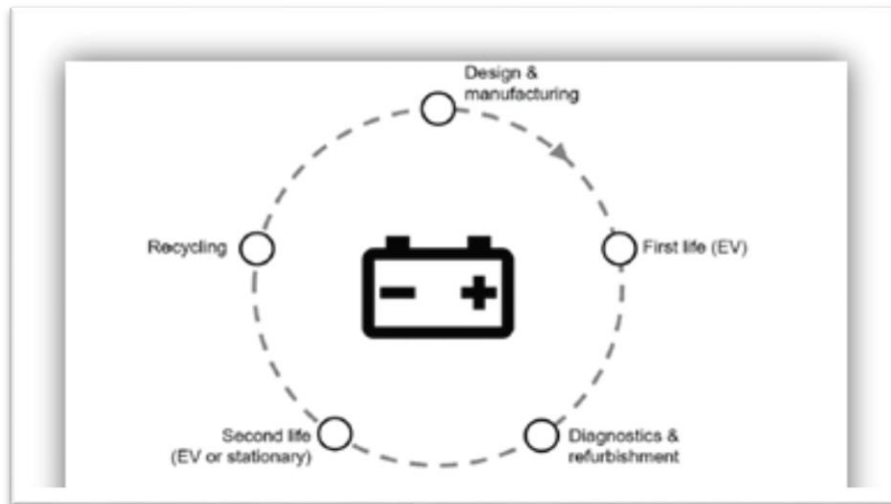

Figure 88: Value chain of EV batteries (simple form)

The main types of technology currently considered are divided into 2 main categories: mobile applications and stationary applications<sup>394</sup>.

Although the second-hand batteries dealt with in this chapter come from road vehicles in general, the main “beneficiary” of this battery stream will be, at least in the beginning, a stationary application as mobile applications require more adjustment efforts<sup>395</sup>.

For example, in the future, used batteries from BMW vehicles, can serve as stationary storage units for wind and solar power, which is currently the case on the premises of the BMW Leipzig plant<sup>396</sup>.

<sup>392</sup> Standard for Evaluation for Repurposing Batteries, ANSI/CAN/UL 1974

<sup>393</sup> Olsson, L.; Fallahi, S.; Schnurr, M.; Diener, D.; Van Loon, P. Circular Business Models for Extended EV Battery Life. *Batteries* 2018, 4, 57.

<sup>394</sup> <https://www.idtechex.com/tw/research-report/second-life-electric-vehicle-batteries-2019-2029/626>

last accessed on 13.08.2020

<sup>395</sup> <https://pdfs.semanticscholar.org/49a1/d62cda83ed072ef77f169e71b8a0f0877f0a.pdf> last accessed on 06.08.2020

<sup>396</sup> <https://www.press.bmwgroup.com/global/article/detail/T0313566EN/more-than-seven-million-vehicles-with-all-electric-or-plug-in-hybrid-drive-systems-by-the-year-2030?language=en> last accessed on 14.08.2020



Nissan formalized a partnership with Sumitomo Corporation to reuse battery packs from the Nissan Leaf for stationary distributed and utility-scale storage systems. In September 2018, Renault announced its Advanced Battery Storage Program<sup>397</sup>.

In the near future, with a steep proliferation of the Electric Vehicle, the reuse of propulsion batteries is crucial for the sustainability of the grid. According to the calculations, a single average electric vehicle would double the energy consumption of a regular household<sup>398</sup>. Given the household consumption pattern and the vehicle charging particularity, this consumption could be also extremely intensive (without smart charging) if it takes place during a consumption peak which could result in severe production-consumption-grid stress<sup>399</sup>.

Second life batteries (both stationary and mobile) will have a key role in storing the green energy (fundamentally weather dependent) and shaving the consumption peaks that may cripple the grid, especially in the countries where the infrastructure is still old/weak. For the beginning, the most accessible applications appear to be the stationary ones as the batteries used for such purposes are bulky and storage capacity impaired (e.g. 80% SoH in the best case scenario).

A study<sup>400</sup> published in *Applied Energy* by MIT researcher Ian Mathews and five other current and former MIT researchers concluded that lithium-ion batteries could have a profitable second life as backup storage for grid-scale solar photovoltaic installations, where they could operate for a decade or more in this less-demanding role<sup>401</sup>.

So, the first envisaged efficient application for the second life battery would be the (small scale) “battery farm” that could be conveniently located either near/in the big cities in order to store the conventional energy during the day for the subsequent use when the demand peaks or near the wind turbines / solar panel farms in order to store the green

<sup>397</sup> <https://www.mckinsey.com/industries/automotive-and-assembly/our-insights/second-life-ev-batteries-the-newest-value-pool-in-energy-storage#> last accessed on 14.08.2020

<sup>398</sup> <https://www.wall-street.ro/special/casa-ta-verde/201281/cata-electricitate-consuma-in-medie-o-locuinta-pe-ce-loc-se-situeaza-romania.html#gref> last accessed on 14.08.2020

<sup>399</sup> <https://www.ofgem.gov.uk/ofgem-publications/136142>, last accessed on 14.08.2020

<sup>400</sup> <https://news.mit.edu/2020/solar-energy-farms-electric-vehicle-batteries-life-0522> last accessed on 14.08.2020

<sup>401</sup> <https://www.greentechmedia.com/articles/read/car-makers-and-startups-get-serious-about-reusing-batteries> last accessed on 14.08.2020

energy and provide a constant stream around the clock<sup>402</sup>. Small scale battery farm solution is one of the best applications to jump start the trend as it is a pioneering enterprise. As an adaptation of a second-hand item to a different usage than the one it was initially designed for, there are many adjustments that need professional care and competent supervision. A battery farm is the only way this can be done in a cost-efficient manner. Even if the technology these days allows for efficient unmanned monitoring and intervention through automation, the associated costs are not to be belittled: all the required devices such as thermal cameras, regular cameras, remote control valves, sensors and so on (i.e. for safety reasons) add up to amounts that an average EV user or home owner might not afford.

Another possible type of stationary application for second life battery would be the power regulation hub for a small residential community such as a “cul-de-sac” or a group of homesteads that are within a small range away from one another, even though not all of them own energy production devices.

The third type of stationary application regards the single household with or without its own energy generation device.

The fourth type regards the stranded consumers such as off-grid homesteads or meteorological stations located in remote areas that only rely on the electricity generated by their own devices/sources. Even in the case of a consumer that relies mainly on the diesel generator, the battery provides a storage capability that comes in handy for the wellbeing of the generator (avoids the frequent on-and-off function thereof). Pairing up second-life batteries with solar panels and charging stations is also foreseeable for small communities or country roads.<sup>403</sup>

<sup>402</sup> <https://www.sciencedirect.com/science/article/pii/S0301479718313124?via%3Dihub> last accessed on 20.08.2020

<sup>403</sup> Example of a project: <https://www.obnovitelne.cz/clanek/969/opravdu-cista-elektрина-pro-elektromobily-solarni-panely-a-baterie-nabiji-az-sedm-aut/> last accessed on 20.08.2020



Regarding the mobile applications considered up to this point, the most appropriate would be the following:

- ◆ Road applications: sightseeing trackless trains<sup>404</sup> and airport buses<sup>405</sup>
- ◆ Non-road applications: forklifts, front loaders and AGVs in automated container ports<sup>406</sup>

### 3.6.3.2 Challenges

Despite the benefits and potential for second-life batteries in energy storage applications, there are significant challenges in exploiting the expected volume of decommissioned batteries. These include a lack of standardization generally, and specifically in communication protocols. There are also technical barriers associated with the variations of battery cells, shapes, chemistries, capacities, and sizes, in addition to challenges with the accessibility of data. Each battery is designed for a given EV model by its manufacturer and automotive OEM, which further fragments the volume of similar battery packs and increases the complexity of refurbishment. For example, more than 250 new EV models are planned by 2025 from more than 15 manufacturers further stressing this challenge<sup>407</sup>. On top of that, there is a lack of standardization for the battery management system (BMS) which leads to difficulties in guaranteeing second-life battery quality and performance.

Furthermore, decisions will need to be made about whether to invest in remanufacturing second-life batteries or opt for direct redeployment. While direct redeployment uses the original battery pack, remanufacturing (or reconfiguration) requires a cell quality selection process that results in enhanced battery pack quality. The cost difference between the two options can differ in favour of direct re-use, but remanufacturing has a higher quality output and overcomes several technical barriers.

<sup>404</sup> <https://www.visiter-bordeaux.com/en/discovering-bordeaux/bordeaux-visit-electric-touristic-train.html> last accessed on 06.08.2020

<sup>405</sup> <https://www.buslife.de/en/2015/10/german-airport-electric-bus> last accessed on 06.08.2020

<sup>406</sup> <https://e.huawei.com/topic/leading-new-ict-en/yangshan-port-case.html> last accessed on 06.08.2020

<sup>407</sup> <https://www.mckinsey.com/industries/automotive-and-assembly/our-insights/second-life-ev-batteries-the-newest-value-pool-in-energy-storage> last accessed on 04.08.2020

It is expected that remanufacturing, if it can be standardized, is likely to be the best way to create value from second-life applications and overcome some of the challenges.<sup>408</sup>

In a presentation made by Na Jiao, PhD, Technology Analyst with IDTechEx<sup>409</sup>, the challenges for second-life batteries are very well synthesized, as follows:

- ◆ Data availability and security
- ◆ Competition from new batteries
- ◆ Regulation and standards
- ◆ Uncertain raw material price
- ◆ Battery design for second life
- ◆ Battery collection

Regarding the professional decision on the reusability of a propulsion battery and the information that is necessary to have the right decision, the solution is a provision that exists in the legislation in force in the European Union. The End-of-Life Directive 2000/53/EC stipulates the obligation of manufacturers of components to supply appropriate information concerning dismantling, storage and testing of components which can be reused (Art.8, paragraph 4): *“4. Without prejudice to commercial and industrial confidentiality, Member States shall take the necessary measures to ensure that manufacturers of components used in vehicles make available to authorised treatment facilities, as far as it is requested by these facilities, appropriate information concerning dismantling, storage and testing of components which can be reused.”*

The only issue here is that the regulatory act is a directive (not a regulation) which has to be properly transposed in the national legislation and reasonably implemented in order to function as intended. The scheduled revision of this act might bring the clarifications needed (extension of the applicability of the requirement to “economic operators” (instead of “authorised treatment facilities”) and the general applicability in all member states.

Once the regulatory framework is properly set, the certification mechanism can be adjusted to involve the operators that are already present in the economic environment: TÜV<sup>410</sup>, SGS, etc. This certification is extremely important as: it can allow a complete

<sup>408</sup> <https://www.pv-magazine.com/2020/02/20/new-markets-for-old-batteries/> last accessed on 27.07.2020

<sup>409</sup> <https://www.idtechex.com/users/action/dl.asp?documentid=22273> last accessed on 27.07.2020

<sup>410</sup> <https://www.tuvsud.com/en/industries/energy>, last accessed on 21.08.2020

assessment of the energy capacity remaining in a battery pack at the end of the first life; it may allow a more optimized design of the full battery system for a stationary application since more balanced battery racks and battery banks can be achieved; enable developers and integrators of second-life batteries to provide product warranties to their customers, thus facilitating the widespread adoption of such solutions in the market.

Besides the legislative framework, there is another issue that must be dealt with as soon as possible, as practical applications are impossible without: the necessary tools to ship batteries across the country in a safe and expeditious manner as well as to ensure the right conditions for a proper and efficient second life.

The aforementioned challenges also derive from the inherent technical and technological challenges related with this second-life opportunity, particularly when repurposing EV batteries to stationary electrical grid applications. There is still insufficient knowledge about the behaviour and performance of Li-ion battery systems beyond a certain SoH level, particularly upon the change of the type of usage of the system. This hinders not only the sizing of the system for a certain application but also leads to the lack of performance warranties that might lead to the lack of confidence and lower investments from the user.

For stationary applications, there are also challenges at the integration level with two main grounds: Li-ion based batteries have their internal resistance increased with age and utilisation, meaning that the design needs to consider that in terms of cooling and safety. Having a robust characterization of such behaviour will foster a more optimized design and further solution adoption; designing the solution for the stationary application may mean that a more regular replacement or capacity expansion in projects, which leads to the challenge of designing very flexible solutions, allowing such approach even in a changing EV battery pack design. This is an integration challenge as well as a challenge for the BMS.

### 3.6.3.3 Tools

Before the existence of the users/applications and the stream of functional second life batteries, a proper infrastructure is needed in order to have a successful

implementation. To this purpose some tools are required in order to properly assess the overall state of the battery as well as the safe and efficient second life.

The tools needed to deal with the second-life batteries are divided into two main categories: software and hardware.

The most important software needed is the protocol that can accommodate all common battery management systems (BMS). This can be used for either the assessment of the state of health of the battery (if not already done by the repair workshop with its own tooling) or the functioning over its second life.

Further software solutions can be developed in order to deal with various function related phenomena a battery might encounter during its second life:

- ◆ Vibration monitoring system
- ◆ Premises temperature measuring and regulation
- ◆ Core fluid thermal management - for batteries cooled with (antifreeze) liquid or refrigerant fluid
- ◆ Emergency connection cut-off and, if necessary, battery flooding (stationary applications only)
- ◆ Infrared thermal scanning for defective cells<sup>411</sup>

In terms of hardware necessary to cope with the second life of the battery, there are also two main categories, beside the devices necessary to remove the battery from the vehicle which are stipulated by each manufacturer<sup>412</sup>:

- ◆ Storage and shipping hardware, mandatorily standardized regarding at least the following requirements: maximum length – 240cm, maximum width – 200cm, crane compliant, forklift compliant on both large sides, stackable on min 3 levels during shipping and min 6 levels when stowed, lockable between one another when stacked, vibration-proof and provided with detachable/foldable manoeuvring wheels on all bottom corners
- ◆ Final / working position hardware (especially in stationary applications) - cradle (with or without controller box, leak-proof and floodable), cooling ducts/pipes

<sup>411</sup> <https://www.aimspress.com/fileOther/PDF/energy/energy-07-05-646.pdf> last accessed on 14.08.2020

<sup>412</sup> The service literature (spare parts catalogue, diagnosis software and repair manuals) is available on a fee/subscription basis. For example, the specific literature for Skoda vehicles is accessible under this link: <https://erwin.skoda-auto.cz/erwin/showHome.do>

and radiators, with or without fans, connecting cables (both low and high voltage) from battery to consumer / generator, etc.

One item that can be found in both abovementioned categories is basically the “cradle” that could be used for either both tasks or just one of them<sup>413</sup>.

#### 3.6.3.4 Usage

According to a comprehensive study<sup>414</sup>, second-life batteries can be employed for a wide range of applications (stationary and, to a lesser degree, mobile), based on:

- ◆ application area: residential, industrial, and commercial application
- ◆ usage: grid stationery, off-grid stationery, mobile applications

The **Figure 89** shows the applications of ESS (energy storage system) using first life and second life of battery along with their usage pattern and potential.

Due to the requirements for a battery to be used in an EV, where it is required to provide a high C-rating<sup>415</sup> in charging and discharging, i.e. a high rate of charge/discharge due to acceleration and use of superchargers as well as the capacity to allow a significant driving range, such batteries can be used in the different applications shown below. However, the characteristics of each type of battery pack need to be studied in order to define the most appropriate operating regimes for such stationary applications. It is clear that these batteries can be applied for frequency regulation, leveraging their capability of operating at up to 5C.

<sup>413</sup> information based on the ALBATTTS partners experience

<sup>414</sup> Hossain, E., Murtaugh, D., Mody, J., Faruque, H.M., Sunny, M.S., & Mohammad, N. (2019). A Comprehensive Review on Second-Life Batteries: Current State, Manufacturing Considerations, Applications, Impacts, Barriers & Potential Solutions, Business Strategies, and Policies. *IEEE Access*, 7, 73215-73252. (pag 25-31)

<sup>415</sup> <https://energsoft.com/blog/f/c-rate-of-batteries-and-fast-charging> last accessed on 26.08.2020

Also, they can be used to shift renewable energy in time, leading to a greater match between renewable production and consumption. However, the latter application is a more energy oriented application, with a low c-rating, which can result in a less stressed usage of such batteries and can therefore contribute to a longer second-life.

Applications of ESS		1st life usage	2nd life usage
<b>On-grid stationary</b>	Renewable Farming	***	***
	Peak reduction	***	*
	Load levelling	***	**
	Area & frequency regulation	***	***
	Generation-side asset management	***	**
	Voltage or reactive power support	**	*
<b>Off-grid stationary</b>	Microgrid	***	***
	Smart grid	***	***
	Power quality & reliability	***	*
	Load following	***	**
	Spinning reserve	***	*
<b>Mobile applications</b>	EV charging station	***	**
	V2G for fast charging	***	*
	EV for long range trips	***	X
	EV for short range trips	***	**

\*\*\* Frequent, \*\* Occasional, \* Rare, X Infeasible

Figure 89: Applications of ESS

### 3.6.4 Future Markets & Projects

Reusing EV batteries in second-life applications extends their lifetime. Various sources show very different views and predictions regarding the share of batteries that will sustain a second life, emphasizing that the market is currently very uncertain. Second-life batteries can be employed for a wide range of applications<sup>416</sup>:

- ◆ stationary energy storage
- ◆ low-speed vehicles
- ◆ back-up storage systems
- ◆ mobile EV charger
- ◆ industrial forklifts

<sup>416</sup> <https://www.idtechex.com/users/action/dl.asp?documentid=22273> last accessed on 06.08.2020

While portable lithium-ion batteries have been reused for a long time without much public attention, batteries from electric vehicles, which have become the dominant segment in the lithium-ion market, get more and more attention for their potential to be used in other applications. In Europe, several vehicle manufacturers, in particular companies that pioneered the electric car market, have installed used batteries primarily in different types of energy storage systems, ranging from small residential systems to larger containerised grid-scale solutions (**Figure 90**)<sup>417</sup>.

Car maker	Second life initiative	Car maker	Second life initiative
BJEV	EV-charging, backup power	Mitsubishi	C&I energy storage
BMW	Grid-scale energy storage, EV-charging	PSA	C&I energy storage
BYD	Grid-scale energy storage, backup power	Renault	EV-charging, residential energy storage, grid-scale energy storage
Chengnan	Backup power	Tesla	Remanufacturing
Daimler	Grid-scale energy storage, C&I energy storage	Toyota	C&I energy storage, grid-scale energy storage (NiMH)
General Motors	Remanufacturing,	SAIC	Backup power
Great Wall Motor	Backup power	Volkswagen (Audi)	C&I energy storage
Hyundai	Grid-scale energy storage, C&I energy storage	Volvo	Residential energy storage
Nissan	Remanufacturing, C&I energy storage, EV-charging	Volvo Cars	Residential energy storage
		Yin-Long	Backup power, C&I energy storage

Figure 90: Example of projects in use

### 3.6.5 Job Roles and Skills

Most notable jobs that could be classified under the second life of batteries stage are **Inspection Technicians, Service Technicians and Compliance Engineers, End of Warranty Managers** who can determine the parameter of battery to be used as a second life batteries. All of this could be done under supervision of **Safety Specialists and Managers**.

<sup>417</sup> [http://www3.weforum.org/docs/GBA\\_EOL\\_baseline\\_Circular\\_Energy\\_Storage.pdf](http://www3.weforum.org/docs/GBA_EOL_baseline_Circular_Energy_Storage.pdf) last accessed on 14.08.2020

## Skills and knowledge required in relevant advertisements:

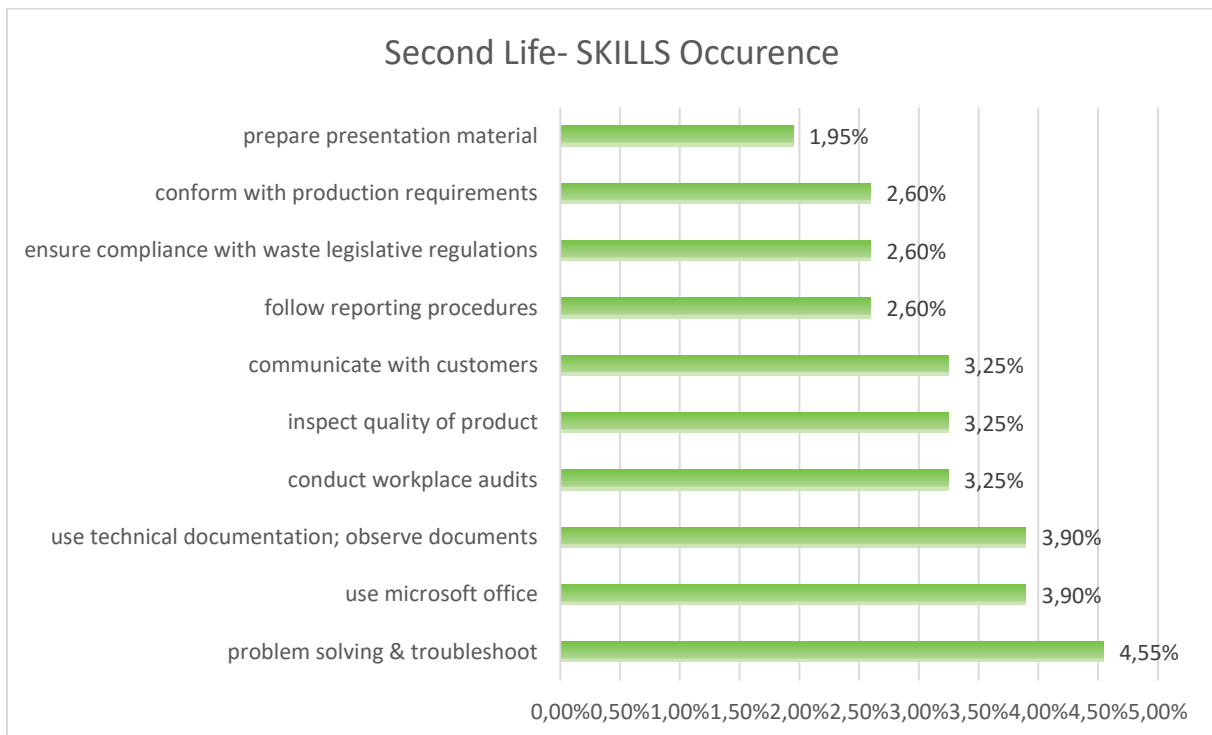

Figure 91 Second Life SKILLS Occurrence

### Skills

Skills occurrence for battery second life is shown in **Figure 91**. Problem solving and troubleshooting, usage of Microsoft Office, documentation and quality inspections, audits and compliance with waste legislation are the most important.



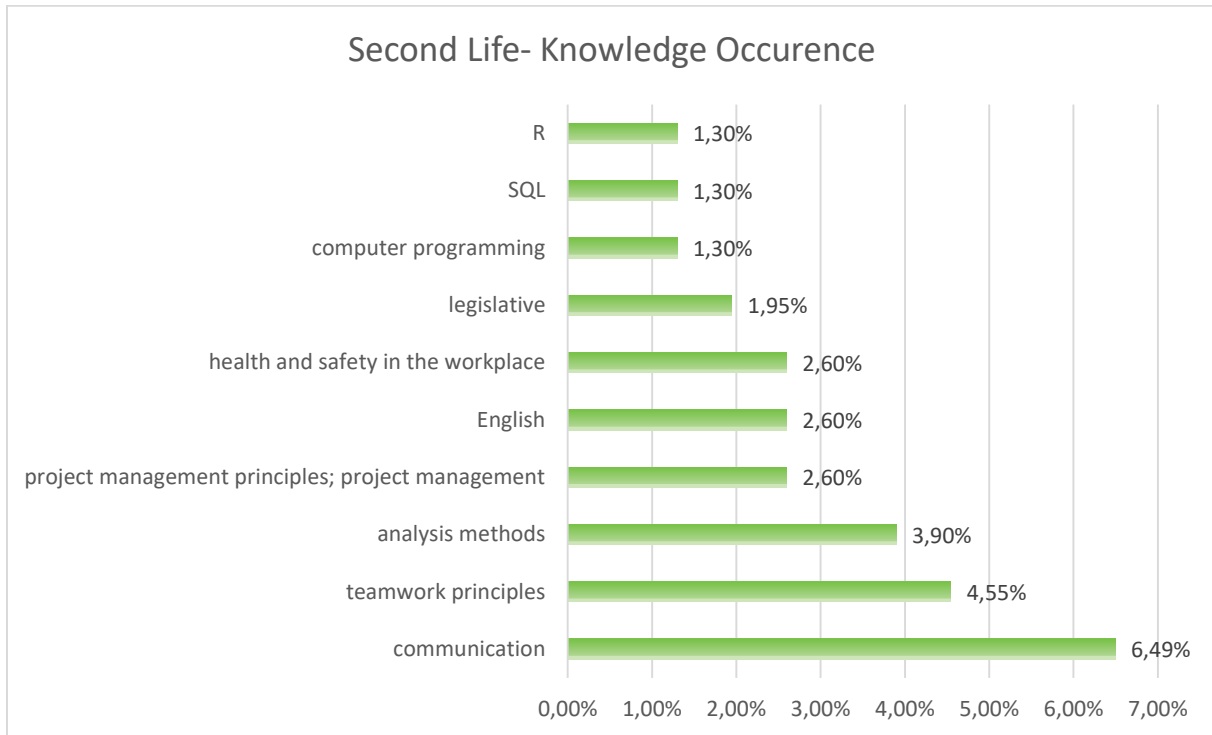

Figure 92 Second Life KNOWLEDGE Occurrence

## Knowledge

Knowledge occurrence for battery second life are shown in **Figure 92**. Communication and teamwork are important knowledge outcomes from the analysis. The most relevant are legislative as well as health and safety knowledge.

## 3.7 RECYCLING

### 3.7.1 Drivers of Change

#### The major factors driving the change of the battery recycling market

The factors such as the increase in demand for electric vehicles globally, the rising environmental concerns, stringent government regulations regarding recycling of used batteries, and growing prices of rare earth metals such as Cobalt, which is used as a raw material for lithium-ion battery manufacturing, are considered as some of the major factors driving the growth of the battery recycling market.

The lithium-ion battery recycling market is estimated at USD 1.5 billion in 2019 and projected to grow from USD 12.2 billion in 2025 to USD 18.1 billion by 2030, at a Compound annual growth rate (CAGR) of 8.2% from 2025 to 2030<sup>418</sup> (**Figure 93**)

Rising investments in the development of electric vehicles are some of the key opportunities for the lithium-ion battery recycling market.

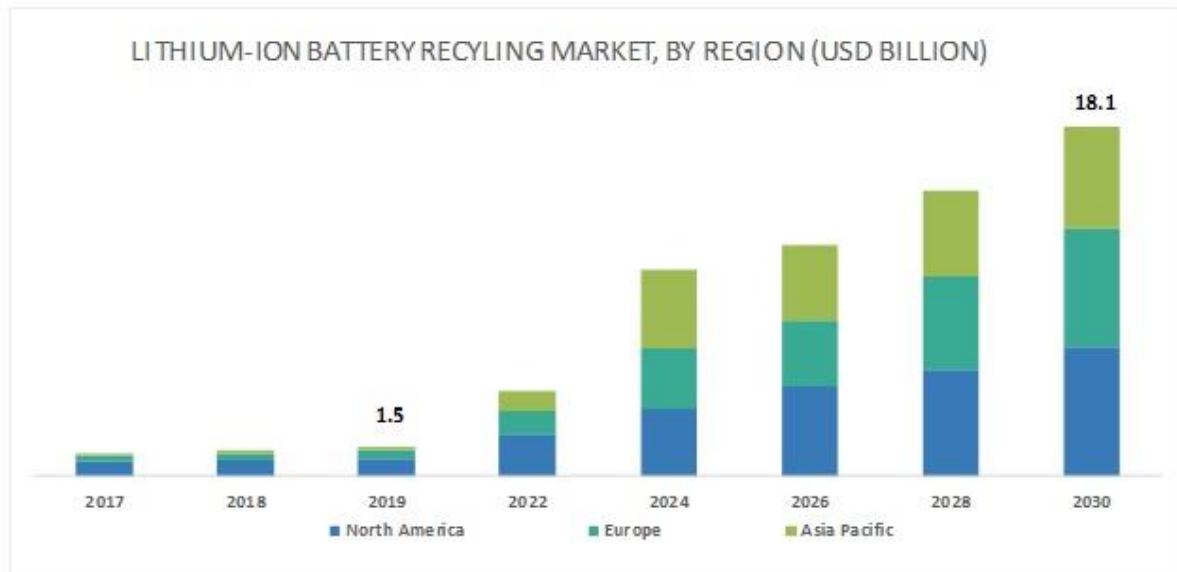

Figure 93 Lithium-ion Battery Recycling Market, by Region (USD Billion)<sup>418</sup>

Automotive is the largest segment in the global Lithium-ion battery market, followed by the industrial and power segments. Lithium-ion batteries are being used in significant quantities for automotive propulsion. Since these batteries offer high energy and power density, there is an increasing demand for them, and this trend is expected to continue in the near future

Batteries for EVs are expected to dominate the demand. The supply of cobalt is a real concern, with batteries alone potentially using over 10% of the world reserves. Superalloys, which are used to make parts for gas turbine engines, are another major use for cobalt<sup>419</sup>. Recycling could reduce the severity of this potential shortage in the long term, and reserves may increase as the price rises.

The end of life of batteries placed on the EU market is regulated by the Batteries Directive 2006/66/EC<sup>420</sup>. It is the only piece of EU legislation dedicated to batteries and seeks to ensure that producers of batteries and products incorporating batteries are responsible for the

<sup>418</sup>Lithium-ion Battery Recycling Market. Retrieved August 03, 2020, from <https://www.marketsandmarkets.com/Market-Reports/lithium-ion-battery-recycling-market-153488928.html>

<sup>419</sup> National Minerals Information Center. Retrieved August 12, 2020, from <https://www.usgs.gov/centers/nmic/cobalt-statistics-and-information>

<sup>420</sup> EUR-Lex Access to European Union Law. Retrieved August, 12, 2020, from [https://eur-lex.europa.eu/resource.html?uri=cellar:02fa83cf-bf28-4afc-8f9f-eb201bd61813.0005.02/DOC\\_1&format=PDF](https://eur-lex.europa.eu/resource.html?uri=cellar:02fa83cf-bf28-4afc-8f9f-eb201bd61813.0005.02/DOC_1&format=PDF)

management of the waste generated. As this directive is currently under revision, the EC has identified a need for:

- ◆ criteria to identify harmful substances which are not currently regulated (cobalt; organic electrolytes such as lithium hexafluorophosphate) and management measures prescribed.
- ◆ considering targets for battery collection or provisions for national schemes, Extended Producer Responsibility (EPR), financing, labelling, or reporting obligations with respect to industrial batteries (which include EV batteries).
- ◆ a mechanism to integrate new battery chemistries into the directive (e.g. solid-state, etc.).
- ◆ targets for the recovery of materials that constitute lithium batteries such as cobalt or lithium – currently, the target for replaced batteries is 50%. According to the provisions of the ELV Directive (2000/53/EC<sup>421</sup> – also under revision) which applies to scrapped vehicles and affects the batteries indirectly, beyond the provisions of the Batteries Directive, the target for propulsion batteries removed from them is around 75%.
- ◆ and the directive to address the “second life” of batteries. Producers currently remain responsible until the battery is eventually scrapped or recycled, independently of the number of intermediate lives it may have had.<sup>422</sup>

Further aspects that might create issues on the proper and efficient recycling and possible solutions:

- ◆ The decrease in quality of the core materials resulted from recycling, rendering them unfit for new batteries.

<sup>421</sup> EUR-Lex Access to European Union Law. Retrieved August, 03, 2020, from [https://eur-lex.europa.eu/resource.html?uri=cellar:02fa83cf-bf28-4afc-8f9f-eb201bd61813.0005.02/DOC\\_1&format=PDF](https://eur-lex.europa.eu/resource.html?uri=cellar:02fa83cf-bf28-4afc-8f9f-eb201bd61813.0005.02/DOC_1&format=PDF)

<sup>422</sup>Powering the future Commercial opportunities and legal developments across the EV batteries lifecycle. Retrieved, August, 03. 2020, from [https://lpscdn.linklaters.com/-/media/files/thoughtleadership/electric-vehicle-batteries/powering\\_the\\_future\\_electric\\_vehicle\\_batteries\\_linklaters.ashx?rev=0921c08b-906a-48fd-b17e-45ff4063bd31&extension=pdf&hash=16DE5CE1C71E309E48836652B17D0AE4](https://lpscdn.linklaters.com/-/media/files/thoughtleadership/electric-vehicle-batteries/powering_the_future_electric_vehicle_batteries_linklaters.ashx?rev=0921c08b-906a-48fd-b17e-45ff4063bd31&extension=pdf&hash=16DE5CE1C71E309E48836652B17D0AE4)

- ◆ Lack of standardization of the batteries, in many respects (shape, cooling solution, wiring, BMS, cell structure).
- ◆ Need for consideration of the broader context, complexity of vehicles and harmonisation of the different waste directives as a prerequisite for better recycling in the EU, as pointed out by the automotive industry representatives. ,<sup>423</sup>.
- ◆ Recycling methods (mechanical and physical processing / pyro / hydro).
- ◆ The necessary investments in a high-capacity, complete recycling plant are considerable. A 1.200 tons/year processing plant would cost around 10 million dollars<sup>424</sup>.
- ◆ Size of the waste stream – as in any other business / activity, the efficiency highly depends on the stream of batteries routed to the operator; frequent interruptions and / or scarcity of incoming stream of batteries might render the economic operator concerned unprofitable.
- ◆ In line with the previous point, it is noteworthy the potential behaviour of some EV owners. More exactly their refusal to have the battery pack replaced once it reaches State of Health (SoH) 80% (or whatever threshold the manufacturer might set for the particular type of vehicle). As the SoH of a battery is not a safety concern, the degradation thereof resulting in the technical requirement to replace it cannot be enforced on owners of electric vehicles, thus unnaturally expanding the battery first life and depriving the second life market of the necessary stream. Furthermore, that particular battery, once it gets replaced, will probably be non-reusable for most of the second life envisaged applications and would have to be scrapped. This phenomenon will probably be more intense in low income countries where many second-hand vehicles including electric ones would end up once the original equipment (OE) battery`s SoH starts to diminish rapidly.

<sup>423</sup> ACEA Position Paper Revision of the EU Batteries Directive (2006/66/EC) Retrieved, August, 03. 2020, from <https://www.acea.be/publications/article/position-paper-revision-of-the-eu-batteries-directive-2006-66-ec>

<sup>424</sup> Research Study on Reuse and Recycling of Batteries Employed in Electric Vehicles: The Technical, Environmental, Economic, Energy and Cost Implications of Reusing and Recycling EV Batteries. Retrieved August, 03, 2020, from <https://www.api.org/~media/Files/Oil-and-Natural-Gas/Fuels/Kelleher%20Final%20EV%20Battery%20Reuse%20and%20Recycling%20Report%20to%20API%2018Sep2019%20edits%2018Dec2019.pdf>

- ◆ The amount of recyclable batteries also depends on the discipline or lack thereof on the market. Even if the stream of unusable batteries is substantial, as long as it is possible to interfere effortlessly in the chain and cherry-pick the valuable, easy-to-remove materials, **the recycling industry will face either a shortage of batteries or the risk of inefficiency.**
- ◆ As it is a technology in its pioneering stage and the challenges are still high, besides the discipline, there is a need of constant and solid support from the authorities, including financial kind. The governments should support the establishment of automotive battery production value chains (from raw material extraction, sourcing and processing, battery materials, cell production and battery systems to reuse and recycling) by consulting key industry stakeholders to understand how to scale up capacity and investments to develop the value chain. Multilateral development agencies should strengthen funding for battery manufacturing, coupling it with requirements for sustainability (e.g. with respect to the transparency of supply chains).<sup>425</sup>
- ◆ Other options could be considered, for example an exclusive value chain for the spent batteries, at least until the technology is mature enough and solid collection and treatment systems are in place, possibly in conjunction with a “battery deposit” to be paid at purchase of the car and redeemed in full once the spent battery or the vehicle altogether is turned over to a certified collector/treatment facility.

The constant stream of spent batteries also depends on the proliferation of electric vehicles today. It is well known that most of the stimuli for the purchase of electric vehicles around Europe are incentives [rebate on the price, Value-added tax (VAT) exemption, registration tax exemption, ownership tax exemption, High-occupancy vehicle lane (HOV) privileges, free charging and parking, road/bridge/tunnel toll exemption, etc.) and the most stimulating ones are the financial kind.

<sup>425</sup> Electric Vehicles On trac . Retrieved July, 15, 2020, from <https://www.iea.org/reports/electric-vehicles>

### 3.7.2 Stakeholders

The stakeholders for battery recycling involve all elements of the battery value chain. This is important for the sustainability of the battery economy but, also, for batteries to become part of the circular economy. Only through the engagement of all current actors and business newcomers as well as through the creation of new business models will such actors tackle the challenge and take advantage of the opportunity that the recycling brings about.

The urgency to have current and new stakeholders involved in the recycling challenge derives from the very limited recycling capacity as in the past batteries have been treated only as hazardous waste. In Europe, battery recycling hosting capacity is only around 33.000 tons per year, not having an efficiency and effective process of recovering valuable metals and rare minerals that can be found in Li-ion batteries. Also, there is not sufficient volume capacity for today's, and even less for tomorrow's market, as electrification ramps-up<sup>426</sup>.

The summary of the potential stakeholders in battery recycling are represented in the following **Figure 94**<sup>427</sup>:

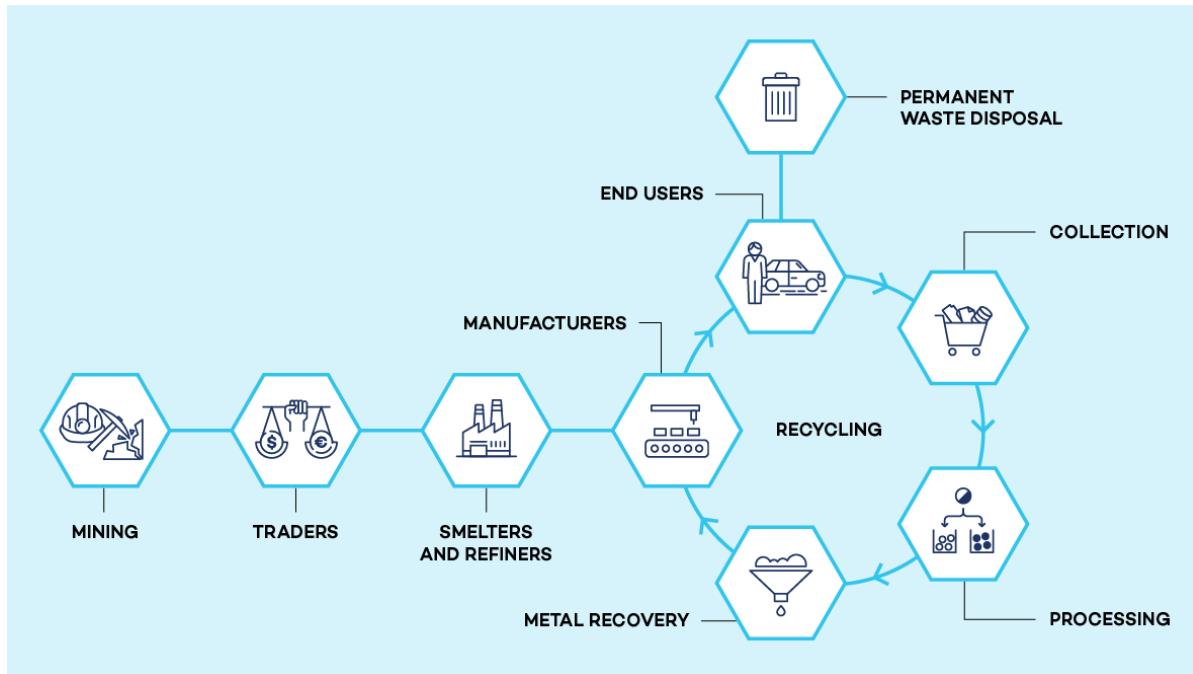

Figure 94 Summary of recycling stakeholders

<sup>426</sup> Northvolt. Retrieved August, 03, 2020, from <https://northvolt.com/stories/RevoltTechnologies>

<sup>427</sup> International Institute for Sustainable Development. Dead Batteries Deserve a Second Life by Claire Church on April 9, 2019. Retrieved August 03, 2020, from <https://www.iisd.org/library/battery-recycling>

The list of categories of stakeholders may be the following:

- ◆ Automobile manufacturers
- ◆ Automotive repair and maintenance workshops
- ◆ Battery manufacturers
- ◆ Citizens/ battery users in general
- ◆ Engineering, Procurement and Construction (EPC) companies with Operations and Maintenance (O&M) services
- ◆ Energy storage integrators
- ◆ Energy utilities
- ◆ Environmental protection agencies/ associations
- ◆ Local authorities/ municipalities
- ◆ Recycling companies
- ◆ Research institutes
- ◆ Telecom companies
- ◆ Waste, energy regulation and taxation authorities
- ◆ Waste management companies

On one hand, **stakeholders are not only focused on the sustainability of battery production** and, on the other hand, they are **changing actions due to new regulations** that increase the responsibility of different actors for battery recycling. Recycling may also foster other revenue streams and could lower the initial price of batteries as metals and rare minerals are recovered. European automakers are being made responsible for ensuring that their installed batteries are properly disposed of at the End of life (EoL). This has resulted in significant investments in recycling capacity, with recycling plants being owned by the automakers themselves or through partnerships. In these cases, recycling plants are responsible for battery manufacturers or materials processing companies while having continuous battery provision from automakers. The former, for example, includes the cases of the circular

Gigafactory of Tesla<sup>428</sup> and the Volkswagen in-house Li-ion battery recycling plant<sup>429</sup>. The recycling plants are being planned or **located near automakers factories** to optimize logistics. An example of the latter is given by BMW<sup>430</sup>, called “4R Energy”, that has built a factory in Japan focused on the reuse and recycling of Li-ion batteries from electric vehicles.

Battery manufacturers, the dominant players in the market, have already presented **circular strategies**, which are focused on recycling that is fundamental for a sustainable battery business and the continuous cost reduction. This is the case of Samsung SDI<sup>431</sup> and Farasis. One of the drivers is also a geographic shift in the location of availability of the resources, once mass recycling is achieved. In China there are regulations that assign responsibility to battery manufacturers for products placed on the domestic market (**Figure 97**). That structure will be leveraged for international battery sales as well. The same happens in Europe with Northvolt, as described previously, with a strong push and broad partnerships.

The same is applicable to providers and users of batteries to such fields as, for example, telecom and energy utilities. Therefore, the trend is that telecom and energy utilities as well as Engineering, Procurement and Construction (EPC) companies and energy storage integrators have a greater responsibility for recycling. Consequently, they can provide more opportunities to generate sustainable and circular products and services.

As there is a need for battery recycling capacity and new business models, new players, completely focused on the recycling or second use of the batteries, are coming to the market. Their main goal is to maximize the reuse potential and the recovery of critical material from Li-ion batteries in a sustainable and safe manner. These new players need to be capable of providing recycled material to battery manufacturers by enhancing the current technology

<sup>428</sup> Cooke, Philip, “Gigafactory logistics in space and time: Tesla’s fourth Gigafactory and its rivals”, 2020, MDPI Sustainability journal

<sup>429</sup> Volkswagen website. Retrieved July, 24, 2020, from <https://www.volkswagenag.com/en/news/stories/2019/02/lithium-to-lithium-manganese-tomanganese.html#>

<sup>430</sup> Nissan Motor Corporation, Global Newsroom, Nissan, sumito Corp. and 4R set up plant to recycle electric-car batteries. Retrieved July 27, 2020, from <https://global.nissannews.com/en/releases/release-487297034c80023008bd9722aa069598-180326-01-e>

<sup>431</sup> “Samsung SDI: Sustainability Report”, Samsung SDI, 2018. Retrieved July, 27, 2020, from [https://www.samsungsdi.co.kr/upload/download/sustainablemanagement/2018\\_Samsung\\_SDI\\_Sustainability\\_Report\\_English.pdf](https://www.samsungsdi.co.kr/upload/download/sustainablemanagement/2018_Samsung_SDI_Sustainability_Report_English.pdf)



and treatment processes and **challenging** existing mining and material processing companies in the value chain. Technologically, they may differ in the applied processes and how many percent of the material can be reclaimed. This is the case, for example, of Li-cycle<sup>432</sup>, OnTo Technology<sup>433</sup>, Anhua<sup>434</sup> and Duesenfeld<sup>435</sup>.

**Finally, the citizens and battery users need to be engaged and need to be aware of the challenge of recycling. Not only will they be shifting towards electric vehicles, but also, they need to know the differences and what to do with Li-ion batteries in different phases of their lifecycle. As the final users, they will be the key factor in the disposal process of batteries at the end of their lifecycles. In this process, local authorities, regulators as well as automotive repair and maintenance workshops will be crucial for the closing of the cycle.**

### 3.7.3 Current Technologies and State of the Art & Types

#### 3.7.3.1 Background

The waste management hierarchy was developed in 1975 from Council Directive 75/442/EEC<sup>436</sup> whose validity ended 2006. A Dutch politician, Ad Lansink, presented in 1979 a schematic picture, where waste is shown from the most to the least environmentally desirable option. In the **Figure 95**, the hierarchy is also considering battery recycling technologies.

<sup>432</sup> Li-Cycle, Li-Cycle Technology, A unique and dependable approach to solving a pressing global issue. Retrieved July, 27, 2020, from <https://li-cycle.com/lithium-battery-recycling-technology/>

<sup>433</sup> OnTo Technology Retrieved July 27, 2020, from <https://www.onto-technology.com/cathode-healing>

<sup>434</sup> Anhua Tai-sem Recycling 2018. Retrieved July 27, 2020, from <http://www.tai-sen.cn/en/>

<sup>435</sup> Duesenfeld, Ecofriendly recycling of lithium-ion batteries. Retrieved July 27.2020, from [https://www.duesenfeld.com/recycling\\_en.html](https://www.duesenfeld.com/recycling_en.html)

<sup>436</sup> EUR-Lex Access to European Union law, COUNCIL DIRECTIVE of 15 July 1975 on waste (75/442/EEC). Retrieved July 22, 2020, from <https://eur-lex.europa.eu/legal-content/EN/TXT/?uri=CELEX%3A31975L0442>

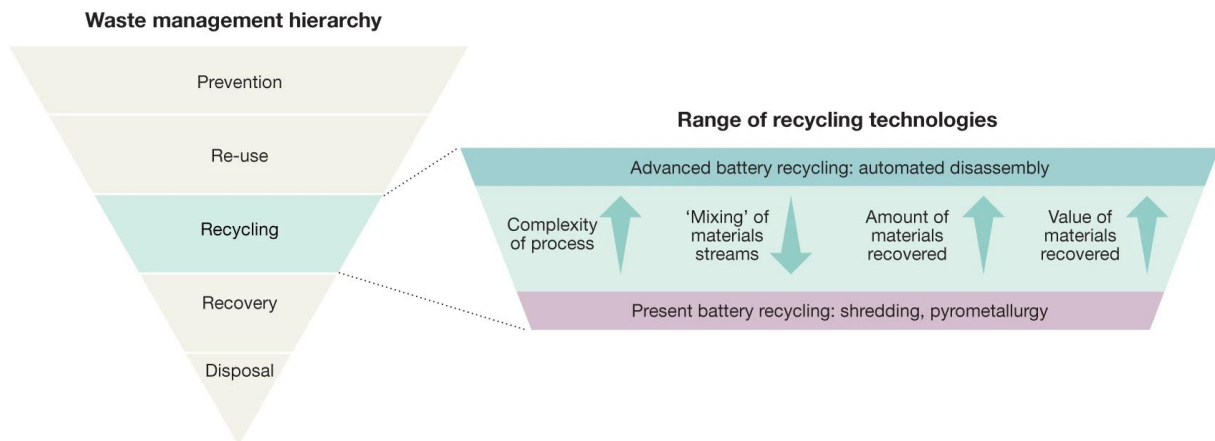

Figure 95 The waste management hierarchy and range of recycling options

The whole section below comes from a single source<sup>437</sup>:

- ◆ “Prevention” means that LIBs are designed to use less critical materials, which have high economic importance but are at risk of short supply. **It also means that EV’s should be lighter and have smaller batteries.**
- ◆ “Reuse” means that EV’s batteries **should have a second use as a stationary battery.**
- ◆ “Recovery” means that some **material is used as a fuel** for pyrometallurgy.
- ◆ “Disposal” means that no value is recovered, and the waste goes to landfill.

<sup>437</sup> Harper, G., Sommerville, R., Kendrick, E. et al. Recycling lithium-ion batteries from electric vehicles. Nature 575, 75–86 (2019). Retrieved July 22, 2020, from <https://doi.org/10.1038/s41586-019-1682-5>

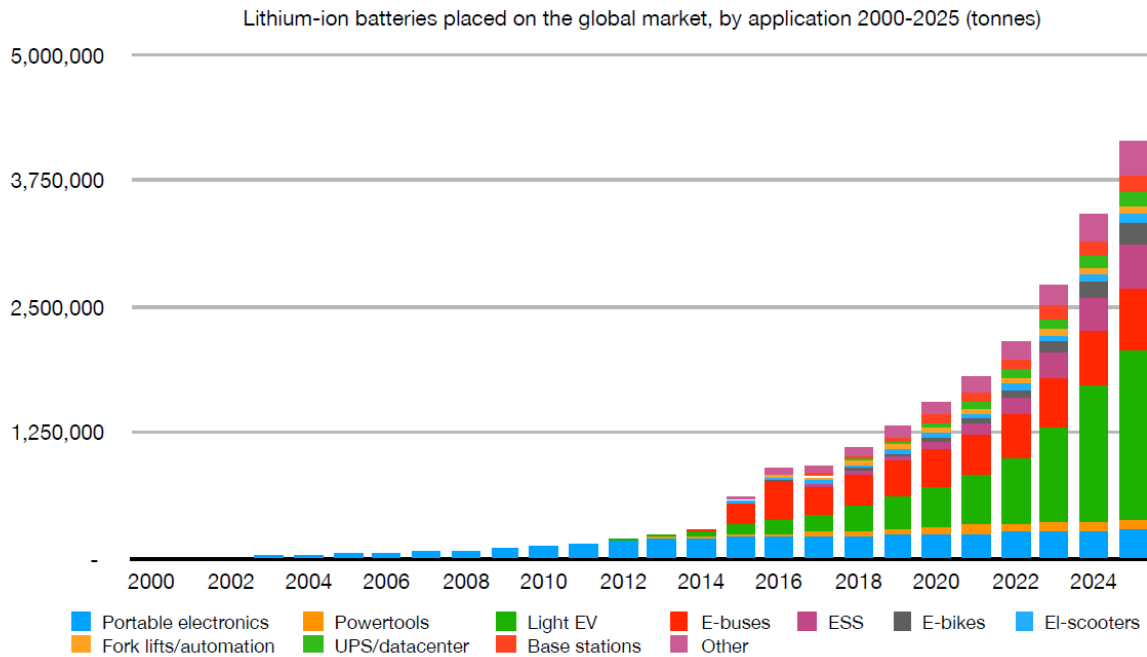

Figure 96 Lithium-ion batteries placed on the global market, by application 2000-2020 (tonnes)<sup>438</sup>

In the EU Legislation there are five important frameworks, where one is a Strategic Action Plan on Batteries: COM (2018) 293 final – Annex 2. In October 2017<sup>439</sup>, the European Commission launched the 'European Battery Alliance'<sup>440</sup> cooperation platform with key industrial stakeholders, interested Member States and the European Investment Bank.

The Commission's Strategic Action Plan on Batteries has put forward actions covering the whole life cycle of battery production until re-use and recycling. Sustainable batteries – produced with responsible sourcing and ethical use of environment, the lowest carbon footprint and using the latest technology to promote second use and comply with the circular economy<sup>441</sup> principles.

<sup>438</sup> Circular Energy Storage Research and Consulting, "The lithium-ion battery end-of-life market". Retrieved September, 2019, from <https://circularenergystorage.com/reports>

<sup>439</sup> European Commission „EUROPE ON THE MOVE Sustainable Mobility for Europe: safe, connected and clean. Brussels, 17.5.2018.“ Retrieved July 15, 2020, from [https://ec.europa.eu/transport/sites/transport/files/3rd-mobility-pack/com20180293-annex2\\_en.pdf](https://ec.europa.eu/transport/sites/transport/files/3rd-mobility-pack/com20180293-annex2_en.pdf)

<sup>440</sup> European Commission, Internal Market, Industry, Entrepreneurship and SMEs Industry, European Battery Alliance. Retrieved July 15, 2020, from [https://ec.europa.eu/growth/industry/policy/european-battery-alliance\\_en](https://ec.europa.eu/growth/industry/policy/european-battery-alliance_en)

<sup>441</sup> European Commission „EUROPE ON THE MOVE Sustainable Mobility for Europe: safe, connected and clean. Brussels, 17.5.2018.“ Retrieved July 15, 2020, from [https://eur-lex.europa.eu/resource.html?uri=cellar:0e8b694e-59b5-11e8-ab41-01aa75ed71a1.0003.02/DOC\\_3&format=PDF](https://eur-lex.europa.eu/resource.html?uri=cellar:0e8b694e-59b5-11e8-ab41-01aa75ed71a1.0003.02/DOC_3&format=PDF)

**A further opportunity represents the development of a world leading recycling technology** by supporting research and innovation. Several battery-related research and innovation projects, which have been funded by EU are Horizon 2020, (approximately EUR 90 million per year) battery integration ,including also second use and vehicle to grid solutions, traditionally attract a non-negligible share of this financing, even if calls are technology neutral. The cluster of smart grid and storage projects (BRIDGE) goes beyond technical innovation aspects and looks into improvements of business models, regulatory issues, data management and consumer acceptance. There are also other initiatives such as “Horizon 2020 support of smart grids and energy storage projects”, as announced in the Clean Energy for all European package [2018-2019] and “Smart Cities and Communities’ projects”.

Several important issues have been studied and results have been published in the European research project **ELIBAMA**<sup>442</sup>. **The project strengthened European electric car battery industry and focused on a large-scale production LIBs. End-of-life comprehensive logistics chain was also studied in a work package.** Given that EU is lacking standardisation, the ELIBAMA project made proposals in three different areas: End-of-life logistics, recommendations for easy disassembly of batteries and standardised eco design for improved recycling.<sup>443</sup>

---

<sup>442</sup> European Commission, TRIMIS Transport Research and Innovation Monitoring and Information System, ELIBAMA European Li-Ion Battery Advanced Manufacturing for Electric Vehicles. Retrieved August 03, 2020, from

<https://trimis.ec.europa.eu/project/european-li-ion-battery-advanced-manufacturing-electric-vehicles>

<sup>443</sup> A Pdf document, Hans Eric Melin, State-of-the-art in reuse and recycling of Lithium-ion batteries, Swedish Energy Agency, June 07 2019.

Retrieved August 03, 2020 from <https://www.energimyndigheten.se/globalassets/forskning--innovation/overgripande/state-of-the-art-in-reuse-and-recycling-of-lithium-ion-batteries-2019.pdf>

## Regulatory Framework for Battery Recycling in China

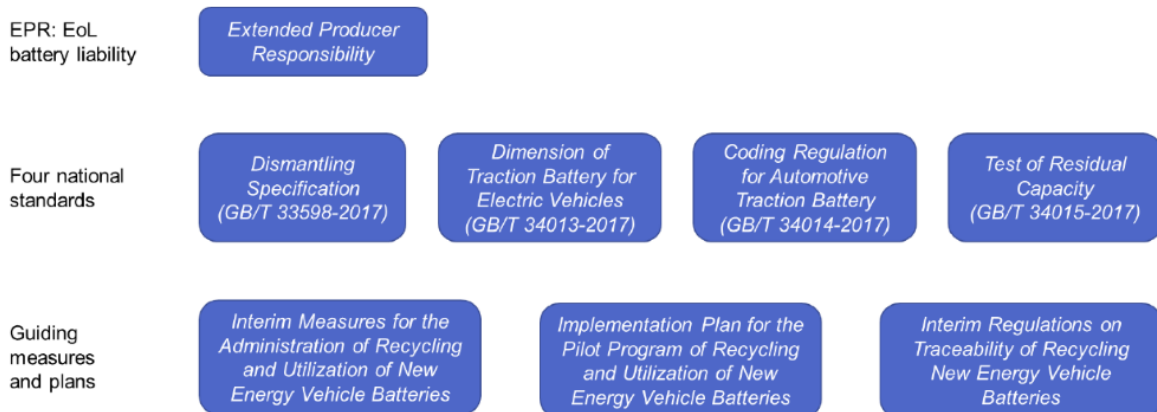

Copyright © IDTechEx. Use in accordance with distribution licence | www.IDTechEx.com 11 IDTechEx

Figure 97 Regulatory Framework for Battery Recycling in China<sup>444</sup>

An introduction to Li-ion Battery Recycling – Where is the Value? Dr Alex Holland, ID TechEx

China, South-Korea, and Japan are countries which recycled most of the LIBs and **they are also paying for the battery waste**<sup>445</sup>. China has a regulatory framework for battery recycling, and manufacturers must apply the **Extended Producer Responsibility (EPR) principles** in the collection of end-of-life LIBs from the market. China also has four national standards for LIBs.

- ◆ 1 Dismantling specifications
- ◆ 2 Dimensions of Traction Battery for Electric Vehicles
- ◆ 3 Coding Regulation for Automotive Traction Battery
- ◆ 4 Test of Residual Capacity

Furthermore, China applies Guiding measures and plans:

- 1 Interim Measures for the Administration of Recycling and Utilization of New Energy Vehicle Batteries

<sup>444</sup> A Pdf document,

An introduction of to Li-ion Battery Recycling-Where's is the Value? Dr Alex Holland, ID TechEx, July 13 2020. Retrieved August 03, 2020 from Simona Tudor APIAI.

<sup>445</sup> A Pdf document, Hans Eric Melin, State-of-the-art in reuse and recycling of Lithium-ion batteries, Swedish Energy Agency, June 07 2019.

Retrieved August 03, 2020 from Simona Tudor APIAI.

- 2 Implementation Plan for the Pilot Program of Recycling and Utilization of New Energy Vehicle Batteries
- 3 Interim Regulations on Traceability of Recycling New Energy Vehicle Batteries

**European Union is lacking this type of regulatory in 2020**, but the work has started. A systematic vision is necessary to design the framework for an integrated European industrial ecosystem, which allows horizontal cooperation between companies, while being supported financially, legislatively, and strategically by Member States and the EC<sup>446</sup>.

Waste can be a renewable resource<sup>2</sup>. **ESOI is an abbreviation of the Energy stored over energy invested** and the ratio between the energy that must be invested into producing the battery and the electrical energy that it will store during its useful life<sup>447</sup>. Based on the ESOI calculation results, it is easier to decide whether the EV used batteries can serve for stationary storage.

### 3.7.3.2 State of the Art

#### Current recycling methods

Current recycling of Li-ion batteries can be divided into two types, **direct and indirect methods**<sup>448</sup> as is shown in the **Figure 98, Figure 99**. Several techniques follow the direct or indirect method, used in combination with each other:

- ◆ Physical material separation
- ◆ Pyrometallurgical separation (thermal treatment Celsius or Fahrenheit)
- ◆ Hydrometallurgical metals reclamation (with aqueous solution)
- ◆ Thermal pre-treatment followed by hydrometallurgical method, also often called a combination of pyrometallurgical and hydrometallurgical methods.

<sup>446</sup> Raphaël Danino-Perraud, „The Recycling of Lithium-Ion Batteries: A Strategic Pillar for the European Battery Alliance“, Études de l’Ifri, Ifri, March 2020. Retrieved August 3, 2020, from

[https://www.ifri.org/sites/default/files/atoms/files/danino\\_recycling\\_batteries\\_2020.pdf](https://www.ifri.org/sites/default/files/atoms/files/danino_recycling_batteries_2020.pdf)

<sup>447</sup> Harper, G., Sommerville, R., Kendrick, E. *et al.* Recycling lithium-ion batteries from electric vehicles. *Nature* **575**, 75–86 (2019). <https://doi.org/10.1038/s41586-019-1682-5>. Retrieved July 22, 2020, from

<https://www.nature.com/articles/s41586-019-1682-5#Fig5>

<sup>448</sup> The Design and Optimization of a Lithium-ion Battery Direct Recycling Process by Panni Zheng, Li Cheng, Qiao Rui, Michael W Ellis, June 17, 2019. Retrieved August, 3, 2020, from

[https://vtechworks.lib.vt.edu/bitstream/handle/10919/93212/Zheng\\_P\\_T\\_2019.pdf](https://vtechworks.lib.vt.edu/bitstream/handle/10919/93212/Zheng_P_T_2019.pdf)

Li-ion batteries contain an **electrode**, which has a **positive charged anode (+)** and a **negatively charged cathode (-)**, **metals** (Aluminium Al, Iron Fe, Copper Cu, Cobalt Co, Nickel Ni), and **polymeric material**. The way **the structure of the cathode material is breaking or not defines the approach method: direct or indirect**. During the recycling process, if cathode is breaking down to different elements, then the method to be applied is indirect.

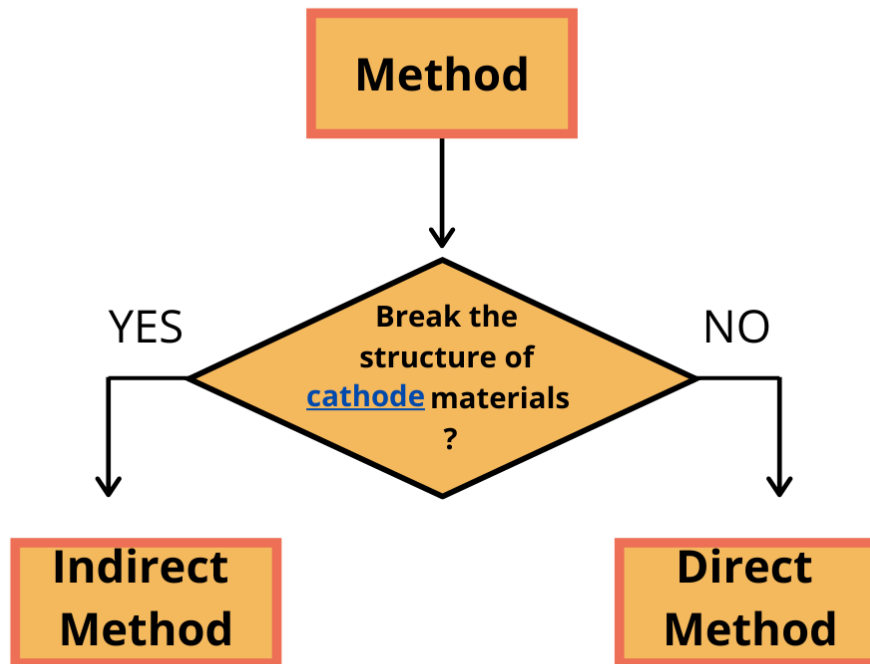

Figure 98 Direct and indirect method to recycle Li-ion batteries

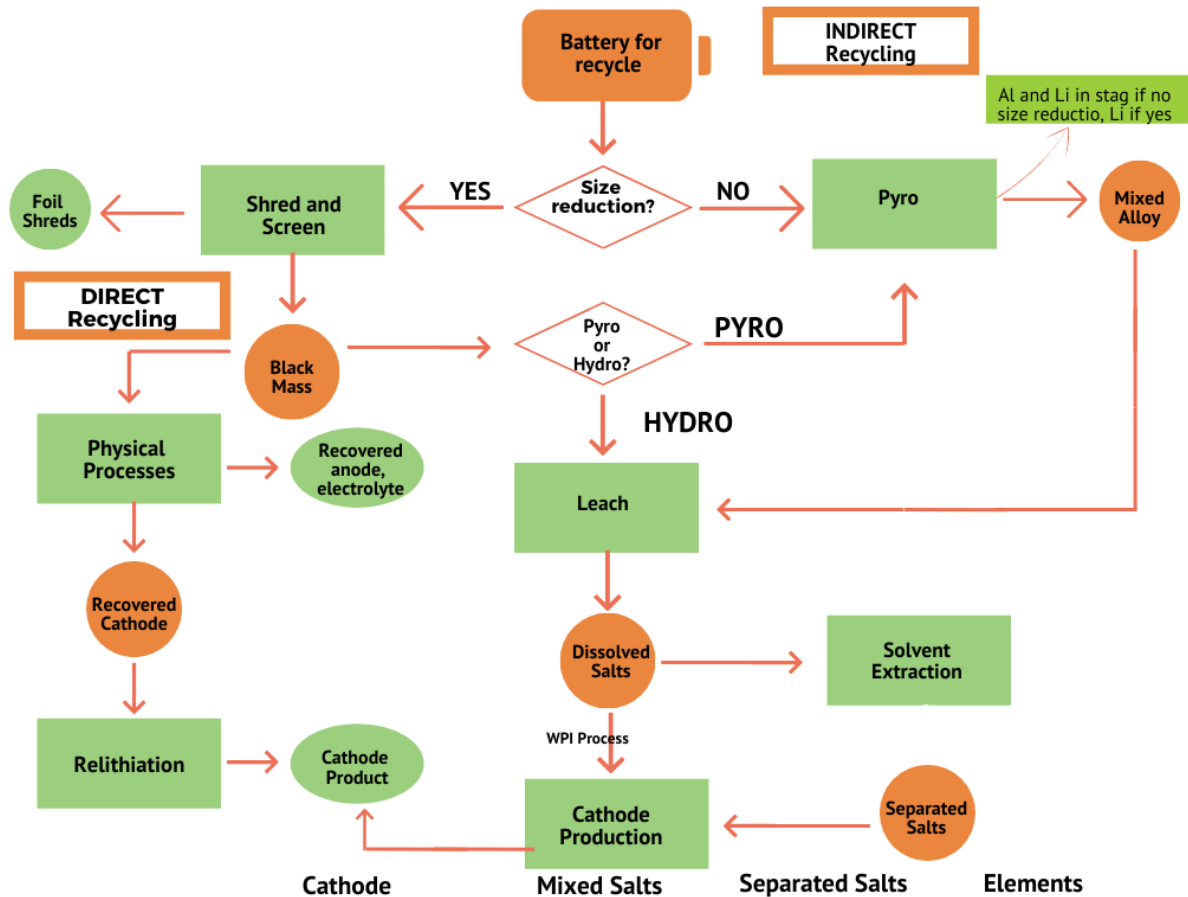

Figure 99 Possible recycling paths for lithium-ion batteries<sup>449</sup>

### 3.7.3.3 Direct Recycling

In the Direct recycling, the removal of anode and cathode material from the electrode, is made with minimal changes to the crystal cathode morphology of the active material. The resulting mixed metal-oxide can be reincorporated into a new cathode electrode. The most valuable component on LIBs is the cathode material, like  $\text{LiCoO}_2$  which contains Cobalt that is an expensive element. Thus, **recycling cathode material generates most value** and the direct method is the most cost effective and energy conservative<sup>450</sup>.

The **Figure 100** below shows a Direct recycling process performed by Farasis Energy. First, they discharge the cell and remove the electrolyte, then the cell is shredded by a milling machine and the result is “black mass” powder. Then active materials are separated from

<sup>449</sup> ScienceDirect, Lithium-ion battery recycling processes: Research towards a sustainable course by Linda Gaines. Retrieved July 3, 2020, from redraw a figure to the ALBATTs report

<https://www.sciencedirect.com/science/article/pii/S2214993718300629>

<sup>450</sup>Harper, G., Sommerville, R., Kendrick, E. *et al.* Recycling lithium-ion batteries from electric vehicles. *Nature* **575**, 75–86 (2019). <https://doi.org/10.1038/s41586-019-1682-5>. Retrieved July 03, 2020, from <https://www.nature.com/articles/s41586-019-1682-5>



“black mass” powder by density differences between the anode and much denser metal oxide cathode materials. In the end, the active materials are purified and re-lithiated.

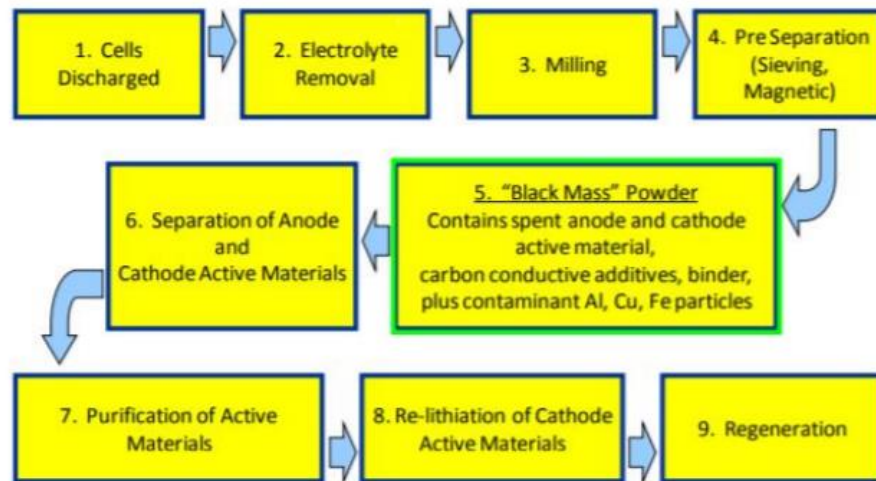

Source: Farasis Energy, Inc

Figure 100 Direct recycling technology from Farasis energy<sup>451</sup>

#### 3.7.3.4 Indirect Recycling

The Indirect method uses Pyrometallurgical and Hydrometallurgical technics to recycle Co, Ni, Mn and then achieve Li precipitation. The leaching process consists of dissolving valuable metals from a raw material by solution purification. In the solution purification step, copper and aluminium are removed first by hydroxide precipitation.

The challenge is to avoid as much as possible the co-precipitation and the absorption of Co and Ni. With a suitable temperature and reaction time, the equilibrium can be completely reached. Equilibrium is the state in which the reactants in a chemical reaction and products do not change because the rate of forward reaction is equal to the rate of reverse reaction.

The Cu and Al particles can grow and aggregate into the right size. Afterwards, the solution can be filtered, and the residue is supplied to copper and aluminium production. At this moment, the Al and Cu are precipitated together, there will be attempts to remove them from the solution separately in future<sup>452</sup>. Precipitated means that solid material is separated from

<sup>451</sup> Larouche F., Demopoulos G.P., Amouzegar K., Bouchard P., Zaghib K. (2018) Recycling of Li-Ion and Li-Solid State Batteries: The Role of Hydrometallurgy. In: Davis B. et al. (eds) Extraction 2018. The Minerals, Metals & Materials Series. Springer, Cham. [https://doi.org/10.1007/978-3-319-95022-8\\_214](https://doi.org/10.1007/978-3-319-95022-8_214). Retrieved July 03, 2020, from [https://rd.springer.com/chapter/10.1007/978-3-319-95022-8\\_214](https://rd.springer.com/chapter/10.1007/978-3-319-95022-8_214)

<sup>452</sup> Wang, H., Vest, M. & Friedrich, B. Hydrometallurgical processing of Li-Ion battery scrap from electric vehicles. 16 (2011). Retrieved 22, July, 2020, from [http://www.metallurgie.rwth-aachen.de/new/images/pages/publikationen/waeng\\_emc2011\\_id\\_2906.pdf](http://www.metallurgie.rwth-aachen.de/new/images/pages/publikationen/waeng_emc2011_id_2906.pdf)

the liquid by gravity. By using the hydrometallurgical recycling method, the final lithium product is reached, and the raw material can be used for synthesis. Further processes are needed to get purified Lithium.

### 3.7.3.5 Pyrometallurgical Recovery<sup>453</sup>

For reclamation after commotion, recovered materials can be subjected to a range of physical separation processes, which include sieves, filters, magnets, shaking tables and heavy medium, used to separate a mixture of lithium-rich solution, low-density plastics and papers, magnetic casings, coated electrodes and electrode powders. The result is generally a concentration of electrode coatings in the fine fractions of material, and a concentration of plastics, casing materials, and metal foils in the coarse fractions<sup>454</sup>.

The product is called “black mass” and consists of electrode coatings (metal oxides and carbon).

To recover graphite and metal oxides from the copper, polymeric binders should be removed from the “black mass”. There are several possible technologies for this purpose, such as: solvents N-methyl-2-pyrrolidone (NMP) or dimethylformamide (DMF) to be applied, thermal heat to decompose the binder or dissolution of the aluminium collector. Unfortunately, all the technologies **are not fast and innovative enough to be commercialized in the near future**. In the next ALBATTs report, this recycling method will be closely explained.

Nevertheless, there are some recent transitions in battery manufacturing i.e. moving away from fluorinated binders. Innovative batteries are moving towards alternative binders on the anode, which are water-soluble and easier to remove at end-of-life. There is also some work

---

<sup>453</sup> The whole section is from this reference : Harper, G., Sommerville, R., Kendrick, E. *et al.* Recycling lithium-ion batteries from electric vehicles. *Nature* 575, 75–86 (2019). <https://doi.org/10.1038/s41586-019-1682-5>. Retrieved July, 03, 2020, from <https://www.nature.com/articles/s41586-019-1682-5#Fig5>

<sup>454</sup> Wang, X., Gaustad, G. & Babbitt, C. W. Targeting high value metals in lithium-ion battery recycling via shredding and size-based separation. *Waste Manag.* 51, 204–213 (2016). Retrieved from an artical, July 5, 2020.

performed on similar cathode transitions, though, it appears to be more complicated<sup>455</sup>.

### 3.7.3.6 Hydrometallurgical Metals Reclamation<sup>456</sup>

Hydrometallurgical treatments involve the use of aqueous solutions to leach away the desired metals from cathode material. By far the most common combination of reagents reported is  $\text{H}_2\text{SO}_4/\text{H}_2\text{O}_2$ . Based on studies performed, it is understood that  $\text{H}_2\text{O}_2$  acts as a reducing agent to convert insoluble Co (III) materials into soluble Co (II).

Other possible alternative leaching acids have been explored, with findings of organic solvents to be able to perform a solvent based extraction. After leaching, the metals may be recovered through several precipitation reactions controlled by manipulating the pH of the solution.

### 3.7.3.7 Biological Metals Reclamation<sup>456</sup>

Bioleaching is an emerging technology for LIB recycling and metal reclamation and is potentially complementary to the hydrometallurgical and pyrometallurgical processes currently used for metal extraction. It is highly useful for metals, which are particularly difficult to separate and which require additional solvent-extraction steps, e.g. cobalt and nickel.

Biological reclamation process uses microorganisms to selectively digest metal oxides from the cathode and to reduce these oxides to produce metal nanoparticles, though there are still extensive scopes for further research of this method

## 3.7.4 Established Technologies

### 3.7.4.1 Retrieval Technologies

Retrieval Technologies (initially known as The Toxco). Large LIB packs undergo preliminary manual disassembly, while small batteries and cells may be processed “as-is”. Process begins

<sup>455</sup> Nirmale, T. C., Kale, B. B. & Varma, A. J. A review on cellulose and lignin based binders and electrodes: small steps towards a sustainable lithium ion battery. *Int. J. Biol. Macromol.* 103, 1032–1043 (2017) Recycling lithium-ion batteries from electric vehicles, *Recycling methods*. Retrieved July,03, 2020, from <https://www.nature.com/articles/s41586-019-1682-5>

<sup>456</sup> This whole section extracted from the reference: Harper, G., Sommerville, R., Kendrick, E. *et al.* Recycling lithium-ion batteries from electric vehicles. *Nature* 575, 75–86 (2019). Retrieved July 03, 2020, from <https://doi.org/10.1038/s41586-019-1682-5>. Retrieved July 03, 2020, from <https://www.nature.com/articles/s41586-019-1682-5#Fig5>

by shredding LIBs submerged in a brine solution to deactivate the cells and prevent fire due to Li oxidation<sup>457</sup>.

The Retrieval process consists of shredding the LIBs and the resulting slurry is processed with a hammer mill whereas larger metallic components are separated by screening. The resulting Cu-CO rich overflow is treated with a shaking table to remove Al and plastic particles. The small cathode-rich particles are filtered to get a cake rich in C and metallic oxides. The filtered liquid is also rich in Lithium. The metallic oxide and Li cakes are used in metal industry and considered downcycled.

#### 3.7.4.2 *Recupyl Valibat*

This whole section is extracted from: “A Critical Review of Lithium-Ion Battery Recycling Processes from a Circular Economy Perspective”<sup>458</sup>.

The Recupyl process was developed as a low-temperature LIB recycling technology, directly addressing the gas emissions resulting from pyrometallurgy in the abovementioned processes. First, LIBs are fragmented in a low-speed rotary shear, in Argon Ar or CO<sub>2</sub> –rich atmosphere to expose the internal compounds. The consequence of using CO<sub>2</sub> is the formation of a surface to LIB whose role is to reduce fire risk. Secondary grinding is carried out in an impact mill on higher speed which reduces particles to the size of 3 mm or smaller.

Then a high-induction magnetic separator removes ferrous metals. The non-magnetic fraction is then processed with a densimetric table, which separates light and heavy particles. There, most of the remaining Cu particles are removed which is an important step, as metal impurity would later affect hydrometallurgical process. The electrode-rich fine fraction is mixed with water, and its pH is adjusted, which releases H<sub>2</sub> due to hydrolysis. In the aqueous phase, Li

<sup>457</sup> Vezzini, A. Manufacturers, Materials and Recycling Technologies. In *Lithium-Ion Batteries*; Elsevier BV: Rome, Italy, 2014; pp. 529–551. [Google Scholar]]. Retrieved August, 03, 2020, from <https://www.sciencedirect.com/science/article/pii/B9780444595133000236?via%3Dihub>

<sup>458</sup> Omar Velázquez-Martínez, Johanna Valio, Annukka Santasalo-Aarnio, M. Reuter, Rodrigo Serna-Guerrero, MDPI, A Critical Review of Lithium-Ion Battery Recycling Processes from a Circular Economy Perspective, <https://doi.org/10.3390/batteries5040068>, Publisher November, 5, 2019. Retrieved July, 03, 2020, from <https://www.mdpi.com/2313-0105/5/4/68/html>

salts are then dissolved, leaving MeO and graphite suspended in the solution, to be separated by a filtration process. A series of leaching steps will continue, by processing it through several chemical stages. The Recupyl process can recover Co-containing cathode powder and  $\text{LiFePO}_4$  whenever it is present in the feed. In addition, processing of the electrolyte  $\text{LiPF}_6$  is possible, recovering  $\text{PF}_6$  and an ammonium salt during a hydrolysis phase<sup>459</sup>.

The losses in Recupyl Valibat process are considerably lower in comparison with Umicore Valeas™. The Recupyl process shows a clear advantage of using the mechanical processing coupled with hydrometallurgical operations. Consequently, Recupyl operational principles are more in line with the idea of circular economy, in comparison to the rest of the processes, as the cathode precursor is recovered<sup>460</sup>.

### 3.7.4.3 Akkuser

The Akkuser process employs low-temperature stages aimed at obtaining a metal-enriched fraction suitable for subsequent refining. This process involves only a mechanical pre-processing treatment and does not include hydro-or pyrometallurgical steps. Then the mixed feed will be sorted, and LIBs are sheared by two cutting mills. The first mill operates at a temperature between 40 °C and 50 °C and reduces the battery to small-sized pieces. During the shearing step, there is a low fire risk. The filtration of residues is done by a cyclonic system and most plastic–metal particles are then processed to recover Ni and Co by leaching. Upon reaching a pristine quality, the associated exhaust gases are then harmlessly released into the atmosphere<sup>461</sup>.

The shredded material is transferred through an air-tight cooling tube into a secondary mill, which further reduces the size of the material. Ferrous metals are recovered employing a magnetic separator. The resulting non-volatile fraction rich in Co and Cu is ready to be refined by either hydro-or pyrometallurgy. The final recovery composition is not detailed in the

<sup>459</sup> Vadenbo, C.O. Prospective Environmental Assessment of Lithium Recovery in Battery Recycling; Institute of Environmental Decisions: Zurich, Switzerland, 2009. [[Google Scholar](#)]]. Retrieved July 22, 2020.

<sup>460</sup> Tedjar, F.; Foudraz, J.C. Method for the Mixed Recycling of Lithium-Based Anode Batteries and Cells. U.S. Patent 7,820,317 B2, 26 October 2010. Retrieved July, 22, 2020, from <https://patents.justia.com/patent/7820317>

<sup>461</sup> Pudas, J.; Erkkila, A.; Viljamaa, J. Battery Recycling Method. U.S. Patent 8,979,006 B2, 17 March 2015. [[Google Scholar](#)]]. Retrieved July 03, 2020.

literature but is likely a mixture of electrode materials and traces of Al<sup>462</sup>.

#### 3.7.4.4 Umicore Valéas™ (Bruxelles, Belgium)

The Umicore process recovers Co and Ni, primarily from LIBs and Ni-MH batteries, and it presents the largest capacity among the discussed processes, as it involves a combination of pyro- and hydrometallurgical steps.

The batteries are first dismantled, and the unnecessary metallic or plastic casing material removed in order to expose the cells. The process begins in a shaft of furnace, where three different temperatures are consecutively applied, low = 300 °C (evaporation of electrolyte); medium = 700 °C (plastics pyrolysis); and high = 1200–1450 °C (smelting and reduction)<sup>463</sup>.

#### 3.7.4.5 Pros

An advantage of direct recycling is that it avoids long, and expensive purification steps and it is particularly advantageous for lower value cathodes such as LiMn<sub>2</sub>O<sub>4</sub> and LiFePO<sub>4</sub><sup>464</sup>

**The direct recycling is a cost effective and energy conservative method** which can be divided into two steps: retrieving the cathode materials from End of Life LIBs and regenerating the cathode materials.

One positive thing about the use of Pyrometallurgical process is that exothermic reactions of burning electrolytes and plastics reduce energy consumption. Exothermic reactions are a chemical reaction in which heat is generated.

Unfortunately, the Pyrometallurgical recovery has a negative environmental footprint,

<sup>462</sup> Zhang, T.; He, Y.; Wang, F.; Ge, L.; Zhu, X.; Li, H. Chemical and process mineralogical characterizations of spent lithium-ion batteries: An approach by multi-analytical techniques. *Waste Manag.* 2014, 34, 1051–1058. [[Google Scholar](#)] [[CrossRef](#)]. Retrieved July 03, 2020.

<sup>463</sup> Georgi-Maschler, T.; Friedrich, B.; Weyhe, R.; Heegn, H.; Rutz, M. Development of a recycling process for Li-ion batteries. *J. Power Sources* 2012, 207, 173–182. [[Google Scholar](#)] [[CrossRef](#)]. Retrieved July 03, 2020.

<sup>464</sup> *Environ. Sci. Technol.* 2012, 46, 22, 12704–12710 Publication Date: October 17, 2012  
<https://doi.org/10.1021/es302420z>

Copyright © 2012 American Chemical Society

Dunn, J. B., Gaines, L., Sullivan, J. & Wang, M. Q. Impact of recycling on cradle-to-gate energy consumption and greenhouse gas emissions of automotive lithium-ion batteries. *Environ. Sci. Technol.* 46, 12704–12710 (2012). Retrieved July 03, 2020.

including production of toxic gases, in addition to that costs of processing that are high, while the quantities of materials recovered are limited. Nevertheless, it is a frequently used process for the extraction of high-value transition metals such as Cobalt and Nickel<sup>465</sup>.

By using hydrometallurgical metals reclamation, the major issues to be addressed about all solvometallurgical processes are the volumes of solvents required, the speed of delamination, the costs of neutralization and the likelihood of cross-contamination of materials. Significant improvements in the field of material segregation can be brought through avoiding cathode and anode materials mixing before a mechanical or a solvent-based separation occurs. The current design of cells makes recycling extremely complex and neither hydro- nor pyrometallurgy currently provide methods that would lead to pure streams of materials that could easily be fed into a closed-loop system for batteries.

The high levels of recycling efficiency of the Akkuser process (i.e., >90%) and its low energy consumption (0.3 kWh/kg material) set this process in a privileged position compared to the rest. However, it is only possible to reach this high cost/efficiency rating because the process involved is based solely on mechanical processing steps and aims at obtaining a black mass for cathode precursor manufacturing by a third party<sup>466</sup>.

Hans Eric Melin found in his studies, “ State-of-the-art in reuse and recycling of Lithium-ion batteries” that economic potential of recycling applications has been identified in over 30 studies, based on modelling, mainly with regard to the degradation and longevity of the battery. Most of the recycling studies have been carried out at a laboratory scale and they entail excellent control of the processes. Separation of cells has often been done by hand which is not the economical way in an industrial scale application. There are still patents covering similar methods, which are based on industrial principles<sup>467</sup>

<sup>465</sup> Lv, W. et al. A critical review and analysis on the recycling of spent lithium-ion batteries. ACS Sustain. Chem. Eng. 6, 1504–1521 (2018).] Recycling lithium-ion batteries from electric vehicles, Recycling methods. Retrieved July 22, 2020, from <https://www.nature.com/articles/s41586-019-1682-5>

<sup>466</sup> Martin, G.; Rentsch, L.; Höck, M.; Bertau, M. Lithium market research—Global supply, future demand and price development. Energy Storage Mater. 2017, 6, 171–179. Retrieved July 15, 2020, from [\[Google Scholar\]](#) [\[CrossRef\]](#)

<sup>467</sup> From a Power Point presentation made by Hans Eric Melin: „State-of-the-art in reuse and recycling of Lithium-ion batteries“. Swedish Energy Agent. June 2019. Retrieved July 21, 2020 from Simona Tudor APIA.



### 3.7.4.6 Cons and Challenges

Nowadays, there are low volumes of electric-vehicle batteries and even fewer used storage batteries, that need to be recycled. It is still a little bit unsure but we strongly believe the EU recycling legislation and standardisation will have been updated and completed by the time **the LIBs powering today`s EVs reach the end-of-life stage**. Also, the economic aspects of recycling operations must be carefully reflected and automation is the key to lower the processing costs. Especially better sorting technologies, a method for separating electrode materials, wider standardization of the manufactured cells and packs, and better recycling design are also crucial for the success of the activity.

**High capital is needed when pyrometallurgical technology is required** especially if the demand is a fully recyclable Li-ion battery. Ideally, the whole battery should be recycled and not only the most economically valuable components, like Cobalt.

When recycling method is a **water-intensive technology, it involves environmental risk**, because some hazardous battery components are water-soluble<sup>468</sup>.

In 2017, the best available technology would allow **Al and Cu to precipitate together**, but soon, **there will be attempts to separate them independently from the solution**. The net LIB production can be reduced if more materials are recovered from end-of-life LIBs and the recycled material has better quality. Unfortunately, **recycling alone cannot compensate by itself the shortage of minerals, especially with an EV market that is rapidly growing** lifespan is three times longer than lead-acid batteries<sup>469</sup>.

<sup>468</sup> Sloop, S.E.; Bend, M.A. Recycling and Reconditioning of Battery Electrode Materials. U.S. Patent 9,484,606 B1, 1 November 2016. Retrieved July, 22, 2020 from [[Google Scholar](#)]

<sup>469</sup> Turcheniuk, K., Bondarev, D., Singhal, V. & Yushin, G. Ten years left to redesign lithium-ion batteries. *Nature* **559**, 467–470 (2018). Retrieved July, 22, 2020 from <https://www.nature.com/articles/s41586-019-1682-5>



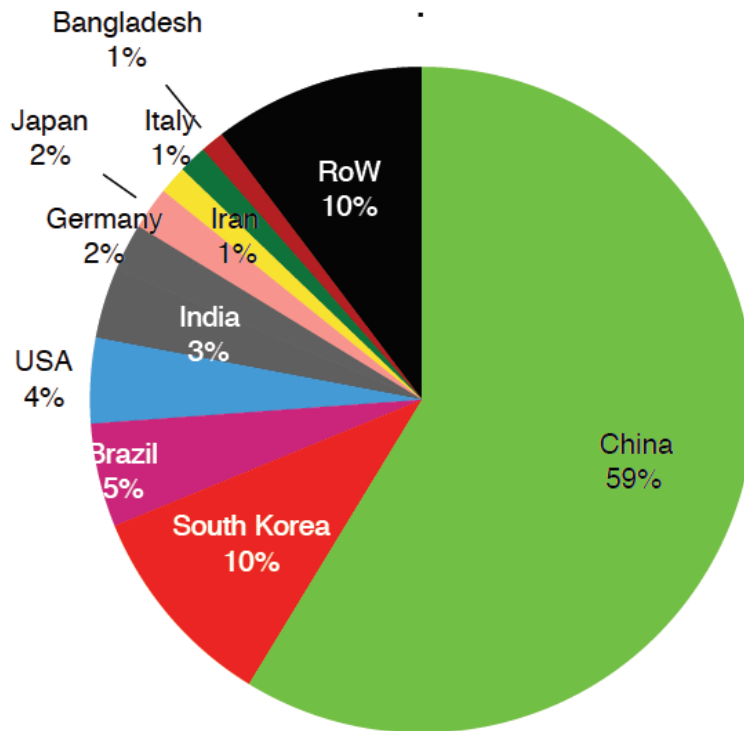

Figure 101 Published Articles about Recycling of Lithium-ion Batteries by Country, 2000-2018

To make recycling and reuse economical in Europe, the battery design should be planned for the whole life cycle, before manufacturing a single cell. Standardisation of materials, cells, packing and marking, could make it easier to disassemble, repair and recycle used LIB's. There was no article found in 2019 on research about design with recycling in mind. Only one piece of information was retrieved describing a British project, Amplifill 117, which is a collaboration between car manufacturers and recycling companies that has got more funds to continue manufacturing modular battery for various uses, vehicles and applications.

The recycling process should be evaluated from different point of views:

- ◆ Cost and efficiency to environmental impact ratio
- ◆ Effects on transport
- ◆ Work environment
- ◆ The consequences for each material pre-treatment solution
- ◆ Material sorting solutions
- ◆ What will/can be the product

There is a lack of **evaluations with more holistic perspective**. One important question has not been researched: why batteries take other paths than the ones both companies and legislators previously intended?

It is challenging to choose the right pre-treatment for a LIB.

- ◆ In LIBs, there are many different chemistry types used, which makes it difficult for recyclers to correctly classify and sort the EoL batteries.
- ◆ When using hydrometallurgical processes, the disintegration time of the modules and cell state of health assessment is also difficult.
- ◆ LIB's can easily catch fire or even explode when exposed to mechanical stress / impact.

Research on sorting, disassembly and discharge of batteries is highly unusual as 2019 published Hans Eric Mellins report shows.

### 3.7.5 Future Technologies

#### 3.7.5.1 Accurec

The Accurec process is designed by the German company Accurec GmbH® (Krefeld, Germany) for LIBs recycling and is supposed to present a combination of mechanical, pyrometallurgical and hydrometallurgical processes aimed at recovering a  $\text{Li}_2\text{CO}_3$  cathode precursor and a Co–Ni–Mn alloy. The process begins with the sorting, cleaning, and manual dismantling of spent LIBs from consumer goods and EVs. The dismantled feed is transported to the company's proprietary vacuum thermal treatment, where it is heated at 250 °C under a vacuum to remove electrolytes, solvents, and volatile hydrocarbons. The produced fraction is then transported to milling and grinding operations to expose the enclosed constituents. Ground material undergoes a series of mechanical separation steps consisting of a vibrating screen, magnetic separator, and a zig-zag classifier<sup>470</sup>.

The fractions of Fe–Ni, Al, and Al–Cu are retrieved after the mechanical separation step, from which base metals can be extracted. The remaining fraction is sent to agglomeration and a two-step pyrometallurgical process. In the end of the second step of the pyrometallurgical

<sup>470</sup> Accurec Recycling GmbH, "Accurec," (official website 2019). Retrieved August 25, 2020 from <https://accurec.de/lithium>

operation, commercially viable Co and Mn are released. Though, as the current market value of Co is higher than that of Mn, the purification of the former is favoured, while the latter is mostly lost in the slag phase<sup>471</sup>.

Needless to highlight, that the Accurec process is able to provide a 90% recovery of  $\text{Li}_2\text{CO}_3$ , which can then be used either as a cathode precursor or as a raw material for glass manufacturing. On the other hand, the technology does not allow an electrolyte to be recovered, which can, without any doubt, be regarded as a drawback to these recycling operations<sup>419</sup>.

### 3.7.5.2 Battery Resources “Closed Loop” Process

The Battery Resources process, according to its developers, is considered to be a “closed loop” one, as it recovers battery components suitable for a further LIB production. The Battery Resources process is majorly based on mechanical and hydrometallurgical operations, with a single sintering step at the end for product refining. The Battery Resources process is designed to treat LIBs with  $\text{LiNi}_x\text{Mn}_y\text{Co}_z\text{O}_2$  cathode chemistry.

Analysing the sequence of technological treatments in a closer way, the first step for the whole recycling process is discharging, which is necessarily undertaken so as to reduce the risk of spontaneous ignition / explosion during shredding. Then the spent LIBs are shredded with a hammer mill to break down the particles, and shredded mixed material is treated by magnetic separation, producing a magnetic fraction with high content of steel and a cathode-containing non-magnetic fraction. The next steps involve different fractions to be treated in separate manners. Consequently, the non-magnetic fraction is mixed with NaOH in order to extract Al and then is filtered and dried at 60 °C. On the other hand, Cu-rich fraction is obtained through having a coarser fraction treated by dense media separation (DMS). Finally, the fine fraction is sent to a four-step hydrometallurgical process. The first stage of it includes removing of C,  $\text{LiFePO}_4$ , and the remaining plastics under high temperature levels, whereas the remaining

<sup>471</sup> Gratz, E.; Sa, Q.; Apelian, D.; Wang, Y. A closed loop process for recycling spent lithium ion batteries (September 15, 2014). Retrieved August 25, 2020 from <https://www.sciencedirect.com/science/article/abs/pii/S0378775314004571>

solution is supposed to contain ionic forms of Co, Ni, Mn, Li, Al, and Cu, which is later treated at a temperature of 40 °C to precipitate  $\text{Li}_2\text{CO}_3$ <sup>472</sup>.

In the long-run, the aforementioned processes enable to have previously extracted  $\text{Co}(\text{OH})_2$ ,  $\text{Mn}(\text{OH})_2$ , and  $\text{Ni}(\text{OH})_2$  mixed with the precipitated  $\text{Li}_2\text{CO}_3$  and some additional virgin  $\text{Li}_2\text{CO}_3$  and be forwarded to synthesizing battery-grade cathode material through compression into pellets and sintering at 900 °C. This way, the Battery Resources process allows to achieve “closed loop” results and obtains the most suitable product for use as a cathode material, although the consumption of various chemical reagents (e.g.,  $\text{MnSO}_4$ ,  $\text{NiSO}_4$ , and  $\text{CoSO}_4$ ) is required<sup>473</sup>.

### 3.7.5.3 Laboratory Process by Aalto University

The process encompasses a mixture of mechanical pre-processing stages followed by a pyrometallurgical step and a thorough hydrometallurgical treatment to recover 99% of the LIB materials. It begins with crushing and sieving, resulting in two distinctive fractions: one formed mostly of the electric peripherals, current collectors and foils, and a second one formed mostly of the electrode materials. As a next step, the mechanically obtained fractions are processed via two parallel paths: a hydrometallurgical and a pyrometallurgical process designed to treat the electrode material and metallic fraction, respectively<sup>474</sup>.

The hydrometallurgical treatment consists of a series of 11 steps specifically designed to obtain cobalt oxalate,  $\text{CoC}_2\text{O}_4$ , while recovering other elements found in the electrode material fraction, including Li, Ni, Fe, and Co. On the other hand, a pyrometallurgical treatment in a rotary kiln has been proposed to recover Al and Cu. As a result of the aforementioned

<sup>472</sup> Porvali, A.; Aaltonen, M.; Ojanen, S.; Velazquez-Martinez, O.; Eronen, E.; Liu, F.; Wilson, B.P.; Serna-Guerrero, R.; Lundström, M. Mechanical and hydrometallurgical processes in HCl media for the recycling of valuable metals from Li-ion battery waste (March 2019). Retrieved August 25, 2020 from <https://www.sciencedirect.com/science/article/abs/pii/S0378775315002694>

<sup>473</sup> Martinez, V.; Porvali, A.; Boogaart, V.D.; Aarnio, S.; Lundström, M.; Reuter, M.; Guerrero, S.; Velázquez-Martinez, O.; Boogaart, K.G.V.D.; Santasalo-Aarnio, A.; et al. On the Use of Statistical Entropy Analysis as Assessment Parameter for the Comparison of Lithium-Ion Battery Recycling Processes (January 31, 2019). Retrieved August 25, 2020 from <https://www.mdpi.com/2313-0105/5/2/41>

<sup>474</sup> A Critical Review of Lithium-Ion Battery Recycling Processes from a Circular Economy Perspective (August 23, 2019). Retrieved August 25, 2020 from <https://www.mdpi.com/2313-0105/5/4/68/htm>

processing and treatments, it is claimed that Aalto University process recovers the vast majority of elements contained in LIBs with a high efficiency. That is, the hydrometallurgical stage recovers 99% of Al, 93% of Li, 89% of Co, 97% of Ni, 98% of Cu, 98% of Mn, and 99% of Fe, whereas the pyrometallurgical path produces a molten phase with 74% of Al and 26% of Cu<sup>475</sup>.

Even though the Aalto University process is supposed to provide a high degree of element recoverability, the recovered forms still require further processing to be considered usable raw materials. What is more, it presents a high quality of products, but at the same time demands a large number of reagents in the hydrometallurgical stages and high energy in the pyrometallurgical step, in addition to efficient mechanical pre-processing stages<sup>476</sup>.

#### 3.7.5.4 Fortum LIB Recycling Solution

This whole section extracted: Fortum's hydrometallurgical recycling technology<sup>477</sup>.

This innovative Fortum's technology enables 80% of li-ion batteries materials to be recycled and it makes it possible that cobalt, manganese and nickel be utilized in producing new batteries. In order to achieve a high recycling rate, the process the company applies is a low-CO<sub>2</sub> one and uses a hydrometallurgical recycling process. The hydrometallurgical recycling process involves a chemical precipitation methodology that allows scarce minerals to be recovered and delivered to battery manufacturers for reuse in the production of new batteries. Originally, this technology was developed by the Finnish growth company Crisolteq that was acquired by Fortum in January 2020.

A closer look at the stages of LIBs recycling reveals that the initial step in this process involves plastics, Aluminium, and Copper to be separated and directed to their own recycling processes, which makes lithium-ion safe for mechanical treatment. The remaining elements

<sup>475</sup> Fortum's official website (2020), Lithium-ion Battery Recycling Technology. Retrieved August 25, 2020 from <https://www.fortum.com/products-and-services/fortum-battery-solutions/recycling/lithium-ion-battery-recycling-solution>

<sup>476</sup> A Critical Review of Lithium-Ion Battery Recycling Processes from a Circular Economy Perspective (August 23, 2019). Retrieved August 25, 2020 from <https://www.mdpi.com/2313-0105/5/4/68/htm>

<sup>477</sup> Fortum's official website (2020), Lithium-ion Battery Recycling Technology. Retrieved August 25, 2020 from <https://www.fortum.com/products-and-services/fortum-battery-solutions/recycling/lithium-ion-battery-recycling-solution>

after the abovementioned treatments are the chemical, mineral components and the ‘black mass’, which is further exposed to industrial-scale processing in Fortum’s facility in Harjavalta. Furthermore, Fortum’s recycling plant in Harjavalta is specialized in hydrometallurgical processing, which helps to initiate a sustainable production of high-grade chemical compounds from various industrial waste and side-streams.

This recovered ‘black mass’ typically consists of a mixture of lithium, manganese, cobalt and nickel in different ratios. Of these, nickel – and especially cobalt – are the most valuable and most difficult to recover. As a consequence, most of today’s recycling solutions for EV batteries are not able to recover these valuable minerals, while Fortum’s solution is applicable therefore.

### 3.7.6 Job Roles and Skills

Recycling procedures must follow strict rules and standards. **Process Engineers for Battery Dismantling and Battery Recycling** improve the processes and align with the technicians. **End of Warranty Managers, Waste Recycling Auditors** and **Compliance Engineers** as well as **Safety Managers and Specialists** ensure the compliance with the legislation and standards; batteries are processed by **Processors** and **Recycling Technicians**, and various **Operators** might be involved.

## Skills and knowledge required in relevant advertisements:

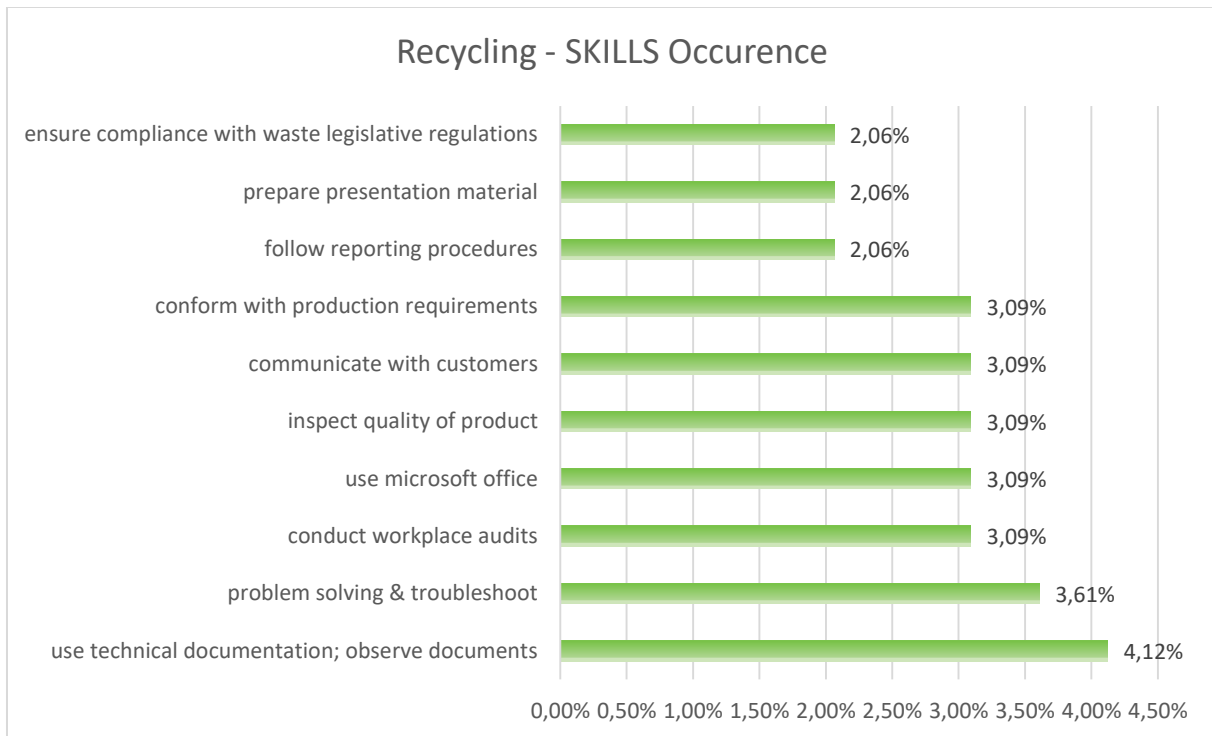

Figure 102 Recycling SKILLS Occurrence

### Skills

Skills occurrence for recycling are shown in **Figure 102**. Problem solving and technical documentation usage, Microsoft Office, quality inspection, reporting procedures and compliance with regulations are the most required skills.

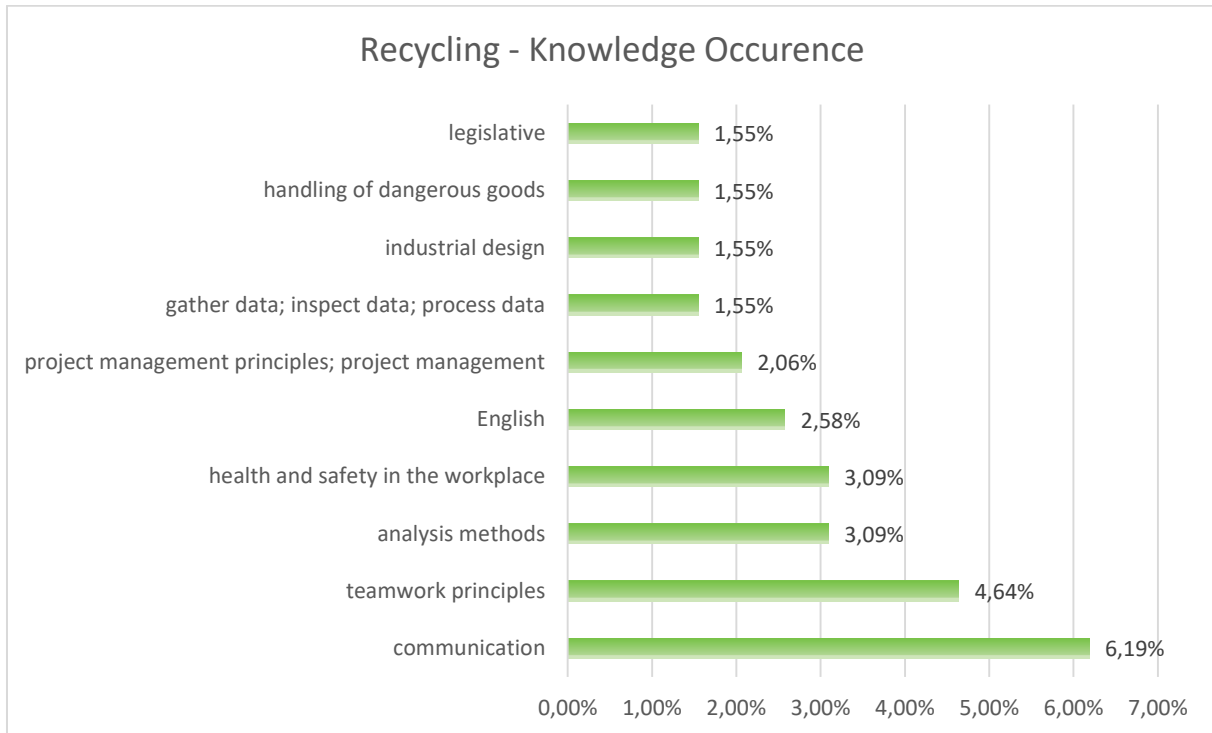

Figure 103 Recycling KNOWLEDGE Occurrence

## Knowledge

Knowledge occurrences relevant to recycling are shown in **Figure 103**. Communication and teamwork principles are in the top positions, as well as knowledge of health and safety in the workplace and experience with analysis methods. Handling of dangerous goods and knowledge of the legislation are also required.



## 4 Training & Education Methods and Approaches

The ALBATTTS project aims at making a blueprint for education and training development to support the emerging battery and electromobility sector in Europe. A first makeshift inventory of existing education and training in the sector has been done in D 6.1: *Report on state of the art and job roles in the sector* (only chosen examples of education and training on different levels are presented here below).

Analysis of desktop research (like this report), surveys and workshops in WP3, 4 and 5 will show what education and training is needed for the emerging new jobs, while other positions may partly vanish. As the education systems in European countries are national, the project must find ways to design learning objectives, job roles descriptions, learning materials and teaching structures in a way that is, on the one hand, modern and innovative but on the other hand, can connect well to existing and varying European education and training systems and practises. Below is a first characterisation attempt on educational providers, prevailing education and training methods and approaches, use of ICTs for education design to address learner access and flexibility, and some examples of training and education at different educational levels in Europe.

There are many ways of teaching and training people for jobs in a sector of the labour market. We have the classical university with full-time co-located offerings on a campus, including *lectures, planned readings, group discussions and assignments, lab work, learning projects*, and possibly *case studies* and *simulations*. The educational institution typically wants full control over the offering and communicates, usually not in detail, with industry and the target groups of potential students, since it views education as generalist education within one or two disciplines primarily. A research university is not expected to teach anything that is not being researched at the same institution.<sup>478;479</sup> The students receive a long and broad education and pass an exam, but will often need skills training after exam. The learning theory

<sup>478</sup> Elen, J., Lindblom-Ylänne, S., & Clement, M. (2007). Faculty development in research-intensive universities: The role of academics' conceptions on the relationship between research and teaching. *International Journal for Academic Development*, 12(2), 123-139.

<sup>479</sup> Hattie, J., & Marsh, H. W. (1996). The relationship between research and teaching: A meta-analysis. *Review of educational research*, 66(4), 507-542.

in universities is nowadays often declared to be constructivism – to make the individual create a personal, deep, and broad understanding.<sup>480</sup> A problem is that this understanding can stay theoretical.

The vocational school or institute typically works closer to industry (like the university college but with minimal or no research ability). In comparison with an academic university, vocational educational providers often reduce *lectures* - and *planned reading* in favour of more *internship* periods and *on-the-job training* in workplaces, use of *simulators*, *role-playing*, *management games*, *peer tutoring*, *coaching and mentoring* by industry professionals, etc. The emphasis is more on skills-training; a good theoretical understanding is also needed, but is developed through a combination of learning methods.<sup>481</sup> The learning theory behind this is often some kind of constructionism, meaning that the student learns best when trying to construct something, or attempting to solve real problems. Constructionism emphasises demonstrable understanding and skills, developed by personal trial- and-error in a context of mentoring. This also makes validation of previous learning easier than in a university context.

The employer or work place is a training stakeholder and sometimes actor or provider as well, working both with specialised introduction at time of employment, so called on-boarding, but continuously also with various on-the-job training, simulators and learning games, coaching and mentoring, peer tutoring, etc.<sup>482</sup> This learning at the workplace is also *situated learning*; it has a clear context, and there is research showing that learners have the optimal conditions to learn in the environment where the learned knowledge and skills will be practised.<sup>483</sup>

Another distinction between training methods often used in a description like this is “*traditional methods*” versus “*e-learning*”. This might be a shallow and not so useful description. Both concepts are moving targets, and there is no accepted definition of

<sup>480</sup> Mueller, S. (2020). The mature learner: understanding entrepreneurial learning processes of university students from a social constructivist perspective (Doctoral dissertation). (p 11 ff)

<sup>481</sup> Backes-Gellner, U., Wolter, S. C., & Tuor, S. N. (2010). Risk-return trade-offs to different educational paths: vocational, academic and mixed. *International journal of Manpower*.

<sup>482</sup> Elkjaer, B., & Wahlgren, B. (2005). Organizational learning and workplace learning—similarities and differences. In *Learning, working and living* (pp. 15-32). Palgrave Macmillan, London.

<sup>483</sup> Lave, J., & Wenger, E. (1991). *Situated learning: Legitimate peripheral participation*. Cambridge university press.

“traditional learning”, for example, nor is there any unified definition of “e-learning”. But where do digital tools come in? A reasonable answer can be “everywhere”, as we live in an “onlife”<sup>484</sup> world where all from lectures to on-the-job-mentoring can be done by using a mix of classical and digital tools.<sup>485</sup> The imagined border between digital and not digital is blurring, to say the least. What Internet-based ICTs have done for education and training recently is to reduce the friction of information flows even more than with print and mass media, postal service, TV and telephone. Digital ICTs do not, however, automatically guarantee modern training methods –behaviouristic setups and purely information-transmission-based lectures also make use of today’s digital technology. What digital technologies excel in, however, is not only lowering information friction, but processing information outside human brains for the first time in history.<sup>486</sup> Such ICTs as learning analytics, adaptive learning, etc., are developing right now – using digital algorithms to adapt a learning track after the individual user/student. We will work with that in the ALBATTTS project as well (WP6/Work Package 6 - Training and Education).

Students’ *access to* and *flexibility in* studies can be much improved already with digital technology’s reduced information friction. This is understood in various ways by stakeholders. Universities can call a course “distance course” just by using some digital technology, but still demand a lot of physical presence for exams, lab work, discussions, etc. – while the individual had expected a very flexible course and almost never visit a campus. The terms “*distance learning*”, “*e-learning*”, “*online learning*”, “*blended learning*”, “*flipped learning*” and so on have no agreed-upon definitions that describes level of access or flexibility or even course design.<sup>487</sup> However, the recent Covid-19 crisis has meant a lot of improvement in work with these practical questions, and we are in a period of change where “the normal” after the crisis

---

<sup>484</sup> The term “onlife” comes from the Oxford Information philosophy Luciano Floridi, and simply says that digital ICTs (information and Communication technologies) are already an integrated part of people’s lives – thereby recommending us to stop thinking in terms of being online or offline and moving between these modalities. See “The Onlife Manifesto” <https://link.springer.com/book/10.1007/978-3-319-04093-6>

<sup>485</sup> Dziuban, C., Graham, C. R., Moskal, P. D., Norberg, A., & Sicilia, N. (2018). Blended learning: the new normal and emerging technologies. *International Journal of Educational Technology in Higher Education*, 15(1), 3.

<sup>486</sup> Floridi, L. (2013) *The Fourth Revolution – How the infosphere is transforming human*

<sup>487</sup> Norberg, A. (2017). *From blended learning to learning onlife: ICTs, time and access in higher education* (Doctoral dissertation, Umeå University).

has changed, especially concerning access to and flexibility in education and training.<sup>488</sup>

A practical way of analysing the level of access to and flexibility in an education package or course is to use *a time- and process perspective*, to clarify how the course design uses the student's time by the blend and shifts of synchronous and asynchronous events. The key is to see how synchronous events and asynchronous events shift in a course and how they are constructed. Here we do not make any distinction if something is digital or not, but it is the digital ICTs that makes considerable difference to new more inclusive course designs. As *synchronous* events we classify all events that happen at a scheduled time the same for all participants, *classroom lectures, video conferenced lectures and meetings, interactive discussions or chats, social simulation games*, etc. These synchronous events can be co-located (as in a classroom or lab) or not (using distance-spanning ICTs). As *asynchronous* events we think of doing *assignments, working in a learning management system, readings, watching recorded lecture videos or tutorials, communicating with peers in forums*, etc. – activities which the individual can plan during a period.<sup>489;490;491</sup> However, in the ALBATTTS project, we must first and foremost take the educational provider's own description of a course, course package or programme at face value. If they say it is a distance course, it is. Next step, if we can get closer into the design of an individual learning expedition (course, programme, etc), is to try to classify after the following<sup>492</sup>:

### SYNC – COLOC

A synchronous course delivered in a room only – no asynchronous assignment, homework, etc. This kind of course is almost exclusively used in the corporate training world.

### SYNC

<sup>488</sup> Burgess, S., & Sievertsen, H. H. (2020). Schools, skills, and learning: The impact of COVID-19 on education. VoxEu. org, 1.

<sup>489</sup> Norberg, A., Dziuban, C. D., & Moskal, P. D. (2011). A time-based blended learning model. On the Horizon.

<sup>490</sup> Power, M. (2008). The emergence of a blended online learning environment. MERLOT Journal of online Learning and Teaching, 4(4), 503-514.

<sup>491</sup> Bradford, G., Kehrwald, B., & Dinmore, S. (2011). A framework for evaluating online learning in an ecology of sustainable innovation (Doctoral dissertation, University of Tasmania).

<sup>492</sup> Norberg, A. (2017) From blended learning to learning onlife – ICTs and access to higher education. Doctoral dissertation, Umeå University, p. 53-58.

[https://www.researchgate.net/publication/312922241\\_From\\_blended\\_learning\\_to\\_learning\\_onlife\\_-\\_ICTs\\_time\\_and\\_access\\_to\\_higher\\_education](https://www.researchgate.net/publication/312922241_From_blended_learning_to_learning_onlife_-_ICTs_time_and_access_to_higher_education)

Similar but without a room for participants in common as the ICT - a video transmitted course with no asynchronous components as assignment or text readings or preparations for exam. Not so common.

### **ASYN**

A web- or print-based course with no times or places, but possibly a deadline. Very flexible but demand a lot of design work to function and are usually expensive to develop. This kind of course is very flexible but also very demanding for a new learner.<sup>493</sup> The continuous feedback from teacher and peers is often missing. MOOC courses (Massive Open Online Courses<sup>494</sup>) are examples of ASYN courses.

### **SYNC-ASYN**

The usual university or school course or program. People meet at lessons, labs, and lectures, and have assignments, reading and flexible projects to work with between meetings. We do not distinguish whether the asynchronous modality/component is digital (web-based) or not (as book readings and assignments on paper). A risk here is that the synchronous and asynchronous tracks run in parallel instead of becoming driving forces for student development in a learning process, a so called “course-and-a half”<sup>495</sup>. For example, ASYN MOOC courses can be made blended SYNC-ASYN courses just by organising interactive learner meetings.<sup>496</sup> Then the question is if these SYNC-ASYN courses are flexible or not, accessible or not from a distance, for students with time difficulties because of work, etc. Often just slight changes in courses can change flexibility a lot, by for example using the HyFlex or similar concept<sup>497;498</sup>, creating an accessible course and a campus course within the same frame.

<sup>493</sup> Guri-Rosenblit, S. (2006). Eight paradoxes in the implementation process of e-learning in higher education. *Distances et savoirs*, 4(2), 155-179. <https://www.cairn.info/revue-distances-et-savoirs-2006-2-page-155.htm#pa37>

<sup>494</sup> MOOC courses are globally accessible orientation courses from universities, often in their specialisation subjects. They do not formally demand previous studies for participation, and can be studied without cost, or with a smaller cost for obtaining a course verification document.

<sup>495</sup> Kenney, J., & Newcombe, E. (2011). Adopting a blended learning approach: Challenges encountered and lessons learned in an action research study. *Journal of Asynchronous Learning Networks*, 15(1), 45-57.

<sup>496</sup> Norberg, A., Händel, Å., & Ödling, P. (2015). Using MOOCs at learning centers in Northern Sweden. *International Review of Research in Open and Distributed Learning*, 16(6), 137-151.

<sup>497</sup> Beatty, B. (2014). Hybrid courses with flexible participation: The HyFlex course design. In *Practical applications and experiences in K-20 blended learning environments* (pp. 153-177). IGI Global.

<sup>498</sup> Irvine, V., Code, J., & Richards, L. (2013). Realigning higher education for the 21st-century learner through multi-access learning. *MERLOT Journal of Online Learning and Teaching*, 9(2), 172-186.

## ASYNCOLOCO

A course or training can be composed of flexible web components for theory understanding, and an open training lab for the student to visit, train in and finally use to demonstrate his or her skill for an instructor in a lab when ready.

The ALBATTTS project can in WP6 possibly assist in improving course design not only concerning content and training methods, but also concerning accessible and flexible design of courses.

### 4.1 EDUCATION OFFERINGS

WP6 made a first draft overview of what educational offerings could be found on the themes of batteries and electromobility (Deliverable 6.1)<sup>499</sup>. This was made fast and early in the project just to lay first foundations. This work will continue within the WP3, 4 and 5 Sectoral Intelligence Work packages.

This first overview of education and training offerings (Deliverable 6.1) only claims to show *examples* of education and training on EQF levels 4-7 in Europe, and online global solutions as these are accessible and used in Europe. EQF levels 3 and 8 will be examined in future reports, when we know have data enough to describe them in more general terms.<sup>500</sup>

## EQF7

On the master level<sup>501</sup> we found many education programmes with occurrences in most EU member countries, following the Bologna declaration<sup>502</sup> model that has developed throughout Europe and surrounding countries since 1999. The Bologna process is a part of the EHEA, the European Higher Education Area.<sup>503</sup> One EU ambition with the EHEA is to promote

<sup>499</sup> Deliverable 6.1 Report on state-of-art of job roles and education in the sector. Will be publicly available on <http://www.project-albatts.eu>

<sup>500</sup> For EQF 1-3, there seems to be hard to find relevant data related to the battery value chain at the present time, and for EQF 8 we find that there are so many local designs and individual solutions that we will work together with WP3 in Batteries2030+ Research Roadmaps next project period, starting in October 2030, to describe the relevant EQF 8 level education.

<sup>501</sup> See page 27ff in ALBATTTS Deliverable 6.1 Report on state-of-art of job roles and education in the sector, soon available via <http://project-albatts.eu>

<sup>502</sup> <http://www.ehea.info/page-ministerial-conference-bologna-1999>

<sup>503</sup> <http://www.ehea.info/>



student mobility within Europe in both phases of education. The Bologna process is a shared ambition among now 48 countries concerning enabling easier student mobility. It should become normal that a student can have a first cycle of education in his home country and continue with a specialised master education in another country.

The master programmes relevant in the ALBATTTS context are mainly to be found at research universities that have batteries or electromobility as one of their priorities. These master programmes are usually 2-year programmes (1 year in the UK) that demand an EQF6 exam (bachelor exam or similar) for entry. They prepare both for research but also for qualified work in industry. They sometimes appear in multi-university setups, where a student can study one semester here, next there, etc. and get a joint-degree exam.

Examples of such families of cooperating universities working together are the EIT InnoEnergy-supported master programmes in energy storage<sup>504</sup>, the MESC<sup>505</sup> (Erasmus Mundus Joint Master) and the Nordic Joint Degree Master in Innovative Sustainable Energy Engineering.<sup>506</sup>

## EQF 6

At the first Bologna cycle level, commonly called bachelor's level, we have not found so many education programmes<sup>507</sup>, but some interesting ones, such as the Norwegian engineering program *Renewable Energy for the Marine Environment*.<sup>508</sup>

Not only technical educations are to be found – we also find, for example, business educations relating to this new developing energy sector in Germany<sup>509</sup>.

## EQF 5<sup>510</sup>

The EQF5 level includes longer vocational post-secondary education programmes, 2-4 years, at a professional university or school. We have found more such programmes related to

<sup>504</sup> <https://www.innoenergy.com/for-students-learners/master-school/>

<sup>505</sup> <https://mesc-plus.eu/> a 2-year programme in Materials Science and Electrochemistry, fully taught in English, involving 5 Universities in 4 European countries (France, Poland, Slovenia and Spain), 2 Universities in USA and Australia, a European Research Institute (ALISTORE), the French Network on Energy Storage (RS2E), the Slovenian National Institute of Chemistry (NIC) and a leading Research Center in Spain (CIC Energigune).

<sup>506</sup> <https://www.ntnu.edu/studies/msisee>

<sup>507</sup> See page 26ff in ALBATTTS Deliverable 6.1

<sup>508</sup> <https://www.ntnu.edu/studies/allstudies?admissions=1&search=enewable>

<sup>509</sup> <https://www.rwth-aachen.de/cms/root/Studium/Vor-dem-Studium/Studiengaenge/Liste-Aktuelle-Studiengaenge/Studiengangbeschreibung/~bmmx/Wirtschaftsingenieurwesen-B-Sc-Fachric/?lidx=1>

<sup>510</sup> See page 24ff in ALBATTTS Deliverable 6.1

electromobility than to battery production so far; just one example is the *CTeSP in Electric and Hybrid Vehicles* course in Portugal<sup>511</sup>. For a vocational school to be attractive, jobs must be available – and battery cell factories are still mostly planned or under construction, while electric and hybrid vehicles are already in use.

#### EQF 4

In secondary education (high school, gymnasium) and same-level adult education, we found rather few education and training programmes, but some in Sweden, in the Netherlands, in Portugal and in the Czech Republic.<sup>512</sup> This level is in many countries standardised with few possibilities to profiling education. Adult education, however, at this same level is often less standardised or easier to make customised educational solutions within. In Skellefteå, Sweden, an 18-week introductory training programme, *Automation operator* starts in the autumn of 2020 for entering jobs as machine operator or material handler in the Northvolt Li-Ion cell factory, beginning production in 2021.<sup>513</sup>

We have also found a lot of examples of training offers for working professionals<sup>514</sup>, for example, for electricians or mechanic technicians that want to develop their competence. These are usually short and intense, come with a cost, and seem to easily grow to fulfil demand. Online asynchronous courses such as MOOC courses have also been found and listed, and presently during the pandemic, some of them are recommended via the special ALBATTs/DRIVES site <https://www.skills4automotive.eu/>

Besides using desktop research to gather information about training and education, including providers, we hope to detect more with the help of networking within the sector and cooperation with stakeholders and partnerships as EITInnoenergy, BatteriesEurope, European Battery Alliance and the research roadmap project Batteries2030+. We will also work with the sectoral stakeholders via a series of workshops and online surveys.

<sup>511</sup> [http://www.si.ips.pt/ips\\_si/](http://www.si.ips.pt/ips_si/)

<sup>512</sup> See page 21ff in ALBATTs Deliverable 6.1

<sup>513</sup> <https://www.skelleftea.se/yrkesutbildning>

<sup>514</sup> See page 44ff in ALBATTs Deliverable 6.1