



European
Commission

JEC Tank-To-Wheels report v5: Heavy duty vehicles

*Well-to-Wheels analysis of
future automotive fuels and
powertrains in the European
context*



This publication is a report by the JEC Consortium for the Joint Research Centre (JRC), the European Commission's science and knowledge service. It aims to provide evidence-based scientific support to the European policymaking process. The scientific output expressed does not imply a policy position of the European Commission. Neither the European Commission nor any person acting on behalf of the Commission is responsible for the use that might be made of this publication. For information on the methodology and quality underlying the data used in this publication for which the source is neither Eurostat nor other Commission services, users should contact the referenced source. The designations employed and the presentation of material on the maps do not imply the expression of any opinion whatsoever on the part of the European Union concerning the legal status of any country, territory, city or area or of its authorities, or concerning the delimitation of its frontiers or boundaries.

EU Science Hub

<https://ec.europa.eu/jrc>

JRC117564

EUR 30271 EN

PDF

ISBN 978-92-76-19928-1

ISSN 1831-9424

doi:10.2760/541016

Luxembourg: Publications Office of the European Union, 2020

© European Union, 2020



The reuse policy of the European Commission is implemented by the Commission Decision 2011/833/EU of 12 December 2011 on the reuse of Commission documents (OJ L 330, 14.12.2011, p. 39). Except otherwise noted, the reuse of this document is authorised under the Creative Commons Attribution 4.0 International (CC BY 4.0) licence (<https://creativecommons.org/licenses/by/4.0/>). This means that reuse is allowed provided appropriate credit is given and any changes are indicated. For any use or reproduction of photos or other material that is not owned by the EU, permission must be sought directly from the copyright holders.

How to cite this report: Röck, M., Martin, R. and Hausberger, S. *JEC Tank-To-Wheels report v5: Heavy duty vehicles*, Hanarp, P., Bersia, C., Colombano, M., Gräser, H., Gomes Marques, G., Mikaelsson, H., De Prada, L., Prussi, M., Lonza, L., Yugo, M. and Hamje, H., editors. EUR 30271 EN, Publications Office of the European Union, Luxembourg, 2020, ISBN 978-92-76-19928-1, doi:10.2760/541016, JRC117564.

Contents

1	Executive summary.....	3
2	Introduction.....	5
3	Reference vehicles.....	7
3.1	Specifications of reference vehicles model year 2016.....	7
3.2	Specifications of reference vehicles model year 2025.....	10
4	Fuels & Propulsion systems.....	15
4.1	Fuel and powertrain combinations.....	15
4.2	Fuel Properties.....	16
4.3	Propulsion systems.....	17
4.3.1	ICE only configurations.....	17
4.3.2	xEV configurations.....	23
4.4	Vehicle performance criteria.....	37
5	Simulation methodology.....	39
5.1	Simulation software VECTO.....	39
5.2	Simulation software PHEM.....	39
5.3	Consolidation of PHEM and VECTO results.....	40
5.4	Mission Profiles.....	40
5.5	Payloads.....	41
5.6	Advanced Driver Assistance Systems (ADAS).....	42
5.6.1	Eco-roll.....	42
5.6.2	Predictive Cruise Control (PCC).....	43
5.6.3	Fuel saving potential of ADAS systems.....	43
5.7	xEV operation.....	43
5.7.1	HEV operation strategy.....	43
5.7.2	BEV and CEV operation strategy.....	44
5.7.3	FCEV operation strategy.....	44
5.8	Total greenhouse gas emissions.....	44
5.9	AdBlue consumption.....	47
6	Results.....	49
6.1	Group 4 rigid trucks (Regional delivery).....	49
6.2	Group 5 tractor-semitrailer combination (Long haul).....	52
7	Summary findings.....	59
8	References.....	60
	Annex I: Results for vehicle group 4 on Urban Delivery cycle.....	62
	Annex II: Tabular results for single VECTO payloads.....	68
	List of abbreviations and definitions.....	73
	List of figures.....	75

List of tables 77

Annexe(s)..... 79

 Annex I: Results for vehicle group 4 on Urban Delivery cycle 79

 Annex II: Tabular results for single VECTO payloads 79

Abstract

This Tank-to-Wheel (TTW) report describes the final use of the various fuels and corresponding powertrain options. For the first time, JEC study consider Heavy Duty Vehicles (HDV). he analysed HDV configurations are either driven with a conventional internal combustion engine (ICE) or an electrified propulsion system (xEV) All considered vehicle concepts have been analysed for the model years 2016 and 2025, whereby 2016 models are representing the state of the art on the European market for the individual application purpose. Vehicle specifications for 2025 are based on a technology assessment of future improvements.

Acknowledgements

This JEC Consortium study was carried out jointly by experts from the JRC (EU Commission's Joint Research Centre), EUCAR (the European Council for Automotive R&D), and CONCAWE (the oil companies' European association for environment, health and safety in refining and distribution) assisted by experts from the Forschungsgesellschaft for Internal Combustions Engines and Thermodynamics (FVT)¹.

Authors

Main authors Tank-to-Wheels (TTW) report

M. Röck	FVT
M. Rexeis	FVT
S. Hausberger	FVT

JEC Scientific Advisory Board

P. Hanarp	Volvo Group
C. Bersia	Iveco
M. Colombano	Iveco
H. Gräser	MAN
G. Gomes Marques	VW AG
H. Mikaelsson	Scania
L. de Prada	EUCAR
M. Prussi	JRC
L. Lonza	DG CLIMA
M. Yugo	Concawe
H. Hamje	Concawe
Members of STF-14	Concawe

¹ The Forschungsgesellschaft for Internal Combustions Engines and Thermodynamics mbH (FVT) is a spin-off of the Institute for Internal Combustions Engines and Thermodynamics (IVT) at the Graz University of Technology (TU Graz). There is a close cooperation between the two institutions which is based on sharing the staff and infrastructure to a large extend.

1 Executive summary

In this study typical figures for fuel consumption (FC), CO₂ and CO₂-equivalent emissions as well as energy consumption of current and future propulsion and fuel configurations for heavy duty vehicles (HDV) have been assessed. This report covers the Tank-to-Wheels (TTW) part of a comprehensive Well-to-Wheel (WTW) analysis. The parts of the study related to Well-to-Tank (WTT) analysis and to integrated WTW view are published in separate reports.

- The following two HDV configurations have been analysed:
- Rigid truck with 18 tons gross vehicle mass rating (GVMR) designed for use in regional delivery mission ("group 4 vehicle")²
- Tractor-semitrailer combination with 40 tons GVMR designed for use in long haul mission ("group 5 vehicle")

The analysed HDV configurations are either driven with a conventional internal combustion engine (ICE) or an electrified propulsion system (xEV). ICE only configurations include the technologies:

- Direct Injection Compression Ignition (CI)
- Port Injection Positive Ignition (PI)
- LNG High Pressure Direct Injection Compression Ignition (HPDI)

For CI engines the fuels Diesel B0, B7 and B100 (FAME) as well as DME, ED95, OME and Paraffinic Diesel were considered. For PI engines CNG and LNG were analysed. The electrified propulsion systems include:

- Hybrid electric vehicle (HEV)
- Battery electric vehicle (BEV)
- Catenary electric vehicle (CEV)
- Hydrogen/Fuel cell (FCEV)

All considered vehicle concepts have been analysed for the model years 2016 and 2025, whereby 2016 models are representing the state of the art on the European market for the individual application purpose. Vehicle specifications for 2025 are based on a technology assessment of future improvements. For xEV concepts it is at the moment not possible to identify typical vehicle configurations as these systems are currently a new technology under development for HDV. As a consequence xEV vehicle specifications and related results as elaborated in the present study shall be understood as examples for these new technologies.

Simulation of vehicles which are driven by an ICE only have been performed with the software Vehicle Energy Consumption Calculation tool (VECTO), the tool which is also used for the CO₂ certification of HDV in the EU. Electrified propulsion systems have been simulated with the model PHEM³ as these propulsion concepts are not covered in the current VECTO version.

Figure 1 and Figure 2 give a summary on the results on transport specific figures (i.e. per tonne-kilometre) for energy consumption and TTW CO₂-equivalent emissions. The main conclusions on the comparison of different propulsion systems drawn from these results are given in chapter 7 of this report.

² Labelling of vehicles by „group“ refers to the method as applied in the European Regulation for CO₂ certification of Heavy Duty Vehicles [EU, 2017]

³ Passenger car and Heavy duty Emission Model, developed at the Institute for Internal Combustion Engines and Thermodynamics at the Graz University of Technology

Figure 1: Summary results vehicle group 4 (Regional Delivery)

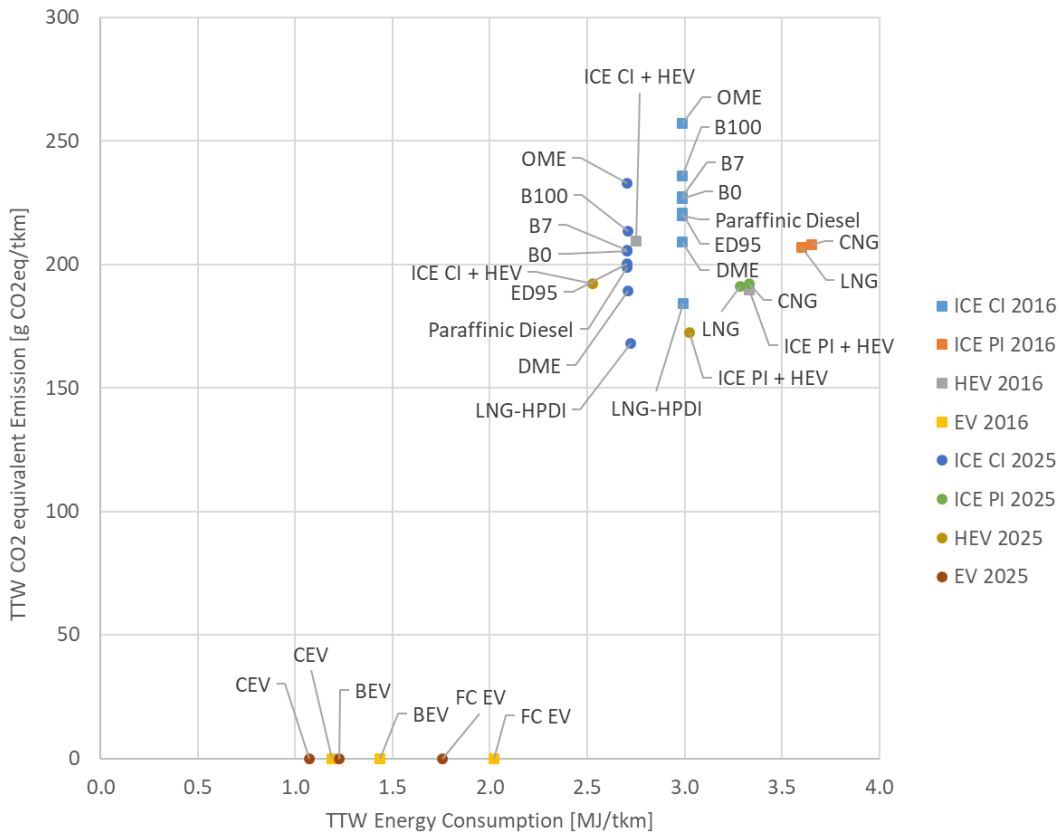

Group 4; VECTO Regional-Delivery cycle; Weighted payload (2650 kg)
 Analysed propulsion systems do vary in performance criteria like operating range, payload capacity or fuelling time

Figure 2: Summary results vehicle group 5 (Long Haul)

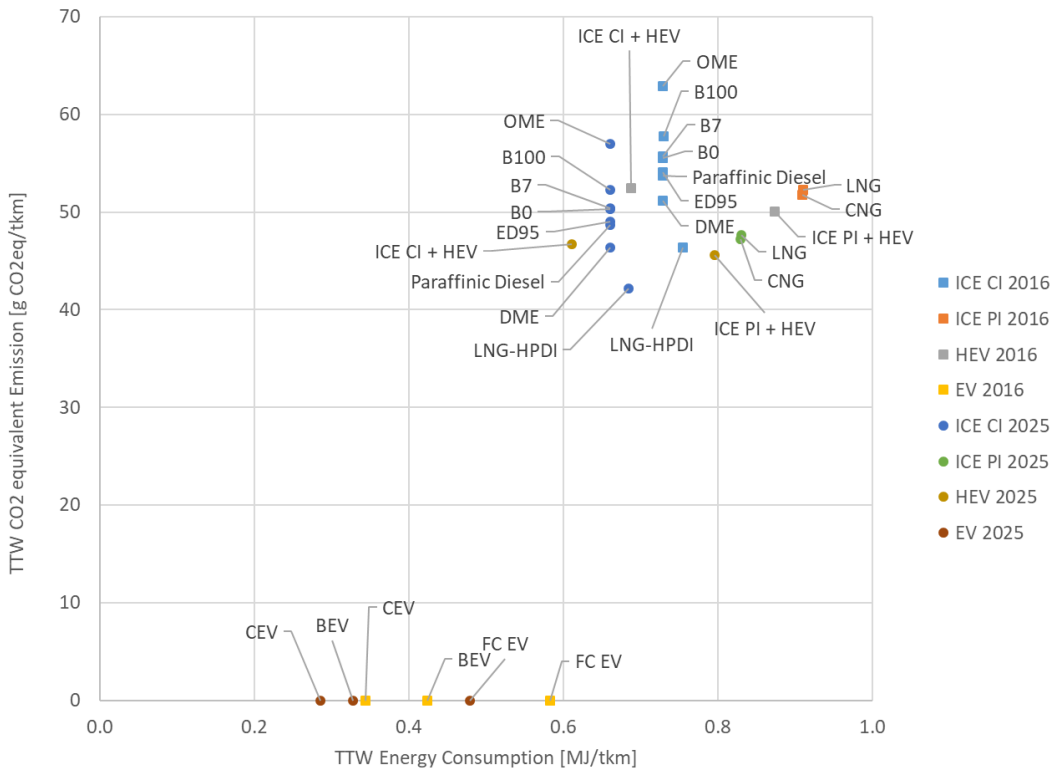

Group 5; VECTO Long-Haul cycle; Weighted payload (13064 kg for BEV 2016; 14290 g for all others)
 Analysed propulsion systems do vary in performance criteria like operating range, payload capacity or fuelling time

2 Introduction

In this study typical figures for fuel consumption (FC), CO₂ and CO₂-equivalent emissions as well as energy consumption of current and future propulsion and fuel configurations for heavy duty vehicles (HDV) have been assessed. This report covers the Tank-to-Wheel (TTW) part of a comprehensive Well-to-Wheel (WTW) analysis. The parts of the study related to Well-to-Tank (WTT) analysis and to integrated WTW view are published in separate reports. The results for TTW CO₂-equivalent emissions as presented in this study have been calculated including the greenhouse effect of the following emission components:

- Tailpipe CO₂ emissions from fuel combustion
- Tailpipe emissions of CH₄
- Tailpipe N₂O emissions
- Leakage of CH₄ from the tank system

Tailpipe CO₂ emissions resulting from the conversion of AdBlue into ammonia have per definition not been included in the figures provided by this report but will be reported in the WTW part of the integrated study.

The following two HDV configurations have been analysed:

- Rigid truck with 18 tons gross vehicle mass rating (GVMR) designed for use in regional delivery mission ("group 4 vehicle")⁴
- Tractor-semitrailer combination with 40 tons GVMR designed for use in long haul mission ("group 5 vehicle")

The analysed HDV configurations are either driven with a conventional internal combustion engine (ICE) or an electrified propulsion system (xEV). ICE only configurations include the technologies:

- Direct Injection Compression Ignition (CI)
- Port Injection Positive Ignition (PI)
- LNG High Pressure Direct Injection Compression Ignition (HPDI)

For CI engines the fuels Diesel B0, B7 and B100 (FAME) as well as DME, ED95, OME and FT-Diesel were considered. For PI engines CNG and LNG were analysed. The electrified propulsion systems include:

- Hybrid electric vehicle (HEV)
- Battery electric vehicle (BEV)
- Catenary electric vehicle (CEV)
- Hydrogen/Fuel cell (FCEV)

All considered vehicle concepts have been analysed for the model years 2016 and 2025, whereby 2016 models are representing the state of the art on the European market for the individual application purpose. Vehicle specifications for 2025 are based on a technology assessment of future improvements. For xEV concepts it is at the moment not possible to identify typical vehicle configurations as these systems are currently a new technology under development for HDV. As a consequence xEV vehicle specifications and related results as elaborated in the present study shall be understood as examples for these new technologies.

Simulation of vehicles which are driven by an ICE only have been performed with the software Vehicle Energy Consumption Calculation tool (VECTO), the tool which is also used for the CO₂ certification of HDV in the EU. Electrified propulsion systems have been simulated with the model PHEM⁵ because these propulsion concepts are not covered in the current VECTO version.

⁴ Labelling of vehicles by „group“ refers to the method as applied in the European Regulation for CO₂ certification of Heavy Duty Vehicles [EU, 2017]

⁵ Passenger car and Heavy duty Emission Model, developed at the Institute for Internal Combustion Engines and Thermodynamics at the Graz University of Technology

In addition to GHG emissions and energy consumption, relevant performance criteria for HDVs such as maximal payload or operating range, etc. have been analysed to get further evaluation criteria for a fair comparison of different propulsion systems.

Data, models and strategies were widely discussed and mutually agreed between EUCAR and TU Graz to ensure a high quality of results. It should be noted that all investigated powertrain configurations are theoretical vehicle configurations and do not represent any existing vehicle or brand. However, the definitions made do ensure that the investigated powertrain configurations - conventional as well as their xEV derivatives - strive to provide a representative overview about today's and expected future automotive technologies and their GHG emissions of typical European HDV.

3 Reference vehicles

This study shall focus on two different HDV categories. One category represents mid-distance goods distribution, the other category relates to long-haul transportation. For both vehicle categories reference vehicles, which cover typical specifications of above mentioned application types have been determined. It was decided to use a rigid truck of vehicle “group 4”⁶ for the mid-distance distribution traffic and a vehicle of “group 5”⁷ for long haul applications. These reference vehicles are the basis for comparison of different fuels and propulsion systems for the model years 2016 and 2025. It is important to note that the reference vehicles do represent the most common but not the average specifications in the fleet of the respective vehicle group.



3.1 Specifications of reference vehicles model year 2016

Table 1 lists the main specifications of the group 4 rigid truck as well of the group 5 long haul truck for the model year 2016. All specifications of the reference vehicles relate to an ICE CI powertrain configuration with B7 Diesel fuel and have been defined in cooperation between EUCAR and TUG. Details on engines and electric powertrain components for xEV vehicles are documented in chapter 4.

⁶ According to [EU, 2017] vehicles of group 4 are defined with rigid chassis configuration, 4x2 axle configuration and a technically permissible maximum laden mass (TPMLM) of more than 16 tons.

⁷ According to [EU, 2017] vehicles of group 5 are defined with tractor chassis configuration, 4x2 axle configuration and a TPMLM of more than 16 t.

Table 1: Specifications reference vehicles model year 2016

	Group 4 	Group 5 
Curb mass (90% Fuel + driver) [kg]*	5800	7550
Curb mass body/trailer [kg]	2100	7500
Engine power [kW]	220	325
Displacement [ccm]	7700	12700
Max. Torque [Nm]	1295 (1100 -1600 rpm)	2134 (1000-1400 rpm)
Rated speed [rpm]	2200	1800
Idling speed [rpm]	600	600
Engine peak BTE (%)	44.3	45.8
RRC [N/kN] (Steer/Drive/Trailer)	5.5/6.1/---	5.0/5.5/5.0
CdxA [m2]/vehicle height [m]	5.6/4	5.57/4
Transmission type	AMT	AMT
Efficiency indirect gear	96%	96%
Efficiency direct gear	98%	98%
Axle Ratio	4.11	2.64
Axle Efficiency	96%	96%
Advanced Driver Assistance Systems (ADAS)	---	Predictive Cruise Control (PCC)** + Eco-roll***
<p>* This definition refers to the mass as specified under the 'actual mass of the vehicle' in accordance with Commission Regulation (EC) No 1230/2012 (1) but without any superstructure ** Predictive cruise control manages and optimises the usage of the potential energy during a driving cycle *** Eco-roll reduce the engine drag losses by disengaging the engine from the wheels during certain downhill conditions</p>		

The reference vehicles are equipped with an automated manual transmission (AMT) with the gear ratios shown in Table 2.

Table 2: Gear ratios AMT transmission

vehicle group	Gear ratio											
	1st gear	2nd gear	3rd gear	4th gear	5th gear	6th gear	7th gear	8th gear	9th gear	10th gear	11th gear	12th gear
4	10.369	8.428	6.487	5.273	4.182	3.399	2.48	2.015	1.551	1.216	1	0.813
5	14.93	11.64	9.02	7.04	5.64	4.4	3.39	2.65	2.05	1.6	1.28	1

The mechanical power demand of auxiliaries has been considered on basis of technology specific average values as given in Annex IX of [EU, 2017]. For conventional powertrain configurations the auxiliary technologies have been defined depending on the vehicle group. Electrified auxiliaries for xEV powertrains were selected similar for both vehicle groups. Table 3 and Table 4 show the auxiliaries technologies chosen for the model year 2016 vehicles.

Table 3: Auxiliary technologies group 4 model year 2016

Auxiliary unit	Auxiliary technology	
	conventional vehicles	xEV vehicles
Engine cooling fan	Crankshaft mounted - Electronically controlled visco clutch	Electrically driven
Steering pump	Fixed displacement	Electric
HVAC	Default*	Default*
Electric System	Standard technology	Default + LED main front headlights**
Pneumatic System	Small Supply 1-stage	Small Supply 1-stage +ESS +AMS

* The actual VECTO version does not differentiate between HVAC technologies but only provides a single standard value

**LED main front headlights reduce the power demand of the standard technology by 50 Watt

Table 4: Auxiliary technologies group 5 model year 2016

Auxiliary unit	Auxiliary technology	
	conventional vehicles	xEV vehicles
Engine cooling fan	Belt driven or driven via transmission, - Electronically controlled visco clutch	Electrically driven
Steering pump	Fixed displacement	Electric
HVAC	Default*	Default*
Electric System	Standard technology	Default + LED main front headlights**
Pneumatic System	Medium Supply 1-stage + mech, Clutch	Small Supply 1-stage +ESS +AMS

* The actual VECTO version does not differentiate between HVAC technologies but only provides a single standard value
**LED main front headlights reduce the power demand of the standard technology by 50 Watt

3.2 Specifications of reference vehicles model year 2025

In order to determine the specifications for model year 2025 vehicles, an assessment of reasonable future improvements of particular vehicle components has been performed. This assessment is based on the assumption that the 1.1% average annual CO₂ reduction of HDV as evaluated in [ACEA, 2017] over the past two decades will continue until the year 2025. The improvements in vehicle characteristics for 2025 vehicles were considered for the different vehicle components as follows:

- Engine

For the engine a reduction of BSFC of 3% from 2016 to 2025 was assumed. This relates to an annual reduction of 0.33% which is one third of the overall improvements on the vehicle level (1.1%) allocated to engine efficiency.
- Tyres

The rolling resistance coefficients for 2025 have been calculated assuming an annual reduction of 1% based on data from [ETRMA, 2016].
- Mass reduction

A mass reduction of 200 kg was assumed for both vehicle groups, which have been allocated as follows:
Group 4 vehicle: chassis –135 kg, superstructure – 65 kg
Group 5 vehicle: tractor –65 kg, semitrailer – 135 kg
- Auxiliaries

For conventional vehicles more efficient auxiliary technologies have been selected for the 2025 model year compared to 2016 (Table 5 and Table 6). Technologies for xEV were not changed as already the most efficient technologies available in VECTO were allocated to the 2016 model year or – for electrified auxiliary technologies – there is only a single technology level available in VECTO.⁸

⁸ Future updates of VECTO might include additional auxiliary technologies or more efficient versions of actually implemented auxiliary systems.

Table 5: Auxiliary technologies group 4 model year 2025

Auxiliary unit	Auxiliary technology	
	conventional vehicles	xEV vehicles
Fan	Crankshaft mounted - Electronically controlled visco clutch	Electrically driven
Steering pump	Variable displacement elec. Controlled	Electric
HVAC	Default*	Default*
Electric System	Default + LED main front headlights**	Default + LED main front headlights**
Pneumatic System	Small Supply 1-stage +ESS +AMS	Small Supply 1-stage +ESS +AMS
<p>* The actual VECTO version does not differentiate between HVAC technologies but only provides a single standard value</p> <p>**LED main front headlights reduce the power demand of the standard technology by 50 Watt</p>		

Table 6: Auxiliary technologies group 5 model year 2025

Auxiliary unit	Auxiliary technology	
	conventional vehicles	xEV vehicles
Fan	Belt driven or driven via transm, - Electronically controlled visco clutch	Electrically driven
Steering pump	Variable displacement elec. Controlled	Electric
HVAC	Default*	Default*
Electric System	Default + LED main front headlights**	Default + LED main front headlights**
Pneumatic System	Medium Supply 1-stage + ESS + AMS	Small Supply 1-stage +ESS +AMS
<p>*The actual VECTO version does not differentiate between HVAC technologies but only provides a single standard value</p> <p>**LED main front headlights reduce the power demand of the standard technology by 50 Watt</p>		

- Advanced driver assistance systems

For the group 4 vehicle model year 2025 additionally the ADAS functionalities Eco-roll and PCC were added compared to the 2016 vehicle. In simplified terms a similar fuel saving effect of ADAS is assumed for the model year 2025 compared to 2016.

- Transmission and axle efficiencies

In the calculations the losses in transmissions and axle have been set constant for both considered model years due to comparable minor contribution on overall fuel consumption. A potential contribution of efficiency improvements of these drivetrain components is however implicitly covered by the calibration of aerodynamics to meet the overall target of 1.1% annual fuel consumption improvement (see next paragraph).

- Aerodynamics (CdxA)

The CdxA values for the 2025 reference vehicles have been determined by a “backward” assessment to achieve the specified target of 1.1% annual fuel efficiency reduction from 2016 to 2025 taking into account the above mentioned improvements of the other vehicle components.



For the group 4 vehicle the necessary improvement was calculated with -0.21 m^2 referring to -3.8% relative improvement in CdxA. This air drag reduction can be achieved by cost-effective modifications such as side and underbody panels or a closable front grill.

For the group 5 vehicle the required CdxA reduction was determined with -0.61 m^2 referring to -11% relative improvement.⁹ This can be achieved by additional measures like rear view cameras and semi-trailer improvements.

Table 7 shows the resulting vehicle specifications for the reference vehicles in 2025. Regarding gear ratios no change was made compared to model year 2016.

⁹ The necessary CdxA reduction for the group 5 vehicle is significantly higher than for the group 4 vehicle as the latter can apply ADAS to improve the fuel efficiency in 2025 compared to 2016. ADAS is already part of the 2016 vehicle configuration for the group 5 vehicle.

Table 7: Specifications reference vehicles model year 2025

	Group 4 	Group 5 
Curb mass (90% Fuel + driver) [kg]*	5665	7485
Curb mass body/trailer [kg]	2035	7365
Engine power [kW]	220	325
Displacement [ccm]	7700	12700
Max. Torque [Nm]	1295 (1100 -1600 rpm)	2134 (1000-1400 rpm)
Rated speed [rpm]	2200	1800
Idling speed [rpm]	600	600
Engine peak BTE (%)	45.6	47.2
RRC [N/kN] (Steer/Drive/Trailer)	5.02/5.57/---	4.57/5.02/4.57
CdxA [m2]/vehicle height [m]	5.39/4	4.96/4
Transmission type	AMT	AMT
Efficiency indirect gear	96%	96%
Efficiency direct gear	98%	98%
Axle Ratio	4.11	2.64
Axle Efficiency	96%	96%
ADAS	PCC** + Eco-roll***	PCC + Eco-roll
<p>* This definition refers to the mass as specified under the 'actual mass of the vehicle' in accordance with Commission Regulation (EC) No 1230/2012 (1) but without any superstructure ** Predictive cruise control manages and optimises the usage of the potential energy during a driving cycle *** Eco-roll reduce the engine drag losses by disengaging the engine from the wheels during certain downhill conditions</p>		

During the course of this study the European Commission published its proposal for CO₂ standards for HDV [EU, 2018]. This proposal foresees a fleet level reduction of CO₂ emissions for certain HDV groups – which cover both vehicle categories analysed in this study - by 15% from 2019 to 2025. The 1.1% annual improvement for conventional propulsion concepts as applied in this study – which were taken over from a market development of two decades without CO₂ standards – correlate to a reduction of CO₂ emissions of 6.4% from 2019 to 2025. To reach the prescribed 15% reduction in the 6 years period OEMs have the following options:

- (a) implement more costly fuel saving technologies into vehicles with conventional propulsion systems than in a scenario without CO₂ standards
- (b) increase the share of alternative powertrain concepts e.g. alternatives in this report that show lower CO₂ emissions
- (c) take advantage of provisions for super credits for zero and low emission vehicles where - within a certain limit - also sold vehicle of other vehicle categories (vans and buses) can be taken into account (double counting does not however change real CO₂ emissions)

It is most likely that a well balanced mix of options a) to c) will be used by most OEMs to meet the CO₂ standards.

4 Fuels & Propulsion systems

4.1 Fuel and powertrain combinations

Table 8 gives a short description of the fuels considered in this study.

Table 8: Description of fuels considered in this study

Fuel Type	Description
Diesel B0	Diesel fulfilling EN590, with no FAME addition.
Diesel B7 market blend	Diesel fulfilling EN590, with up to 7% FAME addition.
FAME (B100)	Fatty Acid Methyl Esters biodiesel (B100) specified in EN14214.
ED95	Ethanol with ignition improver fulfilling SS 155437. ED95 can be used in dedicated compression ignition engines.
Paraffinic Diesel	Paraffinic Diesel fulfilling EN 15940. Gas to liquid (GtL or XtL) or Hydrogenated Vegetable oils (HVO).
DME	DiMethyl Ether, CH_3OCH_3 , fulfilling base fuel standard ISO 16861. It can be used in dedicated compression ignition engines.
OME	Oxymethylene Ether, $\text{CH}_3\text{O}(\text{CH}_2\text{O})_n\text{CH}_3$, $n=3,4,5$. OME can be used in dedicated compression ignition engines.
H-CNG (2016)	Compressed Natural Gas, EU mix of H-Gas, specified in EN 16723-2.
H-CNG (2030)	Compressed Natural Gas, projected EU mix of H-Gas for 2030.
Hydrogen (CGH2)	Compressed hydrogen at 700 bar.
LNG (EU mix. 2016/2030)	Liquified Natural Gas, specified in EN 16723-2.

All analysed combinations of fuels and powertrain configurations are summarised in Table 9. For both model years 2016 and 2025 the same fuel and powertrain combinations were considered. Configurations highlighted in blue were simulated with both vehicle categories, green marked ones with vehicle group 4 only and red marked configurations are simulated with group 5 vehicles only.

Table 9: Investigated fuel and powertrain configurations and simulated vehicle groups

Powertrain Fuel	ICE CI	ICE PI	ICE +HEV CI	ICE +HEV PI	BEV	FC-EV	CEV
Diesel B0	4, 5						
Diesel B7 market blend	4, 5		4, 5				
DME	4, 5						
ED95	4, 5						
Electricity					4, 5		4, 5
FAME (B100)	4, 5						
Paraffinic Diesel	4, 5						
H-CNG		4, 5		4			
Hydrogen						4, 5	
LNG (EU mix.)	4, 5	4, 5		5			
OME	4, 5						

4.2 Fuel Properties

The main properties of the fuels considered in the current study are listed in Table 10. For each fuel the density, the Cetane Number (CN), the Lower Heating Value (LHV), the mass portion of Carbon and the CO₂ emission factors of relevant fuels used in the current study are given. The data is based on a recent analysis performed by CONCAWE/EUCAR and shall reflect typical fuel on the European market.¹⁰ Figures for CN have no influence on the simulation results and are only quoted for the sake of completeness.

Simulations for CNG vehicles were performed with properties of H-CNG (H... high calorific value gas). H-CNG represents the EU mix but with the L-CNG (L... low calorific value gas) excluded.¹¹ Differences between H-CNG 2016 and H-CNG 2030 are caused by a different gas composition: H-CNG 2016 includes piped CNG and vaporized LNG, H-CNG 2030 includes additionally biogas. The WTW analysis of the study also takes non-fossil gases such as CBG (Compressed Bio Gas) and LBG (Liquefied Bio Gas) into account. In the assessment it is assumed that the fuel properties of those alternative gaseous fuels are very close to CNG and LNG as considered in the present study.

¹⁰ These fuel specifications are not identical with the figures as implemented in the recent VECTO version (December 2017).

¹¹ L-gas is only available in some regions such as the Netherlands, Belgium, France and parts of northern Germany. In this study it was decided to exclude L-gas in the average CNG specifications because picking a random CNG fuel station in the EU H-CNG will be correct in most cases, but wrong in case of L-gas. The average CNG mix would be little bit wrong in most cases, and quite a lot wrong in case of L-gas.

Table 10: Fuel properties for WTW study

Fuel Type	Density	CN	LHV	Elemental composition of Carbon	CO2 emission factor	
	kg/m ³ i.N.*	---	MJ/kg	%m	g/MJ	kg/kg
Diesel B0	832.0	51.0	43.1	86.1	73.2	3.16
Diesel B7 market blend	836.1	53.0	42.7	85.4	73.4	3.13
FAME (B100)	890.0	56.0	37.2	77.3	76.2	2.83
ED95	820.0	n.a.	25.4	49.4	71.3	1.81
Paraffinic Diesel	780.0	70.0	44.0	85.0	70.8	3.12
DME	670.0	55.0	28.4	52.2	67.3	1.91
OME	1066.6	84	19.2	43.5	83.3	1.60
H-CNG (2016)	**	---	48.0	73.5	56.2	2.69
H-CNG (2030)	**	---	48.0	73.5	56.2	2.70
Hydrogen (CGH2)	0.084	---	120.0	0.00	0.00	0.00
LNG (EU mix. 2016/2030)	**	---	49.1	75.6	56.4	2.77
*) All values are related to the pressure of $101.32 \cdot 10^5$ Pa and at the temperature of 288.15 K, according to DIN 1343 and ISO 2533						

4.3 Propulsion systems

This section describes the specifications of the different propulsion systems, which have been analysed in this study.

4.3.1 ICE only configurations

The powertrain systems of ICE only HDV configurations consist of the main components engine, transmission and axle. For all analysed combinations of engine concepts and fuels the main vehicle specifications as engine rated power, transmission type and gear ratios, axle ratio, CdxA values etc. have been taken over from the reference vehicles (defined for B7 Diesel, see chapter 3). The only exceptions are the NG PI vehicles for group 5 where the axle ratio was shortened to 2.91 according to the ratios of engine max torque from Diesel to NG.

4.3.1.1 Engine data for compression ignition (CI) engines

ngine respectively.

Figure 3 shows the efficiency maps and the full-load characteristics for the 7.7 litres engine of the group 4 vehicle and Figure 4 the corresponding data for the 12.7 litres engine of the group 5 vehicle. The peak efficiencies are at 44.2% for the smaller engine and at 45.8% for the bigger engine respectively.

Figure 3: Efficiency map of 2016 CI engine for group 4

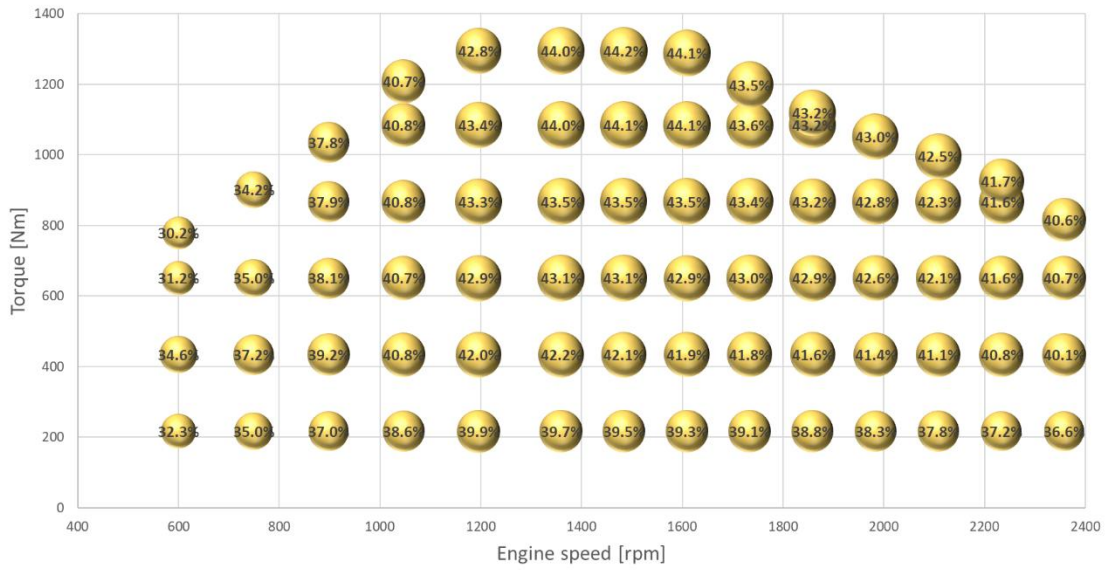
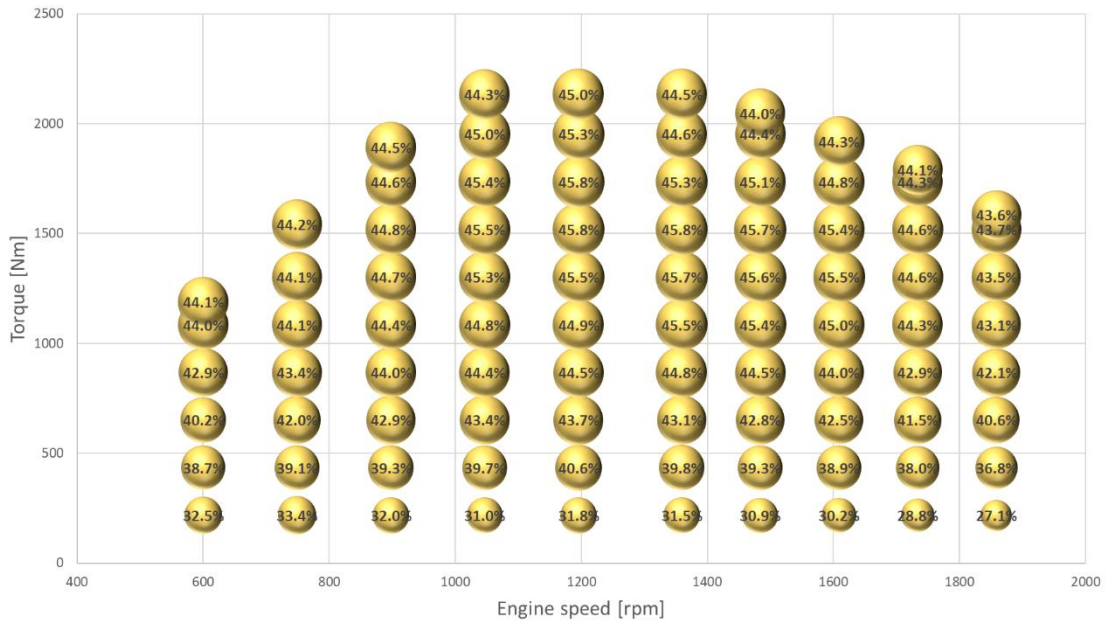

Figure 4: Efficiency map of 2016 CI engine for group 5



For CI engines of model year 2025 a reduction of fuel consumption of 3% in the entire engine map compared to the 2016 engine generation has been assumed. The resulting engine efficiencies are given in Figure 5 and Figure 6.

Figure 5: Efficiency map of 2025 CI engine for group 4

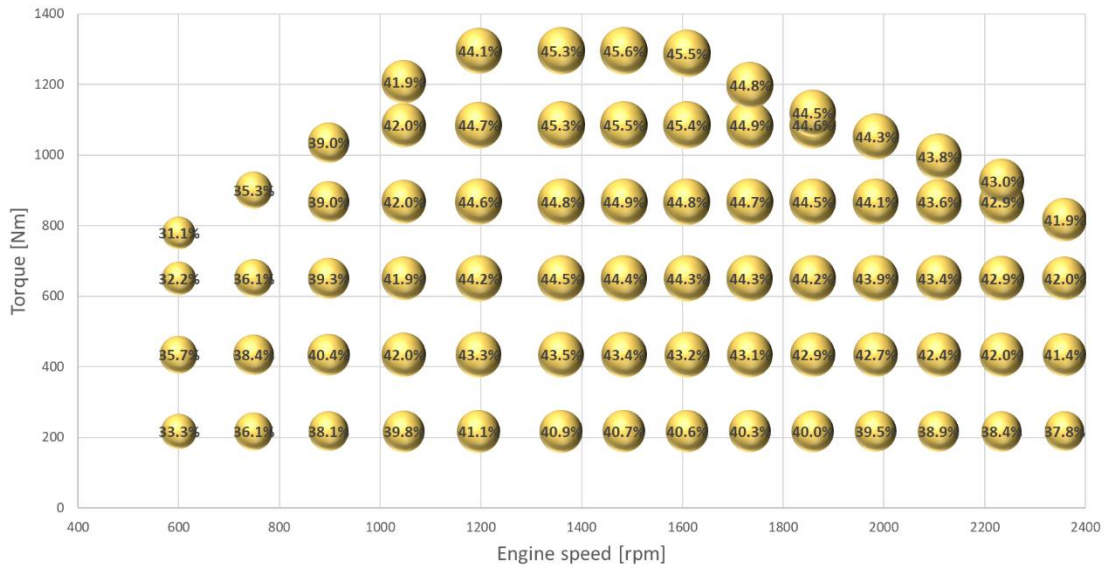
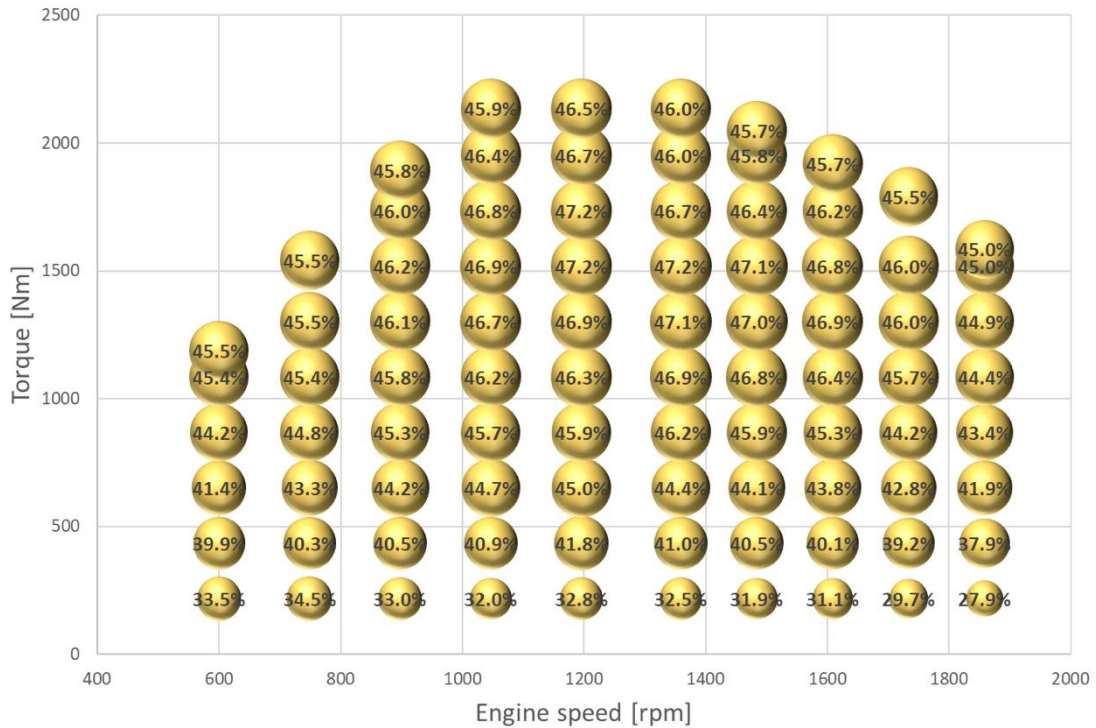

Figure 6: Efficiency map of 2025 CI engine for group 5



For CI engines running on other fuels than market blend B7 Diesel no specific adaptations of the engine applications like e.g. for B100 Biodiesel have been assumed. Hence in the simulations for these alternative fuels similar engine efficiencies and full-load characteristics have been applied. Dual fuel high pressure direct ignition (HPDI) engines have been simulated with a separate set of engine data. This technology is described in more detail in chapter 4.3.1.3.

4.3.1.2 Engine data for positive ignition (PI) engines

Figure 7 gives the efficiency maps and the full-load characteristics for the positive ignition (PI) engines of model year 2016. PI engines are a niche product in the HDV sector and no detailed analysis of engine efficiencies depending on engine capacity could be made based on the data available. For this reason, the same engine efficiencies were assumed for all PI engines independent of displacement and tank system (CNG, LNG). For the smaller engine installed in the group 4 vehicle only the lower torque range of the maps has been used as indicated in Figure 7 and Figure 8.

Figure 7: Efficiency maps for 2016 PI engines in group 5 (full map) and in group 4 (lower torque range)

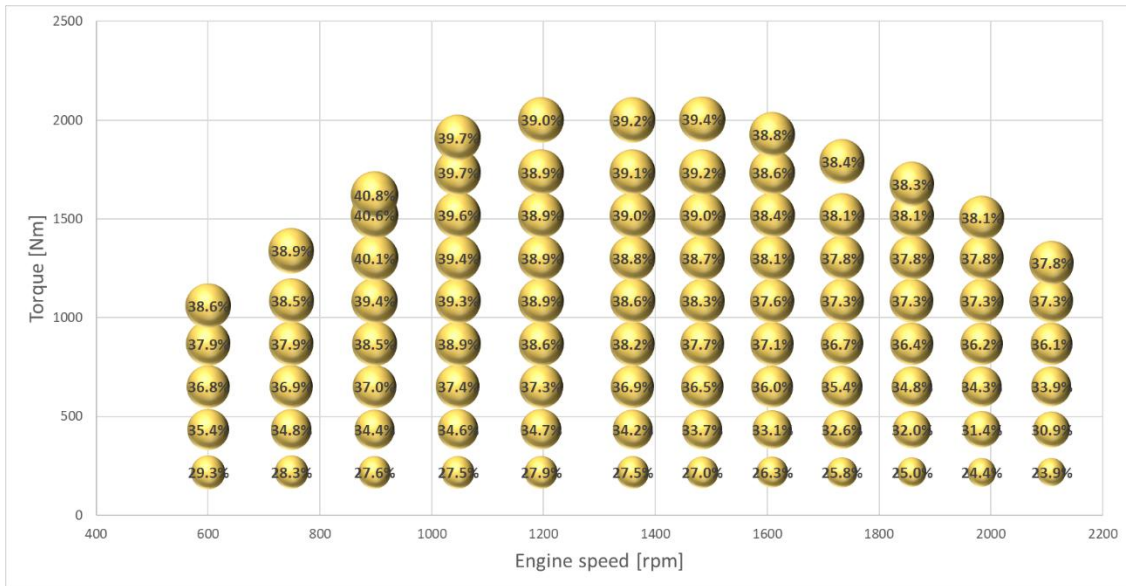

Similar to CI engines also for PI engines a reduction of fuel consumption of 3% for 2025 vs. 2016 engine generation was estimated (Figure 8).

Figure 8: Efficiency maps for 2025 PI engines in group 5 (full map) and in group 4 (lower torque range)

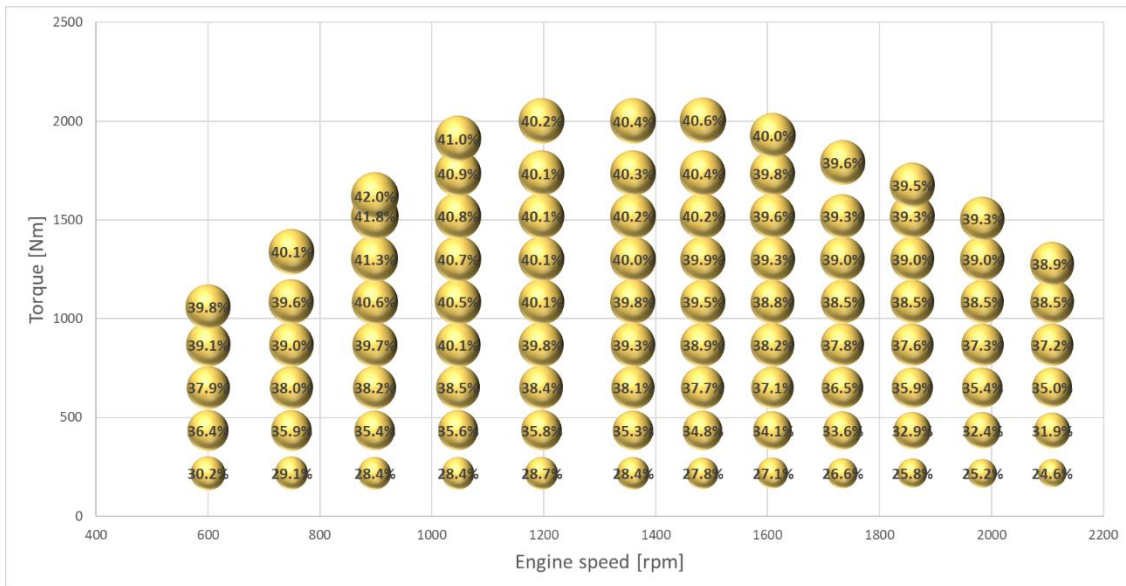

4.3.1.3 Engine data for dual fuel LNG–Diesel (HPDI)

Similar to a Diesel engine, a dual fuel LNG–Diesel (HPDI) engine uses the CI combustion principle and can hence combine the compared to a PI combustion higher efficiencies of the Diesel combustion process with the lower C/H-ratio of natural gas fuel.

In dual fuel HPDI engines the intake charge is a mixture of air and recirculated exhaust gases. Before end of the compression stroke Diesel is injected to initiate the combustion, followed by a high-pressure natural gas injection and a diffusion combustion of the cylinder charge. The injection of Diesel and NG fuel is done by a twin fuel injector and controlled by the engine control unit (ECU).

HPDI engines are able to deliver the same torque and power as conventional diesel engines [Magnusson, 2012]. Therefore, similar full load characteristics as for CI engines have been considered in this study. A relevant parameter for the assessment of the CO₂ emissions of this technology is the energy ratio between NG charge and Diesel injection. Figure 9 shows illustrative for the group 5 vehicle the energy content of the Diesel injection as a function of load, by a constant pilot quantity of 1700 g/h (with exception of the idling point).

Figure 9: Share of Diesel injection on overall fuel energy (Dual fuel HPDI, group 5 vehicle)

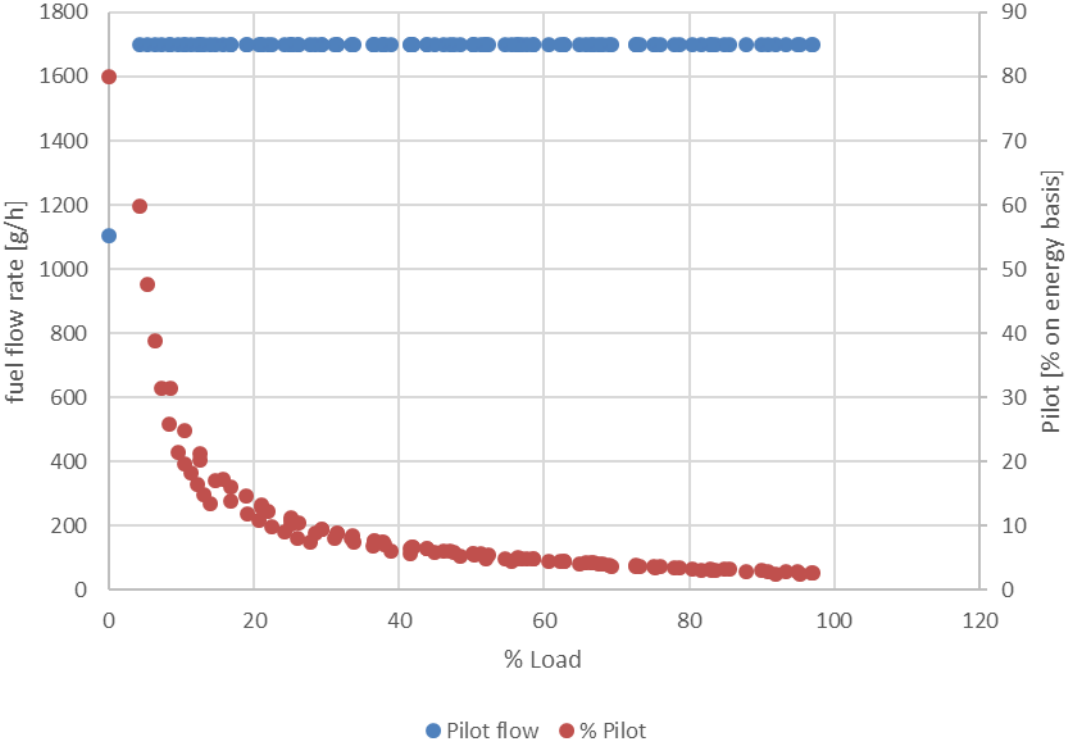
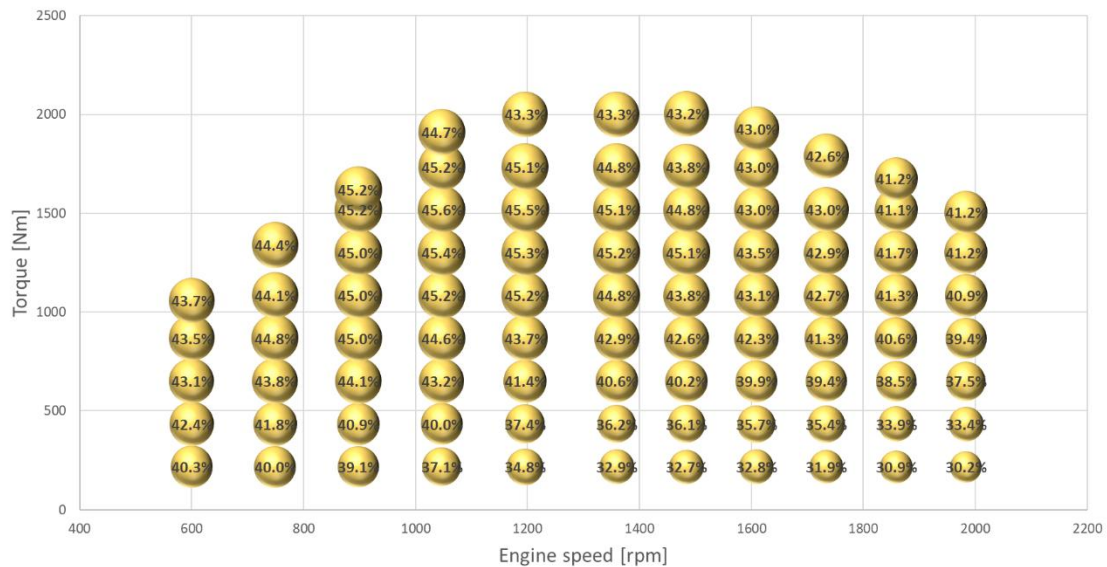

Figure 10 gives the resulting engine efficiencies for the model year 2016 dual fuel LNG–Diesel (HPDI) engine. This results in a peak engine efficiency of 45.5%.

Figure 10: Efficiency map and full-load characteristics of 2016 dual fuel HPDI engines in group 5



For the HPDI engine map of the group 4 vehicle the same values for engine efficiencies have been applied as no separate set of efficiency data for smaller HPDI engines was available. Also the ratio of Diesel to NG fuel have been taken over from the group 5 vehicle.

4.3.1.4 Fuel tank systems of ICE only configurations

In the simulations ICE CI and ICE PI configurations of the long-haul truck have been considered with two 500 litres aluminium fuel tanks for 2016 as well as for the 2025 model year. The fuel tank system of the rigid truck consists of one steel tank with a capacity of 500 litres, as common in this vehicle segment. Also in this case, no changes in tank system for 2025 are expected.

The fuel tank capacities of the CNG vehicles have been derived from the operating range of vehicles available on the market. To reach an operation range of approximately 500 kilometres the internal tank volume of the group 4 vehicle has been defined with 650 litres and of the group 5 vehicle with 900 litres. Used CNG tanks comply to CNG-3 of ECE R110, stainless steel metal liners reinforced with resin impregnated continuous filament (fully wrapped). Such tanks have a mass to volume ration of 0.75 kg/l [Getzlaff, 2012]. The operating pressure of the CNG tanks is at 200 bar.

Liquefied storage of natural gas allows an increase of the operating range compared to CNG. This however requires double walled, super isolated tanks to ensure storage at -150°C and a system pressure of 3 bar. The mass of LNG tanks is calculated with a tank to volume ratio of 0.58 kg/l derived from [Westport, 2013]. LNG PI group 4 vehicles are equipped with a 500 litres cryogenic tank and the group 5 vehicles with two 500 litres internal tank volume.

LNG-HPDI trucks were defined according to [Lastauto Omnibus, 2018] to have a 500 litres LNG tank and a Diesel tank with a capacity of 170 litres, independent of the vehicle group.

4.3.1.5 Vehicle masses of ICE only configurations

Table 11 and Table 12 give an overview about the vehicle curb masses of ICE only configurations for the model year 2016. The ICE mass refers to the engine inclusive operating equipment but without cooling system, which is listed separately. Exhaust systems include the exhaust aftertreatment system as well as the piping. Components of the aftertreatment system are the oxidation catalyst, particle filter and the SCR-catalyst for CI engines, exhaust aftertreatment of positive ignition NG engines is done by a three way catalyst. Curb mass of body or trailer refers to generic data as defined in the VECTO¹² “declaration mode”.

Reference for the determination of vehicle masses was the curb weight of the configuration ICE CI fuelled with B7 Diesel, which is 5800 kg for group 4 and 7550 kg for the group 5 vehicle. Mass changes for other fuels combusted in an ICE CI engine only depend on the difference of density of respective fuel to B7 diesel

¹² VECTO stands for Vehicle Energy Consumption calculation Tool. Chapter 0 provides a description of “VECTO”.

as the same mass of remaining components like ICE, exhaust system and tank system has been assumed. According to [Lastauto Omnibus, 2018], LNG-HPDI long haul trucks have an additional weight of 106 kg with given tank specifications compared to a conventional diesel truck. Regarding to the mass balance of the LNG-HPDI rigid truck, differences of tank capacity and fuel masses have been taken into account

For 2025 ICE only configurations a weight reduction of 200 kg is expected as already mentioned in section 3.2. Masses changes of individual components have not been considered, an exact allocation would not have impacted the results of this study.

Table 11: Vehicle masses of group 4 vehicles model year 2016

Mass balance group 4 2016											
		B7	B0	B100	Paraffinic Diesel	ED95	DME	OME	CNG	LNG-PI	LNG-HPDI
Fuel tank capacity	l	500	500	500	500	500	500	500	650	500	500 (LNG) + 170 (Diesel)
Adblue tank capacity	l	50	50	50	50	50	50	50	0	0	65
Adblue mass	kg	55	55	55	55	55	55	55	0	0	71
Fuel mass (90% filled)	kg	376	374	401	351	369	302	480	98	182	324
ICE mass	kg	680	680	680	680	680	680	680	680	680	---
Coolingsystem	kg	80	80	80	80	80	80	80	80	80	80
Exhaustsystem incl. Aftertreatment	kg	166	166	166	166	166	166	166	151	151	166
Transmission mass incl. Intarder	kg	263	263	263	263	263	263	263	263	263	263
Drive shaft	kg	70	70	70	70	70	70	70	70	70	70
Powertrain mass change	kg	Reference	0	0	0	0	0	0	0	0	0
Tank system mass change	kg	Reference	0	0	0	0	0	0	368	170	524
Fuel mass change	kg	Reference	-2	24	-25	-3	-75	104	-278	-194	
Adblue + Denox system	kg	Reference	0	0	0	0	0	0	-75	-75	
actual curb mass (90% Fuel + driver)	kg	5800	5798	5824	5775	5797	5725	5904	5814	5701	6324
Corrected actual curb mass (50% Fuel + driver)*	kg	5633	5632	5646	5619	5633	5591	5690	5771	5620	6152
Curb mass body	kg	2100	2100	2100	2100	2100	2100	2100	2100	2100	2100

* This definition refers to "corrected actual mass" of the base vehicle according to point 4 of Annex III of Regulation (EU) 2017/2400.

Table 12: Vehicle masses of group 5 vehicles model year 2016

Mass balance group 5 2016											
		B7	B0	B100	Paraffinic Diesel	ED95	DME	OME	CNG	LNG-PI	LNG-HPDI
Fuel tank capacity	l	1000	1000	1000	1000	1000	1000	1000	900	1000	500 (LNG) + 170 (Diesel)
Adblue tank capacity	l	100	100	100	100	100	100	100	0	0	65
Abblue mass	kg	109	109	109	109	109	109	109	0	0	71
Fuel mass (90% filled)	kg	752	749	801	702	738	603	960	136	365	324
ICE mass	kg	1160	1160	1160	1160	1160	1160	1160	1160	1160	---
Coolingsystem	kg	100	100	100	100	100	100	100	100	100	100
Exhaustaftertreatment system	kg	261	261	261	261	261	261	261	236	236	261
Transmission mass incl. Intarder	kg	411	411	411	411	411	411	411	411	411	411
Drive shaft	kg	80	80	80	80	80	80	80	80	80	80
Powertrain mass change	kg	Reference	0	0	0	0	0	0	0	0	0
Tank system mass change	kg	Reference	0	0	0	0	0	0	555	460	106
Fuel mass change	kg	Reference	-4	49	-50	-5	-149	207	-616	-388	
Adblue + Denox system	kg	Reference	0	0	0	0	0	0	-130	-130	
actual curb mass (90% Fuel + driver)	kg	7550	7546	7599	7500	7545	7401	7757	7359	7492	7656
Corrected actual curb mass (50% Fuel + driver)*	kg	7216	7214	7243	7188	7217	7133	7331	7298	7330	7484
Curb mass trailer	kg	7500	7500	7500	7500	7500	7500	7500	7500	7500	7500

* This definition refers to "corrected actual mass" of the base vehicle according to point 4 of Annex III of Regulation (EU) 2017/2400.

4.3.2 xEV configurations

The power of xEV propulsion systems is delivered either by a combination of electric motor and ICE or by an electric motor only. Following xEV propulsion systems are considered in this study:

- Hybrid electric vehicle (HEV)
- Battery electric vehicle (BEV)
- Catenary electric vehicle (CEV)
- Hydrogen/Fuel cell electric vehicle (FCEV)

Table 13 gives an overview on the main specifications of powertrain for the xEV configurations of model year 2016. HEV have been configured with an ICE of similar rated power than the conventional vehicle and a rated

power of the electric motor of 80 kW (group 4 vehicle) and 140 kW (group 5 vehicle). Fully electrified xEV trucks were dimensioned with an electric engine of similar rated power than the conventional vehicle. The determination of the battery capacities for BEV of group 4 relates to an operating range of approximately 350 km based on a literature study of current electric distribution trucks [Eforce, 2018] [Daimler, 2018]. For vehicle group 5, the same target regarding the operating range was assumed as a larger range - which would be useful for long haul operation in general - would result in an unreasonable restriction in payload capacity. Further details on vehicle configurations are explained later in this report.

Table 13: Vehicle specifications of xEV configurations for model year 2016

Vehicle group	Propulsion system ID	Fuel	Engine power ICE [kW]	Transmission type	Operating range [km]	Output power e-Motor [kW]	Battery pack capacity [kWh]	SOC range	Specific energy density battery system [Wh/kg]	Rated speed [rpm]
4	ICE CI + HEV	B7	220	AMT 12	1468	80	3	0.3-0.7 SOC	80	2200*
5	ICE CI + HEV	B7	325	AMT 12	1816	140	10	0.3-0.7 SOC	80	1800*
4	ICE PI + HEV	CNG	220	AMT 12	591	80	3	0.3-0.7 SOC	80	1900*
5	ICE PI + HEV	LNG	325	AMT 12	798	140	10	0.3-0.7 SOC	80	1900*
4	BEV	el. grid	---	AMT 2	367	220	570	0.2-0.8 SOC	110	1400-5000
5	BEV	el. grid	---	AMT 2	371	325	840	0.2-0.8 SOC	110	1400-5000
4	CEV	el. road	---	AMT 2	70**	220	100	0.2-0.8 SOC	110	1400-5000
5	CEV	el. road	---	AMT 2	66**	325	150	0.2-0.8 SOC	110	1400-5000
4	FCEV	H2	---	AMT 2	608	220	10	0.3-0.7 SOC	80	1400-5000
5	FCEV	H2	---	AMT 2	614	325	20	0.3-0.7 SOC	80	1400-5000

* The rated speed of HEV relates to the ICE
** Operating range in battery mode

Main changes of the vehicles specifications for 2025 xEV models (Table 14) compared to the 2016 data are lower specific energy densities of the battery system and an extended usable SOC range which leads to lower required storage capacity of the installed battery on the basis of a similar operating range as for 2016.

Table 14: Vehicle specifications of xEV configurations for 2025

Vehicle group	Propulsion system ID	Fuel	Engine power ICE [kW]	Transmission type	Operating range [km]	Output power e-Motor [kW]	Battery pack capacity [kWh]	SOC range	Specific energy density battery system [Wh/kg]	Rated speed [rpm]
4	ICE CI + HEV	B7	220	AMT 12	1599	80	3	0.3-0.7 SOC	142.5	2200*
5	ICE CI + HEV	B7	325	AMT 12	2042	140	10	0.3-0.7 SOC	142.5	1800*
4	ICE PI + HEV	CNG	220	AMT 12	651	80	3	0.3-0.7 SOC	142.5	1900*
5	ICE PI + HEV	LNG	325	AMT 12	990	140	10	0.3-0.7 SOC	142.5	1900*
4	BEV	el. grid	---	AMT 3	370	220	420	0.2-0.9 SOC	160.4	1400-5000
5	BEV	el. grid	---	AMT 3	382	325	616	0.2-0.9 SOC	160.4	1400-5000
4	CEV	el. road	---	AMT 3	58**	220	65	0.2-0.9 SOC	160.4	1400-5000
5	CEV	el. road	---	AMT 3	65**	325	105	0.2-0.9 SOC	160.4	1400-5000
4	FCEV	H2	---	AMT 3	700	220	10	0.3-0.7 SOC	142.5	1400-5000
5	FCEV	H2	---	AMT 3	746	325	20	0.3-0.7 SOC	142.5	1400-5000

* The rated speed of HEV relates to the ICE
** Operating range in battery mode

In the following sections the assumed made and the data used for simulation of xEV are described in more detail.

4.3.2.1 Electric motor

As traction motor for xEV configurations a permanent magnet synchronous motor (PMSM) was selected. This motor type is characterised by relative low weight and volume and higher efficiencies compared to other electric machines. For all considered xEV configurations a direct-current system has been considered as storage system or energy source respectively. As a consequence an inverter is necessary to convert the direct current into alternating current to feed the PMSM. Figure 11 gives the combined efficiency for the PMSM and the inverter for the group 5 vehicle. In order to use the efficiency map for different engine sizes following

approach has been done. The power of the basis map (Figure 11) was first normalized by the rated power (Equation 1) then denormalized with the rated Power of the chosen engine. The engine speed range remains the same.

$$P_{norm} = \frac{P}{P_{rated}} \quad \text{Equation 1}$$

Figure 11: Efficiency map for PMSM electric motor incl. inverter

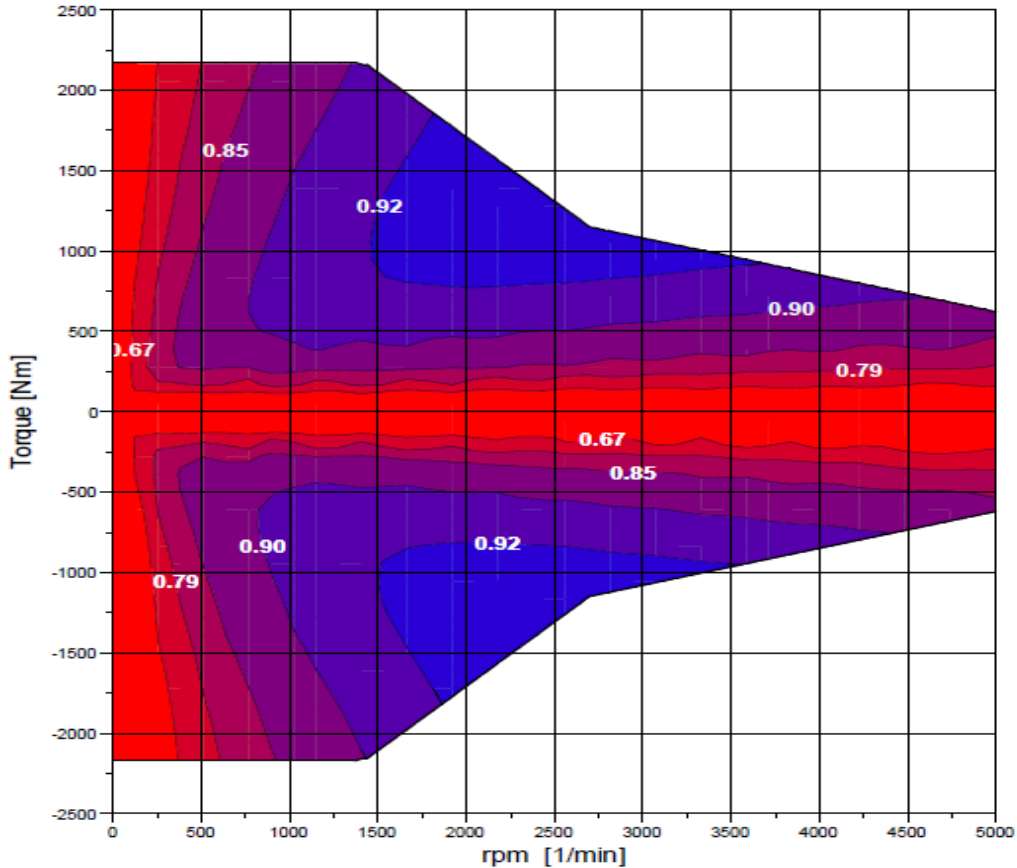

In the simulations a similar performance of electric motors for both model years 2016 and 2025 was assumed. Any improvement in technology was estimated to be rather be used for cost optimisation than for further improvements of efficiencies.

4.3.2.2 Battery systems and converter efficiencies

Batteries were assumed to be based on Li-NMC¹³ technology and designed for an operating voltage of 700 V. The nominal voltage on cell level is at 3.7 V. and the internal resistance at 1.39 mOhm per cell [Brusa, 2018]. The applied energy densities depend on the individual propulsion system. BEVs and CEVs are equipped with energy optimised battery systems with a specific energy density of 110 Wh/kg, battery systems of HEV and FCEV propulsion systems are rather power optimised, hence the specific energy density is with 80 Wh/kg lower for these configurations [Thielmann, 2015]. Before mentioned specific energy densities relate to vehicles of model year 2016.

For model year 2025 batteries, an increase of the specific energy density is expected. The assessment of future energy densities was taken over from the actual work in EUCAR on a parallel study on TTW emissions from passenger cars. The derived figures are at 160 Wh/kg for BEVs and CEVs and at 142.5 Wh/kg for HEVs and FCEVs.

¹³ The cathode material consist of Lithium Nickel Manganese Cobalt Oxide

CEVs and FCEVs needs a DC/DC converter to transfer electric power between different voltage levels. In the simulations the DC/DC converter was modelled with a constant efficiency of 98%.

4.3.2.3 Drivetrain configurations

With exception of HEV – which were configured with a similar transmission axle configuration than the conventional vehicle - electrified vehicles of model year 2016 have been modelled with a two speed transmission for 2016. Table 2 gives the according overall drivetrain ratios. For the model year 2025 vehicles it is assumed that the three gear transmission is applied.

Table 15: Overall drivetrain ratios of BEV, CEV and FCEV

vehicle group	model year	Gear		
		ratio 1st gear	ratio 2nd gear	ratio 3rd gear
4	2016	8.43	2.775	---
5	2016	11.1	2.775	---
4	2025	14.93	4.83	2.02
5	2025	17.5	6.49	2.48

4.3.2.4 Hybrid electric vehicles (HEV)

This study covers HEVs with ICE CI engines fuelled with B7 diesel as well as ICE PI engines. For the latter engine concept the group 4 vehicle is configured with a CNG tanks system and the long haul truck (group 5) - due to the higher driving range - with an LNG tank system. All considered HEVs have a parallel hybrid drivetrain layout. In this HEV topology both the ICE and the electric motor are connected to the drive shaft of the vehicle (see Figure 12). In the configuration simulated in this study the electric engine is located between ICE clutch and transmission. For components of ICE, transmission and axle identical specifications to the conventional vehicle are used.

Figure 12: Topology of parallel hybrid electric vehicles

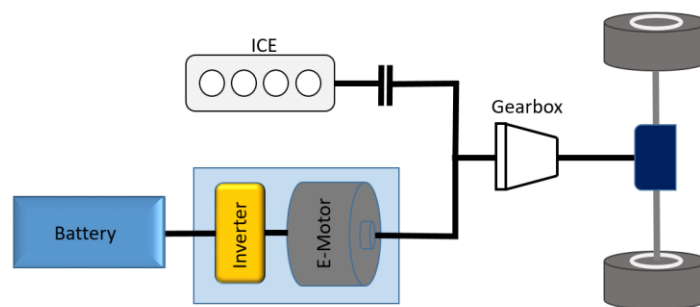

Dimensioning of e-motor size (nominal power) and battery capacity is a crucial part of HEV design. Decision criteria for an optimum configuration are overall vehicle efficiency, component lifetime and costs. The lifetime factor is considered by state of charge (SOC) window to be used as battery operating range. This range was defined the between 0.3 and 0.7 SOC. Furthermore the achievable fuel savings compared to a conventional powertrain depend on combination of driving cycle and payload conditions. In order to determine the optimum HEV layouts for the typical HDV as analysed in this study an parameter study has been performed by varying nominal power of the e-motor between 20 and 140 kW and the battery capacities from 1 to 20 kWh.

Figure 13 shows the CO₂ reduction potential of different HEV-CI propulsion configurations of the group 5 vehicle simulated in the long haul mission profile and for the weighted payload mix (see chapter 5.5). All battery capacities from 10 to 20 kWh were found to give nearly the same reduction potential. Increasing the

electric motor size above 140 kW gives only small benefits on the disadvantage of increased system costs. The same analysis has been performed for the group 4 rigid truck based on the regional delivery cycle. Based on the results the following specifications for xEV components have been chosen:

- 80 kW electric engine and a battery capacity of 3 kWh for the group 4 rigid truck
- 140 kW electric engine and a battery capacity of 10 kWh for the group 5 long haul truck

Figure 13: CO₂ reduction potential of different HEV-CI propulsion configurations (group 5)

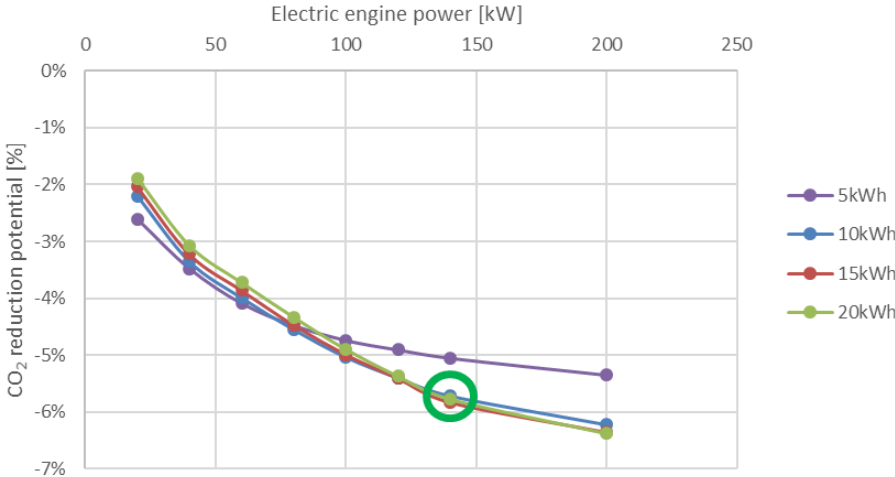

4.3.2.5 Battery electric vehicles (BEV)

Battery electric vehicles are characterised by a purely electric propulsion system with battery as energy storage .

Figure 14: Topology of battery electric vehicles (BEV)

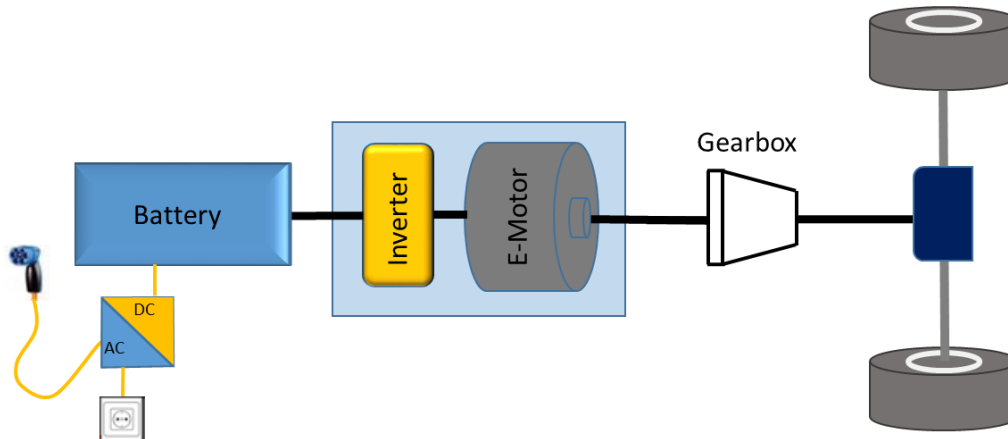

Due to the significantly lower specific energy density of batteries compared to conventional fuels BEVs are characterised by a lower operating range as well as a higher curb weight than conventional vehicles. For the BEVs analysed in this study an operating range of 350 km has been chosen based on a literature study of current electric distribution trucks [Eforce, 2018] [Daimler, 2018]. For vehicle group 5, the same target regarding the operating range was assumed as a larger range - which would be useful for long haul operation in general - would result in an unreasonable restriction in payload capacity. As usable SOC limits the range between 0.2 and 0.8 for model year 2016 and between 0.2 and 0.9 for model year 2025 was defined. This results in the installed battery capacities as shown in Table 16.

Table 16: BEV battery capacities

Vehicle group	Model year	Battery pack capacity [kWh]
4	2016	570
5	2016	840
4	2025	420
5	2025	616

Due to the additional weight of the batteries the maximum payload of BEVs is lower than for a conventional vehicle. The impact of this effect on the average payload conditions is described in section 5.5.

Charging losses from grid into the battery have been included in the TTW energy analysis performed in this study. As balancing point was the interface between the grid and the charging station defined. Battery charging losses depend on the position of the AC/DC converter and thus on the charging type. For low power charging up to 50 kW (AC charging) the converter is positioned on the vehicle, but for high power charging (fast charging or DC charging) the converter is position inside the charging station. For HDV of group 4 and 5 it is assumed that mainly DC charging is relevant. To assess the charging losses, a distinction was made between losses in the vehicle (internal resistance of the battery and battery cooling) and losses in the charging station (AC/DC converter and cooling of the charging station). The losses for high power charging in the vehicle have been assessed with 7% [Faltenbacher, 2016]. Charging station losses were assumed with 7% as well. Table 17 shows the allocation of the charging losses and the resulting average charging efficiencies. Given shares for depot or public charging are based on the assumption that group 4 vehicles will manage

most of its daily missions with overnight charging, while a group 5 vehicle will need one fast charging per day most days.

Table 17: BEV charging efficiencies

Charging losses on vehicle	Charging losses on charging station	Approximation of average efficiency
7%	7%	86.5% efficiency

4.3.2.6 Catenary electric vehicles (CEV)

Catenary electric vehicles use overhead lines (catenary) or conductive tracks for supply with electric energy. Under the boundary conditions of availability of the required infrastructure, this propulsion systems provides all advantages of fully electric propulsion without the limitations on operating range, lower maximum payloads and high costs for battery systems as inherent to BEVs.

A pantograph takes over the electrical power from overhead line to the vehicle. According to [Wietschel, 2017] conduction losses of 2% are applied for the pantograph in the simulation. Considered overhead lines were assumed to have a constant operating voltage of 700 V direct current. CEV allow for recuperative braking where the energy is charged back into the grid or into the battery, depending on the SOC. A battery is used to operate on street sections without a catenary line, i.e. access roads to and from the highway exits and also sharp curves on the highway. Figure 15 shows the topology of for catenary electric vehicles as simulated in this study.

Figure 15: Topology of catenary electric vehicle (CEV)

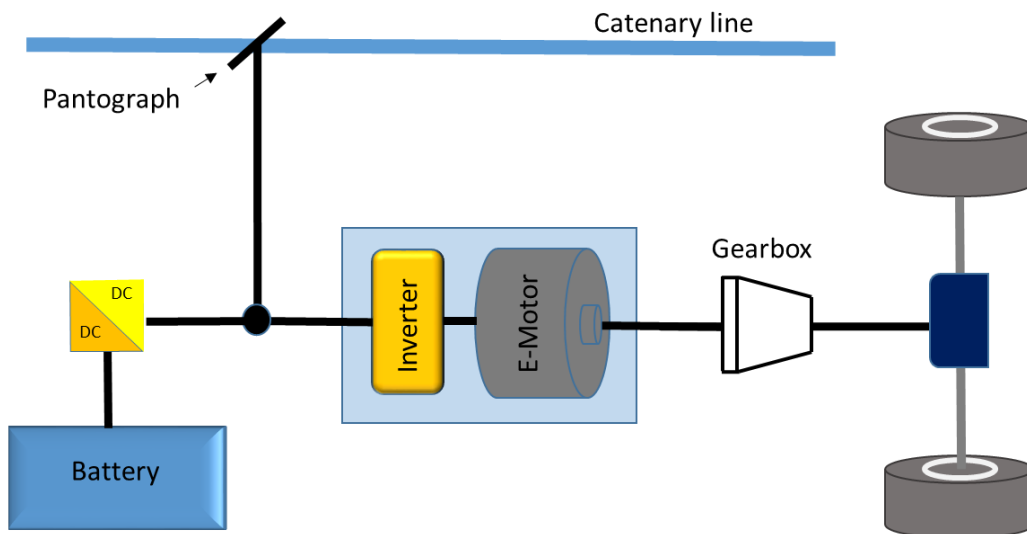

In both 2016 and 2025 a driving range in battery mode of about 60 km was assumed in this study. A lower battery capacity would require a dense network of overhead lines, which is not realistic for the 2025 time horizon. Installed battery capacities are given in Table 18. The reduction of battery capacities for 2025 results from the lower energy consumption of the 2025 models, a larger SOC range and small design-related differences in operating range. In the simulations, it was assumed that 25% of the considered cycle is not electrified and driven in battery mode, this means that 25 % of the required propulsion energy is taken from the battery. Recharging of the battery was considered via charging from the overhead line. Due to the DC/DC converter arranged between the overhead line and the battery, additional losses in the amount of 2% occur.

Table 18: Installed battery capacity of CEVs

Vehicle group	Model year	Battery pack capacity [kWh]
4	2016	100
5	2016	150
4	2025	65
5	2025	105

4.3.2.7 Fuel cell electric vehicles (FCEV)

Fuel cell electric vehicles use hydrogen as energy carrier and a fuel cell as energy converter to provide the electrical energy for propulsion. A battery serves as buffer to cover peaks in propulsion energy demands, to reduce the dynamics on the fuel cell to increase its lifetime and for recuperation of brake energy. These functions result in battery capacity demands as shown in Table 19, which are higher compared to HEV application. The operating range of the batteries was assumed with an SOC window from 0.3 to 0.7 equal to HEVs. The layout of FCEV is shown in Figure 16. The DC/DC converter is positioned on the battery side, which results in optimised losses, since less energy flow from battery than from fuel cell to the e-motor. The losses for the DC/DC converter were assumed with 2%, as in the case for the CEV.

Figure 16: Topology FCEV

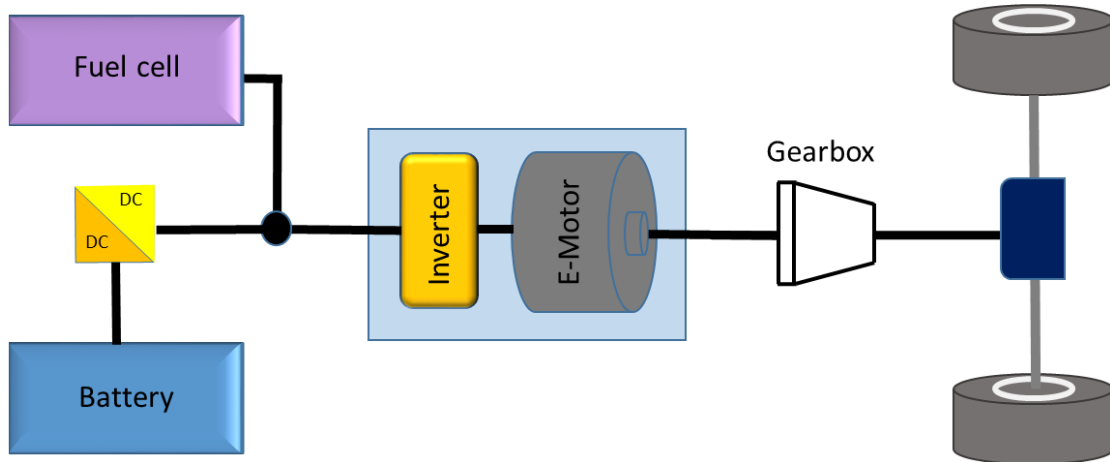

Table 19: Installed battery capacity for FCEV

Vehicle group	Model year	Battery pack capacity [kWh]
4	2016	10
5	2016	20
4	2025	10
5	2025	20

In the simulations the efficiency of the fuel cell has been characterised by an efficiency line as a function of percentage of nominal output power of the system. Figure 17 gives the data used in this study for both model years. Losses of fuel cell auxiliaries such as compressor, cooling pump losses etc. are already included in the

efficiency lines. The data for model year 2016 refer to the actual work in EUCAR on a parallel study on TTW emissions from passenger cars. For model year 2025 efficiencies are assumed to be increased by some 5%. Since future systems will have better catalysts to reduce the voltage drops additionally, the system auxiliaries could be further optimised for the usage in fuel cell vehicles.

Figure 17: Efficiency fuel cell systems for 2016 and 2025

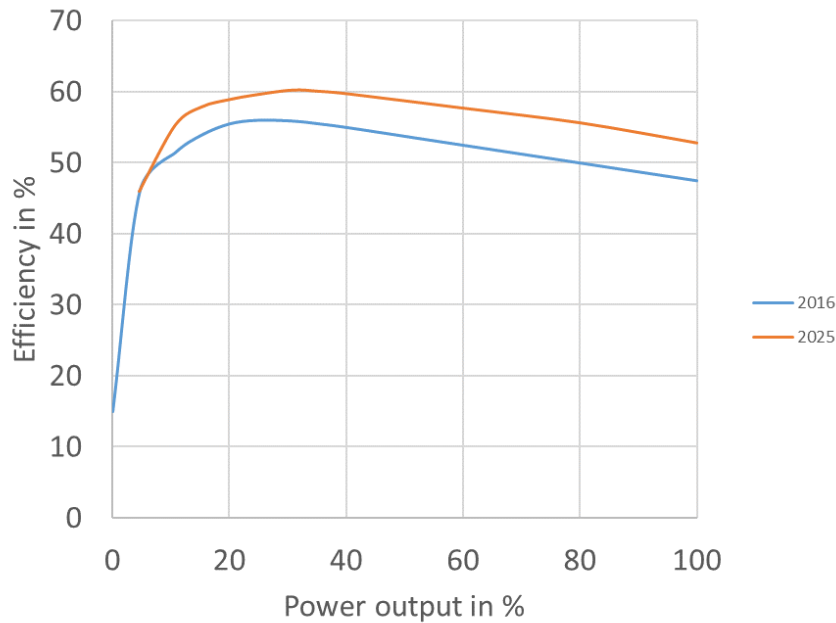

4.3.2.8 Overview electric losses of xEV configurations

This section summarises the modelling of electric losses for the considered xEV.

Electrical losses of BEVs

Table 20 gives an overview of the electrical loss mechanisms considered for BEV during normal vehicle operation as well as for the charging process.

Table 20: Overview electric losses for BEV (EM ... Electric motor)

Electric loss mechanism	Vehicle operation	Charging
Battery - internal resistance	relevant (PHEM battery model, 1.39 mΩ per cell)	relevant (lump sum in-vehicle charging losses assumed with 7%)
Battery - cooling	not considered*	
Inverter between battery and electric motor	relevant (included in EM efficiency map, see section 4.3.2.1)	not relevant
Electric motor - internal resistance		not relevant
Electric motor - cooling		not relevant
Charging station – AC/DC converter	not relevant	relevant (lump sum external charging losses assumed with 7%)
Charging station – cooling	not relevant	

* Energy consumption of battery cooling systems during vehicle driving have not been considered in this study as no specific data was available and the impact was assessed to be minor compared to other types of losses

Electrical losses of HEVs

For HEVs only the losses according to Table 20 during vehicle operation are relevant. Charging of the battery at an external source is not possible.

Electrical losses of CEVs

Based on the assumption that CEVs are only charged at the overhead line the following electrical losses have been considered:

- Losses in the electric motor according to Table 20
- Pantograph losses in the amount of 2%
- Battery losses during vehicle operation according to Table 20
- Losses for the DC/DC converter between battery and electric motor (2%)

Battery operation is only considered by a simplified assessment as BEV (see section 4.3.2.6), trip characteristics not defined explicitly.

Electrical losses for FCEV:

Additionally to the losses during vehicle operation listed in Table 20 losses in the DC/DC converter between battery and electric motor or fuel cell occur.

4.3.2.9 Fuel tank systems of xEV configurations

HEV with CI engine were configured with an internal tank volume of 300 litres for the group 4 vehicle and 500 litres tank volume for the group 5 vehicle. These tank volumes are significantly smaller than for the CI vehicle with conventional drivetrain (500 litres for group 4, 1000 litres for group 5). For hybrids with ICE-PI engines the same tank capacity as for the ICE-PI conventional variants was assumed (see 4.3.1.5), due to the lower operating range of NG vehicles compared to Diesel vehicles.

FCEVs considered in this study are equipped with a tank system for compressed hydrogen with a pressure of 700 bar, relating to the available infrastructure of current hydrogen service stations. The tank capacity for 2016 vehicle models has been assessed with an internal volume of 700 litres on basis of the driving range of comparable NG vehicles. The mass of the hydrogen tank system was determined using a mass to volume ratio of 0.5 kg per litre internal tank volume.

Fuel tank systems for model year 2025 vehicles were configured similar to 2016 systems.

4.3.2.10 Vehicle masses xEV configurations

Masses of xEV propulsion systems have been determined by a mass balance calculation compared to the B7 Diesel vehicles as reference (see section 4.3.1.5) considering the components tank system (incl. fuel), powertrain, exhaust system, fuel cell and electric components. For CEVs furthermore an increased chassis mass was assumed, due to the need of a reinforced roof for the pantograph. Table 21 to Table 24 list the mass balance of xEV propulsion systems for both considered vehicle groups and the model years 2016 as 2025.

Table 21: Mass balance xEV group 4 vehicles model year 2016

Mass balance xEV group 4 2016						
		BEV	HEV Diesel	HEV Otto	EV	FCEV
Curb weight reference vehicle		5800 kg (B7)	5800 kg (B7)	5942 kg (CNG)	5800 kg (B7)	5800 kg (B7)
Tank system						
Fuel tank capacity	[l]	0	300	650	0	700
Tank mass change	[kg]	-120	-15	0	-120	380
Fuel mass change	[kg]	-376	-150	0	-376	-349
<i>Mass change of tank system</i>	[kg]	-496	-165	0	-496	31
Exhaust system						
Adblue tank capacity	[l]	0	50	0	0	0
Adblue tank mass change	[kg]	-10	-10	0	-10	-10
Adblue mass change	[kg]	-54.5	-27	0	-54.5	-54.5
Mass change exhaust aftertreatment system	[kg]	-166	0	0	-166	-166
<i>Mass change exhaust system</i>	[kg]	-230	-37	0	-230	-230
Powertrain						
ICE mass	[kg]	0	680	680	0	0
Coolingsystem ¹	[kg]	80	80	80	80	80
Transmission mass	[kg]	50	263	263	50	50
Drive shaft	[kg]	0	70	70	0	0
<i>Powertrain mass change</i>	[kg]	-963	0	0	-963	-963
Fuel cell						
<i>Fuel cell system mass²</i>	[kg]	0	0	0	0	512
E-Components						
Electric motor	[kg]	76	52	52	76	76
Battery	[kg]	5182	38	38	909	125
Battery cooling + wiring	[kg]	98	20	20	85	20
DC/DC controller ³	[kg]	40	40	40	40	40
Inverter ⁴	[kg]	75	75	75	75	75
Pantograph mass	[kg]	0	0	0	300	0
<i>E-Components mass change</i>	[kg]	5470	224	224	1485	336
<i>Additional chassis mass (reinforced roof)</i>	[kg]	0	0	0	300	0
actual curb mass (90% Fuel + driver)	[kg]	9581	5821	6166	5896	5485
corrected actual curb mass (50% Fuel + driver)⁵	[kg]	9581	5696	6112	5896	5472
Curb mass body	[kg]	2100	2100	2100	2100	2100
1) Same coolingsystem mass is assumed for e-motor and ICE 2) Does not include the mass of the DC/DC converter 3) High voltage + low voltage converter 4) Includes also the inverter for charging with AC 5) This definition refers to "corrected actual mass" of the base vehicle according to point 4 of Annex III of Regulation (EU) 2017/2400						

Table 22: Mass balance xEV group 5 vehicles model year 2016

Mass balance xEV group 5 2016						
		BEV	HEV Diesel	HEV Otto	EV	FCEV
Curb weight reference vehicle		7550 kg (B7)	7550 kg (B7)	7359 kg (LNG)	7550 kg (B7)	7550 kg (B7)
Tank system						
Fuel tank capacity	[l]	0	500	1000	0	1800
Tank mass change	[kg]	-120	-60	0	-120	680
Fuel mass change	[kg]	-752	-376	0	-752	-710
<i>Mass change of tank system</i>	[kg]	-872	-436	0	-872	-30
Exhaust system						
Adblue tank capacity	[l]	0	75	0	0	0
Adblue tank mass change	[kg]	-15	-15	0	-15	-15
Adblue mass change	[kg]	-109	-27	0	-109	-109
Mass change exhaust aftertreatment system	[kg]	-261	0	0	-261	-261
<i>Mass change exhaust system</i>	[kg]	-385	-42	0	-385	-385
Powertrain						
ICE mass	[kg]	0	1160	1160	0	0
Coolingsystem ¹	[kg]	100	100	100	100	100
Transmission mass	[kg]	85	411	411	85	85
Drive shaft	[kg]	0	80	80	0	0
<i>Powertrain mass change</i>	[kg]	-1566	0	0	-1566	-1566
Fuel cell						
<i>Fuel cell system mass²</i>	[kg]	0	0	0	0	756
E-Components						
Electric motor	[kg]	153	77	77	153	153
Battery system (housing, cooling system, etc)	[kg]	7636	125	125	1364	250
Battery cooling + wiring	[kg]	130	25	25	110	25
DC/DC controller ³	[kg]	40	40	40	40	40
Inverter ⁴	[kg]	75	75	75	75	75
Pantograph mass	[kg]	0	0	0	300	0
<i>E-Components mass change</i>	[kg]	8034	342	342	2042	543
<i>Additional chassis mass (reinforced roof)</i>	[kg]	0	0	0	300	0
actual curb mass (90% Fuel + driver)	[kg]	12761	7413	7700	7068	6867
corrected actual curb mass (50% Fuel + driver)⁵	[kg]	12761	7204	7497	7068	6846
Curb mass trailer	[kg]	7500	7500	7500	7500	7500
1) Same coolingsystem mass is assumed for e-motor and ICE 2) Does not include the mass of the DC/DC converter 3) High voltage + low voltage converter 4) Includes also the inverter for charging with AC 5) This definition refers to "corrected actual mass" of the base vehicle according to point 4 of Annex III of Regulation (EU) 2017/2400						

Table 23: Mass balance xEV group 4 vehicles model year 2025

Mass balance xEV group 4 2025						
		BEV	HEV Diesel	HEV Otto	EV	FCEV
Curb weight reference vehicle		5665 kg (B7)	5665 kg (B7)	5679 kg (CNC)	5665 kg (B7)	5665 kg (B7)
Tank system						
Fuel tank capacity	[l]	0	300	650	0	700
Tank mass change	[kg]	-120	-15	0	-120	380
Fuel mass change	[kg]	-376	-150	0	-376	-349
<i>Mass change of tank system</i>	[kg]	-496	-165	0	-496	31
Exhaust system						
Adblue tank capacity	[l]	0	50	0	0	0
Adblue tank mass change	[kg]	-10	-10	0	-10	-10
Adblue mass change	[kg]	-54.5	-27	0	-54.5	-54.5
Mass change exhaust aftertreatment system	[kg]	-166	0	0	-166	-166
<i>Mass change exhaust system</i>	[kg]	-230	-37	0	-230	-230
Powertrain						
ICE mass	[kg]	0	680	680	0	0
Coolingsystem ¹	[kg]	80	80	80	80	80
Transmission mass	[kg]	50	263	263	50	50
Drive shaft	[kg]	0	70	70	0	0
<i>Powertrain mass change</i>	[kg]	-963	0	0	-963	-963
Fuel cell						
<i>Fuel cell system mass²</i>	[kg]	0	0	0	0	512
E-Components						
Electric motor	[kg]	76	52	52	76	76
Battery	[kg]	2618	21	21	405	70
Battery cooling + wiring	[kg]	98	20	20	85	20
DC/DC controller ³	[kg]	40	40	40	40	40
Inverter ⁴	[kg]	75	75	75	75	75
Pantograph mass	[kg]	0	0	0	300	0
<i>E-Components mass change</i>	[kg]	2907	208	208	981	281
<i>Additional chassis mass (reinforced roof)</i>	[kg]	0	0	0	300	0
actual curb mass (90% Fuel + driver)	[kg]	6883	5670	5887	5257	5296
corrected actual curb mass (50% Fuel + driver)⁵	[kg]	6883	5544	5843	5257	5282
Curb mass body	[kg]	2035	2035	2035	2035	2035
1) Same coolingsystem mass is assumed for e-motor and ICE 2) Does not include the mass of the DC/DC converter 3) High voltage + low voltage converter 4) Includes also the inverter for charging with AC 5) This definition refers to "corrected actual mass" of the base vehicle according to point 4 of Annex III of Regulation (EU) 2017/2400						

Table 24: Mass balance xEV group 5 vehicles model year 2025

Mass balance xEV group 5 2025						
		BEV	HEV Diesel	HEV Otto	EV	FCEV
Curb weight reference vehicle		7485 kg (B7)	7485 kg (B7)	7427 kg (LNG)	7485 kg (B7)	7485 kg (B7)
Tank system						
Fuel tank capacity	[l]	0	500	1000	0	1800
Tank mass change	[kg]	-120	-60	0	-120	680
Fuel mass change	[kg]	-752	-376	0	-752	-710
<i>Mass change of tank system</i>	[kg]	-872	-436	0	-872	-30
Exhaust system						
Adblue tank capacity	[l]	0	75	0	0	0
Adblue tank mass change	[kg]	-15	-15	0	-15	-15
Adblue mass change	[kg]	-109	-27	0	-109	-109
Mass change exhaust aftertreatment system	[kg]	-261	0	0	-261	-261
<i>Mass change exhaust system</i>	[kg]	-385	-42	0	-385	-385
Powertrain						
ICE mass	[kg]	0	1160	1160	0	0
Coolingsystem ¹	[kg]	100	100	100	100	100
Transmission mass	[kg]	85	411	411	85	85
Drive shaft	[kg]	0	80	80	0	0
<i>Powertrain mass change</i>	[kg]	-1566	0	0	-1566	-1566
Fuel cell						
<i>Fuel cell system mass²</i>	[kg]	0	0	0	0	756
E-Components						
Electric motor	[kg]	153	77	77	153	153
Battery system (housing, cooling system, etc)	[kg]	3840	70	70	655	140
Battery cooling + wiring	[kg]	130	25	25	110	25
DC/DC controller ³	[kg]	40	40	40	40	40
Inverter ⁴	[kg]	75	75	75	75	75
Pantograph mass	[kg]	0	0	0	300	0
<i>E-Components mass change</i>	[kg]	4238	287	287	1333	433
<i>Additional chassis mass (reinforced roof)</i>	[kg]	0	0	0	300	0
actual curb mass (90% Fuel + driver)	[kg]	8900	7293	7580	6294	6693
corrected actual curb mass (50% Fuel + driver)⁵	[kg]	8900	7084	7378	6294	6672
Curb mass trailer	[kg]	7365	7365	7365	7365	7365
1) Same coolingsystem mass is assumed for e-motor and ICE 2) Does not include the mass of the DC/DC converter 3) High voltage + low voltage converter 4) Includes also the inverter for charging with AC 5) This definition refers to "corrected actual mass" of the base vehicle according to point 4 of Annex III of Regulation (EU) 2017/2400						

4.3.2.11 Uncertainties related to modelling of xEV in this study

Electrified propulsion systems are currently a new technology under development for HDV. While it is possible to reasonably well identify a vehicle configuration that represent a typical vehicle with conventional powertrain technology, the situation for the heavy xEV is quite different. There is only few information available on heavy xEV in actual operations and most of the data is related to prototypes which might not reflect future series production vehicles optimised for certain applications in the market. Additionally technologies for xEV propulsion components (especially batteries but also electric motors, transmissions etc.) are under rapid development.

As a consequence data for xEV vehicle specifications and results for xEV energy consumptions as elaborated in the present study cannot claim to be typical, but should rather be understood as examples of these new technologies from today's point of knowledge. Nevertheless the data elaborated for xEV should be a good foundation of a basic comparison for TTW and WTW energy consumption and emissions of different HDV propulsion concepts.

4.4 Vehicle performance criteria

To guarantee a fair comparison between all investigated vehicle configurations, the main propulsion system of all powertrains concepts has been dimensioned with the same nominal power, namely 220 kW for group 4 and 325 kW for group 5 vehicles. However, differences in other vehicle performance criteria may occur, due to different powertrain specifications and vehicles masses. In this study the following criteria of significant importance for HDV operation in real world use have been determined for each analysed propulsion concept:

- Maximum permissible payload [kg]
- Operating range [km]
- Gradeability at 80 km/h with maximum permissible weight [%]
- Maximum constant speed at 8% gradient with maximum permissible payload [km/h]

Table 25 and Table 26 show the results of this analysis. Results for ICE-CI vehicles operated with fuels different from B7 diesel are not listed as figures differ only slightly from the B7 reference vehicle.

Regarding maximum permissible payload capacity BEV vehicles of model year 2016 were found to have the most significant limitation compared to a conventional powertrain (group 4: BEV 6.3 tons, conventional 10.1 tons; group 5: BEV 19.7 tons, conventional 25.0 tons). To consider this limitation, the average payload distribution of model year 2016 BEVs has been adapted compared to conventional vehicles (see section 5.5). For model year 2025 BEVs the higher specific energy density of batteries nearly compensates this disadvantage.

Even more significant variations between different propulsion systems can be found for operating range. Also for this criterion BEVs were found to have the greatest limitations, but also vehicles which are fuelled with natural gas as well as FCEVs cannot keep up with the performance of Diesel powertrains. The operating ranges as specified in Table 25 and Table 26 for CEVs refer to the battery only mode, this means vehicle operation in which the vehicle is not connected with the overhead line. Operating ranges for vehicles of model year 2025 are in the same order of magnitude as for 2016 vehicles, due to the underlying assumptions made in the definition of 2025 vehicle configurations. It should be noted, that all specified values regarding operating range refers to weighted payload conditions as documented in section 5.5.

Gradeability figures like maximum constant speed at 8% gradient or maximal gradeability at 80 km/h, results in small advantages for xEV configurations compared to ICE only vehicles. However, the enhanced figures for HEVs depend on the charging level of the battery, hence the additional power is only available for a restricted time period. ICE-only and HEV configurations of model year 2025 show slightly better gradeability performance than for 2016. This can be attributed to reduced driving resistances for 2025 models. Gradeability performances of all other xEV configurations are furthermore increased for model year 2025, due to changes in gear ratios compared to 2016 vehicles.

Table 25: Performance criteria for 2016 vehicles

Vehicle group	Model year	Propulsion system ID	Fuel	max. payload [kg]	operating range [km]	gradeability at 80 km/h with max. payload [%]	max. speed at 8% gradient with max. payload [km/h]
4	2016	ICE CI	B7	10100	2253	3.50	45.1
4	2016	ICE PI	CNG	9966	540	2.54	44.0
4	2016	ICE PI	LNG-PI	10168	1042	2.54	44.0
4	2016	ICE CI	LNG-HPDI	9576	1374	3.50	45.1
4	2016	ICE CI + HEV	B7	10079	1468	3.58	58.7
4	2016	ICE PI + HEV	CNG	9742	592	3.02	53.8
4	2016	BEV	el. grid	6319	367	3.78	47.3
4	2016	CEV	el. road	10004	70*	3.78	47.3
4	2016	FCEV	H2	10415	608	3.78	47.3
5	2016	ICE CI	B7	24950	3425	1.68	31.0
5	2016	ICE PI	CNG	25009	557	1.80	31.5
5	2016	ICE PI	LNG-PI	25066	1529	1.80	31.5
5	2016	ICE CI	LNG-HPDI	24844	996	1.68	31.0
5	2016	ICE CI + HEV	B7	25087	1816	3.17	46.2
5	2016	ICE PI + HEV	LNG	24667	1593	2.37	44.5
5	2016	BEV	el. grid	19739	372	2.58	32.9
5	2016	CEV	el. road	25432	66*	2.58	32.9
5	2016	FCEV	H2	25633	614	2.58	32.9

* Operating range in battery mode

Table 26: Performance criteria for 2025 vehicles

Vehicle group	Model year	Propulsion system ID	Fuel	max. payload [kg]	operating range [km]	gradeability at 80 km/h with max. payload [%]	max. speed at 8% gradient with max. payload [km/h]
4	2025	ICE CI	B7	10300	2457	3.52	50.7
4	2025	ICE PI	CNG	10174	592	3.36	44.1
4	2025	ICE PI	LNG-PI	10346	1142	3.36	44.1
4	2025	ICE CI	LNG-HPDI	9776	1517	3.52	50.7
4	2025	ICE CI + HEV	B7	10295	1599	3.67	59.2
4	2025	ICE PI + HEV	CNG	9958	653	3.60	54.2
4	2025	BEV	el. grid	9082	370	3.89	47.6
4	2025	CEV	el. road	10708	58*	3.89	47.6
4	2025	FCEV	H2	10669	700	3.89	47.6
5	2025	ICE CI	B7	25150	3782	1.72	31.3
5	2025	ICE PI	CNG	25209	611	2.40	31.8
5	2025	ICE PI	LNG-PI	25222	1677	2.40	31.8
5	2025	ICE CI	LNG-HPDI	25044	1103	1.72	31.3
5	2025	ICE CI + HEV	B7	25342	2042	3.52	46.5
5	2025	ICE PI + HEV	LNG	24922	1750	3.00	44.8
5	2025	BEV	el. grid	23735	376	3.08	37.1
5	2025	CEV	el. road	26341	65*	3.08	37.1
5	2025	FCEV	H2	25942	746	3.08	37.1

* Operating range in battery mode

5 Simulation methodology

This chapter gives a documentation on the used simulation models and the underlying generic data like mission profiles, payload conditions and vehicle operation strategies.

5.1 Simulation software VECTO

VECTO is a software tool developed on behalf of the European Commission DG CLIMA for certification of fuel consumption and CO₂ emissions of HDV. VECTO uses input data on CO₂ relevant vehicle components like engine, transmission, axle, tyres and air drag from certified component tests to cost efficiently determine the TTW CO₂ performance of the complete vehicle. The model is based on a time resolved vehicle longitudinal dynamics approach to determine the required vehicle propulsion power as well as internal combustion engine torque and speed and to interpolate from a fuel consumption map (Figure 18). A driver model operates the simulated HDV in a realistic way over predefined target speed over distance cycles (“mission profiles”, see section 5.4). An extensive description of the VECTO model can be found in [Rexeis, 2017].

In this study the VECTO version 3.2.1.1079 released in December 2017 has been used¹⁴. This tool version does not cover any type of electrified propulsion systems, hence vehicles of types HEV, BEV, CEV, and FCEV have been simulated with the model PHEM (see next section).¹⁵

Figure 18: VECTO calculation scheme

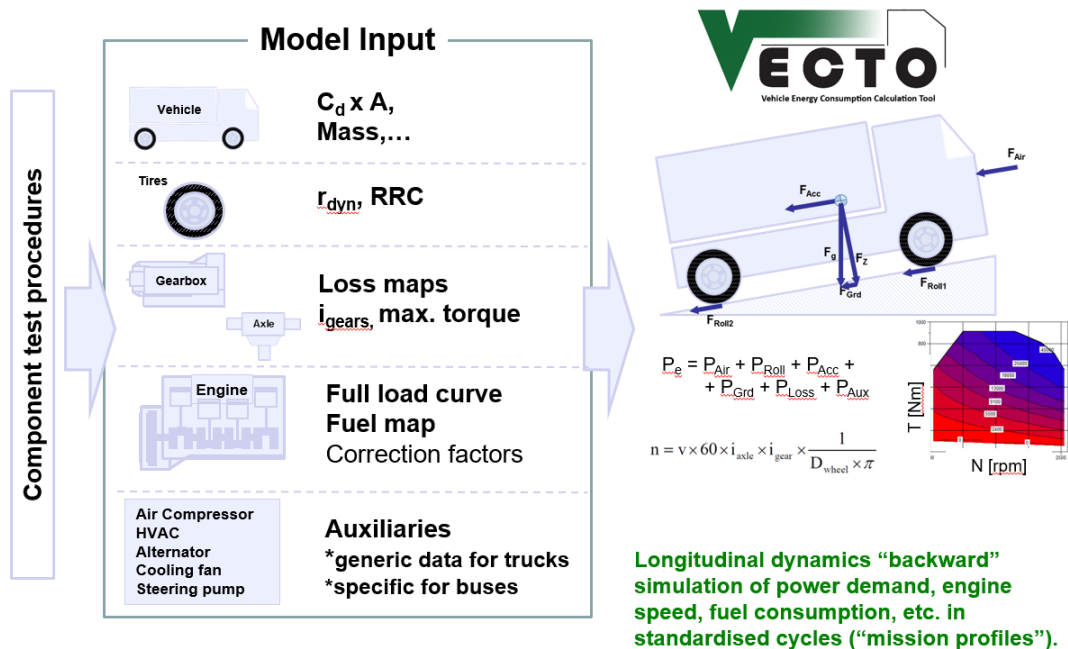

5.2 Simulation software PHEM

The model PHEM (Passenger car and Heavy duty Emission Model) is used for the simulation of all xEV concepts within this study. PHEM is an instantaneous emission model developed at TU Graz since the late 1990ies designed for simulation of fuel and energy consumption, CO₂ and pollutant emissions. Amongst other applications PHEM is used to calculate the emission factors as implemented in the “Handbook emission factors for Road Transport” (HBEFA), e.g. [Matzer, 2017].

PHEM is based on vehicle longitudinal dynamics simulation, engine fuel consumption and pollutant maps and modules for simulation of exhaust gas aftertreatment. A driver model is implemented to provide representative gear shift manoeuvres. For simulation of electrified vehicle concepts, models for the depiction of the behaviour of electric motor and energy storage system as well as generic operation strategies are

¹⁴ In order to cover additional fuel properties, which can not be changed in the standard VECTO input, a specific software version related to this project was created.

¹⁵ A project for extension of VECTO to be able to simulate HEV and BEV has already be announced by the European Commission to start end of 2018. It is assumed that in the long term emissions and energy consumption of all relevant HDV propulsion concepts will be integrated into VECTO.

implemented. A scheme of the PHEM model is given in Figure 19. More details on modelling approach for xEV vehicles are provided in later sections of the report.

Figure 19: PHEM model structure

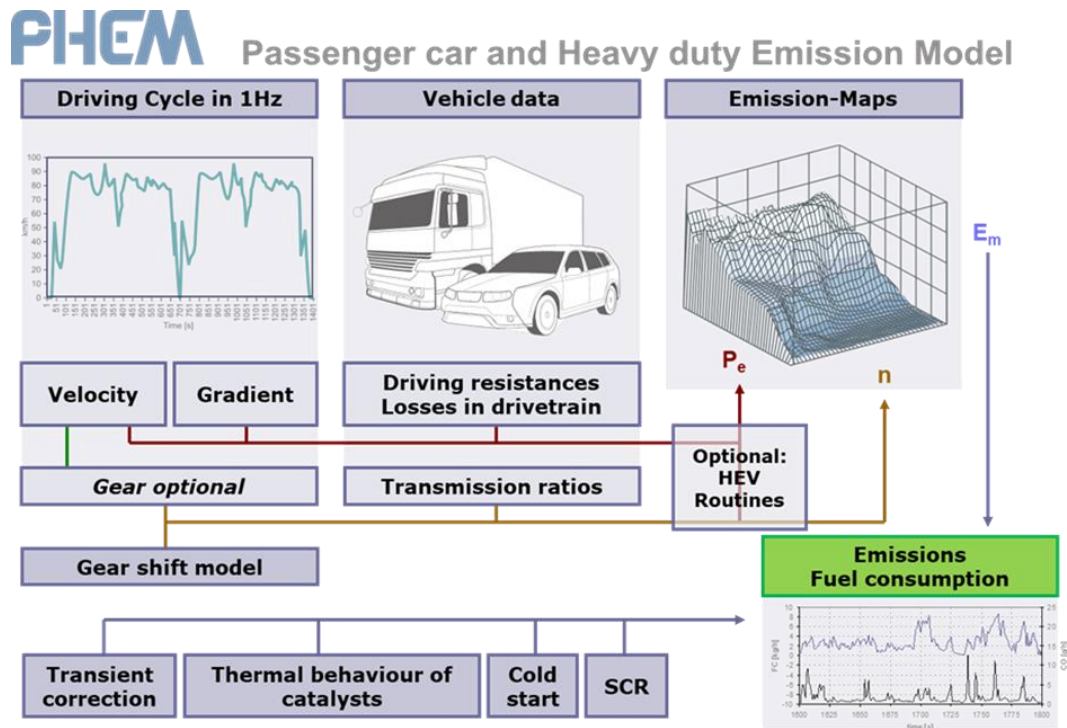

5.3 Consolidation of PHEM and VECTO results

Comparing results for different propulsion concepts calculated by different models is a sensitive issue. Differences can be attributed either to real vehicle performance - which is intended to be evaluated - but also to differences from the modelling approach - which gives artefacts in the comparison. In order to eliminate such errors the results for xEV vehicles have been determined as follows:

- In PHEM both the xEV vehicle and the allocated conventional vehicle were simulated: $CO_{2,xEV,PHEM}$, $CO_{2,conv,PHEM}$
- From the comparison of PHEM results the relative “technology difference” of xEV vs. conventional was calculated $\Delta CO_{2,PHEM} = CO_{2,xEV,PHEM} / CO_{2,conv,PHEM}$
- The results in absolute numbers for the xEV concept has been calculated based on the absolute results as calculated for the conventional vehicle in VECTO and the relative technology influence as calculated by PHEM:
 $CO_{2,xEV} = CO_{2,conv,VECTO} * (1 + \Delta CO_{2,PHEM})$

This approach was applied in a similar way applied also to other evaluated quantities results, e.g. energy consumption, fuel consumption.

5.4 Mission Profiles

The driving cycles used in this study are based on “mission profiles” as implemented in the VECTO version 3.2.1.1079. Mission profiles are defined by vehicle target speed and road gradient over distance. Based on this input the VECTO driver model operates the vehicle in a realistic way, applying typical acceleration and deceleration behaviour and considering the specific full-load acceleration capabilities of the simulated vehicle.

For the main analyses performed in this study group 4 vehicles have been simulated on the “Regional Delivery” mission profile. This cycle covers a distance of 100 km with an average speed of approximately 60 km/h (Figure 20).

Figure 20: Target speed and gradient profile of the Regional Delivery cycle

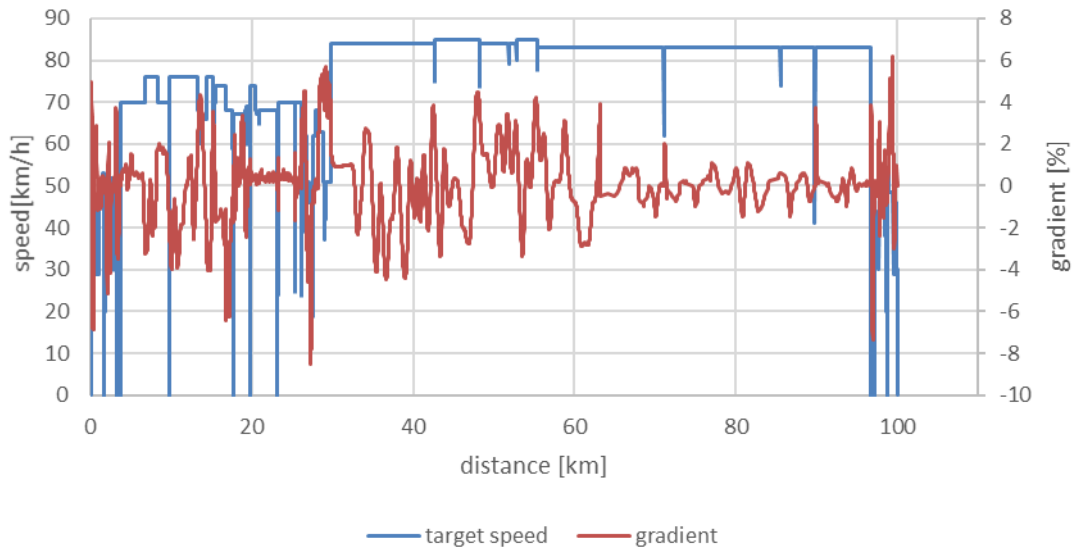

Vehicles of group 5 have been simulated on the “Long Haul cycle” (Figure 21). mission profile. This cycle covers a distance of 100 km with an average speed of approximately 79 km/h

Figure 21: Target speed and gradient profile of the Long Haul cycle

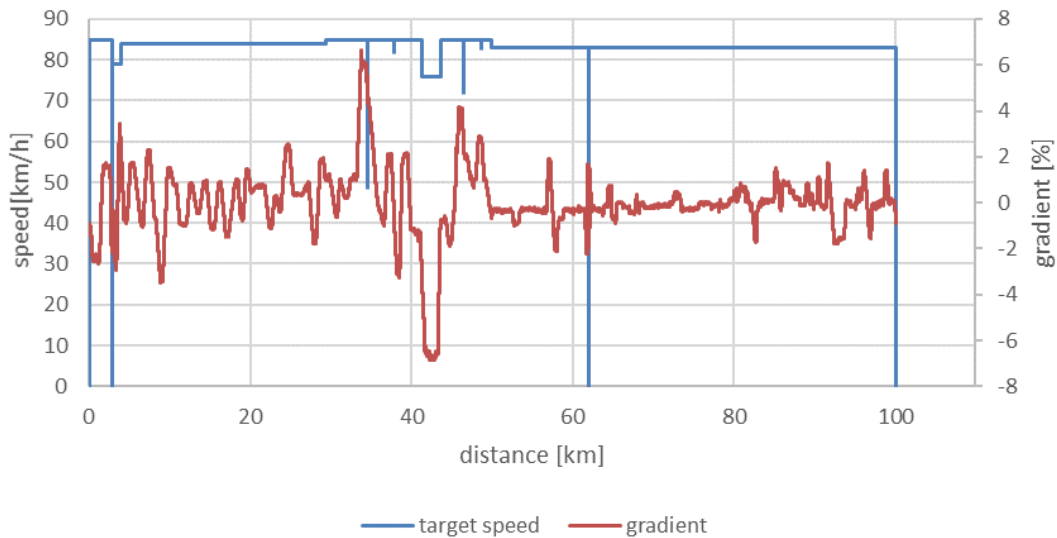

For further analysis group 4 vehicles were additionally simulated in the “Urban Delivery” mission profile. This mission profile is actually just available in a draft version and shall be updated for CO₂ certification in VECTO in late 2018. For this reason the related results are not included in the main part of the results but shown in Appendix I to this report

5.5 Payloads

All vehicles have been simulated in VECTO as foreseen in [EU, 2017] with two different payloads (representative payload, low payload). The masses for payloads are defined in VECTO as a function of vehicle group and mission profile. The figures relevant for this study are shown in Table 27.

Table 27: Generic payloads

Group	Cycle	Representative payload [kg]	Low payload [kg]
4	RD, UD	4400	900
5	LH	19300	2600

To consolidate the results to a single representative value for each combination of vehicle group and technology the weighting factors are proposed in the actual proposal for EU CO₂ standards [EU, 2018] have been used (Table 27). The weighting factors shall represent the average loading of HDVs in the fleet including empty trips.

Table 28: Payload weighting factors

Group	Representative payload [-]	Low payload [-]
4	50%	50%
5	70%	30%

BEVs of model year 2016 have significant lower payload capacity compared to other vehicle configurations due to the high curb mass primarily caused by the batteries. To consider this limitations a separate set of payload weighting factors according to Table 29 was applied.

Table 29: Payload weighting factors for BEV model year 2016

Group	Representative payload [-]	Low payload [-]
5	62.7%	37.2%

These figures have been calculated starting from a continuous distribution of payloads for the conventional vehicle, which matches with the average payload values resulting from data in Table 27 and Table 28. This distribution was corrected for the 2016 BEV by transferring payloads which exceed the payload capacity to vehicle operation with maximum payload value. This is done taking into consideration that additional kilometres driven with max. BEV payload are needed for similar tonne-km, if the number of drives with lower payloads are kept constant.

This correction has only been applied for group 5 vehicles. For group 4 the average payloads are so low (2.6 tons compared to approx. 10 tons payload capacity) so that any correction would not have any significant impact.

5.6 Advanced Driver Assistance Systems (ADAS)

All vehicles of model year 2025 as well as the 2016 long-haul trucks are equipped with the ADAS functionalities “Eco-roll” and “Predictive Cruise Control” (PCC). These technologies are not covered in the current versions of used simulation tools neither in VECTO nor in PHEM. In order to determine the impact of ADAS on fuel consumption which is compatible to a future implementation in VECTO, a post-processing method based on time-resolved VECTO results was elaborated. Assumption on functional features of ADAS systems have been taken from [ACEA; 2016]. The following sections describes the calculations of CO₂ reduction potential for above mentioned driver assistance systems.

5.6.1 Eco-roll

The benefit of Eco-roll is the reduction of engine drag losses by disengaging the engine from the wheels during certain downhill conditions. During these phases the engine is operated at idling conditions instead of overrun operation. An additional fuel saving benefit can be achieved if the internal combustion engine is turned off during the Eco-roll event. This functionality however requires additional hardware on the vehicle, like an electric power steering system. For the vehicles simulated in the current study Eco-roll without engine-stop-start is assumed.

5.6.2 Predictive Cruise Control (PCC)

PCC manages and optimises the usage of the potential energy during a driving cycle. A prerequisite is the availability of high quality road gradient data for the entire planned trip. In the assessment of the PCC functionality, according to [ACEA; 2016] a differentiation is made between three “use cases”, which are shown in Table 30.

Table 30: Modelled cases for predictive cruise control features.

Use case ID	Situation and description
1	Crest coasting: The vehicle reduces the velocity at uphill driving to reduce the downhill braking
2	The vehicle accelerates on negative slope, without any engine power
3	Dip coasting: PCC allows to increase the over-speed to end the downhill driving with a high velocity

For all three use cases, the gain of kinetic energy was in a first step calculated over the course of the cycle. This energy gain was then converted into a fuel consumption benefit over the total cycle.

5.6.3 Fuel saving potential of ADAS systems

The determination of the fuel saving potential for ADAS technologies according to above mentioned descriptions are based on vehicles with a conventional propulsion system. Hybrids and FCEVs have more potential due to battery management over crests and lower potential because recuperation is already a part of the standard HEV strategy. Thus, the same ADAS potential have been assessed HEVs and FCEVs as for conventional vehicles. The second effect includes also BEVs and CEVs, hence these configurations have only 50% of ADAS potential compared to conventional vehicles.

Table 31 gives the allocated reduction potentials of the ADAS combination PCC and Eco-Roll.

Table 31: Fuel saving potentials of combined ADAS systems for conv. and hybrid vehicles.

Combined ADAS system	Payload	Conv./HEV/FCEV		BEV/CEV	
		Group 4	Group 5	Group 4	Group 5
		Reg. Delivery	Long Haul	Reg. Delivery	Long Haul
PCC w. Eco-roll	representative	1.44%	1.94%	0.72%	0.97%
	low	1.03%	0.99%	0.52%	0.50%

These fuel saving potentials have been applied for both model years 2016 and 2025 as a quantification of the improvement of ADAS over the years was not possible.

5.7 xEV operation

In xEV vehicles a control unit manages the interaction between the different powertrain components of as ICE, e-motor, battery, fuel cell and catenary line depending on the individual vehicle concept. This section gives an overview of operation strategies implemented in the vehicle simulation of the current study.

5.7.1 HEV operation strategy

The aim of any xEV operation strategy is to minimize the energy consumption over the complete operation of the vehicle. The following effects are considered in the HEV control strategy as implemented in the PHEM model used in this study:

- Recuperation of braking energy up to a predefined maximum SOC
- Engine stop at zero power demand as long as SOC is above predefined minimum value
- Electric driving or assistance of ICE propulsion as long as SOC is above a minimum value.
- Shifting the load point of the combustion engine in areas with higher efficiency by generation of electric energy up to the maximum SOC
- The mode selection between electric driving, electric assistance, power generation and driving with combustion engine only is based on a comparison of the efficiencies of the three possible modes taking into account a typical operation pattern of the vehicle (e.g. frequency of recuperation events).

A detailed description of the PHEM HEV operation strategy can be found in [Lipp, 2017].

5.7.2 BEV and CEV operation strategy

The main considered functionality in the operating strategy for BEVs is the management of regenerative braking, since the e-motor is the only source of propulsion and the battery is the only available energy source.

For catenary electric vehicles (CEV) there are two energy sources available namely the battery and the catenary line. The battery is only used in cases without a catenary such as roads to and from the electric highway. In these operation modes the same operating strategy as for BEVs has been used in the simulations. Charging of battery is performed via catenary line whenever possible.

5.7.3 FCEV operation strategy

The control strategy for fuel cell vehicles depends on the power demand on the e-motor, the efficiency characteristics of the fuel cell and the operable SOC window of the battery. The operation strategy has been taken over from [Huss, 2013] and can be structured into four different operation modes (Table 32).

Table 32: Operation strategy of FCEVs [Huss, 2013]

SOC \ Demanded Power	< P _{opt}	> P _{opt}
	< SOC _{min}	P _{fc} = P _{opt}
> SOC _{min}	P _{fc} = 0	P _{fc} = k · P _{req}

Where:

P_{opt} ... Electrical power output of fuel cell with highest efficiency [kW]

P_{fc} ... Actual electrical power output of fuel cell [kW]

P_{req} ... Actual required electrical power for vehicle propulsion [kW]

k ... Calibration factor in operation strategy (0.85 used in this study) [-]

Furthermore recuperation of braking energy is part of the operation strategy for FCEV as for any type of xEV.

5.8 Total greenhouse gas emissions

The total Tank-to-Wheels GHG emissions of the different propulsion concepts have been evaluated based on direct CO₂ emissions from fuel combustion and additionally considering the GHG impact of emissions of CH₄ and N₂O. The total CO₂ equivalent emission have been calculated based on [UNFCCC, 2014] as follows:

$$E_{CO_2eq} = E_{CO_2} + 25 \cdot E_{CH_4} + 298 \cdot E_{N_2O}$$

The following emission mechanisms have been quantified for CH₄ and N₂O:

I. Emissions in hot operation conditions:

$$E_{\text{hot}} = E_{\text{hot,spec}} \cdot W_{\text{pos,ICE}} / D_{\text{mp}}$$

where:

E_{hot}	...	Tailpipe emissions in engine hot operation conditions [g/km]
$E_{\text{hot,spec}}$...	Brake specific emission levels [g/kWh]
$W_{\text{pos,ICE}}$...	Positive engine work simulated for the mission profile[kWh]
D_{mp}	...	Distance of the mission profile

II. Emissions from cold start effects:¹⁶

$$E_{\text{cold}} = E_{\text{cold,spec}} \cdot P_{\text{rated}} \cdot \#\text{coldstarts}_{\text{day}} / D_{\text{day}}$$

where:

E_{cold}	...	Tailpipe emissions from cold start effects [g/km]
$E_{\text{cold,spec}}$...	Specific cold start emissions per cold start and per kW engine rated power [(g/Start)/kW]
P_{rated}	...	Engine rated power [kW]
$\#\text{coldstarts}_{\text{day}}$...	Number of cold starts per day [-] (1.5)
D_{day}	...	Average distance travelled per day [km] (Long haul: 640km, Regional Delivery: 420 km, Urban Delivery: 180 km)

Specific emission levels for CH₄ and N₂O used in the current study are given in Table 33 for CH₄ and Table 34 for N₂O. As underlying data for CH₄ from ICE-PI CNG and LNG engines measurement data from different EURO VI NG trucks were available. The CH₄ emission level for LNG-HPDI engines was assessed with 60% of the EURO VI legislation limit. Basis of N₂O emission factors are the emission database HBEFA and EMISIA as well as [TNO, 2017], [TØI, 2013a], [TØI, 2013b], [Mendoza, 2017].

¹⁶ The term $E_{\text{cold,spec}} \cdot P_{\text{rated}}$ gives a simple quantification of the absolute emission difference in a complete engine warm-up cycle due to cold start effects compared to hot engine operation. This emission difference can be negative for certain exhaust gas components (e.g. N₂O). Consolidation of emission effects from I) and II) gives only valid results if the work $W_{\text{pos,ICE}}$ is sufficient to completely warm up engine and exhaust gas aftertreatment.

Table 33: Specific CH₄ emission levels

Combustion principle	Fuel	E _{hot} [g/kWh]	E _{cold,spec} [(g/Start)/kW _{rated}]
Compression ignition (CI)	B0	0.000	0.000
Compression ignition (CI)	B7	0.000	0.000
Compression ignition (CI)	FAME (B100)	0.000	0.000
Compression ignition (CI)	Paraffinic Diesel	0.000	0.000
Compression ignition (CI)	ED95	0.000	0.000
Compression ignition (CI)	DME	0.000	0.000
Compression ignition (CI)	OME	0.000	0.000
Positive ignition (PI)	LNG	0.200	0.031
Positive ignition (PI)	CNG	0.200	0.031
Compression ignition (CI) (Dual fuel HPDI)	LNG + B7	0.300	0.000

Table 34: Specific N₂O emission levels

Combustion principle	Fuel	E _{hot} [g/kWh]	E _{cold,spec} [(g/Start)/kW _{rated}]
Compression ignition (CI)	B0	0.090	-0.015
Compression ignition (CI)	B7	0.090	-0.015
Compression ignition (CI)	FAME (B100)	0.090	-0.015
Compression ignition (CI)	Paraffinic Diesel	0.090	-0.015
Compression ignition (CI)	ED95	0.090	-0.015
Compression ignition (CI)	DME	0.090	-0.015
Compression ignition (CI)	OME	0.090	-0.015
Positive ignition (PI)	LNG	0.010	0.000
Positive ignition (PI)	CNG	0.010	0.000
Compression ignition (CI) (Dual fuel HPDI)	LNG + B7	0.090	-0.015

- Emissions from Boil-off (only relevant for CH₄ from LNG)

There is the possibility of CH₄ leakage for vehicles running on LNG either due to an increase of the of the tank pressure caused by heat up of fuel during long standstills, or by a blow of during service, maintenance or repair. Second can be excluded if the work is carefully executed.

From technical requirements Boil-off must not occur for standstill events shorter than 5 days. The amount of boil off events can vary significantly depending on the number and distribution of vehicle standstills. This study considered one boil off event per year. If a Boil-off event occurs the amount of leaking CH₄ is about 3% of the initial fuel mass per "Boil-off" day [TNO, 2017].

However, it is difficult to generalize, since the magnitude of vented CH₄ depends on many different parameters as fuel pressure, fuel level, ambient conditions and others. The calculation of the Boil-off gas (BOG) emissions is based on tank sizes given in chapter 4.3.1.4 and with the assumption of one boil-off event per year. That results in BOG emissions as given in Table 35.

Table 35: CH₄ BOG of LNG vehicles

Tank volume [lit.]	500	1000
Tank capacity [kg]	202.5	405.1
Boil off per event	3%	3%
CH ₄ boil-off per year [kg]	6.08	12.15

The evaluation of distance related BOG emissions is derived from an average annual mileage of 78.000 km for group 4 and 116.000 km for group 5 vehicles (Table 36).

Table 36: BOG in CO₂equ per km

BOG in CO ₂ equ [g/km]			
Vehicle group	Cycle	500 lit. tank	1000 lit. tank
4	RD	1.95	---
5	LH	1.31	2.62

The contribution of emissions CH₄ and N₂O on total CO₂equ emissions was found to be around 4% for CI engines (triggered by N₂O emissions from SCR exhaust aftertreatment), at approx. 1.5% for CNG and LNG PI engines (caused by CH₄ emissions) and at about 6% at dual fuel LNG-PI engine (due to the combination of above mentioned effects).

5.9 AdBlue consumption

In order to calculate the WTT emissions from AdBlue production, the AdBlue consumption of the individual powertrain configurations had to be assessed. CO₂ emitted from hydrolyse of AdBlue to NH₃ will be taken into account in the WTT part of the study, and thus are not balanced in this report in the total TTW CO₂ equivalent.

The determination of the AdBlue consumption has been calculated based on typical BS NO_x engine out and BS NO_x tailpipe emissions and was calculated as shown below.

$$AdBlue \left[\frac{l}{kWh} \right] = \frac{(NO_{x,EO} - NO_{x,TP}) \left[\frac{g}{kWh} \right]}{46 \left[\frac{g}{mol} \right]} * \left(\frac{1}{1 - S_{NH3,loss}} \right) * \frac{1}{2} * 60.1 \left[\frac{g}{mol} \right] * \frac{1}{0.325} * 0.001 * \frac{1}{1.09 \left[\frac{kg}{t} \right]}$$

where:

NO_{x,EO} BS NO_x emissions (in NO₂ mass equivalent) at engine out

NO_{x,TP} BS NO_x emissions (in NO₂ mass equivalent) at tailpipe

S_{NH3,loss} Share of NH₃ slip before slip-cat, used value in calculation = 10%

Table 37 gives the figures for NO_x emission levels and the resulting numbers for AdBlue consumption. Values for BS NO_x from CI engines fuelled with conventional Diesel has taken from data available at FVT. NO_x engine out emissions of FAME (B100) fuel were assessed by an increase of 20% compared to B0, due to the high O₂ content. NO_x engine out emissions for B7 were derived from a linear correlation between B0 and FAME (B100). For diesel alternatives like DME, OME, FT diesel, etc. the same values were used as for B7.

A reliable forecast regarding AdBlue consumption for 2025 requires knowledge about the NO_x engine out and NO_x tailpipe emissions in 2025, which depends on the one hand of the share of SCR only vehicles and to a lower extent on the NO_x limits in the pollutant regulation. Since it is difficult to evaluate these parameters, the same AdBlue consumption for 2016 and 2025 has been assumed.

Table 37: AdBlue consumption

Combustion principle	Fuel	NOx engine out	NOx tailpipe [g/kWh]	AdBlue [l/kWh]
Compression ignition (CI)	B0	6.0	0.3	0.012
Compression ignition (CI)	B7	6.1	0.3	0.012
Compression ignition (CI)	FAME (B100)	7.2	0.3	0.014
Compression ignition (CI)	Paraffinic Diesel	6.1	0.3	0.012
Compression ignition (CI)	ED95	6.1	0.3	0.012
Compression ignition (CI)	DME	6.1	0.3	0.012
Compression ignition (CI)	OME	6.1	0.3	0.012
Positive ignition (PI)	LNG	no SCR	no SCR	0.000
Positive ignition (PI)	CNG	no SCR	no SCR	0.000
Compression ignition (CI) (Dual fuel HPDI)	LNG + B7	6.1	0.3	0.012

6 Results

This chapter gives a detailed discussion of TTW energy consumption and TTW CO₂ equivalent emissions of the different analysed HDV propulsion concepts. The results are given in figures specific per transport performance i.e. in the “per tonne-kilometre” unit. Shown values refer to the mission profiles “Regional delivery” for the group 4 rigid truck and to the “Long haul” for the group 5 truck-semitrailer combination (see section 5.4 on page 40) and a weighted payload mix (see section 5.5 on page 41). TTW energy consumption was calculated using the lower heating value (LHV) of the consumed fuel and the amount of electricity taken from the grid or from the catenary line. TTW CO₂ equivalent emissions have been calculated based on the carbon content of the consumed fuel (fuel properties see section 4.2 on page 16) and the additional contributions of emissions of CH₄ and N₂O (see section 5.7 on page 43). The complete set of payload weighted calculation results (incl. figures for fuel consumption, CO₂ emissions and share of CH₄ and N₂O on CO₂equ) is given in Table 38 to Table 49 at the end of this chapter.

For any results related to xEV concepts it shall be mentioned that these figures are affected by significantly higher uncertainties compared to conventional propulsion systems as electrified propulsion is currently a new technology under development for HDV.

6.1 Group 4 rigid trucks (Regional delivery)

Figure 22 shows the results for energy consumption of group 4 vehicles of model year 2016. Minor differences between different fuel types used in mono-fuelled combustion ignition (CI) engines are related to small differences in vehicle weight caused by different fuel densities. All other vehicle characteristics including engine efficiencies were assumed to be similar for all mono-fuelled CI engines. Energy consumption of the dual-fuelled LNG (-Diesel) HPDI vehicle is nearly identical to diesel-only concepts. Vehicles driven by a positive ignition (PI) combustion engine have a some 20% higher specific energy consumption compared to the B7 vehicle mainly caused by the lower engine efficiencies but also due to higher vehicle curb masses caused by the NG tank system. The LNG vehicle was calculated with some 2% less energy consumption compared to CNG due to the lower vehicle mass. HEV vehicles were assessed to have a 8% (for the B7 ICE engine) and 9% (for the CNG ICE engine) lower energy consumption compared to their ICE-only counterparts. For the analysed xEV concepts catenary electric vehicles (CEV, electric road) were analysed to have the lowest TTW energy consumption (-60% compared to B7) followed by battery electric vehicles (BEV el. grid, -52% compared to B7). Compared to BEV the CEV propulsion concept has the advantage of lower vehicle weight caused by a smaller battery and lower energy losses in the electric system. Fuel cell electric vehicles running on H₂ were calculated with 32% lower TTW energy consumption compared to a conventional B7 vehicle. Compared to BEVs and CEVs the energy consumption of FCEV additionally includes the energy losses in the fuel cell.

Figure 22: Group 4 vehicles model year 2016 - energy consumption

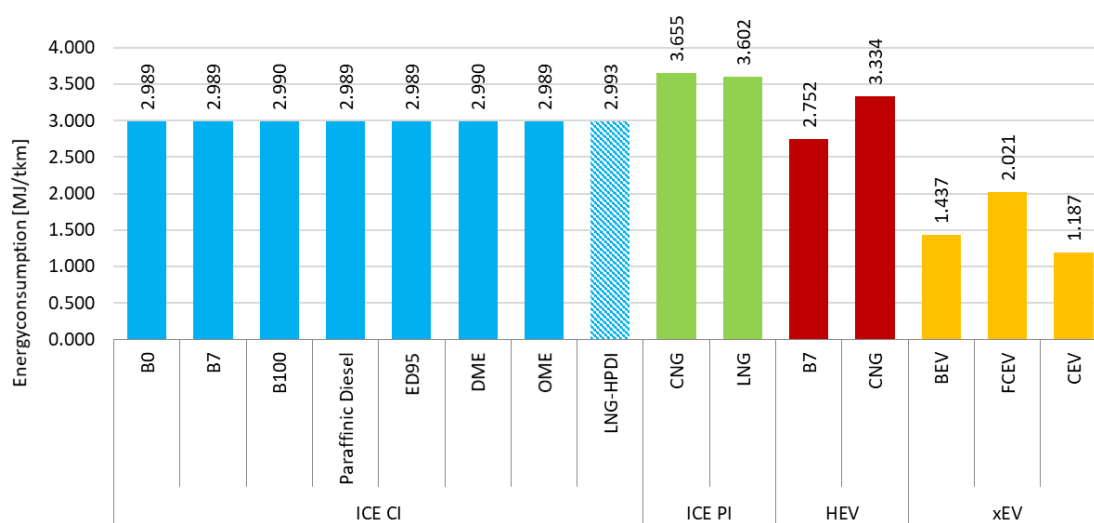

Group 4; VECTO Regional-Delivery cycle; Weighted payload (2650 kg)

Figure 23 gives the results for TTW CO₂ equivalent emissions per tonne-kilometre for the 2016 group 4 vehicles. Results for the mono-fuelled CI engines are in the range from 209.1 g/tkm for DME and 257.0 g/tkm for OME. This is a range of -8% to +13% compared to conventional B7 fuel due to differences in the LHV specific carbon content of the fuel. LNG-HPDI vehicles were calculated with 184.2 g/tkm, which is 19% lower CO₂ equivalent emissions compared to the B7 vehicle due to the high amount of NG burned with engine efficiencies close to a Diesel engine. CO₂ equivalent emissions of conventional PI vehicles have been assessed with 208.0 g/tkm for CNG and 206.7 g/tkm for LNG. Compared to the B7 vehicle the lower carbon content of the NG fuels overcompensates the lower energy efficiency resulting in some 9% lower TTW CO₂ equivalent figures. HEV vehicle were simulated to have 209.2 g/tkm for the B7 ICE and 189.8 g/tkm for the CNG ICE. Compared to the ICE-only counterparts these numbers give same advantage than for energy consumption (-8% for the B7 ICE engine and -9% for the CNG ICE engine). xEV configurations per definition do not have any TTW CO₂ equivalent emissions.

Figure 23: Group 4 vehicles model year 2016 – CO₂ equivalent emissions

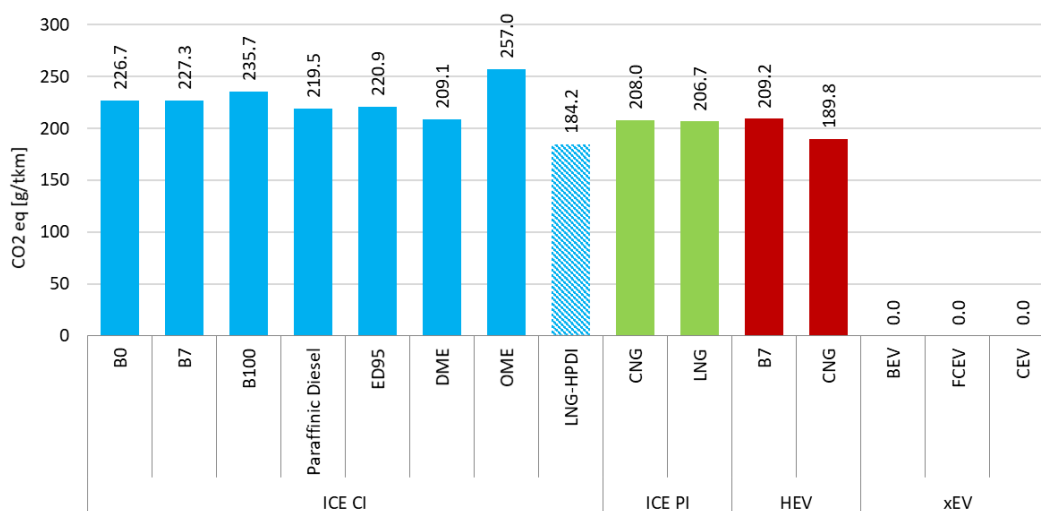

Group 4; VECTO Regional-Delivery cycle; Weighted payload (2650 kg)

Figure 24 shows the results for energy consumption of the group 4 vehicles of model year 2025. Relative ranking of different propulsion concepts stays unchanged compared to model year 2016. Based on the assumptions as documented in chapters 2 and 3 ICE driven propulsion concepts were assessed to improve by some 10% from 2016 until 2025. For xEV concepts the reduction in energy consumption until 2025 was

calculated in the range from 10% (CEV, el. road) to 15% (BEV, el. grid). Future improvement for xEV vehicles are mainly related to higher battery energy densities (and as a consequence a lower vehicle weight when a similar operating range is assumed) and an optimised powertrain (3 instead of 2 gear transmission).¹⁷

Figure 24: Group 4 vehicles model year 2025 - energy consumption

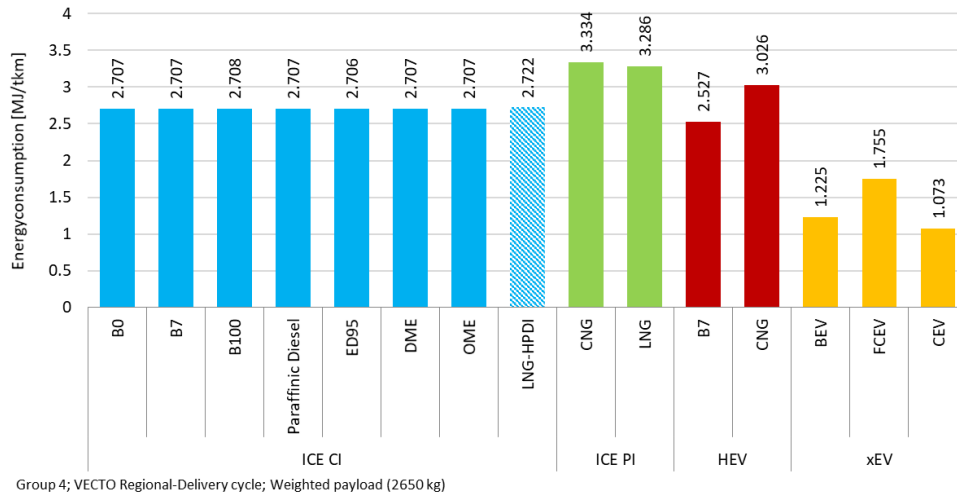

Figure 25 shows the results for CO₂ equivalent emissions of the model year 2025 group 4 vehicles. As for energy consumption the relative ranking between the different propulsion concepts remains unchanged.

Figure 25: Group 4 vehicles model year 2025 – CO₂ equivalent emissions

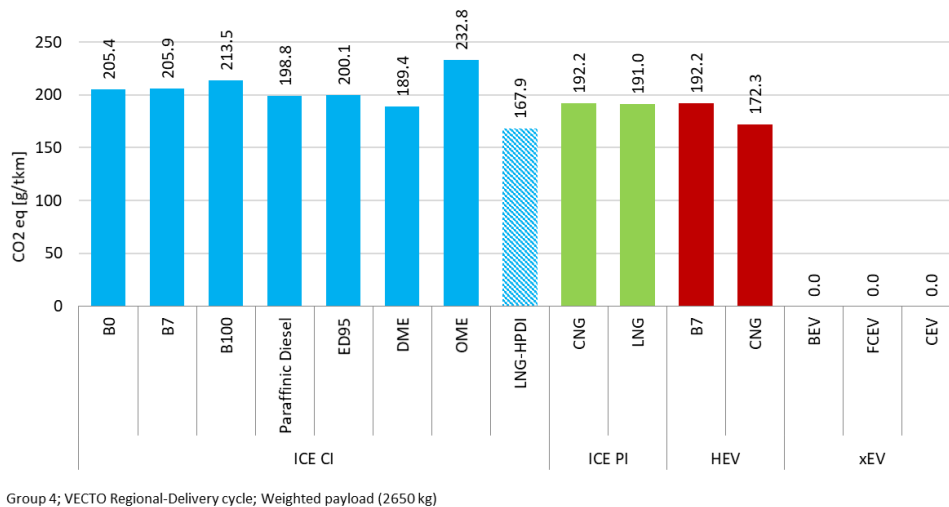
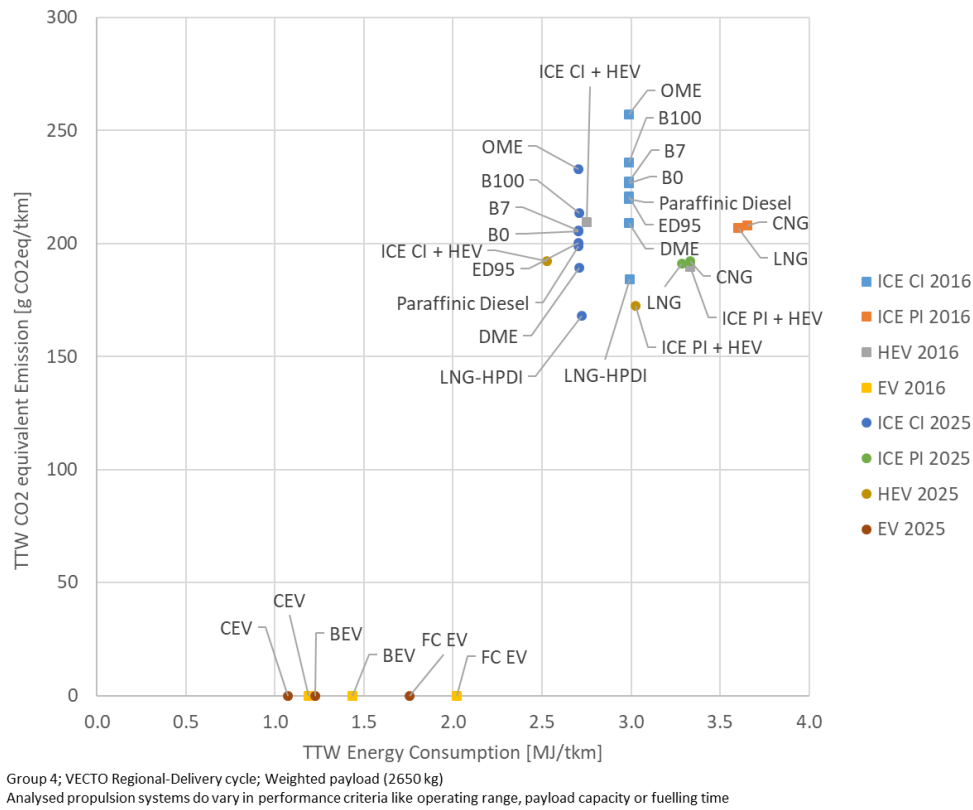

Figure 26 gives the summary of results for energy consumption as well as CO₂ equivalent emissions for all 2016 and 2025 propulsion configurations of the group 4 rigid truck.

¹⁷ This predicted improvement of energy efficiency from 2016 to 2025 for xEV technologies is higher than estimated for conventional powertrains in the scenario as described in section 3.2. This appears reasonable as xEV is currently a new technology with higher optimisation potentials compared to well established technologies. However, as mentioned in detail in section 4.3.2.11, all results for xEV shall be considered as affected with higher levels of uncertainties.

Figure 26: Summary results vehicle group 4 (Regional Delivery)



6.2 Group 5 tractor-semitrailer combination (Long haul)

Figure 27 shows the results shows the results for energy consumption of the group 5 tractor-semitrailer vehicle model year 2016. Significant higher payload conditions and a different mission profile lead to clearly lower transport specific figures compared to the group 4 truck. As for the group 4 vehicles all mono-fuelled CI engines were calculated with a nearly identical energy demand. Compared to B7 the dual fuelled LNG-HPDI was assessed with +3% energy consumption. Conventional PI engines were calculated to have a some 25% higher energy consumption compared to B7. HEV propulsion concepts in the simulated configuration were found to have some 6% (for B7 CI ICE) and 4% (for LNG PI ICE) advantage in fuel use compared to the conventional counterpart. As expected, the benefit from the HEV driveline is lower in the long haul mission than in the regional delivery cycle. Similar to the group 4 vehicle also for group 5 catenary electric vehicles (CEV, el.road) were analysed to have the lowest TTW energy consumption (~53% compared to B7) followed by battery electric vehicles (BEV el. grid, -42% compared to B7). Fuel cell electric vehicles running on H2 were calculated with 20% lower TTW energy consumption compared to a conventional B7 vehicle.

Figure 27: Group 5 vehicles model year 2016 - energy consumption

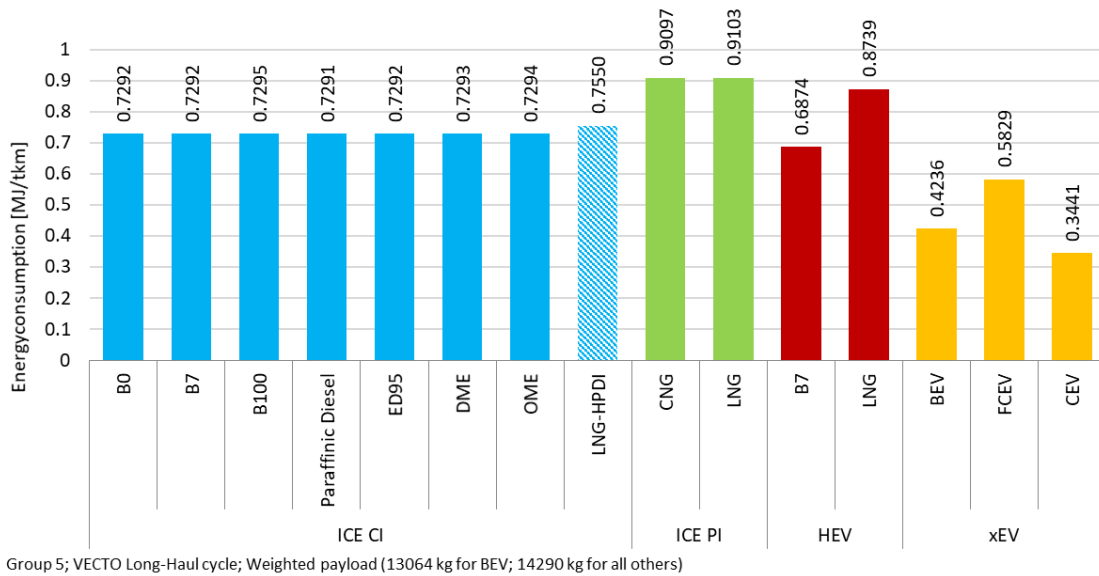

Figure 28 gives the results for TTW CO₂ equivalent emissions per tonne-kilometre. Results for the mono-fuelled CI engines are in the range from 51.2 g/tkm for DME and 62.9 g/tkm for OME. Similar to the group 4 vehicle this is a range of -8% to +13% compared to conventional B7 fuel due to differences in the LHV specific carbon content of the fuel. LNG-HPDI vehicles were calculated with 46.4 g/tkm, which is 17% lower CO₂ equivalent emissions compared to the B7 vehicle due to the high amount of burned NG. CO₂ equivalent emissions of conventional PI vehicles have been assessed with 51.8 g/tkm for CNG and 52.2 g/tkm for LNG. Compared to the B7 vehicle the lower carbon content of the NG fuels overcompensates the lower energy efficiency resulting in some 6% to 7% lower TTW CO₂ equivalent figures. HEV vehicles were simulated to have 52.5 g/tkm for the B7 ICE and 50.1 g/tkm for the CNG ICE. xEV configurations do not have any TTW CO₂ equivalent emissions.

Figure 28: Group 5 vehicles model year 2016 - CO₂equivalent emissions

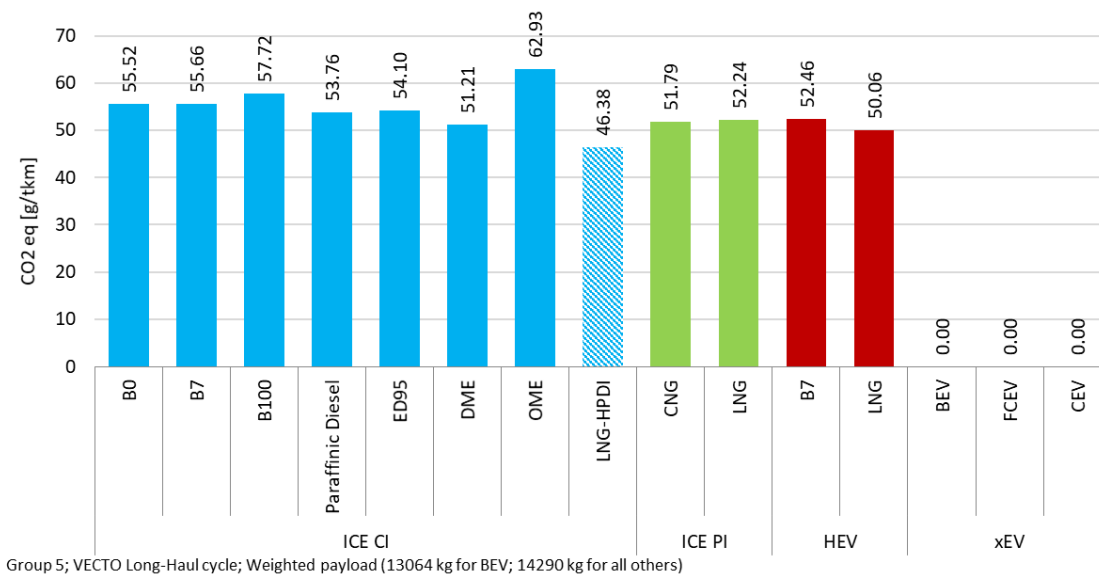

Figure 29 shows the results for energy consumption of the group 5 vehicles of model year 2025. Relative ranking of different propulsion concepts stays unchanged compared to model year 2016. Based on the assumptions as documented in chapters 2 and 3 ICE driven propulsion concepts were assessed to improve

similar to group 4 vehicles by some 10% from 2016 until 2025. For xEV concepts the reduction in energy consumption until 2025 was calculated in the range from 17% (CEV, el. road) to 23% (BEV, el. grid),¹⁸

Figure 29: Group 5 vehicles model year 2025 - energy consumption

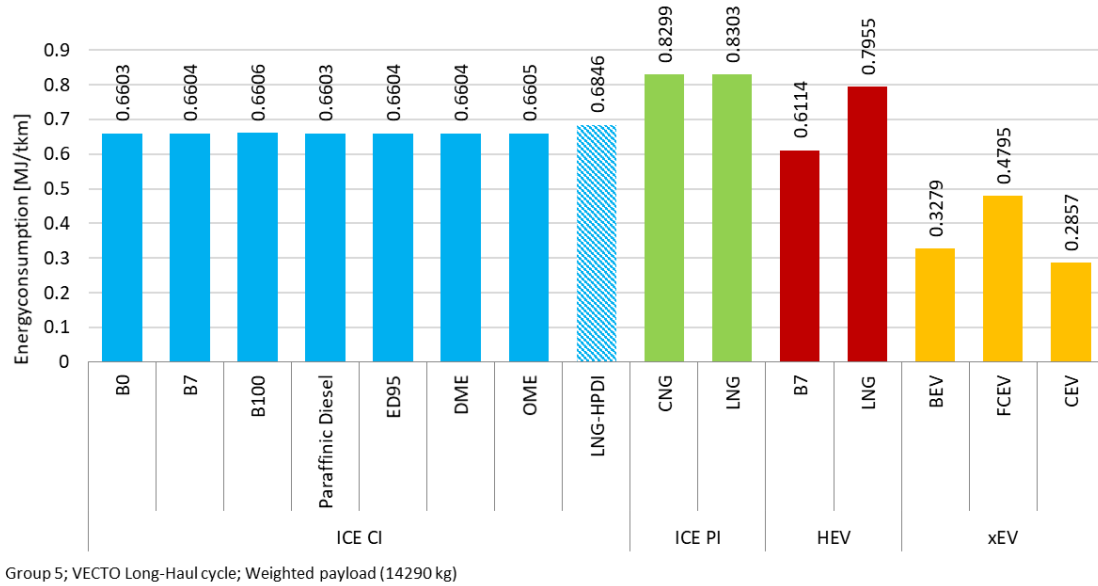

Figure 30 shows the results for CO₂ equivalent emissions of the model year 2025 group 5 vehicles. As for energy consumption the relative ranking between the different propulsion concepts remains unchanged.

Figure 30: Group 5 vehicles model year 2025 – CO₂equivalent emissions

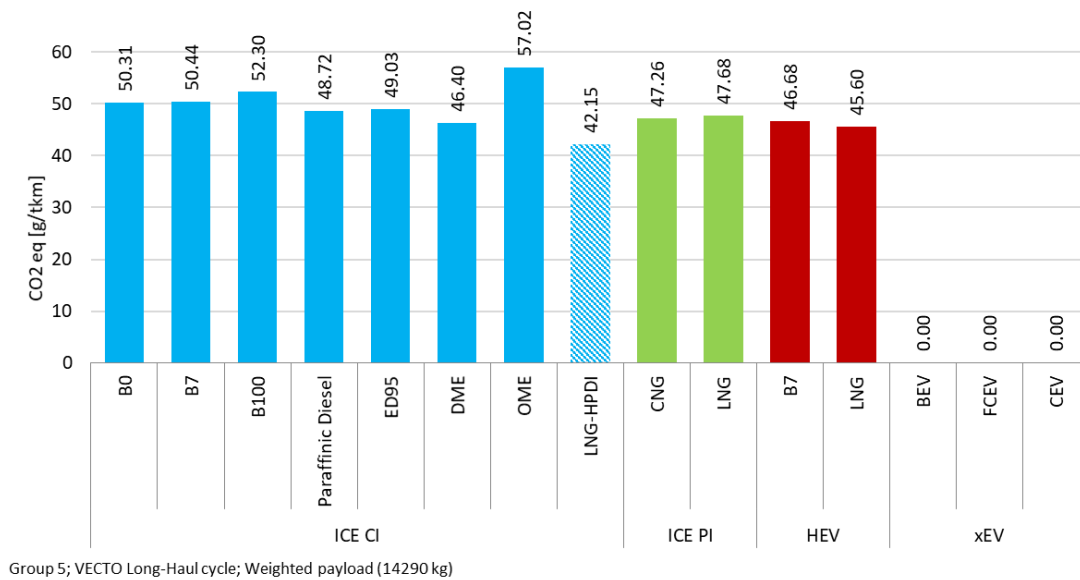
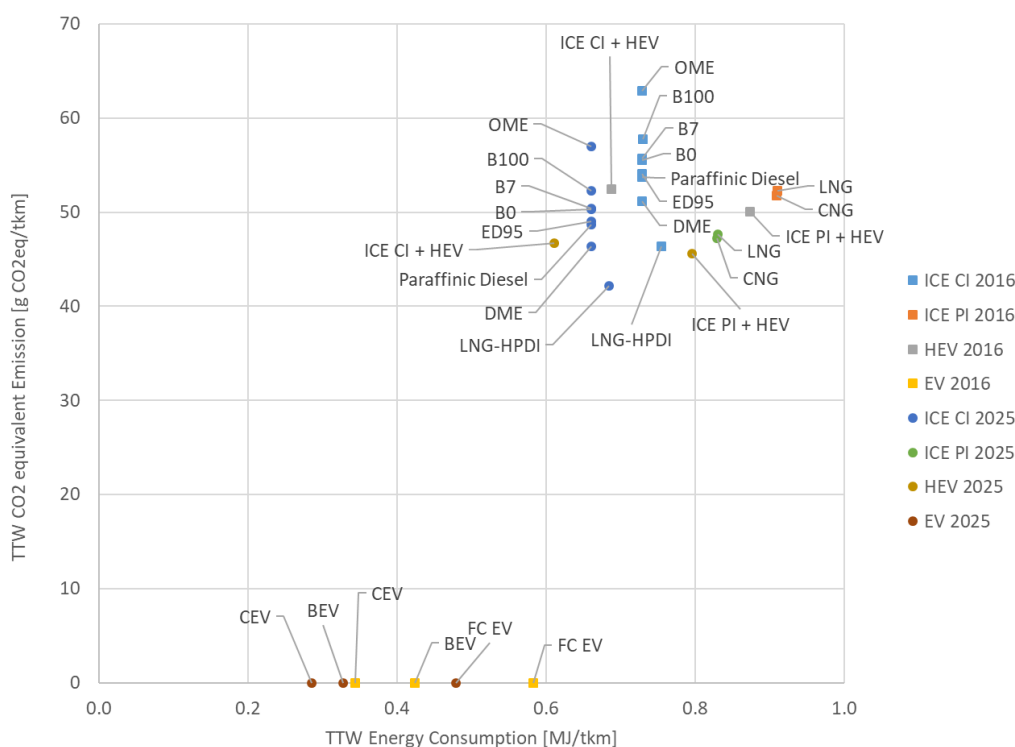

Figure 31 gives the summary of results for energy consumption as well as CO₂ equivalent emissions for all 2016 and 2025 propulsion configurations of the group 5 tractor-semitrailer combination.

¹⁸ see also footnote 17 on page 70

Figure 31: Summary results vehicle group 5 (Long Haul)



Group 5; VECTO Long-Haul cycle; Weighted payload (13064 kg for BEV 2016; 14290 g for all others)
 Analysed propulsion systems do vary in performance criteria like operating range, payload capacity or fuelling time

Table 38 to Table 49 contain the complete set of results (fuel consumption, energy consumption, CO₂ and CO₂ equivalent emissions) for both considered vehicle groups and both model years in weighted payload conditions. Additionally the share of CH₄ and N₂O emissions on overall CO₂ equivalent emissions and the percentage difference of CO₂ equivalent and energy consumption to the ICE CI B7 vehicle of the same model year is given.

Table 38: Results group 4 Regional Delivery 2016 for ICE only configurations with weighted payload (2650 kg)

Group 4										
Model year	Propulsion system ID	Fuel ID	Fuel consumption		Energy consumption [MJ/tkm]	CO2 [g/tkm]	CO2equ [g/tkm]	Share CH4, N2O on CO2equ [%]	CO2equ deviation to ICE CI B7 [%]	Energy consumption deviation to ICE CI B7 [%]
			liquid [l/100km]	gasous [kg/100km]						
2016	ICE CI	B0	22.07	18.37	2.989	218.8	226.7	3.5%	-0.3%	0.0%
2016	ICE CI	B7	22.20	18.56	2.989	219.4	227.3	3.5%	---	---
2016	ICE CI	B100	23.93	21.30	2.990	227.8	235.7	3.3%	3.7%	0.0%
2016	ICE CI	Paraffinic Diesel	23.08	18.00	2.989	211.6	219.5	3.6%	-3.4%	0.0%
2016	ICE CI	ED95	38.03	31.18	2.989	213.0	220.9	3.6%	-2.8%	0.0%
2016	ICE CI	DME	41.60	27.87	2.990	201.2	209.1	3.8%	-8.0%	0.0%
2016	ICE CI	OME	38.76	41.34	2.989	249.1	257.0	3.1%	13.1%	0.0%
2016	ICE CI	LNG-HPDI	1.940	14.74	2.993	173.3	184.2	5.9%	-18.9%	0.1%
2016	ICE PI	CNG	---	20.20	3.655	205.3	208.0	1.3%	-8.5%	22.3%
2016	ICE PI	LNG	---	19.43	3.602	203.2	206.7	1.7%	-9.1%	20.5%

Table 39: Results group 4 Regional Delivery 2025 for ICE only configurations with weighted payload (2650 kg)

Group 4											
Model year	Propulsion system ID	Fuel ID	Fuel consumption		Energy consumption	CO2	CO2equ	Share CH4, N2O on CO2equ	CO2equ deviation to ICE CI B7	Energy consumption deviation to ICE CI B7	
			liquid	gasous							
			[l/100km]	[kg/100km]	[MJ/tkm]	[g/tkm]	[g/tkm]	[%]	[%]	[%]	
2025	ICE CI	B0	20.24	16.63	2.707	198.1	205.4	3.5%	-0.3%	0.0%	
2025	ICE CI	B7	20.35	16.80	2.707	198.7	205.9	3.5%	0.0%	0.0%	
2025	ICE CI	B100	21.95	19.29	2.708	206.3	213.5	3.4%	3.7%	0.0%	
2025	ICE CI	Paraffinic Diesel	21.16	16.30	2.707	191.6	198.8	3.6%	-3.4%	0.0%	
2025	ICE CI	ED95	34.87	28.24	2.706	192.9	200.1	3.6%	-2.8%	0.0%	
2025	ICE CI	DME	38.14	25.23	2.707	182.2	189.4	3.8%	-8.0%	0.0%	
2025	ICE CI	OME	35.54	37.43	2.707	225.6	232.8	3.1%	13.1%	0.0%	
2025	ICE CI	LNG-HPDI	1.835	13.35	2.722	157.8	167.9	6.0%	-18.5%	0.6%	
2025	ICE PI	CNG	---	18.42	3.334	189.6	192.2	1.3%	-6.7%	23.2%	
2025	ICE PI	LNG	---	17.73	3.286	187.7	191.0	1.7%	-7.2%	21.4%	

Table 40: Results group 4 Regional Delivery 2016 for HEV configurations with weighted payload (2650 kg)

Group 4											
Model year	Propulsion system ID	Fuel ID	Fuel consumption		Energy consumption	CO2	CO2equ	Share CH4, N2O on CO2equ	CO2equ deviation to ICE CI B7	Energy consumption deviation to ICE CI B7	
			liquid	gasous							
			[l/100km]	[kg/100km]	[MJ/tkm]	[g/tkm]	[g/tkm]	[%]	[%]	[%]	
2016	ICE CI + HEV	B7	20.44	17.09	2.752	202.0	209.2	3.5%	-7.9%	-7.9%	
2016	ICE PI + HEV	CNG	---	18.42	3.334	187.2	189.8	1.4%	-16.5%	11.5%	

Table 41: Results group 4 Regional Delivery 2025 for HEV configurations with weighted payload (2650 kg)

Group 4											
Model year	Propulsion system ID	Fuel ID	Fuel consumption		Energy consumption	CO2	CO2equ	Share CH4, N2O on CO2equ	CO2equ deviation to ICE CI B7	Energy consumption deviation to ICE CI B7	
			liquid	gasous							
			[l/100km]	[kg/100km]	[MJ/tkm]	[g/tkm]	[g/tkm]	[%]	[%]	[%]	
2025	ICE CI + HEV	B7	18.76	15.69	2.527	185.4	192.2	3.5%	-6.6%	-6.7%	
2025	ICE PI + HEV	CNG	---	16.72	3.026	169.9	172.3	1.4%	-16.3%	11.8%	

Table 42: Results group 4 Regional Delivery 2016 for BEV, FCEV and CEV configurations with weighted payload (2650 kg)

Group 4											
Model year	Propulsion system ID	Fuel ID	Fuel consumption		Energy consumption w.o. charging losses	Energy consumption w. charging losses	CO2	CO2equ	Share CH4, N2O on CO2equ	CO2equ deviation to ICE CI B7	Energy consumption deviation to ICE CI B7
			liquid	gasous							
			[l/100km]	[kg/100km]	[MJ/tkm]	[MJ/tkm]	[g/tkm]	[g/tkm]	[%]	[%]	[%]
2016	BEV	el. grid	---	---	1.266	1.437	0	0	0.0%	-100.0%	-51.9%
2016	FC EV	H2	---	4.465	2.021	---	0	0	0.0%	-100.0%	-32.4%
2016	CEV	el. road	---	---	1.171	1.187	0	0	0.0%	-100.0%	-60.3%

Table 43: Results group 4 Regional Delivery 2025 for BEV, FCEV and CEV configurations with weighted payload (2650 kg)

Group 4											
Model year	Propulsion system ID	Fuel ID	Fuel consumption		Energy consumption w.o. charging losses	Energy consumption w. charging losses	CO2	CO2equ	Share CH4, N2O on CO2equ	CO2equ deviation to ICE CI B7	Energy consumption deviation to ICE CI B7
			liquid	gasous							
			[l/100km]	[kg/100km]	[MJ/tkm]	[MJ/tkm]	[g/tkm]	[g/tkm]	[%]	[%]	[%]
2025	BEV	el. grid	---	---	1.079	1.225	0	0	0.0%	-100.0%	-54.8%
2025	FC EV	H2	---	3.877	1.755	---	0	0	0.0%	-100.0%	-35.2%
2025	CEV	el. road	---	---	1.065	1.073	0	0	0.0%	-100.0%	-60.4%

Table 44: Results group 5 Long Haul 2016 for ICE only configurations with weighted payload (14290 kg)

Group 5											
Model year	Propulsion system ID	Fuel ID	Fuel consumption		Energy consumption	CO2	CO2equ	Share CH4, N2O on CO2equ	CO2equ deviation to ICE CI B7	Energy consumption deviation to ICE CI B7	
			liquid	gasous							
			[l/100km]	[kg/100km]	[MJ/tkm]	[g/tkm]	[g/tkm]	[%]	[%]	[%]	
2016	ICE CI	B0	29.04	---	0.7292	53.38	55.52	3.9%	-0.3%	0.0%	
2016	ICE CI	B7	29.20	---	0.7292	53.52	55.66	3.8%	---	---	
2016	ICE CI	B100	31.49	---	0.7295	55.58	57.72	3.7%	3.7%	0.0%	
2016	ICE CI	Paraffinic Diesel	30.36	---	0.7291	51.62	53.76	4.0%	-3.4%	0.0%	
2016	ICE CI	ED95	50.03	---	0.7292	51.96	54.10	4.0%	-2.8%	0.0%	
2016	ICE CI	DME	54.71	---	0.7293	49.07	51.21	4.2%	-8.0%	0.0%	
2016	ICE CI	OME	51.00	---	0.7294	60.78	62.93	3.4%	13.0%	0.0%	
2016	ICE CI	LNG-HPDI	2.238	20.34	0.7550	43.54	46.38	6.1%	-16.7%	3.5%	
2016	ICE PI	CNG	---	27.10	0.9097	51.09	51.79	1.4%	-7.0%	24.8%	
2016	ICE PI	LNG	---	26.49	0.9103	51.36	52.24	1.7%	-6.2%	24.8%	

Table 45: Results group 5 Long Haul 2025 for ICE only configurations with weighted payload (14290 kg)

Group 5											
Model year	Propulsion system ID	Fuel ID	Fuel consumption		Energy consumption	CO2	CO2equ	Share CH4, N2O on CO2equ	CO2equ deviation to ICE CI B7	Energy consumption deviation to ICE CI B7	
			liquid	gasous							
			[l/100km]	[kg/100km]	[MJ/tkm]	[g/tkm]	[g/tkm]	[%]	[%]	[%]	
2025	ICE CI	B0	26.30	---	0.6603	48.34	50.31	3.9%	-0.3%	0.0%	
2025	ICE CI	B7	26.44	---	0.6604	48.47	50.44	3.9%	---	---	
2025	ICE CI	B100	28.51	---	0.6606	50.33	52.30	3.8%	3.7%	0.0%	
2025	ICE CI	Paraffinic Diesel	27.49	---	0.6603	46.75	48.72	4.0%	-3.4%	0.0%	
2025	ICE CI	ED95	45.31	---	0.6604	47.06	49.03	4.0%	-2.8%	0.0%	
2025	ICE CI	DME	49.54	---	0.6604	44.44	46.40	4.2%	-8.0%	0.0%	
2025	ICE CI	OME	46.18	---	0.6605	55.04	57.02	3.5%	13.0%	0.0%	
2025	ICE CI	LNG-HPDI	2.148	18.36	0.6846	39.53	42.15	6.2%	-16.4%	3.7%	
2025	ICE PI	CNG	---	24.73	0.8299	46.61	47.26	1.4%	-6.3%	25.7%	
2025	ICE PI	LNG	---	24.16	0.8303	46.84	47.68	1.8%	-5.5%	25.7%	

Table 46: Results group 5 Long Haul 2016 for HEV configurations with weighted payload (14290 kg)

Group 5											
Model year	Propulsion system ID	Fuel ID	Fuel consumption		Energy consumption	CO2	CO2equ	Share CH4, N2O on CO2equ	CO2equ deviation to ICE CI B7	Energy consumption deviation to ICE CI B7	
			liquid	gasous							
			[l/100km]	[kg/100km]	[MJ/tkm]	[g/tkm]	[g/tkm]	[%]	[%]	[%]	
2016	ICE CI + HEV	B7	27.53	---	0.6874	50.46	52.46	3.8%	-5.7%	-5.7%	
2016	ICE PI + HEV	LNG	---	25.43	0.8739	49.30	50.06	1.5%	-10.1%	19.8%	

Table 47: Results group 5 Long Haul 2025 for HEV configurations with weighted payload (14290 kg)

Group 5										
Model year	Propulsion system ID	Fuel ID	Fuel consumption		Energy consumption	CO2	CO2equ	Share CH4, N2O on CO2equ	CO2equ deviation to ICE CI B7	Energy consumption deviation to ICE CI B7
			liquid	gasous						
			[l/100km]	[kg/100km]	[MJ/tkm]	[g/tkm]	[g/tkm]	[%]	[%]	[%]
2025	ICE CI + HEV	B7	24.48	---	0.6114	44.87	46.68	3.9%	-7.4%	-7.4%
2025	ICE PI + HEV	LNG	---	23.14	0.7955	44.88	45.60	1.6%	-9.6%	20.5%

Table 48: Results group 5 Long Haul 2016 for BEV, FCEV and CEV configurations with weighted payload (13064 kg for BEV, 14290 kg for all others)

Group 5											
Model year	Propulsion system ID	Fuel ID	Fuel consumption		Energy consumption w.o. charging losses	Energy consumption w. charging losses	CO2	CO2equ	Share CH4, N2O on CO2equ	CO2equ deviation to ICE CI B7	Energy consumption deviation to ICE CI B7
			liquid	gasous							
			[l/100km]	[kg/100km]	[MJ/tkm]	[MJ/tkm]	[g/tkm]	[g/tkm]	[%]	[%]	[%]
2016	BEV	el. grid	---	---	0.3731	0.424	0	0	0.0%	-100.0%	-41.9%
2016	FC EV	H2	---	6.943	0.5829	---	0	0	0.0%	-100.0%	-20.1%
2016	CEV	el. road	---	---	0.3424	0.344	0	0	0.0%	-100.0%	-52.8%

Table 49: Results group 5 Long Haul 2025 for BEV, FCEV and CEV configurations with weighted payload (14290 kg)

Group 5											
Model year	Propulsion system ID	Fuel ID	Fuel consumption		Energy consumption w.o. charging losses	Energy consumption w. charging losses	CO2	CO2equ	Share CH4, N2O on CO2equ	CO2equ deviation to ICE CI B7	Energy consumption deviation to ICE CI B7
			liquid	gasous							
			[l/100km]	[kg/100km]	[MJ/tkm]	[MJ/tkm]	[g/tkm]	[g/tkm]	[%]	[%]	[%]
2025	BEV	el. grid	---	---	0.2889	0.328	0	0	0.0%	-100.0%	-50.3%
2025	FC EV	H2	---	5.712	0.4795	---	0	0	0.0%	-100.0%	-27.4%
2025	CEV	el. road	---	---	0.2843	0.286	0	0	0.0%	-100.0%	-56.9%

7 Summary findings

This study is the first comprehensive analysis comparing TTW fuel and energy consumption as well as CO₂-equivalent emissions of different HDV propulsion concepts for typical European applications. The assessment is based on the methods (component data, VECTO software tool, cycles etc.) as defined in Regulation (EU) 2017/2400 on the CO₂ certification of HDV. For evaluation of propulsion systems not yet covered in this legislation, consistent approaches have been applied.

The main conclusions drawn from the comparison of propulsion systems are summarised below. The comparison takes into account the performance of the complete vehicle e.g. including effects from vehicle mass differences. Compared to the simulation results as given in chapter 6 the numbers stated below are rounded figures with extended ranges to account for uncertainties in the assessment.

TTW energy consumption:

- Vehicles operated with single fuel positive ignition (PI) natural gas (NG) engines have some 20% to 25% higher energy consumption compared to vehicles using conventional Diesel technology.
- Energy consumption of dual-fuelled LNG (-Diesel) HPDI vehicles is very close to conventional Diesel technology.
- In the configuration of electric components as analysed in this study hybrid electric vehicles (HEV) have some 5% energetic advantage in long-haul and some 5% to 10% energetic advantage in regional delivery missions compared to their ICE-engine only counterparts. Clearly higher energy saving potentials can be expected by hybridisation for urban delivery missions.
- For the analysed xEV concepts catenary electric vehicles (CEV, electric road) were analysed to have the lowest TTW energy consumption (some -50% to -60% compared to conventional Diesel) followed by battery electric vehicles (BEV, approx. -40% to -55% compared to conventional Diesel). The CEV propulsion concept has the advantage of lower vehicle weight caused by a smaller battery and lower energy losses in the electric system when compared to a BEV propulsion system. Fuel cell electric vehicles (FCEV) were calculated with some 20% to 35% lower TTW energy consumption compared to a conventional Diesel vehicle. In comparison to BEV and CEV technology the energy consumption of FCEV additionally includes the energy losses in the fuel cell.
- Analysed propulsion systems do vary in performance criteria like operating range, payload capacities or fuelling time. These characteristics have to be taken into consideration in a complete comparison of different concepts.

TTW CO₂ equivalent emissions:

- Alternative fuels in used in Diesel CI engines can change the TTW CO₂ equivalent emissions compared to market blend B7 Diesel from -8% (DiMethyl Ether, DME) to + 13% (OxyMethylene Ether, OME) due to differences in the LHV specific carbon content of the fuel.
- PI engine driven vehicles using CNG or LNG have some 5% to 10% lower TTW CO₂ equivalent emissions than conventional Diesel technology. This mainly results from the fact that the energetic disadvantage is overcompensated by the lower energy specific carbon content of NG (ca. -23% compared to B7).
- TTW CO₂ equivalent emissions of dual-fuelled LNG (-Diesel) HPDI vehicles are some 15% to 20% lower than conventional Diesel technology due to the use of high shares of NG.
- Advantages of HEVs compared to ICE-only powertrains regarding TTW CO₂ equivalent emissions are similar than for energy consumption (numbers see paragraph above).
- For BEV, CEV and FCEV propulsion systems TTW CO₂ equivalent emissions are zero per definition.

8 References

- [ACEA, 2016] White Book on CO₂ declaration procedure HDV ACEA Workgroup-CO₂HDV; Version White Book April 2016
- [ACEA, 2017] ACEA Third-party assessment; Reducing CO₂ from trucks: progress in practice; April-2017
- [Brusa, 2018] Online; Battery datasheet Brusa; https://www.brusa.biz/files/drive/05_Sales/Datasheets//BRUSA_DB_EN_EVB1.pdf; downloaded on the 16.04.2018
- [BU, 2018] Online; Battery University; Types of Lithium-ion; http://batteryuniversity.com/learn/article/types_of_lithium_ion, downloaded on the 01.06.2018
- [Daimler, 2018] Online; Daimler; Elektrische Vision. Der E-FUSO Vision One; <https://www.daimler.com/innovation/case/electric/efuso.html>; downloaded on the 05.06.2018
- [Eforce, 2018] Online; EFORCE ONE AG; E-TRUCKS; <http://eforce.ch/e-trucks.html>; downloaded on the 05.06.2018
- [ETRM, 2016] ETRMA Position paper; Low Emission Mobility Focus on Freight Transport; Brussels, 14.11.2016
- [EU, 2017] Commission Regulation (EU) 2017/2400 of 12 December 2017 implementing Regulation (EC) No 595/2009 of the European Parliament and of the Council as regards the determination of the CO₂ emissions and fuel consumption of heavy-duty vehicles
- [EU, 2018] Commission proposal for a regulation of the European Parliament and of the Council setting CO₂ emission performance standards for new heavy-duty vehicles; COM(2018) 284 final; Brussels, 17.5.2018
- [Getzlaff, 2012] Getzlaff, Jörn; Habilitationsschrift; Erdgas als Kraftstoff für Kfz – Verbrennungsmotoren; Althirschstein, Juli 2012
- [Lastauto Omnibus, 2018] Lastauto Omnibus; 1-2 2018; Vol 95; pp. 18-24
- [Huss, 2013] Huss A., Maas H., Hass H.; Well-To-Wheels Analyses of Future Automotive Fuels and Powertrains in the European Context, Tank-to-Wheel Report; JEC; 2013
- [Lipp, 2017] Lipp, Silke; Hausberger, Stefan; Schreiber, Lukas; Measurement and simulation of hybrid and plug in hybrid vehicles for the handbook of emission factors; Institute for Internal Combustion Engines and Thermodynamics, Graz University of Technology; Graz, 2017
- [Luz, 2011] Luz, Raphael; Hausberger, Stefan; Rexeis, Martin; et al.: Optimisation tool for Hybrid Electric Recuperation and Operation Strategies. Endbericht des Projektes „HERO“ finanziert im Rahmen der 2. Ausschreibung der Programmlinie a3plus des Forschungs- und Technologieprogramms iv2splus. Graz, 30.5.2011
- [Magnusson, 2012] Magnusson, Ingemar; (Volvo Technology Corporation); 2012; Natural Gas Optimized Advanced Heavy-Duty Engine; California Energy Commission. Publication number CEC-500-2013-144
- [Renhart, 2010] Renhart W., Magele C., Hausberger S., Zallinger M., Luz R.; Recent NiMH-battery Modeling Supported by Finite Element Thermal Analysis, 20. Symposium on Power Electronics, Electrical Drivers, Automation and Motion (SPEEDAM), Pisa, 14.-16.06.2010
- [Rexeis, 2009] Ascertainment of Real World Emissions of Heavy Duty Vehicles; PHD at University of Technology Graz; 2009
- [Rexeis, 2017] Rexeis, Martin; Quaritsch, Markus; Hausberger, Stefan; Silberholz, Gerard; Steven, Heinz, Goschütz, Martin; Vermeulen Robin; VECTO tool development: Completion of methodology to simulate Heavy

Duty Vehicles' fuel consumption and CO₂ emissions.Final Report By order of EUROPEAN COMMISSION DG CLIMA Report No. I 15/17/Rex EM-I 2013/08 1670 from 07.08.2017

https://ec.europa.eu/clima/sites/clima/files/transport/vehicles/docs/sr7_lot4_final_report_en.pdf

[Thielmann, 2012] Thielmann, Axel; Produkt-Roadmap Lithium-Ionen-Batterien 2030; Fraunhofer-Institut für System und Innovationsforschung ISI; Karlsruhe, Februar 2012

[Thielmann, 2015] Thielmann, Axel; Sauer, Andreas; Wietschel, Martin; Gesamt-Roadmap Energiespeicher für die Elektromobilität 2030; Fraunhofer-Institut für System und Innovationsforschung ISI; Karlsruhe, Dezember 2015

[TNO, 2017] Vermeulen, Robin; Verbeek, Ruud; van Goethem, San; Smokers, Richard; TNO 2017 R11336; Emissions testing of two Euro VI LNG-heavy

[UNFCCC, 2014] Report of the conference of the Parties on its nineteenth session, held in Warsaw from 11 to 23 November 2013

[Westport, 2013] John, Howell; Jim, Harger; Presentation: CNG and LNG: What's Best for Your Fleet?; Westport; June 20, 2013

[Wietschel, 2017] Wietschel, Martin et al; Machbarkeitsstudie zu Ermittlung der Potentiale des Hybrid-Oberleitungs-LKW; Bundesministerium für Verkehr und Digitale Infrastruktur (BMVI); Karlsruhe; Februar 2017

Annex I: Results for vehicle group 4 on Urban Delivery cycle

Group 4 rigid trucks were additionally simulated in the “Urban Delivery” mission profile (Figure 32). This cycle is actually just available in a draft version and shall be updated for CO₂ certification in VECTO in late 2018. In the simulations except for the cycle the same vehicle specifications and input parameters as those applied for the Regional Delivery cycle have been used.

Figure 32: Velocity and gradient profile of the Urban Delivery cycle

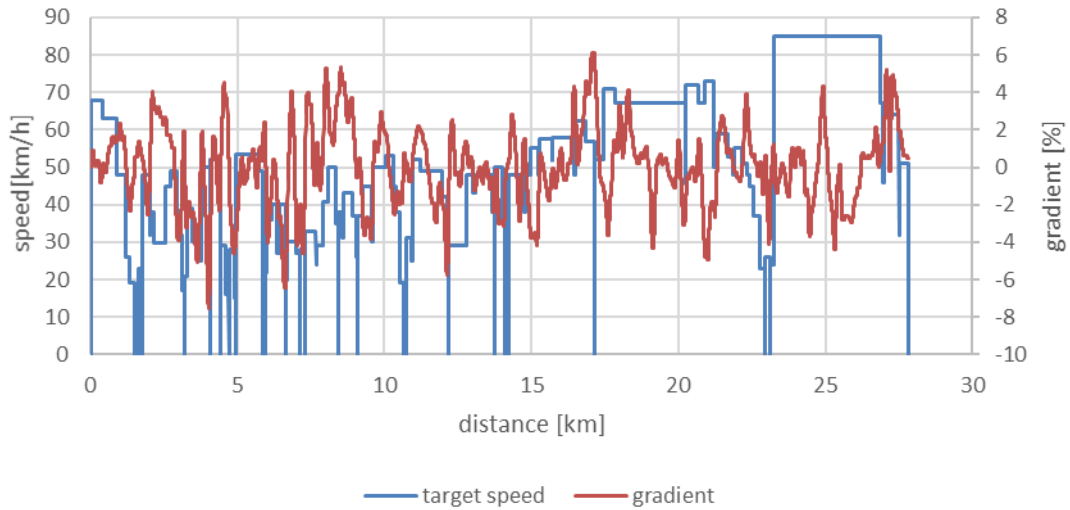
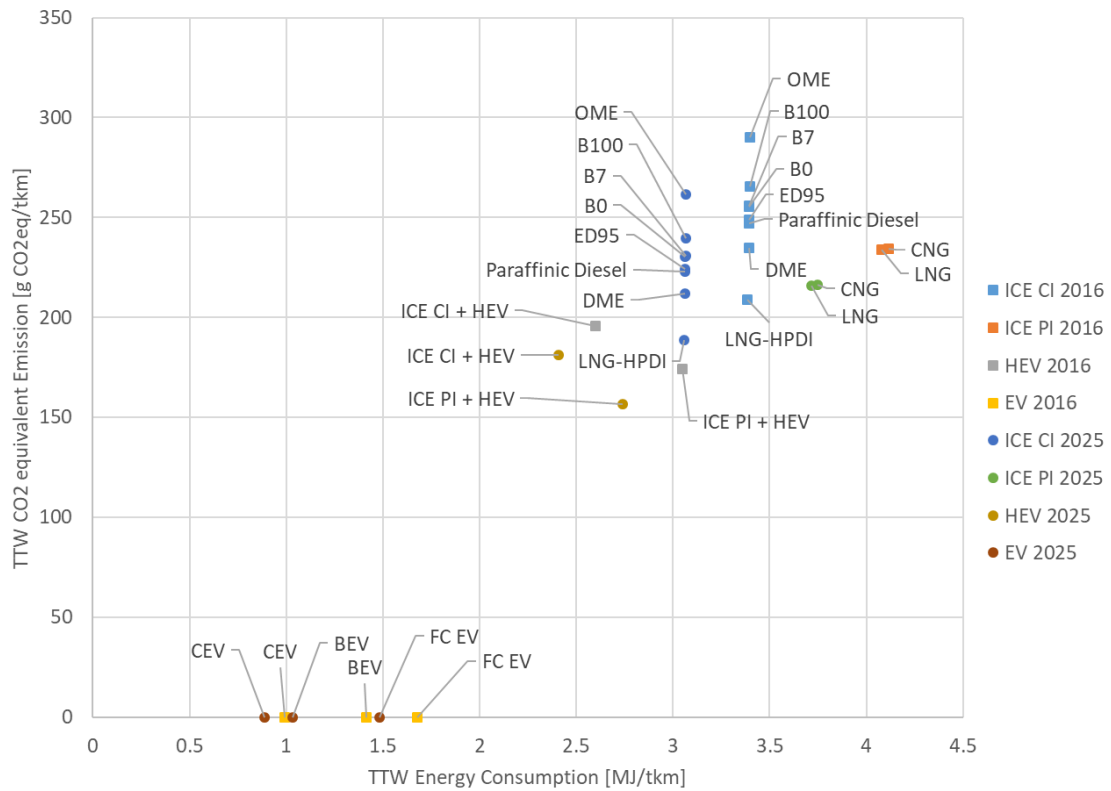

Figure 33 gives the summary of the results for energy consumption and CO₂ equivalent for both model years. The most striking difference in the ranking of propulsion concepts between the RD and UD cycle is the significant higher energy saving potential from HEV technology. The UD cycle has a more transient speed profile as the RD cycle which leads to an increase of the regenerated brake energy. Compared to ICE only vehicles HEVs were simulated with some 25% less energy consumption and CO₂ emissions.

Figure 33: Summary results vehicle group 4 (Urban Delivery)



Group 4; VECTO Urban-Delivery cycle; Weighted payload (2650 kg)
 Analysed propulsion systems do vary in performance criteria like operating range, payload capacity or fuelling time

Figure 34 to Figure 37 show the separate ranking between different propulsion systems for CO₂ equivalent emissions and energy consumption of group 4 vehicles for the model years 2016 and 2025 on the Urban Delivery cycle.

Figure 34: Group 4 vehicles model year 2016 - energy consumption (Urban Delivery)

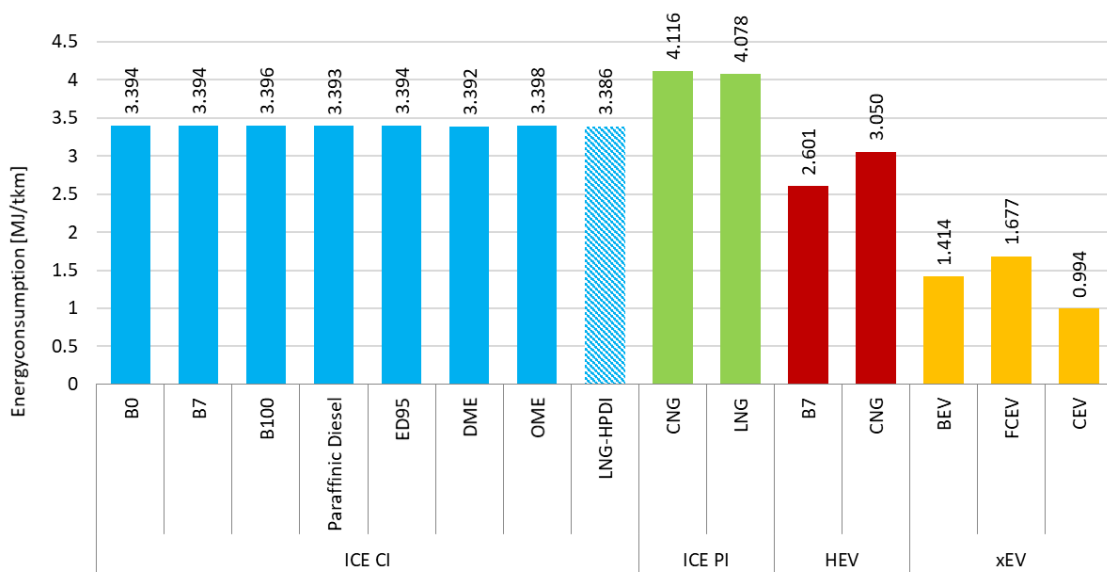

Group 4; VECTO Urban-Delivery cycle; Weighted payload (2650 kg)

Figure 35: Group 4 vehicles model year 2016 – CO₂equivalent emissions (Urban Delivery)

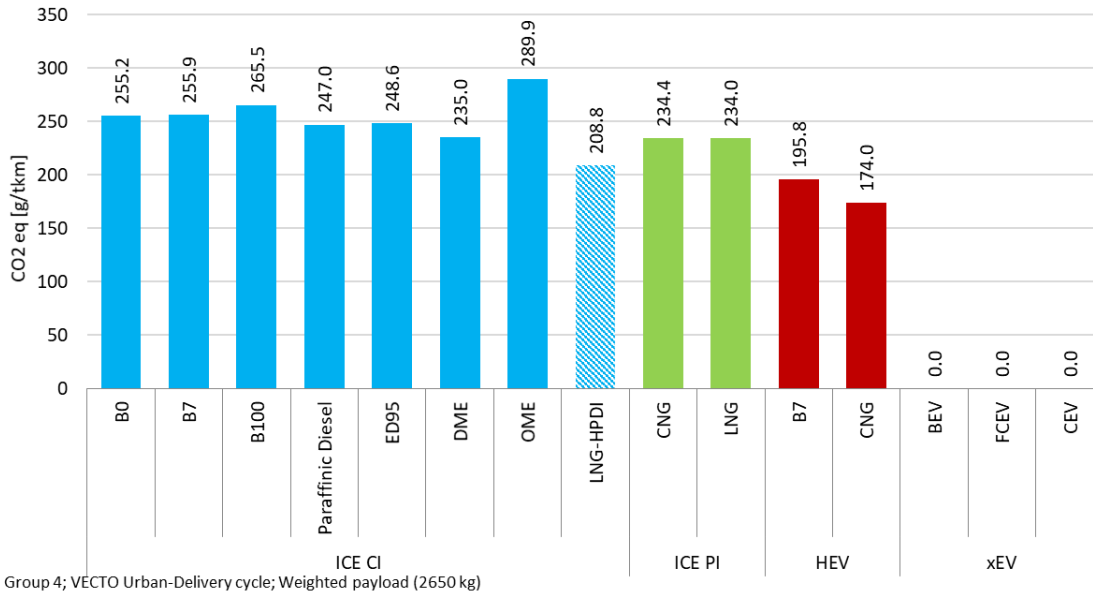

Figure 36: Group 4 vehicles model year 2025 - energy consumption (Urban Delivery)

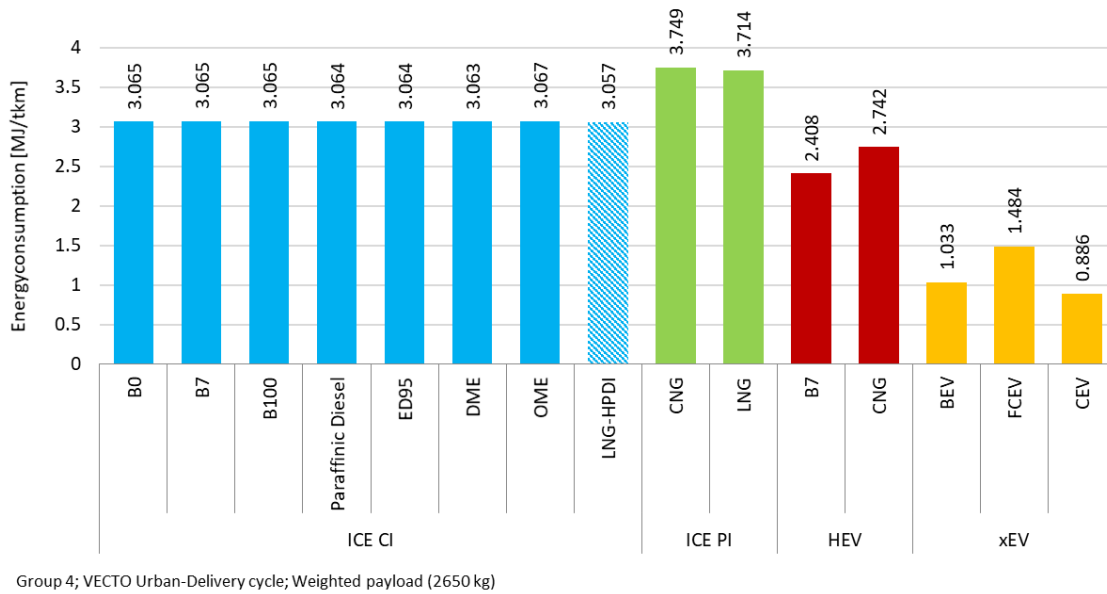
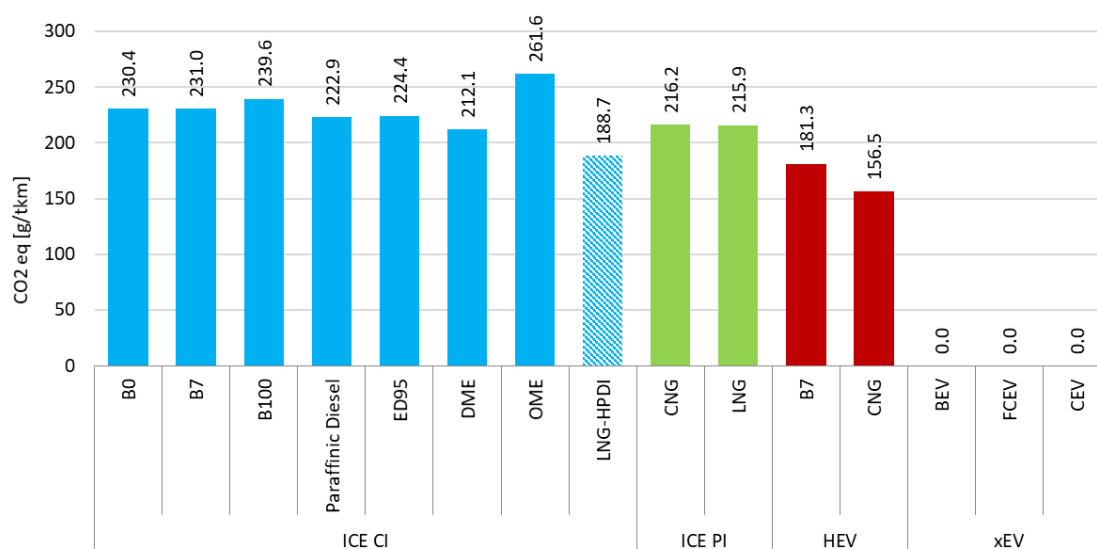

Figure 37: Group 4 vehicles model year 2025 – CO₂equivalent emissions (Urban Delivery)



Group 4; VECTO Urban-Delivery cycle; Weighted payload (2650 kg)

Table 50 to **Table 54** give the complete set of payload weighted results for the group 4 vehicle in Urban Delivery.

Table 50: Results group 4 Urban Delivery 2016 for ICE only configurations 2016 with weighted payload (2650 kg)

Group 4 UD											
Model year	Propulsion system ID	Fuel ID	Fuel consumption		Energy consumption	CO ₂	CO ₂ eq	Share CH ₄ , N ₂ O on CO ₂ eq	CO ₂ eq deviation to ICE CI B7	Energy consumption deviation to ICE CI B7	
			liquid	gasous				[%]	[%]	[%]	
			[l/100km]	[kg/100km]	[MJ/tkm]	[g/tkm]	[g/tkm]				
2016	ICE CI	B0	25.07	20.86	3.394	248.5	255.2	2.6%	-0.3%	0.0%	
2016	ICE CI	B7	25.21	21.07	3.394	249.1	255.9	2.6%	---	---	
2016	ICE CI	B100	27.19	24.20	3.396	258.8	265.5	2.5%	3.8%	0.1%	
2016	ICE CI	Paraffinic Diesel	26.20	20.44	3.393	240.2	247.0	2.7%	-3.5%	0.0%	
2016	ICE CI	ED95	43.18	35.41	3.394	241.9	248.6	2.7%	-2.8%	0.0%	
2016	ICE CI	DME	47.19	31.62	3.392	228.3	235.0	2.9%	-8.2%	-0.1%	
2016	ICE CI	OME	44.06	46.99	3.398	283.1	289.9	2.3%	13.3%	0.1%	
2016	ICE CI	LNG-HPDI	0.915	15.88	3.386	198.6	208.8	4.9%	-18.4%	-0.2%	
2016	ICE PI	CNG	---	22.74	4.116	231.1	234.4	1.4%	-8.4%	21.3%	
2016	ICE PI	LNG	---	22.00	4.078	230.1	234.0	1.7%	-8.6%	20.1%	

Table 51: Results group 4 Urban Delivery 2025 for ICE only configurations with weighted payload (2650 kg)

Group 4 UD											
Model year	Propulsion system ID	Fuel ID	Fuel consumption		Energy consumption	CO2	CO2equ	Share CH4, N2O on CO2equ	CO2equ deviation to ICE CI B7	Energy consumption deviation to ICE CI B7	
			liquid	gasous	[MJ/tkm]	[g/tkm]	[g/tkm]	[%]	[%]	[%]	
			[l/100km]	[kg/100km]							
2025	ICE CI	B0	22.92	18.83	3.065	224.3	230.4	2.6%	-0.3%	0.0%	
2025	ICE CI	B7	23.05	19.03	3.065	225.0	231.0	2.6%	0.0%	0.0%	
2025	ICE CI	B100	24.85	21.84	3.065	233.5	239.6	2.5%	3.7%	0.0%	
2025	ICE CI	Paraffinic Diesel	23.96	18.45	3.064	216.9	222.9	2.7%	-3.5%	0.0%	
2025	ICE CI	ED95	39.49	31.97	3.064	218.4	224.4	2.7%	-2.8%	0.0%	
2025	ICE CI	DME	43.15	28.55	3.063	206.1	212.1	2.8%	-8.2%	-0.1%	
2025	ICE CI	OME	40.27	42.42	3.067	255.6	261.6	2.3%	13.3%	0.1%	
2025	ICE CI	LNG-HPDI	0.851	14.27	3.057	179.5	188.7	4.9%	-18.3%	-0.2%	
2025	ICE PI	CNG	---	20.71	3.749	213.2	216.2	1.4%	-6.4%	22.3%	
2025	ICE PI	LNG	---	20.04	3.714	212.2	215.9	1.7%	-6.5%	21.2%	

Table 52: Results group 4 Urban Delivery 2016 for HEV configurations with weighted payload (2650 kg)

Group 4 UD											
Model year	Propulsion system ID	Fuel ID	Fuel consumption		Energy consumption	CO2	CO2equ	Share CH4, N2O on CO2equ	CO2equ deviation to ICE CI B7	Energy consumption deviation to ICE CI B7	
			liquid	gasous	[MJ/tkm]	[g/tkm]	[g/tkm]	[%]	[%]	[%]	
			[l/100km]	[kg/100km]							
2016	ICE CI + HEV	B7	19.32	16.15	2.601	190.9	195.8	2.5%	-23.5%	-23.4%	
2016	ICE PI + HEV	CNG	---	16.85	3.050	171.3	174.0	1.6%	-32.0%	-10.2%	

Table 53: Results group 4 Urban Delivery 2025 for HEV configurations with weighted payload (2650 kg)

Group 4 UD											
Model year	Propulsion system ID	Fuel ID	Fuel consumption		Energy consumption	CO2	CO2equ	Share CH4, N2O on CO2equ	CO2equ deviation to ICE CI B7	Energy consumption deviation to ICE CI B7	
			liquid	gasous	[MJ/tkm]	[g/tkm]	[g/tkm]	[%]	[%]	[%]	
			[l/100km]	[kg/100km]							
2025	ICE CI + HEV	B7	17.88	14.95	2.408	176.8	181.3	2.5%	-21.5%	-21.4%	
2025	ICE PI + HEV	CNG	---	15.15	2.742	154.0	156.5	1.6%	-32.2%	-10.5%	

Table 54: Results group 4 Urban Delivery 2016 for BEV, FCEV and CEV configurations with weighted payload (2650 kg)

Group 4 UD											
Model year	Propulsion system ID	Fuel ID	Fuel consumption		Energy consumption w.o. charging losses	Energy consumption w. charging losses	CO2	CO2equ	Share CH4, N2O on CO2equ	CO2equ deviation to ICE CI B7	Energy consumption deviation to ICE CI B7
			liquid	gasous	[MJ/tkm]	[MJ/tkm]	[g/tkm]	[g/tkm]	[%]	[%]	[%]
			[l/100km]	[kg/100km]							
2016	BEV	el. grid	---	---	1.245	1.414	0	0	0.0%	-100.0%	-58.4%
2016	FC EV	H2	---	3.705	1.677	---	0	0	0.0%	-100.0%	-50.6%
2016	CEV	el. road	---	---	0.981	0.994	0	0	0.0%	-100.0%	-70.7%

Table 55: Results group 4 Urban Delivery 2025 for BEV, FCEV and CEV configurations with weighted payload (2650 kg)

Group 4 UD											
			Fuel consumption		Energy consumption w.o. charging losses	Energy consumption w. charging losses	CO2	CO2equ	Share CH4, N2O on CO2equ	CO2equ deviation to ICE CI B7	Energy consumption deviation to ICE CI B7
Model year	Propulsion system ID	Fuel ID	liquid	gasous	[MJ/tkm]	[MJ/tkm]	[g/tkm]	[g/tkm]	[%]	[%]	[%]
			[l/100km]	[kg/100km]							
2025	BEV	el. grid	---	---	0.910	1.033	0	0	0.0%	-100.0%	-66.3%
2025	FC EV	H2	---	3.278	1.484	---	0	0	0.0%	-100.0%	-51.6%
2025	CEV	el. road	---	---	0.880	0.886	0	0	0.0%	-100.0%	-71.1%

Annex II: Tabular results for single VECTO payloads

All powertrain configurations were calculated with the two generic VECTO payloads and then weighted according to the method as described in section 5.5 in order to achieve a representative loading of the fleet in the EU. This Annex lists all unweighted VECTO output results for der group 4 on RD cycle and group 5 on LH cycle.

Table 56: Results group 4 Regional Delivery for ICE only configurations (single payloads)

Group 4									
Model year	Propulsion system ID	Payload	Fuel ID	Fuel consumption		Energy consumption	CO2	CO2equ	Share CH4, N2O on CO2equ
				Liquid	Gasous	[MJ/tkm]	[g/tkm]	[g/tkm]	[%]
				[l/100km]	[kg/100km]				
2016	ICE CI	900	B0	21.02	---	8.379	613.4	635.2	3.4%
2016	ICE CI	4400	B0	23.13	---	1.886	138.1	143.1	3.5%
2016	ICE CI	900	B7	21.13	---	8.379	615.0	636.8	3.4%
2016	ICE CI	4400	B7	23.26	---	1.886	138.5	143.5	3.5%
2016	ICE CI	900	B100	22.79	---	8.383	638.6	660.4	3.3%
2016	ICE CI	4400	B100	25.08	---	1.887	143.8	148.8	3.4%
2016	ICE CI	900	Paraffinic Diesel	21.97	---	8.379	593.2	615.0	3.5%
2016	ICE CI	4400	Paraffinic Diesel	24.19	---	1.887	133.6	138.6	3.6%
2016	ICE CI	900	ED95	36.21	---	8.379	597.1	618.8	3.5%
2016	ICE CI	4400	ED95	39.85	---	1.886	134.4	139.5	3.6%
2016	ICE CI	900	DME	39.60	---	8.380	563.9	585.6	3.7%
2016	ICE CI	4400	DME	43.60	---	1.888	127.0	132.0	3.8%
2016	ICE CI	900	OME	36.90	---	8.379	698.3	720.1	3.0%
2016	ICE CI	4400	OME	40.61	---	1.886	157.2	162.2	3.1%
2016	ICE CI	900	LNG-HPDI	1.970	13.91	8.374	485.7	516.1	5.9%
2016	ICE CI	4400	LNG-HPDI	1.910	15.57	1.893	109.4	116.3	6.0%
2016	ICE PI	900	CNG	---	19.37	10.32	579.8	587.5	1.3%
2016	ICE PI	4400	CNG	---	21.02	2.291	128.7	130.4	1.3%
2016	ICE PI	900	LNG	---	18.64	10.17	573.7	583.5	1.7%
2016	ICE PI	4400	LNG	---	20.23	2.258	127.4	129.6	1.7%
2025	ICE CI	900	B0	19.24	---	7.593	555.8	575.8	3.5%
2025	ICE CI	4400	B0	21.24	---	1.707	125.0	129.6	3.6%
2025	ICE CI	900	B7	19.35	---	7.593	557.3	577.3	3.5%
2025	ICE CI	4400	B7	21.36	---	1.707	125.3	129.9	3.6%
2025	ICE CI	900	B100	20.86	---	7.596	578.7	598.7	3.3%
2025	ICE CI	4400	B100	23.03	---	1.708	130.1	134.7	3.4%
2025	ICE CI	900	Paraffinic Diesel	20.12	---	7.594	537.6	557.6	3.6%
2025	ICE CI	4400	Paraffinic Diesel	22.20	---	1.707	120.8	125.5	3.7%
2025	ICE CI	900	ED95	33.15	---	7.592	541.0	561.0	3.6%
2025	ICE CI	4400	ED95	36.59	---	1.707	121.6	126.3	3.7%
2025	ICE CI	900	DME	36.26	---	7.596	511.1	531.1	3.8%
2025	ICE CI	4400	DME	40.01	---	1.707	114.9	119.5	3.9%
2025	ICE CI	900	OME	33.79	---	7.595	632.9	652.9	3.1%
2025	ICE CI	4400	OME	37.29	---	1.707	142.3	146.9	3.2%
2025	ICE CI	900	LNG-HPDI	1.870	12.62	7.630	443.1	471.2	6.0%
2025	ICE CI	4400	LNG-HPDI	1.800	14.09	1.718	99.42	105.8	6.1%
2025	ICE PI	900	CNG	---	17.70	9.434	535.3	542.6	1.3%
2025	ICE PI	4400	CNG	---	19.14	2.086	118.9	120.5	1.4%
2025	ICE PI	900	LNG	---	17.04	9.299	530.1	539.3	1.7%
2025	ICE PI	4400	LNG	---	18.42	2.057	117.7	119.8	1.7%

Table 57: Results group 4 Regional Delivery for HEV configurations (single payloads)

Group 4									
Model year	Propulsion system ID	Payload	Fuel ID	Fuel consumption		Energy consumption	CO2	CO2equ	Share CH4, N2O on CO2equ
				Liquid	Gasous	[MJ/tkm]	[g/tkm]	[g/tkm]	[%]
				[l/100km]	[kg/100km]				
2016	ICE CI + HEV	900	B7	19.55	---	7.750	568.9	589.0	3.4%
2016	ICE CI + HEV	4400	B7	21.33	---	1.730	127.0	131.6	3.5%
2016	ICE PI + HEV	900	CNG	---	17.72	9.442	530.3	537.5	1.4%
2016	ICE PI + HEV	4400	CNG	---	19.12	2.084	117.0	118.7	1.4%
2025	ICE CI + HEV	900	B7	18.02	---	7.145	524.4	543.3	3.5%
2025	ICE CI + HEV	4400	B7	19.50	---	1.582	116.1	120.4	3.6%
2025	ICE PI + HEV	900	CNG	---	16.13	8.597	482.8	489.6	1.4%
2025	ICE PI + HEV	4400	CNG	---	17.30	1.886	105.9	107.4	1.4%

Table 58: Results group 4 Regional Delivery for BEV, FCEV and CEV configurations (single payloads)

Group 4										
Model year	Propulsion system ID	Payload	Fuel ID	Fuel consumption		Energy consumption w.o. charging losses	Energy consumption w. charging losses	CO2	CO2equ	Share CH4, N2O on CO2equ
				Liquid	Gasous	[MJ/tkm]	[MJ/tkm]	[g/tkm]	[g/tkm]	[%]
				[l/100km]	[kg/100km]					
2016	BEV	900	el. grid	---	---	3.539	4.017	0	0	0%
2016	BEV	4400	el. grid	---	---	0.801	0.909	0	0	0%
2016	FC EV	900	H2	---	4.223	0	---	0	0	0%
2016	FC EV	4400	H2	---	4.707	0	---	0	0	0%
2016	CEV	900	el. road	---	---	3.251	3.295	0	0	0%
2016	CEV	4400	el. road	---	---	0.745	0.755	0	0	0%
2025	BEV	900	el. grid	---	---	3.026	3.435	0	0	0%
2025	BEV	4400	el. grid	---	---	0.681	0.773	0	0	0%
2025	FC EV	900	H2	---	3.667	0	---	0	0	0%
2025	FC EV	4400	H2	---	4.087	0	---	0	0	0%
2025	CEV	900	el. road	---	---	2.977	3.001	0	0	0%
2025	CEV	4400	el. road	---	---	0.674	0.679	0	0	0%

Table 59: Results group 4 Urban Delivery for ICE only configurations (single payloads)

Group 4 UD									
Model year	Propulsion system ID	Payload	Fuel ID	Fuel consumption		Energy consumption	CO2	CO2equ	Share CH4, N2O on CO2equ
				Liquid	Gasous	[MJ/tkm]	[g/tkm]	[g/tkm]	[%]
				[l/100km]	[kg/100km]				
2016	ICE CI	900	B0	23.04	---	9.185	672.4	689.6	2.5%
2016	ICE CI	4400	B0	27.10	---	2.210	161.8	166.4	2.8%
2016	ICE CI	900	B7	23.17	---	9.186	674.2	691.4	2.5%
2016	ICE CI	4400	B7	27.25	---	2.210	162.2	166.8	2.8%
2016	ICE CI	900	B100	24.99	---	9.192	700.3	717.5	2.4%
2016	ICE CI	4400	B100	29.38	---	2.211	168.5	173.1	2.7%
2016	ICE CI	900	Paraffinic Diesel	24.08	---	9.182	650.1	667.3	2.6%
2016	ICE CI	4400	Paraffinic Diesel	28.32	---	2.209	156.4	161.0	2.9%
2016	ICE CI	900	ED95	39.69	---	9.185	654.5	671.7	2.6%
2016	ICE CI	4400	ED95	46.68	---	2.210	157.5	162.1	2.9%
2016	ICE CI	900	DME	43.33	---	9.170	617.0	634.2	2.7%
2016	ICE CI	4400	DME	51.06	---	2.210	148.7	153.3	3.0%
2016	ICE CI	900	OME	40.50	---	9.196	766.3	783.6	2.2%
2016	ICE CI	4400	OME	47.62	---	2.212	184.3	189.0	2.5%
2016	ICE CI	900	LNG-HPDI	0.9298	14.33	9.147	538.5	565.3	4.7%
2016	ICE CI	4400	LNG-HPDI	0.9003	17.43	2.208	129.0	135.9	5.0%
2016	ICE PI	900	CNG	---	21.17	11.28	633.7	642.5	1.4%
2016	ICE PI	4400	CNG	---	24.31	2.650	148.8	150.9	1.4%
2016	ICE PI	900	LNG	---	20.47	11.17	630.3	641.2	1.7%
2016	ICE PI	4400	LNG	---	23.53	2.627	148.2	150.7	1.7%
2025	ICE CI	900	B0	20.99	---	8.284	606.4	621.6	2.4%
2025	ICE CI	4400	B0	24.85	---	1.997	146.2	150.3	2.8%
2025	ICE CI	900	B7	21.11	---	8.284	608.1	623.2	2.4%
2025	ICE CI	4400	B7	24.98	---	1.997	146.6	150.7	2.7%
2025	ICE CI	900	B100	22.75	---	8.282	631.0	646.1	2.4%
2025	ICE CI	4400	B100	26.95	---	1.999	152.3	156.4	2.7%
2025	ICE CI	900	Paraffinic Diesel	21.94	---	8.281	586.3	601.4	2.5%
2025	ICE CI	4400	Paraffinic Diesel	25.97	---	1.997	141.4	145.5	2.8%
2025	ICE CI	900	ED95	36.17	---	8.283	590.3	605.4	2.5%
2025	ICE CI	4400	ED95	42.80	---	1.997	142.3	146.4	2.8%
2025	ICE CI	900	DME	39.52	---	8.277	557.0	572.1	2.6%
2025	ICE CI	4400	DME	46.78	---	1.996	134.3	138.4	3.0%
2025	ICE CI	900	OME	36.87	---	8.287	690.6	705.9	2.2%
2025	ICE CI	4400	OME	43.67	---	1.999	166.6	170.8	2.4%
2025	ICE CI	900	LNG-HPDI	0.8689	12.84	8.246	486.2	510.3	4.7%
2025	ICE CI	4400	LNG-HPDI	0.8326	15.71	1.996	116.7	123.0	5.1%
2025	ICE PI	900	CNG	---	19.25	10.26	582.2	590.5	1.4%
2025	ICE PI	4400	CNG	---	22.17	2.417	137.7	139.7	1.4%
2025	ICE PI	900	LNG	---	18.62	10.16	579.2	589.5	1.7%
2025	ICE PI	4400	LNG	---	21.46	2.395	137.1	139.5	1.7%

Table 60: Results group 4 Urban Delivery for HEV configurations (single payloads)

Group 4 UD									
Model year	Propulsion system ID	Payload	Fuel ID	Fuel consumption		Energy consumption	CO2	CO2equ	Share CH4, N2O on CO2equ
				Liquid	Gasous	[MJ/tkm]	[g/tkm]	[g/tkm]	[%]
				[l/100km]	[kg/100km]				
2016	ICE CI + HEV	900	B7	17.73	14.83	7.032	516.1	528.4	2.3%
2016	ICE CI + HEV	4400	B7	20.90	17.47	1.695	124.4	127.8	2.6%
2016	ICE PI + HEV	900	CNG	---	15.65	8.341	468.4	475.9	1.6%
2016	ICE PI + HEV	4400	CNG	---	18.05	1.967	110.5	112.2	1.6%
2025	ICE CI + HEV	900	B7	16.55	13.84	6.563	481.7	493.1	2.3%
2025	ICE CI + HEV	4400	B7	19.22	16.07	1.559	114.4	117.5	2.6%
2025	ICE PI + HEV	900	CNG	---	14.04	7.484	420.3	427.2	1.6%
2025	ICE PI + HEV	4400	CNG	---	16.26	1.772	99.53	101.2	1.6%

Table 61: Results group 4 Urban Delivery for BEV, FCEV and CEV configurations (single payloads)

Group 4 UD										
Model year	Propulsion system ID	Payload	Fuel ID	Fuel consumption		Energy consumption w.o. charging losses [MJ/tkm]	Energy consumption w. charging losses [MJ/tkm]	CO2 [g/tkm]	CO2equ [g/tkm]	Share CH4, N2O on CO2equ [%]
				Liquid [l/100km]	Gasous [kg/100km]					
2016	BEV	900	el. grid	---	---	3.263	3.704	0	---	0%
2016	BEV	4400	el. grid	---	---	0.833	0.945	0	---	0%
2016	FC EV	900	H2	---	3.416	0	---	0	---	0%
2016	FC EV	4400	H2	---	3.993	0	---	0	---	0%
2016	CEV	900	el. road	---	---	2.604	2.640	0	---	0%
2016	CEV	4400	el. road	---	---	0.648	0.657	0	---	0%
2025	BEV	900	el. grid	---	---	2.446	2.776	0	---	0%
2025	BEV	4400	el. grid	---	---	0.596	0.676	0	---	0%
2025	FC EV	900	H2	---	2.966	0	---	0	---	0%
2025	FC EV	4400	H2	---	3.591	0	---	0	---	0%
2025	CEV	900	el. road	---	---	2.351	2.370	0	---	0%
2025	CEV	4400	el. road	---	---	0.579	0.583	0	---	0%

Table 62: Results group 5 Long Haul for ICE only configurations (single payloads)

Group 5										
Model year	Propulsion system ID	Payload	Fuel ID	Fuel consumption		Energy consumption [MJ/tkm]	CO2 [g/tkm]	CO2equ [g/tkm]	Share CH4, N2O on CO2equ [%]	
				Liquid [l/100km]	Gasous [kg/100km]					
2016	ICE CI	2600	B0	23.86	---	3.293	241.1	250.4	3.7%	
2016	ICE CI	19300	B0	31.26	---	0.581	42.54	44.27	3.9%	
2016	ICE CI	2600	B7	24.00	---	3.294	241.7	251.0	3.7%	
2016	ICE CI	19300	B7	31.43	---	0.581	42.66	44.38	3.9%	
2016	ICE CI	2600	B100	25.88	---	3.296	251.1	260.4	3.6%	
2016	ICE CI	19300	B100	33.89	---	0.581	44.29	46.02	3.8%	
2016	ICE CI	2600	Paraffinic Diesel	24.95	---	3.293	233.1	242.4	3.8%	
2016	ICE CI	19300	Paraffinic Diesel	32.68	---	0.581	41.14	42.87	4.0%	
2016	ICE CI	2600	ED95	41.11	---	3.293	234.7	244.0	3.8%	
2016	ICE CI	19300	ED95	53.85	---	0.581	41.41	43.14	4.0%	
2016	ICE CI	2600	DME	44.96	---	3.294	221.6	230.9	4.0%	
2016	ICE CI	19300	DME	58.89	---	0.581	39.11	40.84	4.2%	
2016	ICE CI	2600	OME	41.93	---	3.296	274.7	284.0	3.3%	
2016	ICE CI	19300	OME	54.88	---	0.581	48.43	50.16	3.5%	
2016	ICE CI	2600	LNG-HPDI	2.325	16.37	3.411	197.8	210.3	5.9%	
2016	ICE CI	19300	LNG-HPDI	2.200	22.05	0.602	34.63	36.91	6.2%	
2016	ICE PI	2600	CNG	---	---	22.90	4.224	237.2	240.4	1.3%
2016	ICE PI	19300	CNG	---	---	28.91	0.718	40.34	40.90	1.4%
2016	ICE PI	2600	LNG	---	---	22.38	4.228	238.5	242.7	1.7%
2016	ICE PI	19300	LNG	---	---	28.24	0.719	40.55	41.24	1.7%
2025	ICE CI	2600	B0	21.49	---	2.966	217.1	225.5	3.7%	
2025	ICE CI	19300	B0	28.36	---	0.527	38.60	40.19	4.0%	
2025	ICE CI	2600	B7	21.61	---	2.966	217.7	226.1	3.7%	
2025	ICE CI	19300	B7	28.51	---	0.527	38.70	40.30	4.0%	
2025	ICE CI	2600	B100	23.30	---	2.967	226.1	234.5	3.6%	
2025	ICE CI	19300	B100	30.75	---	0.527	40.19	41.78	3.8%	
2025	ICE CI	2600	Paraffinic Diesel	22.47	---	2.965	209.9	218.4	3.9%	
2025	ICE CI	19300	Paraffinic Diesel	29.65	---	0.527	37.33	38.92	4.1%	
2025	ICE CI	2600	ED95	37.02	---	2.966	211.3	219.8	3.8%	
2025	ICE CI	19300	ED95	48.86	---	0.527	37.57	39.17	4.1%	
2025	ICE CI	2600	DME	40.48	---	2.965	199.5	207.9	4.0%	
2025	ICE CI	19300	DME	53.43	---	0.527	35.48	37.08	4.3%	
2025	ICE CI	2600	OME	37.75	---	2.967	247.3	255.7	3.3%	
2025	ICE CI	19300	OME	49.80	---	0.527	43.95	45.55	3.5%	
2025	ICE CI	2600	LNG-HPDI	2.241	14.67	3.078	178.9	190.3	6.0%	
2025	ICE CI	19300	LNG-HPDI	2.108	19.94	0.546	31.49	33.60	6.3%	
2025	ICE PI	2600	CNG	---	---	20.80	3.838	215.5	218.4	1.3%
2025	ICE PI	19300	CNG	---	---	26.41	0.656	36.85	37.37	1.4%
2025	ICE PI	2600	LNG	---	---	20.33	3.840	216.6	220.6	1.8%
2025	ICE PI	19300	LNG	---	---	25.80	0.657	37.04	37.70	1.7%

Table 63: Results group 5 Long Haul for HEV configurations (single payloads)

Group 5									
Model year	Propulsion system ID	Payload	Fuel ID	Fuel consumption		Energy consumption	CO2	CO2equ	Share CH4, N2O on CO2equ
				Liquid	Gasous	[MJ/tkm]	[g/tkm]	[g/tkm]	[%]
				[l/100km]	[kg/100km]				
2016	ICE CI + HEV	2600	B7	22.65	---	3.109	228.2	236.8	3.6%
2016	ICE CI + HEV	19300	B7	29.62	---	0.548	40.20	41.82	3.9%
2016	ICE PI + HEV	2600	LNG	---	21.48	4.058	228.9	232.5	1.5%
2016	ICE PI + HEV	19300	LNG	---	27.11	0.690	38.93	39.53	1.5%
2025	ICE CI + HEV	2600	B7	19.31	---	2.651	194.6	201.8	3.6%
2025	ICE CI + HEV	19300	B7	26.70	---	0.494	36.23	37.73	4.0%
2025	ICE PI + HEV	2600	LNG	---	19.49	3.682	207.7	211.0	1.6%
2025	ICE PI + HEV	19300	LNG	---	24.71	0.629	35.47	36.05	1.6%

Table 64: Results group 5 Long Haul for BEV, FCEV and CEV configurations (single payloads)

Group 5										
Model year	Propulsion system ID	Payload	Fuel ID	Fuel consumption		Energy consumption w.o. charging losses	Energy consumption w. charging losses	CO2	CO2equ	Share CH4, N2O on CO2equ
				Liquid	Gasous	[MJ/tkm]	[MJ/tkm]	[g/tkm]	[g/tkm]	[%]
				[l/100km]	[kg/100km]					
2016	BEV	2600	el. grid	---	---	1.585	1.799	0	0	0
2016	BEV	19300	el. grid	---	---	0.2759	0.3132	0	0	0
2016	FC EV	2600	H2	---	5.604	0	---	0	0	0
2016	FC EV	19300	H2	---	7.517	0	---	0	0	0
2016	CEV	2600	el. road	---	---	1.513	1.534	0	0	0
2016	CEV	19300	el. road	---	---	0.2730	0.2754	0	0	0
2025	BEV	2600	el. grid	---	---	1.319	1.497	0	0	0
2025	BEV	19300	el. grid	---	---	0.2295	0.2605	0	0	0
2025	FC EV	2600	H2	---	4.672	0.0	---	0	0	0
2025	FC EV	19300	H2	---	6.158	0.0	---	0	0	0
2025	CEV	2600	el. road	---	---	1.282	1.299	0	0	0
2025	CEV	19300	el. road	---	---	0.2252	0.2272	0	0	0

List of abbreviations and definitions

ADAS	Advanced Driver Assistance System
AMT	Automated-Manual-Transmission
B0	Pure conventional Diesel fuel
FAME (B100)	Pure Biodiesel
B7	Blend of conventional Diesel and 7% Biodiesel
BEV	Battery Electric Vehicle
BSFC	Brake Specific Fuel Consumption
BTE	Brake Thermal Efficiency
CEV	Catenary Electric Vehicle
CH ₄	Methane
CI	Compression Ignition (combustion principle)
CO ₂	Carbon dioxide
CO ₂ eq	Carbon dioxide equivalent
DC	Direct Current
DME	Dimethylether
E _{CO₂eq}	Specific Carbon dioxide equivalent
ECU	Engine Control Unit
EO	Engine Out
EUCAR	European Council for Automotive R&D
FC	Fuel Consumption
FCEV	Fuel Cell Electric Vehicle
FC _{xEV}	Fuel Consumption Hybrid electric vehicle
GHG	Green House Gases
GVMR	Gross Vehicle Mass Rating
HBEFA	Handbook Emission Factors for Road Transport
HDV	Heavy duty vehicle
HEV	Hybrid Electric Vehicle
HPDI	High Pressure Direct Injection

ICE	Internal Combustion Engine
K	Control parameter
LH	Long Haul
LHV	Lower Heating Value
N ₂ O	Nitrous oxide
OME	Oxymethylenether
P	Power
PCC	Predictive Cruise Control
P _{FC}	Fuel cell Power
PHEM	Passenger car and Heavy duty Emission Model
PI	Positive Ignition (combustion principle)
PM	Permanent Magnet
P _{opt}	Fuel cell Power at max. efficiency
P _{rated}	The maximum power output of a device
P _{requ}	Required Power
RD	Regional Delivery
RRC	Rolling Resistance Coefficient
SoC	State of Charge
TP	Tailpipe
TPMLM	Technically Permissible Maximum Laden Mass
TTW	Tank-to-Wheels
TU Graz	Graz University of Technology
UD	Urban Delivery
VECTO	Vehicle Energy Consumption Calculation Tool
WTT	Well-to-Tanks
WTW	Well-to-Wheel
xEV	Vehicle with an electrified propulsion system

List of figures

Figure 1: Summary results vehicle group 4 (Regional Delivery)	4
Figure 2: Summary results vehicle group 5 (Long Haul).....	4
Figure 3: Efficiency map of 2016 CI engine for group 4	18
Figure 4: Efficiency map of 2016 CI engine for group 5	18
Figure 5: Efficiency map of 2025 CI engine for group 4	19
Figure 6: Efficiency map of 2025 CI engine for group 5	19
Figure 7: Efficiency maps for 2016 PI engines in group 5 (full map) and in group 4 (lower torque range) ...	20
Figure 8: Efficiency maps for 2025 PI engines in group 5 (full map) and in group 4 (lower torque range) ...	20
Figure 9: Share of Diesel injection on overall fuel energy (Dual fuel HPDI, group 5 vehicle)	21
Figure 10: Efficiency map and full-load characteristics of 2016 dual fuel HPDI engines in group 5	22
Figure 11: Efficiency map for PMSM electric motor incl. inverter.....	25
Figure 12: Topology of parallel hybrid electric vehicles	26
Figure 13: CO ₂ reduction potential of different HEV-CI propulsion configurations (group 5)	27
Figure 14: Topology of battery electric vehicles (BEV)	28
Figure 15: Topology of catenary electric vehicle (CEV)	29
Figure 16: Topology FCEV.....	30
Figure 17: Efficiency fuel cell systems for 2016 and 2025.....	31
Figure 18: VECTO calculation scheme	39
Figure 19: PHEM model structure	40
Figure 20: Target speed and gradient profile of the Regional Delivery cycle	41
Figure 21: Target speed and gradient profile of the Long Haul cycle	41
Figure 22: Group 4 vehicles model year 2016 - energy consumption	50
Figure 23: Group 4 vehicles model year 2016 - CO ₂ equivalent emissions	50
Figure 24: Group 4 vehicles model year 2025 - energy consumption	51
Figure 25: Group 4 vehicles model year 2025 - CO ₂ equivalent emissions	51
Figure 26: Summary results vehicle group 4 (Regional Delivery).....	52
Figure 27: Group 5 vehicles model year 2016 - energy consumption	53
Figure 28: Group 5 vehicles model year 2016 - CO ₂ equivalent emissions	53
Figure 29: Group 5 vehicles model year 2025 - energy consumption	54
Figure 30: Group 5 vehicles model year 2025 - CO ₂ equivalent emissions	54
Figure 31: Summary results vehicle group 5 (Long Haul)	55
Figure 32: Velocity and gradient profile of the Urban Delivery cycle.....	62
Figure 33: Summary results vehicle group 4 (Urban Delivery).....	63
Figure 34: Group 4 vehicles model year 2016 - energy consumption (Urban Delivery)	63
Figure 35: Group 4 vehicles model year 2016 - CO ₂ equivalent emissions (Urban Delivery)	64

.....64

Figure 36: Group 4 vehicles model year 2025 - energy consumption (Urban Delivery)64

Figure 37: Group 4 vehicles model year 2025 – CO₂equivalent emissions (Urban Delivery)65

List of tables

Table 1: Specifications reference vehicles model year 2016.....	8
Table 2: Gear ratios AMT transmission.....	9
Table 3: Auxiliary technologies group 4 model year 2016	9
Table 4: Auxiliary technologies group 5 model year 2016	10
Table 5: Auxiliary technologies group 4 model year 2025	11
Table 6: Auxiliary technologies group 5 model year 2025	11
Table 7: Specifications reference vehicles model year 2025	13
Table 8: Description of fuels considered in this study	15
Table 9: Investigated fuel and powertrain configurations and simulated vehicle groups.....	16
Table 10: Fuel properties for WTW study	17
Table 11: Vehicle masses of group 4 vehicles model year 2016	23
Table 12: Vehicle masses of group 5 vehicles model year 2016.....	23
Table 13: Vehicle specifications of xEV configurations for model year 2016	24
Table 14: Vehicle specifications of xEV configurations for 2025	24
Table 15: Overall drivetrain ratios of BEV, CEV and FCEV	26
Table 16: BEV battery capacities	28
Table 17: BEV charging efficiencies	29
Table 18: Installed battery capacity of CEVs	30
Table 19: Installed battery capacity for FCEV	30
Table 20: Overview electric losses for BEV (EM ... Electric motor)	31
Table 21: Mass balance xEV group 4 vehicles model year 2016	33
Table 22: Mass balance xEV group 5 vehicles model year 2016	34
Table 23: Mass balance xEV group 4 vehicles model year 2025	35
Table 24: Mass balance xEV group 5 vehicles model year 2025	36
Table 25: Performance criteria for 2016 vehicles	38
Table 26: Performance criteria for 2025 vehicles	38
Table 27: Generic payloads	42
Table 28: Payload weighting factors	42
Table 29: Payload weighting factors for BEV model year 2016	42
Table 30: Modelled cases for predictive cruise control features.	43
Table 31: Fuel saving potentials of combined ADAS systems for conv. and hybrid vehicles.	43
Table 32: Operation strategy of FCEVs [Huss, 2013]	44
Table 33: Specific CH ₄ emission levels	46
Table 34: Specific N ₂ O emission levels	46
Table 35: CH ₄ BOG of LNG vehicles	47

Table 36: BOG in CO ₂ equ per km	47
Table 37: AdBlue consumption	48
Table 38: Results group 4 Regional Delivery 2016 for ICE only configurations with weighted payload (2650 kg)	55
Table 39: Results group 4 Regional Delivery 2025 for ICE only configurations with weighted payload (2650 kg)	56
Table 40: Results group 4 Regional Delivery 2016 for HEV configurations with weighted payload (2650 kg)	56
Table 41: Results group 4 Regional Delivery 2025 for HEV configurations with weighted payload (2650 kg)	56
Table 42: Results group 4 Regional Delivery 2016 for BEV, FCEV and CEV configurations with weighted payload (2650 kg)	56
Table 43: Results group 4 Regional Delivery 2025 for BEV, FCEV and CEV configurations with weighted payload (2650 kg)	57
Table 44: Results group 5 Long Haul 2016 for ICE only configurations with weighted payload (14290 kg) ..	57
Table 45: Results group 5 Long Haul 2025 for ICE only configurations with weighted payload (14290 kg) ..	57
Table 46: Results group 5 Long Haul 2016 for HEV configurations with weighted payload (14290 kg)	57
Table 47: Results group 5 Long Haul 2025 for HEV configurations with weighted payload (14290 kg)	58
Table 48: Results group 5 Long Haul 2016 for BEV, FCEV and CEV configurations with weighted payload (13064 kg for BEV, 14290 kg for all others)	58
Table 49: Results group 5 Long Haul 2025 for BEV, FCEV and CEV configurations with weighted payload (14290 kg)	58
Table 50: Results group 4 Urban Delivery 2016 for ICE only configurations 2016 with weighted payload (2650 kg)	65
Table 51: Results group 4 Urban Delivery 2025 for ICE only configurations with weighted payload (2650 kg)	66
Table 52: Results group 4 Urban Delivery 2016 for HEV configurations with weighted payload (2650 kg) ..	66
Table 53: Results group 4 Urban Delivery 2025 for HEV configurations with weighted payload (2650 kg) ..	66
Table 54: Results group 4 Urban Delivery 2016 for BEV, FCEV and CEV configurations with weighted payload (2650 kg)	66
Table 55: Results group 4 Urban Delivery 2025 for BEV, FCEV and CEV configurations with weighted payload (2650 kg)	67
Table 56: Results group 4 Regional Delivery for ICE only configurations (single payloads)	68
Table 57: Results group 4 Regional Delivery for HEV configurations (single payloads)	69
Table 58: Results group 4 Regional Delivery for BEV, FCEV and CEV configurations (single payloads)	69
Table 59: Results group 4 Urban Delivery for ICE only configurations (single payloads)	70
Table 60: Results group 4 Urban Delivery for HEV configurations (single payloads)	70
Table 61: Results group 4 Urban Delivery for BEV, FCEV and CEV configurations (single payloads)	71
Table 62: Results group 5 Long Haul for ICE only configurations (single payloads)	71
Table 63: Results group 5 Long Haul for HEV configurations (single payloads)	72
Table 64: Results group 5 Long Haul for BEV, FCEV and CEV configurations (single payloads)	72

List of annex(s)

Annex I: Results for vehicle group 4 on Urban Delivery cycle

Annex II: Tabular results for single VECTO payloads

GETTING IN TOUCH WITH THE EU

In person

All over the European Union there are hundreds of Europe Direct information centres. You can find the address of the centre nearest you at: https://europa.eu/european-union/contact_en

On the phone or by email

Europe Direct is a service that answers your questions about the European Union. You can contact this service:

- by freephone: 00 800 6 7 8 9 10 11 (certain operators may charge for these calls),
- at the following standard number: +32 22999696, or
- by electronic mail via: https://europa.eu/european-union/contact_en

FINDING INFORMATION ABOUT THE EU

Online

Information about the European Union in all the official languages of the EU is available on the Europa website at: https://europa.eu/european-union/index_en

EU publications

You can download or order free and priced EU publications from EU Bookshop at: <https://publications.europa.eu/en/publications>. Multiple copies of free publications may be obtained by contacting Europe Direct or your local information centre (see https://europa.eu/european-union/contact_en).

The European Commission's science and knowledge service

Joint Research Centre

JRC Mission

As the science and knowledge service of the European Commission, the Joint Research Centre's mission is to support EU policies with independent evidence throughout the whole policy cycle.



EU Science Hub
ec.europa.eu/jrc



@EU_ScienceHub



EU Science Hub - Joint Research Centre



EU Science, Research and Innovation



EU Science Hub



Publications Office
of the European Union

doi:10.2760/541016

ISBN 978-92-76-19928-1