



"A Unified Model for Context-aware Adaptation of User Interfaces"

Genaro Motti, Vivian ; Vanderdonckt, Jean

Abstract

The variety of contexts of use in which the interaction takes place nowadays is a challenge for both stakeholders for the development and end users for the interaction. Stakeholders either ignore the exponential amount of information coming from the context of use, adopting the inaccessible approach of one-size-fits-all, or they must dedicate a significant effort to carefully consider context differences while designing several different versions of the same user interface. For end users, web pages that are not adapted become often inaccessible in non-conventional contexts of use, with mobile devices, as smart phones and tablet PCs. In order to leverage such efforts, we propose in this paper a meta-model that by means of a unified view supports all phases of the implementation of context-aware adaptation for user interfaces. With such a formal abstraction of an interactive system, stakeholders can generate different instantiations with more concrete UI's that can properly handle an...

Document type : *Article de périodique (Journal article)*

Référence bibliographique

Genaro Motti, Vivian ; Vanderdonckt, Jean. *A Unified Model for Context-aware Adaptation of User Interfaces*. In: *Romanian Journal of Human-Computer Interaction*, Vol. 6, no.3, p. 211-248 (2013)

A Unified Model for Context-aware Adaptation of User Interfaces

Vivian Genaro Motti, Jean Vanderdonck

Louvain Interaction Laboratory - Université catholique de Louvain
Place des Doyens, 1, 1348, Louvain la Neuve
E-mail: vivian.genaromotti@uclouvain.be

Abstract. The variety of contexts of use in which the interaction takes place nowadays is a challenge for both stakeholders for the development and end users for the interaction. Stakeholders either ignore the exponential amount of information coming from the context of use, adopting the inaccessible approach of *one-size-fits-all*, or they must dedicate a significant effort to carefully consider context differences while designing several different versions of the same user interface. For end users, web pages that are not adapted become often inaccessible in non-conventional contexts of use, with mobile devices, as smart phones and tablet PCs. In order to leverage such efforts, we propose in this paper a meta-model that by means of a unified view supports all phases of the implementation of context-aware adaptation for user interfaces. With such a formal abstraction of an interactive system, stakeholders can generate different instantiations with more concrete UI's that can properly handle and adapt accordingly to the different constraints and characteristics of different contexts of use. We present CAMM, a meta-model for context-aware adaptation covering different application domains and also a complete adaptation lifecycle. Moreover we also present various instantiations of such a model for different scenarios of a car rental example.

Keywords: modeling, context-awareness, adaptation, user interfaces.

1. Introduction

Users interact from different environments, using different platforms and devices, and have also different profiles. This multitude of scenarios in which the interaction takes place poses a challenge not only for developers but also for end users. Developers are not always aware about how to handle such differences properly, then they do not know how to prioritize the possible contexts, moreover implementing one single version of each system UI for each specific context is not feasible neither scalable. However if such constraints and characteristics are ignored while implementing applications, it is likely that the end users access will be reduced, hindered

or even prevented. In order to support stakeholders in the development of UI's that are able to adapt themselves properly, we propose the adoption of a unified model, i.e. by starting from a formal abstraction of interactive systems that support adaptation, the navigation, presentation and contents of system can be adapted. A model-based approach enables the generation of different versions of the same application, in an automatic or semi-automatic manner, properly accommodating the different requirements imposed by different interaction scenarios. For instance the same application for renting a car can be used in a smartphone, a tablet PC or a Desktop, by a young or an elderly user. The work presented in this paper relies on the assumption that in spite of the requirements required in different contexts vary, a model-based approach can efficiently leverage the efforts needed to generate adapted versions of a system.

2. Background Information

This section presents the fundamental concepts that are the basis of this work.

Context-aware Adaptation

Context-aware Adaptation (CAA) involves the identification of the relevant *context* information that surrounds the user during her interaction in order to properly adapt elements of an interactive system aiming at enhancing the end user interaction. The main goals of CAA are improving the usability levels of the system by using the relevant information of the user context to properly transform a system.

Figure 1 illustrates the 7 phases of an adaptation lifecycle (according to Norman's theory of action (Norman, 1986) relating it to its 4 core components (adapter, context, models and rules) and respective reference information (who, to what, why, what, when, where and how) (Motti & Vanderdonckt, 2013). On the top of the cycle the adapter (*who*), i.e. the agent responsible for triggering or deciding the adaptation, has a goal and an intention in mind. Based on this information (*why*) and in what (*to what*) context information that surrounds the interaction moment, the system, by means of rules, can specify the actions that will change (*how*) one or more

elements (*what*) of the interactive system, at design or run time (*when*), at the client, server or proxy (*where*). A transition can be then used to present the results of the adaptation in the models to the end user. Such results will be finally interpreted and evaluated by the agent (i.e. the end user, the system, or a third party). Depending on the evaluation given, the adaptation cycle can be concluded (if satisfactory results have been obtained), or continue (until satisfactory results are reached).

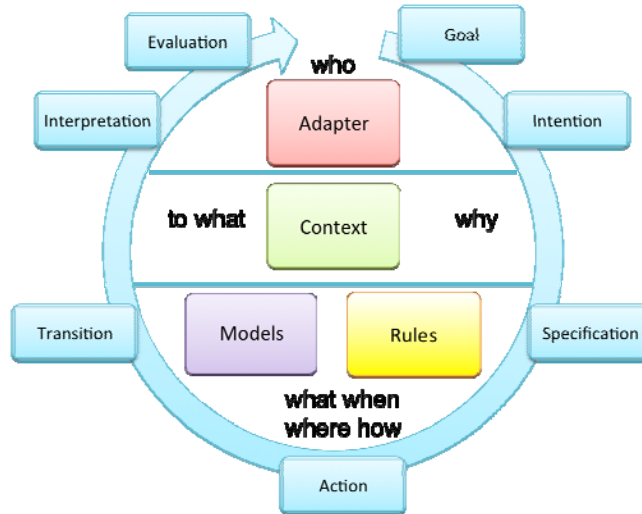

Figure 1. Adaptation lifecycle structured according to: its four core components (Adapter, Context, Models and Rules), seven reference information (who, to what, why, what, when, where, and how) [Motti, 2013] and seven phases (goal, intention, specification, action, transition, interpretation and evaluation) according to Norman's theory of action [Norman, 1986]

Although CAA aims at better usability levels and at improving the user experience, many drawbacks can be foreseen, e.g. (i) there are sets of contextual information that surround the user and it is hard to select or prioritize the most relevant ones, (ii) the processing of the adaptation may have a cost, so the benefits of its results must be greater to compensate for it, (iii) the UI and system changes, however the user should not feel confused, lost or out of control during her interaction, (iv) CAA involves several variables it is up to the designer to define the adaptation with an optimal (and not maximum) amount of information available about the user context, (v) the contexts evolve dynamically, posing a continuous challenge for developers to keep themselves updated regarding novel technologies that may rise and potential approaches to handle them. Furthermore, there is no

single approach or ready-to-use solution about CAA, so developers must dedicate a significant effort to search for and retrieve important information about CAA.

Models

Models aim at simplifying, abstracting and formalizing systems concepts, including their properties, methods, relationships, cardinalities and constraints. A model is a simplification of reality, i.e. a semantically close abstraction of a system, the objective being to better understand the system being created (Koch, 2000). On one hand they provide a version of the system to be that is sufficiently complete to comprehend the system goals, on the other hand by being a simplified version of the reality, system models may lack important details about the concepts of interest. Humans adopt models to better deal with complex information and processes, and also to simplify the reality in a way that it can be better handled or processed. We propose a unified model for CAA because so far there is no work that covers at once all its essential concepts and its complete lifecycle. A meta-model can serve as a basis for developers to instantiate their own applications following a consistent structure. The resulting applications may be also more compatible, extensible and flexible due to the fact that different applications will comply with consistent definitions. Besides this, a meta-model enables a (semi)automatic generation of an application, reducing development efforts, time to market, inconsistent results, and facilitating the reuse. The next section summarizes the state-of-the-art of CAA models.

2 Related Works

Due to the wide range of application domains, aspects and contexts of use, it is not scalable for the human programmers to create UI versions for each CAA scenario. Instead, an automated solution is necessary. In this sense, different models have already been proposed to facilitate the design, implementation, execution and evaluation of CAA. This section exemplifies models that support CAA, and that inspired the design decisions and requirements for creating CAMM.

Models and Meta-models

Models abstract system concepts and their relationships. In the domain of CAA, models have been used to represent: context information, adaptation rules, and multimodal properties. This section briefly summarizes, in a chronological order, a selection of seven models that support specific concepts of adaptation.

Munich. a reference model defines techniques for designing adaptive hypermedia applications. The domain model requires a conceptual design of the problem domain, which evolves into a navigation and presentation model. The user model defines attributes and relationships with the domain model. The adaptation model specifies domain and user elements, the set of acquiring and adaptation rules and their collaborations (Koch, 2000).

Customization Model. Kappel et al. (2002) model the customization according to context regarding user profile, network and location. For them context provides relevant information about an interactive application and the environment. Context influences requirements elicitation and triggers customization according to context changes.

ADAPTS. explicitly models task, domain and users, in an integrated manner aiming to support the adaptation according to the context. A diagnostic engine employs the user and expert models to update the navigation selecting the most appropriate tasks for the user based on pre-defined weights (Brusilovsky and Cooper, 2002).

Adaptation Model. Vrieze et al. (2004) base on dynamic behaviors of the user to handling events and use ECA rules to pull and push adaptations in a more flexible fashion. It focuses on hypermedia systems.

Context Information. Fuchs et al. (2005) created a meta-model that defines context information and its associations. The main concepts considered include: devices and persons, their properties, e.g.: mobile phone, phone number, gender, and their relationships, e.g.: *is located nearby*, *has phone number*, *has last name* or *is supervised by*.

Comets. Calvary et al. (2005) state that an adaptation model specifies evolution and transition rules to be applied if the context changes. They propose adaptation models for defining tasks, abstract, concrete and final UIs and widgets extensions, always considering plasticity as the main principle. They remark the benefits of using model-based approaches to implement CAA, and they also emphasize the adoption of certain principles, namely: plasticity and continuity.

CAWAR. Fahrmaier et al. (2005) proposed a calibrateable context adaptation model for ubiquitous applications. It includes the context sensors, interpreters and also actuators.

User Model. Kobsa (2007) identified required characteristics for a user model for adaptation. They include domain independence, inference and reasoning capabilities, support for quick adaptation, extensibility, and privacy support. As future trends for this domain they remark ubiquitous and mobile computing, and smart appliances.

Mobile Applications. Farias et al. (2007) defined a MOF¹-model for context-aware mobile applications. The concepts considered are abstract and include: classifier, attribute, entity, contents, associations, dependencies, groups and constraints.

Adaptation Rules. Ganneau et al. (2007) and Sottet et al. (2007) created a meta-model that defines adaptation rules, targeting at plasticity as a goal for ubiquitous applications. This meta-model helps designers to take decisions and to implement CAA considering three phases: the context perception, the reaction, and the learning. The rules respect the ECA structure (i.e., *on event if condition do action*). After the adaptation is defined, the users are able to request, accept or reject it.

Adaptation Rules. López-Jaquero et al. (2008) represented adaptation rules by means of a meta-model that includes concepts as: preconditions, events, sensors, data, transformation and transformation rules.

UsiXML. supports an MDE approach to cover all models required for user interface analysis and design, targeting the context of use, a dynamic entity, whose models are usually subject to continuous changes (Luyten et al., 2010). Mainly the platform is taken into account, information considered include: the type of hardware (e.g. colors, sound output, text input, touch screen, keyboard), the network characteristics (e.g. capacity), browser type (e.g. name, version, html support), and the software type (e.g. handwriting recognition, and audio input encoder) (Limbourg et al, 2005).

Context of Use. A generic model for context was created for Morfeo project. This model represents elements, properties, entities, aspects,

¹ MOF stands for Meta-Object Facility, it is a standard from the Object Management Group (OMG) for model-driven engineering, designed as a four-layered architecture. Each layer corresponds to a specific abstraction level, ranging from a meta-meta-model (M3) to an instance of the objects (M0)

components, characteristics, descriptions of environment and user (Morfeo, 2012).

The models briefly presented in this session were selected based on their similarity with the topic of interest for this work, i.e. modeling CAA. Once they target at specific concepts of CAA, they complement or specialize each other in a certain way. For instance, the meta-model of Farias et al. (2007) can be seen as a specialization of the work of Fuchs et al. (2005), Calvary et al. (2005) and (Morfeo, 2012). Although the works of Ganneau et al. (2007), Sottet (2007) and López-Jaquero et al. (2008) all focuses on CAA rules, the formers are more specific, respectively targeting at the adoption of principles and at the user feedback.

Table 1. Meta-models for CAA and their main focus

Meta-Model	Focus
Munich Reference Model [Koc00]	User models (preferences, tasks, goals, experience) for adaptation, includes also rules.
Customization [Kap02]	User profile, network and locations.
ADAPTS [Bru02]	Task, domain and users. Tasks are then selected based on the user model.
Adaptation Model [Vri04]	Focuses on hypermedia systems, considers user models and ECA rules to pull and push adaptations.
Context Information [Fuc05]	Defines rules, context in terms of device and person, quality and associations.
CAWAR [Fah05]	Models the adaptation in terms of context interpreters, sensors and actuators, focusing on ubiquitous computing.
Comets [Cal05]	Context-aware adaptation and MBUI oriented to the plasticity of interactive systems.
Generic User Models [Kob07]	User modeling systems characteristics of architectures, requirements and trends.
Mobile [Far07]	Context-aware mobile applications.
Rules [Sot07, Gan07]	Evolution and transition rules based on context's changes. Adaptation rules for ubiquitous computing.
Rules [Lop08]	Rules in terms of conditions and transformations.
UsiXML [Lim05, Luy10]	Considers the context as a dynamic entity and the platform characteristics mainly.
MORFEO [Mor12]	Context-awareness and the users' profile.

Table 1 summarizes the works presented above and highlights their focus. They can be broadly organized in two groups: while Vrieze et al, (2011), Ganneau et al (2007) and Lopez-Jaquero (2008) focus on rules, Kapperl et al. (2002), Calvary et al, 2005, Fuchs et al (2005), Fahrmeier et al. (2005), and Morfeo (2012) focus on context. More specifically Koch (2000), Brusilovsky and Cooper (002), and Kobsa (2007) focus on user

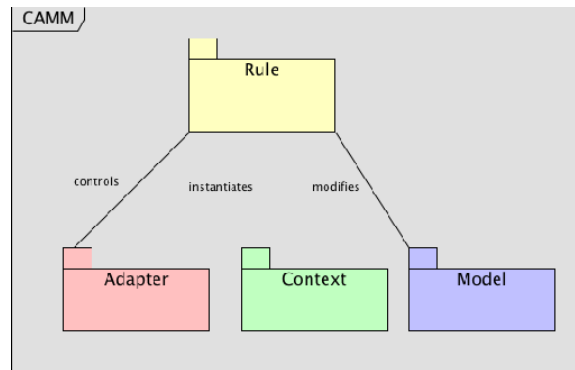

Figure 2. CAMM Packages: Adapters controls the Rules, that are instantiated by the Context and when applied modify the Models

Aiming to formalize the most essential concepts that are necessary to implement and execute CAA, a meta-model was created; it is illustrated by Figure . This meta-model, named CAMM, uses the OMG notation for UML Class diagrams: MetaObject Facility (MOF). In this notation the associations are represented by named lines (e.g., triggers), aggregations represented by open diamonds (e.g., resource property), and compositions represented by closed diamonds (e.g., User). This meta-model covers the complete adaptation process; it abstracts the necessary concepts, establishes their relationships and defines their properties. Besides this, additional information, such as constraints and cardinality of the relations, are also specified.

The CAMM was created based on the analysis of the systematic review results. Four colors were applied in the meta-model in order to separate concepts belonging to distinct domains. Therefore, the classes represented by red blocks refer to the adaptation agents, the ones represented by green classes refer to the context of use, the yellow classes refer to the core of the adaptation process, and purple classes refer to the model generation.

This MOF-based meta model diagram, as Figure illustrates, shows with the red blocks three possible agents to trigger an adaptation process: the system, the end user or a third party. These agents are abstracted as 'Adapter'. Considering that an adaptation process may be composed by several phases, different agents can be responsible for each of them [Hor99]. For instance, the end user may start an adaptation process, and the

system decides which is the most appropriate method among the available ones.

Besides, the agent roles can be further refined according to their specific characteristics and interrelationships, which permits collaboration and hierarchies. When a group of users is responsible for the adaptation, a crowd-sourced adaptation takes place [Neb11].

A CAA process can also be triggered by a change in the context of use. The green classes in the meta-model diagram represent concepts related to the context information. The context defines the adaptation rules since it provides information to instantiate them. For instance, when the user changes the orientation of the device, a technique like ‘change the UI orientation’ must be applied, rotating the content of the UI according to the new device position (information gathered for instance by a sensor).

As the context is a composition of information gathered from different dimensions, there are sets of rules that can be simultaneously applied. An adaptation process is then governed by one or more rule. Rules, represented in the meta-model diagram by the yellow classes, can be syntactically structured in the form of ECA rules (event, condition and actions) [Dit95], instantiated and triggered by context information. Event-Condition-Action (ECA) is commonly used and adopted in several workflow prototypes as a modeling tool. The limitation of capturing rules evaluation context in ECA rules leads to the usage of JECA rules where justification (J) provides a reasoning context for evaluations of ECA rules in order to support context dependent reasoning processes in dealing with uncertainties [Ngeow et al., 2007]. Due to the fact that more than one rule is normally applied simultaneously, conflicts may appear. In order to solve them, priorities must be assigned for certain contexts: adaptation techniques may be abstracted in policies (meta-rules) that can also be further abstracted as strategies (meta meta-rules)². An extension of ECA rules that includes also Justification can be applied.

CAA results can be presented to the end user with different methods to prevent the end user disruption that is commonly caused by significant differences existing between the original UI and the adapted one. Animation is one possible method that can be applied in this sense. By using animation,

² [Cal05] also describes strategies and policies, however such concepts are not composed by abstractions of adaptation techniques, they work as a classification or restrictions to the techniques.

the intermediary steps of a transition are explicitly presented to the end user, permitting her to intuitively comprehend sequential changes (Dessart et al, 2011).

As consequences of the actions performed by rules, models for SFE are generated. In the meta-model diagram, the models are represented by purple classes. Following the principles of the model driven approach, the models range from task and concept level, abstract level, to concrete level and then final level (Calvary, 2005). While a task model specifies the tasks and subtasks involved to accomplish a specific user goal, the final UI level specifies the layout issues (assuming a GUI), e.g. style, alignment, and colors.

CAMM is composed by 34 classes organized in 4 main packages, 3 enumerations, which are defined in Figure 2.

Adapters

The Adapters, represented by red classes in Figures 1 and 2, refers to the agent or the set of agents that is responsible for triggering or supporting the decisions for the adaptation phases, they are defined as follows:

Adapter

- **Definition:** the agent or the set of agents that is responsible for triggering or supporting the decisions for each of the adaptation phases;
- **Examples:** the end user that customize the interactive system;
- **Attributes:** id (the identifier of the adapter, a unique value), name (the name associated to the adapter), and priority (could be in a qualitative approach a value like low, medium, or high according to the priority associated to the adapter);
- **Methods:** get() and set() (generic functions used to retrieve the information about the adapters available in a given moment and to associate it to the attribute values, instantiating the adapter);
- **Relationships:** is_composed_by one or a set of *User*, *System*, and *Third-Party*, and triggers an *AdaptationProcess*

System

- **Definition:** the computational application (e.g. a function, a program or an API) that interacts directly with the system;
- **Examples:** a web service;
- **Attributes:** id (the identifier of the system, a unique value), name (the name associated to the system) and its description (a summary of its definition and goals);
- **Methods:**
- **Relationships:** composes one or a set of *Adapter*

Third-Party

- **Definition:** an external agent able to intervene in the adaptation process;
- **Examples:** an agent;
- **Attributes:** id (the identifier of the third-party, a unique value), name (the name associated to the third-party) and its description (a summary of its definition and goals);
- **Methods:**
- **Relationships:** composes one or a set of *Adapter*

User

- **Definition:** the end user that is interacting with a system in a given moment, a human user;
- **Examples:** John Doe is the end user interacting with the system, his description includes his personal information, impairments (cognitive, motor, visual, etc.), and preferences;
- **Attributes:** id (the identifier of the user, a unique value) and its description (a summary of its definition and goals);
- **Methods:**
- **Relationships:** can compose one or a set of *Adapter* and also one or a set of *Context*

When several users are considered in the decision, the adaptation is classified as crowd sourced [Neb11], and a mixed approach occurs when a combination of agents collaborate to take the adaptation decisions [Hor99]. The user is part of both *Adapter* and *Context*, first as the agent responsible for taking adaptation decision and then its description is also relevant to composed contextual information.

Context

The context, represented by green classes in Figure 2 and Figure , refers to all the information that characterizes the context of use, the interaction scenario and that can be relevant for defining and executing the adaptation. It is defined mainly in terms of:

Context

- **Definition:** all the information that characterizes the context of use, the interaction scenario and that can be relevant for defining the adaptation lifecycle;
- **Examples:** the user John Doe interacting with a tablet PC in a train;
- **Attributes:** id (a unique identifier value for that context), and a priority value (if in a qualitative approach could be high, medium, low levels, this information is useful to solve potential conflicts between adaptation techniques)
- **Methods:** get() (to retrieve information about the context, coming for instance from sensors in the environment), set() (function to instantiate the values for the context, such values can be treated and processed beforehand if necessary, e.g. to convert units), isAvailable() (to check whether there is information to be retrieved), isDynamic() (to check whether the information varies along the time), isValid() (to check whether the information is still holding);
- **Relationships:** is_composed_by at least one but not necessarily all *User*, *Platform*, *Environment* and *Application*, aggregates a *Quality*, an *Element*, a *Property*, and instantiates a *Justification*, an *Event* and a *ContextInformation*

User (see previous definition at Section 4.1 for information)

Platform

- **Definition:** the device or set of devices used to interact, and all their relevant characteristics as accessories available, connections, technologies supported;
- **Examples:** a tabletPC with Android, specification about the connections, ports, compatibility, drivers, etc;
- **Attributes:** id (unique identifier associated to the platform) and its description (a brief summary of the devices available and their characteristics);
- **Methods:**
- **Relationships:** a set of *Platform* can compose a set of *Contexts*;

Environment

- **Definition:** the scenario in which the interaction takes place, defined for instance in terms of light level, noise level, stability level, location, etc;
- **Examples:** a train, with medium noise, light and stability level;
- **Attributes:** id (unique identifier associated to a given environment) and a description (a brief summary of the devices available and their characteristics);
- **Methods:**
- **Relationships:** composes *Context*;

Application

- **Definition:** the description of the interactive system and its domain, described by (domain and data) models, (functional and non-functional) requirements, task tree, etc;
- **Examples:** a safety-critical system, a medical system;

- **Attributes:** id (unique identifier associated to the environment) and its description (a brief summary of the characteristics of the environment);
- **Methods:** *is_contained_by Context* and *is_associated_with Resources* (the components of the UI's of the interactive system)
- **Relationships:** composes *Context* and has *Resources*;

Quality

- **Definition:** a qualitative value used to evaluate certain characteristics of the context information (e.g. its validity, availability, precision);
- **Examples:** the information has a high level of precision (adopting a qualitative approach for implementation);
- **Attributes:** name (associated name with the quality, e.g. precision) and level (associated to the degree in which the quality is provided);
- **Methods:**
- **Relationships:** *is_aggregated_in Context*

Element

- **Definition:** one specific object of the context (i.e. the name of a context information);
- **Examples:** user;
- **Attributes:** name (the name given to the properties of the contextual information) and description (a brief summary explaining the name of the element);
- **Methods:**
- **Relationships:** *is_aggregated_in Context*

Property

- **Definition:** one specific attribute that characterizes one element of the context;
- **Examples:** the birthdate of the user;

- **Attributes:** name (the name given to the properties of the contextual information) and description (a short explanation about the property of the element);
- **Methods:**
- **Relationships:** *is_aggregated_in Context*

Adaptation Core

The adaptation core involves the design decisions taken based on the processing of the contextual information available. This core includes inference and reasoning on top of the context in order to select and prioritize adaptation rules and their respective actions, completing a set of activities and functions performed to adapt some element of the interactive system;

Adaptation Process

- **Definition:** is the set of steps necessary to perform the adaptation, i.e. an adaptation lifecycle;
- **Examples:** given a specific context, the UI elements change, and are presented in a certain approach to the end user
- **Attributes:** id (a unique identifier associated to an adaptation process)
- **Methods:** *start()* (to begin the adaptation process), *pause()* (to temporarily terminate the process), and *stop()* (to terminate the process);
- **Relationships:** *is_triggered_by an Adapter*, *is_composed_by one or more AdaptationRules*

Adaptation Rule

- **Definition:** is a formal association connecting the context with the adaptation techniques, specifying how the system dynamically adapts according to the context [Koc00]. It can be structure according to the JECA approach [Ngeow et al., 2007], defined as follows;

- **Examples:** if the user is dyslexic, then change the font type of the text;
- **Attributes:** id (a unique identifier associated to an adaptation rule), name (a unique name that characterizes the rule)
- **Methods:** calculatePriority() (to calculate the weight of the rule, based on context information provided) and apply() (to execute the rule in a given application);
- **Relationships:** composes *AdaptationProcess*, is_composed_by *Justification*, *Event*, *Condition*, and *Action*, and can be part_of one or several *Policy*

Justification

- **Definition:** a reason associated to the context, that provides a rationale, and aids to prioritize the adaptation and to justify with qualitative or quantitative information the selection of one specific action, it forms the reasoning context in which evaluation of the specific JECA rule to be performed [Ngeow et al., 2007];
- **Examples:** there is no information available about the environment (then a default scenario must be considered);
- **Attributes:** id (a unique identifier for the justification), weight, priority, argument (associated values to support reasoning);
- **Methods:** check() (verifies whether there is a justification available for a given instance of the context);
- **Relationships:** composes an *AdaptationRule* and is_instantiated_by the *Context*

Event

- **Definition:** a specific status or change of status regarding the system, the user interaction or the context that supports specific actions;
- **Examples:** when the device is rotated;

- **Attributes:** id (a unique identifier to the event), name (a word or statement to qualitatively identify the event) and description (a brief description that characterizes the event);
- **Methods:** detect() (the event is listened and detected by the application);
- **Relationships:** composes an *AdaptationRule* and is_instantiated_by an instance of the *Context*

Condition

- **Definition:** an association between a given element and a given instance by means of an operator (e.g. equal, greater than) that enables comparison and evaluation (an enumeration named *OperatorType* provides possible instances for the operators);
- **Examples:** the user visual impairment is colour blindness;
- **Attributes:** id (a unique identifier for the given condition);
- **Methods:** evaluate() (function to check whether the condition is valid or not)
- **Relationships:** composes one or several *AdaptationRules* and it aggregates *Value*, *Operator* (specified by the enumeration *OperatorType*) and *ContextInformation*

Value

- **Definition:** the actual value that comes from the context of use, can be processed if needed (e.g. treated, converted), and verified according to the rule specification;
- **Examples:** 50;
- **Attributes:** name (a name associated to the value);
- **Methods:** process() (function to refine the value if needed, e.g. convert to a given unit or treat the information as necessary);
- **Relationships:** is_aggregated_with a *Condition* and instantiates a *Technique*

Operator

- **Definition:** the operator that permits a comparison between values;
- **Examples:** equal, greater than, different;
- **Attributes:** Type (an enumeration of possible instances is provided including equal, notequal, and, or, lessthan, greaterthan, lessthanorequal, greaterthanorequal);
- **Methods:**
- **Relationships:** is_aggregated_with a *Condition* and is_related_to a *Technique*

ContextInformation

- **Definition:** an element of the context that can be retrieved and evaluated;
- **Examples:** the list of visual impairments associated to the given user;
- **Attributes:** id (a unique identifier associated to the contextual information of interest);
- **Methods:** retrieves() (function to associate a value with the element)
- **Relationships:** is_aggregated_with a *Condition*, is_related_to a *Technique* and is_instantiated_by the *Context*

Action

- **Definition:** a function that defines and activates the execution of the adaptation;
- **Examples:** change the font size to 12;
- **Attributes:** name (the name of the action);
- **Methods:** execute() (function that performs a given action) and cancel() (to interrupt the execution of the action);
- **Relationships:** composes one *AdaptationRule*, generalizes a *Technique*, is_presented_by a specific *PresentationMethod*, modifies a given *Model*, and aggregates a *Method*, a *Classifier*, a *Resource*, and a *Parameter*

Technique

- **Definition:** an operation that specifies a change in the system or in one or more properties of the system in order to adapt it;
- **Examples:** increase the font size;
- **Attributes:** id (a unique identifier associated with the technique), name (a name that characterizes the technique), reference (sources that define the technique, authors), description (a brief summary explaining it), rationale (steps needed to accomplish it), example (illustrative uses for the technique), context (context associated with it), advantages (qualities that are enhanced when applying it), disadvantages (qualities that are hindered while applying it), sample (a piece of code that implements it, e.g. an URL linking to web service that implements the technique), images (illustrative pictures of its application), observation (commentaries and notes about it), categories (tags to classify it);
- **Methods:**
- **Relationships:** *is_associated_with Value, Operator, and ContextInformation* and *is_generalized_by an Action*

Policy

- **Definition:** an abstraction of a technique that governs it;
- **Examples:** if the user has low vision, but also a screen augments (as assistive device), there is no sense in augmenting the font size;
- **Attributes:** id (a unique identifier associated to the policy);
- **Methods:**
- **Relationships:** *is_associated_with AdaptationRules* and *is_part_of Strategy*;

Strategy

- **Definition:** an abstraction of a policy that governs it based on inferences performed with several contextual information;

- **Examples:** a combination of two or more given policies;
- **Attributes:** id (a unique identifier associated to the strategy);
- **Methods:** apply() (a function to activate a given strategy);
- **Relationships:** is_associated_with one or more given *Policy*

Method

- **Definition:** one specific function applied to change an element of the interactive system;
- **Examples:** re-size;
- **Attributes:** name (a given name associated with the method);
- **Methods:** execute() (function to apply a given method);
- **Relationships:** is_aggregated_with an *Action*

Classifier

- **Definition:** a definition of amount (subset, union, intersection or complement);
- **Examples:** all, any;
- **Attributes:** type (a given name that characterizes the classifier);
- **Methods:** set() (a function to associate a classifier with a given action);
- **Relationships:** is_aggregated_with an *Action*

Resource

- **Definition:** a component of the UI or the system that can be subject to adaptation, different granularity levels are considered, e.g. navigation, UI images, tables, their rows, columns or cells;
- **Examples:** image;
- **Attributes:** type (the name of the given resource defining the UI element);
- **Methods:** set() (a function to associate a given resource with an action)
- **Relationships:** is_aggregated_with an *Action*

Resource Property

- **Definition:** a specific characteristic or attribute of a resource;
- **Examples:** width of a table;
- **Attributes:** name (a characterization of the resource property);
- **Methods:**
- **Relationships:** belongs_to *Resource*

Parameter

- **Definition:** a value related to a given unit that specifies a parameter for the adaptation technique;
- **Examples:** +50%;
- **Attributes:** specification (a given value that characterizes the action);
- **Methods:** set() (a function to associate a given parameter to the action);
- **Relationships:** is_aggregated_with an *Action*

Presentation Method

- **Definition:** a explicit manner of presenting the adaptation to the end user aiming at avoiding disruption, possible types are listed as enumeration;
- **Examples:** an animation to present the re-sizing of an edit box;
- **Attributes:** id (a unique identifier associated with the presentation method), name (a short descriptive name associated with the presentation), and type (a characterization of the presentation);
- **Methods:** play() (a function to activate the execution of an presentation method), stop() (a function to stop the presentation method), pause() (a function to pause the presentation method), checkCompatibility() (a function to check whether the action is compatible with a given presentation method);
- **Relationships:** presents an *Action*;
- **Enumeration:** possible presentation types include animation, brighten, blind, bounce, clip, cross fade, collapse, dim, drop, expand, explode, fade, fade in, fade out, fold, highlight, morph, plug in, plug

out, progressive rendering, puf, pulsate, scale, self healing, shake, size, slide, spotlight, transfer.

Model-based Approach

An abstract representation of the reality (of the system, its different perspectives and the UI) that by means of reification or specialization is transformed from one abstraction level to another:

Model

- **Definition:** a formal definition of an interactive system, that can be decomposed in different abstraction levels, and complemented by different views, commonly expressed by means of a given notation (e.g. UML, XML, CTT);
- **Examples:** a UsiXML model specifying an interactive system;
- **Attributes:** id (a unique identifier of the model) and a description (the model definition);
- **Methods:** reify() (an specialization of a model to make it more concrete) and abstract() (transformation to a higher abstraction level);
- **Relationships:** is_composed_by one or several models of a *Task*, *AUI*, *CUI* and *FUI* and is_modified_by an *Action*

Task

- **Definition:** a set of actions and activities to be executed according to given constraints, as ordering, to achieve a specific goal while interacting with the system;
- **Examples:** an CTT or an HTA task tree;
- **Attributes:** id (a unique identifier associated to the task tree) and description (a definition of the task tree: nodes, relationships, properties, etc.);
- **Methods:** reify() (function to transform a task tree into an AUI model);
- **Relationships:** composes one or several *Models*

AUI (Abstract User Interface)

- **Definition:** the abstract definition of the system and its UI that is domain and platform-independent;
- **Examples:** a UsiXML model expressing an AUI model;
- **Attributes:** id (a unique identifier associated to the AUI model) and description (a definition of the AUI components);
- **Methods:** reify() (function to transform an AUI model into a more concrete definition, i.e. a CUI model) and abstract() (function to transform an AUI model into a more abstract definition, i.e. a Task Tree);
- **Relationships:** composes one or several *Models*

CUI (Concrete User Interface)

- **Definition:** a more concrete definition of the system, its UI and its components;
- **Examples:** a UsiXML model expressing a CUI model;
- **Attributes:** id (a unique identifier associated to the CUI model) and description (a definition of the CUI components);
- **Methods:** reify() (function to transform an CUI model into a more concrete definition, i.e. a FUI model) and abstract() (function to transform an CUI model into a more abstract definition, i.e. an AUI model);
- **Relationships:** composes one or several *Models*

FUI (Final User Interface)

- **Definition:** the (graphical) user interface to be presented and/or rendered to the end user;
- **Examples:** a running application;
- **Attributes:** id (a unique identifier associated to the FUI model) and description (a definition of the FUI components);

- **Methods:** `abstract()` (function to transform an FUI model into a more abstract definition, i.e. an CUI model);
- **Relationships:** composes one or several *Models*

4 Applying CAMM

The approach adopted to validate CAMM in this paper is two-fold: first the concepts of related works were analyzed and the common and the complementary definitions were extracted, then the model proposed has been applied and three different case studies to verify whether the concepts encompassed were enough complete to support the whole development lifecycle of CAA. As such we defined as case study for instantiating CAMM, a car rental scenario. It has been instantiated according to the definitions associated with the meta-model proposed in the Section 4 for three different scenarios of usage that lead to three different implementations of the model.

Documentation

To formalize the definitions of the case study and to ensure more consistent instantiations, a common documentation for the case study has been defined. It includes a use case diagram (Figure 4), a domain model (Figure) and a task tree (Figure).

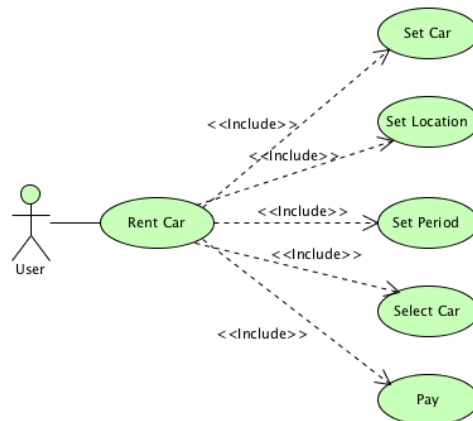

Figure 4. Use Cases for the Car Rental example

Use Cases. For all the three instantiations the main goal of the end user is to rent a car. To do so first the user set the preferences of the car (choosing one among the list of option available), then the location for picking up and returning the car is defined, as well as the period of interest. The car is selected and the payment information is provided. This definition (Figure 4) is specified in a high level of abstraction, to leave room for different design decisions for the adaptation ensuring as such that the model can indeed cover a generic-purpose.

Domain Model. The car rental task involves three main concepts: the customer, the car and the reservation. The customer is the person who will rent the car and the reservation includes information about the car itself (e.g. name, type and extras), information about the location (pickup and return place) and the period (pickup and return dates). Alternative definitions and further refinements can be used to specify the same case study, in our approach (Figure) we opt for a concise definition aiming simplification, and also leaving enough room for different adaptations to be applied.

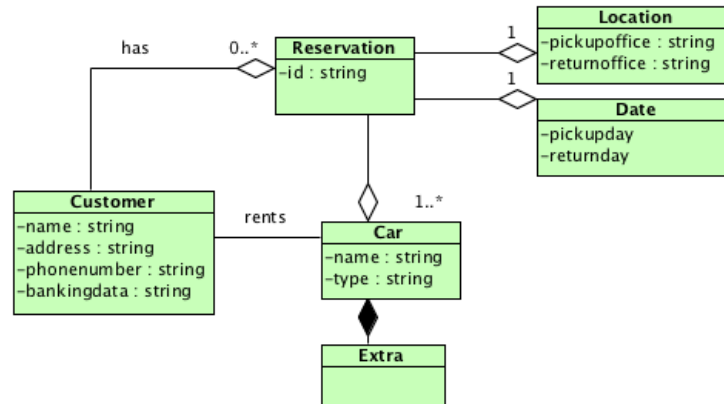

Figure 5. Domain model for the Car Rental example: the customer rents a car through a reservation that comprises its location (pickup and return place) and also its period (pickup and return dates)

Task Tree. The task model (Figure) is structured in 5 main hierarchical levels and encompasses 15 elementary tasks. It provides a generic representation of the essential tasks and it enables other adaptations according to the context of use.

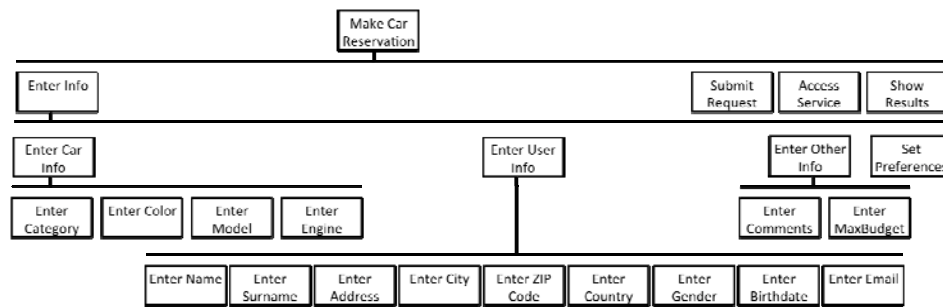

Figure 6. Generic Task Tree for the Car Rental example (in HTA notation)

5.1.1 First Scenario

The first implementation of the car rental example takes into account the platform of the user, i.e. an Android tablet was adopted as platform, the user profile (level of experience in the domain of interest) and environment. Two specific contexts of use were envisaged:

- a. Users with low experience in car rental systems, medium experience in mobile applications, using a tablet device as a platform, and located in a calm environment (i.e. no loud noises, stable, enough free time);
- b. Users with high experience in car rental systems, and in mobile applications, using an Android tablet device as platform, located in a stressful environment and with a short time to conclude the task.

The design decisions concerning the specification of the platform are the same for both contexts, as such they can be considered for implementing the meta-rules for CAA, mainly an Android tablet has limited screen dimensions and input controls. Android guidelines must be first respected, e.g.: highlighting the selections in a touch-screen interface (thus providing immediate feedback of the users' actions). More specific CAA rules that consider the context of use A include:

- If the user is a beginner, then
 - all interaction steps must be clear in the UI and next possible steps must be clearly indicated;
 - the amount of information displayed in the UI must be low, aiming to reduce the cognitive load;
 - UI elements must be intuitive and simpler;
- If the environment is calm, then

- detailed information about each interaction step can be provided;
- the main task can be split in several sub-tasks, and the respective UIs dedicated to more specific actions;

Given that the task tree is affected by the adaptation, we illustrate different versions showing the adaptations performed in Figure and in Figure 88, such trees are based on the original task tree provided in Figure 9. They were adapted according to the constraints imposed by the contexts of use in scenarios *a* and *b*, i.e. users in a relaxed situation and with low level of expertise in the domain should have more detailed information and the task should be split in several sub-tasks that are more specific, while more experienced users in a stressful environment must have higher performances, thus the interaction tasks provided can be quickly concluded.

Respecting the adapted task trees, UIs were generated to enable users to perform the car rental task. The Figure and Figure 10 illustrate respectively such UIs.

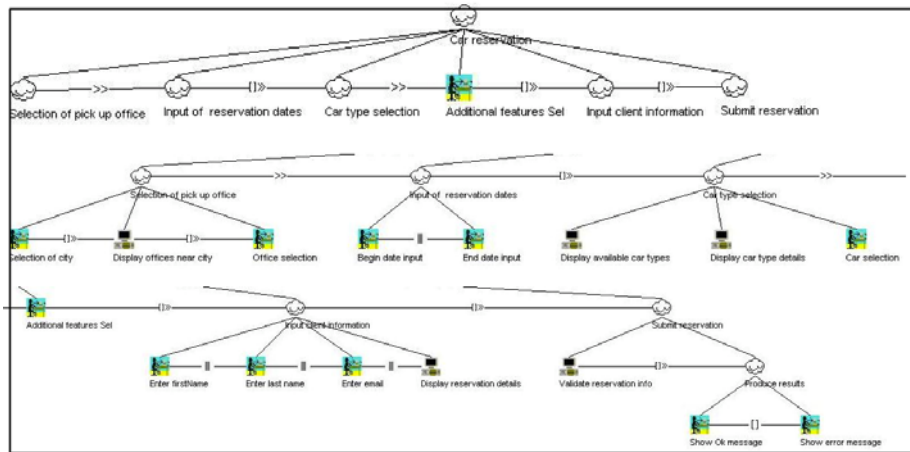

Figure 7. Task Tree adapted for Context of Use a (using CTT notation)

The later UI also provides auto-completing features, e.g. the calendar for the period and the possible office locations. Although these features improve the users' performance (in case of experienced users), they can cause cognitive overload for beginners, thus in these examples just users with time constraints and high experience levels interact with these features.

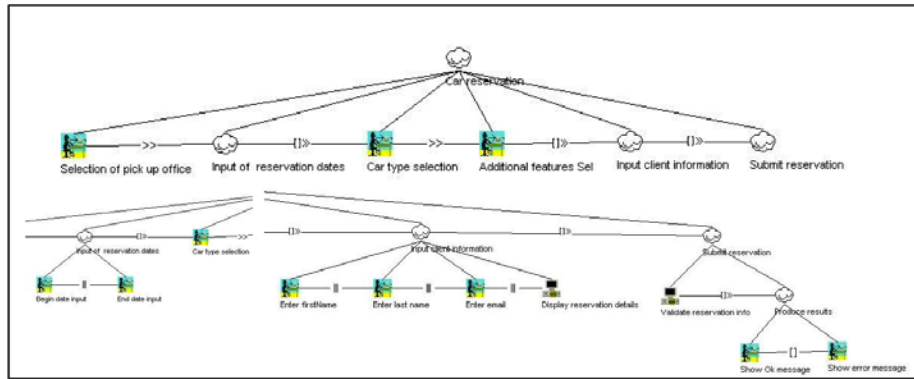

Figure 8. Task Tree adapted for Context of Use b (using CTT notation)

While in the former 4 interaction steps were envisaged, in the later just 2 interaction steps were defined to accomplish the main task.

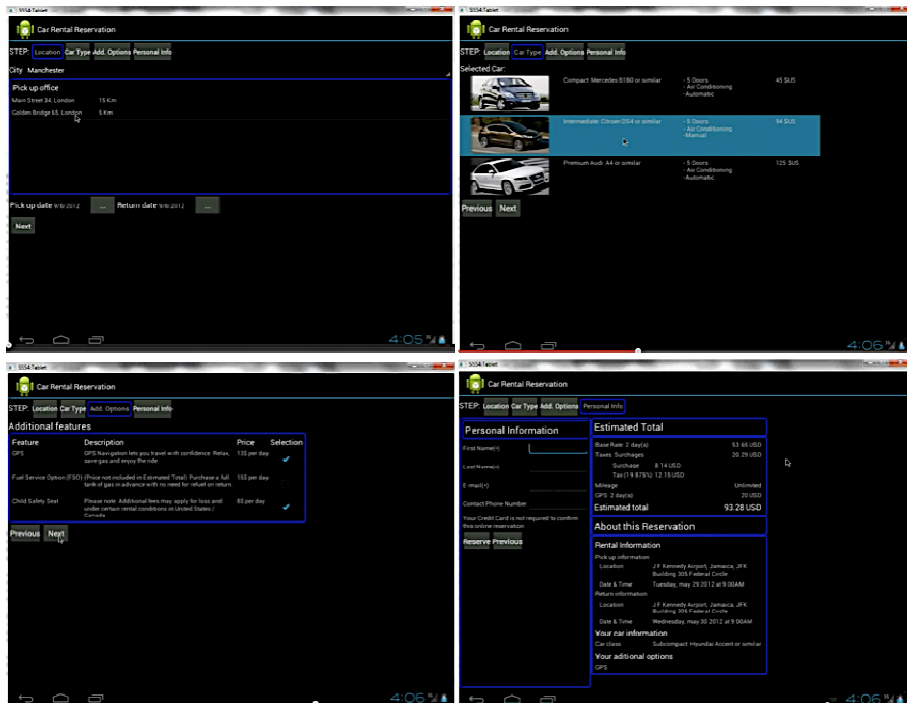

Figure 9. Car Rental Example UIs for Android Tablet Context A: 4 interaction steps are available (Location, Car Type, Options, Personal Info), the UIs are simple and intuitive

5.1.2 Second Scenario

For the second implementation the specificities in the context for the car rental example take into account the screen dimensions and resolution. The layout of the web page is adapted automatically and progressively to fit the contents in all space available and therefore minimize scrolling.

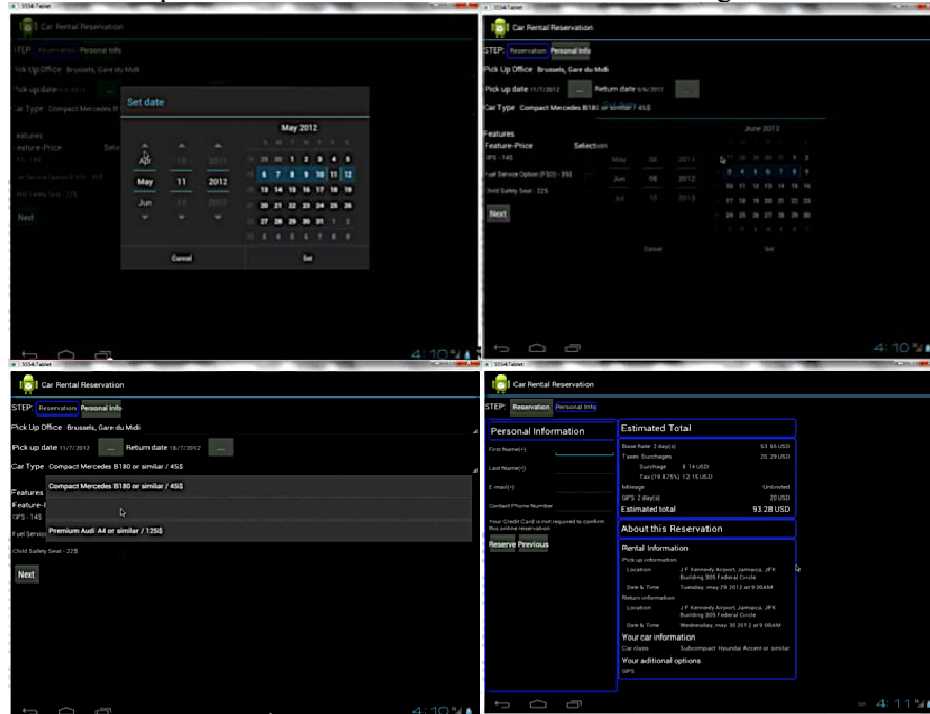

Figure 10. Car Rental Example UIs for Android Tablet Context B: 2 interaction steps are available (Reservation, Personal Info), users have auto-complete features included

jQuery Masonry is a plugin of jQuery that arrange the UI components according to the re-size of the browser. Each UI component is treated individually, and moves to another column (or row) of the layout to fit accordingly in the new browser window size. Thresholds are used to assure the balance of the layout, avoiding unnecessary scrolling. The drawback of this solution is that developers must organize the components of the page in

logical units. Once it is done, the re-organization is automatically and progressively performed.

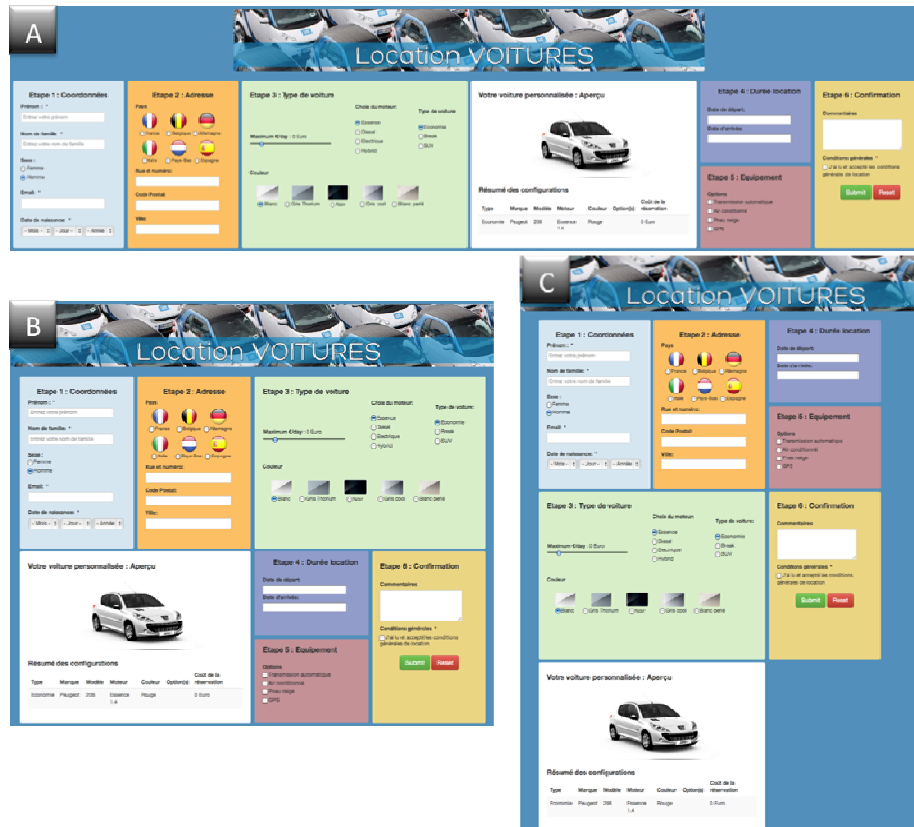

Figure 11. Car rental website adapted examples: (A) Horizontally aligned (e.g. for super wide screens); (B) Balanced Layout (e.g. for a tablet pc); (C) Vertically aligned (e.g. for vertically-oriented screens)

Any screen dimension can be considered, because the fine-grained adjustment of the layout is done based on the progressive re-sizing of the browser. Three types of adaptation techniques were adopted to compose the CAA rules:

- Resizing elements: scaling font size, UI elements as videos and images;
- Reorganizing elements: changing the position of the components horizontally and vertically to assure a balanced layout;

- Mixed approach: a combination of resizing and reorganizing.

The instantiation of the conditions of the CAA rules vary proportionally according to the re-size of the browser window, i.e. the bigger the window, the bigger the UI elements and amount of columns and rows of layout.

(1) User adaptation		(2) Dynamic capabilities adaptation	
			
Nokia 5800 (HTML4) Common user No adaptation	Nokia 5800 (HTML4) Color-blind user Change the color palette	Nexus S (HTML5) Battery level 20%	Nexus S (HTML5) Battery level 90%
(3) Static capabilities adaptation			
			
iPad (tablet device)		iPhone (mobile device)	

Figure 12. Adapted UIs for car rental according to three different contexts of use: (1) user impairments (colour-blindness); (2) battery level; and (3) static device capabilities, i.e. device type (tablet or smart phone)

The car rental example comprehends three main interaction tasks: first users authenticate themselves, then they provide personal information, and finally they select the car and period of the rental. To enable users to accomplish these three tasks, seven logical units were defined (Figure):

personal information, address, car type, car specification, period of the rental, additional specifications, and comments. Figure illustrates three adaptation examples, in A a horizontally-oriented alignment is displayed, e.g. for a super-wide screen all UI components can be co-located, in B a balanced UI layout is presented, both horizontal and vertical alignments are considered, and in C a vertical alignment is considered, i.e. the UI components are displayed one above the other. Once only the screen properties and the UI components (size and position) are considered in this ex-ample, further rules with more specific CAA can be adopted extending it.

5.1.3 Third Scenario

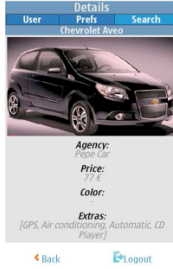
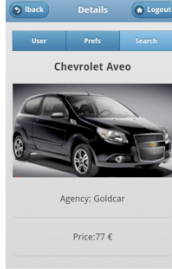
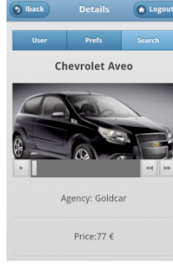
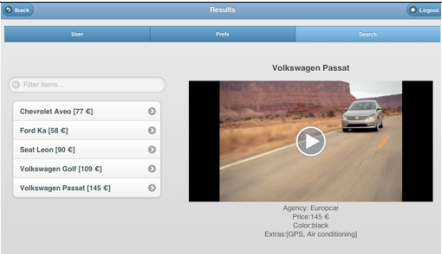
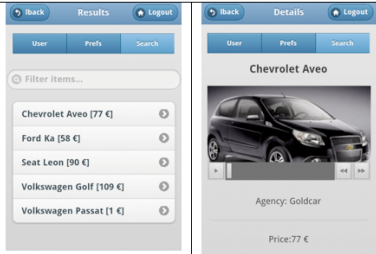
The car rental example was also applied in a third scenario of CAA according to: the user visual impairment (color blindness), the platform type (mobile phone, tablet device), its battery level, and user preferences (set in the system). Six adaptation techniques were chosen and implemented (e.g.: changing the modality and the image colors), aiming at assuring good usability and accessibility levels, by adapting the presentation (e.g. menu elements), and the content (images and text). The CAA was collaboratively decided by: the user, the system and the developer, and it was executed in the server during both: run time and design time.

Contexts, as different platforms and user profiles, were considered and developed using different technologies. The adapted UIs consider respectively: the color-blindness of the user, the battery level and the static capabilities of the device (tablet or smartphone).

Figure illustrates the adapted UIs of the car rental application, in 1 the adaptation according to the user visual impairment (color-blind), in 2 according to the device capabilities (battery level) and in 3 static capabilities of the device (tablet or mobile).

Discussion

Implementing the case study for different scenarios of context proved to be feasible by adopting the concepts as defined in CAMM. As *adapters* both system and end user have been considered. As *contexts* information from users, platforms and environments have been used. Different *rules* composed the adaptation processes, matching context information with appropriate adaptation techniques. The results applied in the *task tree* were presented to the end user in the *final user interface*.

The implementations were built with different technologies, for different contexts and comprising a significant set of rules. The meta-model showed to be enough generic and also complete enough to accommodate all steps and all concepts needed for these adaptation scenarios.

5 Final Remarks

Adaptation has continuously raised awareness since the early 90's. With the growth in the amount and variety of technology, in terms of both applications and devices, it became impossible for stakeholders to properly develop systems that are adapted to single contexts. Several attempts have been done to leverage the development process of context-aware adaptation. However there is not yet an easy-to-use, unified and widespread solution that properly supports all the development lifecycle.

In this sense, by means of a meta-model proposed in this work, we aim at providing a unified description for the complete adaptation lifecycle that properly support developers in all development phases. Although the context evolves dynamically, being continuously subject to changes, CAMM covers an abstraction level capable of supporting further extensions whenever needed. The main contributions of this model are: (i) defining a standard approach able to accommodate several instances of adaptation independently of the context, application domain and complexity level; (ii) providing a unified methodology, terminology and structure for context-aware adaptation in both semantic and syntactical aspects; and (iii) enabling validation by means of a Schema definition.

The instantiations presented in this paper proved the model to be enough generic (accommodating different contexts), enough complete (covering all phases of CAA) and also flexible (leaving room for specific design decisions, implementation approaches and different technologies).

As a future work the definitions provided by this meta-model, including syntactic and semantic aspects, can also be applied to generate a specific adaptation language.

References

P. Brusilovsky and D. W. Cooper, "Domain, task, and user models for an adaptive

- hypermedia performance support system," In: Proc. of the 7th int. conference on Intelligent user interfaces. ACM, p. 23-30, 2002
- G. Calvary, O. Daassi, J. Coutaz, and A. Demeure, "Des widgets aux comets pour la Plasticité des Systèmes Interactifs," *Revue d'Interaction Homme-Machine*, v. 6, n. 1, p. 33-53, 2005.
- Ch.-E. Dessart, V. G. Motti and J. Vanderdonckt, J, "Showing User Interface Adaptivity by Animated Transitions" In Proc. of 3rd ACM Symp. on Eng. Interactive Comp. Sys. EICS'2011. ACM, NY, 95-104.
- Dittrich, K.R., Gatzju, S., Geppert, A. The Active Database Management System Manifesto: A Rule- base of ADBMS Features. In Proceedings of the 2nd International Workshop on Rules in Database Systems, Vol. 985, Springer-Verlag, 1995, pp. 3-20.
- Fahrmaier, M., Sitou, W., Spanfelner, B. 2005. An engineering approach to adaptation and calibration. In Proceedings of the Second international conference on Modeling and Retrieval of Context (MRC'05), Thomas R. Roth-Berghofer, Stefan Schulz, and David B. Leake (Eds.). Springer-Verlag, Berlin, Heidelberg, 134-147.
DOI=10.1007/11740674_9 http://dx.doi.org/10.1007/11740674_9
- C. R. G. de Farias, M. M. Leite, C. Z. Calvi, R. M. Pessoa, and J. G. Pereira Filho, "A MOF metamodel for the development of context-aware mobile applications," In: Proceedings of the 2007 ACM symposium on Applied computing. ACM, 2007. p. 947-952.
- F. Fuchs, I. Hochstatter, M. Krause, and M. Berger, "A metamodel approach to context information," In: Pervasive Computing and Communications Workshops, 2005. PerCom 2005 Workshops. Third IEEE International Conference on. IEEE, 2005. p. 8-14.
- V. Ganneau, G. Calvary, and R. Demumieux, "Métamodèle de règles d'adaptation pour la plasticité des interfaces homme-machine," In: Proceedings of the 19th International Conference of the Association Francophone d'Interaction Homme-Machine. ACM, p. 91-98, 2007.
- Horvitz, E.: Principles of Mixed-Initiative User Interfaces. Proc. of ACM Conf. on Human Aspects in Computing Systems CHI 1999, ACM Press, New York, 1999, pp. 159-166.
- Kappel, T.G., Retschitzegger, W., Kimmerstorfer, E., Proll B., Schwinger, W., Hofer, T. Towards a Generic Customisation Model for Ubiquitous Web Applications. In Proceedings of the Second Int. Workshop on Web-Oriented Software Technology (IWWOST'02), 79-104, Malaga, Spain, June 2002. ISBN: 84-931538-9-3.
- Kobsa A. 2007, Generic User Modeling Systems. In The Adaptive Web (LNCS), Vol. 4321, 136-154.
- N. P. D. Koch, "Software engineering for adaptive hypermedia systems and development process," 2000. PhD Thesis
- V. López-Jaquero, J. Vanderdonckt, F. Montero, P. González, "Towards an extended model of user interface adaptation: the ISATINE framework," In: Engineering Interactive Systems. Springer Berlin Heidelberg, 2008. p. 374-392.
- Limbouurg, Quentin, Jean Vanderdonckt, Benjamin Michotte, Laurent Bouillon, and Victor López-Jaquero. "USIXML: A language supporting multi-path development of user interfaces." In Engineering human computer interaction and interactive systems, pp.

- 200-220. Springer Berlin Heidelberg, 2005.
- Luyten, K., Haesen, M., Ostrowski, D., Coninx, K., Degrandart, S., Demeyer, S.: Storyboard creation as an entry point for model-based interface development with UsiXML. In: UsiXML, pp. 1–8 (2010)
- Morfeo Project, (2012) Context of Use Meta model. Available online at: http://forge.morfeo-project.org/wiki_en/index.php/Context_Of_Use_Metamodel#Introduction.
- Motti, V. G., Vanderdonckt, J. A Computational Framework for Context-aware Adaptation of User Interfaces, In Proc. of the Seventh IEEE International Conference on Research Challenges in Information Science (2013)
- Nebeling, M. Context-Aware and Adaptive Web Applications: A Crowdsourcing Approach, In Proc of ICWE, 2011.
- Ngeow, Y.C., Mustapha, A.K., Goh, E., Low, H.K.: Context-aware Workflow Management Engine for Networked Devices. International Journal of Multimedia and Ubiquitous Engineering (IJMUE) 2(3), 33-47 (2007).
- Norman, D.A.:1986, Cognitive Engineering. In: Norman, D.A., Draper, S.W. (Eds.): User Centered System Design. Lawrence Erlbaum Associates, Hillsdale, pp. 31–61.
- Sottet, Jean-Sébastien, Vincent Ganneau, Gaëlle Calvary, Joëlle Coutaz, Alexandre Demeure, Jean-Marie Favre, and Rachel Demumieux. "Model-driven adaptation for plastic user interfaces." In Human-Computer Interaction–INTERACT 2007, pp. 397-410. Springer Berlin Heidelberg, 2007.
- UsiXML Specification. Available at: usixml.org
- Vanderdonckt, J., Limbourg, Q., Michotte, B., Bouillon, L., Trevisan, D., Florins, M., UsiXML: a User Interface Description Language for Specifying Multimodal User Interfaces, in Proc. of W3C Workshop on Multimodal Interaction WMI'2004 (Sophia Antipolis, 19-20 July 2004).
- de Vrieze, Paul, Patrick van Bommel, and Theo van der Weide. "A generic adaptivity model in adaptive hypermedia." In Adaptive Hypermedia and Adaptive Web-Based Systems, pp. 344-347. Springer Berlin Heidelberg, 2004. Walsh, S.P., White, K.M., Cox, S., Young, R.M. (2011) Keeping in constant touch: The predictors of young Australians' mobile phone involvement. Computers in Human Behavior 27 (1), 333-342.