

# Application of IR Thermography for Determination of Material Properties

by M. Berković-Šubić, I. Boras, J. Frančeski, J. Kodvanj,  
A. Rodić, M. Surjak, S. Švaić, Z. Tonković

Univ. Zagreb , Faculty of Mechanical Engineering and Naval Architecture, 10000 Zagreb, I.Lucica 5, Croatia  
[ssvaic@fsb.hr](mailto:ssvaic@fsb.hr)

## Abstract

The paper presents the results of experimental research in which the flat specimens have been tested under tensile loading. The specimens are made of nodular cast iron. The experiments are performed under two different deformation rates using standard specimens. Displacement and temperature distribution on the surfaces of the specimens, during experiment, are determined using the optical measuring system ARAMIS 4M (digital image correlation system), thermocouples and infrared thermography. The goal of the research was to find correlation between the elastic deformations and increase of the surface temperatures.

Key words: static tensile test, metal samples, thermo-elasticity, IR thermography

## 1. Introduction

Describing the elastoplastic deformation process of material is very important in solid mechanics. Recently, the distribution of the displacement and temperatures on the sample surface are determined using Digital Image Correlation (DIC) and IR thermography [1]. It allows for significantly more accurate determination of the material parameters in the thermoplastic constitutive models based on the experimental results [6]. In this work the goal was to find the correlation between the elastic deformations and increase of the surface temperatures during the tensile test performed on the samples made of nodular cast iron. The tests have been performed on the standard flat samples for two deformation rates. For analysis of the displacement and deformations on the sample surface the optical measuring system ARAMIS 4M has been used which is based on the digital image correlation (DIC). The temperature distribution on the sample surface has been recorded during the experiment by means of IR camera FLIR 2000 SC and measured in the same time in the four points on the sample surface using thermocouples type K.

## 2. Thermoelastic stress analysis

Thermoelastic stress analysis is based on the temperature change of the weighed sample. During the experiment the temperature of the sample is changed and this gives the possibility to determine the stress intensity in the sample as well as the points of stress concentration in the sample. Thermoelastic analysis dates back in 19<sup>th</sup> century when W. Weber has been discovered the thermoelastic effect during the experiments performed on the iron wires.

A little beat later W. Thomson (Lord Kelvin) establish the relation between temperature and stress, the basic equation of the thermoelasticity [1].

$$\Delta T = -\frac{\alpha T}{\delta c} \Delta \sigma \quad (1)$$

where:

$\alpha$  – coefficient of temperature expansion,

$T$ – ambient temperature,

$\rho$  – material density,

$c$  – specific heat capacity,

$\Delta \sigma$  – stress difference.

Equation (1) is valid for adiabatic state and elastic stress [6].

The first experiments to prove the theory of thermoelasticity has been performed by J.P. Joule in 1857 and Compton and Webster in 1915. This measurements were not sufficiently accurate because of using the contact thermometers. Development of thermography allows for much more accurate measurements and it was applied in 1967 by M.H. Belgen. Today there are different systems for measurement like SPATE (Stress Pattern Analysis by Thermal Emission), FAST (Focal Plane Array for Synchronous Thermography), etc. [6].

## 3. Experiment

### 3.1 Samples

The samples are made of cast iron. All together there were 5 samples which shape and dimensions are given in Figure 1 and Table 1.

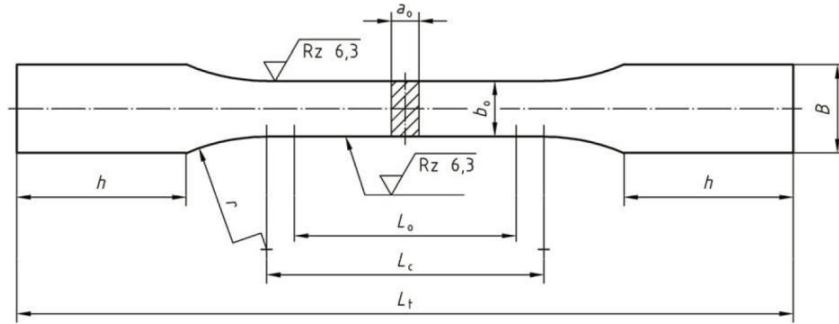

**Fig. 1. Sample**

Dimensions		[mm]
$a_0$	thickness	5
$b_0$	width	16
$B$	head width	22
$h$	head length	40
$L_0$	length	50
$L_c$	test length	64
$L_t$	total length	162

**Table 1. Sample dimensions**

### 3.1 Measuring equipment

#### 3.1.1 Tensile strength machine

The tests are carried out at room temperature on a Walter Bai servohydraulic testing machine with a load capacity of 750 kN and digital control unit DIGWIN 2000-EDC120 (see Figure 2).



**Fig. 2. Walter Bai servohydraulic testing machine**

### 3.1.2 Optical measuring system

ARMIS 4M, GOM, Germany, contactless 3D measuring system used for analysis of the displacement distribution and deformations on weighed objects based on DIC is presented in Figure 3.



*Fig. 3. Optical measuring system ARAMIS*

### 3.1.3 Temperature measurement

In Figure 4 Infrared camera FLIR ThermoCAM 2000 SC for contactless measurement of temperature distribution on the sample surface connected to PC is shown. Thermocouples type K for temperature measurement, placed on the four points of sample surface, connected to the AD converter type AGILENT and PC are shown in Figure 4.

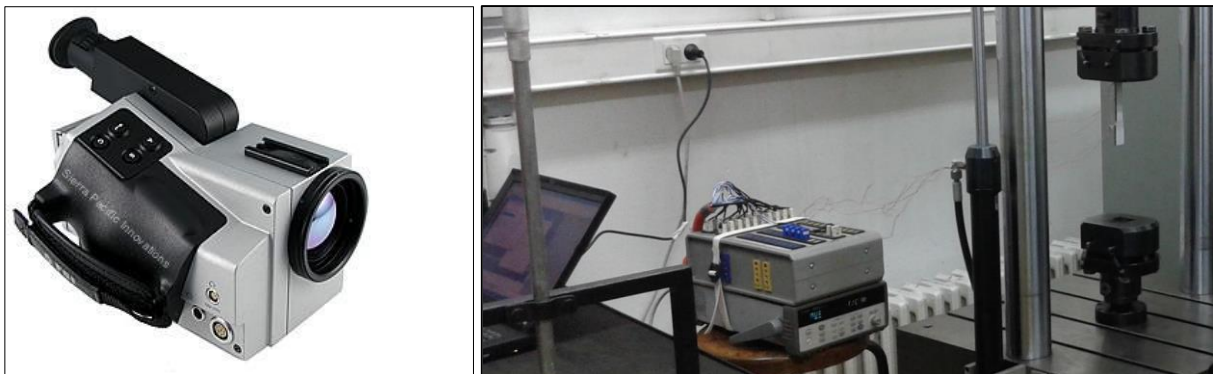

*Fig. 4. IR camera and configuration with thermocouples*

## 3.2. Preparation of samples

### 3.2.1 Surface preparation

The samples surfaces are treated with white opaque paint to eliminate reflection and after that sprayed with black stochastic raster, deformations of which are measured by optical system, Figure 5.



*Fig. 5. Clear and treated samples surfaces and stochastic raster layer*

### 3.2.2. Determination of the surface emissivity

The emissivity has been measured by means of IR camera and thermocouples in stationary state. Average value of all five samples was  $\varepsilon=0,98$ , see Figure 6.

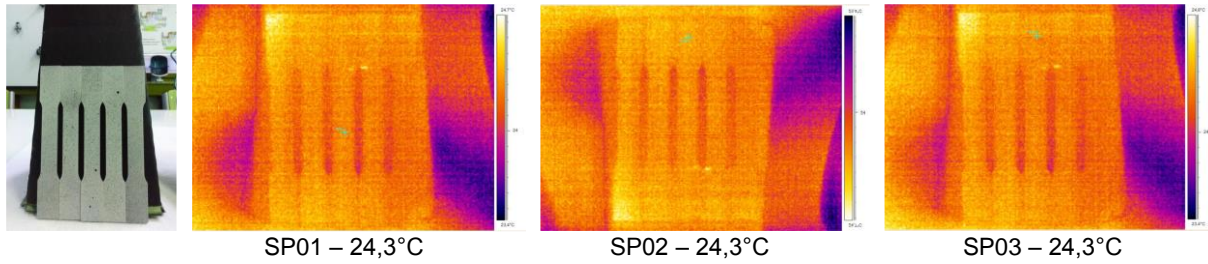

Fig. 6. Determination of the sample emissivity

### 3.2.3. Positioning of thermocouples

Thermocouples type K are placed on the vertical axes of the sample. By means of them the temperatures versus time are measured in four points during the test. The positions of thermocouples can be seen in Figure 7.

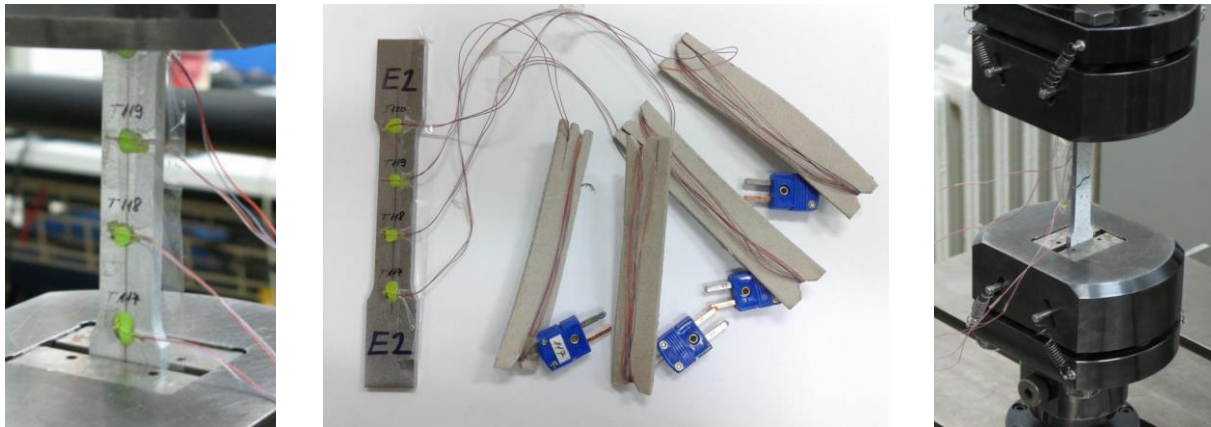
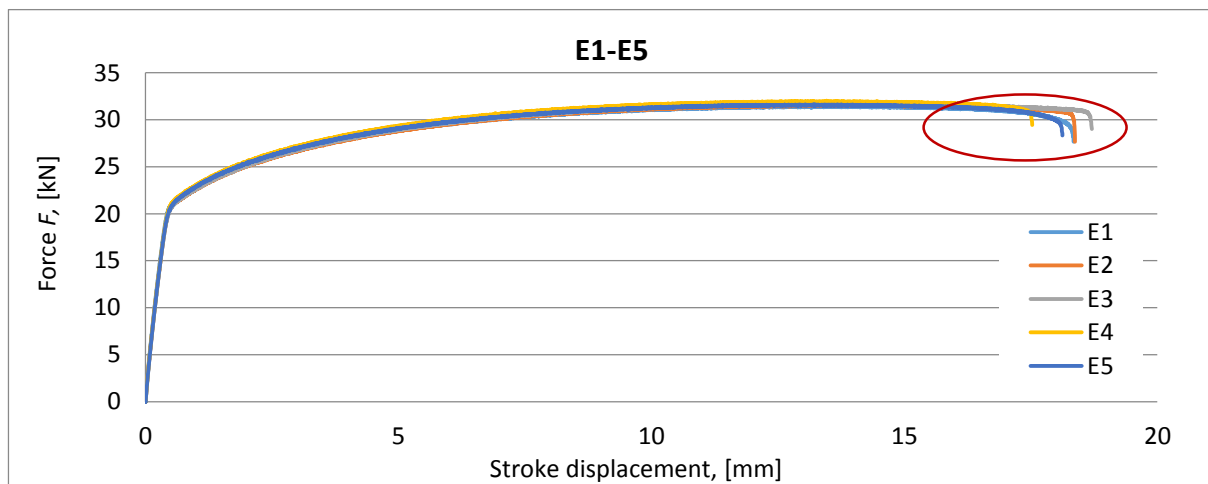

Fig. 7. Sample with thermocouples (in the middle), before test (left) and after test (right)

## 4. Results of static tensile strength

Five samples are treated (E-1 to E-5). First three samples are weighted with velocity of  $w=0,1$  mm/s and the last two with velocity of  $w=0,2$  mm/s. The results can be seen on diagrams given in Figures 8 and 9. The tensile strength could be calculated from the maximal force value and the cross-section of the sample  $A_0=80$  mm<sup>2</sup>.

### 4.1 Results obtained by Servo-hydraulic test unit



Detailed view:

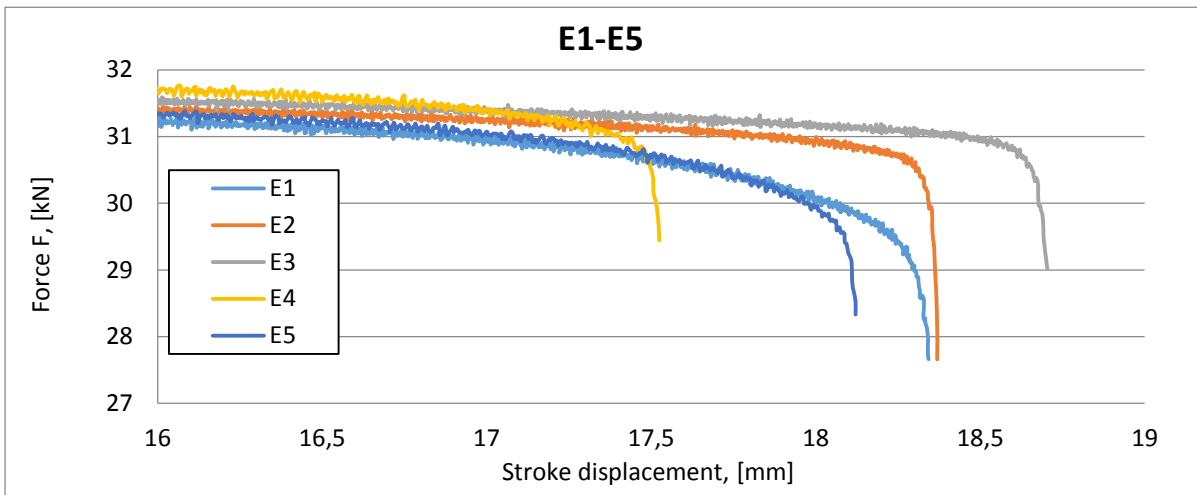

**Fig. 8.** Load-stroke displacement diagram for all five samples

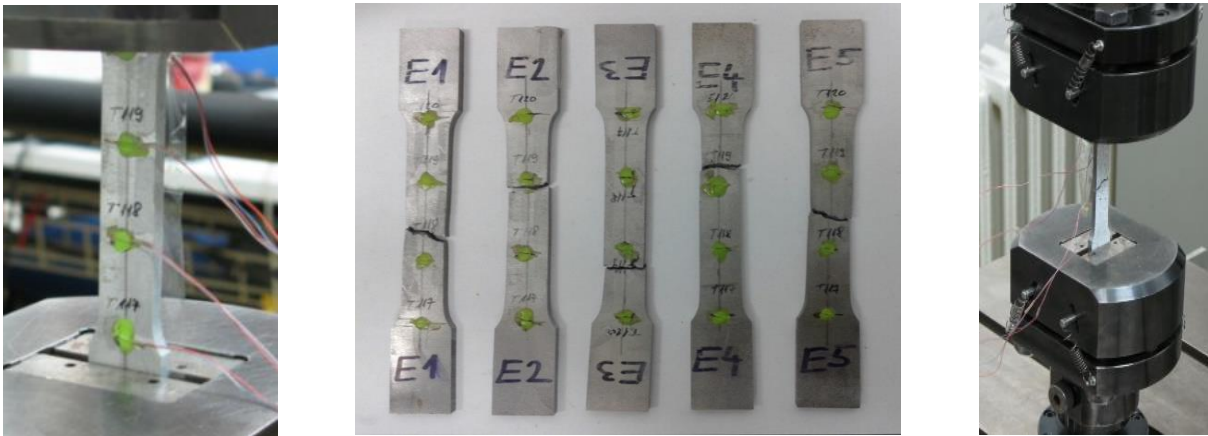

**Fig 9.** Samples after test

#### 4.2. Results obtained by thermocouples

In Figure 10 the results obtained by thermocouple are presented for sample E-5, velocity  $w=0,2$  mm/s.

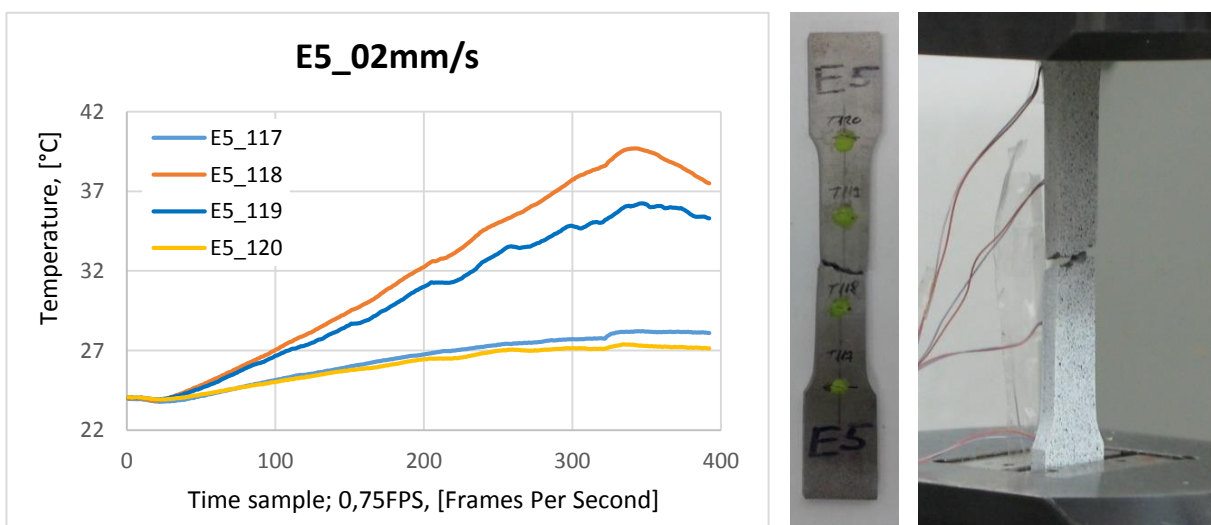

**Fig.10.** Temperature change versus time for sample E-5

### 4.3. Results obtained by IR camera

Results obtained by IR camera, sample E-5, are given in Figures 11 and 12, for the three time steps together with temperature distribution along the vertical axes. They represent a link between displacement and thermograms.

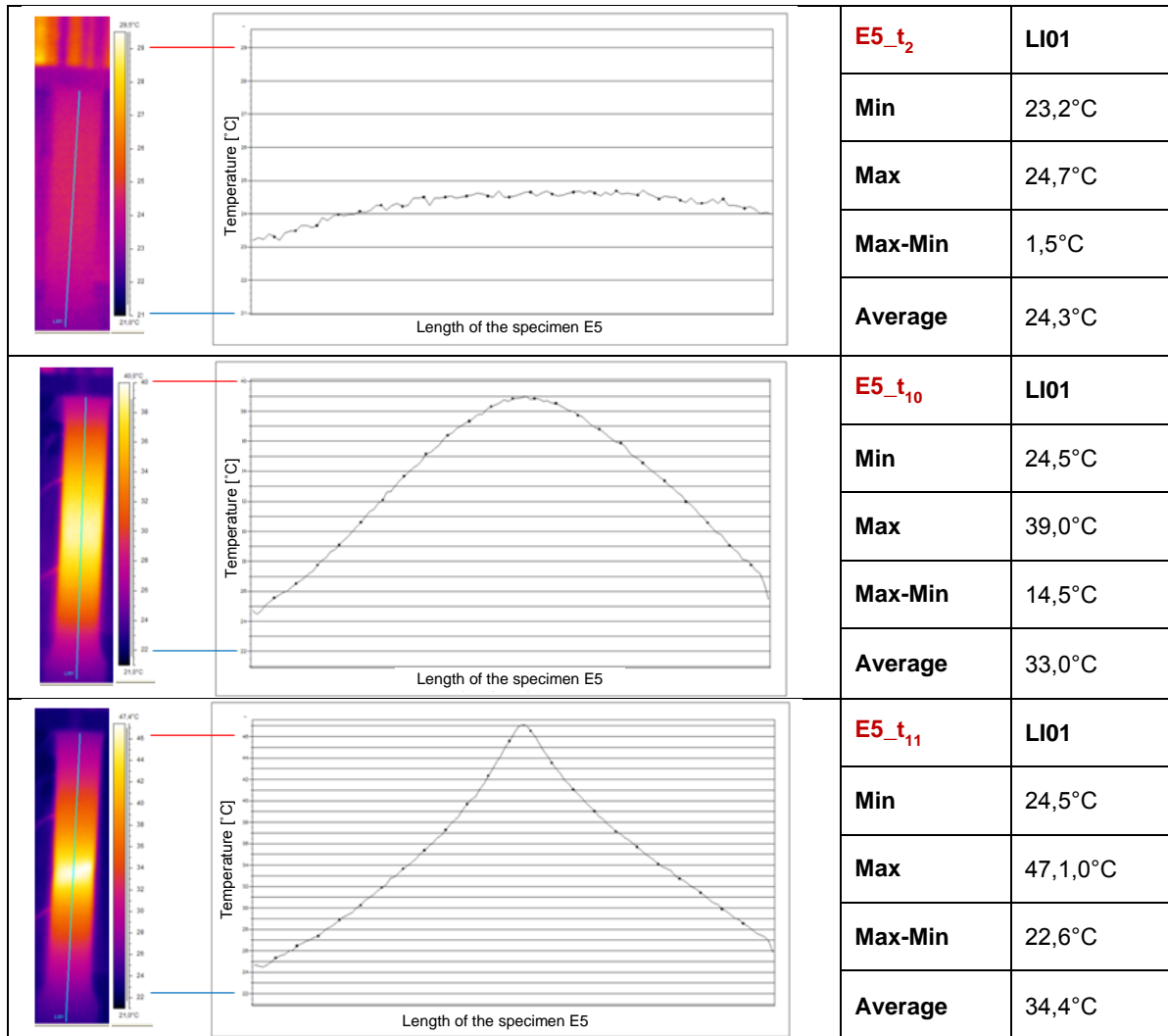

**Fig. 11.** Temperature distribution along vertical axes for three time moments

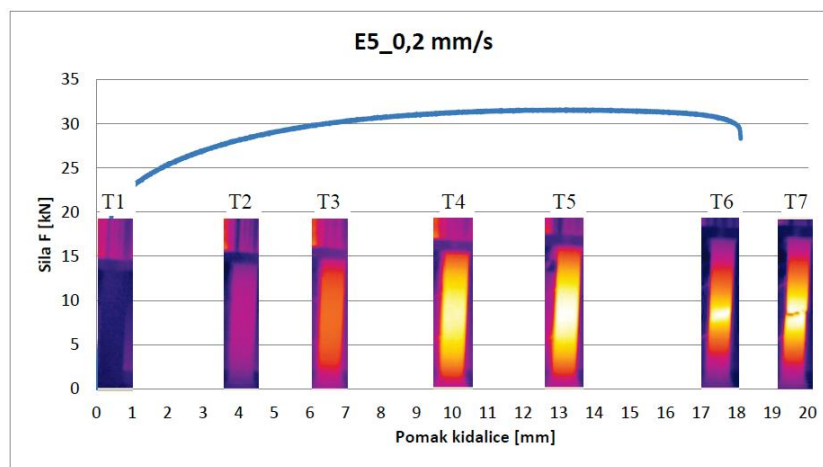
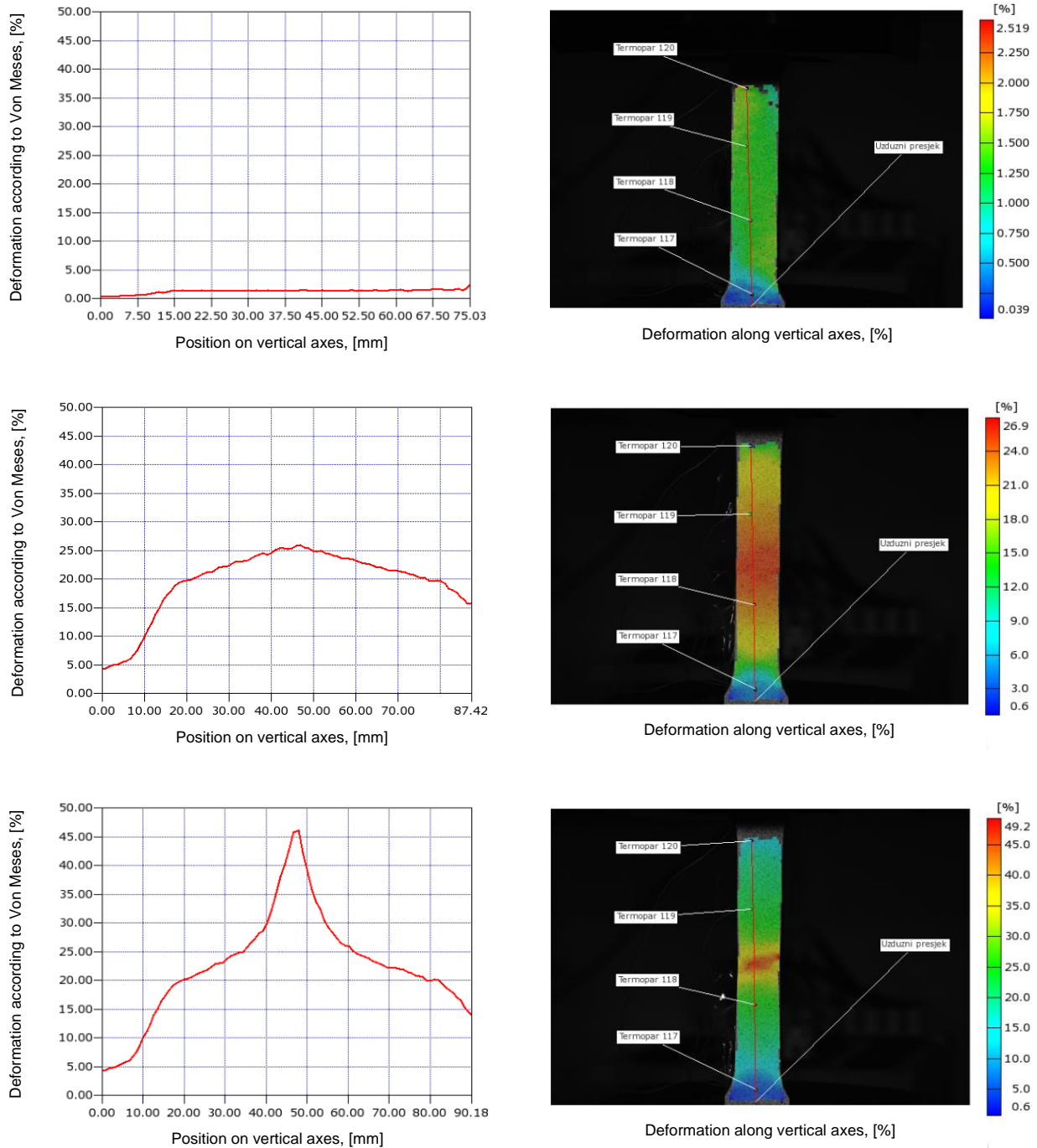

**Fig. 12** Link between displacements and thermograms



#### 4.4 Results obtained by optical system ARAMIS

Results obtained by optical system, sample E-5, are given for three time steps, together with deformation distribution on vertical axes, as presented in Figures 13. Figure 14 represents deformations at the same points where thermocouples are placed.



**Fig. 13.** Deformations along vertical axes of the sample E-5



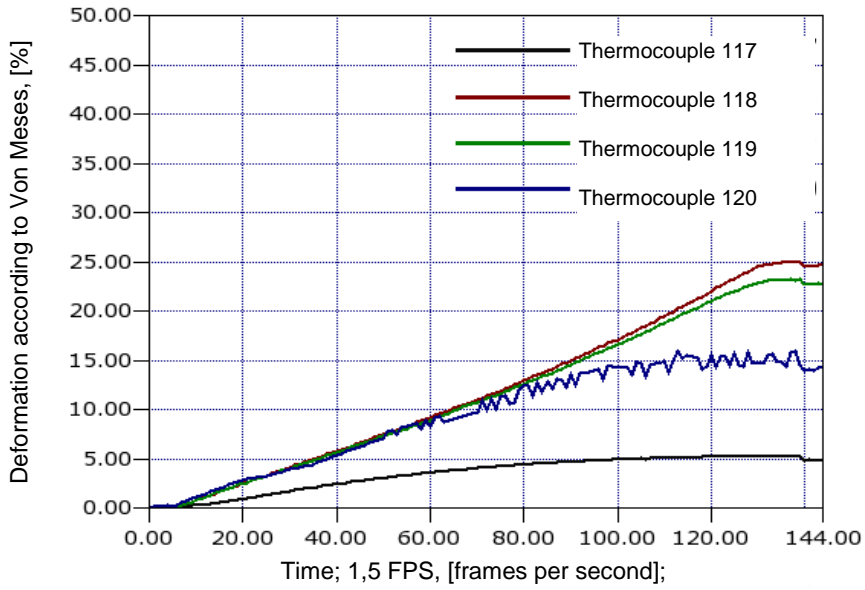
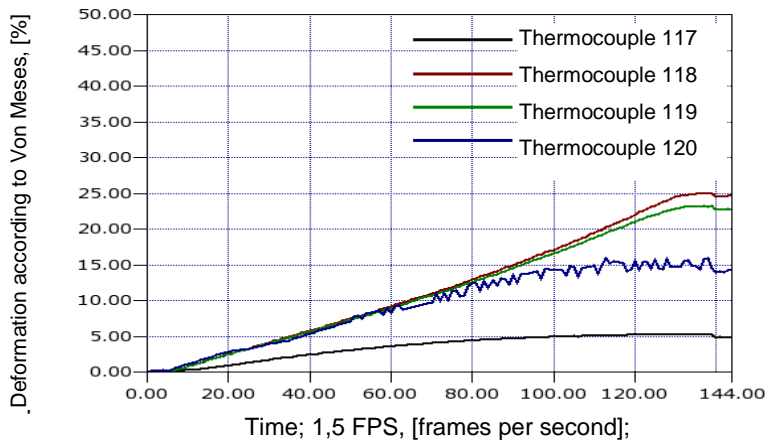
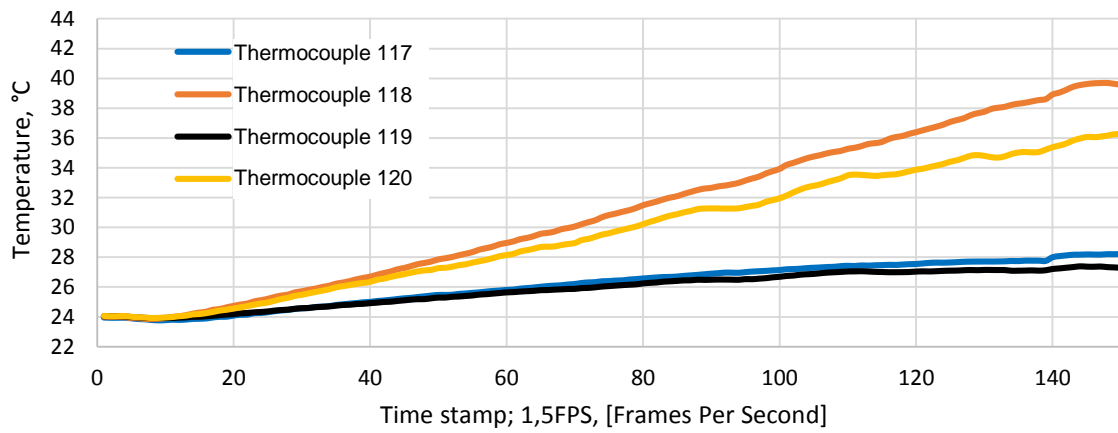

**Fig. 14.** Deformations at the points where thermocouples are placed

## 5. Conclusion and comments

### 5.1 Comparison of the results obtained by thermocouples and optical system

The temperature and deformation change during the experiment as a function of time, sample E-5, are given in Figure 15.



**Fig.15.** Temperature and deformation change versus time

**5.2 Optical system and IR camera**

Temperature and deformation change during the experiment recorded by ARAMIS and IR camera, sample E-5, are given in Figure 16.

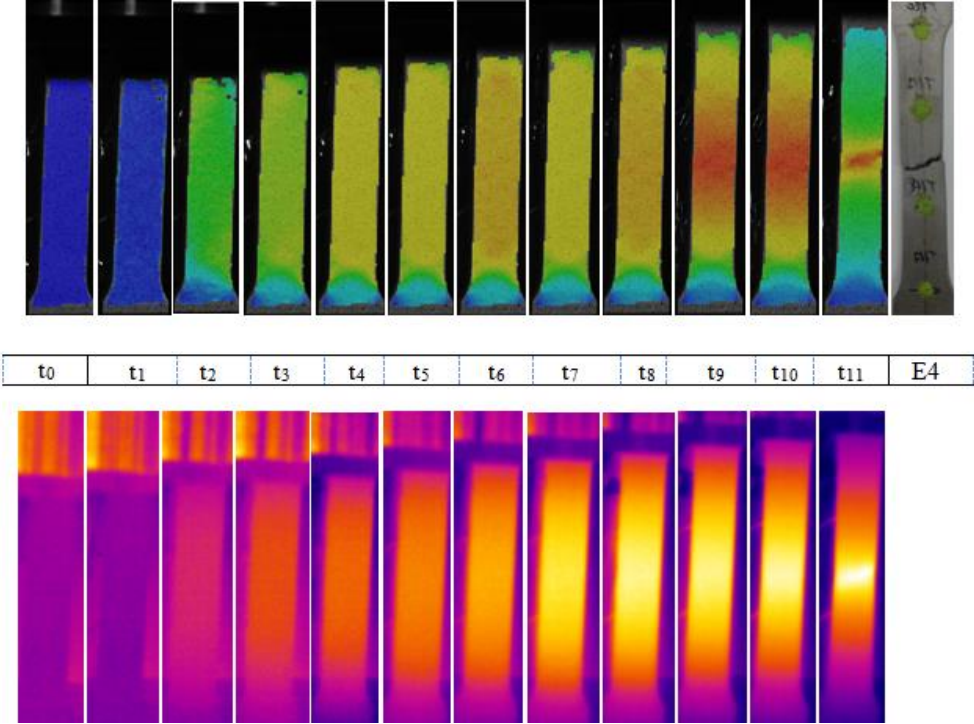

**Fig. 16.** Deformations versus time (up) ARAMIS and temperature versus time (down) Thermograms

The results for samples E-1, E-2, E-3 and E-4 are given in Figure 17. They, like results obtained for sample E-5, show the same behaviour during the test period giving the visible connection between deformations and temperatures.

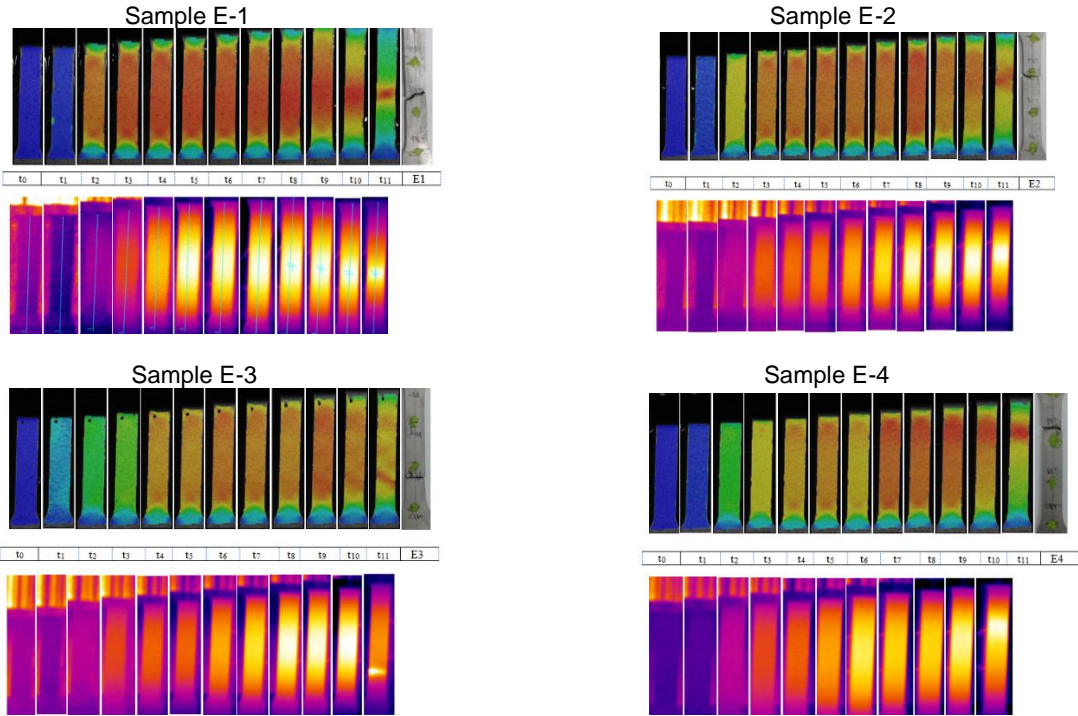

**Fig. 17.** Deformations and temperature as a function of applied force versus time

When compared the results obtained, it can be concluded that they could be used in further investigation to find better correlation between the elastoplastic deformations and increase of the sample temperatures. The relation between stress and temperature distribution is clearly seen on recorded thermograms and deformations. The results will be used in further investigations in the field of thermoelastic stress analysis. The project was performed in the Laboratory for Experimental Mechanics with support of Laboratory for Applied Thermodynamic at the Faculty for Mechanical Engineering and Naval Architecture Zagreb, Croatia. This research was a part of RCOP project "Centre of Excellence for Structural Health" (CEEStructHealth) co-financed by European Union.

## REFERENCES

- [1] Prakash, R.V., Pravin, T., Kathirvel, T., Krishnan Balasubramaniam: Thermo-mechanical measurement of elasto-plastic transitions during cyclic loading, Theoretical and Applied Fracture Mechanics, 2011.
- [2] Frančeski, J., Tonković, Z., Skozrit, I., Surjak, M., Krstulović-Opara, L., Vesenjaj, M., Kodvanj, J., Domazet, Ž.: Validacija numeričkog modela primjenom modela digitalne korelacije slike i termografije, Šesti susret Hrvatskoga društva za mehaniku, Rijeka, 2014.
- [3] Galović, A.: Termodinamika I, Fakultet strojarstva i brodogradnje, Zagreb, 2003.
- [4] Andrassy, M., Boras, I., Švaić, S.: Osnove termografije s primjenom, Kigen d.o.o., Zagreb, 2008.
- [5] Ivušić, V., Franz, M., Španiček, Đ., Ćurković, L.: "Materijali I", Fakultet strojarstva i brodogradnje, Sveučilište u Zagrebu, Zagreb, 2012
- [6] Marenić, P., Veljača, T., Krstulović-Opara, L., Domazet, Ž.: Uvod u termoelastičnu analizu naprezanja, Drugi susret Hrvatskog društva za mehaniku, Split, 2008.
- [7] Čanžar, P., Tonković, Z., Kodvanj, J.: Microstructure influence on fatigue behaviour of nodular cast iron. Materials Science & Engineering A., Vol **556**, 2012, 88-99.
- [8] Filetin, T., Kovačićek, F., Indof, J.: Svojstva i primjena materijala, FSB, Zagreb, 2002.
- [9] ARAMIS: User Manual - Software, GOM.
- [10] ThermaCAM Researcher: User Manual, FLIR
- [11] Pustaić, D., Cukor, I.: Teorija plastičnosti i viskoelastičnosti, sažetak predavanja, 2002.