

Joško PARUNOV¹
Tomislav URODA²
Ivo SENJANOVIĆ¹

Structural Analysis of a General Cargo Ship

Professional paper

The purpose of the calculations described in the paper is to analyse the structural behaviour of a General Cargo Vessels of 2240 dwt. Analysis procedure and most interesting results of the complete ship model (CSM) calculation are presented. The main concern of such study is to analyse torsional behaviour of the ship with a large deck opening and corresponding stress concentration at hatch corners. Global strength assessment is performed using "coarse mesh" finite element model, while the areas where stress concentrations occur are further analysed by the fine mesh analysis. The study demonstrates how 3D FEM (Finite Element Method) analysis may be employed as a tool for improving structural safety of general cargo ships.

Keywords: *general cargo ship, finite element method, stress concentration*

Authors' addresses (Adrese autora):

¹ University of Zagreb, Faculty of Mechanical Engineering and Naval Architecture,
I. Lučića 5, Zagreb, Croatia; e-mail:
jparunov@fsb.hr; ivo.senjanovic@fsb.hr

² A. Pandakovica 13, Zagreb; e-mail:
tomislav.uroda@fsb.hr

Received (Priljeno): 2009-02-26

Accepted (Prihvaćeno): 2009-09-29

Open for discussion (Otvoreno za raspravu): 2011-03-31

Strukturna analiza broda za prijevoz općeg tereta

Stručni rad

Svrha rada je prikazati postupak i najvažnije rezultate strukturne analize broda za prijevoz općeg tereta nosivosti 2240 dwt. Primijenjen je postupak modeliranja cijelog broda metodom konačnih elemenata. Osnovni problem koji se analizira je torziona ponašanje brodske konstrukcije s velikim palubnim otvorom i koncentracija napreznja koja se kao posljedica javlja na uglovima grotla. Proračun globalne čvrstoće je proveden koristeći "grubu mrežu" konačnih elemenata, dok su područja u kojima se javljaju koncentracije napreznja usitnjena finom mrežom konačnih elemenata. Studija pokazuje primjenu metode konačnih elemenata kao alata za poboljšanje sigurnosti konstrukcije broda za prijevoz općeg tereta.

Ključne riječi: *brod za prijevoz općeg tereta, metoda konačnih elemenata, koncentracija napreznja*

1 Introduction

The term "general (multipurpose) cargo ships" covers many different ship designs that do not fit into other more specialised cargo ship types. Thus, general cargo ships are not specialised for transport of *only* dry bulks, *only* containers or *only* heavy-lift cargoes, but they have flexibility to carry any of these cargo types. General cargo ships are the world's most numerous ship types, excepting fishing vessels. Thus, in the year 2002 their share in the overall world merchant fleet amounted to about 37% in numbers and to about 11% in dwt [1].

The average deadweight of the world fleet of general cargo ships is about 5600 dwt. Larger vessels, up to about 30000 dwt are intended to carry break-bulk cargo (bagged, boxed and palletised cargo) or containers, while small general cargo ships, usually below 5000 dwt are mostly found as flexible solutions for many dry-cargo types in shortsea shipping.

The concern for structural safety of general cargo ships follows from the fact that during the period from 1995 to 2000 approximately 90 losses of these ships per year occurred, which in other words means one ship every 4 days, with 170 fatalities per year. Even 42% of losses of all merchant ships belong to general cargo ships and similar percentage is valid also for fatality experience. Despite these figures, general cargo ships are not

considered in publicity as risky ships, probably because general cargo ship accidents are not as spectacular as for example accidents of oil tankers *Erika* or *Prestige* [2].

There are several reasons for poor statistical records of general cargo ships. Ship ages, inappropriate maintenance, poor quality in operation of these ships and deficiencies in design are some of the main causes of a large number of accidents. Smaller general cargo ships are particularly vulnerable to collision and grounding accidents because of their frequent operation in inland waterways and coastal waters.

The present paper presents procedure of 3D FEM structural analysis of general cargo ships as a tool for improving their structural safety. Although 3D FEM analysis of small general cargo ship is not an obligation with respect to requirements of classification societies, conscientious ship owners undertake such analysis in order to reveal and eliminate possible structural weak points of ship's design.

The specific purpose of the presented calculations is to analyse the structural behaviours of general cargo vessels of about 2200 dwt. Since such a ship has only one and open large cargo hold, the analysis method employed is the complete ship model (CSM) analysis. Such analysis is necessary in order to correctly determine the coupling between torsion and horizontal bending of the hull, which is very important for open ship types.

The principles of the analysis are quite similar to the analysis of containerships [3].

2 Ship description

The studied ship is a single-screw, diesel engine driven sea going general cargo vessel having a bulbous bow and transom. The vessel has only one, rather long, double skinned and box shaped cargo hold. The ship is designed to carry heavy cargo, general cargo, containers and grain in bulk. The main particulars of the vessel are listed in Table 1.

Table 1 **Main particulars of the vessel**
Tablica 1 **Glavne značajke broda**

Length between perpendiculars	L_{PP}	75.50	m
Scantling length	L	75.50	m
Moulded breadth	B	12.40	m
Moulded depth	D	6.10	m
Scantling draught	T	4.50	m
Deadweight		2240	dwt

The ship is able to carry 60 TEU (Twenty-foot Equivalent Units) containers in the hold and 80 TEU containers arranged in two tiers on the deck. Therefore, the maximum capacity of the ship is 140 TEU containers.

3 Modelling characteristics

The model, calculations and post-treatments in the present study are carried out using software VeriSTAR CSM Version 1.3c developed by classification society Bureau Veritas (BV). Consequently, the analysis is performed according to BV Rule, Edition from December 2003, with April 2004 Amendments.

The whole ship FE model is shown in Figure 1. The ship is modelled by so called "coarse mesh" model, where the principal finite element type employed is the quadrilateral orthotropic shell element defined by four nodes, each with six degrees of freedom, including secondary stiffeners. Generally, one such orthotropic element represents stiffened panel between web

Figure 1 **Complete ship finite element model**
Slika 1 **Model konačnih elemenata cijelog broda**

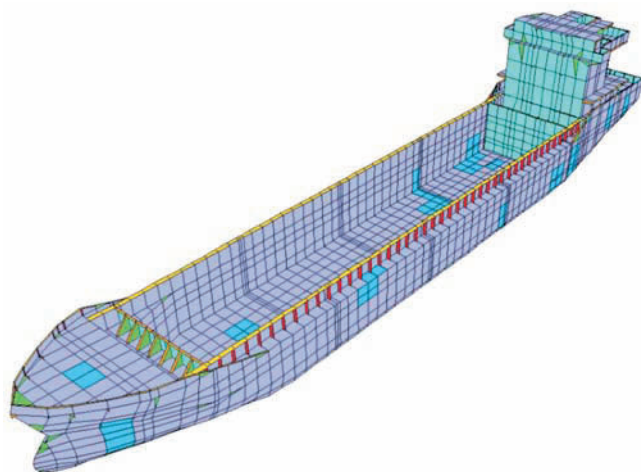

frames in longitudinal direction and includes 2-4 stiffeners in the transverse direction.

"Net" thickness approach has been used in the analysis, which means that the analysis is performed on thicknesses reduced due to corrosion. Corrosion deduction thickness is taken according to BV rules. In this way, it is ensured that the cargo ship will have satisfactory structural strength not only in "as-built" condition, but also at the end of her design life. Of course, this conclusion implies appropriate maintenance, which in other words means that excessive corrosion levels, outside limits proposed by classification societies, will not occur.

3.1 Calculation data and assumptions

Boundary conditions

In order to prevent rigid body motions of the overall model, the constraints specified in Table 2 are applied.

Table 2 **Boundary conditions**
Tablica 2 **Rubni uvjeti**

Boundary conditions	Displacements in directions *		
	X	Y	Z
One node on the fore end of the ship at centreline	free	fixed	fixed
One node on the starboard side at aft end	fixed	fixed	free
One node on the portside at aft end	free	fixed	fixed

*X- longitudinal direction; Y- vertical direction; Z-transverse direction

Schematic representation of boundary conditions is shown in Figure 2.

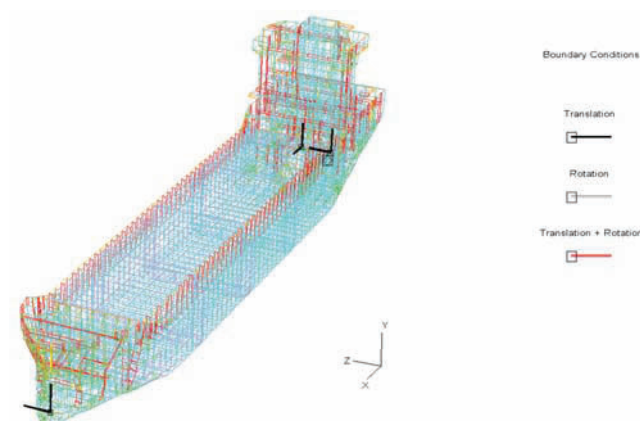

Figure 2 **Boundary conditions of the complete ship model**
Slika 2 **Rubni uvjeti modela cijelog broda**

Loading conditions

The following loading conditions from the loading manual have been analysed:

- Ballast, Departure
- Full load with containers, Arrival
- Full load, homogenous cargo, Arrival.

Loading conditions contain several types of cargo:

- liquid cargo (ballast water, diesel oil, fresh water, heavy fuel oil, lubricating oil)
- bulk cargo in cargo hold
- containers in hold and on the deck.

Lightship weight is distributed over the model length, according to the actual lightship weight distribution. Schematic representation of the ship loaded with containers is shown in Figure 3.

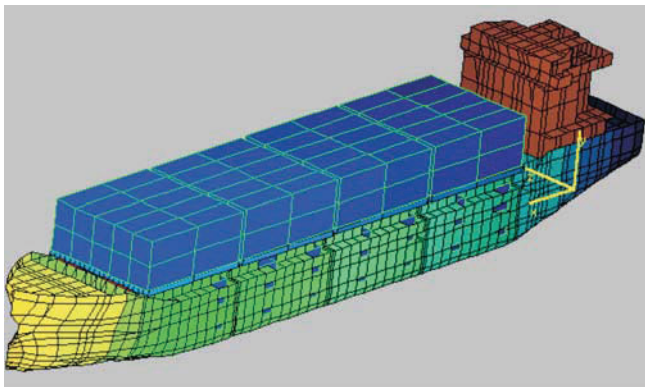

Figure 3 **Schematic representation of the ship loaded with containers**

Slika 3 **Shematski prikaz broda s kontejnerima**

Hydrostatic calculations

For each of loading conditions, hydrostatic calculations of the FE model are performed in order to check if displacement, trim and still water bending moment are in accordance with the loading manual. According to BV rules, convergence is deemed satisfactory if within the following tolerances:

- 2% of displacement
- 0.1 deg. of the trim angle
- 10% of the still water bending moment.

All comparisons were within permissible tolerances, leading to the conclusion that the FE model and mass distribution are created with satisfactory accuracy.

Hydrodynamic analysis

The wave load is taken into account by *Design Wave Method*. The principle of the method is that various load components which occur simultaneously are combined by setting the characteristics of regular waves that maximise the dominant load parameters. The parameters of design waves are selected based on the results of hydrodynamic analysis.

Hydrodynamic analysis is performed by strip-theory seakeeping program SHIPMOT, which is integrated in VeriSTAR CSM. The purpose of the seakeeping calculation is to provide Response Amplitude Operators (RAOs) and phase angles of wave-induced motions, accelerations and load effects. Dominant frequencies of RAOs are taken as frequencies of design waves.

For rule calculation the ship speed equal to 0.6V is considered. The analysis is performed for wave headings ranging from following seas (0 degree) to head seas (180 degrees) by increment of 15 degrees.

Load cases

Load cases are combinations of still water loads and wave loads. Load cases are selected aiming to maximise dominant load effects having dominant influence on the strength of some part of the structure. For the purpose of illustration, Table 3 presents some of the considered load cases maximising selected dominant load effects. It should be mentioned that other load cases are also

Table 3 **Sample load cases considered in the analysis**
 Tablica 3 **Uzorci slučajeva opterećenja korišteni u analizi**

Dominant load effect	Loading condition	Schematic representation of ship in wave
Hogging bending moment	Ballast	
Transverse acceleration at deck at sides	Container loads	
Wave torque	Homogenous cargo	

considered in the analysis, but they are omitted herein because the aim of the paper is to provide overview of the procedure without entering into details.

For each load case, design wave is determined based on the results of the hydrodynamic analysis and rule value of dominant load effect. However, parameters of design wave are further corrected in order to take into account non-linear effects due to the hull shape and due to the pressure distribution above the mean water line.

For the purpose of further validation of the FE model, global deformations of the ship hull for different load cases are also checked. For illustration, deformation of FE model for load case maximising hogging bending moment is shown in Figure 4.

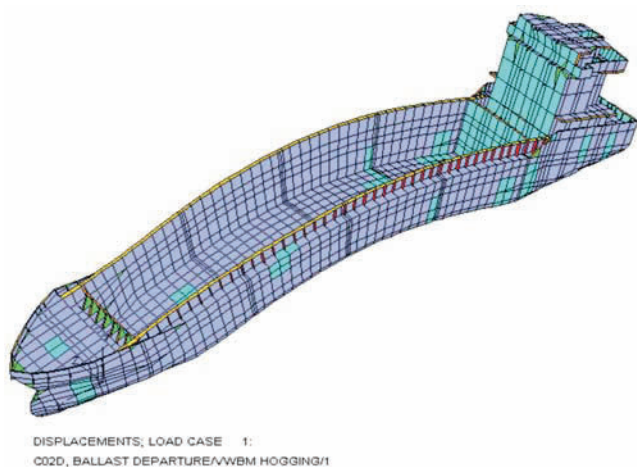

Figure 4 Complete ship deformation on the crest of the wave
Slika 4 Deformacija cijelog broda na valnom brijegu

4 Results

Coarse mesh model

Coarse mesh model is mainly used to check global stress levels and buckling of longitudinally effective plates. Therefore, the results for all loading cases are scanned in order to verify compliance with the BV criteria for yielding and buckling failure modes. It has been found that the structure fully complies with the rule requirements, with the stress ratio of actual and permissible stresses no larger than 0.85.

Fine mesh models

In many areas with steep stress gradients, coarse mesh analysis is not accurate enough. In order to obtain more realistic distribution of stresses, fine mesh analyses have to be performed. The principle of the fine mesh analysis is that the boundary conditions imposed on the fine mesh model are displacements obtained by the coarse mesh analysis. In addition, local pressures and concentrated forces are added to the fine mesh model.

For ships with a large hatch opening, torsional moments are producing large diagonal deflections of the hatch opening and corresponding stress concentrations in the hatch corners. Therefore, hatch corner plates should be reasonably rounded and thickness should be significantly increased locally. This

famous *hatch corner problem* was in the focus of the presented fine mesh analysis.

Fine mesh model of the aft hatch corner is created and shown in Figure 5. In the fine mesh model, spacing between longitudinals is covered by two elements, while four elements are used between transverse web frames.

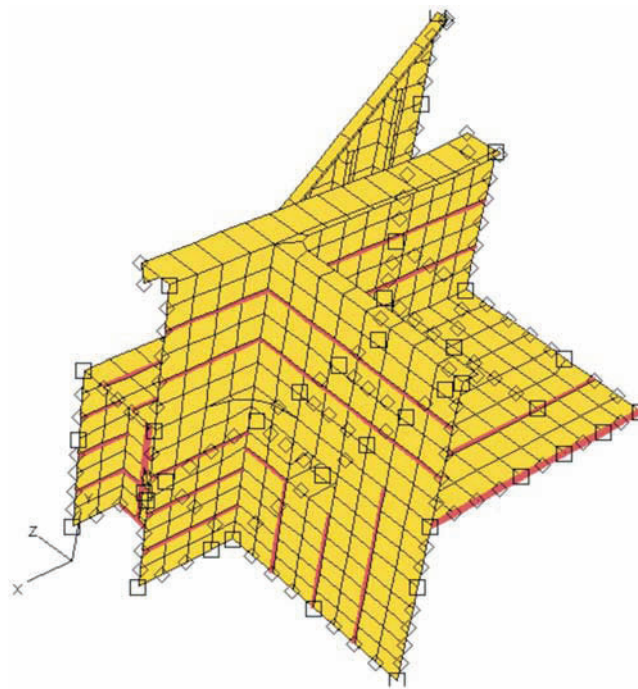

Figure 5 Fine mesh model of the aft hatch corner (squares represent imposed displacements from the coarse mesh model)

Slika 5 Model fine mreže krmenog grotlenog ugla (kvadrati predstavljaju narinute pomake iz grube mreže konačnih elemenata)

The critical load case for the hatch corner problem is the wave torque case from Table 3. The von Mises stresses in the main deck area at hatch corner for that load case are presented in Figure 6.

Figure 6 Von Mises stresses on the deformed shape for the critical load case at the connection of the main deck in the cargo area and engine room

Slika 6 Von Misesova naprezanja na deformiranom modelu spoja glavne palube u teretnom prostoru i strojarnici za najnepovoljniji slučaj opterećenja

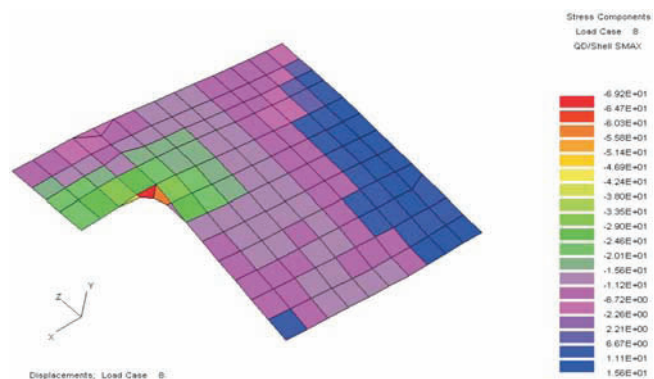

The level of stresses in the critical area is acceptable, i.e. it has been found that the main deck is appropriately reinforced.

Another interesting detail analysed by the fine mesh is the hatch coaming in the midship area. The hatch coaming stays are loaded by forces caused by containers on the main deck. The most interesting loading case is the one maximising transverse acceleration at the main deck at side (see Table 3). Deformations of the hatch coaming fine mesh model are shown in Figure 7 together with concentrated forces on the top of the hatch coaming.

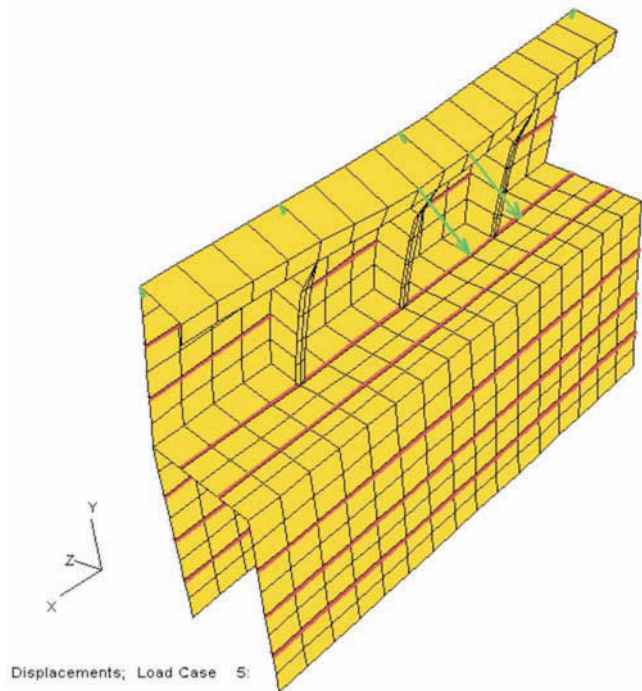
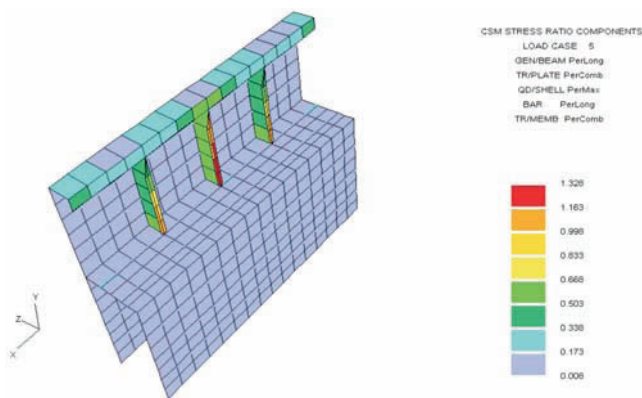

Figure 7 Concentrated forces and deformations of the fine mesh hatch coaming model

Slika 7 Koncentrirane sile i deformacije fine mreže modela pražnice grotla

Figure 8 Ratio of actual and permissible stresses on the hatch coaming

Slika 8 Omjer stvarnih i dopuštenih napreznja na pražnici grotla



Results for the most important loading case are shown in Figure 8. The results may be summarized as follows:

- the highest stress ratio reads 1.328 and occurs in the flange of the hatch coaming stay at connection with the main deck
- shear stresses in stays are satisfactory and well below their permissible values.

Based on the obtained results, reinforcement of the hatch coamings is proposed. The fine mesh of the final design of the hatch coaming complying with the stress criteria is shown in Figure 9.

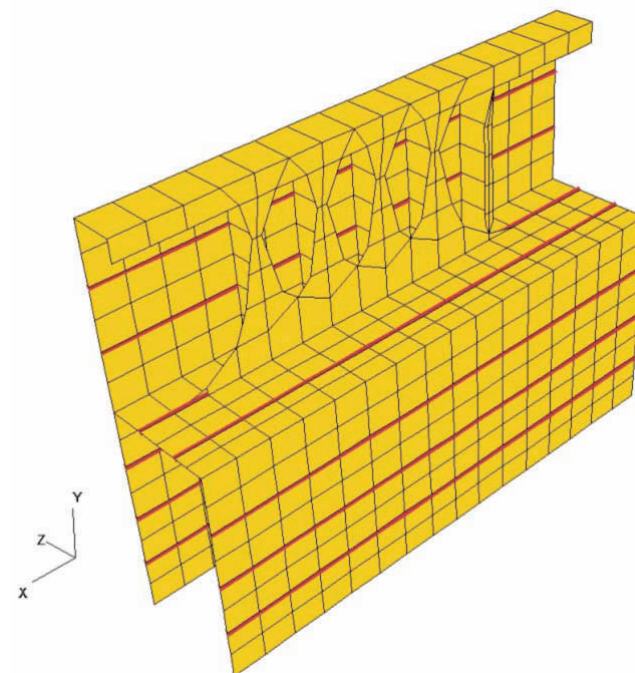

Figure 9 Fine mesh model of the reinforced hatch coaming

Slika 9 Model ojačane pražnice grotla

5 Conclusion

The paper deals with the structural FE analysis of the general cargo ship intended for shipping of dry bulk cargo, heavy cargo and containers. Complete ship analysis is employed using design wave approach. Global strength assessment is performed by the so called “coarse mesh” model, while the areas susceptible to stress concentration are further analysed by fine mesh modelling. Such typical areas are hatch corners at the ends of the large cargo hold and the hatch coaming at the central part of the cargo hold.

Performed structural analysis enables appropriate structural reinforcement of the critical areas and thus contributes to the improvement of the structural safety of general cargo ships. The ship analysed in the present study (Figure 10) is already built. It should be noted that the built ship is 12.8 m shorter than the analysed vessel as a consequence of specific agreement between the ship owner and the shipyard. The structural assessment of the shorter ship, performed in the similar way, resulted in lower stress levels, since the structural design is identical to that of the longer vessel.

Disclaimer

Opinions stated in the paper are personal views of the authors and should not be construed as reflecting the views of any institution.

Acknowledgement

The authors are grateful to *Kraljevica* Shipyard for their cooperation and support during the work on this project and for permission to publish this paper.

References

- [1] LINDE, H.: "Multipurpose Cargo Ships", Ship Design and Construction, Vol. II, Ch.27, SNAME, 2004.
- [2] SPOUGE, J.R.: "The Safety of General Cargo Ship", International Journal of Maritime Engineering, Vol. 145, 2003, p. 252-264.
- [3] VALSGARD, S., SVENSEN, T.E., THORKILDSEN, H.: "A Computational Method for Analysis of Container Vessels", SNAME Transactions, Vol.103, 1995, p. 371-393.

Figure 10 General cargo ship analysed in the present study
Slika 10 Brod za prijevoz općeg tereta analiziran u ovom radu

