



International Institute for  
Applied Systems Analysis  
[www.iiasa.ac.at](http://www.iiasa.ac.at)

# Status and Structure of the Forest Industry in Siberia

**Obersteiner, M.**

**IIASA Working Paper**

**WP-95-030**

**March 1995**



Obersteiner, M. (1995) Status and Structure of the Forest Industry in Siberia. IIASA Working Paper. WP-95-030 Copyright © 1995 by the author(s). <http://pure.iiasa.ac.at/4562/>

**Working Papers** on work of the International Institute for Applied Systems Analysis receive only limited review. Views or opinions expressed herein do not necessarily represent those of the Institute, its National Member Organizations, or other organizations supporting the work. All rights reserved. Permission to make digital or hard copies of all or part of this work for personal or classroom use is granted without fee provided that copies are not made or distributed for profit or commercial advantage. All copies must bear this notice and the full citation on the first page. For other purposes, to republish, to post on servers or to redistribute to lists, permission must be sought by contacting [repository@iiasa.ac.at](mailto:repository@iiasa.ac.at)

# Working Paper

## **Status and Structure of the Forest Industry in Siberia**

*Michael Obersteiner*

WP-95-30  
March 1995



International Institute for Applied Systems Analysis □ A-2361 Laxenburg □ Austria

Telephone: +43 2236 807 □ Fax: +43 2236 71313 □ E-Mail: [info@iiasa.ac.at](mailto:info@iiasa.ac.at)

# Status and Structure of the Forest Industry in Siberia

*Michael Obersteiner*

WP-95-30  
March 1995

*Working Papers* are interim reports on work of the International Institute for Applied Systems Analysis and have received only limited review. Views or opinions expressed herein do not necessarily represent those of the Institute, its National Member Organizations, or other organizations supporting the work.



International Institute for Applied Systems Analysis □ A-2361 Laxenburg □ Austria

Telephone: +43 2236 807 □ Fax: +43 2236 71313 □ E-Mail: [info@iiasa.ac.at](mailto:info@iiasa.ac.at)

# Table of Contents

1. Introduction.....	1
2. The Official Russian System of Data Collection .....	1
3. Critical Points in the System of Data Collection of GOSKOMSTAT .....	2
4. The IIASA Siberian Forest Study's Forest Enterprise Database .....	5
5. The Forest Industry of Siberia in an International Comparison .....	5
6. Short Historical Overview .....	5
7. The Forest Industry Sector of Siberia.....	7
7.1 Wood Supply.....	7
7.2 Wood Processing Industry .....	11
8. References .....	17
Appendix I.....	19
A. TABLES.....	19
B. FIGURES.....	23
Appendix II.....	27
Appendix III.....	32

## Foreword

IIASA, the Russian Academy of Sciences and Russian governmental organizations initiated the Siberian Forest Study in 1992, with the overall objective of the Study to be:

- identification of possible future sustainable development options of the Siberian forest sector (assess the biospheric role of Siberian Forests, and identify suitable strategies for sustainable development of forest resources, the industry, the infrastructure and the society);
- identification of policies for the different options to be implemented by Russian and international agencies.

The first Phase of the Study was to build relevant and consistent databases for the upcoming analyses of the Siberian forest sector (Phase II). Nine cornerstone areas have been identified for the assessment analyses, namely further development of the databases, greenhouse gas balances, forest resources and forest utilization, biodiversity and landscapes, non-wood functions, environmental status, forest industry and markets, transportation infrastructure, and socio-economics.

The work presented in this paper deals with the cornerstone Forest Industry and Markets. More specifically it describes the system of the forest industry statistics in Russia and a rough description of the Siberian forest industry based on this data system.

## 1. Introduction

Siberian forest industry<sup>1</sup> has received scant attention in the past. The latest political changes in Russia have brought the Siberian forest resources and forest sector to the world's attention (e.g., Newsweek, 1993). The forest resources are not only an important economic resource for the whole forest industry, but they are also a precious ecological asset, which has attracted the attention of the international environmental community.

Siberia constitutes nearly 20% of the world's forest area and 17% of the world's growing stock and 38% of the growing stock of coniferous forests. From the perspective of the forest resources Siberia has a large potential to be a major participant of the international forest products sector and by being able to generate hard currency might become one of the most important motors such development. Recent political outrages have led to a deep crisis of the forest sector (*Figure 1*). From a structural, organizational, managerial, and technological point of view the whole forest industry will probably have to undergo fundamental changes in order to meet future international market requirements.

When looking at the present state of the forest industry in Russia it becomes apparent that long-term increases in forest industry production require the investment of large sums of capital for infrastructure and industrial development (Backman and Waggener, 1991). According to Burdin (1992), in the path of transition of the forest industry to a market economy the following specific factors should be taken into consideration:

- the lack of technological and cooperative ties between logging, woodworking, and pulp and paper enterprises at the regional and interregional levels;
- the low technological production levels;
- the inefficient transportation;
- the insufficient social infrastructure;
- the lack of qualified personnel to work under market conditions;
- the weak legal basis for proper forest utilization.

A number of different development scenarios for the Siberian forest sector are possible at present. The objective of this article is to present the current structure of the Siberian forest industry based on data collected by the IIASA Siberian Forest Study (Nilsson, 1994), which will be employed in an upcoming analysis of plausible development options of the forest sector of Siberia.

## 2. The Official Russian System of Data Collection

The data employed in the description of the forest industry in this article basically stems from data collected by GOSKOMSTAT (Russian central statistical organization) and calibrated by regional experts involved in the Siberian Forest Study. There are two sources of data within the overall GOSKOMSTAT system

---

<sup>1</sup>In this article we use Siberia for West Siberia, East Siberia and the Far East.

concerning the forest industry. These sources are labeled **A1** and **A2** (see *Figure 2*)<sup>2</sup>. The fundamental source for all data, however, remains **A1**. Data source, **A2**, relies on data obtained from **A1**.

Data describing **A1** can be categorized into five groups, labeled **F1** through **F5**. Data type, **F1**, is entirely local in distribution, and generally is not available beyond **A1**. Data type **F2** can be distributed to **A2**, while **F3** is channeled to organization **A2**. Data type, **F4**, can be funneled through organization **A2**, and tends to have a regional distribution with a possible national reach.<sup>3</sup> Data type, **F5**, has national distribution, and is normally distributed to either of, or both of, statistical organizations, **S1** and **S2**, with possible routing through **A2**.

The data, **F2** through **F5**, either directly, or through organization **A2**, are then sent to statistical organizations, **S1** and **S2**, before being placed, in paper form, in the storage locations, **X1** and **X2**. Part, but not all, of the data in paper form is then placed into computer oriented databases,  $\sigma$ **D1** and  $\sigma$ **D2**.

Interacting with the flow of information are a number of experts, identified as **E1** through **E5**. Experts **E3** through **E5** are called upon to answer two types of questions, the typical question, **TZ**, and the non-typical question, **NTZ**.<sup>4</sup> Experts **E1** and **E2** are not normally involved in the queries directed to the statistical organizations, but are available for consultation over questions with a local interest.<sup>5</sup>

When answering the **NTZ** or **TZ**, the experts rely on data located in the electronic and paper data bases, modified, as required, by their own experience. The degree to which subjective factors influence the responses to the questions is higher in the case of the non-typical question, **NTZ**, since the  $\sigma$ **D** was constructed to handle the typical question. An overall description of the variables involved in the system is presented in Appendix II. The data collection on the Siberian forest industry was carried out by IIASA's Siberian Forest Study enrolled the whole system described in *Figure 1* in Appendix I. The description of the data collection system is based on an appraisal carried out by Backman and Waggener (1993).

### **3. Critical Points in the System of Data Collection of GOSKOMSTAT**

There are three types of critical points with the data collection system. The first type addresses the degree to which original data are modified, intentionally, or unintentionally. The second type is linked to the location of the data in reference to the organization posing the question, or needing the data. The third type is linked to the location of the organization which has acquired the data and the organization which contracted for the data delivery.

---

<sup>2</sup>See detailed description of the abbreviations used in this section in Appendix II

<sup>3</sup> Information type **F4** can also be sent directly to statistical organization **S1**.

<sup>4</sup>The same expert, **E3** or **E4**, may or may not be the person who routinely handles the typical inquiries.

<sup>5</sup>Data of a local interest can be considered enterprise specific.



## Data Modification

The critical points are distributed throughout the system. These points are segregated into points at which data can be modified by expert opinion, and points where data can be contaminated.<sup>6</sup>

### Data Modified by Expert Opinion

Discernible from *Figure 1*, located in **Appendix I**, modification of the basic data can take place at seven locations within the system, identified as Roman numerals I through VII. Two (2) of the points are located at the interface between the typical question, **TZ**, and the electronic database,  $\sigma D$ . Three (3) are located at the juncture with the non-typical question, **NTZ**.<sup>7</sup> The last two (2) are linked to the interface between the local experts, **E1** or **E2**, and the non-typical question.

#### *The Typical Question*

The data system in the past has been structured to handle the typical question in an efficient manner. Accordingly, for the most part, modification of the existing data is not a large factor when dealing with the **TZ**. Expert opinion can, however, play a significant role when compensating for contamination of the data, discussed below, which from time to time can occur.

#### *The Non-Typical Question*

It is when answering the non-typical question, **NTZ**, that the subjective input of experts can have the largest impact. Since the scope of the non-typical question lies outside of the boundaries for which the data base was designed to accommodate, manipulation of the data base,  $\sigma D$ , does not in itself guarantee sufficient data with which to answer the question. Not only must the computerized data base be referenced, but the data located in the paper storage unit, **X**, must also be accessed. In situations where the data is not sufficient to answer the question, the expert, **E**, must introduce his subjective opinion.

#### *Questions at an Enterprise Level*

The degree to which expert opinion contributes to answering the **NTZ** is also larger when considering data which falls within categories, **F1** and **F2**. The data requested are usually enterprise specific which may or may not be readily available from the electronic and paper data base of the enterprise. The request for data at this level of detail traditionally fell outside of the boundaries of the normally expected question.

---

<sup>6</sup>Modified refers to intentional change of the data based on the subjective judgment of experts, **E**. Contamination refers to unintentional modification brought on by clerical error, or purposeful change of input data in order to, *inter alia*, mask underlying conditions.

<sup>7</sup>The first five points do not necessarily involve direct contact with the enterprises or local experts, **E1** or **E2**.

Consequently, expert opinion can be expected to have played a role in addressing enterprise specific questions, particularly when addressing questions linked to physical characteristics such as the forest fund.

### **Contamination of the Basic Data**

The most fundamental point in the data system is located at organizational unit, **A1**. With the exception of **F1**, all of the data varieties, **F2** through **F5**, require someone at the enterprise, or census organizations, to complete the data forms. Much of the data is derived based on the flow from the people in the field such as production superintendents at the forest harvesting enterprises. The data are then compiled, usually within the accounting department, for inclusion within the overall operating reports which should be delivered on a regular basis to enterprise management and other management entities within the organizational hierarchy.

It is possible that the basic flow of data from the individual departments of the enterprise, or from departments of more senior organizations could be intentionally contaminated. While contamination is possible under the old system, there were checks and balances built into the system which reduced the risk of collusion. Large scale contamination would involve collusion among people from: (1) different organizations within the same ministry; and/or (2) organizations from other ministries.

Clerical errors linked to compilation of the data within individual enterprises could occur, but are unlikely to have been significant. The people preparing the basic information are also close to the actual activity underlying the data being collected. Significant errors are likely to be noticed and corrected before data is transmitted either up the organizational structure within the enterprise, or to other organizations within the data system.

Information which was routinely passed on to the corporate level of management was utilized to monitor the performance of the enterprises to their budget. Consolidation of the information at organization, **A2**, **S1** and **S2** all introduce a greater degree of uncertainty than at organization, **A1**. Individuals consolidating the data at these organizations are further removed from the actual operations described by the data. Consequently, large scale errors brought on during the consolidation process would not be as easily detected, and consequently, could be introduced into the data flow quite by accident.<sup>8</sup>

Introduction of the additional data collection step connected with the agenda of the IIASA Siberian Forest Study's enterprise specific data adds another stage at which data could be contaminated. The risk of contamination is completely independent of the accuracy of the data originating from the storage units, **X** or  $\sigma D$ . Thus, for example, our basic data collection, when relying on the paper based source of data, **X**, could potentially have clerical error in transcribing the data or have selected data which is completely inappropriate for the indicator requested. This last error also exists when accessing data through the computer,  $\sigma D$ .

---

<sup>8</sup>*Goskomstat* is oriented to working on questions at a regional or *oblast* level of detail. Because of this, the information base for enterprises is not always utilized. Accordingly, the information remains in part uncalled for, and consequently, control for receipt, storage, and verification is not strictly enforced.

#### **4. The IIASA Siberian Forest Study's Forest Enterprise Database**

There were mainly three sources for the individual enterprise data which a team of experts located in Novosibirsk delivered to IIASA. These include GOSKOMSTAT (system described above), the Forest Industry Institute, and a network of local experts. The network of local experts were utilized to screen the data received from the other two official data sources. These experts gave recommendations for data correction to the central team in Novosibirsk which finally delivered data to IIASA. These data were screened for possible inconsistencies with other data sources available at IIASA and data were checked for logical mistakes. Data sources at IIASA consisted of aggregated GOSKOMSTAT data and a publication from NPO Nauka (BIZNES-KARTA) which has produced a series of books which contain basic enterprise information of the forest sector throughout the former Soviet Union. All uncertain data items of the data set delivered to IIASA were eliminated after discussion with the team in Novosibirsk. The list of indicators collected is presented in Appendix III. The data collected is valid for the year 1989.

#### **5. The Forest Industry of Siberia in an International Comparison**

The total land area of Siberia is 12,766 million km<sup>2</sup>. This is larger than the US, EC and Japan together. The forested area of 497.1 million hectares in 1988, which is 39% of the total area of Siberia, is two times larger than all of the 12 EC-countries.

In 1989, 142,325 thousand CUM of round wood were harvested. This is 4.1% of the world's total round wood production. Harvest per capita of inhabitants is 4.4 CUM in Siberia which is one-third less than in Canada and Sweden. However, only 37% of the AAC is actually harvested in Siberia.

The industrial utilization of the harvested wood is 83% in Siberia and 96% in Canada and 92% in Sweden. Mismanagement, lack of transportation infrastructure and lack of modern logging technology account for huge losses of round wood during the harvesting procedure (cit. Shvidenko and Nilsson, 1994).

The production of industrial wood amounted to 118,590 thousand CUM in 1989 in Siberia. This is 7.1% of the total world production and 37.2% of the production of the former USSR of industrial wood. Calculated with the export values from the FAO's yearbook of Forest Products the industrial wood production would be worth 6.5 billion dollars (FAO, 1989). Lumber production amounts to 6.8% and particle board productions to 2.3% of the world production. All other wood processing industry holds only a share of production which is below 1% of the world production. Especially noticeable is the paper and paperboard capacity which only reaches a share of 0.1% of the world production.

#### **6. Short Historical Overview**

Shabad (1983) distinguishes two major stages in the development of Siberia: the Stalin period when integrated development of Siberia was stressed, and the post-

Stalin period when power-intensive industries economizing on the use of labor were developed as a result of labor shortages.

The advent of central planning and the depreciation associated with World War I accelerated timber harvesting – especially with the ample supply of expendable labor in the prison camps of Siberia. Peaks in roundwood harvest coincided with peasant farm collectivization (1931) and the years of great terror (1937–1938) when millions were imprisoned (United Nations Economic Commission for Europe 1953). Raw materials from wood-harvesting camps flowed to regional and world markets and helped the USSR to develop a large forest products industry prior to World War II (Barr and Braden, 1988). By the outbreak of World War II, only around 10% of the timber harvesting in the USSR took place in Eastern Siberia and the Far East. Major regional rivers and their tributaries facilitated movement of timber for industrial consumption and export. The expanding railway system also ensured that traditional areas of consumption in the St. Petersburg region and Belorussia and markets in Western Europe could be supplied with additional amounts of timber from previously unexploited forests. Forest industries did not receive, and have never subsequently received high priority in the prewar central allocation of Soviet investment funds. Myriad competing demands by sectors of the economy deemed crucial for forced industrialization, autarchy and national survival have traditionally left the forest industry in an inferior technological position with many unrealized opportunities for product and regional growth. After 1950, many wood-processing industries moved to Asian regions of Russia. The wisdom of the move was questioned both nationally and abroad. Large wood-processing complexes such as Ust-Ilimsk and Bratsk were built in Siberia even though they faced inadequate infrastructure (utilities, roads, labor) pollution, local shortages of timber resources, and severe distribution and supply bottlenecks. The strategies and the structure for the development of the forest sector in Bratsk is discussed in (Voevoda *et al.*, 1977). Central planners promoted the wood-processing industry as a vital component of the domestic economy and international trade during this era (Barr and Braden, 1988; Cardellichio *et al.*, 1990), but it never fully met national needs and failed to meet the export potential (Burdin, 1992). The traditional sectors (coal-, forest-industry) prevailed in the development after World War II until the mid fifties. Although the forest sector was neglected compared to other industries in the USSR the share of the industrial gross production of the Siberian forest industry compared to the forest industry of the USSR increased during 1960 from 12% to 15% in 1970 up to 16% in 1980 (Gramatzki, 1986). However, compared with the development with other industries in Siberia the share of the forest sector was declining from 11.8% in 1960, and 8.2% in 1975 to 6.9% in 1980 (Gramatzki, 1986).

The creation of the Commonwealth of Independent States in December 1991 and the growing autonomy of the republics have stimulated the dismantling of former administrative structures, and the responsibility for management of forest resources has shifted more and more to the republics. The year 1989 was the last year when the forest industry of the Russian federation showed a net growth of 1% whereas in 1992 the growth declined to -14.6% which is, however, less decline than the whole economy which declined from 1.4% to -18.8% respectively (The World Bank, 1993). If this trend will continue in the future is a question mark.

## 7. The Forest Industry Sector of Siberia

The forest industry of the former Soviet Union was not completely under the direction of the former Ministry of Forest Industry. Control and ownership of the forest resource were distributed among more than 40 ministries and agencies. The major ones being the State Committee for Forestry and the Ministry of Internal Affairs (prisoner camps). Nearly all of the formerly planned sector was accounted for by output from the Ministry of the Forest Industry (Backman and Waggener, 1990).

The economic system in the former Soviet Union could be divided into: Promyslennyj punkt (industrial enterprise); promyslennyj centr (industrial center); promyslennyj uzel (industrial bundel); promyslennyj rajon (industrial region); promyslennoterritorial'nyj (industrial territory with regional importance); and territorial'no-promyslennyj kompleks (Territorial Production Complex with national importance) (Roos, 1986). As partly discussed earlier, the same organizational structure could be found in the forest industry starting with the "lesopunkts" which are under the jurisdiction of a "lespromkhoz". Today the forest industry is organized under the Russian Ministry of Industry.

The classification of the forest resources is described in Backman and Waggener (1990), Cardellichio *et al.* (1990) and Nilsson *et al.* (1992) and will therefore not be discussed in further detail here.

### 7.1 Wood Supply

The Annual Allowable Cut (AAC) serves as a useful guide for potential harvest levels. The amount of AAC may seem small relative to the enormous land base (*Table 1*). Timber stock calculations suggest that AAC levels are appropriate considering even-flow regulations of fiber in the USSR (Cardellichio *et al.*, 1990). The AAC is not a measure which reflects a long-term sustainable cutting regime. There are scientific and political uncertainties over the calculation on the level of the AAC. AAC's can be changed continuously within a year and in many cases the scientific knowledge is not reflected by the final AAC for a given year (Nilsson *et al.*, 1994). The AAC is differently distributed over the country due to mainly climatic and geomorphic differences.

In the year 1989 the AAC accounted for 382,278 thousand CUM for Siberia. The shares were 27% for West Siberia and the Far East, and 46% for East Siberia (*Table 1*). In Siberia it is also important to distinguish between currently accessible and potential accessible AAC. The transportation infrastructure and the harvesting technology are the two main criteria for accessibility of the AACs.

As illustrated in *Table 2* the potential accessibility of the AAC is especially low in the Far East. Cardellichio *et al.* (1990) states that only areas along the mainlines like the Baikal-Amur railway magistral (BAM) can seriously be considered potential sources of supply in the near term. According to Cardellichio *et al.* (1990) and Barr (1988) harvests around the BAM cannot even be considered as high-quality virgin timber. Some of the areas have already been harvested or have been damaged by fire.

There is some considerable mismatch between the actual AAC and the actual harvest. In Siberia only 37% of the AAC was harvested. A number of reasons may account for a low harvest level as described for the European USSR by Nilsson *et al.* (1992) as follows:

- ◆ Too many authorities involved in the decision process.
- ◆ Defective administration and planning systems.
- ◆ Regional overharvesting and deforestation.
- ◆ Mismanagement and lack of silviculture measures.
- ◆ Waste of raw material.
- ◆ Forest fires.
- ◆ Lack of skilled labor.
- ◆ Inefficient forest industry.

The ratio of delivered harvest to AAC range from 11% for the Yakutsk ASSR to 86% in the Magadan region. As a general observation, it can be stated that in regions with a low ratio of forested area to total land area (sparse forest cover) the AAC was actually harvested to 70–80% (*Table 1*). This is particularly true for the Magadan region, Novosibirsk region and Altai territory. However, the total amount of harvest in these regions was low (*Table 1*). This suggests that harvest was not located where the growing stock was high. Correlation is also weak between the size of the growing stock per hectare and the amount of the actual cut in cubic meters ( $r^2 = 0.14$ ;  $n = 402$ ) performed with harvesting enterprise data. Other factors were more decisive for allocation of the forest industrial production. Forest industry was usually located where infrastructure had already been built or was built in conjunction with other industry.

The harvest generally peaked in 1987 and 1988 before falling during the last years (*Figure 1*). The decline from 1989 and onwards is not believed to be connected with arbitrary reduction of the AAC. Rather, the decline is believed to be linked with the general deterioration of the infrastructure to sustain the flow of goods and services necessary for continued harvest levels, and decreased investment in the harvesting sector (Backman, 1994). About 50% of the total harvest in Siberia took place in East Siberia where 46% of the AAC is located and 27% in West Siberia and the Far East.

The Soviet price structure fostered a situation where physical output is maximized. Timber quality, however, is an issue which has never been considered carefully by Russian experts and where the knowledge of market requirements are still limited. Problems concerning marketing of larch from the Far East are discussed in Braden (1983) and Cardellichio *et al.* (1990). Larch currently makes up 48% (*Table 6*) of the total harvest in the Far East. Larch was able to successfully penetrate the Japanese market many years ago and is now widely accepted. Many technological breakthroughs have increased its consumption for plywood manufacture and pulping (Cardellichio *et al.*, 1990). Pinus has been the preferred species for harvest. In Siberia, 34% of the total harvest was pine (*Table 6*). Almost no Pinus was harvested in the Far East. Calculation of the relative use of the AAC (*Table 3*) reveals that pines and spruce were exploited the most and deciduous species and cedar were less utilized in 1989. This can be due either to the fact that there were economic advantages to have these preferences or the centers of production happened to be

in the area where these species grow. It should also be pointed out that cedar forests are also protected through different legislations. Certainly, the price structure and silvicultural regulations favored the use of coniferous species. There is also a considerable impact of the forest law on the harvesting practices. For example in the Khabarovsk Kray diameter cutting limits are 16 cm for softwoods and 20 cm for hardwoods (Cardellicchio *et al.*, 1990). Another quality attribute for the lumber and plywood industry is the size of the logs. Roughly 3/4 of the stocking timber has a trunk diameter under 24 cm in Siberia (Braden, 1983). Diameter is one of the decisive factors for the piece cost-function of harvesting and processing.

As illustrated in *Figure 3* which shows the geographic distribution of harvest, harvest is concentrated in certain areas. ANOVA analysis revealed significant differences in the distribution of the harvest output for the Tyumen region, Krasnoyarsk Kray and the Irkutsk region. This means not only the largest total output of timber but also the largest harvesting enterprises are located there. As a result of this concentration of the logging operations the average extraction distance for timber has become five-fold since 1950, and doubled since 1970 in Russia (Blandon, 1985). Forest harvesting enterprises were designed to operate for a limited time period (20 to 40 years). After the marketable timber was harvested, the sites were abandoned and closed. Nearly 450 of such sites were closed during the last 15 years in Russia (Melnikov, 1990).

The current harvest technology stems to a great part from the former Soviet union. Blandon (1985) gives a good overview of the equipment and harvesting procedure. The major problem the forest industry in Siberia and the harvesting enterprises in particular face is an acute labor shortage and high labor turnover. As a result of Stalin's labor camps, forestry is thought of as being a job for criminals and people who cannot get other employment; it is not really being considered a job for a "respectable person". In Siberia and the Far East the labor turnover has exceeded 100% from 1965 to 1975 (Blandon, 1985). Of the people leaving forestry in 1975, one-fifth complained about the poor living conditions and the lack of facilities associated with a career in forestry and the concomitant necessary to live in remote areas. Nearly one-third left for reasons concerning the nature of work in the logging industry – the heavy physical nature of the job (Traktinski, 1977). Furthermore, it needs to be acknowledged that housing, social services such as child-care, educational and medical facilities, and the retail turnover are relatively inferior and unsatisfactory in Siberia (Lewis, 1983).

The Far East and the Siberian parts of Russia show a net in-immigration of workers between the age of 20 to 29 (Blandon, 1985). This may be interpreted as being a temporary movement of young mobile workers, moving to Siberia and the Far East to take advantage of the higher salaries and wages offered there and to see a bit of the country, only to return later to other areas of the European part of the Soviet Union. Young, inexperienced, mobile workers are more likely to be less skilled in the use of new forestry equipment thereby reducing productivity and reliability and increasing servicing and repair requirements. Also cheap foreign labor is employed by the forest industry. Some 17% of the population of the Khabarobski Kray are temporary foreign workers from North Korea, Mongolia, and China and are mainly employed by the timber industry (Bulantsev and Woergoetter, 1993).

Analysis of productivity (rubles per employee) showed that in the Far East productivity was higher. This might be attributed to the fact that the regional coefficient for price calculation was set higher. Also Irkutsk and Krasnoyarsk showed higher productivity which was thought to be attributed to the fact that enterprises had higher production outputs and could benefit from their advantages of scale. However, this hypothesis needed to be rejected. The  $r^2$  between amount of harvest and productivity reached only a level of 0.10 ( $n = 526$ ).

Analysis using physical labor productivity (CUM per employees) revealed that there are two types of harvesting enterprises. The first group of harvest enterprises is with low productivity. These enterprises can be characterized by a productivity lower than 2,000 CUM per employee and year. No correlation between size of production and physical labor productivity ( $r^2 = 0.16$ ) was detected for enterprises of this productivity class. Two reasons may account for this observation. At first, these enterprises were not only involved in harvesting operations but also produced other products such as fuel wood, needle flour, fir oil, and others. Secondly, outdated harvest technology did not allow higher productivity. Interestingly, for these enterprises no dependency of productivity on the stocking volume was detected which could have also been a reason for low productivity. The second group of enterprises reveals a different pattern. These were enterprises with a productivity of more than 2,000 CUM per employee and year. Here one can observe some correlation between harvest output and physical productivity ( $r^2 = 0.69$  and Durbin–Watson 1.88). These enterprises are more likely to work with modern equipment. However, only 35% of the harvest is produced in this category and only 5% of all the employees were employed by enterprises in this category (*Figure 4*). Only a low percentage of employees of harvesting enterprises have, in fact, worked with high productive equipment. This leads to the conclusion that future investment in the harvesting sector will also have to consider the question of training workers. Combined with a high labor turnover this might become costly and difficult.

In Siberia the difference between harvest and the production of industrial wood can be accounted for different reasons among which are use of fiber as fuel wood, round wood used for construction, consumption of wood by the chemical industry, harvest losses and transportation losses to processing facilities located at the lower landing or beyond the lower landing. The wood waste rate depends on logging and transportation conditions, original wood quality, and management of the site, among other factors. The total wood waste rate in the European part of Russia was estimated by Nilsson *et al.* (1992) to be 26.2% of the volume harvested. Cardellicchio (1990) estimated felling losses to vary considerably across regions in the Far East – from 5% in Sakhalin oblast to 35% in Primorsky Krai.

71% of the total area burned over in Siberia occurred in West Siberia in 1989. The Tomsk region (441.099 ha) and the Tyumen region (636.010 ha) showed the largest area impact by forest fires. However, on a relative scale the highest impact of forest fires on the Forested area was found on the Sakhalin (4.1%). Only the Novosibirsk region (1.7%), the Tomsk region (2.6%), and the Tyumen region (1.5%) showed figures above 0.3%. Calculated for Siberia, 0.32% of the forested area was damaged by fire. This would mean that in about 300 years all of the forested area would be burned once. It has been estimated that 90% of the forest fires were caused by



anthropogenic influences (Stadelbauer, 1986). Two major reasons may account for this. First, there is the industrial development, and second, the silvicultural practices generate slash left on cut-over sites, which acts as fuel.

Fiber necessary to support the forest industry is mainly derived through harvesting operations. In 1989, the principle harvest represented 66% of the total estimated fiber supply in Russia (Backman and Waggener, 1991). Since 1989, there is a decline in the use of wood residues. In 1990 43 million CUM of "compressed wood waste" were utilized in the Russian Federation, whereas in 1992 only 31 million CUM were utilized (GOSKOMSTAT, 1993). However, less than 10 million CUM were utilized by the industry and transformed into pulp or boards in 1989 (Backman and Waggener, 1991). Around 800,000 CUM of chips were exported to Japan in 1989 (FAO, 1989). Since 1978, Japan has almost always been the only country buying chips from Russia. In regions with large integrated enterprises, such as in Bratsk and Ust-Ilimsk, secondary wood resources were used. In the third largest saw milling town, Lesosibirsk, however, wood residues are not utilized nor burned. This low level of utilization of the secondary wood resources might in part be due to the spatial and output quantity distribution of the saw mills as the greatest supplier of these products (Blandon, 1985). Barr (1988) mentions that a large volume of wood residues was consumed as fuel, which to a large extent reflects shortages of coal, peat, and oil shale in the Far East. Burning is also the fate for most of the bark produced in debarking operations which was introduced in 1966 (Blandon, 1985).

There are no deinking facilities in Siberia, even of the most rudimentary (washing) design. Russia has a low per capita consumption of paper and hence a relatively low retrieval and recycling potential. Transport of wastepaper from Europe to Siberia would not be possible with the current transportation infrastructure and would also be questionable from an economic and ecological point of view. In Russia the amount of waste paper utilized amounted 1,623,000 MT in 1990, which dropped to 882,000 MT in 1992 (GOSKOMSTAT, 1993).

## 7.2 Wood Processing Industry

The overall industrial structure of Russia, as viewed upon in Russia and the West, is characterized by large enterprises operating in highly concentrated industries. Large enterprises produce most of the total output of any production segment. This pattern has already been illustrated in *Figure 2* for harvesting enterprises and is also true for the wood processing industry as illustrated in *Figure 5* for the saw milling industry. The largest consumer of industrial round wood in Siberia was the lumber industry with a production of 33,960 thous. CUM of lumber and the pulp industry with a production of 2,619 thous. MT in 1989 (*Table 1*). According to our calculations only around 50% of the wood harvested in Siberia was actually processed in Siberia. From a total of 850 forest industry enterprises represented in the IIASA Forest Study enterprise database, 283 enterprises belong to wood processing industry, 137 were lumber mills combined with harvesting enterprises. The rest were 52 lumber mills, 2 plywood mills, 5 particle board mills, 2 paper mills and 2 pulp mills, and 46 furniture producers. In addition to these, there were 34 enterprises designed as production complexes. All of the fiber boards and pulp were produced in such production

complexes. Over 75% of the plywood, particle board, paper, and paper board production and only 26% of the lumber production and 35% of the furniture production were produced in production complexes according to the Siberian Forest Study's database. Production of processed wood products was concentrated in mainly two areas as illustrated in *Figure 7*. The first area is the region around southern Krasnoyarsk and southern Irkutsk and the second area is located along the Pacific Rim.

One of the largest enterprises with combined production is the Bratsk-Ilimsk Territorial Production Complex (Voevoda *et al.*, 1977). Territorial Production Complexes were designed to be major contributors to the national economy in order to meet national requirements not only for wood and wood products. However, enterprises never had to set up links to the actual consumer and were solely responsible for production. Under central planning GOSNAP was responsible for creating and managing the wholesale trade system, including identification of appropriate trading partners, setting the contractual terms of delivery, and arranging for the transportation of goods. This system was designed to prevent enterprises from developing their own trading links and forcing adherence to the plan. As a consequence, enterprises tended to become highly isolated without knowledge of national and in some cases local market structure. Vertical dependence among enterprises is, to a great extent, the consequence of the arbitrary demarcation between processes in the former Soviet industry. Ministers made divisions for reasons of control. Enterprise directors suppose that they were tied to a vertical chain which is very difficult to escape from. One could view the economy of the former Soviet Union as segmented along historically determined chains of production, in which each firm in the chain may be acting as both monopolist and monopsonist.

Almost one-half of all cities have only one firm and more than three-quarters have four firms or less in the Russian federation. In this situation the firm can act as a monopsony on the labor market. This is especially typical for the forest industry, which needs to be close to the resource. The labor productivity (CUM per worker) of Siberia is six times less than compared with Canada based on calculations for the lumber industry. Employees are not always defined as production related workers. It has been estimated that in the Siberian North the release of one worker in basic production usually results in the release of three additional auxiliary and service workers, and if family members are included, nine to ten people may be affected (Lewis, 1983). It must be realized that whole communities depend on wood processing enterprises or complexes for their source of employment, health care, farm produce, and transportation.

According to aggregated GOSKOMSTAT data the total number of employees is around 101,000 employees. However, summing up all employees of the enterprise database, which is incomplete, one gains a number of more than 370,000 persons employed by the forest industry in Siberia. An estimation of the total employees for the entire output of the forest industry, including the production of needle oil, needle flour, etc., is around 650,000 employees. This is about 2% of the total population of Siberia. Only around 160,000 are estimated to be employed by the harvesting enterprises which is around 1.8% of the rural population in Siberia. However, there

are still large uncertainties over how many people are actually production related workers.

Braden (1983) summarized the state of the art of the Soviet forest industry as follows. Low capital investment, outdated technology, and low priorities of the planners for the forest sector in general, and the pulp and paper sector in particular, have led to a largely non-competitive industry.

There has been a change on the investment strategy in the forest sector in the USSR over time. After World War II the greatest part of the investments went for installment of new capacities (Barr, 1970). This pattern changed then in the late seventies. More investment was directed to the modernization of existing capacity. Another observation is that the amount of investment stayed almost constant over this period which confirms the observations made in the historic overview that the forest industry was neglected compared to other sectors. This pattern is illustrated in *Figure 4*.

The total amount of lumber produced in Siberia is 33.960 thousand CUM, which was 6,8% of the total world production and 34% of the domestic production of the former USSR. The Siberian Forest Study's database covers only about 48% of the total production as claimed by GOSKOMLES (1990) in 1989. Approximately 40% of the output of lumber documented in the Siberian Forest Study's database stemmed from lumber mills which were combined with harvesting enterprises and around 26% of this output was produced by production complexes.

In Siberia, a large part of the total production stems from saw milling enterprises with large capacities. Unlike, for example, in Sweden relatively few enterprises are in the size class below 5,000 CUM and more are in the size class larger than 150,000 CUM (*Figure 6*). When excluding lumber mills with a production of less than 1,000 CUM 55% of the lumber output of Siberia is produced by enterprises larger than 150,000 CUM production, which makes up for only 15% of the total number of enterprises. In Sweden, only 13% of the production is in this size class and only 2% of the enterprises are of this size class. In our data set there were 206 lumber producing enterprises which captured 48% of the total production as reported on aggregated level<sup>9</sup>. The largest lumber producing facility is located in Lesosibirsk with a production of 515,000 CUM.

Serious investments in sawmilling capacity in the heavily forested areas began in the mid-1950s. It was at this time that the large sawmilling capacities in the Bratsk, Krasnoyarsk areas and along the Yenisey river were built. But, despite the fact that the investment in sawmilling capacity began so long ago, there are still capacity constraints in the production of saw timber in the areas where logging is being developed. Therefore it happens that Siberia exports timber to other regions to service processing capacities there. In total, round wood in the former Soviet Union for sawmilling was transported, on average, some 1,800 km (Shvidenko and Nilsson, 1994). The ratio of production of lumber and production of industrial wood gives an

---

<sup>9</sup>Note that data used to produce *Figure 4* only covered 48% of the total production as reported by Goscomstat. In seven regions the smallest production reported is larger than 10.000 CUM suggesting that at the lower end of the curve it can look similar as the curve for Sweden.

indication of the proportion of the quantity of fiber that is directed to the lumber industry. This ratio is 0.286 for Siberia and varies from 0.646 in the Novosibirsk region to 0.149 in the Sakhalin region . There is a slight decrease in this ratio from West to East . The Irkutsk region is the largest supplier of lumber with 8,817 thous. CUM. The total production of lumber for all West Siberia was 9,120 thous. CUM and that of the Far East was 6,253 thous. CUM (*Table 1*).

The lumber industry is a good example for production which is only partially centralized. The sawmilling industry consists of three distinct classes of manufacturing facilities. The first class are mills which were managed by the former Ministry of Forest Industry, and the second class are those under ministries and organizations other than the Ministry of Forest Industry. The third category was formed by the mills which were outside the planned system. These were probably exclusively oriented toward the domestic market lacking linkages to EXPORTLES (Backman, 1994).

Foreign sawmilling technology represents around 5% of the capacity in Russia. Mainly lines for drying and packaging (Valmet) and handling (Plan-Sell) were imported to the former USSR. The largest producer of sawmilling equipment is Severnyj Kommunar at Vologda (Eronen, 1987).

The production of plywood has been almost stable since 1970 in Russia and for all of the former USSR. Eastern Siberia, however, showed drastic increases in production (*Table 4*).

Some 14% of the total production in Russia takes place in Siberia. The largest plywood production is found in Bratsk as part of an integrated unit. Although the capacity of this plant is 200,000 CUM of plywood the actual production was only 122,000 CUM because of a lack of primary materials in 1981(Eronen, 1987). According to our information the capacity in 1989 was 173,000 CUM and the production amounted to 179,000 CUM in this mill. From the 42% of the production represented in the Siberian Forest Study's database, some 86% of the plywood production was produced in combination with other forest industries, which were mainly particle board and furniture production. The production of plywood has a long history, and its production in the former Soviet Union began at the end of the nineteenth century. In the former Soviet Union birch is used for up to 85% of the plywood production. Also birch, oak, alder, lime, and some of the coniferous species, like pine and some larch are occasionally made into plywood (Blandon, 1985). At present, about 95% of the plywood is produced in one standard size. Little of the output is of exterior grade plywood.

Some 15% of the total particle board production of Russia is manufactured in Siberia. Particle board production has been favored in the former USSR and especially in Siberia. *Table 5* illustrates the rapid development of the particle board industry in both Russia and Siberia.

The majority of the particle board plants are integrated plants. In our database we could observe such interaction in nine out of fourteen enterprises. These nine integrated plants produced 76% of the particle board production of Siberia in 1989.

Enterprises producing only particle boards showed an average productivity of 14 employees per 1000 CUM output per year. Some 90% of the production was under the control of MINLESBUMPROM which had jurisdiction and control of all its suborganizations and was, *inter alia*, also responsible for the five-year plans that had to be broken down into one-year plans which were expressed at the enterprise level. The rest of the plants were under the control of the Ministry of Construction and other federal ministries, such as the Ministry of Armed Forces. During the years 1950 to 1970 Soviet and Polish technology was predominant in Russia. The plants with these technologies had a capacity of about 25,000 CUM per year. As of 1970, Finnish and East German technology became more prevalent, since Soviet and Polish technology became obsolete. In 1983, one-third of the particle board production in the former Soviet Union was produced by Finnish and East German technologies (Eronen, 1987). Most of the Siberian capacities are likely to be of the same origin.

The ability to make use of low quality wood and the waste from other forest industries means that there is less incentive to locate these industries in the Far East and Siberia. In Russia about 8% to 10% of the raw material used is in the form of waste from the sawmilling industry, and another 10% stems from the veneer and plywood industry. The main source of wood however, between 65% to 67%, comes from the use of low quality wood. The major consumer is the furniture industry. This takes almost 75% of the particle board output with construction work taking about 17% (Blandon, 1985). Around 70% of the particle board production came out of plants combined with furniture production.

Most of the fiber board production plants are located in the European USSR. Some 10% of the total production occurs in Siberia and the Far East. All six fiber board production plants in Siberia are combined with lumber production. This suggests that also fiber board plants were built to utilize wood residues from the lumber production. The Siberian Forest Study's enterprise data covered 75% of the production reported as the aggregated production data by GOSKOMSTAT. The average size of production output was 15.3 million sq. m with the largest production facility located in Tomsk with a production capacity of 21.6 million sq. in 1989. The other facilities are located in Krasnoyarsk and three others in the Far East. Most of the fiber boards are compressed with a standard thickness of 3 mm. Initially, the Swedish company Defibrator was the principal deliverer of technology to the former USSR, but then Polish companies were more successful with a copy of the original (Eronen, 1987).

The share of high value added production is very low. When it comes to the use of pulp for the production of paper and board Siberia has little capacity for production. Most of the pulp produced is exported to other regions. A good illustration of this structure is the Irkutsk region, where 1623,4 thous. MT of pulp are produced and only 201,4 thous. MT of boards and 11,1 thous. MT of paper are produced.

Pulp mills are only captured by 15% in our enterprise database. These pulp mills are very unevenly distributed over Siberia. According to aggregated data there is no pulp mill in all of West Siberia. In the eighteen regions of Siberia there are only five regions with pulp production. In regions where pulp is produced, paper and boards are also produced, except for West Siberia (*Table 1*), where 108.3 thousand MT of

paperboards are produced with no domestic pulp production which is one-eighth of the total paperboard production of Siberia.

IIASA's Siberian Forest Study enterprise database captured 98% of the paper production as reported on an aggregated level. To our knowledge there are 10 productive locations. Seven are located at Sakhalin island with an average size of 29.100 MT, the largest is located in Krasnoyarsk Kray with an output of 107.200 MT. Six out of ten production sites in Siberia were combined with pulp and another two were combined with paperboard production. Some 84% of the total paper production of Siberia originated from integrated plants. All six paperboard production sites were combined with paper and/or pulp production. 90% of the total paperboard production was captured by the enterprise database.

Paper production in Russia is manpower intensive. On average, 34 employees were necessary to maintain an output of 1000 MT of paper in 1989. Theoretically, the paper mill Vyborg (near the Finnish border) could operate with 100 people, but it uses 350. About one-third of those are on hand to maintain equipment. Yet, another quirk of the Soviet system is that the mill complex owns the small nearby town, so in effects, it has 2,500 employees. With the changes that have taken place in Russia, the complex may be able to sell off those properties (Meadows, 1992).

Eronen and Simula (1993) report that the Soviet paper industry produces around 800 types of paper. The significance of Russia's exports of high quality paper and other more sophisticated products such as tissue, specialty board, coated and uncoated fine paper is minimal. The quality of the bulk of Russian paper is low which can, in part, be attributed to a lack of testing equipment standards and research and development. Production has not been consumer oriented. The Russian consumer had to be satisfied with what he received. If, for example, curl properties were so poor as to render it useless for this purpose, then it could be used for store wrapping paper (Eronen and Simula, 1993).

In 1937 0.4% of the total production of paper came from Siberia and central Asia. There was no production of paper in the Far East. By 1950, 2% were produced in Siberia and central Asia and 7% in the Far East. The mills were located in Barnaul, Krasnoyarsk, Ulegorsk, Kholmsk, Poronaisk, Dolinsk, Yuzhno-Sakhalinsk, Dubrovka. The mills in the Far East, which were taken over by the Japanese in 1944, had a total capacity of a quarter million tons. The combination of output from these mills probably provided an important surplus for distribution in other parts of Siberia (Rogers, 1955). Qualified reports indicate that in Russia 16% of the paper machines are 90 years old or older, 14% are older than 60 years, and more than 40% of paper and paperboard machines were installed 30 years ago. Nearly 50% of all the equipment should be replaced immediately according to Terentiev and Ivanioukin (1993).

The geographic distribution of the printing industry is changing due to political disintegration. However, 88% of all books and booklets were produced in Moscow and 5% in St. Petersburg in 1990. Almost 99% of the newspapers and periodicals appeared in the Russian language, although Russians make up only 82% of the population. The Far East consumed 1% and Siberia 4% of Russia's newsprint in

1992 (Eronen and Simula, 1993). Russia is a major producer of packing papers and boards, but still uses important quantities of, e.g., sawn wood for packaging purposes.

The IIASA database captures 65% of the furniture production as reported on the aggregated level in 1989. The average size of output of the 65 enterprises was around 10.000.000 rubles in 1989<sup>10</sup>. About 47% of the output is produced in West Siberia which is closer to the consumer of the European part of the Russian Federation. Furniture dominated the consumption of particle board accounting for three-quarters of the domestic consumption in Russia in 1987. Also significant amounts of fiberboard and lumber were used for furniture production. According to the Siberian Forest Study's database around one third of the furniture manufacturers were combined with lumber, plywood, particle board or fiberboard production. The largest furniture production was found in Khabarovsk which was combined with lumber, particle board and fiber board production. The three largest enterprises accounted for 14% of the total output of Siberia and all were combined with other wood processing industries.

## 8. References

- Backman, C.A., and Waggener, T.R. 1993. Prospects for Wood Raw Material Exports from Russia to Pacific Rim and European Markets up until the year 2000, Unpublished Doctoral Dissertation, Seattle: University of Washington, 1993.
- Backman, C.A., and Waggener T.R. 1991. Soviet Timber Resources and Utilization. The Wood Product Demand and the Environment Conference. Nov.13-15, 1991, Vancouver, B.C., Canada.
- Backman, C.A., and Waggener, T.R. 1990. Soviet Forests at the Crossroads. Emerging Trends at a Time of Economic and Political Reform, Working Paper 28, CINTRAFOR, University of Washington, Seattle, WA
- Barr, B.M., 1970. The Soviet Wood-processing Industry, University of Toronto Press, Chicago, IL.
- Barr, B.M. 1988. Perspectives on Deforestation in the USSR, in J.F. and R. P. Tucker, eds., World Deforestation in the Twenties Century, Duke University Press, Durham, NC.
- Barr, B.M., and Braden, K.E. 1988. The Disappearing Russian Forest: A Dilemma in Soviet Resource Management, Rowman and Littlefield, Totowa, NJ.
- Blandon, P., 1985. Soviet Forest Industries. Westview Press, Boulder, Colorado.
- Braden, K., 1983. The Role of Imported Technology in the Export Potential of Soviet Forest Products. In: Soviet Natural Resources in the World Economy. Jensen R. G., Shabad T., and Wright A. W.. The University of Chicago Press, Chicago.
- Bulantsev, V.Y., and Woergoetter A. 1993. The Impact of Transition on the Russian Regions. Institute for Advanced Studies, Vienna, Austria.
- Bulantsev, V.Y., and Woergoetter, A. 1993. Many-faced Russia: The Impact of Transition on the Russian Regions. Institute for Advanced Studies. Published and edited by Bank Austria Aktiengesellschaft, Economics Department, Vienna, Austria.
- Burdin, N.A. 1992. Specific Features of Transition of Forest Industry to a Market Economy. "Integrated Sustainable Multiple-use Forest Management under the Market System - Conference". Sept. 6-12, 1992, Pushkino, Moscow Region, Russia.
- Cardellichio, P.A., Binkley, C.S., and Zausaev, V.K. 1990. Sawlog Exports from the Soviet Far East. Environmental, institutional, and economic factors limit the possibilities. Journal of Forestry June 1990:12-17
- Elliott, D., Glick, D., and Bogert, C 1993. The Waste Land: Russia's Far East. Newsweek: July 26, 1993

---

<sup>10</sup>Calculated with an exchange rate of 1.588 US\$ for a rouble (FAO 1989) for 1989 the total output of the Siberian furniture industry amounted to about 1.6 billion US\$.

- Eronen, J., and Simula, M. 1993. Russia and other Ex-soviet Republics as Future Paper Markets. Paper presented at the Prima Conference, 12–14 May 1993, Helsinki.
- Eronen, J., 1987. L' Industrie Forestiere et du Bois en USSR: Situation Presente et Perspectives d'Avenir. *Le Courier des Pays de l'Est* 322:34–49.
- FAO, 1989. *FAO Yearbook: Forest Products 1989*, Rome, Italy.
- GOSKOMSTAT, 1993. *Rassiysskaja Federatia b 1992 gady, statistitscheskiy eschegodnik*, Moscow 1993.
- GOSKOMLES, Gosydarstbenniy Komitet SSSR po Lesy. 1990. *Po otpusky drebesini, meram yxoda za lecom, podsotschke i pobotschnim polzobaniyam za 1989 gadu*. Moscow 1990.
- Gramatzki, H.E 1986. *Industrialisierung und Kapitalbildung in Sibirieschen Entwicklungsprozess*. In: *Sibirien: Ein russisches und Sovietisches Entwicklungsproblem*. (ed.) G. Leptin. Verlag: Arno Spitz, Berlin.
- Krankina, O.N., and Dixon, R.K. 1992. *Forest Management in Russia. Challenges and Opprtunities in the Era of Perestroika*. *Journal of Forestry*. June 1992:29–34.
- Lecnoy Kompleks SSSR, 1991. *Statistitscheskiy spravotschnik*. Tschast , p. 59. Moscow 1991.
- Lewis, R.A. (1983) *Regional Manpower Resources and Resource development in the USSR: 1970-1990*, p. 72-92. In: *Soviet Natural Resources in the World Economy* (eds.) Jensen R. G., Shabad T., and Wright A. W.. University of Chicago Press.
- Meadows, D. 1992. *The European Papermaker, 1992*.
- Melnikov, V.I. 1990. *Difficult tasks of 1990*. *Lesnaya Industriya (For. Ind.)* 1:3–6. Moscow.
- Newsweek, 1993. *Waste Land: The race to exploit Russia's Far Eastern Fronier*. *Newsweek* July 26, 1993.
- Nilsson, S., Sallnaes, O. Hugosson M., and Shvidenko A., 1992. *The Forest Resources of the Former European USSR*. Parthenon Publishing, Lancs, United Kingdom.
- Nilsson, S. 1994. *Siberian Forest Study – Phase II*. Unpublished manuscript, IIASA, Laxenburg, Austria.
- Nilsson, S., Shvidenko, A., Bondarev, A., and Danilin, I. 1994. *Siberian Forestry*. IIASA WP-94-08. Laxenburg, Austria.
- Rodgers, A. 1955. *Changing Locational Patterns in the Soviet Pulp and Paper Industry*. *Annals of the Association of American Geographers*. Vol. XLV, 1955:85–104.
- Roos, J. 1986. *Der Westsibirische Territoriale Produktionskomplex*. In: *Sibirien: Ein russisches und Sovietisches Entwicklungsproblem*. (ed.) G. Leptin. Verlag: Arno Spitz, Berlin.
- Shabad, T. 1983. *The Potential in Natural Resources: An Overview*. In: *Soviet Natural Resources in the world Economy* (eds.) Jensen R. G., Shabad T., and Wright A. W.. University of Chicago Press.
- Shvidenko, A., and Nilsson, S. 1994. *What Do We know about the Siberian Forests?* Forthcoming *Ambio*.
- Wright, A.W. The University of Chicago Press, Chicago.
- Stadelbauer, J. 1986. *Die Erschliessung Sibiriens. Räumliche Gefügemuster eines historischen Prozesses*. In: *Sibirien: Ein Russisches und Sowjetisches Entwicklungsproblem*. (ed.) G. Leptin. Verlag: Arno Spitz, Berlin.
- Terentiev, O., and Ivanioukin, V. 1993. *Problems and Possibilities in Russia. Current status of pulp and paper industry of Russia*. *European Papermaker* 4:18–20.
- The World Bank. 1993. *Statistical Handbook 1993. States of the Former USSR. Studies of economies in transition*, Paper number 8. Washington DC. 1993.
- Traktinski, E.B. 1977. *The five-year Plan and the Problem of Preparing the Work Force*. *Lesnaya Industriya (For. Ind.)* June 1977, Moscow.
- Voevoda, I.N., Teplov, A.N., and Sokov, M.A. 1977. *Optimum Use and Conservation of Forest Resources of the BITPC*. In: *The Bratsk-Ilimsk Territorial Production Complex. Proceedings of the second IIASA conference on case studies of large scale planning projects*. March 22–25, 1976. H. Knop (ed.). CP-77-3:311–319
- Yakunin, A.G., Shlykov, V.M., and Grachyev, V.N., *Lesnaya Industriya Dal'ego Vostoka (The Forest Industry of the Far East)*. Moscow: Lesnaya Promyslennost, 1987.



## **Appendix I:**

### **A. TABLES**

Political region	Land area	Forested area	Annual Allowable Cut	Harvest	Harvested industrial wood	Lumber production	Plywood production	Particle board production	Fiberboard production	Paper production	Paperboard production	Chemical Pulp production	Mechanical Wood Pulp production	Furniture production	Not processed harvested wood	Estimation of the harvest not processed
	'000,000 ha	'000,000 ha	'000 CUM	'000 CUM	'000 CUM	'000 CUM	'000 CUM	'000 CUM	'000 CUM	'000 MT	'000 MT	'000 MT	'000 MT	'000,000 tbs	'000 CUM	% of Harvest
Altai territory	26170	4927	5153	3484	2353	1121	16.0	9.6	0.0	0.0	44.2	0.0	14.3	96.0	1340	38%
Kemerovo region	9550	4584	8285	3214	2790	1604	5.1	6.5	5.1	0.0	18.0	0.0	0.0	88.6	295	9%
Novosibirsk region	17820	2379	1661	1404	1125	727	0.0	0.0	0.0	0.0	0.0	0.0	0.0	132.3	95	7%
Omsk region	13970	2531	6266	2065	1649	1031	19.3	87.6	0.0	0.0	46.1	0.0	0.0	62.5	17	1%
Tomsk region	31690	17030	34373	8634	6954	1774	0.0	111.8	21.7	0.0	0.0	0.0	0.0	25.8	5218	60%
Tyumen region	143520	41769	47719	16132	12975	2863	22.2	391.2	0.0	0.0	0.0	0.0	0.0	61.7	10273	64%
<b>West Siberia</b>	<b>242720</b>	<b>73220</b>	<b>103457</b>	<b>34933</b>	<b>27846</b>	<b>9120</b>	<b>62.6</b>	<b>606.7</b>	<b>26.8</b>	<b>0.0</b>	<b>108.3</b>	<b>0.0</b>	<b>14.3</b>	<b>466.9</b>	<b>17240</b>	<b>49%</b>
Krasnoyarsk territory	240160	111262	80171	26266	21709	7123	0.0	143.0	26.7	107.2	161.4	214.9	54.3	97.6	12031	46%
Irkutsk region	76790	51839	66623	37858	34646	8817	224.0	189.2	44.2	11.1	201.4	1623.4	0.0	72.4	14567	38%
Chita region	43150	23681	16081	4684	3361	1167	0.0	0.2	0.0	0.0	0.0	0.0	0.0	26.1	2583	55%
Buryat ASSR	35130	16978	8228	4618	3682	1306	0.0	67.5	0.0	0.0	145.2	163.0	0.0	31.9	1503	33%
Tuva ASSR	17050	7671	3254	517	423	174	0.0	0.0	0.0	0.0	0.0	0.0	0.0	2.9	204	39%
<b>East Siberia</b>	<b>412280</b>	<b>211431</b>	<b>174357</b>	<b>73943</b>	<b>63821</b>	<b>18587</b>	<b>224.0</b>	<b>399.9</b>	<b>70.9</b>	<b>118.3</b>	<b>508.0</b>	<b>2001.3</b>	<b>54.3</b>	<b>230.9</b>	<b>30888</b>	<b>42%</b>
Primorski territory	16590	11110	14969	5001	3956	1325	20.8	115.4	1.9	0.0	0.0	0.0	0.0	107.0	2371	47%
Khabarovsk territory	82460	35832	36978	13765	11780	2165	10.1	111.0	22.1	8.8	174.2	297.9	0.0	99.7	8430	61%
Amur region	36370	19825	10916	6457	5357	1024	1.6	0.0	0.0	3.7	0.0	0.0	0.0	37.3	4610	71%
Kamchatka region	47230	5330	2198	829	608	254	0.0	0.8	0.0	0.0	0.0	0.0	0.0	6.5	370	45%
Magadan region	119910	9732	362	311	219	165	0.0	0.0	0.0	0.0	0.0	0.0	0.0	10.1	14	5%
Sakhalin region	8710	5007	6000	3370	3000	458	0.0	0.0	0.0	204.1	91.4	320.1	58.4	17.1	973	29%
Yakutsk ASSR	310320	125627	33041	3716	1943	862	0.0	0.0	0.0	0.0	0.0	0.0	0.0	9.6	2164	58%
<b>Far East</b>	<b>621590</b>	<b>212463</b>	<b>104464</b>	<b>33449</b>	<b>26923</b>	<b>6253</b>	<b>32.5</b>	<b>227.2</b>	<b>24.0</b>	<b>216.6</b>	<b>265.6</b>	<b>618.0</b>	<b>58.4</b>	<b>287.3</b>	<b>18933</b>	<b>57%</b>
<b>Siberia</b>	<b>1275590</b>	<b>497114</b>	<b>382278</b>	<b>142325</b>	<b>118590</b>	<b>33960</b>	<b>319.1</b>	<b>1233.8</b>	<b>121.7</b>	<b>334.9</b>	<b>881.9</b>	<b>2619.3</b>	<b>127.0</b>	<b>986.1</b>	<b>67061</b>	<b>47%</b>

Table 1: Summary of indicators describing the Siberian forest industry. Various Sources.  
Forested area is defined here as forested area including only major species managed by the forest authority.

Not processed harvested wood was calculated by using the following conversion figures:

lumber production (1.8 CUM of logs per 1 CUM of lumber)

plywood (2.5 CUM of logs per 1 CUM of plywood)

particle board (1.570.9 CUM of logs per 1 CUM of particle board)

fiber board (1.66 CUM of logs per 1 CUM of fiber board)

chemical pulp (4 CUM of logs per 1 MT of chemical pulp)

mechanical (wood) pulp (3 CUM of logs per 1 MT of mechanical pulp)

It was assumed that no secondary wood residues were incorporated in other products.

**Table 2:** Estimation of the potentially accessible Annual Allowable Cut (AAC) (Backman 1990) and the share of the potentially accessible AAC of the current AAC (Lesnoy Kompleks SSR 1991) in the year 1989.

Region	Potentially Accessible AAC	% of the current AAC (1989)
West Siberia	45 (CUMx10 <sup>6</sup> )	43
East Siberia	57 (CUMx10 <sup>6</sup> )	33
Far East	18 (CUMx10 <sup>6</sup> )	17

**Table 3:** Coefficient of the utilization of the AAC in 1989 calculated as the % of harvest of the AAC. Source: Gosydarstbennyi Komitet SSR po Lesy 1990.

	Pinus	Spruce	Cedar	Larch	Hard deciduous	Soft deciduous	All Species
<b>West Siberia</b>	43%	43%	17%	34%	-	18%	28%
<b>East Siberia</b>	70%	45%	2%	31%	-	10%	37%
<b>Far East</b>	52%	52%	25%	29%	18%	13%	31%
<b>Siberia</b>	60%	47%	13%	30%	18%	14%	33%

**Table 4:** Geographic distribution of plywood production in `000` CUM beginning from 1940 to 1989 in Russia and Siberia. Source: Glotov, 1977 cit. Blandon, 1983; GOSKOMSTAT, 1989; FAO, 1989

	1940	1960	1975	1989
Soviet Union	731	1.354	2.196	2.303
Western Siberia	23	32	54	63
Eastern Siberia	7	17	50	224
Far East	14	31	46	32

**Table 5:** Geographic distribution of particle board production in `000` CUM from 1960 to 1989 in Russia and Siberia. Source: Glotov 1977 cit. Blandon 1983; GOSKOMSTAT 1993, FAO 1989

	Particle Board	Particle Board	Particle Board
Year	1960	1975	1989
USSR	161	3994	8342
Western Siberia	2	97	607
Eastern Siberia	0	174	340
Far East	0	66	227

**Table 6:** Distribution of species in percent of the total harvest by political regions in 1989 in Siberia.

Source: Gosydarstbenniy Komitet SSR po Lesy 1990.

% of harvest	Pinus	Spruce	Cedar	Larch	Hard deciduous	Soft deciduous	All Species
Altai territory	17%	27%	0%	12%	0%	44%	100%
Kemerovo region	1%	61%	0%	0%	0%	38%	100%
Novosibirsk region	21%	12%	0%	0%	0%	67%	100%
Omsk region	15%	3%	0%	0%	0%	82%	100%
Tomsk region	33%	15%	7%	0%	0%	44%	100%
Tyumen region	55%	16%	5%	3%	0%	21%	100%
Krasnoyarsk territory	37%	45%	0%	11%	0%	7%	100%
Irkutsk region	64%	11%	0%	17%	0%	8%	100%
Chita region	24%	0%	0%	66%	0%	10%	100%
Buryat ASSR	33%	1%	0%	56%	0%	9%	100%
Tuva ASSR	4%	0%	1%	93%	0%	2%	100%
Primorski territory	0%	63%	14%	3%	16%	4%	100%
Khabarovsk territory	0%	52%	0%	41%	2%	6%	100%
Amur region	3%	1%	0%	89%	0%	8%	100%
Kamchatka region	0%	13%	0%	66%	13%	8%	100%
Magadan region	0%	0%	0%	99%	0%	1%	100%
Sakhalin region	0%	84%	0%	16%	0%	0%	100%
Yakutsk ASSR	0%	0%	0%	80%	0%	0%	100%
<b>West Siberia</b>	38%	20%	4%	2%	0%	35%	100%
<b>East Siberia</b>	49%	21%	0%	22%	0%	8%	100%
<b>Far East</b>	0%	38%	2%	48%	3%	5%	100%
<b>Siberia</b>	34%	25%	2%	24%	1%	13%	100%

**B. FIGURES:**

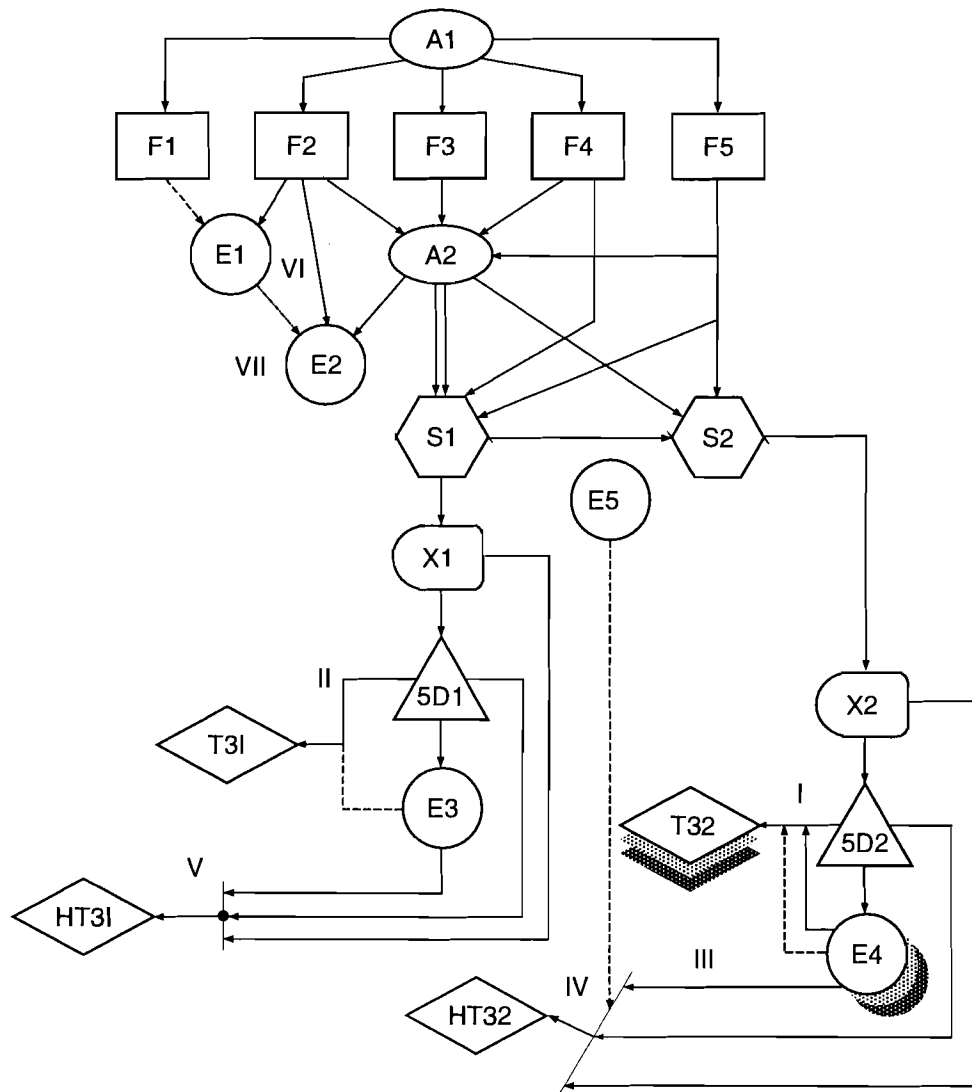

**Figure 1:** Diagram featuring the system of data collection by GOSKOMSTAT.

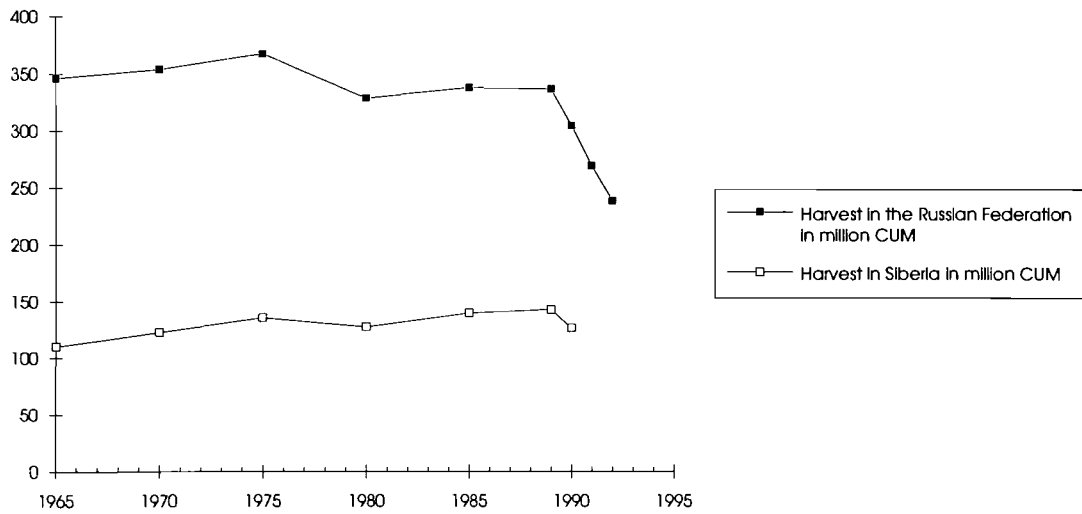

**Figure 2:** Decline of harvest output in the Russian Federation and in Siberia from 1965 to 1992.

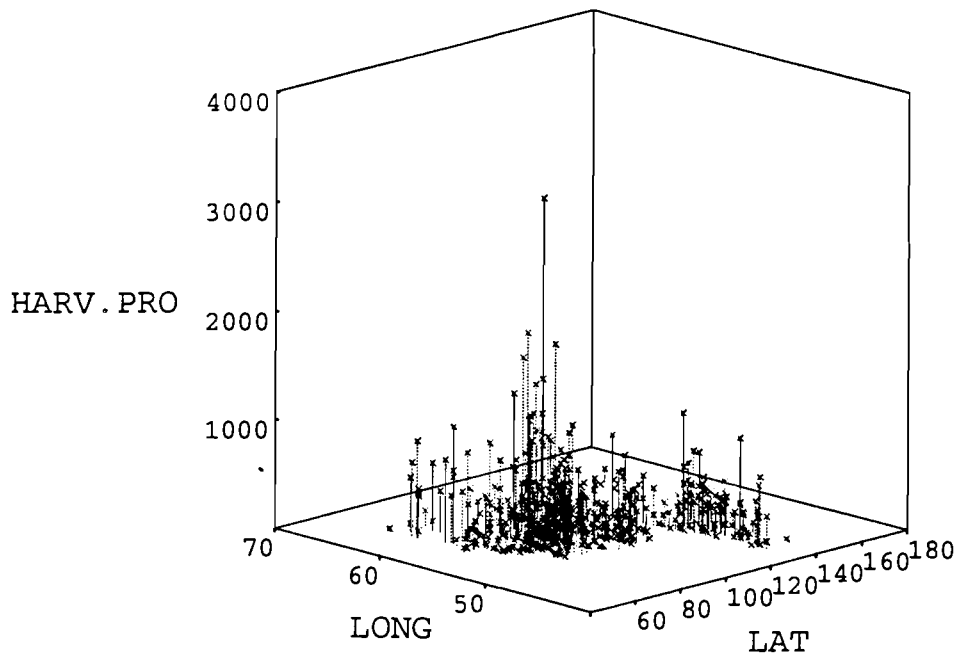

**Figure 3:** Geographic distribution of harvest enterprises. Spikes indicate the amount of timber harvested in `000` CUM of each individual enterprise. Longitude and latitude are measured in degrees.

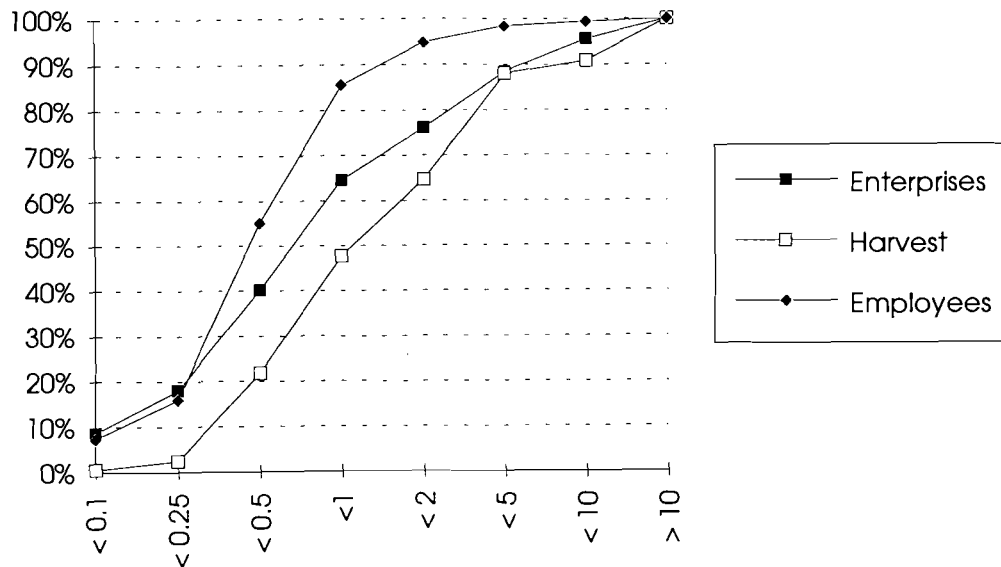

**Figure 4:** Percent of enterprises, harvest output, and employees in 1989 of different productivity classes ( $1000 \text{ CUM} \cdot \text{employees}^{-1}$ ).

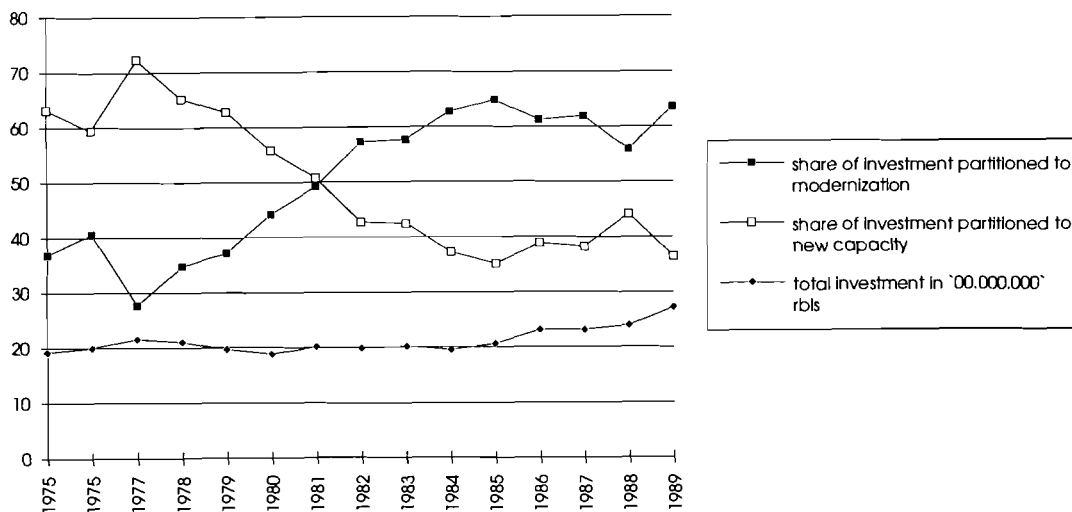

**Figure 5:** The share of investment partitioned to modernization of existing capacity, the share of investment to new capacity (construction and expansion of enterprises), and the amount of total investment from 1975 to 1989 in the USSR. Source: Lesnoj Kompleks CCCP Moscow (1991).

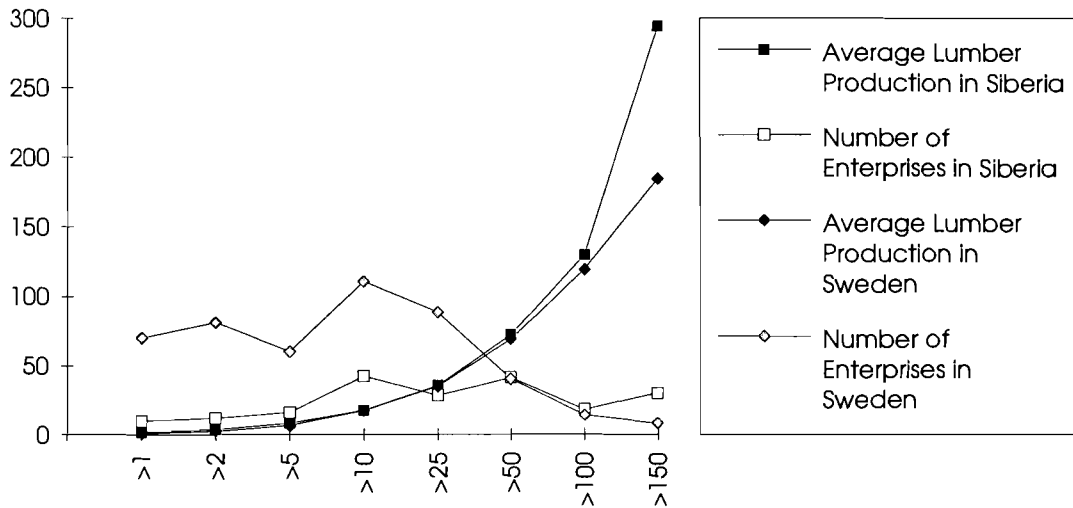

**Figure 6:** Comparison of the structure of the Swedish and the Siberian lumber industry. The abscissa shows the size classes of lumber production and the ordinate measures the average production in `000` CUM of lumber and the number of enterprises according to each size class.

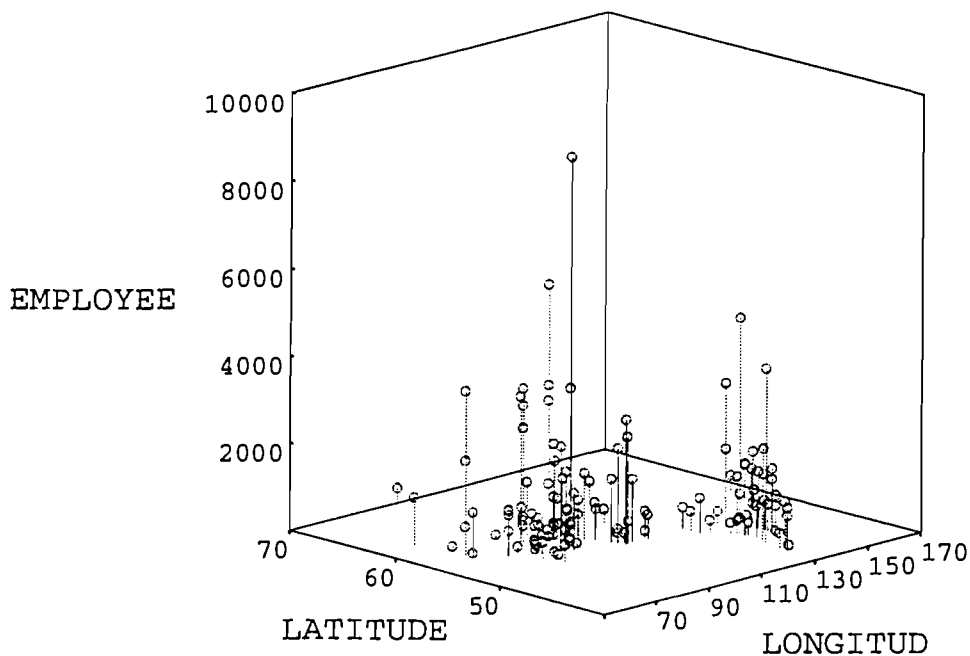

**Figure 7:** Geographic distribution of employees of the wood processing industry including furniture production.



## Appendix II:

### Variables

The description of the individual variables is segregated into six parts. Each part corresponds to the role which the variables play within the data system. The six parts are: (1) Sources of Basic Data; (2) Format of Basic Data; (3) Statistical Organizations; (4) Storage Media; (5) Expert Opinion and Appraisal; and (6) Inquiries of the Data Base.

### Sources of Basic Data

There are two fundamental sources of data within the data system, **A1**, and **A2**.

#### A1

The basic organizational structures are either the individual enterprise, or local organizations charged with collecting census type of material from the population. It is from these sources that the fundamental data for the system flows.

#### A2

The second organizational structure from which data flows relies on data collected from the enterprises, or from local census bureaus. It is not a source of primary data, but one which consolidates data from the fundamental source, **A1**.

Examples of these types of organizations would be an industrial association, like a *Dallesprom* or *Sverdlesprom*.<sup>11</sup>

### Format of Basic Data

There are five distinct types of data collected within the system.

#### F1

Data in this category describes characteristics of the operating enterprises, or local population. Within the Russian statistical system, such data do not need to be distributed to higher levels of authority within the corporate structure, such as to either the association management, or to the statistical agencies at a regional or national level of responsibility.

Information at this level of detail could describe physical characteristics of the enterprise. Examples of such indicators for two categories of enterprises are:

#### *Forest Harvesting Enterprise*

- o qualitative characteristics of the forest fund

---

<sup>11</sup> *Dallesprom* or *Sverdlesprom* under the former system were analogous to a corporate head office within the traditional organizational structure of a Western business firm. Each association had a number of enterprises over which it had responsibility.

- o ground cover
- o climatic conditions

#### *Woodworking Enterprises*

- o decline in the quality of the delivered raw material
- o distribution of the raw material by size and specie

Data in this category, describing the enterprises, can only be obtained through contact with experts (**E1**), who, either are employed by or have been employed by the individual enterprises, or who are specialists within the regional association organization, **A2**, and who have considerable local experience and/or have personal contacts with **E1** type of people, or, who can draw on similarities with the characteristics of enterprises about which they are familiar and which are adjacent to the one(s) under consideration.

#### *F2*

Data in this category are prepared based on queries from higher levels of authority within the corporate structure such as **A2**, or, within the organizational structure, **A1**. Data does not need to be sent to the statistical agencies. Consequently, this information does not necessarily appear throughout the statistical system.<sup>12</sup> The largest single example of this type of data is the accounting information.

#### *F3*

Data within this category are regularly delivered to higher levels of authority within the corporate organizational structure, **A2**, and from there, to regional statistical organizations, **S1**. Data in this category are often prepared utilizing a standard methodology with quality control provided by a single specialist within each originating enterprise or association, or census bureau.

Data captured under this category are used to: (a) manage the activity of lower organizations through different aspects of operation; and (b) generate information about industrial associations, and their participation in the regional economy.

#### *F4*

Data collected in a standard format are characterized by this category. They are initially delivered to regional statistical agencies, **S1**, and/or the regional industrial organizations, **A2**, before delivery to the regional statistical agencies. The regional statistical agencies, **S1**, then can pass the data onto the national data agency, **S2**, located in Moscow for inclusion in the national data base.

Data at this level relate to the utilization of the resources of a given territory (regions which are not managed from the Center). Within this category of data are indicators

---

<sup>12</sup>It may, or may not be, available from the management of the individual enterprises, or management of the associations. Additionally, data in this category can sometimes be found in the research institutes of the forest sector.

about utilization of the infrastructure of the region. Regional statistical agencies can prepare consolidated data for delivery to higher statistical agencies.

#### *F5*

Within this category are data collected according to a fixed format and methodology. The data are delivered to all organizational levels of *Goskomstat* (from lower, regional, to higher, governmental). Presently, all of the data defined under this category remain in paper format, **X**. Only part of the paper data base, **X**, is accessible in electronic form,  $\sigma\mathbf{D}$ . Consequently, collection of data describing economic, social, and political behaviour up until 1990 is not necessarily a smooth or guaranteed process.<sup>13</sup>

### **Statistical Organizations**

There are two levels of statistical organizations, **S1** and **S2**, reflecting the geographic scope of responsibility.

#### *S1*

Statistical organizations under this category are local in nature, and can be considered as part of the *kray, oblast'* or *ASSR* level of responsibility. These organizations are part of *Goskomstat*.

#### *S2*

The statistical organization under this category refers to the central location of *Goskomstat*, situated in Moscow.

### **Storage Facilities**

There are two varieties of storage media within the system. The storage media are paper, **X**, and electronic,  $\sigma\mathbf{D}$ .

#### *X1 and $\sigma\mathbf{D1}$*

The data which the local statistical organizations receive from the different sources are placed into storage. Selected data from the paper storage, **X1**, are then placed on a local computer data base system,  $\sigma\mathbf{D1}$ .

---

<sup>13</sup>The process of collecting data from the electronic data base,  $\sigma\mathbf{D}$ , involves a direct transfer of data stored in computer readable format from one computer to either, another computer, or to some form of transfer media such as computer diskette. Assuming that the data originally inputted into the computer data base are correct, and did not suffer from either clerical input error or from contamination further upstream in the data system, errors at this stage are restricted to inability to link the basic data in machine readable form with the appropriate variable name which represents what the data stands for.

## *X2 and $\sigma D2$*

The storage areas under this category refer to the central paper storage, **X2**, and computer data base,  $\sigma D2$ , of the principal statistical organization in Moscow. The central data base cannot only contain information passed on from the regional statistical organizations, **S1**, but also sent data directly to it from the myriad of organizations, **A1**, distributed across the country.

## **Expert Opinion and Appraisal**

Interacting with the collection and amalgamation of data are five types of experts, **E1** through **E5**. The classification of expert is based on the level of responsibility and experience.

### *E1*

Experts in this category have localized knowledge about the enterprises, or local regions, in question. For example, the chairman of a *leskhoz* may have an understanding of the character of the Forest Fund for all forest harvesting enterprises located within the boundaries of his *leskhoz*.

### *E2*

Experts in this category can have links with specific enterprises and can supply expert opinion and/or data for a given selection of enterprises. These people can be part of the management of the forest sector of the given region.<sup>14</sup> People of this category, individually, may be an expert for specific questions, or by virtue of work experience as members of research institutes, can have a much broader focus.

### *E3*

Experts in this capacity often have considerable work experience in the regional forest sector. This extensive background allows them to make recommendations concerning the correction of fundamental data. Additionally, due to their experience and knowledge, these experts often know where data are located, and how to access it.

### *E4 & E5*

Experts in these two categories usually have high academic qualifications, and considerable experience with manipulating the data from the different regions. The experience can be scientific work supplemented by practical work in the forest sector. These individuals can be major specialists in ministries, governmental bodies, advanced sectoral institutes, and sectoral departments of branches of *Goskomstat*.

---

<sup>14</sup>The forest sector organizations include industrial enterprises and associations, forestry organizations, and leading research institutes of the region.

## **Inquiries of the Data Base**

There are two different types of questions which the data base system is called upon to answer, the typical question (**TZ**), and the non-typical question (**NTZ**).

### *TZ*

The typical question to the data base can be illustrated by the statistical reference book of the national economy, or by publication of data describing the state of the economy. Questions which fall into this category usually probe no deeper than the *oblast, kray, or ASSR* level of detail.

### *NTZ*

The non-typical question to the data base is similar to the part of the list of indicators requested by the IIASA Siberian Forest Study referring to individual enterprise data.

## **Appendix III:**

### **Forest industrial enterprise information**

1. Code of region
2. Code of enterprise
3. Geographic location (latitude)
4. Geographic location (longitude)
5. POST INDEX
6. Address
7. Production value, thous. roubles
8. Number of employees (production personnel), pers
9. Labor productivity, roubles/person
10. Coefficient for utilization of basic machinery and equipment (number of working shifts)
11. Harvest (capacity), thous. cub. meters
12. Harvest (production), thous. cub. meters
13. Industrial wood (production), thous. cub. meters
14. Lumber (capacity), thous. cub. meters
15. Lumber (production), thous. cub. meters
16. Veneer (capacity), thous. cub. meters
17. Veneer (production), thous. cub. meters
18. Part. board (capacity), thous. cub. meters
19. Part. board (production), thous. cub. meters
20. Fiber board (capacity), thous. sq. meters
21. Fiber board (production), thous. sq. meters
22. Paper (capacity), thous. cub. meter
23. Paper (production), thous. cub. meter
24. Board (capacity), thous. cub. meters
25. Board (production), thous. cub. meters
26. Pulp (capacity), thous. cub. meters
27. Pulp (production), thous. cub. meters

### **Harvest enterprises (Leskhoz) information**

1. Code of region
2. Code of enterprise
3. Maximum allowable cut, thous. cubic meters
4. Actual cut, thous. cubic meters
5. Species composition of harvest, % of pine
6. Species composition of harvest, % of fir
7. Species composition of harvest, % of spruce
8. Species composition of harvest, % of cedar
9. Species composition of harvest, % of larch
10. Species composition of harvest, % of oak
11. Species composition of harvest, % of birch
12. Species composition of harvest, % of aspen
13. Species composition of harvest, % of other species
14. Average growing stock per hectare, cubic m per ha