



Environmental Problems of Agriculture -- II. Pest and Weed Management: Monitoring and Forecasting in the German Democratic Republic

**Ebert, W., Gutsche, V., Schwaehn, P. and
Trommer, R.**

**IIASA Collaborative Paper
December 1979**



Ebert, W., Gutsche, V., Schwaehn, P. and Trommer, R. (1979) Environmental Problems of Agriculture -- II. Pest and Weed Management: Monitoring and Forecasting in the German Democratic Republic. IIASA Collaborative Paper. Copyright © December 1979 by the author(s). <http://pure.iiasa.ac.at/1184/> All rights reserved.

Permission to make digital or hard copies of all or part of this work for personal or classroom use is granted without fee provided that copies are not made or distributed for profit or commercial advantage. All copies must bear this notice and the full citation on the first page. For other purposes, to republish, to post on servers or to redistribute to lists, permission must be sought by contacting repository@iiasa.ac.at

NOT FOR QUOTATION
WITHOUT PERMISSION
OF THE AUTHOR

ENVIRONMENTAL PROBLEMS
OF AGRICULTURE
II. Pest and Weed Management:
Monitoring and Forecasting
in the German Democratic
Republic

Werner Ebert
Volkmar Gutsche
Peter Schwähn
Reinhard Trommer

December 1979
CP-79-18

Collaborative Papers report work which has not been performed solely at the International Institute for Applied Systems Analysis and which has received only limited review. Views or opinions expressed herein do not necessarily represent those of the Institute, its National Member Organizations, or other organizations supporting the work.

INTERNATIONAL INSTITUTE FOR APPLIED SYSTEMS ANALYSIS
A-2361 Laxenburg, Austria



PREFACE

Intensive agricultural production requires constant control of an agroecosystem. One of the most important aspects of this control is plant protection through pest and weed management. Proper management should minimize economic losses from pests and weeds, while not forgetting environmental protection. The present paper describes a national system of pest and weed control which is in operation in the German Democratic Republic. At present, 87 types of pests, diseases, and weeds are monitored and controlled throughout the entire country.

In the GDR, three national operational systems have been developed as parts of an overall system for control of agricultural production. These are: a system of pest and weed management, a system of irrigation control, and a system of fertilizer application. They are fine examples of applied systems analysis which lie within the range of interests of the Resources and Environment Task 3, "Environmental Problems of Agriculture". Therefore, the principal authors of the systems were asked to describe their work in a Collaborative Paper which could be distributed through IIASA's information network.

Although emphasis in this paper is given to monitoring and forecasting issues, all stages of a management system, from monitoring through analysis of information, and forecast to a management decision, are described. The authors of the paper are affiliated with the Institute of Plants Protection in Eberswalde, GDR; the Institute is a part of the GDR Academy of Agricultural Sciences.

Genady Golubev
Leader of the Task
"Environmental Problems of Agriculture"



The Problem

The agricultural policy pursued by the German Democratic Republic is characterised by an all-out effort to accomplish steady increase of production and effectiveness of farming and the food industries, with the view to ensuring high-stability and continuously improving high-quality food supplies to the general public and raw materials for the manufacturing industries and to bringing living conditions in the countryside closer to those in urban areas. This actually is the major objective from which the demand is derived for further intensification of agricultural production and for its step-wise transition towards industrialised production methods. In that context, emphasis is laid on more effective land use along with enhancement of soil fertility, as a principal prerequisite for more intensification of crop production. Those aims will not be accomplished, after all, unless production is planned, concentrated and specialised, and large highly specialised production units set up. Action of that kind has to be accompanied by growing use of agrochemicals, such as fertilisers, herbicides and pesticides, and growth regulators, as well as by substantive enlargement of sprinkled areas.

The above conditions, on the other hand, are likely to provide favourable circumstances for proliferation of certain

contaminants. Intensification of crop production, consequently, adds to the importance of plant protection. The latter, therefore, has become a policy measure of the greatest relevance to production at large. It is essential not only to stabilising yields but also to ensuring effectiveness of all assets, in terms of labour and material, applied to achieving high production (1).

Chemical herbicides and pesticides were preferably used over the past decades to fight pathogenic organisms. Uncritical or even unskilled use of that approach, however, may bring about some serious environmental problems, such as pollution of the air, water, and soil, endangerment of man and domestic animals, and destruction of ecosystems. Many pathogenic organisms also developed resistance to pesticides or were even directly or indirectly activated by them. Ever new control measures became necessary and led to growing dependence of yield on effectiveness of pest control.

Therefore, ground is being gained internationally by the demand for turning from the control of individual pest species towards regulation of the ecosystem, all for the purpose of ensuring maximum crop productivity and providing unfavourable conditions for pathogenic organisms (2).

Knowledge of the agricultural ecosystem and its response to natural and artificial effects is an important condition for such change. Required for that purpose are regular information on the given condition of the agricultural ecosystem as well as on the direction and rate of its development. Inadequate knowledge may lead to sub-optimum decisions and to uncertain outcome. Therefore, if the system is to be kept under control, pathogenic populations have to be monitored by means of appropriate techniques of random sampling, and pesticides must not be applied until a certain threshold is surpassed (3).

This has been the general background against which efforts began to be undertaken in the German Democratic Republic in 1971 to develop one nation-wide operational computer-aided

information system to trace crop pests and weeds and to translate parts of the system into practice, as soon as they were ready for use.

The system was planned for the following principal purposes:

(a) The information system had to meet the demands likely to result from industrialised crop production under socialist conditions.

(b) It had to be applicable to all sources of contamination, including pests, diseases, and weeds, and to be capable of recording both the occurrence of contaminating populations and all control measures undertaken against them.

(c) The system had to be compatible with other national information systems and data memories used in agriculture, in order to enable repeated use of recorded data.

(d) The techniques used for data collection had to enable calculation of topical, quantitative, and area-related indices of infestation and control situations and to provide for topical analysis and prognostication.

(e) The system had to be of dynamic and flexible nature for convenient adjustability to modified demands on information and to structural changes.

(f) The system had to be regionally organised and capable of collecting and processing large amounts of data with no delay and with high accuracy.

(g) All users had to be given random access to the results of data processing, which called for the adoption of the on-line principle and for real-time processing.

(h) The programme system had to be of hierarchic nature and organised by the modular principle for operation with main programmes and sub-programmes.

Several research institutes of the Academy of Agricultural Sciences of the GDR, other universities and colleges, as well as plant protection institutions are involved in the develop-

ment of the information system. It has been such broad cooperation between most of these research institutions which has provided the condition for comprehensive treatment of the problem as well as for no-delay trial in practice and its smooth translation into plant protection proper.

Master Model of an Operational Information System for Plant Protection

A master model of an operational information system for plant protection was developed in the wake of a comprehensive analysis of the plant protection situation in the GDR and by generalisation of international experience (4). The general principles laid down in that master model may be applied also to computer-aided plant protection systems of other countries.

Collection, transmission, processing, and storage of information usually are the major components of any information system, but there is another very important aspect which quite often is not sufficiently considered in the preparation of information systems, that is use of information. Detailed rules of use have to be observed if in practice problems are to be avoided.

The information system for plant protection may be subdivided into the following sub-systems and elements, all in key with the specified requirements and objectives (Fig. 1):

1. Data collection;
2. Analysis, prognostication (of infestation and damage), and decisions on control action;
3. Planning, preparation, and implementation of control.

The data memory is the heartpiece of the information system. It consists of several sub-memories (or files), for example, for infestation data, coefficients or herbicides and pesticides. Transmission of information, such as long-distance data transmission, may be required between each of the above

sub-systems, if control measures have to be taken at different sites.

Sub-systems 1. and 2., summarised under the heading of "Monitoring and Forecasting System", will be the subjects of this paper. The monitoring and forecasting system, which also includes decision-finding and issuance of optimised control recommendations, is the very foundation for early planning and purpose-oriented implementation of plant protection as well as for an objective assessment of both the biological success and economic benefit obtained from it. The phases and levels of the monitoring and forecasting system planned for plant protection in the GDR are depicted in a block diagram given in Fig. 2.

Monitoring and forecasting take place at three levels, regional, national, and local (field level). These are oriented to different objectives and associated to different methods. However, close dialectical correlations do exist between them (5).

Monitoring of specific crops at farm level is controlled by plant protection authorities in the form of warnings and instruction which are derived from regional monitoring. For that purpose, reference will be made to phenological events in the development of pathogenic organisms or crops. There may be reference, as well, to infestation thresholds specified in advance. Field checks at farm level will be ordered, when such thresholds are reached. These values are defined as signalling thresholds.

Current analysis may also be used for specific instructions regarding farm monitoring activities in greater detail, for example, in the context of infested varieties or sites.

The results of farm monitoring and farm-based assessment of infestation, on the other hand, will be used for more comprehensive assessment of the given phytosanitary situation at regional or national level.

Regional monitoring, finally, helps to follow up the implementation of legal provisions for plant protection at farm level.

Monitoring and Forecasting at Regional/National Level -
Data Collection

The following rules have to be observed in setting up a system of data collection which is to provide the information needed for management:

(a) The amount of data collected must not exceed the upper limit required to attain the given objective or the number of data which can be processed immediately and stored immediately for recalling.

(b) All data collected must be related to characteristics on which information is essential.

(c) All data must be collected at minimised effort. Therefore, the method used for a given purpose must be the least expensive.

The information demand at regional/national level may be subdivided as follows:

1. Biological information

1.1. Information on pathogenic organisms

1.1.1. Phenological events in the development of pathogenic organisms

1.1.2. Populations of pathogenic organisms; density and distribution of infestation

1.1.3. Intensity and distribution of symptoms of damage

1.1.4. Information on structures of populations of pathogenic organisms

1.2. Information on crops

1.2.1. Phenological events in crop development

1.2.2. Information on structure and condition of crop stand

2. Meteorological information

2.1. Daily weather data

2.2. Weather forecasts

2.3. Long-term climate data

3. Agrotechnical information

3.1. Soil condition

3.2. Information on amelioration and tillage

3.3. Production cost

3.4. Harvested yield

The information and advisory system set up for plant protection in the GDR differs from comparable systems in other countries, in that its scope is not confined to providing qualitative information on the occurrence of pathogenic organisms. It rather has been designed to producing high-accuracy numerical information on infestation of larger areas, such as naturally delimited landscapes, large coherent crop production areas, regions or the entire territory of the GDR. This is considered to be essential to managerial decision-making on the need for and extent of monitoring and control measures. Quantitatively differing infestation situations may, as well, be represented and marked in district maps.

Those objectives, which so far were never incorporated in any other system, called for new approaches to data collection and for the development of a new technique of random sampling.

Two important principles of random sample choice had to be adapted to meet the purpose, stratification and multiphase random sample choice.

These are two principles of selection which, in combination, constitute the point of departure for the majority of large-area random sample techniques in agriculture and forestry. Some aspects and experience associated with the planning of data collection by means of such random sampling techniques and with evaluation of results (data processing) will be reviewed in the following paragraphs.

Planning of Data Collection

Planning and preparation of random sampling includes, in its first stage, a decomposition of the total entity into sub-entities, a procedure defined as stratification.

For statistical reasons and in order to achieve the greatest possible overall accuracy in estimating the indices of interest, it is recommended to undertake such decomposition in a way that each sub-entity, representing one parameter, is highly homogeneous in itself, while more pronounced differences should be allowed between various sub-entities.

This particular demand may be difficult to satisfy, since in practice sub-entities tend to be differentiated by administrative rather than biologically-ecological characteristics. Administrative characteristics are more easily detectable and thus recordable, when needed for stratification variables (number of selected units or area of sub-entity).

The multiphase nature of selection is another characteristic of large-area random sampling techniques. Its planning calls for solution of the following sub-problems in the various phases:

- (a) Decision on number of phases and delimitation of units;
- (b) Decision on sizes of random samples;
- (c) Choice of selection method.

The structure of the basis available for selection as well as techno-economic aspects of the recording method are of primary importance to the solution of the first sub-problem.

Subdivision of the total entity into natural units will be the principal assumption, according to possibilities. This actually has proved to be a favourable basis for selection for regional monitoring of populations in the GDR, since comprehensive farm files and plot maps were available.

Therefore, the area in which one crop was grown (total entity) was broken down, within one stratum, by farms (1. phase of se-

lection), and at farm level it was further subdivided by plots (2. phase of selection), although there may be cases in which the first phase (farms) may be skipped.

The single plant then would be the next natural unit for selection. However, since simple random selection of single plants from a given plot is not practicable, artificially demarcated selector units had to be intercalated, that is control areas and control points (Fig. 3).

This brings the total of selection phases to five maximum (Table 1), with the phase "control area" being established also for calculation of quantitative area-related indices of the given infestation situation.

The following aspects should be taken into due consideration for decisions on random sample sizes in all phases:

(a) Cost or man-hours required for each random sample unit within one selection phase (information often being rare or inaccurate);

(b) Estimated values for the variances of a given characteristic tested in various phases; these can be calculated from the results of earlier surveys; the phases of selection in which random samples should be enlarged or reduced then can be determined by calculation from the estimated variance components (6, 7).

An analysis of results so far obtained from monitoring of populations of pathogenic organisms has shown accuracy of estimated infestation indices to depend primarily on proper selection of units in the first two phases, namely the number of farms and plots. It was less affected by single-plot intensity.

First, the following two cases have to be differentiated, before selection methods can be decided for each of the phases involved (Fig. 4):

If all selection units in the phase under review are of equal size, selection will be undertaken with equal probabilities

and without setting aside. (If selection is done without setting aside, any selection unit within one total entity can be chosen only once as a random sampling unit. However, if selection is done with setting aside, any selection unit can be chosen repeatedly.) Selection with equal probabilities will be ineffective, if selection units are unequal in size. Selection with unequal, dimensionally proportional probabilities, is an optimum approach (7). This can be attained most conveniently by setting aside. However, selection without setting aside will be more effective, if the total number, N, of the selection units is very small (size of random sample, n larger than 0.2 N). This may be the case, if the total entity is subdivided into a great number of strata.

Yet, when selection is based on unequal probabilities without setting aside, a number of mathematical problems will have to be faced, because the order in which to draw random sampling units will have to be taken into account.

In mathematical research that particular problem so far has been treated primarily for the case of drawing precisely n = 2 random sampling units, and this case, consequently, should be emphasised for all practical purposes. There are several possible selection methods with unequal probabilities without setting aside. The following is recommended:

From among N (N - 3) units of the stratum, one unit will be drawn first (e.g. No. i) with the following dimensionally proportional probability:

$$P_i \quad (1) = z_i = \frac{F_i}{F}, \quad F = \sum_{i=1}^N F_i$$

(F_i = area variable of ith unit).

Then, draw from the remaining N-1 units a second unit (e.g. No. j) with the following relative dimensionally proportional probability:

$$P_{j/i} \quad (2) = \frac{z_j}{1-z_i} = \frac{F_j}{F-F_i} .$$

Selection in the context of monitoring of populations of pathogenic organisms so far has been undertaken in the first two phases (farms, plots), with dimensionally proportional probabilities and with setting aside. Selection in the other phases (uptake by control plot) is conducted with the same probabilities and without setting aside.

While the standard methods of random sampling proved applicable to selection of farms and plots, a suitable substitution method had to be found for recording from control plots, since high-accuracy random selection at those lower levels of recording proved extremely difficult for practical problems.

The preparation of such substitutional methods for random sampling quite often has been one of the most crucial and difficult problems involved in the preparation of practicable random sampling techniques.

Therefore, it was necessary to obtain information on spatial distribution of populations of pathogenic populations on plots under conditions of industrialised production.

Three basic types of spatial plot distribution were derived from these studies which were conducted by means of what is called grid recording (8. 9) (Fig. 5).

The recording diagram given in Fig. 3 could be applied to most of the populations, since pronounced marginal infestation so far has been found to be an exceptional case, while at the same time, and in line with the very purpose of the technique, high-accuracy estimation of infestation density at regional level was not necessary for the single plot. The control areas, in that context, have to be distributed along the marginal zone of the plot, and recording starts from the plot side most easily accessible by car. Such approach has proved to provide quite favourable conditions for random sampling, in that it helps to save time and effort.

The recording diagram described in this paper is applicable to all pests and diseases, to quantitative measurement of both symptoms of damage and structures of contaminating populations. It can be used just as well on any other field parameter, such as development, structure, and quality of crops, as well as for random sampling in the context of toxicological tests. Such coherent and comprehensive applicability of the method has attached to it the even greater advantage of applicability of the techniques and programmes for evaluation devised along with the method proper.

Weed herbs and grasses call for special methods on the basis of the methodological master concept, on account of the following characteristics:

- (a) Close dependence on certain soil conditions and climates;
- (b) Weeds occur almost exclusively in association with others and, consequently, can be assessed only by their compound action;
- (c) Weeds are not associated with one certain plant in a given crop stand;
- (d) Competition depends decisively on the area covered by weeds rather than the number of weed species involved.

Special methods are required primarily for recording from the control field. (Studies are in progress into selection of control plots and delimitation of total entities or parent populations, with particular reference being made to soil conditions and climates.) Four control areas of 0.5 m x 0.5 m (0.25 m²) are pegged out on each field, and the number of weed herbs and grasses to be recorded is established on each of them. Total coverage by the entire weed association is estimated to be 5 m x 5 m (25 m²) on two control areas.

The control area approach was introduced in GDR plant protection in 1976. The surveys proper are conducted primarily by the plant protection authorities of the GDR. The general organisational setup of the monitoring system is depicted in Fig. 6.

At present, this method is being used in the monitoring of 87 species, including pests, diseases, and weeds. Roughly 100 individual parameters are involved by repeated recording in the course of one vegetation period. All of them are quantitatively recorded, calculated, and evaluated. At national level, each of those parameters is assessed on about 450 plots and on 80 single plants of each plot. The resulting total is about 3.5 million plants on which occurrence of damage is annually checked.

A differentiation is made between topical and non-topical pathogens, in conformity with their economic relevance. Topical pathogens call for immediate decisions and no-delay control action, as soon as a defined threshold of infestation is reached. The interval between data collection from control plots and feedback information to the user should not exceed five days. A ten-day interval may be allowed for non-topical pathogens, because they usually are species about which information is only of forecasting value, since they cannot be fought immediately and directly under the present conditions.

Analysis of Infestation

Analysis of infestation is a mathematico-statistical method by which to evaluate random sampling on the basis of data recorded on infestation density. Such analysis is undertaken for the following purposes:

- (a) Quantitative assessment of infestation at national and regional levels (printing of infestation maps);
- (b) Comparison between infestation situations which differ in terms of time and area;
- (c) Regular analysis (e.g. to establish effects of intensification factors upon density and distribution of pathogenic populations);
- (d) Monitoring of regional use of plant protection agents (e.g. success, comparison between planned and real control).

Analysis of infestation, consequently, will provide substantive prerequisites for decision-making at both central and regional levels. It has proved to be particularly helpful in the following contexts:

- (a) Drafting of high-accuracy planning documentation;
- (b) Collection and processing of statistical data;
- (c) Prognostication of infestation and damage;
- (d) Preparation of recommendations for control and optimization of control measures (best possible application of herbicides, etc.).

An analysis of infestation is based on the following mathematical algorithm. Simple summation and arithmetic averaging (Table 2) are the methods used for transition from one selection phase to the next up to stratum level.

The same approach will be taken to plot or farm level, if selection is based on dimension-proportional probabilities with setting aside.

However, a systematic error of estimation is likely to result from simple, unweighted arithmetic averaging, if selection is undertaken with unequal probabilities and without setting aside (for higher accuracy in the context of very small strata). Choice is not easy between the more highly involved unbiased estimation methods available, because by all accounts in the context of theoretical mathematico-statistical studies, there actually is no best unbiased linear estimation at all.

Empirical calculations based on comprehensive data material, so far recorded from monitoring of pathogenic populations, have shown that if $n = 2$ units of the first phase are selected for each stratum with dimension-proportional probabilities without setting aside, favourable results may be obtained from what is called disordered estimation, according to Basu-Murthy.

This estimation (10) is calculated by the following formula:

$$\bar{y} = \frac{1}{2 - z_i - z_j} \left[(1 - z_j) y_i + (1 - z_i) y_j \right].$$

It has a variance which, in most cases, is smaller by not less than factor

$$\frac{N - 2}{N - 1}$$

as compared to the variance of estimation

$$\bar{y} = \frac{1}{2} (y_i + y_j)$$

which will be used for selection with dimension-proportional probabilities with setting aside.

When transition is to take place from one stratum to a regional area, which consists of several strata, the indices determined at stratum level will have to be summarised by means of stratum surfaces as weights for overall estimation.

Information beyond average data per single plant which fully express infestation and its distribution among plots as well as the extent of necessary control action may be obtained from classification of control plots by classes of infestation (as described below) and from their subdivision by controlled and uncontrolled plots. The classes of infestation can be used as criteria by which to decide plant protection measures, and they also provide good reference points for assessment of real damage and forecasting of possible loss.

An effort was made to obtain information which was widely independent of the amount of random samples (number of plants checked per control area). Therefore, when the control areas were subdivided by classes of infestation, non-infestation in a random sample was not recorded as a separate class of infestation, but it was rather added to class 1 with low infestation. Classification was undertaken in conformity with ecological and economic aspects. An algorithm was prepared for each pathogenic species and used for precise coordination with one class of infestation of all infestation data recorded from a given control area.

The classes of infestation have proved to be useful instruments for decision-making. Quite generally, they may be defined, as follows:

- Class of infestation 1: No or very low infestation, with no economic consequences;
- Class of infestation 2: Moderate infestation, with no or minor yield loss expected; control action necessary in exceptional cases only; continued monitoring at regional level;
- Class of infestation 3: Medium infestation; economically palpable yield loss expected; field checks (local monitoring) necessary; control action required, when specified threshold reached;
- Class of infestation 4: Severe infestation; yield loss unavoidable unless immediate control action taken on the basis of intensive field checks; control action decided by plots.

Such area-related quantified assessment of infestation proved useful in delimitating endangered areas and in taking large-scale control decisions. It is also conducive to proper re-assessment of control and its results, depending on weather conditions.

Estimation of indices by which to describe a real infestation situation and its course over time (first processing phase of infestation analysis) will be followed by more detailed infestation analysis of a larger region (in which a sufficient number of control plots is available for multivariable statistical analysis). That second phase of analysis is to help identify correlations between intensity of infestation of the control plots and certain plot-related factors and possible repercussions of such correlations on yield.

Such factors of influence may include site, preceding crop, variety, fertilisation, and sprinkling. They are entered into basic data form sheets opened especially for the control plot concerned, and they will be referred to, in the following paragraphs, as basic data characteristics. Attached to each of the basic data characteristics will be a number of classes which refer to matters of substance rather than organisational aspects. This is done for evaluation.

If two, three or more basic data characteristics are used as sorting characteristics, at one and the same time, the multitude of possible combinations of different characteristics, theoretically, will cease to be overseable, provided that a larger number of classes is attached to each of the characteristics involved. Analyses of infestation, therefore, have to be undertaken in several phases to avoid the need for analysis of combinations which may be of little interest or not suitable for producing sufficient statistically secured information because of too few control areas. Analysis of infestation so far has proved to be quite productive, if undertaken in the three following phases which were separated from one another also in terms of electronic data processing:

First phase:

Exclusively included in the first phase are storage of basic data characteristics and their evaluation, without any consideration of infestation data. The output of monodimensional and polydimensional frequency distributions is used to find out those manifestations of a basic data characteristic or of a combination of two (e.g. variety, preceding crop) to three basic data characteristics maximum which occur sufficiently often and, consequently, are qualified for incorporation in an analysis of infestation (second phase) and also to identify those which should be omitted for poor occurrence (small number of control areas).

Second phase:

This is the phase in which the basic data characteristics are related to the infestation data. This is done by separate calculation of infestation indices (percentage of infested plants, density of pathogenic organisms) and frequency distribution of infestation classes for the manifestations of basic data characteristics or combinations of some of them, according to what has been established in the first phase. Estimation of plots will be somewhat similar to projection of infestation data, in that it is done by subdividing the control areas into classes of infestation. Such evaluations then are helpful in establishing empirical interdependencies and in setting up hypotheses on assumed causative relationships (configurational hypotheses). These may be improved to higher accuracy and their validity verified in the third phase.

Third phase:

While all evaluations in the first and second phases were of a more or less descriptive, heuristic nature, the data thus prepared will be exposed to more profound, scientific analysis in the third phase. More specialised methods of multivariable statistical analysis will be used to verify multivariable relationships and to check the validity of hypotheses on assumed interdependencies, with particular emphasis being laid on correlation analysis (for metrically graduated characteristics) and the method of polydimensional contingency tables (for nominally graduated characteristics).

Analyses of the above kind have been undertaken over several years and provide ground for additional conclusions as to the planning of herbicides and pesticides, monitoring and control strategies, and plant breeding research.

The following example of mildew of barley is to indicate the extent to which economic information in terms of yield loss may be derived from analysis of infestation.

Winter barley was grown on plots covering 15,000 hectare of one of the regions in the GDR, in 1974. The average yield in that region was 4.71 tons/ha. The following mildew infestation was recorded by projection:

<u>Assessment</u>	<u>Percentage of infested plants</u>	<u>Area infested (1,000 ha)</u>
9 (no infestation)	48.2	7.3
7 (minor infestation)	36.8	5.5
5 (medium infestation)	12.0	1.8
3 (high infestation)	2.2	0.3
1 (severe infestation)	<u>0.7</u>	<u>0.1</u>
	100.0	15.0

The following economic information on the amount of real damage may be derived from the mathematically secured area data, in the context of the above projection and on the basis of secured infestation-damage relationships (mean yield loss per assessment level):

Mildew infestation of 7,700 ha of winter barley in 1974 reduced the average yield of the region from 4.71 tons/ha to 4.59 tons/ha, resulting in an overall loss of 0.12 tons/ha. Average yield loss may be estimated to 1,876 tons of winter barley. (The real loss figure can be determined, if the yield had been accurately predicted.)

Control action, using Calixin or SaproI, might give benefit coefficients between 1.7 and 6.2 at assessment levels from 5 to 1.

Possibilities to reduce the amount of control action and, consequently, contamination of the environment by herbicides and pesticides can be improved sizeably by regional monitoring. This may be explained by the example of 35,000 hectare of rapeseed and control action against rapeseed pests in the region of Neubrandenburg, a centre of rapeseed cultivation in the GDR.

Regional monitoring helped to delimitate areas endangered by the blossom beetle, *Meligethes aeneus* L., and to introduce systematic, density-related control action. While in the year before, routine treatment had been applied to the entire rapeseed area, the amount of control could be reduced by 92 per cent (1) in 1975, though density of pathogenic organisms was comparable.

A similar situation was observed in the context of cabbage stem weevil, *Ceuthorrhynchus assimilis* Payk.. In 1975, treatment had been applied to 31,669 ha instead of merely 1,060 ha in need of treatment according to analysis of infestation. Therefore, appropriate measures were prepared for more target-oriented control in 1976. Treatment then was applied to 6,064 ha versus a treatment-requiring area of $6,207 \pm 2,184$ ha. Reduction, consequently, accounted for 80 per cent.

Infestation and Damage Forecast

The term of infestation forecast is used to describe predictive assessment of the development of a given population of pathogenic organisms, with particular reference being made to the probability, site, time, and intensity of occurrence. Forecasts may be differentiated by purposes, such as deadline, abundance, dispersion or positive and negative. There are short-term, medium-term, and long-term forecasts. The latter, no doubt, are most useful in terms of economy, but they are the most difficult to undertake and usually suffer from greater uncertainty (11).

The term of damage forecast stands for predictive assessment of the extent to which the very objective of production is affected by pathogenic organisms in terms of yield, quality or cost. The infestation forecast is a prerequisite for the damage forecast, as may be seen from the master model, and the latter differs from the former, in that it contains economic aspects, as well.

Infestation forecasts may be prepared in two ways, namely by means of econometric or mathematico-statistical procedures and by means of mathematico-cybernetic population models. Included in the first group of procedures are curve projection (trend calculation), regression analysis and other methods of quantitative multivariable analysis, such as the path coefficient method and discriminance analysis, and the use of two-dimensional and polydimensional contingency tables.

The procedures of the first group are part of the second phase in the development of the information system for plant protection, and they follow immediately after the infestation analysis or are components of the latter.

The third phase of development, however, is characterised by use of population as well as of agro-ecosystem models, with the view to regulating populations of pathogenic organisms and optimising harvested yields. These models, used in an attempt to represent major causative implications and correlations between all elements of the system, may produce information on the present and future condition of the ecosystem concerned, that is information applicable to pest management. Weather data are the most important input elements for model runs.

A general simulation concept for simulation models (12, 13), devised by the Academy of Sciences of the GDR, Central Institute of Cybernetics and Information Processes, is used and continuously improved for the information system for plant protection.

The modelling concept, SONCHES (simulation of non-linear complex hierarchical ecological systems), has been designed for visualising both the dynamics of each of the populations involved and the agro-ecosystems concerned.

The following elements and relations of the ecosystem are considered in the above model:

1. Quantity, U , of environmental factors with impact upon the biotic elements of the system, including their mutual geophysical, geochemical, and other relations;

2. Quantity, M , of biotic elements of the ecosystem, including matter and energy flows through those biotic elements, and other effects of environmental factors on those elements;

3. Relations of order between the biotic elements of the ecosystem, M_0 ;

4. Correlations between the biotic elements;

5. Correlations within one biotic element, M_c .

The biotic elements of the ecosystem are defined as "ecological compartments". The term of an ecological compartment is to be understood as the totality of members in a community of living creatures with one common function in that community. Compartments, in the context of this paper, may be functional groups of species, such as phytophagous species, individual species or ontogenetic stages of species (adult, pupa, egg, larva) or, when it comes to several species, phytophagous insect larvae, etc..

The specific structure of a real ecosystem is reflected equivalently by the model configuration by means of the relations of order, M_0 . This applies, for example, to the properties of the hierarchy of real ecosystems which is likely to result from the trophic relations that exist between compartments. That particular property is simulated by the model by ordering the compartments in various strata (trophic levels). Such treatment will turn the exterior environment, which so far has acted on the biological elements of the system, into the interior environment of the system which then will "flow" through the system, proceeding from stratum to stratum. The intensive (indivisible) part of the exterior environment can be modified by the ecological compartments (e.g. modification of temperatures for insect attack due to high crop stand density).

The extensive (divisible) part can be introduced to the system either from outside or it can be produced by the biotic elements (e.g. leaf weight). It will be more or less "used up" in the strata of the compartments. When it comes to singular population models, compartments merely are part of one stratum or there may be cases in which the hierarchic order may be left unconsidered, depending on the given purpose of population model construction (Fig. 7).

To simulate all relations between the elements of the system as control mechanisms is another principal concept of the authors' model. Those control mechanisms actually control the ecological process behaviour of the system reviewed. They are required to produce ecological behaviour from the auto-ecologically and physiologically described compartments. The control mechanisms are algorithmised and programmed in the form of modules. Compartment substitution, for example, is one of the important modules. It simulates the ontogenetic process of a given species. Several standard variants are offered by compartment substitution for compartmental transition from one ontogenetic stage to the next. A generally algorithmised rule for temperature sums is one of those variants.

The response of a given compartment, such as growth or death as a change of biotic presence, is produced by the modules of interaction within one and the same biotic element. That response is a reaction to environmental effects acting from outside. Response to such environmental effects is more or less delayed. Variables, therefore, have to be found which do represent the physiological condition of the compartment concerned and on which additional responses will depend. These variables must be suitable, as well, for simulating an average delay of compartmental response to environmental changes. Compartmental response is likely to take place in the following three phases, depending on the given physiological conditions:

1. Materialisation of input (uptake of extensive and action of intensive variables of the environment);
2. Processing of input (change of physiological condition, depending on materialisation of input);
3. Biological performance (growth, death, depending on physiological condition, etc.).

The third group of modules, finally, concerns correlations between various compartments. One of the modules, named trophic feedback, produces the trophic relations between the compartments. It simulates, for example, flows of biomasses from supplier compartments (e.g. prey) to consumer compartments (e.g. predatory species).

Competition, another module, simulates competition for limited extensive environmental factors, while the effect of adaptation to intensive environmental factors is simulated by a module called competence.

Standard variants for each of those modules are offered by SONCHES. All of them have been verified on various test objects. There also is one "blank" in each of the modules into which another purpose-specific algorithm can be inserted by the user, if so required. When it comes to a specific object, such as a given agro-ecosystem or population, relevant control mechanisms will be selected out of many and furnished with specific parameters, before the model then is composed by means of a recipe derived from SONCHES. A model for a system under review can be composed by means of only few modules even at an early stage of development. The same model, if so required, may be expanded and improved by adding additional modules which are constructed and validated in the course of work. For example, a model for the epidemic course of *Phytophthora infestans* (Mont.) de Bary, the pathogen of potato blight, was constructed in close cooperation with experts specialised in that particular field. Compartment substitution, density feedback, and direct reaction were the only modules used, in that context.

Good results were obtainable even from such relatively simple model approach, as may be seen from Figs. 8 through 10. The epidemic course model was validated, first of all, by individual modules. They were put into parameters and tested for reactivity equivalence in laboratory and freeland experiments. The second stage of validation was preceded by computer implementation of the whole model. Data obtained from several years in the past were used for that purpose. The real infestation curves recorded from test plots were compared to the curves obtained by simulation. Relative humidity, air temperature, and precipitations were the meteorological data measured parallel to infestation for input into the simulation model.

While primarily variants of compartment substitution and direct reaction are used and tested by the Phytophthora model, a study into simulation of growth of the vegetative compartment of *Stellaria media* (L.) CYR. was undertaken, with the view to testing internal mechanisms of the compartment. Food uptake feedback, input coupling, external feed-forward, internal feed-forward, and density feedback were the modules used in the latter model. The module variants generated a growth curve which, again, was very close to the curve observed in reality, as may be seen from Fig. 11.

These examples were given to underline that the results obtainable with regard to various specific populations from the SONCHES concept, even in the preparatory phase of drafting complex agro-ecosystem models, were properly suitable for application to an information system for plant protection. This is the stepwise approach taken to setting up a theoretical foundation on which to resolve forecasting problems of the agro-ecosystem.

Monitoring at Field Level

Monitoring at field level is undertaken for the purpose of high-accuracy assessment of infestation of specific crop stands

for optimised decision-making on control action and proper follow-up assessment of the biological result of control.

Two major elements of monitoring at field level may be derived from the above purpose, the assessment method for high-accuracy determination of infestation of a given crop stand and the method for ecologico-economic evaluation of infestation developments (14). Monitoring at field level is carried out under the responsibility of farm-based plant protection experts.

Assessment Method

An approach known by the name of line assessment (15) constitutes the methodological basis on which infestation is assessed at field level. The plot concerned is scanned rectangularly, beginning at the boundary. The line begins between 20 and 30 steps from the boundary. Then five plants or parts of plants are tested for infestation at five points, with intervals of 20 steps in between (Fig. 12).

Judgement proper is made by specified parameters established beforehand to describe the pathogenic effect.

Chronologically, a differentiation is made between three variants of monitoring of crop stands. Surveying assessment usually is the first step, and this is applied primarily to plots considered to be in particular danger. Surveying assessment is undertaken for the purpose of getting general information on infestation developments at a given crop production unit and of keeping any further development of the pathogenic population under close surveillance.

Decision assessment follows, as soon as occurrence of pathogenic organisms has been established on one of the fields thus tested and found to be of sufficient severity to justify or necessitate control action. All fields on which the crop concerned is grown have to be covered in such case, and at least one line has to be assessed on either side of each of the fields. Decision

assessment is of particular importance in situations in which parts of larger crop stands have to be pegged out and delimited for control action, with the rest of the fields left untouched. Comprehensive and high-intensity studies (16) have shown that by using partial-plot treatment chemical pest control of cereals was reduced by orders between 50 and 80 per cent, as compared to whole-plot treatment in the past.

Control action then is followed by outcome assessment by which to define the effects of control on the population of pathogenic organisms. The results of assessment at all levels as well as all the measures taken are entered into plot files. An assessment form sheet has been devised for that purpose. The results obtained from assessment are entered into a computer-adjusted "plant protection plot card" for later analysis or secondary evaluation.

Decision-Finding

Real infestation of a given crop stand, as recorded by means of decision assessment, is ecologico-economically evaluated by means of a system of control indices which are conclusive indicators of those pests which have to be controlled. There are regional and local indices, in conformity with the monitoring approach. The approach taken to the problem under socio-economic conditions of socialism differs from the purely farm-oriented approach taken to decision-finding in capitalist countries, in that in a socialist society aspects of relevance to both national economy and farm management are duly taken into consideration, yet, with emphasis being laid on the former. The regional control index, in full compliance with the overruling context of the national economy, therefore, is the established and accepted basis for optimum decision-finding in the GDR.

This is an index which characterises the need for control of a pest or complex of pests in an area with similar ecological

and agrotechnical conditions. It gives the lowest population density or infestation intensity of a given pathogenic organism at a given time or stage of development, from which counter-action becomes essential to national economy, under the standard conditions given in the area concerned. The control index, consequently, is used to meet demands in terms of national economy, such as high and stable yields, good crop quality, prevention of resistance among populations of pathogenic organisms, and minimisation of detrimental impact upon the environment which might otherwise result from the use of herbicides and pesticides.

The control index has to be of a dynamic and flexible nature, since it is derived from ecological and economic conditions which may be subject to sizeable variation in terms of time and space. Such dynamic nature is required particularly in the context of the following factors:

- (a) World market situation of the commodity concerned or the herbicide or pesticides, if the latter have to be imported;
- (b) Expected harvest;
- (c) Prevailing weather conditions;
- (d) Expected developments of pathogenic organisms and crops.

Decision-finding at field level will have to take place on the basis of such national or regional index values of control (i.e. management data of national economy). Control indices, therefore, have to be adjusted to the specific conditions under which crop stands grow. Plant protection specialists have provided various kinds of instruments to that end, including tables, graphs, and nomograms. The value thus determined to characterise the need for control of a given pest or weed or complexes of them on a given field is defined as the control threshold, and this is used directly for control decisions. The control threshold consequently, defines a certain state of the agro-ecosystem at a given time of monitoring at which appropriate action has to be

taken to avoid immediate occurrence of economic loss due to pathogenic organisms which cannot be tolerated for reasons of national and farm economy, such loss being reduced yield quantity or quality, lower labour productivity, rise of technological outlays, etc..

The following local field conditions are of particular relevance to occurrence of a control threshold:

- (a) Means of production (in quality and quantity);
- (b) Crop variety and its vulnerability or resistance to a given pathogenic organism;
- (c) Production methods used (agrotechnical measures) and their effects on populations of pathogenic organisms and/or crops;
- (d) Latest condition of a given crop stand (stage of development, stand density, vitality, etc.);
- (e) Occurrence of natural adversaries to populations of pathogenic organisms (predatory species, parasites, etc.);
- (f) Site peculiarities (major deviations from standard conditions of region concerned), with particular reference to soil conditions and climate.

Biologically and ecologically, both the control index and control threshold are based on the infestation-damage relation. The latter is one part of the host-parasite relation, the one which determines, under varying environmental conditions, the action of a certain density of pathogenic organisms on the objective of production, above all, on the harvested yield. A wide range of experimental methods is being applied to studying this particular problem, from black-box procedures to model simulation of the correlations involved. However, causative analysis of such correlations still is in an infantile stage. A heuristic master model for the infestation-damage relation is given in Fig. 13. Weather, variety, and date of infestation

(relative to the development stage of the crop) are some of the decisive environmental factors, in that context. The conditions under which experiments and test were conducted have to be duly considered, as well. Those are the three factors, grouped in complex classes, which determine the experimental variants used. A family of curves, as depicted in Fig. 14, is the result of such studies. All the other ecological and economic factors of influence may be derived from such basic studies, either directly or via experiments proceeding from the latter.

It is quite obvious from the above considerations that comprehensive investigations over many years are required for eventual assessment of all relevant factors of influence and all complex correlations between them, with the view to mobilising them for the control of populations of pathogenic organisms or even for yield optimisation. This is a wide and important field, indeed, for the construction of models of agroecosystems and for the control of such systems. Yet, all results so far obtained in this field have produced evidence to the effect that sufficient conditions for such accomplishment can be provided by high-accuracy ecological and economic research.

Two more examples are given, in conclusion, to demonstrate the economic importance attributable to local field monitoring and its effective control by regional monitoring and forecasting:

Systematic control action was undertaken against corn louse, *Macrosiphum avenae* L., in a winter wheat area of 11,953 ha in the region of Halle, 1977, stimulated by results obtained from regional and local monitoring. The yield loss thus prevented was carefully estimated to something between 5,000 and 6,000 tons of wheat, the estimation being based on profound knowledge of damage development (17). Careful application of herbicides and pesticides helped to prevent bee loss and the occurrence of residualisation problems as well as excessive damage to

other useful animals. Monitoring between 1974 and 1976 helped to cancel all plans and programmes for insecticide treatment of the same pest, without running any risk in terms of yield.

The Colorado beetle, *Leptinotarsa decemlineata* (Say.), is a dangerous enemy of potato stands. Comprehensive control campaigns have to be annually undertaken against that pest. Local monitoring for pin-point application of insecticides was conducted by research assistants of the Plant Protection Institute of Kleinmachnow, GDR, on a large farm with high concentration of potato, between 1976 and 1978. While all potato plots of that farm had been exposed to full-fledged treatment in the years before, control coverage over the experimental years was reduced by something between 95 and 48 per cent, with the annual mean value having been 74 per cent.

The method of field monitoring was tested nation-wide on 28 farms which were representative of the entire territory of the GDR, in 1978. The area in which control action against Colorado beetle was necessary could be reduced by the order of 52 per cent

These two examples alone are sufficient evidence to the great importance of comprehensive and skilled monitoring. Reduction of loss as well as savings on material and time, however, are only one achievement obtainable from the system of monitoring. Even more and long-term importance should be attributed to the environmental aspect, since the toxicological consequences otherwise resulting from unsystematic routine application of herbicides and pesticides are avoided, and detrimental impact upon soil fertility is reduced.

REFERENCES

- (1) MÜLLER, H. J.; BEER, W.; BURTH, U.: Gezielter Pflanzenschutz in der intensiven Pflanzenproduktion - Möglichkeiten und Erfordernisse. Nachr.-Bl. Pflanzenschutz DDR, Berlin 32 (1978), 10, S. 193-197
- (2) POLJAKOV, J. Ja.: Mehrjährige Prognose über die Veränderung der Bedeutung der Schädlinge der landwirtschaftlichen Kulturen. Nachr.-Bl. Pflanzenschutzdienst DDR, Berlin 26 (1972), 9, S. 177-184
- (3) RUESINK, W. G.: Status of systems approach to pest management. Annu. Rev. Entomol., Palo Alto 21 (1976), S. 27-44
- (4) EBERT, W.: Die theoretischen Grundlagen für ein operatives Informationssystem im Pflanzenschutz der DDR. Tag.-Ber. Akad. Landwirtsch.-Wiss. DDR, Berlin 1973, 125, S. 97-109
- (5) EBERT, W.; TROMMER, R.; SCHWÄHN, P.: Überwachung tierischer Schaderreger in der industriemäßigen landwirtschaftlichen Pflanzenproduktion. Nachr.-Bl. Pflanzenschutz DDR Berlin 29 (1975), 9, S. 181-184
- (6) TROMMER, R.: Zur optimalen Gestaltung zweistufiger Erhebungen im Pflanzenschutz. Biom. Z., Berlin 14 (1972), 6, S. 372-386
- (7) TROMMER, R.: Anwendung mehrstufiger Stichprobenverfahren mit Auswahleinheiten ungleicher Größe zur Überwachung von Schaderregern in der landwirtschaftlichen Pflanzenproduktion der DDR. Biom. J., Berlin 19 (1977), 7, S. 535-548
- (8) EBERT, W.; GUTSCHE, V.; TROMMER, R.: Die Anwendung mathematischer Methoden und der EDV zur Kontrolle, Analyse und Prognose des Schaderregerauftretens in der Land- und Forstwirtschaft. Fortschr.-Ber. Landwirtsch. u. Nahrungsgüterwirtsch., Berlin, DDR 15 (1977), 3, 52 S.
- (9) TROMMER, R.: Methodik der Durchführung und Auswertung von Erhebungen auf Einzelschlägen zur Untersuchung der räumlichen Verteilung von Schaderregern. Tag.-Ber. Akad. Landwirtsch.-Wiss. DDR, Berlin (1974) 131, S. 169-179
- (10) SUKHATME, P. V.; SUKHATME, B. V.: Sampling theory of surveys with applications. Ames: Iowa State Univ. Press, 1970.452 pp.
- (11) EBERT, W.; GUTSCHE, V.; MENDE, F.: Theoretical problems of infestation and damage forecasts in agriculture crop production. In: 3. Internat. Plant Protect. Congr., Rep. Inform., Sect. 2, Moscow 1975, S. 144-159

- (12) KNIJNENBURG, A.; MATTHÄUS, E.; Simulationsmodell zur interspezifischen Wechselwirkung in Abhängigkeit intensiver Umwelteinflüsse, Arch. Naturschutz u. Landesforsch., Berlin 17 (1977), 4, S. 247-265
- (13) GUTSCHE, V.; KNIJNENBURG, A.: Mathematische Modellierung von Populationsabläufen. Biol. Gesellsch. DDR, Sekt. Ökol., Vortr. d. Arbeitsberatung Populat.-Ökol., Berlin 1979, S. 91-97
- (14) EBERT, W.; FOCKE, I.; FREIER, B.; MENDE, F.; WETZEL, Th.; Möglichkeiten einer objektiven Bekämpfungsentscheidung bei Schaderregern im Feldbau mit Hilfe von Bekämpfungsrichtwerten. Nachr.-Bl. Pflanzenschutz DDR, Berlin 33 (1979), 5, S. 85-88
- (15) EBERT, W.; SCHWÄHN, P.; RÖDER, A.: Das Verfahren der Bestandesüberwachung und seine Anwendung in der Getreideproduktion. Nachr.-Bl. Pflanzenschutz DDR, Berlin 31 (1977), 8, S. 164-167
- (16) WETZEL, Th.: Untersuchungen zur Aufklärung von Schadzusammenhängen bei Schadinsekten des Getreides. Getreidewirtschaft, Berlin 10 (1976), 12, S. 271-275
- (17) WETZEL, Th.; FREIER, B.; RESSEL, B.; MATHES, P.: Erfahrungen bei der Überwachung und Bekämpfung von Getreideblattläusen im Jahre 1977 im Bezirk Halle. Nachr.-Bl. Pflanzenschutz DDR, Berlin 32 (1978), 2, S. 21-24



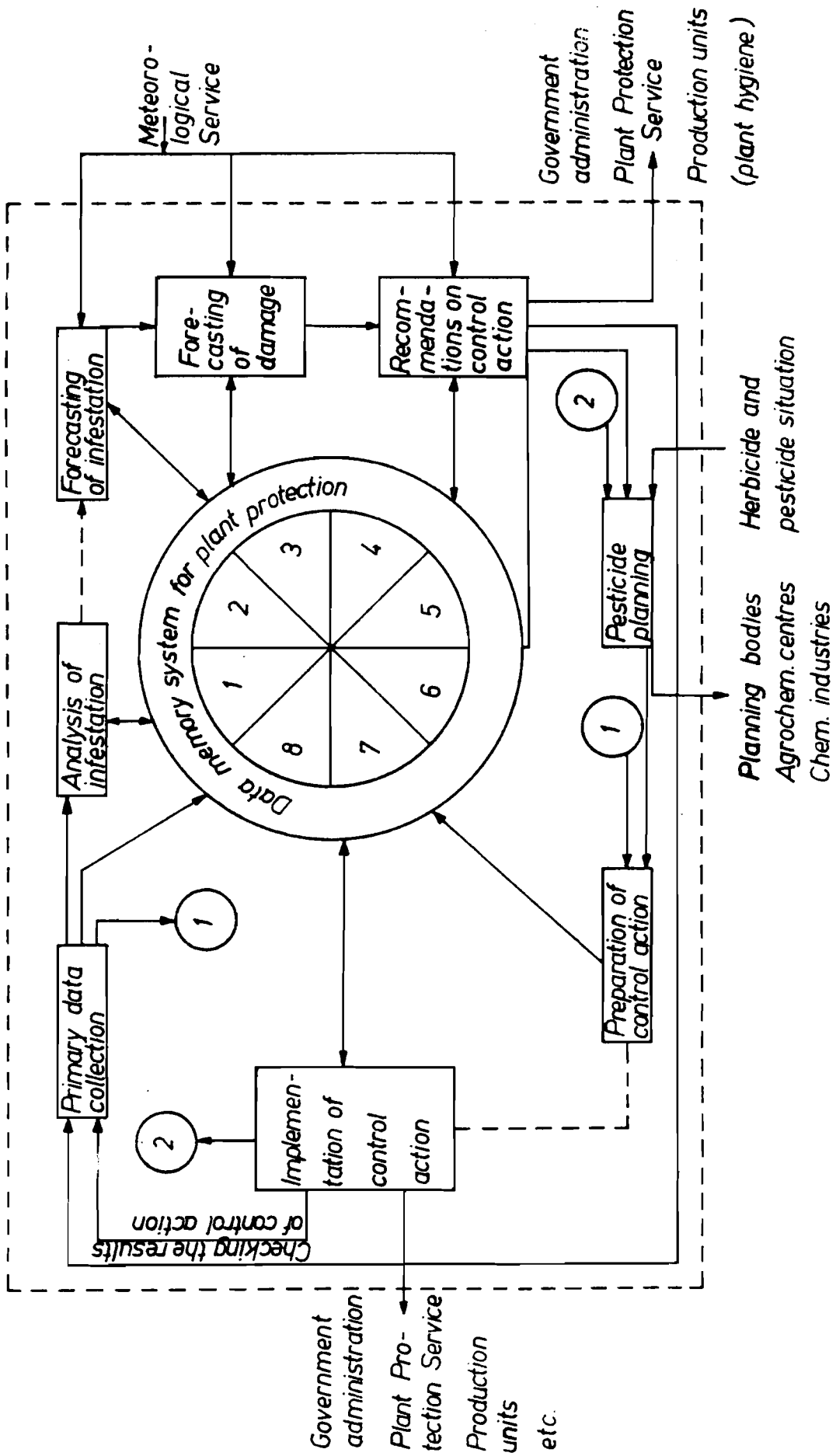

Fig. 1. Master model of an operational information system for plant protection

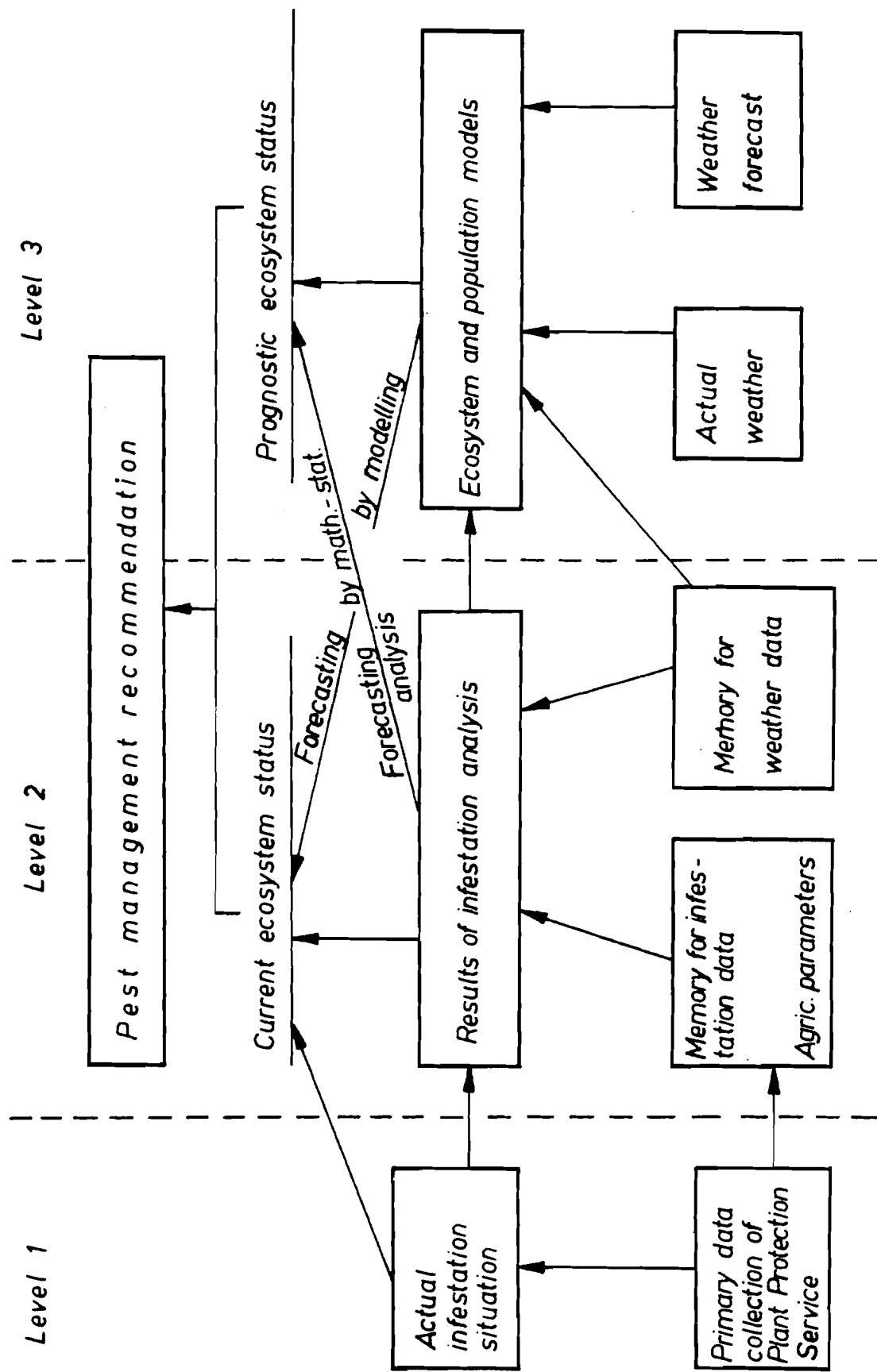

Fig. 2. Phases and levels of the monitoring and forecasting system for plant protection in the GDR

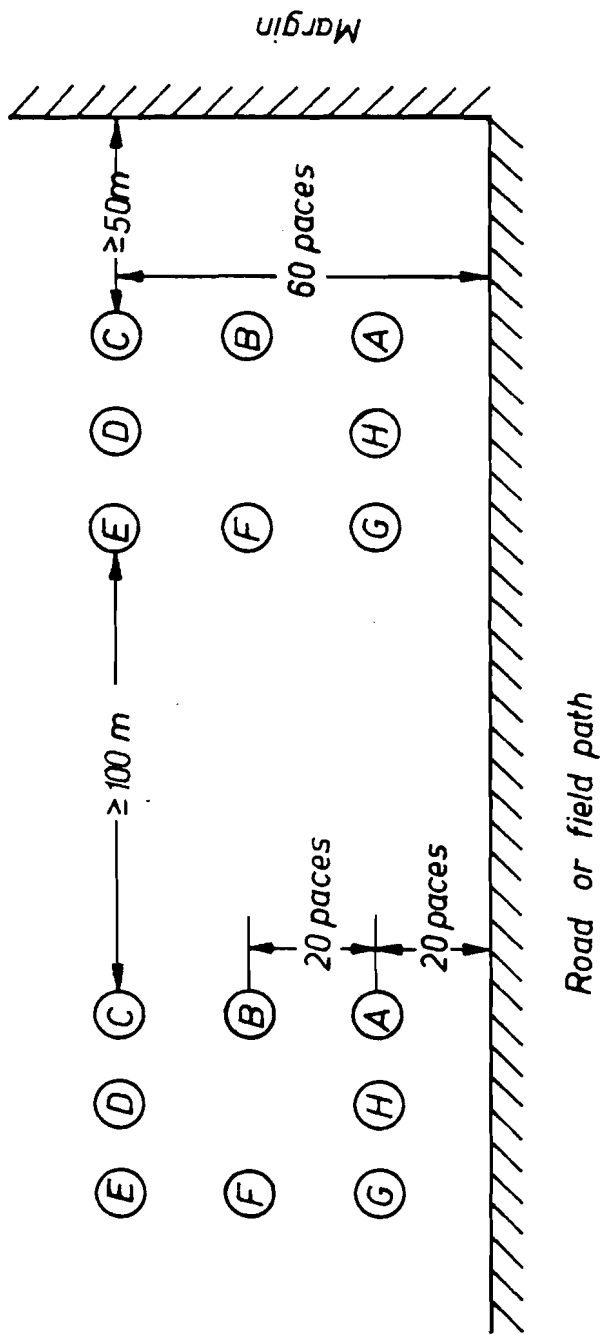

Fig. 3. Master scheme for recording pathogenic organisms on the control units within the frame of regional monitoring (area sampling method)

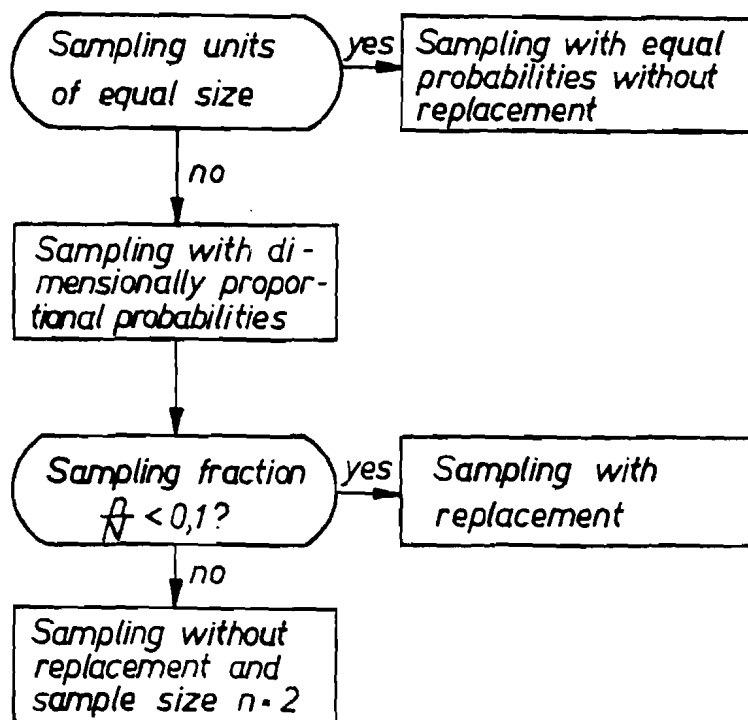

Fig. 4 Logical scheme for deciding the sampling method for each phase of a multi-phase sampling method

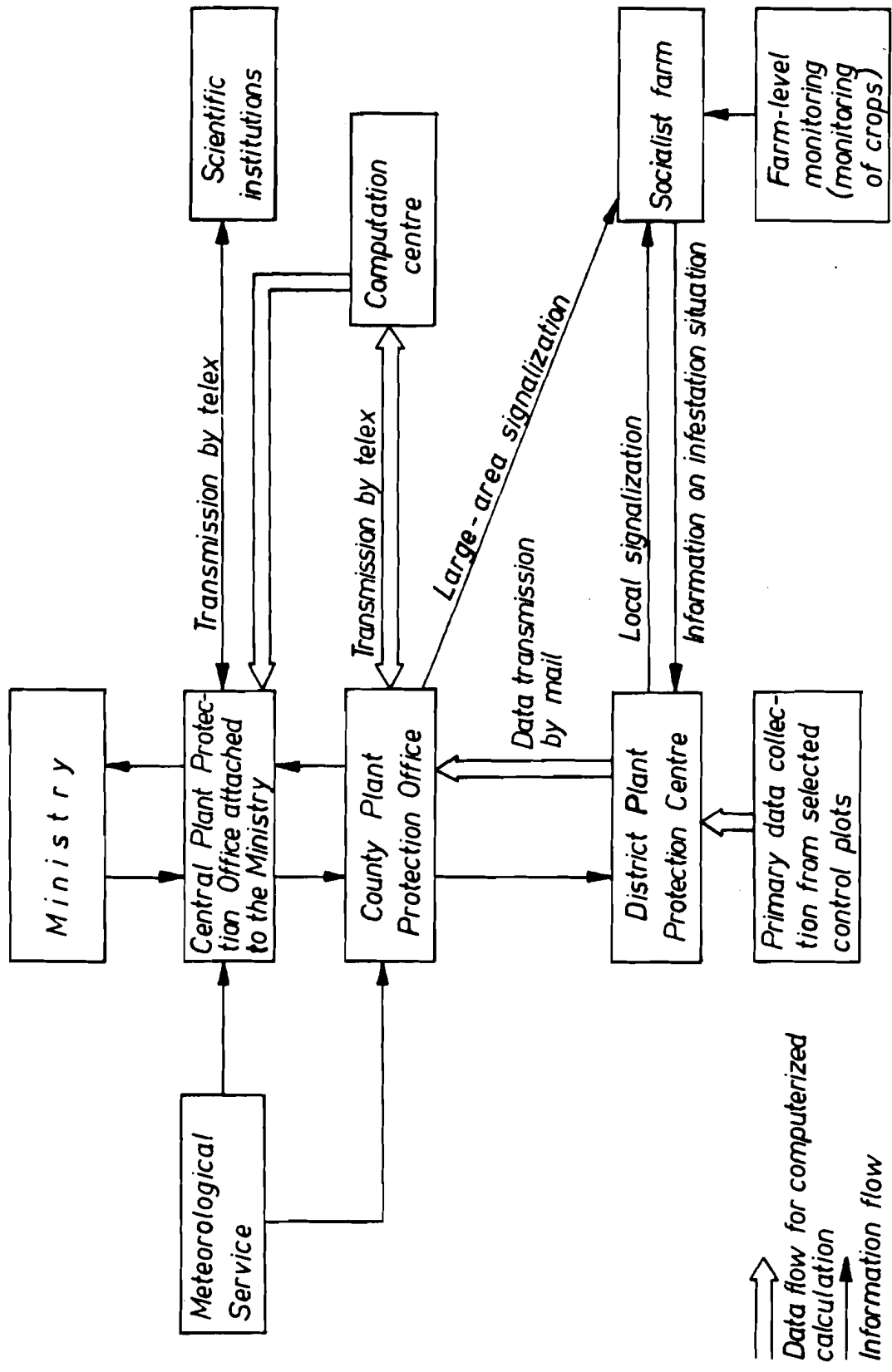

Fig. 6. General organizational setup of the computer-based monitoring system in the GDR

Abiotic and biotic outside environment

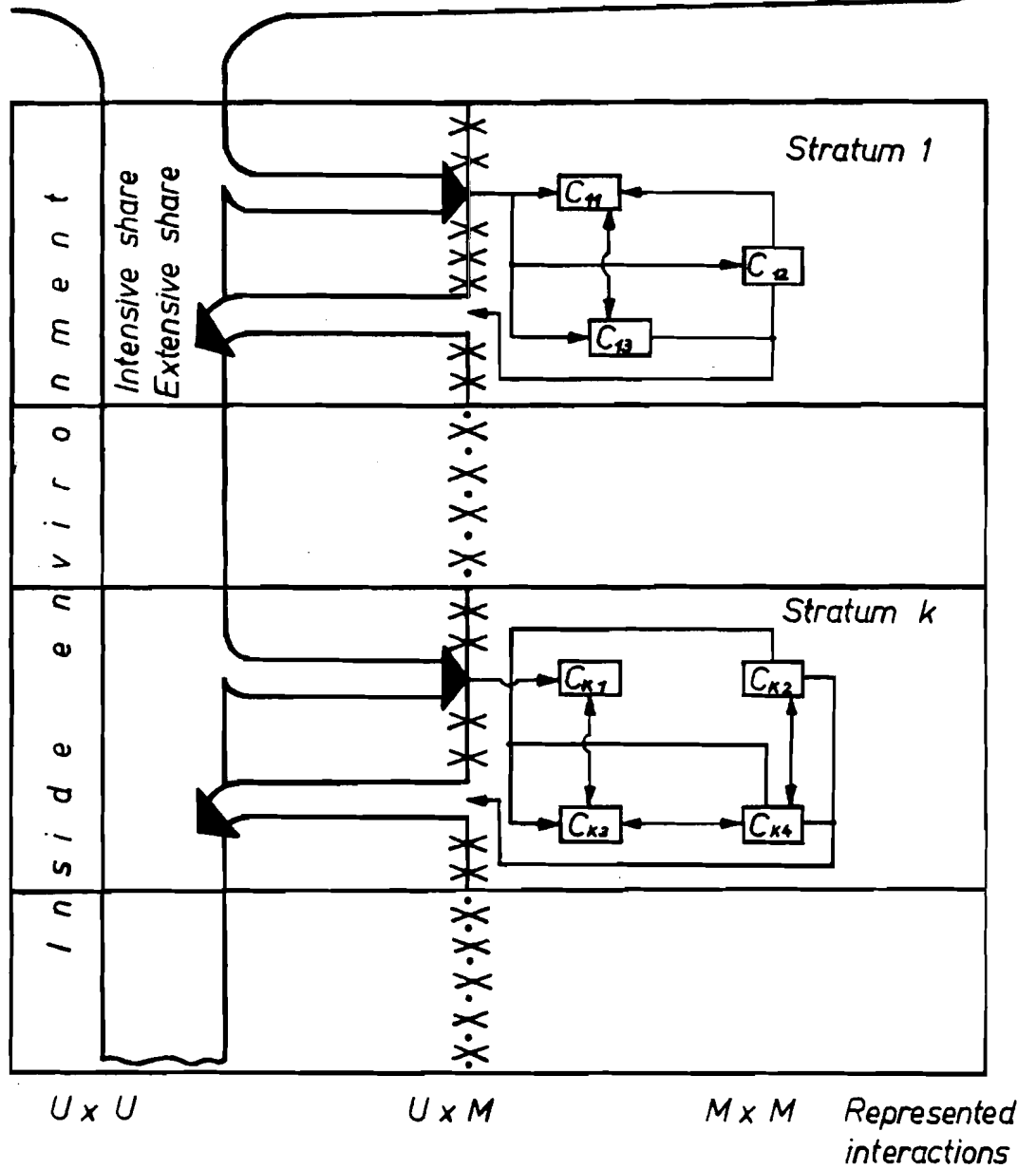

Fig. 7. Model structure of a general agro-ecosystem

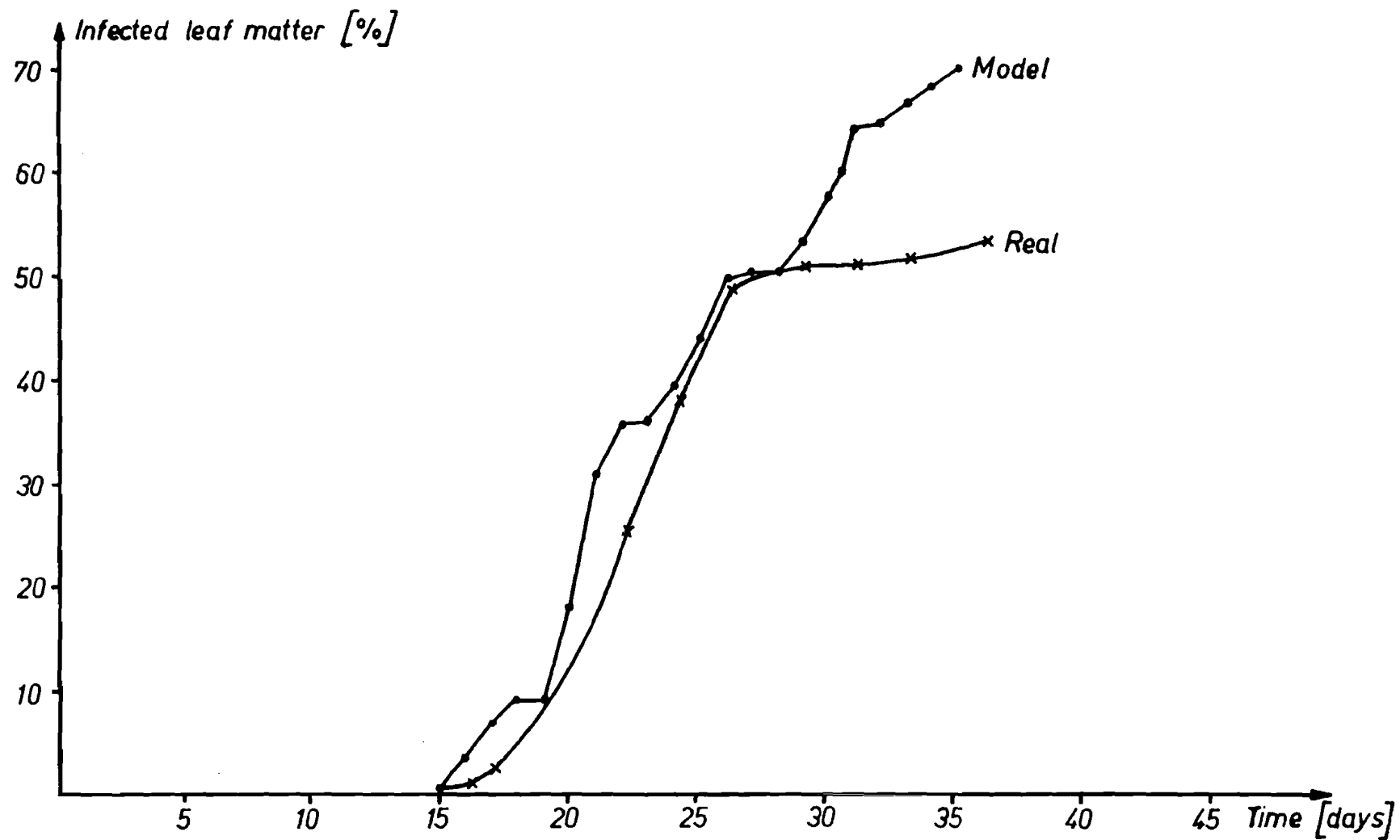

Fig. 8. Comparison of the epidemic course of *Phytophthora infestans* on potato obtained when using the SIMPHYT simulation model (epidemic model), and the results from field observation in 1962

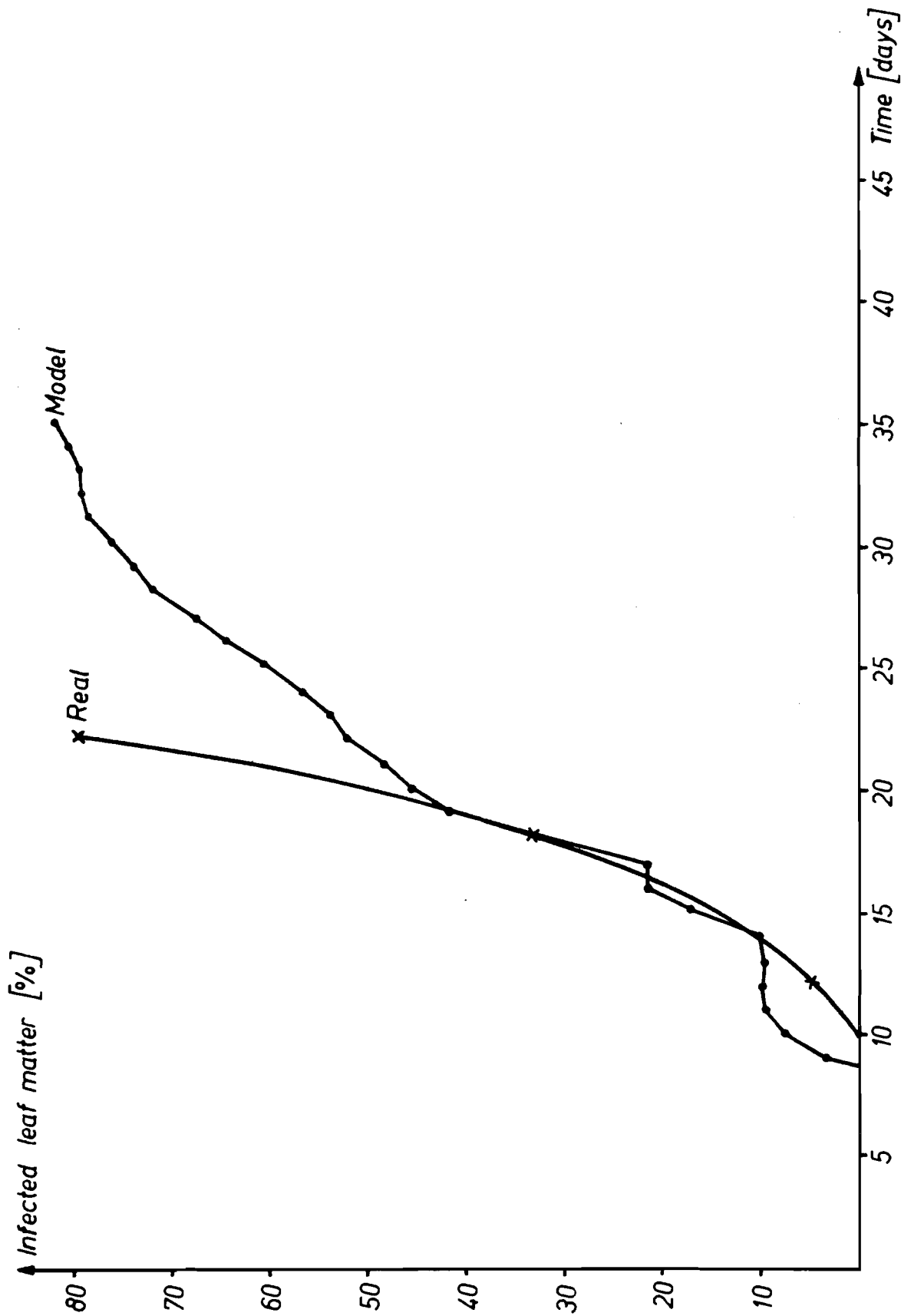

Fig. 9. Comparison of the epidemic course of *Phytophthora infestans* on potato obtained when using the SIMPHYT simulation model (epidemic model), and the results from field observation in 1966

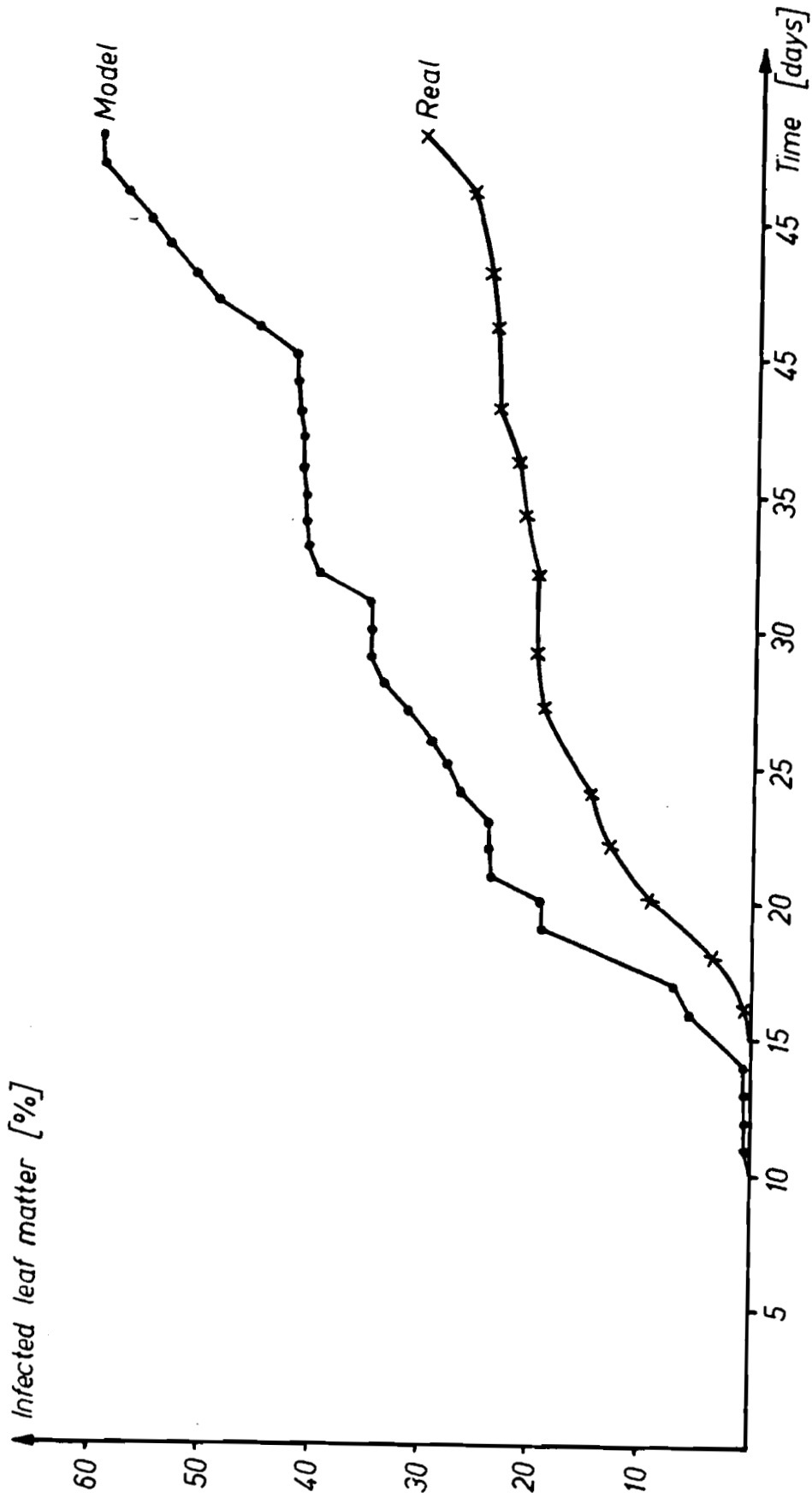

Fig. 10. Comparison of the epidemic course of *Phytophthora infestans* on potato obtained when using the SIMPHYT simulation model (epidemic model), and the results from field observation in 1961

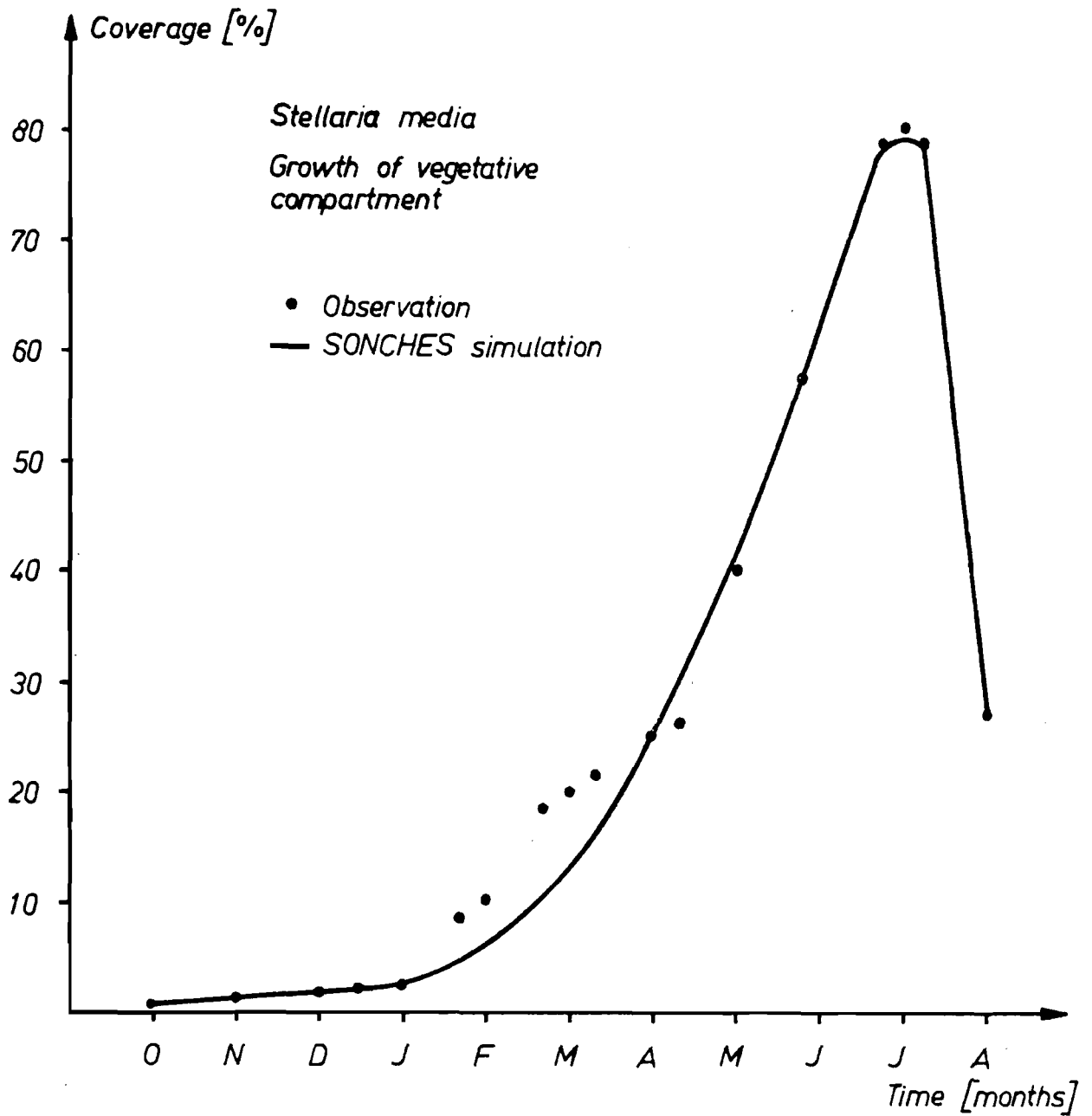

Fig. 11. Comparison of the growth of the vegetative compartment of the weed plant *Stellaria media* obtained when using the SONCHES simulation model (growth model), and the results from field observation in 1974/75

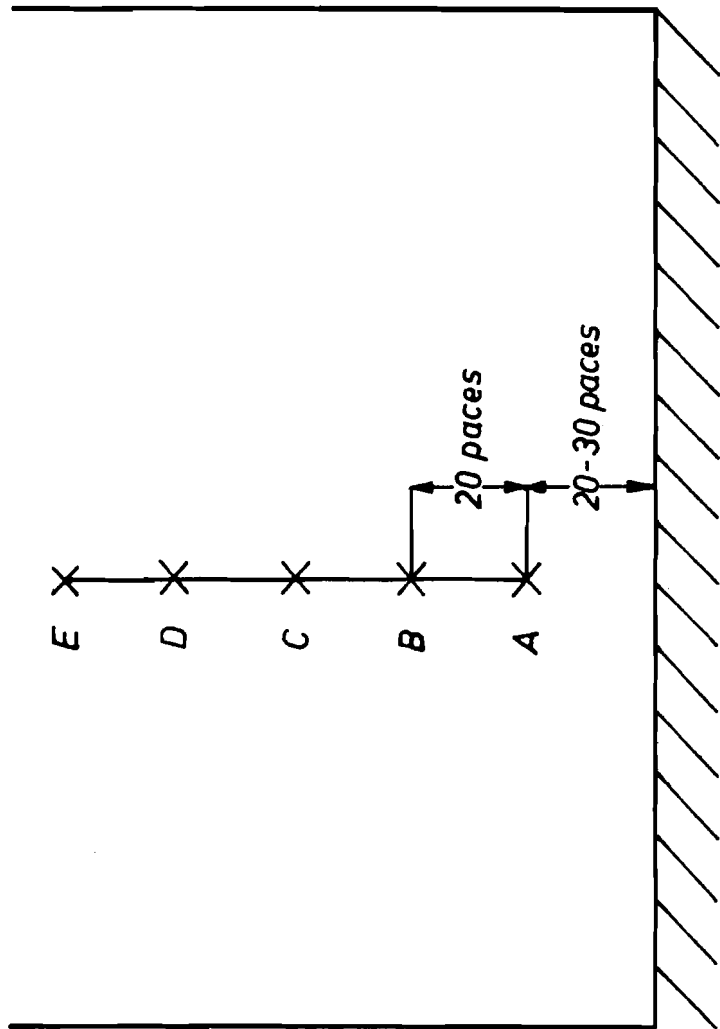

Fig. 12. Master scheme (line assessment) for recording pathogenic organisms within the frame of monitoring at field level

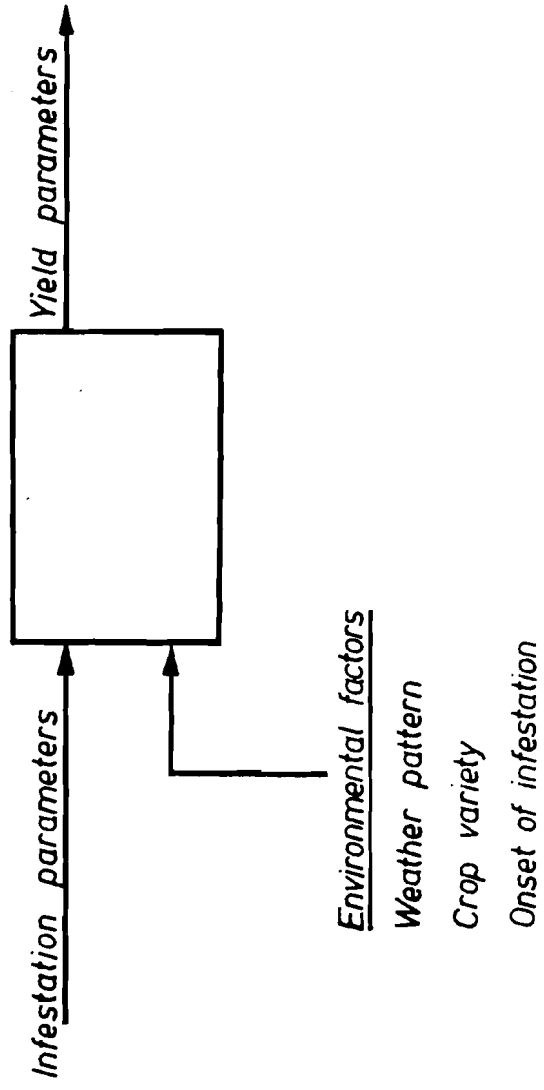

Fig. 13. Heuristic master model for the infestation- damage relation

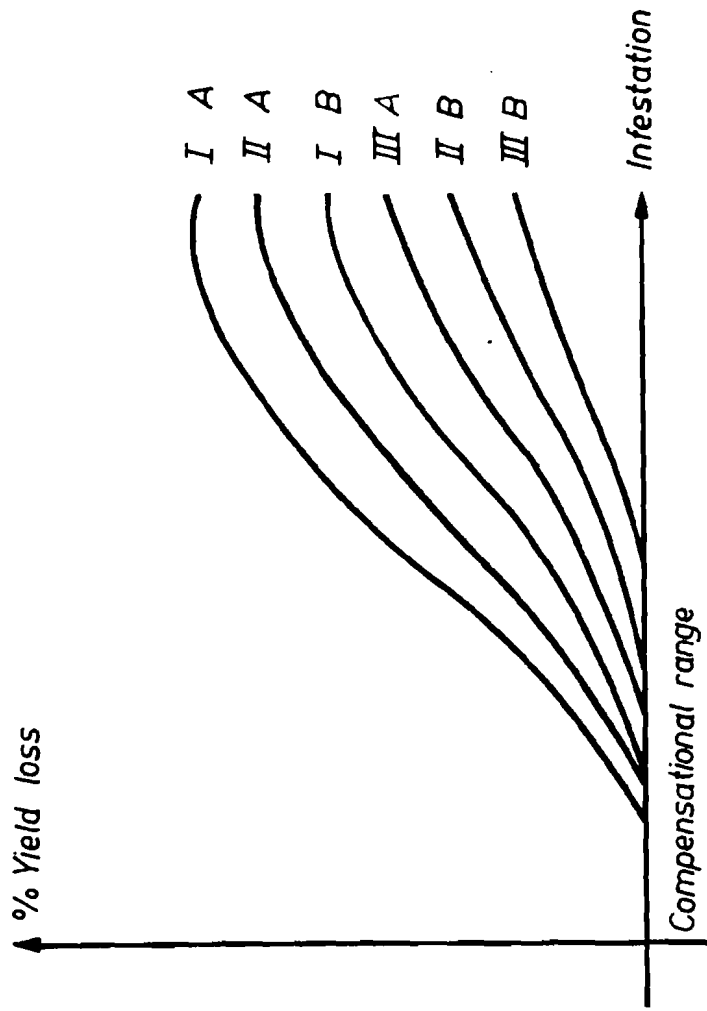

Fig. 14. Schematic representation of hypothetical infestation-
-loss relations under different environmental conditions

Table 1. Selection method for monitoring pathogenic organisms within one stratum

Selection phase	Phase 1	Phase 2	Phase 3	Phase 4	Phase 5
Name of phase	Farm	Plot	Control area	Control point	Observation unit (single plant)
All the selection units of equal size ?	No	No	Yes	Yes	Yes
Selection units natural or artificial?	Natural	Natural	Artificial	Artificial	Natural or Artificial
Number of selection units per stratum	At least 2 per stratum and 30-40 plots per County		2	Max. 8	Max. 5
Selection method	Dimensionally proportional with setting aside		Replacement method for simple random sampling with- out setting aside	System. selection	Cluster sampling from control points

Table 2. Analysis for monitoring of pathogenic populations

Level	Kind of analysis
Observation unit	Recording of infestation and, if applicable, of infestation intensity (assessment levels for plant diseases, number of specimens for insects, coverage for weeds)
Control area	Percentage of infested plants and percentage of plants within the individual infestation levels, mean value per observation unit. Putting the control area in one of four infestation classes.
Control plot	Analysis per observation unit as above. number of control areas in the four infestation classes. Classifying the control plot as controlled or uncontrolled.
Stratum	Analysis per observation unit and control plot as above. Number of controlled plots.
Sub-territory/County	Analysis per observation unit as above. Percentage of control areas in the four infestation classes and percentage of controlled plots, and conversion in area estimates for the entire cropping area
Whole territory of the GDR or sub-territories including several Counties	Analysis as above. In addition, separate analysis acc. to specific classification characteristics of the control plot (e.g. variety, preceding crop, fertilization, etc.)