



Nuclear Energy and its Alternatives

**Häfele, W., Avenhaus, R., Sassin, W. and
Weingart, J.M.**

**IIASA Research Memorandum
December 1975**



Häfele, W., Avenhaus, R., Sassin, W. and Weingart, J.M. (1975) Nuclear Energy and its Alternatives. IIASA Research Memorandum. Copyright © December 1975 by the author(s). <http://pure.iiasa.ac.at/443/> All rights reserved. Permission to make digital or hard copies of all or part of this work for personal or classroom use is granted without fee provided that copies are not made or distributed for profit or commercial advantage. All copies must bear this notice and the full citation on the first page. For other purposes, to republish, to post on servers or to redistribute to lists, permission must be sought by contacting repository@iiasa.ac.at

NUCLEAR ENERGY AND ITS ALTERNATIVES *

W. Häfele

with contributions by
R. Avenhaus, W. Sassin, and J. Weingart

December 1975

Research Memoranda are informal publications relating to ongoing or projected areas of research at IIASA. The views expressed are those of the author, and do not necessarily reflect those of IIASA.

* Survey paper presented at the 1975 Nuremberg Reactor Conference.

Abstract

Irrespective of the type of primary energy considered, every large-scale use of primary energy has its specific disadvantages. The problem is therefore to select and combine the various types of primary energy in a way that is optimal in terms of economics and has acceptable side effects. In the medium term, coal is the only real alternative to nuclear energy, and in fact is its partner rather than a competitor. The large-scale use of solar energy opens up supra-regional perspectives such as the demand for land and the storage and transportation of energy. Secondary energy becomes a more important factor and hydrogen seems to be a better partner for solar energy than is electricity. The timely build-up of a modern secondary energy system is of importance for the longer-term energy supply requirements.



I. Introduction

One decisive motive for the peaceful use of nuclear energy ushered in by the first Geneva Conference in 1955 was technological and industrial innovation. Particularly for the Federal Republic of Germany it was of fundamental importance that the consequences of the lost war be overcome; a highly industrialized nation could not afford to lag behind in development in an industrially critical field. No doubt there were other motives, and questions of energy supply as such were certainly under consideration at a rather early stage; but innovation was the primary concern.

For some years now the situation has been fundamentally different. Technological innovation was achieved by the development of nuclear energy for peaceful purposes, and efforts in the F.R.G. were successful. Meanwhile the question of an adequate and guaranteed energy supply has come to the forefront, and at least since autumn 1973 the energy problem is of concern to everyone. The experts in the field of nuclear technology must realize that the primary motives for the use of nuclear energy have changed. The energy problem as a whole now sets the goals for nuclear technology. This has also influenced the questions raised in connection with nuclear energy, since it is now being introduced on an economically significant scale. One of these questions concerns possible alternatives.

II. Energy Resources and Consumption

An insight into the entire range of energy problems is gained by considering the available fossil energy resources in a general way. Table 1 shows the fossil resources for some parts of the world and for the entire world [1]. It is striking to see how big coal resources are as compared to oil, and how unevenly both are distributed. The table also shows that the energy content of coal resources in the F.R.G. by far exceeds that of the Middle East oil resources. In this context it should be noted that data on fossil resources are a problem requiring a special methodology. Without going into methodological questions here, we want to stress that data such as those given in Table 1 should be understood as a quantitative description of a qualitative situation.

Table 1. Fossil energy resources.

	F.R.G.	Western Europe	Middle East	U.S.A.	World
Coal and Lignite (10 ⁹ t.c.e.)*	258	422	--	2459	9294
Oil and Gas (10 ⁹ t.c.e.)*	0.43	15	160	50	400? (possibly more)

* 1 t.c.e. $\hat{=}$ 2.73×10^{10} Wattsec

Table 2 gives the number of years each of these resources would last if it alone were used to meet a demand of 10 kW/capita¹ of the 1974 population in the regions considered. These figures of course merely, reflect the resource situation in a different way. But it may be useful to realize that with a world population of four billion in 1974 and a demand of 10 kW/capita, oil resources alone would last only for 8.8 years. This illustrates the importance of coal resources, which would last

Table 2. Ratio of resources and total consumption.[†]

	F.R.G.	Western Europe	U.S.A.	World
Coal and Lignite (years)	385	120	1105	204
Oil and Gas (years)	0.9	4.2	22	8.8

[†] 10 kW thermal equivalent per capita for the population of 1974

¹ Here and in the following energy figures given in kW/capita are to be understood as $\frac{\text{kW years}}{\text{capita} \cdot \text{year}}$

for only fifty years, with a world population of ten billion, the expected figure in 2000. As mentioned before, the figures in Table 2 are meant to give an impression of the time scale.

In the long run we will not have to rely on fossil fuels; there is more than one option for a practically unlimited energy supply. Table 3 shows four options for "unlimited" supply that seem feasible today. Of these, only the utilization of nuclear fission is technologically fully developed. We know least about the use of geothermal energy.

Table 3. Options for "unlimited" energy supply.

(1Q \equiv 10^{18} BTU)	Resources	Technological Maturity	Side Effects
Coal	200Q	Mature at present scale To be developed for large scale	Unfavorable working conditions Land requirements CO ₂ and other pollutions
Fission (Breeder)	$\approx 5 \cdot 10^6 Q$	Sufficient for power plants Not yet sufficient for large scale fuel cycle	Storage of fission products Emission of radio nuclides
Solar	∞	To be developed for large scale	Land requirements Materials requirements Climatic disturbance? Storage and transportation
Fusion (D - T)	$\approx 10 \cdot 10^6 Q$	To be developed	Storage of activated material Emission of radio nuclides
Geothermal	$5 \cdot 10^3 Q$ (?)	To be developed	Storage of waste? Emission of pollutants? Earthquakes?

In the following, large-scale utilization will be discussed, including the possibility of meeting the entire primary energy demand of the world by one option. At that rate effects that would be negligible in case of small-scale use become fundamental issues that are decisive for the choice of one option or the optimum combination of options. In the case of nuclear fission energy, there is much discussion today about final storage of radioactive waste. Such problems would occur in any option if it were utilized on a large scale: in the case of solar energy, the enormous land demand and related material demand. Here the systems analyst could contribute a great deal [2]. In the long run the most critical issue is not the question of resources for an adequate energy supply, but rather the restrictions introduced by the above-mentioned effects. In the short run, however, we are faced with the problem of energy supply stemming from resources, while other issues are not yet important. In a comparison of the short- and long-term energy situation, the transition period becomes highly interesting and decisive. The three obvious phases of the energy problem are shown below.

Phase	Characteristics	Period
Short term	Administration of fuel shortages. Preparation for the transition phase.	Now - 1985 (?)
Transition	Substitution of oil by coal, nuclear electricity.	1985 - 2050
Asymptotic	Based either on: fission, fusion solar, or geothermal Or on: coal	2000 Onwards

Seen in this perspective, it becomes clear that even long-term aspects are relevant today, because technological and institutional preparation for the transition period must begin now, and must be adjusted to the asymptotic phase.

The time scale for the transition from the short-term to the asymptotic phase of the energy problem is determined largely by energy consumption. Measures to save energy prolong the time scale; that is, we gain time. Since we have dealt with the question of energy resources in a worldwide context, energy consumption has to be regarded in the same way. In Figure 1 the number of countries is given as a function of the per capita energy consumption for the year 1971 [3]. It shows the overwhelmingly large number of countries with a per capita consumption of less than 2 kW and the very small number of countries

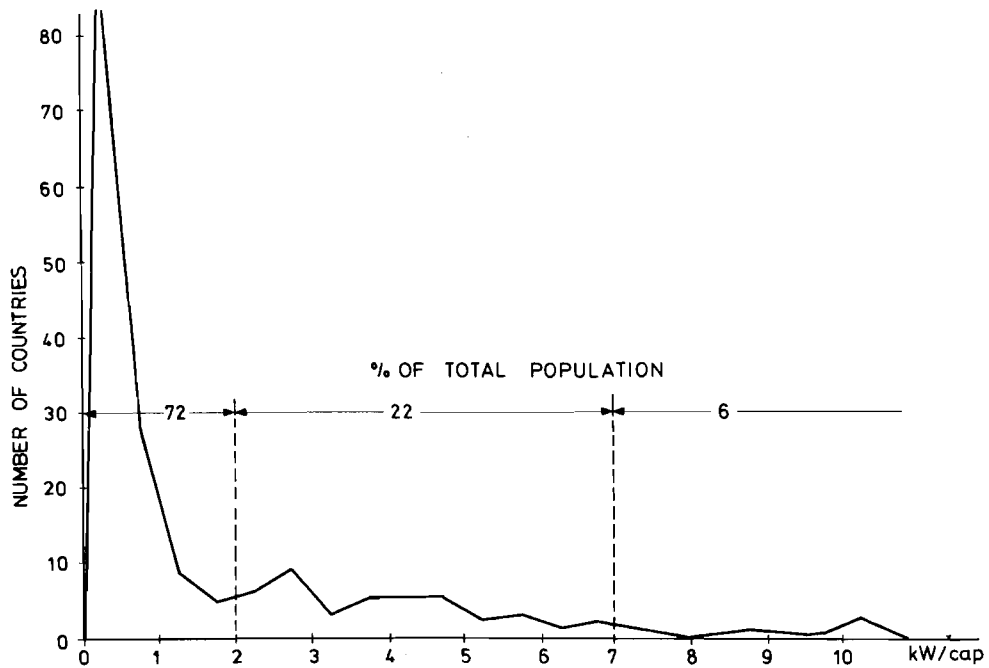

Figure 1. Distribution of per capita energy consumption in 1971.

with a high per capita consumption. The resulting political problem is recognized more clearly today. Table 4 shows roughly the distribution of demand. The sector "other" refers mainly to households and small consumers. The percentage of this

Table 4. Energy consumption for some groups of countries (annual).

Group	(kW years/cap)	Percentage of Sectors		
		Industry	Transport	Other
U.S.A.	$E > 7$	42	22	36
Europe, Japan	$2 < E < 7$	56	14	30
Developing Countries	$E < 2$	47	29	24

sector increases with rising per capita consumption and has to be taken into account in addition to the industrial sector.

A more detailed description of the relationship between primary energy and final consumption in the F.R.G. is given in Figure 2 [4]. Energy consumption in 1971 amounted to 350 million t.c.e.² Only about 27% of the primary energy demand is used for electricity generation, and in the case of consumption only 12%. As was mentioned, the sector "households and small consumers" is practically equal to the sector "industry". The large proportion of oil as shown in Figure 2 should be noted; it amounts to 55% of the primary energy demand.

When in the following chapters we deal with questions of nuclear energy and its alternatives, we want to go beyond the sub-sector electricity because this aspect alone would not suffice to solve the problem of an adequate and guaranteed energy supply. In the introduction we stated that in general an adequate and guaranteed energy supply is the framework for proper assessment. In practice the various types of primary energy will always exist side by side. It is thus advantageous to carry each individual type to its extreme.

III. Nuclear Energy on a Large Scale

One example of a reactor configuration that would, at least in principle, meet the entire primary energy demand is shown in Figure 3. If in the long run one wants to rule out de facto all limitations imposed by fuel resources, breeding is one way. Using the breeding product of a fast breeder to cover the U 233 net demand of a high-temperature gas-cooled reactor (HTGR), the latter can operate with thorium 232 alone. Of course the further growth of a reactor population of that type would then be severely restricted, unless--as in the transition phase--one again enriches cheap uranium and operates light water reactors, as is being done in the present development phase. Such a configuration can generate both electricity and process heat. Process heat can be used e.g. for thermochemical production of hydrogen as a secondary energy source. In a linear programming model of medium size, A. Manne and W. Häfele studied in detail the conditions for a transition from the present situation to supply by the above-mentioned reactor configuration [5]. It was assumed that the ratio between electric and non-electric energy demand is 1:1. According to the assumption used, the transition to the asymptotic state considered took about fifty years. One of the results of this analysis was that the restrictions imposed by the limited resources of cheap uranium are as serious as those imposed by limited oil resources; oil, coal and light water reactors are expressly required for the transition phase. It should be stressed again that the

² 1 t.c.e. $\hat{=}$ $2.73 \cdot 10^{10}$ Wattsec.

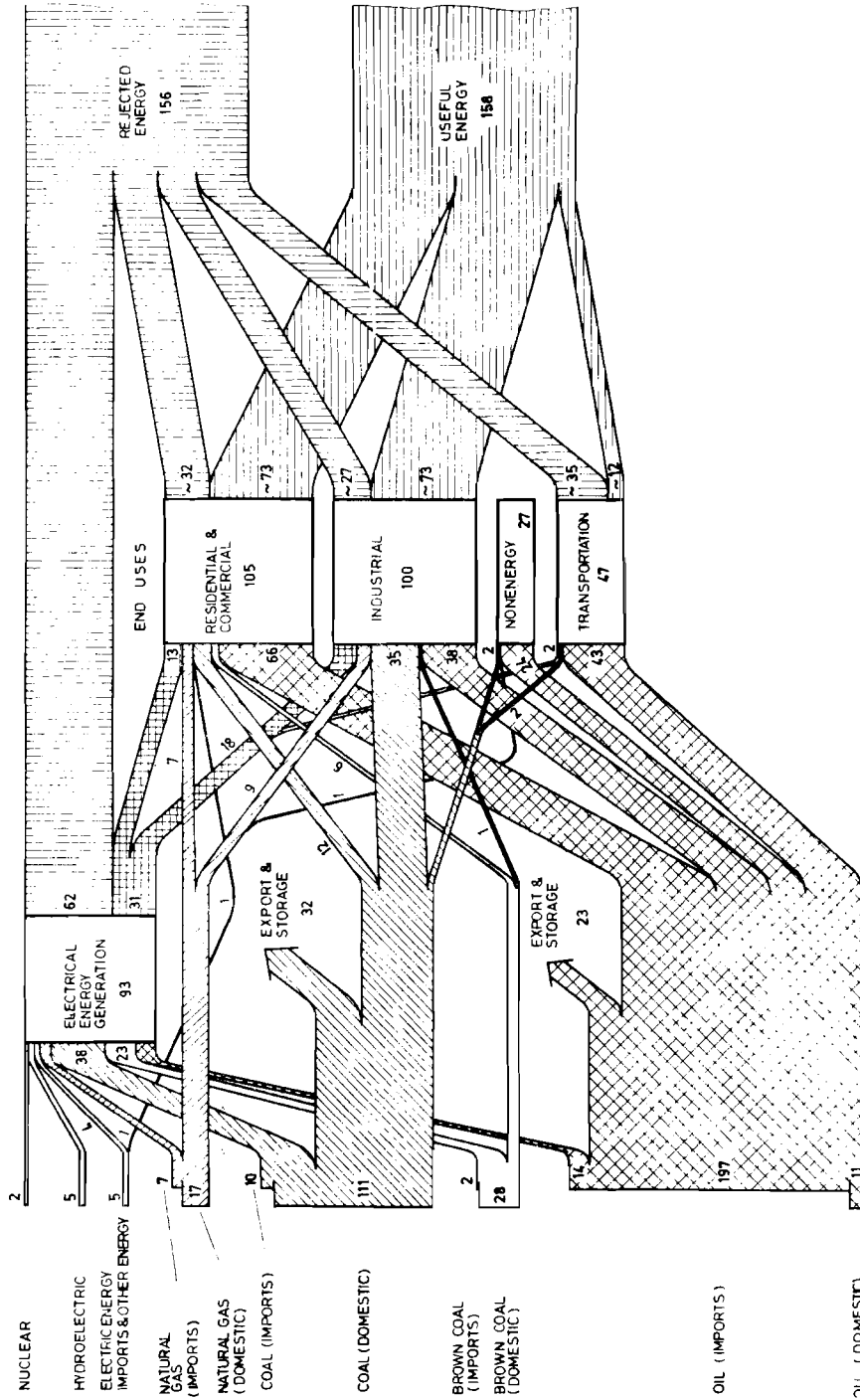

Figure 2. Total energy flow pattern, F.R.G. 1971 (in million t.c.e.).

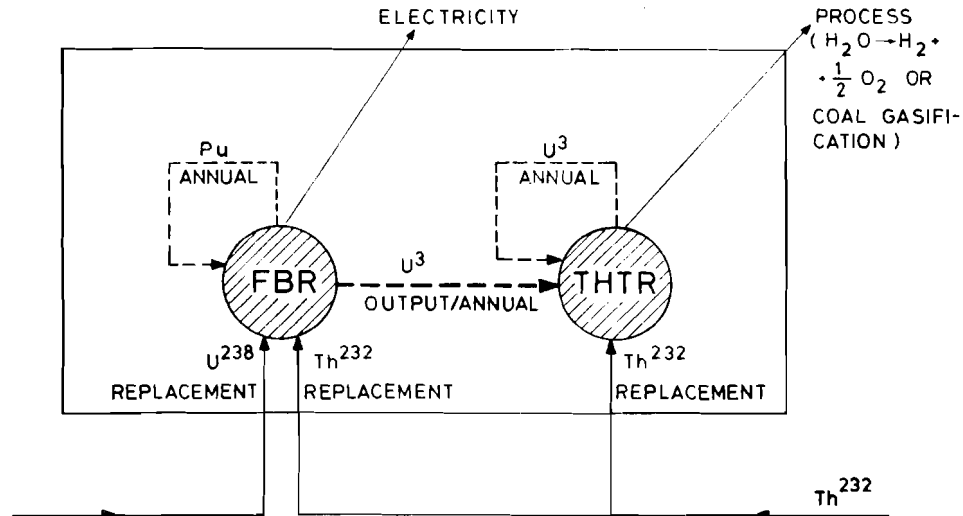

Figure 3. Asymptotic integrated reactor system.

reactor configuration discussed here is an example of energy supply based entirely on the utilization of nuclear fission energy. Naturally other configurations are possible.

In a scenario of 360 million people--corresponding to Western Europe--with a primary energy demand of 10 kW/capita, the following nuclear power facilities are required: 200 reactor sites with 18 GW_{th} each, about twenty fabrication plants, twenty reprocessing plants, 140 intermediate storage facilities, and ten final storage facilities. Of course these figures depend on the size of the plant involved, but according to the present state of the art they are representative. To obtain the figures that would apply to the F.R.G., one would have to use an appropriate fraction, i.e. one sixth.

According to a study by R. Avenhaus, W. Häfele, and P. McGrath [6], the fuel amounts shown in Figure 4 are processed in the fuel cycle of the scenario outlined here. A total of 1702 tons of nuclear material (U^{238} and thorium) is consumed annually. Only 1382 tons/year remain as fission products. (320 tons/year go into side processes--the formation of actinides, plant losses, and actual emissions into the ecosphere; see Figure 4.) For the breeder cycle and the breeder and HTGR cycle, the corresponding annual figures are 924 tons plutonium and 363 tons U^{233} respectively. All these figures characterize the problem arising at normal operation from nuclear power on a large scale. On this basis, the constraint factors and safety precautions can be evaluated that must accompany the installation of a

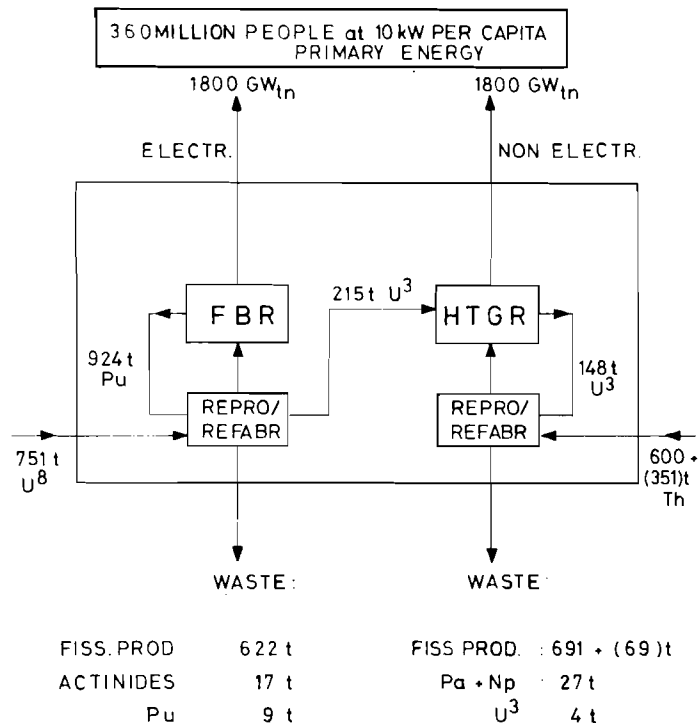

Figure 4. A fuel cycle for an all nuclear society (yearly throughputs).

nuclear fuel cycle. Nuclear technology has to face these challenges openly. In public discussions on nuclear energy such issues come up again and again.

Before we turn to solar energy, just a few words on nuclear fusion, the second of the four options mentioned. Today realization of the D-T reaction can be expected with some confidence [7]. When the Lawson criterion is met, a net energy gain is possible. Here primarily the 14 MeV neutrons carry the energy released. In the presence of 14 MeV neutrons activations and radiation damage are inevitable. In view of the diversified nature of the activation patterns, which have to take into account not only (n,γ) but also (n,α), (n,2n), (n,p) and other nuclear processes that may be pronounced with 14 MeV, activations comparable to the radioactivity of fission products may well occur. This is true e.g. for niobium, which was being considered as a structural material some years ago [8].

Today stainless steel and vanadium are considered as structural materials for fusion reactors. Consequently, the total activity released in a fusion reactor cycle may be lower by a factor of 30 to 100 than that of nuclear fission reactors. Qualitatively, however, we are faced with the same critical questions on constraint factors and safety measures that were discussed for the utilization of nuclear fission energy. Here we want to refer to a study made by C. Starr and W. Häfele two years ago, comparing fast breeder reactors and fusion breeders, i.e., D-T reactors [9]. This comparison is currently being extended and improved. Since there is no reference model today of a technologically operational fusion reactor, we conclude this brief outline.

IV. Solar Energy

Nuclear energy is a highly concentrated form of energy. As is well known, 1g or a fraction of 1 cm³ of fissile material produces 1MW of energy. In contrast, solar energy comes to us in a dilute, non-stable and diffuse form. Figure 5 shows the solar power flows of the atmosphere. The figures given are average values comprising all ranges, including day and night. Of the 340 W/m² which enter per m² of the earth's surface, approximately 160 W/m² reach the surface. This provides at least a rough idea of the average solar power density. One should also keep in mind that approximately 75 W/m² are used for the rain-evaporation cycle.

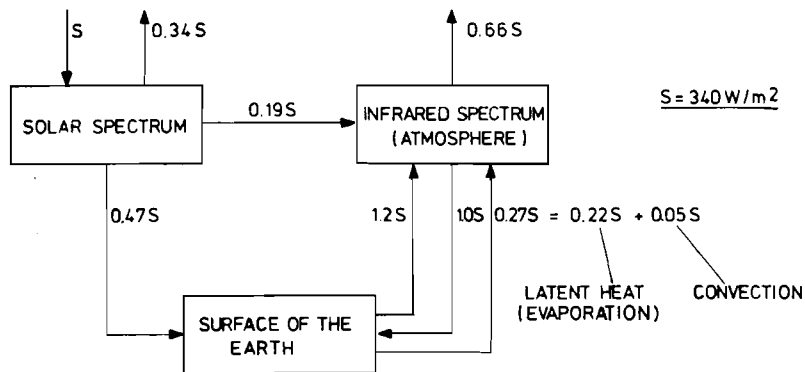

Figure 5. Solar power flows.

Some basic questions of importance for evaluating the solar option are listed below.

- What technologies are potentially available
- Timetable for development, commercial use
- Expected costs, capital and operating
- What are the impacts of large-scale construction and operation of such systems:
 - Environmental
 - Land use
 - Water use
 - Regional and global climatic
 - Air and water pollution
 - Materials
 - Energy

Technology, timing, and costs are obviously among them. Less obvious are the side effects on the environment. Land and water demand, micro- and macro-climatic effects, and the impact on air and water connected with the clearing of large land areas have to be considered. Structural materials and energy required for building large solar power plants must also be taken into account. Many such aspects are not significant if solar energy is utilized on a small scale. As in the case of nuclear energy, such effects become important only with large-scale application, but then can become crucial.

Before going into details on the utilization of solar energy, some basic data on the subject is presented. The global solar radiation in Vienna and in Phoenix, Arizona, according to Lof et al. [10], is shown below (in kWh/m² - day).

<u>City</u>	<u>January</u>	<u>April</u>	<u>July</u>	<u>October</u>	<u>Annual</u>
Vienna (Austria)	0.8	3.9	5.3	1.9	2.96
Phoenix, Arizona (U.S.A.)	3.5	7.5	7.6	5.3	6.05

The annual average in Vienna is 3 kWh/m² · day: in Phoenix it is twice as much. Apart from the difference in annual averages, there are also deviations from this average. In Vienna the ratio of maximum to minimum is approximately seven, while for Phoenix it is approximately two. These figures give an indication of the crucial importance of energy storage for the utilization of solar energy. The land required to supply 1 GWe average power

is given below.

<u>System Efficiency</u>	<u>Insolation (kWh/m² - day)</u>			
	3	4	5	
0.1	80	60	48	km ²
0.2	40	30	24	km ²

With a systems efficiency of 0.1 the land area required to generate 1 GWe with average insolation of 3 kWh m² - day is eighty km². This figure is very high. The question now arises whether such contiguous areas can be provided; for the F.R.G. the answer is a clear no.

Figure 6 shows the area of land that would be required

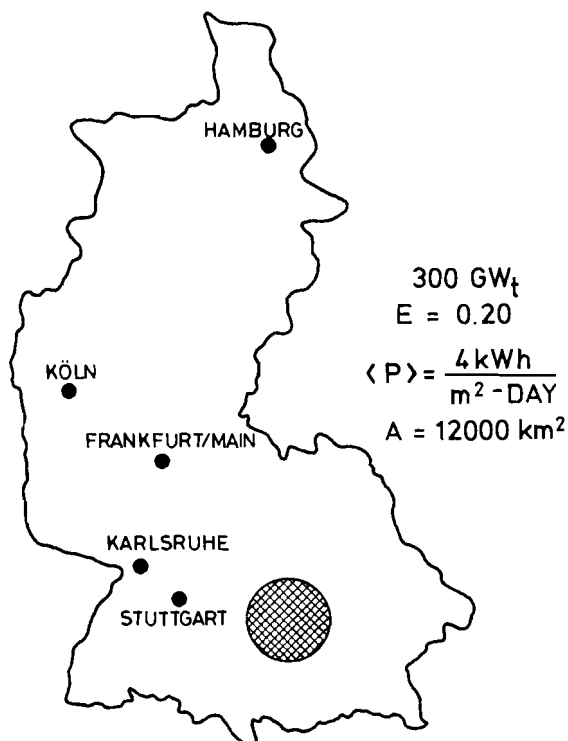

Figure 6. Land demand: solar energy.

for the utilization of solar energy if 300 million t.c.e. were to be provided; this figure corresponds to 85% of the energy consumed in the F.R.G. in 1970. It is clearly impossible to supply solar converted energy on this scale in the F.R.G. This would be true even if a limited number of smaller areas were used. If one were to rely entirely on solar energy in the F.R.G., the secondary energy gained from solar energy would have to be transported over long distances. Thus not only energy storage but also energy transport become crucial aspects of the large-scale utilization of solar energy. If a number of smaller solar energy converters and their storage systems are integrated, power conditioning also becomes a major factor. It is not enough to consider only the energy converter.

All this demonstrates that electricity is not necessarily the secondary energy form best suited for large-scale conversion of solar energy. The situation is different in the case of mechanical energy. In Austria a large part of the electricity is generated by means of hydroelectric facilities. This opens up some possible bulk-storage solutions. Another approach is storing energy in chemical form. Hydrogen as a secondary energy source seems to offer especially good prospects for storage and transport; it may be the secondary energy form most suitable for solar energy. (More on this topic will be discussed later.) These reflections apply only to the utilization of solar energy on a large scale. In view of the abundance of schemes for the utilization of solar energy now being discussed, it may be helpful to look more closely at four of them.

Solar house, 3-10 kW
Tower concept, 100 MWe
Photovoltaic, many small sites
Ocean thermal gradient; 10 GWe ?

These four greatly differing schemes provide the frame within which the use of solar energy must be examined. They are briefly outlined here.

The least spectacular but perhaps most important scheme at our latitude is the solar house. The basic idea is to make use of the roof of a house. Figure 7 shows how photovoltaic and thermal panels are arranged. In line with our earlier reflections on energy storage, a thermal storage unit and a battery must be provided. The fact that the solar house still needs backup power connections necessitates power conditioning. Energy transport is hardly relevant for the solar house. The entire scheme is usually restricted de facto to a range of 3-10 kW.

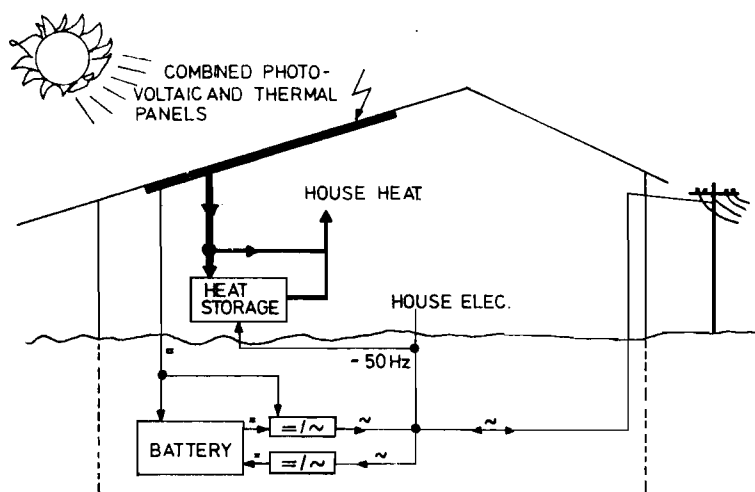

Figure 7. Solar house (simplified diagram).

Figure 8 shows the central receiver concept (tower scheme); this is an electric station scheme. A surface fitted with adjustable mirrors collects solar energy and focuses one direct component of solar energy on a steam boiler mounted on top of the tower. This scheme is thus not suitable when the sky is clouded. Assuming a tower height of approximately 200-300 m, the expected output of such a power plant could be in the range of 100 MWe. For assessing the land demand, the type of operation envisaged is decisive. Twelve hours storage requires three times as much space as short-term operation that merely supplements a fossil or nuclear power plant. In the first case, three modules are required; in the second case, only one. If we want twelve hours storage and want to replace a base-loaded nuclear power station of 1 GWe, thirty modules of 1.3 km² each are necessary, i.e. approximately forty km². This figure applies to the Southwestern U.S.A.; at our latitude it would be closer to eighty km², with the additional problem of long-term (seasonal) storage. (See comments on the storability of hydrogen.)

Figure 9 shows the chain of losses as they occur in the tower scheme. If direct solar radiation incident on the total mirror surface is taken as 100%, we must deduct geometrical losses through shadowing and the angle of incidence, decreasing the percentage from 100 to seventy. Reflection losses further reduce the figure to sixty-two, absorption losses to fifty-six,

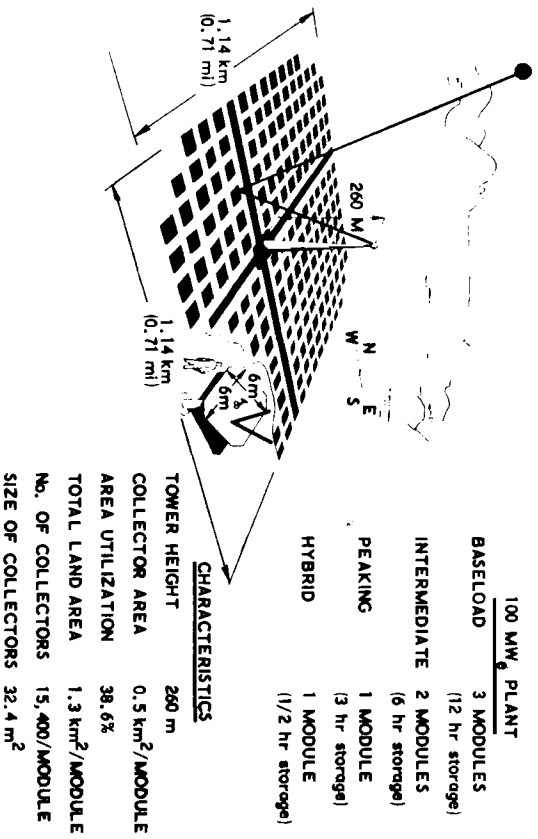

Figure 8. Solar thermal conversion: central receiver concept.

Source: Aerospace Corporation

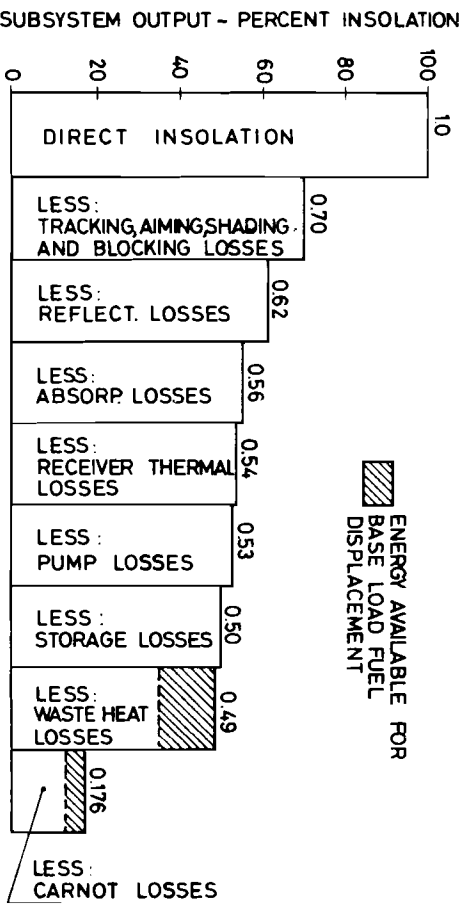

Figure 9. Central receiver system performance.

Source: Aerospace Corporation

thermal losses at the receiver to fifty-four, pumping losses to fifty-three, storage and thermal losses to forty-nine. With a normal turbine-generator thermodynamic efficiency of 0.34, we finally reach 17%. These figures apply to the clear sky environment typical of the Southwestern U.S.A.

The third scheme for solar energy utilization employs photo cells, i.e. uses the visible portion of the solar spectrum and does not depend on cloudless sky. Note also that, as photo cells do not require contiguous areas, small units of land can be used--an advantage that is of particular relevance for Central Europe. On the other hand the need arises to integrate the small power outputs of widespread areas. The scheme is a kind of agricultural approach to "harvesting" solar energy if uncropped land or wasteland is used. In the F.R.G. profits would be DM 30,000 per hectare and year for DM .03/kWh production costs, while current agricultural profits are DM 10,000 per hectare and year. Integration into an electricity or hydrogen network seems advantageous.

The fourth scheme involves the use of large, coherent areas of the open sea. It would be natural to make use of the temperature gradient of the upper layers of the sea; for studies on this topic see [11, 12]. Covering large parts of the sea with floating platforms should also be envisaged. Such utilization of solar energy is still far from feasible, both technologically and economically. More important than the technological details is the fact that this solution approaches geo-engineering, which by its nature goes far beyond national boundaries and planning and therefore demands a political and international situation different from the present one. Note that energy storage and transport again have a decisive function.

What about the costs of electricity produced by solar energy conversion? For an answer to that question we refer to studies by the Aerospace Corporation [13], which did a comparative rating of technological schemes.

Table 5 gives the computed costs for a solar power plant in Arizona (central receiver system). Depending on the mode of operation, costs range from \$ 1000/kWe to \$ 500/kWe.³ It should be recalled that at the latitude of Central Europe, the area of land and thus the number of mirrors associated with a specific

³The final costs are a function of the type and size of the on-site energy storage subsystem employed. Also, these costs per kWe are for a nameplate capacity (turbine-generator rating) of 50 to 100 MWe, with a solar utilization factor in Arizona of roughly 0.2 to 0.25 (maximum of six hours per day average over the year).

Table 5. Power plant cost estimates (Arizona)
central receiver concept (100MWe) [\$/kWe].

	Baseload	Intermediate	Peaking
Collector area (km ²)	1.5	1.0	0.5
Storage (h)	12	6	3
Land	3	2	1
Structures and Facilities	44	44	44
Heliostats	450	300	150
Central Receiver/Tower/Heat Exchanger	124	95	68
Storage/Tanks	180	90	45
Boiler Plant	-	-	-
Turbine Plant Equipment	80	80	80
Electric Plant Equipment	21	21	21
Miscellaneous Plant Equipment	4	4	4
Allowance for Cooling Towers	<u>20</u>	<u>20</u>	<u>20</u>
Total Direct Cost	926	656	433
Contingency Allowance	51	39	27
Spare Parts Allowance	5	3	2
Indirect Costs	<u>92</u>	<u>78</u>	<u>66</u>
Total Capital Investment (1973)	1074	776	528

Source: Aerospace Corporation

annual kWh generation requirement would be twice as high; accordingly the capitalized costs of the solar-derived electricity would be at least twice as high as in Arizona (or similar environments).

Table 6 compares some reference data of photo cells and the central receiver system in Arizona. In the case of Arizona the estimated costs for base-loaded⁴ operation are higher by a factor of three to five than for nuclear energy. At our latitude this factor is even greater.

V. Coal

Strictly speaking coal is not one of the four options mentioned which are de facto not limited by fuel resources. However, coal resources in some places are so large that the coal option must be seriously considered, at least for the F.R.G. Let

⁴The utilization factor drops to as low as 0.1 for regions of Central Europe.

Table 6. Some characteristics: photovoltaic cells and central receiver system.

	Tower	Photovoltaic
Efficiency	0.12	0.10-0.20
Module Size	100 MWe	0.3-3.0 kWe (mean)
Minimum Demand for Land	~1-3 km ²	~100 m ²
Optimistic Costs	25-30 million/kWe \$500-1200/kWe	30-50 million/kWe \$1-2000/kWe
First Demonstration Plant	~1985 (10 MWe)	~1980 (100 kWe)
Normal Operation	~1985-1990 ?	~1985 ?

Source: Aerospace Corporation

us look once again at world resources. Table 7 lists the coal resources of some countries. Most noticeable are those of the U.S.A., U.S.S.R. and China; compared to the coal resources of other countries the F.R.G. holds the top position. With a possible future primary energy consumption of 1000 million t.c.e. (today approximately 400 million t.c.e.), the F.R.G.'s resources would last for another 260 years. As member of the European Communities the F.R.G. has certain supply obligations within Europe, on account of which European demand can be met only for another 80 to 100 years.

In practice the mining output is considerably smaller. Table 8 shows the coal production in the F.R.G. In 1964 142 million t were produced, in 1972 only 102 million t. The number of those employed decreased from 399,000 to 221,000; the mining output increased from 2.6 t per person and shift to 4.0 t. The first revision ("Fortschreibung") of the Federal Government's energy program of 1974 (see Table 9) estimates for 1980 a mining capacity of ninety-four million t, the electricity production industry and the iron and steel industry being the main potential customers. For comparison, recall that in 1980 a primary energy consumption of more than 400 million t.c.e. is to be expected.

The relatively small and decreasing annual mining output in spite of the existing large resources is not mere coincidence. Coal mining is difficult and entails hard working conditions. Coal deposits in the F.R.G. are at great depths. Despite the large resources, the market share of coal has decreased.

Table 7. World coal resources (in 10^9 t.c.e.).

	Commercial	Total
F.R.G.	32.8	258.2
U.S.S.R.	83.8	4853.4
U.S.A.	173.98	2459
China	80	1000
Great Britain	3.88	163.68
Poland	16	53.17
C.S.S.R.	4.43	16.5
Canada	4.47	101.63
Columbia	0.1	4.9
Australia	16.43	155.14
Japan	0.98	7.88
India	9.28	81.96
South Africa	8.5	44.42
World	472.94	9293.81

Source: World Energy Conference 1974

Table 8. Coal production in the F.R.G.

	1964	1968	1972
Production (million t)	142	112	102
Employed (thousands)	399	264	221
Production performance per man and shift (t)	2.6	3.5	4.0

Source: Energy Program of the F.R.G., 1973

Table 9. Production and selling of coal
in the F.R.G. (in million t).

Production Capacity 1980	94
Possible Customers:	
Electricity	35
Iron and Steel Industry	25
Residential and Industry	11
Exports	18
Total	89

Source: First revision (Fortschreibung) of the
F.R.G. Energy Program, 1974.

Figure 10 shows the relative market shares F of primary energy in the F.R.G. It indicates the decreasing share of coal, the increasing share of oil up to a maximum, and the still increasing share of natural gas, as well as the projected share of nuclear energy. The graph also includes a share "additional coal", which is increasing greatly. This share was listed separately from traditional coal because it will have to be mined and used differently than in the past.

These interrelations become clearer when the partitioning and final consumption of secondary energy, shown in Figure 11, are considered. Since 1950 consumers have tended to switch from solid fuels, to liquid first and later to gaseous secondary energy. Obviously the reason for this is that liquid or gaseous fuels are easier to handle. The same applies to electricity as a secondary energy source, whose share is also increasing.

In the long term, approximately by the year 2000, it is to be expected that liquid secondary energy will be confined to the transport sector, that the share of electricity will make up 20% of the consumer market, and that gaseous secondary energy will take over the largest part of the secondary energy market. The share of hot water will probably be limited. Consequently, the share of "additional coal" indicated in Figure 10 will have to be produced by gasification of coal. Also liquefaction of coal appears possible. But the latter is expensive: an oil price of \$ 11/bl corresponds to a price of DM 20/Gcal. With energy prices of that order, coal gasification is under serious consideration; however, the main problem with this strategy would be the long-term guarantee of an energy price of DM 15-20/Gcal. This is a political and institutional

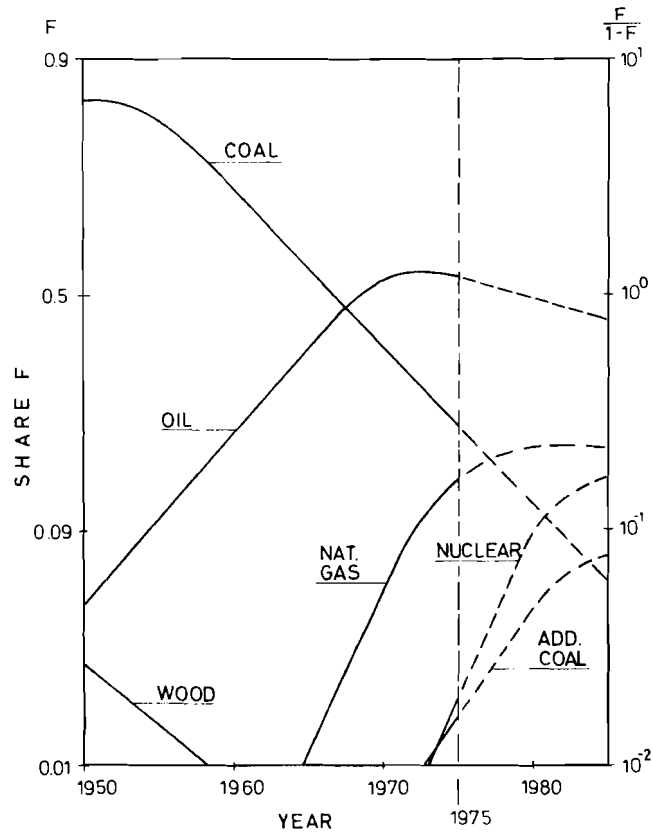

Figure 10. Past and intended energy shares in the F.R.G. (1975-1985 Energy Program of the F.R.G.).

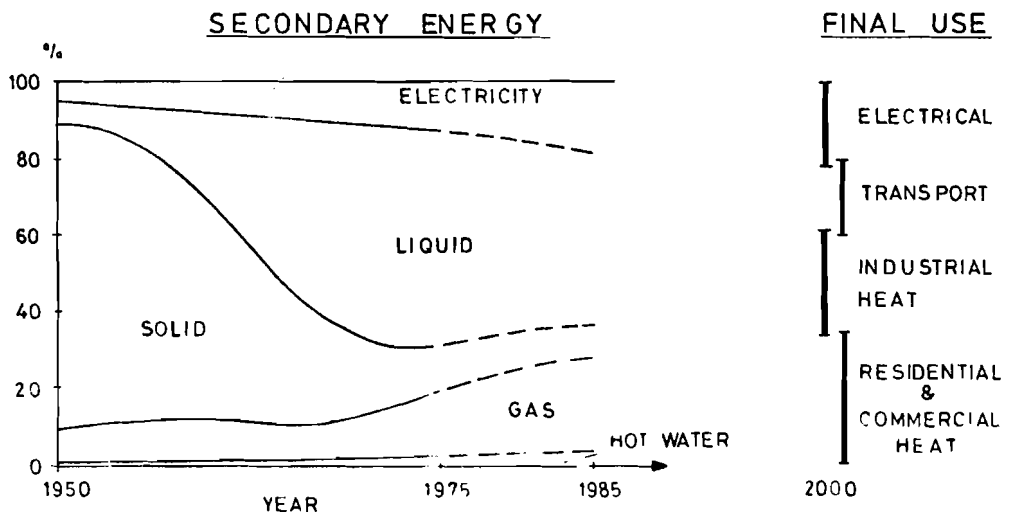

Figure 11. Partitioning and final use of secondary energy (F.R.G.).

problem. The "additional coal" program will not be implemented if energy price reduction by international politics may at any moment endanger investments in the coal sector. Furthermore we must face the fact that highly subsidized coal may turn out to be uneconomical in the long run. A new way to use coal leads to very complex economic questions not primarily of a technological nature.

These questions do not arise in connection with the utilization of nuclear energy, where production costs for thermal power are DM 9/Gcal. One should also remember that the price difference between coal energy and nuclear energy is considerably smaller than that between solar and nuclear energy.

The following critical questions come up when introducing "additional coal" on a large scale.

Guarantee of long term energy prices

Social requirements

- Prestige
- Salaries

Land requirement, damage to landscape

Environmental impacts of mining on the site

Accident and health risks

Global effects of burning coal

Mining technique

Transport of energy from coal

- As coal
- As secondary energy

Coupling to forms of secondary energy

Required

- Manpower
- Capital
- Energy

Timing

These questions must be seen in the light of our comments on the use of additional coal. If coal is to be an alternative to nuclear energy and not only a supplementary form, more than 350 million t must be produced. For Western Europe 1000 million t are required now and 2000-3000 million t later on; this means that we must reckon with a factor of eight to ten. Side effects then turn into decisive effects. One aspect in particular should be stressed: the global effects of burning coal. Even with complete removal of dust and desulfurization of coal, the CO₂ problem necessarily remains: the "greenhouse effect" which could lead to thermal pollution of the atmosphere. Much has been said on this topic recently [14]. An increase in CO₂ concentration involves a climate-risk problem that is

somewhat similar to risks of nuclear technology: it cannot be tested by the conventional trial and error method. Once impacts on the climate occur, they must be regarded as irreversible and very serious. Moreover, the time periods involved are longer than man's technological experience in this field. Evidently, there are parallel features with the nuclear-waste problem. In the case of nuclear technology these aspects have been considered; in the case of alternatives to the nuclear option, we must force ourselves to think along these lines: our experience in the utilization of coal (or another option) on a small scale has kept us from analysing the residual risks.

What would the rigorous reduction of the residual risk connected with the utilization of coal on a truly large scale imply? We offer a somewhat speculative but typical view: the combustion product CO_2 should not be released into the atmosphere but transported directly to the deep sea, where in the very long run CO_2 as carbonate is deposited in any case. One must bypass the long time constants of mass transport in the sea in various depths.

Marchetti [15] has proposed that a number of large coal parks be located in the Strait of Gibraltar, where, by burning coal, ammonia and hydrogen are produced, which do not cause a CO_2 problem when burnt. The Strait of Gibraltar offers the advantage of an ocean current flowing at small depth from the Atlantic Ocean into the Mediterranean, while at greater depth another current flows into the opposite direction and falls rapidly into the depths of the Atlantic. This deeper current could in principle rapidly transport large amounts of CO_2 into great depths, provided that CO_2 is released not into the atmosphere but directly into the sea. There are other similar precipitating ocean currents. Just as in the case of solar energy utilized on a truly large scale, here again one approaches the field of geo-engineering. It is not our intention to elaborate the Gibraltar proposal here in great detail. Rather, we want to define the criteria to be applied to the utilization of coal if it is to be regarded as an alternative to nuclear energy, and if, as was done for nuclear technology, the hypothetical residual risks are to be reduced. Instead of becoming an alternative, it is more likely that in the medium term coal will become a valuable partner for nuclear energy. If we examine the transition to that relationship, the utilization of coal involves less dramatic aspects; but some critical questions remain.

The guarantee of a long-term energy price was discussed earlier. An equally difficult problem is that of the social conditions of mine workers. The problem cannot be solved by wages alone. If coal is used on a large scale in the F.R.G., land demand and subsidence have to be very carefully studied as a systems problem. Environmental problems and mining

techniques are problems that are known as such. The transport of coal or its linkage with marketable secondary energy forms are predominantly a technological problem. Labor, capital, and energy demand for new mines and new mining techniques also create a problem. The serious question arises how much time is left to implement these basic changes.

Table 10 gives the time periods it took various primary energy sources to gain or lose 50% of a market [16]. These periods are all longer than fifty years. One should keep in mind that the world oil supply also seems to be guaranteed for only about fifty years. Traditionally this has been considered a long term; in reality little time remains to carry out the enormous technological-economic changes and adaptations that have become necessary.

Table 10. Penetration periods.

ΔT : Period for gaining or losing a market share of 50%.

	<u>Wood</u>	<u>Coal</u>	<u>Oil</u>	<u>Gas</u>
ΔT (years)	60	66	52/135	95

VI. Comments on Geothermal Energy

Before trying to arrive at a synthesis, a few comments on the heat of the earth's crust, since it has been listed among the long-term options. While the term geothermal covers the heat of the dry rock as well as heat from sources of hot water or steam, we will discuss here mainly dry heat because of its importance as a long-term option. The global potential of sources of hot water and steam amounts to approximately sixty GWe and is therefore no alternative to nuclear energy. For the same reason we do not include wind, waves, and tide. These energy sources have local importance, if any; they cannot be regarded as an alternative to primary energy sources of global dimensions.

Per 1000 m depth the earth temperature rises by 30°C. This is an average value; there may be local variations. If we take the area of the F.R.G. at a depth of 5000 m, this would, in mathematical terms, mean a certain energy content, amounting approximately to that of world oil reserves. In this statement a temperature level of 100°C is assumed.

With conversion into usable mechanical energy, the figures change accordingly.

These are purely mathematical considerations. The soil below the F.R.G. certainly cannot be equipped with a network of pipes. Such a network would have to be very dense given the low thermal conductivity of the soil. Moreover, the effect of a temperature decrease on the mechanical equilibrium of the ground cannot be foreseen. These questions would have to be answered, particularly for earthquake zones.

It must be admitted that the conditions relating to large-scale utilization of geothermal energy are as yet little understood; much more analysis [17] is necessary. With these few comments we will leave this topic.

VII. A Synthesis

After this brief outline of the options nuclear energy, solar energy, and coal, the question arises: where does this lead us? For an answer to this question, we refer to Figure 12, which sketches a decision tree for creating an advanced energy system. We start the decision tree by asking, for example,

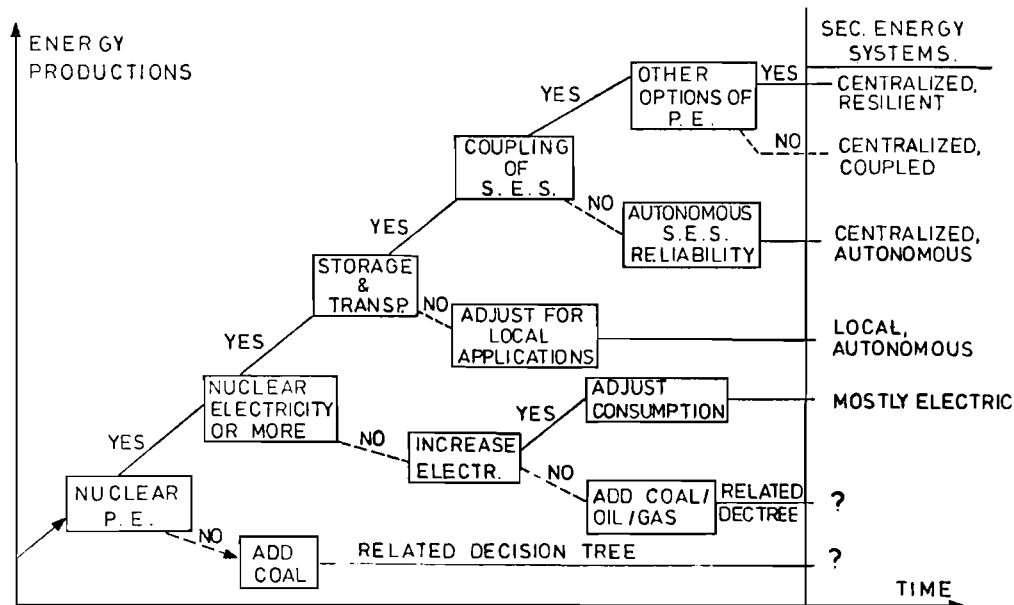

Figure 12. A decision tree for advanced energy systems.

whether nuclear energy is to be introduced on a large scale in the F.R.G. This question can be answered only in the light of existing alternatives. As things stand now, "additional coal" seems one likely alternative; in this case the appropriate decision tree is used.

If the answer to the question of nuclear energy is yes, the next question is whether electricity only or also other forms of energy are to be generated by nuclear power. If only electricity is to be produced, then the share of electricity in final consumption can be greatly increased by specific measures, including subsidies; otherwise the share of nuclear energy is limited and again we have to resort to "additional coal". If nuclear primary energy is to be used for more than generating electricity, the next question is whether one wants to go into the fundamental problem of energy transport and storage. If not, one must rely on local, independent generation of nuclear process heat. The amount of energy thus produced is very limited--5% to 7% of the secondary energy consumption--since the major part of non-electric consumption is divided into many small units. We have seen that the secondary energy market demands, in addition to electricity, a gaseous source of energy. Here we have reached a critical point: what the consumer market requires accords with the expected integration of primary energy sources. Certainly synthetic hydrocarbons will be the first to be integrated. If the process heat required for gasification of coal, i.e. the use of "additional coal", is provided by nuclear sources, the value of coal reserves will be doubled, since nuclear heat would allow the production of twice as much synthetic gas. At the same time the most promising primary energy sources, nuclear energy and coal, would be integrated in a way that is responsive to the consumer's needs.

A secondary energy network distributing hydrocarbons can easily accommodate large amounts of hydrogen. Also, a really large network acts as a natural storage unit. If solar energy is utilized, it can also be integrated into the existing consumer network. This implies that solar energy should produce primarily hydrogen. Figure 13 shows the European pipeline network existing today [19]. It reaches areas that are more suitable for the utilization of solar energy than Central Europe.

The next question on the decision tree is whether the two forms of secondary energy should be mutually convertible or not. In case of long-term use of hydrogen, convertibility is ensured by electrolysis and/or fuel cell [18].

Thus the pattern of an adaptable, modern energy system with an inherent redundancy emerges, in which the problem of a suitable combination of primary energy sources is solved on the basis of logical and economical considerations, while the consumer market is decoupled and can follow its own trends.

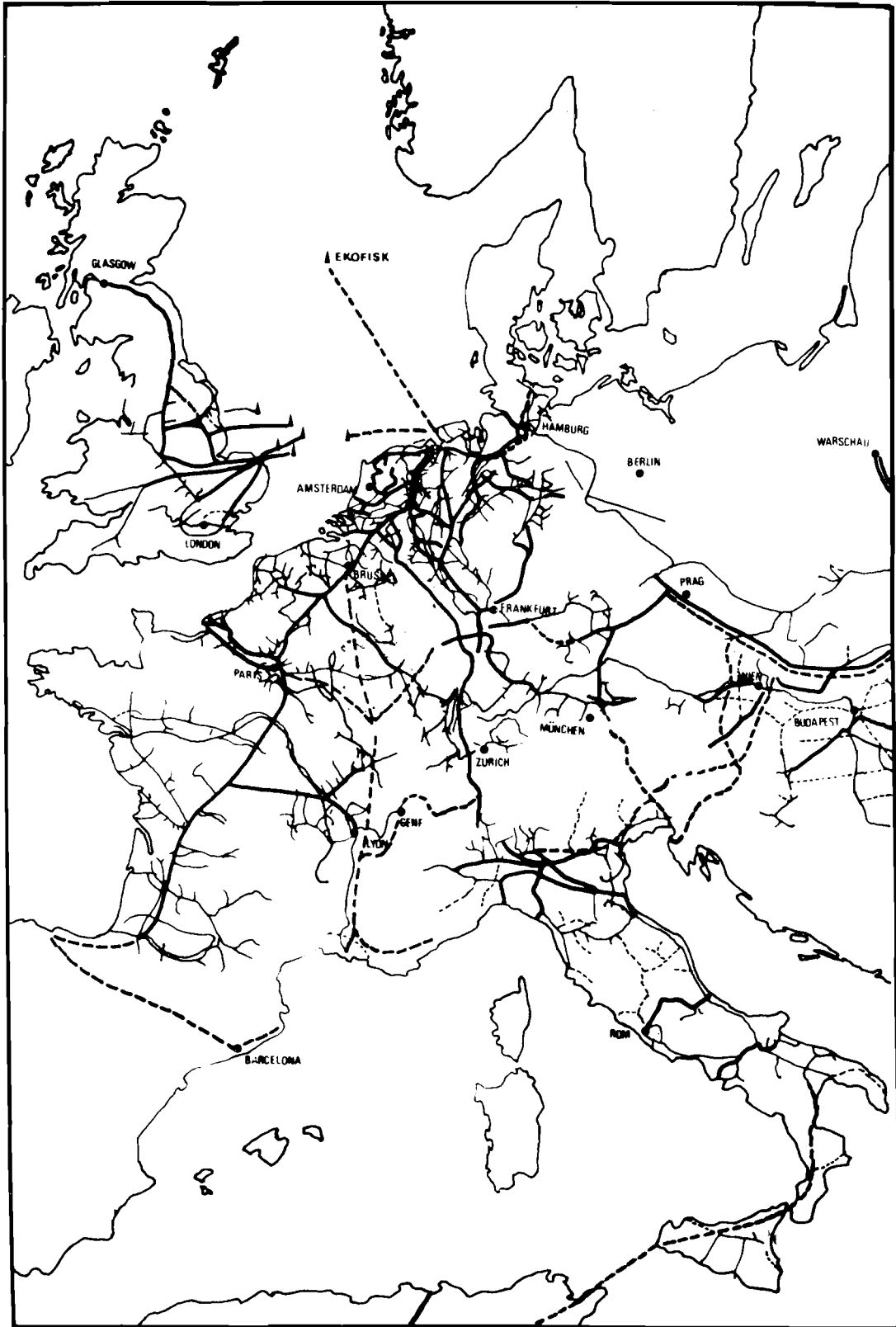

Figure 13. European pipeline network.
(Source: Reference [13]).

VIII. Final Remarks

1. The large-scale utilization of any primary energy source involves specific disadvantages that occur as negligible side effects when applied on a small scale but turn into decisive effects if applied on a large scale. The ensuing problem is the choice of an optimum combination of primary energy sources that is economical and whose disadvantages are tolerable.

2. In the medium term, the only alternative to nuclear energy is energy from coal. In contrast to nuclear energy, its utilization beyond today's level, i.e. on a truly large scale, leads primarily to the political and institutional problem of long-term guarantees for a minimum energy price. On this basis drastically new techniques of coal mining and coal use can be envisaged, with gasification of coal having top priority. We must clarify to what extent residual risks accompanying such a development are acceptable. Rather than being an alternative coal will function as a partner of nuclear energy. The necessity for this follows from the demand of the consumer market for a gaseous source of secondary energy.

3. At our latitude solar energy can be used initially only by way of the "solar house"; that is, it can meet only a fraction of the demand for secondary energy. Large-scale utilization of solar energy directly involves superregional dimensions, in particular land demand, energy storage, and energy transport. Hydrogen is more suitable for solar energy than electricity. Today solar energy is still three to five times more expensive than nuclear energy. It will thus gain ground--if at all--only in the long run; the time scale for the possible introduction of hydrogen as a secondary energy source accords with this fact.

4. The necessity for a long-term guaranteed and economical primary energy supply suggests that priority should be given to the prompt establishment of a modern secondary energy system, with a gaseous secondary energy source in addition to electricity. A possible long-term solution is hydrogen, since the two forms of secondary energy would be mutually convertible. This also means that secondary energy could be stored.

5. The time scale for the developments discussed here is thirty to fifty years. Considering the time required for the adaptation of the consumer market and the establishment of suitable secondary energy systems, as well as the necessary investments, the limited production factors, and the limited resources of crude oil and natural gas, we conclude that the problems ahead are not of a long-term nature, but that they really demand urgent action.

References

- [1] Goeller, H.E. et al., Eds. Survey of Energy Resources 1974. Ninth World Energy Conference, Detroit, Michigan, September 1974. World Energy Conference, London, 1974.
- [2] Häfele, W. "Energy Systems." Bulletin of the International Atomic Energy Agency, 16, 1,2; and "A Systems Approach to Energy." American Scientist, 62, 438-447.
- [3] Charpentier, J.-P. "Toward a Better Understanding of Energy Consumption." In Proceedings of the IIASA Workshop on Energy Demand, Ed. W.D. Nordhaus. International Institute for Applied Systems Analysis, Laxenburg, Austria, forthcoming.
- [4] Energy flow diagram for the F.R.G., 1971. Bergbauforschung GmbH, Essen, 1973.
- [5] Häfele, W. and Manne, A.S. "Strategies for a Transition from Fossil to Nuclear Fuels." IIASA RR-74-7. International Institute for Applied Systems Analysis, Laxenburg, Austria, 1974. Also in Energy Policy, March 1975.
- [6] Avenhaus, R., Häfele, W. and McGrath, P. "Considerations on the Large Scale Deployment of the Nuclear Fuel Cycle." IIASA RR-75-36. International Institute for Applied Systems Analysis, Laxenburg, Austria, 1975.
- [7] Schlüter, A. "On the Way to a Fusion Reactor." Plenary Lecture, Second General Conference, European Physical Society, Wiesbaden, 1972.
- [8] Fraas, A.P. "Conceptual Design of the Blanket and Shield Region and Related Systems for a Full Scale Toroidal Fusion Reactor." ORNL-TM-3096. Oak Ridge National Laboratory, Oak Ridge, Tennessee, May 1973.
- [9] Häfele, W. and Starr, C. "A Perspective on Fusion and Fission Breeders." Journal of the British Nuclear Energy Society, 13, 2, 131-139.
- [10] Lof, George O.G., Duffie, John A. and Smith, Clayton O. "World Distribution of Solar Radiation." Report, Solar Energy Laboratory, University of Wisconsin, Madison, Wisconsin, July 1966.

- [11] Proceedings of the Solar Sea Power Plant Conference and Workshop, June 1973. Sponsored by the National Science Foundation, Washington, D.C., RANN Grant No. G139115.
- [12] Interagency Task Force on Solar Energy, Federal Energy Administration, Project Independence Blueprint - Final Task Force Report. U.S. Government Printing Office, Washington, D.C., 1974.
- [13] Aerospace Corporation. Solar Thermal Conversion Mission Analysis, Vol. IV - Comparative Systems/Economics Analysis. Report No. ATR-74(7417-16)-1, Vol. IV. Aerospace Corporation, El Segundo, California, 1974.
- [14] Matthews, W.N., Kellogg, W.W. and Robinson, G.D., Eds. Man's Impact on the Climate. M.I.T. Press, Cambridge, Massachusetts, 1971.
- [15] Marchetti, C. "Geoengineering and the Energy Island." (Draft). International Institute for Applied Systems Analysis, Laxenburg, Austria, 1974.
- [16] Manne, A.S. and Marchetti, C. "Hydrogen: Mechanisms and Strategies of Market Penetration." IIASA RR-74-4. International Institute for Applied Systems Analysis, Laxenburg, Austria, 1974.
- [17] Robson, G.S. "Geothermal Electricity Production." Science, 184, 4134, 371-375.
- [18] Häfele, W., Sassin, W., et al. "Applications of Nuclear Power Other Than for Electricity Generation." Paper presented at the European Nuclear Conference, Paris, April 1975. In conference proceedings, Enrichment and Special Applications, Vol. 13. Pergamon Press, Oxford, forthcoming.
- [19] Niedersächs. Landesamt für Bodenforschung, Hannover. Jahrbuch für Bergbau Energie, Mineralöl und Chemie. Glückauf, Essen, 1973.