

# The effects of structural change in agriculture on the spread of animal disease in Finland





Evira Research Reports 3/2015

# **The effects of structural change in agriculture on the spread of animal disease in Finland**



### **Project group**

Tapani Lyytikäinen<sup>1</sup>  
Jarkko K. Niemi<sup>2</sup>  
Leena Sahlström<sup>1</sup>  
Terhi Virtanen<sup>1</sup>  
Simo Rintakoski<sup>1</sup>  
Jonna Kyyrö<sup>1</sup>  
Alina Sinisalo<sup>2</sup>  
Heikki Lehtonen<sup>2</sup>

<sup>1</sup> Finnish Food Safety Authority (Evira), Risk Assessment Research Unit

<sup>2</sup> Natural Resources Institute Finland (Luke), Economic Research

### **Supervisor group**

Taina Aaltonen, Evira  
Laura Kulkas, Valio Ltd.  
Katri Levonen, Ministry of Agriculture and Forestry (MAF)  
Olli Ruoho, Finnish Association for Animal Disease Prevention (ETT)  
Anna-Maija Virtala, Helsinki University, Faculty of Veterinary Medicine  
Leena Suojala, Central Union of Agricultural Producers and Forest Owners (MTK)  
Perttu Pyykkönen, Pellervo Economic Research (PTT)



## Description

Publisher	Finnish Food Safety Authority Evira
Title	The effects of structural change in agriculture on the spread of animal disease in Finland
Authors	Tapani Lyytikäinen, Jarkko K. Niemi, Leena Sahlström, Terhi Virtanen, Simo Rintakoski, Jonna Kyyrö, Alina Sinisalo and Heikki Lehtonen
Abstract	<p>The structure of Finnish agricultural production has changed rapidly resulting in an increase in the average farm size and a reduction in the number of farms.</p> <p>Three animal diseases were used to illustrate the impacts of changing production structures and their consequences on the spread and control of disease: Foot-and-mouth disease (FMD), African Swine Fever (ASF) and Bluetongue (BT).</p> <p>The aim of this study was to assess how changes in the structure of animal production impact on animal disease risks and the economic consequences of diseases. The spread of diseases was simulated according to three predicted future production structure scenarios for 2033 and compared with reference simulations applying the production structure of the year 2009.</p> <p>FMD had the highest spread potential as the probability of spread and magnitude of an epidemic outbreak were the largest. ASF and BT had clearly lower spread potential and also structural change will affect them less. Spread potential is strongly dependent on how logistics will develop in relation with farm size increase.</p> <p>Economic losses due to FMD were similar in 2009 and 2033 simulations. Losses caused by ASF were smaller than those by FMD. In both cases distortions in the food exports were the main source of losses. Losses associated with BT were estimated to be smaller in the future.</p>
Publication date	November 2015
Keywords	Bluetongue, Foot-and-mouth disease, African swine fever, structural change, simulation, economic consequences, future production structure
Name and number of publication	Evira Research Reports 3/2015
Pages	159
Language	English
Confidentiality	Public
Publisher	Finnish Food Safety Authority Evira
Layout	Finnish Food Safety Authority Evira, In-house Services
	ISSN 1797-2981      ISBN 978-952-225-146-6

## Kuvailulehti

Julkaisija	Elintarviketurvallisuusvirasto Evira
Julkaisun nimi	Kotieläintalouden rakennemuutoksen vaikutukset eläintautien leviämiseen Suomessa
Tekijät	Tapani Lyytikäinen, Jarkko K. Niemi, Leena Sahlström, Terhi Virtanen, Simo Rintakoski, Jonna Kyyrö, Alina Sinisalo ja Heikki Lehtonen
Tiivistelmä	<p>Kotieläintilojen keskikoko on kasvanut ja tilojen määrä on vähentynyt. Kehityksen voidaan arvioida jatkuvan myös tulevaisuudessa. Kolme eläintautia, suu- ja sorkkatauti, afrikkalainen sikarutto ja sinikielitauti, käytettiin esimerkkinä siitä, kuinka muutokset kotieläintuotannon rakenteessa vaikuttavat taudin leviämiseen ja hallintaan.</p> <p>Tutkimuksen tarkoituksena oli arvioida kuinka kotieläintalouden rakennemuutos vaikuttaa eläntautiriskiin ja tautien taloudellisiin vaikutuksiin. Tautien leviämistä simuloitiin kolmen vuoteen 2033 ajoittuvan tulevaisuuskenaarion mukaan ja verrattiin simulointeihin, jotka pohjautuivat kotieläintalouden rakenteeseen vuonna 2009.</p> <p>Suu- ja sorkkataudilla oli suurin leviämispotentiaali, koska leviämisen todennäköisyys ja epidemian koko olivat suurimmat. Afrikkalaisella sikarutolla ja sinikielitaudilla oli selvästi matalampi potentiaali ja rakennemuutos vaikuttaa niihin vähemmän. Leviämispotentiaali on voimakkaasti riippuvainen logistiikan kehityksestä tilakoon kasvuun nähden.</p> <p>Suu- ja sorkkataudin aiheuttamat taloudelliset menetykset olivat samaa suuruusluokkaa nyt ja tulevaisuudessa. Afrikkalaisen sikaruton aiheuttamat tappiot jäivät maltillisemmiksi. Molemmilla taudeilla elintarvikeviennin häiriintyminen aiheutti eniten tappioita. Sinikielitaudin menetyksen arvioitiin olevan nykyistä vähäisemmät tulevaisuudessa.</p>
Julkaisuaika	Marraskuu 2015
Asiasanat	Sinikielitauti, suu- ja sorkkatauti, afrikkalainen sikarutto, rakennemuutos, simulointi, taloudelliset seuraukset, tulevaisuuden tuotantorakenne
Julkaisusarjan nimi ja numero	Eviran tutkimuksia 3/2015
Sivuja	159
Kieli	Englanti
Luottamuksellisuus	Julkinen
Julkaisun kustantaja	Elintarviketurvallisuusvirasto Evira
Taitto	Elintarviketurvallisuusvirasto Evira, virastopalveluyksikkö
	ISSN 1797-2981      ISBN 978-952-225-146-6

## Beskrivning

Utgivare	Livsmedelssäkerhetsverket Evira
Publikationens titel	Påverkan av lantbrukets strukturförändringar på spridningen av djursjukdomar i Finland
Författare	Tapani Lyytikäinen, Jarkko K. Niemi, Leena Sahlström, Terhi Virtanen, Simo Rintakoski, Jonna Kyyrö, Alina Sinisalo och Heikki Lehtonen
Resumé	<p>En snabb strukturförändring inom lantbruket i Finland har resulterat i större men färre gårdar. Denna utveckling förväntas fortsätta även i framtiden. Tre sjukdomar; mul- och klövsjuka, afrikansk svinpest och blåtunga, har använts som exempel för att undersöka hur strukturförändringen påverkar smittspridningen och sjukdomskontrollen i framtiden.</p> <p>Syftet med arbetet var att utvärdera hur strukturomvandlingen i lantbruket påverkar djursjukdomsriskerna och de ekonomiska konsekvenserna av sjukdomarna. Sjukdomsspridningen simulerades enligt tre tänkta framtida produktionsstrukturer för år 2033 och jämfördes sedan med simuleringar baserade på produktionen år 2009.</p> <p>Mul- och klövsjuka hade den största spridningspotentialen eftersom sannolikheten för spridning och storleken av ett epidemiskt utbrott var störst. Afrikansk svinpest och blåtunga hade klart lägre spridningspotential och även strukturförändringarna kommer att påverka dem mindre. Spridningspotentialen är starkt beroende av hur logistiken utvecklas i relation till gårdsstorleken.</p> <p>Ekonomiska förluster på grund av mul- och klövsjuka var lika stora i simuleringarna både för år 2009 och 2033. Förluster på grund av afrikansk svinpest var mindre än de orsakade av mul- och klövsjuka. I båda fallen var förlusterna orsakade av störd livsmedellexport den huvudsakliga orsaken till ekonomiska förluster. Förluster orsakade av blåtunga verkade vara mindre i framtiden.</p>
Utgivningsdatum	November 2015
Referensord	Blåtunga, mul- och klövsjuka, afrikansk svinpest, strukturförändring, simulering, ekonomiska konsekvenser, framtida produktionsstruktur
Publikationsseriens namn och nummer	Eviras undersökningar 3/2015
Antal sidor	159
Språk	Engelska
Konfidentialitet	Offentlig handling
Förläggare	Livsmedelssäkerhetsverket Evira
Layout	Livsmedelssäkerhetsverket Evira, Enheten för ämbetsverkstjänster
	ISSN 1797-2981      ISBN 978-952-225-146-6



# Table of Contents

---

Table of contents .....	6
Abbreviations and definitions .....	8
<b>1 Introduction .....</b>	<b>12</b>
<b>2 Materials and methods .....</b>	<b>14</b>
<b>3 Results and discussions.....</b>	<b>16</b>
<b>3.1 Reference simulations - the spread of diseases under the conditions of 2009..</b>	<b>16</b>
<b>3.2 The effect of the sheep/goat production on the spread of the studied diseases</b>	<b>18</b>
3.2.1 Foot-and-mouth disease (FMD).....	18
3.2.2 The impact of detection time on the results for sheep farms in FMD simulations	20
3.2.3 Bluetongue (BT) .....	21
3.2.4 Discussion, the effect of sheep and goat production.....	22
<b>3.3 The effect of specialized production on the spread of fmd.....</b>	<b>24</b>
3.3.1 Discussion, the effect of specialized production .....	27
<b>3.4 Projected changes in production structure and expected consequences of structural change .....</b>	<b>29</b>
3.4.1 Discussion, projected changes in production structure.....	33
<b>3.5 Structural development and economies of scale .....</b>	<b>35</b>
<b>3.6 Disease spread in production structures of the future .....</b>	<b>37</b>
3.6.1 Foot-and-mouth disease (FMD).....	37
3.6.1.1 Alternative scenarios .....	43
3.6.1.2 Discussion, FMD.....	44
3.6.2. African swine fever (ASF) .....	46
3.6.2.1 Discussion, ASF.....	49
3.6.3 Bluetongue (BT) .....	50
3.6.3.1 Discussion, BT.....	53
<b>3.7 Simulated economic impacts of the diseases .....</b>	<b>55</b>
3.7.1 Reference simulations .....	55
3.7.2 FMD in the baseline future projections.....	56
3.7.2.1 FMD in alternative future projections .....	58
3.7.2.2 Discussion, FMD, economic.....	60
3.7.3 ASF in future projections.....	61
3.7.3.1 Discussion, ASF, economic future projections.....	64
3.7.4 BT in future projections.....	65
3.7.4.1 Discussion, BT, economic future projections.....	66
<b>3.8 Risk management in the future.....</b>	<b>67</b>
3.8.1 Changes in biosecurity measures due to increased farm size.....	67
3.8.2 Protective measures associated with animal trading .....	70
3.8.3 Discussion, biosecurity and protective measures.....	71
3.8.4 Discussion, official measures during an outbreak in the future .....	73



<b>4 Summary and final conclusions .....</b>	<b>75</b>
Acknowledgements .....	85
References .....	86
Appendices .....	91
<b>Appendix 0: Simulated diseases .....</b>	<b>91</b>
Foot-and-mouth disease (FMD) .....	91
African swine fever (ASF) .....	93
Bluetongue (BT).....	95
<b>Appendix 1: Data sources.....</b>	<b>96</b>
Farm database .....	96
Database of animal transportation between farms .....	96
Slaughterhouse transportation database.....	97
Ai technician movement database.....	97
Dairy logistics database .....	97
Questionnaires to farmers.....	98
Questionnaire to veterinarians .....	98
Questionnaires to farmers about biosecurity.....	98
Other sources.....	99
Cost parameters.....	99
<b>Appendix 2: Livestock production structure in Finland 2009.....</b>	<b>100</b>
Pig production.....	100
Farm type classification.....	101
Sow pools.....	101
Multi-site systems .....	102
Cattle production .....	102
Dairy farms .....	103
Beef cattle farms.....	103
Suckler cow farms .....	103
Sheep and goat production.....	104
Quantities marketed and unit prices.....	105
<b>Appendix 3: Epidemiological simulation models .....</b>	<b>106</b>
FMD model, year 2009.....	106
ASF model, year 2009.....	106
Bluetongue model, year 2009.....	107
Spread model – the simulation process for FMD and ASF.....	107
Spread model – the simulation process for bluetongue.....	119
<b>Appendix 4: Risk management 2009–2011 .....</b>	<b>124</b>
Voluntary risk management measures .....	124
Protective measures associated with animal trading .....	126
Official risk management measures during an FMD or ASF outbreak.....	127
Official risk management measures during a bt outbreak .....	128
<b>Appendix 5: Reference simulation results under the 2009 situation .....</b>	<b>129</b>
FMD simulation (without sheep/goat production related spread) .....	129
ASF simulation .....	133
BT simulation (without sheep and goat production-related spread).....	136
Simulated economic impacts of FMD in year 2009 .....	138
Simulated economic impacts of ASF in 2009.....	143
Simulated economic impacts of BT in 2009.....	145
<b>Appendix 6: Future projections .....</b>	<b>147</b>
Development of production costs in the 2000s.....	150
Structural development and economies of scale .....	155
<b>Appendix 7: Spread simulation of future projections.....</b>	<b>156</b>
Simulation of spread in the future .....	156
Building a realisation from a projection.....	156

## Abbreviations and definitions

<b>ASF</b>	African swine fever
<b>BT</b>	Bluetongue disease
<b>BTV</b>	Bluetongue virus
<b>ETT</b>	Finnish Association for Animal Disease Prevention
<b>EU</b>	European Union
<b>Evira</b>	Finnish Food Safety Authority
<b>FABA</b>	The Finnish Animal Breeding Association
<b>FMD</b>	Foot-and-mouth disease
<b>FMDV</b>	Foot-and-mouth disease virus
<b>Luke</b>	Natural Resources Institute Finland*
<b>MAF</b>	Ministry of Agriculture and Forestry
<b>Mela</b>	The Farmers' Social Insurance Institution
<b>MTT</b>	MTT Agrifood Research Finland*
<b>MVO</b>	Municipal Veterinary Officer
<b>OIE</b>	World Organisation for Animal Health
<b>PVO</b>	Provincial Veterinary Officer
<b>FGFRI</b>	The Finnish Game and Fisheries Research Institute (RKTL)
<b>TIKE</b>	Information centre of the Ministry of Agriculture and Forestry*

\* As of 1 January 2015, MTT, the Finnish Forest Research Institute, the Finnish Game and Fisheries Research Institute, and the statistical services of the TIKE were merged to form Natural Resources Institute Finland (Luke).

### Definitions

#### **AI**

Artificial insemination: a technique for placing semen from a male in the reproductive tract of a female by other means than natural service.

#### **Case of FMD**

An individual animal infected by foot-and-mouth disease virus (FMDV).

#### **Coefficient of variation (CV)**

The standard deviation divided by the mean; can be given as a percentage, which then indicates the proportion of the standard deviation from the mean.

#### **Competent authorities**

The authority of a member state competent to carry out veterinary checks.

**Consumer's surplus**

The excess of the benefit a consumer gains from purchases of goods over the amount paid for them. Typically obtained by integrating the area below the inverse demand curve minus the market value of goods purchased at market price.

**Demand curve**

A graph relating the demand for a good or service to its price. Its reverse is the inverse demand curve, which represents the price as a function of the quantity of a good.

**Detection time**

The time between the introduction of a virus and the positive diagnosis of a disease on a farm.

**Direct costs**

Costs of implementation of disease eradication and preventive measures after an infection has been observed at a farm. In this study, direct costs mainly refer to expenditures that are paid by tax payers.

**Endemic disease**

The constant presence of disease within a given population or a geographical area.

**Epidemic**

The introduction of a contagious pathogen into a susceptible population followed by the spread of the pathogen within the susceptible population.

**Epidemic outbreak**

The introduction of a contagious pathogen into a farm, followed by the spread within the farm and to other farms.

**Export shock**

A situation where importing countries prohibit the importation of animals and products originating from animals from a country where FMD, ASF has been observed. Consequences of the shock are referred to as trade distortions.

**Farrowing farm**

A farm mainly producing piglets to be sold to finishing farms.

**Farrowing-to-finishing farm**

A farm producing piglets and raising all or a proportion of the piglets until slaughter.

**Finishing farm**

A farm purchasing piglets from farrowing farms and rearing them until slaughter.

**Heifer**

A cattle female less than three years of age that has not given birth to a calf.

**High-risk period**

The time period between the release of FMD, ASF or BT virus into the susceptible population and the execution of the first restrictive measures due to a suspicion of disease. The high-risk period includes the incubation period.

**Incubation period**

The time period between the exposure of the animal to the pathogen and the occurrence of the first clinical signs of the disease.

**Indicator**

A variable that has a value of 1 when the argument is true and otherwise has a value of 0.

**Indirect costs**

Indirect costs – or consequential costs – include all other economic effects of a disease outbreak except direct costs. Trade losses, business interruption losses on farms located in restriction and surveillance zones, and the costs of breeding new animal stock after the outbreak are examples of indirect costs.

**Iteration**

One simulated outcome starting from a case of FMD, ASF or BT infection on one farm to the end of an outbreak. In this report, an iteration is a Monte Carlo simulated outbreak.

**Monitoring**

Ongoing programmes to detect changes in the prevalence of disease in a given population.

**Neighbourhood spread**

Disease transmission between herds in close proximity, where no other means of transmission of the disease can be identified.

**Outbreak of FMD/ASF/BT**

FMD/ASF/BT virus has been introduced into a farm and caused more than one case of disease after introduction.

**Partial equilibrium**

A situation where the demand and supply in a certain sector are equal, and the buyers and sellers are in agreement over the prices required for the transaction. In the equilibrium, changes in this particular sector would not increase the net benefit to consumers and producers. However, changes in other sectors could contribute to the net benefit.

**Percentile**

An approximate value of a cumulative distribution located on a given percentage of the distribution, whereby the same percentage of the population is either smaller than or equal to the given value.

**Probability of epidemic outbreak**

Simulated estimate of how probable it would be that an epidemic outbreak (>1 infected farm) would occur.

**Probability of large outbreak**

Simulated estimate of how probable it would be that an epidemic outbreak would include more than 17 infected farms.

**Protective vaccination**

Emergency vaccination is carried out in holdings in a designated area in order to protect animals of a susceptible species within this area against contagious animal disease. The animals are intended to be kept alive following vaccination (2003/85/EY) (“vaccination to live”).

**Protection zone**

An area around an infected herd with a minimum radius of 3 km.

**Risk**

The likelihood of occurrence and the likely magnitude of the consequences of an adverse event for, in this report, animal health in a specified area during a specified time period.

**Relative variation in epidemic outbreak size**

Coefficient of variation of the size of an epidemic outbreak = (standard deviation of size/ mean of size)

**Risk assessment**

In this report, risk assessment includes the evaluation of the biological and economic consequences of the entry of a pathogenic agent into the cattle and/or pig population in Finland.

**Semi-connected transports**

Semi-connected means that either end of a transport (i.e. a farm) has stopped operating in 2033 and the corresponding number of animals needs to be transported from or to another farm still operating in 2033 in the simulation.

**Simulation**

A set of iterations that have been carried out with a certain set of parameters, in order to estimate the mean and variance of outcomes of iterations. Simulation typically includes several thousands of iterations.

**Size of epidemic outbreak**

The number of farms with infected animals of a certain contagious disease at the end of an outbreak.

**Stamping-out**

Killing of infected herds and/or other herds that have been exposed to infection by direct animal-to-animal contact, or by indirect contact likely to cause the transmission of disease. All carcasses of killed animals are destroyed by burning or burial, or by any other method that will eliminate the spread of infection through the carcasses or products of the animals killed.

**Suckler farm**

A farm with a herd of cattle composed of dams and their young calves up to the point of weaning.

**Surveillance zone**

A surveillance zone includes an area around an infected herd with a minimum radius of 10 km, excluding the protection zone.

**Weaner calf farm**

A farm where 1- to 2-week-old calves are moved and raised until they are 5-6 months old.



# 1 Introduction

---

The structure of Finnish agricultural production has changed rapidly during the last decades. The most notable changes have been an increase in the average farm size and a reduction in the number of farms. For instance, in 2000, only 3% of dairy cows were located on farms having more than 50 cows, but in 2007 this percentage had already reached 15%. Correspondingly, the percentage of sows on farms having more than 200 sows increased from 17% to 41% during the same time period (Eurostat 2008). During recent decades, the number of farms has decreased approximately by half per decade.

Changes in the production structure may affect the risk of spread of animal diseases and economic consequences of diseases. Risk management in a changing situation is more difficult, as the impacts of the increasing farm size and decreasing number of farms, the concentration of production and the impacts of specialised production are not properly known. Sow pools, the three-stage breeding of cattle, multi-site pig farming and the rise in sheep and goat production all influence the future potential for animal disease spread and the effectiveness of risk management measures. An increasing farm size can increase animal disease risks, but the potential to invest in biosecurity measures may also simultaneously increase. It is important to assess how much the risks are increasing and what means are available to reduce the negative impacts of structural change.

Structural change is a set of irreversible investment decisions and decisions to exit the industry. The animal disease risk should be taken into account in investment decisions, because the costs of the risk may reduce the potential benefits of structural change. Therefore, it is important to know whether the structural change will require changes in risk management. For instance, one should know whether precautionary efforts should be targeted towards new network-type production units that have great importance in the supply of domestic animal products.

Epizootic diseases are controlled by European Union directives and domestic legislation. Different management options are used to combat these diseases in case of an outbreak. Stamping out, restrictions on animal movements and emergency vaccination, to mention a few, are among the options used depending on the disease and decision-making context. It is important to know whether these management options remain relevant when the production structures changes. Finnish livestock production differs from that of many other regions in Europe. For instance, while the average farm size in Finnish animal production is equivalent to that of central Europe, the farm density in Finland is very low compared to many other regions in Europe.



Three animal diseases were used to illustrate the impacts of changing production structures and their consequences on the spread and control of disease. Foot-and-mouth disease (FMD), African Swine Fever (ASF) and Bluetongue (BT) are diseases that are not currently observed in Finland, but which could spread to Finland at any time. Finland has been free from FMD since 1959, and ASF and BT (serotype 8) have never been detected here. FMD is a disease of all cloven-footed animals such as pigs and ruminants. ASF is predisposed to pigs, while BT is a disease of ruminants only. FMD and BT can, in other words, additionally affect sheep and goats. Therefore, it is important to also assess the influence of sheep and goat production on the risk of disease spread.

It is possible to reduce the disease risk with on-farm biosecurity. Knowledge of the biosecurity level is crucial in order to determine whether it needs to be improved and in what sense. Economic incentives might be a way to stimulate farmers to improve and implement biosecurity measures.

The aim of this study was to assess how changes in the structure of animal production impact on animal disease risks and the economic consequences of diseases. FMD, ASF and BT were used as examples to reflect how production structures and changes in them affect the animal disease risk on farms and the risks for the whole country. The spread of diseases was simulated in the predicted future production structures (three different scenarios) and compared with reference simulations that were performed by applying the production structure of the year 2009.

Additionally, specialized production types and the importance of sheep and goat production to disease spread were examined under 2009 conditions. The implementation frequencies of biosecurity measures were estimated to identify sections that could be improved within each production sector and to study factors influencing the implementation frequency.



## 2 Materials and Methods

---

In this study, we projected future scenarios for structural change in Finnish livestock production and simulated the spread and impacts of animal diseases in the Finnish livestock sector. The year 2009 was chosen to represent a reference point against which the future scenarios were compared. The same simulation models were applied for the 2009 situation and then modified and applied to reflect future scenarios in the year 2033.

Epidemiological simulation models (FMD, ASF, BT) were developed to simulate the spread of infectious diseases between the pig, cattle, sheep and goat farms in Finland. The models were parameterized using data from 2009. The models were network models, which means that the spread was partially simulated in real, historical networks. The models for the spread of FMD and ASF resemble models such as InterSpread (Sanson 1993; Mourits et al. 2002; Stevenson 2003; Velthuis & Mourits 2007), NAADSM (Harvey et al. 2007) and the earlier Finnish Classical Swine Fever (CSF) (Raulo & Lyytikäinen 2005) and FMD models (Lyytikäinen et al. 2011). The simulation of BT spread was performed with the same framework, but applying the models of Koeijer et al. (2011) and Turner et al. (2012a and 2012b). The spread of the disease between farms was simulated using the Monte Carlo approach. The models were programmed in the Matlab environment. Sampling from distributions (other than normal and uniform) was performed using functions of the Econometrics Toolbox (Le Sage 2002).

The models describe how the virus can spread between farms through different types of contacts. Relevant contacts are those that have occurred during an infective period on a farm, and are dependent on the simulated disease. Because the models used detailed historical data (from databases, as described later) in defining contacts, they can be considered as network models that describe potential networks connected with infected farms in a given time. Using registry data also meant that the models were mainly non-parametric, i.e. the contact processes were not parameterized, but described as they existed in the databases. This approach was complemented by adding parameterized data on contact types obtained from questionnaires. Part of the spread is initiated by spatial processes (FMD and BT). Contact type-specific infectivity and the duration of the infectious period prior to the first detection of the disease in the country are two major parameters of the model that were parameterized using existing models of the same type and other information sources (see Appendix 3).

In FMD and ASF models, the detection time was shortened by administrative actions taken on farms other than the primary infected farm: an infected farm can be

detected earlier if it is located in the control, protection or surveillance zone of the infected farm, or if it is traced as a contact farm. These routes may shorten the detection time and infective period of a farm. Farms are subject to restrictive measures if they are traced as contact farms, or they are located in the control, protection or surveillance zone. Consequently, no contacts are formed from infected farms during the period of restrictive measures, even if the disease has not been detected on them. Our simulations continued until no new disease transmission arose. In the BT model, the simulations took into account the end of the vector-active period.

Economic losses caused by FMD and ASF were simulated by using the model presented by Lyytikäinen et al. (2011). The estimated direct costs due to the disease were updated to correspond to price ratios observed in 2009–2011. These data were collected from various statistics, and market price data were enquired from various sources such as service providers. For some cost items, 2009 data were not available and data from 2010–2011 were used instead. Market implications due to disease outbreaks were simulated using the same partial equilibrium stochastic dynamic programming model as described by Lyytikäinen et al. (2011) and Niemi and Lehtonen (2014). The model used to produce the current results was calibrated against data from 2009 and 2006. The model was extended by unpacking the stochastic results (the result of the dynamic programming model was previously packed and reported as the expected value, and this result was unpacked to represent the distribution implicitly included in the results).

Estimates regarding the costs of BT were based on epidemiological simulations, Finnish regulations, past surveillance programmes and guidelines, and BT outbreaks recorded in the Netherlands and Belgium during the past years. One of the main sources of data was the study of Velthuis et al. (2010). Regarding BT, the impacts of disease on the markets were not simulated, because previous research and the OIE Terrestrial Animal Health Code did not suggest the disease to have significant impacts on dairy and meat markets in Finland.

Future projections were incorporated into the models to resemble various scenarios that present optional production structure alternatives in the year 2033. For future projections, the baseline model was used, because it allowed us to compare economic results between the baseline and future scenarios. The economic benefits of the structural change in agriculture were examined separately from the sector model, because changing production costs in the epidemiological-economic model did not fully allow analytical comparison of the different effects of structural change.

The probability of a livestock farm continuing production in the future was estimated by using a logit regression model and data obtained from the Finnish farm register. The same data were used to assess how farm size has changed over time at farms belonging to different farm size categories. These estimates were used to determine the probability of continuing production and the range of farm size growth in a Monte Carlo simulation model that projected the structure of pig and poultry farming in 2033.

## 3 Results and discussions

---

### 3.1 Reference simulations - The spread of diseases under the conditions of 2009

Reference simulations (Table 1, Appendix 5) indicated that an FMD outbreak would be more likely to escalate to an epidemic outbreak than an ASF or BT outbreak in Finland. Of these diseases, FMD can be expected to cause the largest outbreaks. FMD outbreaks may involve more species than outbreaks of other diseases. However, an FMD outbreak is more likely to be contained within the cattle sector when the primary infected farm is a cattle farm than within the pig sector when the primary infected farm is a pig farm.

The coefficient of variation (CV) of the epidemic outbreak size was largest in FMD and lowest in ASF simulations. This indicates that there is inherently a more unevenly distributed spread potential in FMD outbreaks, probably due to the higher number of spread routes and larger number of susceptible farms. This higher variation makes the prediction of a single outbreak more difficult. The consequences of an outbreak may also be more variable than for other diseases. The probability of a large outbreak was over ten times higher for FMD than for the other two diseases, also indicating a higher potential for extreme consequences.

Spatial spread was more important for BT than for FMD due to vector transmission. It is noteworthy that spread by other contact types also has a spatial component, e.g. animals are more likely to be transferred to nearby farms than to farms located further away. For instance, approximately 20% of animals are transported to farms that are less 20 km from the source farm according to the Finnish animal movement registry for 2009. This means that for all three diseases, control, surveillance and protection zones capture a proportion of the infected contact farms before they are even identified as contact farms. This increases the efficiency of official risk management measures and acts as an additional insurance against failing to trace contact farms – at least when they are located near (<10 km) the infected farm.

**Table 1.** Outcomes of reference simulations: the spread of three diseases applying the data of 2009 and estimated economic losses (€ million on average).

Variable	FMD	ASF	BT
Mean size of epidemic outbreak (number of farms)	11.91	2.60	2.80
CV of epidemic size	1.71	0.46	0.75
P(epidemic outbreak)	0.63	0.23	0.24
P(large outbreak)	0.10	<0.01	<0.01
Economic losses	27.7	10.5	4.8
Range of economic losses (95%)	11.6–74.4	4.6–22.7	2.8–9.0

Indirect influences of an outbreak (measured as the number of involved, non-infected farms) were the largest in BT outbreaks and smallest in ASF outbreaks. BT outbreaks result in large control, protection and surveillance zones. A typical BT outbreak would cause over 1/3 of Finnish cattle farms to be in control, protection and surveillance zones.

ASF shows a low ability to spread in Finland. This result is consistent with the study of Nigsch et al. (2013), in which the typical outbreak size in Finland was predicted to be 1–2 infected farms. Although we did not simulate a situation where the Finnish wild boar population would be infected, the results indicate that even if ASF entered the domestic pig population, the spread would be moderate and there would be a low probability for an epidemic outbreak. However, there is still some potential for further spread. The disease management should therefore be swift and effective for our prediction to be applicable. We assumed that there are no time lags in addition to those mentioned in Appendix 3. It is unlikely that even a moderate increase in time lags would markedly alter the expected outcome, because the spread potential is so low.

There are definite spatial differences in the outcomes. An epidemic outbreak of BT would be two times more likely to start in the Vaasa PVO district than in any other PVO district. By comparison, the probability of an epidemic outbreak of FMD would also be high in the Oulu and Kuopio PVO districts, in addition to the Vaasa PVO district. An epidemic ASF outbreak would be most likely if the primary infected farm was either in the Turku or Kuopio PVO district. These results indicated that contingency planning requires adaptation to the specific characteristics of the district and the disease.

Distances between farms influence the spread dynamics differently for different diseases. In ASF, neighbourhood spread and airborne spread can be disregarded. On the other hand, BT may spread over very long distances along via the air. The probability of spread of BT decreases slowly as a function of increasing distance between farms. The spatiality of the spread of FMD is in between ASF and BT: in our model, there was a 3 km radius for neighbourhood/airborne spread. Other spatiality is due to spatially dependent contacts such as animal transportation.

Models give only conditional answers when a certain farm of a certain farm type, area or production sector is the primary infected farm. We started outbreaks on every Finnish pig and cattle farm with the same probability. Our assumption was that the probability of introduction would be evenly distributed among Finnish farms. If import risk is unevenly distributed, the results should be weighted accordingly. This would require a full quantitative import risk assessment for each disease at the farm level, which is an unreasonably large task for the

purposes of this report. When the results of this document are applied in practice, this limitation should be taken in account. The results show the potential range of outcomes, but the expected value (mean) may shift considerably if the risk of introduction deviates strongly from the assumed distribution.

## 3.2 The effect of the sheep/goat production on the spread of the studied diseases

### 3.2.1 Foot-and-mouth disease (FMD)

Sheep and goat production had little interaction with the other production sectors. Inclusion of sheep/goat farms in the simulations did not alter the results when a pig or cattle farm acted as the primary infected farm (Table 1 vs. Appendix 5). Sheep or goat farms as the primary infected farm caused markedly lower mean size of epidemic outbreaks, and lower probabilities of epidemic and large outbreaks than other farm types. Outbreaks that started on professional sheep or goat farms showed larger relative variability in the outbreak size than on other farm types (Table 2).

As a result of the lower mean epidemic size and probability of epidemic outbreak in sheep/goat initiated outbreaks, the overall expected mean size of an epidemic outbreak (11.40) and probability of epidemic outbreak (0.59) are estimated to be 5–8% lower with the inclusion of sheep/goat production than when sheep/goat farming is ignored.

**Table 2.** The effect of farm type on the simulated outcomes of FMD spread, based on 100 000 iterations in simulations where sheep and goat farms as well as cattle and pig farms may act as the primary infected farm and the contacts of sheep/goat production are also simulated.

Farm type of primary infected farm	Mean size of epidemic outbreak	CV of size of epidemic outbreaks	P(epidemic outbreak)	P(large outbreak)	Total N of iterations
Farrowing farm	6.26	1.44	0.68	0.04	3 466
Farrowing-to-finishing farm	5.84	1.48	0.59	0.03	4 023
Finishing farm	5.32	1.76	0.50	0.02	3 315
Dairy farm	13.15	1.64	0.73	0.14	58 418
Beef cattle farm	9.36	1.96	0.41	0.05	12 176
Suckler cow farm	7.62	2.17	0.34	0.03	7 526
Professional sheep farm	3.41	1.57	0.25	<0.01	716
Semi-professional sheep farm	3.35	2.32	0.22	<0.01	3 430
Hobby sheep farm	3.56	2.36	0.21	<0.01	5 190
Goat farm	3.25	1.98	0.21	<0.01	1 740

When a pig farm acts as the primary infected farm, most of the further spread occurs within the pig production sector and only 2–3% of infected farms are either sheep or goat farms. Similarly, cattle farms tend to infect sheep and goat farms rarely. Only 1–3% of farms infected by cattle farms were sheep/goat farms. The same applies when sheep and goat farm were the primary infected farms. Most of the infected farms were from the same production sector as the primary infected farm. Sheep and goat farms were estimated to promote further spread more often towards cattle farms (22–38% of infected farms) than towards the pig production sector (2–4% of infected farms). The sheep production sector and goat production sector did not infect each other much more often than the pig production sector (Table 3).



The inclusion of sheep/goat production had only a low impact on risk management estimates such as the number of non-infected farms under risk management measures. Because the expected epidemic size was lower than in the simulation without sheep and goat production, the mean number of non-infected farms in surveillance and protection zones remained almost the same (Table 2 vs. Table 38). The slopes of regression functions showed more significant changes. If sheep/goat farms were included in simulations, an infected farm could be expected to cause 5.3% more non-infected farms to be in protection zones and 7.4% more of them to be in surveillance zones (Table 4).

**Table 3.** The effect of farm type of the primary infected farm on the distribution of infected farms across different production sectors.

Farm type of the primary infected farm	The proportion (%) of different farm types among farms infected by further spread				
	To pig farms	To cattle farms	To sheep farms	To goat farms	Total
Farrowing farm	77.30	20.16	2.06	0.47	100
Farrowing-to-finishing farm	76.57	20.96	1.88	0.59	100
Finishing farm	72.00	24.70	2.69	0.60	100
Dairy farm	1.79	97.05	1.00	0.17	100
Beef cattle farm	1.94	96.39	1.41	0.25	100
Suckler cow farm	1.95	95.10	2.50	0.45	100
Professional sheep farm	3.55	37.55	58.39	0.51	100
Semi-professional sheep farm	2.04	24.91	72.40	0.65	100
Hobby sheep farm	2.10	21.58	75.50	0.82	100
Goat farm	2.62	24.33	4.48	68.58	100

**Table 4.** The relationship between the number of FMD-infected farms (when the primary infected farm is a pig, cattle, sheep or goat farm) and the number of non-infected farms (y) in protection and surveillance zones. The relationship equation is  $y = a * (\text{number of infected farms}) + b$ , where a,b are regression model coefficients. Models are only valid if the number of infected farms is >1. The SE of the coefficient is given in parentheses.

Variable y	a	b	R <sup>2</sup>	Mean number of farms for epidemic outbreaks (SD)*
Number of non-infected farms in protection zones	5.896 (0.005)	-2.694 (0.094)	0.937	64.1 (124.2)
Number of non-infected farms in surveillance zones	21.480 (0.018)	16.421 (0.324)	0.934	267.1 (449.5)

\*Only indicative of variation, as the distribution is highly skewed

In reference simulations, cattle and pig farms that also had sheep/goats (mixed farms) were able to produce 5% smaller epidemic outbreaks, and 23% less frequently than cattle and pig farms that did not have sheep or goat production (Appendix 5, Table 42).

In an additional simulation, outbreaks were always started on mixed farms including sheep or goat production (100 000 iterations with and without sheep and goat related contacts). The probability of an epidemic outbreak was slightly higher if sheep- and goat-related contacts were taken into account (0.50 vs. 0.48; the relative increase is approximately 4%). On the contrary, the mean size of an epidemic outbreak

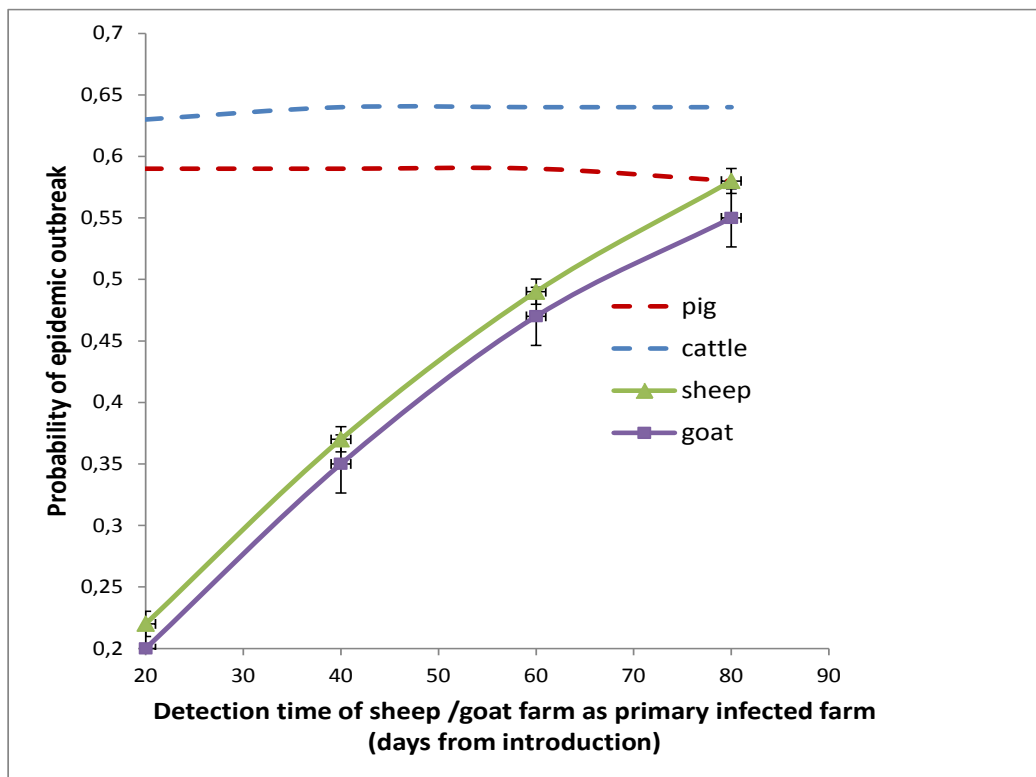
was slightly smaller (10.99 vs. 11.40). Mixed farms with sheep or goats have more frequent contacts with sheep and goat farms than with other farms, which results in a lower tendency to promote further spread of disease (see Tables 2 and 3). The difference between these two simulations was spatially consistent, i.e. the inclusion of sheep- or goat-related contacts promoted the probability of an epidemic outbreak approximately equally within each PVO district.

### 3.2.2 The impact of detection time on the results for sheep farms in FMD simulations

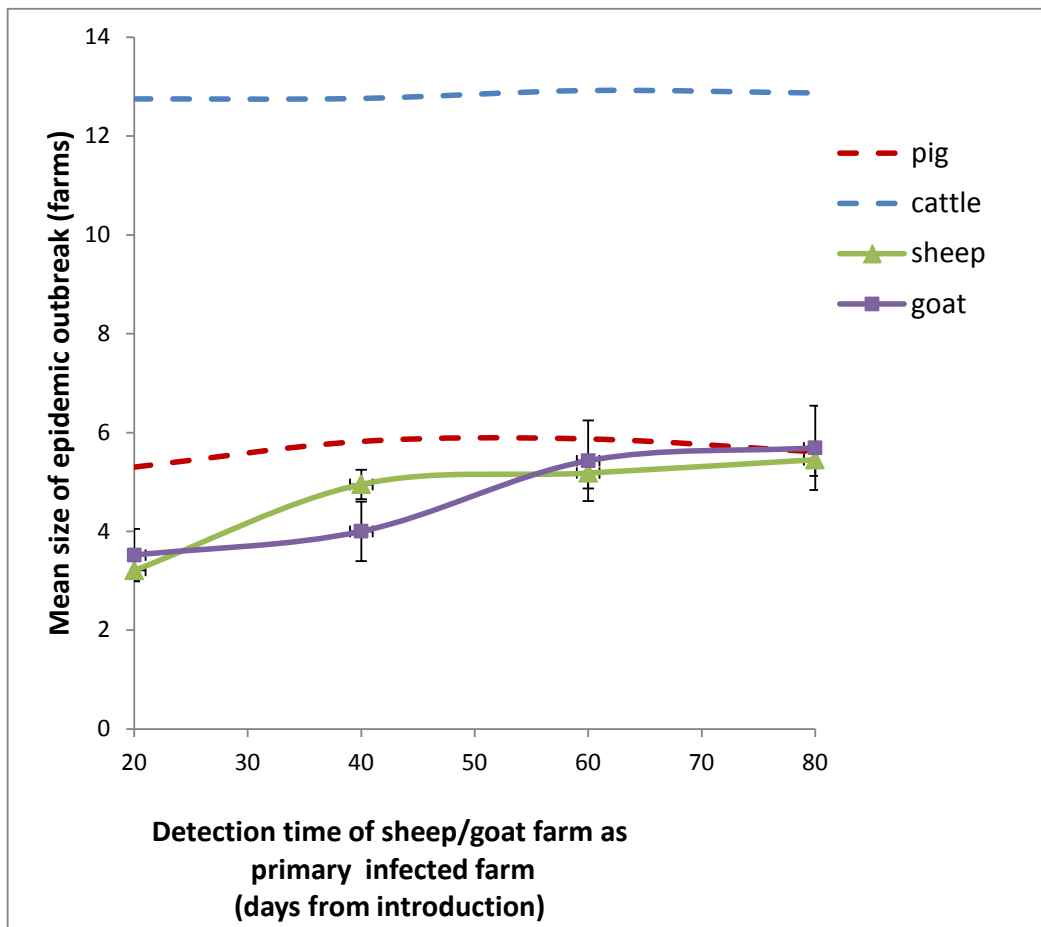
We performed sensitivity simulations in which primarily infected sheep and goat farms were detected 20, 40 or 60 days later after virus introduction compared to when primary farm was a pig or cattle farm. This parameter defines the duration of the high-risk period when the primary infected farm is a sheep or goat farm.

The probability of an epidemic outbreak increased almost linearly as a function of increasing detection time. Similarly, the mean size of epidemic outbreaks increased with increasing detection time, but the relationship showed more variability. The results for cattle and pig farms acting as the primary infected farm were unaffected by the detection time applied to sheep and goat farms.

The results suggest that a four-fold increase in the detection time on sheep and goat farms would be required for a probability of an epidemic outbreak equal to the value for pig farms. A three-fold increase in the detection time would lead to the same result for the mean size of an epidemic outbreak (Figures 1 and 2).



**Figure 1.** The impact of the detection time of FMD on the probability of an epidemic outbreak when the primary infected farm is a sheep or a goat farm. Results for pig and cattle farms as the primary infected farm from the same simulation runs are given as references. The detection times for pig and cattle farms are assumed to be 20 days (Appendix 0, Appendix 3), whereas for sheep and goat farms they vary as represented by the horizontal axis. Error bars represent the normal approximated 95% confidence interval of the expected percentage.



**Figure 2.** The impact of the detection time of FMD on the mean size of an epidemic outbreak when the primary infected farm is a sheep or a goat farm. The results for pig and cattle farms as the primary infected farm from the same simulation runs are given as references. The detection times for pig and cattle farms are assumed to be 20 days (Appendix 0, Appendix 3), whereas for sheep and goat farms they vary as represented by the horizontal axis. Error bars represent the 95% confidence interval of the mean.

### 3.2.3 Bluetongue (BT)

The inclusion of sheep or goat production in the BT simulation did not change the expected outcomes of cattle farms when they act as the primary infected farm. The mean size of epidemic outbreaks increased by 0.05–0.1 farms, depending on the type of primary infected farm.

The probability of an epidemic outbreak and the probability of a large epidemic remained the same as when sheep/goat farms were not included in the simulation (Table 5).

On the contrary, the probability of epidemics and large outbreaks was markedly lower when the primary infected farm was a sheep or goat farm. The mean size of epidemic outbreaks was 2–4 infected farms, depending on the farm type (Table 5). Because the probability of epidemic outbreaks is so low in sheep/goat production, the mean size of an outbreak only indicates that the expected size of an outbreak is on the same level as if would start in the cattle sector.

The mean of epidemic outbreak size was 2.92, the probability of an epidemic outbreak 0.22 and the CV 0.85 when sheep and goat farming was included in the simulation.

The probability of an epidemic outbreak was 0.02 lower than in simulations without sheep and goat farms. The mean size of an outbreak was 0.1 farms higher and the CV 10% larger than in the reference simulation without sheep and goat farms.

**Table 5.** The effect of inclusion of sheep and goat production on the outcomes of BT simulations in relation to farm type. CV = coefficient of variation.

Farm type of primary infected farm	Mean size of epidemic outbreak	CV of size of epidemic outbreaks	P(epidemic outbreak)	P(large outbreak)	Total N of iterations
Dairy farm	2.85	0.83	0.28	<0.01	65 436
Beef cattle farm	3.26	0.94	0.11	<0.01	13 666
Suckler cow farm	3.37	0.94	0.11	<0.01	8 513
Professional sheep farm	2.28	0.44	0.08	<0.01	806
Semi-professional sheep farm	3.00	0.89	0.06	<0.01	3 823
Hobby sheep farm	4.67	0.93	0.04	<0.01	5 760
Goat farm	2.48	0.50	0.04	<0.01	1 996

When sheep and goat farms were taken into account, risk management estimates increased. The expected number of non-infected farms in control, protection and surveillance zones increased by 13%. The slopes of functions estimating the numbers of non-infected farms in control and protection zones increased by 6.3% and 5.0%, respectively. The number of non-infected farms in surveillance zones was less dependent on the number of infected farms than were other zones (Table 6).

**Table 6.** The relationship between the number of BT-infected farms (when the primary infected farm is a cattle, sheep or goat farm) and the number of non-infected farms (y) in control, protection and surveillance zones. The estimated relationship equation is  $y = a \cdot (\text{number of infected farms}) + b$ , where a and b are regression model coefficients. Models are only valid if the number of infected farms is >1. The SE of coefficients is given in parentheses.

Variable y	a	b	R <sup>2</sup>	Mean size of epidemic outbreak (number of farms) (SD)*
Number of non-infected farms in control zones	127.276 (0.194)	-1.454 (0.387)	0.811	373 (341)
Number of non-infected farms in protection zones	919.059 (2.336)	1 205.401 (4.563)	0.608	4 142 (2627)
Number of non-infected farms in surveillance zones	171.960 (2.096)	2 034.723 (4.176)	0.063	2 873 (1150)

\* Only indicative of variation, as the distribution is highly skewed

### 3.2.4 Discussion, the effect of sheep and goat production

Sheep and goat farming plays a minor role in the potential spread dynamics of FMD and BT in Finland. The probabilities of epidemic outbreaks were lower than in the cattle and pig sector, indicating that the initial ability of sheep and goat farms to promote further spread is low. The same also applies to the expected magnitude of an outbreak. An outbreak initiated from the sheep or goat production sector is usually smaller than an outbreak initiated from cattle or pig production sectors. The affinity of spread towards the cattle sector can occasionally promote slightly larger outbreaks. This is due to the tendency of cattle farms to spread disease further.

However, even in cases of spread towards the cattle sector, the probability of large outbreaks is lower in outbreaks originating from sheep or goat farms than in those starting on other types of farms.

These results indicate that, in general, sheep and goat production is not able to efficiently promote the further spread of FMD or BT. The large coefficients of variation in the FMD simulation indicate that there might be individual farms and locations where FMD may spread efficiently from sheep and goat farms. The same does not apply to BT simulations. However, the BT model is simpler and does not utilise as much farm level information as the FMD and ASF models. Thus, the BT model leads to coarser outcomes than the FMD and ASF models.

Disease spread mostly occurred within production sectors, and spread to other sectors was particularly seldom when the primary infected farm was a cattle farm. Therefore, production sectors did not substantially modify each other's spread potential. A risk estimate could be approximated simply by estimating the spread within each sector. When classifying pig or cattle farms according to their ability to promote the spread of disease to other farms, the inclusion of sheep and goat farms in the simulations would add little value.

Sheep and goat farming was excluded from the future projections of this study. Our results suggest that this had only minor consequences for the outcomes. Sheep production in Finland is a relatively minor sector (Virtanen et al. 2013). Although the number of sheep and goat farms is quite large, the average size of farms is small and their impact on livestock production is quite small. For instance, the number of sheep and goat farms is approximately the same as the number of pig farms in Finland. Nevertheless, less than 0.3% of meat produced in Finland is sheep or goat meat, whereas almost half of meat produced in Finland is pig meat (Appendix 2, Table 29).

The number of sheep in Finland is only 0.3% of the sheep population in Great Britain, where sheep farms have been promoting the spread of some animal diseases. The number of sheep in Finland decreased between 1995 and 2000. Since 2000, the number of sheep has increased, but is still lower than in 1995. There is no clear indication as to what the future entails for sheep production in Finland. However, it can be assumed that there will be a slight trend towards increasing production.

The small impact of sheep production on disease spread under 2009 conditions indicates that if sheep production increase and the increase concentrated on sheep farms with only sheep, the expected impacts on the risk of other production sectors would probably be relatively low. Goat production is even smaller in Finland. The number of does is less than 1/10 of the number of ewes. The future impact of goat farming on other production sectors can be expected to be even smaller than that of sheep production.

Mixed farms of sheep or goats with pigs or cattle are not efficient amplifiers of disease spread. In Finland, the number of mixed farms is low and they are generally smaller and thus less connected with other farms than an average-sized farm. The probability of an epidemic outbreak increased by approximately 4% and the mean size of an epidemic outbreak decreased slightly when simulations of spread were started on mixed farms and sheep and goat connections were included. The results indicate that most of the spread potential of mixed farms is due to connections related to pig and cattle production. Even in this limited group of farms, the inclusion of sheep and goat contacts added little value to the predictions.

A clear result is that the inclusion of sheep and goat farms in the simulations increased the number of non-infected farms in control, protection and surveillance zones by 13%. Thus, the exclusion of sheep and goat farms leads to an underestimation of the direct costs of risk management and disease control measures, as the costs of inspections in restrictive zones and tracing of contact farms are related to the number of farms, their location and size.

The sheep and goat registry was introduced in 2008. TIKE considered the total number of sheep in official statistics for 2008–2012 to be only approximate. The animal movement data from 2009 used in this study were probably an underestimate of sheep and goat movements between Finnish farms. Therefore, the overall picture of sheep farming as a low-ability spreader should be considered with caution.

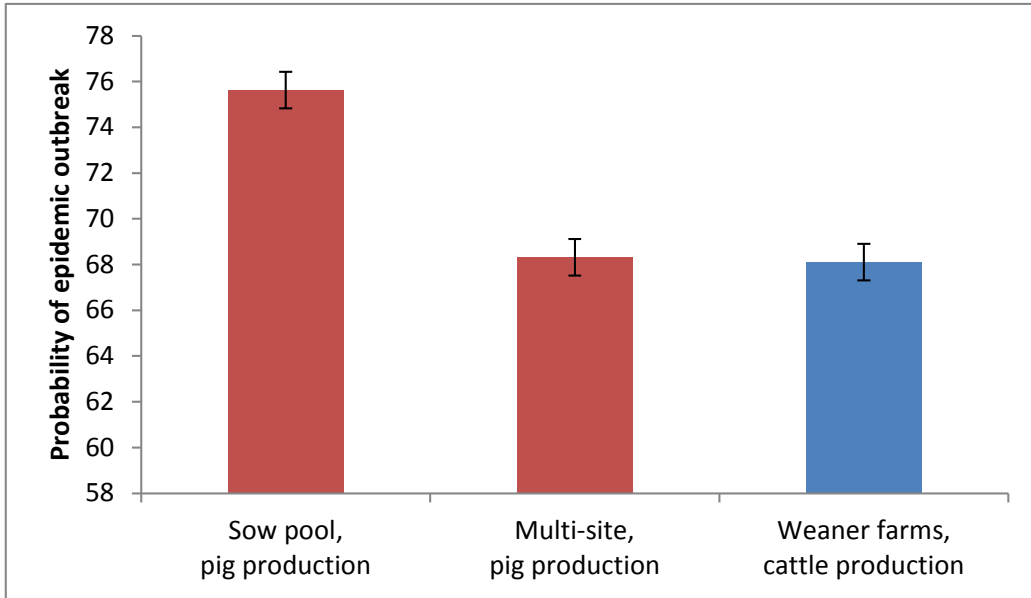
Assumptions regarding the detection time have marked effects on the outcome of simulations. We applied the same detection time assumptions as for the primary infected farm on all farms. Infected sheep, cattle, goat and pig farms would be detected 20 days after virus introduction in our simulations. Only a considerable deviation from this assumption on sheep farms would warrant revision of the claim that sheep and goat production have a lower spread potential than pig and cattle farms. Sensitivity analysis revealed that to reach the same spread potential as a pig farm, the detection time of an outbreak starting from a sheep or goat farm would need to be 4 times longer than it is for a pig farm. However, McLaws & Ribble analysed 24 non-endemic epidemic outbreaks between 1992 and 2003 and found that FMD outbreaks are detected within 25 days from virus introduction, and the average detection time is markedly lower. This suggests that a four times longer detection time in situations where a sheep or goat farm acts as the primary infected farm would be unlikely.

### 3.3 The effect of specialized production on the spread of FMD

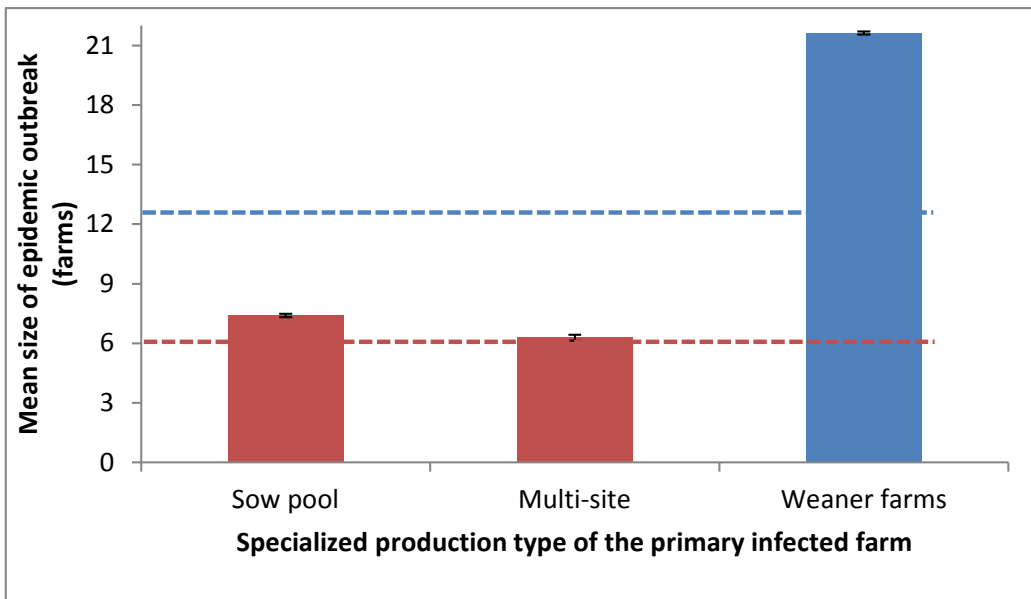
Specialized production (sow pools, multi-sites and weaner farms) was only assessed in FMD simulations. The probability of an epidemic outbreak (i.e. disease spreading to other farms) was higher when the outbreak started from a pig farm that is part of a sow pool or a multi-site production system when compared to other pig production. Similarly, if an outbreak started on a weaner farm for calves, the probability of an epidemic outbreak was markedly higher than on average in outbreaks starting from the cattle sector (Figure 3).

The mean size of an epidemic outbreak was also higher when the outbreak started in any of these three specialized production forms. Most notably, the mean epidemic outbreak size was 21.6 farms and the probability of a large outbreak was 0.23 when the outbreak started from a weaner farm (Figure 4). The corresponding probability was 0.07 for sow pools and 0.04 for multi-sites. Additional analysis of the reference simulations (Appendix 5) showed that the weaner farms were involved (either as primary or secondary infected farms) in 70.6% of all large simulated outbreaks, although they comprise only 0.3% of Finnish cattle farms.

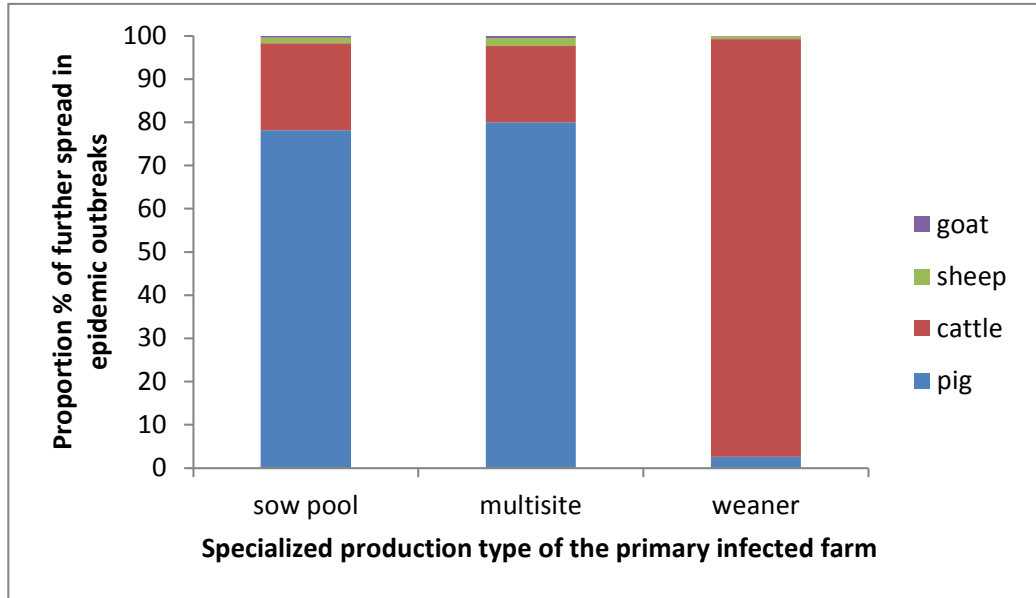




**Figure 3.** The probability of a simulated epidemic FMD outbreak when the primary infected farm is sow pool, multi-site pig farm or weaner farm. The blue dashed line indicates the probability of epidemic outbreak when the simulation has started from any farm in the cattle sector and the red line when the simulation has started from any farm in the pig sector. Error bars represent the 95% confidence interval for the estimates.



**Figure 4.** The mean number of infected farms in a simulated epidemic FMD outbreak when the type of the primary infected farm is sow pool, multi-site pig farm or weaner farm. The blue line indicates the mean when the epidemic outbreak has started from any farm in the cattle sector and the red line when the outbreak has started from any farm in the pig sector. Error bars represent the 95% confidence interval for the estimates.



**Figure 5.** The proportion of goat, sheep, cattle and pigs farms as the destination of disease spread when the primary infected farm is a sow pool, a multi-site pig farm or a weaner farm.

When specialized farm types acted as the primary infected farm, disease spread usually remained within the same production sector. In cases of spread between production sectors, the pattern was the same as when an outbreak had started on an ordinary farm (Figure 5). In multi-site systems, 27.6% of further spread stayed within the system. If an outbreak started in a sow pool system, 12.1% of further infected farms belonged to sow pool systems. When focusing only on animal transport, in outbreaks starting on a farm that is part of a multi-site system, 33.6% of infected farms that were infected by direct animal contact also belonged to a multi-site system. In sow pools, the corresponding number was 13.0%.

Compared with the farm type-specific results from the reference simulations (Appendix 5), it becomes even more apparent that the probabilities of an epidemic and a large outbreak are higher within multi-site production. Moreover, the mean size of an epidemic outbreak was larger than typically on sow farms. The relative variation in outbreak size was slightly lower than in reference simulations for the corresponding farm type (Table 7). Similar observations are also valid in sow pool systems with a few exceptions. Farms classified as finishing farms were more capable of inducing epidemic outbreaks, and the mean size of epidemic outbreaks was higher than on the finishing farms of multi-site systems (Table 8).

Other traffic (see Appendix 7, Table 54) has more relevance in cases of spread from weaner calf farms than from networked pig farms (Figure results 6). In contrast, the size of epidemic outbreaks from networked pig farms is more defined by animal transport-related contacts (Figure 6).

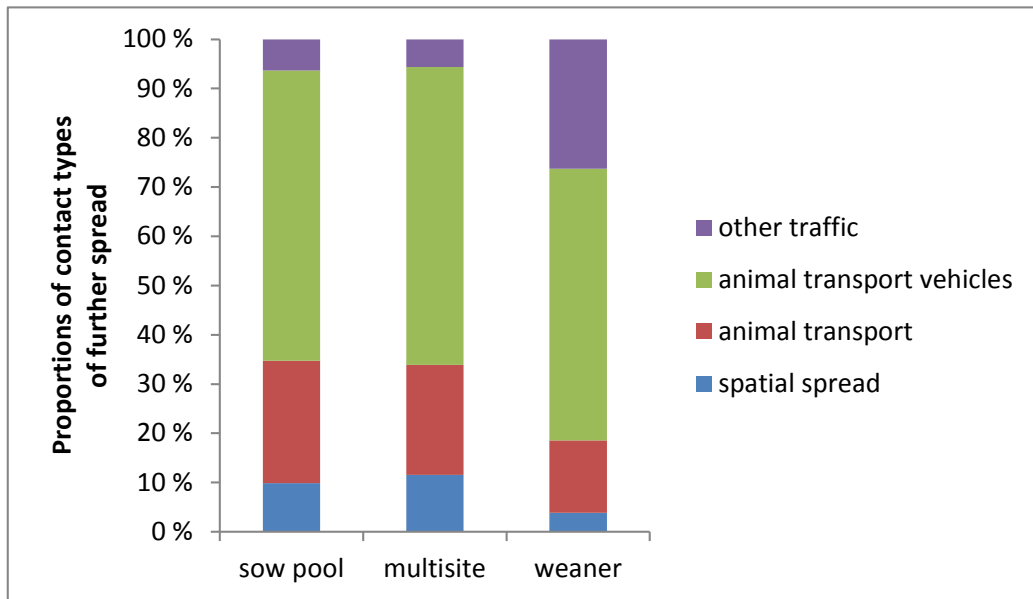
**Table 7.** The effect of farm type within a multi-site production system on the simulated FMD spread (N = 100 000 iterations) starting from a specialised production farm. CV = coefficient of variation.

Farm type of primary infected farm	Mean size of epidemic outbreak	CV of size of epidemic outbreaks	P(epidemic outbreak)	P(large outbreak)	Total N of iterations
Farrowing farm	7.96	1.28	0.79	0.07	13 448
Farrowing-to-finishing farm	6.81	1.33	0.80	0.04	10 956
Finishing farm	5.33	1.35	0.61	0.02	38 005

**Table 8.** The effect of farm type within a sow pool system on the simulated FMD spread (N = 100 000 iterations) starting from a specialised production farm \*.

Farm type of primary infected farm	Mean size of epidemic outbreak	CV of size of epidemic outbreaks	P(epidemic outbreak)	P(large outbreak)	Total N of iterations
Farrowing farm	7.79	1.31	0.81	0.07	12 217
Farrowing-to-finishing farm	6.69	1.21	0.73	0.06	7 985
Finishing farm	7.81	1.05	0.76	0.08	1 504

\*Note that only a proportion of finishing pigs are grown on farms identified as part of a sow pool system in this study.



**Figure 6.** Proportional contribution of contact routes to the simulated spread of FMD when the type of the primary infected farm is a sow pool, multi-site pig farm or weaner farm (for definitions: Appendix 7, Table 1).

### 3.3.1 Discussion, the effect of specialized production

Multi-sites and sow pools as the primary infected farm were simulated to produce larger outbreaks than average-sized pig farms in reference simulations. In addition, the probability of epidemic outbreak was larger for multi-site and sow pool farms. Farms belonging to sow pools and multi-site systems were divided into the same farm type classes (farrowing, farrowing-to-finishing, finishing farms) as conventional farms. This enabled more appropriate comparison with the outcomes of typical farms. When these approximate farm types were compared against a standard produc-

tion system, the difference was larger than when special and standard production systems were compared as groups.

Only a small fraction of further spread remained within these specialized production networks. Thus, pigs are also frequently delivered outside these networks. This may in part be an identification and classification issue. The data may not have been able to fully identify all the farms belonging to the networks. Identification was based on information gathered from slaughterhouse companies. Because the delivery of piglets is mostly coordinated by slaughterhouse companies, they are able to identify farms belonging to networked production. The intensity at which the farms operate as part of a network may vary. For instance, farms may have additional production capacity and animals raised with this additional capacity may originate from or end up to outside the network. Partially networked production systems may produce larger outbreaks because they “leak” outside the system. In FMD simulations, part of the leak is due to airborne spread towards the cattle sector. Part of the leak is also due to transport to pig farms outside the network. Farms in these pig production systems were on average larger than a typical pig farm in Finland. This may contribute to the larger outbreaks and higher probabilities of epidemic outbreaks.

The results suggest that if disease is detected in a networked pig production system, it is relevant to consider all farms within the system as contact farms. In addition, because the systems generally leak, normal contact tracing is important.

Networked pig production systems affected the risk of the cattle sector receiving the disease in a similarly to standard production systems. During an outbreak, the spread of disease from the pig sector to the cattle sector can be considered independently of the type of pig production system.

On average, weaner farms produced markedly larger outbreaks than any other farm type in the cattle sector. They were also involved in the majority of large outbreaks, indicating that they are highly connected with other farms. The higher percentage of weaner farms involved in large outbreaks than all farm types on average suggests that these farms were both effective in spreading the disease and also efficient in receiving an infection. Weaner farms were not particularly large farms. However, because animals spend only a short period of time on the farm, the turnover rate is high and the farms are efficiently connected with other farms. It is important that these farms are not connected with each other. In other words, farms should not deliver animals to several weaner farms.

Information on animal transport vehicles is not available in as much detail from the cattle sector as from the pig sector. In the pig sector, almost all movements can be linked with the vehicle identification number. On the other hand, vehicle movements can only rarely be linked with animal movement in the cattle registry. Therefore, we applied information gathered from slaughterhouse companies to estimate the number of vehicle movements per day. Additionally, we assumed that other animal movements occurring nearby on the same day were likely to utilize the same vehicle. This means that, in case of special arrangements in the logistics of weaner farms, the accuracy of our estimates for the spread potential from weaner farms may decrease.

The number of sow pools has decreased during recent years, and industry representatives have recently estimated that the number will further decrease in the future. The number of sow pools was reduced from 15 in 2002 (Rosengren et al. 2002) to 12 in 2009. By contrast, networked multi-site pig production and three-stage cattle

production may be increasing. It is important that the logistics in these specialized production systems are developed systematically. The development should include epidemiologically relevant preventive operations as the key criteria.

One of the weaknesses of networked pig production is that the systems are not always as closed as they could be. Therefore, these systems are less easily handled in disease outbreaks and other animal health disorders and the consequences of failure are dispersed more widely. Through careful planning, more closed systems can be achieved. Other potential improvements in the logistical solutions, such as improved synchronisation of animal flows and separated animal transport, decrease the risk of disease spread in the system. However, even if a completely closed system would be the goal from the disease risk management perspective, it cannot be achieved completely. Diseases that have spatial spread mechanisms (vector borne, airborne) are not stopped even if the animal transport system is completely closed.

Weaner farms were the most effective production type to spread the diseases further. They have frequent connections with a large number of farms, from which they receive and to which they send animals. One of the problems with this type of operation is that weaner farms do not operate completely separately. Animals from one farm may be transported to several weaner farms that are also connected with a large number of other farms.

### 3.4 Projected changes in production structure and expected consequences of structural change

Luke performed projections for different scenarios of structural change. These needed to be interpreted into a form that could be included into the epidemiological simulations. We applied three scenarios: "Baseline 2033", "Slow pig 2033" and "Fast cattle 2033", which are described in Table 9 (for detail, see Appendices). The scenarios can be summarized as follows:

- **Scenario "Baseline 2033"**: More than 2/3 of pig farms and over 70% of dairy farms operating in 2009 exit the business by 2033. The expected reduction in the number of beef cattle and suckler cow farms is smaller. When the number of farms decreases, the number of animals per farm increases to maintain the presumed production level. The scenario assumes an approximately 20% overall decrease in production. Despite this, the number of animals on the farms increases. The largest relative increase is among farrowing farms and the smallest among beef cattle farms (Tables 9 and 10).
- **Scenario "Slow pig 2033"**: The number of pig farms is 1/3 higher and the average number of animals per farm is 50–60% lower than in the baseline scenario. Cattle farms are as in the baseline scenario (Tables 9 and 10).
- **Scenario "Fast cattle 2033"**: the number of cattle farms decreases more than in the baseline scenario, but the number of animals per farm is higher (Tables 9 and 10).

The scenarios influence the data applied when simulating contacts between farms, because the contact structure is dependent on the future number and size of farms. The "AI technician" and "dairy tanker" data (Appendix 1) were reduced by the same magnitude as the number of dairy farms. Amendments to the slaughterhouse data were somewhat smaller due to a smaller reduction in the number of suckler and beef cattle farms. The smallest reduction was in the animal transport data, but this

depended on the assumptions made concerning animal transportation logistics in 2033 (Appendix 7; Table 11).

**Table 9.** Number of farms in Finland and animals per farm in three different scenarios. The year 2009 is given as a reference. Scenarios are based on the distribution of 1000 projections.

Farm type	Year 2009		Baseline 2033		Slow pig 2033		Fast cattle 2033	
	N	size	N	size	N	size	N	size
Farrowing farm	763	209	56	1 562	87	1 013	56	1 562
Farrowing-to-finishing farm	879	435	206	1 567	314	995	206	1 567
Finishing farm	698	663	222	1 734	359	1 099	222	1 734
<i>Pig farms</i>	<i>2 340</i>		<i>484</i>		<i>760</i>		<i>484</i>	
Dairy farm	12 438	50	3 459	133	3 456	132	2 604	177
Suckler cow farm	1 628	63	1 122	169	1 163	169	856	226
Beef cattle farm	2 588	58	1 179	72	1 182	71	861	95
<i>Cattle farms</i>	<i>16 654</i>		<i>5 760</i>		<i>5 801</i>		<i>4 321</i>	
Total	18 994		6 244		6 561		4 805	

**Table 10.** Relative change (%) in the number of farms and farm size in three different scenarios for 2033 compared to the situation in 2009.

Farm type	Baseline 2033 Relative change % in		Slow pig 2033 Relative change % in		Fast cattle 2033 Relative change % in	
	Number of farms	Farm size	Number of farms	Farm size	Number of farms	Farm size
Farrowing farm	-93	+647	-89	+385	-93	+647
Farrowing-to-finishing farm	-77	+260	-64	+129	-77	+260
Finishing farm	-68	+162	-49	+66	-68	+162
<i>Pig farms</i>	<i>-79</i>		<i>-67</i>		<i>-79</i>	
Dairy farm	-72	+166	-72	+164	-79	+254
Suckler cow farm	-31	+168	-29	+168	-47	+259
Beef cattle farm	-54	+24	-54	+22	-67	+64
<i>Cattle farms</i>	<i>-65</i>		<i>-65</i>		<i>-74</i>	

**Table 11.** The number of records in different databases for 2009 and in three different scenarios for 2033. The relative differences (%) compared to the records in 2009 are given in parentheses.

Database	2009	Baseline 2033	Slow pig 2033	Fast cattle 2033
AI visits database	499 391	152 970 (-69%)	152 590 (-69%)	115 050 (-77%)
Dairy tanker visits database	21 418	6 319 (-70%)	6 305 (-71%)	4 752 (-78%)
Slaughterhouse database	132 814	46 131 (-65%)	54 848 (-58%)	38 656 (-71%)
Animal transport between farms database	117 365	62 475* (-47%)	67 158* (-43%)	51 161* (-56%)
Semi-connected animal transport records between farms	na	52 441	53 934	44 580
Fully connected animal transport records between farms	na	10 034 (-92%)	13 224 (-88%)	6 581 (-94%)

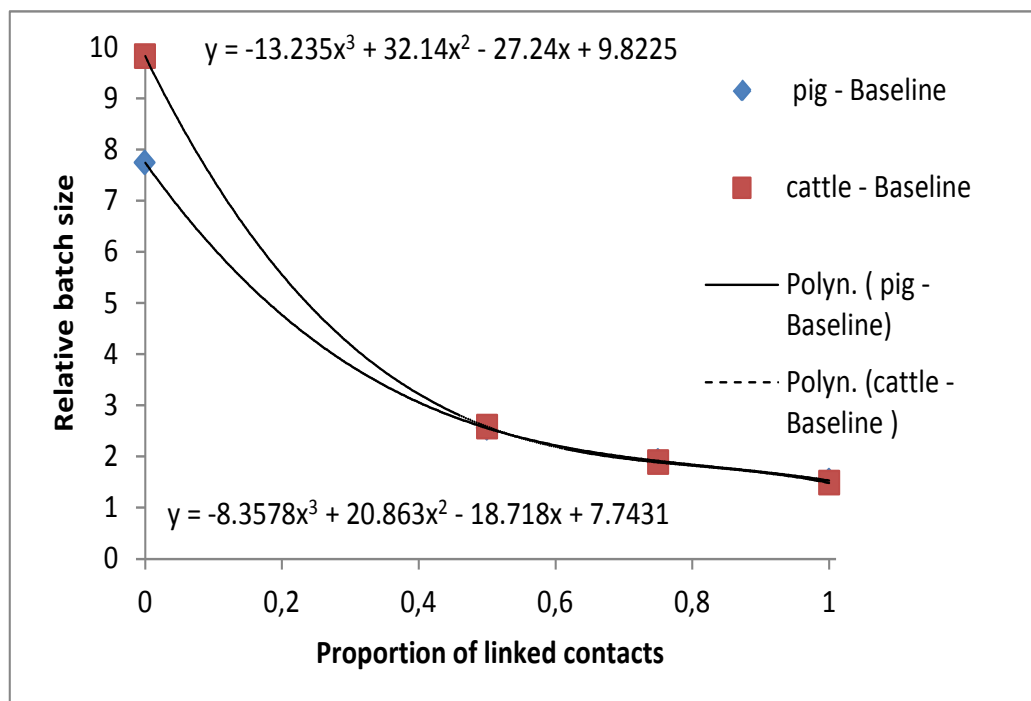
\*All semi-connected animal transport records are re-linked in the scenarios for 2033. (Semi-connected transport records: Animal transport contacts for 2009 in which either the source or target farm has exited the industry before 2033 in an iteration; for more information, see Appendix 7).

na = not applicable

The applied scenario and proportion of re-linked contacts determine the assumed relative batch size in the scenario (Figures 7–9). This assumption also varies between production sectors. In the pig and cattle sectors, the same proportion of re-linking will lead to a different batch size. The proportion of re-linking also defines the number of animals transported per farm per year. If the proportion of re-linked contacts is low, the batch size should increase as the total number of contacts decreases more than with a higher proportion of re-linked contacts.

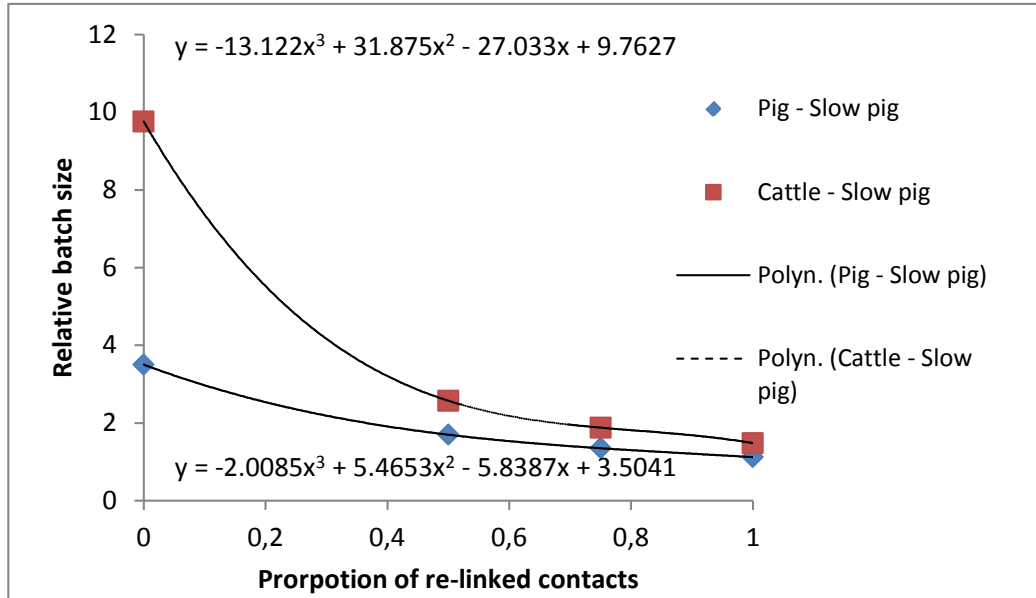
The “Slow pig” scenario deviates from the “Baseline” scenario only in assumptions related to the pig sector. As the number of farms continuing in the business is higher than in the baseline scenario, the expected requirements for a batch size increase are lower than in the baseline scenario. In the “Fast cattle” scenario, in contrast, the increase in batch size expectation is higher than in the baseline scenario for the cattle sector.

Generally, we assume that the total number of contacts will decrease. In all scenarios and proportions of re-linking, the total number of contacts is lower than in 2009 (Figure 10). The intensity per farm is likely to increase, as the number of contacts is higher than in 2009, if the proportion of re-linked contacts is at the 0.15 level in the pig sector and 0.35 in the cattle sector (Figure 11).

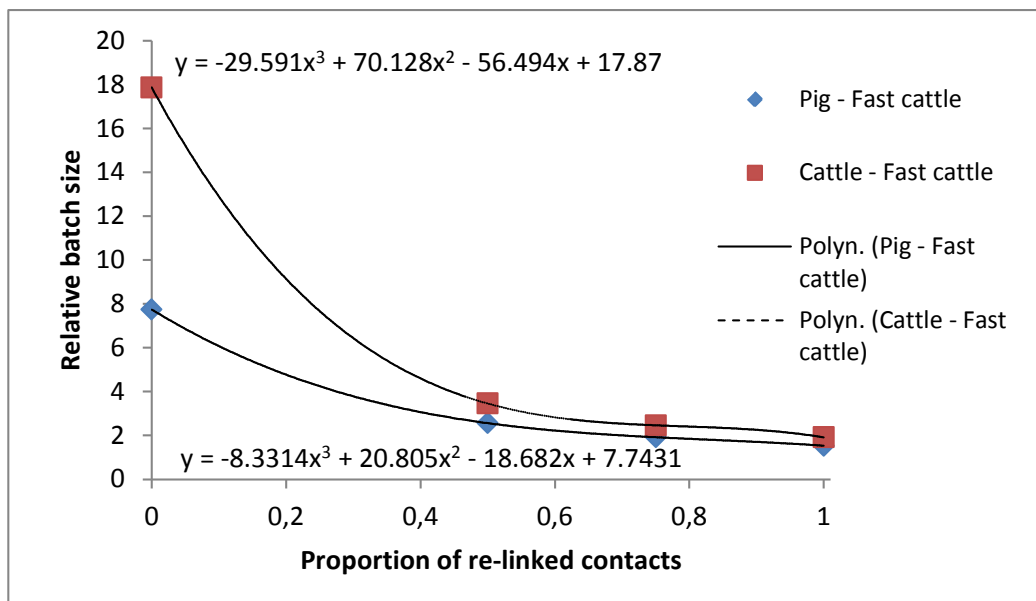


**Figure 7.** The effect of the proportion of re-linked animal transports on the relative batch size in the “Baseline” scenario. The relative batch size describes how many times more animals need to be transferred from one farm to another per transport with a given proportion of linked contacts than in 2009. Third degree polynomial fits are given for interpolations.

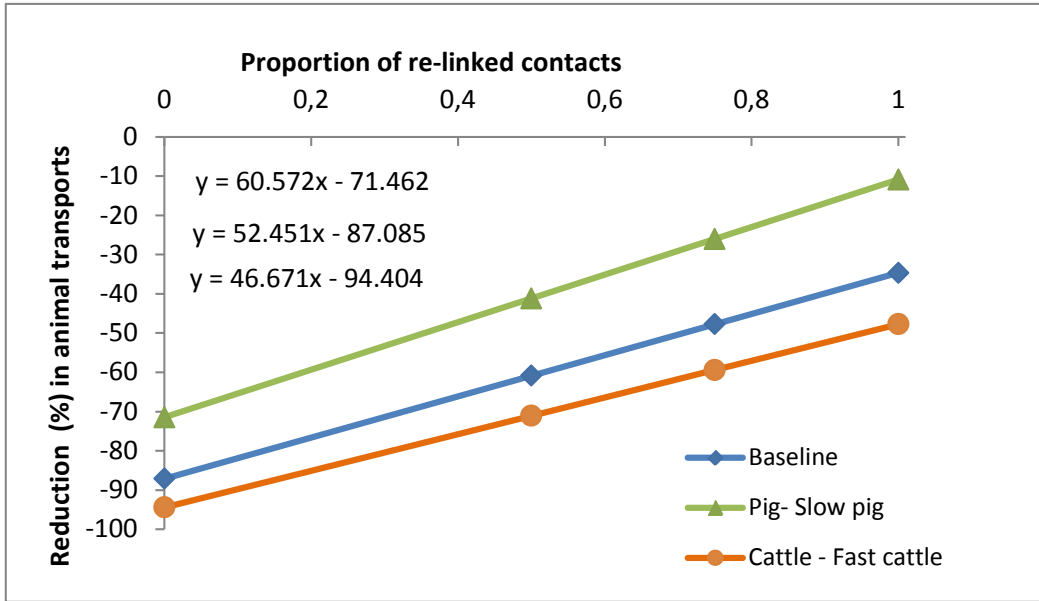




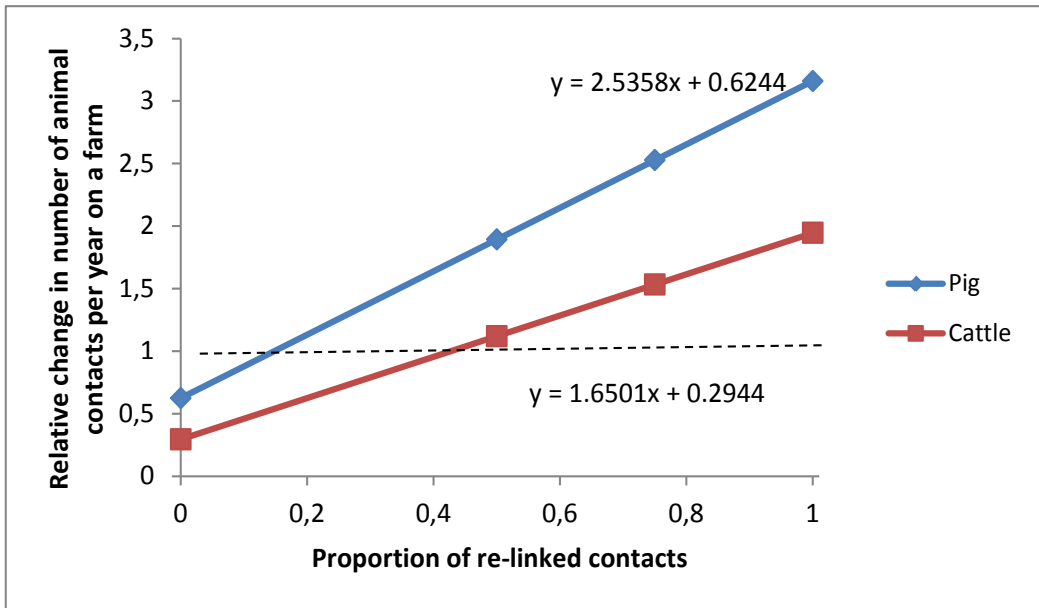
**Figure 8.** The effect of the proportion of re-linked animal transports on the assumed relative batch size in the “Slow pig” scenario. The relative batch size describes how many times more animals need to be transferred from one farm to another per transport with a given proportion of linked contacts than in 2009. Third degree polynomial fits are given for interpolations.



**Figure 9.** The effect of the proportion of re-linked animal transports on the relative batch size in the “Fast cattle” scenario. The relative batch size describes how many times more animals need to be transferred from one farm to another per transport with a given proportion of linked contacts than in 2009. Third degree polynomial fits are given for interpolations.



**Figure 10.** Reduction in total animal transports in Finland in “Baseline”, “Slow pig” and “Fast cattle” scenarios according to the proportion of linked contacts. Linear fits are only suitable for interpolation. The “Baseline” scenario also represents the relative change in the pig sector in the “Fast cattle” scenario and the change in the cattle sector in the “Slow pig” scenario.



**Figure 11.** Relative change in the number of animal transport contacts per year on a farm according to the proportion of re-linked contacts in the pig and cattle sector. Linear fits are only suitable for interpolation.

**3.4.1 Discussion, projected changes in production structure**

The total number of animal movements between farms was assumed to decrease in all scenarios due to the reduction in the number of animals in the country. It can also be expected that the batch size will increase. In our baseline scenario for the pig sector, the minimum batch size increase was assumed to be 50%. This is linked to the assumption that the number of contacts per farm will increase 3-fold and the total number of animal transport contacts in Finland will decrease by 35%. Because the reduction in the number of cattle farms was assumed to be smaller than that of

pig farms, the number of contacts per farm will increase less in the cattle than in the pig sector. However, the total number of animals will be reduced by the same relative factor as the contacts in the pig sector.

Depending on the farm type, the pig farm size was projected to increase by 160–650% in the baseline scenario, while the number of pig farms decreased by 79%. It is unlikely that the annual number of animal contacts of a pig farm will decrease in the future. It would require the batch size in the baseline scenario to be at least 5.37 times larger (i.e. the proportion of re-linked contacts equals approximately 0.15) than in 2009, when the average batch size was 68 pigs. As a result, the average number of pigs per transport between farms would be 365. The 99th percentile of the batch size was 428 pigs in 2009. In other words, an increase to a 5.37 larger batch size appears unlikely. Pig transport vehicles vary in size. This scenario would require that the size of the typical transport vehicle in 2033 would be equal to the largest vehicles in 2009. Infrastructure limitations such as the quality of roads and the size of bridges may limit the possibility to increase the average vehicle size. However, the transportation technology may also change over the 20-year period, so that even larger vehicles may be available in 2033.

Assumptions regarding the increase in farm size also influence the possible range of animal transport contacts. It can be expected that the limiting factor is the size of the receiving farms, i.e. the size of finishing farms. The size was assumed to be only 2.6 times greater than in 2009. This may suggest a re-linking proportion of 0.5. If this criterion is applied, we are simultaneously assuming that the total number of animal transport contacts is only reduced by 60% and the contacts per farm per year increase by at least 160%. Larger increases in the batch size would only be possible if the duration of growing in the finishing stage was markedly reduced, which is not expected.

In the cattle sector, the average batch size was 2.2 animals in 2009. This suggests that a situation is very likely to be achieved where the number of contacts of a farm per year would decrease according to our assumptions (re-linking 0.43). This would require an increase in the batch size to at least 6.6 animals, which is three-fold higher than in 2009. In 2009, the largest batches were markedly larger. The 99th percentile of the batch size was 20 animals in 2009. This suggests that the increase is very possible and that this assumption requires weaker assumptions for the increase in vehicle size than in the pig sector. Even a larger increase in batch size appears possible. Re-linking of all semi-linked contacts (batch size would be 9.8 times higher) would lead to a reduction in the total number of cattle transports by over 80%.

Sweden has a different production structure from Finland. Large cattle farms were more common in Sweden than in Finland in 2006–2008. During recent years, the average farm size in Finland has been similar to that in Sweden 10–20 years earlier. By applying data from Nöremark et al. (2011), it can be estimated that the average batch size in Sweden was 7.75 animals (505 908 individual animal transportation records, 65 201 movements) in 2008. Achieving a similar level in Finland, the batch size should increase by approximately 3.5-fold in the “Baseline 2033” scenario. By combining these two criteria, it can be considered realistic to achieve a 3–4 times larger batch size in the cattle sector by 2033. However, substantial adaptations in logistics may be required.

If we assume that the increase in the batch size is directly related to the farm size increase, the probable increase in the batch size would be lower. In our projection,

dairy and suckler cow farms were 2.7 times larger than in 2009. Larger increases in the batch size would require production-related changes on farms. The end point of cattle production, beef cattle rearing farms, is only slightly larger in our projections than in 2009. Their number is decreasing less than the number of dairy farms. If this is taken into account, it would lead to even smaller batch size increases. The ability of these farms to receive animals would not increase much if they operate as they did in 2009. It may be assumed that the increase in the batch size is probably less than 170% and the relevant proportion of re-linked contacts is at minimum 0.5.

If the efficiency of logistics and production increase less than farm size, the average batch size will probably also increase less. Thus, assuming maximum re-linking (1) of animal transports, it would lead to a situation where only a modest 50% increase in batch size is achieved. However, this would reduce the benefits of increased farm size. A re-linkage of 0.75 would probably cause a more credible lower limit for the batch size increase (90%) along with increasing farm size.

The alternative scenarios differ from the baseline. The “Slow pig 2033” scenario assumes a smaller reduction in the number of farms and a smaller increase in the number of animals on the farms. On the contrary, the “Fast cattle 2033” scenario assumes a larger reduction in the number of cattle farms and a larger increase in the farm size.

Using the above logic, the smallest possible batch size increase in the “Slow pig 2033” scenario is 66%, because the finishing farm size increases accordingly. In the “Slow pig 2033” scenario, a re-linkage proportion of 52% of animal transports corresponds to a 66% increase in the batch size. In the “Fast cattle 2033” scenario, the minimum batch size increase would be slightly higher than in the baseline scenario. This means that the minimum increase in batch size would be 250% (corresponding to a re-linkage of 0.49). If farm size-related criteria are applied in re-linking, the possible re-linking is similar, regardless of the applied scenario. This is because the number of semi-linked contacts changes together with the number of farms defined by a scenario.

Despite what was noted above, in all scenarios and re-linking options, the batch size is larger than in 2009 in both production sectors. This study does not present any results for a situation in which Finnish animal production operates logistically “less efficiently” than today.

### 3.5 Structural development and economies of scale

The data show that wages and materials are the main cost items in livestock farms (Appendix 6). Work on farms is still mainly conducted by the producer and his or her family (on average 95%), because the share of paid labour is on average only 5%. Producers have invested in technology (machinery and buildings), which resulted in the share of labour costs remaining relatively stable or decreasing during 2000–2011. By contrast, the share of costs incurred due to materials, machinery and buildings has increased.

Previous research suggests that as farm size increases, the most significant change is related to the decreased share of labour costs (Ala-Mantila 1998). The biggest share of production costs in dairy farming is accounted for by wages. Other costs (animals,

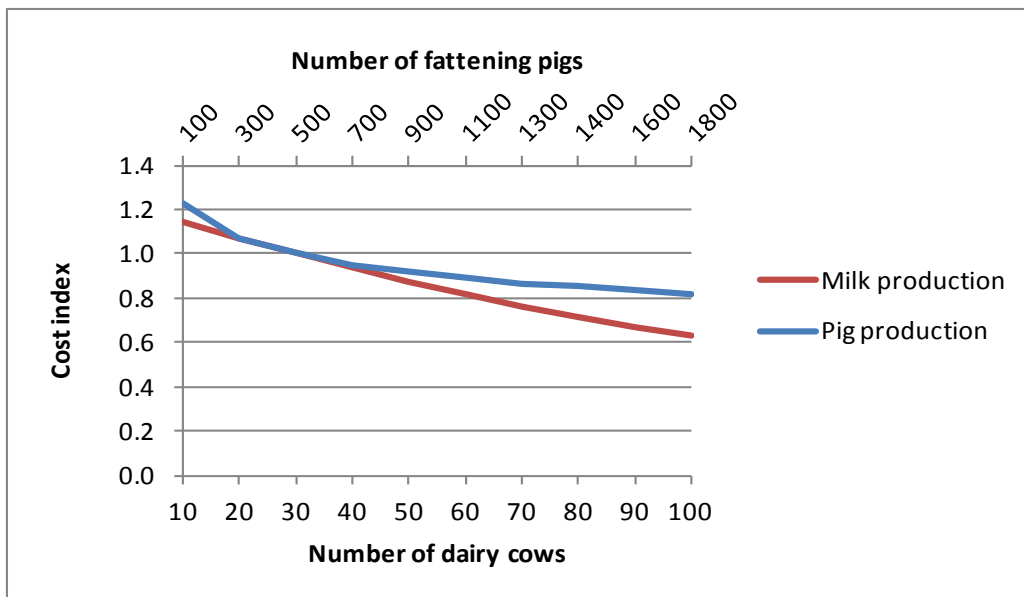
other animal expenses, insurances, electricity and fuels) also form a significant share of production costs. The unit production cost of milk, i.e. the total production costs of a farm divided by the quantity of output, decreases as the number of cows on the farm increases. In pig meat production, the largest individual cost items are piglets and purchased feeds. In pig meat production, the unit cost also typically decreases as more pig meat is produced by the farm.

Ovaska and Heikkilä (2013) have studied the structural development and competitiveness of Finnish dairy farms. They found that for a typical Finnish farm, the most significant cost disadvantages were machinery, wages and other costs. Wage costs decrease proportionally the most significantly as the farm size class increases. Latukka (2013) observed that small farms have the largest unit production cost, and as the number of cows per farm increases, the unit cost decreases.

Unit production costs were studied by using a linear mixed-effect model and farm-level data for the years 2000–2011. The results indicate that the unit production cost increases every year, but the rate of increase varies between farms and the type of production. The unit production costs decrease as farm size increases. Small farms (standard output less than €50 000) have significantly higher unit costs than medium-sized (€50 000–€100 000) or large farms (more than €100 000). This may be due to the relatively rapid growth in farm size in Finland during the 2000s. Hence, large farms may not yet have reached their desired levels of production and input use. The variation between farms and years was also larger for small than for large farms. There were no significant differences in unit costs between similar livestock farms located in different regions. The year-to-year correlation in unit costs was high and the unit costs of farms changed at a different pace over time.

Figure 12 illustrates how production costs per unit of output were estimated to decrease in finishing pig production and dairy production. Figure 12 is based on log-linear costing models ( $\log Y = a + bX + e$ ). This implies that decreasing economies of scale are assumed. The graphs in Figure 12 present the production costs of a dairy farm compared to a farm with 30 dairy cows and the production costs of a finishing pig farm compared to one with 500 pigs (i.e. for these farm sizes, the cost index is 1). The estimates were used to quantify possible economies of scale that would be available in future projected farms by 2033. Possible changes in prices or production technology over time were not accounted for, i.e. the comparison of costs was made at the 2009–2011 price level and by assuming the same production technology as in the bookkeeping data.

In the baseline scenario, the production costs per unit of output were estimated to decrease between 2009–2033 due to structural change by 22% in dairy production, by 8% in finishing pig production and by 6% in piglet production when compared to the farm structure observed in 2009. These results reflect changes in production costs on an average-sized farm. Changes in the costs of suckler beef production were not estimated due to data issues. The results are likely to be realistic, because the farm size in pig production has already increased substantially, whereas dairy farms in Finland are still quite small on a European scale. The results are in line with Rasmussen (2010), who estimated that the elasticity of scale is larger on dairy than on pig farms. Hence, dairy farms could benefit more from expanding their production than pig farms. In the “Slow pig 2033” scenario, the production costs of pig production were estimated to decrease by only 3–4%, while in “Fast cattle” scenario, the production costs of dairy farms were estimated to decrease by approximately 33%.



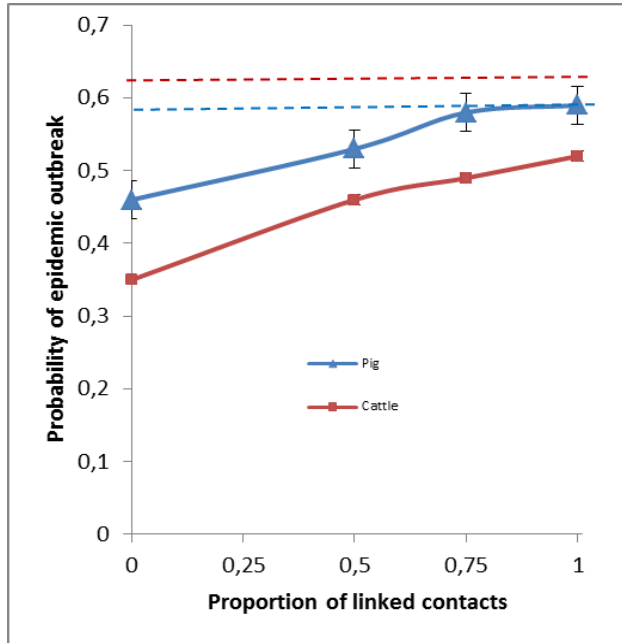
**Figure 12.** Projected change in production costs (cost/unit of output) in relation to farm size in finishing pig and milk production when compared to a finishing farm with 500 pigs or to a dairy farm with 30 cows.

### 3.6 Disease spread in production structures of the future

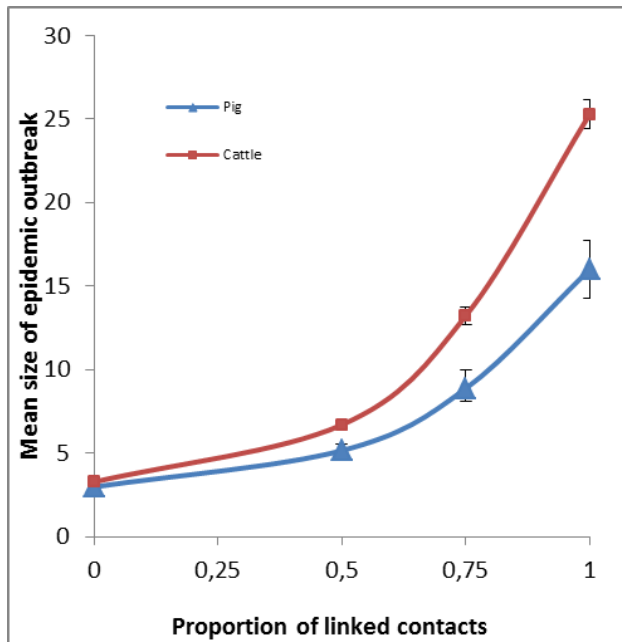
Most of the results are derived from the “Baseline 2033” scenarios for all three diseases. The differences between the scenarios are discussed in the conclusions.

#### 3.6.1 Foot-and-mouth disease (FMD)

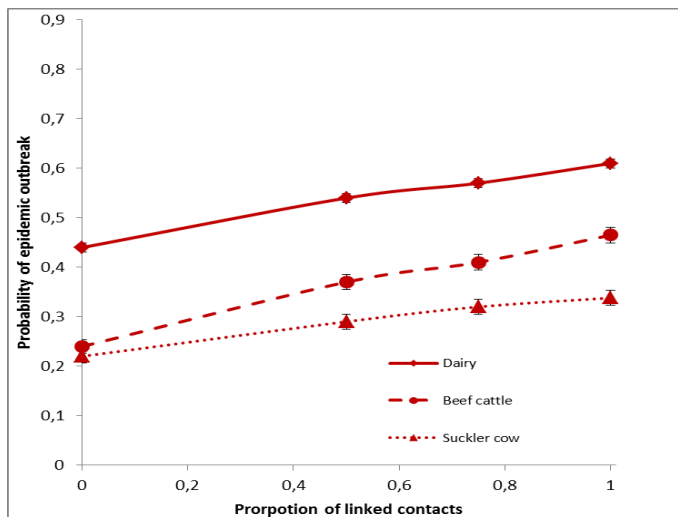
The probability of an epidemic outbreak in 2033 was lower or, at the most, equal to the level of the reference simulation. The greater the proportion of 2009 contacts that were assumed to be linked with animal transports between farms in 2033, the higher was the probability of an epidemic outbreak in 2033. The probability of an epidemic outbreak was generally higher when the outbreak started in the pig sector than when it started in the cattle sector (Figure 13). The mean size of an epidemic outbreak was generally larger when the outbreak started in the cattle sector. The relationship between the size and the proportion of linked contacts appeared to be curvilinear (Figure 14).



**Figure 13.** The probability of an epidemic outbreak in FMD simulations with the “Baseline 2033” scenario. The outbreak has started in either the pig or the cattle sector and a proportion of semi-connected animal transport links have been re-linked. Dashed lines represent the levels in reference simulations of 2009. Error bars represent 95% confidence intervals for the estimates.



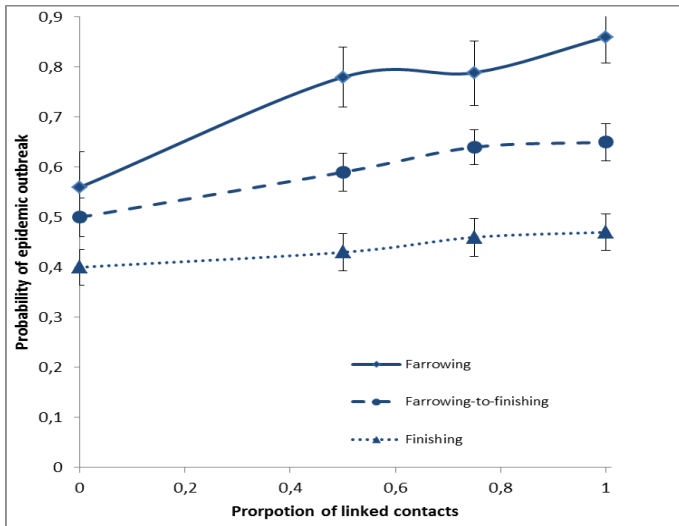
**Figure 14.** The mean size of an epidemic outbreak in FMD simulations with the “Baseline 2033” scenario. The outbreak has started either in the pig or the cattle sector and a proportion of semi-connected animal transport links have been re-linked. Dashed lines represent the levels in reference simulations for 2009. Error bars represent the 95% confidence intervals for the estimates.



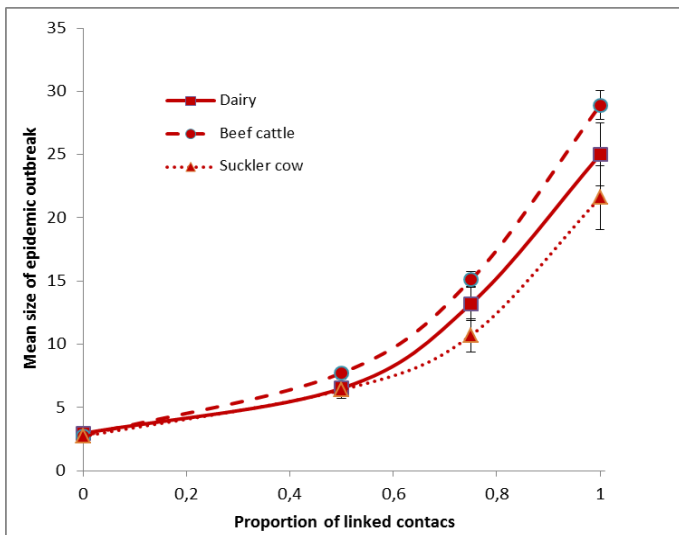
**Figure 15.** The probability of an epidemic outbreak in FMD simulations with the “Baseline 2033” scenario. The outbreak has started in the cattle sector and a proportion of semi-connected animal transport links have been re-linked. Error bars represent the 95% confidence intervals for the estimates.



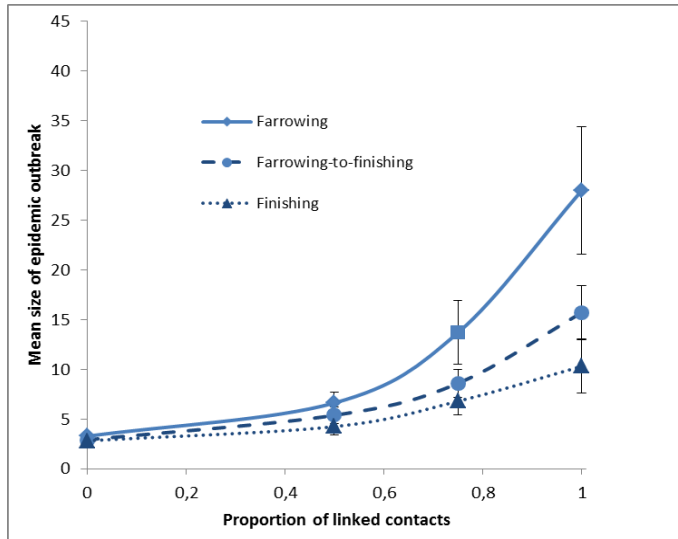
Outbreaks that started on dairy or farrowing farms yielded a larger probability of epidemic outbreak than outbreaks starting from other types of farms (results Figures 15 and 16). Suckler cow and finishing farms had the lowest probability of developing an epidemic outbreak. The mean epidemic outbreak size was high for all farm types in the cattle sector (results Figure 17). In the pig sector, only farrowing farms had a similar spread potential to cattle farms (results Figure 18). On farrowing-to-finishing and finishing farms, the mean size of epidemic outbreaks was markedly lower than on farrowing farms. The probability of large outbreaks appeared to be highest on farrowing farms, followed by the cattle sector, and lowest on finishing farms (results Figures 19 and 20). The variation in results increased as the proportion of linked contacts increased (results Figure 20).



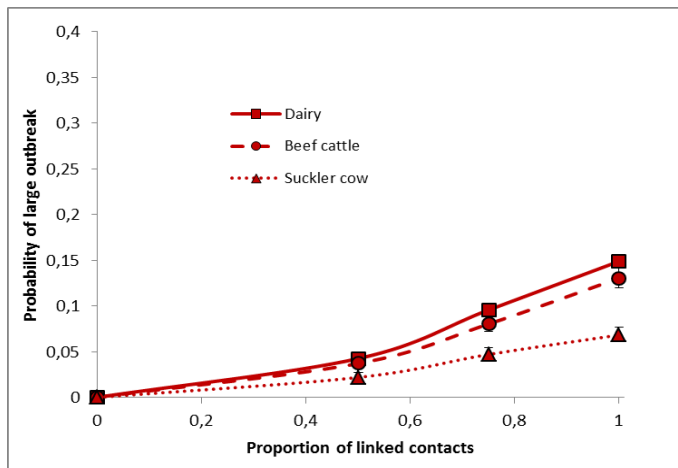
**Figure 16.** The probability of an epidemic outbreak in FMD simulations with the “Baseline 2033” scenario. The outbreak has started in the pig sector and a proportion of semi-connected animal transport links have been re-linked. Error bars represent the 95% confidence intervals for the estimates.



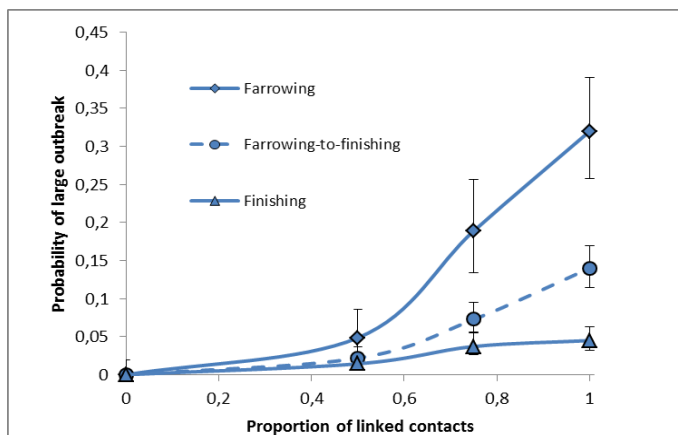
**Figure 17.** The mean size of epidemic outbreaks in FMD simulations with the Baseline 2033 scenario. The outbreak has started in the cattle sector and a proportion of semi-connected animal transport links have been re-linked. Error bars represent the 95% confidence intervals for the estimates.



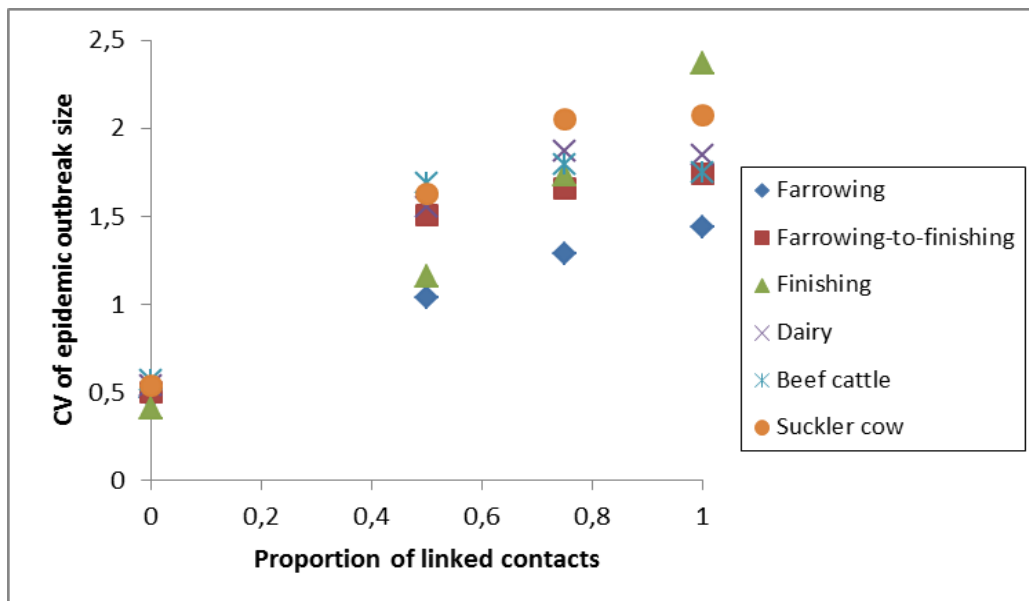
**Figure 18.** The mean size of epidemic outbreaks in FMD simulations with the “Baseline 2033” scenario. The outbreak has started in the pig sector and a proportion of semi-connected animal transport links have been re-linked. Error bars represent the 95% confidence intervals for the estimates.



**Figure 19.** The probability of large (>17 infected farms) epidemic outbreaks in FMD simulations with the “Baseline 2033” scenario. The outbreak has started in the cattle sector and a proportion of semi-connected animal transport links have been re-linked. Error bars represent the 95% confidence intervals for the estimates.



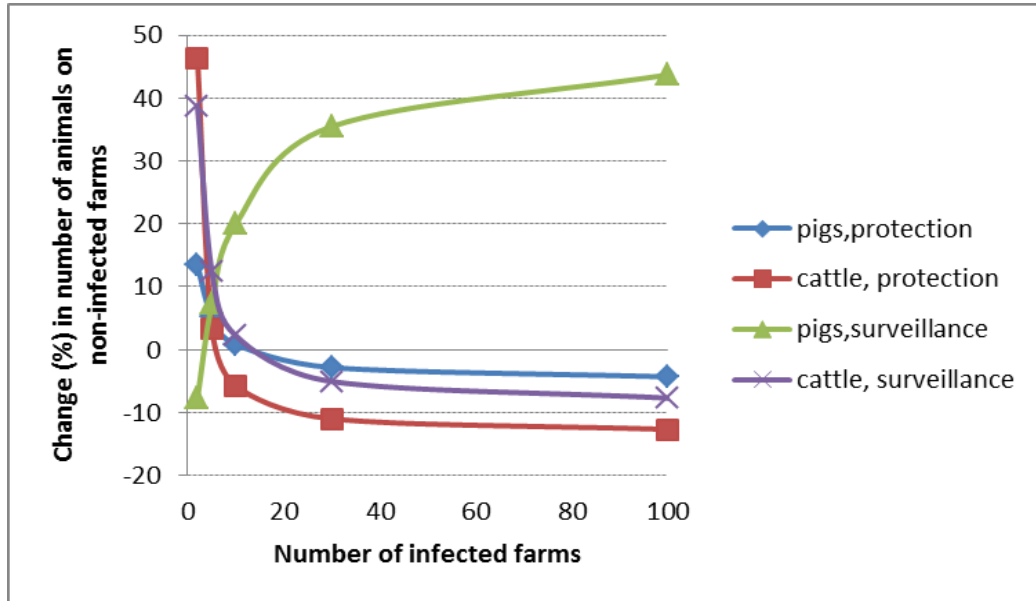
**Figure 20.** The probability of large (>17 infected farms) epidemic outbreaks in FMD simulations with the “Baseline 2033” scenario. The outbreak has started in the pig sector and a proportion of semi-connected animal transport links have been re-linked. Error bars represent the 95% confidence intervals for the estimates.



**Figure 21.** The coefficient of variation (CV) of the size of epidemic outbreaks in FMD simulations with the “Baseline 2033” scenario. The outbreak has started either in the pig or the cattle sector and a proportion of semi-connected animal transport links have been re-linked.

The numbers of non-infected farms per infected farm in protection and surveillance zones will decrease as the total number of farms and farm density decline. The decrease in non-infected farms per infected farm is estimated to be 50–60% in protection zones in epidemic outbreaks (Table 12). In sporadic outbreaks, the decrease is only 20%. Similarly, in surveillance zones, the decrease in non-infected farms within the zones is 50–60% per infected farm, depending on the size of the outbreak. Even in sporadic outbreaks, the reduction is over 40%.

The number of animals on infected farms was estimated to increase in the future, because the size of farms is expected to increase. If the type of the primary infected farm is not specified (any Finnish pig or cattle farm), the number of pigs per infected farm can be expected to decrease by 33–57%. In contrast, the number of cattle per infected farm can be expected to increase by 110–370% (Table 13). The explanation is that the number of pig farms is much lower than the number of cattle farms, and the primary infected farm in this scenario is any cattle or pig farm in Finland. In addition, an outbreak starting from the cattle sector remains within the sector much more frequently than an outbreak starting from the pig sector. In a typical outbreak starting in the cattle sector, the probability that pig farms become infected is smaller than the probability that cattle farms become infected in a typical outbreak starting in the pig sector.



**Figure 22.** The change in the number of animals in protection and surveillance zones in ucar when compared with 2009 conditions in relation to the number of infected farms.

The situation is different when estimating the number of animals on non-infected farms in protection and surveillance zones. In small outbreaks, the number of animals on non-infected farms in protection and surveillance zones can be 15–50% higher than under 2009 conditions (Figure 22). With an increased outbreak size, the impact of the reduced number of farms in the country starts to influence the outcome. This results in a slightly lower number of animals on non-infected farms than in 2009. Pigs in surveillance zones do not follow this general pattern. In larger outbreaks, the number of pigs on non-infected farms may increase slightly, but still clearly less than the size of pig farms (Figure 22). In conclusion, the simulation results do not suggest large changes in similar-sized outbreaks when the number of animals on non-infected farms in surveillance and protection zones is considered.

**Table 12.** The relationship between the number of FMD infected farms and non-infected farms in protection and surveillance zones in the “Baseline 2033” scenario. The relationship equation is  $y = a(\text{number of infected farms}) + b$ , where  $a$  and  $b$  are regression model coefficients. Models are only valid if the number of infected farms is  $>1$ . The SE of the coefficient is given in parentheses.

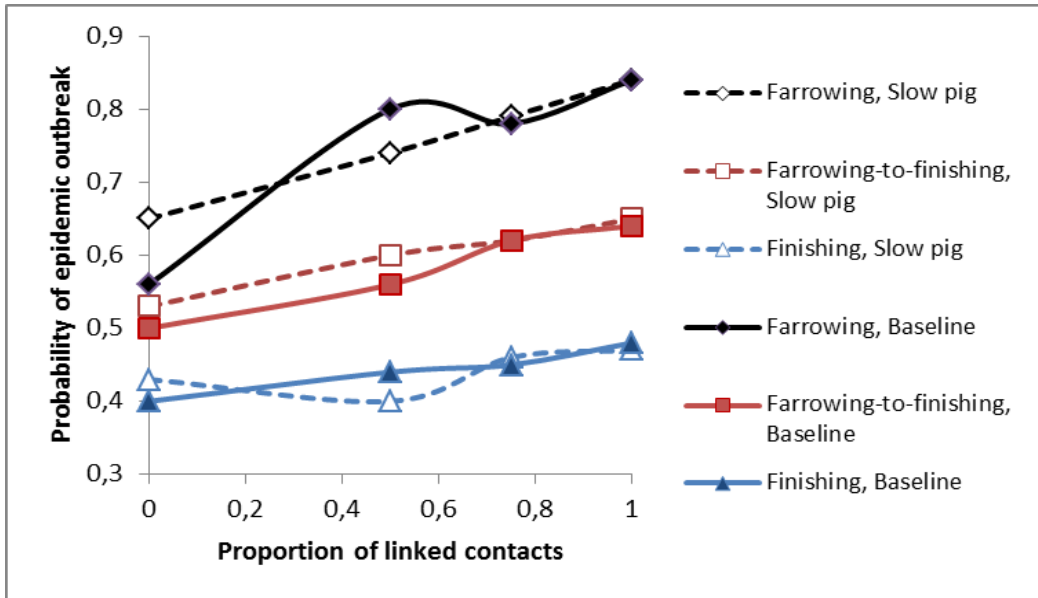
Variable y	a	b	R <sup>2</sup>
Number of non-infected farms in protection zones	2.065 (0.002)	0.187 (0.095)	0.982
Number of non-infected farms in surveillance zones	7.725 (0.008)	12.976 (0.391)	0.979

**Table 13.** The relationship between the number of FMD infected farms and the number of pigs and cattle on infected farms and on non-infected farms in protection and surveillance zones in the “Baseline 2033” scenario. The relationship equation is  $y = a \cdot (\text{number of infected farms}) + b$ , where  $a$  and  $b$  are regression model coefficients. Models are only valid if the number of infected farms is  $>1$ . The SE of the coefficient is given in parentheses. Piglets under 3 months and cattle under 6 months are not included in these figures.

Variable y	a	b	R <sup>2</sup>
Number of pigs on infected farms	10.8 (0.234)	83.6 (11.4)	0.096
Number of cattle on infected farms	209.2 (0.2)	-173.1 (9.7)	0.981
Number of pigs on non-infected farms in protection zones	224.8 (1.2)	548.0 (58.9)	0.634
Number of cattle on non-infected farms in protection zones	270.6 (0.3)	-7.1 (15.4)	0.974
Number of pigs on non-infected farms in surveillance zones	970.1 (3.6)	2 938.5 (175.6)	0.784
Number of cattle on non-infected farms in surveillance zones	964.3 (1.1)	1 622.3 (53.4)	0.975

### 3.6.1.1 Alternative scenarios

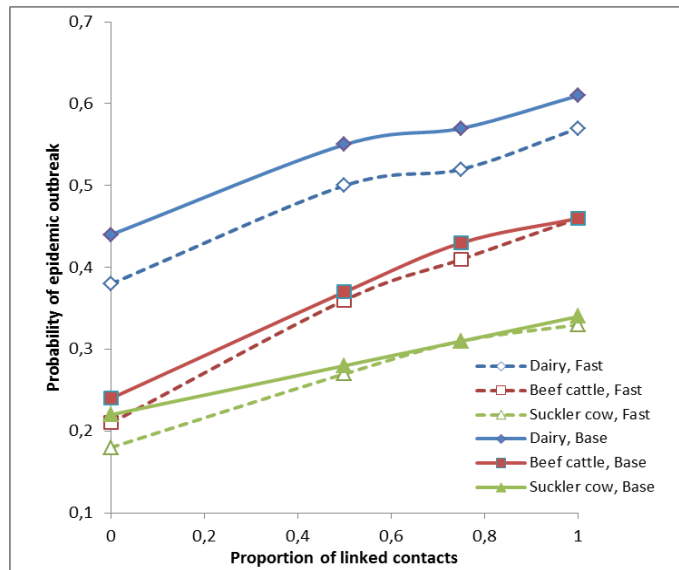
#### “Slow pig 2033”



**Figure 23.** The impact of the “Slow pig 2033” scenario on the probability of an epidemic outbreak.

The “Slow pig 2033” scenario did not have a clear effect on the probability of an epidemic (Figure 23) or a large outbreak, the mean size of an epidemic outbreak or the relative variation in outbreak size when compared to the baseline scenario. The proportion of re-linked contacts is a significantly more important factor in determining the risk of further spread than the future projection scenario.

### “Fast cattle 2033”



**Figure 24.** The impact of the “Fast cattle 2033” scenario on the probability of epidemic outbreaks in the cattle sector.

The “Fast cattle 2033” scenario had a small effect on the probability of an epidemic outbreak (Figure 24). On dairy farms, in particular, the probability of an epidemic outbreak was consistently lower than in the “Baseline 2033” scenario. On suckler cow and beef cattle farms, the effect was not as clear but showed the same tendency. The proportion of re-linked contacts was still a significantly more important factor in determining the risk of further spread than the applied scenario.

#### 3.6.1.2 Discussion, FMD

The outcomes of the different scenarios deviated only slightly, and it was therefore decided to make a general assumption regarding the animal transports (proportion of re-linked contacts) between the farms. It was concluded that a relinking proportion of 0.5–0.75 would probably be the most relevant range for the future scenarios, and this has been applied throughout this section of the report. Naturally, if this assumption is not valid in the future, the further conclusions should be adjusted accordingly.

The probability of an epidemic outbreak may decline in the future, as the probability of an epidemic outbreak at 0.5–0.75 re-linking was lower than the probability in the reference simulations. A larger proportion of re-linked contacts is expected to elevate the probability of an epidemic outbreak in the pig sector to the level of the reference simulations, but this does not apply to the cattle sector. Farm types responded differently to the re-linking assumption. The probability of an epidemic outbreak on farrowing farms was clearly elevated in the future scenarios. On farrowing-to-finishing and finishing farms, it was the same or slightly lower than in the reference simulations. The “Baseline 2033” scenario assumes that the largest farm size increase would occur for farrowing farms, and that the reduction in the numbers of farrowing farms would be larger than that among other pig farms. These assumptions together result in a higher relative concentration of contacts with farrowing farms than with other pig farms in future scenarios.

As in the pig sector, the farm type in the cattle sector influenced the probability of an epidemic outbreak. The reduction in the probability of an epidemic outbreak on dairy farms was at least 20%, while the suckler cow and beef cattle farms retained the same probability levels as in the reference simulations. We assumed that the

routes of dairy tankers and AI technicians would be shortened due to the reduced number of dairy farms. This can be expected to reduce the number of contact-receiving farms along the daily route. These assumptions, together with the reduced numbers of neighbouring farms, reduce the probability of an epidemic outbreak in the baseline simulations starting from dairy farms. The reasons for other cattle farms retaining the probability of an epidemic outbreak at the level of reference simulations may be connected with increased animal movements per farm and the lower significance of other traffic (persons and vehicles) in defining the spread potential.

The size of an epidemic outbreak varies and depends on the proportion of re-linked animal transport contacts, i.e. the increase in the batch size. With a 90% batch size increase, the mean size of epidemic outbreaks was higher than in the reference simulations. If the batch size is assumed to increase by 150%, the average outbreak size is reduced by 28–52% and the outcome is lower than in the reference simulations for all farm types except farrowing farms. This highlights the importance of animal transport logistics in defining the future spread potential.

Even if the batch size increased by 150%, leading to fewer infected farms during an outbreak, there would quite probably be more animals on infected farms, as the farm size is assumed to increase. If the farm type of the primary infected farm is not taken into account, the results mainly include outbreaks that have started from cattle farms. In this situation, the number of pigs per infected farm can be expected to be reduced by 33–57%. The number of cattle per infected farm, on the other hand, can be expected to increase by 110–370%. If the primary infected farm was a pig farm, the number of pigs per infected farms would increase from the level in the reference simulations.

The numbers of non-infected farms in protection and surveillance zones will markedly decrease. This is partially compensated by the increased farm size, and the reduction in the total number of animals in restriction zones thus remains almost equal to the level in the reference simulations. By assuming that the batch size will increase by 150%, the number of animals within the zones is estimated to decrease by 10–40%. If we assume that the batch size will only increase by 90%, the number of animals is estimated to show only a slight increase. These results mean that in the future, the impacts of restrictive zones on the production capacity will approximately remain at the level of the reference simulations.

The collection of data on non-infected contacts during a simulation requires a considerable amount of computational resources, limiting the number of iterations per simulation. Traced non-infected contact farms were therefore not assessed in this study. According to our earlier studies, the number of contact farms may correspond with the number of farms in surveillance and protection zones (Lyytikäinen et al. 2011). Because the number of farms in surveillance and protection zones can be expected to decrease, the number of traced non-infected and infected contact farms should increase. This will increase the importance of tracing in the future and decrease the importance of restrictive zones as risk management measures. It seems reasonable to assume that the reduction in non-infected farms in restrictive zones corresponds with the increase in traced contact farms if the infectivity of the contacts remains the same. Thus, it can be expected that the number of traced contact farms would exceed 80% of the total number of farms under restrictive measures, while in 2006 the proportion was only about 50%. Simultaneously, farms in restrictive zones would be reduced to one-fifth of the total number of non-infected farms under restrictive measures. Therefore, the information on contacts and how the information

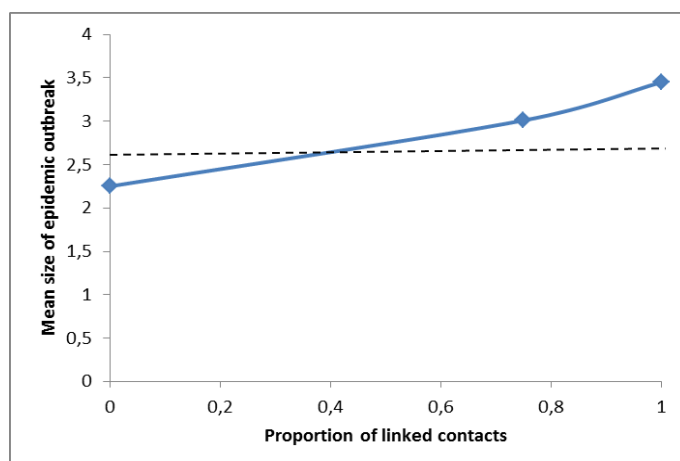


is handled will become more important in the future than it is today. This should lead to savings in direct management costs, as the risk management costs of a traced contact farm are lower than the management costs of a farm in a surveillance or protection zone (Lyytikäinen et al. 2011).

The culling of animals on infected farms can be expected to be more difficult in the future due to the increased numbers of animals per farm. Nevertheless, the total number of culled animals may not change dramatically, as the predicted change in the numbers of infected farms was moderate. Detailed planning is required on how many animals can be culled effectively and how the carcasses are to be stored and transferred to a rendering plant. It is recommended to revise the contingency plans by using the largest farms that are currently operating, because the number of animals on the largest farms can be used as an example of the future capacity requirements related to the culling and rendering capacity of the carcasses.

### 3.6.2 African swine fever (ASF)

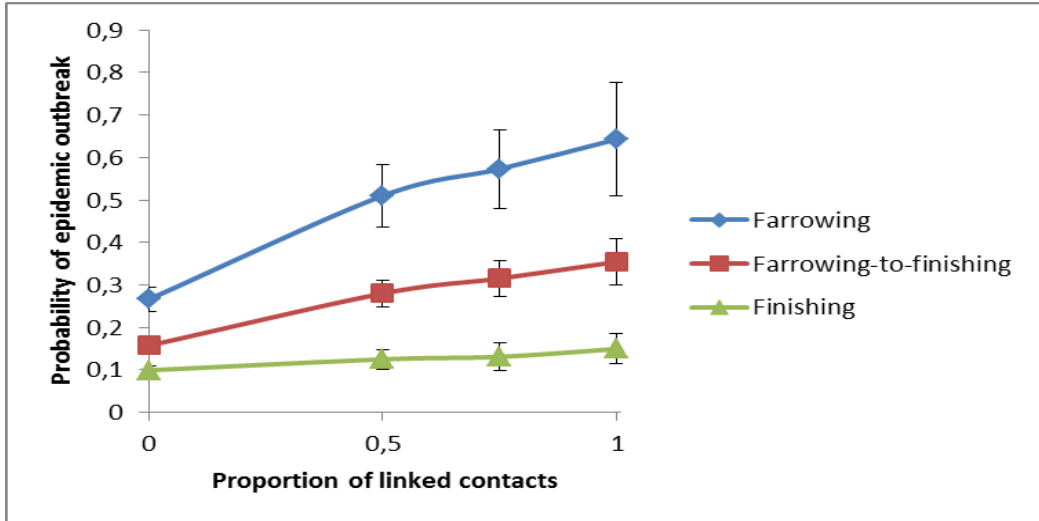
The expected outcome of an ASF outbreak is dependent on the proportion of re-linked contacts, but the slope of the curve of the mean epidemic outbreak size is less steep than in FMD simulations. Re-linking resulted in an expected mean size of epidemic outbreaks of 2.2–3.5 infected farms when applying the “Baseline 2033” scenario (Figure 25).



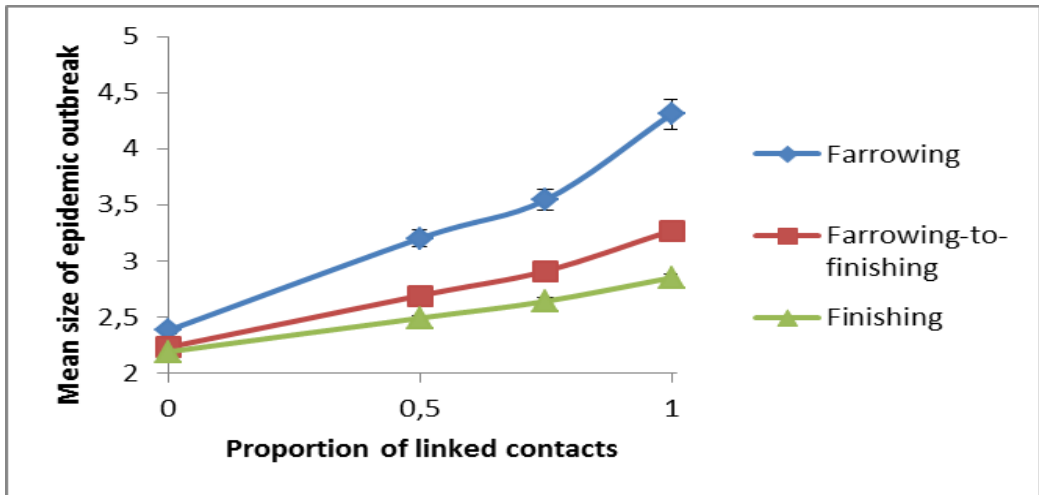
**Figure 25.** The mean size of an epidemic outbreak in ASF simulations with the “Baseline 2033” scenario. The outbreak has started on a pig farm and a proportion of semi-connected animal transport links have been re-linked. Error bars represent the 95% confidence intervals for the estimates.

Farrowing farms were the most effective spreaders of ASF. The probability of an epidemic outbreak and the mean size of epidemic outbreaks were larger than on other farm types in the pig sector (Figures 26 and 27). Finishing farms were the least effective in spreading the disease, and the outcomes of farrowing-to-finishing farms were between the outcomes of finishing and farrowing farms. Relative variation increased in all farm types with an increased proportion of re-linking of animal transport contacts (Figure 28).

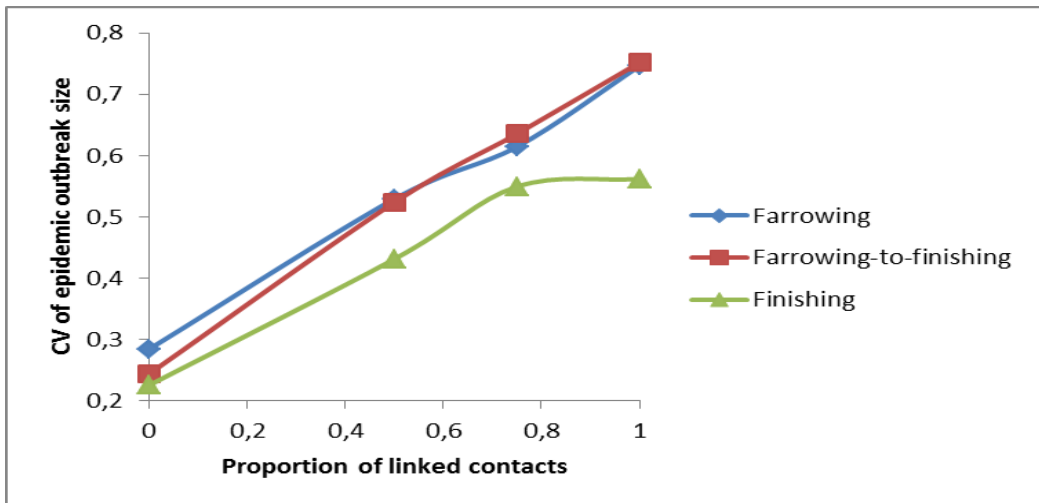
The number of non-infected farms in surveillance and protection zones can be expected to be lower in the future. In the baseline scenario, one infected farm increased expectations on the number of non-infected farms in protection zones by less than one farm, and in the surveillance zone by about four farms. These values are approximately one-third of the corresponding values in the reference simulations (Table 14, Appendix 5).



**Figure 26.** The probability of an epidemic outbreak in ASF simulations with the “Baseline 2033” scenario. The outbreak has started on a pig farm and a proportion of semi-connected animal transport links have been re-linked. Error bars represent the 95% confidence intervals for the estimates.



**Figure 27.** The mean size of an epidemic outbreak in ASF simulations with the “Baseline 2033” scenario. The outbreak has started on a pig farm and a proportion of semi-connected animal transport links have been re-linked. Error bars represent the 95% confidence intervals for the estimates.



**Figure 28.** The coefficient of variation of epidemic outbreaks in ASF simulations with the “Baseline 2033” scenario. The outbreak has started on a pig farm and a proportion of semi-connected animal transport links have been re-linked.

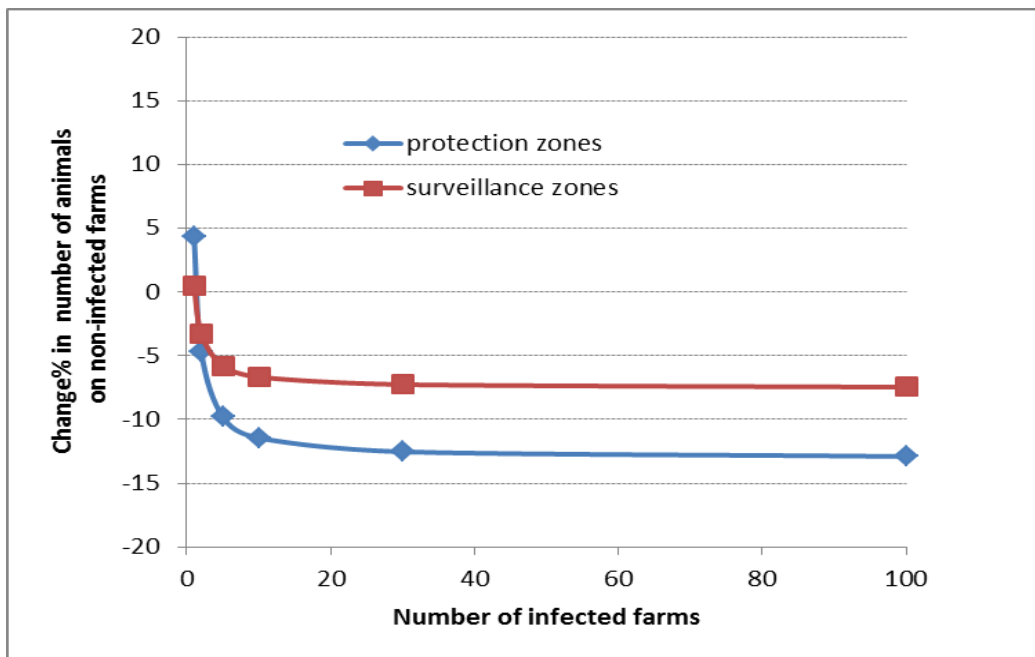
**Table 14.** The relationship between the number of ASF-infected farms and the number of non-infected farms in protection and surveillance zones in the “Baseline 2033” scenario. The relationship equation is  $y = a \cdot (\text{number of infected farms}) + b$ , where  $a$  and  $b$  are regression model coefficients. Models are only valid if the number of infected farms is  $>1$ . The SE of the coefficient is given in parentheses.

Variable y	a	b	R <sup>2</sup>
Number of non-infected farms in protection zones	0.932(0.008)	0.096(0.019)	0.431
Number of non-infected farms in surveillance zones	4.179(0.024)	0.850(0.060)	0.598

**Table 15.** The relationship between the number of ASF-infected farms and the number of pigs\* on infected farms in protection and surveillance zones in the “Baseline 2033” scenario. The relationship equation is  $y = a \cdot (\text{number of infected farms}) + b$ , where  $a$  and  $b$  are regression model coefficients. Models are only valid if the number of infected farms is  $>1$ . The SE of the coefficient is given in parentheses.

Variable y	a	b	R <sup>2</sup>
Number of pigs on infected farms	2075.4 (6.0)	-601.5 (4.2)	0.857
Number of pigs on non-infected farms in protection zones	1507.8 (13.6)	165.6 (33.8)	0.379
Number of pigs on non-infected farms in surveillance zones	6795.8 (42.8)	1405.6 (105.8)	0.558

\*Piglets under 3 months are not included in these quantities



**Figure 29.** Change in the number of pigs in protection and surveillance zones in relation to the number of infected farms. The “Baseline 2033” scenario is compared with the results of the reference simulation.

The number of pigs on infected farms can be expected to increase. This does not apply to the total number of pigs on non-infected farms in protection and surveillance zones, as the number of farms will decrease more than the number of animals per farm will increase (Table 15). Therefore, the sum of animals on non-infected farms is not expected to change much in the future (Figure 28). The results indicate that the increased farm size will compensate almost completely for the reduced number of farms in terms of animals on non-infected farms in restrictive zones in an ASF outbreak.

### 3.6.2.1 Discussion, ASF

By applying the same criteria of re-linking as in FMD (0.5–0.75), it was concluded that the mean size of an epidemic outbreak of ASF was 2–32% larger in future projections than in the reference simulations in all pig farm types. This resulted in a larger number of animals existing on infected farms when the future is predicted by the “Baseline 2033” scenario. Because the expected size of an outbreak is larger than in reference simulations, the number of animals on non-infected farms in restrictive zones can be expected to be larger in the future.

Farrowing farms appeared to have the greatest potential to spread ASF, as the probability of an epidemic outbreak and the mean size of an outbreak were the largest in this farm category. As expected, the farrowing-to-finishing farms were not as effective spreaders as the farrowing farms, and the finisher farms were the least effective farm type in spreading ASF further. These results are consistent with the earlier risk assessments of CSF and FMD spread in Finland (Raulo & Lyytikäinen 2006; Lyytikäinen et al. 2011).

Relative variation in the epidemic outbreak size increased when the proportion of re-linked contacts increased. This implies that the outbreak size becomes more variable when there are more contacts. The relative variation is, however, markedly smaller in ASF than in FMD simulations. Thus, the outcome of an outbreak is much more easily predictable for ASF than for FMD.

Restrictive zones are also relevant in ASF outbreaks. Although ASF does not have a specifically spatial spread component, contacts have spatial properties. The probability of contacts between nearby farms is higher than between farms further away from each other. However, this spatiality is weaker for ASF than for diseases that have an airborne spread component. As a consequence, the significance of restrictive zones will decrease more for ASF than for FMD in the future. Contact tracing will also have relatively higher importance in ASF outbreaks than in FMD outbreaks in the future.

In this study, we did not simulate spread promoted by wild boars. Although the wild boar population in Finland is small, it has presumably been growing slowly during recent decades. In the winter of 2014–2015, large numbers of wild boars were to be hunted in order to reduce the population size. To limit the spread of diseases, it is important that the population of wild boars remains small and that they do not come into contact with domestic pigs and pigs on farms. The spread potential from wild boars to domestic pigs is partially dependent on the type of production. For instance, outdoor access of domestic pigs and materials from the environment that are transferred to pig farms will influence the risk of introducing disease from wild boars to domestic pig production.

According to our simulation results, the domestic pig population is not able to spread ASF rapidly to large numbers of farms. Therefore, an ASF outbreak in the wild boar population may not be a large risk for an escalated ASF epidemic outbreak in domestic pig production. However, if ASF is found in wild boars, it could still have severe implications for pig production and economic impacts on the pig sector in Finland, with reduced possibilities to export pig meat.

It was assumed that ASF is detected rapidly on the farm and is therefore diagnosed swiftly. If the ASF virus evolves into a form that causes less severe clinical symptoms

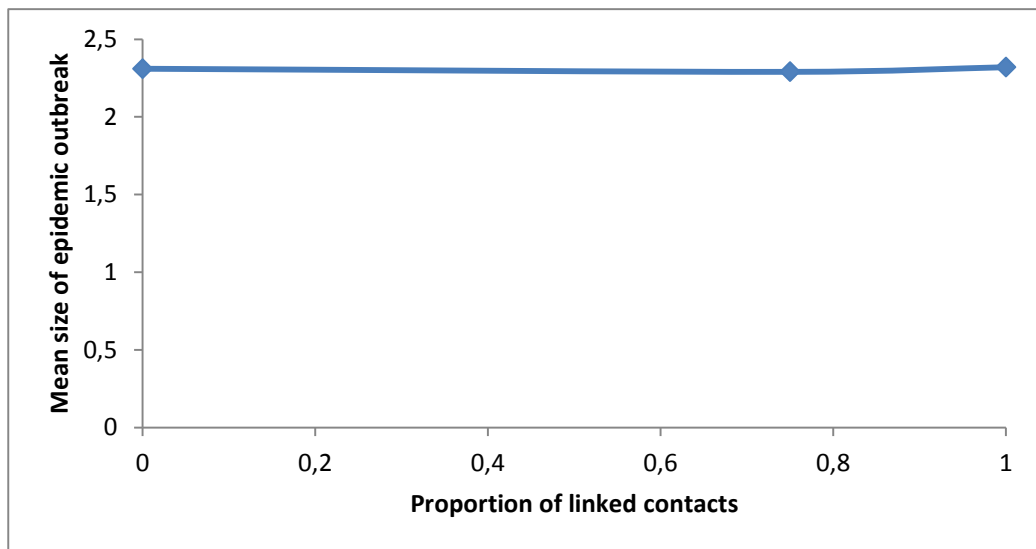
and lower mortality than anticipated, the disease may spread freely for a longer time than we have assumed. In such a situation, larger outbreaks and consequences are possible. Moreover, if the infectivity of ASF increases, larger outbreaks than anticipated by our results are possible.

### 3.6.3 Bluetongue (BT)

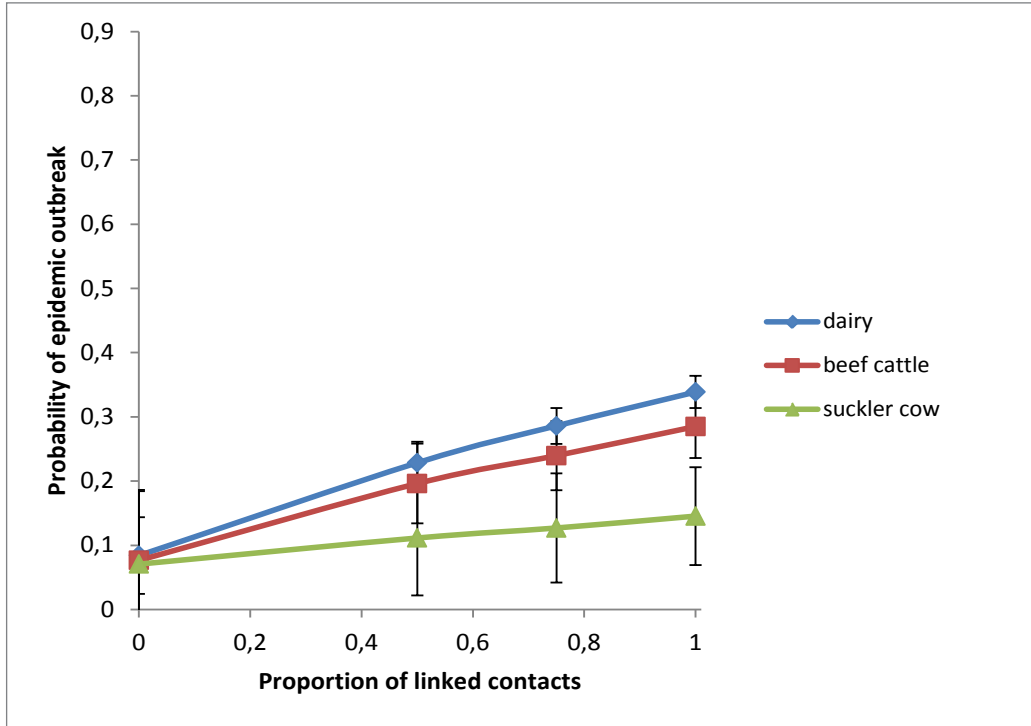
In BT simulations, the mean size of an epidemic outbreak (2.3–2.4 infected farms, depending on the proportion of re-linking) did not exceed the level of the reference simulations for any applied re-linking value (0–1). The mean size of an epidemic outbreak did not increase with the proportion of re-linked contacts. Instead, it was stable across the simulated range of animal transports between farms (Figures 30 and 32).

However, the probability of an epidemic outbreak increased along with an increasing proportion of re-linked animal transportations. It reached the value of the reference simulations (0.24) at a re-linking proportion of 0.75. The highest probabilities of epidemic outbreaks were obtained for dairy farms and the lowest for suckler cow farms as the starting point of an outbreak (Figure 30). Similarly, the increase in the probability of epidemic outbreaks was largest for a dairy farm and lowest for a suckler cow farm as the starting point of an outbreak (Figure 31).

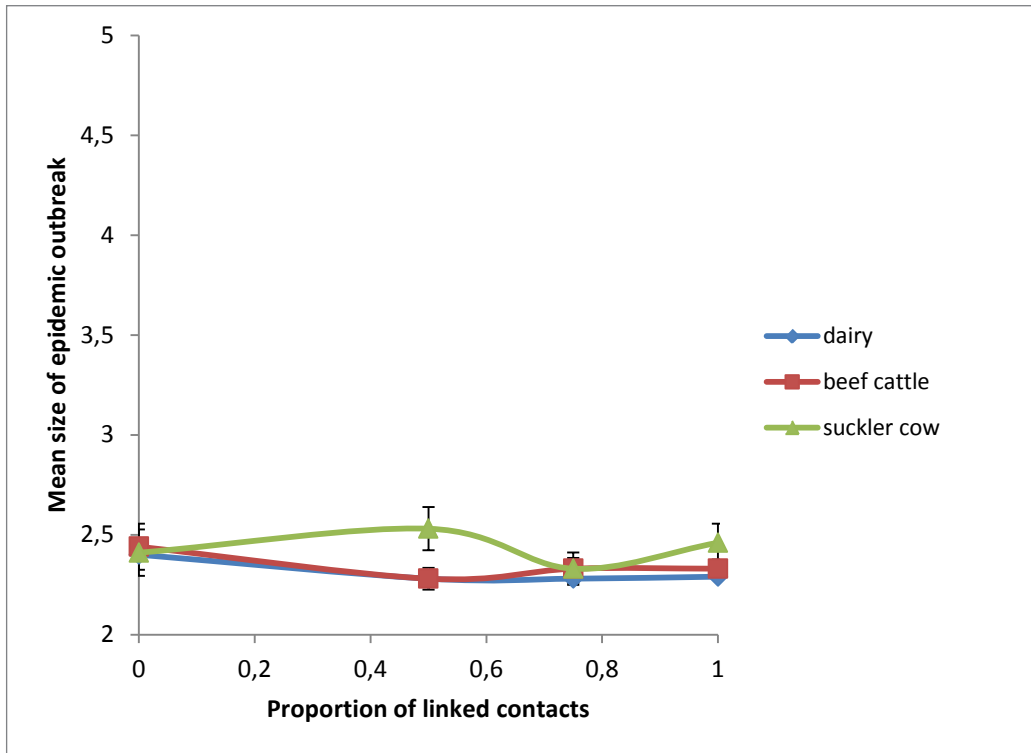
The CV of the epidemic outbreak size (0.32–0.43, depending on the level of re-linking) did not show a clear pattern in relation to the level of re-linked contacts (Figure 32) and was lower than in the reference simulations. There were no clear differences between farm types in the relative variation.



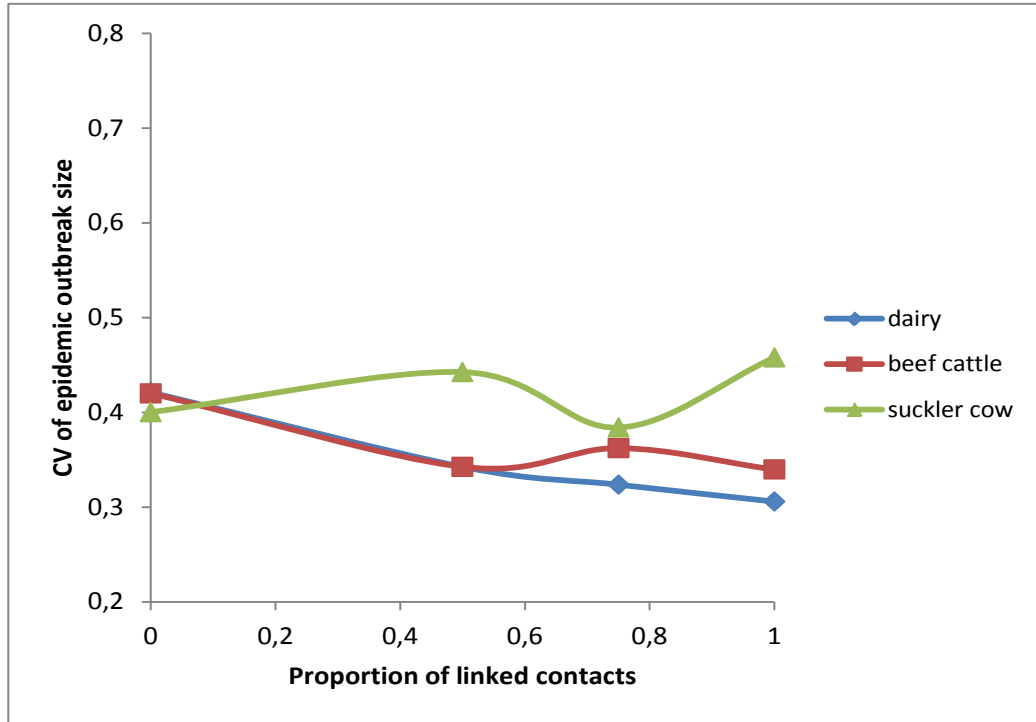
**Figure 30.** The mean size of an epidemic outbreak in BT simulations with the “Baseline 2033” scenario. The outbreak has started on a cattle farm and a proportion of semi-connected animal transports have been re-linked. Error bars represent the 95% confidence intervals for the estimates.



**Figure 31.** The probability of an epidemic outbreak in BT simulations with the “Baseline 2033” scenario. The outbreak has started on a cattle farm and a proportion of semi-connected animal transports have been re-linked. Error bars represent the 95% confidence intervals for the estimates.

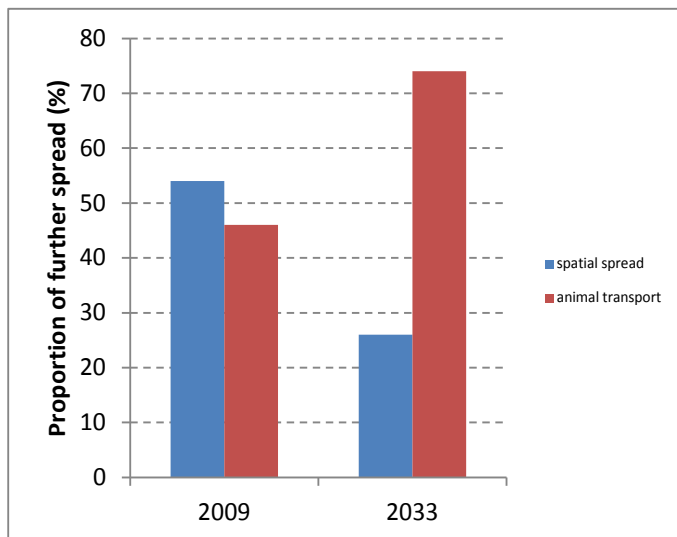


**Figure 32.** The mean size of an epidemic outbreak in BT simulations with the “Baseline 2033” scenario. The outbreak has started on a cattle farm and a proportion of semi-connected animal transports have been re-linked. Error bars represent the 95% confidence intervals for the estimates.



**Figure 33.** The coefficient of variation of an epidemic outbreak size in BT simulation with the “Baseline 2033” scenario. The outbreak has started on a cattle farm and a proportion of semi-connected animal transports have been re-linked.

The importance of animal transports appeared to increase between 2009 and 2033. In 2033, 75% of all further spread was estimated to be due to animal transports and only a quarter due to spatial spread. In 2009, the proportions for both routes were quite similar (Figure 34).



**Figure 34.** The contribution of spatial spread and animal transports to further spread as modelled in BT simulations for 2009 and 2033, assuming 0.75 re-linking in 2033.

In the “Baseline 2033” scenario, the number of farms in control zones was estimated to decrease to one-third of the value observed in the reference simulations. A similar 62–65% reduction was observed in the number of non-infected farms in surveillance and protection zones (Table 16).



**Table 16.** The relationship between the number of BT-infected farms and the number of non-infected farms in control, protection and surveillance zones in the “Baseline 2033” scenario. The relationship equation is  $y = a \cdot (\text{number of infected farms}) + b$ , where  $a$  and  $b$  are regression model coefficients. Models are only valid if the number of infected farms is  $>1$ . The SE of the coefficient is given in parentheses.

Variable $y$	$a$	$b$	$R^2$	Mean number of farms for epidemic outbreaks (SD)*
Number of farms in control zones	46.907 (0.338)	-5.380 (0.510)	0.491	100 (58)
Number of farms in protection zones	460.401 (3.524)	217.043 (5.421)	0.460	1 276 (543)
Number of farms in surveillance zones	204.085 (3.075)	495.370 (4.730)	0.180	1 003 (345)

\*Only indicative of variation, as the distribution is highly skewed

### 3.6.3.1 Discussion, BT

A BT outbreak can be expected to be smaller in the future and the probability of an epidemic outbreak is equal or lower than in 2009. Because the relative variation in outbreaks decreases, the outcome is more predictable than it was in the reference simulations. These findings can be explained by the reduction in the number of farms combined with the patterns of BT spread. Furthermore, the increase in farm size does not substantially affect the spread of BT.

BT outbreaks were quite insensitive to the re-linking assumptions. Only the probability of epidemic outbreak increased when the proportion of re-linked contacts increased, whereas the size and the relative variation did not show a clear pattern. It can be expected that direct animal contacts will be more relevant in the future and spatial spread will be of less importance in defining the size of an outbreak.

The number of non-infected farms in control, protection and surveillance zones is clearly smaller due to a decrease in the number of cattle farms in Finland. The number of non-infected farms in control and protection zones is more dependent on the number of infected farms than is the number of non-infected farms in surveillance zones. Surveillance zones are thus less dependent on the dynamics of an outbreak and more directly dependent on the farm density in Finland.

Future projections were not spatially varied, which means that the probability of farms carrying on or ceasing production was similar across the country. Therefore, structural change is expected to be similar across the country, and will not even out the existing differences in the spread potentiality of BT.

Vaccination is a possible way to prevent the spread of bluetongue. Vaccination usually reduces the infectivity of BT to a level where the disease does not spread efficiently (decrease in  $R_0$  in cattle farms is 70–83%). Our simulations suggest that vaccination is not generally required in Finland. This can be concluded even if vaccination is not simulated explicitly, because the probability of an epidemic outbreak and the final size of an epidemic outbreak are very small. Even if there would be a larger pulse of infected vectors that could infect several farms simultaneously, the conclusion would not change. The spread potential in Finland would still be low due to the relatively low temperatures and long distances between farms.

In our simulations, the vector-active season for spread between farms started at mid-summer. The latent period for spread between farms is long and the detection of infected farms is assumed to be difficult. Therefore, two-thirds of the vector-active season (90 days per year) may already be over before any risk measure is applied. The start of vaccination after the initial detection of the disease will take time. The vaccine could take several weeks to become available after the decision to vaccinate. The vaccination procedure for a 20-km radius control zone will demand vaccination of animals on 100–200 farms. This may take weeks. According to an expert opinion, vaccination would be started after at least 3–5 infected farms are found. According to the current simulations, this type of scenario is highly unlikely.

The first preventive effects of vaccination could be achieved at the end of vector-active season, when they would be of little use in preventing further spread during the ongoing season. However, the effects of a vaccination campaign would probably appear during the following vector-active season. The results of the future projections suggests that due to the lower spread potential of BT in the future, emergency vaccination will be an even less feasible risk management measure in preventing the spread during the ongoing vector-active season.

In 2015, BT surveillance in Finland will concentrate on blood sampling of cows on suckler cow farms. In our simulations, suckler cow farms were the least effective farm types in spreading BT, and when this is taken in account, targeting sampling to them appears ineffective. However, during the vector-active season, suckler cow farms may be as easily infected with BT. The spread of BT mainly occurs during the vector-active season. During this season, suckler cows are kept outdoors, probably more than other cattle. Therefore, BT surveillance in Finland probably concentrates on farms that are “good” at receiving but “poor” at spreading BT. As BT has a low spread potential in Finland, this probably has no practical influence and does not reduce the efficiency of the surveillance system as a preventive management measure.

We assumed that the latent period for BT (length of the period from the time of introduction of virus into the herd to the start of the infective period) is 2 weeks. For an individual animal, the incubation period is markedly shorter than the latent period in the model (Koeijer et al. 2011). If the function of the model by Turner et al. (2012) is applied, which defines how the intra-herd prevalence will develop over time, it can be concluded that indirectly our model assumes that the spread between farms would require at least a 5–8% intra-herd prevalence of infection.

Our simulation model applies data on BT serotype 8 and the parameterisation is based on an outbreak in the Netherlands, Belgium and Germany in 2006 (Koeijer et al. 2011, Turner et al. 2012). More recently, BT serotype 4 has been spreading in south eastern Europe. There is no information on whether it has similar or different biological properties compared to serotype 8. The potential differences between serotypes may limit the possibilities to generalize the results of this study. If the serotype has different properties compared to serotype 8, the outcome could be different. The most relevant factors to spread are the infective dose, incubation time, reproduction speed and temperature for the replication capability.

## 3.7 Simulated economic impacts of the diseases

### 3.7.1 Reference simulations

Economic losses caused by the three diseases under the 2009 situation varied markedly (Table 1 and Appendix 6), among other factors, according to the size of the outbreak, the magnitude of trade disruptions and the type and location of the primary infected farm. The total economic losses caused by an FMD outbreak in Finland were estimated to range from €12 million to €74 million in 95% of the cases. In the event of ASF, the range of losses was estimated at €5 to €23 million. These results are based on an assumption that exports to non-EU-countries<sup>1</sup> would be severely disrupted, and the disruptions would last on average as long as it is suggested in the OIE Terrestrial Animal Health Code (2008), whereas intra-community exports would only be disrupted a little. The results are quite sensitive to assumptions regarding trade disruptions. If the trade disruptions were 30% more severe than assumed above, the total average losses would increase to €31.1 million. Economic impacts varied according to stakeholder group. Among three groups (producers, consumers, taxpayers), producers were expected to suffer the largest losses, whereas consumers could even benefit temporarily due to trade disruptions caused by FMD or ASF. In the event of FMD, export losses represented less than 10% of the value of exports of agricultural goods in 2009.

In contrast to FMD and ASF, BT is not expected to cause major disruption in the markets, because according to the OIE, countries are not recommended to impose any restrictions on the trade of animal products. Foreign trade of animals and also semen is likely to be distorted due to BT, but since the exporting of live animals from Finland is quite marginal, the disease can be expected to have no significant impact on livestock markets in Finland. There is some evidence from the past outbreaks observed elsewhere in Europe that, for instance, calf prices may be affected by BT in some cases. Such effects are, however, mainly related to local restrictions on live animal trade or to changes in the supply and demand for calves. In the baseline scenario, economic losses caused by a bluetongue were estimated to range from €2.8 to €9.0 million.

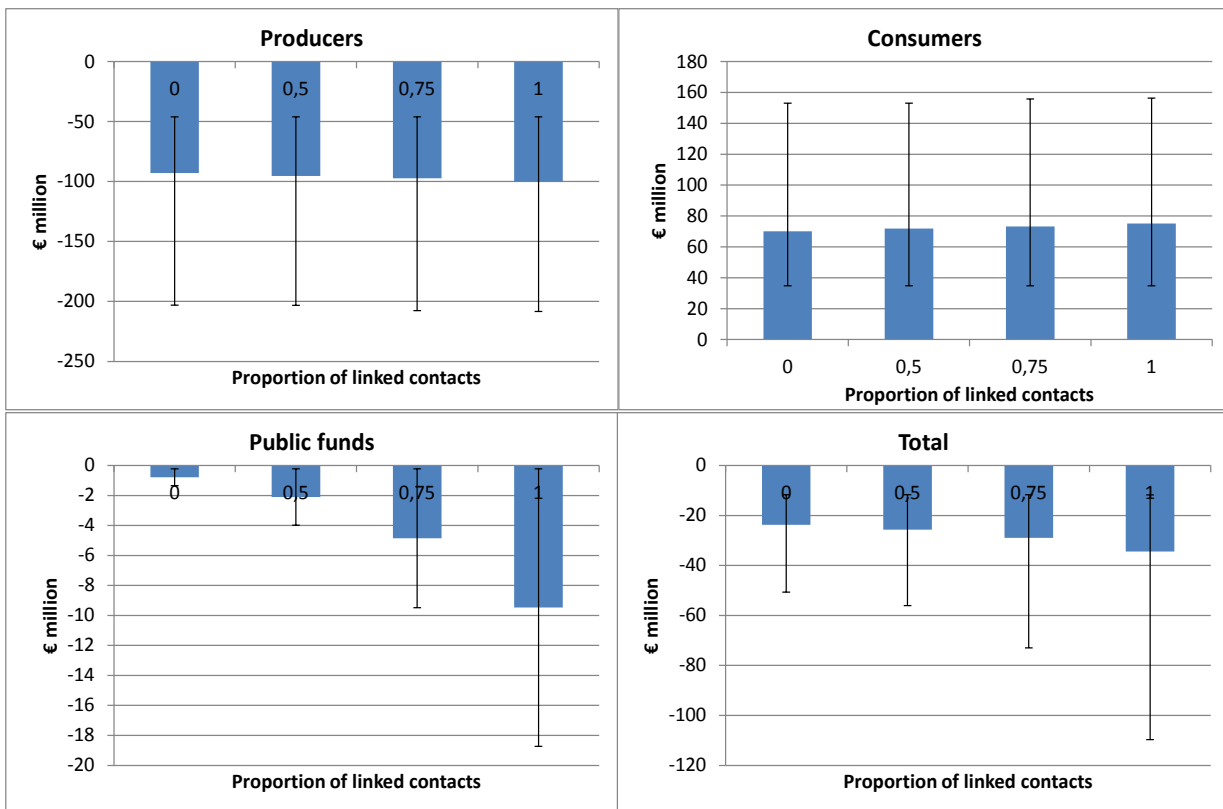
Besides the farm type, the patterns of spread also played a role in determining the economic losses. Epidemic FMD outbreaks resulted on average in €32.6 million (95% CI 12.7–84.8) in losses, whereas losses caused by sporadic cases remained on average at €23.7 million (95% CI 11.5–61.1). In iterations where one or more farms were infected by low-risk human contacts, the losses were on average more than €53 million. Hence, even if these contacts were estimated to spread the disease in only very few cases, relevant outbreaks were quite costly. The result is plausible, although it may be partly due to an artifact.

In the event of ASF and BT, the differences were less substantial. An epidemic ASF outbreak caused on average €12.3 million (95% CI 5.8–29.5) in losses, whereas sporadic cases resulted in only €10.0 million (95% CI 4.3–27.0) in losses. Regarding BT, the values were €4.8 million (95% CI 2.7–10.9) for an epidemic outbreak and €4.0 million (95% CI 2.7–6.5) for a sporadic outbreak.

<sup>1</sup> The most important non-EU export destination for dairy product exports was Russia. For pig meat exports, the main non-EU destinations included Russia and countries in Asia.

### 3.7.2 FMD in the baseline future projections

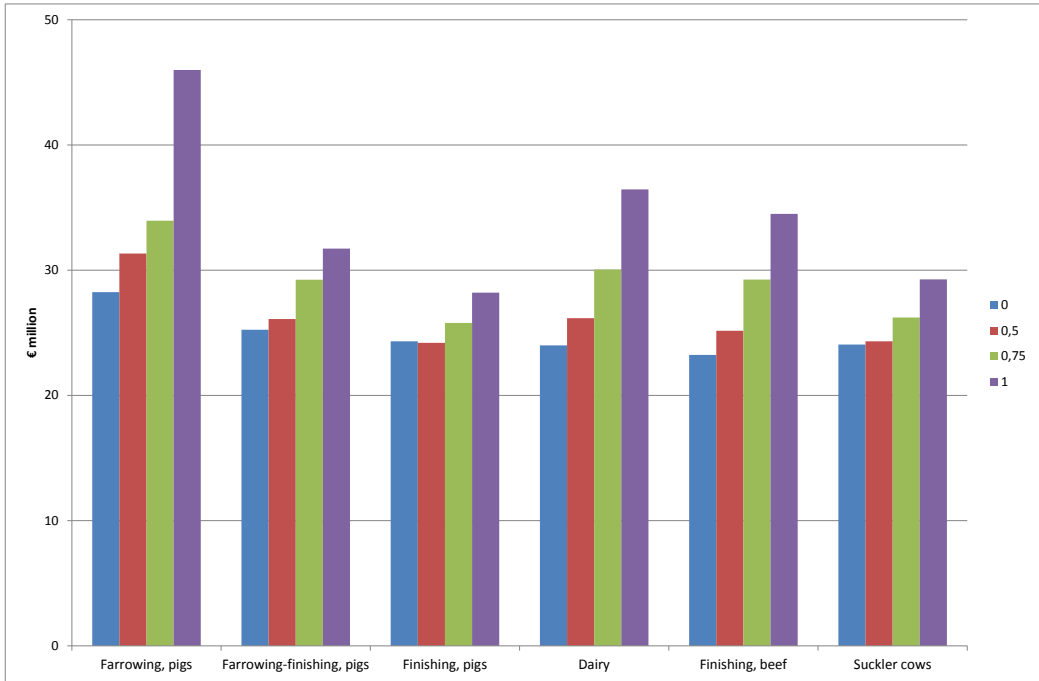
In the baseline future scenario, the degree to which the contacts are linked between farms also impacts on economic losses. Total economic losses on average increased from €23.7 to €34.4 million when the proportion of linked contacts increased from zero to unity. Linking about 75% of contacts resulted in a similar result to the situation in the 2009. The volatility of losses also increased when the proportion of linked contacts increased. In the baseline scenario, linking 100% of contacts resulted in 95% CI ranging from €11.7 to €109.7 million. Although black bars in Figure 35 represent the range of variation in losses, they cannot be interpreted to indicate the statistical significance of differences between the scenarios. Economic losses to producers on average increased from €72.2 to €100 million, benefits to consumers from €54.4 to €75.1 million and losses to public funds from €0.8 million to €9.4 million when the proportion of linked contacts increased from zero to unity (Figure 35). Hence, direct losses in particular could be affected by structural change, although other losses and particularly their variation could also be affected.



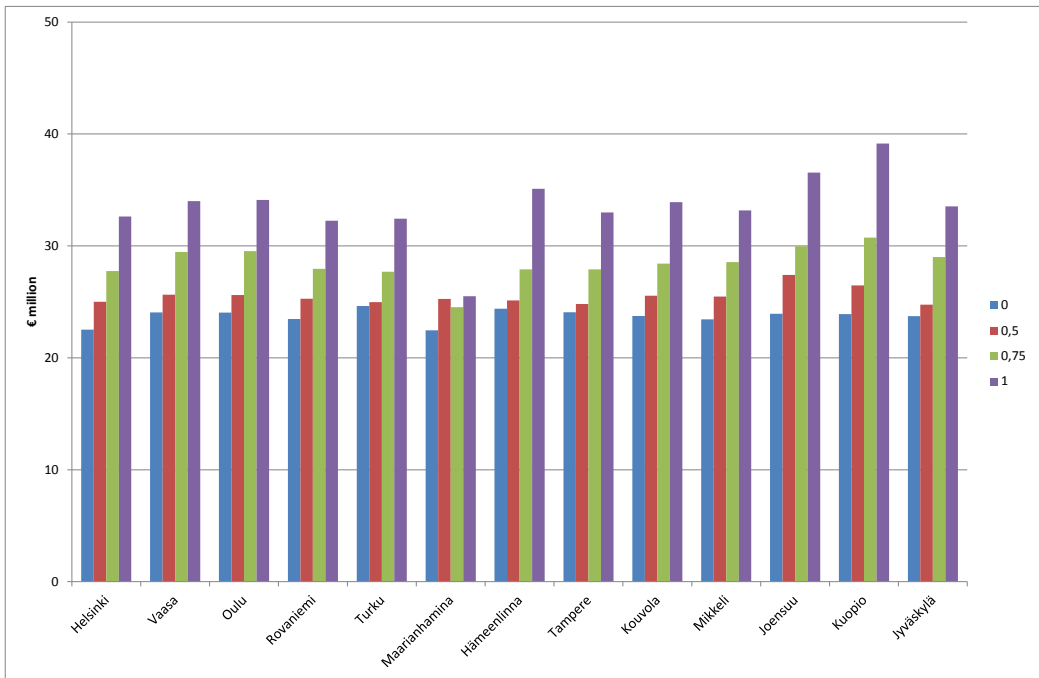
**Figure 35.** Simulated economic impacts of an FMD outbreak to producers, consumers, public funds and in total in the “Baseline 2033” scenario. Blue bars represent average impacts and black bars represent the range of impacts that were simulated occur in 95% of iterations.

Besides the proportion of linked contacts, the type and location of the primary infected farm also affected the results. The results suggested that a farrowing farm as the primary infected farm could particularly result in substantial losses. When the proportion of linked contacts increased from zero to unity, losses caused by outbreaks starting from a farrowing farm increased from €28.2 (95% CI 12.4–60.0) to €46.0 million (95% CI 12.8–139.3) on average, and those caused by outbreaks starting from a dairy farm increased from €24.0 million (95% CI 11.6–61.3) to €36.4 million (95% CI 11.7–142.7) on average. These farm types also had the largest variation in simulated losses when the proportion of linked contacts was high.

Regionwise, outbreaks starting from either Kuopio or Jyväskylä regions were likely to result in more costly outbreaks than on average. This result is most likely related to the structure of livestock production in the region. For instance, the Kuopio region is well known for a strong emphasis on dairy production. When the proportion of linked contacts increased from zero to unity, losses caused by outbreaks starting from the Kuopio region increased from €23.9 (95% CI 11.6–61.4) to €39.1 million (95% CI 39.1–151.9) on average.



**Figure 36.** Simulated total economic losses of an FMD outbreak in the “Baseline 2033” scenario according to the type of primary infected farm and the proportion of linked contacts (0, 0.5, 0.75 or 1.0). The bars represent average impacts and black bars represent the range of impacts that were simulated occur in 95% of iterations.

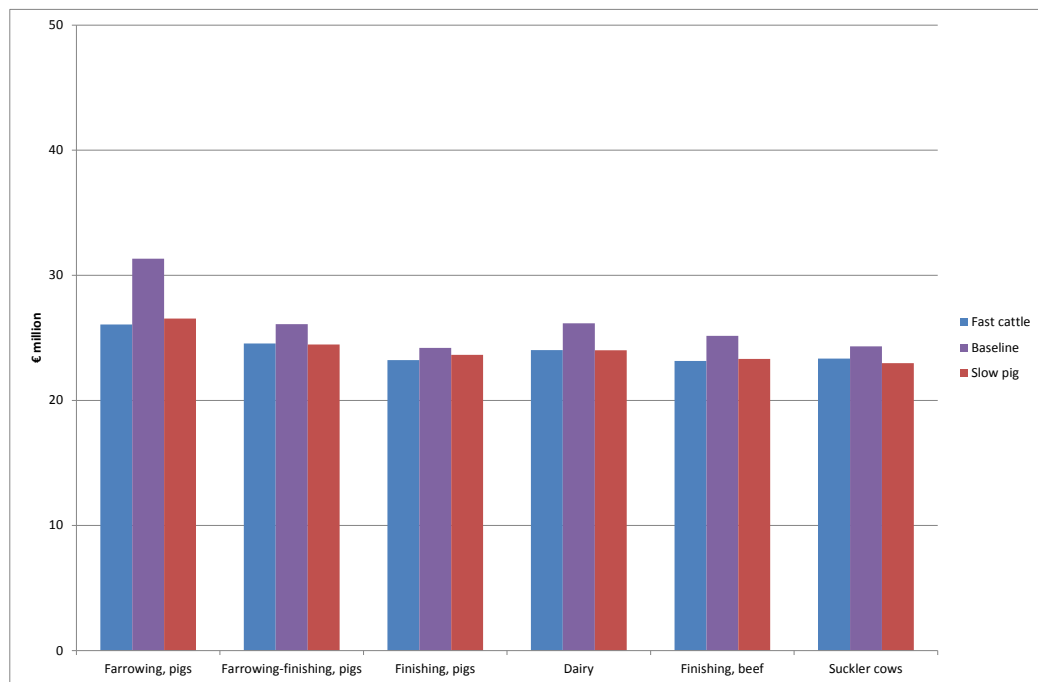


**Figure 37.** Simulated total economic losses due to an FMD outbreak in the “Baseline 2033” scenario according to the location of the primary infected farm and the proportion of linked contacts (0, 0.5, 0.75 or 1.0). The bars represent average impacts for each starting point (region) of the outbreak.

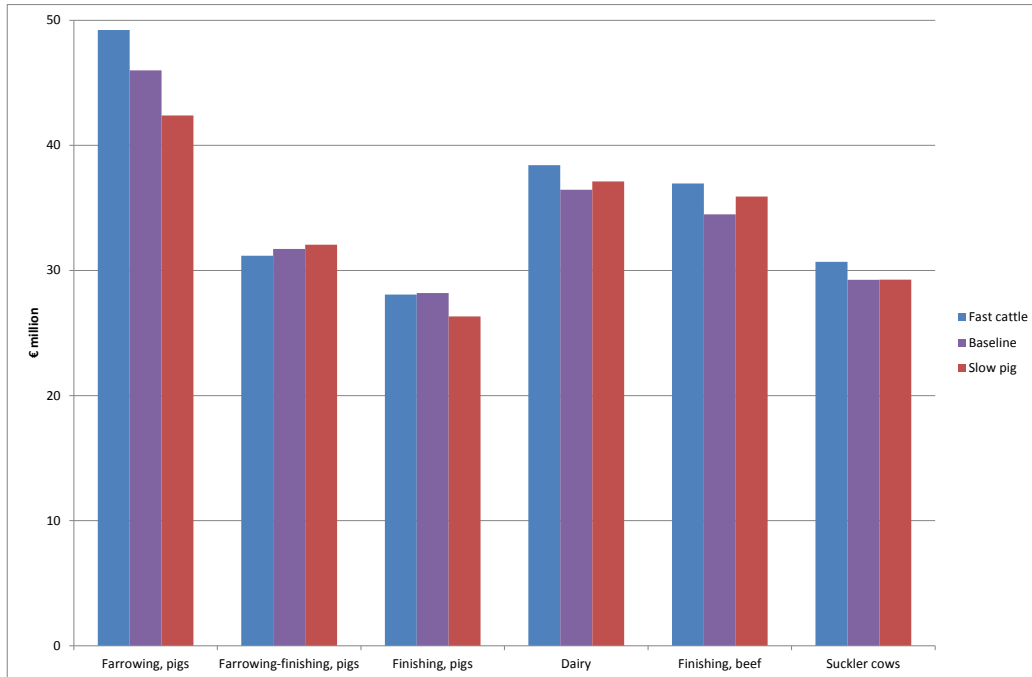
### 3.7.2.1 FMD in alternative future projections

Alternative structural change scenarios result in different economic impacts of an FMD outbreak compared to the baseline scenario. In general, the “Fast cattle 2033” scenario results in larger and the “Slow pig 2033” scenario in smaller economic losses than the “Baseline” scenario. The differences, however, vary according to the type of farm. When the proportion of linked contacts was zero in the “Slow pig” scenario, outbreaks in which the spread of disease begins from a farrowing farm on average resulted in €4.8 smaller losses, while for most other farm types the difference was approximately €2 million. When the proportion of linked contacts was 1, the farrowing farms resulted in €3.6 million smaller losses in the slow cattle than in the baseline projection, whereas for other farm types the differences were less prominent.

Regarding the “Fast cattle” scenario, when the proportion of linked contacts was 1, outbreaks starting from farrowing farms resulted in €3.2 million larger losses than in the baseline projection. Outbreaks beginning from cattle farms resulted in approximately €1.5 to €2.5 million larger losses than in the baseline projection. Hence, cattle farms and piglet production were expected to face a larger risk than in the baseline projection.



**Figure 38.** Simulated total economic losses due to an FMD outbreak in the “Baseline”, “Slow pig” and “Fast cattle” future scenarios according to the type of the primary infected farm when the proportion of linked contacts is 0. The bars represent average impacts for each starting point (farm type) of outbreak.

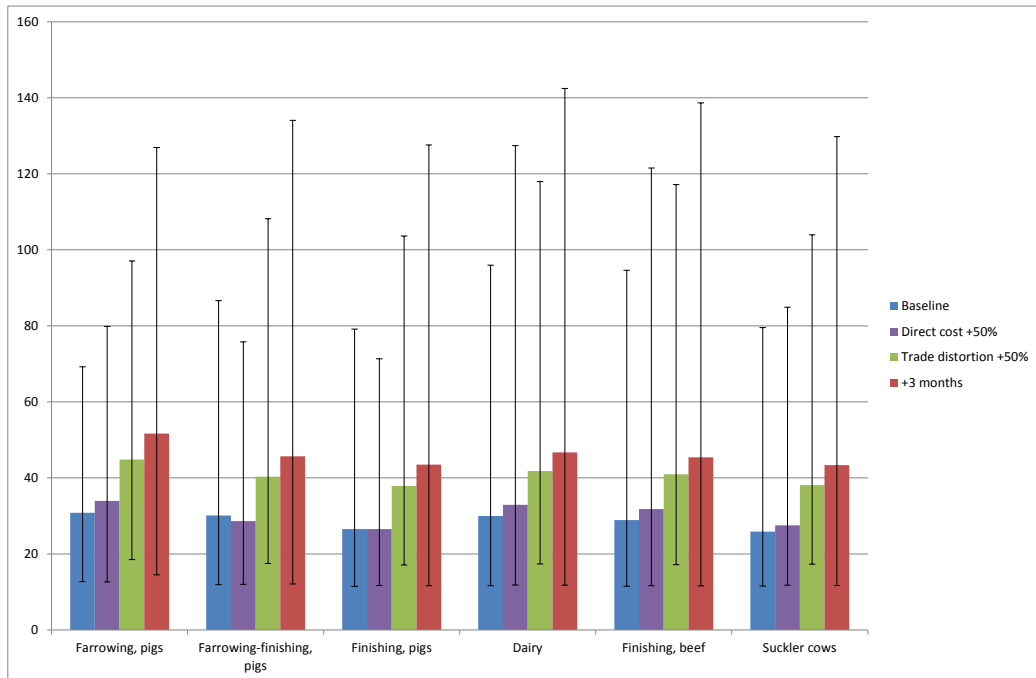


**Figure 39.** Simulated total economic losses due to an FMD outbreak in the “Baseline”, “Slow pig” and “Fast cattle” future scenarios according to the type of the primary infected farm when the proportion of linked contacts is 1. The bars represent average impacts for each starting point (farm type) of outbreak.

As the importance of cost parameters and trade may change in the future, we also conducted analyses regarding cost parameters and trade impacts. Figure 40 presents the total economic losses due to an FMD outbreak according to the type of the primary infected farm when the proportion of linked contacts is 0.75 in the baseline future and in three alternative scenarios in which the level of direct costs is increased by 50%, the duration of trade disruptions is increased by 3 months on average or the magnitude of distorted trade is increased by 50% from the baseline scenario. A 50% increase in the level of direct cost parameters increased the total costs on average by 5–10%. The largest increase was simulated for outbreaks starting from dairy farms. These parameters increased the variation in losses particularly in the cattle sector.

If the impact of FMD on trade distortions was 50% larger than assumed in the baseline scenario (but their duration did not change), the losses were simulated to increase by 40–51% on average. In this scenario, the most substantial increase was simulated for the scenario in which a finishing pig farm was the starting point of the outbreak. However, the variation in losses increased the most in outbreaks starting from dairy or finishing beef cattle farms. Finally, when the duration of trade distortions was increased on average by 3 months from the baseline, but their impact otherwise remained at the level of the baseline scenario, the simulated losses increased on average by 56–73% from the baseline future scenario. In this scenario, the most substantial increases were simulated for outbreaks in which a pig farm was the starting point. However, in this case, the variation in losses also increased the most in outbreaks starting from dairy or finishing beef cattle farms. In general, changes in economic parameters increased the variation in losses, particularly in outbreaks starting from the dairy sector, which may reflect the diversity of the sector.





**Figure 40.** Simulated total economic losses due to an FMD outbreak according to the type of the primary infected farm when the proportion of linked contacts is 0.75 in the baseline future and in three alternative scenarios in which the level of direct costs is increased by 50%, the duration of trade disruptions is increased by 3 months on average or the magnitude of distorted trade is increased by 50% from the baseline scenario.

### 3.7.2.2 Discussion, FMD, economic

In the baseline scenario for 2009, the total economic losses caused by an FMD outbreak in Finland were simulated to range from €11.6 million to €74.4 million in 95% of the cases. On average, the losses were simulated at €27.7 million under the farm structure in 2009. For the future baseline scenario, quite similar figures were simulated, but losses exceeding €100 million were more likely than in 2009. These results are based on an assumption that exports to non-EU-countries would be severely disrupted and the disruptions would last on average as long as is suggested in the OIE Terrestrial Animal Health Code, whereas intra-community exports would only temporarily be disrupted. The results only include impacts on the pig and cattle sectors, because impacts on small ruminants were not estimated. Given the small sheep and goat populations in Finland and the relatively modest production quantity of the small ruminant sector, these impacts were expected to be on average small. However, direct costs could be noticeable in a few special cases if a large number of sheep and goat farms need to be controlled.

The conclusions based on simulations in which economic aspects are taken into account have several similarities with the previously mentioned epidemiology-based conclusions, and hence they are repeated here only to the extent that is relevant for our discussion. Total economic losses on average increased from €23.7 to €34.4 million when the proportion of linked contacts increased from zero to unity. In general, the results suggest that structural change might only result in small changes to losses caused by FMD outbreaks if the proportion of re-linked contacts is 0.5–0.75. However, this conclusion is very sensitive to the scenario assumption. The losses may increase or decrease depending on the proportion of re-linked contacts. The larger the proportion of re-linked contacts, the larger are the economic losses an outbreak

can cause and the more variation there is between different outbreaks. Although economic impacts of re-linking are to some extent smaller than from an epidemiological basis only, it is very important that structural change is controlled so that risks related to the contact structure of livestock farms are reduced.

As in the case of 2009 simulations, future projections also showed large differences in losses between stakeholder groups. The majority of direct costs are covered by public funds. In relative terms, direct costs were impacted more severely by structural change than indirect costs. Direct costs and their variation were also highly sensitive to assumptions regarding the proportion of re-linked contacts. Among three groups (producers, consumers, taxpayers), producers were estimated to suffer the largest losses. These losses are mainly caused by assumed trade disruptions, because disruptions in exports can quickly result in oversupply in the domestic markets, as livestock products cannot be exported either at all or not to conventional trade partners. Hence, producer prices tend to fall, and since production cannot be adjusted instantaneously as much as would be needed, producers face quite large losses. The average loss per farm increased substantially by 2033 because of the increased farm size. By contrast, consumers were estimated to benefit temporarily from an outbreak, but the benefit per individual consumer is quite small.

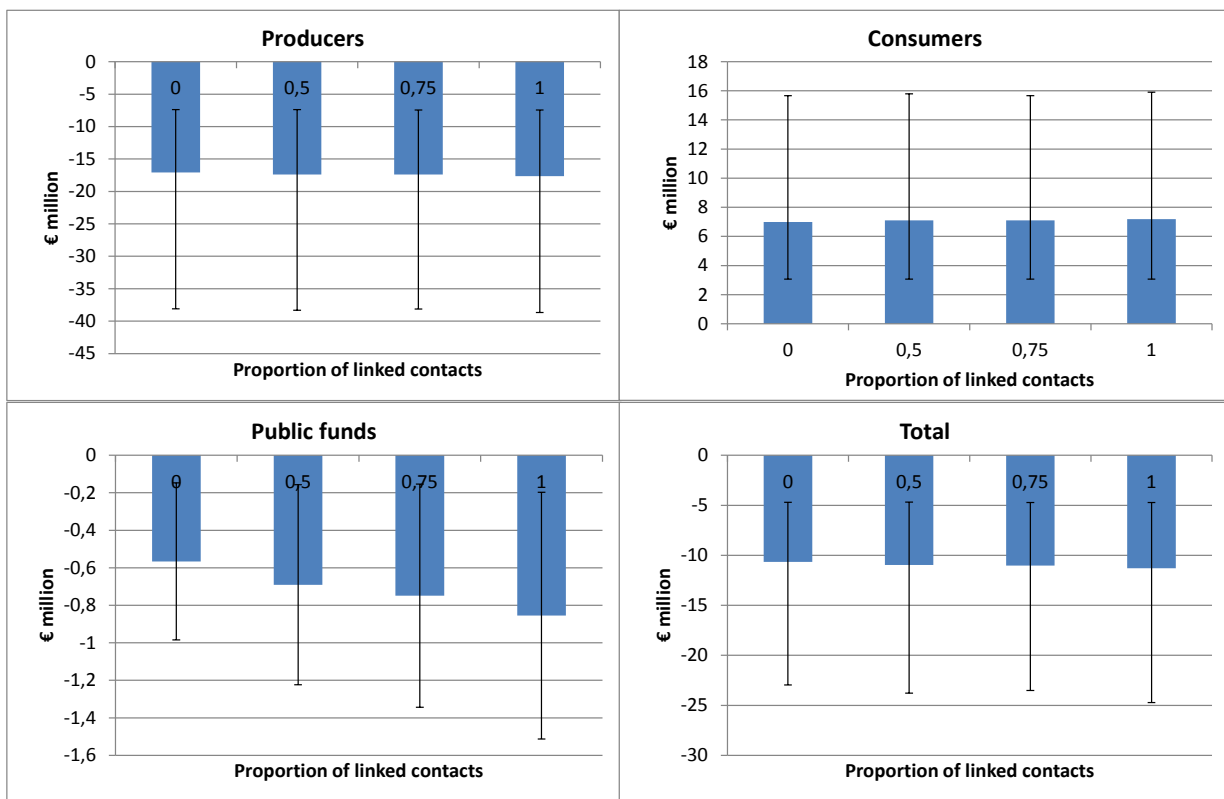
The results suggest that if the structural change in the pig sector slowed down, it could result in smaller losses in the future. By contrast, more rapid structural change in either the pig or the cattle sector would be expected to increase the costs of risk associated with an FMD outbreak. However, the impacts may vary according to the type of farm. The results suggest that the rate of structural change could have the largest impact on outbreaks starting from farrowing farms. Hence, it would be advisable to pay attention to the development of piglet production, including the concentration of piglet production in fewer farms.

Besides structural changes in the farming business, it is also important how markets will change. If the costs of controlling FMD increase in the future, this may have the largest impact on outbreaks starting from farrowing, dairy or beef cattle farms. In the future, animal health may become a more important criterion for countries willing to control their foreign trade. If the importance of trade increases, it is likely to have a major impact on the risks caused by FMD. Uncertainty concerning the losses caused by dairy farms can increase. Hence, the results suggest that change in the structure of dairy farming is of economic concern when the risks of FMD are considered. Both the duration and the magnitude of trade distortions are important. From the policy point of view, it would therefore be important to prepare approaches to mitigate trade distortions, such as arguments to reduce distortions, methods to control and prove that the production is of low risk, and the capacity to increase trade with markets that may remain open.

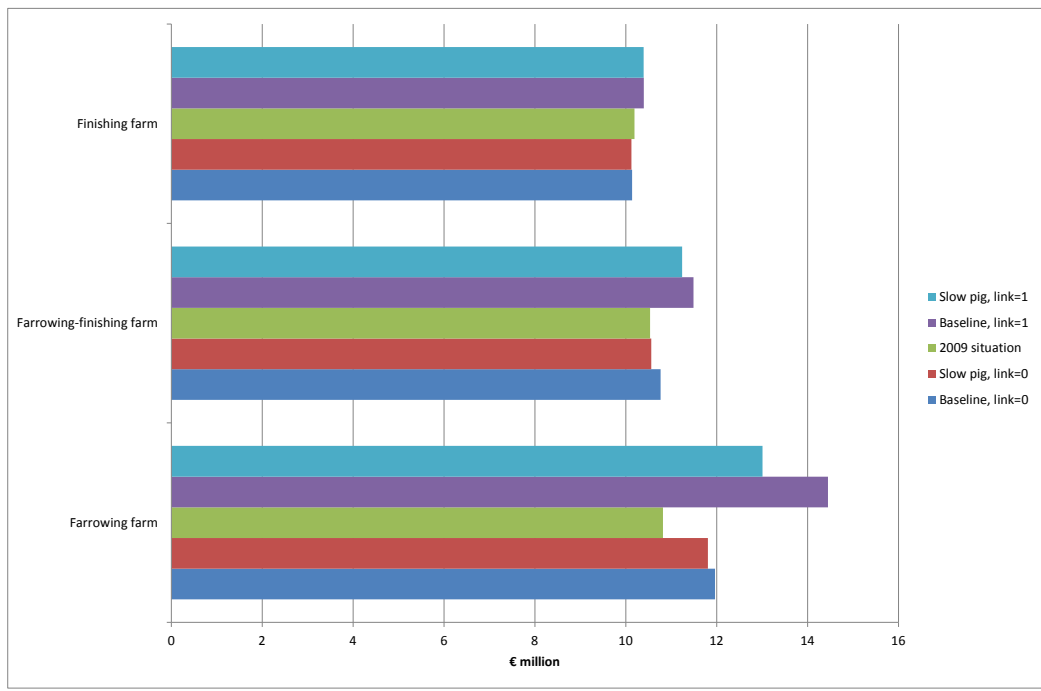
### **3.7.3 ASF in future projections**

In the baseline future scenario, the total economic losses due to an ASF outbreak range on average from €10.5 to €11.5 million, depending on the proportion of linked contacts. Hence, the losses are close to the numbers simulated for the 2009 situation. However, about 95% of simulations are between €5 and €25 million. Producers' losses increase slightly when the proportion of linked contacts increases. However, in relative terms, the costs to public funds increase more than other cost items and their variation also increases (Figure 41).

The economic impacts of ASF varied to some extent according to the type of the primary infected farm. In future projections, simulated losses tended to increase in piglet-producing farms, even if the proportion of linked contacts was close to zero. Under the “Slow pig” scenario, the increase was smaller than under the baseline scenario. For a farrowing farm as the primary infected farm, the expected increase in the costs was approximately €1 million, whereas for other farm types the increase was smaller. The range of variation in losses also slightly increased. By contrast, when the proportion of linked contacts approached unity, when a farrowing-to-finishing farm was the primary infected farm, the increase was on average less than €1 million, whereas a farrowing farm as the primary infected farm increased the costs on average by about €2–4 million (Figure 42). In the latter case, and under the baseline future projection, the range within 95% of simulated losses was situated also increased to €5.4–33.5 million (as compared to €4.5–27.5 million under the 2009 situation).



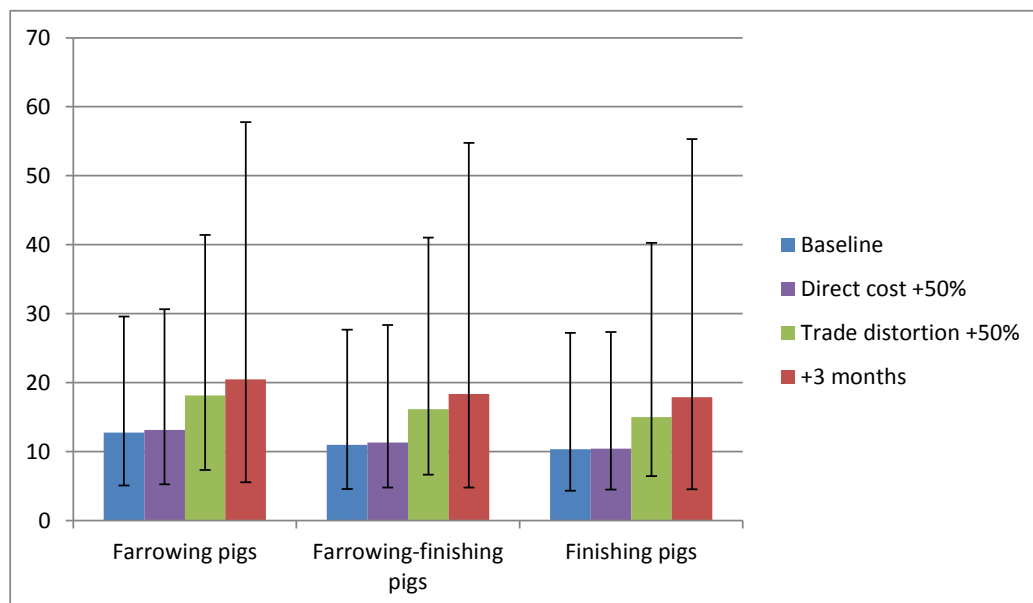
**Figure 41.** Simulated economic impacts of an ASF outbreak for producers, consumers, public funds and in total in the “Baseline 2033” scenario. Blue bars represent average impacts and black bars represent the range of impacts that were simulated occur in 95% of iterations.



**Figure 42.** Simulated total economic losses due to an ASF outbreak in the “Baseline” and “Slow pig” future scenarios and under the 2009 situation according to the type of the primary infected farm when the proportion of linked contacts is 0 or 1. The bars represent average impacts for each starting point (farm type) of the outbreak.

As the importance of cost parameters and trade may change in the future, we also conducted analyses regarding cost parameters and trade impacts. Figure 43 presents the total economic losses due to an ASF outbreak according to the type of the primary infected farm when the proportion of linked contacts is 0.75 in the baseline future and in three alternative scenarios in which the level of direct costs is increased by 50%, the duration of trade disruptions is increased by 3 months on average or the magnitude of distorted trade is increased by 50% from the baseline scenario. A 50% increase in the level of direct cost parameters increased the total costs on average by less than 5%.

If the impact of ASF on trade distortions was 50% larger than assumed in the baseline scenario, but their duration did not change, the losses were simulated to increase by 42–45% on average and depending on the type of the primary infected farm. In this scenario, the most substantial increase was simulated for a piglet-producing farm as the starting point of the outbreak. In addition, the variation in losses was increased substantially. Finally, when the duration of trade distortions was increased on average by 3 months from the baseline, but otherwise their impact remained at the level of the baseline scenario, simulated losses increased on average by 60–73% from the baseline future scenario. In this scenario, the most substantial increases were simulated for outbreaks in which a finishing pig farm was the starting point. In this case, the variation in losses also increased substantially, as the largest simulated losses were more than €50 million per outbreak (Figure 43). In general, changes in economic parameters increased the variation in losses, particularly in outbreaks starting from the dairy sector, which may reflect the diversity of the sector.



**Figure 43.** Simulated total economic losses due to an ASF outbreak according to the type of the primary infected farm when the proportion of linked contacts is 0.75 in the baseline future and in three alternative scenarios in which the level of direct costs is increased by 50%, the duration of trade disruptions is increased by 3 months on average or the magnitude of distorted trade is increased by 50% from the baseline scenario.

### 3.7.3.1 Discussion, ASF, economic future projections

In the reference scenario for 2009, economic losses caused by an ASF outbreak to Finnish society in total were estimated at €10.5 million (95% CI 4.6–22.7). The proportion of public funds used to cover losses was on average only €0.4 million (0.1–1.1). In the baseline future scenario, the total economic losses due to an ASF outbreak were at the same level, ranging on average from €10.5 to €11.5 million, depending on the proportion of linked contacts. Hence, the losses were close to the numbers estimated for the 2009 situation, but the range of variation increased slightly. However, in relative terms, the costs to public funds increased more than other cost items, and their variation also increased. Under the “Slow pig” scenario, the increase was smaller than under the “Baseline” scenario.

The results suggest that ASF was economically less affected by the changes in the contact structure than FMD. In the future scenarios, farrowing farms also played an important role as the farm type leading to the most costly outbreaks. Hence, improving biosecurity and the contact structure of piglet production is also advisable from an ASF point of view. As the importance of cost parameters and trade may change in the future, it is important to be prepared for larger outbreaks. The authorities could prepare contracts and contingency plans for how to undertake official and other mitigative measures in the future so that society would be prepared to respond promptly to disease outbreaks. This would also help to control direct costs paid by taxpayers.

By contrast, the results suggested that ASF losses in future scenarios were more affected by possible changes in the role of trade distortions than in the case of FMD. Contingency planning is also important from the market point of view. Regarding ASF, the duration of trade distortions seems to be particularly important. This is partly due to our modelling approach, but also partly due to the structure of pig meat trade. The potentially increasing importance and severity of trade distortions associated with ASF outbreaks can substantially increase both the expected losses and uncertainty

concerning the losses faced by different stakeholders. Hence, as in the event of FMD, society and the livestock sector should be prepared to mitigate both trade distortions and disease spread.

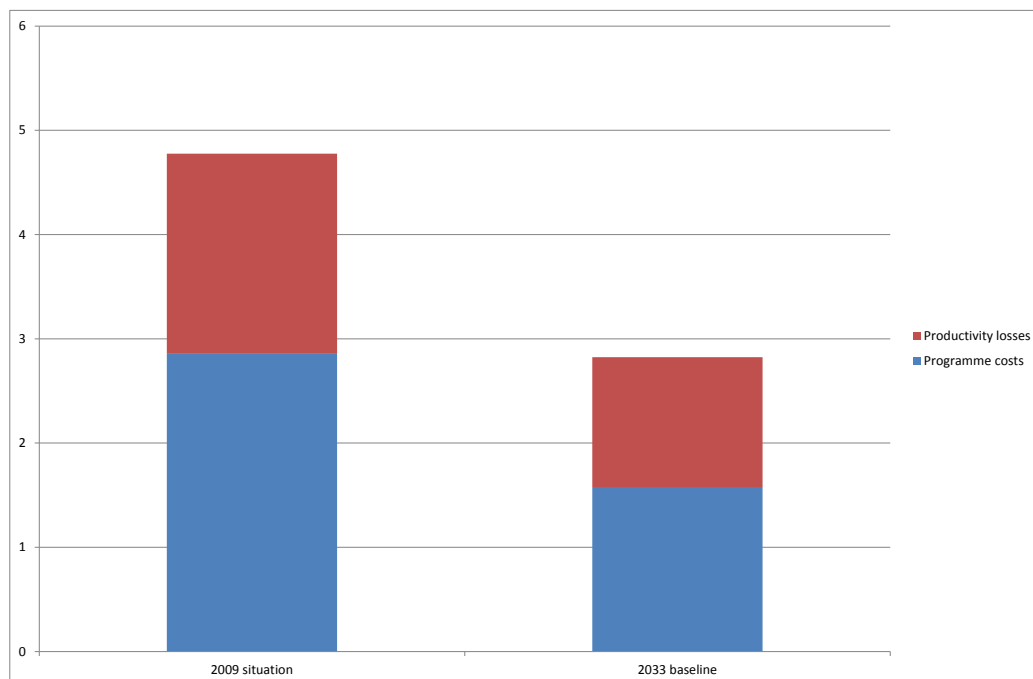
### 3.7.4 BT in future projections

Unlike FMD and ASF, BT is not expected to cause major disruption in the markets, because according to the OIE Terrestrial Animal Health Code, countries are not recommended to impose any restrictions on the trade of animal products in case of a BT outbreak. Foreign trade of live animals is likely to be disrupted, but since the exportation of live animals from Finland is quite marginal, the disease can be expected to have no or an insignificant impact on livestock markets in Finland. There is some evidence from past outbreaks observed elsewhere in Europe that, for instance, calf prices may be affected by BT in some cases. The prices of live young sheep could also be affected. Such effects are, however, mainly related to local restrictions in live animal trade or to changes in the supply and demand for calves.

In the future scenario, losses caused by BT were estimated to decrease when compared to the 2009 situation. While under the 2009 situation the losses were simulated on average at €4.7 million, in the baseline future scenario they were simulated to be only €2.8 million (95% CI €2.3–6.3 million). Eradication and surveillance costs (“programme costs”) were simulated to fall by about 50%, whereas productivity losses were simulated to fall by less than 20% (Figure 44). The reduction was simulated mainly because of the decrease in the number of farms and animals. A substantial proportion of programme costs was associated with the number of farms concerned rather than their size. Hence, a reduction in the number of farms, while the average farm size increases, results in a proportional reduction in the costs. The simulated average losses ranged from €2.5 million to €2.9 million when the proportion of linked contacts was increased from zero to unity. Hence, the linking of contacts did not have a major impact on estimated losses.

Regarding the losses caused by BT, essential factors are the extent to which farms are tested and monitored, which measures are taken to prevent the spread of the disease in the zones, and how large different zones are. A large proportion of losses are related to monitoring and surveillance carried out to determine whether BT still exists in the country. However, the magnitude and practical implementation of these measures can have a substantial impact on the losses. In practice, BT should spread into a completely new region before direct losses due to BT would increase substantially. Farm size and procedures taken to combat BT also matter. If restrictions are imposed on farm operations within the zones, their economic impacts can be large because the zones are quite large.

In the current situation and in the current future projections, the results do not suggest that vaccination against BT would be a preferred option. This is mainly due to two reasons: Firstly, the zones are large and the number of vaccinated farms would most likely be so large that the procedure would in most cases be more costly than potential savings due to a reduced number of infections. Secondly, quite a large proportion of losses are related to the measures to prove that the country is disease-free. Hence, vaccination would have only a small impact on the losses, as these are mostly unavoidable after the disease has been introduced into the country. However, if the disease increased mortality and reduced productivity on infected farms, this could increase the importance of mitigation measures. A similar change in emphasis could be possible if BT affected the trade in animal products in the future.



**Figure 44.** Simulated economic losses due to a BTF outbreak in the 2009 situation and in the “Baseline” future scenario (the proportion of linked contacts is 0.75).

### 3.7.4.1 Discussion, BT, economic future projections

The results suggest that in the future, losses caused by BT may decrease when compared to the 2009 situation. While under the 2009 situation the losses were simulated on average at €4.7 million, in the baseline future scenario they were simulated at only €2.8 million (95% CI €2.3–6.3 million). The size of a BT outbreak was estimated to be usually quite small. The results suggest that the losses caused by BT are strongly dependent on the extent of surveillance and monitoring measures taken in the country, because the number of farms and geographical area covered can be quite large. In addition, they are strongly dependent on the additional costs, production distortions and reduced productivity impacts of the disease.

The results suggest that surveillance-related costs may decrease in the future, mainly because the number of farms is decreasing. A substantial proportion of “programme costs” was associated with the number of farms concerned rather than their size. Hence, this conclusion is conditional on surveillance and monitoring costs being non-linearly dependent on farm size, i.e. costs per farm do not increase as much as farm size. The costs of BT were also not as closely related to the future contact structure as were losses estimated for ASF and FMD. Hence, regarding the future, it is important to optimize the efficiency of surveillance and monitoring associated with BT. In addition, climate change and structural change in the livestock sector can increase the losses faced by livestock producers. In any case, losses per farm can be expected to increase in the future. Hence, it might be important to develop measures that protect herds as entities and prevent the spread of disease within the farm.

Unlike FMD and ASF, BT is not expected to cause major disruption in the markets. However, if the disease was persistent, there could be economic impacts on the trade in live animals within the country. Due to globalization, these impacts on the Finnish livestock sector may be more prominent in the future than they are currently.



## 3.8 Risk management in the future

### 3.8.1 Changes in biosecurity measures due to increased farm size

An increase in the average farm size affects the implementation frequency of several biosecurity measures. Increased use was predicted for 9 out of 17 studied biosecurity measures on at least one farm type. In the pig sector, 7 biosecurity measures were predicted to be in more frequent use on average-sized farms in the baseline scenario of 2033. In the cattle sector, an increase was predicted in the use of 8 different biosecurity measures.

The most obvious increases in the use of biosecurity measures in the pig sector were involved with using leak-proof containers for dead animals, keeping doors locked and arranging the production facilities into compartments. Increased implementation of biosecurity measures concerning visitors was also predicted. Loading areas are likely to be more common on average-sized farrowing and finishing farms in the future and the biosecurity aspects of traffic are probably taken in greater account on average-sized finishing farms. Average-sized finishing farms are expected to increase the use of biosecurity measures more than average-sized farms of other types in the pig sector (Table 17).

In the cattle sector, improvements in the implementation of biosecurity measures on average-sized farms were predicted to mainly be introduced on dairy farms. The use of 8 biosecurity measures was predicted to become more frequent. Average-sized dairy farms are expected to have a higher implementation frequency of measures targeted towards visitors. Boots and coveralls will presumably be offered more often in the future. Biosecurity will probably be more often taken into account when organising farm traffic. Even compartmentalisation, the use of loading areas and the use of hygiene barriers can be expected to be more frequently applied on average-sized dairy farms in 2033 than in 2009. By comparison, we estimated that on average-sized beef cattle farms, none of the biosecurity measures would be implemented more frequently than in 2009, and only 3 measures were estimated to be implemented more frequently on suckler cow farms (Table 17).

An increase in the average farm size was predicted to have no impact on the frequency of hand washing, washing of loading areas, cleaning of animal stables between batches or control of rodents and birds. On dairy farms, however, an increasing average size of the farm had a negative effect on the implementation frequency of the prevention of rodents and birds at the feeding table of the animal shelter.

**Table 17.** Implementation of biosecurity measures in 2033 in the baseline scenario. Coefficients from the GLM models are transformed into likelihoods for the implementation of biosecurity measures on average-sized pig and cattle farms in Finland based on a questionnaire survey among farmers [% ( $\pm$ 95% CI)]; see Appendix 4 and Sahlström et al. (2014). Estimates in black are derived from a model in which the farm size effect was statistically significant and was not within the 95% confidence limit of typical-sized farms in 2009. Estimates in grey are from a model in which there was no statistically significant farm size effect and/or the estimate overlaps with the 95% confidence limit of a typical-sized farm of year 2009.

Variable description	Pig farm type			Cattle farm type		
	Farrowing	Farrowing-to-finishing	Finishing	Dairy	Beef cattle	Suckler cow
The farmer and his family use protective clothing in the stables	99 ( $\pm$ 1)	88 ( $\pm$ 9)	92 ( $\pm$ 6)	67 ( $\pm$ 5)	67 ( $\pm$ 7)	72 ( $\pm$ 11)
The farmer and his family use boots or protective shoes in the stables	87 ( $\pm$ 12)	80 ( $\pm$ 11)	92 ( $\pm$ 6)	71 ( $\pm$ 5)	60( $\pm$ 7)	62( $\pm$ 12)
Visitors use protective clothing (coveralls)	95 ( $\pm$ 7)	88 ( $\pm$ 9)	93 ( $\pm$ 6)	75 ( $\pm$ 5)	46 ( $\pm$ 8)	41( $\pm$ 12)
Visitors use boots	80 ( $\pm$ 16)	91 ( $\pm$ 7)	90 ( $\pm$ 7)	84 ( $\pm$ 4)	57 ( $\pm$ 8)	78 ( $\pm$ 10)
The farmer and his family wash their hands after working in the stable	71( $\pm$ 24)	95 ( $\pm$ 6)	89 ( $\pm$ 8)	92 ( $\pm$ 3)	86 ( $\pm$ 5)	86 ( $\pm$ 8)
Visitors wash their hands after the visit	64 ( $\pm$ 22)	76 ( $\pm$ 12)	73 ( $\pm$ 12)	65 ( $\pm$ 5)	46 ( $\pm$ 7)	43 ( $\pm$ 12)
The use of a barrier that separates the clean area from the dirty area and that is not passed without changing protective clothing and shoes.	59 ( $\pm$ 20)	43 ( $\pm$ 15)	33 ( $\pm$ 13)	21 ( $\pm$ 4)	10 ( $\pm$ 5)	9 ( $\pm$ 6)
The use of a separate loading area	94 ( $\pm$ 6)	83 ( $\pm$ 11)	54 ( $\pm$ 14)	12 ( $\pm$ 3)	2 ( $\pm$ 2)	7 ( $\pm$ 5)
Washing the loading area after use	42 ( $\pm$ 20)	47 ( $\pm$ 14)	31( $\pm$ 12)	3 ( $\pm$ 1)	2 ( $\pm$ 1)	3 ( $\pm$ 3)
Outside the animal stables there is a leak-proof container for dead animals	90 ( $\pm$ 9)	85 ( $\pm$ 10)	88 ( $\pm$ 8)	1 ( $\pm$ 1)	0 ( $\pm$ 1)	0 ( $\pm$ 1)
The animal stables are cleaned between each “batch”	50 ( $\pm$ 20)	55 ( $\pm$ 14)	85 ( $\pm$ 9)	18 ( $\pm$ 4)	50 ( $\pm$ 8)	24 ( $\pm$ 10)
Doors are locked	78( $\pm$ 16)	68 ( $\pm$ 13)	79( $\pm$ 11)	14 ( $\pm$ 4)	16 ( $\pm$ 6)	8 ( $\pm$ 6)
Animals are divided into compartments	96( $\pm$ 5)	77 ( $\pm$ 12)	80 ( $\pm$ 11)	29 ( $\pm$ 5)	29 ( $\pm$ 8)	32( $\pm$ 11)
The traffic on the farm is organized so that biosecurity aspects are taken into account	57 ( $\pm$ 20)	60 ( $\pm$ 14)	55 ( $\pm$ 14)	49 ( $\pm$ 6)	26 ( $\pm$ 8)	45 ( $\pm$ 12)
Control of rodents and birds	96 ( $\pm$ 7)	91 ( $\pm$ 8)	99( $\pm$ 2)	80( $\pm$ 4)	79 ( $\pm$ 7)	78( $\pm$ 10)
Control of rodents and birds in the animal stable or shelter at the feeding table	37 ( $\pm$ 20)	60( $\pm$ 14)	59 ( $\pm$ 13)	43 ( $\pm$ 5)	38 ( $\pm$ 7)	12 ( $\pm$ 3)
Control of rodents and birds in the feed storage	54 ( $\pm$ 20)	75( $\pm$ 12)	74 ( $\pm$ 12)	36( $\pm$ 5)	35 ( $\pm$ 7)	29 ( $\pm$ 10)

A statistically significant effect of farm size is marked as follows: \*\*\*<0.001, \*\*<0.01 and \*<0.05. Average-sized farms in the model: farrowing = 1 562, farrowing-to-finishing = 1 567, finishing = 1 734, dairy = 133, beef cattle = 72, suckler cow = 169 animals. Note: these refer to the mean number of animals on the original scale in the baseline scenario of 2033. The models apply ln-transformed size and are as reported in Sahlström et al. (2014).

**Table 18.** Indicative forecast for the change in the implementation frequency of biosecurity measures on average-sized farms in the baseline scenario for 2033 when compared to the implementation frequency of average-sized farms in 2009

Variable description	Pig farm type			Cattle farm type		
	Farrowing	Farrowing-to-finishing	Finishing	Dairy	Beef cattle	Suckler cow
The farmer and his family use protective clothing in the stables						
The farmer and his family use boots or protective shoes in the stables				+		
Visitors use protective clothing (coveralls)			+	++		+
Visitors use boots		+	+	+		++
The farmer and his family wash their hands after working in the stable						
Visitors wash their hands after the visit						
The use of a barrier that separates the clean area from the dirty area and that is not passed without changing protective clothing and shoes.				+		
The use of a separate loading area	++		++	+		
Washing the loading area after use						
Outside the animal stables there is a leak-proof container for dead animals	++	++	+			
The animal stables are cleaned between each “batch”						
Doors are locked	++	+	+			
Animals are divided into compartments	++	+	++	+		
The traffic on the farm is organized so that biosecurity aspects are taken into account			+	++		+
Control of rodents and birds						
Control of rodents and birds in the animal stable or shelter at the feeding table				-		
Control of rodents and birds in the feed storage						

Symbols: - = reduction less than 10%; + = increase less than 20%; ++ = increase over 20%

### 3.8.2 Protective measures associated with animal trading

Protective measures associated with animal trading were not highly correlated with farm size in our questionnaire data. Thus, predictions of implementations based on farm size are only slightly affected. Requiring a health certificate when purchasing animals and the aim to buy animals from as small a number of farms as possible are predicted to remain at the level of 2011, even if the average farm size is expected to increase. Average-sized beef cattle and farrowing-to-finishing farms are expected to retain protective measures on the level of average-sized farms in 2011. Average-sized farms of other types may show an improvement potential in the implementation of 1–2 measures. The difference in the pattern of protective measures between the pig and cattle sectors is also expected to remain the same, regardless of the increase in farm size (Table 19).

In the pig sector, average-sized farrowing farms appear to increase the frequency of checking the origins of animals before buying and transporting them in their own vehicles. Average-sized finishing farms try to buy animals from the same farms more frequently than in 2011. Average-sized dairy farms may apply quarantine of purchased animals more often than in 2011. Average-sized suckler cow farms purchase animals more often from slaughterhouse animal trading, and the purchased animals are less frequently transported in vehicles owned by the farms themselves (Table 19).

**Table 19.** Implementation of biosecurity measures in 2033 in the baseline scenario. Coefficients from the GLM models are transformed into likelihoods for the implementation of biosecurity measures on average-sized pig and cattle farms in Finland based on a questionnaire survey among farmers [% ( $\pm$ 95% CI)]; see Appendix 4 and Sahlström et al. (2014). Estimates in black are derived from a model in which the farm size effect was statistically significant and was not within the 95% confidence limit of typical-sized farms in 2009. Estimates in grey are from a model in which there was no statistically significant farm size effect and/or the estimate overlaps with the 95% confidence limit of a typical-sized farm of year 2009.

Variable description	Pig farm type			Cattle farm type		
	Farrowing	Farrowing-to-finishing	Finishing	Dairy	Beef cattle	Suckler cow
Follow the instructions of ETT	100 ( $\pm$ 1)	85 ( $\pm$ 13)	95 ( $\pm$ 7)	96( $\pm$ 3)	85 ( $\pm$ 6)	93 ( $\pm$ 7)
Checking the origins of animals before buying	92 ( $\pm$ 12)	53 ( $\pm$ 20)	52 ( $\pm$ 16)	90 ( $\pm$ 5)	38 ( $\pm$ 9)	91 ( $\pm$ 8)
Requiring a health certificate before buying	45 ( $\pm$ 30)	40 ( $\pm$ 20)	20 ( $\pm$ 14)	67( $\pm$ 7)	11 ( $\pm$ 6)	75 ( $\pm$ 12)
Trying to buy animals from as small a number of farms as possible	94( $\pm$ 11)	86( $\pm$ 14)	78 ( $\pm$ 12)	65( $\pm$ 8)	50 ( $\pm$ 9)	61 ( $\pm$ 14)
Buying animals mainly from the same farms	53 ( $\pm$ 17)	37 ( $\pm$ 20)	10( $\pm$ 9)	38( $\pm$ 8)	39 ( $\pm$ 9)	11 ( $\pm$ 10)
Transport animals using own vehicle	92 ( $\pm$ 13)	82( $\pm$ 14)	95( $\pm$ 6)	26( $\pm$ 7)	87( $\pm$ 6)	73( $\pm$ 12)
Animals are handled by a slaughterhouse	51( $\pm$ 14)	35( $\pm$ 18)	10( $\pm$ 9)	25( $\pm$ 7)	42( $\pm$ 9)	37( $\pm$ 15)

The probability of a typical-sized farm buying animals according to the questionnaire: farrowing = 69%, farrowing-to-finishing = 68%, finishing = 93%, dairy = 33%, beef cattle = 92% and suckler cow = 74% in 2011. Predictions that deviate from the mean of average-sized farms of that farm type in 2011 by more than 2 standard errors are marked in black, while others are marked in grey.

### 3.8.3 Discussion, biosecurity and protective measures

Our forecast for the implementation of biosecurity measures in the future is based on the projected changes in the average farm size. Numerous other factors may influence the frequencies of implementation. Therefore, the results must be considered only as a possible scenario that may be realized. However, economic factors, changes in the overall disease situation in Finland and legislation, as well as the future prospects and motivation of farmers will affect the implementation of biosecurity measures in Finnish pig and cattle farms in the future. The costs and realized benefits of the measures will also play a role.

A positive effect on the implementation frequency in relation to farm size can be thought as an indication of an existing economic or other incentive that is positively correlated with the farm size. According to our results, farm size-related incentives appeared to cover 23–70% of the studied biosecurity measures, depending on the farm type.

Even though the implementation of some biosecurity measures did not correlate with farm size at the time of our questionnaire, it does not mean that an incentive leading to an improvement in biosecurity with increasing farm size cannot be found. One of the options could be to strengthen economic incentives and impose conditions on possible support payments to farms such that increased implementation of biosecurity measures would be required from enlarging farms. If improvements in biosecurity cannot be achieved through farm-size-related incentives, other motivating factors should be considered.

Many livestock farms will exit the industry by 2033. Exiting farms will predominantly be small farms that do not invest in new production facilities and infrastructure. If improvements are focused on those farms that continue and invest in new production capacity, they can cover a substantial proportion of future livestock production.

Another argument that can be presented when targeting the improvements in biosecurity measures is that small farms have more to improve than large farms. The costs of biosecurity measures may limit the introduction of costly biosecurity measures, particularly on small farms (Niemi et al. 2015). Small farms and especially hobby farms may also be a potential group for introducing new diseases into the country. They may be less familiar with the laws and regulations than large farms. Hence, efforts should also be targeted at these farms.

However, small farms are usually less connected with other farms, especially with large professional farms. Small farms are also more likely to end production, and the investments do not therefore necessarily provide as permanent an improvement in the biosecurity conditions of the country as they do on large farms. In summary, small farms may have a large amount of improvement potential related to biosecurity measures, but improvement may be more difficult to achieve and they may be less efficient in relation to the production volume than if the same effort is targeted towards larger farms. Highly connected farms would be an obvious group for targeted incentives in order to improve the overall biosecurity level. These farms are not necessarily the largest farms in the country, although farm size and connectivity with other farms generally correlate positively. In the pig sector, one of the most efficient groups in spreading a disease is elite breeding and multiplying herds (Raulo & Lyytikäinen 2006). Sow pools and multi-site pig farms were also efficient in spreading

diseases in the present study. In the cattle sector, the most effective group was the weaner calf farms. Hence, it may be advised to promote biosecurity measures that are related to animal transports in these farm groups.

Generalized linear models (Appendix 4) indicated 24 farm-size-dependent effects in implementation frequencies in the pig sector and 22 in the cattle sector. Half of the effects in the cattle sector and 58% of those in the pig sector were so large that the prediction for typical-sized farms in 2009 and 2033 clearly deviated (by at least 2 standard errors). Only one decline in implementation frequency was large enough to be considered relevant (Table 18). Changes appeared to be the smallest on beef cattle farms, as was also the predicted increase in farm size.

A farm size increase may also lead to minor improvements in the implementation frequency of measures that are not strongly dependent on farm, because the farm size range is larger than the change in an average-sized farm. Although the practical importance of this change is smaller, it probably has some relevance in determining the spread potential in the country as a whole.

In the pig sector, factors such as the locking the doors of the animal shelter, the use of containers for the storage of dead animals and the use of compartments within the production units showed clear farm-size dependence. These measures are relevant for the protection of pig farms. According to our results, their implementation will be more prevalent in the future. In the cattle sector, most improvements were related to visitors. In the future, the use of boots or coveralls as protective clothing will become more common than today. On cattle farms, traffic-related arrangements will also be more frequently applied in the future. Moreover, it is not rational to apply certain pig sector biosecurity measures in the cattle sector.

This raises some concerns that the use of protective measures related to animal trading is not expected to increase much in the future. This may partly be a result of the outsourcing of animal trading to slaughterhouse companies reducing the control of farmers regarding the purchasing of pigs. It is also possible that risk management is presently too concentrated on biosecurity measures. Direct animal contact is always a potential route for disease spread. The low prevalence and occurrence of animal diseases in Finland may have led to a situation where the risks related to animal trading within the country are overlooked. Some indications for this can be seen in the implementation frequencies reported in the questionnaire. For instance, internal and external traffic on the farm are separated much more seldom than visitors are offered coveralls.

The possibility to concentrate animal purchases in the same farms is lower in the cattle sector than in the pig sector. According to our questionnaire, this will not improve in the future with an increase in farm size. As farm sizes increase, there may be a peak in the demand to fill the added capacity. This period has the potential to expose the farm to animal disease risks, and it may have incentives to accept animals that are "leftover animals" from several farms. The ability of farms to select the source of their incoming animals may be dictated by the availability of animals. There should be precautionary plans for how new stock is introduced to farms, and what kind of time window and sources to acquire animals are required in order to minimise disease risks.

We performed an additional future FMD simulation in which the animal contact network was re-organized by taking the spatial distance between farms into account.

If all possible animal trading contacts of the farm were linked to those farms within a 20 km radius, this was estimated to reduce the mean epidemic outbreak size in the future by only 10%. This is partly due to farms being further apart in the future. A 20-km distance implies that the farms within the 20 km range potentially share at least some of the same farms in their restrictive zones (the radius of a protective zone is 10 km). When any farm is detected as positive, part of the potential contact network of other farms within the 20 km range is also put under restrictive measures. The decreasing farm density and increasing distance between farms will reduce the importance of this spatial risk management strategy.

It was not simulated how much the outcome would be affected if a farm could buy animals from or sell to only a limited number of farms. This type of limitation is expected to mainly affect the maximum size of an outbreak. It would be a valuable limitation if the spread potential of an animal disease in the country was high. Under Finnish conditions, such a limitation would at least be effective for weaner farms, which seemed to be the subgroup most frequently associated with large outbreaks. However, this type of limitation would not offer additional protection value to Finnish farms against the spread of FMD, ASF or BT, because the spread potential was estimated to be low and spatial risks were limited. If the future is different from our baseline scenario and animals are moved substantially more often than we estimated, the outcome of such a limitation could be different.

#### **3.8.4 Discussion, official measures during an outbreak in the future**

The results suggest that in the future, contact tracing and related risk management measures will become more important than they are currently. This is due to growing distances between farms, resulting in restrictive zones capturing potentially less of the spread. Therefore, it will be increasingly important to collect and store information on animal transport contacts in the future. The quality of the data needs to be adequate for risk management purposes and it should be stored in an easily usable format. Presently, official animal movement databases contain information on transactions. Animal transport contacts between farms are constructed from these transactions. For this reason, information on cattle movements is not easily paired with vehicle movements and routes. This can be partially solved by applying unofficial data sources from the industry. For instance, information from slaughterhouse companies may be useful. However, different slaughterhouse companies presumably have different systems, and some information may potentially be lost between the different systems. The development of official registries focusing on animal movement and contact databases would be costly. A development decision warrants sufficient benefits for the development to be economically feasible.

The increasing importance of contact tracing can be drawn from all of the simulated diseases of this study. Even vector-borne diseases may spread more by animal transport than by vector movements in the future, as indicated by our BT results. This highlights the importance of ensuring that the available information and tools for tracing are efficient.

In the future, culling in connection with an epidemic will become more challenging than today. The movement of carcasses to rendering plants will also need to be planned more carefully than at present. This is due to the much larger numbers of animals and biomass on a farm that will need to be culled and destroyed. Requirements for the rendering and storage capacity would increase in FMD and ASF outbreaks due to an increased farm size.



The potential number of visits by veterinary officers on farms under restrictive measures in protection and surveillance zones will decrease in the future for a given outbreak size. The number of traced contact farms will increase correspondingly. If these farms are visited for the inspection of clinical signs, the number of visits will increase accordingly. The total number of farm visits would then remain unchanged but be sparser.

For FMD and ASF, the official measures determined by EU regulations also seem to be adequate in the future when controlling outbreaks, as the probability of epidemic outbreak or a large outbreak did not change substantially in the future scenarios when compared to the current situation. The results suggest that in BT outbreaks, the culling of positive herds may be a feasible option when compared to emergency vaccination. Vaccination could be considered as a longer term strategy (1–2 years) for the eradication of the disease. The results do not provide support for emergency vaccination as a beneficial policy during an ongoing vector-active season, although it may help to limit the spread of BT during the next vector-active season.



## 4 Summary and final conclusions

---

### **There is lower risk associated with sheep and goat production and a higher risk associated with networked beef and pig production**

The aim of this study was to assess how changes in the structure of animal production impact on animal disease risks and the economic consequences of diseases. FMD, ASF and BT were used as examples to reflect the risks posed by contagious animal diseases under current and hypothetical future production structures. The spread of diseases and their implications were simulated in three different future production structure scenarios and then compared with the results obtained when simulating the production structure for the year 2009. In addition, the effects of different production types on disease outbreaks in the 2009 structure were simulated.

The simulation results regarding conventional farms such as dairy, beef cattle, farrowing, farrowing-to-finishing and finishing pig farms were in line with previous research by Lyytikäinen et al. (2011). Hence, we first discuss the roles of other types of farms. The data show that in 2009, cattle were the most dominant production type in the event of FMD. Typical sheep and goat farms are currently small and they represent only less than one per cent of livestock production, as highlighted by Virtanen et al. (2013) and Appendix 2. The results suggest that sheep and goats have a minor role when the potential spread of FMD and BT in Finland is considered. Sheep and goat farms are less likely to spread the disease to another farm and thus an epidemic is less likely, and a possible epidemic is expected to be smaller when a sheep or a goat farm is infected than when a cattle or a pig farm is infected. The small impact of sheep production suggests that although specialized sheep production may increase, it is likely to have quite a modest impact on the risks of the evaluated diseases.

In addition, the results suggest that a dairy farm as the starting point of an outbreak was able to result in larger outbreaks and larger economic losses than a pig farm. However, the variation in outcomes was quite large and individual farms, including sheep and goat farms, are able to result in very large outbreaks. Similarly, there are situations in which economic losses can soar. The same does not seem to apply to BT. However; the BT model had in use less farm-level information than the FMD and ASF models.

The results also suggest that in most cases the disease, even if it spreads to other farms from the primary infected farm, is contained within the same production sector that the primary infected farm represents. This was particularly common when the

primary infected farm was a cattle farm, but this result may partly be due to the large share of cattle farms among all farms.

Mixed farms having sheep or goats with pigs or cattle are slightly less likely to cause an epidemic than specialized cattle or pig farms. Mixed farms are typically smaller than an average-sized specialized farm. In addition, on mixed farms having sheep and goats, the risk of spreading FMD is mainly caused by pigs and cattle. Increased specialization of farms towards a single species may reduce the overall risk of disease spread across production sectors. In this sense, specialization may also have provided some benefits through animal disease risks. However, even in cases of spread towards the cattle sector, the probability of large outbreaks is lower in outbreaks originating from sheep or goat farms than in outbreaks that have started from other types of farms.

The number of sow pools has decreased during the past decade, whereas multi-site pig production and three-stage cattle production may be increasing. The results suggest that some specialized production types, particularly multi-sites and sow pools, are at risk of causing an epidemic, and a larger epidemic than farms representing conventional types of production in the same production sector. In addition, less than 30% of further spread remained within these specialized production networks. Hence, they also pose a risk to farms not belonging to these networks. Further research is warranted on what types of farms are at risk when these networked farms are infected. These networked farms require special attention when the targeting of surveillance and biosecurity measures is considered. Their importance may partly be due to farm size and partly to mixing the production practices of specialized and conventional farms, which leads to their contact network being extensive, i.e. the systems are not as closed as they could be.

Similar principal results also apply to weaner (beef cattle) farms. They are more likely to cause epidemics, and these are larger and more costly epidemics than conventional beef cattle farms. They have a rather high probability of being involved in large outbreaks, because they are intensively connected with other farms. From the risk management point of view, it is important that other cattle farms do not deliver animals to several weaner farms or take animals from several weaner farms, because there can be large multiplier effects of disease occurrence.

### **Farm size to increase substantially in the future**

According to our analysis, farm size is likely to increase substantially (by 160–650%) in the future. This means fewer but larger farms taking care of the supply of livestock products. The largest increase in farm size was mainly simulated in the pig sector, because the future projection is partly based on previous structural development, which has been stronger in the pig than in the cattle sector. Because of this, we also examined alternative scenarios: the “Slow pig 2033” scenario assumes a smaller reduction in the number of farms and a smaller increase in the number of animals within the farms, whereas the “Fast cow 2033” scenario assumes a larger reduction in the number of cattle farms and a larger increase in the farm size.

Regarding the spread of contagious animal diseases, how contact networks between farms will change is critical. According to our simulations, the total number of animal movements between farms is likely to decrease in the future, whereas the frequency of contacts per farm is expected to increase. This implies that the batch size per

animal movement contact will increase. Infrastructure limitations such as the quality and carrying capacity of roads and the size and carrying capacity of bridges may limit the possibilities to increase the average vehicle size. The development projected in our study is quite feasible when compared to the current situation in Sweden (Nöremark et al. 2011) or Denmark. The transportation technology may also change over the next two decades so that larger vehicles are available in 2033 than now. This study does not present any results for a situation where Finnish animal production would operate logistically “less efficiently” than today.

### **Restructuring of contacts determined how the risk of FMD spread will change**

The results suggest that a change in the contact structure is the most critical factor determining the risk of disease spread in the future. In our simulations, this was related to the proportion of contacts that were re-linked from farms that exit the industry by 2033 to the farms that continue production until 2033. The probability of an epidemic outbreak may decline in the future, because the probability of an epidemic outbreak with 0.50–0.75 re-linking was lower than the probability in the reference simulations. The larger the proportion of re-linked contacts, the higher the probability of an epidemic outbreak in the pig sector is expected to be. On average, pig farms were simulated to result in about 9 and cattle farms in about 13 infected farms should an epidemic outbreak occur when the proportion of re-linked contacts was 0.75.

It is important to take the farm type into account in the analysis, because the proportion of different farm types was projected to change in the future. Both economic and epidemiological results suggest large variation in the outcomes in the future. The results suggest that the number of cattle per infected farm can be expected to increase by 110–370%. If the primary infected farm is a pig farm, the number of pigs in infected farms will increase from the 2009 structure. Farm types responded differently to the re-linking assumption and future scenarios. The proportion of re-linked contacts impacted more strongly on the size of an outbreak starting from cattle than from pig farms. When compared to the 2009 structure, the probability of an epidemic outbreak affected dairy farms more than suckler cow or beef cattle farms. Although the probability of an epidemic outbreak could even decrease from the 2009 situation, epidemic outbreaks on average were predicted to be larger in the future if a high proportion were re-linked. Variation in outbreak size also increased. Hence, the results suggest that dairy farms are particularly likely to cause large outbreaks in the future. By contrast, the results suggest that farrowing farms are particularly likely to result in an epidemic outbreak unless a very small proportion of contacts is re-linked. The results also suggest that farrowing farms are likely to be more capable of spreading FMD in the future than finishing farms. These results are realistic, because the average batch size of an animal transportation in the cattle sector is only 2–3 animals, whereas the batch size of a typical pig transportation is much larger. Hence, there are more possibilities to control for the animal transport batch size in the cattle than in the pig sector, and hence to control for the risk of disease spread.

For instance, if the batch size is assumed to increase to 150% of that in the year 2009, the average outbreak size is reduced by 28–52% and is smaller than in the reference simulations in all farm types except for farrowing farms. This highlights the importance of animal transport logistics in defining the spread potential of the future. The number of uninfected farms in protection and surveillance zones is anticipated to decrease. However, as farm size is expected to increase, the total number of animals in restriction zones will remain close to the 2009 situation.

## **Economic losses due to FMD become less predictable**

In the baseline scenario for 2009, the total economic losses caused by an FMD outbreak in Finland were simulated to range from €11.6 million to €74.4 million in 95% of the cases, with a mean loss of €27.7 million. The total economic losses on average increased from €23.7 to €34.4 million when the proportion of linked contacts increased from zero to unity. Hence, the results suggest that economic losses due to FMD might not change dramatically in the future if the proportion of re-linked contacts is 0.5–0.75. However, the results also highlighted that economic losses on average and their variation were affected by the proportion of re-linked contacts, as a higher degree of re-linking increased the losses. Although the economic impacts of re-linking seem to be smaller than in the epidemiological results, it is very important to control for structural change so that risks related to the contact structure are reduced. These results are in line with previous research discussed by Backer et al. (2007), which suggests that while the number of farms will decrease, the remaining farms could be more efficient in spreading disease.

The assumption regarding trade disruptions is also very critical to the economic losses. The baseline results are based on an assumption that exports to non-EU countries would be severely disrupted, and the disruptions would last on average as long as it is suggested in the OIE Terrestrial Animal Health Code, whereas intra-community exports would be disrupted only temporarily. As in the case of 2009 simulations, future projections also showed large differences in losses between stakeholder groups and suggested that the producers were the main group suffering economic losses due to an FMD outbreak. Disruptions in exports can quickly result in saturated domestic markets and falling producer prices. If the importance of trade increases, it is likely to have major impact on risks caused by FMD. From the policy point of view, it may be important to prepare approaches for mitigating trade distortions, such as arguments and methods to control the disease and to prove that the production is of low risk, as well as the capacity to increase trade with markets that may remain open. Import restrictions set by Russia in 2014 for EU products already suggest that industries can suffer substantial losses due to trade disruptions. As the EU is an important seller in the international livestock markets, the restrictions have increased the supply of livestock products to the EU markets. However, this case also shows the flexibility of the markets, because, for instance, dairy product exports from the EU to the United States and Middle East increased substantially during 2014 (European Commission 2015), and the industry has thus been able to reduce the losses by adjusting the marketing.

In relative terms, direct costs mainly covered by public funds were impacted more severely by structural change than indirect costs. The culling of animals on infected farms can be expected to be more difficult in the future due to increased numbers of animals per farm. Hence, more planning will be needed to ensure smooth culling and transportation of carcasses to the rendering plant. The need for rendering capacity is also expected to increase in both future FMD and ASF outbreaks. However, the total number of culled animals may not change dramatically. It is recommended to revise the contingency plans by using the largest farms that are currently operating, because the number of animals on the largest farms can be used as an example of the future capacity requirements related to the culling and rendering capacity of the carcasses. Information on contacts and how the information is handled will also become more important in the future. This could lead to savings in direct costs, as the costs of a traced contact farm are usually lower than the costs of a farm in a surveillance or protection zone (Lyytikäinen et al. 2011). If the unit prices of controlling

FMD increase in the future, this may have the largest impact on outbreaks starting on farrowing, dairy or beef cattle farms. The results suggest that changes in the structure of dairy farming, particularly if the changes become more rapid, are of particular economic concern when the risks of FMD are considered. By contrast, a possible slowing in the rate of change in the pig sector could result in smaller losses in the future. As the results suggest the largest impact of structural change on outbreaks starting on farrowing farms, it could be beneficial to control the development of piglet production, including the concentration of piglet production in fewer farms.

An important aspect related to trade disruptions is that importing countries may not follow the OIE Terrestrial Animal Health Code. Instead, they may enforce import restrictions that have heavier consequences than those suggested by our baseline scenario. Both the duration and product coverage of restrictions can differ substantially from OIE recommendations, as the restrictions are solely decided by the importing country. As our sensitivity analysis suggests, more stringent import restrictions can cause the losses to soar. It is therefore important that stakeholders take measures to build confidence that the Finnish animal health system is able to control the situation. Perhaps the most important measures in this respect are the establishment of a credible surveillance and monitoring system and rapid response (and contingency plans related to the response) to an outbreak, should it occur.

Previous disease outbreaks observed in other countries suggest that the countries respond differently to disease news. Countries such as Japan and South Korea may impose quite strong measures, whereas some other countries seem to respond with fewer restrictions. Russia, which is an important trading country for the Finnish food industry, may also have exaggerated responses, as suggested by measures in 2013–14 in relation to ASF outbreaks in Poland and Baltic countries. In addition, non-disease-related policy issues may also trigger import restrictions, as suggested by the measures following the conflict in Ukraine in 2014.

### **ASF outbreaks to remain quite small**

In the 2009 situation, 23% of ASF outbreaks on average were simulated to be epidemic outbreaks, and the mean size of epidemic outbreak was 2.6 infected farms. These results suggest that with the same re-linking assumption as in FMD (0.5–0.75), epidemic ASF outbreaks were on average 2–32% larger in future projections than in the 2009 structure for all pig farm types. In addition, there were more animals on infected farms in the future baseline scenario than in 2009. The number of animals in uninfected farms in restrictive zones can also be expected to be larger in the future. As in the case of FMD, farrowing farms had the greatest potential to spread ASF, and outbreaks originating from them were the most costly ones. Hence, improving bio-security and the contact structure of piglet production is also advisable from the ASF prevention viewpoint. These results are consistent with the earlier risk assessments of CSF and FMD spread in Finland (Raulo & Lyytikäinen 2006; Lyytikäinen et al. 2011).

For 2009, the total economic losses caused by an ASF outbreak to Finland were estimated on average at €10.5 million (95% CI 4.6–22.7), of which public funds covered €0.4 million (0.1–1.1). In the baseline future scenario, total economic losses due to an ASF outbreak ranged on average from €10.5 to €11.5 million, depending on the proportion on linked contacts. Hence, the average losses were estimated to change only slightly. These results are also consistent with previous research on CSF and FMD (Niemi et al. 2008; Lyytikäinen et al. 2011).

Similarly to FMD, the variation in outbreak size and economic losses increased when the proportion of re-linked contacts increased. The variation was, however, substantially smaller in ASF than in FMD simulations, and ASF was less affected by the contact structure than FMD. Regarding economic losses, costs to public funds are likely to increase more than other cost items, and their variation will also increase. This result is related to above-mentioned changes in farm structure. The results suggest that the importance of restrictive zones will decrease more for ASF than for FMD in the future, and contact tracing will also have relatively higher importance in ASF outbreaks than in FMD outbreaks.

In most cases, the domestic pig population seems to be unable to spread ASF to a large number of farms, both at present and in the future. However, larger outbreaks might be possible if the ASF virus evolves into a form that causes less severe clinical symptoms and lower mortality than anticipated, as these will affect the detection time, or if the infectivity of ASF increases.

Similarly to FMD, trade disruptions play a major role in determining the economic losses caused by an ASF outbreak at present and in the future scenarios. The logic is also similar, and similar factors tend to affect the losses caused by ASF and FMD. Trade distortions, particularly their duration, seem to be more important in the case of ASF than FMD. Even though careful contingency plans to reduce disease spread may not have a substantial impact on the epidemic size, they may be necessary to reduce the economic losses, as these and other measures taken by authorities may help to ensure trade counterparties that the country does not pose a risk to them. This may also help to control the direct costs paid by taxpayers. Hence, as in the event of FMD, society and the livestock sector should be prepared to mitigate both trade distortions and disease spread.

### **Results suggest limited bluetongue spread**

BT outbreaks were typically limited to 1–2 infected farms. In the future, a BT outbreak could be smaller and the probability of an epidemic outbreak equal to or lower than in 2009. In addition, the variation in outbreaks may decrease. These findings can be explained by the reduction in the number of farms combined with the patterns of BT spread.

Farm size and the contact structure do not appear to play as large a role in a BT outbreak as in an FMD outbreak. Therefore, future changes in the contact structure will have only a small impact on BT spread. However, direct animal contacts could still be more relevant in the future, because on average there will be longer distances between farms, which will reduce the spatial spread. In addition, there will be fewer farms in control, protection and surveillance zones in the future. This will directly reduce the economic losses. In particular, the number of farms in surveillance zones is quite dependent on the farm density in Finland, as the zones are large. Since regional differences in structural change were quite small, the results suggest that structural change is unlikely to cause large regional differences in the spread of BT.

The results suggest that structural change may reduce the losses caused by BT. Under the 2009 situation, the losses were estimated on average at €4.7 million, whereas in the baseline future scenario they were reduced to €2.8 million only (95% CI €2.3–6.3 million). The losses caused by BT are strongly dependent on the extent of surveillance and monitoring measures taken in Finland, because the number of farms



and geographical area covered can be quite large. In addition, the losses are strongly dependent on the scale of additional costs, production distortions and productivity impacts the disease can cause.

A substantial proportion of costs related to monitoring the disease situation were associated with the number of farms in the monitored region rather than their size. Hence, regarding the future, it is important to optimize the efficiency of surveillance and monitoring measures associated with BT. In addition, climate change and structural change in the livestock sector could increase the losses faced by livestock producers. Unlike FMD and ASF, BT is not expected to cause major market disruptions. However, if the disease is persistent, economic impacts on the trade of live animals within Finland could occur.

Vaccination is a possible way to prevent the spread of bluetongue. Vaccination usually reduces the infectivity of BT to a level where the disease does not spread efficiently (the decrease in  $R_0$  in cattle farms is 70–83%). Our simulations suggest that in most cases, vaccination is not justified economically or epidemiologically. This can be concluded even if vaccination is not simulated explicitly. The probability of an epidemic outbreak and its final size are likely to be very small, and losses that could be avoided by vaccination are likely to be modest.

In our simulations, the vector-active season for spread between farms started in June. The start of vaccination after the initial detection of the disease and the completion of vaccination will take time, even several weeks. Therefore, two-thirds of the vector-active season may already be over before any risk measure is applied. The first preventive effects of vaccination could be achieved at the end of vector-active season. Hence, the main effects of a vaccination campaign would probably take place during the following vector-active season. The results suggest that in the future, emergency vaccination will be an even less likely risk management measure in preventing the spread of BT during the ongoing vector-active season.

In 2015, BT surveillance in Finland will concentrate on blood sampling from cows kept on suckler cow farms. In our simulations, suckler cow farms were the least effective farm type to spread BT. From this narrow perspective, targeting sampling at suckler cow farms appears ineffective. However, suckler cows are kept outdoors more than other types of cattle. Therefore, BT surveillance in Finland in 2015 is likely to concentrate on farms that can effectively receive but not spread BT.

Based on our parameter assumption and applying information from the literature (Koeijer et al. 2011, Turner et al. 2012), it can be concluded that indirectly our model assumes that the spread between farms would require at least a 5–8 % intra-herd prevalence of infection.

### **Biosecurity is likely to improve**

Numerous factors may influence the implementation of biosecurity measures on Finnish pig and cattle farms in the future. Economic factors, changes in the overall disease situation in Finland and legislation, as well as future prospects and the motivation of producers can affect the implementation of biosecurity measures. The costs and realized benefits of the measures also play a role. Furthermore, the farm type affects the implementation of biosecurity measures in many ways.

When farms have insufficient incentives to adopt efficient biosecurity measures, it could be possible to use targeted policies. For example, support payments could be provided conditional on the adoption of biosecurity, especially by enlarging farms. Larger farms usually have higher incentives to adopt biosecurity measures than smaller farms. If improvements are concentrated on farms that continue and invest in new production capacity, they can cover a substantial proportion of the future livestock production. On the other hand, smaller farms usually have a lower biosecurity level and hence more to improve than larger farms. However, the costs of biosecurity measures may limit the introduction of costly measures, particularly on small farms (Niemi et al. 2015). Efforts should also be targeted at these smaller farms, even if they usually have fewer contacts with other farms than larger farms have.

Farms having a large number of contacts with other farms are an important group concerning the spread of diseases and should be prioritised when targeting measures to improve biosecurity. In the pig sector, among the most efficient farms in spreading diseases are those with elite breeding and multiplying herds (Raulo & Lyytikäinen 2006). Sow pools, multi-site pig farms and weaner calf farms may also be efficient in spreading diseases. Hence, it may be advisable to promote biosecurity especially on these farm types.

Our results suggest that the majority of biosecurity measures will be implemented more frequently in the future than now. In the pig sector, measures such as locking the doors of animal shelters, the use of containers for the storage of dead animals and the use of compartments within the production units are more likely to be implemented more frequently. In the cattle sector, most future improvements were predicted to be related to visitors, such as using boots or coveralls as protective clothing or traffic-related arrangements. However, it is of some concern that the use of protective measures related to animal trading is not expected to increase in the future. This may require further training and education among producers.

The possibility to concentrate animal purchases to a few farms is lower in the cattle sector than in the pig sector, and it appears that this will not improve in the future. A particular problem is that farms investing in new production capacity may accept animals that are “leftover animals” from several farms. This poses a risk of animal disease spreading to the farm. Hence, better planning is required to control for the health of animals coming to the farm.

### **Contact tracing measures gain importance**

The results highlight the increased importance of contact tracing and risk management measures related to it in the future. As already mentioned, the reason is the increased distance between farms, resulting in restrictive zones capturing potentially less of the spread. Even vector-borne diseases may spread more by animal transport than by vector movements in the future, as indicated by our BT results.

Controlling contact networks can be considered as one of the biosecurity measures of a farm. The results suggest that restricting animal contacts to within 20 km radius from the farm would reduce the size of FMD outbreaks in the future only by 10%. This is partly due to farms being further away from each other in the future. Hence, the decreasing farm density will reduce the importance of restriction zones as a risk management measure. Another contact-related measure that has been used in some European countries to reduce outbreaks is limitation of the number of farms from/to which animals are transported. Such a measure is likely to reduce the largest

outbreaks. However, the results suggest that in most farms, this measure would also have only a small impact, partly because the number of contact farms is already quite limited.

As the number of contact farms increases, the need for veterinary personnel inspecting the farms also increases. When infected farms become larger, more capacity is required to cull, transport and render animals and disinfect premises. Planning of these activities will require more attention in the future, because previously designed methods may no longer represent the best practices. Planning requires the collaboration of stakeholders. In addition, insights into how to implement, for instance, culling could be obtained by consulting countries that have larger farms and which have experiences of disease eradication. It may be necessary to agree on the implementation and the costs of these measures in advance before the outbreak to prevent the costs from soaring.

In conclusion, for FMD and ASF, it appears that the official measures determined by EU regulations will also be adequate in the future when controlling outbreaks, as the probability of an epidemic outbreak did not change substantially in the simulations when compared to the 2009 situation. This conclusion is in line with our previous findings regarding FMD and CSF (Raulo & Lyytikäinen 2006, Lyytikäinen et al. 2011). Regarding BT, vaccination also does not provide a quick solution, if any, but in some cases it could be a multi-year policy (term 1–2 years) to eradicate the disease. The culling of BT-positive herds may be a feasible option when compared to emergency vaccination. The results do not support the use of emergency vaccination as a general risk management measure for any of the simulated diseases.

### **Structural change seems to provide more benefits rather than increase disease risks**

Production costs per unit of output on average decrease when farm size increases. Producers have invested in technology and reduced the use of labour during 2000–2011. The main benefit of farm size growth seems to be related to the more efficient use of labour input. These results are in line with previous research (Ala-Mantila 1998, Ovaska and Heikkilä 2013, Latukka 2013).

The costing models suggest that the dairy sector is able to benefit more from economies of scale in the future due to the increasing average farm size than the pig sector. In the pig sector, the benefits were estimated at less than 10% by 2033. Hence, dairy farms could benefit more from expanding their production than pig farms. Changes in the costs of suckler beef production were not estimated due to a lack of consistent data. The results are in line with Rasmussen (2010), who estimated that the elasticity of scale is larger in dairy than in pig farms. If passed across all farms, the benefits from economies of scale to the pig sector can be estimated (roughly) to amount to well over €20 million, and in the dairy sector to well over €200 million per year.

The results suggest that economic gains from structural change in the livestock sector are likely to be larger than the possible additional costs of risks caused by the simulated diseases. This conclusion is based on the assumption that the probability of introduction of disease will approximately be the same in the future as it is currently. However, structural change requires that increased risks related to animal health and other factors that may increase the risk are taken into consideration when changing production structures. Hence, there is scope for improvement in biosecurity and

animal logistics, even if current results do not suggest major changes in the costs of disease outbreaks on average. Moreover, the impacts may be more severe because of the risk posed by diseases such as PRRS in pigs or respiratory diseases that are not to be eradicated from the country by the authorities.

There are a few examples from different countries, such as the spread of FMD in the UK and CSF in the Netherlands around the millennium via intensive and unexpected animal movements, and the spread of Salmonella in Finland via the feed transport network in 2009, which suggest that sometimes either a practice or exceptional actions may pose a risk to the sector. Because some production types can be particularly risky, projects leading to new animal production facilities and redesigned input (e.g. feeds) and output (e.g., milk, meat, piglets, calves) logistics should also be evaluated from the animal disease risk viewpoint before they are established. The means for this include, for instance, building permits being subject to epidemiological evaluation regarding the location and the operational design of the building, the location of a new animal shelter being evaluated with respect to the disease risks, and subsidy payments to the livestock production being subject to complementary conditions that require the producers to apply proper biosecurity measures.

### **Topics for further research**

One of the most important topics for future research is the impact of production structures on the spread of and economic losses from diseases that can become endemic in Finland. The control policies for such diseases should also be investigated in order to determine the conditions under which each policy is justified. In general, further research could focus on analysing the conditions under which different policy measures should be implemented. An additional question is how the structural change can be generalized to other diseases that are not officially controlled.

The simulations presented in this study utilized farm and animal movement registries. Although pig and cattle registries are well established, the sheep and goat registry was founded in 2008. Based on previous experiences, it is likely that the animal movement data from 2009 were sparse, and hence our simulations may underestimate the spread potential of sheep and goat farms. Analysis of the coverage and accuracy of the movement registry could be useful to validate the simulation results. Available information on animal transport vehicles is not as detailed for the cattle sector as for the pig sector. Hence, the robustness of movement contact data could be further investigated. In our study, the impacts of data issues were analysed by sensitivity analysis and by simulating different scenarios. The farm data could also be complemented by more exact identification of farms of a special production type.

In the future, it will be even more important to obtain robust data on animal transport contacts for the purposes of contact tracing. The quality of the data must be adequate for risk management purposes, and the data should be stored in an easily usable format. Regarding practical risk management, the accessibility of data to authorities could also be evaluated. In the future, it would be cost-effective to combine efforts and use data from several sources to form a perception of the contact network of a farm. Cross-validation may provide additional improvements to the quality of the data.

In the current simulations, the same disease detection time assumption was applied to all farms. Results for the sheep and goat sector were insensitive to large changes in the detection time. However, further research on the efficiency of the detection

process and surveillance in general would be warranted to support the planning of surveillance activities.

Simulations for the future for FMD and BT did not include sheep farms. The results suggest that sheep and goat farms would not be efficient in spreading disease. The inclusion of sheep and goat farms might decrease the spread estimates but increase the direct costs of FMD, because sheep and goat farms are also subject to control measures.

Regarding BT, our simulation model applied data on BT serotype 8. More recently, BT serotype 4 has been spreading in south eastern Europe. However, there is no information on whether it has similar or different biological properties compared to serotype 8.

The collection of data on non-infected contacts during a simulation requires considerable computational resources, which limits the number of iterations. According to our earlier studies, the number of contact farms may correspond to the number of farms in surveillance and protection zones (Lyytikäinen et al. 2011). Because the number of farms in surveillance and protection zones can be expected to decrease in the future, the number of contact farms outside the protection and surveillance zones may increase.

In this study, we did not simulate the spread of disease with wild boars. Although the wild boar population in Finland is small, it has increased during recent decades. To limit the spread of diseases, it is important that the population of wild boars remains small and that they do not come into contact with domestic pigs or farmed wild boar. Regarding biosecurity, one of the items that could be considered further is how the risk posed by wild boars affects domestic pig production. Moreover, if ASF is only found in wild boars, it could still have severe implications for pig production and the economics of the pig sector in Finland, with reduced possibilities to export pig meat. Hence, more information on the role of markets upon an outbreak would be warranted. In general, future research could also investigate how market disruptions have been mitigated in the past, to learn from those experiences.

The simulation results for the future only include impacts on the pig and cattle sectors, as impacts on small ruminants were not estimated. Given the small sheep and goat population in Finland and the relatively modest production quantity of small ruminants, the impact was expected to be small in most cases. However, direct costs could be noticeable in a few special cases if a large number of sheep and goat farms were to be in the restriction zones or serve as contact farms. Hence, further research must be aware of potential risks related to sheep and goat production.

## Acknowledgements

This study was co-financed by MAKERA, Evira, MTT Agrifood Research Finland and the Oiva Kuusisto Foundation. Since 1 January 2015, MTT has been part of the Natural Resources Institute Finland (Luke). We are thankful to Arja Lahtinen for participation in earlier phases of this project. Members of the expert panels and other researchers with different expertise who have contributed to this work are also acknowledged. We are grateful to all persons, companies and institutions that have kindly provided us with valuable information. We also appreciate all the comments we have received regarding the report. Kitty Schulman gave valuable help during the writing phase. Final language polishing was performed by Roy Siddahl.

## References

**Ala-Mantila O (1998).** The production costs of agricultural products according to farm models [In Finnish with English abstract]. In: *Research reports 222*. Agricultural Economics Research Institute, Helsinki.

**Alexandersen S, Oleksiewicz MB, Donaldson AI (2001).** The early pathogenesis of foot and mouth disease in pigs infected by contact: a quantitative time-course study using TaqMan RT-PCR. *J. Gen. Virol.* 82, 747-755.

**Alexandersen S, Donaldson AI (2002).** Further studies to quantify the dose of natural aerosols of foot-and-mouth disease virus for pigs. *Epidemiol. Infect.* 128(2), 313-23.

**Alexandersen S, Kitching RP, Mansley LM, Donaldson AI (2003a).** Clinical and laboratory investigations of five outbreaks of foot-and-mouth disease during the 2001 epidemic in the United Kingdom. *Vet. Rec.* 152, 489-496.

**Alexandersen S, Quan M, Murphy C, Knight J, Zhang Z (2003b).** Studies of quantitative parameters of virus excretion and transmission in pigs and cattle experimentally infected with foot-and-mouth disease virus. *J. Comp. Pathol.* 129(4), 268-82.

**Alexandersen S, Mowat N (2005).** Foot and mouth disease: host range and pathogenesis. *CTMI* 288, 9-42.

**Anderson EC (2003).** Foot and mouth disease control programmes: factors that influence the strategy for wildlife. In: *FMD control strategies, Symposium. Proceedings, 2-5 June 2002, Lyon, France*, pp. 146-151.

**Backer JA, Hagenaars, TJ, de Jong MCM (2007).** Effectivity of vaccination strategies to control CSF epidemics. Society for Veterinary Epidemiology and Preventive Medicine proceedings, Annual meeting, Dipoli, Helsinki/Espoo, Finland, 28th-30th March 2007. pp. 141-156

**Barnett PV, Cox SJ (1999).** The role of small ruminants in the epidemiology and transmission of foot- and -mouth disease. Review. *Vet J.* 158, 6-13.

**Belbis G, Bréard E, Cordonnier N, Moulin V, Desprat A, Sailleau C, Viarouge C, Doceul V, Zientara S, Millemann Y (2013).** Evidence of transplacental transmission of bluetongue virus serotype 8 in goats. *Vet Microbiol*; 166(3-4), 394-404.

**Cox SJ, Barnett PV (2009).** Experimental evaluation of foot-and-mouth disease vaccines for emergency use in ruminants and pigs: a review. *Vet. Res.* 40, 13.

**De Clercq, K. De Leeuw, I. Verheyden, B. Vandemeulebroucke, E. Vanbinst, T. Herr, C. Meroc, E. Bertels, G. Steurbaut, N. Miry, C. De Blecker, K. Maquet, G. Bughin, J. Saulmont, M. Lebrun, M. Sustronck, B. De Deken, R. Hooyberghs, J. Houdart, P. Raemaekers, M (2008)** Transplacental Infection and Apparently Immunity Induced by a Wild-type Bluetongue Virus Serotype 8 Natural Infection. *Transboundary & Emerging Diseases*, 55(8), 352-359.

**Doel TR (2003).** FMD vaccines. *Vir. Res.* 91, 81-99.

**Donaldson AI, Alexandersen S, Sörensen JH, Mikkelsen T (2001).** Relative risks of the uncontrollable (airborne) spread of FMD by different species. *Vet. Rec.* 12, 602-604.



**Donaldson AI, Alexandersen S (2002).** Predicting the spread of foot and mouth disease by airborne virus. *Rev. sci. tech. Off. int. Epiz.* 21 (3), 569-575.

**EFSA (2010a).** Scientific Opinion on African Swine Fever. EFSA Panel on Animal Health and Welfare (AHAW). European Food Safety Authority, Parma Italy. *EFSA Journal* 2010 8(3): 149 pp. doi:10.2903/j.efsa.2010.1556.

**European Commission (2015).** Milk market situation. Milk market observatory 24.3.2015. [http://ec.europa.eu/agriculture/milk-market-observatory/pdf/market-situation-presentation\\_en.pdf](http://ec.europa.eu/agriculture/milk-market-observatory/pdf/market-situation-presentation_en.pdf)

**Evira (2014a).** Finnish contingency plan of FMD, Evira instructions 15812-07/01.

**Evira (2014b).** Finnish contingency plan of ASF, Evira instructions 15817-07/01.

**Falconi C, López-Olvera JR, Gortázar C (2011).** BTV infection in wild ruminants, with emphasis on red deer: A review. *Vet. Microbiol.* 151(3-4),209-219.

**Farez S, Morley RS (1997).** Potential animal health hazards of pork and pork products. *Rev. Sci. tech. Off. int. Epiz.* 16(1), 65-78.

**Fenner F, Bachmann PA, Gibbs EPJ, Murphy FA, Studdert MJ, White DO (1987).** Picornaviridae In: *Veterinary virology. Academic press inc (London) Ltd.* p. 429.

**Gibbens JC, Sharpe CE, Wilesmith JW, Mansley LM, Michalopoulou E, Ryan JBM, Hudson M (2001).** Descriptive epidemiology of the 2001 foot-and-mouth disease epidemic in Great Britain: the first five months, *Vet. Rec.* 149, 729-743.

**Gogin A., Gerasimov V., Malogolovkin A., Kolbasov D (2013).** African swine fever in the North Caucasus region and the Russian Federation in years 2007–2012. *Virus Research* 173, 198–203.

**Grubman MJ, Baxt B (2004).** Foot-and-mouth disease. *Clin. Microbiol. Rev.* 17, 465-493.

**Gubbins S, Hartemink NA, Wilson AJ, Moulin V, Vonk Noordgraaf CA, van der Sluijs MTW, de Smit AJ, Sumner T, Klinkenberg D (2012).** Scaling from challenge experiments to the field: Quantifying the impact of vaccination on the transmission of blue-tongue virus serotype 8 – *Prev. Vet. Med.* 105,297-308.

**Kitching RP (2002).** Clinical variation in foot and mouth disease: cattle. *Rev. Sci. Tech. Off. Int. Epiz.* 21(3), 499-504.

**Kitching RP, Hughes GJ (2002).** Clinical variation in foot and mouth disease: sheep and goats. *Rev. Sci. Tech. Off. Int. Epiz.* 21(3), 505-512.

**Kleiboeker S (2002).** Swine fever: classical swine fever and African swine fever. *Vet. Clin. North. Am. Food Anim. Pract.* 18(3), 431-51.

**Knowles NJ, Samuel AR, Davies AR, Kitching RP, Donaldson AI (2001).** Outbreak of foot and mouth disease virus serotype O in the UK caused by a pandemic strain. *Vet Rec.* 148, 258-259.

**Koeijer AA de, Boender GJ, Nodeljik G, Staubach C, Moroc E, Elbers ARW (2011).** Quantitative analysis of transmission parameters for bluetongue virus serotype 8 in Western Europe in 2006. *Veterinary research* 42(54),1-9.



**Latukka A (2013).** Mitä maitoliträn tuottaminen maksaa? Kustannusrakenteen tuntemus auttaa kehittämään kannattavuutta [In Finnish: How Much Does it Cost to Produce a Milk Litre? Knowledge on Cost Structure Helps Developing Profitability.]. *Maito ja Me*, issue 3/2013, pp. 50-51.

**Lehtonen H (2001).** Principles, structure and application of dynamic regional sector model of Finnish agriculture. *MTT Taloustutkimus. Julkaisuja* 98/2001.

**Le Sage JP (2002).** Econometrics toolbox. <http://www.spatial-econometrics.com/>.

**Lyytikäinen T, Niemi J, Sahlström L, Virtanen T, Lehtonen H (2011).** The spread of foot and mouth disease (FMD) within Finland and emergency vaccination in case of an outbreak. *Evira research reports* 1/2011.

**McCullagh P, Nelder JA (1989).** Generalized linear models, second edition. Chapman & Hall. 511 p.

**McLaws M, Ribble C (2007).** Description of recent foot and mouth disease outbreaks in nonendemic areas: Exploring the relationship between early detection and epidemic size. *Can. Vet. J.* October; 48(10), 1051-1062.

**Menzies FD, McCullough SJ, McKeown IM, Forster JL, Jess S, Batten C, Murchie AK, Gloster J, Fallows JG, Pelgrim W, Mellor PS, Oura CAL (2008).** Evidence for trans-placental and contact transmission of bluetongue virus in cattle. *Veterinary Record*, 163, 203-209

**Mourits MCM, Nielen M, Léon CD (2002).** Effect of control measures on the course of simulated foot and mouth disease epidemics started on different farm types in various Dutch areas. In *Proceedings of Society for Veterinary Epidemiology and Preventive Medicine, Cambridge, UK*, pp.190-200.

**MTT Economydoctor (2015a).** Structural data of Agriculture. [mtt.fi/economydoctor](http://mtt.fi/economydoctor). Access: 09.02.2015.

**MTT Economydoctor (2015b).** Agriculture and horticulture. [mtt.fi/economydoctor](http://mtt.fi/economydoctor). Access: 09.02.2015.

**Nigsch A, Costard S, Jones BA, Pfeiffer DU & Wieland B (2013).** Stochastic spatio-temporal modelling of African swine fever spread in the European Union during the high risk period. *Prev Vet Med.* 108, 262-275

**Niemi JK, Lehtonen H, Pietola K, Lyytikäinen T, Raulo S (2008)** Economic implications of potential classical swine fever outbreaks for Finnish pig production sector. *Preventive Veterinary Medicine* 84, 194-212.

**Niemi JK, Sahlström L, Virtanen T, Kyrrö J, Lyytikäinen T, Sinisalo A (2015).** Farm characteristics and perceptions regarding costs contribute to the adoption of bio-security in Finnish pig and cattle farms. *Submitted for publication to Review of Agricultural and Environmental Studies - Revue d'Etudes en Agriculture et Environnement*

**Niemi JK, Lehtonen H (2014).** Livestock product trade and highly contagious animal diseases. Contributed Paper prepared for presentation at the 88th Annual Conference of the Agricultural Economics Society, AgroParisTech, Paris, France, 9 - 11 April 2014. [http://www.aes.ac.uk/upload\\_area/member\\_documents/Jarkko\\_Niemi\\_Niemi%20and%20Lehtonen%20AES%20paper%202014%20final.pdf](http://www.aes.ac.uk/upload_area/member_documents/Jarkko_Niemi_Niemi%20and%20Lehtonen%20AES%20paper%202014%20final.pdf)

**Nokireki T (2010).** Personal communication. 5.8.2011.

**Nöremark M, Håkansson N, Sternberg Lewerin S, Lindberg A, Jonsson A (2011).** Network analysis of cattle and pig movements in Sweden: measures relevant for disease control and risk based surveillance. *Prev.Vet.Med.* 99,78-90.

**OIE Terrestrial animal health code 2008.**

[http://www.oie.int/fileadmin/Home/eng/Animal\\_Health\\_in\\_the\\_World/docs/pdf/AFRICAN\\_SWINE\\_FEVER\\_FINAL.pdf](http://www.oie.int/fileadmin/Home/eng/Animal_Health_in_the_World/docs/pdf/AFRICAN_SWINE_FEVER_FINAL.pdf)

**OIE WAHID Interface.** Summary of Immediate notifications and Follow-ups – 2012-2013, African swine fever. [http://www.oie.int/wahis\\_2/public/wahid.php/Diseaseinformation/Immsummary](http://www.oie.int/wahis_2/public/wahid.php/Diseaseinformation/Immsummary)

**Oravainen J, Sahlström L, Lyytikäinen T (2011).** Possible routes of entry into the country for African swine fever - Risk profile. *Evira Research Reports* 5/2011.

**OSF(2015).** Number of livestock. Retrieved: <http://www.maataloustilastot.fi/en/tilasto/163>. Access: 09.02.2015.

**OSF (2014a).** Index of Purchase Prices of the Means of Agricultural Production. Retrieved: [http://www.stat.fi/til/ttohi/index\\_en.html](http://www.stat.fi/til/ttohi/index_en.html). Access: 22.01.2014.

**OSF (2014b).** Consumer Price Index. Retrieved: [http://www.stat.fi/til/khi/index\\_en.html](http://www.stat.fi/til/khi/index_en.html). Access: 22.01.2014.

**Pongsumpun P, Garcia-Lopez DG, Favier C, Torres L, Lhosa J & Dubois MA (2008).** Dynamics of dengue epidemics in urban contexts. *Tropical medicine and International health* 13,9,1180-1187.

**Rasmussen S (2010).** Scale efficiency in Danish agriculture: an input distance – function approach. *European Review of Agricultural Economics* 37: 335–367.

**Raulo S, Lyytikäinen T (2005).** Epidemic outbreak of classical swine fever in Finland, quantitative risk assessment (In Finnish). National Veterinary and Food Research Institute EELA Publications. 06/2005. 192 p.

**Risk Solutions (2005).** FMD CBA Epidemiological Model Specification and Description. A report for Defra. [http://www.defra.gov.uk/animalh/diseases/fmd/pdf/epidem\\_model.pdf](http://www.defra.gov.uk/animalh/diseases/fmd/pdf/epidem_model.pdf). Accessed November 2008.

**Rosengren H, Sahlström L, Tammiranta N. (2009).** Bluetonguen maahantulo ja leviäminen Suomessa- riskiprofiili (in Finnish with English summary). *Evira research reports* 3/2009.

**Ryan E, Mackay D, Donaldson A (2008).** Foot-and-mouth disease virus concentrations in products of animal origin. *Transb. Emerg. Dis.* 55, 89-98

**Sanchez-Vizcaino JM., Mur L., Martinez-Lopez B. (2013).** African swine fever (ASF): Five years around Europe. *Veterinary Microbiology* 165, 45–50.

**Sahlström L, Virtanen T, Kyyrö J, Lyytikäinen T (2014).** Biosecurity on Finnish cattle, pig and sheep farms – results from a questionnaire, *Prev.Vet.Med.* 117, 59-67.

**Sanson RL (1993).** The development of decision support system for an animal disease emergency. Ph.D. Thesis, Massey University, Palmerston North, New Zealand, 264 p.

**Sanson RL, Stern MW, Morris RS (1994).** Interspread – a spatial stochastic simulation model of epidemic of foot-and-mouth disease, *The Kenya Veterinarian* 18, 493-495.

**Sellers RF, Parker J (1969).** Airborne excretion of foot-and-mouth disease virus. *J. Hyg. Camb.* 67, 671-677.

**Sternberg Lewerin S, Hallgren G, Mieziowska, K Treiberg Berndtsson L, Chirico J, Elvander M (2010).** Infection with bluetongue virus serotype 8 in Sweden in 2008. *The Veterinary record.* 07/2010; 167(5),165-170.

**Stevenson MA (2003).** The spatio-temporal epidemiology of bovine spongiform encephalopathy and foot-and-mouth disease in Great Britain. Ph.D. Thesis. Institute of Veterinary, Animal and Biomedical Sciences, Massey University, Palmerston, New Zealand. 249p.

**Sumner D, Bervejillo J, Jarvis L (2005).** Public Policy, Invasive Species and Animal Disease Management. *Int. Food Agribusiness Manag. Rev.* 8, 78-97.

**Sutmoller P (2001).** Importation of beef from countries infected with foot and mouth disease: a review of risk mitigation measures. *Rev. Sci. Tech. Off. Int. Epiz.*, 20 (3), 715-722,

**Sutmoller P, Barteling SS, Olascoaga RC, Sumption KJ (2003).** Control and eradication of foot-and-mouth disease. Review. *Virus Research* 91, 101-144.

**Taylor NM, Honhold N, Paterson AD, Mansley LM (2004).** Risk of foot-and-mouth disease associated with proximity in space and time to infected premises and the implications for control policy during the 2001 epidemic in Cumbria. *Vet. Rec.* 154, 617-626.

**Turner J, Bowers RG, Baylis M (2012a).** Modelling bluetongue virus transmission between farms using animal and vector movements. *Scientific reports* 2:319:1-7.

**Turner J, Bowers RG, Baylis M (2012b).** Modelling bluetongue virus transmission between farms using animal and vector movements. *Scientific reports* 2:319:1-7, supplemental material.

**Virtanen T, Sahlström L, Lyytikäinen T (2013).** Lammas- ja vuohitalous eläintautien leviämisympäristönä (In Finnish, with English summary). *Evira research report* 1/2013.

**Wernery U, Kaaden O-R (2004).** Foot and mouth disease in camelids: a review. *Vet. J.I.* 168, 134-142.

## Legal acts

### *National legislation*

**MAF 1296/2001** Decree of the MAF on the identification and registration of swine (Maa- ja metsätalousministeriön asetus sikojen merkitsemisestä ja rekisteröinnistä).

**MAF 1429/2006** Laki eläinten kuljetuksesta.

**MAF 1391/2006.** Decree of the MAF on the identification and registration of cattle (Maa- ja metsätalousministeriön asetus nautaeläinten merkitsemisestä ja rekisteröinnistä).

### *EU legislation*

**Commission Decision 2003.** 2003/422/EC approving an African swine fever diagnostic manual. Official Journal of the European Union. L 143: 35–49.

**EC 1760/2000 Regulation** (EC) No 1760/2000 of the European Parliament and of the Council of 17 July 2000 establishing a system for the identification and registration of bovine animals and regarding the labelling of beef and beef products and repealing Council Regulation (EC) No 820/97.

**Council Directive 2003/85/EC** of 29 September 2003 on Community measures for the control of foot-and-mouth disease repealing Directive 85/511/EEC and Decisions 89/531/EEC and 91/665/EEC and amending Directive 92/46/EEC (Text with EEA relevance).

**2008/71/EC COUNCIL DIRECTIVE** 2008/71/EC of 15 July 2008 on the identification and registration of pigs.

## Appendices

### *Appendix 0: Simulated diseases*

#### **Foot-and-mouth disease (FMD)**

FMD is a highly contagious epizootic disease of cloven-hoofed animals and is controlled both by domestic and EU legislation. FMD has not been found in Finland since 1959. In Europe, large outbreaks of FMD have occurred in the United Kingdom in 2001 and 2007. In January 2011, FMD was detected in three wild boars hunted in Bulgaria close to the Turkish border. Europe is currently free from FMD.

FMD may affect all cloven-hoofed animals, but those of greatest significance are found among domestic species: cattle, pigs, sheep and goats. FMD is not considered zoonotic. Cattle are the most sensitive to FMD, but swine and sheep are also severely affected. Clinical signs are apparent for 7–10 days (Alexandersen et al. 2001), but vesicles may be visible in sheep for less than three days (Kitching & Hughes 2002). However, virus excretion usually starts 1–5 days before vesicles are apparent.

The first symptoms in cattle are usually fever (around 40 °C) (Kitching 2002), depression, decreased milk production and a reluctance to eat. Vesicular lesions on the tongue, nose, feet and teats, lameness and drooling develop within 12–24 hours from the first signs (Sutmoller 2001; Kitching 2002). Lameness and drooling are due to vesicular lesions and erosions on the feet and in the mouth, respectively. The mortality rate is low, except in young animals, but the morbidity rate is very high.

The clinical disease in pigs is dominated by lameness and a reluctance to stand due to painful foot lesions. Vesicular lesions in the mouth are less prominent than in cattle, but large vesicles that quickly rupture are common on the snout.

FMD in sheep is difficult to detect due to the mild clinical signs (Barnett & Cox 1999). The duration of viraemia in sheep is 1–5 days. The first symptoms that appear about three days after the onset of viraemia in sheep, goats and wild ruminants are foot lesions accompanied by lameness. Sheep and goats also develop fever, are reluctant to walk and may separate themselves from the rest of the flock. Vesicles are not as common and are more difficult to observe in sheep and goats than in cattle. Deaths occur (up to 90% of an affected flock) among young lambs and kids due to heart failure and without the appearance of vesicles (Kitching & Hughes 2002).

The incubation time is in general 2–7 days in cattle and pigs and 3–8 days in sheep. However, the incubation time might be as short as one day or as long as two weeks. (Sutmoller et al. 2001; Gibbens et al. 2001; Alexandersen & Mowat 2005; Ryan et al. 2008).

The FMD virus (FMDV) belongs to the genus *Aphthovirus* and family *Picornaviridae*. Seven different serotypes have been identified (Grubman & Baxt 2004). The serotype in the UK outbreaks of 2001 was identified as an O PanAsia lineage virus (Knowles et al. 2001), and this is the serotype of primary interest in this report. This particular serotype was selected because it is the one that has caused widespread epidemics in Europe, and sufficient literature was available to parameterize the model for this strain.

The FMD virus is stable between pH 6–9 (optimum pH 7.4–7.6), but is rapidly destroyed at a pH lower than 4 and higher than 11. Inactivation in the environment is mainly due to a combination of high temperature, solar radiation and low humidity. The virus is stable at temperatures of up to 56 °C and can survive for one year at 4 °C. In freezing temperatures, it is stable and survives for a very long time.

FMD is transmitted by air, directly or indirectly. The disease spreads very rapidly and in a few days all sensitive animals kept in the same space are infected. Transmission between infected and susceptible animals mainly occurs through the respiratory route by virus aerosols.

Cattle are the most sensitive animals to FMDV aerosols. They are mainly infected via the respiratory route and considered as an “indicator host” for the disease. Pigs are relatively resistant to airborne FMDV infection compared to cattle and sheep (Alexandersen & Donaldson 2002; Donaldson & Alexandersen 2002).

Virus excretion already begins during the incubation period, and airborne excretion mainly occurs during a 4- to 5-day period in the infected animal (Sellers & Parker 1969; Donaldson et al. 2001). Maximal excretion occurs during the early acute phase

of the disease, i.e. the peak coincides with the appearance of vesicles (Alexandersen et al. 2003b). Sheep differ from other species with their maximum viral emission 1–2 days before the onset of clinical disease (Donaldson & Alexandersen 2002).

Pigs are considered as an “amplifying host” because they act as effective disease transmitters, exhaling more infective virus particles than cattle and sheep (Donaldson & Alexandersen 2002). Due to their smaller lung volume, sheep excrete fewer virus particles than cattle and pigs. In contrast to pigs and cattle, FMD can spread in a sheep herd without visible clinical symptoms.

Animals that have recovered from the disease may remain as infective carriers for a variable period of time. Up to 50% of cattle can remain infective for weeks, months, or in extreme cases for several years. Sheep and goats less frequently remain as carriers than cattle (Sutmoller et al. 2003), and for a shorter period of time, up to 6–9 months (Doel 2003; Wernery & Kaaden 2004). Pigs do not remain persistently infected (Fenner et al. 1987; Davies 2002).

Vaccination does not stop the virus from entering the body. In other words, vaccinated individuals can also be carriers of the virus that they are vaccinated against. Vaccinated animals may intermittently emit virus, but significantly less than unvaccinated infected animals.

For more information about FMD, please see Lyytikäinen et al. (2011).

### **African swine fever (ASF)**

African swine fever is a viral disease that spreads easily to domestic pigs and wild boar and has considerable socioeconomic consequences. Clinically and pathologically, African swine fever is very similar to classical swine fever. Laboratory diagnosis is necessary to separate these two diseases from each other (Kleiboeker 2002). There is no vaccine against ASF and it is not communicable to humans. ASF has a high mortality rate and significant impact on the operations of the swine industry (i.e. restrictions concerning animal traffic, costs due to preventive measures and complications in international trade).

The disease occurs in domestic pigs as well as in wild boar. It is endemic to a large extent in sub-Saharan Africa and in Sardinia (EFSA 2010a). Since 2007, the disease has occurred in the Caucasus region in Georgia and in its neighbouring countries Armenia, Azerbaijan and Russia. In spite of measures to combat it, ASF continues to spread into new areas in Russia. Several cases have been reported in the areas surrounding Moscow, both in domestic pigs and wild boars (Gogin et al. 2013). The disease has also spread to the countries neighbouring Russia, and in 2014 to the Baltic countries and Poland. The first case of the disease in Belarus was reported in June 2013 near the Lithuanian border. Measures to combat the disease still continue. The first case in Ukraine was detected in 2012, where an outbreak was successfully halted (OIE WAHID Interface).

The causative agent of African swine fever is the *Asfivirus*, a DNA virus and a member of the *Asfarviridae* family. It is very resistant and can survive for months or years in frost or at refrigerator temperature (EFSA 2010a). The ASF virus is destroyed at normal cooking temperature, but unheated or inappropriately heated food waste and pork products prepared by salting and smoking constitute a considerable risk for spreading



the disease. The virus survives more than 300 days in ham prepared by salting or drying (e.g. Parma ham). Furthermore, the ASF virus lasts well at pH 4-13 and at temperatures under 60 °C. In faeces, the virus survives in room temperature for 11 days and in pig blood at 4 °C for 18 months. (Kleiboeker 2002). Infected blood inactivates in 30 minutes at a temperature of 60 °C (Farez & Morley 1997).

The virulence of ASF virus strains varies. Subsequently, the disease can be acute, sub-acute or chronic (EFSA 2010a). The virus in the Caucasus and in Russia is especially virulent and the virulence has persisted since the first outbreak of the disease in Caucasia in 2007. The virulence can manifest itself as a high mortality rate (Gogin et al. 2013). Therefore, in this report, we describe the hazard of African swine fever with a virulence similar to that of the virus strain circulating in Russia. In other regions, the virulence has subsided with time, enabling some pigs to develop a chronic form of the disease and become disease carriers (EFSA 2010a).

The incubation period is usually 3–15 days, in the acute form 3–4 days (OIE 2008). In the peracute form, the pig may die without preceding symptoms. In the acute form of the disease, pigs can show symptoms including high fever, haemorrhages in the skin (especially on the ears and flank), anorexia, blood in the stool and possibly diarrhoea. The haemorrhages in the skin can cause necrosis before death. Mortality rates are very high (almost 100%), and the disease can cause death within 6–13 days from infection (OIE 2008).

The disease usually transmits through the nasal cavity and the mouth when animals are in direct or indirect contact with infected pigs or through feed contaminated by the virus. However, in areas where ticks of the *Ornithodoros* genus occur, transmission by these vectors is significant for the maintenance and spread of the virus. ASF can even spread by indirect contact with contaminated material or by way of biting insects transporting the ASF virus mechanically. The disease might also spread through the semen of infected hogs. (Commission Decision 2003/422/EC).

The European Commission Decision (EC) No 422/2003 on approving an African swine fever diagnostic manual describes diagnostic and sampling methods and evaluation criteria for laboratory results to confirm ASF. Confirmation must be based on the detection of clinical signs and post-mortem lesions of disease, the detection of the virus, antigen or genome in samples of pig tissues, organs, blood or excreta or the demonstration of a specific antibody response in blood samples.

The selection of tests is dependent on the disease situation and the laboratory's available methods (OIE 2008). Evira uses PCR for genome detection and Elisa for the detection of antibodies. Evira recommends the sending of tonsil, lymph node, spleen, kidney and lung samples. In addition, whole blood samples without coagulation inhibitors are taken. Evira does not have the ability to isolate the virus. When necessary, samples are sent to a reference laboratory in Spain (Nokireki 2011).

One of the main challenges for ASF control in the Russian Federation is the absence of a centralized programme to combat the disease. Another significant challenge is the illegal movement of animals and infected meat. In many areas of Eastern Europe, raising pigs in the backyard or on family farms with little or no biosecurity is common. In this kind of production, swill and other sub-products are commonly used as feed. Backyard farmers also often choose not to report cases in order to avoid the loss of their pigs. Wild boar populations have additionally been affected by ASF outbreaks in the Caucasus area and also in the Tver region near Moscow, where the disease seems



to have established itself in domestic and wild boar populations (Sanchez-Vizcaino et al. 2012).

For more information about ASF, see Oravainen et al. (2011).

### **Bluetongue (BT)**

Bluetongue is a vector-borne disease of ruminants. Different species of the midge *Culicoides* act as the vector of the virus. The virus belongs to the genus *Orbivirus* and the family *Reoviridae*. There are 26 known serotypes (Maan et al. 2012).

In 2006, BT serotype 8 (BTV-8) emerged in Northern Europe, including Belgium, France, Germany, Luxembourg and the Netherlands. The next year (2007), it reappeared in the mentioned countries and further spread to the UK, Switzerland, Denmark and the Czech Republic. Since then, BT has also spread to Sweden in 2008 and to Norway at the beginning of 2009 (Zientara & Sanchez-Vizcaino 2013). So far, bluetongue has not been detected in Finland. However, there are *Culicoides* midges in Finland that may act as vectors for the disease.

The symptoms of BT are most severe in sheep. They include fever, depression, excessive salivation, dyspnea and panting. Other typical symptoms are ulceration in the mouth and swelling of the head and neck region, especially around the muzzle and eyes. Cattle may be asymptomatic or have only mild symptoms. In the case of an apparent infection, the symptoms are similar to those in sheep. The symptoms of BT resemble those of FMD and must therefore be considered as a differential diagnosis. In Sweden, during the BT epidemic, hardly any cattle showed symptoms. The infection was detected through passive surveillance. During the period of BT infection in Sweden, active surveillance generated a number of clinical suspicions, including symptoms such as fever, lacrimation and salivation, but none could be confirmed. (Sternberg Lewerin et al. 2010).

In addition to cattle, sheep and goats, almost all wild ruminants are also susceptible to BTV infection. This includes white-tailed deer, which are common in Finland, but they are usually asymptomatic (Falconi et al. 2011).

The incubation time of BT is 2–20 days (see, for instance, Rosengren et al. 2009). Bluetongue is mainly spread by blood-sucking midges (*Culicoides*), which spread the disease from one infected animal to another. The virus needs to be replicated in the midge. The virus might also spread via semen, transplacentally or through milk to the newborn (Menzies et al. 2008, De Clercq et al. 2008, Belbis et al. 2013). BTV cannot be naturally transmitted from animal to animal. Therefore, no disinfection of the stables is needed.

Sheep may be viremic for 3–20 days, while cattle might be asymptomatic but viremic for as long as 60 days.

There is a potent vaccine against BTV. After the epidemic in Sweden was detected, a massive vaccination programme was started (Sternberg Lewerin et al. 2010). This was very successful and BT was considered eradicated from Sweden later on. Gubbins et al. (2012) estimated that  $R_0$  can be reduced by 70–83% in cattle farms and 98% in sheep farms by vaccination.

For more information on BT, please see Rosengren et al. (2009).

## **Appendix 1: Data sources**

The spread models apply several databases that either describe or define the potential group of susceptible farms, relevant contacts of the farm during the infective period and/or the time when contacts have occurred. All databases were constructed using data sources from 2009, except for the AI technician movement database, for which older data from 2006 were applied.

### **Farm database**

In Finland, it is mandatory (2008/71/EC, regulation 1760/2000; MAF 1391/2006, MAF 1296/2001) to register livestock premises. The Finnish farm registry was used as the source of data for the location and the number of cattle and pigs on the farms (registry maintained by TIKE, the Information Centre of the Ministry of Agriculture and Forestry). The registry covers the majority of the Finnish cattle and pig farm populations. A further economic incentive for registration is that registration is required in order to receive livestock subsidies.

The farm database combines several information sources. Identification codes were used to link data from the Finnish farm registry with the yearly notifications for EU subsidies and monthly notifications of the number of animals on the farms. The farms that did not keep cattle or pigs and did not sell or buy cattle, pigs or milk in 2009 were excluded from the database. If a farm had several animal holdings, the information on these sub-units was aggregated into one row of information. Altogether, 0.7% of farms had more than one animal holding in the registry. Different classes of animals were combined into two classes of animals: pigs were divided into sows and finishers, and cattle into dairy and other cattle. The database also contained the number of ewes and goats on the farms.

Finnish farm coordinates are based on either the address, the centre of the fields of the farm or the location of the central unit of the farm. Each farm was assigned to regions according to the veterinarian, relief worker, PVO, advisor, municipality and carcass collection. The proportions of different production types in the database are given in Table 21.

### **Database of animal transportation between farms**

Data on the transportation of pigs and cattle are collected in the Pig Registry and the Cattle Registry, which are maintained by TIKE and Evira. The animal movement database was constructed from the official animal movement registries of 2009.

Pig transportations between farms were based on the pig registry, which contained information on the pigs sold, purchased and transported between farms in Finland. The full database of pig movements between farms contained 24 000 notifications. The linking of pig trade events was based on farm-specific marks of sold piglets and the date, which were used to link separate notifications of farms either selling or buying pigs. By linking the notifications of farmers with those of pig traders, it was possible to link over 90% of the pig transportations with the transport vehicle.

The cattle transport database was constructed by linking two notifications of an animal with the same identification number: the first from the farm from which it was transported and the second from the farm that received it. Because the informa-

tion on the trader could not be linked with these events, linking of the vehicle with the transportation event was not possible and the database therefore contains no information on transportation vehicles. The full database of cattle transports between farms contained 92200 notifications.

Sheep and goat transports were linked similarly to cattle notifications. Sheep and goat transports comprised 1138 notifications.

Domestic animals traded in Finland are mostly transported by entrepreneurs registered for animal transportation. Registration of the vehicle and the case/event is obligatory, based on animal welfare legislation (MAF 1429/2006).

### **Slaughterhouse transportation database**

Data on the transportation of pigs to slaughter were directly retrieved from the pig transport registry and contained over 55 300 notifications of pig deliveries to slaughterhouses. Data on the transport of cattle to slaughter were directly retrieved from the cattle transport registry and contained over 77 600 notifications.

Data on the transportation of sheep and goats to slaughter were directly retrieved from the animal transport registry and contained 775 notifications. Usually, there was only one notification to the same slaughterhouse during one day. Therefore, sheep transports were not included in the slaughterhouse transportation database.

None of the registries contained sufficient information on the transportation vehicles, so detailed information on vehicle movements could not be included in the slaughterhouse transportation database.

### **AI technician movement database**

Artificial insemination (AI) technicians mostly visit dairy farms. The Finnish Agriculture Calculation Centre holds a registry that contains the daily actions of every AI technician operating in Finland. AI technicians are obligated to register the farms they have visited and the time and date of visit to the centre. Because the registry contains the farm identification numbers and times of the visits, it was possible to construct a database that contained every route of AI technicians during 2006. Notifications for farms that no longer operated in 2009 were removed from the database, and the filtered database contained 494 100 notifications of AI technician visits.

### **Dairy logistics database**

The dairy industry provided us the routes of each dairy tanker for weeks 22 and 50 in 2009. A dairy tanker typically visits a farm every second day to transport the milk from the farm to the dairy. The routes are changed approximately twice a year, during spring and autumn. The routes were adequate data sources to construct the dairy tanker logistics. The database contained over 80% of farms classified as dairy farms in the country when dairy farm was defined as a farm that had at least one dairy cow during 2009. The dairy industry plans the logistics of the tankers, so the order of visits within a day could also be included in the dairy logistics database. The database contained the collection routes of 9990 dairy farms.

### **Questionnaires to farmers**

Two postal questionnaire surveys, one directed to Finnish cattle farms and the other to Finnish pig farms, were conducted in the spring of 2007. The aim was to obtain information on the contacts of the farms that are not registered elsewhere. To estimate the frequencies of contacts, the farmers were asked about the number of visits per year that may lead to contacts with other farms. Data for 2006 obtained from the questionnaire were applied to estimate the unknown frequency of contacts. Both questionnaires consisted of 6 printed pages.

A wide variety of people visit farms, including animal caretakers, holiday substitutes, agricultural advisers, veterinarians and others. The frequencies of visits by people to cattle and pig farms or production units were estimated from a questionnaire study performed during 2007. The number of posted questionnaires, 2 699, covered 13.1% of Finnish cattle farms ( $n = 20\ 652$ ). The recipient farms were randomly selected from the whole Finnish cattle farm population. Another questionnaire was sent to pig farmers ( $n = 1\ 118$ ), which covered 34.6% of Finnish pig farms ( $n = 3\ 228$ ) (National Farm Registry 2006). Sampling in this questionnaire was partitioned, as all farms that belonged to the highest 10% fraction according to either the number of sows or finishers received the questionnaire (13.6% of the Finnish pig farm population). The rest of the questionnaires were sent randomly to 21% of the other pig farms. There were 1180 respondents among the cattle farmers (response rate of 44%) and 571 respondents among the pig farmers (response rate of 51%).

### **Questionnaire to veterinarians**

To estimate how many farms a veterinarian visits during a day and how the farm production type would influence this frequency, a questionnaire was sent (in 2007) to 350 municipal veterinary officers in Finland, of whom 134 (38%) returned the questionnaire. The questionnaire was completed like a diary, where the practitioners reported their daily visits to farms during two five-day periods. They were asked to report which farms (pig, cattle or other) they visited during a 2-week period.

### **Questionnaires to farmers about biosecurity**

Two questionnaires were designed to collect information about the level of biosecurity and hygiene practices on Finnish cattle, pig and sheep farms. The first questionnaire was sent in March 2011 to each of 3000 cattle and 1000 pig farmers. Another slightly modified questionnaire was sent in June 2011 to 866 sheep farmers and 144 goat farmers in Finland. The sheep and goat questionnaire also contained a several questions concerning potential contacts, persons visiting the farm, vehicles and co-operation potentially leading to enhanced spread during an epidemic outbreak (for more details see Virtanen et al. 2013).

The questionnaires were sent by mail but could also be answered online. The online link was provided in the mailed questionnaire and on the reminder card, but also in the main agricultural newspapers in March 2011. A link to the pig and cattle questionnaire was published in two agricultural newspapers and the websites of the Association for Animal Disease Prevention (ETT), the National Health Classification Registry (Sikava and Naseva) and the Finnish Food Safety Authority Evira. The link to the sheep and goat questionnaire was published in June 2011 in two agricultural newspapers, an electronic newsletter (Saparo) and the website of the Finnish Food Safety Authority Evira.

## Other sources

Other sources were applied when needed to define parameters that were not estimable from the previous mentioned sources. This additional information was required to parameterize vehicle movement patterns when animals were transported to slaughter and when cattle were transported between farms. Carcass collection of both pigs and cattle, and the operation of relief workers were also parameterized using additional information.

A telephone questionnaire to slaughterhouses was performed to define how many farms a vehicle would visit per day transporting either animals to slaughter or cattle to another farm. Cattle carcass collection data from one week in Finland were used to estimate the spatial range of carcass collection vehicles and the number of cattle farms visited on one route. For pig carcass collection, the average number of visited farms during a route was estimated from the statistics for the whole of 2006.

Official statistics of the Farmers' Social Insurance Institution were used as a parameter indicating how many days a relief worker might work on a single farm during one year.

## Cost parameters

Information regarding the costs and material resources needed to mitigate and eradicate FMD and ASF were estimated according to procedures characterised by the terms of reference for veterinary officers with regard to a disease outbreak in Finland. The costing procedure was similar to that of Lyytikäinen et al. (2011). Labour requirements, the expenditures of which are paid from public funds, were estimated using data provided by Risk Solutions (2005). These data indicate the labour resources needed for field operations during hypothetical FMD epidemics of different sizes in the United Kingdom. Estimates of the labour required by a national crisis centre were based on a Finnish study (Niemi et al. 2008) and consultation with the officials. Updated unit prices for each resource were collected from official statistics or requested from officials and companies capable of providing relevant services and goods. These cost parameters represented situation during years 2009-2011.

Market-level losses and losses due to business interruptions during and after FMD and ASF outbreaks were simulated with a partial-equilibrium model, further details of which are described provided by Lyytikäinen et al. (2011) and Niemi and Lehtonen (2014). The model used to produce current results was calibrated against 2009 and 2006 data. The model was extended by unpacking stochastic results (Lyytikäinen et al. 2011) representing the result of a dynamic programming model as the expected value, and this result was then unpacked to represent the distribution implicitly included in the results.

Estimates regarding the costs of BT were based epidemiological simulations, Finnish regulations, past surveillance programs and guidelines. BT outbreaks recorded in the Netherlands and Belgium during the past years (see e.g. Velthuis et al., 2010) were used to parameterize the main events. In addition similar cost data as in the event of FMD and ASF were used to calculate the costs of BT. Regarding BT, the impacts of disease on markets were not simulated because previous research and OIE Terrestrial animal health code did not suggest the disease to have significant impacts on dairy and meat markets in Finland.

## Appendix 2: Livestock production structure in Finland 2009

In Finland, agriculture has been gradually changing from family managed farms towards larger farms in both the cattle and the pig sector. This change has led to an increase in herd size and a decrease in the number of farms, but the total number of animals has remained about the same. Sheep farming may be growing in Finland, but is still small-scaled and most farms do not gain their income solely from sheep farming. The number of farms in Finland was approximately 20 000 in 2009 (Table 20).

**Table 20.** The number of farms according to type in Finland.

Species/Farm type	Number of farms
<b>Cattle</b>	
Dairy	12 438
Beef cattle	2 588
Suckler cow	1 628
<b>Pigs</b>	
Farrowing	763
Farrowing-to-finishing	879
Finishing	698
<b>Sheep</b>	
Professional sheep	150
Semi-professional sheep	734
Hobby sheep	1 097
Goat	371

### Pig production

There were 2 340 pig farms and little over 1 million pigs in Finland in 2009. On average, there were 366 pigs on a farm and the largest farm had 6 251 animals. Traditional pig farms are classified in this study into three production types; **farrowing farms**, **farrowing-to-finishing farms** and **finishing farms**. In addition to these farm types, there are two special pig production types: **sow pools** and **multi-sites**. Sow pools and multi-sites consist of multiple specialized pig farms that usually have very specific contracts to secure the availability of pigs for meat production.

When farm and animal numbers are viewed geographically according to Provincial Veterinary Officer (PVO) districts, it can be seen that the pig industry is heavily concentrated on the coast of south western and western Finland (PVO districts Turku and Vaasa) (Table 21).

**Table 21.** The number of pigs and pig farms in Finnish PVO districts in 2009. Pigs under 3 months excluded.

PVO	Farms	Pigs
Helsinki	67	32 180
Hämeenlinna	170	77 607
Joensuu	36	9 353
Jyväskylä	72	15 909
Kouvola	110	31 998
Kuopio	69	26 665
Maarianhamina	10	279
Mikkeli	53	13 196
Oulu	80	37 645
Rovaniemi	7	1 509
Tampere	104	32 302
Turku	818	388 919
Vaasa	744	337 574
Total	2 340	1 005 136

### Farm type classification

Traditional pig farms produce pigs for meat production (Table 22). The classification of farm types in this study is based on the ratio of finishing pigs to sows on the farm. Farms that have on average less than two finishing pigs per sow are classified as farrowing farms. Farms that have two or more finishing pigs per sow are classified as farrowing-to-finishing farms. Farms that do not have any sows are finishing farms.

**Table 22.** Number of farms and average number of pigs per farm in 2009.

Farm type	Number of farms	Number of sows	Number of finishers	Mean number of pigs
Farrowing farm	763	88 508	70959	209
Farrowing-to-finishing farm	879	60 651	321 714	435
Finishing farm	698	0	462 774	663

### Sow pools

A sow pool is a networked production system that has several production units. In sow pool systems, all dry sows are kept at a central unit and before farrowing they are leased by piglet producing units (satellites). Following weaning, the sows are returned to the central unit for mating or insemination. The system is operated in cycles of 16 weeks at the satellites, starting with the arrival of pregnant sows three weeks prior to farrowing, followed by weaning in this unit at 5 weeks of age and the return of sows to the central unit before the arrival of a subsequent group of sows eight weeks later. In 2009, 60 farms were identified as part of a sow pool. Sow pools contained 5% of Finnish sows and 2% of the finisher population. Finishing farms that were part of a sow pool were larger than other pig farms. Farms that were identified as farrowing farms were almost 1.7 times larger than farrowing farms on average (Table 23).



**Table 23.** Average number of sows and finishers on Finnish pig farms participating in a sow pool and other farms.

Farm type	Number of sows, sow pool	Number of sows, other	Number of finishers, sow pool	Number of finishers, other
Farrowing farm	180	114	94	68
Farrowing-to-finishing farm	76	69	350	369
Finishing farm	0	0	2 095	651

### Multi-site systems

A multi-site system consists of a number of herds that form a chain, through which all animals pass from birth until slaughter. Each herd in this chain is specialised in only one production stage. A multi-site system consists of one or several farrowing herds where the insemination of sows and the weaning of piglets are performed. The piglets from one or several farrowing herds are reared at a separate rearing facility from where the young finishing pigs are distributed to several finishing herds. On the other hand, it is also possible that several small farrowing herds have joined and deliver piglets together to one or more large finisher unit/s without an intermediate phase. Multi-site farms comprised 169 pig farms in 2009. Approximately 16% of Finnish sows and finishers were produced in multi-site systems. Pig farms that were part of multi-site system were on average larger than other pig farms (Table 24).

**Table 24.** Average number of sows and finishers on Finnish pig farms operating as part of a multi-site system and the others.

Farm type	Number of sows, multi-site	Number of sows, other	Number of finishers, multi-site	Number of finishers, other
Farrowing farm	512	96	109	92
Farrowing-to-finishing farm	189	65	551	362
Finishing farm	0	0	1 154	550

### Cattle production

In 2009, there were 876 782 cows on 16 752 farms in Finland. Cattle production can be divided into three categories: dairy farms, beef cattle farms and suckler farm (Table 26).

The majority of the farms were dairy farms encompassing the majority of all cows (Table 25). However, most dairy farms were also meat producers, and out of 600 000 heads on dairy farms, approximately 50% were raised for meat production.

**Table 25.** The number of cattle farms and animals in Finnish PVO districts in 2009.

PVO	Number of farms		Number of animals		
	Dairy farms	Other farms*	Dairy cows on dairy farms	Beef cattle on dairy farms	Cattle on other farms**
Helsinki	310	134	9 169	7 435	5 609
Hämeenlinna	659	253	16 710	14 292	11 532
Joensuu	859	294	19 866	19 085	17 165
Jyväskylä	744	367	16 316	14 842	18 506
Kouvola	653	223	15 911	13 480	9 491
Kuopio	1 623	440	40 799	38 664	31 381
Maarianhamina	63	61	1 924	1 933	2 966
Mikkeli	775	310	16 806	15 192	14 556
Oulu	2 148	537	55 022	53 188	40 609
Rovaniemi	541	161	12 111	11 967	10 986
Tampere	587	284	15 190	14 594	12 214
Turku	902	402	21 104	21 155	26 524
Vaasa	2 574	750	73 113	77 308	50 362
Total	12 438	4 216	314 041	303 135	251 901

\* Suckler cow and beef cattle farms included; \*\* includes beef cattle and suckler cows

## Dairy farms

A cattle farm was defined in this study as a dairy farm if it had one dairy cow on the farm, even though it produced both milk and meat. Dairy farms in Finland were fairly small and had 25.3 dairy cows on average. The average number of cattle on dairy farms is 50 heads per herd. Typically, dairy cows are raised on the farm on which they are born. Calves suitable for dairy production can also be sold to other dairy farms.

## Beef cattle farms

Beef cattle farms consist of weaning farms and finishing farms. Because of the large calf production on dairy farms, the majority of the meat (80%) came from dairy breed cows. Over 80% of all male calves and those female calves not used for dairy production were sold to **weaning farms** at the age of two weeks (with the exception of those raised for meat on dairy herds). In 2009, there were 47 weaning farms in Finland, i.e. less than 1% of the Finnish "other cattle" population is located on weaning farms. On weaning farms, calves become ruminants and are accustomed to solid feed. At the age of 5 to 6 months, calves are transferred from weaning farms to **finishing farms**. Finishing farms are the final stage in meat production. This final stage lasts from 12 to 16 months, after which the animals are sent to slaughter.

## Suckler cow farms

Beef cattle are also grown on suckler farms that are farms specialized in meat production. Cows are mated on the farm and calves are kept on pasture together with their dams until weaning (around 6 months). Calves are then transferred to finishing farms. It is possible for a suckler farms to grow cattle from birth to slaughter, but larger suckler cow farms are concentrated on producing weaning age calves for finishing farms. There were 1 628 suckler cow farms in Finland in 2009.

**Table 26.** Types of farms and number of cows and other cattle in 2009 in cattle production sector.

Farm type	Number of farms	Dairy cows	Other cattle	Mean number of cattle
Dairy	12 438	314 041	303 135	50
Beef cattle	2 572	0	149 799	58
Suckler cow	1 628	0	102 103	63
Total	16 638	314 041	555 037	52

## Sheep and goat production

Sheep and goat production is small-scaled in Finland. Sheep and goat farms in this study were divided into three classes: professional, semi-professional and hobby farmers (Virtanen et al. 2013). Because of the small numbers of professional (14) and semi-professional (36) goat farmers and the similarity of the two farming types, sheep and goat farm statistics are combined in Table 27. The number of animals on sheep and goat farms is commonly reported as the number of ewes and does because the majority of lambs and kids are slaughtered after six months from birth. In 2009, there were approximately 119 000 sheep, of which 64 000 were ewes, and approximately 6 700 goats, of which 6 000 were does. Professional sheep farms are more common in Oulu and Rovaniemi PVO districts than on other parts of the country (Table 28).

Half of all ewes and does were located on professional farms, although they comprised only a small percentage of the farms having sheep or goats. One fifth of the sheep and goats were on pig or cattle farms. There were also organic sheep and goat farms. Organic sheep farms were larger and the average number of ewes on an organic sheep farm was 97 compared to 22 ewes on a traditional sheep farm.

**Table 27.** Number of sheep/goat farms, ewes and does and average number of sheep/goats per farm in Finland in 2009.

Farm type	Number of farms	Ewes and does	Other sheep and goats	Mean number of of sheep and goats
Professional sheep farm	150	26 996	19 640	311
Semi-professional sheep farm	734	21 768	21 034	58
Hobby sheep farm	1 097	2 930	2 470	5
Goat farm	371	4 056	631	13

\*Pig and cattle farms had 14 266 ewes and does (20 %) and 12 379 other sheep and goats (22 %) in 2009.

**Table 28.** The location of different types of sheep and goat farms in 2009.

PVO	Professional sheep farms	Semi-professional sheep farms	Hobby sheep farms	Goat farms
Helsinki	6	57	129	38
Hämeenlinna	4	34	98	43
Joensuu	7	30	60	22
Jyväskylä	7	44	60	14
Kouvola	5	38	81	29
Kuopio	5	35	74	23
Maarianhamina	11	56	25	4
Mikkeli	6	33	64	19
Oulu	24	69	121	35
Rovaniemi	30	83	31	13
Tampere	3	61	98	34
Turku	19	108	160	70
Vaasa	23	86	96	27

### Quantities marketed and unit prices

The production of dairy milk in 2009 totalled 2 215 million litres. The volume of pig meat production was 206, beef meat 81 and sheep meat 0.8 million kg. The average producer price paid was €0.41/kg for milk, €2.47/kg for beef and €1.41/kg for pig meat (Table 29).

**Table 29.** Quantity of milk and meat production and producer prices paid in 1997–2014.

	Dairy milk		Beef		Pig meat		Sheep meat
	Million litres	€ per 100 kg	Million kg	€ per t	Million kg	€ per t	Million kg
1997	2 301	34.82	99	209	180	140	1.27
1998	2 300	34.46	93	224	184	126	1.18
1999	2 325	34.31	90	216	182	113	0.91
2000	2 371	35.33	91	206	173	129	0.75
2001	2 378	36.48	90	208	174	150	0.67
2002	2 376	37.29	91	190	184	137	0.64
2003	2 323	37.31	94	186	193	115	0.59
2004	2 304	36.37	91	190	198	120	0.65
2005	2 293	35.55	84	205	203	128	0.62
2006	2 279	36.90	85	212	208	126	0.65
2007	2 226	39.05	87	221	213	132	0.74
2008	2 188	44.79	80	241	217	144	0.77
2009	2 215	40.11	81	247	206	141	0.76
2010	2 222	40.59	82	240	203	137	0.79
2011	2 190	43.90	82	253	202	146	0.95
2012	2 188	46.26	80	281	193	163	0.95
2013	2 220	47.27	80	311	194	174	0.98
2014	2 289	45.05	82	303	186	158	1.09

Source: OSF: Luke, Milk and milk products statistics, Meat production and Producer prices of agricultural products

### **Appendix 3: Epidemiological simulation models**

In this study, we applied three disease-specific models. Two of them (FMD and ASF) essentially represent different parameterisations of the same model. The bluetongue model applies the same framework, but it has several differences when compared to FMD and ASF models.

#### **FMD model, year 2009**

The FMD model is based on an earlier simulation model of a Finnish FMD risk assessment (Lyytikäinen et al. 2011). In that model, we applied production information and the structure of the year 2006, and it did not contain information on sheep/goat production.

The changes can be summarized as: Farm and animal movement databases were updated to 2009.

The number of farm types was reduced in the cattle production sector. Cattle farms in the model are dairy, beef or suckler farms. Definitions of farm types were also simplified. A dairy farm was any farm containing at least one dairy cow and a suckler farm a farm with at least one suckler cow and but no dairy cows. Beef cattle farms were all those cattle farms that were neither dairy nor suckler farms. Pig farm typing remained similar to that applied in Lyytikäinen et al. (2011).

Sheep and goat production was included in the model. Sheep and goat farms that did not have cattle or pig production were added to the farm database (mixed farms that had pigs/cattle were already included). Contacts within sheep/goat production and with cattle/pig production were parameterised according to Virtanen et al. (2013) and included in the simulation framework.

Cadaver collection simulation was changed so that contacts between sheep/goat production and cattle production within the cadaver collection zone were noted.

Veterinary and relief worker functions were also modified so that contacts between all production sectors were noted.

Additional airborne transmission parameters were modified so that the affinity of cattle farms to receive airborne infection from a pig farm remained as in the FMD risk assessment, but for sheep farms the affinity was scaled down by a factor of 0.1 and for pig farms by 0.01.

#### **ASF model, year 2009**

The ASF model framework was developed from the FMD model by excluding cattle, sheep and goat production as well as irrelevant contact information and spread routes.

The parameterisation of ASF was mostly based on a Finnish classical swine fever risk assessment (Raulo & Lyytikäinen 2006) and an FMD risk assessment (Lyytikäinen et al. 2011).

Time lags applied in modelling of risk management operations were the same as in the FMD 2009 model.

Transmission probabilities applied in the simulation originated from the CSF risk assessment (Raulo & Lyytikäinen 2006).

Contact processes of relevant contact types originated from the FMD model in pig farms, except that the ASF model did not contain neighbourhood spread or airborne spread.

Detection of the disease was assumed to be more rapid than that of CSF outbreak and achieved at the latest when the outbreak would reach the third epidemiological generation of pigs on the farm. If  $R_0$  is assumed to be 8–11, by the time of the third generation, there would be tens to hundreds of infected pigs. Due to more severe clinical symptoms than in CSF, this was assumed to lead to rapid diagnosis. By assuming a 4-day incubation period, a 5-day infective period and a time of death of 13 days after infection, we concluded that the detection should eventually happen before the 28th day after the introduction of the virus.

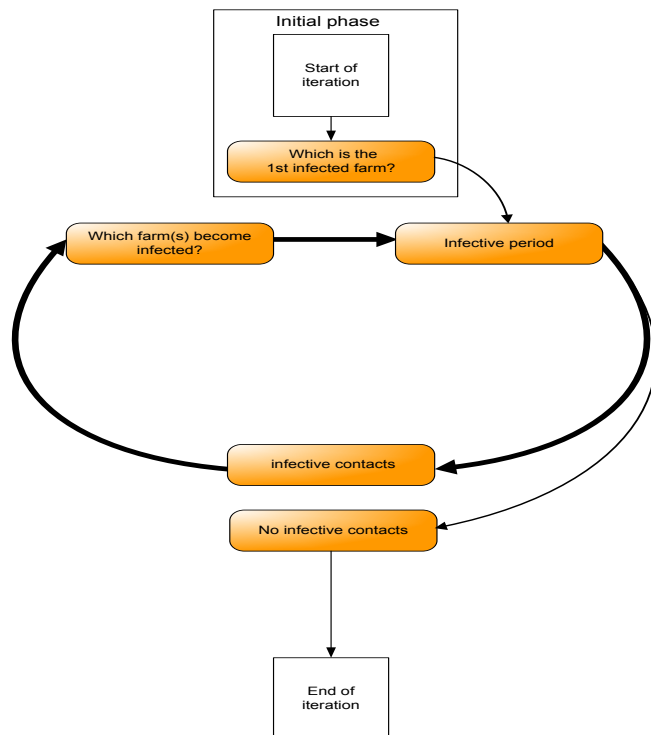
### Bluetongue model, year 2009

The bluetongue model applied the same farm database as in the FMD model, but the simulation of spread was modelled differently.

The bluetongue model was a combination of a spatial kernel model (de Koeijer et al. 2011) and an animal transport-induced spread model (adapted from Turner et al. 2012). Simulation of contacts utilized the animal transport database as in the FMD and ASF models. The model utilises temperature information from 2009.

### Spread model – The simulation process for FMD and ASF

The simulation process has five distinctive phases: 1) an initial phase that is required once per iteration, 2) estimation of the infective period of a farm, 3) estimation of the infective contacts, 4) the selection of a new infective farm and 5) if there are no new infected farms, the end phase of the iteration.



**Figure 45.** Figure 45. The basic process describing the simulation principle of the Finnish FMD and ASF models. An iteration starts by randomly selecting the first infected farm in the country. Knowledge of the length of the infective period and the identity of the farm makes it possible to define the infective contacts (see details later). By selecting new infective farms (end points of infective contacts), the iteration continues until no new infective contacts are formed.

## Initial phase

One farm is sampled randomly from the Finnish farm population to be the first infected farm of the iteration (Figure 45). In FMD simulations, the first infected farm may be a pig, cattle, sheep or goat farm, and in ASF simulations only a pig farm is suitable to be the first infected farm.

In this assessment, the iterations were started on 21 May 2009 and the contacts of the first infected farm were simulated for the following infective period (Figure 45). Some of the contacts were sampled directly from the databases and were thus dependent on the starting date of the iteration. In the initial phase of an iteration, all parameters used in equations estimating the number of visits to a farm (Table 32, Figure 48) were simulated by sampling from a covariance-variance matrix and estimated parameters of the model (for details, see Appendix 2, Table 20 in Lyytikäinen et al. 2011). The level of other country-level parameters containing uncertainty due to information sources was also sampled at the start of the iteration.

## Infective period of a farm

The length of the infective period was given as an input parameter for the first infected farm, but for the following infected farms it was simulated by comparing different routes that could put a farm under restrictive measures and/or allow it to become detected according to EU legislation. For the first infected farm, it was assumed that the detection was always initiated by a suspicion of FMD or ASF. For other infected farms, there was no closed form to define the length of the infective period, because it was also dependent on other events such as which farms have already been detected as infected during the iteration and when the virus had been introduced to the farm (Figure 46). If a farm was infected by a detected farm, it could be traced as a contact farm. If it was in the protection or surveillance zones of an already detected farm, it could be detected earlier than by suspicion. Events defining the infective period were simulated conditionally: this means that an initial condition has to be met before the next event could be simulated. Because different operations take time, there are time lags between events (Table 30).

The infective period of a farm has two phases: In the first phase, all contact types can be infective and the farm is not under restrictive measures. When restrictive measures are effective for the farm, only neighbourhood and airborne spread in FMD simulations remain as infective pathways, until the farm has been initially cleaned (Figure 46).



**Table 30.** The duration of the infective period, time lags and parameters used to simulate events relevant in the determination of the infective period of a single infected farm during iteration.

Parameter	Initial condition	Duration of period or time lag (days)	Event following after the end of period or after the time lag
Non-infective period	Virus has been introduced to the farm	FMD 2 ASF 2	The start of an infective period
Latent period	Virus has been introduced to the farm	FMD 4 ASF 4	Clinical signs are possible on infected farm
The day of suspicion of farms infected before 1st detection	Virus has been introduced to the farm	FMD 20 ASF 28	The end of first phase of the infective period of farms under suspicion*
The day of suspicion of farms infected after the 1st detected farm in the country	Virus has been introduced to the farm	FMD 14 ASF 21	The end of first phase of the infective period of farms under suspicion*
Time lag of diagnosis of primary infected farm	Farm has been suspected to be FMD/ASF positive	1–3	Positive diagnosis of FMD/ASF
Time lag of sending samples of farms in protection zones	Farm is in the protection zone	0–7	Laboratory has received samples
Time lag of sending samples of farms in surveillance zone	Farm is in the surveillance zone	0–7	Laboratory has received samples
Time lag of tracing	Farm is diagnosed as FMD/ASF positive	0–7	Connected farms can be traced
Time lag of sending samples of traced contact farms	Farm is traced as a contact farm of a farm diagnosed as FMD/ASF positive	0–7	Laboratory has received samples
Time lag of diagnosis of farms after 1st detected farm in the country	Samples have been sent due to clinical screening or protective zone serological screening or due to farmer notification or activity	0–1	Positive diagnosis of FMD/ASF
Time lag of eradication**	Farm has been diagnosed as FMD/ASF positive	1–7	Animals of the infected farm have been culled
Time lag of initial cleaning**	Culling on the farm has been completed	1–8	Initial cleaning of the farm has been completed, the end of second phase of the infective period

\*Under suspicion means only those farms that are not detected by administrative operations, namely due to zone and contact farm inspections

\*\*McLaws & Ribble 2007

The following definitions were used in the model (Figure 46):

**Day of introduction of a virus:** The day when the virus enters a specific farm.

**Starting day of the infective period:** After the virus is introduced to a farm and the non-infective latent period has ended, the infective period begins

**Infective period:** When a farm is under restrictive measures, the infective period of all contact types except neighbourhood and airborne spread in FMD simulation will end. The infective period of neighbourhood spread and airborne spread lasts until the initial cleaning of the farm has been completed in FMD simulations. In ASF simulations, the infective period ends when the last infected farm is put under restrictive measures.

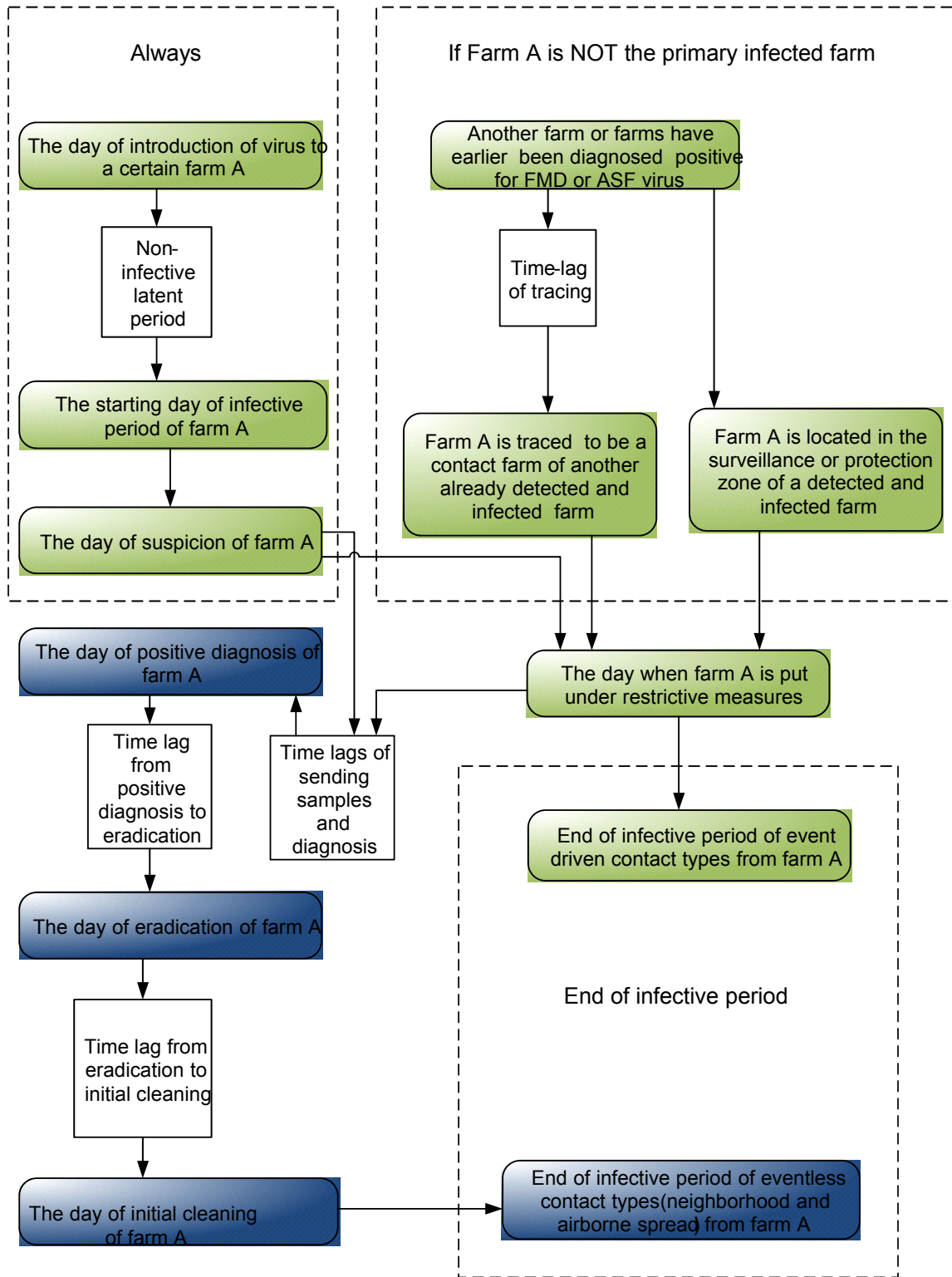
**Day of suspicion:** The day when a farm is placed under suspicion of having FMD or ASF.

**Day of restrictive measures:** Restrictive measures are put in force on farms under suspicion or on those located in the surveillance or protection zone around a possibly infected farm. Tracing is contact type dependent and has a time lag (0–7 days). After tracing, farms are put under restrictive measures. All other contact types, except neighbourhood spread and airborne spread in the FMD model, are assumed to be non-infective after this time point.

**Day of positive diagnosis:** For the primary infected farm, a positive diagnosis is assumed to be obtained 1–3 days after suspicion. Confirmative diagnosis needs to be carried out before the animals are culled. On suspected farms and those infected following the primary infected farm, the decision to cull would be made according to the first positive indication of FMD or ASF. For the later infected farms, following the primary infected farm, the day of a positive diagnosis also depends on whether the farm is traced as a contact farm, or is located in the protection or surveillance zone around a positively diagnosed infected farm.

**Day of eradication:** Eradication is completed 1–7 days (Table 30) after the day of positive diagnosis. The time lag is defined according to recent FMD epidemics in the EU (McLaws & Ribble 2007) (Table 18). The day of eradication is the day when the eradication is completed.

**Day of initial cleaning:** Initial cleaning is completed 1–8 days (Table 30) after the day of eradication. The time lag is defined according to recent FMD epidemics in the EU (McLaws & Ribble 2007). The end of the initial cleaning is the endpoint of neighbourhood and airborne spread.



**Figure 46.** The events that define the infective period of an infected farm. A farm can become detected by suspicion. If a farm is not the first infected farm in the country, it is also possible that a farm becomes detected either by the tracing of contact farms of already detected farms, or by location in the protection/surveillance zones of other infected farms. The detection process has several time lags due to time limits in EU legislation and other processes that require resources or efforts. See Table 18 for applied values of time lags and periods preceding the events. The infective period partially ends when restrictive measures are in force and finally when the farm is initially cleaned. Blue events are applicable to spread simulation only for FMD while green are applicable to both FMD and ASF.

## Simulation of spread from infected farm(s)

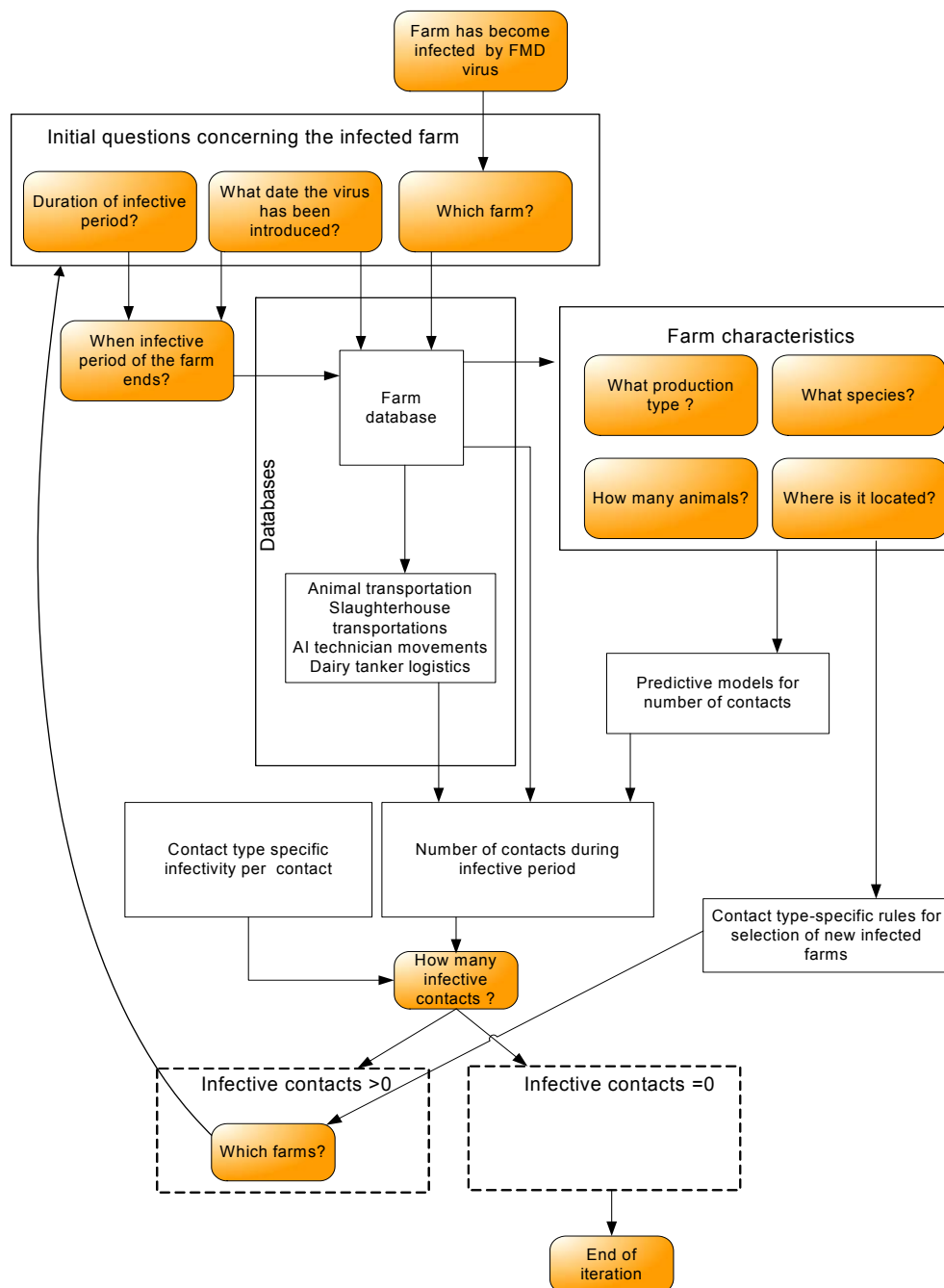
The infectivity of viruses and contacts during the infective period defines the number of new farms becoming infected from an already infected farm (Figure 47). If new farms become infected, the infective contacts of these farms are then simulated and iteration continues.

When the infective period of a farm is known, it is possible to sample infective contacts from databases. This sampling also partly defines the contact farms (Table 31). If the contacts following a visit to an infected farm are not explicitly known, for instance if information on the order of events is lacking within a day, the order of events (contacts due to a visit) is randomly simulated to estimate the contacts and contact farms. If events such as visits to the farm are not sampled from the database, they are estimated by equations (Figure 48). Each visit is then further simulated to estimate the contacts, their timing and contact farms from the population of susceptible farms (Table 31). Neighbourhood and airborne spread are tested separately for each farm in the susceptible population, which is determined by the distance from an infected farm (Table 31).

Steps applied in the simulation of a certain contact type are as follows:

1. Estimation or sampling of visits to an infected farm(s), (Figure 47, Table 31 and 32);
2. Estimation or sampling of potential contacts due to every visit to an infected farm (if applicable) (Figure 47);
3. Estimation of contacts based on the potential contacts (Figure 47);
4. Testing to determine which contacts are infective (Bernoulli trials) (Figure 48 and Table 33);
5. If the number of infective contacts is less than the number in the susceptible population, sampling of contact farms that will become infected (Table 31).

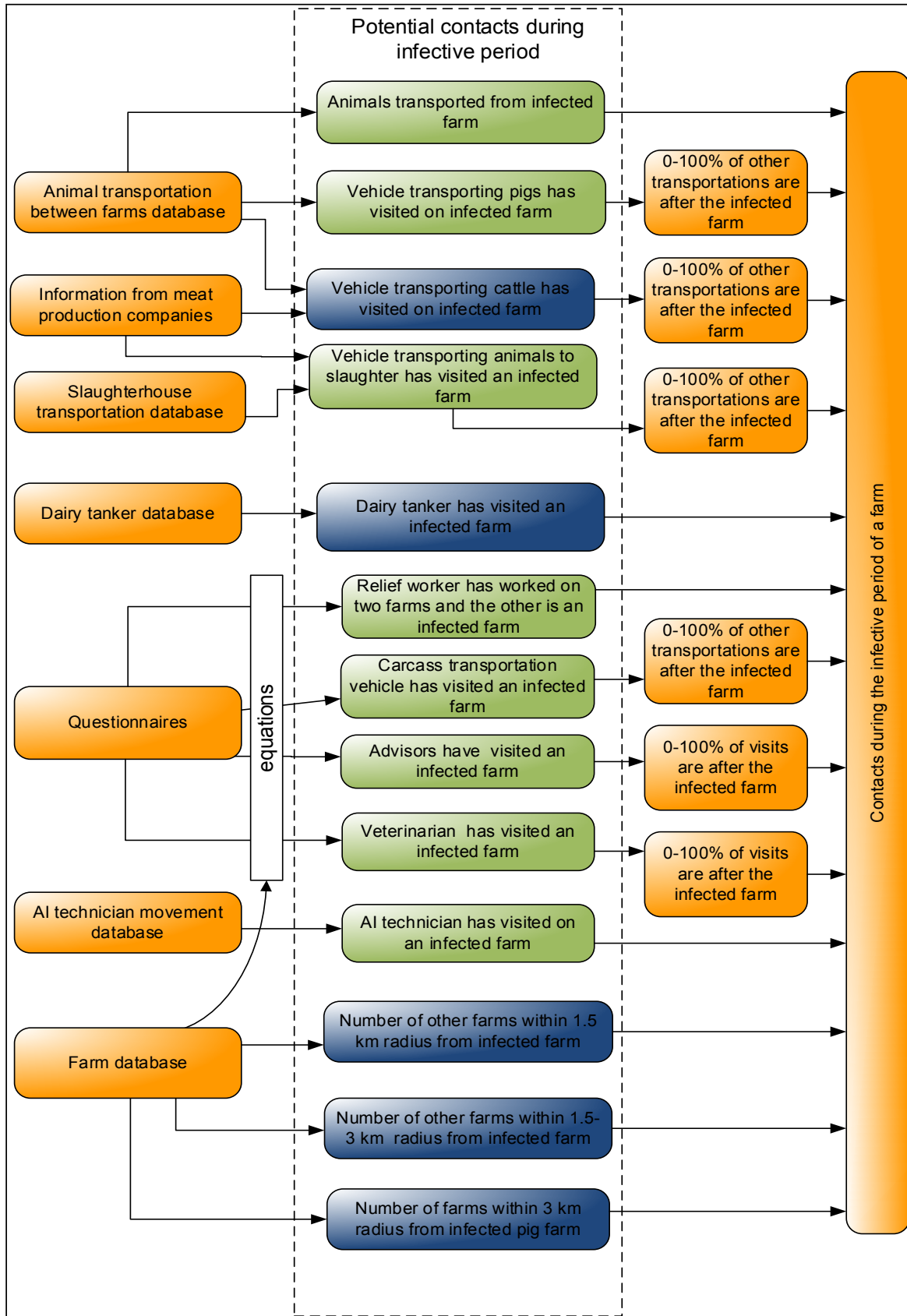
The steps are repeated for each contact type to estimate all farms that one infected farm would infect. If the same farm is infected by several farms or by several different contacts, the fastest route of spread is taken into account. When there are no more new infections during the iteration, the iteration ends (Figure 47).



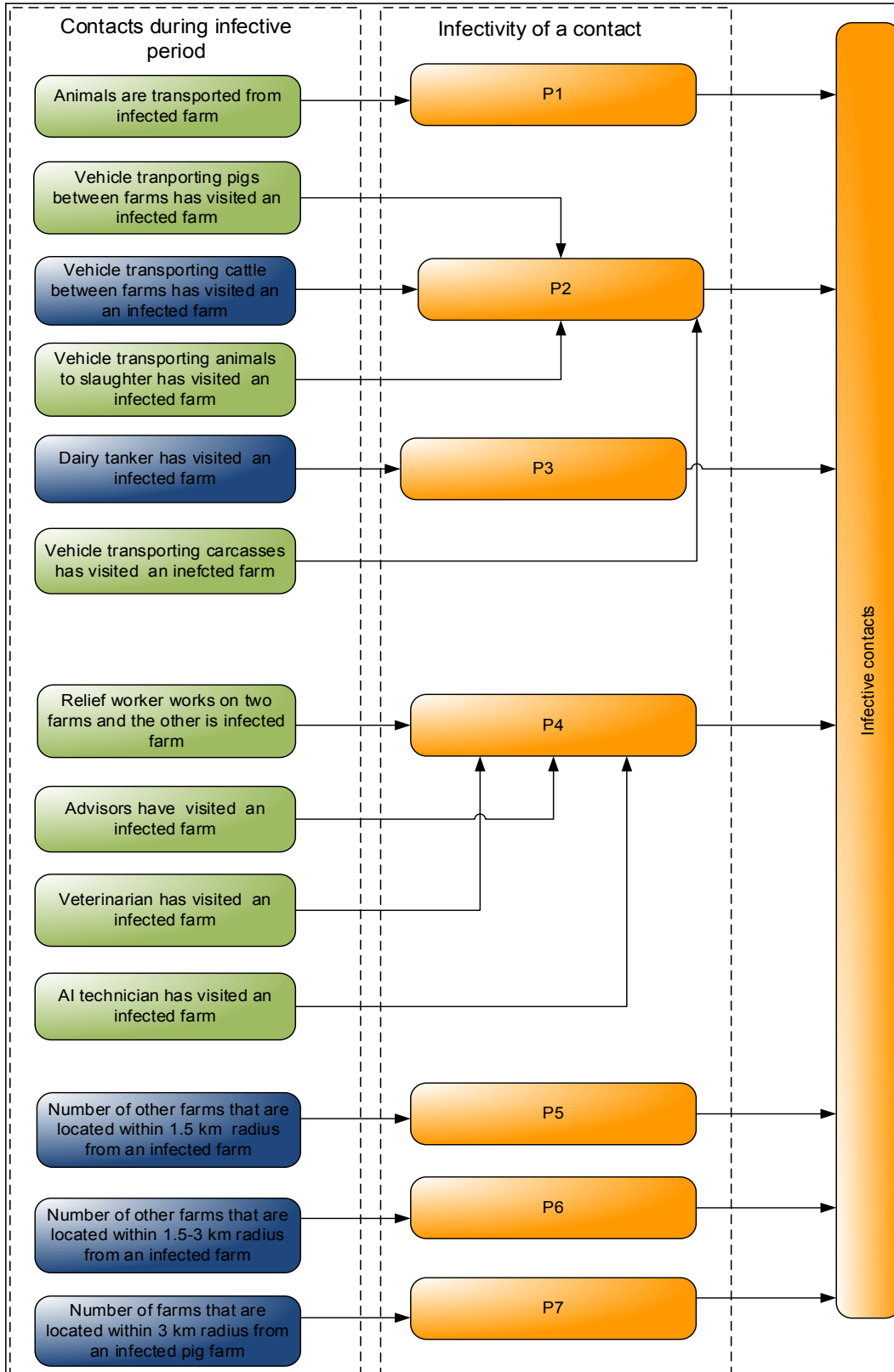
**Figure 47. The information used to simulate the infective process of a farm.** Different information sources and characteristics of the infected farm influence how many contacts an infected farm would give rise to within the infective period and which farms would become infected. The number of infected farms is also dependent on the infectivity of the contact types.

The following logic and definitions are used in the model:

**Contacts** are estimated for the infected farm or farms and only for the infective period (see the simulation of the infective period above). A contact is an event during the infective period that links farms and can potentially cause the transmission of disease to the extent that it could cause new outbreaks among the population of susceptible farms.



**Figure 48.** Schematic description of how different information sources will affect potential contacts by different contact types of a certain infected farm and how these are related to the contacts during the infective period. See parameters and definitions in Tables 31 and 32. Green indicates potential contacts that are applicable to both FMD and ASF models and blue indicates those potential contacts that are only relevant to FMD.



**Figure 49.** Different contact types have different infectivity per contact. Contacts during the infective period and the infectivity of contact types together define which contacts are simulated to be infective. Because different contact types may infect the same farms, the number of infected farms may be smaller than the number of infective contacts. See parameters and definitions in Tables 31, 32 and 33. Green indicates potential contacts that are applicable to both FMD and ASF models and blue indicates those potential contacts that are relevant only to FMD. P1-P7 are contact type-specific transmission probabilities (see Table 33).



**Potentially infective contact types:** All those types of contacts that are assumed to be able to transmit the virus to another farm (Figure 48). Those operators who only visit the farm but not the animal holdings were not regarded as potentially infective contact types. Potentially infective contact types can be divided into two categories: event-driven contact types, where the transmission can be tested for a specific event such as a visit to the animal holdings, and eventless contact types (neighbourhood and airborne spread), where there are no distinctive events leading to transmission (Table 31, column 4).

**Infectivity of contact types:** The probability that one contact of a certain contact type from an infected farm would introduce an adequate dose of virus to another farm and initiate an outbreak of FMD or ASF on that farm. Values for infectivity were retrieved from the scientific literature (Table 33).

**Visits to the farm:** Visits of any contact type during the infective period to a certain farm. The number of visits is defined directly from a database, and is sampled for the infective period of the farm (Table 31) or estimated by equations (Table 32). If an equation or parameter is used as a value for the number of visits per year, the number of visits during the infective period is sampled by a binomial distribution,  $\sim \text{Bin}(\text{number of visits per year}, t/365)$ , where  $t$  is the length of the infective period. If the number of visits per year is not an integer, it is treated as a Poisson parameter and sampled before the binomial sampling to define the integer value for that particular farm in the simulation.

**Potential contacts due to a visit:** Farms visited by a vector (person) that on the same day has visited an infected farm. Potential contacts are contact-type dependent and are either directly sampled from a database or estimated according to questionnaires and other data sources (Figure 48).

**Contacts due to a visit:** The farms that either a vehicle or a person has visited on the same day after a visit to an infected farm. This is the proportion of potential contacts (0-100%), if not known specifically (Figure 48).

**Infective contact:** A contact that generates an FMD or ASF outbreak on another farm. This is defined by performing a Bernoulli trial for contacts due to visits by using the infectivity of a contact type as the probability rule of the trial. If the random number is less than the probability rule, then a contact generates a new infected farm.

**Susceptible farms:** Those uninfected farms that can be potentially connected with the infected farm during the infective period. The definition of susceptible farms is dependent on the contact type and the identity of the infected farm (due to its location and operational region) (Table 31).

**Contact farms:** Those farms that can acquire the infection if a contact turns out to be infective in a Bernoulli trial. The definition of contact farms is dependent on the contact type, and the identity of infected farm (due to its location and operational region). Contact farms are sampled from the contact type-specific population of susceptible farms by a fraction defined by infective contacts, if not specified in the databases (Table 31).

**Table 31.** Potentially infective contact types in the FMD and ASF models, spatiality, temporality and the rules for defining susceptible and contact farms during the infective period of an infected farm.

Vector	Incident leading to transmission of infection	Spatiality of network	Source for temporal events	Susceptible farms	Contact farms
Pigs <sup>ASF</sup> , cattle, sheep or goat	Transportation of live pigs or cattle between farms from an infected farm	Animal transportation database	Animal transportation database	Year 2009, animals are transported from infected farms	Same as susceptible farms
Vehicle <sup>ASF</sup>	Vehicle transporting pigs or cattle between farms has visited an infected farm earlier on the same day	Animal transportation database	Animal transportation database, in addition cattle: farm database, slaughterhouse transportation database	Year 2009, pigs: the same transportation vehicle and day, cattle: the same slaughterhouse, day and closeness	Sampled from susceptible farms
Vehicle <sup>ASF</sup>	Vehicle transporting pigs or cattle to slaughter has visited an infected farm earlier on the same day	Slaughter transportation database	Slaughter transportation database	Year 2009, the same slaughterhouse and day of slaughter	Sampled from susceptible farms
Dairy tanker	Same vehicle transporting milk to dairy has visited an infected farm earlier on the same day	Dairy logistics database	Dairy logistics database	Year 2009, the same dairy tanker after a visit to the infected farm	Same as susceptible farms
Carcass collection vehicle <sup>ASF</sup>	Carcass collection vehicle has visited an infected farm earlier during the collection route	Carcass collection regions, distance from infected cattle farm within the defined region	Simulated Poisson process	Pigs: the same carcass collection region, Cattle, Sheep, Goats within a given distance from an infected farm	Sampled from susceptible farms
Advisor <sup>ASF</sup>	Visit to the production unit on another farm after a visit to the production unit of an infected farm earlier on the same day	Depending on the operational region of the advisor	Simulated Poisson process	Same operational region as an infected farm	Sampled from susceptible farms
AI technician <sup>ASF</sup>	AI technician has visited the production unit of an infected farm earlier on the same day	AI technician movement database	AI technician movement database	Year 2006, same AI technician after a visit to the infected farm	Same as susceptible farms
Veterinarian <sup>ASF</sup>	Veterinarian has visited the production unit of an infected farm earlier on the same day	Depending on the operational region of the veterinarian	Simulated Poisson process	Same operational region as the infected farm	Sampled from susceptible farms
Substitute worker <sup>ASF</sup>	Substitute worker operates on two farms during the same day and one of them is infected	Depending on the operational region of the substitute worker	Simulated Poisson process	Same operational region as the infected farm	Sampled from susceptible farms
Unknown	Neighbouring farms within 1.5 km	Farm database	Eventless	Proximity from infected farm below the given value	Same as susceptible farms
Unknown	Neighbouring farms within 1.5-3 km	Farm database	Eventless	Proximity from infected farm within given values	Same as susceptible farms
Airborne	Neighbouring pig farms within 3 km	Farm database	Eventless	Proximity from infected farm below the given value	Same as susceptible farms

<sup>ASF</sup> Contact types that are relevant also in ASF simulation; others are only relevant in FMD simulation.

**Table 32.** Number of visits per year and number of potential contacts per visit for those contact types where potential contacts during the infective period are estimated by an equation or a parameter.

Contact type	Number of visits per year	Number of potential contacts per visit
Relief worker, pig farm <sup>a, c</sup>	31	0–1
Relief worker, cattle farm <sup>b, c</sup>	31	0–1
Relief worker, sheep/goat farm <sup>b, f</sup>	31	0–1
Cadaver transportation, pig farm <sup>d</sup>	Bin(Poisson $(0.376Z_{\max} + 2.035)^2$ , 0.66)	0–11
Cadaver transportation, cattle farm <sup>e</sup>	Bin(Poisson $(0.026N_{\text{dai}} + 0.003N_{\text{oth}} + 1.507)^2$ , 0.27)	0–14
Cadaver transportation, sheep/goat farm	Professional sheep farm = 3.3; other sheep and goat farms = 0.8	0–14
Advisor, pig farm <sup>d</sup>	Bin(Poisson $(0.376Z_{\max} + 2.035)^2$ , 0.34)	0–2
Advisor, cattle farm <sup>e</sup>	Bin(Poisson $(0.026N_{\text{dai}} + 0.003N_{\text{oth}} + 1.507)^2$ , 0.73)	0–2
Advisors and other visitors, sheep/goat farm	Professional = 18; Semi-professional/hobby farm = 17; goat farm = 7	0–2
Veterinarian, pig farm	Sow herd = 7.5; Mixed Herd = 7.9; Finisher herd = 4.2	0–2
Veterinarian, cattle farm	$0.30N_{\text{dai}} + 0.02N_{\text{oth}} + 1.53I_{\text{dai}} + 1.53$	0–2
Veterinarian, sheep/goat farm	2.2	0–2

<sup>a</sup> The probability that a pig farm uses a relief worker =  $\frac{\exp^{(0.171+0.871I_f+0.792I_m+0.660Z_{\max})}}{[1+\exp^{(0.171+0.871I_f+0.792I_m+0.660Z_{\max})}]}$

<sup>b</sup> The probability that a cattle farm other than a dairy farm uses a relief worker is 10%

<sup>c</sup> The probability that a relief worker works on two farms at the same time is sampled from beta(21,110)

<sup>d</sup> Cadaver collection and advisors for pig farms are simulated together: the total number sampled from a Poisson distribution is divided by binomial sampling between advisors and cadaver collection

<sup>e</sup> Cadaver collection and advisors for cattle farms are simulated together: the total number sampled from a Poisson distribution is divided by binomial sampling between advisors and cadaver collection

<sup>f</sup> The probability that a sheep/goat farm uses relief workers is 20%

**Symbols:**

$I_f$  = Indicator of farrowing farm,

$I_m$  = indicator of farrowing-to-finishing farm,

$Z_{\max}$  = standardised sum of pigs, cattle, sheep and goats on the farm,

$N_{\text{da}}$  = Number of dairy cattle on the farm,

$N_{\text{oth}}$  = Number of other cattle on the farm,

$I_{\text{dai}}$  = Indicator of dairy farm, random distributions:

Bin = binomial distribution,

Poisson = Poisson distribution

**Table 33.** Infectivity (probability of transmission of disease / one contact) of contact types in FMD and ASF models.

Parameter	Value	Contact types	Reference
FMD-model			
P1	0.4	Direct animal contact	Stevenson 2003
P2	0.15	Animal transportation vehicles, Cadaver collection vehicles	Stevenson 2003
P3	0.005	Dairy tanker	Stevenson 2003
P4	0.01	Relief worker, Advisor, Veterinarian, AI technician	Stevenson 2003
P5 <sup>a</sup>	0.063	Neighbourhood spread up to 1.5 km	Taylor et al. 2004
P6 <sup>a</sup>	0.025	Neighbourhood spread within 1.5–3 km	Taylor et al. 2004
P7 <sup>b</sup>	0.00438	Airborne spread from pig farms to cattle farms	Velthuis & Mourits 2007
ASF-model			
P1 <sup>c</sup>	~N(0.065; 0.030) *Coef	Direct animal contact	As in Raulo & Lyytikäinen 2006; Based on Stegeman et al. 2002
P2 <sup>c</sup>	~N(0.011; 0.005) *Coef	Animal transportation vehicles, Cadaver collection vehicles	As in Raulo & Lyytikäinen 2006; Based on Stegeman et al. 2002
P4 <sup>c</sup>	~N(0.007; 0.004) *Coef	Relief worker, Advisor, Visitor, Veterinarian, AI technician	As in Raulo & Lyytikäinen 2006; Based on Stegeman et al. 2002

<sup>a</sup> Airborne spread from a cattle farm to other cattle farms in the FMD model is included in P5 and P6 –Taylor et al. (2004) estimated the spread among cattle farms.

<sup>b</sup> For sheep farms, the value is scaled down by multiplying by 0.1 and for pig farms by multiplying by 0.01

<sup>c</sup> A sampled value from the normal distribution was multiplied by a coefficient estimated (Coef) by initial sampled values of that iteration; the coefficient followed a normal distribution: N(2.65; 0.61)

## Spread model – The simulation process for bluetongue

The simulation process follows the same framework as the FMD and ASF models. The simulation process has five distinctive phases: 1) an initial phase that is required once per iteration, 2) estimation of the infective period of a farm, 3) estimation of the infective contacts, 4) the selection of a new infective farm and 5) if there are no new infected farms, the end phase of the iteration.

### Initial phase

One farm is sampled randomly from the Finnish farm population to be the first infected farm of the iteration (Figure 45). In BT simulations, the first infected farm can be a cattle, sheep or goat farm.

In this assessment, the iterations were started on 15 June 2009 when the vectors are active. Animal transportations are sampled directly from the databases and are thus dependent on the starting date of the iteration.

### Infective period of a farm

The length of the period preceding suspicion is given as an input parameter for all the farms (Table 34). For other infected farms than the first one, there is no closed form to define the day of suspicion (Figure 52), as it depends on the time of introduction of the virus. Restrictive measures are put in force either due to suspicion or by administrative decision due to a farm being traced as a contact farm or being in an established control, surveillance or protection zone (Figure 52).

The infective period of a farm has two phases: In the first phase, when restrictive measures do not apply to the farm, the disease can spread by vectors between farms and by transporting infected animals from one farm to another. When restrictive measures are effective at the farm, only spread by vectors can remain as an infective pathway, until the active season of the vector has ceased (Figure 52).

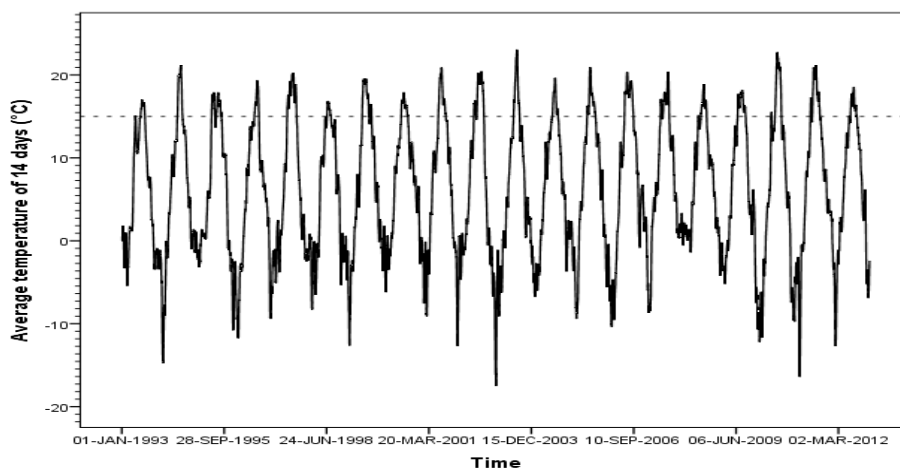
**Table 34.** Time-related parameters in bluetongue spread simulation.

Time-related parameter	Value	Reference
Start of vector-active season	Day = 165*	Finnish meteorological data
Non-infective period of a farm	14 days after virus introduction	de Koeijer et al. 2011
The day of suspicion	59 days after the end of the non-infective period	Finnish BT contingency plan
End of vector-active season	Day = 256	Finnish meteorological data
Duration of vector-active season	91 days	Finnish meteorological data
Time lag of tracing	0–7	

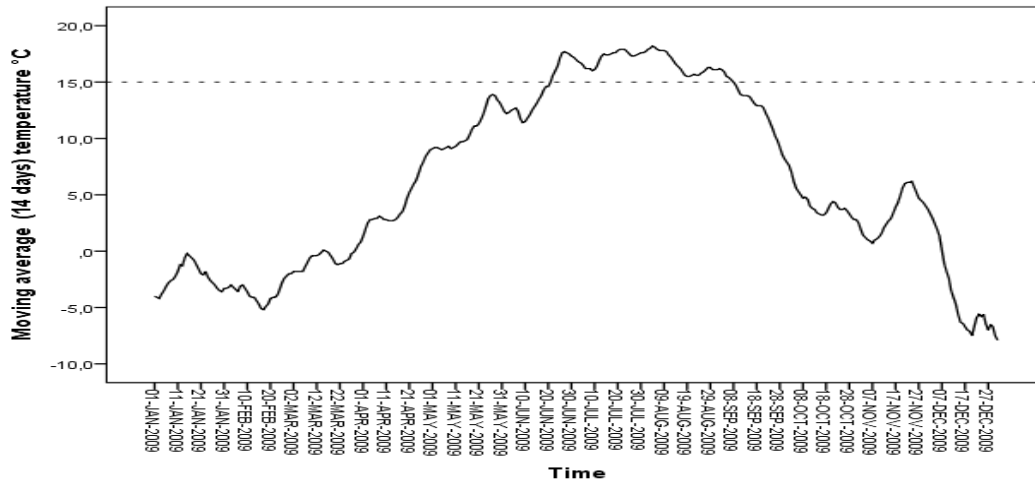
\*Day 0 is 1 January

In vector-borne diseases, spread is possible during the vector-active season. The infective process starts at the beginning of the vector-active season and ceases at the end of the vector-active season. The vector-active season is temperature dependent: according to de Koeijer et al. (2011), spread between farms is mainly observed when the 14-day average temperature is above 15 °C.

According to Finnish meteorological information, there is yearly variation in the length of this period (Figure 50). The simulation time frame, for the sake of simplicity, was defined applying the temperature conditions in Helsinki in 2009. Helsinki is located in the southern part of Finland and has one of the longest vector-active seasons in the country. The vector-active season was estimated to be 91 days in 2009 and started on 15 June (Figure 51).

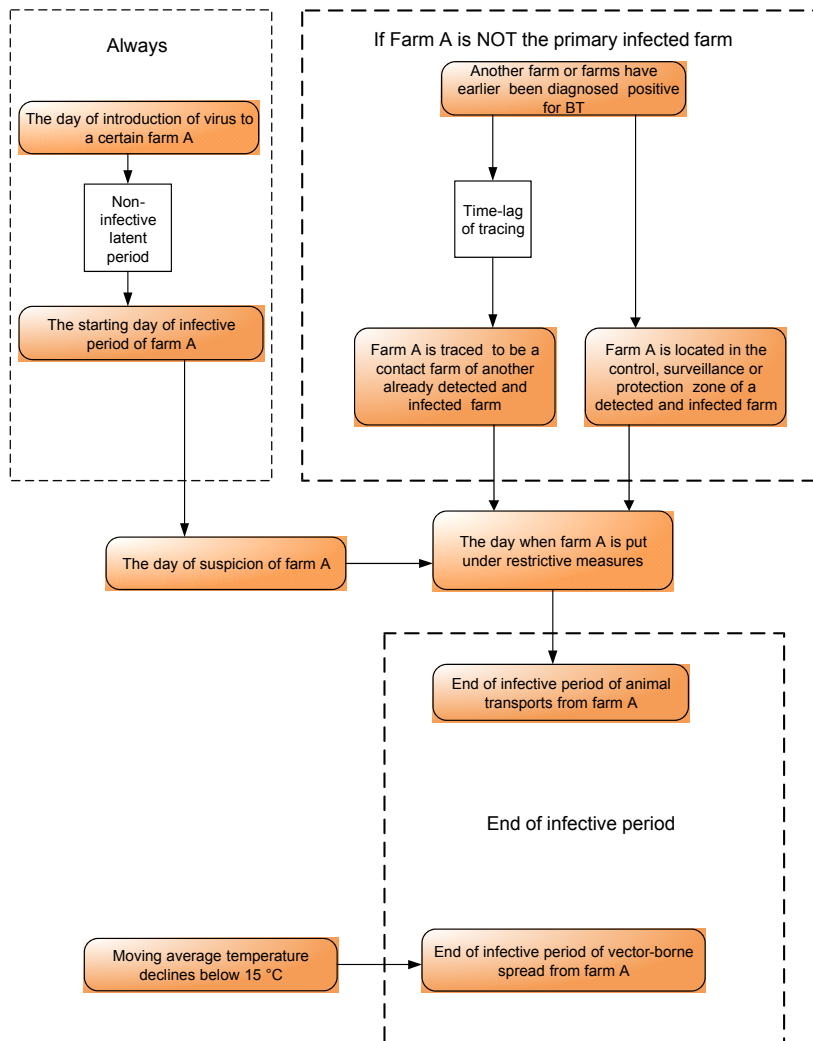


**Figure 50.** Moving average (14 days) temperature in Helsinki in 1993–2012; 15 °C is indicated by a dashed line.



**Figure 51.** Moving average temperature in Helsinki in 2009; 15 °C is indicated by a dashed line. The vector-active season is defined as the area above the dashed line.

The time for the detection of BT was indirectly assumed in the Finnish contingency plan to be 60 days, where the time limit for contact tracing was set. Therefore, a 59-day period before detection was applied in simulations (Table 34).



**Figure 52.** The events defining the infective period of potential pathways of spread to other farms for bluetongue.

## Simulation of spread from infected farm(s)

Infectivity and contacts during the infective period partially define the number of new farms becoming infected. Furthermore, the distance from an already infected farm defines the risk of virus introduction due to vector-borne spread. If new farms become infected, infective contacts and vector-borne spread from these farms are then simulated and the iteration continues.

When the time of introduction of the virus, the non-infective period and the end of the infective period are known, it is possible to sample related animal transports from databases. The prevalence of infection is estimated by a separate function and partially defines the transmission of disease.

The probability that at least one animal in a transported batch is infected is inversely related to the prevalence of infection:

$P(\text{transmission}) = 1 - (1 - \text{Prev})^n$ , where Prev is the prevalence of infection and n is the number of animals in the transported batch. Transmission can then be simulated by performing a Bernoulli trial for each transported batch within the infectious period.

Vector-borne spread is tested separately for each farm in the susceptible population, which is determined by the spatial kernel (see below).

Steps applied in the simulation of bluetongue spread are as follows:

Testing of which contacts are infective (Bernoulli trials) before restrictive measures are in force.

Simulation of vector-borne spread during the vector-active season and testing of whether any vector-induced infections have occurred during the vector-active season.

If a farm is infected by several other farms or by several different contacts, the fastest route of spread is taken into account in the simulation and others are excluded. When there are no more new infections during the iteration, the iteration ends.

## Spatial kernel

Spatial kernel in de Koeijer et al. 2011 was defined as:

$$\lambda(r) = \lambda_0 / [1 + (r/r_0)]^\alpha$$

where r is the inter-farm distance (km),  $\lambda_0$  is the initial rate of transmission and  $r_0$  is a scaling distance. When the distance is known, the probability of transmission can then be estimated by:

$$\rho(r, T) = 1 - \exp^{-\lambda(r)T},$$

where T is the infectious period (days). The probability of transmission for each farm in the country could thereafter be sampled by simulating the binomial distribution  $\text{Bin}(1, \rho(r, T))$ , separately for each farm, conditionally on the distance from a certain infected farm.



The parameters applied for our model (Table 35) were originally estimated for the 2007 outbreak in Germany but suggested by the author (Koeijer, personal communication 2014) to be more suitable for Finnish conditions than the general model describing spread in Belgium, the Netherlands and Germany (Koeijer et al. 2011).

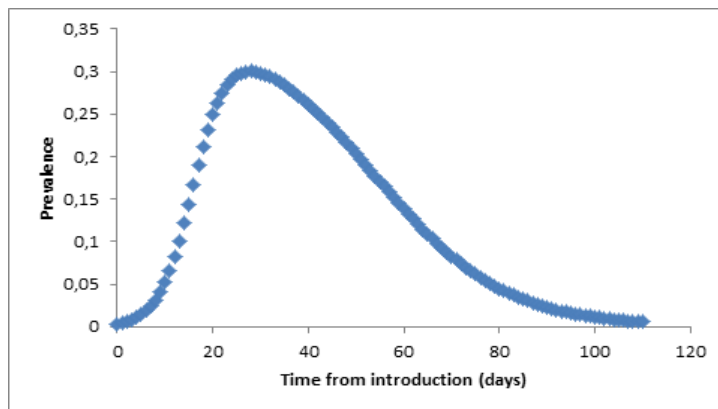
### Prevalence of infection

The prevalence of infection in the bluetongue model was defined similarly as in Turner et al. (2012) (Table 35), where it was assumed to follow a curve analogous to a curve originally developed for dengue fever (Pongsumpun et al. 2008):

$$\text{Prev} = (\text{prevlim}/4) (1-\tanh[(L_1-T_{\text{inf}})/T_1]) (1-\tanh[(T_{\text{inf}}-L_2)/T_2]),$$

where  $t$  = time,  $T_{\text{inf}}$  = time from virus introduction,  $T_1$ ,  $T_2$ ,  $L_1$  and  $L_2$  are parameters defined by Turner et al. (2012). The model is valid when the temperature is above the cut-off temperature of 10.5 °C.

The prevalence of infection appears to peak 20–40 days after virus introduction and then decline slowly (Figure 53).



**Figure 53.** The dynamics of the within-herd prevalence of infection in a bluetongue outbreak, when the temperature remains constantly above the cut-off temperature of 10.5 °C.

**Table 35.** Bluetongue-specific parameters for the simulation of spread in Finland.

Parameter	Value	Reference
$\lambda_0$ , initial rate of transmission	0.0000092	de Koeijer et al. 2011
$r_0$ , scaling distance	18	de Koeijer et al. 2011
$\alpha$	3.2	de Koeijer et al. 2011
$L_1$	16	Turner et al. 2012
$L_2$	54	Turner et al. 2012
$T_1$	7	Turner et al. 2012
$T_2$	27	Turner et al. 2012
prevlima	0.355	Turner et al. 2012

<sup>a</sup> Assuming that the susceptibility of each farm is 1, i.e. no previous bluetongue infections are assumed.

## **Appendix 4: Risk management 2009–2011**

### **Voluntary risk management measures**

#### **Biosecurity on cattle, pig, sheep and goat farms in Finland**

The Finnish Association for Animal Disease Prevention (ETT) is an organisation that promotes animal health and welfare in the Finnish livestock sector. ETT prepares explicit instructions for the import of animals, semen and embryos. In addition, it contributes to the instructions for farms for the management of disease risks and preventive measures.

There are several ways to enhance biosecurity and reduce the risk of disease transmission between farms. Control measures applied to the trade and transport of animals, including quarantine, vaccination, veterinary inspection and documentation, as well as logistical planning of transport routes, are important ways of mitigating the spread of disease.

The most common biosecurity measures applied (based on questionnaires conducted in 2011, see Appendix 1) seem to be protective boots and clothes, hand washing and control of rodents and birds entering the production unit. Generally, the least applied measures were related to loading areas as well as to the cleaning of loading areas and animal stables between batches.

In general, pig herds have better biosecurity than cattle herds in Finland. Several biosecurity measures related to pig production were not generally applied in the cattle sector, which is natural: there is no motivation to have a separate loading area indoors or adjacent to an indoor production facility when the animals are collected from or held outdoors. Similarly, it is not relevant to clean the loading area if it does not exist. The same applies to hygiene barriers controlling the movement of humans into indoor production units. Having a leak-proof container outside the animal stables was seldom applied on average-sized cattle farms. This is probably a result of the small number of animals and low mortality, and the container would consequently be used only rarely.

A positive effect of herd size for applying biosecurity measures was evident: in the pig production sector, 7–8 out of 17 biosecurity measures showed a farm size-related positive effect. In the cattle sector, dairy farms showed the most size-related positive effects (10), and beef cattle (7) and suckler farms (4) clearly less.

**Table 36.** Implementation of biosecurity measures in 2011. Coefficients from the GLM models are transformed into likelihoods for the implementation of biosecurity measures on average-sized pig and cattle farms in Finland based on a questionnaire survey among farmers [% ( $\pm 95\%$  CI)]; see Appendix 1 and Sahlström et al. (2014)

Variable description	Pig farm type			Cattle		
	Farrowing	Farrowing-to-finishing	Finishing	Dairy	Beef cattle	Suckler cow
The farmer and his family use protective clothing in the stables	94 ( $\pm 5$ )*	85 ( $\pm 6$ )	88 ( $\pm 6$ )	63 ( $\pm 3$ )*	68 ( $\pm 7$ )	61 ( $\pm 8$ )*
The farmer and his family use boots or protective shoes in the stables	81 ( $\pm 7$ )	75 ( $\pm 7$ )	88 ( $\pm 6$ )	64 ( $\pm 3$ )***	60( $\pm 8$ )	65 ( $\pm 8$ )
Visitors use protective clothing (coveralls)	89 ( $\pm 6$ )	86 ( $\pm 6$ )***	82 ( $\pm 8$ )***	54 ( $\pm 4$ )***	43 ( $\pm 8$ )***	27 ( $\pm 8$ )*
Visitors use boots	81 ( $\pm 6$ )	81 ( $\pm 7$ )***	80 ( $\pm 8$ )***	70 ( $\pm 3$ )***	52 ( $\pm 8$ )***	54 ( $\pm 9$ )***
The farmer and his family wash their hands after working in the stable	95 ( $\pm 4$ )**	92 ( $\pm 5$ )	87 ( $\pm 6$ )	88 ( $\pm 2$ )**	86 ( $\pm 5$ )	81 ( $\pm 7$ )
Visitors wash their hands after the visit	85 ( $\pm 6$ )*	75 ( $\pm 7$ )	67 ( $\pm 8$ )	63 ( $\pm 3$ )	45 ( $\pm 8$ )	42 ( $\pm 8$ )
The use of a hygiene barrier that separates the clean area from the dirty area and that is not passed without changing protective clothing and shoes.	41 ( $\pm 8$ )*	31 ( $\pm 8$ )*	29 ( $\pm 8$ )	12 ( $\pm 2$ )***	10 ( $\pm 5$ )	9 ( $\pm 5$ )
The use of a separate loading area	72 ( $\pm 9$ )***	77 ( $\pm 7$ )	33 ( $\pm 9$ )***	3 ( $\pm 1$ )***	2 ( $\pm 2$ )	7 ( $\pm 5$ )
Washing the loading area after use	28 ( $\pm 8$ )	39 ( $\pm 8$ )	21( $\pm 8$ )	2 ( $\pm 1$ )	1 ( $\pm 1$ )	3 ( $\pm 3$ )
Outside the animal stables there is a leak-proof container for dead animals	59 ( $\pm 9$ )***	65 ( $\pm 8$ )***	70 ( $\pm 9$ )***	1 ( $\pm 1$ )	0 ( $\pm 1$ )*	0 ( $\pm 1$ )
The animal stables are cleaned between each "batch"	36 ( $\pm 8$ )	42 ( $\pm 8$ )	81 ( $\pm 7$ )	17 ( $\pm 2$ )	48 ( $\pm 8$ )**	25 ( $\pm 7$ )
Doors are locked	57 ( $\pm 9$ )**	52 ( $\pm 8$ )*	64( $\pm 9$ )***	12 ( $\pm 2$ )	16 ( $\pm 6$ )	8 ( $\pm 5$ )
Animals are divided into compartments	69( $\pm 10$ )***	61 ( $\pm 8$ )***	58 ( $\pm 10$ )***	11 ( $\pm 2$ )***	25 ( $\pm 8$ )***	29( $\pm 8$ )
The traffic on the farm is organized so that biosecurity aspects are taken into account	49 ( $\pm 8$ )	47 ( $\pm 8$ )*	36 ( $\pm 9$ )**	28 ( $\pm 3$ )***	21 ( $\pm 8$ )***	27 ( $\pm 8$ )***
Control of rodents and birds	91 ( $\pm 5$ )	91 ( $\pm 5$ )	98( $\pm 3$ )	76 ( $\pm 3$ )**	76 ( $\pm 7$ )***	71( $\pm 8$ )
Control of rodents and birds in the animal stable or shelter at the feeding table	54 ( $\pm 8$ )	64 ( $\pm 8$ )	63 ( $\pm 9$ )	52 ( $\pm 3$ )***	38 ( $\pm 8$ )	16 ( $\pm 6$ )
Control of rodents and birds in the feed storage	55 ( $\pm 8$ )	65( $\pm 8$ )*	68 ( $\pm 9$ )	41 ( $\pm 3$ )*	34 ( $\pm 7$ )	29 ( $\pm 8$ )

The statistically significant effect of farm size is marked as follows: \*\*\*<0.001, \*\*<0.01 and \*<0.05. Average-sized farms in the model: farrowing = 209, farrowing-to-finishing = 435, finishing = 663, dairy = 50, beef cattle = 58, suckler cow = 68 animals. Note that these refer to the mean value in the original scale.

## Protective measures associated with animal trading

According to questionnaires (Appendix 1), farmers may apply several additional biosecurity measures that influence the risk to receive diseases with purchased animals (Table 37). The most applied protective measures involve “follow the instructions of ETT” and “try to buy animals from as small a number of farmers as possible”.

The origin of animals was more often checked before buying if a farm produced animals to sell live to another farm (farrowing, farrowing-to-finishing, dairy and suckler cow farms) and on farms that only occasionally buy animals. A similar trend also applies to requiring health certificates before buying animals, although in pig production health certificates were required far less than in the cattle sector, partly because the actual health certificate system is not applied in the pig sector. However, the health status of the farm of origin can also be checked in the pig sector. Cattle farms and finishing pig farms cannot buy animals from the same farms as often as farms that have sows. Transporting animals in the farm’s own vehicle seemed to be more usual in the cattle than in the pig production sector. Slaughterhouse companies act as animal dealers most often when animals are entering the finishing stage of production (finishing farms and beef cattle farms). Some kind of (quarantine like) isolation for incoming new animals is applied at least on dairy farms and finishing pig farms (Table 37).

**Table 37.** Implementation of biosecurity measures when purchasing animals in 2011. Coefficients from the GLM models are transformed into likelihoods for the implementation of biosecurity measures on typically sized pig and cattle farms in Finland based on a questionnaire survey among farmers [% ( $\pm 95\%$  CI)]; see Appendix 1. Only respondents who have declared that they buy animals were taken into account.

Variable description	Pig farm type			Cattle		
	Farrowing	Farrowing-to-finishing	Finishing	Dairy	Beef cattle	Suckler cow
Follow the instructions of ETT	97 ( $\pm 3$ )	88 ( $\pm 7$ )	94 ( $\pm 5$ )	92( $\pm 5$ )**	85 ( $\pm 7$ )	91 ( $\pm 7$ )
Checking the origins of animals before buying	72 ( $\pm 12$ )*	63 ( $\pm 11$ )	41 ( $\pm 11$ )	90 ( $\pm 4$ )	39 ( $\pm 9$ )	86 ( $\pm 8$ )
Require a health certificate before buying	45 ( $\pm 30$ )	40 ( $\pm 20$ )	20 ( $\pm 14$ )	67( $\pm 7$ )	11 ( $\pm 6$ )	75 ( $\pm 12$ )
Try to buy animals from as few farms as possible	95 ( $\pm 5$ )	93 ( $\pm 6$ )	87 ( $\pm 7$ )	92( $\pm 3$ )	64 ( $\pm 10$ )*	91( $\pm 8$ )
Buy animals mainly from the same farms	87 ( $\pm 8$ )	84 ( $\pm 8$ )	64 ( $\pm 11$ )*	57( $\pm 4$ )*	52 ( $\pm 10$ )	62 ( $\pm 12$ )
Transport animals with own vehicle	17 ( $\pm 9$ )*	27 ( $\pm 10$ )	12( $\pm 7$ )	37( $\pm 6$ )	42 ( $\pm 10$ )*	23 ( $\pm 10$ )*
Animals are dealt with by a slaughterhouse	82 ( $\pm 9$ )	83( $\pm 8$ )	93( $\pm 5$ )	21( $\pm 5$ )*	85 ( $\pm 6$ )**	58 ( $\pm 12$ )*
Animals are placed in quarantine upon arrival	56 ( $\pm 12$ )	35( $\pm 12$ )	14( $\pm 8$ )	16( $\pm 5$ )**	40 ( $\pm 9$ )	48( $\pm 13$ )

According to the questionnaire, the probability of buying animals on a farm of a typical size: Farrowing = 69%, farrowing-to-finishing = 68%, finishing = 93%, dairy = 33%, beef cattle = 92% and suckler cow = 74%.

## Official risk management measures during an FMD or ASF outbreak

FMD and ASF are OIE-listed diseases and their control is regarded as a high priority (Cox & Barnett 2009). Because they are viral diseases, there is no treatment for the sick animal, and as a notifiable disease they should be eradicated.

A possible FMD or ASF outbreak in Finland is dependent on the disease situation in Europe and the rest of the world. Current control policies in Europe are based on strict import and quarantine regulations.

FMD and ASF are controlled both by European directives and through more detailed national legislation and a contingency plans. The national contingency plans contain detailed descriptions of operations in the case of an FMD or ASF suspicion and confirmation. According to the law, all veterinarians under 50 years of age and veterinary students are permitted to work as veterinarians and obliged, if needed, to contribute to inspections and other veterinary work needed in case of an outbreak of FMD or ASF.

The Provincial Veterinary Officer (PVO), Municipal Veterinary Officer (MVO) and the Food Safety Authority (Evira) must immediately be notified about signs of FMD or ASF. In the case of a suspicion of FMD or ASF, a farm will be placed under restrictive measures. This includes the prevention of animal transports, and all traffic to and from the farm is prohibited or strictly controlled. Samples for analysis are taken according to instructions from the competent authorities in the country (Evira). If a diagnosis of FMD or ASF is confirmed, or even earlier if indicated by other evidence, the animals of the susceptible species on the farm are immediately culled and the farm is cleaned and disinfected under the supervision of an official veterinarian.

An epidemiological inquiry that includes identification of the contact farms is performed for the confirmed, infected farm. Contact farm definition is variable and depends on the disease. In case of FMD, the definition of contact farms includes all farms that in some direct or indirect way have been in contact with cloven-hoofed animals at the suspected farm, or may have acquired the infection from the same origin. All farms that have received or delivered animals from or to the suspected or infected farm during the 14 days (cattle and pigs), or 21 days for sheep, prior to the first clinical signs are regarded as contact farms. Contact farms are also farms that are situated within a radius of 1 km from the suspected/infected farm. In addition, farms that have been on the same route as the suspected/infected farm regarding, for instance, a transport vehicle or veterinarian during 2–3 days prior to the detection, are considered as contacts according to the Finnish contingency plan (Evira 2014<sub>a</sub>).

In an ASF outbreak, all farms that have received or delivered pigs from or to the suspected or infected farm during the preceding 40 days are regarded as contact farms. Contact farms are also farms that are situated within a radius of 1 km from the suspected/infected farm. In addition, farms that have been on the same route as the suspected/infected farm regarding, for instance, a transport vehicle or veterinarian during 2–3 days prior to the detection are considered as contacts according to the Finnish contingency plan (Evira 2014<sub>b</sub>). All contact holdings are put under restrictive measures.

Immediately after an outbreak of FMD or ASF is confirmed, the competent authorities establish a protection zone with a minimum radius of 3 km and a surveillance zone with a minimum radius of 10 km around the infected farm. In the protection and

surveillance zones, no animals or animal products may be removed from their holdings.

All animals in the protection and surveillance zone and on contact farms outside the zones must be listed, clinically inspected and the measures documented by an official veterinarian at the latest 7 days after the zone is established or the contact farm is traced. The farms closest to the infected farm (1 km radius) are to be inspected within 2 days. In case of clinical symptoms, samples are taken according to instructions in the contingency plan. No animals are allowed to be moved from the farms where they are kept.

The restrictive measures can be lifted at the infected farm when all susceptible animals have been disposed of and disinfection of the premises has been performed. Restrictive measures can be lifted on contact farms that are not in the restrictive zones when clinical inspection has not indicated any symptoms of disease, and in the case of sheep and goats and FMD, a negative serological survey has been conducted and 21 days has elapsed following the last contact with an infected farm. At farms in restrictive zones, the restrictive measures can be lifted when at least 15 days in the protection zone and 30 days in the surveillance zone has elapsed since the culling of animals and preliminary disinfection of the infected farm, provided that a clinical examination and a serological survey, in case of sheep and goats, has given negative results.

### **Official risk management measures during a BT outbreak**

Bluetongue is an OIE listed disease that has to be controlled according to law and directives. However, in contrast to many other diseases, BT control is not based on disposing of animals and disinfection of stables due to its nature as a vector-borne disease. The control of BT is not as straightforwardly regulated as for ASF and FMD and is dependent on different factors and the disease situation at hand. The control pattern may depend on whether an infected animal is detected during the vector-free period, whether the animal is a recently imported animal, whether the disease is present in neighbouring countries and whether it has already spread to several farms.

In case of a BT suspicion that originates from a native animal, the farm is immediately placed under restrictive measures and it is prohibited to move animals to and from the farm. In the close neighbourhood within a radius of 20 km from the infected farm, an infective zone is established. In the first place, all farms with ruminants in this zone are monitored in order to check for infection and disease spread. A protective zone with a minimum radius of 100 km is established around the infected farm, and a control zone is established 50 km outside the protective zone. Inside the zone, animal movements are restricted without distinct permission from the authorities.

If the infection is detected during summer, most probably the decision to vaccinate herds in the infective zone would be made immediately after the infection is verified, or at least after 2–5 farms are infected. For instance, in Sweden, there is a vaccination plan in case of BT infection stating that vaccination would start immediately if the infection was verified during the vector-active period. In 2008, vaccinations began in Sweden two days after the verification of BT (Lewerin et al. 2010). In Finland, vaccination would, however, start after a longer delay, because there is no valid agreement with any vaccination company about providing vaccines at the moment and it would take some time to gather enough personnel for the vaccination teams.

The experts estimated the time delay due to vaccine delivery to Finland is at least one week from the decision to vaccinate. All other ruminants older than 1 year except goats and exotic ruminants would be vaccinated unless they were planned to be slaughtered within the next two months.

**Appendix 5: Reference simulation results under the 2009 situation**

In order to approximate the magnitude of the change, reference simulation results are compared against the results of future projection simulations. As future projections are not available for sheep/goat production, this sector is excluded from the reference simulations. Basic outcomes for a simulation are the size of an outbreak (number of infected farms at the end) and the probabilities of an epidemic (>1 infected farm) and a large outbreak (>17 infected farms). A coefficient of variation (CV = standard deviation (SD)/mean of epidemic size) can be applied as an indicator of the relative variability of epidemic outbreaks.

Estimated risk management consequences of an outbreak are 1) the number of animals on infected farms, ie. the number of animals that need to be culled due to an outbreak of FMD or ASF 2) the number of farms and animals that are in the control (BT), protection and surveillance zones (FMD, ASF and BT). This reflects the number of farms that are put under restrictive measures and at least part of them are inspected for disease occurrence. The number of traced contact farms is also a relevant outcome of an outbreak, but it is much more difficult to estimate. The economic impact of traced contacts is in general small and they are therefore left out of this assessment.

**FMD simulation (without sheep/goat production related spread)**

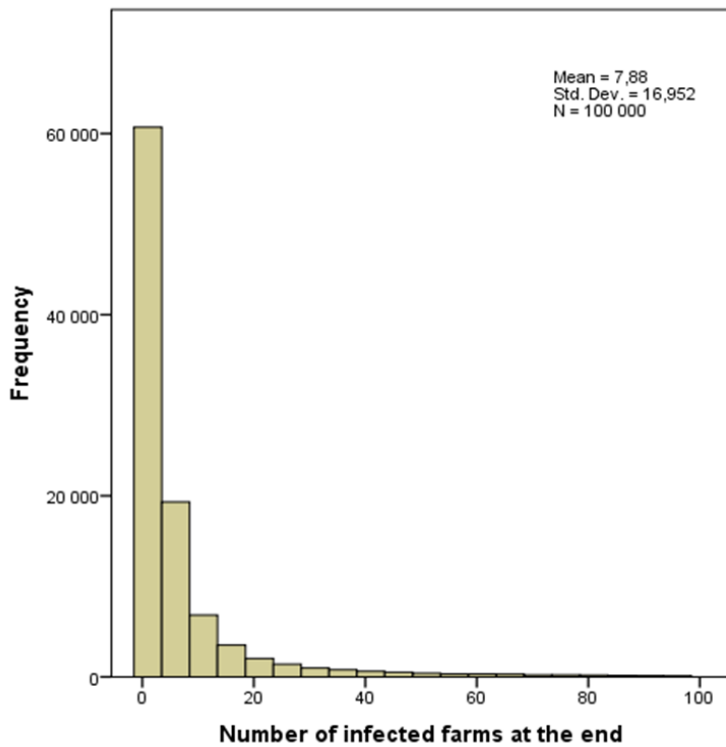


Figure 54. Distribution of the number of infected farms following 100 000 iterations of FMD spread simulation.



FMD simulation typically produced some spread of the disease beyond the index farm (Figure 54). The mean size of an epidemic outbreak was 11.91 farms (CV = 1.71). The probability of an epidemic outbreak was 0.63 and the probability of a large outbreak was 0.10. The number of infected farms markedly influenced the number of farms in the protection and surveillance zones: one infected farm caused on average 6 non-infected farms in the protection zone and 20 non-infected farms in the surveillance zone (Table 38). The models have a high coefficient of determination ( $R^2$ ), but they are not applicable for the prediction of a single outbreak; rather, they describe the general trend. In a typical-sized epidemic outbreak, 65 non-infected farms are located in protection and 265 in surveillance zones.

The number of infected farms can be used to predict the number of animals on infected farms and non-infected farms in protection and surveillance zones. The expected numbers of cattle involved in an outbreak are larger than the expected numbers of pigs. The number of animals on non-infected farms in protection zones appears to be 3–7 times higher and in surveillance zones 13–25 times higher than on infected farms on average (Table 39). Coefficients of determination indicate that the number of cattle involved in an outbreak is much more clearly linearly dependent on the number of infected farms than is the number of involved pigs, as these coefficients are higher for cattle than for pigs (Table 39).

**Table 38.** The relationship between the number of FMD-infected farms and the number of non-infected farms (y) in protection and surveillance zones. The relationship equation is  $y = a \cdot (\text{number of infected farms}) + b$ , where a and b are estimated coefficients. The standard error (SE) of coefficients is given in parentheses. Models are valid when the number of infected farms is >1.

Variable y	Coefficient a (SE)	Coefficient b (SE)	$R^2$	Mean number of farms for epidemic outbreaks (SD)*
Number of farms in protection zones	5.596 (0.005)	-2.978 (0.094)	0.931	64.8 (124.0)
Number of farms in surveillance zones	19.994 (0.017)	16.124 (0.330)	0.933	265.0 (438.7)

\*Only indicative of variation, as the distribution is highly skewed

**Table 39.** The relationship between the number of FMD-infected farms and the number of pigs and cattle on infected farms in protection and surveillance zones. The relationship equation is  $y = a \cdot (\text{number of infected farms}) + b$ , where a and b are estimated coefficients. The SE of the coefficient is given in parentheses. Models are valid when the number of infected farms is >1.

Variable y	Coefficient a (SE)	Coefficient b (SE)	$R^2$	Mean number of animals for epidemic outbreaks (SD)**
Number of pigs on infected farms	15.5 (0.3)	205.6 (5.2)	0.032	495 (1 897)
Number of cattle on infected farms	99.8 (0.1)	-147.9 (1.5)	0.941	1 028 (2 196)
Number of pigs in protection zones	236.6 (0.8)	406.5 (16.2)	0.449	3 455 (7 572)
Number of cattle in protection zones	312.4 (0.3)	-259.6 (6.3)	0.902	3 489 (7 054)
Number of pigs in surveillance zones	655.7 (3.1)	3 976.5 (49.7)	0.318	12 362 (20 113)
Number of cattle in surveillance zones	1 057.8 (1.1)	443.6 (19.4)	0.908	13 072 (21 810)

\*Piglets under 3 months and cattle under 6 months are not included in these quantities.

\*\*Only indicative of variation, as the distribution is highly skewed

The production sector has a large impact on the expected size of an outbreak. If the primary infected farm is in the cattle sector, the average size of the epidemic outbreak is more than twice as large as when the primary farm operates in the pig sector (Table 40). Similarly, the probability of an epidemic and a large outbreak is higher when the primary infected farm is a cattle farm. The cattle sector is even more isolated in this sense. When an outbreak starts in the cattle sector, it affects almost solely cattle farms.

**Table 40.** The mean size (number of infected farms) and CV of an epidemic outbreak, the probability of an epidemic and a large outbreak, and the number of infected farms according to the sector of the primary infected farm.

Production sector of the primary infected farm	Mean size of epidemic outbreak	CV of size of epidemic outbreaks	P(epidemic outbreak)	P(large outbreak)	Infected pig farms/cattle farms
Pig	5.87	1.55	0.58	0.03	4.29/1.58
Cattle	12.71	1.67	0.64	0.11	0.29/12.42

The farm type of the primary infected farm also affects the characteristics of the expected outcome. A pig farm as the primary infected farm is able to produce an epidemic outbreak more often than beef cattle and suckler cow farms, although such epidemics are smaller. Dairy farms have the highest probability of producing epidemics and large outbreaks. In addition, the average size of an epidemic outbreak is the highest when a dairy farm is the primary infected farm (Table 41).

**Table 41.** Effect of the type of the primary infected farm on the simulated outcomes of FMD spread (Total N = 100 000 iterations).

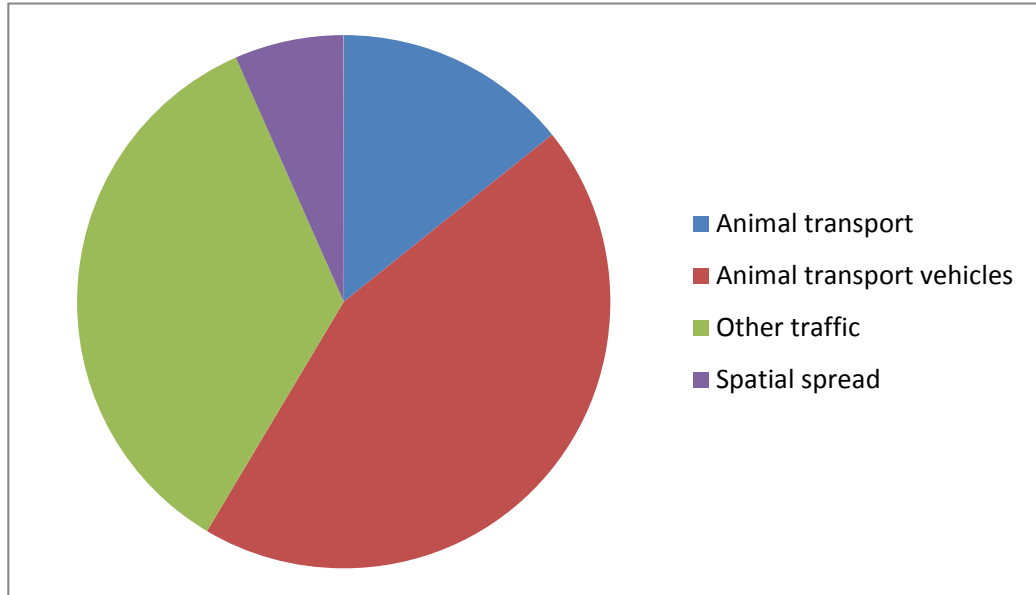
Farm type of primary infected farm	Mean size of epidemic outbreak	CV of size of epidemic outbreaks	P(epidemic outbreak)	P(large outbreak)	N of iterations
Farrowing	6.02	1.24	0.67	0.04	4 125
Farrowing-to-finishing	6.12	1.69	0.58	0.03	4 534
Finishing	5.26	1.77	0.49	0.02	3 635
Dairy	13.35	1.62	0.72	0.14	65 626
Beef cattle	9.70	1.84	0.41	0.05	13 698
Suckler cow	7.77	2.10	0.33	0.03	8 361

When sheep and goat production-related spread is not simulated, cattle and pig farms that have sheep or goats produce 5% smaller epidemic outbreaks than when it is simulated. On these farms, further spread (i.e. an epidemic outbreak) is more infrequent than on cattle and pig farms that do not have sheep or goats (Table 42).

**Table 42.** Simulated outcomes of FMD spread on farms having and not having sheep and goats, when sheep or goat-related spread is not taken in account in the simulation.

Production sector of primary infected farm	Mean size of epidemic outbreak	CV of size of epidemic outbreaks	P(epidemic outbreak)	P(large outbreak)	Number of infected pig farms/cattle farms
Pig and cattle farms with sheep or goats	11.40	1.74	0.48	0.08	0.53/10.87
Pig and cattle farms without sheep or goats	11.95	1.69	0.63	0.11	0.73/11.22

The spread of FMD occurs mostly due to animal transport and vehicles. Spatial spread accounts for less than 10% of the total spread in FMD simulations (Figure 55). The likelihood of an epidemic outbreak is the highest when the primary infected farm is located in the Vaasa, Oulu or Kuopio PVO districts (Table 43).



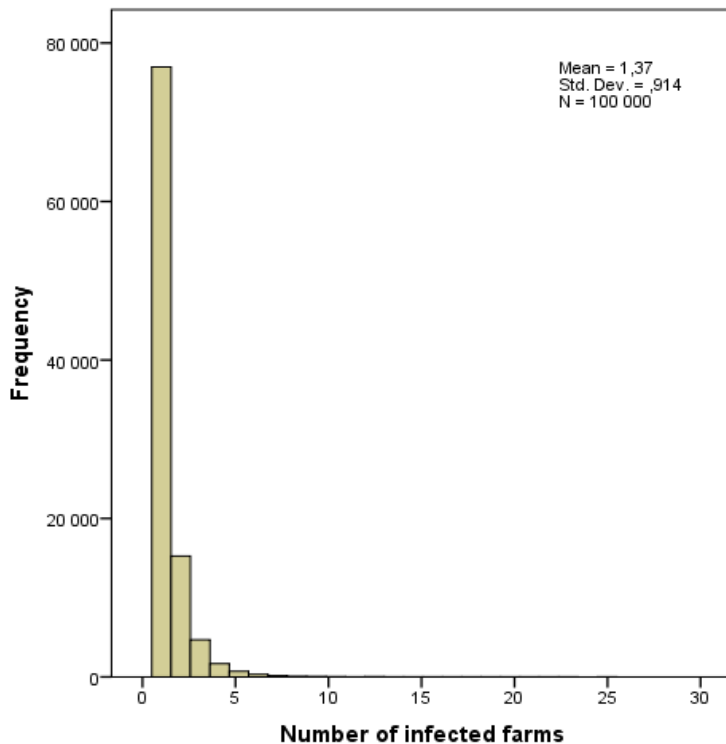
**Figure 55.** The contribution of different contact types to the further spread of FMD ( $n = 100\ 000$ ). The definition of contact types is identical to Table 54.

**Table 43.** The effect of the PVO district of the primary infected farm on the probability of an epidemic outbreak, as well as the mean size (number of infected farms) and coefficient of variation of an epidemic outbreak in FMD spread simulations.

PVO district	P(epidemic)	Mean size of epidemic outbreak (SD)	CV
Helsinki	0.52	9.34 (16.18)	1.73
Vaasa	0.66	11.11 (18.24)	1.64
Oulu	0.66	12.92 (21.80)	1.69
Rovaniemi	0.60	11.21 (19.65)	1.75
Turku	0.57	7.32 (12.53)	1.71
Maarianhamina	0.35	3.77 (5.22)	1.38
Hämeenlinna	0.59	9.56 (16.68)	1.74
Tampere	0.55	9.43 (17.71)	1.87
Kouvola	0.63	11.85 (18.95)	1.59
Mikkeli	0.60	12.56 (20.36)	1.62
Joensuu	0.65	13.54 (21.85)	1.61
Kuopio	0.71	17.92 (27.41)	1.53
Jyväskylä	0.61	10.79 (19.03)	1.76

\*The distributions are not symmetrical and SD cannot therefore be applied directly in confidence limit estimation.

## ASF simulation



**Figure 56.** The distribution of the number of infected farms in ASF spread simulation ( $N = 100\,000$  iterations).

The simulated outcome of ASF (Figure 56) is substantially less variable than in FMD simulations (Figure 54). The grand mean size of an epidemic outbreak was 2.60 farms ( $CV = 0.46$ ) and the probability of an epidemic outbreak was 0.23. The number of infected farms markedly influenced the number of farms in protection and surveillance zones: one infected farm caused on average 3 non-infected farms in the protection zone and 14 non-infected farms in the surveillance zone (Table 44). The regression models have low coefficients of determination, indicating that there are also other factors influencing the number of infected farms than those taken into account in the estimation. An average-sized epidemic outbreak involved 8 non-infected farms in protection zones and 40 non-infected farms in surveillance zones.

The number of infected farms can be used to predict the number of animals on infected farms and non-infected farms in protection and surveillance zones. The number of animals on non-infected farms in protection zones appears to be 3 times higher and in surveillance zones 12 times higher than on infected farms on average (Table 45). Coefficients of determination indicate that the number of animals is also influenced by other things than the number of infected farms (Table 45).

**Table 44.** The relationship between the number of ASF-infected farms and the number of non-infected farms in protection and surveillance zones. The relationship equation is  $y = a \cdot (\text{number of infected farms}) + b$ , where  $a$  and  $b$  are estimated coefficients. The SE of the coefficient is given in parentheses. Models are valid when number of infected farms is  $>1$ .

Variable y	a	b	R <sup>2</sup>	Mean number of farms for epidemic outbreaks (SD)*
Number of non-infected farms in protection zones	3.248 (0.016)	-0.119 (0.026)	0.294	8.4 (7.9)
Number of non-infected farms in surveillance zones	14.139 (0.062)	1.769 (0.102)	0.345	39.7 (30.6)

\*Only indicative of variation, as the distribution is highly skewed

**Table 45.** The relationship between the number of ASF-infected farms and the number of pigs\* on infected farms, in protection and in surveillance zones. The relationship equation is  $y = a \cdot (\text{number of infected farms}) + b$ , where  $a$  and  $b$  are estimated coefficients. The SE of the coefficient is given in parentheses. Models are valid when number of infected farms is  $>1$ .

Variable y	a	b	R <sup>2</sup>	Mean number of pigs for epidemic outbreaks (SD)**
Number of pigs on infected farms	840.3 (2.6)	-429.0 (4.2)	0.520	1 780 (1 622)
Number of pigs in protection zones	1 734.4 (10.3)	-130.2 (17.0)	0.221	4 448 (4 815)
Number of pigs in surveillance zones	7 351.1 (39.0)	807.8 (63.6)	0.262	20 546 (17 079)

\*Piglets under 3 months are not included

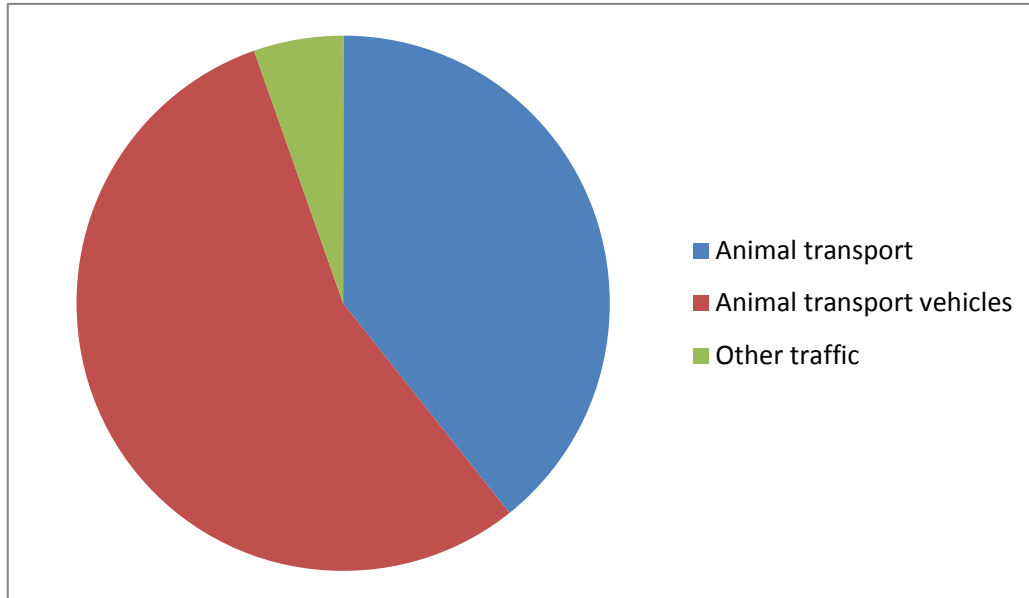
\*\*Only indicative of variation, as the distribution is highly skewed

The type of the primary infected farm influenced the expected outcome of an outbreak. If the outbreak started on a farrowing farm, it had the highest probability of ending up as being an epidemic outbreak (Table 46). The expected size of an epidemic outbreak was not influenced by the farm type of the primary infected farm.

The spread of ASF was mostly due to animal transport and vehicles (Figure 57). An epidemic outbreak was most likely to be initiated when the primary infected farm was located in the Vaasa, Turku or Kuopio PVO districts (Table 47).

**Table 46.** The effect of farm type on the simulated outcomes of ASF outbreaks (Total N = 100 000 iterations).

Farm type of primary infected farm	Mean size of epidemic outbreak	CV of size of epidemic outbreaks	P(epidemic outbreak)	P(large outbreak)	N of iterations
Farrowing	2.66	0.47	0.33	<0.01	32 748
Farrowing-to-finishing	2.65	0.54	0.22	<0.01	37 363
Finishing	2.42	0.36	0.13	0.00	29 889

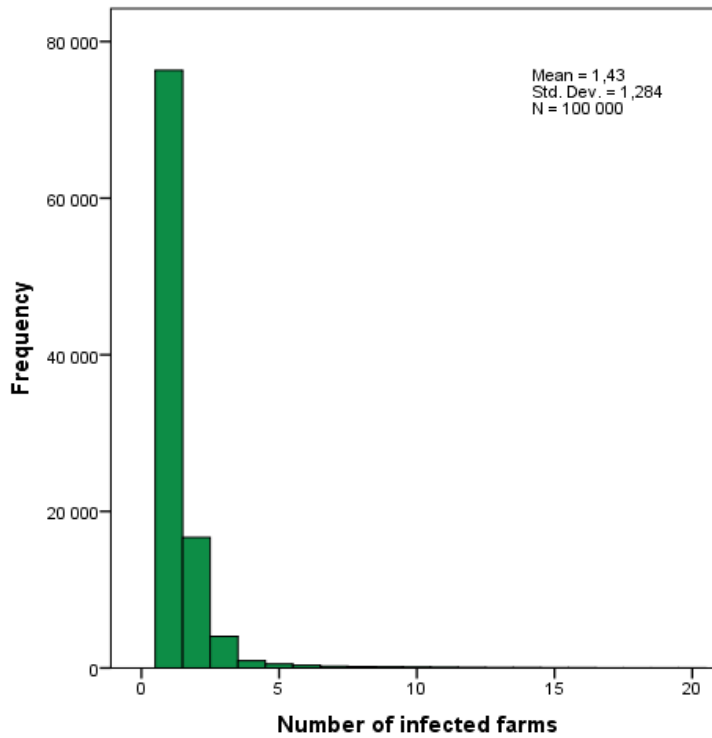


**Figure 57.** The contribution of different contact types to the simulated further spread of ASF in Finland (N = 100 000 iterations). The definition of contact types is identical to Table 54.

**Table 47.** The effect of the PVO district of the primary infected farm on the probability of an epidemic outbreak, as well as the mean size (number of infected farms) and coefficient of variation of an epidemic outbreak in ASF spread simulation.

PVO district	P(epidemic)	Mean size of epidemic outbreak (SD)	CV
Helsinki	0.18	2.47 (0.94)	0.38
Vaasa	0.24	2.64 (1.26)	0.47
Oulu	0.24	2.48 (0.93)	0.38
Rovaniemi	0.04	2.00 (na)	na
Turku	0.25	2.66 (1.41)	0.53
Maarianhamina	0.07	2.22 (0.51)	0.22
Hämeenlinna	0.22	2.53 (0.98)	0.39
Tampere	0.22	2.54 (1.05)	0.41
Kouvola	0.19	2.46 (0.86)	0.35
Mikkeli	0.17	2.32 (0.67)	0.29
Joensuu	0.15	2.28 (0.65)	0.28
Kuopio	0.26	2.99 (1.80)	0.60
Jyväskylä	0.19	2.43 (0.87)	0.36

**BT simulation (without sheep and goat production-related spread)**



**Figure 58.** Number of farms infected according to bluetongue spread simulations (N = 100 000 iterations).

BT was occasionally simulated to spread from the primary infected farm (Figure 58), but the size of an outbreak was markedly smaller and the probability of an epidemic outbreak was lower than in FMD simulations. The grand mean size of epidemic outbreaks was 2.80 farms (coefficient of variation (CV) = 0.75) and the probability of an epidemic outbreak was 0.24. The number of infected farms significantly influenced the number of farms in control, protection and surveillance zones, because for each infected farm there were on average 119 non-infected farms in control zones, 875 non-infected farms in protection zones and 178 non-infected farms in surveillance zones (Table 48). In an epidemic outbreak, 331 non-infected farms are located in control, 3 637 in protection and 2 538 in surveillance zones on average (Table 48).

**Table 48.** The relationship between the number of BT-infected cattle farms and the number of non-infected cattle farms in control, protection and surveillance zones. The relationship equation is  $y = a \cdot (\text{number of infected farms}) + b$ , where a and b are estimated coefficients. The SE of the coefficient is given in parentheses. Models are valid when the number of infected farms is >1.

Variable y	a	b	R <sup>2</sup>	Mean number of farms for epidemic outbreaks (SD)**
Number of farms in control zones	119.044 (0.213)	-2.133 (0.409)	0.757	331 (282)
Number of farms in protection zones	875.288 (2.369)	1051.762 (4.548)	0.577	3 637 (2 238)
Number of farms in surveillance zones	178.323 (2.081)	1814.678 (3.994)	0.068	2 538 (1 029)

\*Only indicative of variation, as the distribution is highly skewed



The number of farms in control, protection and surveillance zones was so high that the number of cattle on the farms could be approximated to be the average number of animals on Finnish farms. For one farm in the zones, it can be expected that on average 19 (SD = 21) dairy and 33 (SD = 50) other cows are involved. These estimates do not include cattle under the age of 6 months.

If the primary infected farm was a dairy farm, the probability of an epidemic outbreak was almost three times higher than when the primary infected farm was a beef cattle or suckler cow farm (Table 49).

**Table 49.** The effect of the farm type on simulated outcomes of BT outbreaks (Total N = 100 000 iterations).

Farm type of primary infected farm	Mean number of farms of epidemic outbreak	CV of size of epidemic outbreaks	P(epidemic outbreak)	P(large outbreak)	N of iterations
Dairy	2.75	0.72	0.28	<0.01	74 899
Beef Cattle	3.12	0.86	0.11	<0.01	15 372
Suckler Cow	3.32	0.94	0.10	<0.01	9 729

There were differences in the spread potentiality between PVO districts. If the primary farm was located in the Vaasa PVO district, the probability of an epidemic outbreak was approximately two times higher than when the primary infected farm was located elsewhere. The expected size of an outbreak was larger if the outbreak started in the Vaasa PVO district than when it started elsewhere (Table 50).

**Table 50.** The effect of the location of the primary infected farm on the probability of an epidemic outbreak, the expected size of the epidemic outbreak (number of infected farms) and the coefficient of variation of size in BT spread simulations.

PVO district	P(epidemic)	Mean number of farms for epidemic outbreak (Std)	CV
Helsinki	0.20	2.08 (0.27)	0.10
Vaasa	0.42	3.92 (3.22)	0.82
Oulu	0.21	2.27 (0.55)	0.24
Rovaniemi	0.18	2.04(0.22)	0.11
Turku	0.15	2.19 (0.50)	0.23
Maarianhamina	0.14	2.06 (0.27)	0.13
Hämeenlinna	0.19	2.16 (0.63)	0.29
Tampere	0.17	2.26 (0.80)	0.35
Kouvola	0.21	2.07 (0.27)	0.13
Mikkeli	0.16	2.09 (0.29)	0.14
Joensuu	0.17	2.16 (0.38)	0.18
Kuopio	0.21	2.27 (0.47)	0.21
Jyväskylä	0.22	2.25 (0.69)	0.31

### Simulated economic impacts of FMD in year 2009

In the baseline scenario, the total economic losses caused by an FMD outbreak in Finland were estimated to range from €11.6 million to €74.4 million in 95% of the cases. On average, the losses were estimated at €27.7 million under the farm structure in the year 2009. In a few individual iterations, losses higher than €100 million were also possible (Figures 59 and 60). These results are based on an assumption that exports to non-EU countries would be severely disrupted and the disruptions would last on average<sup>3</sup> as long as it is suggested in the OIE Terrestrial Animal Health Code (2008), whereas intra-community exports would be disrupted only temporarily. The results are quite sensitive to assumptions regarding trade disruptions. If the trade disruptions were 30% more severe than assumed above, the total average losses would increase to €31.1 million. The results only include impacts in the pig and cattle sectors, because impacts on small ruminants were not estimated. Given small sheep and goat population of Finland and the relatively modest production quantity of the small ruminant sector<sup>4</sup>, these impacts were expected to be small on average. However, direct costs could be noticeable in a few special cases if a large number of sheep and goat farms needed to be controlled.

Direct losses are due to disease eradication measures and measures to prevent the disease. Besides measures taken to cull the animals and clean and disinfect premises, direct costs are also due to the lost value of animals on infected farms, extra costs to acquire replacement animals, officials' work to reduce the disease outbreak and the sampling and surveillance of farms, among other factors. The majority of direct costs are covered by public funds, but livestock producers will also face substantial direct losses due to disruptions in their business. The costs to public funds caused by an FMD outbreak were estimated on average at €3.4 million. In 95% of simulations the costs were between €0.2 million and €28.3 million. These costs are heavily dependent on the number of infected farms and the number of farms located in surveillance and protection zones. Expected losses (thousands of euros) to public funds could be quite well approximated by a second-order polynomial function,  $382.9x+0.4x^2$ , where  $x$  refers to the number of infected premises. This equation was estimated for the simulated data with least squares regression.

<sup>3</sup> In the simulation model, the duration of trade distortions is a stochastic variable and the duration varies in individual iterations, in addition to the variation caused by the duration of the disease outbreak in the epidemiological model. For sensitivity analysis regarding the duration of trade distortions, see Figure 61.

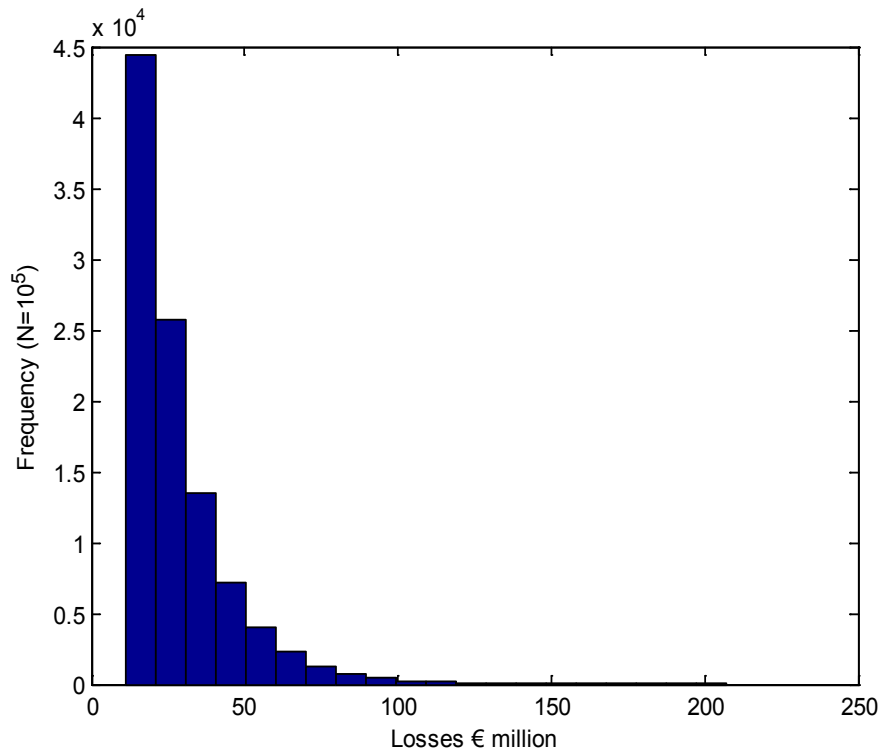
<sup>4</sup> The volume of sheep meat production was approximately 0.2% of the total meat production in Finland in 2009.

Economic impacts vary according to the stakeholder groups: producers, consumers and taxpayers. Producers are expected to suffer the largest losses, amounting on average €98.7 million (95% CI €45.4–247.8 million) in the baseline scenario. Producers' losses include losses to agricultural producers and the food industry. These losses are mainly caused by assumed trade disruptions, because disruptions in exports can quickly result in oversupply in the domestic markets, as livestock products cannot be exported to countries that impose trade restrictions. However, the coverage and duration of imposed restrictions may vary according to the country. Hence, producer prices tend to fall, and since production cannot be adjusted instantaneously as much as would be needed, producers face quite large losses. On average, a livestock farm suffers a loss of €5194 per outbreak, but there are large differences between farms and iterations in losses that individual farms face. Variation in losses is also mainly due to variation in trade impacts, although the size of an outbreak has an impact and it also contributes to trade disruptions. To a smaller extent, producers' losses are also due to impacts of animal movement restrictions, surveillance and protection zones, and the eradication of FMD from infected farms. These measures distort production, result in idling production capacity, affect slaughter weights and cause additional costs to farms. The costs of these effects are of the same magnitude as the costs paid by public funds.

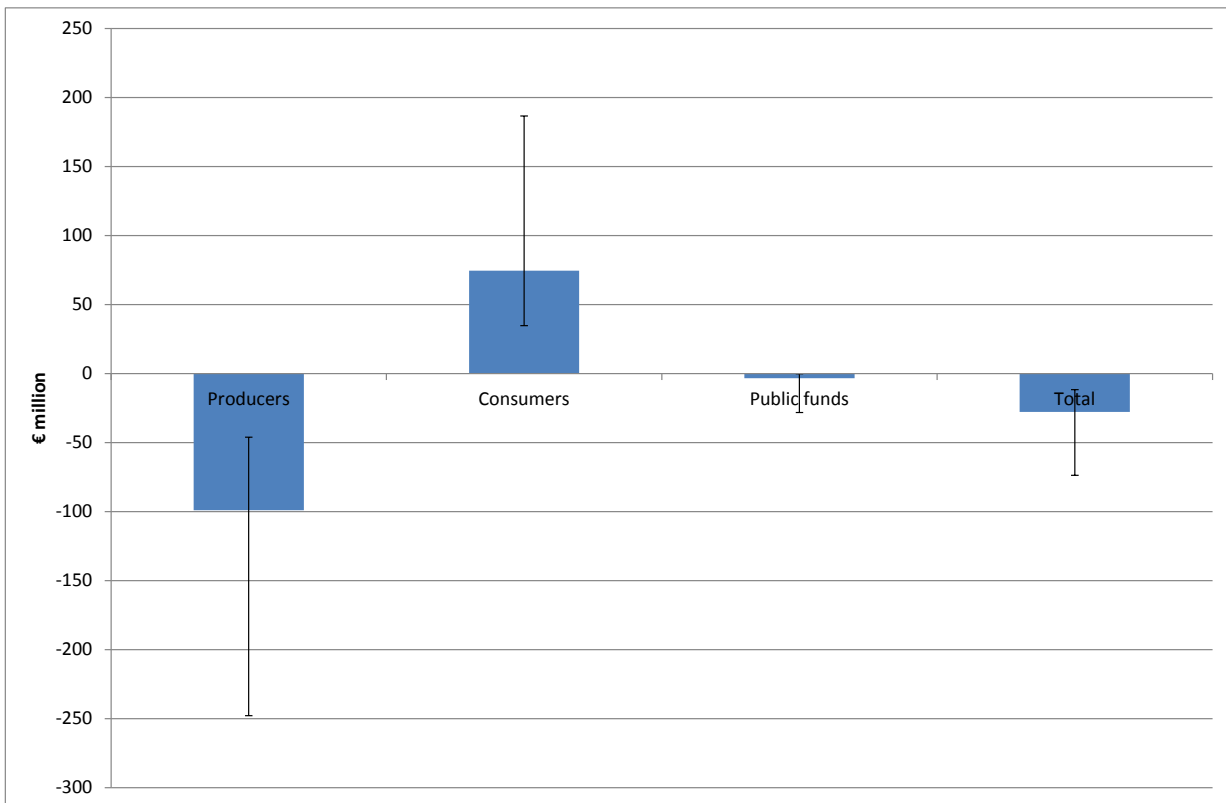
Trade disruptions also impact on the manufacturing of dairy products. The results suggest that the manufacture of butter and cheese, which are important export products when considering the exportation of the fat component of milk. In fact, milk product exports are mainly focused on products with a high fat content. The model also implicitly takes into account changes in the manufacturing of pig and beef products, because, for instance, the exporting and importing of pig meat is focused on different cuts of the carcass and their ratios change as exports and imports change. The issue of changes in dairy product manufacturing during trade disruptions has been discussed further by Niemi and Lehtonen (2014).

Impacts on consumers include effects on consumers and retailers. As opposed to producers, impacts on consumers are positive, as they can temporarily benefit from falling prices. The impact is large, because as in the event of producers, price changes are pertinent to all goods, not just those that would have been destined for export markets. On average, the consumers' benefits amount to €74.3 million (95% CI €34.7–186.6 million), of which more than half is due to falling dairy product prices. Although the impact seems substantial, it is on average less than €15 per citizen in Finland. The results above are in line with previous research regarding the cost impacts of FMD in Finland (Lyytikäinen et al. 2011).

The largest trade effects were caused by the dairy sector. However, when compared to the turnover of pig production, it suffered larger total losses than the dairy sector. The result is affected by the structure and volume of both production and external trade and by the fact that the adjustment potential of the dairy sector was explicitly analysed by optimizing the manufacturing of milk dairy products (see Niemi and Lehtonen 2014). Hence, there was an explicit market adjustment mechanism for the dairy sector in the model, and the losses were reduced by adjusting the manufacturing quantities of butter and cheese, for instance.

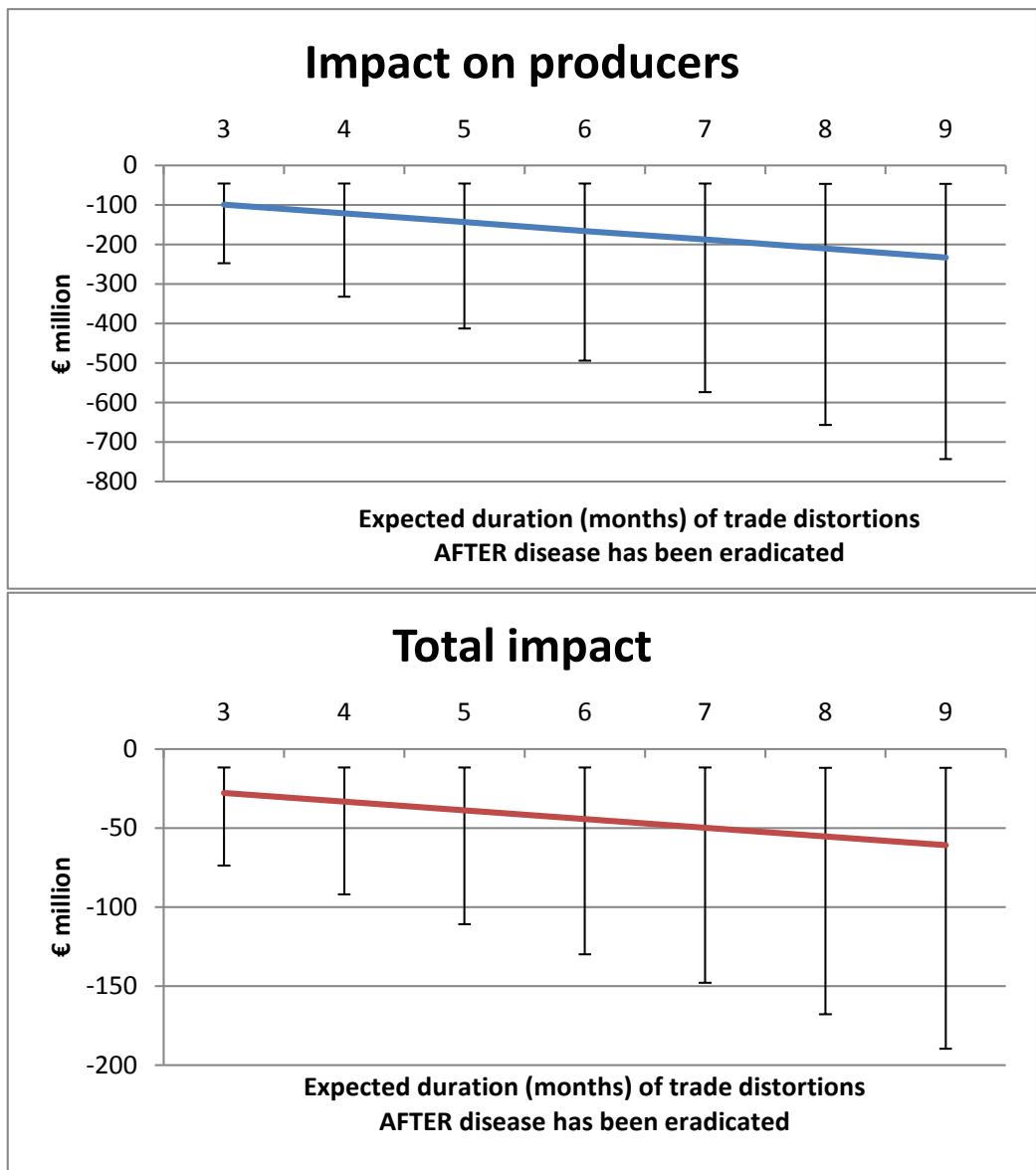


**Figure 59.** Histogram of total losses estimated ( $N = 100\,000$  iterations) to be caused by an FMD outbreak in Finland.



**Figure 60.** Simulated economic impacts of an FMD outbreak on livestock producers (farms and allied food industries together), consumers (also including retailing), public funds and all losses in total. Blue bars represent average effects and black bars represent the range of losses that were simulated to occur in 95% of iterations.

The duration of a disease outbreak and trade disruptions contribute substantially to the simulated losses. On average, €0.43 million in additional total costs was associated with each infected premise. By contrast, each additional month (in terms of “epidemiological duration”) of an outbreak was estimated to increase the total costs by €5.5 million. In addition to the epidemiological duration of the outbreak, the losses could be magnified by the prolonged duration of trade disruptions. For instance, if the expected duration of trade disruptions increased by 3 months, expected losses to producers would increase by €67 million and expected total losses by €17 million. This impact is highlighted by Figure 61, in which the model has been simulated by alternating the duration of trade disruptions. The impact of prolonged trade disruptions on producers is larger than the impact on the total losses. Besides increased average losses, the volatility of losses is also estimated to increase with the increased duration of disruptions, as then there is more uncertainty in their duration.

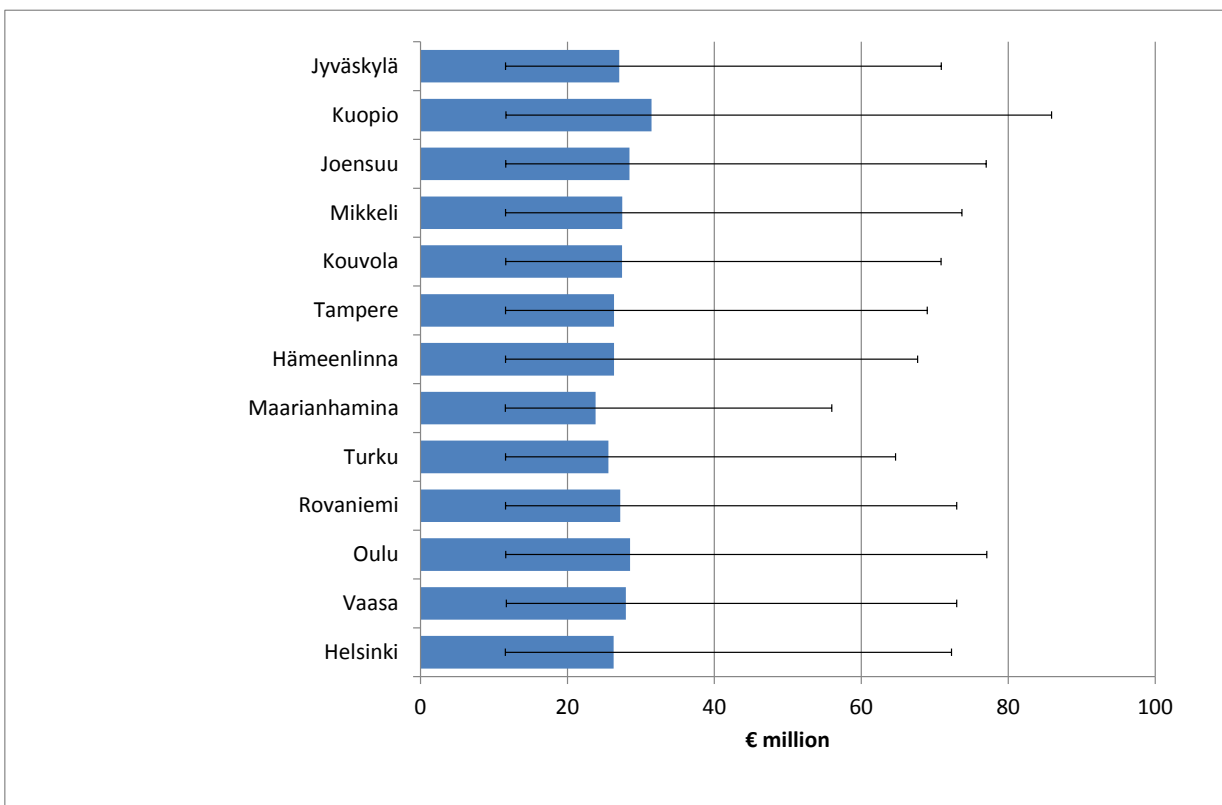


**Figure 61.** Simulated economic impacts of an FMD outbreak on livestock producers (farms and allied food industries together; upper panel) and on all stakeholders (lower panel) according to the **expected** duration of trade disruptions **after** the disease eradication measures on farms have been completed in Finland. Solid lines represent average impacts and black bars represent the range of losses that were simulated to occur in 95% of iterations (i.e. variation due to the size of disease outbreak and the duration of trade disruptions).

### Impact of the location and type of the primary infected farm

The production type of the primary infected farm affected the results. The total losses were the largest, on average €29.2 million (95% CI 11.7–77.8), when a dairy farm was the primary infected farm in the country. A finishing beef cattle or suckler cow farm as the primary infected farm resulted in lower expected total losses, €25.8 million (95% CI 11.5–68.28) and €24.0 million (95% CI 11.6–62.5), respectively. A farrowing, farrowing-to-finishing or finishing pig farm as the primary infected farm resulted on average in €26.1 million (95% CI 11.6–63.4), €25.4 million (95% CI 11.5–63.2) and €24.6 million (95% CI 11.5–60.5) in total losses.

Figure 62 illustrates how the veterinary region in which the primary infected farm is located affects the total losses. The largest average losses as well as the largest variation in losses were simulated for outbreaks beginning from Kuopio, Oulu or Vaasa provincial veterinary districts. These are quite dairy-intensive regions. The smallest losses were simulated for outbreaks beginning from Maarianhamina (i.e. archipelago) or Jyväskylä regions. Although average losses vary according to the region, there is considerable variation in losses in each region.

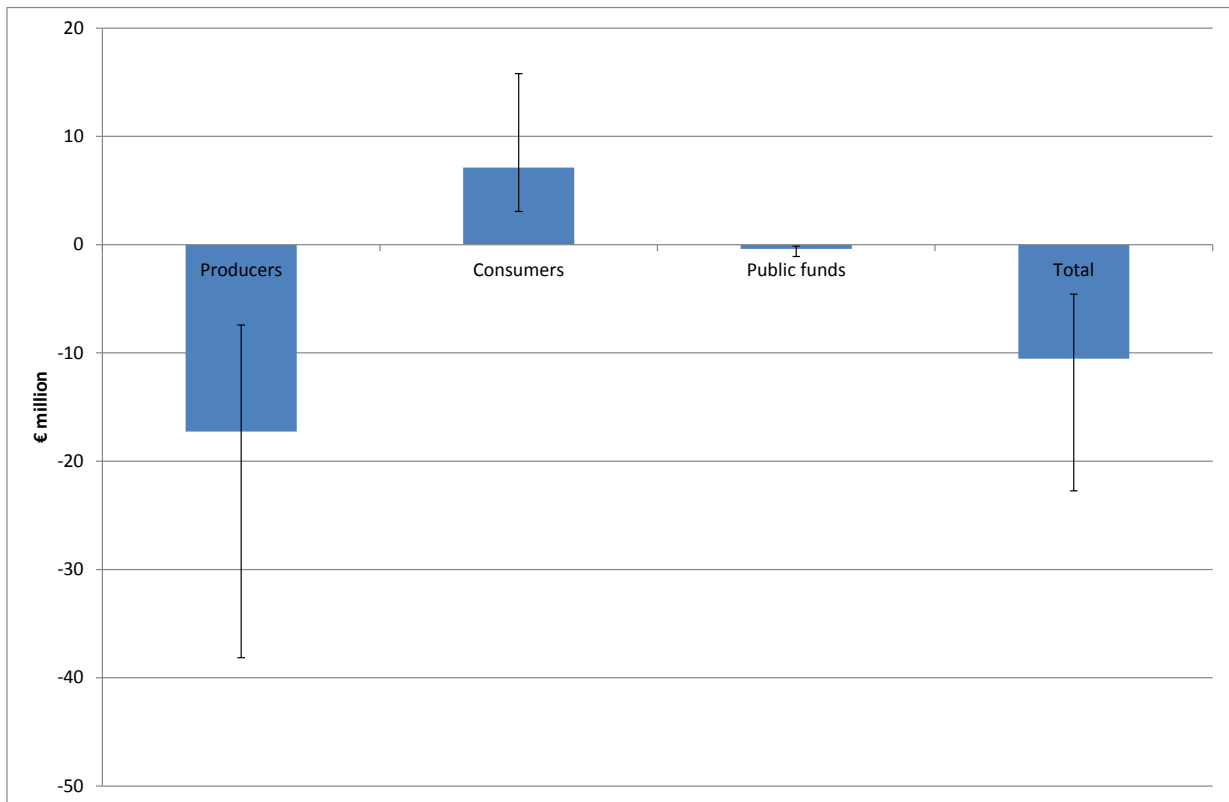


**Figure 62.** Simulated total economic losses due to an FMD outbreak in the baseline scenario according to the veterinary region in which the primary infected farm is located. Blue bars represent average impacts and black bars represent the range of losses that were simulated to occur in 95% of iterations.

### Simulated economic impacts of ASF in 2009

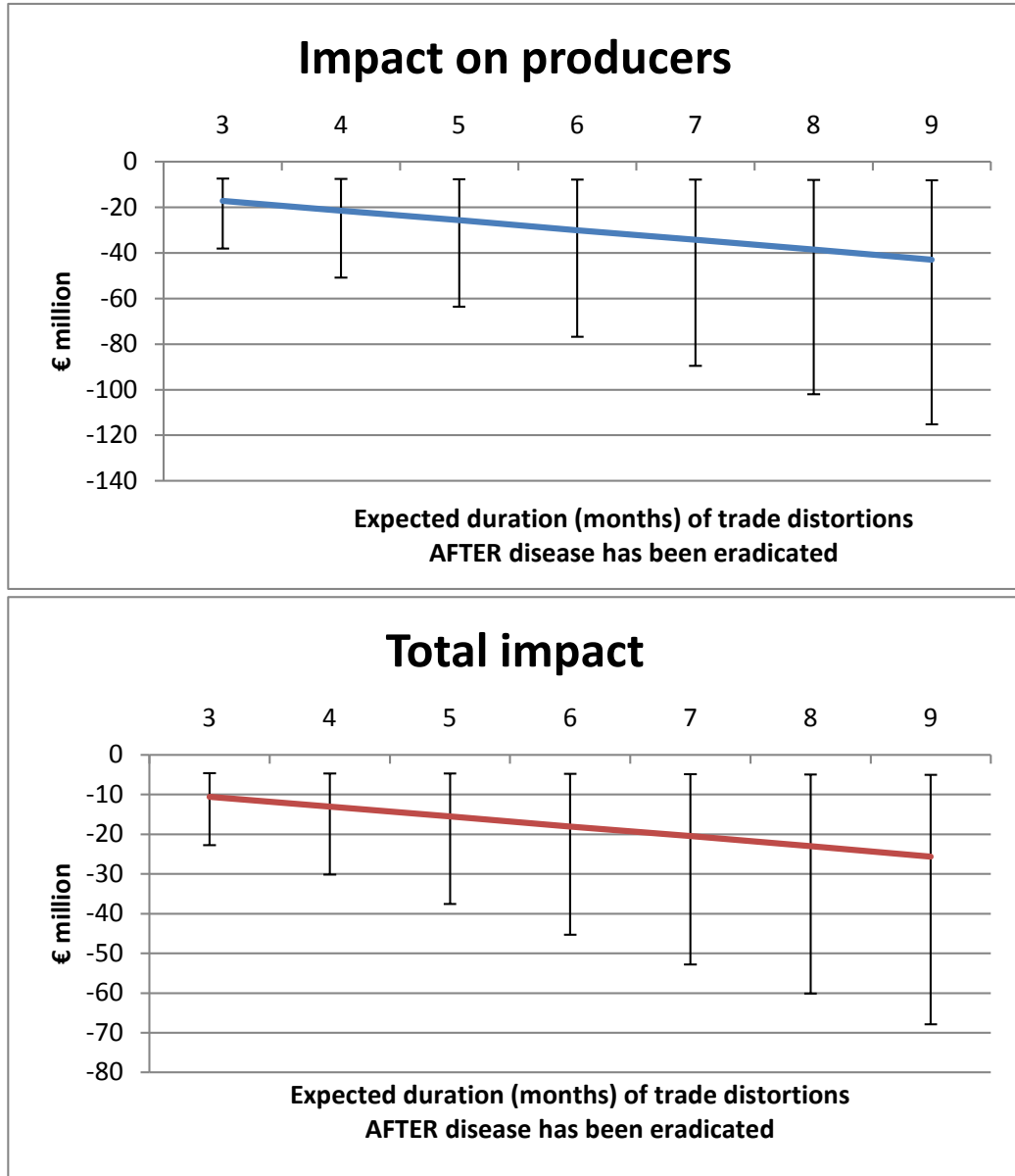
In the baseline scenario, economic losses caused by an ASF outbreak to Finnish society in total were estimated at €10.5 million (95% CI 4.6–22.7). The proportion of public funds used to cover losses was on average only €0.4 million (0.1–1.1). This result is due to the low number of infected farms on average. However, producers (including slaughterhouse companies and meat processing) suffered on average €17.3 million in losses (7.4–38.1) due to trade disruptions and disruptions in their businesses. By contrast, consumers were estimated to gain €7.1 million on average (3.1–15.8) (Figure 63). Hence, a pig farm in Finland suffered on average about €7400 in losses and a consumer in Finland gained on average 1–1.5 euros per outbreak due to temporary market disruptions.

The duration of an outbreak affected the losses in two ways. Firstly, the epidemiological duration of the outbreak contributed to the losses. However, this type of variation was quite small, because the outbreaks often covered only one or two infected farms. Secondly, the duration of trade disruptions could vary because it was a stochastic process. Each additional month of increase in the expected duration of trade disruptions was simulated to increase the total loss on average by €2.5 million, and producer’s losses by €4.2 million (Figure 64).



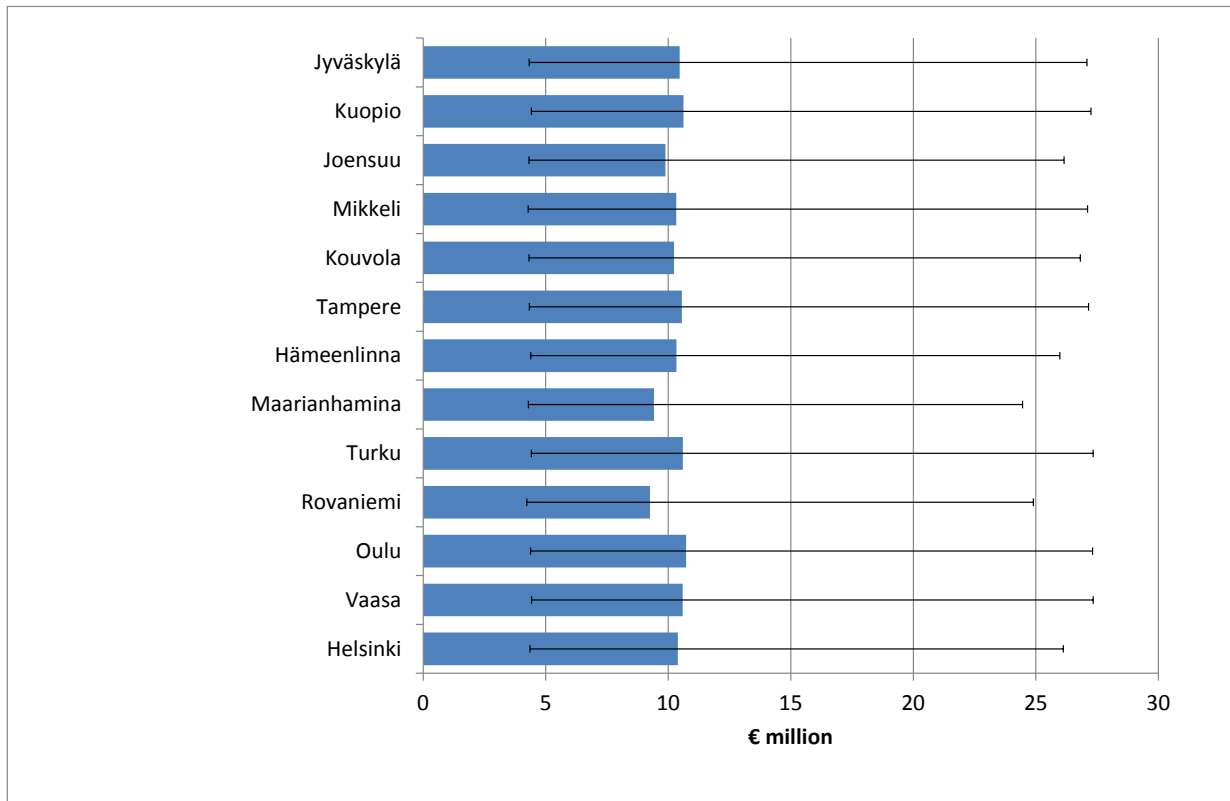
**Figure 63.** Simulated economic impacts of an ASF outbreak on livestock producers (farms and allied food industries together), consumers (including also retailing), public funds and all losses in total. Blue bars represent average effects and black bars represent the range of impacts that were simulated to occur in 95% of iterations.





**Figure 64.** Simulated economic impacts of an ASF outbreak on livestock producers (farms and allied food industries together; upper panel) and on all stakeholders (lower panel) according to the **expected** duration of trade disruptions **after** the disease eradication measures on farms have been completed in Finland. Solid lines represent average impacts and black bars represent the range of losses that were simulated to occur in 95% of iterations (i.e. variation due to the size of the disease outbreak and the duration of trade disruptions).

The type of the primary infected farm also contributed to the losses. Outbreaks in which the primary infected farm was a farrowing farm resulted on average in €10.8 million in losses, whereas losses in outbreaks starting from a farrowing-to-finishing farm were €10.5 and outbreaks starting from finishing farms were on average €10.2 million. The location of the primary infected farm also contributed to the losses. Outbreaks starting from some regions of northern or eastern Finland tended to result in about €0.5 to €1.0 million higher losses than outbreaks starting from the most densely populated pig production areas of Finland (Figure 65).



**Figure 65.** Simulated total economic losses due to an ASF outbreak in the baseline scenario according to the veterinary region in which the primary infected farm is located. Blue bars represent average impacts and black bars represent the range of losses that were simulated to occur in 95% of iterations.

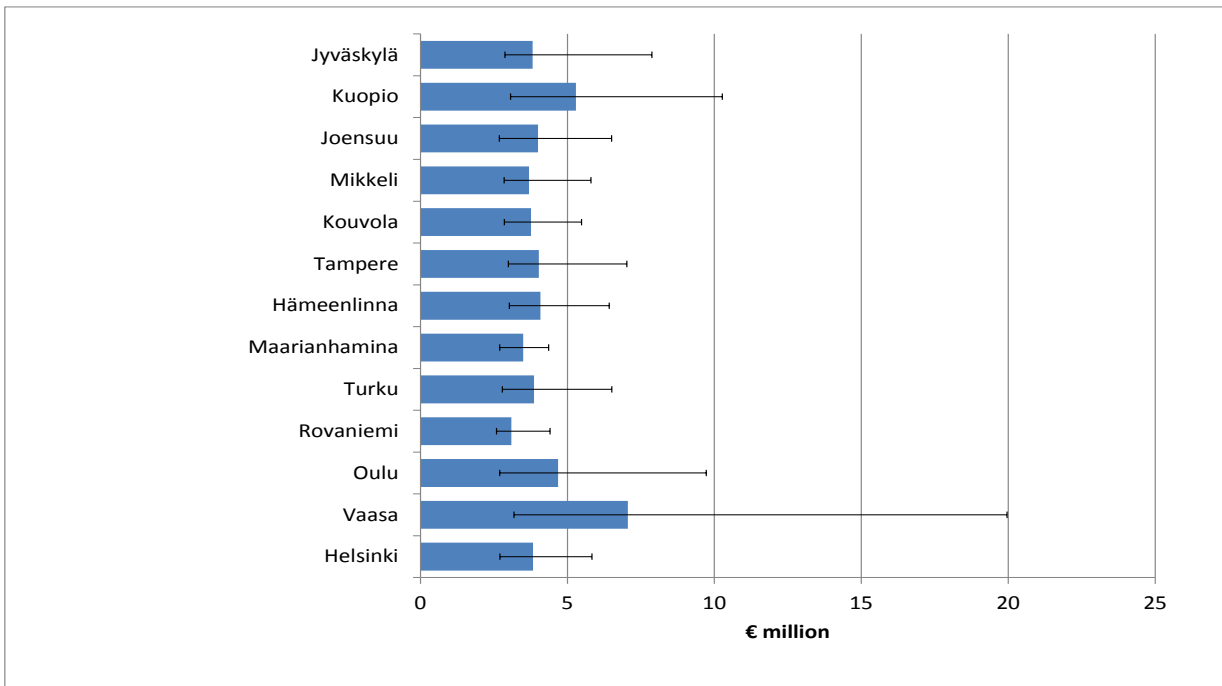
### Simulated economic impacts of BT in 2009

Unlike FMD and ASF, BT is not expected to cause major disruption in the markets, because according to the OIE, countries are not recommended to impose any restrictions on the trade of animal products. Foreign trade of animals and also semen is likely to be distorted due to BT, but since the exportation of live animals from Finland is quite marginal, the disease can be expected to have no significant impact on livestock markets in Finland. There is some evidence from the past outbreaks observed elsewhere in Europe that, for instance, calf prices may be affected by BT in some cases. Live young sheep prices could also be affected. Such effects are, however, mainly related to local restrictions in live animal trade or to changes in the supply and demand for calves.

In the baseline scenario, economic losses caused by bluetongue were simulated on average at €4.8 million per outbreak (95% CI €2.8–9.0 million). However, in the very unlikely worst case, the losses could rise to more than €30 million. The costs of official measures and surveillance were estimated at €2.9 million and the losses due to extra measures taken at farms, reduced productivity and increased mortality were estimated at €1.6 million on average. The losses were quite stable across simulations because of the relatively small number of infected farms and large geographical coverage of protection and surveillance zones. The implication of large zones was that an additional infection near the primary infected farm contributed only a modest amount of additional costs, as it did not have large impacts on the measures taken in the field.

The type of the primary infected farm affected the results. A dairy farm as the primary infected farm resulted on average in €4.9 million (2.7–11.3) in economic losses, whereas other types of farms as the primary infected farm resulted on average in about €0.5 million less in losses. The amount of losses incurred was related to the structure and location of farms. There were some differences between regions in average losses. Outbreaks beginning from the Vaasa provincial veterinary district were on average the most expensive, because €7.1 million in losses were associated with outbreaks beginning from this region, and had the largest variation. Outbreaks beginning from Kuopio or Oulu PVO regions were also more costly than outbreaks beginning from other regions (Figure 66).

The intensity of measures taken by the surveillance and eradication policy (“programme”) affected the results. In the current costing, the sampling and testing programme was assumed to be proportional to the measures implemented during the past years in Finland combined with measures taken in protection and surveillance zones. If all farms located in surveillance and protection zones were to be tested with samples either during the year when an outbreak occurred or for three years in a row, then the costs could increase, because the number of farms in these regions was quite large. The costs would be extrapolated much more if other farms than those located in the zones were intensively tested. If restrictions were imposed on the use of production inputs on farms, as has been the case in some other countries (see e.g. Velthuis et al. 2010), or if there would be severe restrictions on the collection of milk and slaughter animals in the zones, then the losses would also be extrapolated.



**Figure 66.** Simulated economic losses due to a BT outbreak in the 2009 situation according to the provincial veterinary district. Blue bars represent average impacts and black bars represent the range of impacts simulated to occur in 95% of iterations.

## Appendix 6: Future projections

Farm register data from the years 1997 and 2009 were used to estimate how likely different types of farms were to continue livestock production and how the farm size had increased during 1997–2009. The farms were divided into three categories, and the categories were determined separately for five animal types:

- pigs (including growing pigs and other pigs),
- sows,
- cattle (including growing cattle and cows),
- dairy cows and
- suckler cows.

A farm could be included in several animal type categories. For each animal type category, there were three types of farms (continuation status):

- Farms that had continued their business. This was indicated by a farm having the same type of animals in both 1997 and 2009.
- Farms that exited the business. This was indicated by a farm keeping animals in 1997 but not in 2009. The same farm could have exited, for instance, from the dairy business but continued in another type of cattle production.
- Farms (about 900 farms) that had entered the business. This was indicated by a farm keeping a certain type of animals in 2009 but not in 1997. A farm could have entered, for instance, finishing pig production and exited piglet production (i.e. keeping the sows)

**Table 51.** Number of animals per farm on average on farms that have continued, exited or entered the business of keeping a certain type of animals during the years 1997 and 2009, and the percentage increase in the average number of animals per farm within the farm category (continue, exit or enter category).

Year 1997				Year 2009				
Continuation status				Continuation status				
	Continue	Exit	All farms	Continue			Enter	All farms
Animal category	Number of animal	animals	per farm	Number animals	Change	Number animals	Change	Change
Dairy cows	16,2	11,2	15,6	23,7	47 %	23,1	23,7	51 %
Suckler cows	16,6	8,5	6,8	27,9	68 %	19,8	23,1	238 %
Other cattle	24,2	14,8	23,0	35,1	45 %	43,4	35,5	54 %
Sows	53,2	28,9	47,6	69,1	30 %	205,8	83,4	75 %
Finishing pigs	132,6	82,9	102,5	226,5	71 %	328,4	249,6	143 %

Based on the logit model estimated for *cattle farms*<sup>5</sup>, the following characteristics of a farm were (among others) found to be associated with an increased likelihood of a farm continuing to keep *cattle* in the future:

- the farm currently had both cattle and pigs
- the farm was not specialized in beef production
- the farm currently had suckler cows

<sup>5</sup> Detailed estimates are available from the authors upon request.

- there were fewer other cattle farms or more pigs farms within a 10-km radius around the farm
- there were more cattle on the farm
- the farm was currently located further away from a dairy or a slaughterhouse

Among the farms that continued to have cattle in the future, the following characteristics were associated with an increased likelihood of a farm continuing to have *dairy cows* in the future:

- the farm was not specialized in beef production or it did not currently have suckler cows
- there were more dairy cows or fewer suckler cows on the farm
- the price of arable land in the area had increased
- households located in the same region currently had a higher average income, or the unemployment rate in the region had increased, hence reflecting the availability of non-farm employment options.

Among the farms that continued to have cattle in the future, the following characteristics were associated with an increased likelihood of a farm continuing to have *suckler cows* in the future:

- the farm was specialized in beef production
- there were fewer cattle farms within a 10-km radius around the farm
- the farm currently had fewer dairy cows or more suckler cows
- the price of arable land in the area or unemployment rate in the region had decreased.

Based on the logit model estimated for *pig farms*, the following characteristics of a farm were (among others) found to be associated with an increased likelihood of a farm continuing to have *pigs* in the future:

- the farm currently had both cattle and pigs
- the farm currently had sows
- there were more pig farms within a 10-km radius around the farm
- there were more sows and/or more other pigs than sows on the farm
- households located in the same region currently had a lower average income.

Among the farms that continued to have pigs in the future, the following characteristics were associated with an increased likelihood of a farm continuing to have *sows* in the future:

- the farm currently had both cattle and pigs
- the farm was currently specialized in piglet production (i.e. it was not a finishing or farrowing-to-finishing farm)
- the farm currently had more sows
- households located in the same region currently had a lower average income.
- the price of arable land in the region had increased.

Although the above-mentioned factors contributed significantly to the likelihood of a farm continuing in livestock farming, it was also evident that farm-specific factors were important in determining whether a farm continued in livestock production. By contrast, the expansion of farm size was almost completely determined by farm-specific factors (other than size, production type, livestock farm density in the region or region) that our data did not include any information about. Although mixed farms (i.e. farms having both pigs and cattle) were more likely to continue livestock production than non-mixed farms, the amount of mixed farming decreased by 87% during 1997–2009.

Changes in beef cattle, suckler cow, sow and fattening pig numbers suggest that, in relative terms, farm size has increased more on small than on large farms. For instance, finishing pig farms belonging to the group of smallest farms (1/3 of all farms) have on average more than doubled their size, whereas farms belonging to the group of largest farms (1/3 of all farms) have increased their size on average by less than 30%. However, among small farms, farm size growth has varied more than in other groups. In addition, pig farm size has increased more rapidly in areas where the number of pig farms per unit area of land was high. Among dairy farms, it was also noted that changes in the number of dairy cattle were positively correlated with changes in the number of other cattle.

Farm size was simulated to change on average differently in small, medium-sized and large farms, as well as farms belonging to different size classes. Among dairy farms, the interaction between farm size growth and initial farm size was smaller than among suckler cow, beef cattle or pig farms.

**Table 52.** Average change in the number of animals per farm over a 12-year period for farms that were initially in one of three classes according to their size and in one of three classes according to the number of other farms within a radius of 10 km around the farm.

Animal type	Farm density class <sup>2)</sup>	Farm size class in 1997 <sup>1)</sup>		
		Small farm	Average-sized farm	Large farm
Dairy cows	Small density	41	44	42
	Medium density	51	47	44
	Large density	33	55	52
Suckler cows	Small density	557	134	57
	Medium density	1023	188	49
	Large density	438	194	69
Beef cattle, excluding cows	Small density	444	74	37
	Medium density	143	139	37
	Large density	298	66	57
Sows	Small density	62	22	14
	Medium density	141	33	27
	Large density	292	70	29
Finishing pigs	Small density	110	72	13
	Medium density	650	43	10
	Large density	930	97	29

<sup>1)</sup> Each size class contains 33% of farms that operated in 1997. Some of them exited business by 2009. Percentage changes have been calculated for the subset of farms which continued business until 2009.

<sup>2)</sup> Farms were categorized into farm size classes by first calculating the number of other pig and poultry farms within 10 km radius around the farm and thereafter segregating the farms into three classes according to the number of these other farms. Each class contained 33% of farms that operated in 1997. Percentage changes have been calculated for the subset of farms which continued until 2009.

Numbers in each cell indicate percentage change in farm size during 12-year period when compared to the number of animals in 1997. Black bars visualize the percentage changes.

The change in the total number of animals in Finland was simulated with the DREMFIA sectorial model for Finnish agriculture (Lehtonen 2001). According to this projection, the number of animals would decrease in all other categories except in the category of suckler cows (Figure BB). If the future exit rate of farms was similar to the years 1997–2009, then our models which were applied to farm registry data for the year 2009 suggest that a little more than 20% of pig farms would continue production until 2033. Approximately 30% of dairy farms and a little more than 30% of suckler cow farms would continue production until 2033. If the farm size growth was similar to that of 1997–2009, then the size of farms with sows would increase the most. The number of finishing pigs and suckler cows would also increase quite rapidly, whereas the number of dairy cows per farm was projected to increase less rapidly.

The results suggest only small differences between regions regarding the change in the number of farms. Farm size is anticipated to grow relatively more rapidly among small than large pig and beef cattle farms, whereas the size of dairy farms is estimated to increase quite steadily across farm size classes. Since small farms are more likely to exit than large farms, farms continue to grow less rapidly than the increase in the average farm size, i.e. the increase in the average farm size is partly due to small farms exiting the farming business. However, it is possible that the increase in the pig farm size will be smaller and the increase in the cattle farm size will be larger than in 1997–2009, because the abolition of milk quotas and rapid structural change observed previously in the pig sector may have an effect on the future structural change.

### **Development of production costs in the 2000s**

As a part of our analysis, we examined how production costs change over time and as farm size increases. The goal of this analysis was to project potential economic benefits, i.e. changes in production costs of livestock farms, associated with structural change.

Price indices (2000–2013, OSF 2014a) show that the prices of goods and services currently consumed in agriculture (+57%) and goods and services contributing to agricultural investments (+46%) have increased faster than the Consumer Price Index that is used to measure the general inflation rate (+26%) (OSF 2014b). Among goods and services that are targeted at animal and especially dairy production, only the price of veterinary expenses (+23%) and compound feeds for calves (+22%) have risen less than the general inflation rate. Prices for farm machinery and installations used in animal production have increased by 44% and farm buildings by 46% from 2000 to 2013. The prices for energy and lubricants (+106%) have increased substantially, mainly due to crude oil prices (BP, 2013). (Figure 67).



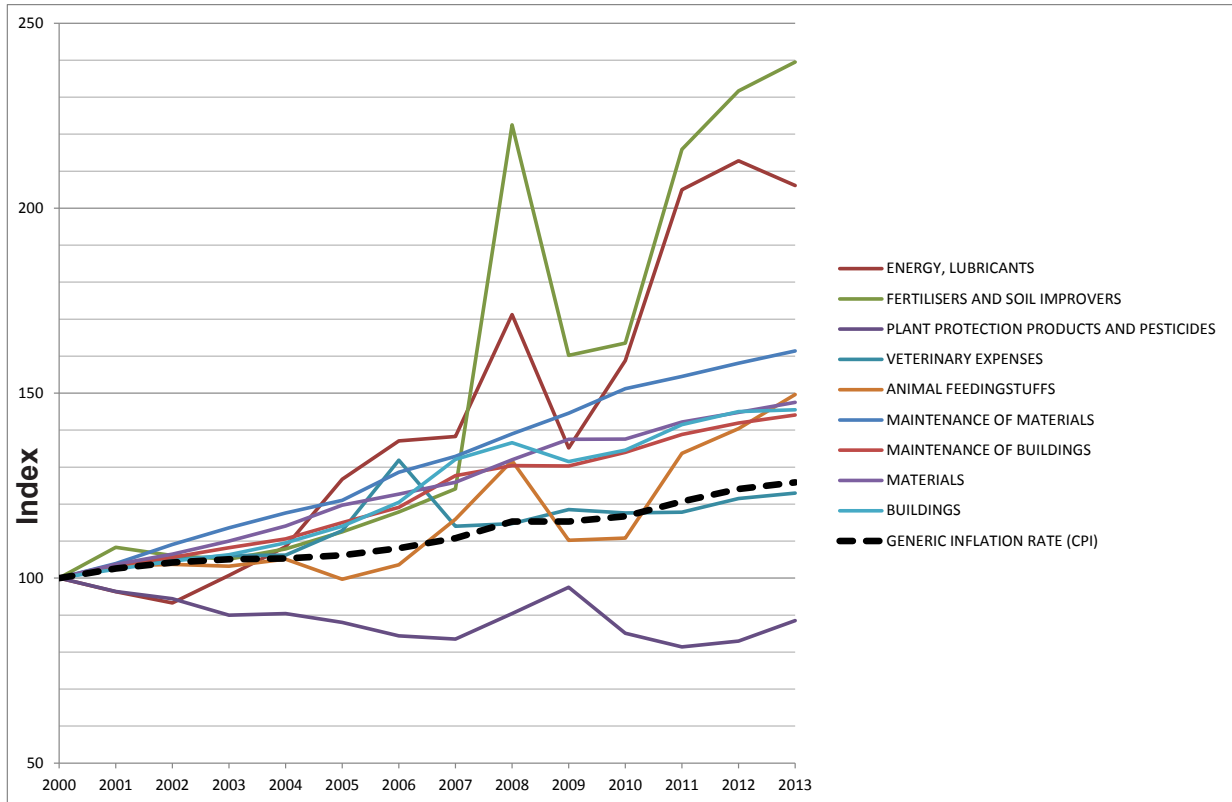


Figure 67. Development of costs 2000–2011 (OSF 2014a).

The production costs of farms have increased. In dairy farming, the production costs increased from 2000 to 2013 by 160% (from €110 300 to €287 300). The production costs have also increased in suckler cow farming (123%), sheep production (211%), piglet production (377%), pork production (199%) and in combined pig production (161%). (Figure 68).

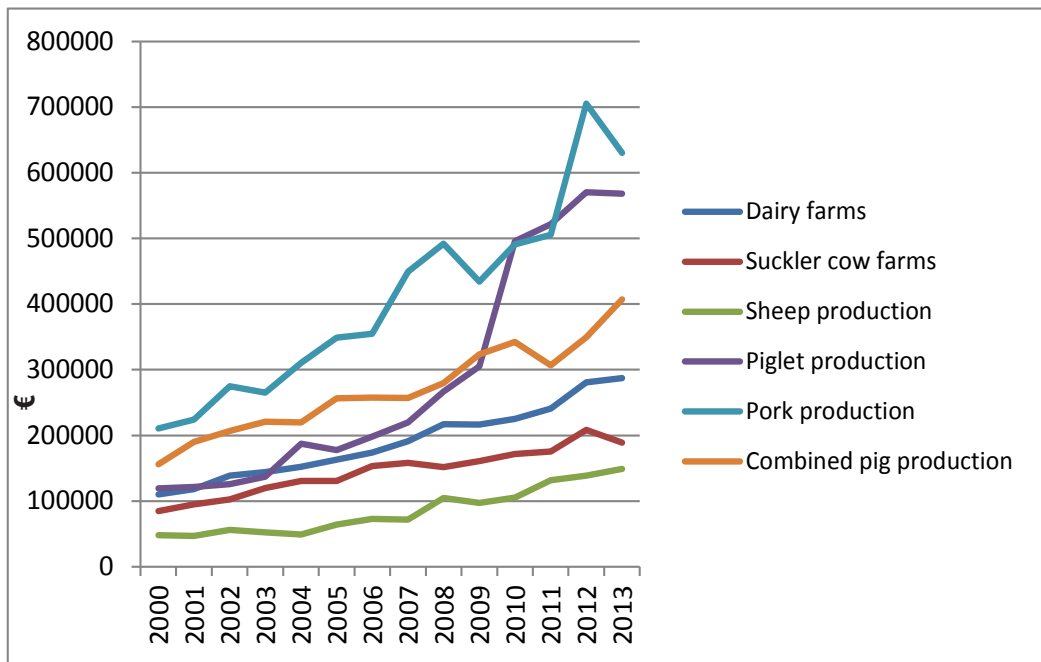


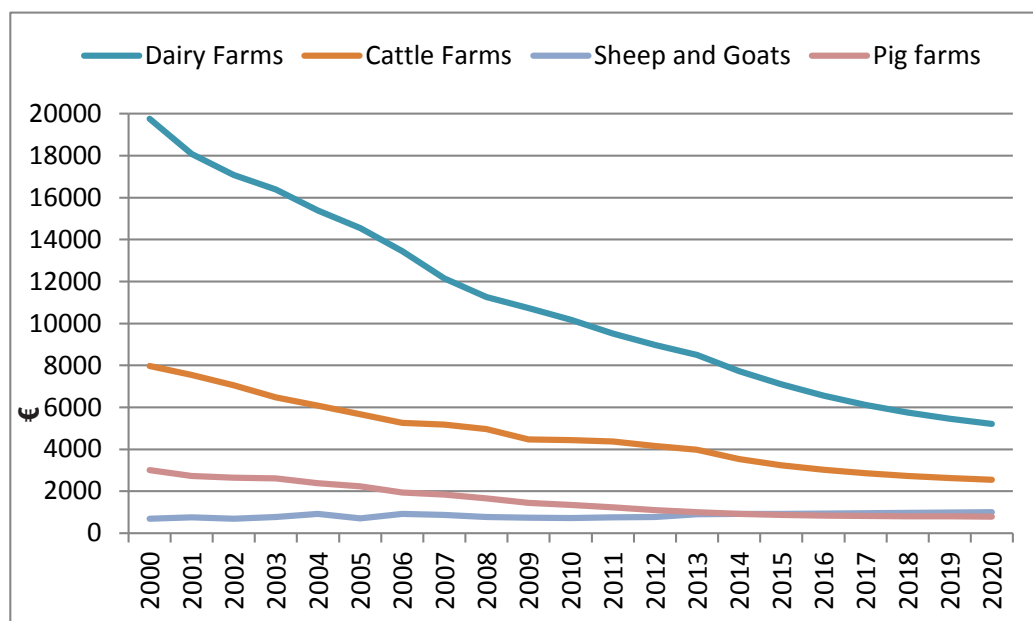
Figure 68. Production costs in animal farming 2000–2013 (MTT Economydoctor 2015b).

The production costs of livestock farms have increased not only due to increased input costs, but also due to the fact that the average farm size has grown over time. The structure of production costs in farming has also changed. The most significant change has been the decrease in the wages cost. In turn, machinery and material costs have increased. In pig farming, the changes have been larger than in cow farming. Hence, the primary economic benefit from structural change has been that the use of labour input has become more efficient and the use of more efficient production technology has increased (Table 53).

The above-mentioned changes are based on the Finnish bookkeeping data. Because the time period under study differs from farm-specific projections, we present information on structural changes for this period. During the period 2000–2013, the number of dairy farms decreased by 57% (from 19 750 farms to 8 497 farms), the number of cattle farms by 50% (7 971 to 3 986) and the number of pig farms by 67% (3 006 to 913). Conversely, the number of sheep and goat farms increased by 31% (697 to 999). The number of farms is forecast to decrease in the future (Figure 69). The number of animals in Finland decreased during 2000–2013 (Figure 70), and the average farm size increased.

**Table 53.** Specification of production costs according to farm type and accounting year (2000 and 2013) (MTT Economydoctor 2015b).

	Material		Farm use		Livestock		Machinery		Buildings		Other		Wages		Interest	
	2000	2013	2000	2013	2000	2013	2000	2013	2000	2013	2000	2013	2000	2013	2000	2013
Dairy farms	18%	22%	11%	12%	5%	5%	12%	15%	5%	5%	9%	11%	32%	23%	9%	8%
Suckler cow farms	13%	14%	15%	13%	2%	4%	16%	17%	6%	7%	14%	15%	21%	20%	13%	10%
Sheep production	16%	16%	9%	13%	2%	2%	11%	13%	3%	6%	9%	17%	43%	25%	7%	8%
Piglet production	26%	31%	6%	9%	6%	17%	13%	9%	8%	5%	9%	8%	21%	15%	10%	7%
Pig finishing production	22%	26%	5%	10%	38%	32%	7%	10%	6%	4%	6%	6%	10%	6%	7%	6%
Farrowing-to-finishing production	28%	37%	7%	9%	5%	10%	12%	8%	7%	6%	11%	9%	19%	13%	12%	8%



**Figure 69.** Structural development of agriculture (MTT Economydoctor 2015a).

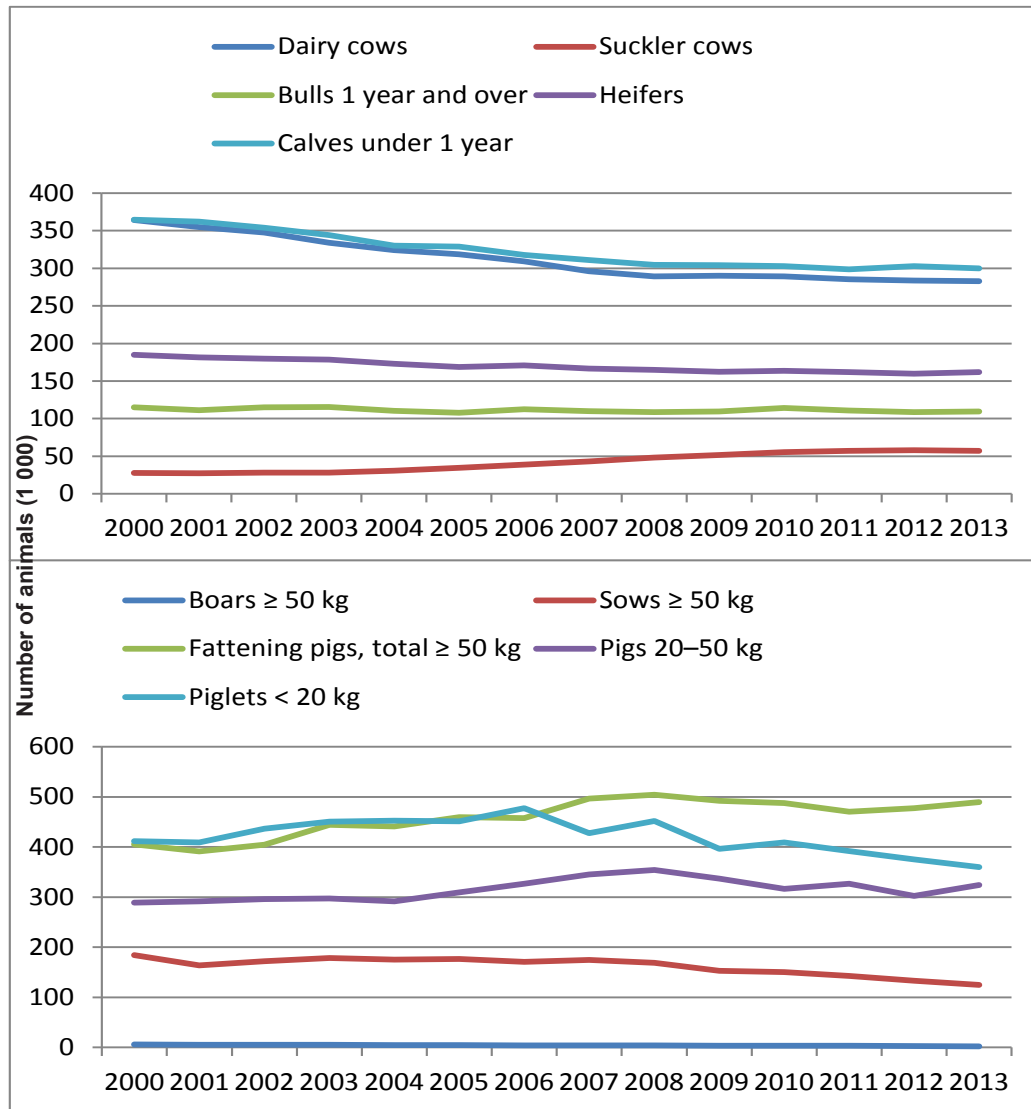
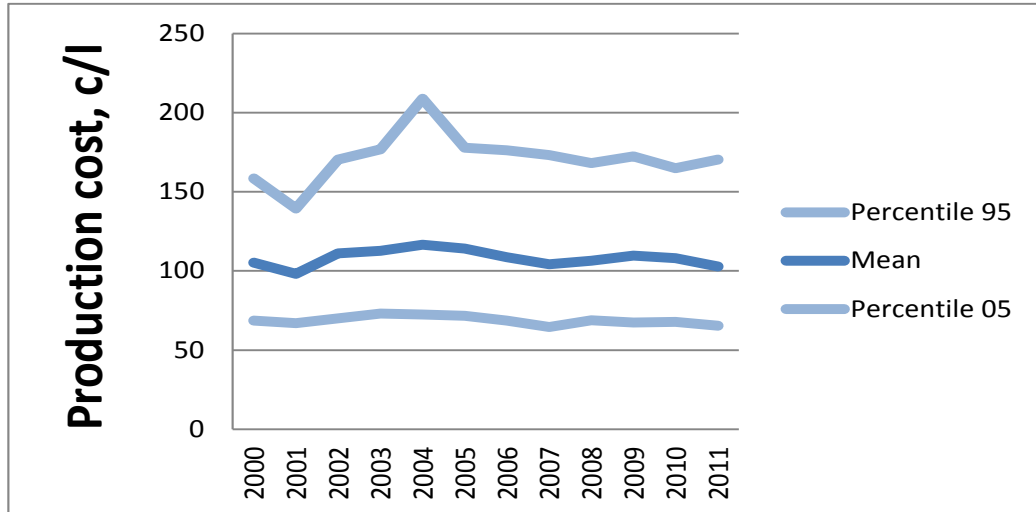


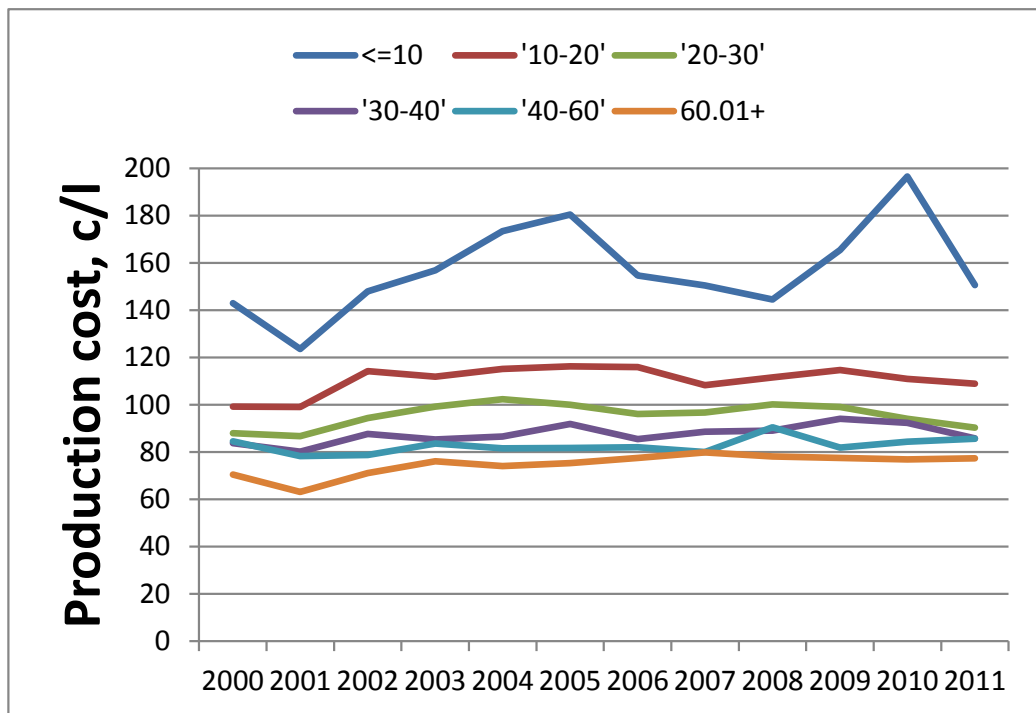
Figure 70. Number of cattle (on the left) and pigs (on the right) in 2000–2013 (OSF2015).

According to descriptive statistics based on MTT Profitability bookkeeping farm-level data for the years 2000–2011, the production costs per unit of the farm’s main product have remained quite stable since 2000. For example, the costs in dairy farming have been on average €1.08 per litre of milk produced (Figure 72). The costs of a finishing pig farm have also remained quite stable, on average €2 per kg pig meat produced (range €2–3/kg). In addition, the average costs of a piglet producing farm have remained quite stable, approximately €91 per piglet produced. Although these numbers include all the costs incurred by the farm (i.e. also costs other than those related to the main output), the impact of other products than the main produce of a farm does not seem to have any major impact on the results. Especially in crop production, subsidies provide a major share of revenues. Hence, the inclusion of unsubsidized costs of crop and feed production is one of the factors increasing the costs of production.



**Figure 71.** The development of the production cost of a dairy farm when all production costs of the farm are divided by the amount of milk produced each year between 2000–2011 (Data: MTT Profitability bookkeeping farm-level data).

The variation in unit costs between farms may be extremely large. Larger farms have smaller unit costs and the variation between farms is smaller. As an example, Figure 72 shows the production costs per unit of output costs of different sized dairy farms. Smaller farms have higher unit costs and the variation is larger. Medium-sized and large farms have small differences that are not statistically significant.



**Figure 72.** The development of unit production costs (cents per milk litre) of dairy farms according to farm size (number of cows) between 2000–2011 (Data: MTT Profitability bookkeeping farm-level data).

## Structural development and economies of scale

The data show that wages and materials are the main cost items in livestock production (Table 53). Work on farms is still mainly conducted by the producer and his/her family (on average 95%), because the share of paid labour is typically small (on average 5%). Producers have invested in technology (machinery and buildings), which has resulted in wages costs remaining relatively unchanged or decreasing during 2000–2011. By contrast, the share of costs incurred due to materials, machinery and buildings has increased.

Previous research suggests that as farm size increases, the most significant change is related to the decreased share of wage costs (Ala-Mantila 1998). The biggest share of production costs in dairy farming is wage costs. Other costs (animals, other animal expenses, insurances, electricity and fuels) also form a significant share of production costs. The unit production cost of milk decreases as the farm size (number of cows) increases. In pig meat production, the largest costs are associated with the purchasing of piglets and purchased feeds. In pig meat production the unit cost also decreases as more pig meat is produced.

Ovaska and Heikkilä (2013) have studied the structural development and competitiveness of Finnish dairy farms. They found that for a typical Finnish farm, the most significant disadvantages were machinery, wages and other costs. The proportion of wage costs decreases as the farm size class increases. Latukka (2013) observed that small farms have clearly the highest unit production costs, and as the number of cows increases the unit costs decrease.

Production costs per unit of output were studied by using a linear mixed effect model and farm-level data for the years 2000–2011. The results indicate that the unit production cost increases every year, but the rate of increase varies between farms and different types of production. An increase in the number of animals and farm size decreases the unit costs. Small farms (standard output less than €50 000) have significantly higher unit costs than medium-sized (€50 000–100 000) and large farms (more than €100 000). This may be due to the quite rapid farm size increase in Finland during the 2000s, as large farms have not yet reached the optimum in production and input use. The variation between farms and years was also large for small farms. Regionwise, there were insignificant differences in unit costs. The correlation between years in unit costs is high, and the unit costs of farms change at a different pace over time.

Economies of scale due to the increasing farm size were estimated by using Finnish bookkeeping data. Multivariate regression models were estimated to explain the production costs of a farm per unit of the main output (milk, meat or piglets). The estimation results were then applied in the future projected farm size to assess how farm size growth could affect production costs in each scenario. All changes were compared to the farm size and production costs of the year 2009. Price levels for the years 2009–2011 were used in the analysis.

## Appendix 7: Spread simulation of future projections

### Simulation of spread in the future

Future scenarios of pig and cattle production were described as farm-level projections (Appendix 6). The projections focused on how likely a farm was to continue producing animals of a certain type and how many animals the farm would be likely to have. Simulation of disease spread in the future by our model is possible after a projection is transformed into a realisation. A realisation comprises:

- an updated farm database that contains the farms assumed to be operational in the future and updated characteristics of those farms corresponding to the year 2033 (Figure 74);
- an updated animal transportation database that contains animal transports between operational farms in a realisation;
- an updated slaughterhouse transportation database that contains transports of animals only from farms that operate in a realisation;
- an updated AI technician movement database containing only visits to operational dairy farms; and
- an updated dairy tanker database containing only visits to operational dairy farms.

A simulation proceeds after the realisation is built as described in Appendix 3. Contact types and relevant production sectors vary and depend on the simulated disease (Table 54). Only spread in the cattle and pig sectors was simulated, as future projections of sheep/goat production were not available.

**Table 54.** Relevant sectors and contacts in simulations of various diseases based on future projections.

	FMD	BT	ASF
Pig sector	X		X
Cattle sector	X	X	
Animal transport	X	X	X
Animal transportation vehicle	X		X
Other traffic	X**		X***
Spatial spread*	X	X	

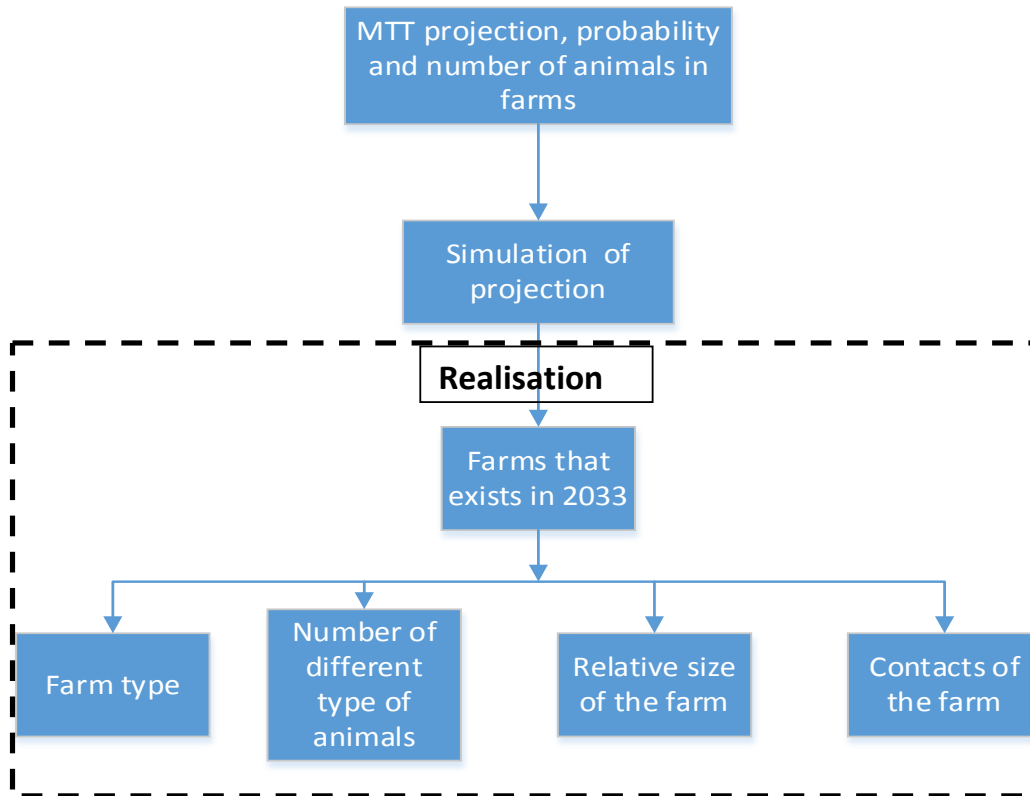
\* Spatial spread refers here to neighbourhood, vector and airborne spread

\*\* Included advisors, AI technicians, dairy tankers, veterinarians, substitute workers and cadaver collection vehicles

\*\*\* Included advisors, cadaver collection vehicles, substitute workers, veterinarians

### Building a realisation from a projection

A projection for the number of farms and the number of animals on the farms in the future was produced. The model predicts the number and probability of animals in 2033: sows, finishing pigs, dairy cows, suckler cows and beef cattle on the farm. A projection is a matrix that contains estimates regarding the continuation of livestock farming separately for each animal type and a conditional number of animals that is valid if the probability is true in reality for every farm operating in 2009, respectively.



**Figure 73.** Illustration of how projected future scenarios are related to the individual realisations of a projection required for epidemiologic simulation. To handle the uncertainty related to realisation, 20 realisations per projection were simulated.

In order to make a realisation of a projection, several steps were performed:

### 1) Simulation of what types of animals a farm continues to produce in 2033

The simulation was executed hierarchically and depended on the production sector:

#### *Pig production:*

- a) The continuation of keeping sows was sampled from a farm-specific probability.
- b) Farms that continued to keep sows and had also had finishing pigs were assumed to also continue pig finishing.
- c) For farms that did not have sows, the continuation of keeping finishing pigs was sampled from a farm-specific probability

#### *Cattle production:*

- a) The likelihood for a farm to continue keeping dairy or suckler cows was sampled from farm-specific probabilities of dairy and suckler cow farming.
- b) Farms that continued to keep dairy cows, suckler cows or both and which also had beef cattle were assumed to continue beef cattle production.
- c) For farms that did not have dairy or suckler cows, the continuation of keeping beef cattle was sampled from a farm-specific probability.

If a farm did not continue to keep any type of animals in an individual realization, it was regarded to exit livestock farming before 2033 and thus removed from the farm database of an individual realisation.



**2) The number of animals on farms that continued livestock production was adjusted to correspond to the total number of animals**

The number of animals on a farm was adjusted by the following coefficients:  
 Coefficient for animal type X =  $\frac{\text{The sum of all animals of type X on realised farms}}{\text{Projected total number of animals of type X}}$

The adjusted number of animals on the farm was then calculated:  
 The number of animals of type X on a certain farm =  $\text{rnd}\left(\frac{\text{realised number of animals of type X in a certain farm}}{\text{coefficient for animal type X}}\right)$

X is either a sow, finisher pig, dairy cow, suckler cow or beef cattle farm, rnd = value is rounded to the nearest integer. The adjusting ensured that the number of animals in the country stayed the same in each realisation of a projection.

**3) Farm types of continuing farms were estimated**

The farm types were classified as in the 2009 model using information on different types of animals on the farm:

- Farrowing farm = sows and less than 2 finishers per sow
- Farrowing-to-finishing farm = sows and at least two finishers per sow
- Finishing farm = finishers only; no sows
- Dairy farm = dairy cows (minimum one dairy cow), suckler cows, beef cattle
- Suckler cow farm = suckler cows and beef cattle only; no dairy cows
- Beef cattle farm = beef cattle only; no dairy cows, no suckler cows

**4) A standardized size of the continuing farms was estimated (number of animals)**

Farm size was transformed to correspond with the standardised farm size of 2006, as parts of the predictive functions were developed for a standardised farm size of 2006 within each farm type (Lyytikäinen et al. 2011):

Transformed farm size = a\*farm size +b, where farm size = number of sows + number of finishers + number of dairy cows + number of other cattle. Farm size information is based on the 2009 farm database (Table 55).

**Table 55.** Linear transformation functions applied to scale farm size to correspond with the standardised farm size in 2006 within each farm type\*.

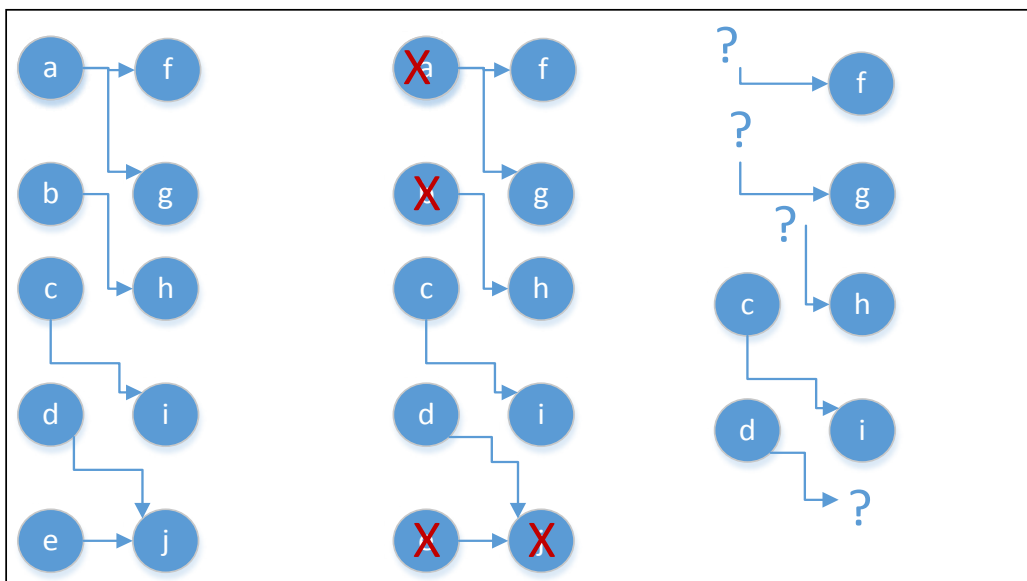
Farm type	Transformation function
Farrowing	0.003436*farm size -0.573813
Farrowing-to-finishing	0.002278*farm size -0.888383
Finishing	0.002058*farm size -0.925926
Dairy	0.038462*farm size -1.192308
Beef cattle	0.010989*farm size -0.714286
Suckler cow	0.017544*farm size -0.912281

\* These are complete transformations and the coefficient of determination is 100% in every function.

**5) Contact-related databases were updated**

The simulation of animal transports between farms was originally based on the animal transport database of 2009. When the database was updated to the year 2033, part of the database was changed: either the source or the destination farm, or both, for an animal transport may have disappeared because they had been simulated to have discontinued livestock production. This required contacts, their sources

or destinations, to be re-estimated. The key question was to what extent this re-estimation was to be performed: should we re-estimate all the contacts or only part of them? Because there was no clear evidence-based answer to the question, we applied different levels of re-linking.



**Figure 74.** Schematic illustration of the impact when a proportion of the farms have exited livestock production and the animal transport database is updated to take into account the exits. Part of the database is to be re-linked in order to maintain the operation of animal transports at the country level in a possible and logical manner.

Re-linking was applied by using the following logic: if the source farm had disappeared, a new source farm was sampled randomly from the animal movement database. The sampling was performed among source farms of the same animal kind (pig or cattle) still operating in that realisation and of the same farm type as the original source farm. Similar logic applied if the destination farm was missing in a realisation. Spatial spread was taken into account so that farms <10 km and within 10–20 km of the source or target farm had the same share of contacts as in 2009 if that was possible. In some parts of the country, the number of farms in the future became so small that there were no suitable farms within this region. If both the source and the target farm disappeared, the transport was excluded from the database in that realisation.

### 6) Other contact types

The animal transportation database also contained vehicle identification information for the pig sector. This information remained in a realisation, even if the movement was re-linked. The number of farms a pig transporting vehicle can visit a day was therefore a simulated variable that was defined separately in each realisation. The number of visited farms per vehicle in a day was assumed to decrease by 50% in the cattle sector due to the increased distance between farms and increased batch size.

The slaughterhouse transportation database was updated. All records referring to farms that did not exist in a realisation were removed from the database. Daily visits of a vehicle were assumed to decrease by 50% due to the increased distance between farms and increased batch size.

The AI technician movement database and dairy tanker database were updated and farms that did not operate in dairy production in 2033 were removed from the databases of a realisation.

