

Howes, Michael (1992) The design and control of mine refrigeration systems. PhD thesis, University of Nottingham.

**Access from the University of Nottingham repository:**

<http://eprints.nottingham.ac.uk/29325/1/335811.pdf>

**Copyright and reuse:**

The Nottingham ePrints service makes this work by researchers of the University of Nottingham available open access under the following conditions.

- Copyright and all moral rights to the version of the paper presented here belong to the individual author(s) and/or other copyright owners.
- To the extent reasonable and practicable the material made available in Nottingham ePrints has been checked for eligibility before being made available.
- Copies of full items can be used for personal research or study, educational, or not-for-profit purposes without prior permission or charge provided that the authors, title and full bibliographic details are credited, a hyperlink and/or URL is given for the original metadata page and the content is not changed in any way.
- Quotations or similar reproductions must be sufficiently acknowledged.

Please see our full end user licence at:

[http://eprints.nottingham.ac.uk/end\\_user\\_agreement.pdf](http://eprints.nottingham.ac.uk/end_user_agreement.pdf)

**A note on versions:**

The version presented here may differ from the published version or from the version of record. If you wish to cite this item you are advised to consult the publisher's version. Please see the repository url above for details on accessing the published version and note that access may require a subscription.

For more information, please contact [eprints@nottingham.ac.uk](mailto:eprints@nottingham.ac.uk)

**The design and control of mine refrigeration systems**

by Michael Howes, ACSM

Thesis submitted to the University of Nottingham  
for the degree of Doctor of Philosophy,  
October, 1992



## CONTENTS

Abstract .....	i
List of tables .....	ii
List of figures .....	v
List of symbols .....	viii

### 1 INTRODUCTION

1.1 The need for mine refrigeration system control .....	1
1.2 Objectives of the research .....	3
1.3 Historical perspective .....	5
1.4 Location of the research .....	10

### 2 REFRIGERATION SYSTEM MODELLING

2.1 Overall plant size .....	14
2.1.1 Mine heat load .....	17
Heat from autocompression .....	17
Heat from surrounding rock .....	18
Broken rock and fissure water ....	19
Heat from mine equipment .....	20
Summary of heat loads .....	23
2.1.2 Design surface climatic conditions	27
2.1.3 Acceptable thermal environments ..	33
Human heat balance .....	34
Thermoregulation .....	36
Limiting body temperature .....	37
Cooling power of the air .....	38
Other heat stress indicators .....	41
The measurement of heat strain ...	46
Actual heat stroke risk .....	47
Application of heat stress limits	49

2.1.4	The refrigeration load profile ...	54
	Productivity and the environment .	54
	Reduced shift lengths .....	59
	Optimisations .....	64
	Cooling capacity and load profiles	73
<b>2.2</b>	<b>Refrigeration plant analysis .....</b>	<b>76</b>
2.2.1	Background to simulations .....	76
	Air conditioning industry .....	78
	Mining industry .....	81
	Development of this work .....	83
2.2.2	Refrigeration system simulation ..	87
2.2.3	Refrigerant properties .....	88
	Ammonia R717 .....	91
	Refrigerant R22 .....	92
	Refrigerant R11 .....	93

### **3 EQUIPMENT PERFORMANCE**

<b>3.1</b>	<b>Compressors .....</b>	<b>95</b>
3.1.1	Compressor part load operation ...	96
3.1.2	Centrifugal compressors .....	98
3.1.3	Screw compressors .....	101
	Broken Hill underground plant ....	101
	Mount Isa surface plants .....	102
	Broken Hill surface plant .....	108
<b>3.2</b>	<b>Condensers .....</b>	<b>113</b>
3.2.1	Shell and tube .....	114
3.2.2	Closed plate .....	115
3.2.3	Evaporative condensers .....	118
<b>3.3</b>	<b>Evaporators .....</b>	<b>123</b>
3.3.1	Shell and tube .....	124
3.3.2	Direct expansion shell and tube ..	126
3.3.3	Closed plate .....	129
3.3.4	Open plate .....	131

<b>3.4 Surface cooling towers</b> .....	136
3.4.1 Pre-cooling towers .....	138
3.4.2 Condenser cooling towers .....	139
3.4.3 Surface bulk air coolers .....	141
<b>3.5 Underground air cooling</b> .....	144
3.5.1 Air cooling coils .....	144
3.5.2 Mesh coolers .....	148
3.5.3 Multistage spray chambers .....	150
3.5.4 Modular cooling towers .....	155
3.5.6 Capacity control .....	156
<b>3.6 Miscellaneous equipment</b> .....	159
3.6.1 High pressure heat exchangers ....	159
3.6.2 Pipe insulation and heat transfer	160

#### **4 ACTUAL PLANT SIMULATIONS**

<b>4.1 Simulation structure and components</b> ....	167
4.1.1 The chiller subsystem .....	168
Evaporator modules .....	168
Condenser modules .....	170
Compressor modules .....	174
Chiller set modules .....	177
4.1.2 The heat rejection subsystem ....	178
4.1.3 The load subsystem .....	182
Surface bulk air cooler .....	182
Underground chilled water systems	184
High pressure heat exchangers ....	185
Cooling coils .....	188
Multistage spray chambers .....	189
The underground load .....	194
4.1.4 Overall plant operation .....	194
<b>4.2 Mount Isa R63 plant</b> .....	200
4.2.1 Base system model .....	200
4.2.2 Extended system model .....	203

System design .....	203
System performance .....	207
<b>4.3 Broken Hill underground plant .....</b>	<b>213</b>
4.3.1 Base system model .....	214
4.3.2 Extended system model .....	219
Expanded mine load .....	219
Open plate evaporator .....	221
Increased motor size .....	224
Chilled water storage .....	227
<b>4.4 Mount Isa surface chilled water plant ..</b>	<b>231</b>
4.4.1 Refrigeration plant design .....	232
4.4.2 Control strategy .....	235
The chiller sets .....	236
Chilled water supply system .....	241
Mine load .....	242
Return water system .....	244
4.4.3 Commissioning tests .....	245
4.4.4 System performance .....	251
Condenser cooling towers .....	251
Chiller set performance .....	252
Pre-cooling and mine cooling .....	255
<b>4.5 Broken Hill North Mine surface plant ...</b>	<b>261</b>
4.5.1 Surface plant justification .....	261
4.5.2 System design and selection .....	266
General .....	268
Tender evaluation .....	269
Plant control strategy .....	272
4.5.3 Plant performance .....	276
April 1991 performance tests .....	277
Pump flow rates .....	280
Surface bulk air cooler .....	281
Closed plate evaporator .....	282
Evaporative condensers .....	286
Input power measurements .....	293
4.5.4 Simulation model .....	295

<b>4.6 Mount Isa U62 bulk air cooler .....</b>	<b>298</b>
4.6.1 General .....	298
4.6.2 Supplier 1 proposals .....	301
4.6.3 Supplier 2 proposals .....	306
4.6.4 Supplier 3 proposals .....	314
4.6.5 Summary of proposals .....	316
<b>5 SUMMARY AND RECOMMENDATIONS</b>	
<b>5.1 Summary of research .....</b>	<b>321</b>
<b>5.2 Recommendations for further work .....</b>	<b>326</b>
<b>6 REFERENCES .....</b>	<b>328</b>
<b>APPENDIX 1 - CALCULATION OF COOLING POWER ....</b>	<b>A1</b>
<b>APPENDIX 2 - PRODUCTIVITY ANALYSIS .....</b>	<b>A2</b>
<b>APPENDIX 3 - NORTH MINE SURFACE PLANT LISTING</b>	<b>A5</b>
<b>APPENDIX 4 - MOUNT ISA U62 PLANT LISTINGS ....</b>	<b>A14</b>

# THE DESIGN AND CONTROL OF MINE REFRIGERATION SYSTEMS

by

Michael John Howes

## ABSTRACT

The research is directed towards modelling the chiller set, the heat rejection and the load subsystems of a complete mine refrigeration system and simulating the performance in order that the design can be optimised and the most cost effective control system determined. The refrigeration load profile for a mechanised mine is complex and primarily a function of surface climatic variations, the strongly cyclic sources of heat resulting from the operation of diesel powered mining equipment and the associated differences in thermal environmental acceptance criteria.

Modelling of the central element of the system, the compressor, is based on empirical relationships which use the actual cooling duty and input power rather than general compressor curves using theoretical flow and head coefficients. This has a more general application and is not restricted to a single compressor type. The steady state modelling of five refrigeration systems has included two types of compressor, four types of evaporator, three types of condenser, two types of cooling tower and five types of mine cooling appliances.

The research has extended modelling of refrigeration systems by incorporating fully the heat rejection and load subsystems and has demonstrated that relatively complex mine refrigeration systems can be modelled and the simulation results related to actual measurements with an acceptable accuracy. This has been further improved by testing the system elements and adjusting the theoretical performance analysis where necessary. These adjustments concern either the more difficult to assess factors such as evaporating and condensing heat transfer coefficients or factors influenced by unusual operating conditions.

The research has shown that, despite the complexity of the load profile and the refrigeration system, modelling and simulation can be used effectively to optimise both the design and the control system.



## List of tables

2.1	Average wet bulb temperature increases in a development heading .....	26
2.2	Expected wet bulb temperature increases in a development heading .....	26
2.3	Comparative mine heat loads .....	26
2.4	Design surface wet and dry bulb temperatures .....	32
2.5	Number of half-hourly periods in which a given temperature is exceeded .....	32
2.6	Mount Isa : summary of measured and expected thermal productivities .....	65
2.7	Six hour work limits in mechanised and non-mechanised stopes .....	65
2.8	Mount Isa 3000 ore bodies : refrigeration optimisation .....	75
2.9	Mount Isa 3000 ore bodies : effect of thermal productivity .....	75
3.1	Performance analysis of shell and tube condensers .....	120
3.2	Constructional details of shell and tube condensers .....	121
3.3	Performance analysis of closed plate condensers .....	121
3.4	Performance analysis of evaporative condensers .....	122
3.5	Performance analysis of shell and tube evaporators .....	125
3.6	Constructional details of shell and tube evaporators .....	128
3.7	Performance analysis of direct expansion evaporators .....	128
3.8	Performance analysis of closed plate evaporators .....	133

3.9	Performance analysis of open plate evaporators .....	133
3.10	Performance analysis of a counter flow cooling tower .....	143
3.11	Performance analysis of a cross flow cooling tower .....	143
3.12	Performance analysis of air cooling coils ..	146
3.13	Performance analysis of mesh coolers .....	152
3.14	Measured performance of multistage horizontal spray chambers .....	153
3.15	Performance analysis of high pressure water to water heat exchangers .....	161
3.16	Method of estimating heat gains in water distribution pipes .....	166
4.1	Mount Isa R63 : base plant comparison between measured and predicted values .....	205
4.2	Mount Isa R63 : extended plant comparison between measured and predicted values .....	212
4.3	Broken Hill underground plant : April 1987 comparison between measured and predicted values .....	218
4.4	Broken Hill underground plant : April 1987 predicted plant performance .....	221
4.5	Broken Hill underground plant : extended mine load - predicted plant performance ....	222
4.6	Broken Hill underground plant : four compressors and open plate evaporator - predicted plant performance .....	225
4.7	Broken Hill underground plant : three compressors and open plate evaporator - predicted plant performance .....	228
4.8	Broken Hill underground plant : summer operation - predicted plant performance ....	229
4.9	Broken Hill underground plant : mid-seasonal operation - predicted plant performance ....	230

4.10	Mount Isa K61 : analysis of commissioning test results .....	250
4.11	Mount Isa K61 : analysis of condenser cooling tower results .....	253
4.12	Mount Isa K61 : condenser cooling tower heat balances .....	253
4.13	Mount Isa K61 : chiller set performance July 1990 .....	256
4.14	Mount Isa K61 : two chiller set performance November 21st 1990 .....	257
4.15	Mount Isa K61 : one chiller set performance November 21st 1990 .....	258
4.16	Mount Isa K61 : two chiller set performance November 23rd 1990 .....	259
4.17	Mount Isa K61 : two chiller set performance January 21st 1990 .....	260
4.18	Comparison of options for the Broken Hill refrigeration system .....	267
4.19	Broken Hill surface plant : bulk air cooler performance .....	284
4.20	Broken Hill surface plant : EMS data summary for March 3rd 1992 .....	296
4.21	Broken Hill surface plant : predicted values for March 3rd 1992 .....	297
4.22	Mount Isa U62 : Baltimore Aircoil bulk air cooler performance .....	302
4.23	Mount Isa U62 : Sulzer bulk air cooler performance .....	303
4.24	Supplier 1 : continuous process operation ..	307
4.25	Supplier 1 : batch process operation .....	308
4.26	Supplier 2 : continuous process operation ..	312
4.27	Supplier 2 : batch process operation .....	313
4.28	Supplier 3 : continuous process operation ..	318
4.29	Supplier 3 : batch process operation .....	319
4.30	Mount Isa U62 : summary of costs .....	320

## List of figures

1.1	The vapour compression refrigeration cycle .	4
2.1	Heat balance in a development heading .....	24
2.1	Mount Isa : distribution of wet and dry bulb temperatures over three summers .....	30
2.3	Mount Isa : 10 year average hourly wet and dry bulb temperatures .....	31
2.4	Thermoregulation and equilibrium core and skin temperatures .....	39
2.5	Equilibrium skin temperatures and risk .....	39
2.6	Lepanto : working place wet bulb temperature distribution .....	53
2.7	Control of the thermal environment : reduced shift length strategy .....	53
2.8	Mount Isa : relationship between six hour and surface wet bulb temperatures .....	60
2.9	Mount Isa : relationship between six hour and expected productivity .....	61
2.10	Mount Isa : working place performance .....	62
2.11	Six hour and stop work charts .....	66
2.12	General refrigeration system algorithm .....	89
2.13	Definitions of refrigerant properties .....	94
3.1	Carrier centrifugal compressor performance - adiabatic head .....	99
3.2	Carrier centrifugal compressor performance - efficiency .....	100
3.3	Sullair C25 screw compressor performance ...	103
3.4	Howden 321-193 screw compressor performance	104
3.5	Stal S93E screw compressor performance .....	105
3.6	Stal S93E with economiser performance .....	106
3.7	Sabroe 536H screw compressor performance ...	109
3.8	Howden 321-132 screw compressor performance	110
3.9	Sullair L25 screw compressor performance ...	111
3.10	Mycom 320MU screw compressor performance ...	112

3.11	Rated and calculated heat transfer for air cooling coils .....	149
4.1	Evaporator module analysis .....	169
4.2	Condenser module analysis .....	172
4.3	Evaporative condenser module analysis .....	173
4.4	Compressor module analysis .....	176
4.5	Chiller set module analysis .....	179
4.6	Condenser cooling tower module analysis ....	180
4.7	Bulk air cooler module analysis .....	183
4.8	High pressure pipe analysis .....	186
4.9	High pressure heat exchanger analysis .....	187
4.10	Cooling coil analysis .....	190
4.11	Spray chamber stage analysis .....	191
4.12	Multistage spray chamber analysis .....	192
4.13	The load subsystem analysis .....	195
4.14	Overall plant analysis .....	199
4.15	Mount Isa R63 : schematic of the basic refrigeration system .....	202
4.16	Mount Isa R63 : effect of evaporator flow rate and set configuration .....	206
4.17	Mount Isa R63 : effect of number of passes in the 19DG evaporator .....	210
4.18	Mount Isa R63 : effect of condenser and secondary water flow rates .....	211
4.19	Broken Hill underground plant : schematic of system in 1987 .....	215
4.20	Mount Isa K61 : overall control strategy ...	237
4.21	Mount Isa K61 : chiller set control strategy .....	238
4.22	Mount Isa K61 : chilled water supply control strategy .....	243
4.23	Mount Isa K61 : return water control .....	246
4.24	Mount Isa K61 : arrangement for commissioning tests .....	249
4.25	Mount Isa K61 : recirculation water flows ..	249

4.26	Broken Hill surface plant : summary of proposed systems .....	270
4.27	Broken Hill surface plant : basic control strategy .....	273
4.28	Broken Hill surface plant : layout of equipment .....	278
4.29	Broken Hill surface plant : variable speed evaporator pump calibration .....	283
4.30	Broken Hill surface plant : closed plate evaporator performance .....	287
4.31	Broken Hill surface plant : comparison of estimated and actual plant duties .....	296
4.32	Broken Hill surface plant : evaporative condenser performance .....	291
4.33	Mount Isa U62 : Supplier 1, general arrangement of proposals .....	304
4.34	Mount Isa U62 : Supplier 2, general arrangement of proposals .....	311
4.35	Mount Isa U62 : Supplier 3, general arrangement of proposals .....	317

## List of symbols

### Symbols

a	surface area ( $m^2$ )
$B_{4SR}$	basic four hour sweat rate (l)
C	capacity rates (kW)
COP	coefficient of performance
CP	air cooling power ( $W/m^2$ )
d	diameter (m)
e	vapour pressure (kPa)
e	effectiveness
$E_{cf}$	evaporative condenser factor ( $m^2$ )
f	factor
f	fin efficiency
$f_p$	compressor part load factor
F	cooling tower factor of merit
$F_f$	evaporative condenser airflow factor
h	adiabatic head (kJ/kg)
h	heat transfer coefficient ( $kW/m^2K$ )
$h_f$	fouling factors ( $kW/m^2K$ )
HPHE	high pressure heat exchanger
I	ideal power to cooling ratio
k	thermal conductivity (kW/mK)
kW	compressor motor input power (kW)
l	water flow rate (l/s)
LMTD	log mean temperature difference ( $^{\circ}C$ )
m	mass flow rate (kg/s)
M	metabolic heat generation rate ( $W/m^2$ )
MWR	refrigeration capacity (MW)
n	efficiency
n	number of readings
N	number of cassettes
N	cooling tower factor
NTU	number of heat transfer units

$N^*$	cooling tower factor
$N_a$	total nominal plate surface area ( $m^2$ )
$N_l$	total nominal length of plate (m)
$P$	pressure (kPa)
$P_{if}$	compressor part load factor
$P_{4SR}$	predicted four hour sweat rate (l)
$q$	heat transfer (kW/m)
$Q$	heat transferred (kW)
$r_p$	ratio of condensing to evaporating pressures
$R$	cooling tower capacity ratio
$s$	standard deviation
$S$	sigma heat (kJ/kg)
$S$	surface
$S_r$	sweat rate (l)
$t$	temperature ( $^{\circ}C$ )
$tpa$	production rate (million tonnes per year)
$U$	thermal resistance (kW/K)
$UA$	overall heat transfer coefficient (kW/K)
$v$	specific inlet volume flow rate ( $m^3/s/kW$ )
$V$	velocity (m/s)
$V$	compressor inlet volume flow rate ( $m^3/s$ )
$W$	work rate ( $W/m^2$ )
$WBGT$	wet bulb globe temperature ( $^{\circ}C$ )
$x$	wall thickness (m)
$x$	mean value
$y$	cooling tower factor
$z$	cooling tower factor
$z$	ratio of capacity rates



## Subscripts

a	air
bc	bulk cooler
c	convective, compressor, condenser, condensing
cc	cooling coils
db	dry bulb
e	evaporative, evaporator, evaporating
h	high pressure side, hot
i	in, inside
l	low pressure side
m	mean
n	nominal, stage number
o	out, outside
r	radiant, radiative, return, refrigerant
s	skin, saturated, sprays
t	tower
w	water
wb	wet bulb

## 1 INTRODUCTION

### 1.1 The need for mine refrigeration system control

In the last 25 years, two principal factors have led to an almost exponential increase in installed mine refrigeration plant capacity throughout the world. The first is associated with the increasing scarcity of minerals of a mineable grade at shallow depths and the second is the acceptance that there are significant decreases in productivity when working in adverse thermal environmental conditions.

Ventilation and increasingly refrigeration, are taking a greater proportion of the resources used in mining. In some South African gold mines, ventilation and refrigeration costs are absorbing almost 45% of the total mining cost and the design and operation of the refrigeration plants is of necessity a compromise between reliability and efficient operation. The loss in mineral revenue resulting from a plant breakdown will depend on the extent and duration of the failure but will usually be significant.

In most South African mines the primary refrigeration plant design consideration is reliability as a result of the problems associated with a shortage of capable and experienced personnel to operate the plants. Despite the large installed refrigeration capacity which totals over 1500 MWR, none of the plants are

controlled to provide the optimum performance consistently. The relatively low cost of electrical power also results in a reduced financial incentive to optimise the refrigeration system operation.

In Australia, a combination of the increased depth of economic mineralisation and high surface ambient air temperatures is resulting in a rapid increase in the amount of mine refrigeration required. The total is significantly less than in South Africa and will probably not exceed 50 MWR by 1995. Most of the Australian mines are in relatively remote areas with high power costs resulting from the necessity to either generate their own power or to amortise long power transmission lines.

Most of the mines in Australia also have access to a relatively large and stable pool of capable and experienced maintenance and operating personnel. It therefore becomes a realistic proposition to control and operate the refrigeration systems in the most cost effective manner in addition to ensuring that plant reliability is unaffected.

## 1.2 Objectives of the research

The primary objective of the research was to model the steady state performance of the individual components which make up a refrigeration system, to combine these into an overall simulation which is used to develop control strategies and to optimise the design of the refrigeration system such that the most cost effective arrangement and operation results. An essential part of the research was testing the performance of each element and its effect on the overall simulation and adjusting the model to reflect the actual operation.

Mine cooling plants are exclusively based on the vapour compression refrigeration cycle as illustrated in figure 1.1. Optimising the system design requires the introduction of the cost of individual components and the comparison of the cost of improving the performance of one element with the cost of improving the performance of other elements in the system.

To achieve this, it is necessary to mathematically model the thermal performance of the system components and their interaction with the system as a whole. This allows the performance of a particular system to be examined over a wide range of steady state operating conditions. Mining is a dynamic process and, in addition to diurnal and seasonal climatic variations, there will be changes in the refrigeration load with time which are associated with the mining processes.

Figure 1.1 - The vapour compression refrigeration cycle

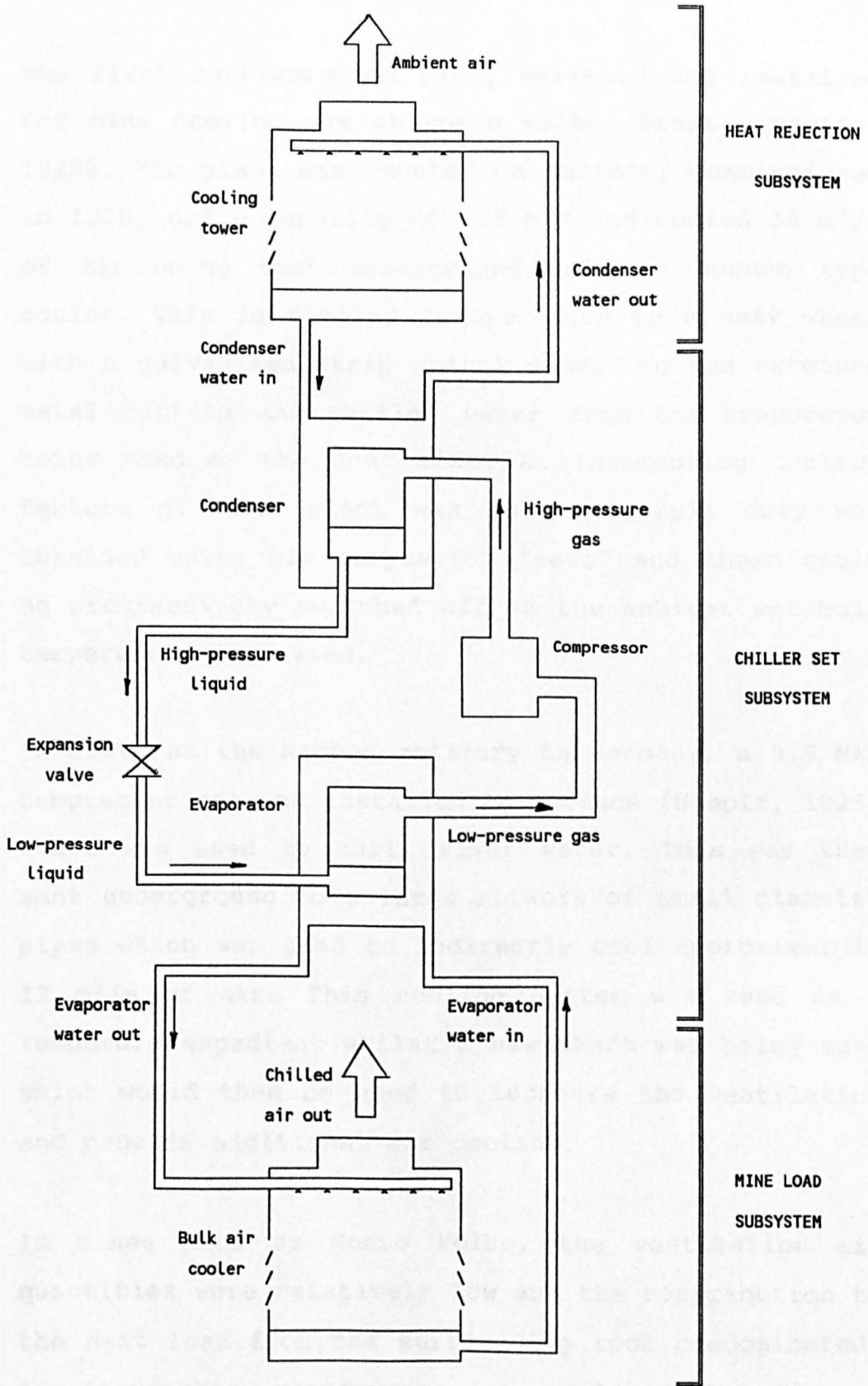

### 1.3 Historical perspective

The first refrigeration plant designed and installed for mine cooling was at Morro Velho, Brazil (Davies, 1922). The plant was located on surface, commissioned in 1920, had a capacity of 1.8 MWR and cooled 38 m<sup>3</sup>/s of air being sent underground using a Heenan type cooler. This is similar in operation to a heat wheel with a galvanised strip spiral providing the extended metal surface and chilled water from the evaporator being used as the heat sink. An interesting control feature of this plant was that the full duty was obtained using six compressor "sets" and these could be progressively switched off as the ambient wet bulb temperature decreased.

In 1924, at the Radbod colliery in Germany, a 0.5 MWR compressor set was installed on surface (Stapff, 1925) which was used to chill river water. This was then sent underground to a large network of small diameter pipes which was used to indirectly cool approximately 12 m<sup>3</sup>/s of air. This cooling system was used as a temporary expedient whilst a new shaft was being sunk which would then be used to increase the ventilation and provide additional air cooling.

In mines such as Morro Velho, the ventilation air quantities were relatively low and the contribution to the heat load from the surrounding rock predominated. An inevitable consequence of cooling the air on

surface was that the heat flow from the surrounding rock increased and the benefits diminished as mining became more remote from surface i.e. the positional efficiency of the plant was low. To counter this, Morro Velho was also the first mine to install a plant underground with the heat rejected to a cooling tower in the bottom of the upcast shaft.

South African gold mines followed the experience gained at Morro Velho and the first surface plant which cooled the mine intake air was installed at Robinson Deeps in 1935 (MacWilliam, 1937). It had a capacity of 7.0 MWR and used a direct contact spray system to cool 190 m<sup>3</sup>/s of intake air. In 1936 the first underground refrigeration plant was commissioned at the East Rand Proprietary Mines (Gorges, 1952). The plant provided 1.8 MWR and a total of 80 m<sup>3</sup>/s of air was cooled.

This trend was followed in other mining areas with deep and hot mines such as Ooregum Mine in the Kolar Goldfields, India in 1939 (Spalding, 1940) where a surface 4.0 MWR plant chilling air on surface was installed. In Europe, a 2.9 MWR surface plant was installed at Les Liegeois in Belgium (Bidlot, 1950). This was a surface plant which supplied 33 l/s of chilled water to underground where it was used to cool air as close to the face as possible. Interestingly, a pelton wheel was used to recover the energy from the chilled water set underground.

The growth in world wide mine refrigeration capacity was linear at about 3 MWR per year until 1965 when the total capacity was approximately 100 MWR. Since 1965 the growth has been exponential and has doubled approximately every six years. South African deep gold and platinum mines have been the main users of mine refrigeration with installed capacities of between 75 and 80% of the capacity used in mining throughout the world. This dominant position has resulted in most of the developments in refrigeration system design and operation originating in South Africa.

From the late 1940's to the mid 1970's, most of the refrigeration systems installed on mines followed the developments made in the rapidly expanding building air conditioning industry. Chilled water systems were used to distribute the coolth from the central plant and indirect contact cooling coils to cool the air delivered to the mine workings. The chilled water was produced in standard chiller sets comprising of a centrifugal compressor and shell and tube evaporators and condensers. In deep metal mines, the plant was invariably located underground (Howes, 1975) whereas in shallower coal mines, both surface and underground locations were used (Hamm, 1979 and Reuther, 1984).

In the mid 1970's it became increasingly evident that the underground refrigeration systems were not meeting the design objectives. This was mainly a result of fouling in the heat exchangers of the chiller sets and



the difficulty of controlling large chilled water distribution systems (Howes, 1983). In many cases, the problems associated with condenser heat rejection was constraining the installation of even larger systems underground. Open circuit evaporator and chilled water systems using direct contact water to air cooling were found to offer significant benefits with respect to the distribution and use of the coolth in the working areas in the mine (Howes, 1979).

From the late 1970's, the majority of mine cooling plants have been located on surface and have supplied chilled water to either underground where it is used for direct contact cooling and as service water, or to bulk air coolers on surface or both. In South Africa, the growth in surface plant capacity since 1976 was more than four times that installed underground. By 1985, from no surface refrigeration plant capacity (the sole surface plant surviving from the 1930's and 1940's at ERPM was shut down in 1975), the capacity installed on surface exceeded that installed underground (Ramsden, 1990).

In the South African mines during the 1980's, the increasing depth of mining had a threefold effect on plant design and location. Firstly, autocompression of the intake air resulted in the necessity to bulk cool the air on surface to ensure that the air supplied from the intake shafts underground did not exceed the design temperature limit.

Secondly, the heat rejection capacity of the underground ventilation air decreases with increasing depth of workings and increasing mine heat load. This limits the maximum underground plant capacity and its performance (increasing condensing temperatures result in lower overall coefficients of performance) and therefore the ability to meet the design working place conditions (Stroh, 1984).

Thirdly, the logistics of circulating large water quantities (over 1000 l/s in pipes of up to 1 m in diameter) to distribute the coolth underground, prompted the investigation of using ice instead of water. This can reduce the circulating mass flow between surface and underground by a factor of between three and five depending on the ice fraction of the system selected (Shone, 1988).

#### 1.4 Location of the research

Achieving the full objectives of the research required access to existing and new refrigeration systems and a direct input into the design and operation of these systems. Two Australian mines, Mount Isa and North Broken Hill offered the necessary opportunity with the increased mining at depth requiring larger cooling plants and the author being involved with both in an advisory capacity.

The first main mine refrigeration plant installed in Australia was the R63 plant at Mount Isa in 1954. Two 1.2 MWR chiller sets (a combination of compressor, condenser, evaporator and expansion valve usually mounted on a common base plate) provided chilled water to indirectly cool intake air using cooling coils on surface at M64 shaft. This was used to supplement the ventilation during the first part of a mine expansion programme which resulted in the mine tonnage being increased fourfold to 4.0 million tonnes per year.

In 1963 the plant was converted to send the chilled water underground in closed circuit to two high pressure water to water heat exchangers. The cold water in the secondary circuit was used to distribute the coolth to coils and used for indirectly cooling the air used to ventilate the new rock handling system and the deepest service areas.

In 1973 the plant was expanded with a third chiller set to a nominal capacity of 3.6 MWR (Allen, 1975). An additional 0.6 MWR was provided by eight spot coolers which were used in the more remote diamond drill and development locations. A fourth chiller set was installed as a spare unit in 1985 and a third high pressure heat exchanger was installed underground. The secondary water circuit for this third heat exchanger was open at the point of application and supplied direct contact water to air spray coolers.

This system was the first to be modelled in 1983 and showed that the performance of the interacting components within the system could be predicted with acceptable accuracy. The underground section was de-commissioned in 1989 and replaced with a new 11 MWR surface plant at K61 which supplied chilled water in open circuit for the new 3000 and 3500 ore bodies (Barua, 1988).

The design and the control strategy for this new plant was determined prior to its installation by modelling the system based on the rated performance of its components. After commissioning, the model was adjusted to reflect the actual performance and is now used as a diagnostic tool in the planned maintenance programme. The experience gained from the modelling resulted in stage 2, a 12.0 MWR expansion in cooling capacity, being assessed in a similar manner and the simulations used to optimise the plant design.

The first refrigeration plant at North Broken Hill mine was installed underground in 1967, had a capacity of 0.2 MWR and was used to cool the ventilation air required when deepening the main production and service shaft. This plant along with three small spot coolers with a total cooling capacity of approximately 0.1 MWR, were replaced with a new 0.5 MWR chilled water plant (Mew, 1977) in 1976 and used during the exploration of the Fitzpatrick ore body.

The first 1.8 MWR chiller set used to provide cooling for development of the Fitzpatrick ore body was installed underground in 1980 (Collison, 1982). A second set was installed in 1982 and a third in 1984 resulting in a total installed capacity of 5.4 MWR which should have been sufficient for the mining of the Fitzpatrick ore body.

The chiller sets provide cold water which was supplied to both indirect (coils) and direct contact (spray) coolers. Operational problems and design faults have resulted in no more than 3.5 MWR being consistently available and prompted a detailed review in 1987. This involved modelling the existing system and considering alternative equipment and arrangements within this overall system. An alternative option was to consider a completely new surface based system which would either completely replace the underground system or supplement it.

In 1990 a surface plant which supplies chilled water to a surface bulk air cooler at the main production shaft was selected. The installation was completed in 1991 and can provide up to 6.5 MWR which is used to cool the intake ventilation air. One of the 1.8 MWR underground sets is required to provide chilled service water and chilled water to the development coolers in the deepest section of the ore body.

## 2 REFRIGERATION SYSTEM MODELLING

The successful application of refrigeration in a mine is measured by the costs of installation and operation relative to the benefits of improved productivity. A mine is dynamic in that it is continually changing and consequently, the control of the refrigeration system should be able to adapt to these changes such that the cooling is applied in the most cost effective manner.

The amount of refrigeration required will vary with the mine heat load, the surface climatic conditions and the cooling power of the air required in the working places. In a mechanised mine with relatively short intake airways and cyclic operation of diesel powered equipment, all three of the above elements will vary and affect the control required.

In the first part of this section, the factors affecting the mine heat load, the importance of obtaining valid climatic data and the background to what are acceptable thermal environmental criteria leading to a full refrigeration load profile will be discussed.

The multiplicity of components within a refrigeration system and the complex interrelationships between them precludes the possibility of a simple numerical analysis being adequate to design and control such a system in a cost effective manner. The overall system

can be split into three subsystems which consider the chiller sets, the heat rejection and the mine load.

In the second part of this section, previous work on modelling of refrigeration systems is examined with respect to the air conditioning industry and mining. Most work has concentrated on the chiller sets and in particular compressor performance using theoretical flow and head coefficients for centrifugal machines.

An alternative approach is to use an empirical method of expressing compressor performance which is based on the actual refrigeration effect and the input power for a given compressor and refrigerant. The required model has been extended to include fully the heat rejection and load subsystems. A general algorithm which is the basis of all the different system models is given along with the refrigerant properties which are specific to the empirical method used.



## 2.1 Overall plant size

The mine refrigeration load is generally defined as the mine heat load less the cooling capacity of the ventilation air.

The mine heat load normally includes the effects of autocompression of the air in the intake airways, heat flow into the excavations from the surrounding rock surfaces, heat removed from the broken rock or any fissure water prior to leaving the intakes or working sections of the mine and the heat contribution resulting from the operation of any equipment used in the ore breaking and transportation mining processes.

The cooling capacity of the ventilation air depends on both the design thermal environmental conditions in the working places and the actual climatic conditions on surface. Working place conditions are limited by maximum allowable heat stress requirements and are normally a function of the extent of the increased mining costs that occur as a result of less than ideal conditions and therefore productivities.

As a result, the amount of cooling required to be supplied by a mine refrigeration system is not constant. Consequently, the design and the control of the system must be able to cope with the variations in duty in the most cost effective manner.

### 2.1.1 Mine heat load

#### Heat from autocompression

Ventilation air which is on surface relative to that underground in the working areas of the mine has a higher potential energy which is a function of the difference in elevation. As air flows down the intake shafts and airways to the working horizons, most of this potential energy is converted to enthalpy and results in increases in temperature, pressure and internal energy (Hemp, 1982).

The greater the difference in elevation (depth of mine workings) the greater the increases which are more commonly known as the effects of autocompression. In the return airways to surface, the reverse effect known as auto-decompression takes place although this has no effect on the conditions in the working places.

The effects of autocompression in a mine are virtually independent of airflow rate although its contribution to the total mine heat load is air quantity dependent. Despite the disparate mining methods and consequent differences in productivity involved in metalliferous mining, the specific ventilation rates (tonnes of air supplied per tonne of rock broken) for the majority of mines, fall within the fairly narrow range of between 5 and 10 tonne/tonne (Howes, 1990).

## Heat flow from the surrounding rock

The heat flow from the surrounding rock in the intake airways and the actual mine workings is a complex function of the thermal properties of the rock and the air, the boundary conditions including the effects of moisture and the proximity of other mine openings, the time since excavation and the ventilation and inlet air temperature history. The cyclic effects of other heat sources such as where mechanised mining equipment operates, can further complicate the assessment of heat flow and may result in transient values which are significantly different than the longer term average heat flows (Howes, 1988).

For a typical airway of 20 m<sup>2</sup> cross sectional area, of average wetness in rock with a medium value of thermal conductivity and three years since excavation, the expected heat flow is of the order of 20 W/m for each degree difference between the virgin rock and the dry bulb temperature of the air (Howes, 1988). Larger and wetter "young" airways which have been open for only six months and have high ventilation rates would have heat flows about 2.5 times greater. Smaller and drier "old" airways that have been open for ten years and have low ventilation rates would have heat flows about 2.5 times lower.

Heat flow from the surrounding rock can be the main contribution to the total heat load for mines with

scattered low productivity working areas which are remote from the main intake shafts and have high virgin rock temperatures. Because heat flow from the rock is a function of the difference between the air and rock temperatures, its contribution to the total will also vary seasonally with the change in surface climatic conditions unless surface bulk air cooling of the intake ventilation air is practised.

#### Broken rock and fissure water

The heat load resulting from cooling the rock broken and removed from a mine will depend on the rock and air temperatures and whether the material is removed exclusively through the intake airways. In metal mines this tends to be the general case and the rock will normally be cooled to within a couple of degrees of the intake air dry bulb temperature. This will also depend on the moisture content of the broken rock and any seasonal variation in heat load or whether surface bulk air cooling is in use.

Fissure water entering the mine may also add to the heat load in a similar manner to that for the broken rock. The thermal capacity of water is approximately 4.5 times that of rock and if fissure water enters the mine in significant amounts it may have a profound effect on the total heat load. The specific water inflow rates are typically between 0.2 and 5 tonnes of water per tonne of rock broken. Provided that the

water is removed from the mine through pipes and not open drains, the contribution to the heat load is dependent on the dry bulb temperature of the air.

#### Heat from mine equipment

The operation of mine equipment normally adds heat to the mine air. A possible exception is that powered by compressed air, however, this is usually small enough to be ignored. For pumps, hoists and conveyors which lift material against gravity, the contribution to the mine heat load results from motor inefficiencies and friction. For other equipment such as lighting, fans, drills, short and long haul rock transportation equipment, all the input energy ends up as part of the mine heat load (Hemp, 1982).

The amount of electric power used underground in mines (excluding pumps and hoists) is usually between 10 and 25 kWh/tonne. This could be as high as 50 kWh/tonne where rock handling is carried out almost exclusively with electric powered equipment such as scrapers. Most electrical equipment is operated continuously at a more or less uniform load and consequently the use of electric power underground results in a relatively constant contribution to the mine heat load.

In mines that are more mechanised with concentrated mining in high productivity stopes, diesel powered equipment currently meets the optimum cost and

mobility requirements. The diesel engine efficiency results in a heat load which is approximately three times the engine output and can result in peak heat outputs of up to 800 kW. Machine operation can be broadly classified into either semi-continuous such as moving broken rock between a draw point and an ore pass or strongly cyclic such as that which occurs during rock removal in a development heading.

In a semi-continuous operation the peak output heat release is approximately 10 kWh/tonne. This, however, only occurs for relatively short periods such as when the bucket is being filled. The 24 hour average heat release is of the order of 4 kWh/tonne for diesel powered load-haul-dump equipment.

The mass of rock surrounding the excavation in which the equipment operates semi-continuously, acts as a thermal flywheel with heat being stored and released. This dampens the peak equipment heat outputs and the contribution to the mine heat load can be considered as relatively constant and equal to the average 24 hour values. The operation of mine service vehicles and some inevitable re-handling of the broken rock (secondary blasting etc) will result in an actual diesel equipment heat load some 25% higher than the 24 hour average.

In cyclic mining operations such as that which occurs in mine development and cut and fill stoping, the peak

values for heat release can be as high as 70 kWh/tonne where a load-haul-dump machine is working with diesel powered haulage trucks. A typical 24 hour average would be 6.5 kWh/tonne although a limited mining infrastructure often necessitates re-handling of the broken rock and average values which are two or three times higher. Although the storage and release of heat from the rock dampens the peak values, the heat increase to the air is two or three times the 24 hour average values when the diesel powered equipment is operating (Howes, 1988).

In a recent detailed study of the heat flow in a development heading with a VRT of 50°C (Nixon, 1992), the average amount of heat removed by the ventilation air was 254 kW of which the rock contributed less than half at 118 kW, diesel equipment 105 kW, electric equipment (excluding fans) 11 kW, explosives 9 kW and the broken rock 12 kW. The relationship between heat removed from the ventilation air and the mining operations is illustrated in figure 2.1.

From the 37 temperature surveys undertaken during the study, the average wet bulb temperature increases relative to the intake air are given in the Table 2.1. The wet bulb temperature increases predicted with the heat and moisture transfer simulations using the average heat loads and for multiples of this are also given in Table 2.2.

The underestimate of the face wet bulb temperature is a result of the presumption in the simulation that the ducting supplies all the air to the working face. With a standard 20 to 30 m duct to face distance the actual face air quantity is between half and two thirds of that available at the end of the duct. This would then result in local wet bulb temperature increases at the face some 50% greater than predicted.

The two distinct thermal environments that result from the cyclic operation of large diesel powered equipment needs to be accommodated when assessing the heat load and designing the ventilation and cooling system.

#### Summary of heat loads

To illustrate the effect of the mining methods and mechanisation on the heat load, Table 2.3 compares the heat load in a typical deep South African gold mine with an Australian base metal mine using a mechanised cut and fill mining method. Both mines have a mean rock breaking virgin rock temperature of 55°C and produce 1.0 million tonnes of ore per year. The surface climatic conditions for both mines are the same and the geothermal gradient for the Australian base metal mine is twice that for the South African gold mine i.e. the mean rock breaking depths are 1650 and 3300 m respectively.



Figure 2.1 - Variation in entering and leaving wet bulb temperatures, heat removed by the ventilation air related to equipment operation

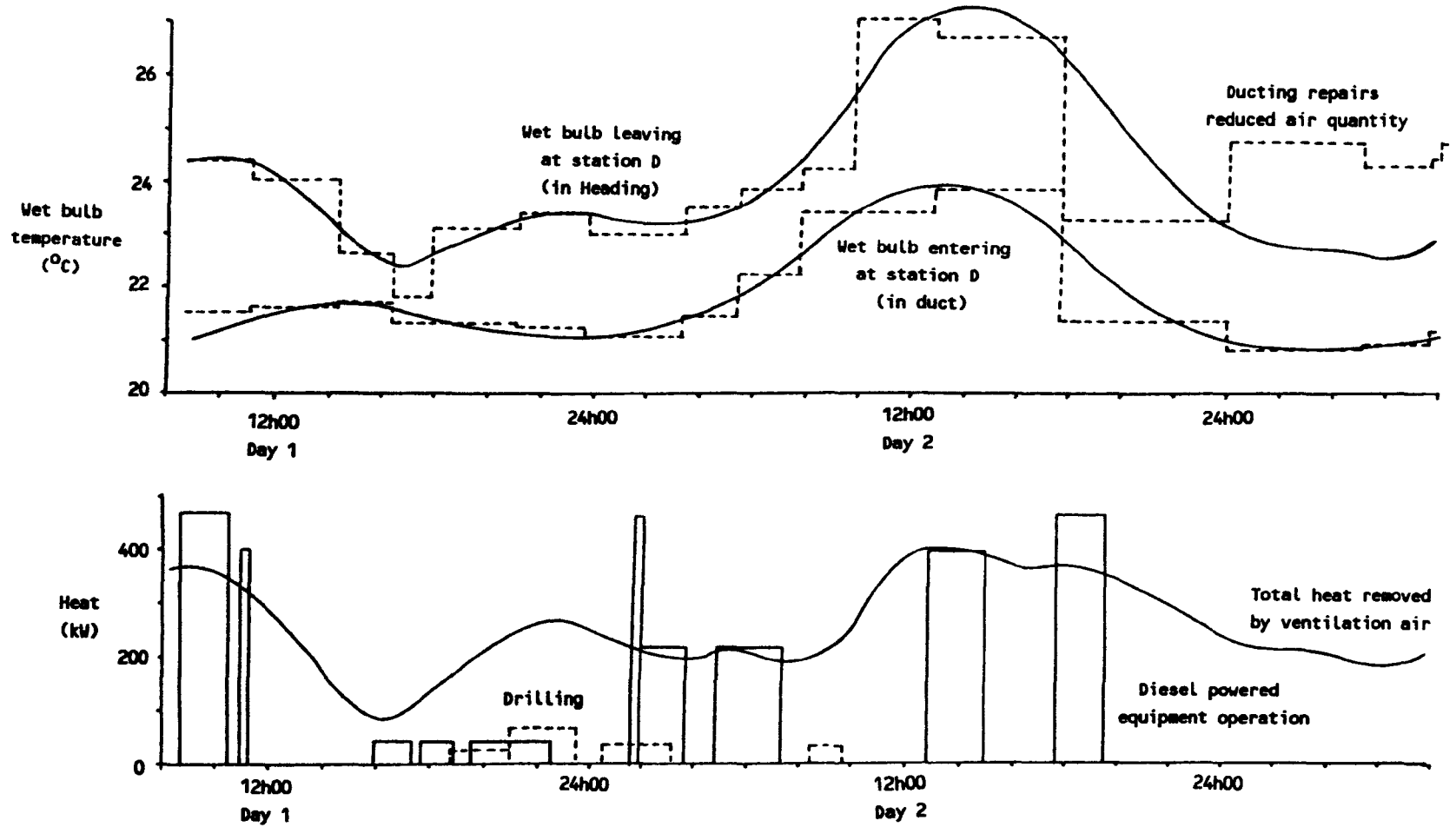

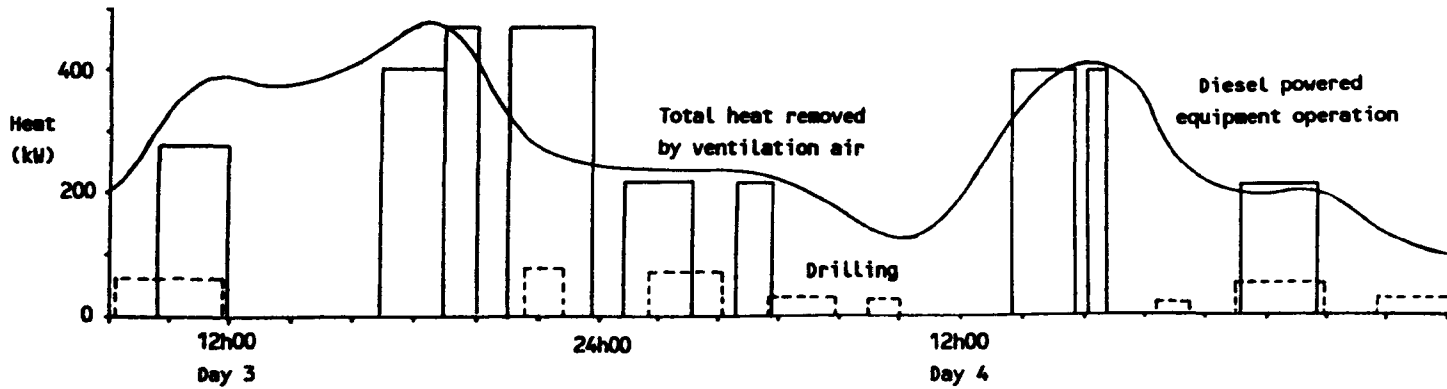
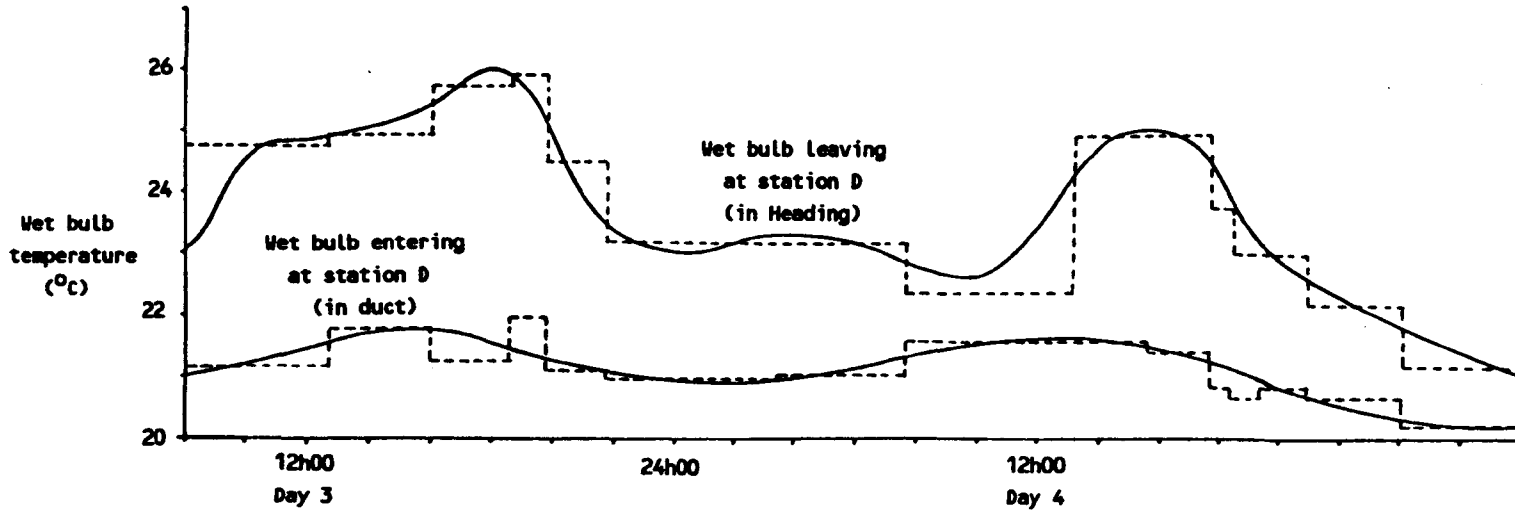

Figure 2.1 (cont) - Variation in entering and leaving wet bulb temperatures, heat removed by the ventilation air related to equipment operation

**Table 2.1 - Average wet bulb temperature increases relative to the intake air**

Mining operation	Working face	Leaving face box	Leaving heading
LHD clearing the face	4.8°C	3.2°C	3.7°C
LHD and truck operation			3.0°C
Face drilling	2.0°C	1.5°C	1.8°C
Other work	1.8°C	1.5°C	1.8°C

**Table 2.2 - Expected wet bulb temperature increases based on the average heat load**

Location and parameter	Spot and linear heat loads			
	Average x 1	Average x 2	Average x 3	Average x 4
Wet bulb at face (°C)	1.3	2.2	3.0	3.6
Leaving face box (°C)	1.6	2.6	3.4	4.2
Leaving heading (°C)	2.2	3.1	4.0	5.0
Total heat increase (kW)	252	364	482	606
Heat flow from rock (kW)	115	90	71	58
Total moisture increase (g/s)	107	141	190	256
Moisture evaporation (g/s)	96	120	158	213

**Table 2.3 - Comparative mine heat loads**

	Deep gold mine	Mechanised mine
Total heat load (MW)	36.1	20.2
Autocompression (%)	38	43
Surrounding rock (%)	48	16
Broken rock (%)	2	4
Fissure water (%)	5	4
Electrical equipment (%)	7	6
Diesel equipment (%)	-	27*
Total	100	100

\* If the 24 hour average value is used the total heat load is reduced to 16.9 MW and the diesel equipment contribution is 13% of the total.

### 2.1.2 Design surface climatic conditions

Most deep Australian mines are located in subtropical arid desert or semi-desert regions. The surface wet and dry bulb temperatures during the summer months are higher than those experienced in Europe or in many other mining areas, including the main South African gold mining areas.

The wet and dry bulb temperatures used for design and given in Table 2.4, are based on measurements either taken at the mine site or obtained from the nearest meteorological stations. The comparative design surface climatic conditions for South African gold mines are similar to those given for Broken Hill in this table.

The 2.5% design values are used to determine the worst underground conditions and are those temperatures which are only exceeded for 2.5% of the four month summer period i.e. for 72 hours. If a refrigeration plant is required, these temperatures will be used to determine the minimum size of plant. The other three pairs of temperatures are the mean values for the three main climatic periods and they could be used to give an indication of the plant operating costs.

The summary of surface climatic conditions given in Table 2.4 is obtained by averaging the observations over several years. Figure 2.2 shows the distribution

of wet and dry bulb temperatures over three summer periods at Mount Isa and serves to illustrate the wide spread of values that is possible in the data between years. In considering the operation of a refrigeration plant it is advantageous to refer to the temperature data for the whole year - the temperatures given in figure 2.3 are based on observations made over a ten year period at Mount Isa.

The number of hours during which a given temperature is exceeded can be established and the operational parameters of the refrigeration plant determined for this condition. By examining these parameters for, say, wet bulb temperature increments of 2°C the refrigeration load profile can be defined and the most effective plant arrangement can be determined.

The pattern of occurrence of high temperatures during the summer period also has an important bearing on the design elements of the overall refrigeration system, such as the capacities of the surface and underground storage dams if these are required.

The values given in Table 2.5 are the number of half-hour periods that a given temperature was exceeded during January, 1982, at Mount Isa. This demonstrates that the total of 72 hours during which the 2.5% design condition prevails is contained in five to eight peak temperature periods, each of which lasts for several days.

Underground, the maximum and minimum temperatures occur after the temperature extremes on surface and the magnitude of the surface fluctuations are dampened by the time the air reaches the underground working place (Vost, 1980). The extent of the damping is influenced by the amount of surrounding rock which acts as a thermal flywheel and it is therefore more significant in South African gold mines where the contribution to the heat load from this source is much greater than in the Australian mechanised mines.

Figure 2.2 - Mount Isa distribution of wet and dry bulb temperatures over three summers

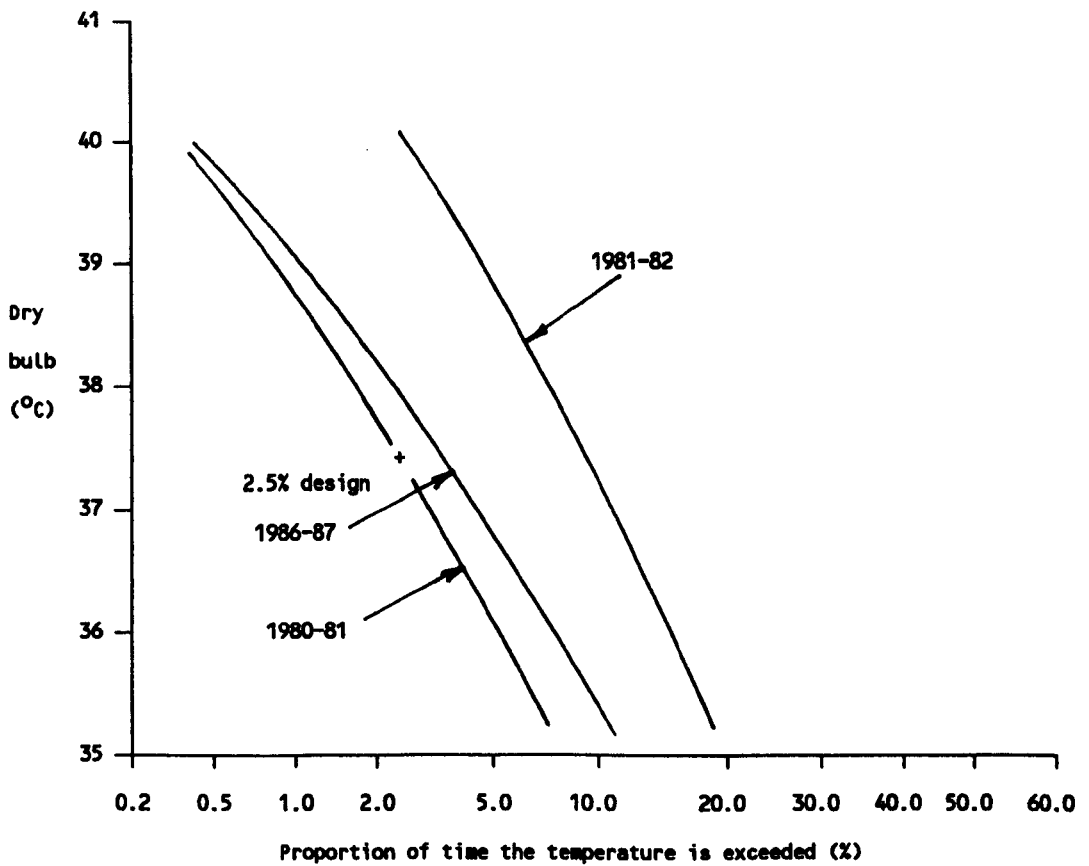
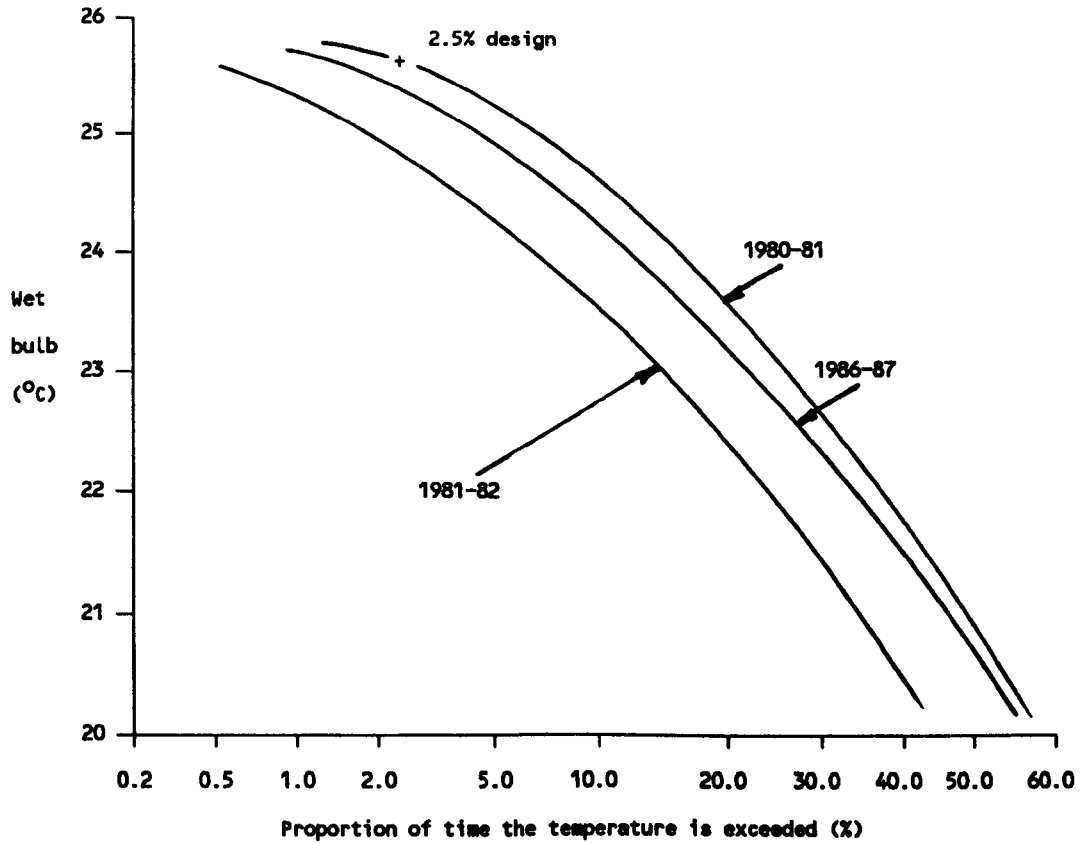





Table 2.4 - Design surface wet and dry bulb temperatures

Mine	Location	2.5X design	Mean summer	Mid-seasonal	Mean winter
Jabiluka	Australia	27.5/35.0	26.0/34.0	23.0/32.0	20.0/30.0
Emperor	Fiji	26.0/32.5	24.5/30.0	23.0/27.5	21.0/25.0
Mount Isa	Australia	25.5/37.5	20.5/30.0	15.5/25.0	11.0/20.0
Olympic Dam	Australia	24.5/40.0	18.5/25.5	14.0/21.0	8.0/15.0
Palabora	S Africa	24.5/35.0	22.5/32.5	18.0/27.5	12.0/20.0
Broken Hill	Australia	22.0/37.0	17.0/25.5	13.0/20.0	8.0/14.0
Lepanto	Phillipines	21.5/30.5	20.5/28.5	18.5/25.5	15.5/21.5

Table 2.5 - Number of half-hourly periods in which a given temperature is exceeded

Date	Wet bulb temperature (°C)						Dry bulb temperature (°C)					
	20	21	22	23	24	25	35	36	37	38	39	40
1	45	39	21	4			24	22	19	15	14	12
2	48	41	35	26	13		24	22	20	17	15	13
3	48	48	46	39	27	11	14	12	11	9	7	4
4	41	34	25	15			22	17	15	10	8	
5	14	10					23	22	19	17	14	13
6	13	2					28	26	21	19	16	14
7	18						28	26	23	21	18	16
9	44	42	36	28	13		15	14	12	11	10	9
10	48	48	29	3			12	9	1			
11	48	48	35	14	5		9	8	4			
12	48	48	48	29	19		19	17	16	11	3	
13	48	48	48	47	23	2	14	13	11	10	5	
14	33	30	29	17			22	14	11	5		
15	26	16	1				22	19	16	11	8	1
16	23	20	13				23	20	17	11	8	
17	40	36	20	10			21	17	14	7		
18	48	45	26	2			21	18	16	9	1	
19	48	48	5				21	20	19	16	13	5
20	48	48	38	4			25	22	20	17	15	9
21	48	48	30	6			26	23	19	17	14	10
22	48	48	44	27	2		17	14	10	7	5	1
23	48	48	46	30	11		13	6	3	1		
24	48	48	48	33	23	1	15	7	6			
25	48	48	48	41	19	6	15	10	4			
26	48	48	39	16	11		15	11	2			
27	48	48	48	38	18		18	17	11	9	4	
28	48	48	30	20	10		20	18	17	15	14	3
29	48	48	26	10	1		24	20	16	15	12	3
30	48	40	10	7			24	22	19	15	14	12
31	48	46	26	8			24	22	20	17	15	13

### 2.1.3 Acceptable thermal environmental criteria

Increasing heat stress causes discomfort, reductions in productivity, increased accident rates and ultimately death due to heat stroke. Ventilation and refrigeration systems are used to minimise the adverse effects of heat stress in a mine. The design of any ventilation and refrigeration system should therefore incorporate the assessment of both a safe and a cost effective strategy in dealing with a potential heat stress problem.

A safe heat stress limit would define the worst thermal environmental conditions that could be tolerated. It would relate to the limiting climatic condition and the minimum possible ventilation. This would invariably involve a considerable reduction in productivity and a cost effective strategy would balance the increased ventilation and refrigeration costs with improvements in productivity.

Controlling the exposure of mining personnel to adverse thermal environments in mines is normally based on heat stress rather than comfort and there is no reason why this should not continue to be so. The application of reduced length shifts is to warn mine personnel that the limiting thermal environmental condition is being approached and that corrective ventilation and cooling procedures must be instigated.

## Heat balance

In simplistic terms, the operation of the human engine is analogous to any other engine. The conversion of the chemical energy resulting from the oxidation of food to useful mechanical energy is inefficient. In a diesel engine the efficiency is of the order of 33% and in a human engine less than 20%. This means that there will be at least five times as much heat produced by the metabolic process as useful work done.

Metabolic energy production is related to the rate at which oxygen is consumed and is approximately 340 W for each litre of oxygen consumed per minute. Using measured oxygen consumption and, assuming an average body surface area of 2.0 m<sup>2</sup>, the metabolic energy production associated with different mining tasks (Morrison, 1968) is:-

- Rest, 50 W/m<sup>2</sup>
- Light work, 75 to 125 W/m<sup>2</sup> (machine operation i.e. LHD or drill jumbo operator)
- Medium work, 125 to 175 W/m<sup>2</sup> (airleg drilling, light construction work)
- Hard work, 175 to 275 W/m<sup>2</sup> (barring down, building bulkheads and timbering)
- Very hard work, over 275 W/m<sup>2</sup> (shovelling rock)

A heat balance will be achieved when the rate of producing heat (the metabolic heat production rate) is

equal to the rate at which the body can reject heat. Heat is rejected from the body mainly by radiation, convection and evaporation (Stewart, 1981). The heat exchange between the lungs and the air inhaled and exhaled is normally less than 5% of the total and can, therefore, usually be ignored. Any heat not rejected to the surroundings will cause an increase in body core temperature.

Since heat stress is related to the balance between the body and the surrounding thermal environment, the main parameters required to be known when determining acceptable conditions are those associated with the heat production and transfer mechanisms. These can be summarised as follows:-

- Metabolic heat production rates ( $M - W$ )
- Skin surface area ( $A_s$ ) (and effects of clothing)
- Dry bulb temperature ( $t_{db}$ )
- Radiant temperature ( $t_r$ )
- Air velocity ( $V$ )
- Air pressure ( $P$ )
- Air vapour pressure ( $e_a$ )

The rate of heat transfer to or from the environment depends on the equilibrium skin temperature  $t_s$  and the sweat rate  $S_r$ . These in turn depend on the response of the body to the imposed heat stress and the effect of thermoregulation.

## Thermoregulation

The body contains temperature sensitive structures which send impulses to the brain at a rate depending on the temperature. Both hot and cold signals can be differentiated and the thermoregulatory response activated according to which signal predominates.

If "cold" signals are dominant, body heat loss is reduced by minimising the peripheral blood supply to the skin and additional metabolic heat is generated by shivering. If "hot" signals predominate, body heat loss is maximised by increasing the peripheral blood flow to the skin and by producing sweat which can be evaporated from the skin surface. These processes start when the body core temperature is about 36°C.

A typical set of thermoregulatory responses to work in hot conditions is illustrated in Figure 2.4. The portion of the curve illustrated with broken lines represents the start of work where both the skin temperature and the core temperature increase. As the "hot" signals dominate, the increased peripheral blood circulation and sweating from the skin surface allow the skin temperature to increase whilst the body core temperature remains essentially constant.

This thermoregulatory process is controlled by the imbalance between the "hot" and "cold" signals and consequently the body temperature is not maintained at

a fixed level. There is a limit to the increase in peripheral blood supply and when the body surface is fully wet from sweat, evaporation cannot be increased. The thermoregulatory process cannot therefore maintain the almost constant core temperature and eventually there is a steeper increase in both skin and body core temperatures.

#### Limiting body temperatures

A safe core temperature is that which will present a negligible risk of incurring a heat related illness. Experience with mine personnel exposed to and working in hot conditions has indicated that this should not be greater than 40°C (Wyndham, 1966). Since both the response to heat and the degree of acclimatisation varies between individuals, it is not sufficient to simply read off a value of skin temperature  $t_s$  which corresponds to this limiting core temperature from Figure 2.4.

The curves relating the skin and core temperatures in figure 2.4 are the mean response of a representative population and, by definition, half of the personnel will exceed the limiting temperature. Observations have shown that the human response to hot conditions follows a log normal distribution (Wyndham, 1974). Figure 2.5 illustrates how a limiting core temperature can be related to an equilibrium skin temperature  $t_s^*$  by incorporating an acceptable risk.

A risk of a one-in-a-million chance that a limiting core temperature will be exceeded is generally found to be acceptable in mining and is used to identify the equilibrium skin temperature  $t_s^*$  related to risk. A limiting core temperature of  $40^{\circ}\text{C}$  corresponds to a mean response of just over  $38^{\circ}\text{C}$  for acclimatised personnel. The American Conference of Governmental Industrial Hygienists (ACGIH, 1986) threshold limit values for heat stress are based on a limiting deep body temperature of  $38^{\circ}\text{C}$ .

#### Cooling power of the air

Almost 100 different heat stress indices have been developed and, in general, these involve one or more of the parameters outlined in the section on heat balance. Since very few take into account all of the parameters the majority can only partially represent the thermal environment. The rate of heat transfer to the surrounding environment or the cooling power (CP) can be determined from (Stewart, 1981):-

$$\text{CP} = h_r (t_s - t_r) + h_c (t_s - t_{db}) + w h_e (e_s - e_a)$$

Where  $h_r$ ,  $h_c$  and  $h_e$  are the radiative, convective and evaporative heat transfer coefficients,  $e_s$  is the saturated vapour pressure at the skin temperature and  $w$  is the proportion of the skin surface area which is wet with sweat. Since  $t_s$  and  $w$  vary with the metabolic heat generation rate, the cooling power is related to

**Figure 2.4 - Thermoregulation and equilibrium core and skin temperatures**

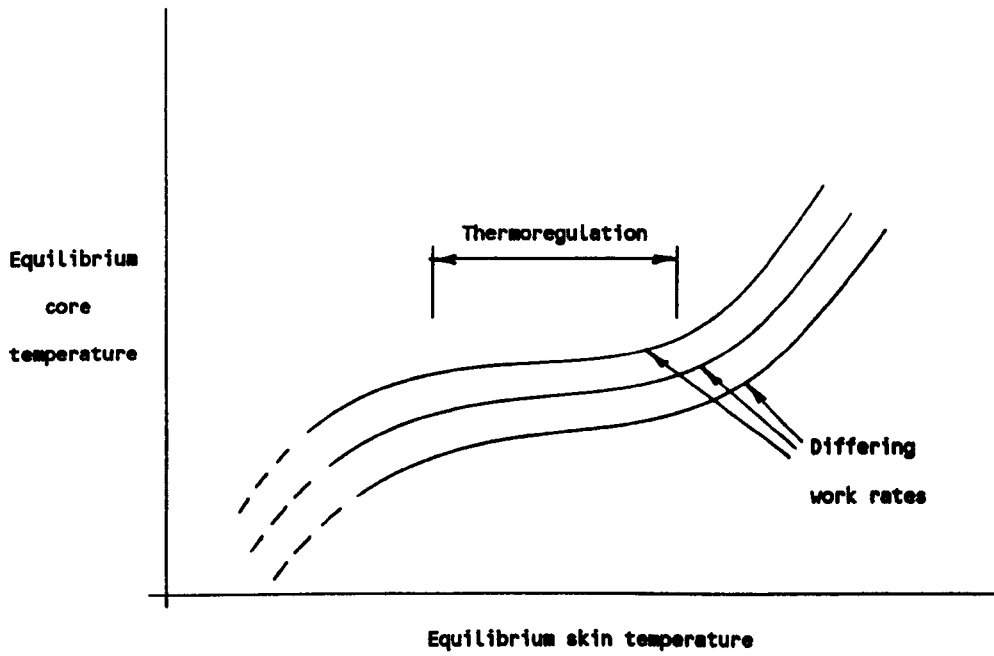

**Figure 2.5 - Equilibrium skin temperatures and risk**

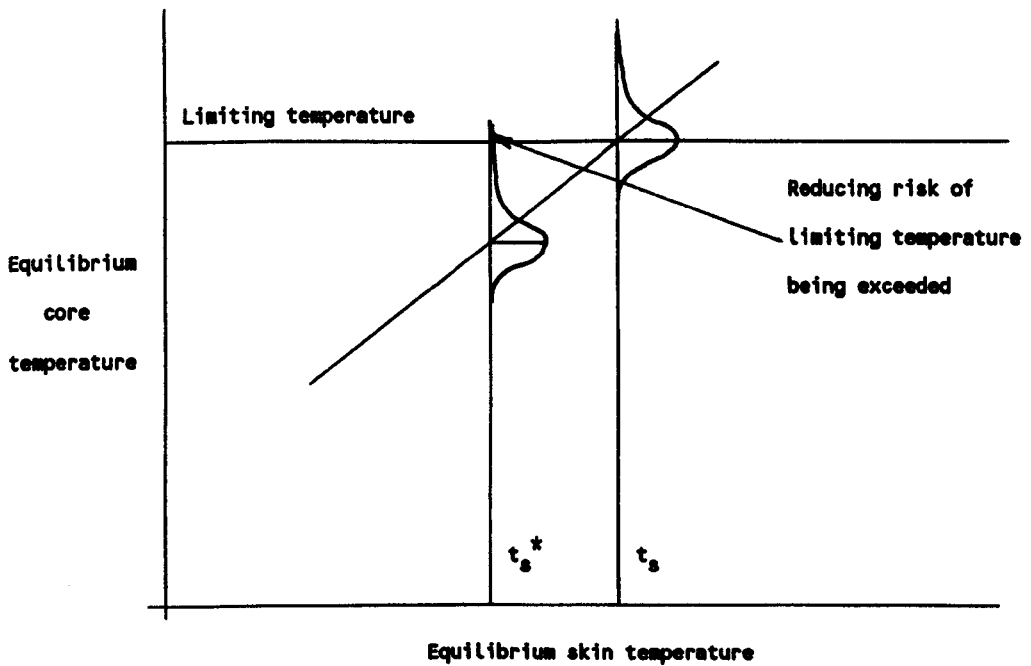



the work rate. If the values of  $t_s$  and  $w$  can be related to a safe limiting temperature, it follows that, providing that the metabolic heat generation rate of a particular mining task is less than the cooling power of the surrounding environment, then a safe or acceptable level of heat stress will prevail.

Cooling power is therefore an "ideal" heat stress index which is based on the heat balance equation and allows for the variability in human responses by introducing the element of risk. Its main drawback is that its calculation is complex and iterative and at the moment a simple instrument that can be used in underground working places is not available.

An algorithm which can be used to obtain numerical values is given in Appendix 1. The equilibrium skin temperatures and sweat rates used in the calculations are based on the response of acclimatised personnel. Charts can be developed which may be used to assess cooling power and heat stress underground.

Care should be exercised when using tables and charts of cooling power which originate from South Africa (Stewart, 1982) where an arbitrary increase in air velocity of 0.3 m/s is applied. This is claimed to allow for the effects of body movement and, even in narrow South African gold and platinum stopes, it is difficult to justify.

In a working place with a uniform air velocity, body movements will be both with and against the air current in equal measure and the relative velocity of body movement will average out to the air velocity.

#### Other heat stress indicators

Other indices used to classify the thermal environment fall into two main categories - instruments that simulate heat exchange and empirical scales relating physiological and subjective responses. In the first category, the main instruments used are wet and dry bulb thermometers, wet and dry globe thermometers and the wet kata thermometer.

In the second category, the main empirical scales used are effective temperature, wet bulb globe temperature and the predicted fourth hour sweat rate.

Although wet bulb temperature is an important heat stress parameter, its sole use is fraught with problems. It can be used as an indicator that a potential problem exists i.e. in South Africa only personnel that have undergone an acclimatisation procedure may work where the wet bulb exceeds 27.5°C.

Where mining and ventilation practices result in a relatively narrow spread of environmental conditions in the working places, a single index such as wet bulb temperature can be used as a practical guide.

For a typical air velocity of between 0.5 and 1.0 m/s, wet bulb temperatures in excess of 32.5°C are invariably associated with cooling powers of less than 150 W/m<sup>2</sup> and it will therefore be impractical to expect anything more than the lightest of work rates to be sustained without increasing the risk of heat stroke. In a similar manner a wet bulb temperature of 30.0°C would be a practical limit for sustained hard work. These limits would be significantly different if the air velocities were much lower.

The wet kata thermometer measures the cooling power of an environment using a fully wet surface maintained at 36.5°C. The size of the wet kata bulb, the constant surface temperature and its fully wet surface limit the accuracy of the method to directly measure cooling power. Despite these inaccuracies the kata thermometer is considered to be an acceptable index of heat stress particularly in hot humid conditions (Stewart, 1982).

The major drawbacks are the necessity to carry hot water and the fragile nature of the thermometer. It is, however, a basis for a suitable instrument to directly measure cooling power.

Effective temperature is an index of relative equal thermal sensations which was determined by the successive comparison of different combinations of wet and dry bulb temperatures and air velocity and related to saturated conditions and minimum air velocity

(Yaglou, 1926). The two nomograms available for obtaining the effective temperature are the normal and basic scales. The normal scale is applicable to men normally clothed and undertaking light to moderate work whereas the basic scale is used for men stripped to the waist.

Although effective temperature includes air velocity as well as the wet and dry bulb temperatures, it is based on subjective assessment and does not include work rate. European coal mines use the basic effective temperature scale as a heat stress index (Graveling, 1988). In Germany the shift length is reduced to five hours when the effective temperature exceeds 29°C.

Over a range of air velocities of 0.15 to 1.0 m/s and differences between the wet and dry bulb temperatures of 2 to 12°C, both of which are not untypical, the cooling power varies between 150 and 250 W/m<sup>2</sup> for the same effective temperature of 29°C.

When using the wet bulb globe temperature index (ACGIH, 1986), cognizance is taken that the dry bulb and radiant temperatures as well as the wet bulb also influence heat stress. For most underground operations where the radiant and the dry bulb temperatures are within a degree or so of each other, the wet bulb globe temperature (WBGT) can be obtained from:-

$$\text{WBGT} = 0.7 t_{wb} + t_{db}$$

The ACGIH adopted threshold limit values for heat stress provide a fairly comprehensive range of permissible values which are related to the rate of work. In broad terms, the wet bulb globe temperature limits for light, medium and hard work are 30, 26.7 and 25°C respectively.

The wet bulb globe temperature does not include air velocity and when equating the work rates to cooling power, air velocities of 0.12, 0.19 and 0.38 m/s are required. These are reasonably consistent irrespective of the difference in wet and dry bulb temperatures.

Air velocities of less than 0.2 m/s are rare when practising modern mining methods although they may be encountered in difficult to ventilate non-mechanised mining methods such as undercut and fill and square set timbered stoping. Where mechanised equipment such as diesel powered haulage units are used, the minimum exhaust gas air dilution requirements result in air velocities of between 0.5 and 1.0 m/s.

Applying the wet bulb globe temperature as a heat stress index would result in safe values and in most situations would result in significant overestimates of the actual heat stress conditions.

The predicted four hour sweat rate ( $P_4SR$ ) can be obtained from a nomogram combining wet and dry bulb or globe temperatures, air velocity, work rate and

clothing (McPherson, 1960). The basic fourth hour sweat rate ( $B_4SR$ ) is obtained from the dry bulb and wet bulb temperatures and is adjusted for clothing and the work rate. The adjustment for clothing is  $0^{\circ}C$  for shorts and  $1^{\circ}C$  for overalls and the adjustment for work rate varies from  $0^{\circ}C$  when resting to  $4^{\circ}C$  at a work rate of  $250 W/m^2$ .

The  $B_4SR$  obtained from the nomogram is then adjusted for the work rate using relationships which are clothing dependent. This heat stress index was developed as a result of work undertaken between 1944 and 1946 at the National Hospital for Nervous Diseases in Queen Square, London. The index was subsequently validated by a comprehensive series of experiments undertaken between 1948 and 1953 in Singapore.

Two factors are important when considering the  $P_4SR$  index. The first is that it arose from a recognition that effective temperature does not provide a suitable heat stress index for the full range of hot conditions that may be encountered. Secondly, the index was based mainly on wartime activities where the prime objective was to determine the maximum activity that could be tolerated before collapse. Mining does not fit into this category in that life does not depend on high activity at limiting heat stress levels.

Despite this limitation the index gives a good indication of what constitutes a limiting heat stress

condition. It recognises the importance of metabolic (work) rate and the influence of clothing when defining heat stress conditions. A limiting heat stress condition defined by a  $P_4SR$  of between 4.5 and 5.0 is valid as a limiting condition in mining. The index is not often used, probably because of the complexity of the nomogram.

To summarise, for a general application covering all types of mining and environmental conditions, the cooling power concept will provide a consistent assessment of heat stress. Where mining operations are such that there is a small variation in most of the parameters used to assess heat stress, a single parameter such as wet bulb temperature can be used as a practical guide. The advantage being that this can be readily measured by all personnel involved and has a straightforward interpretation.

The measurement of heat strain

The measurement of heat strain is an alternative to measuring the environment in which the exposure takes place. The four main parameters of directly evaluating heat strain are body core temperature, heart rate, skin temperature and weight loss through sweating. Although all of these parameters can be evaluated under laboratory conditions, their extension to the underground working place results in unsurmountable practical problems.

Body core temperature measurements are usually invasive and have a low acceptability. Heart rate measurements require interruptions to the work processes and require calibration. Skin temperature measurements involve a weighted average from representative sites and are subject to practical limitations in the work place. Sweat loss requires the accurate measurement of body mass which also has practical limitations in the work place.

Although any of the above will indicate that a problem may exist, the reason for the problem and therefore a possible solution is not indicated. Consequently it is unlikely that a direct measurement of heat strain will become a practical proposition in mines and the measurement of the working environment using heat stress indices will remain the most suitable method of evaluating the hazards encountered in hot mines.

#### Actual heat stroke risks

On the assumption that the limiting thermal environmental conditions should be based on heat stress rather than comfort, the acceptance of a risk of heat stroke occurring is implicit. Air cooling power was based on a one-in-a-million chance that a core temperature of 40°C will be exceeded. Heat stroke is not automatic with a greater than 40°C core temperature but it becomes more likely.



On South African gold mines between 1970 and 1979, the actual risk of heat stroke occurring was of the order of one-in-six-million. If a true thermal equilibrium existed it could be argued that the risk should be lower. Each heat stroke case is investigated and almost invariably an abnormal condition existed such as a fever or excessive peer pressure. Limiting the occurrence of heat stroke therefore becomes linked to an educational and management programme.

During the eight years between 1980 and 1988, the average number of personnel employed underground by the gold mines was 375 000 of which 68% or 254 000 worked in areas where the wet bulb temperature exceeded 27.5°C. There have been 103 heat stroke cases during this period with no fatalities in the last three years. The incidence of heat stroke was one-in-five-million.

Investigations of all heat stroke cases have indicated that they often have multiple causes with 64% resulting from strenuous work, 52% from dehydration (80% attributed to an excessive alcohol intake) and 29% resulting from work in very hot conditions of over 32.5°C wet bulb temperature.

In Australian terms, work by C H Wyndham at Mount Isa (Wyndham, 1967) confirmed that employees working in "hot" conditions became acclimatised naturally. This takes several weeks and is the period of greatest risk

from heat stroke. It can be reduced by the selection and education of personnel. Selection is concerned with ensuring that heat intolerant personnel are not exposed to "hot" conditions. In South Africa during 1988, heat tolerance testing of new personnel showed that 44% were heat tolerant, 2% were heat intolerant and 54% required acclimatisation.

Using the South African data, the level of risk is such that a heat stroke case could be expected once every 20 years for each 1000 underground employees working in "hot" conditions. It could be argued that Australian miners, because of a greater continuity of employment than South African miners, are more aware of the risks of working in "hot" conditions and the actual risk would be substantially reduced. This is borne out by the absence of a recorded heat stroke case in an Australian mine.

#### Application of heat stress limits

The two main reasons for assessing the level of heat stress in a mine are:-

- to assess the average heat stress which can then be used to determine the optimum cooling and ventilation when related to productivity.
- to assess the limiting heat stress conditions resulting from the normal spread of values about an average condition.

In any system using ventilation and refrigeration to control the thermal environment, there will be a spread of actual values about the mean condition. This is associated with the dynamic nature of the mining processes and the inevitable step function resulting from implementing most corrective actions. For example, in a development heading, the initial face conditions will be better than average with short duct lengths, low leakage and smaller heat gains. The face conditions will worsen as the face advances.

The actual spread of values will depend on site specific conditions. In the Enargite mine of Lepanto in the Philippines, from a total of 169 working places surveyed during June 1989, the mean wet bulb temperature was 32.0°C with a standard deviation of 1.7°C. Of significance was both the high mean wet bulb and the large standard deviation as illustrated in figure 2.6. Statistically it is expected that 16% (27 workplaces) will have wet bulbs over 33.7°C and 2% (3 workplaces) will have wet bulbs over 35.4°C.

Reducing the mean wet bulb temperature by 3°C would still result in three or four working places with wet bulbs above 32.5°C. This example serves to illustrate that in addition to providing optimum mean conditions, the ventilation and refrigeration systems should be designed to minimise the standard deviation about this mean. Despite the very high wet bulb temperatures on this mine, there were no known cases of heat stroke

although the productivity in the deeper and hotter sections of the mine was significantly lower than in other sections.

Figure 2.7 illustrates a normal distribution about a mean value and the application of six hour (reduced shift length) and stop work. The mean condition is that based on optimum productivity. The six hour work criteria is a warning to the mine management that the ventilation and refrigeration control systems are not meeting the requirements and that potential heat stress conditions exist. Stop work conditions are a recognition that personnel would have difficulty sustaining even low work rates in that environment.

When applying cooling power as a heat stress index it is important to recognise that the heat balance is based on essentially nude man. The amount of clothing worn underground depends on both safety requirements and the air temperatures and normally decreases with decreasing cooling power. Clothing will generally add an additional thermal resistance between the skin and the surrounding air and therefore reduce the cooling power of the environment (Murray-Smith, 1987).

Until an expression is developed which takes into account clothing, the following adjustment is used for air cooling powers over  $125 \text{ W/m}^2$ .

$$CP^* = 0.5 CP + 62.5$$

Where  $CP^*$  is the cooling power corrected for clothing. When the cooling power is less than  $125 \text{ W/m}^2$ , no clothing correction is applied since it is assumed that the minimum amount of clothing is being worn.

This suggested correction can only be considered as a logical deduction. It was tested using South African productivity data (Howes, 1978a), was adjusted to give the best fit to the correlation and is consistent with the  $P_4SR$  clothing correction.

Figure 2.6 - Working place wet bulb temperature distribution at Lepanto : Philippines

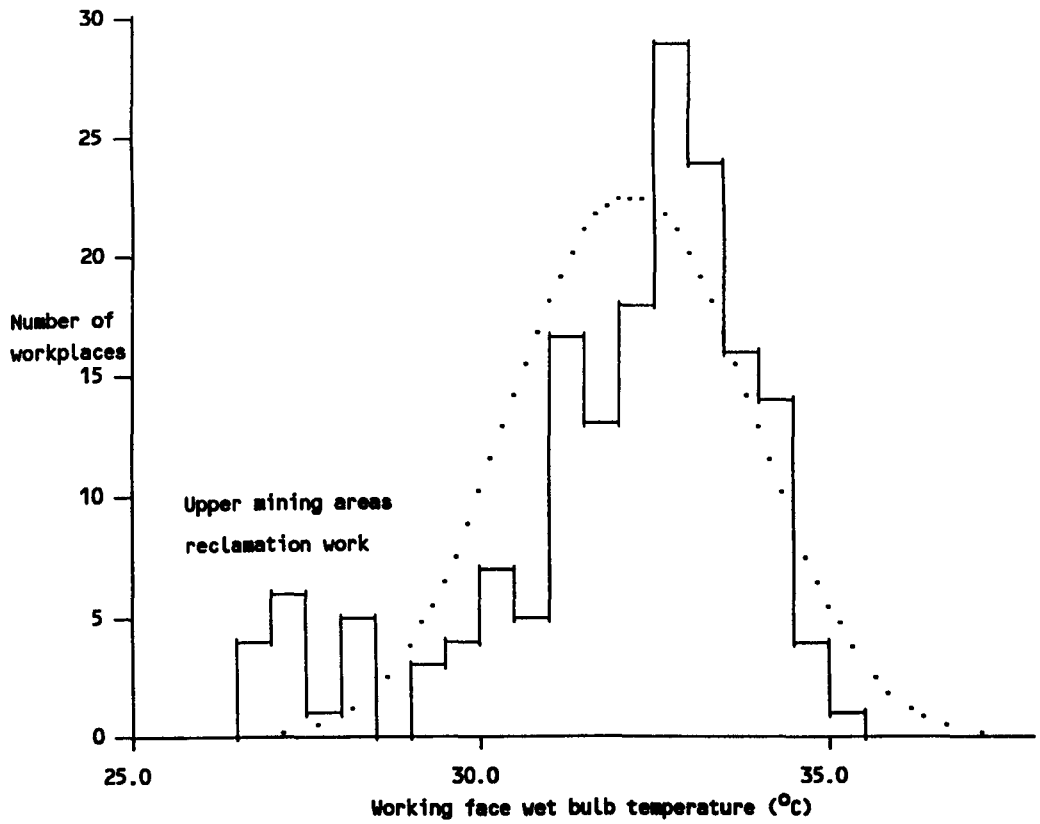
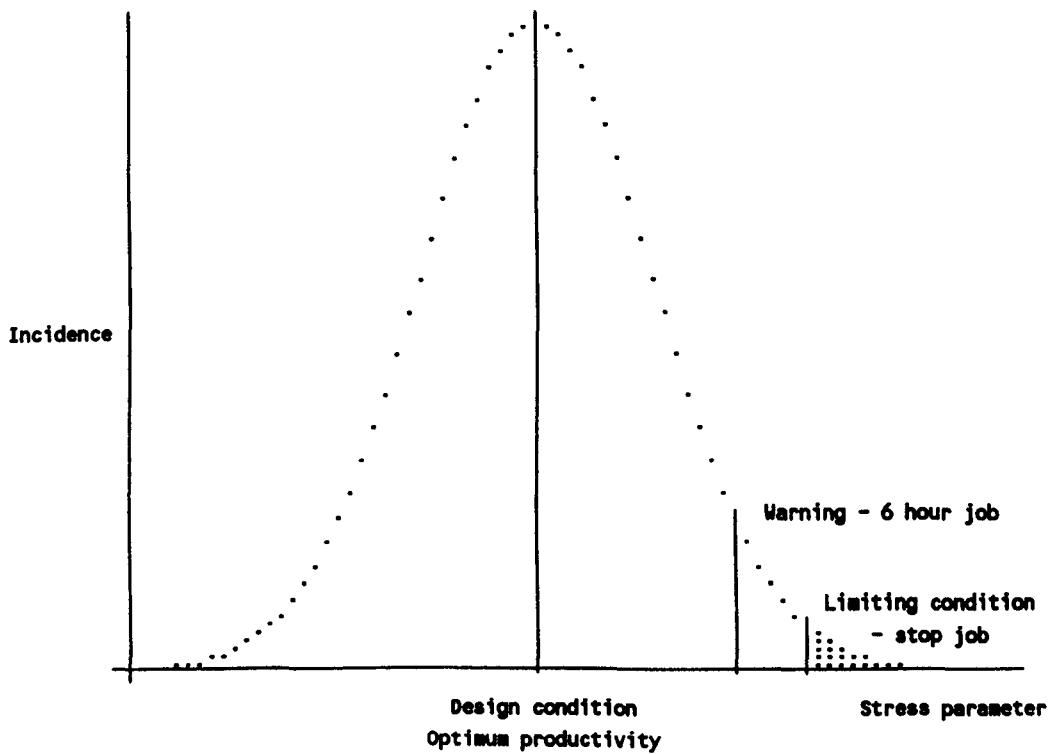

Figure 2.7 - Control of the thermal environment : reduced shift length



#### 2.1.4 The refrigeration load profile

##### Productivity and the environment

Maintaining an equivalent heat stress standard implies that the cooling power of the air must be equal to or greater than the metabolic heat production rate associated with the required work rate. Where the air cooling power is less than the work rate, two options are possible. In the first option, the work rate is maintained, the body core temperature increases and heat stroke ultimately results.

In practice, the second option is far more likely, where the work rate and therefore the metabolic heat production rate is decreased to match the air cooling power by taking more rest periods. In any work system involving muscular activity a relaxation allowance is necessary. This increases with increasing muscular activity or work rate.

The metabolic heat production rates given in the section on heat balance incorporate these relaxation allowances by averaging the oxygen consumption over at least 15 minutes. This can be illustrated by considering the oxygen consumption for a person shovelling rock with an average of 1.4 l/min and a standard deviation of 0.3 l/min. For short periods, usually less than a minute, the oxygen consumption could be almost double the average value.

There is therefore a natural reduction in work output to equate the metabolic heat production rate with the cooling power of the thermal environment. For example, if the cooling power in a work place is  $150 \text{ W/m}^2$  and the metabolic heat production rate associated with the work activity is  $200 \text{ W/m}^2$ , by assuming that the metabolic heat production rate for persons at rest is  $50 \text{ W/m}^2$  and by equating the metabolic heat production rates with the air cooling power, thermal equilibrium occurs with a rest factor of 0.333.

This means that for thermal equilibrium, only two thirds of the available time could be spent working at the  $200 \text{ W/m}^2$  rate and the remaining third of the time is spent resting. How the rest time is actually used depends on the type of work i.e. either reducing the pace of work or by taking longer pauses between periods of work. In this context, productivity is defined as the ratio of work rate permissible in a given environment, at a predetermined heat stroke risk, to the maximum work capacity.

This definition, when examined, precludes the possibility of obtaining perfect agreement between the calculated and actual productivity in that the degree of risk varies according to conditions which are not related to the thermal environment. This has been illustrated by the work carried out at the South African Applied Physiological Laboratories where the difference in productivity with different qualities of



leadership for the same thermal environment was demonstrated (Cooke, 1961). It was also shown that the workers with good leadership, in addition to a higher productivity also had higher core temperatures (measured as oral temperatures), thus the risk of heat stroke was increased.

This logic was tested by considering productivity on 31 South African gold mines between 1973 and 1975 (Howes, 1978a). Because the mines all had similar ore bodies and mining methods, the relationship between productivity and wet bulb temperature by itself was significant with a coefficient of linear correlation of 0.41 (a value of 0.2 is significant for the number of results considered). The coefficient of correlation increased to 0.69 when the relationship between productivity and cooling power was tested.

Although the 31 gold mines had similar mining methods there were considerable differences in the extent to which stoping was mechanised and the ratio between development and stoping production rates. When these differences were taken into account, the coefficient of correlation between productivity and the thermal environment increased to 0.84.

Many other parameters affect productivity, not the least of which was a concerted campaign to improve productivity throughout the gold mining industry midway through the period considered in the study. It

could, however, be concluded that the thermal environment was the major reason for the differences in productivity on "hot" mines. For the 31 gold mines considered in the study, over 60% of the differences in productivities within the mine and between mines could be attributed to the thermal environment.

Although the environmental conditions currently encountered in mechanised Australian mines are significantly better than those prevailing in South Africa during the period considered, a detailed analysis should confirm the effects of improving environmental conditions on productivity. Although poor environmental conditions will affect all types of work, a valid comparison of cause and effect requires measurable quantities to be used in the analysis.

From the detailed monthly production reports, the tonnes mined from stoping and development metres could be obtained for the X41 mining area at Mount Isa for each month over the last four years. The actual number of working shifts (excluding supervision) involved was obtained from the mine labour statistics report over the same four years. The detailed monthly report also had recorded the average climatic conditions and the number of six hour shifts awarded.

From this data, the relationship between the number of six hour shifts awarded and average surface wet bulb temperature is illustrated in figure 2.8. The X41

mining area is generally above its critical ventilation depth of 1150 m (the depth at which the ventilation air has zero cooling power) and consequently control of the thermal environment is achieved using ventilation only i.e. refrigeration is not essential.

One significant feature of the curve is the incidence of six hour shifts at low wet bulb temperatures. This is a result of the inevitable spread of environmental conditions about a mean value that in turn results from the dynamic nature of the mining processes. When assessing the implications of "hot" conditions, in addition to the mean value it is necessary to also determine the "spread" of values given by the standard deviation about the mean value.

The expected relationship between the incidence of six hour shifts and productivity is illustrated in figure 2.9 and is based on a normal distribution of values with a standard deviation of  $5.95 - 0.128 t_{wb}$  where  $t_{wb}$  is the mean wet bulb temperature. Figure 2.10 illustrates the grouped productivity data for winter, the mid seasonal periods and summer for the four years. The values for stoping are in tonnes/manshift and for development in metres/manshift. Development metres were converted to tonnes/manshift using actual development dimensions and used to obtain the combined stoping and development productivity.

The expected trend towards lower productivities during the mid seasonal (MS) and summer (S) periods when compared to the winter (W) periods is evident although not always consistent. This must be expected where the thermal environment is not the sole reason for variations in productivity. A summary of the measured and expected productivities for the four year period is given in Table 2.6 and confirms the approach taken to determine the ventilation and cooling required.

#### Reduced shift length

To understand the background to the application of a shortened shift length heat strain control strategy in Australia, it is necessary to compare the air cooling powers that are encountered in typical mechanised and non-mechanised stoping systems.

In a non-mechanised working area such as that found in a timber stope (square set or undercut and fill), the air velocity is usually very low as a result of the practical difficulties in providing adequate intake and return ventilation and is typically between 0.1 and 0.2 m/s. The absence of significant heat outputs from machinery results in a small difference between the wet and dry bulb temperatures, typically between 1.0 and 2.0°C.

In a mechanised working area such as that found in a primary cut and fill stope or in an open stoping

**Figure 2.8 - Mount Isa X41 area : six hour jobs and surface wet bulb temperature**

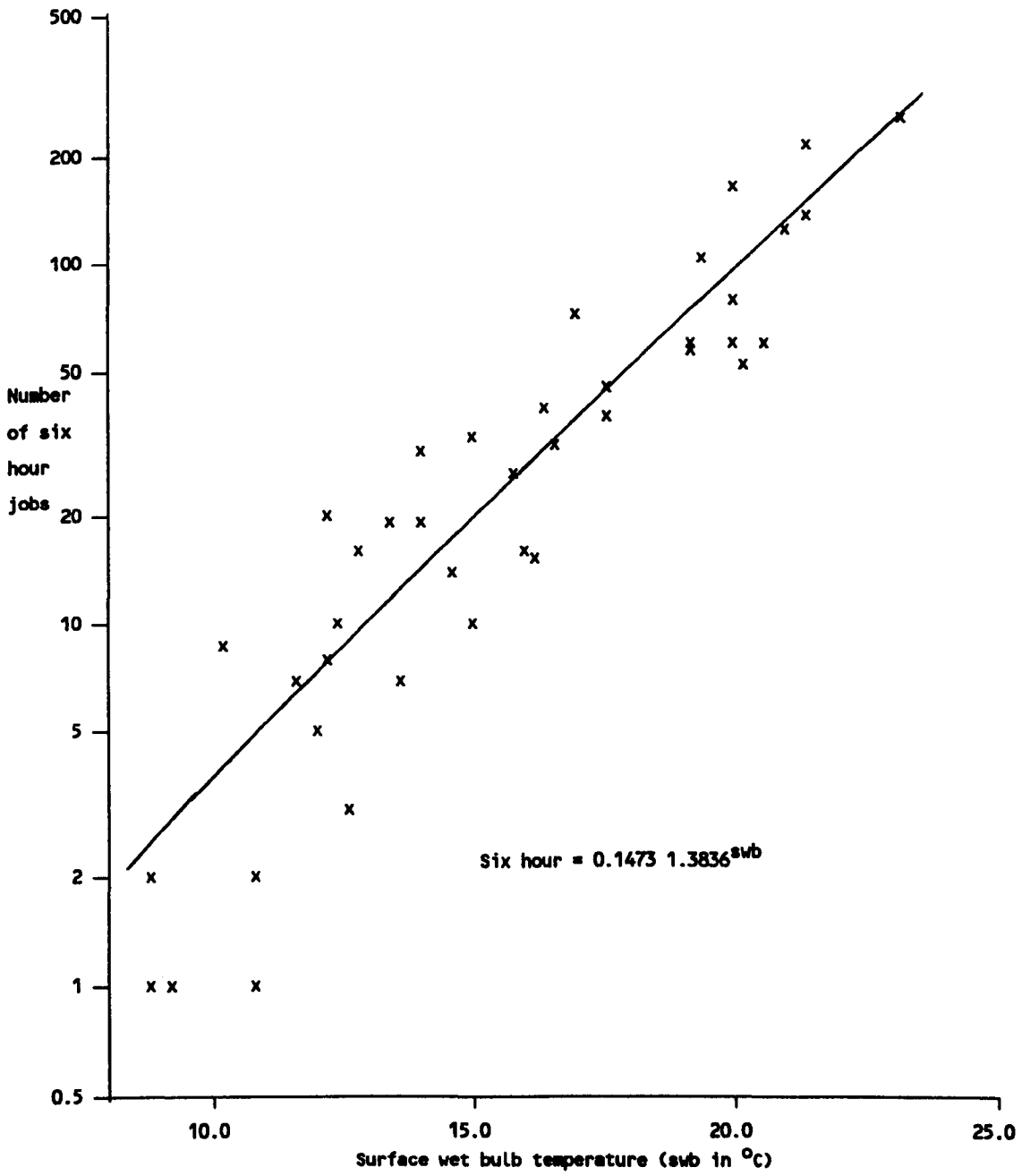
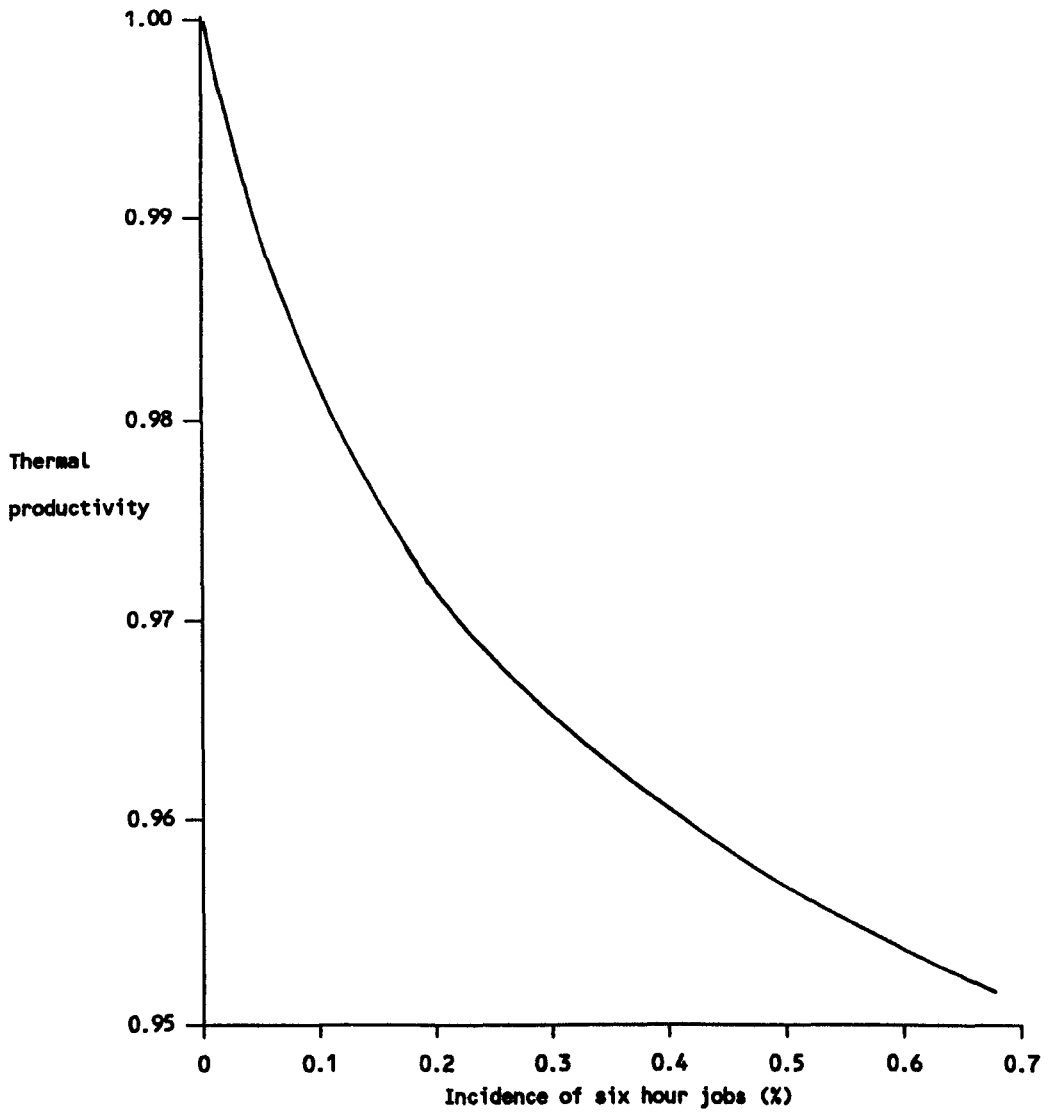
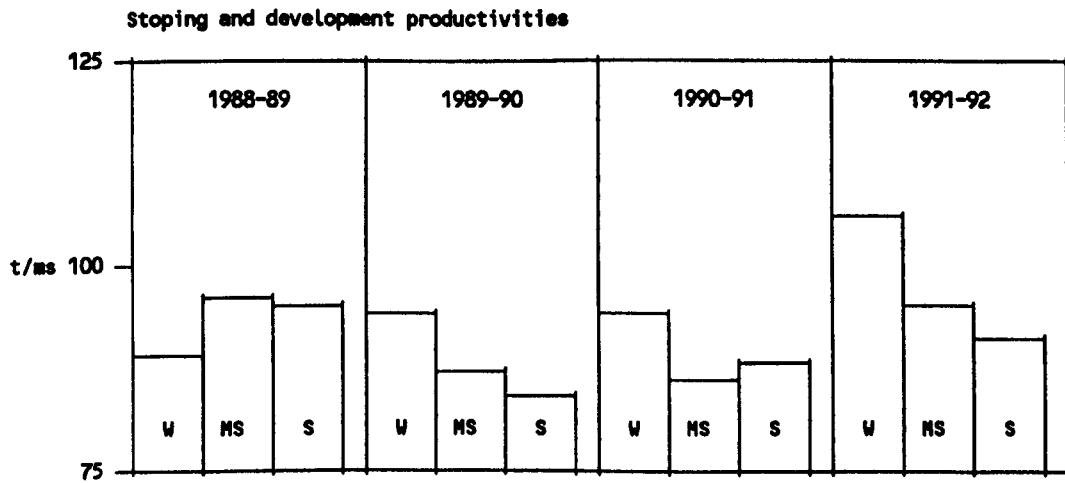
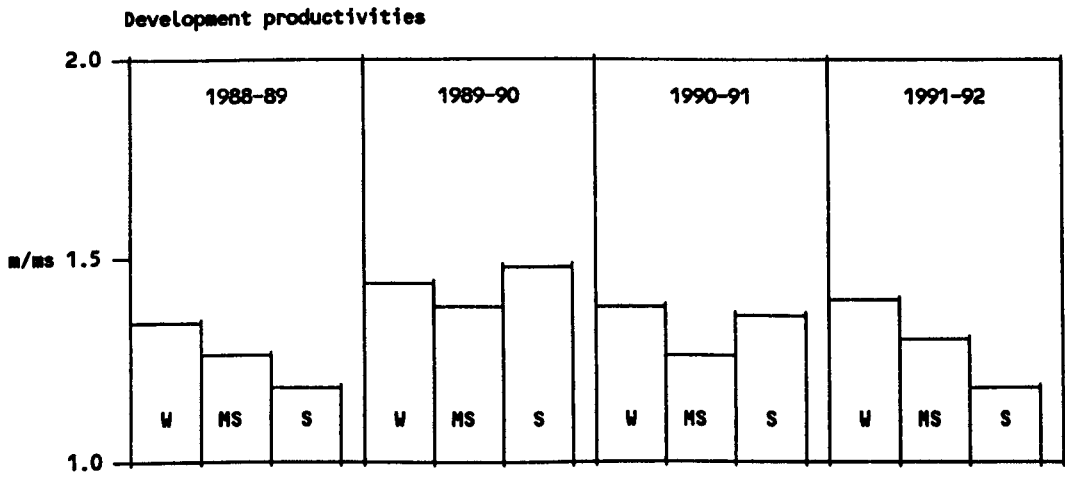
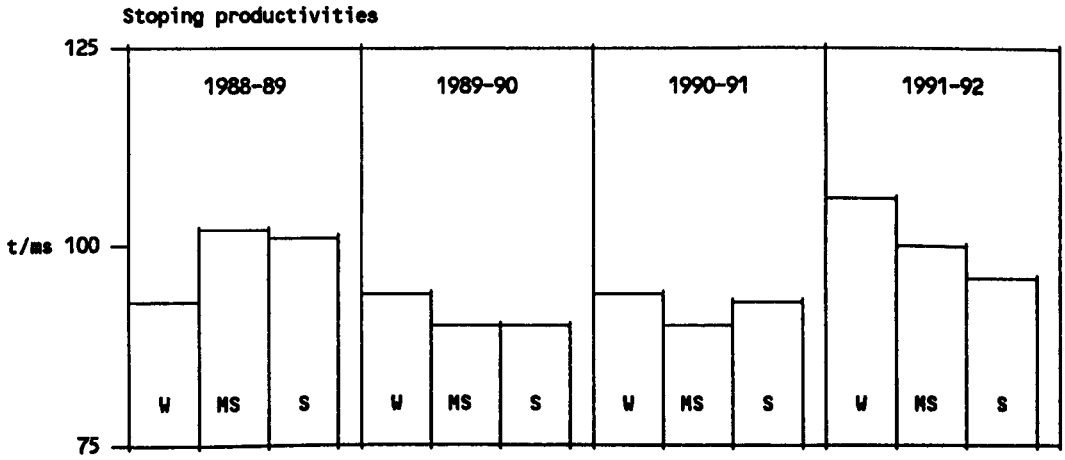

Figure 2.9 - Mount Isa : relationship between six hour jobs and expected productivity



**Figure 2.10 - Mount Isa X41 area : stoping and development performance**



system, the air velocity is usually at least 0.5 m/s as a result of the minimum air quantities required for diesel exhaust dilution. The large and mainly sensible heat outputs caused by the operation of the diesel powered equipment result in a difference between the wet and dry bulb temperatures which is larger than that encountered in non-mechanised stoping areas and is typically between 8 and 12°C.

The data presented in table 2.7 compares the air cooling powers expected in a mechanised mining method and that obtained using the current New South Wales six hour work limit of 26.75°C wet bulb temperature in timber stopes with low air velocities. The air cooling power at this wet bulb temperature is of the order of 150 W/m<sup>2</sup>. In a mechanised stoping system the same air cooling power would occur with wet bulbs between 29.0 and 30.0°C.

The 26.75°C wet bulb limit for a six hour work was introduced into the New South Wales legislation as a result of the conditions experienced in the timber stopes at Broken Hill in the late 1920's and is very difficult to justify in a mechanised stoping system. Indeed, in 1991 a proposed new heat stress regulation based on cooling power, was circulated by the NSW Mines Inspection Branch for comment. The minimum air cooling power for six hour and stop work conditions would be 140 W/m<sup>2</sup> and 115 W/m<sup>2</sup> respectively.



The original research for six hour and stop work charts was carried out at Mount Isa (Wyndham, 1967). The heat stress index used in deriving the limits was the predicted four hour sweat rate ( $P_4SR$ ) with a limit of 3.8 litres for six hour work and 5.0 litres for the stop work condition.

The combination of wet and dry bulb temperatures and air velocities derived equate approximately to air cooling powers of 140 and 115  $W/m^2$  for the six hour and stop work limits respectively. The current exemption from the mine regulations used at Olympic Dam in South Australia is based on a six hour work limit of 150  $W/m^2$ .

The charts given in figure 2.11 are similar to the Mount Isa charts and are used as a practical guide and part of a "hot" condition control strategy. When working in "hot" conditions, personnel will naturally reduce their work rate to remain in balance with the thermal environment. This takes place continuously throughout the shift. A reduced shift length such as a six hour shift, although not physiologically necessary, will provide forewarning that stop work conditions are being approached.

### Optimisations

The cooling power of a thermal environment can be controlled by both ventilation and refrigeration which

Table 2.6 - Mount Isa X41 mining area : summary of measured and expected productivities

Season	Average actual productivity	Actual % of six hour jobs	Expected productivity factor	Expected average productivity
Winter	92.19	0.081	0.981	91.90
Mid-seasonal	90.88	0.148	0.973	91.14
Summer	89.65	0.475	0.957	89.67

Table 2.7 - Six hour work limits in mechanised and non-mechanised stopes

Stope type	Wet bulb (°C)	Dry bulb (°C)	Air velocity (m/s)	Air cooling power (W/m <sup>2</sup> )
Timbered	26.75	28.75	0.1	134
Timbered	26.75	28.75	0.2	157
Mechanised	30.00	45.00	0.5	133
Mechanised	29.00	44.00	0.7	160

Figure 2.11 - Six hour and stop job charts

(a) Air velocity less than 0.5 m/s

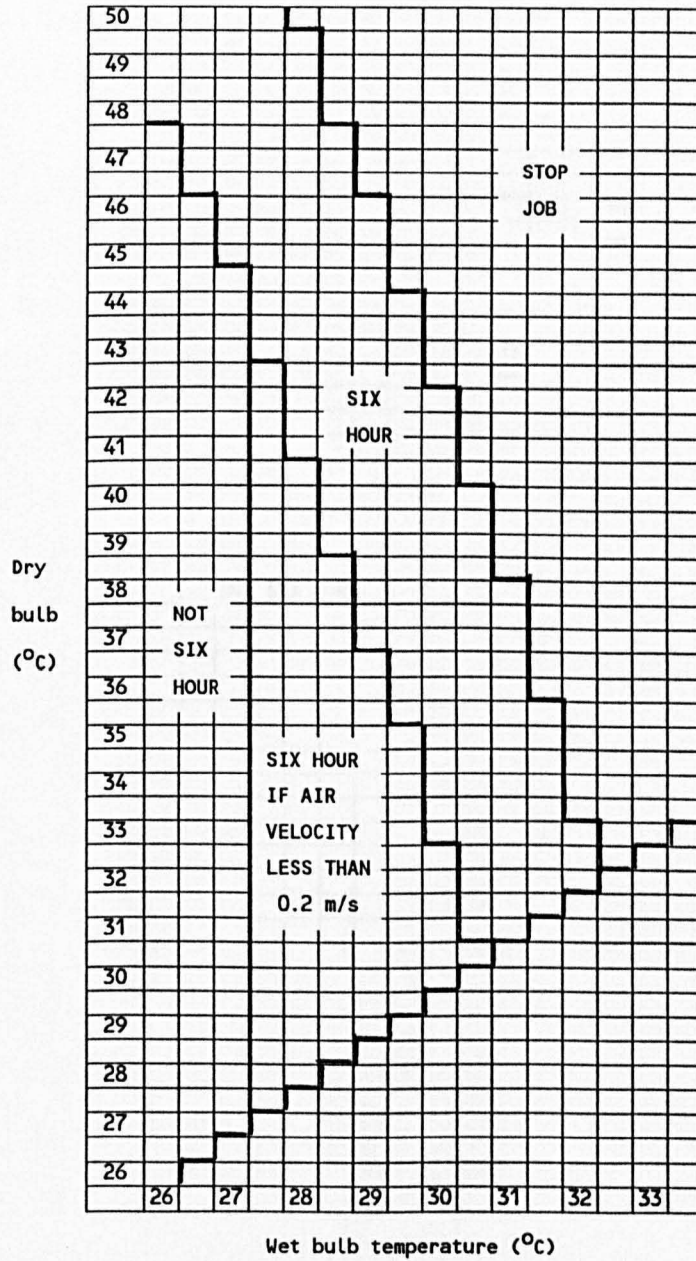
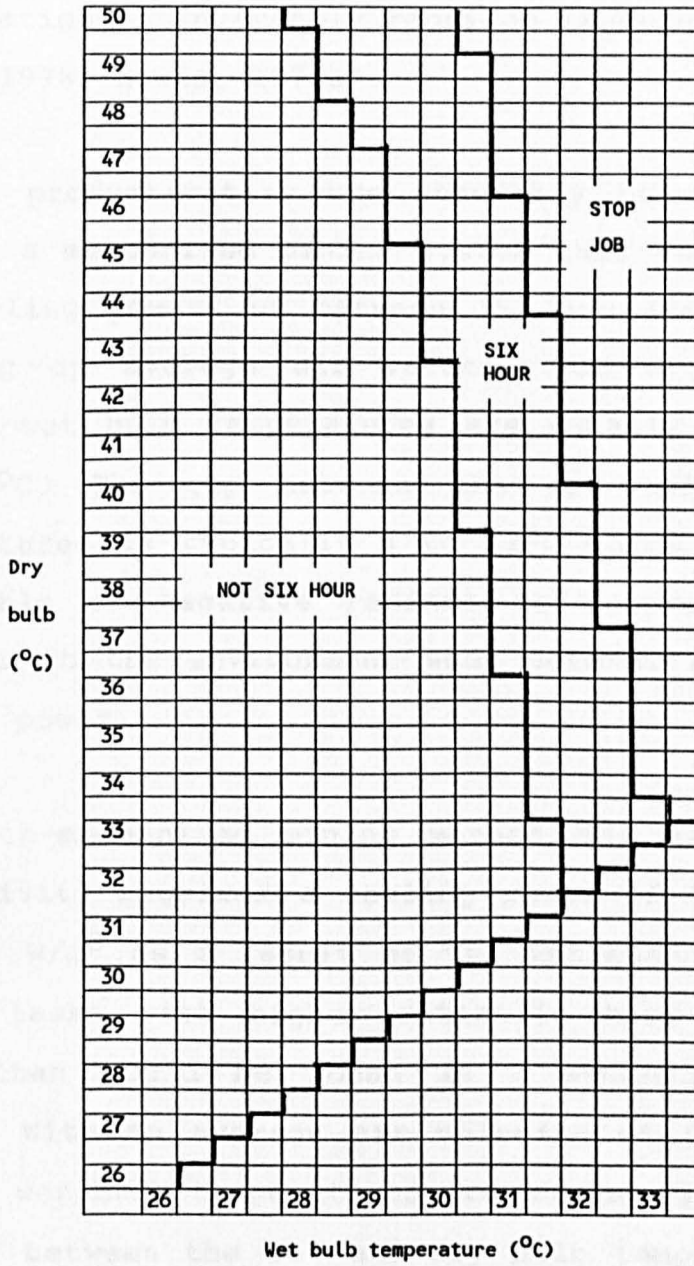

Figure 2.11 - Six hour and stop job charts

(b) Air velocity 0.5 m/s or greater



allow the air velocities and temperatures to be varied. There is no simple method of determining the extent to which either is used and a detailed optimisation is invariably required (Lambrechts, 1967; Howes, 1978; Howes, 1979a).

Optimum productivities are generally between 90 and 95%. In a mechanised mining system this would require air cooling powers of between 150 and 170 W/m<sup>2</sup> and, assuming an average air velocity of 0.7 m/s, the optimum wet bulb temperatures are usually between 28 and 29°C. The gap between the wet and dry bulb temperatures is typically 8 to 12°C which results in negligible or negative radiant and convective heat transfer to the environment when determining the air cooling power.

In a non-mechanised mining method the same optimum productivity requires a cooling power of between 180 and 200 W/m<sup>2</sup> as a result of the increased number of mining tasks with higher metabolic heat production rates than would be found in a mechanised mining method. With an average air velocity of 0.5 m/s the optimum wet bulb temperatures are between 27 and 28°C. The gap between the wet and dry bulb temperatures is typically 2°C.

Although the 2.5% design climatic condition is normally used to determine the plant size, the optimum underground temperatures throughout the year are not

constant and usually decrease as the surface climatic temperatures decrease. This is a result of a greater cost benefit resulting from improving productivity than the cost of operating the refrigeration plant when operating at less than full plant duty.

Network simulations based on mass flow balance at the junctions and incorporating heat and moisture transfer routines (Moreby, 1988) can be used to help determine the optimum ventilation and cooling systems. At Mount Isa, the 3000 ore bodies development and production schedule was used to identify future ventilation and cooling arrangements. Intake and return airways to the ore bodies already exist and consequently the air quantity supplied was consistent with the systems air handling capacity.

By repeating the simulation for different surface wet bulb temperatures and amounts of refrigeration, a relationship between the surface values (swb) and the mean underground values could be established. For the 3000 ore bodies where the effective amount of cooling (MW) is a function of the production rate (tpa) in million t/y and the installed amount of refrigeration (MW\*) available, these relationships are:-

$$wb = (18.65 - 0.01223 MW^2 - 0.01190 MW) \times (1.023 + 0.00001058 MW^2 - 0.0002315 MW)^{swb}$$

$$MW = 1.2 \times (MW^* - 6.7)/tpa + 3.9$$

From a knowledge of the surface and underground wet bulb temperature distributions, the mean productivity and the proportion of six hour and stop work shifts can be determined for any production rate, ventilation and refrigeration arrangement. As an example, for a surface wet bulb temperature of  $22.0^{\circ}\text{C}$ , the mean expected underground wet bulb temperature is  $28.44^{\circ}\text{C}$  with an 11 MW refrigeration plant (stage 1) and a mining rate of 1.0 million t/y. This is equivalent to an air cooling power of  $164.8 \text{ W/m}^2$ .

At Mount Isa the six hour and stop work limits are equivalent to air cooling powers of 140 and  $115 \text{ W/m}^2$  respectively. For the air velocity and the wet and dry bulb gap expected the limits equate to wet bulb temperatures of  $30.27$  and  $31.67^{\circ}\text{C}$  respectively.

For the six hour work shift, the difference between the limit and the mean value is  $30.27 - 28.44$  or  $1.83^{\circ}\text{C}$ . For a mean wet bulb temperature of  $28.44^{\circ}\text{C}$  the standard deviation is 2.31 and the limit is therefore  $1.83/2.31 = 0.792$  standard deviations to the right of the mean value (x).

Using tables of the area under the normal probability curve to the left of a given value of x, for  $x = 0.792$  the area is 0.7859. This means that 78.59% of the working places will have temperatures below  $30.27^{\circ}\text{C}$ . Conversely, 21.41% will have temperatures above  $30.27^{\circ}\text{C}$  i.e. will have six hour work conditions.

In a similar manner the percentage of stop work shifts that may be expected when the surface wet bulb is 22.0°C can be established. The temperature difference is 31.67 - 28.44 or 3.23°C, the value of x is 1.398 and the expected proportion of working places above 31.67°C is 8.10%. Since 8.10% of the working places are stop work shifts above 31.67°C, 21.41 - 8.10 or 13.31% are between 30.27 and 31.67°C i.e. six hour work shifts.

The thermal environmental correction factor (TECF) is based on the air cooling power, the work rate and the proportion of time spent at each work rate. It is the net productivity ratio weighted for the different types of work involved in the mining operations and can be obtained from:-

$$TECF = \frac{(CP - 50) P_n}{(M - W) - 50} \quad \text{where} \quad \frac{(CP - 50)}{(M - W) - 50} < 1.0$$

Where CP = the corrected cooling power (W/m<sup>2</sup>)

(M - W) = the metabolic heat production rate (W/m<sup>2</sup>)

The proportion of time spent working at each metabolic heat production rate P<sub>n</sub> will depend on the mining method and ground conditions. Typical values for a cut and fill or open stoping mechanised mining method can be summarised as follows:-



Operation	Proportion P <sub>n</sub>	(M - W)
Construction and general	25%	250
Development and services	25%	200
Drill, fill and blasting	20%	150
Supervision and extraction	30%	125

Using this method of analysis which is summarised in Appendix 2, the expected productivity and proportion of six hour and stop work shifts can be established for a given mining, refrigeration and ventilation system arrangement and based on the surface climatic profile. The relevant values for the 3000 ore bodies with 11 MW of refrigeration (i.e. the K61 surface chilled water plant only) and a production rate of 1.0 million t/y are given in Table 2.8.

The justification for installing more refrigeration is to offset the increased number of shifts required to achieve the same mine production rate as thermal environmental conditions worsen. Based on the methods outlined in the previous sections, the increased number of shifts required for the different production rates and amounts of refrigeration are summarised in Table 2.9 for the 3000 ore bodies at Mount Isa.

A simplistic view would be to apply the cost of an overtime shift for each of the additional shifts required to achieve the mine production. This does, however, imply that both the organisation and the

infrastructure is sufficiently flexible to adjust and accommodate all the additional shifts necessary to meet the production targets.

In practice, this is rarely the case and there will be an inevitable shortfall in production and a consequent loss in revenue. The difference between in situ ore value and mining and smelting costs depends on the ore grade and has a financial impact of up to five times the value of the overtime shift cost. The actual cost will lie somewhere between these two extremes.

#### Air cooling capacity and load profiles

In a non-mechanised mine where the heat loads are relatively uniform, the cooling capacity of the air will depend on the optimum conditions which includes the effects of a decrease in productivity. As a result of the dynamic nature of mining and the inevitable spread of environmental conditions, there will some reduced shift lengths which are used to ensure that personnel will not be exposed to limiting heat stress conditions.

On mechanised mines, the air cooling capacity of the air depends on both ensuring that the optimum conditions are met and, for the cyclic mining operations, that the limiting climatic conditions are also achieved.

For example, in a development heading, when the diesel powered equipment is not operating, the air cooling power may meet the optimum value of say 170 W/m<sup>2</sup>. Providing that the air cooling power is greater than the six hour limit of say 140 W/m<sup>2</sup> when the diesel is operating, the system could be considered as adequate. If, however, the six hour limit was not met, the air cooling capacity should be determined by this criteria and not the optimum values.

**Table 2.8 - Mount Isa 3000 ore bodies : 11 MW refrigeration and 1.0 million tonnes/year**

Surface wet bulb	Number of hours	Mean air cooling power	Mean wet bulb temperature	% stop jobs	% six hour	Productivity TECF
26.0	120	128.9	31.05	37.75	27.66	0.6881
24.0	912	147.6	29.72	18.16	21.70	0.7799
22.0	1080	164.8	28.44	8.10	13.31	0.8348
20.0	1296	180.7	27.22	3.55	7.24	0.8811
18.0	1272	191.0	26.05	1.58	3.74	0.9113
16.0	1200	200.1	24.93	0.73	1.91	0.9376
14.0	984	207.7	23.85	0.35	0.99	0.9471
12.0	864	214.7	22.83	0.16	0.52	0.9559
10.0	552	221.3	21.85	0.09	0.29	0.9641
8.0	336	227.5	20.91	0.05	0.16	0.9718

Weighted productivity = 0.8993

Weighted stop jobs = 4.3268%

Weighted six hour jobs = 6.3463%

Additional shifts = 5408.6

**Table 2.9 - Mount Isa 3000 orbodies : additional shifts required to achieve full production**

Total refrigeration	Production rate million tonnes/year							
	1.0	1.2	1.5	2.0	2.5	3.0	3.5	4.0
11 MW	6401	8571	11824	17324	22836	28554	34317	40074
15 MW	3146	4914	7791					
17 MW	2098	3574	6200	11102	16467	21893	27315	32780
19 MW	1360	2544	4809					
21 MW	837	1782	3668					
23 MW	417	1211	2792	6473	10997	15856	21116	26533
29 MW		102	1061	3494	6960	11134	15801	20623
34 MW				1984	4599	8048	12092	16659

## 2.2 Refrigeration plant analysis

### 2.2.1 Background to refrigeration simulations

A refrigeration system can be broadly classified into three main components; the chiller subsystem, the load subsystem and the heat rejection subsystem. Simulating the operation of a refrigeration system may be either dynamic or steady state depending on the purpose for which the simulations are to be undertaken.

The chiller subsystem comprises of the compressor, the evaporator and the condenser. Refrigerant compressors can be either positive displacement which includes both reciprocating and screw types or aerodynamic such as the centrifugal compressor. The evaporator interfaces with the load subsystem and, because the cooling load is normally remote from the compressor, a secondary fluid such as water is used to distribute the coolth extracted from the refrigerant. The condenser interfaces with the heat rejection subsystem which may also use water to transfer the heat to a point where it can be rejected to the atmosphere.

The load subsystem comprises of the equipment necessary to distribute the coolth to the point of use and the appliances used to transfer the coolth to the air being conditioned. The heat rejection subsystem comprises the equipment necessary to transfer the heat removed from condensing the refrigerant to the point

where it can be rejected to the atmosphere and the equipment necessary to effect this heat transfer.

Dynamic modelling and simulation of refrigeration systems is concerned mainly with the response times and stability characteristics of the equipment, the capacity control devices and the sensitivity of the sensors. The objectives are to determine the effect of perturbations in the system resulting from differences in equipment response times and other real time applications, such as system monitoring, parameter estimation, fault detection and diagnosis.

Although the effects of system design changes can be simulated, a dynamic model is not the most suitable for this purpose because of its complexity and a consequent increasing difficulty of converging towards a solution.

A steady state model can be much simpler and more complex systems which include an extensive load subsystem, can be simulated without compromising the ability of the model to converge towards a solution. This type of model is more suitable to evaluate the effects of changes in equipment and design and to determine the most effective overall control strategy.

It can also be used to evaluate the results obtained from the monitoring system of an operating plant over a representative time period and, providing that the

control devices are limited in number and complexity, it can be used to initiate changes which control the performance of the system.

#### Air conditioning industry

The first reported refrigeration simulations in the 1970's were concerned with heat pumps and residential air conditioners (Freeman, 1975; Hiller, 1976; Flower, 1978; Ellison, 1978; Rice, 1981). All the systems being simulated used reciprocating compressors whose performance was relatively straightforward to model, and refrigerant to air heat exchangers for both the load and heat rejection.

The main objectives of the studies were to examine equipment design and performance improvements and for comparative work with alternative energy sources such as solar heating systems. Commercial sized systems using reciprocating compressors and suitable for air conditioning, were subsequently modelled and simulated (Fischer, 1983).

A dynamic analysis (James, 1973) was attempted on a laboratory sized refrigeration system which also used a reciprocating compressor. Although shell and tube heat exchangers were used for the evaporator and condenser, the load was held constant using immersion heaters and the condenser water was once through i.e. not cooled in a tower and recirculated.

The model for this system contained 16 differential and 92 algebraic time dependent equations based on mass and energy balances, momentum equations relating force and flow rate and state equations for each zone. The simulation had stability problems and failed to converge if the step length was too great (suitable values were between 2 and 10 ms).

Both dynamic and steady state computer simulations for centrifugal chiller systems using refrigerant to water heat exchangers were developed in the early to mid 1980's (Clark, 1985; Hwang, 1986; Jackson, 1987). The simulations were generally limited to the chiller subsystem by assuming independent or constant water temperatures for the load and heat rejection.

The load subsystem was assumed to "drive" the chiller unit i.e. the refrigeration unit responded to changes in return water temperature which is an input value to the simulation. The heat rejection system was assumed to maintain a constant return condenser water temperature by either using variable speed fans in the cooling towers used for heat rejection or a supply from an very large and constant temperature source such as seawater.

Although a cooling tower subsystem was introduced to subsequent simulations (Nadira, 1987), the models continued to have independent load subsystems and to model the compressor performance from a compressor map



which was fitted to polynomial equations. From the map, the compressor refrigerant mass flow rate and isentropic efficiency are determined as functions of the impeller tip Mach number and the theoretical compressor flow and head coefficients.

The models are based on a standard refrigeration cycle with superheating, sub-cooling, effects of hermetic motors and a hot gas bypass where appropriate, and use standard refrigerant properties to determine the state points of the cycle.

This method of modelling compressor performance relies on the relationships that are used in the design of centrifugal compressors and is representative of well designed centrifugal compressors. The generality of the method removes possible limitations resulting from incomplete performance data and is not specific to a single refrigerant. An alternative method using empirical compressor performance relationships which are fitted to the manufacturers published test data (Davis, 1973) is more representative of the performance of a specific system.

Other work on refrigeration system modelling in the air conditioning industry has concerned individual component performance such as a thermostatic expansion valve (James, 1987) and the analysis of measurements of plant operation taken to determine performance characteristics when the manufacturers data is not

available (Braun, 1987). Although simulations have been developed to consider the load subsystem (Park, 1986), they have not been combined with the chiller and heat rejection subsystems.

#### Mining industry

In a paper discussing the assessment and prediction of cooling plant performance (Hemp, 1981) a different approach was taken to the method of modelling the compressor performance. Instead of attempting to model the aerodynamic performance and relating this to the state points on the refrigeration cycle, an empirical method was used which related the compressor adiabatic head and the efficiency to the refrigerant inlet volume flow rate.

This had the advantage that instead of detailed compressor performance maps being required, the necessary information could be obtained from knowledge of the refrigeration effect and input power required at a sufficient number of combinations of evaporating and condensing temperatures.

With the limited information normally available from the manufacturers of compressors, this method is of wider application and not necessarily limited to a single type of compressor. The compressor curves obtained are, however, limited to the refrigerant for which the data or measurements are available.

Although the main thrust of the paper by Hemp was to outline a manual method for the performance assessment of the chiller set, computer simulations were also developed (Hemp, 1986). These were extended to include a fixed underground cooling tower subsystem for heat rejection and cooling coils for the load subsystem and were used mainly for predictive purposes and some optimisation of operating arrangements.

Research work undertaken at the South African Chamber of Mines (Bailey-McEwan, 1984; 1987) on refrigeration system simulations was similar to the direction taken in the air conditioning industry and concentrated on modelling chiller sets. The simulation programme (COM, 1987) produced does not consider the load and heat rejection subsystems and uses general rather than actual compressor performance curves.

Although multiple chiller sets, part duty operation and performance with different refrigerants can be simulated, the absence of manufacturers' specific compressor curves limits the usefulness of the simulation programme to general and preliminary design features. It is unable to provide the information that may be used as a basis for a control system and for optimising the design and operation of a complete refrigeration system.

Deep coal mines in Germany have the second largest installed mine refrigeration plant cooling capacity

after South Africa. Computer modelling has also concentrated on centrifugal chillers (Grollius, 1986) and does not include the load and heat rejection subsystems. Modelling the compressor operation is again based on general compressor maps and has the same drawbacks as the simulation developed by the South African Chamber of Mines.

Other related work has involved monitoring the control system used for chiller sets and, in addition, certain selected water temperatures and water flow rates (Baker-Duly, 1984; 1988). From this information, which is transmitted from the underground plant to a surface information centre, time trends and some performance analysis can be undertaken. This is mainly concerned with the plant heat balance and the compressor coefficient of performance.

Control of the plant operation including start and stop is still manual using the attendants who are present on a 24 h basis. The cooling load on the underground plants is essentially constant and any changes which require operator decisions are infrequent and would not require the results of a detailed plant simulation.

Development of this research work

Deficiencies in the methods and techniques available to assess performance and to optimise the design of

future plants were evident when reviewing the mine cooling practice in South African gold mines (Howes, 1975) and the design of the new Unisel refrigeration plant (Howes, 1979b). The Unisel plant was the first to be designed which was located on surface, had an integrated chilled and service water reticulation system in open circuit and used a pelton wheel to recover energy from the water supplied to the mine.

The justification for and the design of the plant was restricted by the time required to undertake manual performance assessment of the plant operation as a whole. Individual elements such as the pre-cooling tower were optimised independently.

In 1981, a review of the ventilation and cooling for the 3000 ore bodies at Mount Isa Mine indicated a significant future refrigeration requirement. The existing R63 plant had a rated capacity of 3.6 MWR and supplied a maximum of 2.5 MWR using chilled water to two underground high pressure heat exchangers and a cooling coil reticulation system.

In 1982/83 the actual performance of this plant was modelled to determine whether it could provide sufficient cooling for the initial development of the 3000 ore bodies. In addition to the multiple chiller subsystem, the heat rejection and underground load subsystems including pipe losses were incorporated into the model.

In 1984 a new surface chilled water plant was considered as a replacement and modelling was used to optimise the preliminary plant design and to evaluate the tenders. Low copper prices in mid 1984 resulted in a deferment of the 3000 ore body production date and the new surface refrigeration plant.

The R63 plant model was reviewed and modified to determine the effect of installing a third underground high pressure heat exchanger which would be used to supply chilled water in open circuit to a direct contact spray cooler. A fourth compressor was to be installed as a spare and the heat rejection system expanded by incorporating the original spray system (replaced with a cross flow cooling tower in 1981).

The modifications to the plant were completed in 1985 and it was used to provide cooling until replaced with the new K61 surface plant in 1989. A data acquisition system was used to monitor the plant performance and analysis of the data confirmed the suitability of the model to represent the system operation.

In 1987, when the new K61 refrigeration plant was being planned and designed, modelling of the system was used to determine the optimum control strategy for the overall system. This model was adjusted to first design and then assess the surface plant commissioning tests which were to be undertaken before the mine load could be applied.

Thorough testing of the plant has resulted in the model elements being adjusted and it is now used as a maintenance diagnostic programme. In 1991 the modelling techniques were used to assess the tenders submitted for the stage 2 plant expansion and to optimise the design and operation of this plant.

At Broken Hill, by late 1986 it was evident that the underground plants were not providing the amount of cooling required and a full review of the system was required. This was completed in 1987 and a model developed which included the multiple chiller subsystem, the heat rejection subsystem and the mine load subsystem. The effects of changes to both the system and of equipment could be simulated and improvements to the overall plant operation were made.

Despite delays resulting from the uncertainty of the mine life in the deeper Fitzpatrick ore body, a surface plant which is used to bulk cool the mine intake air was installed in 1991. The tenders for the plant were evaluated using a refrigeration simulation model and plant commissioning attempted in 1991. This was completed in 1992 and the model adjusted to reflect the actual plant operating conditions.

### 2.2.2 Refrigeration system simulation

The general algorithm used to model the operation of the overall mine refrigeration system is illustrated in figure 2.12. To initiate the iterative process which balances the estimated and the actual compressor adiabatic heads ( $h$  and  $h_c$ ), a series of start values are assumed. These include evaporator duty, compressor input power, evaporating and condensing temperatures and are normally taken as the design values for the refrigeration plant.

For the refrigeration systems being considered, the coolth provided is distributed using chilled water. The initial compressor, condenser and evaporator (chiller subsystem) balance is therefore based on a fixed water temperature into the evaporator ( $t_{wie}$ ) and perfect condenser heat rejection.

The second compressor balance is obtained by equating the condenser thermal performance with the condenser heat rejection system and repeating the chiller subsystem balance until the condenser load matches the heat rejection capacity.

The final compressor balance is obtained by equating the evaporator thermal performance with the heat transfer characteristics of the mine cooling appliances (the mine load subsystem). Both the chiller subsystem and the heat rejection subsystem balances



are repeated until the evaporator load matches the mine load. Where necessary, at low evaporating temperatures or at high compressor motor powers, the compressors are allowed to unload.

Figure 2.12 - General refrigeration system algorithm

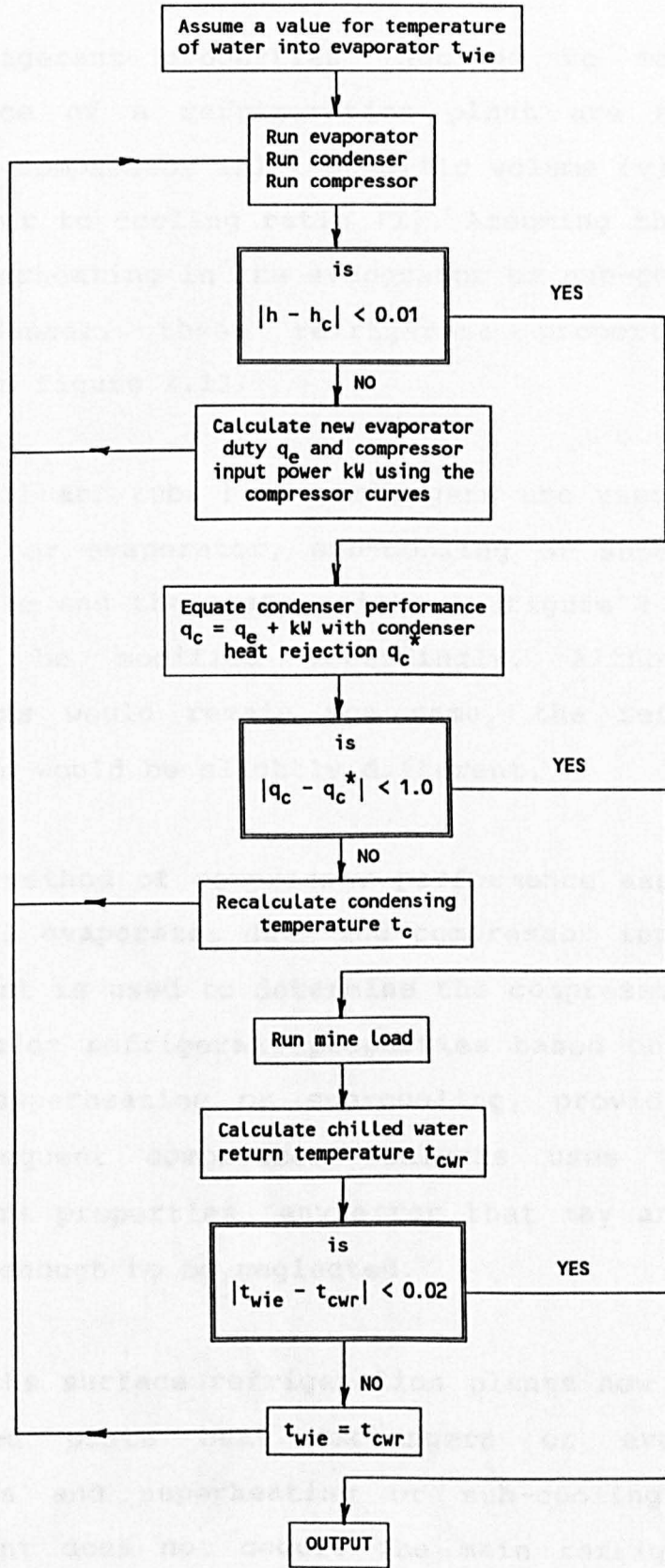

### 2.2.3 Refrigerant properties

The refrigerant properties required to model the performance of a refrigeration plant are adiabatic head ( $h$ ), compressor inlet specific volume ( $v$ ) and the ideal power to cooling ratio ( $I$ ). Assuming that there is no superheating in the evaporator or sub-cooling in the condenser, these refrigerant properties are defined in figure 2.13.

Where shell and tube heat exchangers are used for the condenser or evaporator, sub-cooling or superheating is possible and the state points in figure 2.13 would need to be modified accordingly. Although the definitions would remain the same, the refrigerant properties would be slightly different.

For this method of compressor performance assessment, the actual evaporator duty and compressor input power requirement is used to determine the compressor curve. If this uses refrigerant properties based on a cycle without superheating or sub-cooling, providing that the subsequent compressor analysis uses the same refrigerant properties, any error that may arise will be small enough to be neglected.

Most of the surface refrigeration plants now use open or closed plate heat exchangers or evaporative condensers and superheating or sub-cooling of the refrigerant does not occur. The main refrigerant is

ammonia although R22 is used in the underground plant at Broken Hill and R11 in the original Mount Isa R63 centrifugal chiller plant.

#### Properties of ammonia

Using the data available from published tables of refrigerant properties (Perry, 1973), curve fitting was used to obtain the approximate relationships between the refrigerant properties and the evaporating and condensing temperatures  $t_e$  and  $t_c$ ). Within the normal operating range of temperatures, the approximate relationship is usually within 0.2% of the tabulated value with a maximum error of 0.5%.

$$h = (4.5963 - 0.03042 t_e + 0.00020314 t_e^2) t_c - 4.6621 t_e + 0.03051 t_e^2 + 1.17$$

$$v = [(230.07 + 0.75653 t_c + 0.006057 t_c^2) - (8.6295 + 0.029523 t_c + 0.00022937 t_c^2) t_e + (0.1887 + 0.0007022 t_c + 0.00000455 t_c^2) t_e^2] / 1000^2$$

$$I = (0.0018635 - 0.003797 t_e + 0.00002933 t_e^2) + (0.0035361 - 0.000032146 t_e - 0.0000002773 t_e^2) t_c + (0.000018434 + 0.0000003681 t_e + 0.00000001349 t_e^2) t_c^2$$

where  $h$  = adiabatic head (kJ/kg)  
 $v$  = specific inlet flow rate (m<sup>3</sup>/s/kW)  
 $I$  = ideal power to cooling ratio

## Refrigerant R22

In a similar manner to that used for ammonia, curve fitting routines were used to obtain the approximate relationships for refrigerant R22 from published data of refrigerant properties (IIR, 1981). The estimated values using the approximate relationships are within 0.25% of the published value for a range of condensing temperatures between 20 and 48°C and for evaporating temperatures between -10 and +10°C. This range of evaporating and condensing temperatures covers the normal operating range for a mine refrigeration plant compressor either on surface or underground.

$$h = (0.6583 - 0.002167 t_e + 0.00001429 t_e^2) t_c - 0.7677 t_e + 0.003788 t_e^2 - 0.001541 t_c^2 + 0.1048 t_c + 0.008$$

$$v = \{[2.343 \exp(-0.03613 t_e) - 0.0002537 t_e + 0.0003045 t_e^2 - 0.01197] t_c + 211.8717 \exp(-0.03301 t_e) - 0.01175 t_e + 0.02366 t_e^2 - 0.935 - (1.5345 t_c - 0.02241 t_c^2 - 24.38) \exp(-0.03791 t_e)\} / 1000^2$$

$$I = [5278.16 \exp(-0.01320 t_e) - 0.1125 t_e + 0.1391 t_e^2 - 5.5] t_c / 1000^2 - 0.003153 t_e - 0.00001949 t_e^2 + 0.02853 - (0.002347 t_c - 0.00003419 t_c^2 - 0.03736) \exp(-0.02056 t_e)]$$

## Refrigerant R11

For refrigerant R11, the approximate relationships were obtained from published tables of properties supplied by the manufacturer (Du Pont, 1965). For these simpler relationships, the estimated value is usually within 1.5% of the published value for the adiabatic head, within 1.0% for the specific inlet volume and 2.5% for the ideal power to cooling ratio for condensing temperatures of between 20 and 50°C and evaporating temperatures of between -5 and +15°C.

$$h = (0.5972 - 0.0007018 t_e) t_c - 0.6709 t_e + 1.526$$

$$v = [0.002111 \exp(-0.005519 t_c)] \exp[(0.04100 (- t_e) \exp(-0.0004119 t_c))]$$

$$I = 0.002882 t_c^{1.1} - [0.003448 (\exp(0.009268 t_c))] t_e$$

**Figure 2.13 - Definition of refrigerant properties used to assess compressor performance**

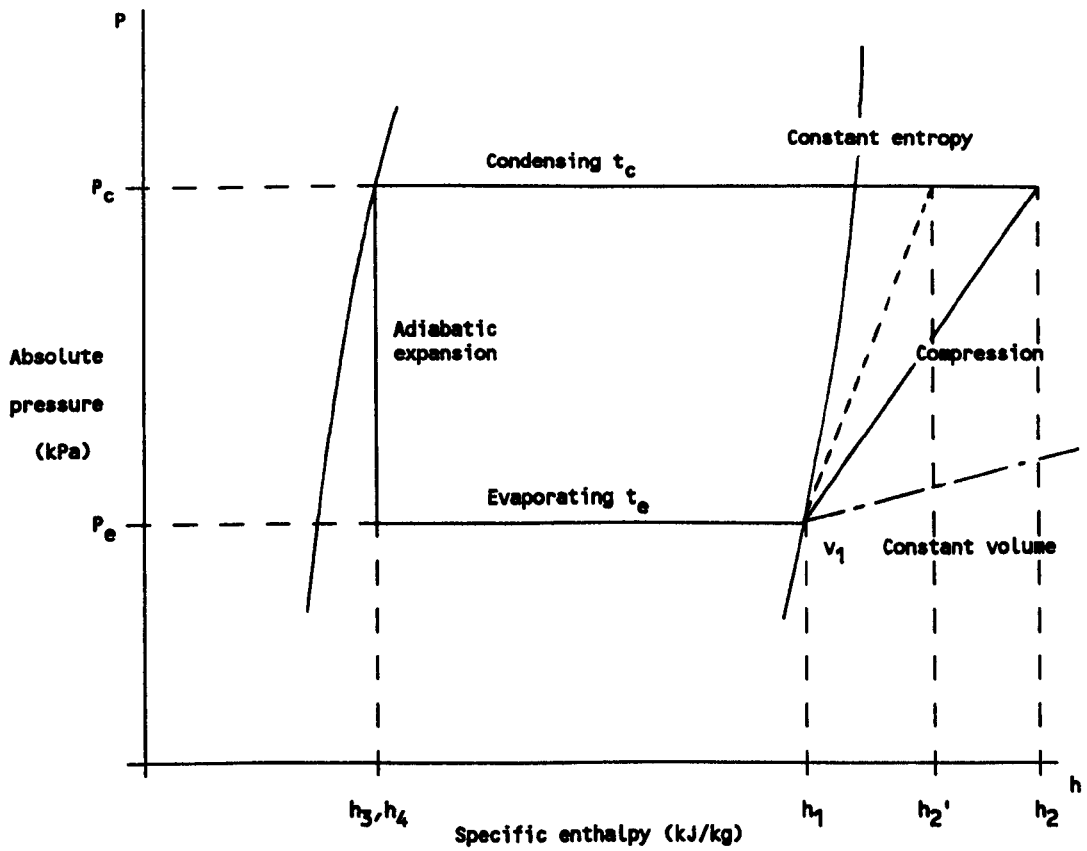

Adiabatic (isentropic) head =  $h_2' - h_1$  kJ/kg

Inlet volume flow rate =  $\frac{v_1}{h_1 - h_4}$  m<sup>3</sup>/s/kW

Ideal power to cooling ratio =  $\frac{h_2' - h_1}{h_1 - h_4}$

### 3 EQUIPMENT PERFORMANCE

For the five refrigeration system models considered, two types of compressor (nine different models), four types of evaporator, three types of condenser, two types of cooling tower and five types of cooling appliance are used. In this section the performance of each is considered and the method of analysis defined.

#### 3.1 Compressors

Using the definitions and approximate refrigerant property relationships outlined in section 2.2.3 and the compressor performance data provided by the manufacturers, the compressor performance curves of adiabatic head and efficiency plotted against the refrigerant inlet volume flow rate can be established for each of the compressors modelled.

For each combination of evaporating and condensing temperature, the manufacturers data gave the amount of cooling transferred at the evaporator and the required power input to the compressor. Using the evaporating and condensing temperatures, the adiabatic head  $h$  (kJ/kg), the specific compressor inlet flow rate  $v$  ( $\text{m}^3/\text{s}/\text{kW}$ ) and the ideal power to cooling ratio,  $I$ , can be calculated.

The actual compressor inlet flow rate is obtained by multiplying the specific inlet flow rate by the



cooling transferred at the evaporator. The ideal power input to the compressor is obtained by dividing the cooling transferred at the evaporator by the ideal power to cooling ratio. The compressor efficiency is determined by dividing the ideal power input by the manufacturers rated power input.

### 3.1.1 Compressor part load operation

The two main control options available to operate a refrigeration plant use either batch or continuous evaporator water supply. With batch supply, the compressor operates intermittently at full load and storage tanks are used to provide and store water when the cooling load is reduced. With continuous water supply, when the mine cooling load is reduced, the compressors continue to operate but unload to meet the actual cooling demand.

For the centrifugal compressors used in the Mount Isa R63 plant, part load operation of the 17 M compressors is achieved by reducing the compressor speed (driven by a variable speed motor). When this is modelled, the compressor inlet volume flow rate is assumed to vary in direct proportion to the change in speed and the compressor efficiency is assumed to be unchanged.

The 19DG compressor has a hot gas by-pass which is used to avoid surge (unstable recirculation around the impeller blades) when operating at part load. Since

this recirculates refrigerant between the impeller discharge and inlet, the power requirement is the same as if the compressor was running at full load.

For screw compressors, as the compressor unloads the efficiency decreases, the extent of which is dependent on the ratio of the discharge to suction pressures. An estimate of the discharge (condensing) or suction (evaporating) pressures when using ammonia as the refrigerant can be obtained from:-

$$P = 428.28 + 16.0 t + 0.23193 t^2 + 0.0017368 t^3 \text{ kPa}$$

where  $t$  = evaporating or condensing temperatures ( $^{\circ}\text{C}$ )

If the ratio of condensing to evaporating pressures  $r_p = P_c/P_e$  and the compressor part load factor is  $f_p$ , the part load power factor  $P_{if}$  can be obtained from:-

$$P_{if} = r_p (0.808 f_p^2 - 0.288 f_p^3 - 0.812 f_p + 0.292) \\ + (6.8625 f_p^2 - 3.0521 f_p^3 - 5.0394 f_p \\ + 2.2290)$$

Although this relationship was obtained using the part load data provided by Stal Refrigeration, it is valid for all the compressors using ammonia as refrigerant.

For the Sullair screw compressors using refrigerant R22 in the North Mine Broken Hill underground cooling plant, the fraction of the input power required  $P_{if}$

with respect to the reduction in evaporator capacity can be obtained from:-

$$P_{if} = 0.3421 \exp (1.073 Q_e/Q_e^*)$$

where  $Q_e$  = the actual evaporator duty

$Q_e^*$  = the evaporator duty with the compressor  
at full load

### 3.1.2 Centrifugal compressors

The compressors used in the Mount Isa R63 plant are all of the centrifugal type and comprise the two original 17M Carrier compressors purchased for the 1954 cooling plant and supplemented in 1973 and 1985 with two 19DG hermetic units. The performance of the units based on refrigerant R11 is summarised in figures 3.1 and 3.2. The 17M compressors are driven with variable speed 265 kW motors and the 19DG with refrigerant cooled 360 kW motors.

Both compressors will surge when the compressor inlet flow rate is less than 2.9 m<sup>3</sup>/s. The older 17M units have high peak compressor efficiencies and are no longer commercially available. The 19DG units are essentially packaged air conditioning industry water chillers and in addition to hermetic motors have uni-shell (combined in a single pressure vessel) evaporators and condensers.

Figure 3.1 - Carrier centrifugal compressor performance curves : adiabatic head

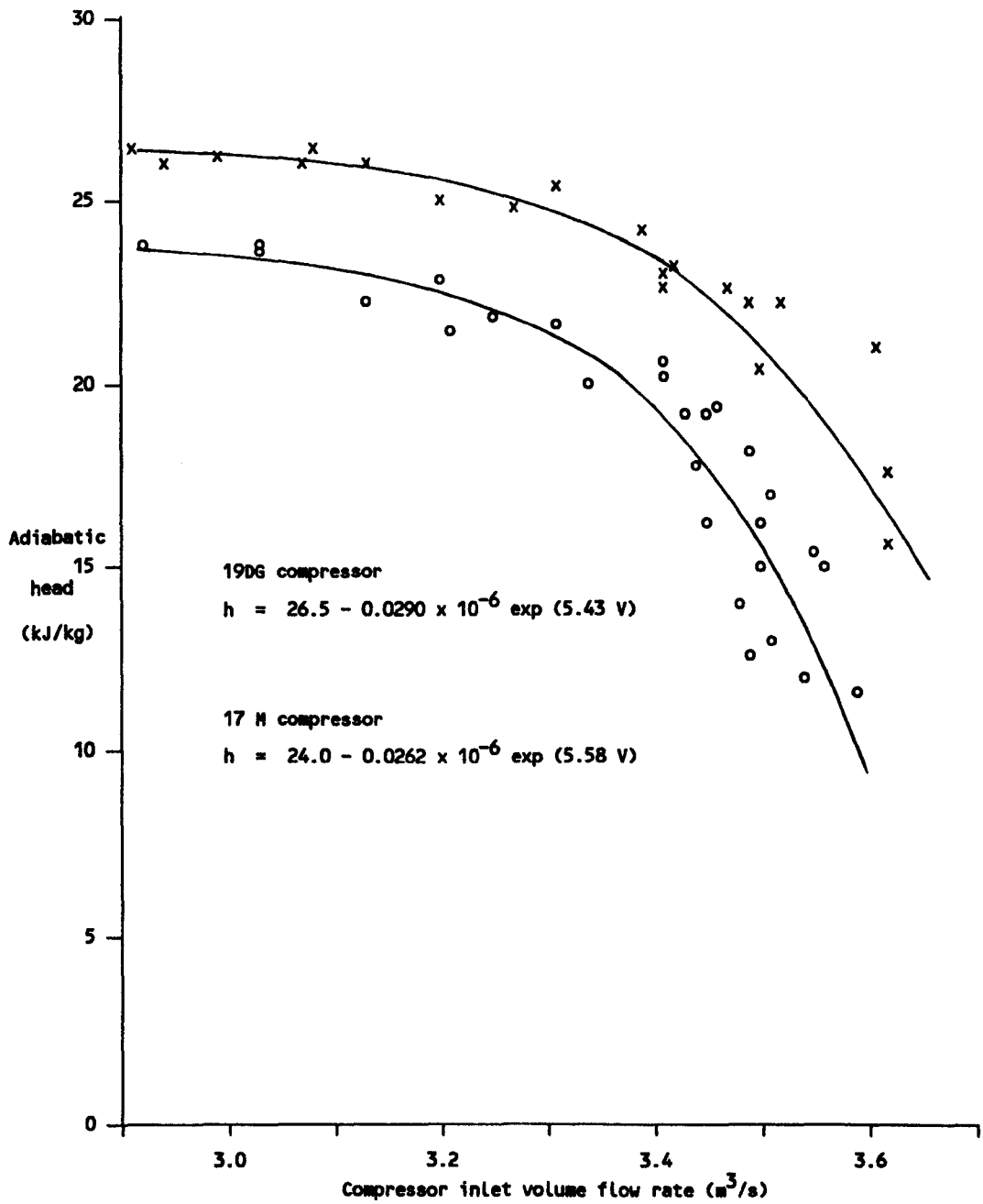
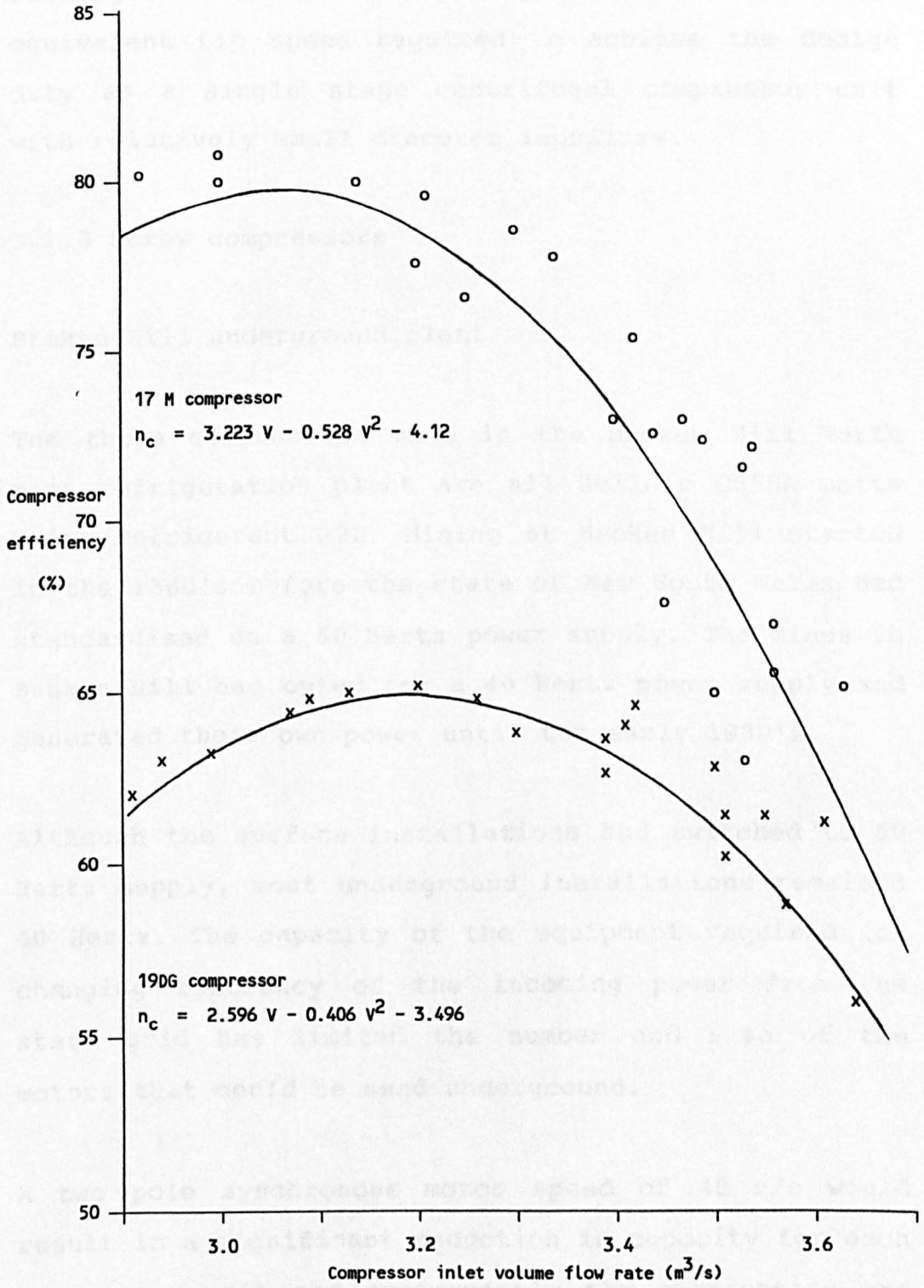

Figure 3.2 - Carrier centrifugal compressor performance curves : efficiency



The relatively low compressor peak efficiency of the 19DG compressors is partly a result of the refrigerant cooling of the motor and partly a result of the high equivalent tip speed required to achieve the design duty as a single stage centrifugal compressor unit with relatively small diameter impellers.

### 3.1.3 Screw compressors

#### Broken Hill underground plant

The three compressors used in the Broken Hill North mine refrigeration plant are all Sullair C25SA units using refrigerant R22. Mining at Broken Hill started in the 1880's before the state of New South Wales had standardised on a 50 Hertz power supply. The mines in Broken Hill had opted for a 40 Hertz power supply and generated their own power until the early 1980's.

Although the surface installations had switched to 50 Hertz supply, most underground installations remained 40 Hertz. The capacity of the equipment required for changing frequency of the incoming power from the state grid has limited the number and size of the motors that could be used underground.

A two pole synchronous motor speed of 40 r/s would result in a significant reduction in capacity for each compressor unit and consequently the compressors are driven at 62.5 r/s using a gear box and 387 kW motors.

The performance curves for the compressors at this speed are given in figure 3.3.

The maximum power required by the compressor is 460 kW when operating at both high condensing and evaporating temperatures (over 45°C and 10°C respectively). Consequently, to protect the motor, the compressor unloads by progressively closing the slide valve capacity control when the amperage drawn by the motor reaches a pre-set maximum value.

#### Mount Isa surface plants

The compressors tendered for the Mount Isa stage 1 surface chilled water plant and the stage 2 surface bulk air cooler plants are the Howden 321-19321, Stal S93-26 and the Sabroe 536H screw compressors.

The Howden compressors were used for the stage 1 surface chilled water plant and have 321 mm diameter rotors, a length to diameter ratio of 1.93 and a built-in volume ratio of 2.1. The rated performance of this compressor using ammonia as the refrigerant is illustrated in figure 3.4. Witnessed compressor tests were undertaken on the two units at the factory prior to delivery. The capacity was found to vary by -2.5% and -0.5% and the input power by +1.5% and +2.7% for units 1 and 2 respectively.

Stal compressors have been selected for the stage 2

Figure 3.3 - Sullair C25SA screw compressor performance curve : refrigerant R22

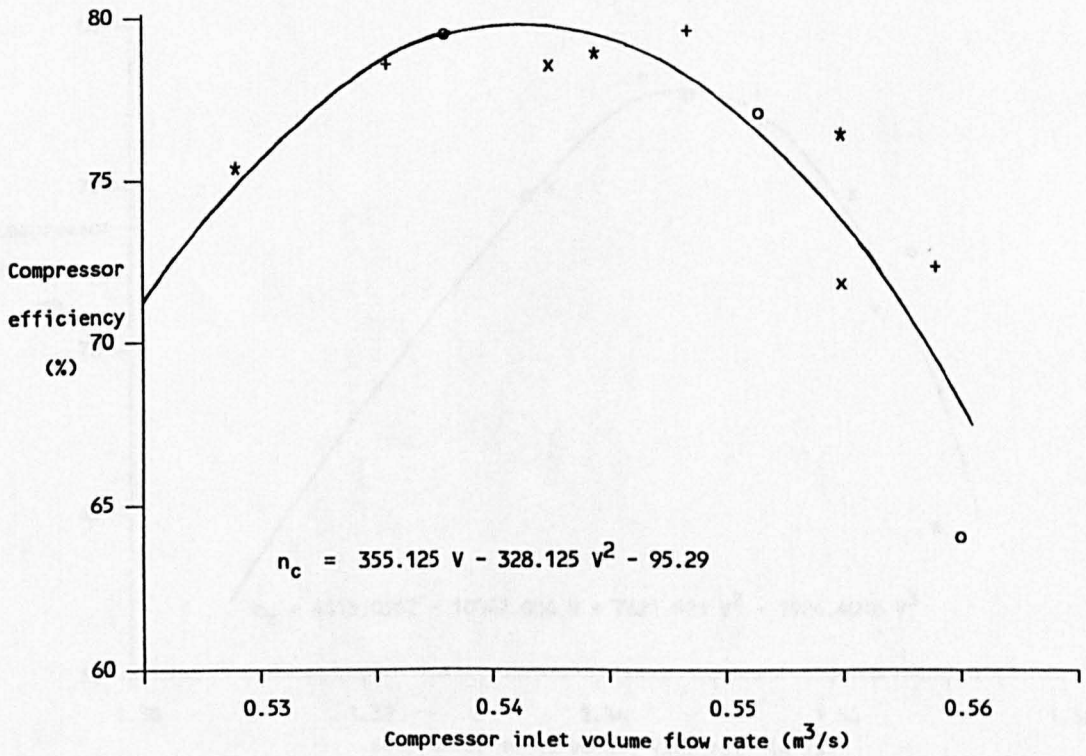
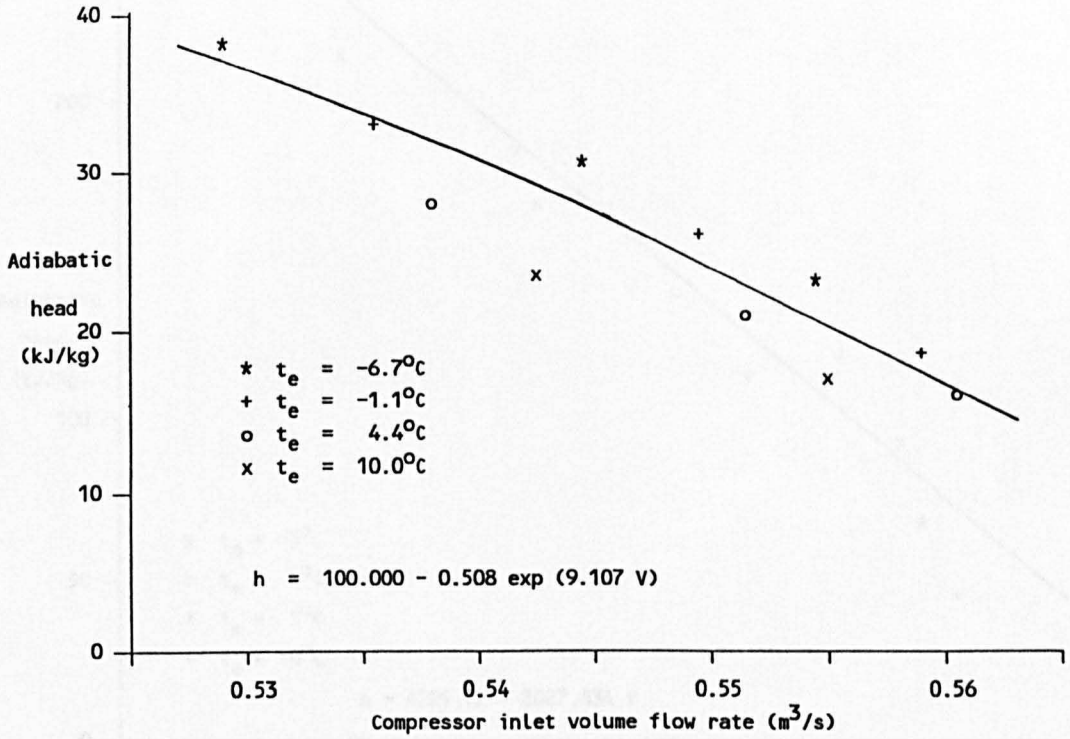



Figure 3.4 - Howden 321-19321 screw compressor performance curves : ammonia R717

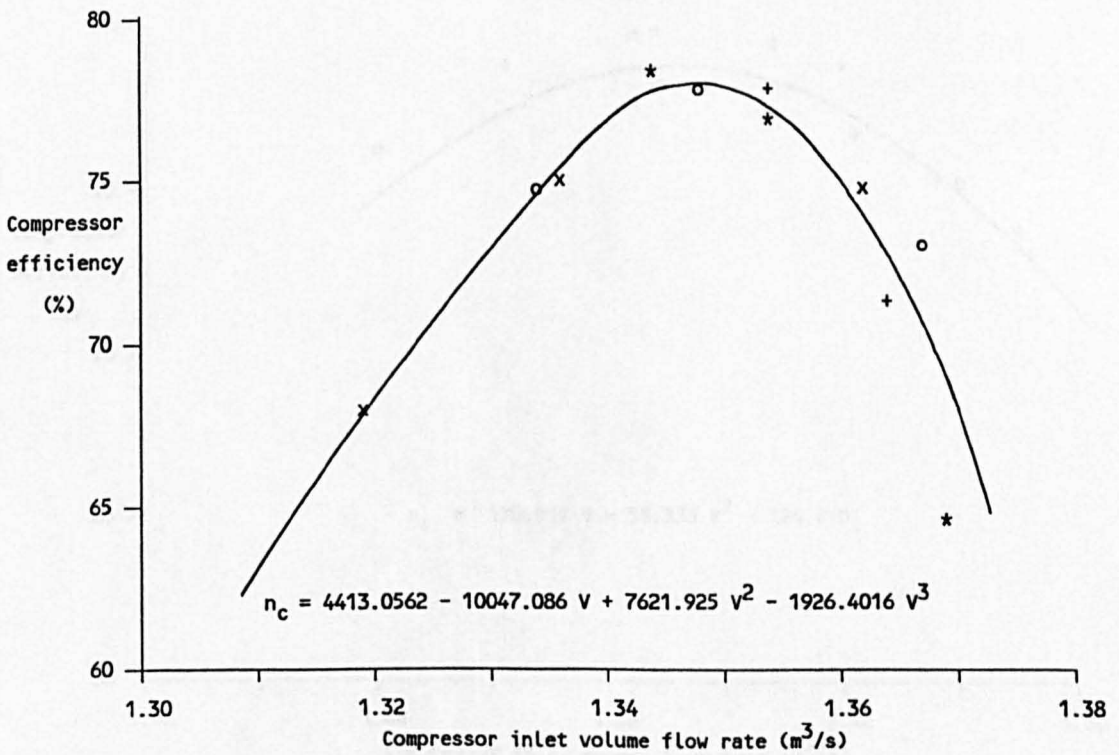
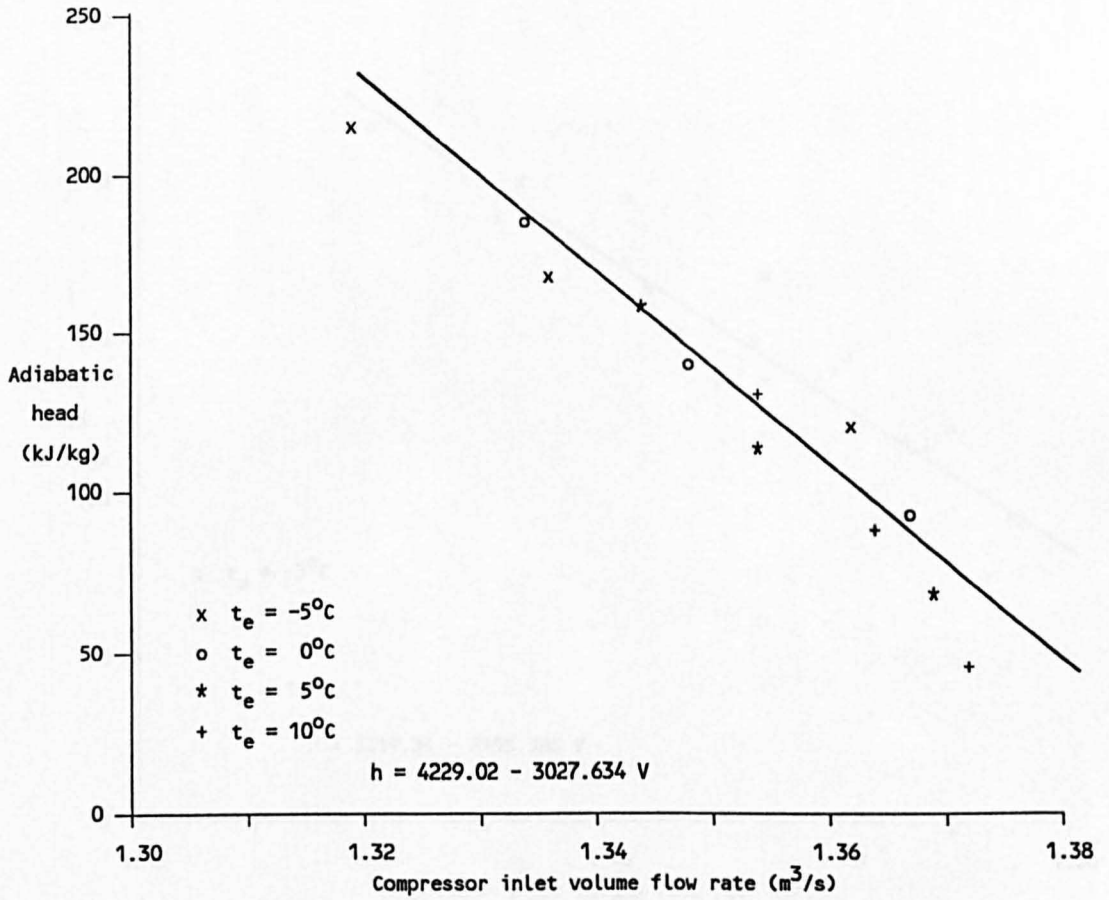

Figure 3.5 - Stal S93E-26 screw compressor performance curves : ammonia R717

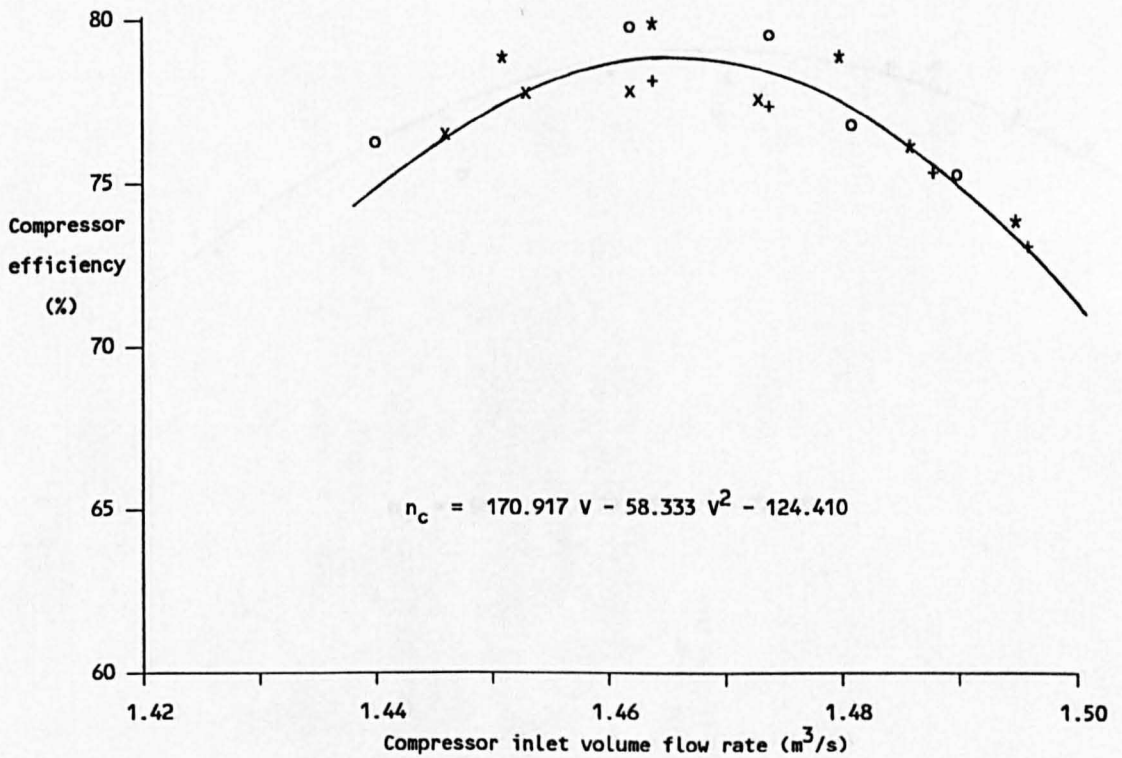
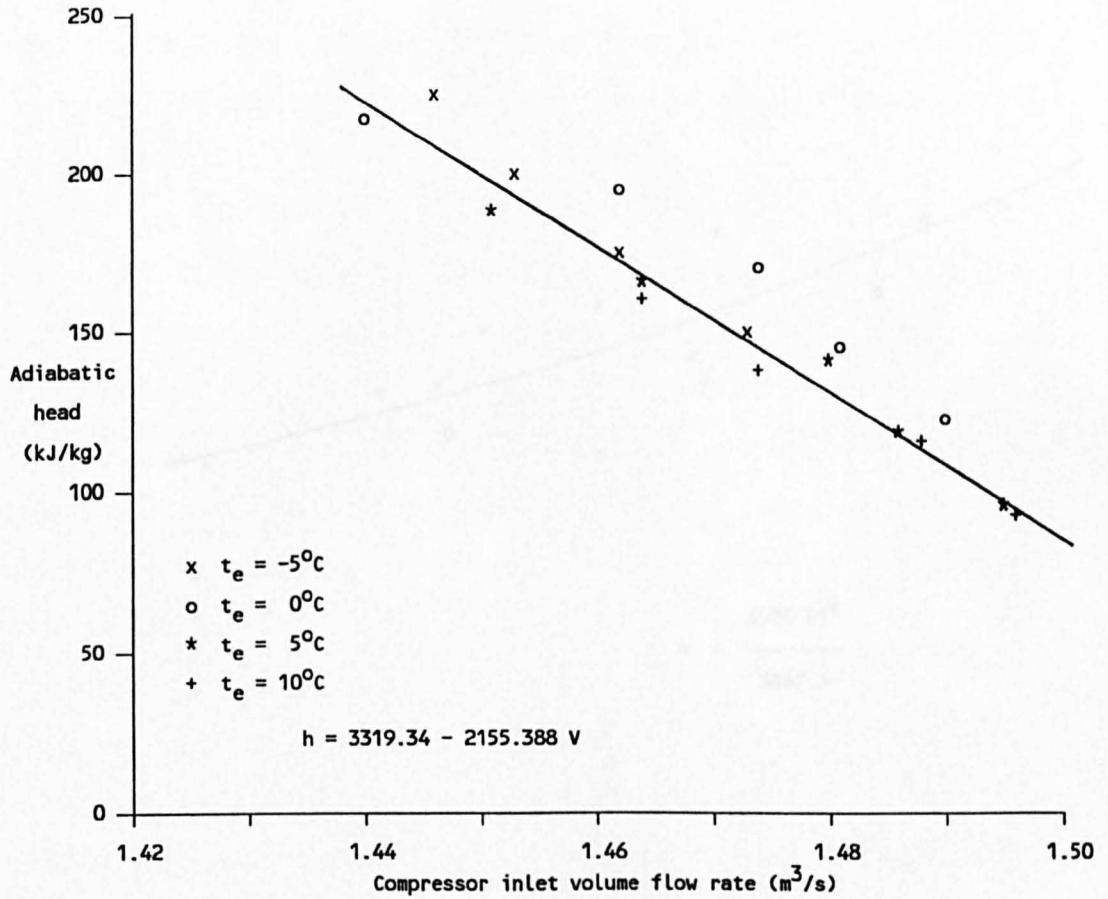
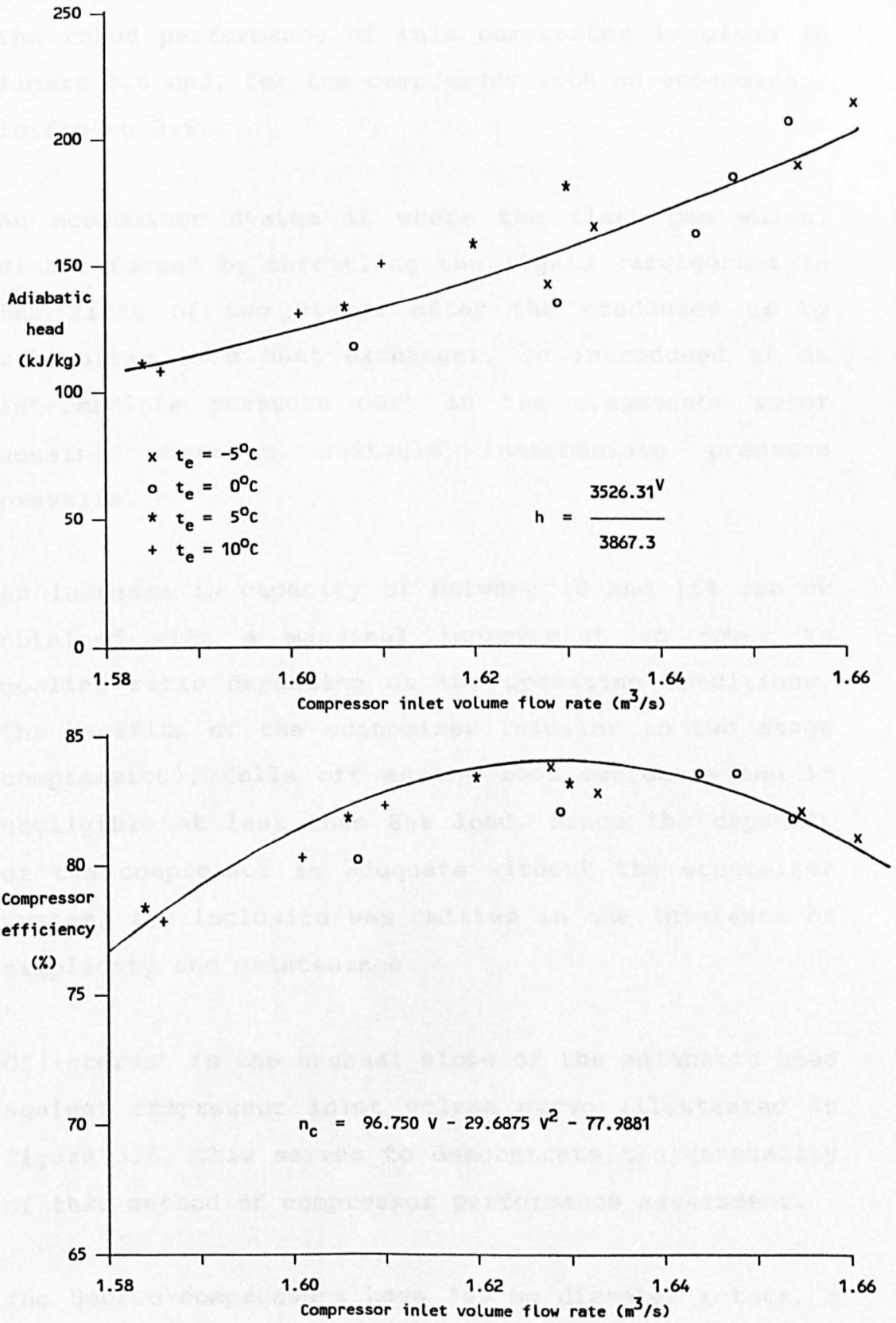

Figure 3.6 - Stal S93E-26 (economiser) screw compressor performance curves : ammonia R717



surface bulk air cooling plant and have 330 mm diameter rotors and a built-in volume ratio of 2.6. The rated performance of this compressor is given in figure 3.5 and, for the compressor with an economiser, in figure 3.6.

An economiser system is where the flash gas which, either formed by throttling the liquid refrigerant in the first of two stages after the condenser or by subcooling in a heat exchanger, is introduced at an intermediate pressure port in the compressor rotor housing where a suitable intermediate pressure prevails.

An increase in capacity of between 10 and 15% can be obtained with a marginal improvement in power to cooling ratio depending on the operating conditions. The benefits of the economiser (similar to two stage compression), falls off as the load decreases and is negligible at less than 80% load. Since the capacity of the compressor is adequate without the economiser system, its inclusion was omitted in the interests of simplicity and maintenance.

Of interest is the unusual slope of the adiabatic head against compressor inlet volume curve illustrated in figure 3.6. This serves to demonstrate the generality of this method of compressor performance assessment.

The Sabroe compressors have 345 mm diameter rotors, a

length to diameter ratio of 1.60 and a built-in volume ratio of 2.3. The performance curves of the compressor when using ammonia are illustrated in figure 3.7.

All the compressors considered for the Mount Isa plants are either driven by or to be driven by 1200 kW motors at a speed of 49.2 r/s.

#### Broken Hill surface plant

The compressors tendered for the Broken Hill surface bulk air cooler plant were Howden 321-13226, Sullair L25LA and Mycom 320 MU-LX.

Two Howden compressors were selected for this plant and they have a 321 mm diameter rotors, a rotor length to diameter ratio of 1.32 and a built-in volume ratio of 2.6. The performance of the compressor with ammonia as the refrigerant is illustrated in figure 3.8. The compressors are to be driven with 750 kW motors at a speed of 49.2 r/s.

The performance of the Sullair and Mycom compressor alternatives are illustrated in figures 3.9 and 3.10. The Mycom compressor is similar in size and capacity to the Howden compressor whereas the Sullair unit with a rotor diameter of 250 mm, is significantly smaller and three units are required to achieve the total plant duty.

Figure 3.7 - Sabroe 536H screw compressor performance curves : ammonia R717

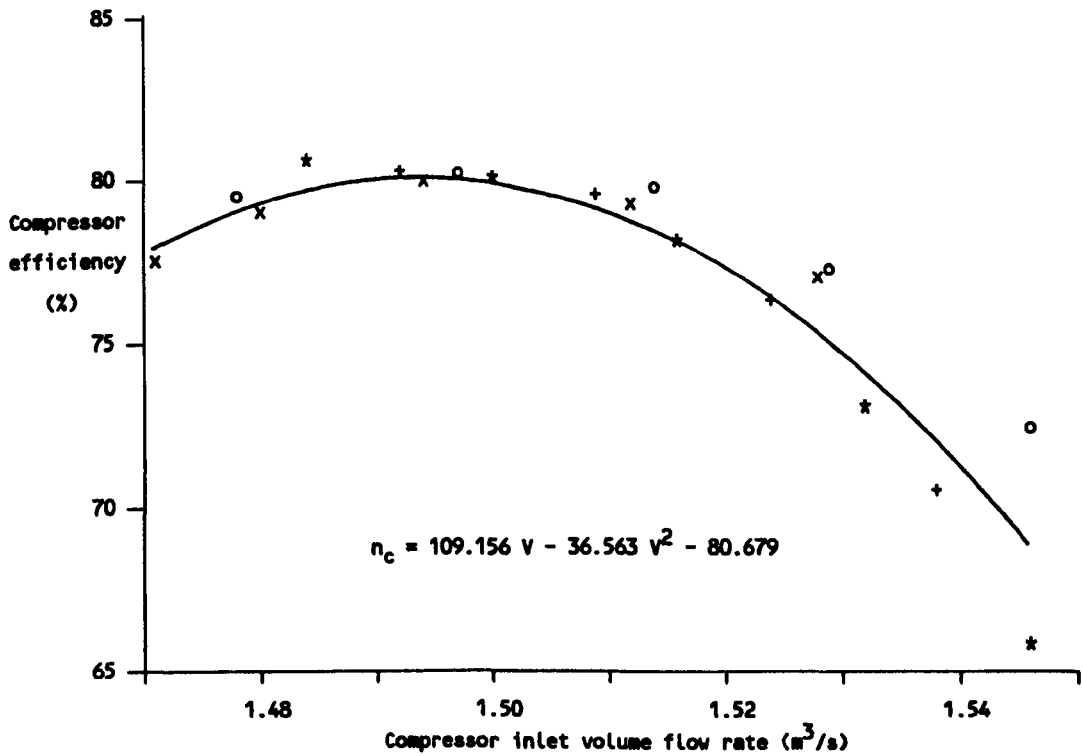
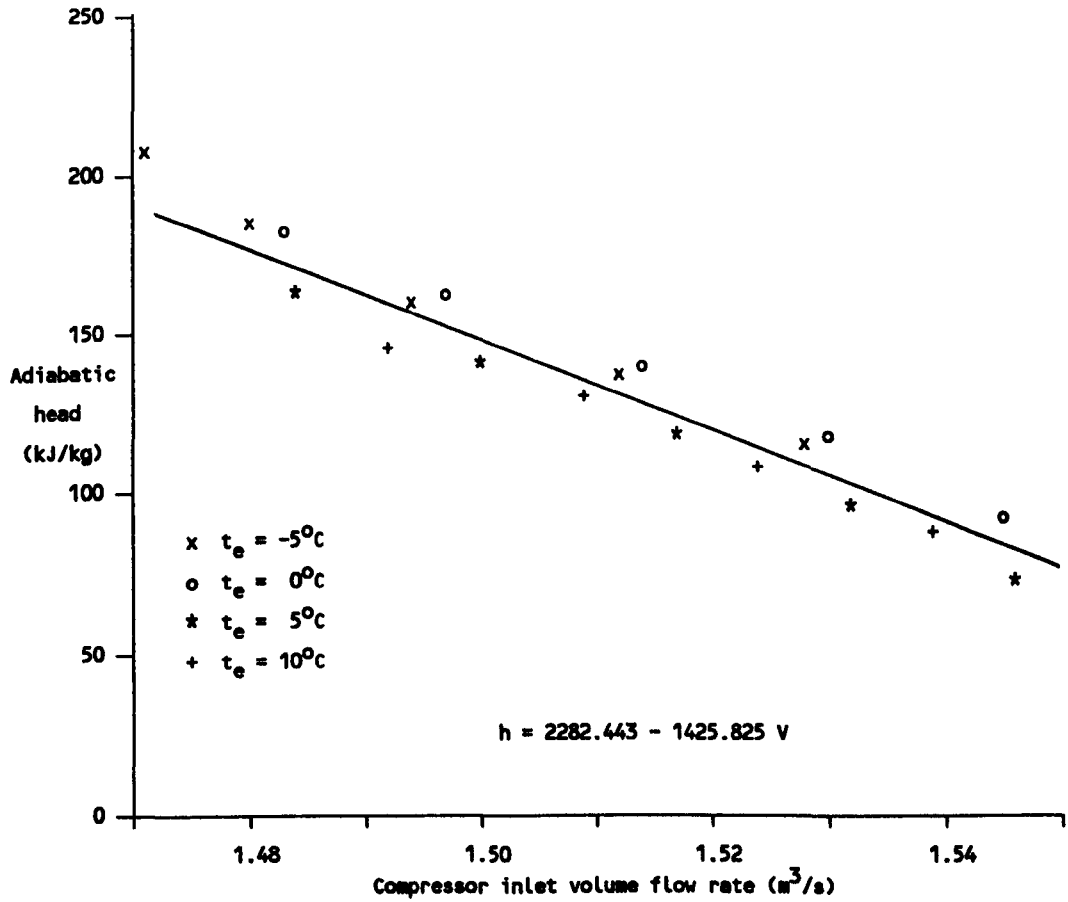

Figure 3.8 - Howden 321-13226 screw compressor performance curves : ammonia R717

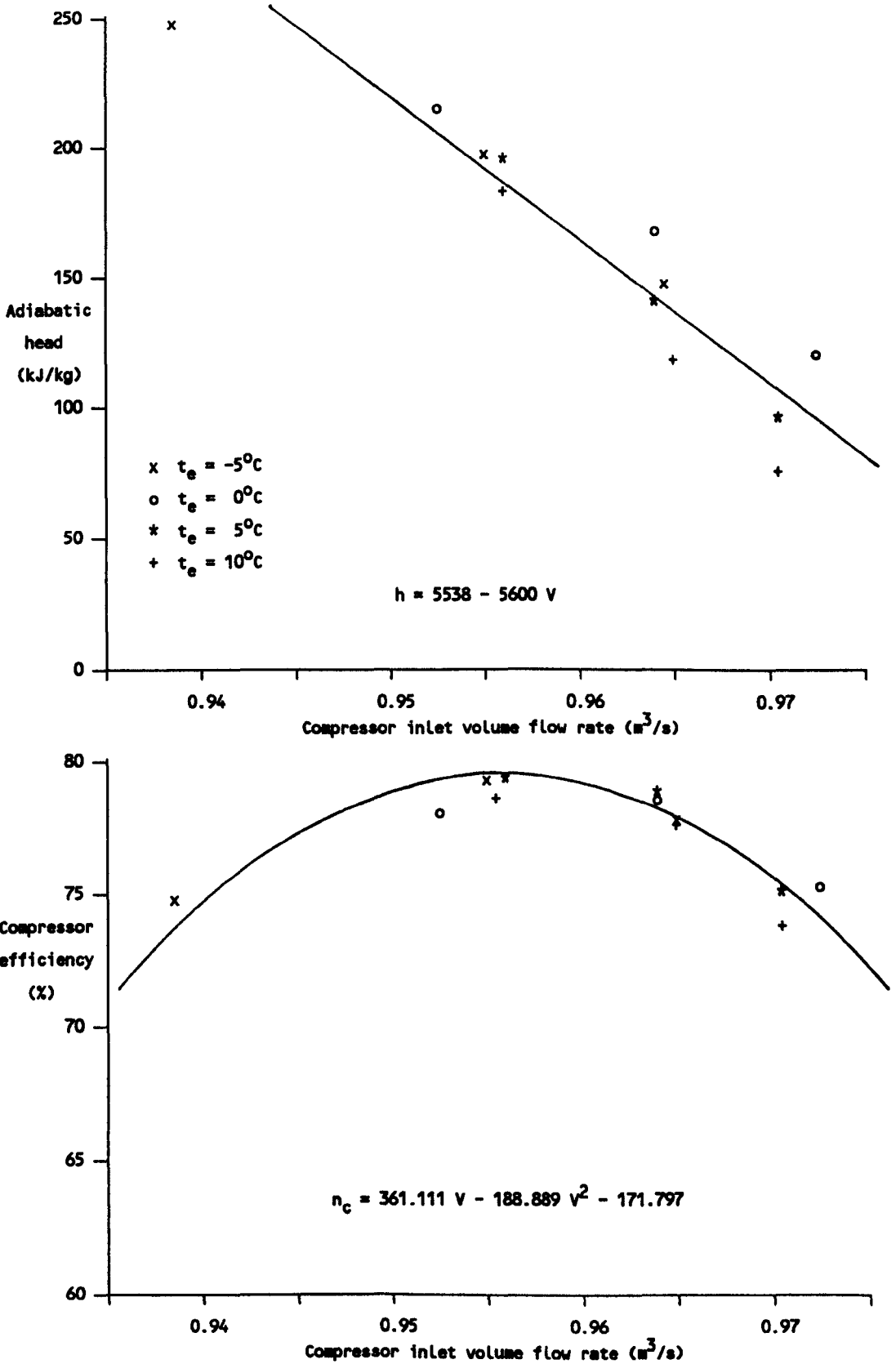

Figure 3.9 - Sullair L25LA screw compressor performance curves : ammonia R717

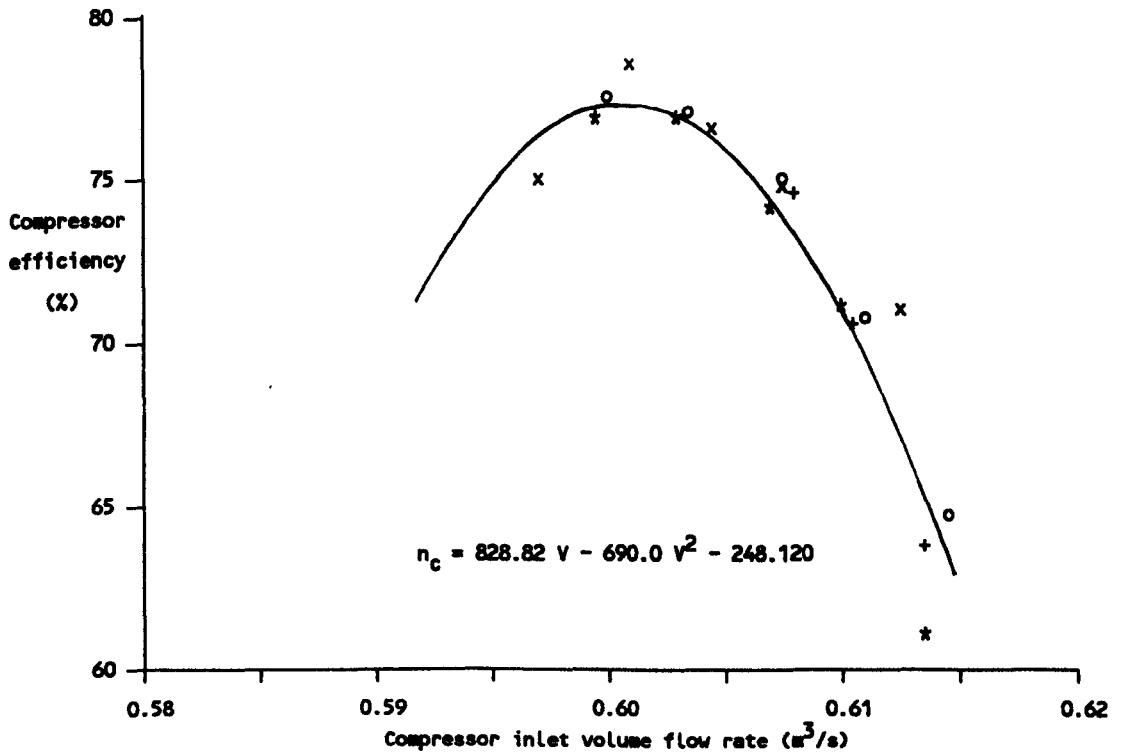
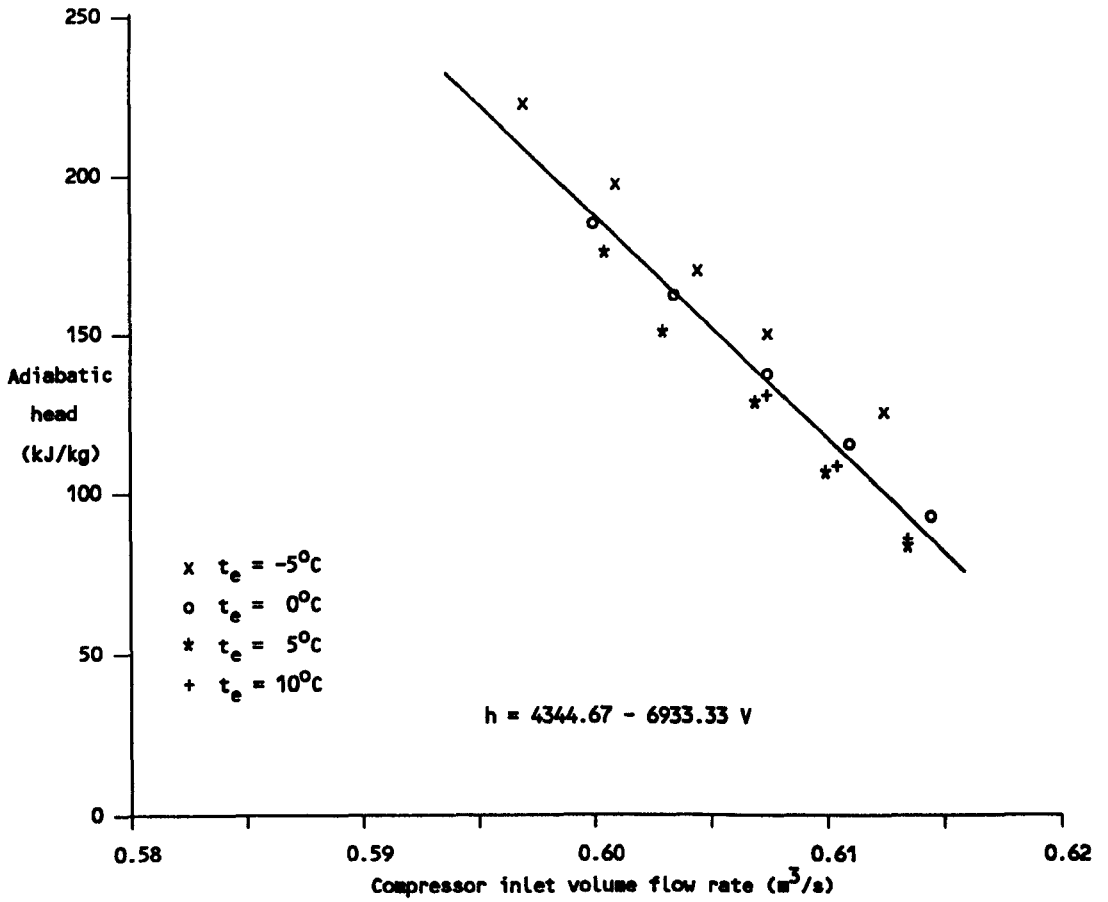
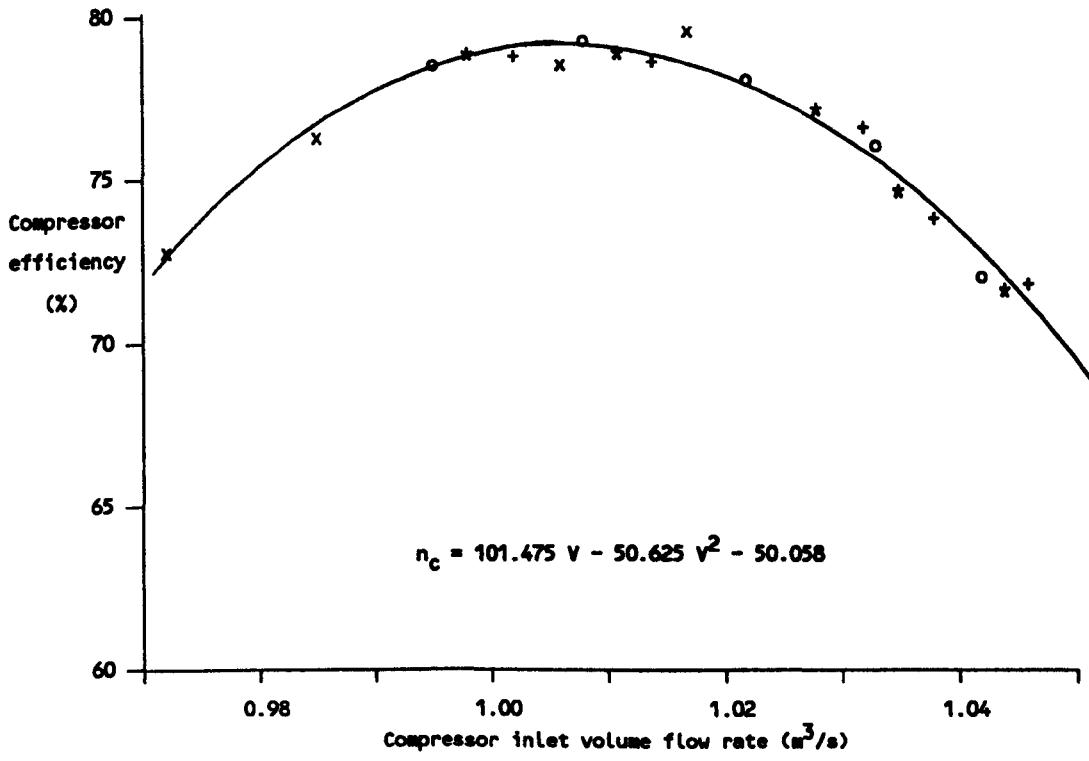
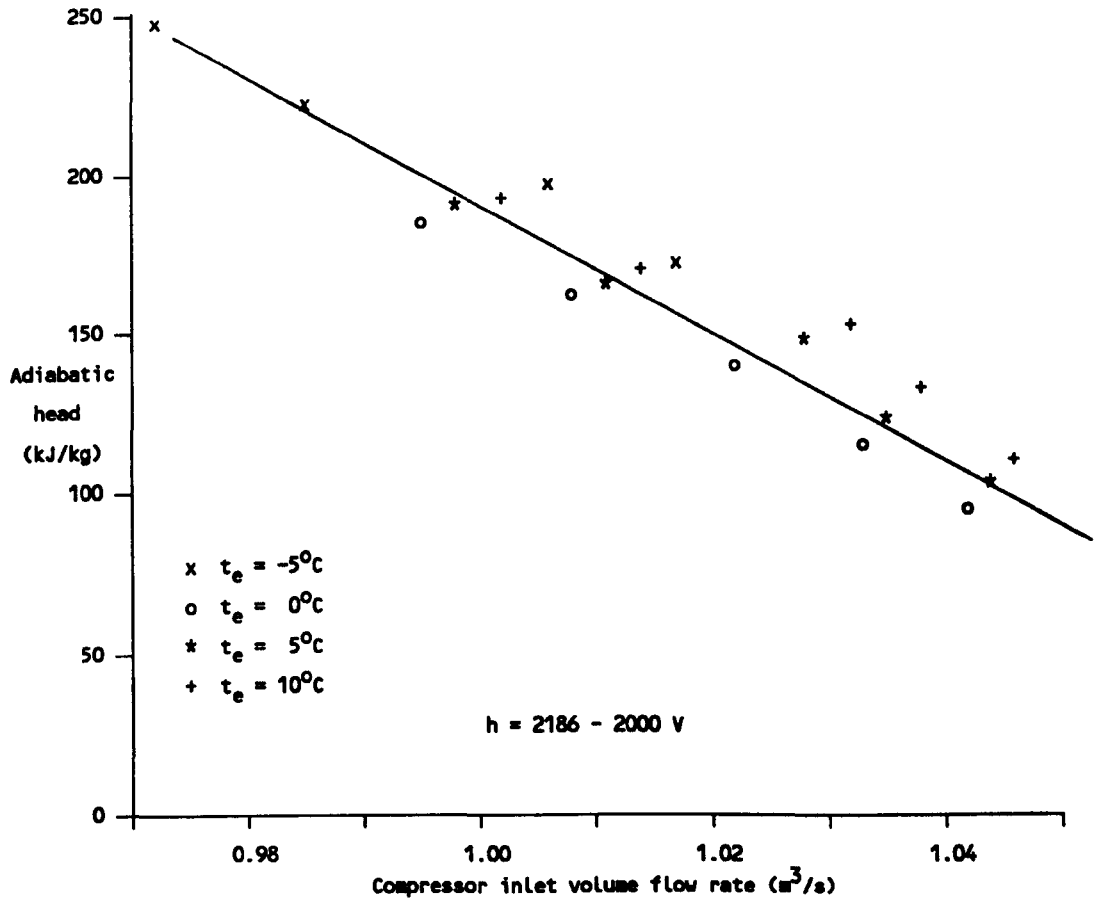



Figure 3.10 - Mycom 320 MU-LX screw compressor performance curves ; ammonia R717



### 3.2 Condensers

The thermal performance of a condenser is a function of an overall heat transfer coefficient ( $UA$ ) and a driving force. The value of the overall heat transfer coefficient depends on the heat exchange areas, the thermal resistances of both the refrigerant and the heat rejection fluid boundary layers, the thermal resistance of the material separating the refrigerant and the heat rejection fluid and the thermal resistance of accumulating impurities on the surface exposed to the heat rejection fluid (fouling).

For shell and tube and closed plate condensers where water is used as the heat rejection fluid, the driving force is the log mean temperature difference (LMTD) between the water entering and leaving the condenser and the condensing temperature of the refrigerant. For an evaporative condenser where both air and water are used as the heat rejection fluids, the driving force is the difference between the vapour pressure of air which is saturated at the refrigerant condensing temperature and the vapour pressure of air saturated at the inlet wet bulb temperature.

When modelling condenser performance, either the condensing temperature of the refrigerant or the heat rejection fluid side surface fouling factor (scale) is to be evaluated. Plant optimisation and design including tender and control system evaluation require

calculation of the condensing temperature. Fouling factor calculations are normally required for routine maintenance and use measurements obtained from the monitoring of an operating plant.

The refrigerant condensing heat transfer coefficient is the most difficult to evaluate with accuracy. It is a function of the refrigerant properties, the geometry of the condensing surface and the difference between the film temperature and the saturated condensing temperature (ASHRAE, 1972; Howes, 1975). Although the simplified relationships can be used, the values are confirmed with test data where possible.

### 3.2.1 Shell and tube condensers

When modelling shell and tube condenser performance, the condenser water flow rate, the water temperature into the condenser and the condenser duty are known. The cooling water is supplied through the inside of the tubes and the refrigerant is supplied to the shell and condenses on the outside of the tubes.

Multiple (two or three) water pass arrangements are common and achieved by using baffles in the water boxes at the ends of the tubes. The number of water passes used is a compromise between the improved heat transfer associated with high water velocities in the tubes and the increased pressure loss and associated pump power resulting from the higher water velocities.

In most shell and tube condensers the magnitude of the refrigerant heat transfer coefficient is usually between 20 to 30% of the water side heat transfer coefficient. The total number of tubes required and therefore the cost of the condenser, is minimised by extending the refrigerant side heat transfer surface area with ribs or fins on the outside of the tubes.

The refrigerant which is condensed on the outside of the tubes is collected in the bottom part of the condenser shell. This liquid will be subcooled if the refrigerant level is above the bottom rows of tubes in the tube bundles.

The general method of analysis used to obtain the condensing temperature is summarised in Table 3.1. The two refrigeration plants which use shell and tube condensers are the Mount Isa R63 surface plant and the Broken Hill underground plant. The constructional details of each condenser used in the simulations are summarised in Table 3.2.

### 3.2.2 Closed plate condensers

Closed plate heat exchangers comprise of individual corrugated thin plates which are assembled in packs and clamped into a frame. Each adjacent pair of plates forms a flow channel with the refrigerant and the heat rejection water flowing in alternate channels. A gasket is located along the perimeter and the corners

of each plate which both separates the plates and prevents any mixing of the refrigerant and water.

Headers are formed by holes in the corners of each plate and the fluids are permitted into the passages between the plates by arrangement of the gaskets, the refrigerant is directed into every second passage while the water is let into the passage in between.

The corrugations in the plates maintain the correct spacing between the plates, provide support for each plate against adjacent plates and promotes turbulence of the refrigerant and water which improves the heat transfer. This support allows relatively thin plate material to be used and 0.6 mm thickness is typical.

In closed plate heat exchangers, the magnitude of the refrigerant heat transfer coefficient is usually 70 to 80% of the water side heat transfer coefficient. An extended refrigerant side surface is not practical and consequently, to meet the refrigerant side heat transfer area requirements, the water side surface area is larger than an equivalent shell and tube condenser whilst maintaining a competitive cost.

The advantage of this is that increased fouling on the water side of the plates can be permitted whilst maintaining an equivalent thermal performance to that of the shell and tube heat exchanger.

Condensers operate at relatively high pressures and to avoid refrigerant leakage, the two plates providing the refrigerant path are usually welded together to form a cassette. To protect the gaskets from high temperature refrigerant leaving the compressor, the discharge gas is sometimes de-superheated prior to entering the plate heat exchanger.

The general method of analysis used to obtain the condensing temperature is identical to that for a shell and tube condenser except for the calculation of the overall heat transfer coefficient. The method used for this is summarised in Table 3.3. Closed plate condensers unlike shell and tube condensers, have no refrigerant storage and therefore there is no subcooling of the condensed refrigerant.

The closed plate heat exchangers used for condensers in these simulations were all supplied by the same manufacturer. The empirical relationships used to determine the water and refrigerant heat transfer coefficients were obtained by an analysis of the rated and actual performance data and have a similar form to those used to assess the performance of shell and tube condensers. The area of plate in each cassette is  $3.193 \text{ m}^2$  and is the same for the water, refrigerant and mean surface areas. The plate thickness is 0.6 mm and the material used is 316 stainless steel with a thermal conductivity of 0.0163 kW/mK.

### 3.2.3 Evaporative condensers

In an evaporative condenser, the refrigerant is circulated through and condensed in tubes or plates over which water is sprayed and air is drawn. In these units, the removal of the heat required to condense the refrigerant is transferred directly to the air which is ultimately used for heat rejection from all mine condensing systems.

The heat gained by the water recirculating in both shell and tube and closed plate condensers is normally rejected to the air in direct contact cooling towers. The combination of stages in an evaporative condenser usually results in the most cost effective method of rejecting heat from the refrigeration process.

The procedure required to model the performance of an evaporative condenser is given in Table 3.4. The empirical relationship used to assess the overall heat transfer coefficient allows the effects of fouling to be taken into account and is based on the analysis of available measurements and performance data (see section 7 of Table 3.4).

The evaporative condenser factor is essentially the area available for heat transfer and includes the influence of pipe or plate geometry and the pipe wall or plate thickness and thermal conductivity. The airflow factor is mainly used to avoid excessively low

condensing temperatures and is applied where the units either have multiple fans which are allowed to cycle on and off or where the fans are driven by two speed motors.

The amount of air used for heat rejection lies between the relatively narrow limits of 0.0175 and 0.0210 m<sup>3</sup>/s per kW of base heat rejection with an average value of 0.0190 m<sup>3</sup>/s/kW. The recirculating water mass flow rate is approximately equivalent to the air mass flow rate used for heat rejection in the evaporative condenser.



**Table 3.1 - Performance analysis of shell and tube condensers**

<p>1 Calculate the temperature of the water leaving the condenser</p> $t_{woc} = t_{wic} + \frac{Q_c}{4.185 l_c}$ <p> <math>t_{woc}</math> = water temperature out of the condenser (°C)  <math>t_{wic}</math> = water temperature into the condenser (°C)  <math>Q_c</math> = heat to be transferred in the condenser (kW)  <math>l_c</math> = condenser water flow rate (L/s)                 </p>
<p>2 Calculate the overall heat transfer coefficient</p> $\frac{1}{UA} = \frac{1}{h_w a_w} + \frac{1}{h_{fc} a_w} + \frac{x}{a_m k} + \frac{1}{h_r a_r}$ <p> <math>UA</math> = overall heat transfer coefficient (kW/K)  <math>h_w</math> = water side heat transfer coefficient (kW/m<sup>2</sup>K)  <math>= 1.427 [1 + 0.0075(t_{wic} + t_{woc})] V_w^{0.8} d_i^{-0.2}</math>  <math>V_w</math> = water velocity in the tubes (m/s)  <math>d_i</math> = tube inside diameter (m)  <math>a_w</math> = water side tube surface area (m<sup>2</sup>)  <math>h_{fc}</math> = water side fouling factor (kW/m<sup>2</sup>K)  <math>x</math> = tube wall thickness (m)  <math>k</math> = thermal conductivity of tube material (kW/mK)  <math>a_m</math> = mean tube surface area (m<sup>2</sup>)  <math>h_r</math> = refrigerant side heat transfer coefficient (kW/m<sup>2</sup>K)  <math>= \frac{4.3}{[t_c - (t_{wic} + t_{woc})/2]^{0.25}}</math> for R11 and R22  <math>a_r</math> = refrigerant side tube surface area (m<sup>2</sup>)                 </p>
<p>3 Calculate the log mean temperature difference</p> $LMTD = \frac{(t_c - t_{wic}) - (t_c - t_{woc})}{\ln [(t_c - t_{wic})/(t_c - t_{woc})]}$
<p>4 Calculate the overall heat transfer rate</p> $Q = UA LMTD$
<p>5 Compare Q and Q<sub>c</sub> and repeat 1 to 4 until  Q - Q<sub>c</sub>  &lt; 0.1 kW</p>
<p>6 Obtain revised values of condensing temperature t<sub>c</sub> from:-</p> $LMTD^* = Q_c / UA$ $f_c^* = \exp[(t_{woc} - t_{wic}) / LMTD^*]$ $t_c = \frac{(t_{wic} - f_c^* t_{woc})}{(1 - f_c^*)}$

Table 3.2 - Constructional details of the shell and tube condensers used in the simulations

Refrigeration plant	Mount Isa R63 surface plant		Broken Hill plant
Condenser designation	17 M size 8	19 DG size 69	White 16501
Number of water passes	2	2	2
Inside tube surface area (m <sup>2</sup> )	88.6	47.8	193.2
Outside tube surface area (m <sup>2</sup> )	314.0	192.5	860.8
Mean tube surface area (m <sup>2</sup> )	95.6	53.4	227.7
Tube wall thickness (m)	0.00108	0.00075	0.00163
Tube thermal conductivity (kW/mK)	0.386	0.386	0.386
Total number of tubes	532	310	760
Inside diameter of tubes (m)	0.01372	0.01600	0.0140
Total tube cross sectional area (m <sup>2</sup> )	0.07860	0.06233	0.1169

Table 3.3 - Calculation of the overall heat transfer coefficient for closed plate condensers

<p>2 Calculate the overall heat transfer coefficient</p> $\frac{1}{UA} = \frac{1}{h_w a_w} + \frac{1}{h_{fc} a_w} + \frac{x}{a_m k} + \frac{1}{h_r a_r}$ <p>           UA = overall heat transfer coefficient (kW/K)            h<sub>w</sub>a<sub>w</sub> = water side heat transfer (kW/K)            = 16.9 [1 + 0.0075(t<sub>wic</sub> + t<sub>woc</sub>)] L<sub>c</sub><sup>0.8</sup> N<sub>c</sub><sup>0.2</sup>            N<sub>c</sub> = number of cassettes in the plate heat exchanger            a<sub>w</sub> = water side plate surface area (m<sup>2</sup>)            h<sub>fc</sub> = water side fouling factor (kW/m<sup>2</sup>K)            x = plate thickness (m)            k = thermal conductivity of plate material (kW/mK)            a<sub>m</sub> = mean plate surface area (m<sup>2</sup>)            a<sub>r</sub> = refrigerant side plate surface area (m<sup>2</sup>)            h<sub>r</sub>a<sub>r</sub> = refrigerant side heat transfer (kW/K)            = 21.6 N<sub>c</sub> exp (t<sub>c</sub>/65) for ammonia R717         </p>
--

Table 3.4 - Performance analysis of evaporative condensers

<p>1 The required condenser heat rejection rate is <math>Q_c</math> (kW)</p>
<p>2 Calculate the overall heat transfer coefficient UA</p> $\frac{E_{cf} F_f^{0.8}}{UA} = \frac{1}{1.851} + \frac{1}{h_{fc}}$ <p> <math>E_{cf}</math> = evaporative condenser factor (<math>m^2</math>)  <math>F_f</math> = evaporative condenser airflow factor  <math>h_{fc}</math> = water/air side fouling factor (<math>kW/m^2K</math>)         </p>
<p>3 Calculate the difference in vapour pressures</p> $e_s = 0.6105 \exp[(17.27 t)/(237.3 + t)]$ <p><math>t</math> = condensing or inlet wet bulb temperature (<math>^{\circ}C</math>)</p>
<p>4 Calculate the overall heat transfer rate</p> $Q = UA_c (e_{sc} - e_{sa})$ <p> <math>e_{sc}</math> = vapour pressure at the condensing temperature (kPa)  <math>e_{sa}</math> = vapour pressure at the wet bulb temperature (kPa)         </p>
<p>5 Compare <math>Q</math> and <math>Q_c</math> and repeat steps 2 to 4 until <math> Q - Q_c  &lt; 0.1</math> kW</p>
<p>6 Revised values of <math>t_c</math> are obtained from:-</p> $e_{sc}^* = \frac{Q_c}{UA} + e_{sa}$ $f_c^* = \ln(e_{sc}^*/0.6105)$ $t_c = \frac{237.3 f_c^*}{17.27 - f_c^*}$
<p>7 From the published performance data for evaporative condensers the heat rejected in the condenser is</p> $Q = \frac{F'}{\text{factor}} (e_{sc} - e_{sa})$ <p> <math>F'</math> = base heat rejection (kW)  <math>\text{factor} = 0.207 e_{sc} + 2.235</math> </p> <p>This expression, although accurate to within 1% of the rated values, is based on medium clean heat transfer surfaces and has no provision for changes in fouling. The evaporative condenser factor <math>E_{cf}</math> is obtained by equating the above expression with that given in steps 2 to 4. The rated values are assumed to be based on a fouling factor of <math>5.0 \text{ kW}/m^2K</math> and a condensing temperature of <math>35^{\circ}C</math> is used as a typical value.</p>

### 3.3 Evaporators

Similar to condensers, the thermal performance of an evaporator is a function of an overall heat transfer coefficient (UA) and a driving force. The value of the overall heat transfer coefficient depends on the heat exchange areas, the thermal resistances of both the refrigerant and the chilled water boundary layers, the thermal resistance of the material separating the refrigerant and the chilled water and the thermal resistance of accumulating impurities on the surface exposed to the chilled water (scale or fouling).

For all four types of evaporator being considered, the driving force is the log mean temperature difference (LMTD) between the water entering and leaving the evaporator and the evaporating temperature of the refrigerant. When modelling evaporator performance, either the evaporating temperature of the refrigerant or the chilled water side surface fouling factor (scale) is to be evaluated.

Plant optimisation and design including tender and control system evaluation require calculation of the evaporating temperature. Fouling factor calculations are normally required for routine maintenance and use measurements obtained from the monitoring of an operating plant.

The refrigerant evaporating heat transfer coefficient

is the most difficult to evaluate with accuracy. It is a function of the refrigerant properties, the boiling or evaporating surface nucleating characteristics and geometry and the heat flux density (Stephan, 1972). Although simplified relationships are normally used, the values are confirmed with the results of test data where possible.

### 3.3.1 Shell and tube evaporators

When modelling shell and tube evaporator performance, the evaporator or chilled water flow rate, the water temperature into the evaporator and the evaporator duty are known. The water to be chilled is supplied through the inside of the tubes and the refrigerant is supplied to the shell and evaporates or boils on the outside of the tubes.

Multiple (two to four) water pass arrangements are common and achieved by using baffles in the water boxes at the ends of the tubes. Similar to condensers, the number of water passes used is a compromise between the improved heat transfer associated with high water velocities in the tubes and the increased pressure loss and associated pump power resulting from the increased water velocities.

In most shell and tube evaporators, despite the lower water velocities, the magnitude of the refrigerant heat transfer coefficient is usually between 20 to 30%

**Table 3.5 - Performance analysis of shell and tube evaporators**

<p>1 Calculate the temperature of the water leaving the evaporator</p> $t_{woe} = t_{wie} - \frac{Q_e}{4.185 l_e}$ <p> <math>t_{woe}</math> = water temperature out of the evaporator (°C)  <math>t_{wie}</math> = water temperature into the evaporator (°C)  <math>Q_e</math> = heat to be transferred in the evaporator (kW)  <math>l_e</math> = evaporator water flow rate (l/s)                 </p>
<p>2 Calculate the overall heat transfer coefficient</p> $\frac{1}{UA} = \frac{1}{h_w a_w} + \frac{1}{h_{fe} a_w} + \frac{x}{a_m k} + \frac{1}{h_r a_r}$ <p> <math>UA</math> = overall heat transfer coefficient (kW/K)  <math>h_w</math> = water side heat transfer coefficient (kW/m<sup>2</sup>K)                      = 1.427 [1 + 0.0075(t<sub>wie</sub> + t<sub>woe</sub>)] v<sub>w</sub><sup>0.8</sup> d<sub>i</sub><sup>-0.2</sup>  <math>v_w</math> = water velocity in the tubes (m/s)  <math>d_i</math> = tube inside diameter (m)  <math>a_w</math> = water side tube surface area (m<sup>2</sup>)  <math>h_{fe}</math> = water side fouling factor (kW/m<sup>2</sup>K)  <math>x</math> = tube wall thickness (m)  <math>k</math> = thermal conductivity of tube material (kW/mK)  <math>a_m</math> = mean tube surface area (m<sup>2</sup>)  <math>h_r</math> = refrigerant side heat transfer coefficient (kW/m<sup>2</sup>K)                      = 0.46 (Q<sub>e</sub>/a<sub>r</sub>)<sup>0.7</sup> for refrigerants R11 and R22  <math>a_r</math> = refrigerant side tube surface area (m<sup>2</sup>)                 </p>
<p>3 Calculate the log mean temperature difference</p> $LMTD = \frac{(t_{wie} - t_e) - (t_{woe} - t_e)}{\ln [(t_{wie} - t_e)/(t_{woe} - t_e)]}$
<p>4 Calculate the overall heat transfer rate</p> $Q = UA LMTD$
<p>5 Compare Q and Q<sub>e</sub> and repeat 1 to 4 until  Q - Q<sub>e</sub>  &lt; 0.1 kW</p>
<p>6 Obtain revised values of evaporating temperature t<sub>e</sub> from:-</p> $LMTD^* = Q_e / UA$ $f_e^* = \exp[(t_{wie} - t_{woe}) / LMTD^*]$ $t_e = \frac{(t_{wie} - f_e^* t_{woe})}{(1 - f_e^*)}$

of the water side heat transfer coefficient. Similar to condensers, the number of tubes required and therefore the cost of the evaporator, is minimised by extending the refrigerant side heat transfer surface area with ribs or fins on the outside of the tubes.

The tube bundles are not always submerged in the liquid refrigerant and some of the tubes are in the refrigerant gas. The chilled water temperature entering is usually significantly higher than the evaporating temperature and consequently there will be superheating of the refrigerant vapour.

The general method of analysis used to obtain the evaporating temperature is summarised in Table 3.5. The two refrigeration plants which use shell and tube evaporators are the Mount Isa R63 surface plant and the Broken Hill underground plant. The constructional details of each evaporator used in the simulations are summarised in Table 3.6.

### 3.3.2 Direct expansion shell and tube

Direct (dry) expansion shell and tube evaporators are similar to standard shell and tube evaporators except that the refrigerant is circulated through the tubes and the water to be chilled passes through the shell. The method of analysis is identical to that for the conventional shell and tube evaporator as summarised in Table 3.5 except for the refrigerant and water heat

transfer coefficients. The different relationships used to obtain the overall heat transfer coefficient are illustrated in Table 3.7.

The refrigerant side heat transfer coefficient is much smaller than the water side heat transfer coefficient and consequently internally finned tubes are used to increase the surface area for heat exchange. In the shell, baffles are used to provide the most efficient heat transfer and to minimise any stratification that may occur.

Determining the refrigerant heat transfer coefficient is further complicated because natural convection boiling takes place in the tubes and the refrigerant is superheated by the water in the shell, the extent of which will vary along the tubes and also according to the load.

Three nominal 650 kWR units are used with the N<sup>o</sup> 1 compressor set in the underground plant at Broken Hill. Each evaporator contained 408 copper tubes with an external diameter of 17.4 mm and a wall thickness of 1.7 mm. The extended inside tube surface area was 137.1 m<sup>2</sup> and the outside tube surface area was 85 m<sup>2</sup>. The tubes are arranged for four refrigerant passes and the baffle spacing is 0.125 m in the 0.61 m diameter shell. The average cross sectional area used to determine the water velocity is 0.0603 m<sup>2</sup>.



**Table 3.6 - Constructional details of the shell and tube evaporators used in the simulations**

Refrigeration plant	Mount Isa R63 plant		Broken Hill plant	
	Size 8	Size 69	Plant 2	Plant 3
Number of water passes	3	1 or 2	3	4
Inside tube surface area (m <sup>2</sup> )	98.8	45.7	171.6	254.2
Outside tube surface area (m <sup>2</sup> )	348.4	183.8	610.9	1047.4
Mean tube surface area (m <sup>2</sup> )	106.6	50.0	202.2	299.6
Tube wall thickness (m)	0.00108	0.00075	0.00163	0.00163
Tube thermal conductivity (kW/mK)	0.386	0.386	0.386	0.386
Total number of tubes	594	296	675	1000
Inside diameter of tubes (m)	0.01372	0.0160	0.0160	0.0160
Total tube cross sectional area (m <sup>2</sup> )	0.08781	0.05951	0.13218	0.19582

**Table 3.7 - Calculation of the overall heat transfer coefficient for direct expansion evaporators**

2 Calculate the overall heat transfer coefficient

$$\frac{1}{UA} = \frac{1}{h_w a_w} + \frac{1}{h_{fe} a_w} + \frac{x}{a_m k} + \frac{1}{h_r a_r}$$

UA = overall heat transfer coefficient (kW/K)  
 h<sub>w</sub> = water side heat transfer coefficient (kW/m<sup>2</sup>K)  
 = 0.718 [1 + 0.005(t<sub>wie</sub> + t<sub>woe</sub>)] V<sub>o</sub><sup>0.6</sup> d<sub>o</sub><sup>0.4</sup>  
 V<sub>o</sub> = water velocity over the outside of the tubes  
 d<sub>o</sub> = tube outside diameter (m)  
 a<sub>w</sub> = water side surface area (m<sup>2</sup>)  
 h<sub>fe</sub> = water side fouling factor (kW/m<sup>2</sup>K)  
 x = tube wall thickness (m)  
 k = thermal conductivity of tube material (kW/mK)  
 a<sub>m</sub> = mean tube surface area (m<sup>2</sup>)  
 a<sub>r</sub> = refrigerant side tube surface area (m<sup>2</sup>)  
 h<sub>r</sub> = refrigerant heat transfer coefficient (kW/m<sup>2</sup>K)  
 = 0.037 (q<sub>e</sub>/a<sub>r</sub>)<sup>0.5</sup> d<sub>i</sub><sup>0.6</sup>  
 d<sub>i</sub> = tube inside diameter (m)

Tests on the evaporator performance resulted in duties approximately half of the rated values at between 350 and 375 kWR. Cleaning the water side of these evaporators is very difficult without dismantling the plant, taking the units to surface and removing the tube bundles from the shell. As a consequence, the evaporators have not been cleaned since installation and, after four years operation, they were very "dirty" with fouling factors between 2 and 3 kW/m<sup>2</sup>K.

### 3.3.3 Closed plate evaporators

The closed plate heat exchangers used for evaporators are similar in construction and operation to those used as condensers. The general method of analysis used to obtain the evaporating temperature is identical to that for a shell and tube evaporator except for the calculation of the overall heat transfer coefficient.

The method used for this is summarised in Table 3.8. The closed plate evaporators in mine refrigeration systems normally operate in conjunction with a large pressure vessel known as a refrigerant accumulator which is used to separate the vapour from the liquid refrigerant.

By locating the accumulator above the evaporator, liquid refrigerant in the bottom of the vessel is supplied to the closed plate evaporator where boiling

takes place. Not all the refrigerant is evaporated and the mixture of refrigerant vapour and liquid is returned to the accumulator. The vapour which collects above the liquid surface in the accumulator is taken off to the compressor inlet.

There is no cooling in the accumulator and therefore there is no superheating of the refrigerant vapour. The circulation of the refrigerant between the accumulator and the evaporator can be either forced by using refrigerant pumps in the liquid supply line or by natural convection.

The driving force for natural convection thermosyphons is the difference in refrigerant density between the liquid supply and the liquid/vapour return pipes connecting the accumulator and the evaporator. When the plant is not operating, both pipes contain liquid refrigerant at the same density and there is no flow.

When the plant starts and the water to be chilled enters the evaporator, the higher temperature water causes some boiling of the refrigerant in the plates which then become partly filled with ascending bubbles of refrigerant vapour. The density of the mixture in the return column decreases causing an imbalance between the supply and return pipes and refrigerant flow starts. The circulation rate increases until refrigerant frictional pressure loss equals the driving force for natural convection.

The closed plate heat exchangers used for evaporators in these simulations were all supplied by the same manufacturer. The empirical relationships used to determine the water and refrigerant heat transfer coefficients were obtained from the rated and actual performance data and similar in form to those used to assess the performance of shell and tube evaporators.

The surface area for heat transfer in each cassette is 3.193 m<sup>2</sup> and is the same for water and refrigerant. The plate thickness is 0.6 mm and the material used is either 316 stainless steel with a thermal conductivity of 0.0163 kW/mK or a titanium alloy with a thermal conductivity of 0.0164 kW/mK.

#### 3.3.4 Open plate evaporators

An open or falling film plate evaporator, comprises two corrugated plates welded together to form a series of horizontal passageways. These are connected at the ends of the plates to form a series of parallel routes from the bottom of the plate to the top. The number of parallel routes used in a plate is a compromise between high refrigerant heat transfer coefficients and low frictional pressure losses.

Liquid refrigerant supplied from an accumulator passes through these passageways where a fraction evaporates and the mixture of refrigerant vapour and liquid returns back to the accumulator.

The water to be chilled is distributed uniformly to both sides of the vertical plates and flows in a thin film over the outer surfaces of the plates. As before, the performance analysis only differs in the methods of estimating the refrigerant and water heat transfer coefficients. A summary of the relationships used to calculate the overall heat transfer coefficient is given in Table 3.9.

Manufacturers performance data was used to confirm the method of analysis and in particular the refrigerant and water heat transfer coefficients. The water side coefficient is based on a turbulent falling-film and is a function of the water film thickness defined by the  $l_e/2 N_1$  term.

Where the refrigerant is pumped through the plates, forced convection takes place inside the passageways or tubes formed by the corrugated plates and the vapour fraction of the refrigerant leaving the plate will depend on the load. Most systems are designed for a 50% vapour fraction when the plant is operating at full load and this decreases as the load decreases.

Where a natural convection thermosyphon is used, the vapour fraction of the refrigerant returning to the accumulator is less affected by changes in load. As a result, the refrigerant heat transfer coefficient given in Table 3.9 will be slightly underestimated for a pumped system when operating at part load.

**Table 3.8 - Calculation of the overall heat transfer coefficient for closed plate evaporators**

2 Calculate the overall heat transfer coefficient

$$\frac{1}{UA} = \frac{1}{h_w a_w} + \frac{1}{h_{fe} a_w} + \frac{x}{a_m k} + \frac{1}{h_r a_r}$$

$UA$  = overall heat transfer coefficient (kW/K)  
 $h_w a_w$  = water side heat transfer (kW/K)  
 =  $16.9 [1 + 0.0075(t_{wie} + t_{woe})] l_e^{0.8} N_e^{0.2}$   
 $N_e$  = number of cassettes in the plate heat exchanger  
 $a_w$  = water side plate surface area (m<sup>2</sup>)  
 $h_{fe}$  = water side fouling factor (kW/m<sup>2</sup>K)  
 $x$  = plate thickness (m)  
 $k$  = thermal conductivity of plate material (kW/mK)  
 $a_m$  = mean plate surface area (m<sup>2</sup>)  
 $a_r$  = water side plate surface area (m<sup>2</sup>)  
 $h_r a_r$  = refrigerant side heat transfer (kW/K)  
 =  $4.46 Q_e^{0.5} N_e^{0.5}$  for ammonia R717

**Table 3.9 - Calculation of the overall heat transfer coefficient for open plate evaporators**

2 Calculate the overall heat transfer coefficient

$$\frac{1}{UA} = \frac{1}{h_w a_w} + \frac{1}{h_{fe} a_w} + \frac{x}{a_m k} + \frac{1}{h_r a_r}$$

$UA$  = overall heat transfer coefficient (kW/K)  
 $h_w$  = water side heat transfer (kW/m<sup>2</sup>K)  
 =  $6.4 [l_e / (2 N_l)]^{0.333}$   
 $N_l$  = total nominal length of plate (m)  
 $a_w$  = water side plate surface area (m<sup>2</sup>)  
 $h_{fe}$  = water side fouling factor (kW/m<sup>2</sup>K)  
 $x$  = plate thickness (m)  
 $k$  = thermal conductivity of plate material (kW/mK)  
 $a_m$  = mean plate surface area (m<sup>2</sup>)  
 $a_r$  = refrigerant side plate surface area (m<sup>2</sup>)  
 $h_r$  = refrigerant heat transfer coefficient (kW/K)  
 =  $0.102 (Q_e / N_a)^{0.5} d_i^{-0.6}$  for refrigerant R22  
 =  $0.148 (Q_e / N_a)^{0.5} d_i^{-0.6}$  for ammonia R717  
 $N_a$  = total nominal plate surface area (m<sup>2</sup>)  
 $d_i$  = equivalent diameter of the tubes in the plates (m)

The multiplication constant used in the calculation of the refrigerant heat transfer coefficient is 0.102 for refrigerant R22 and 0.148 for ammonia. The conversion factor of 1.45 is a function of the differences in refrigerant properties. These include the latent heat of evaporation, saturation pressures, viscosity and thermal conductivity.

The refrigerant and water heat transfer coefficients are not significantly different in magnitude and are approximately in balance with the surface areas. For the same operating conditions, the surface areas are, however, about twice as large as those found in shell and tube and closed plate heat exchangers. This is important where the water to be chilled is dirty and the effects of water side fouling on plant performance will be less pronounced.

Because the water side is open, it is easier to monitor water side fouling and plate cleaning can be undertaken on a routine basis without shutting down the plant.

The most common size of open plate used to chill mine water in evaporators is 2.44 m long by 1.52 m high and results in a nominal surface ( $N_a$ ) of 7.43 m<sup>2</sup>/plate and a nominal length ( $N_l$ ) of 2.44 m. Water is distributed to and only forms a film on approximately 93% of the nominal surface area of the plate.

The passageways formed by the plate corrugations are not perfectly circular and have an equivalent diameter (equivalent in cross sectional area) of 21.2 mm. The inside surface area (applicable to the refrigerant side heat transfer) is approximately 65% of the nominal surface area and the mean surface area is approximately 79% of the nominal surface area.



### 3.4 Surface cooling towers

Cooling towers are direct contact heat exchangers used for either cooling hotter water with ambient air or cooling ambient air with colder water. The three main purposes of the surface cooling towers used in mine refrigeration plants are for pre-cooling water prior to chilling it with refrigeration, to cool condenser water which has been used to condense the refrigerant and, to bulk cool ventilation air which is to be supplied underground.

Although each duty requires direct contact between the air and water to achieve the necessary heat exchange, the performance requirements and therefore the initial cost and design arrangement for each is different.

In direct contact heat exchange, the performance is related to the degree of the contact between the water and the air. The simplest type of cooling tower has a distribution system at the top where the water to be cooled or heated is introduced and made to form droplets which fall through the air being drawn upwards through the tower. The higher the tower, the greater the contact between the water and air and the better the rate of heat transfer or the performance.

The air is in contact with and will cool (or heat as appropriate) the outer surface layer of the water droplets and further cooling of the water in the

droplet will rely on conduction and convection within the droplet. An improvement in performance would therefore be obtained if this colder surface layer could be disturbed and replaced with the water in the centre of the droplet.

This is the purpose of cooling tower fill. The type and amount of fill used in a tower is a compromise between input power (overcoming the resistance to airflow and pumping the water to the distribution point), tower dimensions and quality of the water.

Splash grids (plastic frames with 80 to 95% open area and suspended at about 300 mm intervals on stainless steel wires) have the lowest pressure loss and the least problems with blockage by solids settling out of the water. They also require the greatest height of fill, 5 to 10 m being typical, to achieve an equivalent performance and therefore this type of tower tends to have the highest capital costs.

Closely packed towers originally used timber (redwood) slats and now use plastic honeycombs often with corrugated surfaces. Equivalent performance can normally be achieved with a fill thickness of between 1.0 and 1.5 m and a pressure loss between 50% and 100% higher than splash grids. Blockage of the channels in the fill material can be a problem where water quality is poor and solids may settle out.

### 3.4.1 Pre-cooling towers

The return water temperature in a refrigeration system which supplies chilled water underground will usually be greater than the ambient wet bulb temperature. The actual value will depend on the overall refrigeration strategy i.e. whether bulk air cooling on surface is used, and the design underground climatic conditions. The overall power to cooling ratio for refrigerative cooling will depend on the ambient surface wet bulb temperature and normally varies between 0.15 and 0.20.

The power to cooling ratio of a cooling tower is much lower at between 0.02 and 0.05 and consequently it is advantageous to maximise its duty relative to the refrigeration plant (Howes, 1979b).

An optimisation based on Australian supply and conditions resulted in a design factor of merit of 0.75, an approach (the temperature difference between the entering air and the leaving water) of  $1.0^{\circ}\text{C}$  and a water to air loading (ratio of water to air mass flow rates through the tower) of 0.6. The  $1.0^{\circ}\text{C}$  approach was applicable to the mean summer conditions and not the limiting climatic condition where the optimum value would increase to  $1.6^{\circ}\text{C}$ .

The factor of merit (Whillier, 1977) describes the actual performance of a tower relative to ideal direct contact heat transfer which, in turn, will depend on

the air and water flow arrangements. In a pre-cooling tower, the amount of air available for heat rejection is only limited by economic considerations and consequently high performance and large counter flow towers would normally be selected. The performance of a counter flow cooling tower can be determined using the method outlined in Table 3.10 (Bluhm, 1980).

#### 3.4.2 Condenser cooling towers

Although the performance of a condenser cooling tower has a lesser effect on the overall power requirements of a surface refrigeration plant when compared with a pre-cooling tower, it is still significant. Reducing the approach and therefore the condensing temperature, reduces the plant input power by approximately two thirds that achieved by the same reduction in approach in the pre-cooling tower.

The pre-cooling tower does, however, reduce the overall amount of refrigerative cooling required with a consequent and significant reduction in capital costs for the overall refrigeration system.

The optimum condenser tower arrangement will depend on many factors, however, typical optimum values are an approach of between 3.5 and 4.0°C and a water to air loading of between 1.0 and 1.5. The larger temperature difference between the water leaving and the wet bulb of the air entering (the approach) means that the

tower factor of merit can be lower than that required for a pre-cooling tower. A typical design factor of merit for a condenser cooling tower is 0.6 which in turn means that the tower could be cross flow instead of counter flow.

The advantage of a cross flow tower is that it does not need to be as high as a counter flow tower and the capital cost is significantly lower. Condenser water is normally in closed circuit and the quality is relatively straightforward to control. Close packing is therefore normally used.

In a counter flow tower, the air entrance is below the fill, the air then flows upwards through the fill, counter current to the water flowing downwards. In a cross flow tower, the air is drawn horizontally through the fill adjacent to the inlet of the tower, enters a central plenum and is then drawn upwards and out of the tower. Because the fill is adjacent to the inlet rather than above it, the height of the tower is reduced.

The performance of a cross flow tower (Bluhm, 1981) is determined in a similar manner to that for the counter flow tower illustrated in Table 3.10 except for the empirical relationships between capacity factor, water efficiency and factor of merit given in Table 3.11. In cross flow heat exchange, the air flowing horizontally through the fill whilst the water flows down through

the fill, limits the maximum factor of merit possible to  $0.632 [1 - \exp(-1.0)]$ .

### 3.4.3 Surface bulk air coolers

Cooling the intake ventilation air on surface prior to it being sent underground is straightforward where the main intakes are used for ventilation only. The design requires an optimisation between the proportion of the total air quantity to be cooled and the total amount of heat to be removed from the air.

Low air quantities and high heat transfer rates require low supply water temperatures and therefore an increase in compressor input power. High air quantities require increased fan power in the bulk air cooling tower which is usually offset by the saving in compressor power resulting from higher supply water and increased evaporating temperatures.

Where the main intakes are also operating shafts, the amount of ventilation air that can by-pass the collar has practical limits and the bulk air cooler usually requires low supply water temperatures. A surface bulk cooler therefore normally has a limited air quantity and the optimum approach is between 1.0 and 2.0°C requiring a factor of merit of between 0.75 and 0.80.

The amount of chilled water that can be used to cool the air is only limited by practical and economic

considerations. The towers used for bulk air cooling are invariably counter flow and, because the chilled water is in closed circuit with the bulk air cooler and its quality can be controlled, close packed towers are usually more cost effective.

In a refrigeration system used for bulk cooling air on surface, the performance of the bulk cooler determines the mode of operation and the performance of the rest of the system. The analysis is similar to that given in Table 3.10 with the entering and leaving water temperatures transposed to avoid negative values.

**Table 3.10 - Performance analysis of a counter flow cooling tower**

<p>1. Input data required:-</p> <p>Bulk air cooler water flow rate <math>L_t</math></p> <p>Bulk air cooler air flow rate <math>q_t</math></p> <p>Water temperature into the bulk air cooler <math>t_{wit}</math></p> <p>Water temperature out of the bulk air cooler <math>t_{wot}</math></p> <p>Wet bulb temperature into the bulk air cooler <math>t_{wbi}</math></p>
<p>2. Calculate the water efficiency from:-</p> $\eta_w = \frac{t_{wot} - t_{wit}}{t_{wbi} - t_{wit}}$
<p>3. Calculate the capacity factor from:-</p> $R = \frac{4.185 L_t (t_{wbi} - t_{wit})}{m_a (S_{ai} - S_{wi})}$ <p><math>m_a</math> = mass flow rate of air (kg/s)</p> <p><math>S_{ai}</math> = sigma heat of entering air (kJ/kg)</p> <p><math>S_{wi}</math> = sigma heat of saturated air at the water entering temperature (kJ/kg)</p>
<p>4. Calculate the factor of merit F for the tower from:-</p> $y = \frac{\eta_w - 1}{\eta_w R - 1}, \quad z = \frac{\ln y}{(1 - R)(1/R)^{0.4}} \quad \text{and} \quad F = \frac{z}{z - 1}$
<p>5. Calculate water efficiency if F is known from:-</p> $\eta_w = \frac{[1 - e^{-N(1 - R)}]}{[1 - R e^{-N(1 - R)}]}$ $N = F (1 - F)^{-1} R^{-0.4}$

**Table 3.11 - Performance analysis of a cross flow cooling tower**

<p>4. Calculate the factor of merit F for the tower from:-</p> $F = 1 - \exp[\exp(R^{0.2} N^*) - 1]$ $N^* = \ln \left[ 1 + \frac{\ln(1 - R \eta_w)}{R} \right]$
<p>5. Calculate water efficiency if F is known from:-</p> $\eta_w = (1 - \exp[-R(1 - \exp N^*)]) R^{-1}$ $N^* = (\ln[1 + \ln(1 - F)]) R^{-0.2}$



### 3.5 Underground air cooling

Chilled water which is produced on surface and then sent underground can be used to cool air either directly or indirectly in air cooling appliances, as mine service water for dust suppression or as a power source prior to being used for either cooling or dust control. Except where the water is used as a power source; either directly as high pressure jets to move rock or indirectly through an energy recovery device associated with mining equipment such as a rock drill, most of the chilled water sent underground (usually 80 to 90%) is used in air cooling devices.

#### 3.5.1 Air cooling coils

These are used for indirect air cooling where the air to be cooled and the chilled water are separated by the tube material in the cooling coils. When analysing the performance of cooling coils either the coil air side duty or the air and water fouling factors are to be calculated. The general method of analysis used in the simulations is given in Table 3.12 and is based on the standard NTU method (Rosenow, 1961).

The air side heat transfer coefficient on the outside of the tubes is between 10 and 15% of the water side heat transfer coefficient inside the tubes. As a consequence, the outside tube surface is extended by using fins to between five and ten times the nominal

tube surface area. Large sections of the fins are relatively remote from the tube and the efficiency of the fins relative to the tubes will be reduced (Rosenow, 1961). The air being cooled underground is not usually filtered before being passed through the coil and consequently the outer surface is subject to extensive fouling.

The coils used in the R63 system at Mount Isa were developed in South Africa for underground applications and have circular fins spaced at 3.1 mm and, based on measurements of performance (Ramsden, 1981), have a fin efficiency of  $f = 1.0 - 0.19 h_o$ . The ratio of fin surface area to tube surface area is 5.8:1 and the number of rows is usually limited to four.

Although this design minimises fouling and simplifies cleaning and, despite the relatively clean intake air being cooled, fouling of the finned surface significantly affects performance. To overcome this continuing operational problem, these finned tube cooling coils are being replaced with those that have multiple plain copper tube spirals and no fins at all.

The coils used in the underground refrigeration system at Broken Hill were standard air conditioning system coils with plate fins spaced at 4.2 mm. By analysing the manufacturers rated performance data and assuming fouling factors of 7.0 and 5.0 kW/m<sup>2</sup>K for the water and air sides respectively, the fin efficiency was

**Table 3.12 - Performance analysis of air cooling coils**

<p>1 Calculate the temperature of the water leaving the coil</p> $t_{wocc} = t_{wicc} + \frac{Q_{cc}}{4.185 l_{cc}}$ <p> <math>t_{wocc}</math> = water temperature out of the cooling coil (°C)  <math>t_{wicc}</math> = water temperature into the cooling coil (°C)  <math>Q_{cc}</math> = heat to be transferred in the cooling coil (kW)  <math>l_{cc}</math> = cooling coil water flow rate (l/s)                 </p>	
<p>2 Calculate the overall heat transfer coefficient</p> $\frac{1}{UA} = \frac{1}{h_w a_w} + \frac{1}{h_{fw} a_w} + \frac{x}{a_m k} + \frac{1}{h_a a_o} + \frac{1}{h_{fa} a_o}$ <p> <math>UA</math> = overall heat transfer coefficient (kW/K)  <math>h_w</math> = water side heat transfer coefficient (kW/m<sup>2</sup>K)                      = 2.00 [1 + 0.0075(t<sub>wicc</sub> + t<sub>wocc</sub>)] v<sub>w</sub><sup>0.8</sup> d<sub>i</sub><sup>-0.2</sup>  <math>v_w</math> = water velocity in the tubes (m/s)  <math>d_i</math> = tube inside diameter (m)  <math>a_w</math> = water side tube surface area (m<sup>2</sup>)  <math>h_{fw}</math> = water side fouling factor (kW/m<sup>2</sup>K)  <math>x</math> = tube wall thickness (m)  <math>k</math> = thermal conductivity of tube material (kW/mK)  <math>a_m</math> = mean tube surface area (m<sup>2</sup>)  <math>h_a</math> = air side heat transfer coefficient (kW/m<sup>2</sup>K)                      = 0.19 (m<sub>a</sub>/a<sub>n</sub>)<sup>0.6</sup>  <math>m_a</math> = mass flow rate of the air (kg/s)  <math>a_n</math> = nominal face area of the coil (m<sup>2</sup>)  <math>a_o</math> = effective air side surface area (m<sup>2</sup>)                      = a<sub>o</sub><sup>*</sup> f  <math>a_o^*</math> = actual tube and fin surface area (m<sup>2</sup>)  <math>f</math> = fin efficiency                 </p>	
<p>3 Calculate the coil effectiveness</p> <p>                     Water capacity rate <math>C_w = 4.185 l_{cc}</math>                      Air capacity rate <math>C_a = Q_{cc}/(t_{wbi} - t_{wbo})</math>                      Ratio of capacity rates <math>z = C_{min}/C_{max}</math>                      N° heat transfer units <math>NTU = UA/C_{min}</math>                      Coil effectiveness <math>e = \{[1 - z/4.185][1 - \exp(-NTU)]\}</math>  <math>t_{wbi}</math> = wet bulb temperature in (°C)  <math>t_{wbo}</math> = wet bulb temperature out (°C)                 </p>	
<p>4 Calculate the coil air side duty</p> $Q = e C_{min}(t_{wbi} - t_{wicc})$	
<p>5 Compare Q and Q<sub>cc</sub> and repeat 1 to 4 until  Q - Q<sub>cc</sub>  &lt; 0.1 kW</p>	

estimated to be  $f = 0.34 + 0.3 h_o$ . A comparison of the rated and estimated overall heat transfer coefficients using this relationship and following the method of analysis of Table 3.12 is given in figure 3.11. The ratio of fin surface area to tube surface area is 10.4:1 and the number of rows in the coil is six.

The corrugated plate fins and the six row coil coupled with relatively dusty underground air results in rapid clogging of the unit with particulate and considerable difficulty in cleaning the coils without removing them from the system.

An analysis of the air and water temperatures and flow measurements taken on operating coils resulted in air side fouling factors of between 0.25 and 0.3 kW/m<sup>2</sup>K which is at least ten times the normal "dirty" values. This was confirmed by coil resistance to airflow measurements of 1.2 Ns<sup>2</sup>/m<sup>8</sup> for new coils, 3.7 Ns<sup>2</sup>/m<sup>8</sup> for cleaned coils and between 9 and 16 Ns<sup>2</sup>/m<sup>8</sup> for coils in operation.

Difficulty in cleaning the coils results from the combination of dust and diesel exhaust particulate which is deposited on the fins and tubes and clogs the passageways. As a result of the low effectiveness of fouled cooling coils and the increased fan power necessary to overcome the coil resistance, cooling coils have power to cooling requirements which are up to twice as much as those for direct contact coolers.

This comparison includes the increased pumping power required for the open chilled water circuits necessary when using direct contact cooling.

### 3.5.2 Mesh coolers

A mesh cooler comprises of a series of nozzles that spray water upwards and are located between two layers of knitted stainless steel mesh approximately 500 mm apart. The air to be cooled is drawn upwards through both the mesh and sprays and discharged horizontally through a duct above the top layer of mesh (Bluhm, 1982). The unit is compact with a height above the sump of 2.5 m and occupying a volume of approximately 0.025 m<sup>3</sup> per kW of rated duty.

Most of the heat transfer takes place in the mesh and the upper layer also acts as a droplet eliminator. The air and water are counter flow and the performance can be assessed similar to that for a surface bulk air cooler as outlined in section 3.4.3.

This type of compact heat exchanger can be easily moved to a new location and is ideal for short term air cooling applications such as that required to supply cooling to development headings. Two units were built at Mount Isa and, as a result of lower than expected performance when installed underground, one unit was removed to surface and tested using chilled water from the R63 plant and hot and humid air from

Figure 3.11 - Comparison of rated and calculated heat transfer for cooling coils

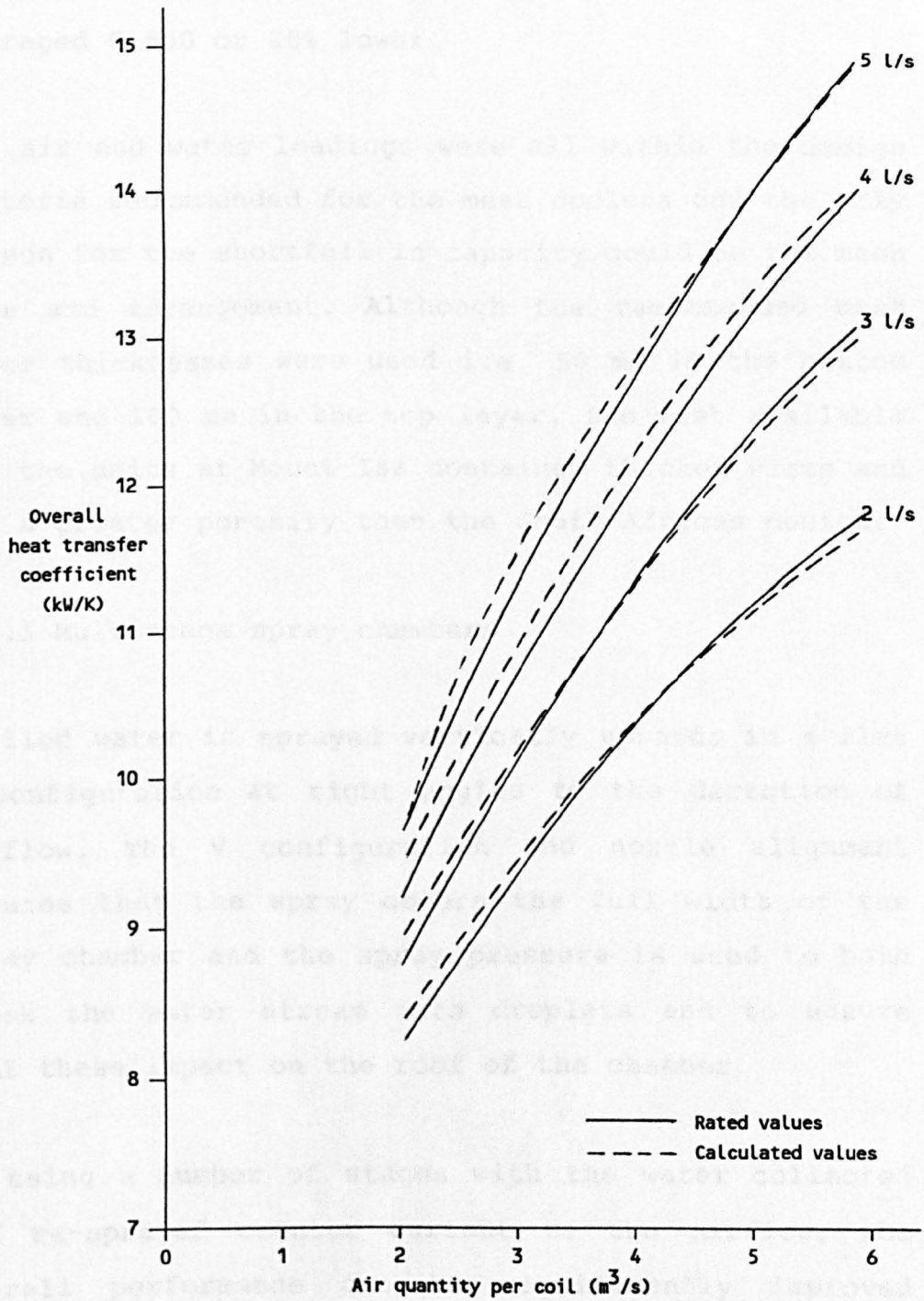

the discharge of the condenser sprays for this plant. The results of a series of 23 tests are summarised in Table 3.13. The expected factor of merit was 0.625 (Bluhm, 1982) and that obtained from the tests averaged 0.500 or 20% lower.

The air and water loadings were all within the design criteria recommended for the mesh coolers and the only reason for the shortfall in capacity could be the mesh type and arrangement. Although the recommended mesh layer thicknesses were used i.e. 50 mm in the bottom layer and 100 mm in the top layer, the mesh available for the units at Mount Isa contained thicker wires and had a greater porosity than the South African design.

### 3.5.3 Multistage spray chambers

Chilled water is sprayed vertically upwards in a flat V configuration at right angles to the direction of airflow. The V configuration and nozzle alignment ensures that the spray covers the full width of the spray chamber and the spray pressure is used to both break the water stream into droplets and to ensure that these impact on the roof of the chamber.

By using a number of stages with the water collected and re-sprayed counter current to the airflow, the overall performance can be significantly improved (Ramsden, 1984). Each stage of the bulk spray cooler has the water and air in cross flow configuration and

can be assessed using the method of analysis outlined in section 3.4.2 and Table 3.11 with the entering and leaving water temperatures transposed to avoid negative values.

With the air and water in counter flow through the stages, an iterative method converging to an acceptable error is necessary to determine the overall performance of a multistage unit. An analysis of the measurements undertaken on the multistage horizontal spray chambers installed at Mount Isa and Broken Hill is summarised in Table 3.14.

The factor of merit for each stage of the conventional units varied between 0.43 and 0.51 and, based on a counter flow overall analysis, the factors of merit for a two stage and a three stage unit was 0.61 and 0.70 respectively. These are within the performance range that could be normally expected (Ramsden, 1984).

Where the stage factor of merit was below 0.45, it was evident that channelling of the air was taking place. In the conventional units this was mainly a result of irregularities in the spray chamber excavation which were not covered by the range and alignment of the sprays.

The two main reasons for using multistage horizontal spray chambers underground were the large cooling duties possible and a perceived lower installation



**Table 3.13 - Performance analysis of Mount Isa mesh coolers**

Air wet bulb temperatures		Chilled water temperatures		Chilled water flow rate	Air Quantity	Cooler duty	Factor of merit
in (°C)	out (°C)	in (°C)	out (°C)	L/s	(m <sup>3</sup> /s)	(kW)	
30.0	20.5	7.0	18.6	10.0	11.4	485	0.512
30.0	20.0	6.9	17.6	10.0	10.1	448	0.498
29.5	19.7	6.8	16.3	10.0	9.3	398	0.471
29.0	16.0	6.6	13.7	10.0	5.6	297	0.473
30.0	23.3	7.1	20.1	7.5	12.9	408	0.486
30.0	23.2	6.7	19.1	7.5	11.6	389	0.469
29.5	19.6	7.0	17.8	7.5	7.8	339	0.510
30.4	25.9	7.2	23.2	5.0	14.9	335	0.492
31.5	26.5	7.4	23.6	5.0	13.2	339	0.494
32.5	24.5	7.4	23.4	5.0	8.3	335	0.543
32.2	24.2	7.6	19.7	10.0	12.7	506	0.466
32.0	25.7	7.3	21.4	7.5	13.7	443	0.470
32.0	26.4	7.2	24.5	5.0	12.5	362	0.522
31.0	19.5	7.2	17.5	10.0	8.4	431	0.505
31.5	22.5	7.1	19.7	7.5	9.2	395	0.501
31.5	24.8	7.0	22.3	5.0	9.6	320	0.509
30.8	20.7	7.4	17.2	10.0	8.9	410	0.473
31.2	21.8	7.4	19.4	7.5	8.6	377	0.505
31.3	24.0	7.2	22.1	5.0	8.7	312	0.522
31.0	25.8	7.2	24.0	5.0	13.4	352	0.519
32.3	25.1	7.6	25.0	5.0	10.0	364	0.564
32.0	29.5	7.6	24.6	3.0	15.4	213	0.418
32.5	30.2	7.9	24.9	2.0	10.9	142	0.405
<b>Summary</b>							
Water flow rate (L/s)		Number of tests		Mean factor of merit		Standard deviation	
10.0		7		0.485		0.018	
7.5		6		0.490		0.016	
5.0		8		0.521		0.023	
Total		21		0.500		0.021	

**Table 3.14 - Measured performance of multistage horizontal spray chambers**

Location	Duty		Number of stages	Stage factor of merit	Overall factor of merit
Mount Isa P45	Air cooling	128 kW	1	0.51	0.51
Mount Isa Q62	Air cooling	592 kW	3	0.45	0.70
Mount Isa 21D modular units	Air cooling	525 kW	3	0.38	0.60
		904 kW	3	0.40	0.66
Broken Hill 32L	Condenser	3925 kW	1	0.51	0.51
Broken Hill 33L	Air cooling	1164 kW	2	0.43	0.61
Broken Hill 36L	Air cooling	515 kW	1	0.44	0.44

cost relative to the other available methods of bulk air cooling. In practice, the low installation costs have not been realised mainly as a result of the problems associated with fractured ground surrounding the spray chamber locations.

This has resulted in overbreak and the cost of additional concrete work as well as difficulties in sealing the sumps that are necessary to collect the water for stage re-spraying. At Mount Isa, the costs of a typical three stage horizontal spray chamber was up to three times that originally estimated and alternative bulk air coolers were considered.

The modular unit was an attempt to reduce costs by designing and fabricating a three stage horizontal spray chamber in fibreglass. The sumps are open tanks supported on a bed of sand. The sides and roof of the spray chamber above the sumps as well as the spray eliminators were also manufactured in fibreglass and the complete unit was to be installed in a standard spray chamber excavation.

Based on performance tests, the measured stage factor of merit varied between 0.38 and 0.40 and the overall factor of merit was between 0.60 and 0.66. The main reason for the low performance was channelling of air above the sprays which did not impact on the roof of the unit. Transportation and installation problems resulted in costs almost six times those estimated.

#### 3.5.4 Modular cooling towers

The poor performance of the mesh coolers and the high cost of the three stage bulk air coolers prompted a review of the underground air cooling methods. Packed counter flow packaged cooling towers are now used for both development air cooling and for bulk air cooling. The greater effectiveness of the counter flow heat exchange results in two stages performing as well as three stages in a cross flow water/air configuration.

The cooling tower module is constructed mainly in fibreglass, has a cross sectional area of  $4.4 \text{ m}^2$  and an overall height of 3.2 m which includes a  $2 \text{ m}^3$  sump, the air inlet section, 900 mm of compact fill and the discharge section. The units can be installed without additional excavation in most underground headings. The design water flow rates are normally between 6 and 25 l/s and the airflow rates between 7.5 and  $15 \text{ m}^3/\text{s}$  resulting in cooling duties between 250 and 1000 kW.

To replace the mesh cooler for development cooling, two units are normally installed in series with respect to water flow and in parallel with respect to airflow. The development fans are used to induce the airflow through the unit and the discharge section of the tower contains an eliminator and a  $90^\circ$  bend. The expected factor of merit for each stage is 0.62 and the combined value for two units is 0.68.

For bulk air cooling and replacing the multistage spray chambers, the cooling towers are installed in modules of two units with the water in series and the airflow in parallel. Each tower has its own fan which is located above the eliminator in the discharge section of the tower. As before, the expected factor of merit for each stage is 0.62 and the combined value for two units is 0.68.

An analysis of the measurements taken on two bulk cooling installations resulted in stage factors of merit varying between 0.49 and 0.60 and an overall value of 0.64 for both installations. This analysis was based on the air temperatures taken in the intake airways to the installation and at the tower discharge.

Air temperature measurements were also taken at the inlet to each tower and confirmed that there was re-circulation between the discharge and the inlet which reduced the overall performance. The amount of re-circulation is reduced by using a wall downstream of the installation and ducting the air discharged from the towers beyond this wall.

### 3.5.5 Capacity control

In order to minimise the overall operating costs of an underground chilled water system it is necessary to maximise the temperature of the water being returned

back to surface for chilling. During the cooler periods when the surface temperatures are lower, the underground temperatures will also be lower and the amount of cooling reduced. Unless the amount of chilled water is reduced the return water temperature will also be lower.

In direct contact heat exchangers it is usually undesirable to reduce the water flow rate through the unit. Low water flow rates cause dry areas in the fill (or low nozzle pressure in spray chambers) and result in air channelling and a much lower unit performance.

It is therefore advantageous to maintain the same water flow rate through the unit and to re-circulate water between the outlet and the inlet. The chilled water supplied to most cooling units is gravity fed from a cascade dam system and the return water is pumped to a return water dam. A flow control valve after the return pump allows return water to re-circulate back to the inlet pipe and mix with the incoming chilled water.

The distribution nozzles in the cooling unit control the total water flow rate and therefore the amount of incoming chilled water used is dependent on the re-circulation water flow rate. The re-circulation valve setting is controlled by the temperature of the air leaving the cooling unit. A simple temperature probe, shielded to minimise the effects of any chilled

water carry over, is located in the air discharge from the unit after the eliminator. In most of the units the air is cooled to below its dew point temperature and it is discharged in a saturated condition. This removes the need to specifically measure the wet bulb temperature of the air.

Where modular cooling towers are used, the temperature of the air from the lead unit (with respect to the water flow) is used for controlling the re-circulation valve setting. Seasonal adjustments to the settings are necessary to maximise the benefits of the cooling system.

### 3.6 Miscellaneous

#### 3.6.1 High pressure water to water heat exchangers

High pressure water to water heat exchangers are used to keep in closed circuit, the chilled water from the evaporator of a central refrigeration plant and, to cool water in a separate circuit which is then used to distribute the coolth to the cooling appliances. The central refrigeration plant may be remote from the cooling appliances and could be located on surface.

By keeping the chilled water in closed circuit, the primary circuit pumping costs are potentially much lower and, by using high pressure heat exchangers, the necessity to have high pressure pipes and cooling coils can be eliminated. The method of analysing the performance of a high pressure water to water heat exchanger is given in Table 3.15.

In a closed circuit, the pump power required is that to overcome friction in the pipes whereas in an open circuit, the energy recovery system inefficiency must also be included. For a refrigeration plant situated on surface, however, this simple comparison is not valid. The high pressure heat exchanger introduces another heat flow resistance to the circuit which reduces the system coefficient of performance. This results from both a decrease in the evaporating temperature necessary to achieve the same cooling load



and by reducing the effect of a pre-cooling tower.

Prior to proceeding with the stage 1 chilled water system at Mount Isa, consideration was given to extending the existing R63 system which used high pressure water to water heat exchangers. Both systems were optimised to provide the most cost effective arrangement. The overall power requirements for the closed circuit system were 32% greater than the open system and the capital cost was three times higher.

### 3.6.2 Pipe heat transfer and heat gains

The greater the distance of the central refrigeration plant from the cooling appliances, the longer the pipe lengths required to distribute the chilled water and the higher potential heat gains. Insulating the underground chilled water pipes is necessary in order to minimise these heat gains. Most of the chilled water pipes are in intake airways and consequently an increase in coolth loss from the chilled water pipes is not necessarily a loss to the system.

Excessive losses from the chilled water pipes do, however, lead to system inefficiencies as a result of cooling being applied too early. The lower temperature air results in an increased heat flow from the surrounding rock surfaces and, because of air leakage, a part of the refrigeration is not effective in the working area. The overall system power to cooling

**Table 3.15 - Performance analysis of high pressure water to water heat exchangers**

<p>1 Estimate low pressure water temperatures</p> $t_{wol} = t_{wih} + 0.1 \quad t_{wil} = t_{wol} + \frac{Q_h}{4.185 l_l}$ <p> <math>t_{wol}</math> = water temperature out of low pressure side (°C)  <math>t_{wih}</math> = water temperature into high pressure side (°C)  <math>t_{wil}</math> = water temperature into low pressure side (°C)  <math>Q_h</math> = heat transferred in the heat exchanger (kW)  <math>l_l</math> = low pressure water flow rate (L/s)                 </p>
<p>2 Calculate the overall heat transfer coefficient</p> $\frac{1}{UA} = \frac{1}{h_h a_h} + \frac{1}{h_{fh} a_h} + \frac{x}{a_m k} + \frac{1}{h_l a_l} + \frac{1}{h_{fl} a_l}$ <p> <math>UA</math> = overall heat transfer coefficient (kW/K)  <math>h_h</math> = high pressure heat transfer coefficient (kW/m<sup>2</sup>K)  <math>= 1.43 [1 + 0.0075(t_{wih} + t_{woh})] V_h^{0.8} d_i^{-0.2}</math>  <math>V_h</math> = water velocity in the tubes (m/s)  <math>d_i</math> = tube inside diameter (m)  <math>a_h</math> = high pressure inside tube surface area (m<sup>2</sup>)  <math>h_{fh}</math> = high pressure side fouling factor (kW/m<sup>2</sup>K)  <math>x</math> = tube wall thickness (m)  <math>k</math> = thermal conductivity of tube material (kW/mK)  <math>a_m</math> = mean tube surface area (m<sup>2</sup>)  <math>h_l</math> = low pressure heat transfer coefficient (kW/m<sup>2</sup>K)  <math>= 0.718 [1 + 0.0075(t_{wil} + t_{wol})] V_l^{0.8} d_o^{-0.4}</math>  <math>V_l</math> = water velocity over the outside of the tubes (m/s)  <math>d_o</math> = tube outside diameter (m)  <math>a_l</math> = low pressure inside tube surface area (m<sup>2</sup>)  <math>h_{fl}</math> = low pressure side fouling factor (kW/m<sup>2</sup>K)                 </p>
<p>3 Calculate the heat exchanger effectiveness</p> <p>                     High capacity rate <math>C_h = 4.185 l_h</math>                      Low capacity rate <math>C_l = 4.185 l_l</math>                      Ratio of capacity rates <math>z = C_{min}/C_{max}</math>                      N° heat transfer units <math>NTU = UA/C_{min}</math>                      Effectiveness <math>e = \{1 - 0.4 z\} \{1 - \exp[-NTU(z/4 - 1)]\}</math> </p>
<p>4 Calculate the expected heat transfer rate</p> $Q = e C_{min}(t_{wih} - t_{wil})$
<p>5 Recalculate low pressure side water temperatures</p> $t_{wil} = \frac{Q_h}{e C_{min}} \quad t_{wol} = t_{wil} - \frac{Q_h}{4.185 l_l}$
<p>6 Compare Q and <math>Q_h</math> and repeat 1 to 5 until <math> Q - Q_h  &lt; 0.1</math> kW</p>

ratio (including the effects of energy recovery) for stage 1 of the Mount Isa system is 0.299.

The insulation of underground pipes is notoriously difficult to achieve with a system that is both cost and "insulation" effective. The major problem is water vapour penetration of the insulation material. Most of the available pipe insulations entrap air (which has a low thermal conductivity of 0.028 W/m K) in a cellular structure i.e. polyurethane foam which has a ratio of 20 parts of air to one of polyurethane by volume and an overall thermal conductivity of 0.037 W/mK.

Most materials used to produce foam have a relatively high vapour permeability and the large difference in vapour pressure between the cold pipe surface and the surrounding air results in rapid moisture penetration. Within three years, insulation that does not have a vapour barrier becomes fully saturated with an overall thermal conductivity of 0.58 W/mK. A vapour barrier will delay rate of moisture penetration, however, maintaining a suitable barrier in underground workings is very difficult.

The most successful insulation systems which also have a reasonable cost are those using plastics such as polyurethane foam with a thick (greater than 5 mm) high density polyethylene vapour barrier. The great drawback is the flammability and potential fire risk. Other systems using fire retardant PVC to provide an

air gap which could be filled with a loose inert material to eliminate natural convection in the air gap have had limited success.

Foamed glass is ideal from the insulation and vapour penetration point of view. The closed cell and almost impermeable glass provides a system that does not rely on a mechanical vapour barrier and has an overall thermal conductivity of 0.055 W/mK. The material is, however, friable, requires outer mechanical protection and is also relatively expensive.

A typical coolth loss for a 200 mm diameter main chilled water distribution pipe with foamed glass insulation is 0.037 kW/m. This presumes that the full pipe length is insulated. Only insulating the straight lengths of pipe and leaving the couplings bare would result in an increase to 0.085 kW/m.

This represents an increase in refrigeration operating costs equal to approximately 50% of the cost of the insulation presuming that none of the cooling from the pipe is useful in the mining area. This would only be true if the air so cooled by the inefficient pipe insulation is not used in the mining area and returned directly to an exhaust.

Overall, this is expected to happen to less than 25% of the air (leakage) and consequently the cost would be reduced to between 10 and 15% of the insulation

cost. For a 6 m length of pipe, the cost of not insulating the couplings would, therefore, be approximately equal to the cost of insulating 1 m and of marginal financial benefit.

The coolth losses from uninsulated pipes would vary between 0.5 and 1.5 kW/m depending on the size and arrangement. The cost of these losses would be between one and ten times the cost of insulation depending on the amount of intake air lost by leakage to the return airways and is not insignificant.

An alternative insulation is based on providing the pipes with a PVC lining on the inside or to fit a larger PVC pipe over the outside of a steel pipe. For a 5 mm thick liner, the coolth loss will be between 0.3 and 0.35 kW/m depending on the application. Relative to the foamed glass insulation, the increased coolth losses would be approximately 0.25 kW/m or about 60% of the insulation cost when assuming a 25% air leakage to the return airways.

Mine refrigeration systems have many kilometres of pipe which is used for distributing chilled water. The potential losses are significant and, when the full refrigeration system is being modelled, these should be included in the assessment. As a result of the complexity of the piping and insulation systems, two simplifications are applied.

Where the pipes are insulated, the heat flow is based on the resistance of the insulation and the difference between the air dry bulb and the chilled water temperatures. Where the pipes are not insulated, condensation is assumed to occur and the heat flow is a function of the air wet and dry bulb temperatures relative to the chilled water temperature. The method of analysis used is summarised in Table 3.16.

Table 3.16 - Method of estimating heat gains in water distribution pipes

<p><b>1 Insulated pipe lines</b></p> <p><math>q = 3.1 d_o U (t_{db} - t_w)</math></p> <p><math>q</math> = heat transfer (kW/m)</p> <p><math>d_o</math> = outside pipe diameter (m)</p> <p><math>U</math> = thermal resistance of the insulation (kW/K)</p> <p>= <math>k/x</math></p> <p><math>k</math> = thermal conductivity of the insulation (kW/mK)</p> <p><math>x</math> = thickness of the insulation (m)</p> <p><math>t_{db}</math> = dry bulb temperature of the air (°C)</p> <p><math>t_w</math> = temperature of the chilled water in the pipe (°C)</p>	
<p><b>2 Uninsulated pipes</b></p> <p><math>q = 3.1 d [(h_c + 0.006)(t_{db} - t_w) + 16 h_c (e_a - e_{sw})]</math></p> <p><math>h_c</math> = convective heat transfer coefficient (kW/m<sup>2</sup>K)</p> <p>= <math>0.005 v^{0.6} d^{-0.4}</math></p> <p><math>v</math> = air velocity over the pipe (m/s)</p> <p><math>e_a</math> = vapour pressure of air (kPa)</p> <p>= <math>e_s - 0.071 (t_{db} - t_{wb})</math></p> <p><math>e_s = 0.6105 \exp[(17.27 t_{wb}) / (237.3 + t_{wb})]</math></p> <p><math>e_{sw}</math> = saturated vapour pressure of air at the water temperature (kPa)</p> <p>= <math>0.6105 \exp[(17.27 t_w) / (237.3 + t_w)]</math></p>	

## **4 ACTUAL PLANT SIMULATIONS**

The five refrigeration systems modelled have a similar structure and method of converging to a solution which allows a modular approach to be taken. In the first part of this section, the general simulation method is outlined in terms of the three subsystems and the interrelationships between them.

In the remaining sections, each model is discussed and its suitability to adequately represent the overall refrigeration system operation is assessed. Also given is the background leading to design and justification for each system and the development of the simulations and control strategies. Comparisons between predicted and actual performance are made and the adjustments necessary as a result of subsequent testing outlined where appropriate.

### **4.1 Simulation structure and components**

The fundamental structure of all the models used to simulate refrigeration plant performance outlined in figure 2.12 can be divided into three main subsystems which are designated as chiller, heat rejection and load. Each subsystem normally comprises of several components which, for all the actual plants modelled, have sufficient similarities in structure and method of analysis to allow a modular approach to be taken in the overall simulation structure.



There will be a difference in emphasis within both the modules and the structure depending on whether the simulation is being used either to optimise plant operation or as a diagnostic device. Although not as amenable, the optimisation model can also be used for diagnostic purposes, consequently only this structure will be described in detail.

#### 4.1.1 The chiller subsystem

##### Evaporator modules

The first component of the chiller subsystem is the evaporator and the module analysis is illustrated in figure 4.1. The evaporator water flow rate  $l_e$  will depend on both the load subsystem and the control strategy and may be either variable where the compressor is maintained at full load or fixed where the compressor is allowed to unload to match the load subsystem. If the evaporator water flow rate is to be variable, a start value is adopted, which is normally taken as that at the design condition.

The temperature of the water entering the evaporator  $t_{wie}$  and the evaporator duty  $Q_e$  will vary according to the load subsystem and the evaporator water flow rate. Again, the start values adopted for the simulation are those at the design condition. The fouling factor  $h_{fe}$  is constant for a particular simulation and will only change with time and water quality. The fouling factor

Figure 4.1 - Evaporator module analysis

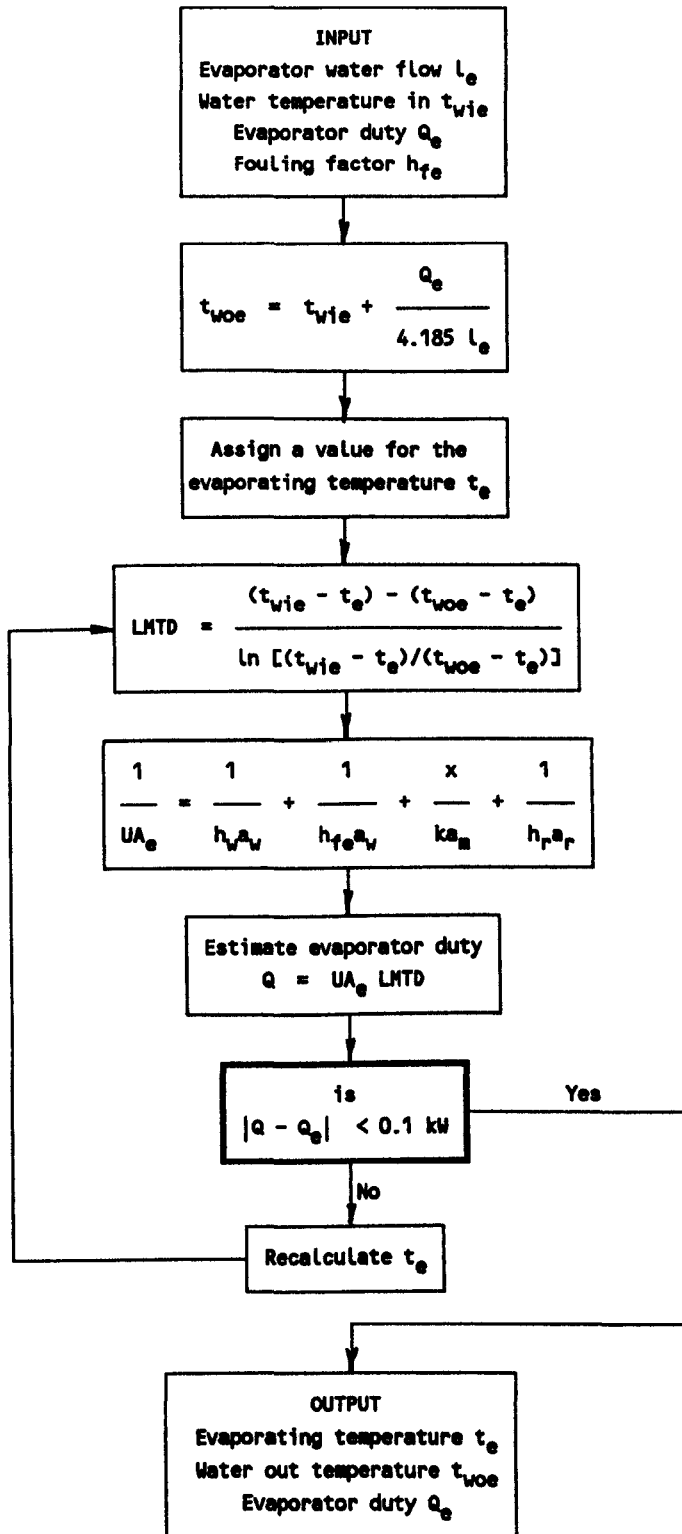

can be used as a variable if the simulation is to be used diagnostically to determine when evaporator cleaning should take place.

With this input information, the temperature of the water leaving the evaporator  $t_{woe}$  is calculated and a value assigned for the evaporating temperature  $t_e$ . Although the design value may be used, it may need to be adjusted if  $(t_{woe} - t_e) < 0$ . This would result in an error (attempting to calculate a negative natural logarithm) when calculating the log mean temperature difference LMTD.

The overall heat transfer coefficient  $UA_e$  is obtained using the heat transfer characteristics for the type of evaporator being used and the input variables defined above. The estimated evaporator duty is the product of the overall heat transfer coefficient and the log mean temperature difference and is compared to the input value. If the difference in evaporator duties is greater than a pre-set test value, a revised evaporating temperature is calculated and the process repeated until the test condition is met.

#### Condenser modules

The second component of the chiller subsystem is the condenser. The analysis of this module is illustrated in figure 4.2 for a condenser with an external heat rejection subsystem and for an evaporative condenser

in figure 4.3. Where applicable, the condenser water flow rate  $l_c$  and the fouling factor  $h_{fc}$  are normally fixed values. The start value for the temperature of the water into the condenser  $t_{wic}$  is usually taken as the design value.

The evaporator duty  $Q_e$ , obtained from the evaporator module, and an estimate of the compressor input power is used to calculate both the condenser duty  $Q_c$  and the temperature of the water leaving the condenser  $t_{woc}$ . A start value for the compressor input power is normally taken as 20% of the design evaporator duty which infers a power to cooling ratio of 0.2.

A start value is also assigned for the condensing temperature  $t_c$ . Although the design value may be used, it may need to be adjusted if  $(t_c - t_{woc}) < 0$ . As before, this would result in an error when calculating the log mean temperature difference LMTD.

The overall heat transfer coefficient  $UA_c$  is obtained using the heat transfer characteristics for the type of condenser and the defined input variables. The estimated condenser duty is the product of the overall heat transfer coefficient and the log mean temperature difference and is compared to the input value. If the difference in condenser duties is greater than a pre-set test value, a revised condensing temperature is calculated and the process repeated until the test condition is met.

Figure 4.2 - Condenser module analysis

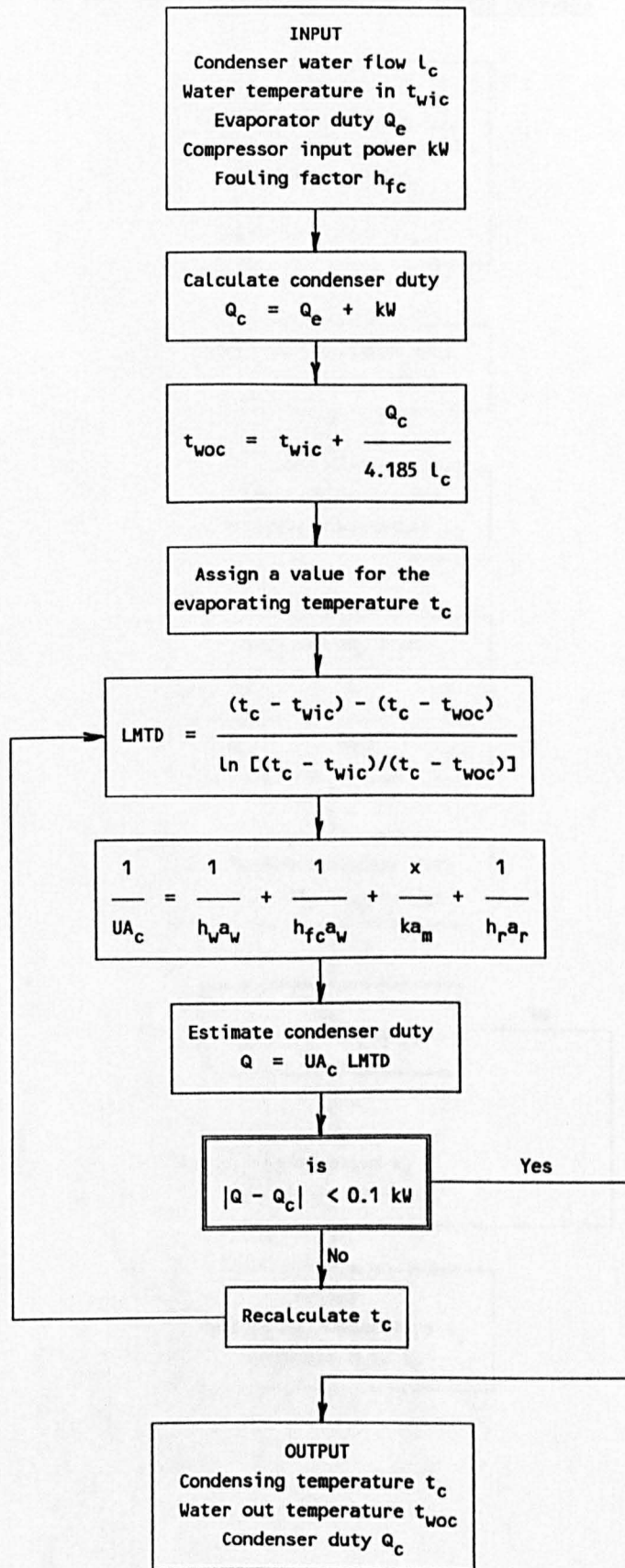
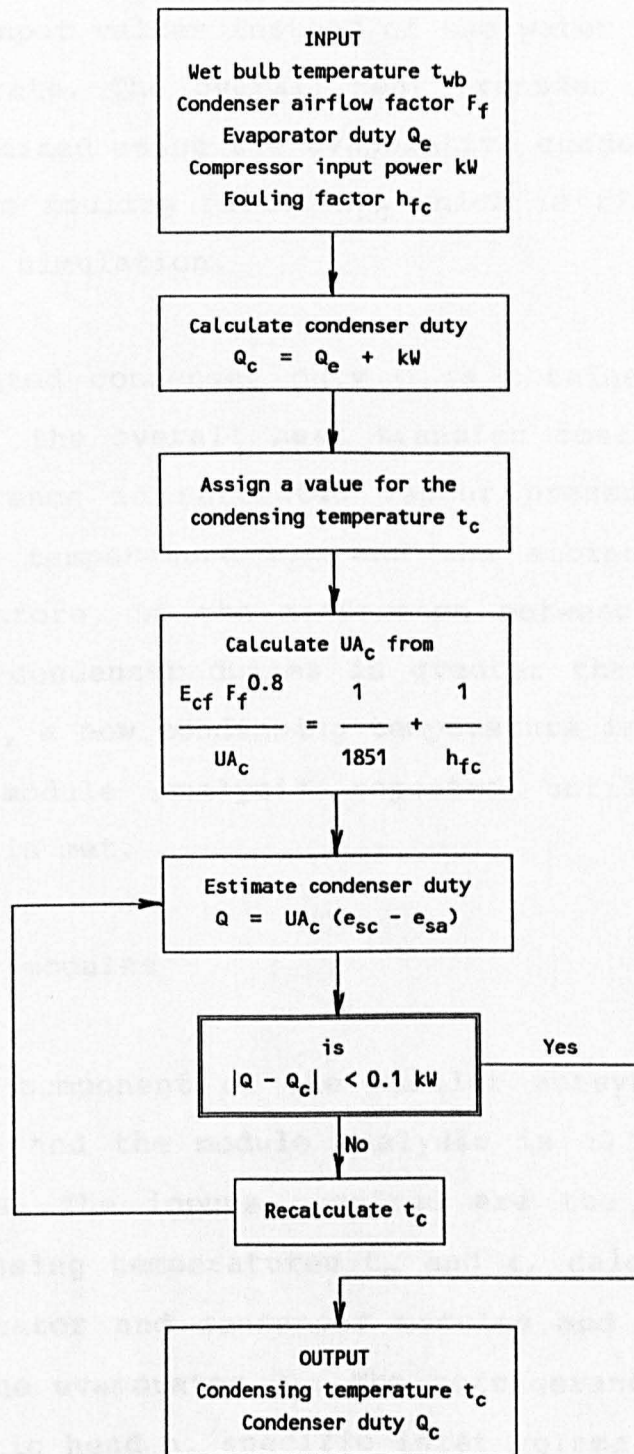

Figure 4.3 - Evaporative condenser module analysis



For an evaporative condenser, the ambient wet bulb temperature  $t_{wb}$  and the airflow factor  $F_f$  are required as fixed input values instead of the water temperature and flow rate. The overall heat transfer coefficient  $UA_C$  is obtained using the evaporative condenser factor  $E_{Cf}$  and the fouling factor  $h_{fC}$  which is fixed for the particular simulation.

The estimated condenser duty  $Q$  is obtained from the product of the overall heat transfer coefficient and the difference in saturated vapour pressures at the condensing temperature  $e_{sc}$  and the ambient wet bulb  $e_{sa}$ . As before, if the difference between calculated and input condenser duties is greater than a pre-set test value, a new condensing temperature is calculated and the module analysis repeated until the test condition is met.

#### Compressor modules

The final component of the chiller subsystem is the compressor and the module analysis is illustrated in figure 4.4. The inputs required are the evaporating and condensing temperatures  $t_e$  and  $t_c$  calculated from the evaporator and condenser modules and the cooling duty at the evaporator  $Q_e$ . The refrigerant properties of adiabatic head  $h$ , specific inlet volume  $v$  and ideal power to cooling ratio  $I$  are calculated using these evaporating and condensing temperatures.

The refrigerant inlet volume refrigerant flow rate  $V$  is calculated as the product of the specific inlet volume  $v$  and the evaporator duty  $Q_e$ . From the equations relating compressor performance to inlet volume flow rate  $V$ , the estimated adiabatic head  $h_c$  and the compressor efficiency  $n_c$  can be established. The ideal input power is the product of the ideal power to cooling ratio and the evaporator duty and the actual compressor input power kW can be obtained by dividing this by the compressor efficiency.

The compressor modules may also contain any tests which require part load operation of the compressors. This includes approaching the surge condition for centrifugal compressors or too low an evaporating temperature with possible freezing of the water in the evaporator. In these instances, part load operation is dealt with in a separate compressor module depending on how the compressor reduces load i.e. a change in compressor speed, hot gas by-pass or a change in slide valve setting.

Where the overall plant control strategy is to reduce the compressor load to match the cooling duty, the compressor part load routines can be incorporated in the main compressor module. The simulations which are used diagnostically, also require part load routines where the load is determined from the motor current. Examples with details of the techniques are given in section 4.5 and 4.6.



Figure 4.4 - Compressor module analysis

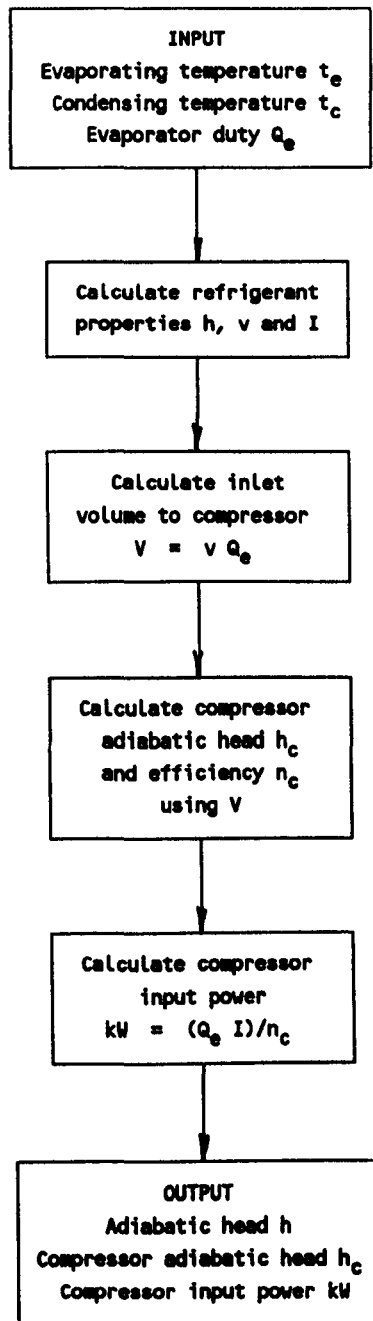

## Chiller set modules

The chiller subsystem control module is illustrated in figure 4.5. When the initial evaporator, condenser and compressor modules have been run, a value for the adiabatic head  $h$  has been obtained from the balanced evaporating and condensing temperatures and the refrigerant properties. An estimated adiabatic head  $h_c$  is also obtained based on the compressor performance curves and the evaporator duty.

If the start evaporator duty matched the compressor capacity, the two values of adiabatic head would be the same. Where this is not the case, the evaporator duty is adjusted and the analysis repeated until the difference in the two values is less than a pre-set test value. The method used to adjust the evaporator duty can result in convergence problems particularly where the adjustment is large.

Where the compressor adiabatic head against inlet volume curve is a straight line (most of the screw compressor curves), the evaporator duty adjustment is simply based on a ratio of compressor inlet volumes. This ratio is obtained by dividing a new compressor inlet volume  $V_c$  obtained from the compressor curves and based on the adiabatic head obtained from the refrigerant properties, by the compressor inlet volume  $V$  based on the original evaporator duty.

Where the compressor curves are not straight lines, using the ratio of inlet volumes may force convergence too rapidly and could result in the simulation becoming unstable. An alternative method using the Newton-Raphson technique to obtain the new estimate has been found to be suitable. The weighting values used to increase the convergence rate were obtained by trial and error.

#### 4.1.2 The heat rejection subsystem

Where evaporative condensers are employed, the heat rejection subsystem is incorporated in the chiller set subsystem and separate routines are not necessary. The ambient wet bulb temperature is used to directly assess the heat rejection to the general atmosphere as illustrated in figure 4.3. Where the heat required to condense the refrigerant is transferred to water in the condenser, a cooling tower is then used to reject this heat to the atmosphere.

The method of analysing the operation of this module is given in figure 4.6. The cooling tower water flow  $l_t$  is usually fixed as the condenser water flow rate or a fraction of it if the cooling tower has several cells. The water temperature entering the tower  $t_{wit}$  is a variable within the simulation and is normally equivalent to the temperature of the water leaving the condenser  $t_{woc}$ .

Figure 4.5 - Chiller set module analysis

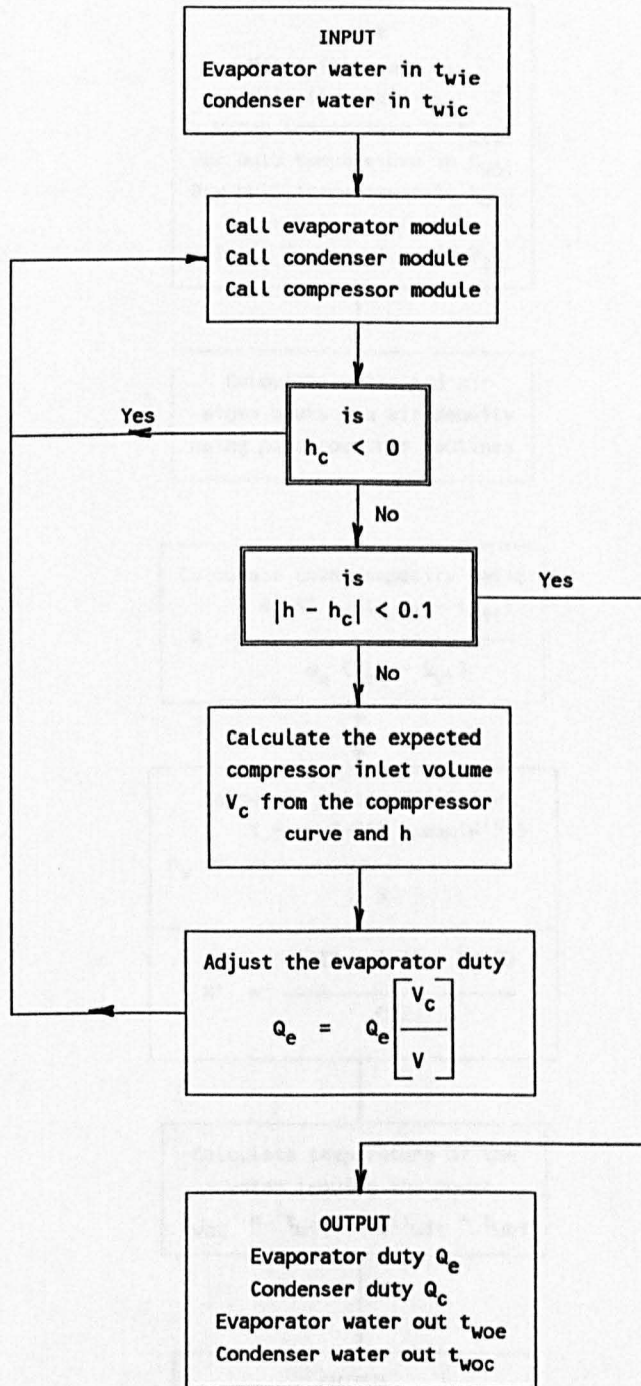
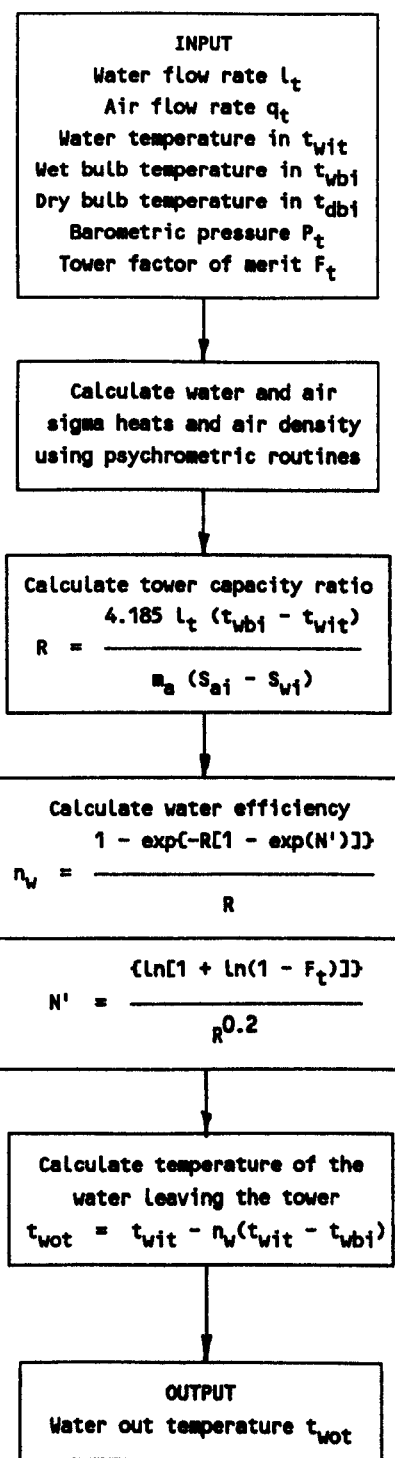

Figure 4.6 - Condenser cooling tower module analysis



Where screw compressors are used, the oil injected into the refrigerant prior to compression and removed from the discharge gas is often cooled in a separate shell and tube heat exchanger using a fraction of the condenser water prior to re-injection. In this case, the water temperature into the condenser cooling tower may be weighted according to the temperatures and flow rates through the condenser and the oil cooler.

More often, the oil cooling load is usually less than 1% of the total condenser load and can be considered as part of the condenser operation rather than a separate heat exchanger without significant error.

Other constant values within the simulation are the ambient wet and dry bulb temperatures  $t_{wbit}$  and  $t_{dbit}$ , the barometric pressure  $P_t$ , the air flow rate in the tower  $q_t$  and the factor of merit for the tower  $F_t$ . Psychrometric routines are used to calculate the sigma heats of the air entering, the saturated air at the entering water temperature and the air density. These are used to calculate the tower capacity ratio  $R$ .

The water efficiency  $n_w$  is a function of the type of tower (cross or counter flow), the tower capacity ratio and the factor of merit. It is used to calculate the temperature of the water leaving the tower  $t_{wot}$  which, ignoring pipe line heat losses or gains, is the temperature of the water entering the condenser  $t_{wic}$ .

### 4.1.3 The load subsystem

The load subsystem can be a straightforward single surface bulk air cooler or a complex sequence of heat exchangers of different types used both in parallel and in series circuits. The module analysis for either system follows the same form with the distributional structure becoming more complex as more elements are introduced into the system.

#### Surface bulk air cooler

The module analysis for a surface bulk air cooler is illustrated in figure 4.7. For a simulation, the only variable is the temperature of the water into the bulk air cooler  $t_{wit}$ . This will be equal to the temperature of the water leaving the evaporator  $t_{woe}$  plus the rise in water temperature resulting from any heat gains in the piping between the evaporator and the bulk cooler. For a given simulation, the air and water flow rates, the air wet and dry bulb temperatures, the barometric pressure and the bulk air cooler factor of merit are all fixed.

In a similar manner to that described for the heat rejection cooling towers, the temperature of the water leaving the bulk air cooler  $t_{wot}$  can be established from the variable water inlet temperature and the remaining fixed parameters. The bulk air cooler duty  $Q_t$  is then calculated and the condition of the air

Figure 4.7 - Bulk air cooler module analysis

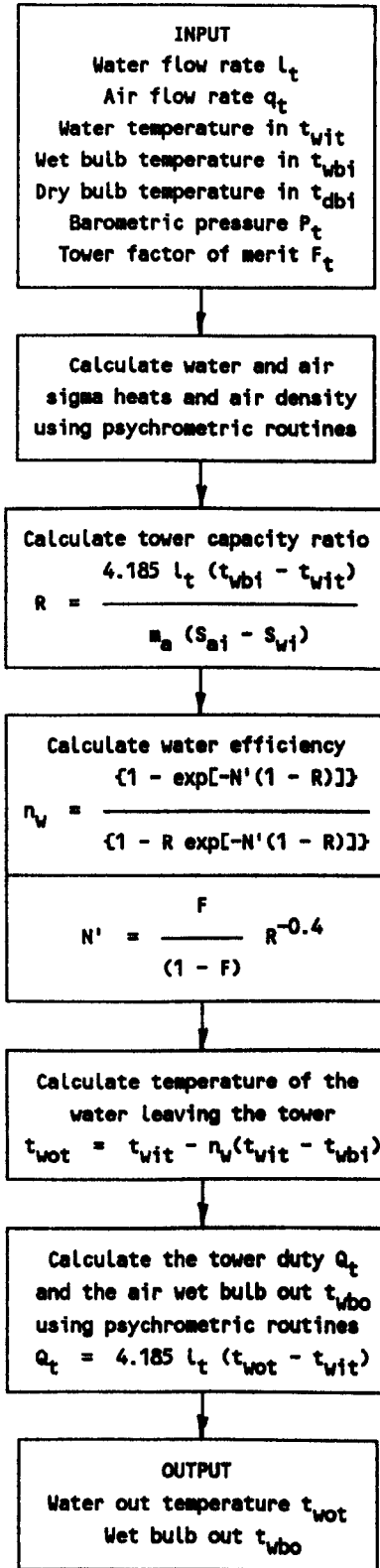



supplied to the mine from the cooler obtained using the psychrometric routines. The temperature of the water leaving the bulk air cooler plus the rise in temperature resulting from any pipe heat gains, is the water temperature returned and supplied to the evaporator  $t_{wie}$ .

#### Underground chilled water systems

The most complex load subsystem has a closed circuit chilled water supply from surface to underground high pressure heat exchangers, a secondary cold water circuit supplying both cooling coils and multistage spray chambers and poor insulation resulting in heat gains in the water distribution system. The module analyses for the individual elements are illustrated in figures 4.8 to 4.12 and the combined analysis is illustrated in figure 4.13.

The first element is the temperature rise resulting from heat gains to the high pressure pipes supplying and returning chilled water between surface and the high pressure heat exchangers (figure 4.8). For a given simulation, the chilled water flow rate  $l_e$ , the thermal resistance of the insulation  $U$  and the dry bulb temperature of the air  $t_{db}$  is fixed. The later assumption presumes that the heat transferred to or from the air does not significantly change its temperature.

The driving force for heat transfer is the difference in temperature between the water and the air dry bulb. The water temperatures are variable and the evaporator water temperature out  $t_{woe}$  is that entering the supply pipe on surface and the evaporator water temperature in  $t_{wie}$  is that leaving the return pipe on surface. Using these values the heat gains and therefore the temperatures of the water leaving the supply pipe  $t_{wih}$  and entering the return pipe  $t_{woh}$  can be calculated.

### High pressure heat exchangers

The temperatures at the supply pipe outlet and the return pipe inlet are the supply and return water temperatures  $t_{wih}$  and  $t_{woh}$  for the high pressure circuit of the high pressure heat exchangers (figure 4.9). For a given simulation, the high and low pressure water flow rates  $l_h$  and  $l_l$  and the fouling factors  $h_{fh}$  and  $h_{fl}$  are fixed.

By assuming an initial value for the low pressure water temperature leaving the heat exchanger  $t_{wol}$  slightly higher than the temperature of the high pressure water into the heat exchanger, the temperature of the water in on the low pressure side  $t_{wil}$  is calculated from the high pressure side heat transfer  $Q_h$ .

Based on the characteristics of the heat exchanger, the overall heat transfer coefficient  $UA$  and the heat

Figure 4.8 - High pressure pipe analysis

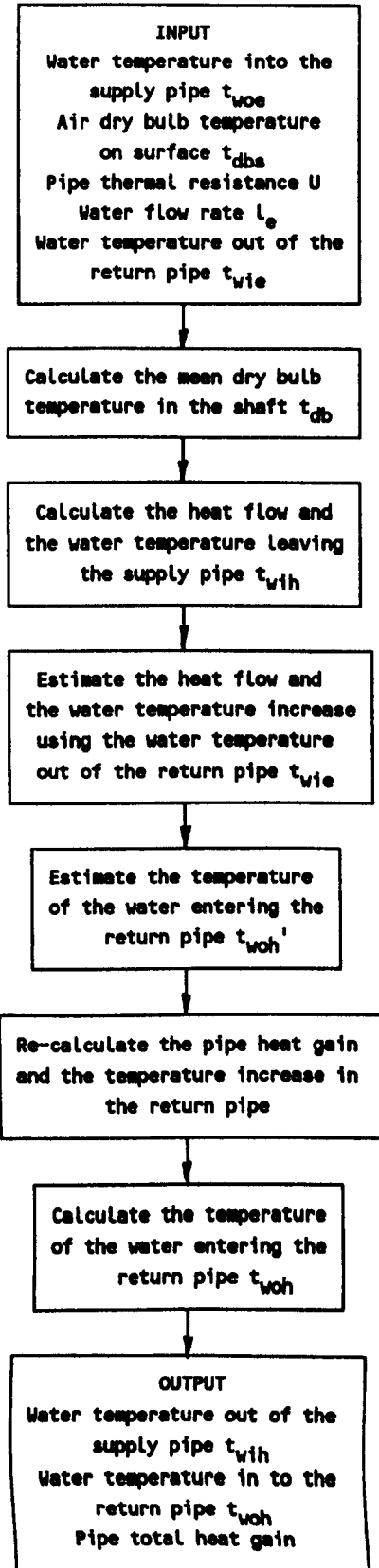
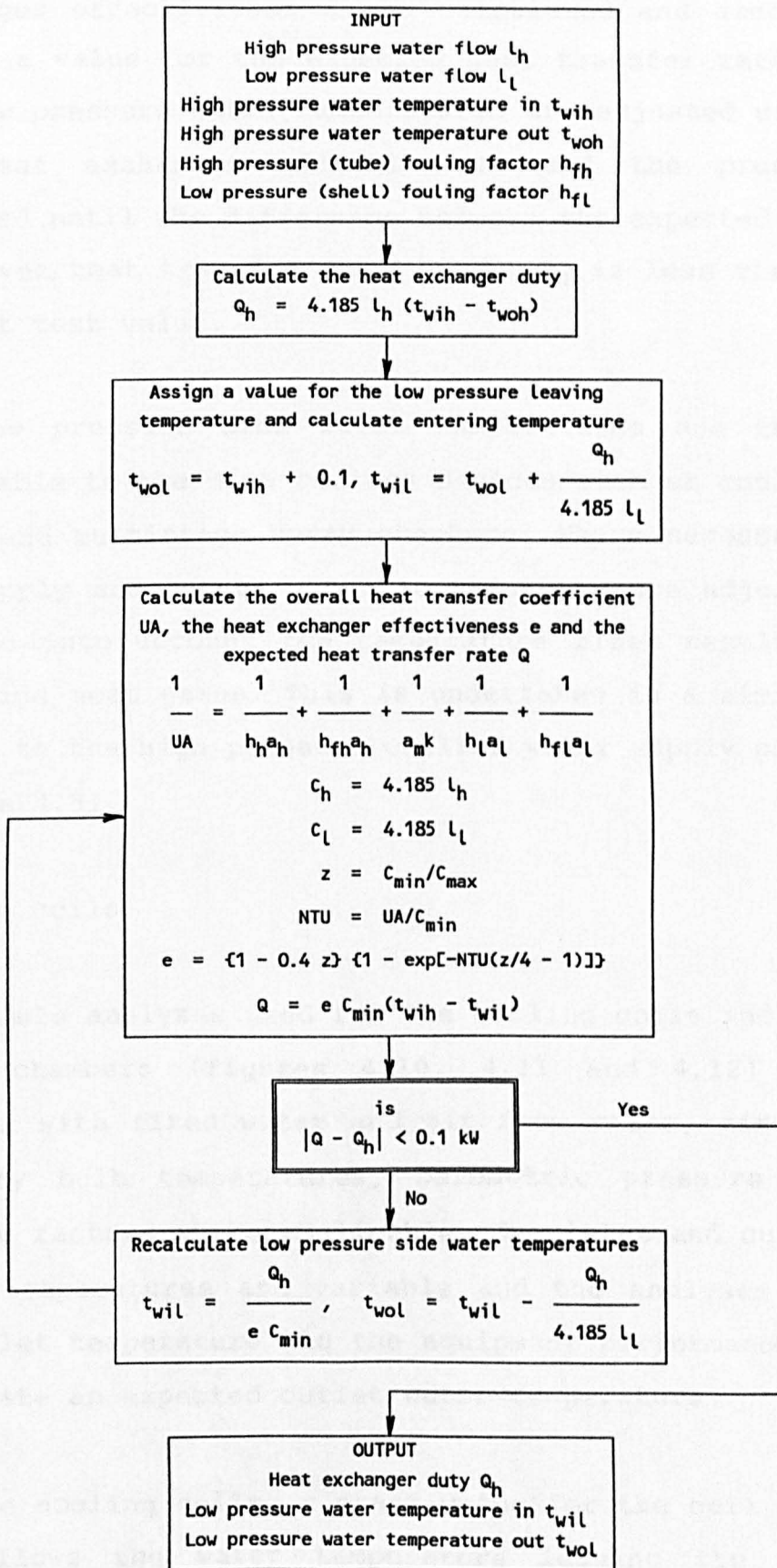

Figure 4.9 - High pressure heat exchanger analysis



exchanger effectiveness  $e$  are calculated and used to obtain a value for the expected heat transfer rate  $Q$ . The low pressure water temperatures are adjusted using the heat exchanger effectiveness and the process repeated until the difference between the expected and the given heat transfer rates  $Q$  and  $Q_h$  is less than a pre-set test value.

The low pressure side water temperatures are those applicable to the mine cooling devices such as cooling coils and multistage spray chambers. Where necessary, the supply and return water temperatures are adjusted to take into account the temperature rises resulting from pipe heat gains. This is undertaken in a similar manner to the high pressure chilled water supply pipes (figure 4.8).

#### Cooling coils

The module analyses used for the cooling coils and the spray chambers (figures 4.10, 4.11 and 4.12) are similar with fixed water and air flow rates, air wet and dry bulb temperatures, barometric pressure and fouling factors where applicable. The inlet and outlet water temperatures are variable and the analyses use the inlet temperature and the equipment performance to calculate an expected outlet water temperature.

For the cooling coils, a start value for the coil duty  $Q_{cc}$  allows the water temperature leaving the coil

$t_{wocc}$  to be calculated. An air side coil duty  $Q$  can then be obtained by calculating the overall heat transfer coefficient  $UA$  and the coil effectiveness  $e$ . This replaces the estimated coil duty  $Q_{cc}$  and the process is repeated until the difference in successive values is less than a pre-set test value.

#### Multistage spray chambers

For the multistage spray chambers where the air and water flows are counter current, the start value for the analysis is taken as the outlet water temperature  $t_{wos}$  being slightly less than the inlet wet bulb temperature  $t_{wbis}$ . If it is assumed that each stage cools one third of the total spray chamber duty (obtained from the water flow rate and the difference between the inlet water temperature  $t_{wis}$  and this assumed value for the outlet water temperature), the temperature of the water entering the first air stage  $t_{wil}$  can be estimated.

The stage analysis (figure 4.11) is now used to calculate the actual temperature of the water leaving the spray chamber  $t_{wo1}$  and the actual stage 1 duty. This is used to calculate the wet and dry bulb temperatures leaving stage 1 i.e. the wet and dry bulb temperatures entering stage 2. The water efficiency calculated for stage 1 is used to estimate the temperature of the water entering stage 2  $t_{wi2}$  and the estimated stage 2 duty  $Q_s$ .

Figure 4.10 - Cooling coils analysis

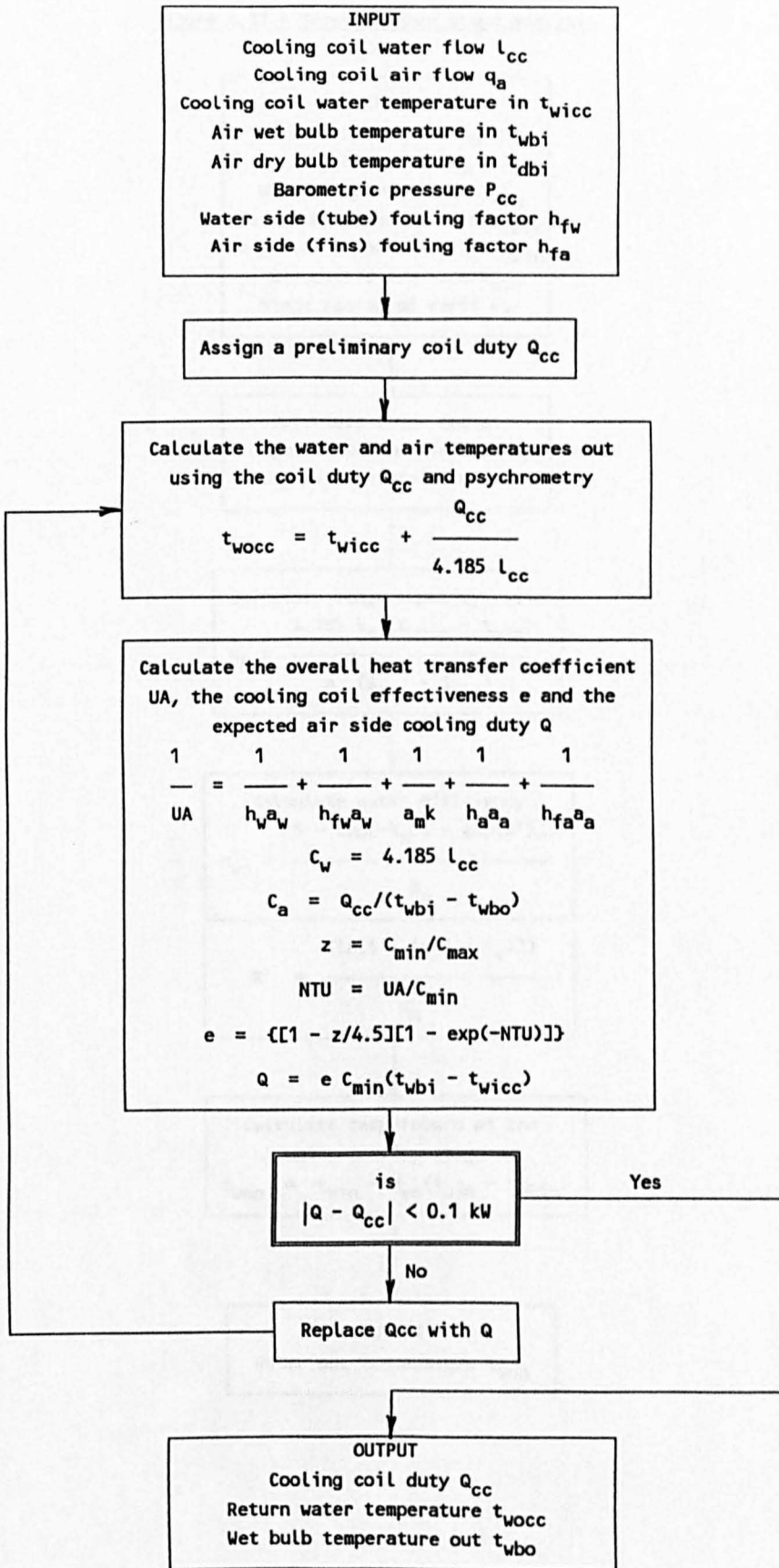

Figure 4.11 - Spray chamber stage analysis

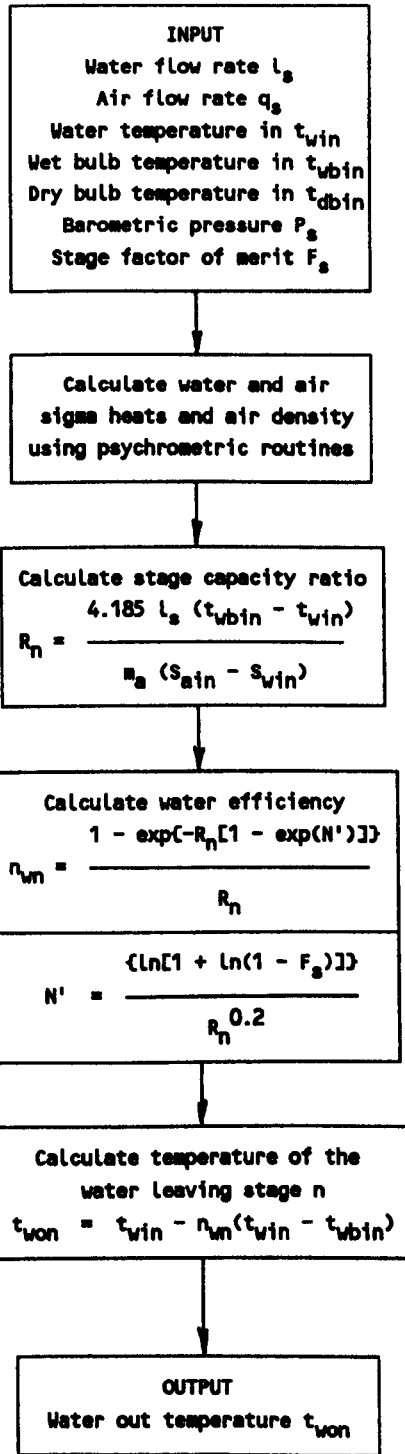
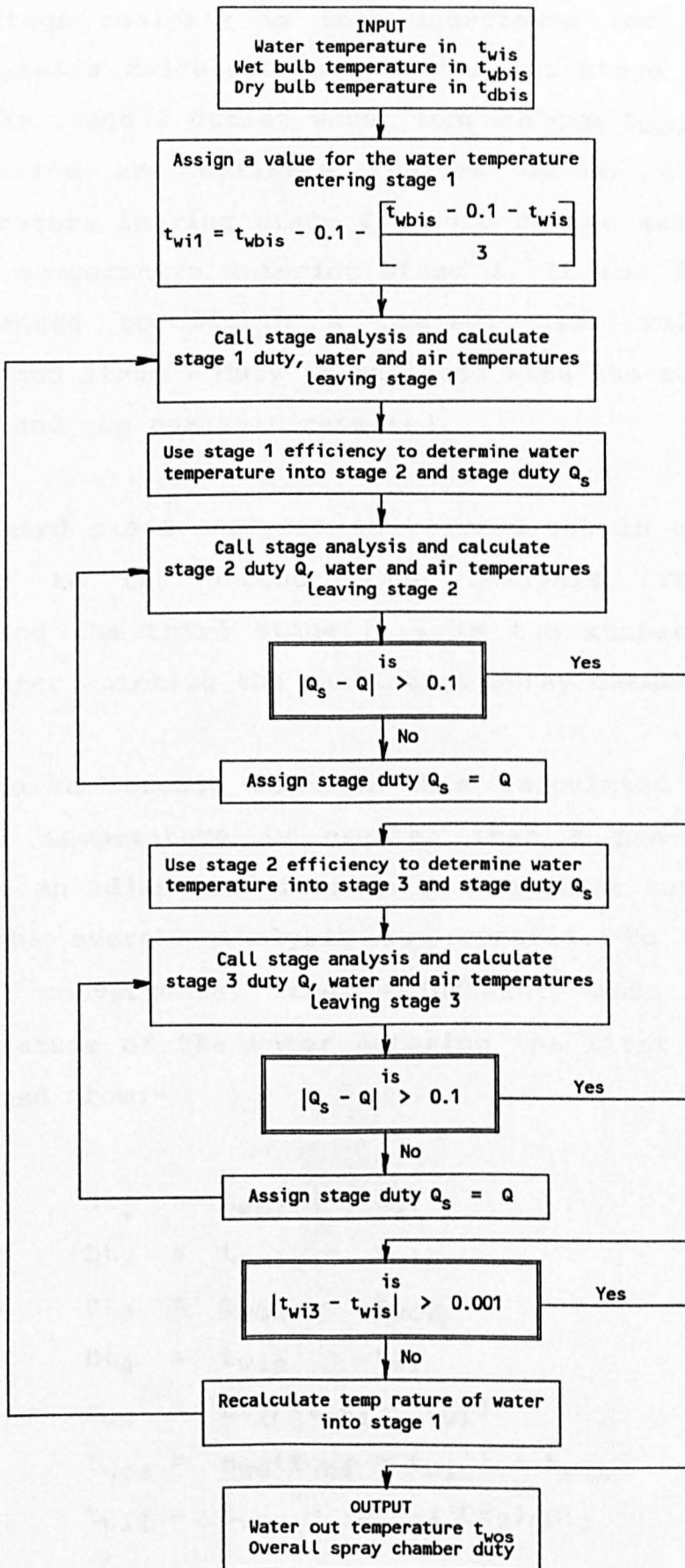



Figure 4.12 - Multistage spray chamber analysis



The stage analysis is then undertaken for stage 2. This yields calculated values for the stage 2 duty Q and the stage 2 outlet water temperature  $t_{wo2}$ . If the calculated and estimated values agree, the water temperature leaving stage 2 should be the same as the water temperature entering stage 1. If the duties do not agree to within a pre-set test value, the estimated stage 2 duty is replaced with the calculated value and the analysis repeated.

The third stage analysis is carried out in a similar manner to the second stage analysis. The water entering the third stage  $t_{wi3}$  is the temperature of the water entering the multistage spray chamber  $t_{wis}$ .

If the difference between this calculated and the actual temperature is greater than a pre-set test value, an adjustment is made to the start temperature and the overall analysis is repeated. To ensure a rapid convergence, the adjustment made to the temperature of the water entering the first stage is obtained from:-

$$\begin{aligned}
 Dt_1 &= t_{wo1} - t_{wi} \\
 Dt_2 &= t_{wo1} - t_{wis} \\
 Dt_3 &= t_{wo1} - t_{wo2} \\
 Dt_4 &= t_{wis} - t_{wi} \\
 n_{ws} &= Dt_1 / (t_{wbi} - t_{wi}) \\
 t_{wos} &= n_{ws}(t_{wbi} - t_{wis}) + t_{wis} \\
 t_{wil} &= t_{wos} - (Dt_3 \times Dt_2) / Dt_1
 \end{aligned}$$

The underground load

The inlet water temperature and the performance of the cooling equipment has determined the temperature of the return water which is then weighted according to the distribution to the cooling appliances. If the difference between this value and that calculated as the high pressure heat exchanger inlet temperature is greater than a pre-set test value, heat exchanger performance is re-evaluated using the mean of the heat exchanger and the cooling appliance duties.

The new high pressure heat exchanger duty and the temperature of the water in on the high pressure side is used to calculate a new value of the temperature of the water leaving on the high pressure side. The process is repeated (figure 4.13) until the heat load at the cooling appliances has converged to match the coolth available at the heat exchangers.

The revised temperature of the water leaving the high pressure side of the heat exchanger and entering the return pipe, when adjusted for pipe heat gains, is the temperature of the water supplied to the evaporator.

#### 4.1.4 Overall plant operation

The overall plant operation modules link the chiller set subsystems with the heat rejection and load subsystems. The modules incorporate the set operating

Figure 4.13 - The load subsystem analysis

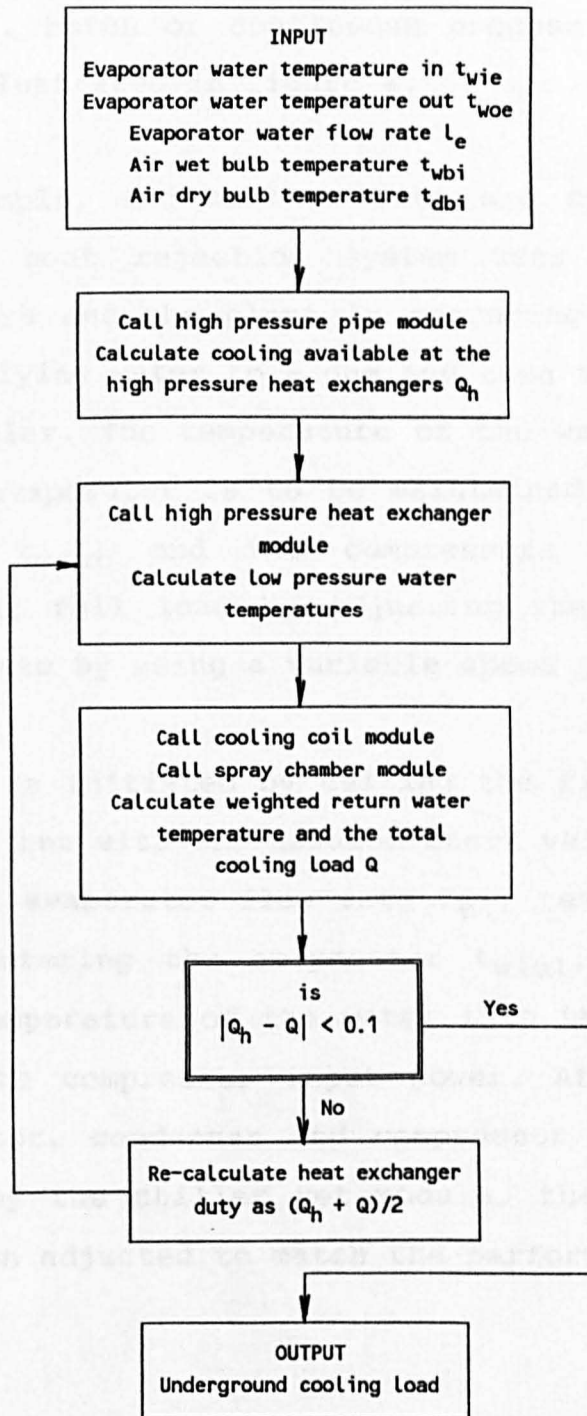

configuration such as the number of sets and whether they are in series or parallel and the plant control strategy i.e. batch or continuous process. A typical module is illustrated in figure 4.14.

In this example, two chiller sets are operating in series, the heat rejection system uses cross flow cooling towers and the plant is operating as a batch process supplying water to a dam and then to a surface bulk air cooler. The temperature of the water leaving the second evaporator is to be maintained at a fixed temperature  $t_{wout}$  and the compressors are to be maintained at full load by adjusting the evaporator water flow rate by using a variable speed pump.

The process is initiated by calling the first chiller set which is run with the assumed start values for the variables of evaporator flow rate  $l_{e1}$ , temperature of the water entering the evaporator  $t_{wie1}$ , evaporator duty  $Q_{e1}$ , temperature of the water into the condenser  $t_{wic1}$  and the compressor input power. After running the evaporator, condenser and compressor set modules controlled by the chiller set module, the evaporator duty has been adjusted to match the performance of the compressor.

When the heat rejection module is called and run, for a given tower input temperature  $t_{wit1}$  (equal in value to the condenser outlet temperature  $t_{woc1}$ ), there will be a tower outlet temperature  $t_{wot1}$  which, if the two

subsystems were in balance, would be equal to the water temperature into the condenser  $t_{wic1}$ . The value for  $t_{wic1}$  is replaced with the value of  $t_{wot1}$  and the chiller set re-run until the difference between the values of  $t_{wic1}$  and  $t_{wot1}$  is less than a pre-set test value. The first chiller set operation, for a given water temperature and flow rate into the evaporator, is now in balance with the compressor and heat rejection system performance.

Since the chiller sets are in series with respect to the evaporator water flow, the temperature of the water into the evaporator of the second chiller is the same as the temperature of the water leaving the first chiller i.e.  $t_{wie2} = t_{woe1}$  and the flow rates are the same i.e.  $l_{e2} = l_{e1}$ . As for the first set, the second chiller set and heat rejection system modules are run until a balance is achieved with the compressor and heat rejection system performance.

The temperature of the water leaving the second chiller set evaporator  $t_{woe2}$  is now compared to the design value of  $t_{wout}$  and, if the difference between these values is greater than a pre-set test value, the water flow rate is adjusted and both chiller set simulations repeated. The method of adjustment has a profound effect on convergence particularly where the surge point is approached and centrifugal compressors are used.

Failure to converge may be a result of either a stable oscillation or an unstable condition where the rate of convergence is becoming progressively smaller or where successive values are actually diverging. Occasionally the simulation becomes locked in a routine mainly as a result of a failure in meeting tolerances. For the particular set of conditions causing this, it is necessary to further tighten the tolerances and to accept the increased simulation time.

A universal method of adjustment that always converges rapidly has not been found. As a consequence, trial and error methods are generally used. The technique having the most success uses a power function of the ratio of the estimated to required water temperature increases  $[(t_{wiel} - t_{woe2}) / (t_{wiel} - t_{wout})]^n$ , where the value of the exponent  $n$  can be increased to speed up convergence or decreased to avoid unstable or oscillating conditions.

When the chiller and heat rejection subsystems are in balance, the load subsystem is applied. For this example, the water leaving the bulk air cooler  $t_{wot}$  should be the same as the temperature of the water into the first chiller set  $t_{wiel}$ . Where the difference in water temperatures exceeds the pre-set test values, the temperature of the water into the evaporator  $t_{wiel}$  is adjusted and the full simulation repeated. Again the adjustment technique is selected to ensure rapid convergence and to be as general as possible.

Figure 4.14 - Overall plant analysis

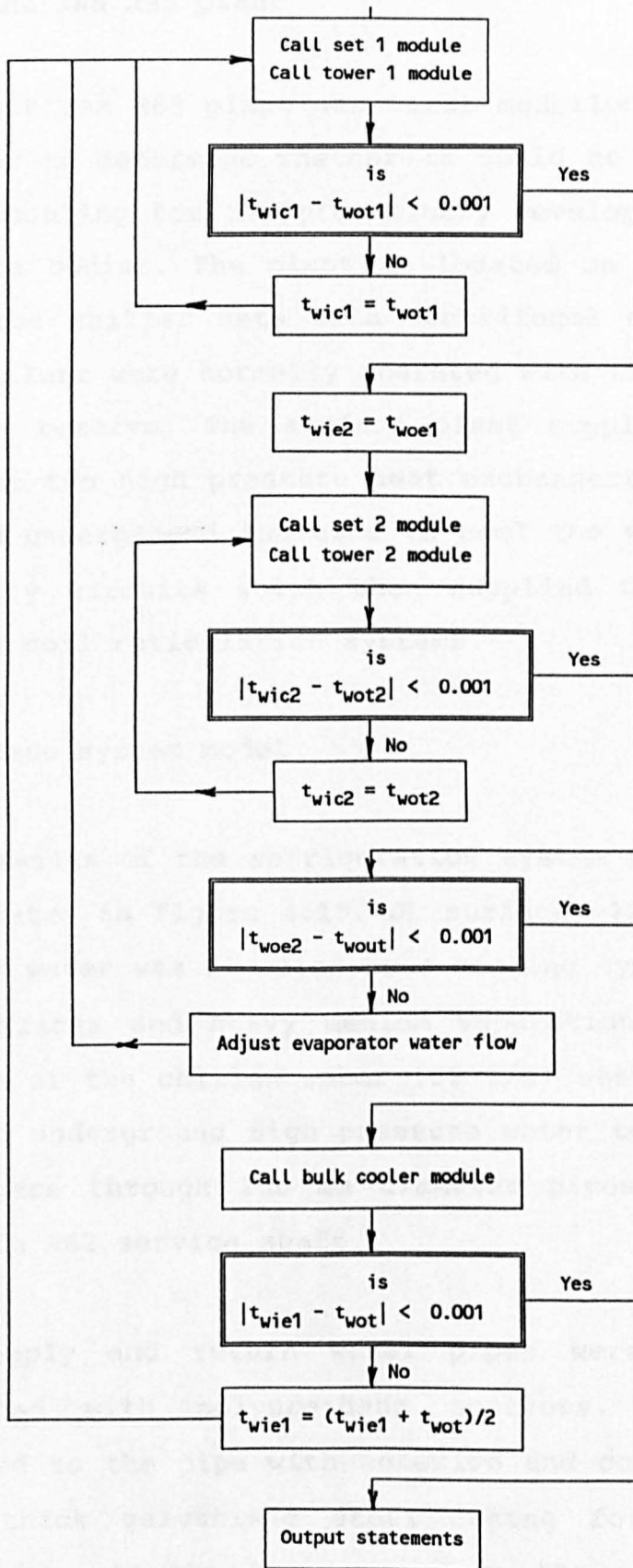



## 4.2 Mount Isa R63 plant

The Mount Isa R63 plant was first modelled in 1982/83 in order to determine whether it could be extended to supply cooling for the preliminary development of the 3000 ore bodies. The plant is located on surface and had three chiller sets with centrifugal compressors. Two chillers were normally operated with the third set held in reserve. The surface plant supplied chilled water to two high pressure heat exchangers which were located underground and used to cool the water in two secondary circuits which then supplied two separate cooling coil reticulation systems.

### 4.2.1 Base system model

The elements of the refrigeration system modelled are illustrated in figure 4.15. On surface, 22 l/s of the chilled water was diverted to a cooling system for the mine offices and heavy medium separation plant. The balance of the chilled water (69 l/s) was supplied to the two underground high pressure water to water heat exchangers through 250 mm diameter pipes located in the main R62 service shaft.

The supply and return water pipes were originally insulated with polyurethane sections. These were attached to the pipe with adhesive and covered with a 1 mm thick galvanised steel casing for mechanical protection. In the 20 years since the original pipe

installation, damage to the mechanical barrier and moisture penetration of the polyurethane foam had significantly reduced the effectiveness of the insulation. Measurements of the chilled water temperature increase in the pipes at low water flow rates was used to determine the overall heat transfer coefficient for these insulated pipes.

The upper high pressure heat exchanger on 17 level provided cold water for 10 cooling coils on 17 and 19 levels. The total volume of air cooled by the cooling coils was 57 m<sup>3</sup>/s. The second heat exchanger on 20 level provided cold water for 19 cooling coils on 20 level, 21C sub and 21 level. The total volume of air cooled in this reticulation system was 125 m<sup>3</sup>/s. The chilled water from the surface plant was split with approximately 25 l/s being delivered to the 17 level heat exchanger and the balance to the 20 level unit.

In 1983, the high and low pressure water reticulation systems were not fully instrumented and measurements of water temperatures and flow rates were obtained using contact thermometers and ultrasonic flow meters. Most of the air cooling was carried out on intake air which had not travelled more than 300 m from the main intake shaft. Although the temperature increase relative to surface of this intake air was due mainly to the heat resulting from autocompression, diurnal storage and release of heat in the shaft lining and steel work smoothed out the surface variations.

Figure 4.15 - R63 basic refrigeration system schematic

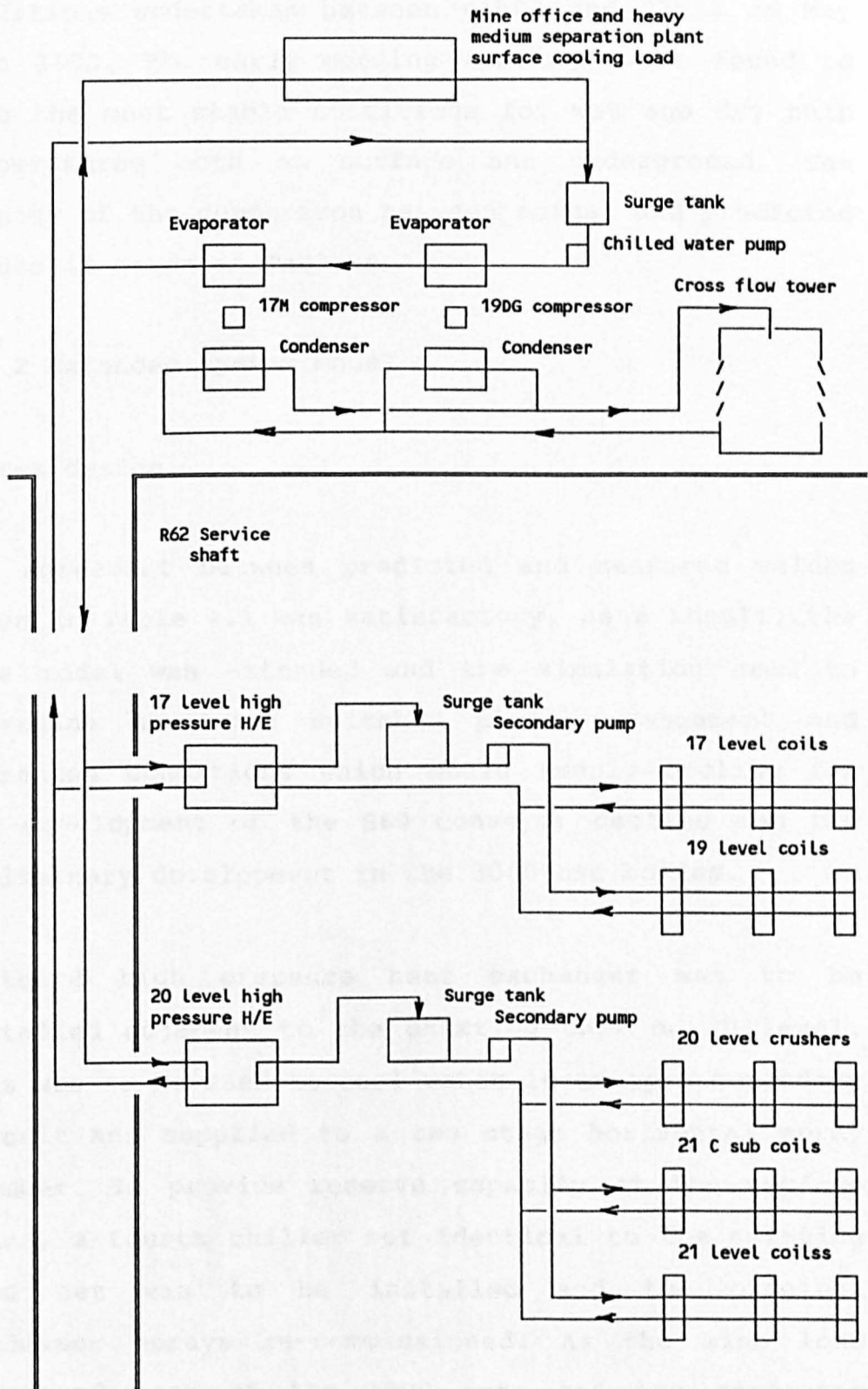

The predicted values from the model were compared to a series of measured values obtained from a survey of conditions undertaken between 06h00 and 07h30 on May 26th 1983. The early morning readings were found to give the most stable conditions for wet and dry bulb temperatures both on surface and underground. The results of the comparison between actual and predicted values is given in Table 4.1.

#### 4.2.2 Extended system model

##### System design

The agreement between predicted and measured values given in Table 4.1 was satisfactory. As a result, the base model was extended and the simulation used to determine the most suitable plant arrangement and operating conditions which would supply cooling for the development of the S60 conveyor decline and the preliminary development in the 3000 ore bodies.

A third high pressure heat exchanger was to be installed adjacent to the existing unit on 20 level. This was to be used to cool water in an open secondary circuit and supplied to a two stage horizontal spray chamber. To provide reserve capacity at the surface plant, a fourth chiller set identical to the existing 19DG set was to be installed and the original condenser sprays re-commissioned. As the mine load increased, one of the 19DG sets and the condenser

sprays was to be used exclusively for the surface refrigeration load associated with the mine offices and heavy medium separation plant.

An important element of the modelling and subsequent analysis of the results, was to determine the plant arrangements which would maximise the amount of cooling without incurring excessive power costs. The results of the simulations to determine the most suitable operating configuration are summarised in figures 4.16 to 4.18.

The effect of the evaporator water flow rate and the set configuration is illustrated in figure 4.16 for both the mean summer and the limiting climatic condition. Operating the chiller sets in series rather than in parallel resulted in more cooling available and a higher coefficient of performance. This was mainly a result of the necessity to operate the 19DG set at part load to avoid low evaporating temperatures and possible freezing in the evaporator.

The broken lines in this figure indicate when one or more of the compressors operates at part load. When operating the chillers in series, the much smaller evaporator of the 19DG set causes lower evaporating temperatures when compared to the 17M sets and, as a result, the 19DG set is used first in the series arrangement. The evaporator water flow rate was set at a compromise value of 100 l/s which should provide

**Table 4.1 - Comparison between predicted and measured values for the R63 base plant**

	Measured values	Predicted values
Total chiller set duty (kW)	2750	2709
17 M compressor duty (kW)		1492
19DG compressor duty (kW)		1217
Evaporator water in (°C)	13.8	13.8
Evaporator water out (°C)	6.5	6.6
17 Level HPHE duty (kW)	625	611
Secondary circuit in (°C)	14.0	14.2
Secondary circuit out (°C)	20.2	20.3
20 Level HPHE duty (kW)	1300	1285
Secondary circuit in (°C)	13.9	13.1
Secondary circuit out (°C)	21.7	20.8
Shaft pipe losses (kW)	200	188
Surface ambient temperatures	24.1/30.5°C	
Surface barometric pressure	96.27 kPa	
Surface refrigeration load	625 kW	

Figure 4.16 - R63 extended plant : effect of evaporator flow rate and set configuration

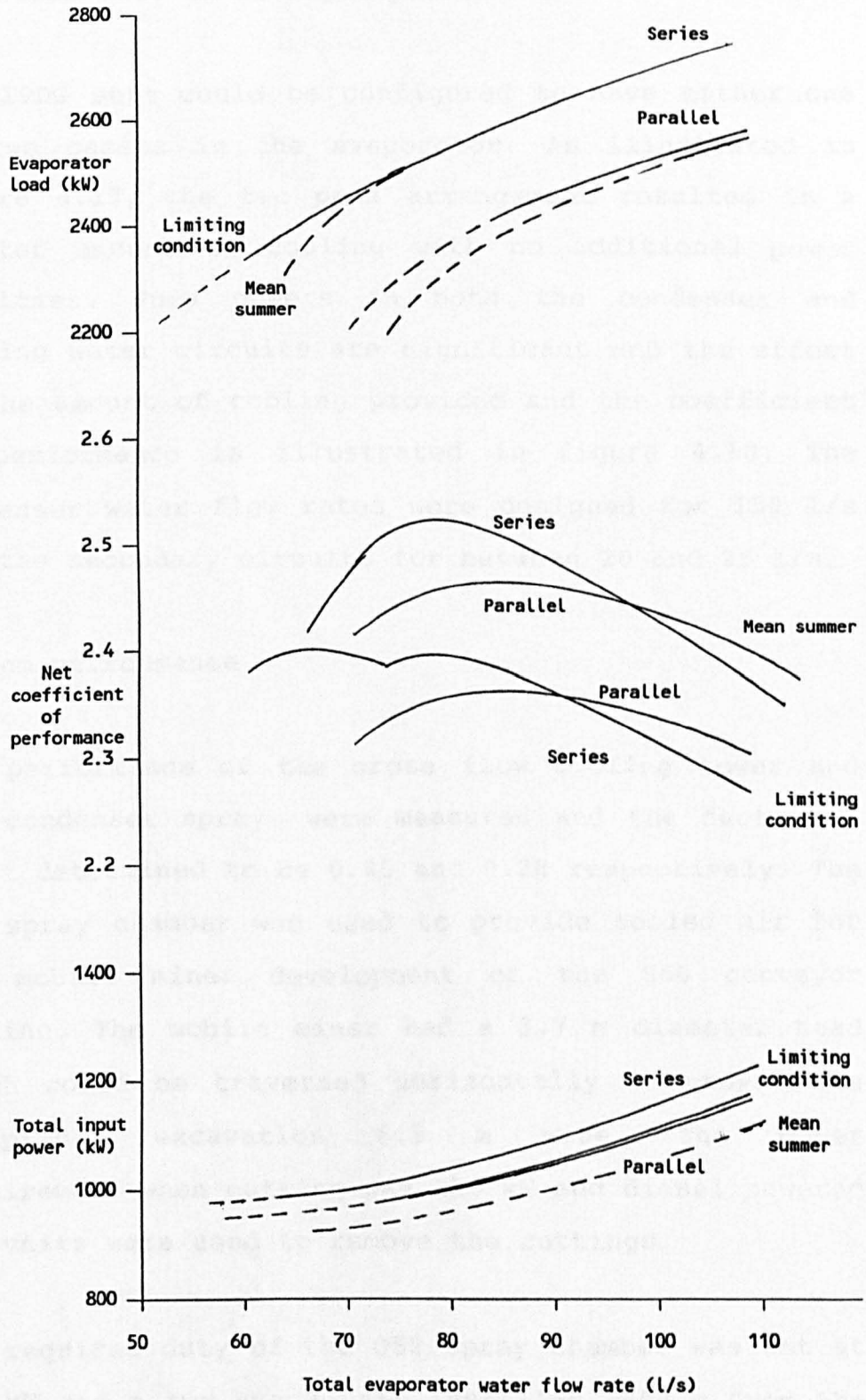

2700 kW of cooling at the coils and sprays and require less than 1200 kW of input power.

The 19DG sets could be configured to have either one or two passes in the evaporator. As illustrated in figure 4.17, the two pass arrangement resulted in a greater amount of cooling with no additional power penalties. Pump powers in both the condenser and cooling water circuits are significant and the effect on the amount of cooling provided and the coefficient of performance is illustrated in figure 4.18. The condenser water flow rates were designed for 150 l/s and the secondary circuits for between 20 and 25 l/s.

#### System performance

The performance of the cross flow cooling tower and the condenser sprays were measured and the factor of merit determined to be 0.45 and 0.28 respectively. The Q52 spray chamber was used to provide cooled air for the mobile miner development of the S60 conveyor decline. The mobile miner had a 3.7 m diameter head which could be traversed horizontally to provide an elliptical excavation 6.5 m wide. The power requirement when cutting was 250 kW and diesel powered LHD units were used to remove the cuttings.

The required duty of the Q52 spray chamber was set at 900 kW and a two stage unit installed 1200 m from the shaft. This was tested in December 1984 and the factor



of merit determined to be 0.41. This was the first multistage spray chamber to be installed at Mount Isa and the low factor of merit was mainly a result of the spray selection and the low chilled water pressure available at the site. The high pressure drop in the spray heads resulted in the water droplets formed not impacting on the roof of the chamber and some air channelling.

The chilled water from the secondary circuit of the high pressure heat exchanger was supplied to and returned from the Q52 spray chamber in uninsulated PVC pipes. The losses in the pipes were incorporated in the model. A comparison of the predicted values with values obtained from the monitoring system are given in Table 4.2. The measured values are based on the average of the five minute readings obtained between 06h00 and 07h00 on December 14th 1984.

The agreement between measured and predicted values was acceptable. The predictive programme was then used to determine the optimum cooling arrangements for the start of the T62 service decline (the main access and temporary truck haulage for the 3000 ore bodies) before the new surface refrigeration plant supplying chilled water underground was available. The underground cooling was to be expanded to two spray chambers and two mesh coolers which would provide approximately 2200 kW of refrigeration.

The cooling coil reticulation systems were changed so that all the cold water for the cooling coils was supplied by the 17 level high pressure heat exchanger. The total number of coils was reduced to twenty and the amount of cooling available for the coils was reduced to approximately 50% of that supplied in 1984. This system and the air cooling requirement remains virtually unchanged and is currently supplied with chilled water from the underground cold water storage dam on 20 level.

Figure 4.17 - R63 extended plant : effect of number of passes in the 190G evaporator

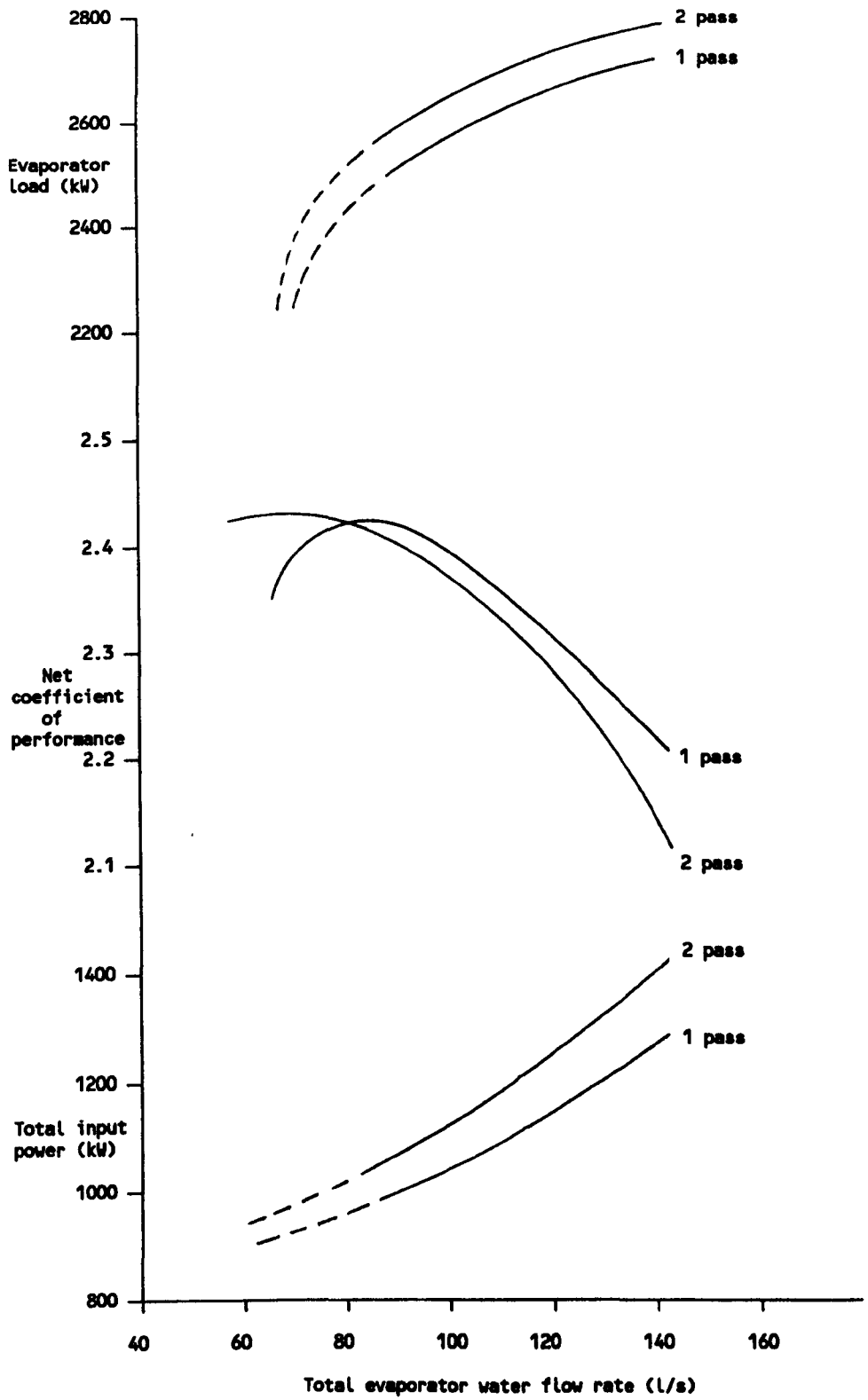

Figure 4.18 - R63 extended plant : effect of condenser and secondary water flow rates

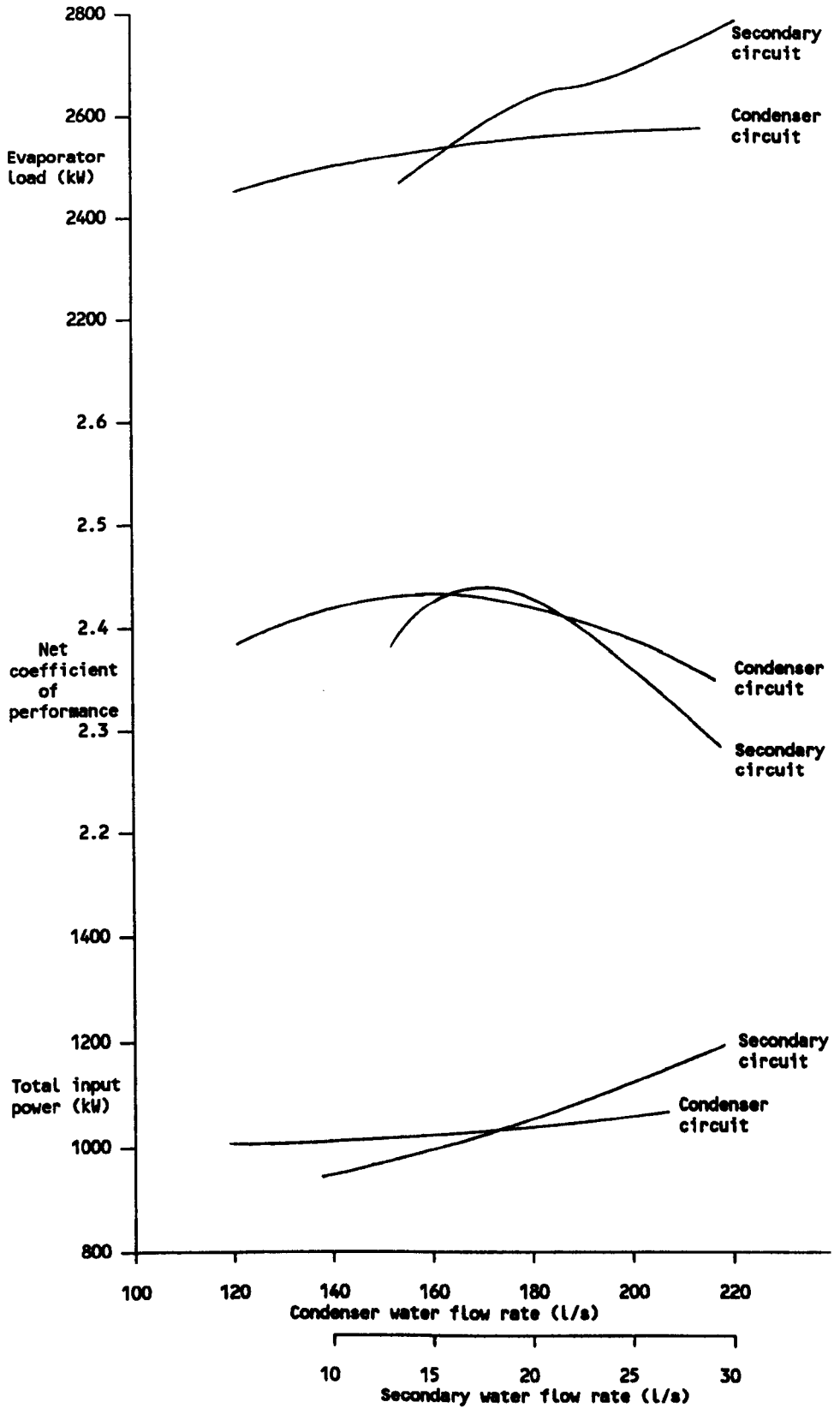

Table 4.2 - Comparison between predicted and measured values for the extended plant

	Predicted values	Measured values
Set configuration 17M51 and 19DG69 in series		
17M51 set leading		
Evaporator duty (kW)	1466	
Evaporating temperature (°C)	3.0	
Condensing duty (kW)	1699	
Condensing temperature (°C)	35.9	
19DG69 set lagging - part load		
Evaporator duty (kW)	1320	
Evaporating temperature (°C)	2.0	
Condensing duty (kW)	1655	
Condensing temperature (°C)	39.4	
Total evaporator duty (kW)	2786	2755
Water temperature in (°C)	14.2	14.0
Water temperature out (°C)	6.9	7.3
Cross flow condenser tower		
Water flow rate (L/s)	180.0	182.0
Water temperature in (°C)	32.6	33.0
Water temperature out (°C)	28.1	28.5
17 level cooling coils circuit		
HPHE - high pressure side		
Water flow rate (L/s)	20.0	19.8
Water temperature in (°C)	7.3	7.4
Water temperature out (°C)	12.9	12.2
HPHE - low pressure side		
Water flow rate (L/s)	20.0	22.7
Water temperature in (°C)	13.9	12.6
Water temperature out (°C)	19.5	17.5
Cooling coils duty (kW)	470.0	465.5
20 level cooling coils circuit		
HPHE - high pressure side		
Water flow rate (L/s)	21.0	20.6
Water temperature in (°C)	7.3	7.8
Water temperature out (°C)	14.3	15.0
HPHE - low pressure side		
Water flow rate (L/s)	20.0	19.7
Water temperature in (°C)	22.8	21.7
Water temperature out (°C)	15.4	14.0
Cooling coils duty (kW)	619.1	634.8
20 level spray chamber circuit		
HPHE - high pressure side		
Water flow rate (L/s)	31.0	33.4
Water temperature in (°C)	7.3	7.7
Water temperature out (°C)	14.6	14.5
HPHE - low pressure side		
Water flow rate (L/s)	34.0	32.8
Water temperature in (°C)	23.9	23.4
Water temperature out (°C)	17.2	16.4
Spray chamber duty (kW)	790.2	795.5*
Shaft pipe losses (kW)	188.0	158.7
Spray pipe losses (kW)	165.4	
Surface ambient temperatures	23.6/28.2°C	
Surface barometric pressure	97.05 kPa	
Surface refrigeration load	550 kW	

\* Measured HPHE duty less estimated chilled water line losses.

### 4.3 Broken Hill North mine underground plant

The North mine underground refrigeration system comprises three Sullair C25 compressor sets of 1800 kW nominal capacity. The first compressor was installed and commissioned during 1981. Water was chilled in two direct expansion evaporators and then supplied in closed circuit to cooling coils. The condenser is a conventional shell and tube heat exchanger with the condenser water heat rejection into exhaust air in a single stage condenser spray circuit.

A year later the plant was expanded with a second C25 compressor set. The poor performance of the direct expansion evaporators used for the first set prompted a change to a flooded shell and tube evaporator for the second set after the initial order was placed. One of the second sets direct expansion evaporators (already purchased) was added to the two used for the first compressor set and the second was to be used to supplement the flooded shell and tube evaporator on the second compressor set.

This was not installed and consequently the second set evaporator capacity is limited. The condenser is identical to that used for the first set. At this time the closed chilled water circuit was converted to an open circuit with water supplied from a storage dam to cooling coils and a two stage spray chamber which was used to bulk cool the intake air into the mining area.

The third plant expansion was undertaken in 1985 with a third C25 compressor set installed. A large flooded shell and tube evaporator was selected for this set. The condenser was identical to that used for the first two sets. A schematic of the overall refrigeration and cooling system as it existed at the end of 1986 is given in figure 4.19.

#### 4.3.1 Base system model

An assessment of the mining plan and ventilation available showed that there was a requirement of between 6.0 and 6.5 MW of refrigeration by 1989. This was partly caused by the extremely stringent six hour job conditions prevailing in the mines of New South Wales which resulted from earlier mining practices (section 2.1.4). If the wet bulb temperature exceeds 26.75°C, the shift length must be reduced to six hours which compares unfavourably with wet bulb temperatures of the order of 30.0°C which would normally be accepted for this type of mining.

The impact of the six hour conditions was exaggerated by the actual shift times available. When travelling time, changing time and meal breaks are taken into account, a shift of eight hours actually becomes five and a half working hours. The six hour shift is applied by allowing a return to surface two hours earlier than scheduled, thus the shift length is reduced to three and a half working hours. Union

Figure 4.19 - North Broken Hill : schematic of 1987 underground refrigeration system

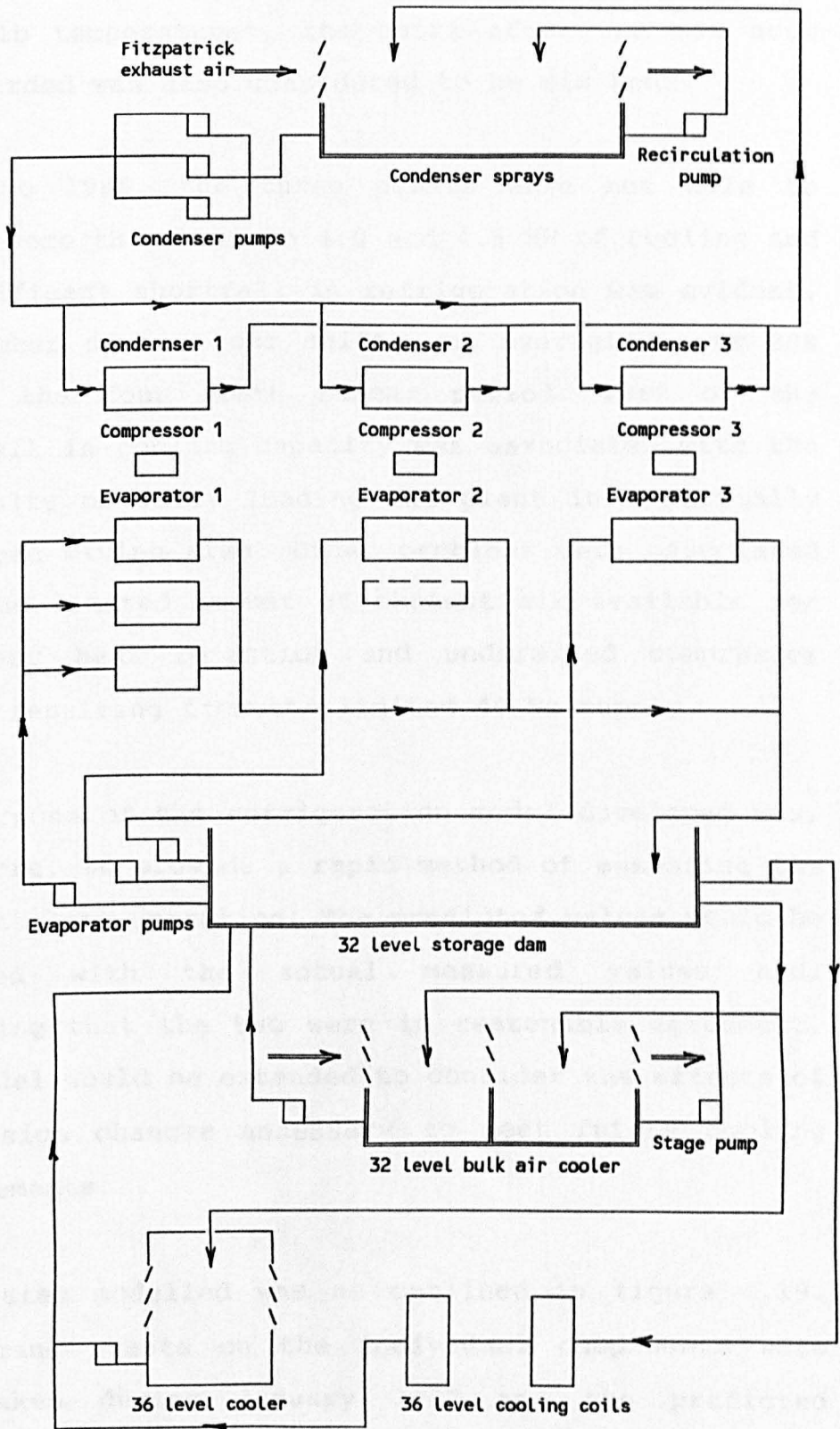



restrictive practices exacerbated this by insisting on a follow on shift where, irrespective of the actual wet bulb temperatures, the shift after the six hour was awarded was also considered to be six hour.

Prior to 1988, the three plants were not able to supply more than between 4.0 and 4.5 MW of cooling and a significant shortfall in refrigeration was evident. The number of six hour shifts was averaging over 80% during the four month summer period. Part of the shortfall in cooling capacity was associated with the difficulty of fully loading the plant in a partially developed mining area. Other problems were associated with the limited amount of exhaust air available for condenser heat rejection and undersized compressor motors resulting from the limited 40 Hz supply.

The purpose of the refrigeration model developed was, therefore, to provide a rapid method of assessing the current plant operation. The predicted values would be compared with the actual measured values and, providing that the two were in reasonable agreement, the model would be extended to consider the effects of the design changes necessary to meet future cooling requirements.

The system modelled was as outlined in figure 4.19. Performance tests on the individual components were undertaken during January 1987 and the predicted results were compared with measurements taken during

April 1987. The model follows the format outlined in section 4.1. Initially the chiller subsystems are examined to obtain compressor, condenser and evaporator balances for a given water temperature into the evaporator and a wet bulb temperature of the air used for condenser heat rejection.

Where appropriate, part load routines are used to ensure that the evaporating temperature is always above a predetermined minimum and that the individual compressor motors are not overloaded. To avoid the possibility of freezing the water tubes in the flooded chillers, a minimum evaporating temperature of 3°C was allowed. This also takes into account the refrigerant line losses between the compressor and the evaporator.

The mine cooling load was established from the cooling system arrangement and the chilled water temperatures into and out of the system. This included the effect of chilled water storage dam mixing if applicable. The total mine load was then compared to the total evaporator duty and the temperature of the water into the evaporators adjusted until the balance between the mine load and the evaporator duty was acceptable.

The results of the comparison between predicted and measured values for the system in April 1987 with compressor sets 1 and 3 operational is given in Table 4.3. The predicted total mine load of 2.82 MW compares favourably with the measured mine load of 2.73 MW. The

**Table 4.3 - Comparison of predicted and actual performance : April 1987**

	Number 1 set		Number 3 set	
	Predicted	Measured	Predicted	Measured
Evaporator duty (kW)	1115	1070	1713	1710
Evaporating temperature <sup>1</sup> (°C)	2.6	0.2	3.6	4.9
Evaporator water in (°C)	11.0	10.8	11.0	10.8
Condensing temperature <sup>1</sup> (°C)	39.1	39.4	44.2	43.7
Condenser water in (°C)	32.6	32.8	32.6	32.8
Condenser water out (°C)	34.9	35.0	36.0	36.1
	<b>32 level bulk air cooler</b>			
			Predicted	Measured
Total heat transfer (kW)			1323	1165
Water temperature in (°C)			7.3	8.7
Water temperature out (°C)			14.3	
Wet bulb temperature in (°C)			21.0	21.0
Wet bulb temperature out (°C)			11.6	12.5
	<b>33 level bulk air cooler</b>			
			Predicted	Measured
Total heat transfer (kW)			560	507
Water temperature in (°C)			7.3	8.5
Water temperature out (°C)			11.3	12.1
Wet bulb temperature in (°C)			21.0	20.7
Wet bulb temperature out (°C)			12.0	12.2
	<b>36 level cooling coils</b>			
			Predicted	Measured
Total heat transfer (kW)			525	569
Water temperature in (°C)			7.3	6.5
Water temperature out (°C)			12.1	12.0
Wet bulb temperature in (°C)			22.5 <sup>2</sup>	22.2 <sup>2</sup>
Wet bulb temperature out (°C)			18.8 <sup>2</sup>	18.2 <sup>2</sup>
1 Temperatures measured or calculated at the compressor (includes line losses)				
2 Weighted averages used for the two sets of cooling coils.				

agreement between predicted and measured values is acceptable and the model can be used to give reasonable estimates of the effect of changes to the system. The full output for this set of operating conditions is given in Table 4.4.

#### 4.3.2 Extended system model

##### Expanded mine load

The first change to be considered was the effect of expanding the mine load by commissioning additional bulk spray coolers to cool the intake air at the three Fitzpatrick cut and fill stopes on 36, 37 and 39 levels. All the cooling coils were to be removed from the system. This model would then represent the fully developed mine system planned for 1989. The results of the analysis for the limiting climatic condition are given in Table 4.5.

The maximum possible evaporator duty is 4.9 MW or 77% of the required mine cooling at the limiting climatic condition. All three sets are running on part load as a result of the motor overload restriction. The 4.9 MW evaporator duty is a maximum value based on clean heat transfer surfaces in both the evaporators and the condensers. With dirty tubes which are not untypical for this type of plant, the evaporator duty would decrease by 0.5 MW to a total of 4.4 MW or 70% of the required mine load.

The contractor involved with the installation of the three sets was more familiar with installations using ammonia as the refrigerant rather than the R22 required for this underground plant. The capacity of the refrigerant lines were more consistent with a design for ammonia and were generally undersized. This was particularly evident between the compressor and the condenser on sets 2 and 3 and between the compressor and the evaporator on set 2, all of which had excessive pressure losses.

Simulations carried out using acceptable suction and discharge line losses indicated that there was only a marginal increase in the amount of refrigeration supplied. This was, however, provided at a lower power requirement (132 kW less when the compressors are at full load) and would more than justify the cost of replacing the refrigerant pipe work.

It was concluded that with the configuration of equipment existing in 1987, the required plant duty would not be met and there would be a deterioration in working conditions within the stopping areas.

#### Open plate evaporators

The three different evaporator arrangements all had operational problems or were too small to provide the required cooling duty. On the first compressor set, the direct expansion evaporators had water on the

Table 4.4 - Predicted plant performance : April 1987

SET NUMBER 1 OPERATION

Part load operation

Evaporator duty	= 1114.89	Evaporating temperature	= 3.00
Evaporator water in	= 11.02	Evaporator water out	= 8.21
Condenser duty	= 1421.84	Condensing temperature	= 38.83
Condenser water in	= 32.64	Condenser water out	= 34.91
Compressor power	= 306.95	Suction pressure	= 539.93 ( 2.59 K)
		Discharge pressure	= 1497.03 (39.14 K)

SET NUMBER 3 OPERATION

Part load operation

Motor at full load

Evaporator duty	= 1712.70	Evaporating temperature	= 4.00
Evaporator water in	= 11.02	Evaporator water out	= 6.20
Condenser duty	= 2099.70	Condensing temperature	= 40.76
Condenser water in	= 32.64	Condenser water out	= 35.99
Compressor power	= 387.00	Suction pressure	= 556.79 ( 3.56 K)
		Discharge pressure	= 1693.11 (44.18 K)

32 LEVEL BULK COOLER PERFORMANCE

Cooler Load	= 1323.34	Air flow rate	= 40.00
		Water flow rate	= 45.00
Water temperature in	= 7.26	Water temperature out	= 14.29
Wet bulb temperature in	= 21.00	Wet bulb temperature out	= 11.58

33 LEVEL BULK COOLER PERFORMANCE

FIRST STAGE

Cooler Load	= 560.29	Air flow rate	= 17.50
		Water flow rate	= 33.00
Water temperature in	= 7.26	Water temperature out	= 11.32
Wet bulb temperature in	= 21.00	Wet bulb temperature out	= 12.00

SECOND STAGE

Cooler Load	= 408.85	Air flow rate	= 17.50
		Water flow rate	= 33.00
Water temperature in	= 11.32	Water temperature out	= 14.28
Wet bulb temperature in	= 21.00	Wet bulb temperature out	= 14.72

36 LEVEL COOLING COIL PERFORMANCE

FIRST COILS

Cooler Load	= 287.10	Air flow rate	= 17.50
		Water flow rate	= 26.00
Water temperature in	= 7.26	Water temperature out	= 9.90
Wet bulb temperature in	= 22.50	Wet bulb temperature out	= 18.46

SECOND coils

Cooler Load	= 238.06	Air flow rate	= 17.50
		Water flow rate	= 26.00
Water temperature in	= 9.90	Water temperature out	= 12.09
Wet bulb temperature in	= 22.50	Wet bulb temperature out	= 19.19

Table 4.5 - Predicted plant performance : Extended mine Load

SET NUMBER 1 OPERATION

Part load operation - Motor at full load

Evaporator duty	= 1691.47	Evaporating temperature	= 8.67
Evaporator water in	= 20.15	Evaporator water out	= 15.40
Condenser duty	= 2078.47	Condensing temperature	= 41.54
Condenser water in	= 34.96	Condenser water out	= 39.10
Compressor power	= 387.00	Suction pressure	= 635.32 ( 7.72 K)
		Discharge pressure	= 1615.21 (42.25 K)

SET NUMBER 2 OPERATION

Part load operation - Motor at full load

Evaporator duty	= 1581.86	Evaporating temperature	= 10.70
Evaporator water in	= 20.15	Evaporator water out	= 14.33
Condenser duty	= 1968.86	Condensing temperature	= 41.18
Condenser water in	= 34.96	Condenser water out	= 38.88
Compressor power	= 387.00	Suction pressure	= 670.98 ( 9.44 K)
		Discharge pressure	= 1667.49 (43.56 K)

SET NUMBER 3 OPERATION

Part load operation - Motor at full load

Evaporator duty	= 1662.60	Evaporating temperature	= 12.28
Evaporator water in	= 20.15	Evaporator water out	= 14.85
Condenser duty	= 2049.60	Condensing temperature	= 41.45
Condenser water in	= 34.96	Condenser water out	= 39.05
Compressor power	= 387.00	Suction pressure	= 724.76 (11.87 K)
		Discharge pressure	= 1713.42 (44.67 K)

32 LEVEL BULK COOLER PERFORMANCE

Cooler load	= 1879.76	Air flow rate	= 65.00	Water flow rate	= 60.00
Water temperature in	= 14.85	Water temperature out	= 22.39		
Wet bulb temperature in	= 27.00	Wet bulb temperature out	= 20.49		

33 LEVEL BULK COOLER PERFORMANCE

Cooler load	= 962.69	Air flow rate	= 35.00	Water flow rate	= 35.00
Water temperature in	= 14.85	Water temperature out	= 21.48		
Wet bulb temperature in	= 27.00	Wet bulb temperature out	= 20.82		

36 STOPE BULK COOLER PERFORMANCE

Cooler load	= 581.49	Air flow rate	= 40.00	Water flow rate	= 30.00
Water temperature in	= 14.85	Water temperature out	= 19.54		
Wet bulb temperature in	= 22.00	Wet bulb temperature out	= 18.36		

37 STOPE BULK COOLER PERFORMANCE

Cooler load	= 1334.05	Air flow rate	= 80.00	Water flow rate	= 60.00
Water temperature in	= 14.85	Water temperature out	= 22.22		
Wet bulb temperature in	= 23.00	Wet bulb temperature out	= 18.93		

39 STOPE BULK COOLER PERFORMANCE

Cooler load	= 191.73	Air flow rate	= 17.50	Water flow rate	= 25.00
Water temperature in	= 14.85	Water temperature out	= 16.74		
Wet bulb temperature in	= 20.00	Wet bulb temperature out	= 17.14		

shell side and could not be cleaned without dismantling the set and sending the evaporators to surface for tube removal and cleaning. As a result, the direct expansion evaporators were operating with very high water side fouling which limited their capacity to approximately half of their design value.

On the second compressor set, the flooded shell and tube evaporator was selected to operate with an additional direct expansion evaporator. Although installed, commissioning problems resulted in it not being available and consequently the set operates with an undersized shell and tube evaporator. On the third set, undersizing of the refrigerant take-off from the shell resulted in liquid refrigerant carry over and additional liquid receivers were necessary.

The main change proposed was therefore to replace all the evaporators with a single falling film open plate evaporator. A pumped refrigerant recirculation system would be used between the evaporator and a refrigerant accumulator vessel. The compressors are fed from the accumulator at a rate determined by the evaporation of the refrigerant.

To achieve the necessary cooling duty, either a fourth compressor and motor was required or the existing three motors replaced with larger units. With four compressors the predicted performance with the expanded mine load is given in Table 4.6. The maximum



evaporator duty is 6.25 MW or 99% of the mine load at the limiting summer condition. All four compressors would be operating at part load as a result of the motor size restriction.

Because the open plate (falling film ) evaporator is not damaged by freezing of the chilled water, the minimum evaporating temperature was set at  $-3^{\circ}\text{C}$ . The 6.25 MW evaporator duty was based on clean tubes in the condensers and a 100 plate evaporator. Space limitations in the adjacent available excavations could result in as few as 55 plates being available. This would result in the evaporator duty being limited to 5.95 MW or 92% of the required mine load.

The effect of fouling in both the condensers and the evaporator is to reduce this duty further to 5.55 MW or 88% of the required mine load. Most of this reduction was a result of the condenser fouling. The large water side surface area in the open plate evaporator minimises the effect of fouling on overall plant performance.

#### Increased motor size

Instead of installing a fourth chiller set, 500 kW motors could be installed on the existing three sets. An additional 50Hz supply from surface was being installed and the motor power restriction was no longer valid. The predicted conditions are summarised

Table 4.6 - Predicted plant performance : Open plate evaporator and four compressors

**SET OPERATION**

=====

Part load operation - Motor at full load

Evaporator duty	= 1559.88	Evaporating temperature	= 6.55
Evaporator water in	= 19.19	Evaporator water out	= 12.25
Condenser duty	= 1946.88	Condensing temperature	= 42.84
Condenser water in	= 36.40	Condenser water out	= 40.63
Compressor power	= 387.00	Suction pressure	= 604.75 ( 6.16 K)
		Discharge pressure	= 1663.16 (43.45 K)

**32 LEVEL BULK COOLER PERFORMANCE**

=====

Cooler load	= 2252.25	Air flow rate	= 65.00	Water flow rate	= 60.00
Water temperature in	= 12.25	Water temperature out	= 21.22		
Wet bulb temperature in	= 27.00	Wet bulb temperature out	= 18.99		

**33 LEVEL BULK COOLER PERFORMANCE**

=====

Cooler load	= 1155.66	Air flow rate	= 35.00	Water flow rate	= 35.00
Water temperature in	= 12.25	Water temperature out	= 20.14		
Wet bulb temperature in	= 27.00	Wet bulb temperature out	= 19.39		

**36 STOPE BULK COOLER PERFORMANCE**

=====

Cooler load	= 786.49	Air flow rate	= 40.00	Water flow rate	= 30.00
Water temperature in	= 12.25	Water temperature out	= 18.52		
Wet bulb temperature in	= 22.00	Wet bulb temperature out	= 16.96		

**37 STOPE BULK COOLER PERFORMANCE**

=====

Cooler load	= 1744.07	Air flow rate	= 80.00	Water flow rate	= 60.00
Water temperature in	= 12.25	Water temperature out	= 19.20		
Wet bulb temperature in	= 23.00	Wet bulb temperature out	= 17.55		

**39 STOPE BULK COOLER PERFORMANCE**

=====

Cooler load	= 289.95	Air flow rate	= 17.50	Water flow rate	= 25.00
Water temperature in	= 12.25	Water temperature out	= 14.98		
Wet bulb temperature in	= 20.00	Wet bulb temperature out	= 15.63		

in Table 4.7. The predicted evaporator duty, assuming clean plates and tubes is 6.3 MW or 100% of the required mine load at the limiting climatic condition. The maximum motor power required is 460 kW which is within the capability of a 500 kW motor with gear box losses. Increasing the fouling or reducing the number of plates has the same effect of reducing the evaporator duty to 5.86 MW or 93% of the mine load.

To achieve the full mine duty whilst operating with dirty condenser tubes and evaporator plates would require a 150 plate evaporator arrangement. When clean this arrangement would provide 6.55 MW or 104% of the expected mine load.

The operation of the system at other times of the year when the surface ambient conditions are cooler was also modelled to determine the most suitable operating arrangement. These are summarised in Tables 4.8 and 4.9. During the cooler parts of the summer and the mid seasonal periods, two compressor will provide 4.35 MW or 105% of the required mine cooling load. The bulk cooler water flow rates need to be reduced by reducing the number of spray nozzles in use.

For the cooler periods during the year, one compressor would provide 2.3 MW or 98% of the required mine load. The main intake air bulk air cooler would not be operated on these occasions.

## Chilled water storage

To provide greater flexibility of compressor operation, it was also proposed to alter the chilled water distribution and return system. In 1987, the cold water was supplied to, and drawn off from the north end of a 3.5 Ml water storage dam. The warm water from the bulk air coolers was returned to and drawn off from the south end of the same water storage dam. Thermal layering within the dam limited the amount of mixing during continuous normal operation.

As the surface climatic conditions change throughout the day, the mine cooling load also varies. To maintain continuous plant operation and to minimise mixing in the dam requires that the compressors should unload and operate less efficiently.

The existing 3.5 Ml dam was converted to store chilled water only. A separate smaller dam adjacent to the refrigeration plant is used to store the warm water returned from the bulk air coolers prior to cooling in the plant. This dam capacity would be supplemented with storage dams at the main bulk air coolers. The compressors could then operate intermittently depending on the actual mine cooling load and the full plant capacity.

Table 4.7 - Predicted plant performance : Open plate evaporator and three compressors

SET OPERATION

Evaporator duty	= 2098.05	Evaporating temperature	= 6.39
Evaporator water in	= 19.12	Evaporator water out	= 12.12
Condenser duty	= 2558.92	Condensing temperature	= 43.45
Condenser water in	= 36.21	Condenser water out	= 40.29
Compressor power	= 460.93	Suction pressure	= 595.70 ( 5.69 K)
		Discharge pressure	= 1708.47 (44.55 K)

32 LEVEL BULK COOLER PERFORMANCE

Cooler load	= 2269.94	Air flow rate	= 65.00	Water flow rate	= 60.00
Water temperature in	= 12.12	Water temperature out	= 21.16		
Wet bulb temperature in	= 27.00	Wet bulb temperature out	= 18.92		

33 LEVEL BULK COOLER PERFORMANCE

Cooler load	= 1164.84	Air flow rate	= 35.00	Water flow rate	= 35.00
Water temperature in	= 12.12	Water temperature out	= 20.08		
Wet bulb temperature in	= 27.00	Wet bulb temperature out	= 19.32		

36 STOPE BULK COOLER PERFORMANCE

Cooler load	= 796.25	Air flow rate	= 40.00	Water flow rate	= 30.00
Water temperature in	= 12.12	Water temperature out	= 18.47		
Wet bulb temperature in	= 22.00	Wet bulb temperature out	= 16.89		

37 STOPE BULK COOLER PERFORMANCE

Cooler load	= 1763.58	Air flow rate	= 80.00	Water flow rate	= 60.00
Water temperature in	= 12.12	Water temperature out	= 19.15		
Wet bulb temperature in	= 23.00	Wet bulb temperature out	= 17.48		

39 STOPE BULK COOLER PERFORMANCE

Cooler load	= 290.41	Air flow rate	= 17.50	Water flow rate	= 25.00
Water temperature in	= 12.12	Water temperature out	= 14.90		
Wet bulb temperature in	= 20.00	Wet bulb temperature out	= 15.55		

Table 4.8 - Predicted plant performance ; Open plate evaporator and summer operation

**TWO SETS OPERATING**

=====

**SET OPERATION**

=====

Evaporator duty	= 2186.05	Evaporating temperature	= 6.64
Evaporator water in	= 17.53	Evaporator water out	= 10.56
Condenser duty	= 2621.95	Condensing temperature	= 40.00
Condenser water in	= 32.53	Condenser water out	= 36.71
Compressor power	= 435.73	Suction pressure	= 599.27 ( 5.87 K)
		Discharge pressure	= 1573.93 (41.19 K)

**32 LEVEL BULK COOLER PERFORMANCE**

=====

Cooler load	= 1829.01	Air flow rate	= 65.00	Water flow rate	= 60.00
Water temperature in	= 10.56	Water temperature out	= 17.85		
Wet bulb temperature in	= 23.00	Wet bulb temperature out	= 15.70		

**33 LEVEL BULK COOLER PERFORMANCE**

=====

Cooler load	= 1155.66	Air flow rate	= 35.00	Water flow rate	= 17.50
Water temperature in	= 10.56	Water temperature out	= 18.78		
Wet bulb temperature in	= 23.00	Wet bulb temperature out	= 18.75		

**36 STOPE BULK COOLER PERFORMANCE**

=====

Cooler load	= 830.60	Air flow rate	= 40.00	Water flow rate	= 30.00
Water temperature in	= 10.56	Water temperature out	= 17.18		
Wet bulb temperature in	= 21.00	Wet bulb temperature out	= 15.50		

**37 STOPE BULK COOLER PERFORMANCE**

=====

Cooler load	= 1122.29	Air flow rate	= 80.00	Water flow rate	= 30.00
Water temperature in	= 10.56	Water temperature out	= 19.50		
Wet bulb temperature in	= 22.00	Wet bulb temperature out	= 18.51		

**39 STOPE BULK COOLER PERFORMANCE**

=====

Cooler load	=	Air flow rate	=	Water flow rate	=
Water temperature in	=	Water temperature out	=		
Wet bulb temperature in	=	Wet bulb temperature out	=		

Table 4.9 - Predicted plant performance : Open plate evaporator and mid seasonal operation

ONE SET OPERATING

SET OPERATION

Evaporator duty	= 2318.93	Evaporating temperature	= 8.49
Evaporator water in	= 16.23	Evaporator water out	= 10.69
Condenser duty	= 2760.15	Condensing temperature	= 39.93
Condenser water in	= 30.63	Condenser water out	= 36.62
Compressor power	= 441.75	Suction pressure	= 633.55 ( 7.63 K)
		Discharge pressure	= 1577.25 (41.28 K)

32 LEVEL BULK COOLER PERFORMANCE

Cooler load =	Air flow rate =	Water flow rate =
Water temperature in =	Water temperature out =	
Wet bulb temperature in =	Wet bulb temperature out =	

33 LEVEL BULK COOLER PERFORMANCE

Cooler load = 392.59	Air flow rate = 35.00	Water flow rate = 17.50
Water temperature in = 10.69	Water temperature out = 16.05	
Wet bulb temperature in = 19.00	Wet bulb temperature out = 15.88	

36 STOPE BULK COOLER PERFORMANCE

Cooler load = 821.25	Air flow rate = 40.00	Water flow rate = 30.00
Water temperature in = 10.69	Water temperature out = 17.23	
Wet bulb temperature in = 21.00	Wet bulb temperature out = 15.56	

37 STOPE BULK COOLER PERFORMANCE

Cooler load = 1110.48	Air flow rate = 80.00	Water flow rate = 30.00
Water temperature in = 10.69	Water temperature out = 19.53	
Wet bulb temperature in = 22.00	Wet bulb temperature out = 18.55	

39 STOPE BULK COOLER PERFORMANCE

Cooler load =	Air flow rate =	Water flow rate =
Water temperature in =	Water temperature out =	
Wet bulb temperature in =	Wet bulb temperature out =	

#### **4.4 Mount Isa surface chilled water plant**

The mining of the deeper 3000 ore bodies at Mount Isa will require up to 35 MW of refrigeration by the year 2000 depending on the mining schedule and the final production rate. It was evident that the existing R63 plant described in section 4.2 could only supply sufficient cooling for the preliminary development work in the new mining area. In 1983 the overall mine refrigeration strategy was reviewed and a three stage programme was defined.

The existing R63 system using closed circuit chilled water from surface to high pressure heat exchangers underground was not suitable for major expansion and had a low coefficient of performance mainly as a result of the increased pump power necessary in the primary and secondary chilled water circuits. The existing high pressure 250 mm diameter pipes between surface and 20 level could, however, be used to supply up to 200 l/s of chilled water to underground in open circuit with an energy recovery system.

A total of 22 MW of cooling could be provided if necessary using this system. The overall coefficient of performance of a surface chilled water plant supplying underground cooling appliances and for use as service water was estimated to be 3.5.

The surface bulk cooling of air which was to be used



to ventilate the mining areas had a higher coefficient of performance of 5.0 (including the poorer positional efficiency). The deeper mining areas have the exclusive use of the U62 intake shaft after 1992 for approximately 60% of the total intake air requirement, the balance being available from shafts which are also ventilating the shallower mining areas. Bulk cooling of the air at U62 shaft was therefore limited by the air quantity to approximately 12 MW.

The three stages were therefore to install an 11 MW chilled water plant by 1989, to install a 12 MW bulk air cooler in 1993 and to increase the size of the chilled water plant to a maximum of 22 MW in 1999.

#### 4.4.1 Refrigeration plant design

The original plant design and tendering was undertaken in 1984. Although the plant was not required for the deep ore bodies until 1987, it was proposed to install the plant ahead of schedule. This would have eliminated the need to expand the R63 plant and the excess capacity from the new plant could have been used in the deeper sections of the 1100 ore bodies. Low commodity prices resulted in different capital expenditure priorities within the Mount Isa Holdings group and the new plant was deferred.

In 1987 the decision to proceed was made and, as a result of the short lead time available, the order was

placed with the most suitable supplier from the 1984 tender review. The full original design was, however, not adhered to and two major changes were made which result in a less cost effective plant with respect to both power costs and maintenance.

The first change concerns the condensers which were originally selected as evaporative condenser units. This was changed to closed plate heat exchangers and cross flow cooling towers. To maintain the same initial cost, the closed plate heat exchangers and the cross flow towers were undersized and resulted in the estimated plant operating power costs to be A\$ 95 000 per year or 5.1% greater.

The second change made was to use closed plate heat exchangers for the evaporator instead of open plates. The initial cost of the closed plate heat exchangers was 30% less than the cost of the open plates (less than 2% of the overall plant cost). The advantage of open plates for an underground chilled water system is that the effects of poorer quality water and fouling of the heat exchange surfaces is less pronounced and can easily be controlled.

When the deeper mining zone is in production it is expected that the water quality will worsen as a result of tailing fill decant water contamination. To control the effects of sedimentation in the closed plate heat exchanger, a back flushing system was

installed. At the end of a run cycle, the water flow through the heat exchanger is reversed and any particulate that has settled should be flushed out. A water treatment system was installed to control the water quality and to minimise fouling.

The plant comprises two chiller sets using Howden 321 screw compressors, two closed plate evaporators containing 93 cassettes, two closed plate condensers with 106 cassettes and two five cell cross flow cooling towers for condenser heat rejection. A separate pre-cooling tower is used to cool the water returned to surface from underground prior to being supplied to the chiller sets.

Associated with the chiller sets and pre-cooling tower are two 1.5 Ml and one 2.25 Ml water storage dams for hot return water, intermediate pre-cooling tower cooled water and chilled water storage respectively. Chilled water is supplied to and returned from the mine through the two 250 mm high pressure water pipe lines. An energy recovery pelton wheel driving an asynchronous generator minimises the energy losses in the chilled water circuit.

Two 1.5 Ml hot water storage dams and one 1.5 Ml chilled water storage dam is located on 20 level which is 1010 m below surface. Chilled water is distributed to the bulk air coolers using a cascade dam system located in the central ramp area between the two main

ore bodies. Chilled water is also used as service water below 20 level and all return water is pumped first to intermediate dams in the central ramp area and then to the main dams on 20 level.

As indicated in section 4.2, the high pressure shaft pipe insulation was in poor condition. The insulation on the cold water supply pipe was completely replaced using 38 mm thick foamed glass with a stainless steel shroud for mechanical protection. The return pipe insulation was stripped off and was not replaced. Any heat gains from the intake air in the shaft being recovered in the pre-cooling tower.

#### 4.4.2 Control strategy

During the design stage, a model of the refrigeration system was developed in order to evaluate the implications of different control strategies. The main components of the overall system are illustrated in figure 4.20. The control strategy evolved based on the following three criteria:-

- to minimise the chilled water supply temperature,
- to maximise the return water temperature, and
- to minimise energy losses and input power.

The chilled water supply temperature was set at 1°C which was felt to be the lowest practical limit when using closed plate heat exchangers. For each 1°C

increase in chilled water supply temperature, the operating power costs were 1.7% (A\$ 31 000) higher. The increase in input power resulting from higher chilled water flow rates of 2.7% per 1°C was offset by a 1.0% per 1°C refrigeration plant power saving as a result of the increase in evaporating temperature.

The return water temperature was to be maximised to reduce both the recirculating water quantity and to obtain the maximum benefit from the pre-cooling tower. For each 1°C decrease in the return water temperature, the operating power costs were 5.2% higher (2.7% in additional pumping costs and 2.5% in additional refrigeration plant power).

Energy losses were to be minimised by using energy recovery systems where possible and by the judicious selection of equipment. Operating the plant as a batch rather than a continuous process had a marginally lower operating power cost of between 2.5% and 4.0% lower and provided maintenance time without disrupting the supply of chilled water to the mine.

The chiller sets

The control strategy adopted for the chiller sets is illustrated in figure 4.21. The storage dam sizes were based on providing a minimum storage of four hours (for maintenance) and a minimum compressor run time of two hours. The initial mine chilled water demand was

Figure 4.20 - Mount Isa K61 refrigeration system : overall control strategy

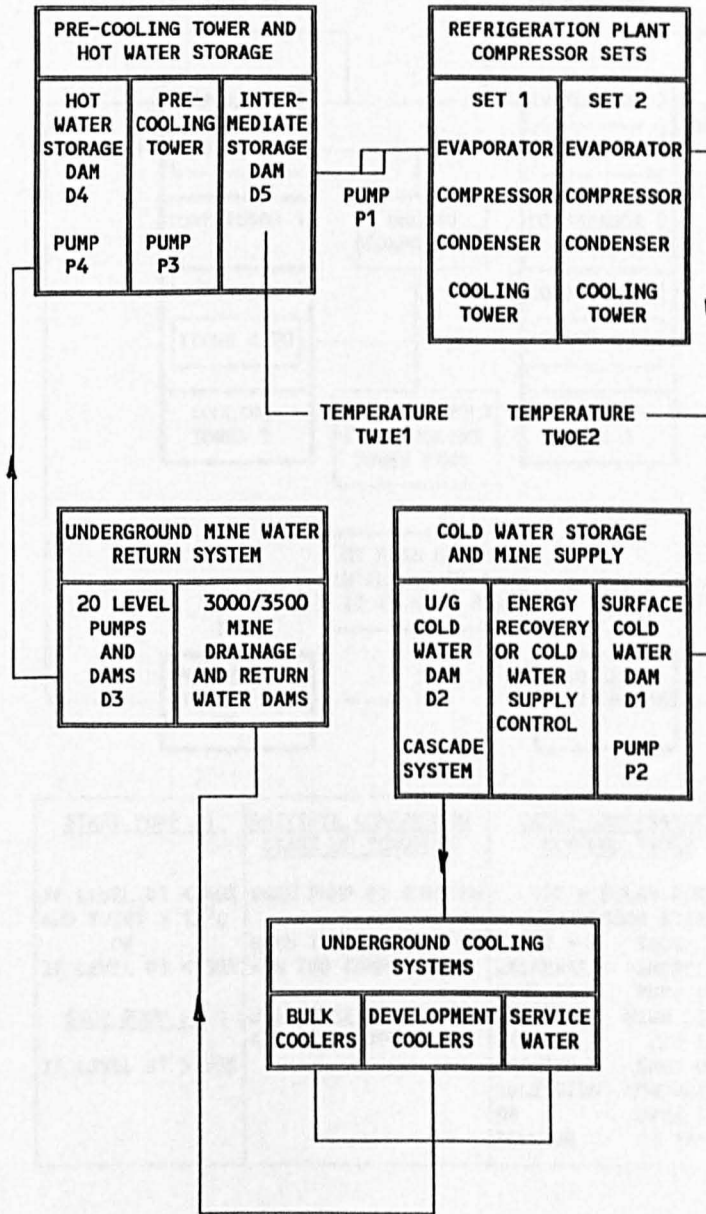
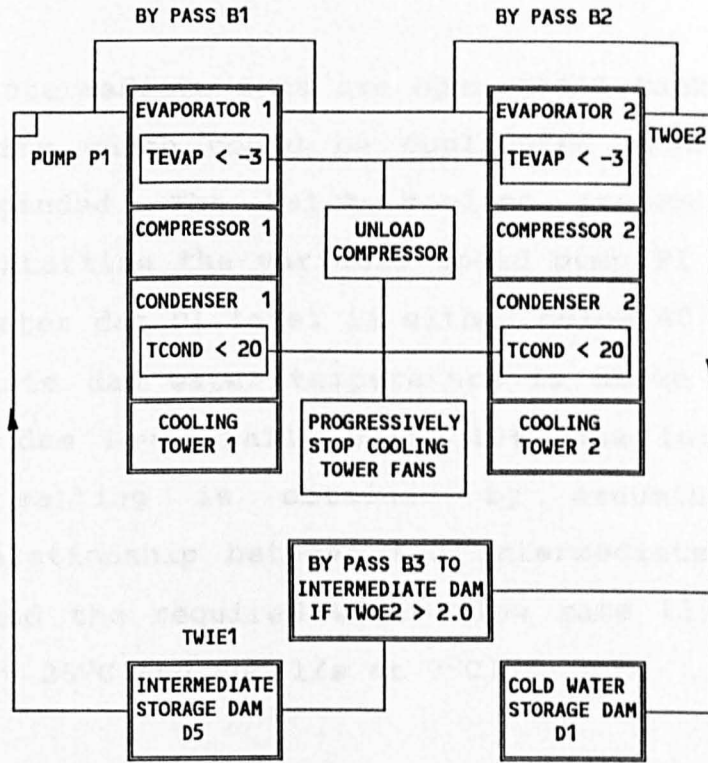

Figure 4.21 - Mount Isa K61 refrigeration system : chiller set control strategy



<u>START PUMP P1</u>	<u>INITIATE COMPRESSOR START UP SEQUENCE</u>	<u>WATER TEMPERATURE CONTROL TWOE2</u>
IF LEVEL D1 < 40% AND TWIE1 > 12°C OR IF LEVEL D1 < 10%	WHEN PUMP P1 RUNNING	150 s DELAY FOR COMPRESSOR START
	WHEN TWIE1 > 13.5°C	TWOE2 > 1    TWOE2 < 1
	RUN TWO COMPRESSORS	DECREASE    INCREASE
<u>STOP PUMP P1</u>	WHEN TWIE1 < 13.5°C	PUMP P1    PUMP P1
IF LEVEL D1 > 95%	RUN ONE COMPRESSOR	LOW LIMIT    HIGH LIMIT
		100L/s    220 L/s
		WARNING    SHUT DOWN
		SELECTION    COMPRESSOR
		OR    OPEN SET
		FOULING    BY PASS

between 100 l/s during summer and 60 l/s in winter. The chilled water dam was constructed with 200 mm thick concrete walls and an insulated cover, had a capacity of 2.25 Ml and was therefore suitable for a chilled water plant up to 16 MW in capacity.

The hot and intermediate dams are open steel tanks of 1.5 ML capacity which could be duplicated when the plant is expanded. The batch cooling process is initiated by starting the variable speed pump P1 when the chilled water dam D1 level is either below 40% and the intermediate dam water temperature is above 12°C or when this dam level falls below 10%. The initial pump speed setting is obtained by assuming a polynomial relationship between the intermediate dam temperature and the required water flow rate (limits are 110 l/s at 26°C and 200 l/s at 7°C).

The operating mode for the chiller sets is pre-set and a change requires an operator input prior to the batch run. The valve settings determine the operating mode which could be two compressors running either in series or in parallel, or either of the two compressors operating singly, or back flushing of the evaporators. When the intermediate dam water temperature is above 13.5°C, two compressors are required and they are normally run in series mode.

When the variable speed pump P1 initially starts up, by-pass 4 is open and the water recirculates back to



the intermediate dam. The lead compressor start sequence is initiated 150 s after pump P1 starts and the load maintained at a minimum. After an additional 180 s, the lag compressor (if two compressors are required) start sequence is initiated and the load is increased to 20%. When this is reached approximately 10 minutes after pump P1 start up, the lead compressor is increased to full load. When this is achieved after approximately 7.5 minutes, the lag compressor load is also increased to full load.

When both compressors are running at full load, the variable speed pump flow rate is adjusted to obtain the 1°C water off temperature when the by-pass valve is closed and chilled water is supplied directly to the cold water storage dam.

The start up time taken to achieve stable conditions has slowly been reducing and is currently 30 minutes. The problem of reducing this to a more acceptable value of 10 minutes is associated with the operating stability of the variable speed pump motor if the compressors are loaded too quickly. When the plant is expanded, a separate electrical supply should allow the design start up time to be achieved.

The compressor PLC provided by the supplier initiated the start up of the condenser pumps and cooling tower fans. This control also allowed the compressors to unload if the evaporating temperature dropped below

-3.0°C in order to avoid freezing in the evaporator. The cooling tower fans could be progressively stopped to ensure that the condensing temperature remained above 20°C and thus avoid problems with the lubricating oil viscosity.

#### Chilled water supply system

The chilled water control system is illustrated in figure 4.22 and comprises of a batch supply at 110 l/s from the surface cold water storage dam through the high pressure supply pipe and pelton wheel energy recovery equipment to the main 1.5 Ml underground chilled water storage dam. The pelton wheel is directly coupled to an asynchronous generator feeding the mine electrical supply and, for the stage 1 duty, has a single nozzle. Both the pelton wheel and the generator are suitable for the final duty which can be achieved by installing a second nozzle and increasing the batch chilled water flow rate to 200 l/s.

The three pipe cascade dam system is used to distribute the chilled water to the mining areas. Since these are accessed by a haulage truck decline, the pipes and 0.1 Ml capacity dams are located in and adjacent to 3 m diameter raise bore holes positioned between the decline loops and connected to the decline at approximately 60 m vertical intervals. Control of the chilled water supply is achieved by using valves which are operated by dam level limit switches.

## Mine load

The system was originally designed to use three stage horizontal spray chambers for bulk cooling the air supplied to an active mining area and mesh coolers for development headings. As indicated in section 3.5, packaged counter flow cooling towers are now used for both applications. This prompted a change in the control strategy. With the horizontal spray chambers, capacity control was obtained in discrete steps by reducing the water quantity and the number of stages.

Each stage had two supply water pumps, the first supplying the two pipes adjacent to the side walls with nozzles at standard spacing and the second supplying a central pipe with nozzles at half spacing. When the spray chamber capacity was to be reduced, the second pump supplying the central pipe was switched off. This reduced the supply of chilled water to 50% whilst maintaining the water coverage i.e. potential air channelling was minimised.

With the packaged counter flow units, this was not practical and recirculation is allowed between the return and the supply water pipes. The flow through a recirculation loop located after the return water pump, is controlled by the discharge air temperature. A typical arrangement using 9.5 l/s of chilled water has a maximum duty of 850 kW during the summer with no water recirculation. By controlling the outlet air

Figure 4.22 - Mount Isa K61 refrigeration system : chilled water supply control

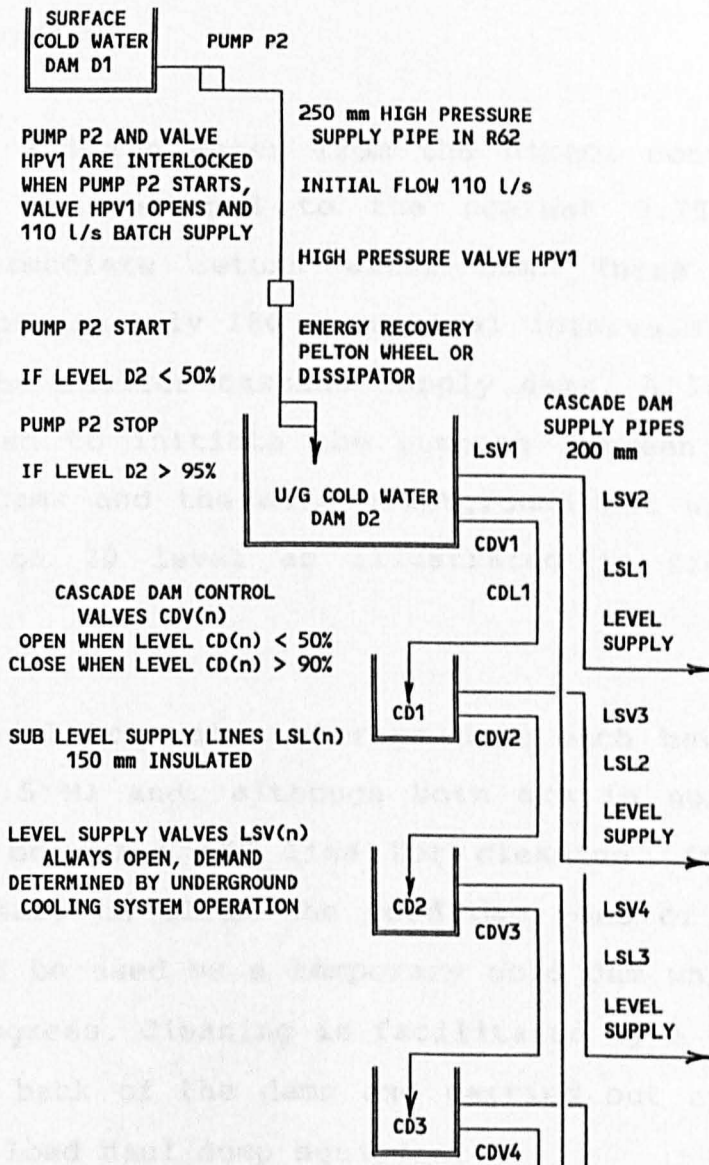

temperature at between 15 and 16°C, the recirculation rate increases to 25% (600 kW cooling duty) for mid seasonal conditions and 60% (450 kW cooling duty) for winter conditions.

#### Return water system

Service water and the water from the direct contact spray coolers is returned to the nearest 0.75 Ml capacity intermediate return water dam. These are located at approximately 180 m vertical intervals and adjacent to the smaller cascade supply dams. A level control is used to initiate the pumping between the intermediate dams and the main underground hot water storage dams on 20 level as illustrated in figure 4.23.

The two 20 level hot water storage dams each have a capacity of 1.5 Ml and, although both are in normal use, one can be taken off line for cleaning. If it becomes necessary to clean the cold dam, one of the hot dams could be used as a temporary cold dam whilst this is in progress. Cleaning is facilitated by a ramp access to the back of the dams and carried out using standard mine load haul dump equipment.

The return water is pumped from the mine to the main surface hot water storage dam using a high lift pump at a rate of 120 l/s. This return water is pre-cooled in a counter flow packed tower prior to being stored

in the intermediate storage dam. Control is by dam level switches and is designed to limit the number of pump motor starts to a maximum of three per day.

#### 4.4.3 Commissioning tests

The refrigeration plant was commissioned in December 1989 before the mine water supply system was completed and the plant could be fully loaded using the actual mine load. Short run tests lasting between two and six hours were possible with the transfer of water between the hot and cold dams. At the end of each test run, the chilled water was run off to the drains and make up water used to provide the new hot water supply.

Longer run tests were achieved by only rejecting the heat of compression in the condenser towers. The chilled water from the evaporator is supplied to the cold dam. For the long run tests, the water from the cold dam, instead of being supplied to the mine is split, a fraction (R) being supplied to the cooling tower sump and the balance being returned to the hot dam as illustrated in figure 4.24.

The water entering the condenser is therefore a mixture of the water leaving the condenser cooling tower and that leaving the evaporator. The water leaving the condenser is also split. Part (equivalent in flow rate to R) is supplied to the hot dam and mixes with the balance of the water supplied from the

**Figure 4.23 - Mount Isa K61 refrigeration system : return water control**

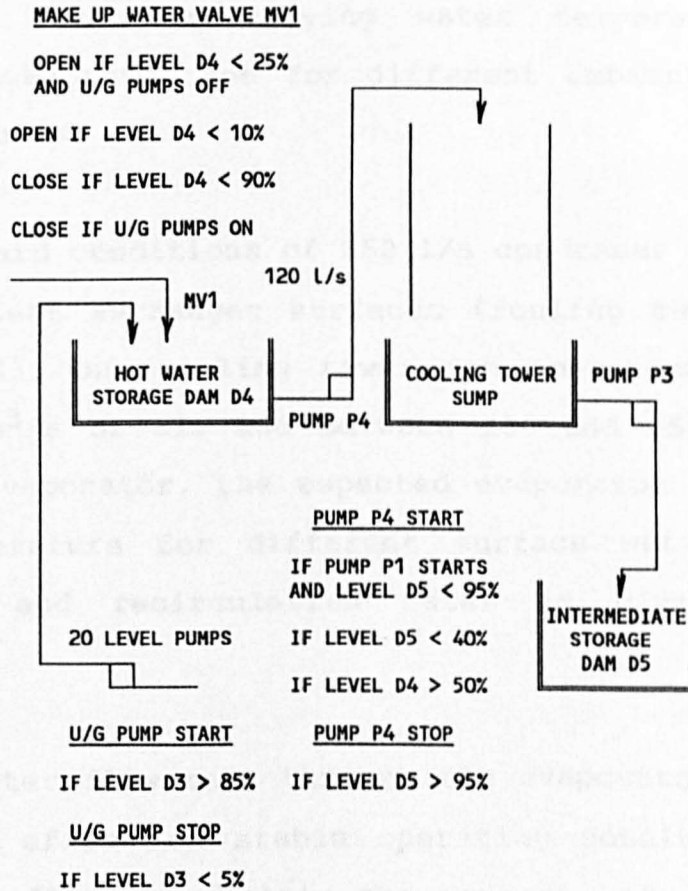

cold dam. The balance of the condenser water is supplied equally to each cell in the cooling tower where only one of the five cell fans is running.

The simulation programme was adjusted to allow for this recirculation and used to determine the required recirculation rate for varying water temperatures leaving the evaporator and for different ambient wet bulb temperatures.

For the standard conditions of 250 l/s condenser water flow, clean heat exchanger surfaces (fouling factors of  $7.5 \text{ kW/m}^2\text{K}$ ), one cooling tower fan operating and handling  $55 \text{ m}^3/\text{s}$  of air and between 100 and 150 l/s through the evaporator, the expected evaporator water leaving temperature for different surface wet bulb temperatures and recirculation rates is given in figure 4.25.

The actual water flow rate through the evaporator has a very small effect on stable operating conditions, the major influences being the amount of water recirculated and the ambient wet bulb temperature. Over relatively long periods of time (several days), unless there is a major climatic change, the variation in wet bulb temperature is normally between 3 and  $4^\circ\text{C}$ . The required recirculation flow rate could therefore be selected according to the expected wet bulb temperatures and whether the high or low temperature module (lead or lag compressor) is being tested.



As an example, consider a 09h00 wet bulb temperature of 18°C. This is typically the average temperature for the 24 hour period and the expected range in wet bulb temperatures for stable climatic conditions would be 16 to 20°C. If the high temperature module (the lead compressor in a series configuration) was to be tested, a recirculation rate of about 100 l/s would be required. If the low temperature module (the lag compressor in a series configuration) was to be tested, the recirculation rate would be 50 l/s.

The analysis of the data available from the commissioning tests concentrated on the performance of the compressors and the plate heat exchangers. A summary of the results from four of the long run tests is given in table 4.10. The results cover a one hour period starting at the time given in the table and are the average of readings taken from the monitoring system at ten minute intervals. These are obtained from the historical time trends and are instantaneous readings and not period averages.

The calculated evaporator fouling factors of between 7.5 and 10 kW/m<sup>2</sup>K were typical for clean plates. The value of 16.8 kW/m<sup>2</sup>K obtained for the 16/12/89 test was probably a result of the inaccuracies involved in averaging the instantaneous compressor discharge pressures obtained from the time trends. The condenser fouling factors were moderately dirty for a new installation at between 5 and 6 kW/m<sup>2</sup>K and, although

Figure 4.24 - Mount Isa K61 plant : arrangement for commissioning tests

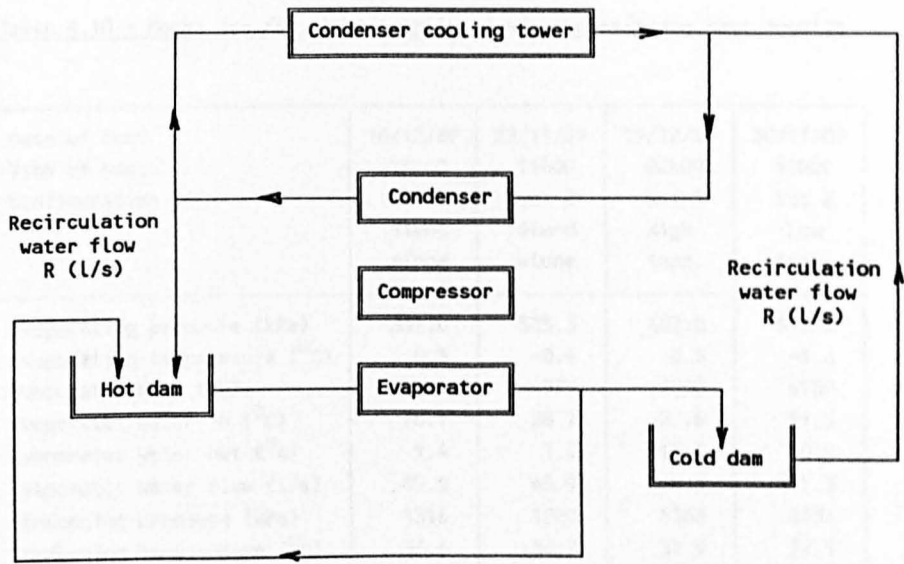

Figure 4.25 - Mount Isa K61 plant : recirculation water flow rates

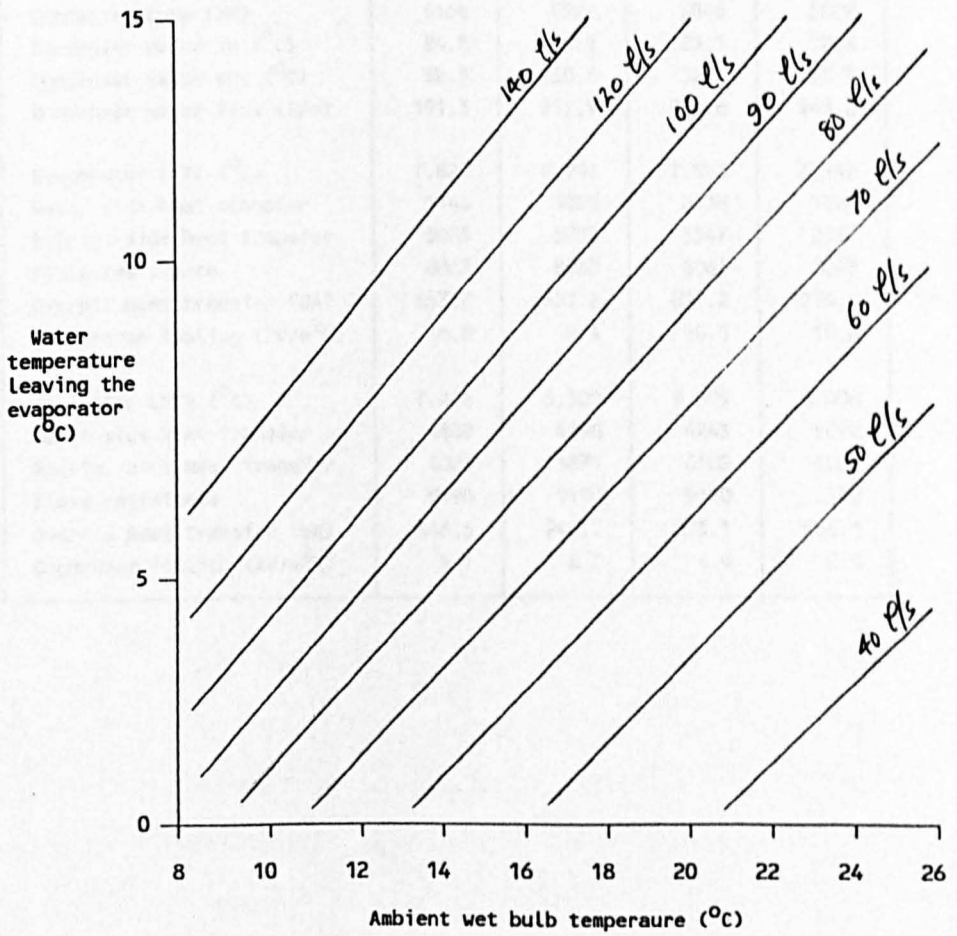

Table 4.10 - Mount Isa K61 plant : Analysis of commissioning test results

Date of test	16/12/89	29/11/89	15/12/89	30/11/89
Time of test	18h00	11h00	02h00	19h00
Configuration	Set 1 Stand alone	Set 2 Stand alone	Set 1 High temp.	Set 2 Low temp.
Evaporating pressure (kPa)	337.0	323.3	482.0	310.0
Evaporating temperature (°C)	0.3	-0.4	8.3	-1.4
Evaporator duty (kW)	5145	4975	6800	4760
Evaporator water in (°C)	26.1	28.1	25.5	11.5
Evaporator water out (°C)	1.4	1.0	11.1	0.9
Evaporator water flow (l/s)	49.8	43.9	112.8	107.3
Condensing pressure (kPa)	1316	1220	1368	1334
Condensing temperature (°C)	36.6	34.2	37.9	37.1
Adiabatic head (kJ/kg)	167.1	162.4	129.7	179.9
Inlet volume (m <sup>3</sup> /s)	1.342	1.344	1.354	1.337
Ideal power/cooling ratio	0.153	0.148	0.119	0.166
Compressor efficiency	77.2	77.4	77.4	76.0
Compressor power (kW)	1021	952	1046	1042
Condenser duty (kW)	6166	5927	7846	5802
Condenser water in (°C)	24.8	24.1	23.1	27.8
Condenser water out (°C)	32.5	30.6	32.4	33.5
Condenser water flow (l/s)	191.3	217.9	201.6	243.2
Evaporator LMTD (°C)	7.829	8.993	7.933	6.147
Water side heat transfer	1146	1050	2338	1926
Refrig. side heat transfer	3085	3033	3547	2967
Plate resistance	8063	8063	8063	8063
Overall heat transfer (UA)	657.2	553.2	857.2	774.4
Evaporator fouling (kW/m <sup>2</sup> K)	16.8	8.4	10.1	10.8
Condenser LMTD (°C)	7.284	6.301	9.395	6.006
Water side heat transfer	4108	4496	4243	5082
Refrig. side heat transfer	4021	3875	4102	4052
Plate resistance	9190	9190	9190	9190
Overall heat transfer (UA)	846.5	940.7	835.1	966.1
Condenser fouling (kW/m <sup>2</sup> K)	5.1	6.2	4.9	6.1

of concern, were not unexpected. The condenser water treatment system was not functioning correctly and biological fouling was evident.

#### 4.4.4 System performance

##### Condenser cooling towers

During the commissioning tests it was noted that the condenser cross flow towers were not performing as expected with factors of merit significantly lower than expected (between 0.44 and 0.57 instead of 0.61). The results of two series of full tests undertaken on the towers are given in Table 4.11. During each test the air quantity was measured at each cell discharge using the average of four anemometer traverses and the leaving wet bulb temperature was the average of twelve readings using calibrated thermometers.

The inlet wet bulb temperatures were obtained by averaging six readings at the inlet to each of the tower cells and compared to the five minute averages obtained from the meteorological station. During the tests it was apparent that there was recirculation between the fan discharge from the tower and the inlet to the tower. The extent of the recirculation depended on the direction and the strength of the wind during the tests. The values given in brackets in Table 4.11 are factors of merit based on the ambient wet bulb temperature.

Water flow rates and temperatures were measured with an ultra sonic flow meter and calibrated mercury in glass thermometers. The expected cooling tower duties were obtained from the evaporating and condensing pressures and the compressor performance curves. These are compared to the actual measured water and air side heat transfer rates in Table 4.12. The agreement between measured and predicted values was satisfactory and confirmed the method of analysis.

When the actual inlet air temperatures are used the factor of merit for the towers is within normal measurement tolerances of the rated value. The total air quantity drawn through the towers by the fans is now only 71% of the rated amount. This, coupled with the recirculation increases the plant operating power costs by 2.8%. In addition to increasing the air quantity handled by the fans it is planned to install 2 m high discharge cones which should almost eliminate the recirculation problem.

#### Chiller set performance

Since the plant was commissioned, five complete sets of comparative readings have been taken to confirm both the values obtained from the monitoring system and the use of the historical trend plots to assess plant performance. Water temperatures were checked with calibrated mercury in glass thermometers and, in general, the readings were within 0.2°C with the

Table 4.11 - Mount Isa K61 plant : Analysis of condenser tower results

Date of test	November 1990		January 1992	
	Lead	Lag	Lead	Lag
Compressor				
Water flow rate $m_w$	264.2	248.8	258.0	270.3
Air mass flow rate $m_a$	232.8	251.6	204.8	210.6
Air wet bulb in $t_{wbi}$	19.7	20.0	22.8	22.9
Air dry bulb in $t_{dbi}$	36.5	36.5	36.2	35.2
Water in $t_{wit}$	30.6	28.6	34.2	31.0
Water out $t_{wot}$	24.3	23.3	27.3	26.4
Air sigma in $S_{ai}$	56.11	57.10	67.83	68.21
Water sigma in $S_{wi}$	101.06	91.20	122.94	104.63
Water efficiency $n_w$	0.5780	0.6163	0.6053	0.5679
Capacity ratio R	1.1515	1.0438	1.0906	1.1946
Factor $N^*$	-3.020	-4.384	-4.551	-2.990
Factor of merit F	0.615 (0.504)	0.627 (0.486)	0.629 (0.581)	0.615 (0.573)

Table 4.12 - Mount Isa K61 plant : Condenser tower heat balance

Date of test	November 1990		January 1992	
	Lead	Lag	Lead	Lag
Compressor				
Evaporating pressure	404	294	473	284
Condensing pressure	1259	1143	1418	1274
Evaporating temperature $t_e$	4.22	-2.45	7.90	-3.08
Condensing temperature $t_c$	35.17	32.09	39.17	35.63
Adiabatic head h	139.3	162.7	137.4	183.0
Inlet volume/kW $v \times 10^6$	226.1	285.9	202.8	297.5
Ideal power/cooling ratio I	0.1270	0.1473	0.1267	0.1683
Inlet flow rate V ( $m^3/s$ )	1.3507	1.3431	1.3514	1.3364
Evaporator duty (kW)	5975	4697	6663	4492
Ideal power (kW)	759	692	844	756
Fractional efficiency	0.7776	0.7735	0.7770	0.7562
Compressor power (kW)	976	894	1086	1000
Compressor load factor	100%	100%	97%	99%
Condenser tower duty (kW)	6951	5591	7516	5437
Water side (kW)	6966	5519	7450	5204
Air side (kW)	7413	5869	7607	5217

exception of the water temperature leaving the lag compressor and entering the cold dam. This has consistently been in error by 0.5°C and appears to be a water stratification and probe location problem rather than an instrument error.

The results of the five sets of readings and the output from the predictive method for the relevant conditions are given in Tables 4.13 to 4.17 and are typical of the plant operation. In July 1990 (Table 4.13) both the evaporator and condenser plates were operating as "moderately dirty". In November 1990 (Tables 4.14, 4.15 and 4.16) both the evaporator plate heat exchangers and the number 1 condenser had just been chemically cleaned.

Water treatment and back flushing are unable to maintain the fouling at acceptable values and the January 1992 values (Table 4.17) are typical of the current operating conditions. The combined effects of the fouling and cooling tower recirculation are to increase the current operating power costs by 9.4%. As an interim measure, the refrigeration plant simulation is used to determine when chemical cleaning of the heat exchangers is necessary and to quantify the benefits of back flushing.

When the plant is expanded in 1999, consideration will be given to replacing the heat exchangers with more suitable equipment. The expected reduction in

operating costs is between 15 and 25% depending on the system selected and the water treatment required.

#### Pre-cooling tower and mine cooling appliances

Tests on the performance of the pre-cooling tower resulted in measured factors of merit of 0.70, 0.82 and 0.79. For the first two tests, the main problem was associated with low return water temperatures from underground which resulted in relatively low heat transfer rates in the pre-cooling tower. A 0.1°C error in measuring the air and water temperatures would change the calculated factor of merit by 0.08.

The performance and selection of the mine cooling appliances has been detailed in section 3.5. Currently a monitoring system is being installed which will report back to the same system as the surface plant. By controlling the recirculation rates at the cooling appliances it is expected that the highest return water temperature consistent with meeting the design working place thermal environmental criteria will be achieved.



Table 4.13 - Mount Isa K61 plant : Chiller set performance July 1990

RESULTS OF MEASUREMENTS		
	First stage	Second stage
Evaporating temperature (°C)	3.6	-2.9
Evaporator water in (°C)	17.4	8.5
Evaporator water out (°C)	8.5	1.3
Evaporator water flow rate (l/s)	152.5	152.5
Condensing temperature (°C)	34.2	33.4
Condenser water in (°C)	23.3	24.1
Condenser water out (°C)	29.9	29.4
Condenser water flow rate (l/s)	245.1	247.1

RESULTS OF SIMULATION		
Two compressors in series - ambient wet bulb temperature = 17.1 *****		
First stage operation - 97% load		
Evaporator duty = 5700.26	Evaporating temperature = 3.65	
Condenser duty = 6632.49	Condensing temperature = 34.13	
Evaporator water temperatures - in 17.40 - out 8.46		
Condenser water temperatures - in 23.35 - out 29.82		
Evaporator water flow rate = 152.26		
Second stage operation - 100% load		
Evaporator duty = 4559.02	Evaporating temperature = -2.99	
Condenser duty = 5498.08	Condensing temperature = 33.61	
Evaporator water temperatures - in 8.46 - out 1.30		
Condenser water temperatures - in 24.08 - out 29.38		
Evaporator water flow rate = 152.26		
Power requirements		
Compressor input power	- No 1 = 932.22	No 2 = 938.75
Evaporator pump power	- No 1 = 24.68	No 2 = 24.68
Condenser fan and pump power	- No 1 = 103.66	No 2 = 100.30
Total input power	= 2124.29	
Total evaporator duty	= 10259.28	
Overall power to cooling ratio	= 4.8295	
Evaporator details		
No 1 Number of cassettes = 93	Fouling factor = 4.8	
No 2 Number of cassettes = 93	Fouling factor = 4.6	
Condenser details		
No 1 Number of cassettes = 106	Fouling factor = 6.0	
No 2 Number of cassettes = 106	Fouling factor = 4.8	
No 1 water flow rate = 245.0	No 2 water flow rate = 247.0	
Cooling tower details - factors of merit No 1 = 0.54 No 2 = 0.48		
No 1 - Number of cells = 5	Airflow per cell = 41.2	
No 2 - Number of cells = 5	Airflow per cell = 38.0	

Table 4.14 - Mount Isa K61 plant : Chiller set performance November 21st 1990

RESULTS OF MEASUREMENTS		
	First stage	Second stage
Evaporating temperature (°C)	4.7	-2.4
Evaporator water in (°C)	18.2	8.7
Evaporator water out (°C)	8.7	1.4
Evaporator water flow rate (L/s)	152.4	152.4
Condensing temperature (°C)	35.1	32.6
Condenser water in (°C)	24.6	22.9
Condenser water out (°C)	31.0	28.6
Condenser water flow rate (L/s)	264.2	248.8

RESULTS OF SIMULATION		
Two compressors in series - ambient wet bulb temperature = 17.6 *****		
First stage operation - 100 % load		
Evaporator duty = 6064.04	Evaporating temperature = 4.74	
Condenser duty = 7033.50	Condensing temperature = 35.04	
Evaporator water temperatures - in 18.20 - out 8.71		
Condenser water temperatures - in 24.62 - out 30.99		
Evaporator water flow rate = 152.63		
Second stage operation - 100% load		
Evaporator duty = 4667.46	Evaporating temperature = -2.42	
Condenser duty = 5573.72	Condensing temperature = 32.54	
Evaporator water temperatures - in 8.71 - out 1.40		
Condenser water temperatures - in 22.94 - out 28.27		
Evaporator water flow rate = 152.63		
Power requirements		
Compressor input power	- No 1 = 969.41	No 2 = 906.12
Evaporator pump power	- No 1 = 24.86	No 2 = 24.86
Condenser fan and pump power	- No 1 = 115.63	No 2 = 112.03
Total input power	= 2152.90	
Total evaporator duty	= 10731.51	
Overall power to cooling ratio	= 4.9847	
Evaporator details		
No 1 Number of cassettes = 93	Fouling factor = 6.7	
No 2 Number of cassettes = 93	Fouling factor = 5.6	
Condenser details		
No 1 Number of cassettes = 106	Fouling factor = 7.3	
No 2 Number of cassettes = 106	Fouling factor = 4.9	
No 1 water flow rate = 264.0	No 2 water flow rate = 249.0	
Cooling tower details - factors of merit No 1 = 0.51 No 2 = 0.52		
No 1 - Number of cells = 5	Airflow per cell = 43.0	
No 2 - Number of cells = 5	Airflow per cell = 46.0	

Table 4.15 - Mount Isa K61 plant : Chiller set performance November 21st 1990

RESULTS OF MEASUREMENTS		
	First stage	Second stage
Evaporating temperature (°C)	-1.1	
Evaporator water in (°C)	18.2	
Evaporator water out (°C)	1.4	
Evaporator water flow rate (L/s)	69.1	
Condensing temperature (°C)	32.1	
Condenser water in (°C)	23.0	
Condenser water out (°C)	28.6	
Condenser water flow rate (L/s)	264.2	
RESULTS OF SIMULATION		
Two compressors in series - ambient wet bulb temperature = 17.6 *****		
First stage operation - 98 % load		
Evaporator duty = 4865.23	Evaporating temperature = -1.01	
Condenser duty = 5755.65	Condensing temperature = 32.21	
Evaporator water temperatures - in 18.20 - out 1.40		
Condenser water temperatures - in 23.61 - out 28.82		
Evaporator water flow rate = 69.20		
Second stage operation - 0% load		
Evaporator duty =	Evaporating temperature =	
Condenser duty =	Condensing temperature =	
Evaporator water temperatures - in	- out	
Condenser water temperatures - in	- out	
Evaporator water flow rate =		
Power requirements		
Compressor input power	- No 1 = 890.27	No 2 =
Evaporator pump power	- No 1 = 2.32	No 2 =
Condenser fan and pump power	- No 1 = 115.63	No 2 =
Total input power	= 1008.22	
Total evaporator duty	= 4865.23	
Overall power to cooling ratio	= 4.8256	
Evaporator details		
No 1 Number of cassettes = 93	Fouling factor = 6.7	
No 2 Number of cassettes = 93	Fouling factor =	
Condenser details		
No 1 Number of cassettes = 106	Fouling factor = 7.3	
No 2 Number of cassettes = 106	Fouling factor =	
No 1 water flow rate = 264.0	No 2 water flow rate =	
Cooling tower details - factors of merit No 1 = 0.51 No 2 =		
No 1 - Number of cells = 5	Airflow per cell = 43.0	
No 2 - Number of cells = 5	Airflow per cell =	

Table 4.16 - Mount Isa K61 plant : Chiller set performance November 23rd 1990

RESULTS OF MEASUREMENTS		
	First stage	Second stage
Evaporating temperature (°C)	5.8	-2.0
Evaporator water in (°C)	20.9	9.9
Evaporator water out (°C)	9.9	1.5
Evaporator water flow rate (L/s)	134.4	134.4
Condensing temperature (°C)	39.1	35.7
Condenser water in (°C)	28.1	26.7
Condenser water out (°C)	34.7	32.1
Condenser water flow rate (L/s)	264.2	248.8

RESULTS OF SIMULATION		
Two compressors in series - ambient wet bulb temperature = 23.1 *****		
First stage operation - 98 % Load		
Evaporator duty = 6069.74	Evaporating temperature = 5.83	
Condenser duty = 7152.66	Condensing temperature = 39.14	
Evaporator water temperatures - in 20.90 - out 9.96		
Condenser water temperatures - in 28.05 - out 34.92		
Evaporator water flow rate = 132.53		
Second stage operation - 100% Load		
Evaporator duty = 4690.46	Evaporating temperature = -1.96	
Condenser duty = 5694.20	Condensing temperature = 35.83	
Evaporator water temperatures - in 9.96 - out 1.50		
Condenser water temperatures - in 26.63 - out 32.09		
Evaporator water flow rate = 132.53		
Power requirements		
Compressor input power	- No 1 = 1082.82	No 2 = 1003.46
Evaporator pump power	- No 1 = 16.27	No 2 = 16.27
Condenser fan and pump power	- No 1 = 115.63	No 2 = 112.03
Total input power	= 2346.49	
Total evaporator duty	= 10760.20	
Overall power to cooling ratio	= 4.5857	
Evaporator details		
No 1 Number of cassettes = 93	Fouling factor = 5.8	
No 2 Number of cassettes = 93	Fouling factor = 6.1	
Condenser details		
No 1 Number of cassettes = 106	Fouling factor = 6.5	
No 2 Number of cassettes = 106	Fouling factor = 5.8	
No 1 water flow rate = 264.0	No 2 water flow rate = 249.0	
Cooling tower details - factors of merit No 1 = 0.54 No 2 = 0.58		
No 1 - Number of cells = 5	Airflow per cell = 43.0	
No 2 - Number of cells = 5	Airflow per cell = 46.0	

Table 4.17 - Mount Isa K61 plant : Chiller set performance January 21st 1992

RESULTS OF MEASUREMENTS		
	First stage	Second stage
Evaporating temperature (°C)	6.9	-3.1
Evaporator water in (°C)	24.0	10.9
Evaporator water out (°C)	10.9	1.6
Evaporator water flow rate (l/s)	111.3	111.3
Condensing temperature (°C)	39.1	35.6
Condenser water in (°C)	27.3	26.4
Condenser water out (°C)	34.2	31.0
Condenser water flow rate (l/s)	258.0	270.3

RESULTS OF SIMULATION		
Two compressors in series - ambient wet bulb temperature = 22.8 *****		
First stage operation - 95 % load		
Evaporator duty = 6066.80	Evaporating temperature = 6.72	
Condenser duty = 7127.61	Condensing temperature = 39.13	
Evaporator water temperatures - in 24.00 - out 10.90		
Condenser water temperatures - in 27.43 - out 34.03		
Evaporator water flow rate = 110.67		
Second stage operation - 96% load		
Evaporator duty = 4307.16	Evaporating temperature = -3.09	
Condenser duty = 5294.44	Condensing temperature = 35.45	
Evaporator water temperatures - in 10.90 - out 1.60		
Condenser water temperatures - in 26.46 - out 31.14		
Evaporator water flow rate = 110.67		
Power requirements		
Compressor input power	- No 1 = 1060.72	No 2 = 986.87
Evaporator pump power	- No 1 = 9.47	No 2 = 9.47
Condenser fan and pump power	- No 1 = 106.55	No 2 = 114.20
Total input power	= 2287.29	
Total evaporator duty	= 10373.96	
Overall power to cooling ratio	= 4.5354	
Evaporator details		
No 1 Number of cassettes = 93	Fouling factor = 5.1	
No 2 Number of cassettes = 93	Fouling factor = 3.4	
Condenser details		
No 1 Number of cassettes = 106	Fouling factor = 5.1	
No 2 Number of cassettes = 106	Fouling factor = 4.5	
No 1 water flow rate = 258.0	No 2 water flow rate = 270.5	
Cooling tower details - factors of merit No 1 = 0.60 No 2 = 0.60		
No 1 - Number of cells = 5	Airflow per cell = 38.6	
No 2 - Number of cells = 5	Airflow per cell = 39.3	

#### 4.5 Broken Hill North mine surface plant

As already described in section 4.3, the existing underground refrigeration plant at North mine could not meet the cooling requirements when mining the deeper sections of the Fitzpatrick ore body. In addition to the options to increase the existing underground plant capacity which are described in section 4.3, a surface plant could be used which would either supply chilled water to the existing underground system or to supplement this system by bulk cooling the intake air on surface.

##### 4.5.1 Surface refrigeration plant justification

The justification for installing additional mine refrigeration is associated with the increase in production resulting from a decrease in the proportion of six hour shifts and an improvement in thermal productivity. A re-evaluation of the 32 level stope (responsibility 131) six hour jobs (6h) between 1985 and 1987 including the follow on shifts resulted in the following relationship with the intake wet bulb temperature at the shaft station ( $t_{wb}$ ):-

$$\% 6h = 0.009333 t_{wb}^3 - 0.4100 t_{wb}^2 + 8.087 t_{wb} - 49.70$$

The following table summarises the application of this relationship to the 32 level stope.

	Summer	Mid-seasonal	Winter
Surface wet bulb	18.0	14.0	8.0
32 level ( $t_{wb}$ )	24.0	20.5	15.4
Actual % 6 hour	38.0	24.9	11.9
Estimated % 6 hour	37.3	24.4	11.7

During the four year period between 1985 and 1989, in the shallower sections of the Fitzpatrick mining area (responsibility 132), there were 24 805 six hour shifts reported out of a total number of shifts worked of 55 707 or 44.5%. If the follow on shifts during 1986 and 1987 are included (see section 4.3.1), the proportion increases to 46.0%. Using the above relationship and the recorded face temperatures, the expected number of six hour shifts is 44.9%.

The cost benefit of improving thermal environmental conditions is based on the difference between the base case and that expected with the modified refrigeration system. The base case is usually taken as the current system with the only modifications related to maintaining continuity of operation. The increased mining revenue is based on 60 mining personnel working for 235 shifts/year and an excess of revenue over costs of A\$ 150.00/tonne. The cost benefit is adjusted by differences in power costs at A\$ 0.07/kWh.

The working place temperatures used to obtain the productivity values (both six hour and productivity) were obtained using the heat and moisture transfer

routines incorporated in a thermodynamic network simulation programme (section 2.1.4). An important heat source in these simulations is that resulting from the use of diesel powered equipment. The wet and dry bulb temperatures predicted for the current refrigeration system were confirmed by comparison with the record of measurements taken in the Fitzpatrick mining area.

The method of financial justification follows that illustrated for the Mount Isa 3000 ore bodies in section 2.1.4. Essentially a load profile for the year is established relating a surface wet bulb temperature to frequency of occurrence. Refrigeration plant performance and working place wet bulb temperatures are obtained from the refrigeration plant and network simulation programmes and related to the surface wet bulb temperatures. A total of six refrigeration options were considered.

**Option 1 - no action.** In this option no expenditure at all is made on refrigeration or replacement parts and the existing plant is allowed to deteriorate to shut down. Essentially the option illustrates the effect of having no refrigeration at all in the Fitzpatrick mining area. The weighted average stope productivity is 16.33 tonnes/manshift (76.9%) and no work is possible when the surface wet bulb temperature exceeds 21.0°C and the stop work condition prevails in the working places.



**Option 2 - retain the existing plant.** This option retains the existing refrigeration plant and only considers sufficient capital expenditure to maintain continuity of operation i.e. replace the N<sup>o</sup> 1 and N<sup>o</sup> 2 chiller set evaporators and to replace all the refrigeration piping for the N<sup>os</sup> 2 and 3 chiller sets. The estimated capital expenditure is A\$ 500 000. The weighted stope productivity is 19.29 tonnes/manshift (90.9%) and the weighted refrigeration plant input power is 1123 kW.

A two thirds refrigeration set availability is assumed for the plant load i.e. one set is continuously shut down for maintenance and repair. This low overall availability is based on actual operational data for the three years between 1987 and 1990. The total input power is constant for most of the year as a result of the limitation with respect to motor input power and unloading of the compressors.

**Option 3(a) - fourth compressor set.** In this option, a fourth compressor set is installed in addition to making the necessary changes to maintain continuity of operation i.e. Option 2 plus a fourth compressor set. The additional capital required is estimated to be between A\$ 1 600 000 and A\$ 1 900 000. The weighted average stope productivity is 20.11 tonnes/manshift (94.7%) and the weighted refrigeration plant input power is 1595 kW.

**Option 3(b) - plate evaporator.** Install a fourth compressor set in addition to modifying the existing underground arrangements to ensure a plant output capacity of 6.4 MW by installing a falling film plate evaporator. The fourth compressor set has a nominal duty approximately double that of the existing sets and should allow modifications to the plant to be undertaken without a reduction in the amount of cooling supplied. The weighted average stope productivity is 20.53 tonnes/manshift (96.7%) and the weighted refrigeration plant input power is 1736 kW. The additional capital required is estimated to be A\$ 2 600 000.

**Option 4 - surface bulk air cooler.** Install a surface plant providing chilled water which is used to cool part of the intake air in a 5.5 MW bulk air cooler. One 1.8 MW underground plant is used to supply chilled water to the 37 level bulk air cooler and to the auxiliary ventilation systems used for development. The weighted average stope productivity is 20.08 tonnes/manshift (94.6%), the weighted refrigeration plant input power is 1109 kW and the estimated capital cost for the new plant is A\$ 3 500 000.

**Option 5 - surface chilled water plant.** In this option the existing underground refrigeration plant is replaced with a surface plant which supplies chilled water from surface through an energy recovery system and into the existing chilled water system. The

weighted average stope productivity is 20.48 tonnes/manshift (96.5%), the weighted refrigeration plant input power is 1088 kW and the additional capital required is estimated to be A\$ 7 300 000.

A summary of the costs and the effectiveness of the options available are summarised in table 4.18. For a project life of between five and seven years, the mine decided to select option 4 as a turn key project. This had the advantage of minimising staffing requirements during construction and, when mining is completed in the Fitzpatrick area, a significant part of the plant could be recovered and used at the South mine. It was expected that the increasing depth of mining at the Southern Cross shaft of the South mine would justify the installation of refrigeration at this time.

#### 4.5.2 System design and selection

The amount of air that could be cooled in the surface bulk air cooler was limited by the size of raise bore hole that could be drilled to the 2 level station and the entrance to the shaft on this horizon. Extensive modification work was not possible without disrupting the production and service requirements of the shaft. With the amount of air to be cooled limited to between 125 and 150 m<sup>3</sup>/s, a supply air temperature of about 4°C was required at the design climatic condition. This in turn resulted in a supply chilled water temperature of between 1 and 2°C.

**Table 4.18 - Comparison of options for the North mine refrigeration system**

Option	Description	Average productivity (%)	Average power (kW)	Initial cost (A\$)*	Annual saving (A\$)*
1	No expenditure	76.9	-	-	-
2	No plant expansion	90.9	1123	0.5	5.6**
3(a)	Fourth compressor underground	94.7	1595	1.9	1.5
3(b)	Underground 6.4 MW plant with open plate evaporator	96.7	1736	2.6	2.3
4	Surface bulk air cooler	94.6	1109	3.5	1.7
5	Surface chilled water plant	96.5	1088	7.3	2.6

\* Costs are given in A\$ 1 000 000.

\*\* Compares option 1 with option 2 - all others are compared with option 2.

## General

The refrigeration plant is required to operate over a wide range of ambient climatic conditions consequently a technical assessment of alternative plants should evaluate performance and input power requirements at "off" design conditions. The refrigerant used in all the proposals was ammonia. The prospective suppliers proposed different compressors and the characteristic curves of adiabatic head and efficiency against compressor inlet refrigerant flow rate are given in section 3.1.

Heat rejection in all the proposals used modular and factory assembled evaporative condensers which are the most cost effective for this application. These are proven in both industrial and mining applications. The relatively short life of the project did not justify custom designed units with longer life materials of construction such as a concrete shell and stainless steel coil supports.

The refrigeration plant supplies chilled water to a bulk air cooler which handles intake air. Evaporator fouling is therefore considered to be relatively low and easily controllable with either slipstream filtration or bleed off and make up water. It is therefore not essential to provide open evaporators with a commensurately higher cost. All prospective suppliers offered closed plate heat exchangers.

To minimise the bulk air cooler air flow rate the cooling tower used must have a high factor of merit. All tenderers proposed to supply a standard counter flow packaged unit design in the conforming offer. Although these cooling towers are extensively used in industrial applications there are reservations with respect to the rated performance in past applications. In this case, the detailed performance criteria supplied and the increased thickness of fill should ensure that the design conditions were met.

#### Tender evaluation

From the information provided in each tender, a model was built up using the modules outlined in section 4.1. The equipment selection and the arrangement for each tender proposal is summarised in figure 4.26.

For proposal 1, the VXC 1060 evaporative condensers are well sized and may be too large relative to their initial cost and the potential power savings. The Alfa Laval closed plate heat exchangers are very undersized at 64 plates each (62 effective or 31 cassettes). The two parallel sets are relatively straightforward to control and operate. Using the plate heat exchangers in parallel involved a power penalty because both operate at the lowest evaporating temperature. Using the North Mine surface climatic temperatures and load profile, the total power required to operate the plant is 7 423 000 kWh/year or a cost of A\$ 519 600/year.

Figure 4.26 - Summary of proposals for the North mine surface regridration plant

Proposal 1

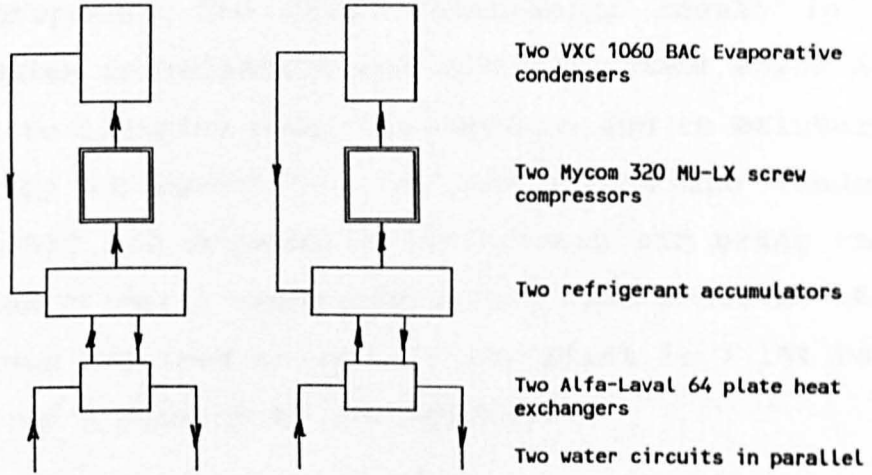

Proposal 2

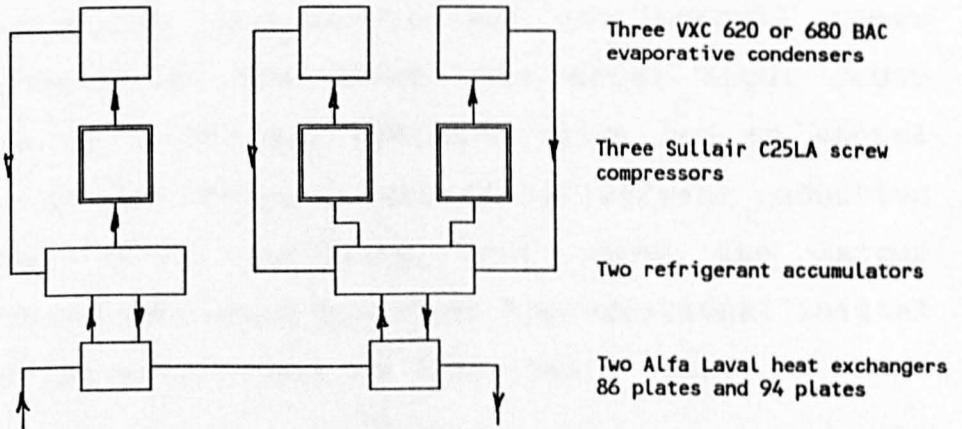

Proposal 3

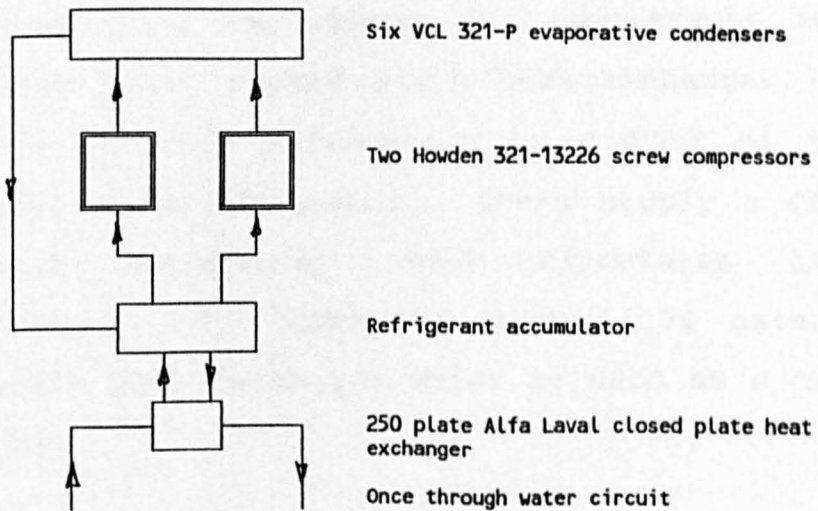

Technically, proposal 2 was the most detailed tender with sufficient information available to support the design proposed. The three compressors result in a more complex installation and operating mode which is designed to minimise power consumption and to maintain flexibility of operation. For the conforming tender with the VXC 620 evaporative condensers and using the North Mine climatic temperatures and load profile, the total power required to operate the plant is 7 154 000 kWh/year or a cost of A\$ 500 800/year.

Using the larger VCX 680 evaporative condenser reduces the condensing temperature and the overall power requirements for the plant. The total input power required is 6 955 000 kWh/year which has an annual cost of A\$ 489 700/year. The A\$ 11 100/year reduction in power costs resulting from using the larger evaporative condenser justifies the additional initial cost of the larger unit in less than a year.

Proposal 3 has the simplest refrigeration equipment arrangement using two Howden 321 compressors and a single Alfa Laval closed plate heat exchanger. Each compressor delivers refrigerant to a bank of three evaporative condenser modules. These supply a common refrigerant accumulator which circulates liquid refrigerant to the large 250 plate (124 cassette) closed plate heat exchanger which is used as a common evaporator.



The refrigerant gas from the accumulator is returned to the compressor(s) depending on the refrigeration demand. At low ambient wet bulb temperatures only one compressor operates using three evaporative condenser modules. Using the North mine climatic temperatures and load profile, the total power required to operate the plant is 7 132 000 kWh/year at an annual cost of A\$ 499 200. When the ambient wet bulb temperature is below 14°C, the lower mine refrigeration load can be achieved with only one of the compressors operating.

All the proposals were technically acceptable and proposal 3 was finally adopted. The decision was based on the much lower initial costs (24% less than the next lowest cost) and an almost negligible increase in operating power costs.

#### Plant control strategy

The control strategy for the surface refrigeration plant is to minimise input power requirements whilst providing the design refrigeration at the bulk air cooler. This is best achieved by maintaining the compressors at full load and by varying the water supply to the bulk cooler in order to supply just the right amount of cooling. The ideal control arrangement is illustrated in figure 4.27.

The system illustrated requires three variable speed pumps, one to maintain the compressor at full load

**Figure 4.27 - North Mine refrigeration plant : basic control strategy**

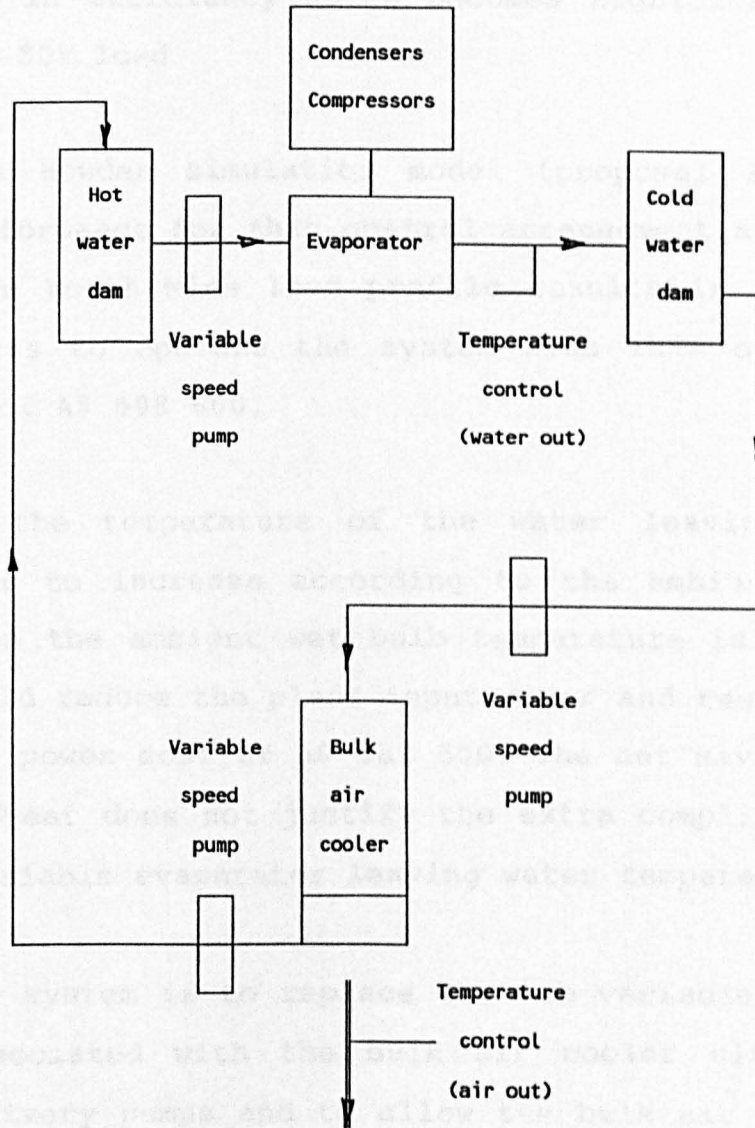

with the varying return water temperature from the bulk air cooler, and, two to maintain the wet bulb temperature out of the bulk air cooler at 4°C. Controlling plant output with a fixed evaporator water flow rate requires the compressors to unload with a reduction in efficiency which becomes significant at less than 80% load.

Using the Howden simulation model (proposal 3) the plant performance for this control arrangement and for the design North Mine load profile results in annual power costs to operate the system with this control strategy of A\$ 498 600.

Allowing the temperature of the water leaving the evaporator to increase according to the ambient wet bulb (when the ambient wet bulb temperature is above 20°C) would reduce the plant input power and result in an annual power cost of A\$ 489 500. The net saving of A\$ 9 000/year does not justify the extra complication of the variable evaporator leaving water temperature.

A simpler system is to replace the two variable speed pumps associated with the bulk air cooler with two fixed delivery pumps and to allow the bulk air cooler outlet air temperature to vary. This will result in an over provision of refrigeration relative to the design condition when the ambient wet bulb temperature is less than 16°C.

The annual power costs to operate the system with this control strategy are A\$ 513 400. If the bulk air cooler pumps are either two speed or multiple parallel units, the bulk cooler water flow could be reduced to 65.0 l/s (down from 100.0 l/s) when the ambient wet bulb temperature is below 12°C. Less cooling would be transferred in the bulk air cooler and the annual power costs would be reduced to A\$ 497 600.

The water storage dams serve two purposes:-

1. To ensure that the compressor motor run time is reasonable and does not cycle on and off too frequently i.e. a minimum run time of two hours.
2. To provide cold water storage which can be used to provide cooling when the compressors are not running i.e. during a scheduled maintenance shutdown.

The storage capacity for a scheduled shutdown of four hours is 1.5 Ml at a fixed bulk cooler water flow rate of 100 l/s. This capacity would also provide a minimum two hour run time at a maximum evaporator water flow rate of 200 l/s. The cold water dam operates between "low" at say 10% - compressors start, and "full" at say 95% - compressors stop. The low level start would be manually overridden if a scheduled maintenance shutdown is due in order to fill the cold dam.

The system using variable water flow through the bulk air cooler does not have a significant power cost benefit and the more complex control system is not justified. The design water flow rate through the bulk air cooler was fixed at 100 l/s. A variable speed pump is used to ensure that the water flow through the evaporator maintains the compressors at full load and the water temperature leaving the evaporator is between 1 and 2°C. Although a by-pass back to the hot dam from the evaporator outlet could be installed, it was not expected to be used except for two or three minutes during start up.

#### 4.5.3 Plant performance

A schematic of the general layout of the plant is given in figure 4.28. The plant comprises two nominal 3.5 MW screw compressors, a 160 cassette closed plate evaporator and six low profile evaporative condensers. Two 1.5 Ml capacity concrete storage dams are used for supply and return water storage. The plant operation is controlled by the level of water in the cold dam and the plant start up sequence is initiated when the water level falls to 0.7 m.

The variable speed pump is started and its speed increased to 50% which provides a flow of 150 l/s from the hot dam through the evaporator. The condenser fans are then started in sequence (the condenser pumps remain running unless switched off for maintenance).

The lead compressor motor is started when the oil pump run status is confirmed with the compressor capacity slide valve fully closed i.e. no load. Ten second pulses activate the solenoid which opens the slide valve and loads the compressor fully in approximately two minutes.

The variable pump speed is then altered to provide water leaving the evaporator at the set temperature. If this is less than 120 l/s, the second compressor start up sequence is initiated. Stable conditions are normally achieved in less than five minutes.

#### April 1991 performance tests

The refrigeration plant installation was completed in March 1991 and acceptance tests were undertaken in April 1991. At the conclusion of the performance tests the refrigeration plant was not acceptable with deficiencies in five main areas. These were not thought to be fundamental design problems and remedial action should be successful. With the onset of winter in the southern hemisphere, the limited opportunity to operate the plant would delay the modifications and future testing.

The factor of merit of the bulk air cooler was 18% lower than claimed with the water flow rate 20% above design and the airflow rate 6% below design. Although the bulk air cooler could meet the design heat

Figure 4.28 - North mine surface plant : equipment layout

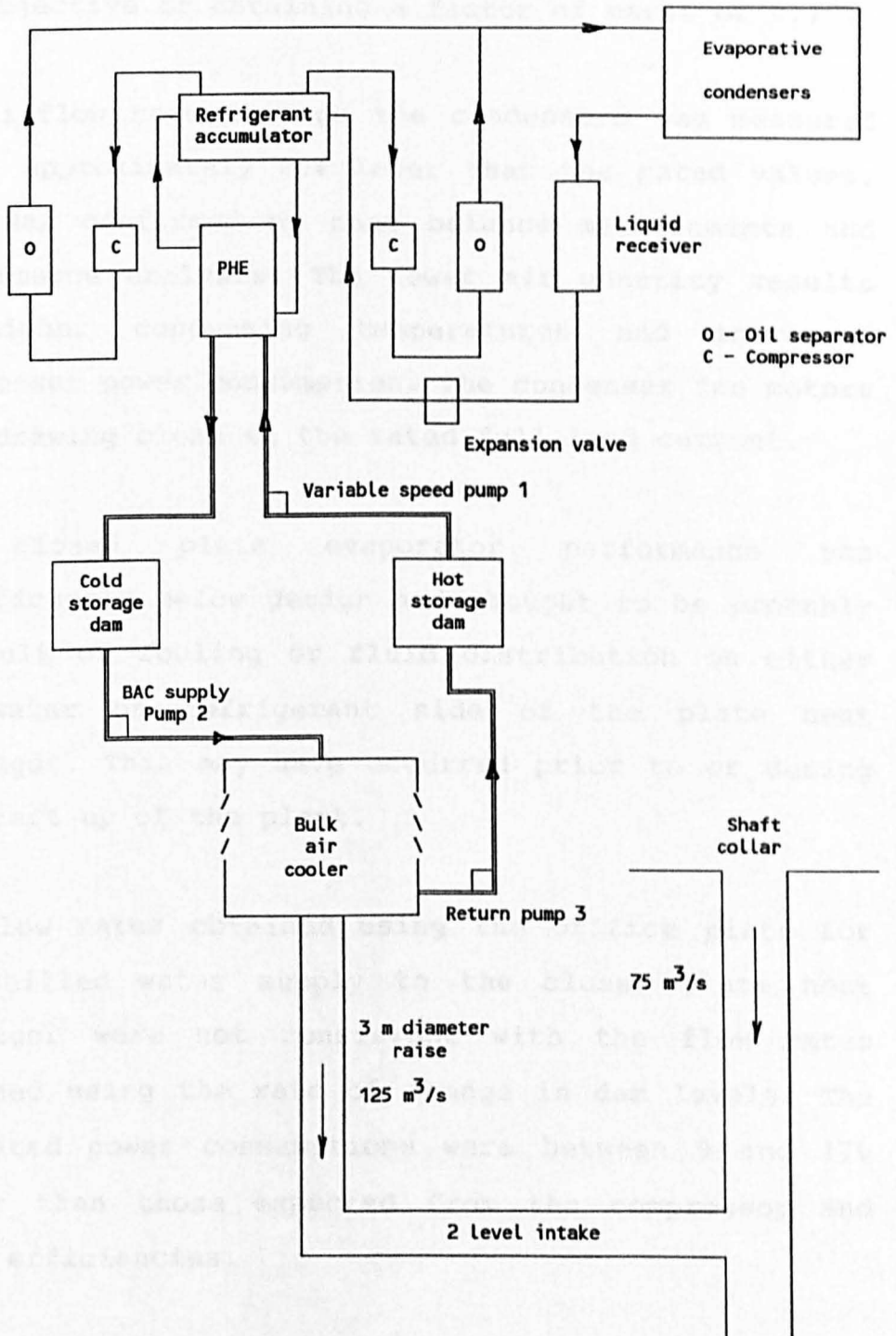

transfer rate if the fan speed was increased by 10%, the water and air distribution was to be reviewed with the objective of obtaining a factor of merit of 0.75.

The airflow rate through the condensers was measured to be approximately 20% lower than the rated values. This was confirmed by heat balance measurements and performance analysis. The lower air quantity results in higher condensing temperatures and increased compressor power consumption. The condenser fan motors were drawing close to the rated full load current.

The closed plate evaporator performance was significantly below design and thought to be probably a result of fouling or fluid distribution on either the water or refrigerant side of the plate heat exchanger. This may have occurred prior to or during the start up of the plant.

The flow rates obtained using the orifice plate for the chilled water supply to the closed plate heat exchanger were not consistent with the flow rates obtained using the rate of change in dam levels. The indicated power consumptions were between 9 and 17% higher than those expected from the compressor and motor efficiencies.

The plant would only provide 88% of the design cooling whilst using 98.5% of the power. Modifying the bulk air cooler to achieve the design mine cooling but not



correcting the condenser and evaporator problems would result in an increased power consumption equivalent to A\$ 60 000 per year.

#### Pump flow rates

It was noted during the April 1991 site visit that the water flow rates obtained using the orifice plates were not consistent with those obtained using the difference in dam levels over a prescribed time period. A detailed series of tests were undertaken during February 1992 to identify these discrepancies and the results are summarised in Figure 4.29. The resultant calibration curves for pumps 1 and 2 are:-

$$\text{Pump 1 } l_e = 1.116 l_e^* + 3.19$$

$$\text{Pump 2 } l_{bc} = 1.0505 l_{bc}^*$$

where  $l_e^*$  = indicated pump 1 water flow rate (l/s)

$l_e$  = actual flow through the evaporator (l/s)

and  $l_{bc}^*$  = indicated pump 2 water flow rate (l/s)

$l_{bc}$  = actual flow through the bulk air cooler

The water level change using the cold water storage dam gave more consistent results than using the hot water dam levels even when pumps 2 and 3 (those supplying and returning water to and from the bulk air cooler) were not operating. This is probably caused by

the effect of the water supply and take off relative to the level indicators. In the cold dam, the chilled water supply and take off are adjacent to each other at the base of the dam and should not cause a surface wave action which would affect the level indicator.

#### Surface bulk air cooler

The surface bulk air cooler is a two cell counter flow tower with 1.8 m thickness of compact plastic fill and a design water to air ratio of 0.7. The air is passed through the tower and down a 3 m diameter raise to 2 level where it joins the balance of the air in the shaft. Two centrifugal fans driven by 110 kW motors through a belt drive are used to overcome the pressure loss in the bulk air cooler and the raise.

When first measured in April 1991, the bulk air cooler had a factor of merit of 0.68 and an airflow rate which was 6% below the design value. Although the manufacturers rated factor of merit averaged 0.818, this was considered to be overly optimistic and a value of 0.75 would be acceptable. The results of the April 1991 and the January/February 1992 tests are given in Table 4.19. The heat balance obtained from the measured values for the water and air sides was satisfactory at between -2.1% and +2.9%.

The average factor of merit for the 1992 tests was 0.745 and the rated airflow is now within 1% of the

design value. The change in water sprays to improve distribution appears to have been successful and the performance of the bulk air cooler is acceptable.

#### Closed plate evaporator

A total of 23 sets of results were obtained in order to assess the performance of the Alfa Laval closed plate heat exchanger used as the evaporator. During the April 1991 site visit, from the results of five tests, the heat exchanger performance was found to be lower than expected with the heat transfer taking place at significantly lower evaporating temperatures than expected from the design values. The overall heat transfer coefficient was found to be between 500 and 600 W/K or 30% below the expected design value.

Refrigerant boiling heat transfer rates in evaporators are difficult to assess and, based on the method of analysis outlined in section 3.3.3 and a water side fouling factor of 5.0 kW/m<sup>2</sup>K, the relationship between the actual and the calculated evaporating  $t_e^*$  temperature was found to be:-

$$\text{Actual } t_e = 1.087 t_e^* - 1.76$$

(coefficient of correlation = 0.912)

In late 1991, the plate heat exchanger was increased in size by 25% by adding an additional 35 cassettes. Although this improved the heat exchanger overall heat

Figure 4.29 - North Mine surface plant : variable speed pump calibration

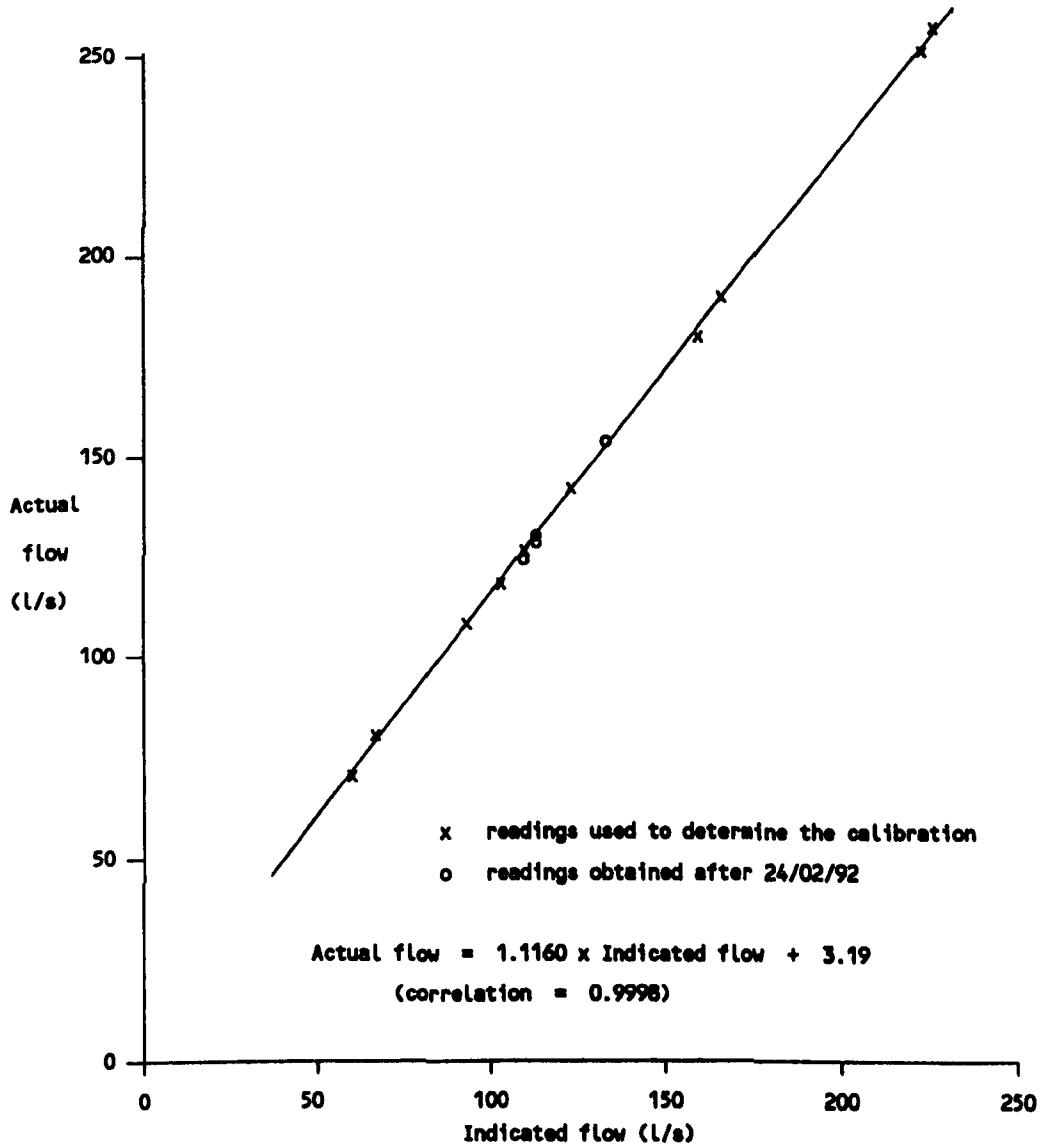

Table 4.19 - North Mine surface plant : Bulk air cooler performance

Date of test	12/04/91	15/04/91	31/01/92	04/02/92
<b>2 Level measurements</b>				
Mean air velocity (m/s)	12.07		13.06	
Cross sectional area (m <sup>2</sup> )	9.06		9.06	
Air quantity (m <sup>3</sup> /s)	109.4		118.3	
Wet and dry bulbs (°C)	6.0/6.5		5.2/5.2	
Barometric pressure (kPa)	99.73		99.45	
Air density (kg/m <sup>3</sup> )	1.239		1.234	
Air mass flow rate (kg/s)	135.5		145.8	
<b>Bulk air cooler measurements</b>				
Wet bulb leaving (°C) n	12	19	5	4
x	4.28	2.96	3.76	11.63
s	0.35	0.15	0.02	0.02
Water entering (°C) n	16	19	5	4
x	2.36	1.31	1.90	10.16
s	0.33	0.13	0.11	0.08
Water leaving (°C) n	16	19	5	4
x	8.41	6.37	10.64	16.51
s	0.17	0.07	0.10	0.11
Wet bulb temperature in (°C) n	6	9	5	4
x	14.67	11.66	17.06	19.66
s	0.09	0.17	0.08	0.11
Dry bulb temperature in (°C) n	6	9	5	4
x	27.58	15.84	32.12	24.26
s	0.30	0.37	0.26	0.41
Water flow rate (L/s) n	4	12	5	4
x	122.6	120.4	121.1	120.7
s	0.08	0.66	0.79	0.91
Corrected water flow rate (L/s)	128.8	126.5	127.2	126.8
Barometric pressure (kPa)	98.96	99.52	98.97	98.71
<b>Performance analysis</b>				
Surface air density (kgm <sup>-3</sup> )	1.143	1.187	1.119	1.134
Fan inlet air quantity (m <sup>3</sup> /s)	118.5	114.2	130.3	128.6
Sigma heat of air out (kJ/kg)	17.3856	14.8347	16.2305	33.0157
Sigma heat of air in (kJ/kg)	41.1730	33.2969	47.4133	55.5176
Sigma heat at water in (kJ/kg)	13.8581	11.9160	12.8292	29.5568
Air side heat transfer (kW)	3223	2502	4546	3280
Estimated fan power (kW)	122	122	164	164
Water side heat transfer (kW)	3261	2679	4653	3346
Balance - (kW)	+84	-55	+57	+99
- % of water side	+2.6	-2.1	+1.2	+2.9
Air into tower (after fan) (°C)	15.05/28.48	12.07/16.74	17.53/33.24	20.10/25.38
Water efficiency (n <sub>w</sub> )	0.4768	0.4703	0.5592	0.6388
Capacity ratio (R)	1.7892	1.8868	1.5981	1.3262
Factor of merit (F)	0.670	0.692	0.741	0.747

n = number of measurements, x = arithmetic mean, s = standard deviation

transfer coefficient to between 750 and 850 W/K and therefore met the design criteria, the performance was still below that which would normally be expected.

During the 1992 tests, when the refrigerant isolation valve was removed from the heat exchanger outlet, there was a noticeable improvement in performance (the overall heat transfer coefficient increased to between 850 and 950 W/K). This is attributed to an improvement in refrigerant distribution in the closed plate heat exchanger. The return refrigerant pipeline would comprise mainly of refrigerant gas and the removal of this valve would reduce the pressure loss and improve the action of the thermosyphon.

A summary of the results of the tests is given in figure 4.30 and also indicates the change resulting from the removal of the isolation valve. From the results of the testwork, the relationship between the actual and the calculated evaporating temperature  $t_e^*$  can be obtained from the following relationship:-

$$\text{Actual } t_e = 1.074 t_e^* - 0.31$$

(coefficient of correlation = 0.995)

#### Evaporative condensers

The testwork undertaken during the April 1991 site visit with respect to the evaporative condenser performance concluded that the condensing temperatures

were too high and that the problem was probably associated with below design air quantities. Each condenser had air supplied to it using two double inlet centrifugal fans on a common shaft which was driven by a single motor. Safety guards precluded an accurate air quantity measurement being taken at the inlet to the fans.

The eliminators at the discharge from the condenser affected the outlet air distribution and made accurate air quantity measurements difficult to achieve. Since the condenser is required to reject both the heat of compression and the evaporator duty, in the absence of accurate air quantity measurements, it is necessary to obtain a good estimate of both of these components from other plant measurements.

To avoid overloading the compressor motors, a maximum discharge pressure causes the compressors to unload when this limit is exceeded. The compressor power requirement does not decrease uniformly with a decrease in load and a method for evaluating the part load compressor performance is given in section 3.1.1. Typically, although dependent on the compression ratio, the increase in expected compressor input power is 6.5% at 80% load, increasing to 21% at 50% load.

A comparison of the measured evaporator performance with that which would be expected based on the compressor performance curves and the part load

Figure 4.30 - North Mine surface plant : closed plate evaporator performance

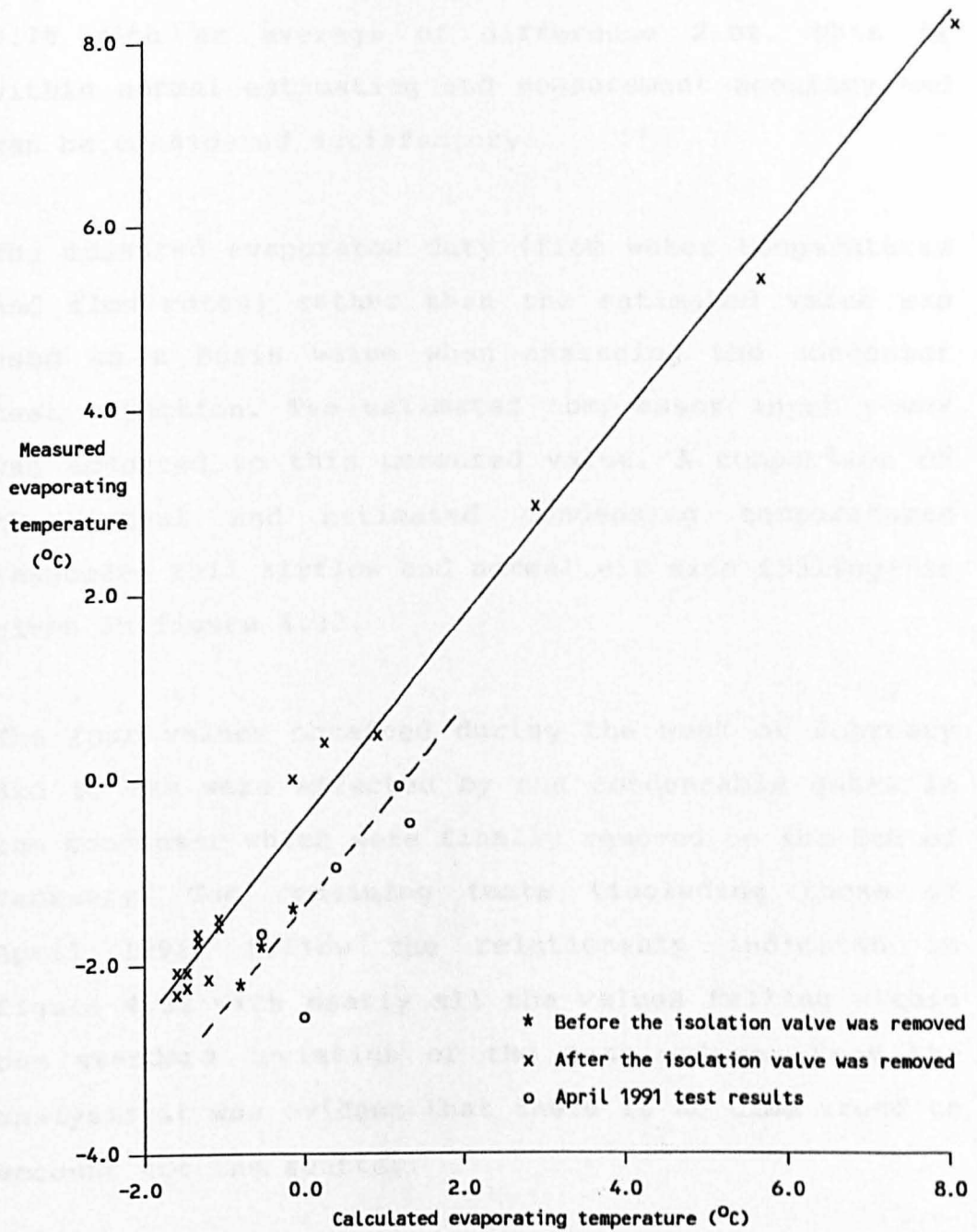

Based on readings taken when the plant was both operating and shut down and measurements of the temperature of the ammonia in the evaporator, the gauge pressure readings were adjusted as follows:-

No 1 compressor suction	-5 kPa
No 2 compressor suction	+4 kPa
Accumulator pressure	+3 kPa



analysis is given in figure 4.31. Although there is some scatter in the results the maximum discrepancy is 4.7% with an average of difference 2.0%. This is within normal estimating and measurement accuracy and can be considered satisfactory.

The measured evaporator duty (from water temperatures and flow rates) rather than the estimated value was used as a basis value when assessing the condenser heat rejection. The estimated compressor input power was adjusted to this measured value. A comparison of the actual and estimated condensing temperatures (assuming full airflow and normal air side fouling) is given in figure 4.32.

The four values obtained during the week of February 3rd to 8th were affected by non condensable gases in the condenser which were finally removed on the 8th of February. The remaining tests (including those of April 1991) follow the relationship indicated in figure 4.32 with nearly all the values falling within one standard deviation of the mean values. From the analysis it was evident that there is no time trend to account for the scatter.

Four measurements of the actual condenser heat rejection obtained using airflow and air temperature measurements indicated discrepancies of -13.9%, +8.0%, +0.2% and +3.3% between the measured and expected values. The large negative discrepancy was probably

associated with the difficulty in taking airflow measurements at the eliminator discharge which could have been significantly in error.

The airflow measurements also indicated that the condenser sump water level had a significant effect on the air quantity delivered by the fan. When measured in April 1991 the airflow factor was reasonably consistent at 0.80. By early February 1992 this had decreased to 0.65. Maintaining the sump level at just below the fan discharge volute, results in an airflow factor of 0.85. Modifications to the pump location and the sump level control are necessary to stabilise this aspect of the condenser performance.

As supplied, the pump suction required a minimum depth in the sump of 140 mm. At this depth the water was level with the bottom of the fan discharge volute and waves were caused. The level control was within 1 m of the fan discharge and the troughs of the waves caused this control to activate and open the make up water supply valve and to increase the water level in the condenser sump.

As the water level increases, the fan discharge area is reduced and the fan supply quantity reduced. By altering the pump suction the minimum depth can be reduced to 100 mm and, by moving the level control further away from the fan discharge, the effects of any wave action can be minimised.

Figure 4.31 - North Mine surface plant : Comparison of estimated and actual plant duties

As the compressor unloads the efficiency decreases, the extent of which is also dependent on the ratio of discharge to suction pressures. An estimate of the discharge (condensing) or suction (evaporating) pressure can be obtained from:-

$$P = 428.28 + 16.0 t + 0.23193 t^2 + 0.0017368 t^3 \text{ kPa}$$

where  $t$  = evaporating or condensing temperatures ( $^{\circ}\text{C}$ )

If the ratio of condensing to evaporating pressures  $r_p = P_c/P_e$  and the compressor part load factor is  $f_p$ , the part load power factor  $P_{if}$  can be obtained from:-

$$P_{if} = r_p (0.808 f_p^2 - 0.288 f_p^3 - 0.812 f_p + 0.292) \\ + (6.8625 f_p^2 - 3.0521 f_p^3 - 5.0394 f_p + 2.2290)$$

A first estimate of the part load factor  $f_p$  is obtained from the ratio of the actual motor current to its full load current. This is used to calculate the first value of the part load power factor  $P_{if}$  which is then used to adjust the part load factor. The process is repeated until the change in subsequent values of the part load factor is negligible. A comparison of the measured evaporator duty to that expected and based on compressor performance (including the adjustment for part load operation) is given in the following graph:-

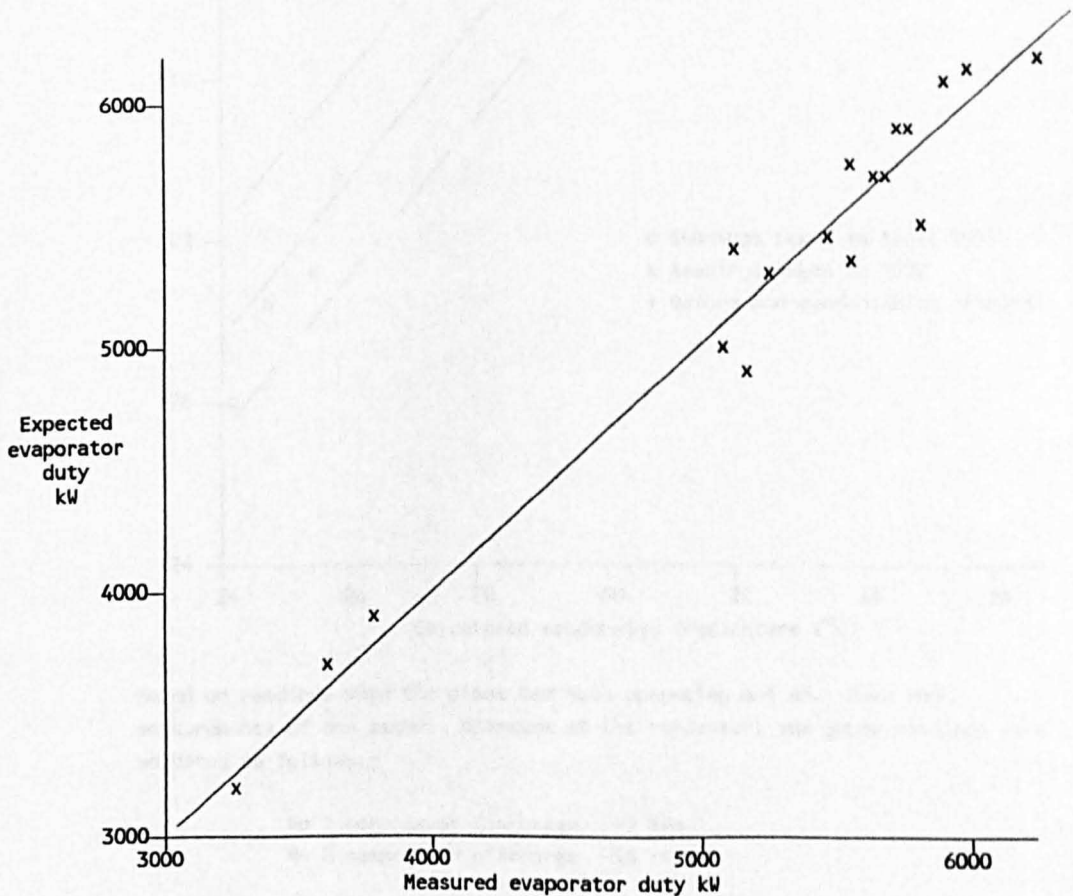
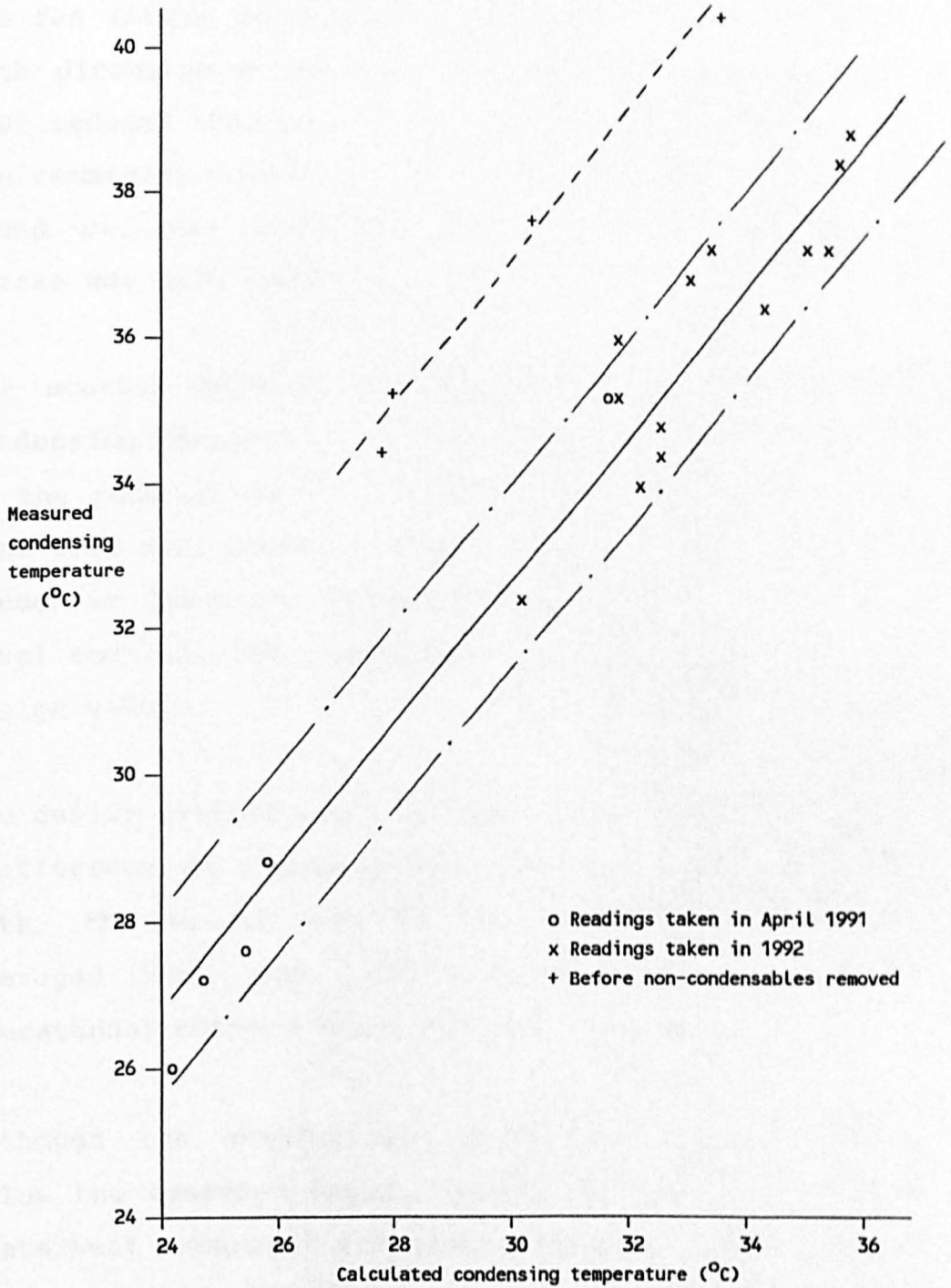

Figure 4.32 - North Mine surface plant : Evaporative condenser performance



Based on readings when the plant was both operating and shut down and measurements of the ammonia pressure at the condenser, the gauge readings were adjusted as follows:-

- No 1 compressor discharge +9 kPa
- No 2 compressor discharge -18 kPa

Air temperature measurements also showed that there was recirculation between the condenser discharge and the fan intake depending on wind direction. The 2.1 m high discharge extensions installed in late February 1992 reduced this but did not completely eliminate it. The remaining condenser heat balances given above were based on some recirculation which resulted in an intake wet bulb temperature  $0.6^{\circ}\text{C}$  above ambient.

The scatter between the expected and the measured condensing temperatures is most probably a combination of the reduced airflow and recirculation factors. The test work did, however, demonstrate that even with the condenser discharge extensions and the improved sump level control, the condensers will not quite meet the design values.

The design overall heat transfer factor was 2350 W/kPa (difference in vapour pressures) and, since February 20th, the actual overall heat transfer factor has averaged just over 2000 (allowing for five cells operational between March 5th and 11th 1992).

Although the evaporative condensers are performing below the tendered design values, the improved closed plate heat exchanger evaporator results in the overall plant requiring an average of 9 kW or 1.2% extra input power. It is planned to replace one of the existing evaporative condensers with one requiring the same fan and pump power and having a greater coil area.

This larger cell will then be used for all the oil heat rejection rather than the three cells currently used. This would then result in reduction in overall plant input power averaging 19 kW i.e. 1.3% less than the original design value. The net saving would be approximately A\$ 12 000/year. The relationship between the actual and the calculated condensing temperature  $t_C^*$  can be obtained from the following relationship:-

$$\text{Actual } t_C = 0.959 t_C^* + 3.78$$

(coefficient of correlation = 0.990)

This is based on an airflow factor of 1.00. With improved water sump level control and the condenser discharge extensions minimising recirculation, an airflow factor of 0.85 has been demonstrated to be achievable. In this case, the relationship between the actual and the calculated condensing temperature  $t_C^*$  can be obtained from the following relationship:-

$$\text{Actual } t_C = 1.019 t_C^* - 0.41$$

#### Input power measurements

During the April 1991 tests, the power consumption determined from the EMS (Energy Management System used for plant control) print outs were higher than expected and indicated a much higher power consumption than expected for most of the equipment and in particular the compressors. These were reviewed in

February 1992 by accurately timing the kilowatt hour meter disc rotation and relating the values obtained to the equipment performance.

An analysis of two sets of measurements resulted in inferred combined motor efficiencies of 91.3% and 93.1%. Although not consistent between compressor motors and allowing for measurement inaccuracies, the inferred motor efficiencies are lower than that which would be expected for new motors and probably of the right order of magnitude for the rewound motors which are actually used to drive the compressors.

The variable speed pump power requirement is dependent on the hot water storage dam level and care must be exercised in setting the maximum speed control limit when starting the plant when the hot storage dam level is low. The additional static head results in the maximum motor current limit being exceeded and the plant start up sequence being aborted.

The results of the power supply measurement to the variable speed pump was satisfactory. The amount of water that will be delivered by the chilled water pump as a function of pump speed control setting and depth of water in the hot water storage dam can be obtained from the following relationship. The coefficient of correlation between the measured and expected values for ten sets of measurements obtained from the test work is 0.996.

$$l_e = 3.424 N + d_h/52 - 82.6$$

where  $l_e$  = chilled water pump delivery (l/s)

$N$  = pump speed control setting (%)

$d_h$  = hot dam water level (mm)

#### 4.5.4 Simulation model

A full listing of the computer simulation used to model the North mine surface plant is given in Appendix 3. The computer language used is Quick Basic and the simulations take between 5 and 20 seconds to converge when using an IBM-PC 386.

The simulation method follows that outlined in section 2.2.2 and uses the modular structure described in section 4.1. The method of assessing the performance of the individual components is described in section 3 and adjusted in line with the performance testing summarised in section 4.5.3.

The performance of the simulation is illustrated in Tables 4.20 and 4.21. The first table summarises the data obtained from the EMS monitoring system and includes the corrections to the measurements obtained during the performance testing. The second table summarises the simulation input and output data and demonstrates the suitability of the model to represent actual steady state operating conditions.



Table 4.20 - North mine simulation model : EMS data summary, 11/03/92

<p>Time period - 15h20 to 16h20, readings at two minute intervals (31 readings)</p>
<p>Compressor 1</p> <p>Suction gauge pressure <math>x = 300.1</math> kPa, <math>s = 0.8</math> kPa  Corrected absolute pressure = <math>393.6</math> kPa, <math>t_e = -2.26^{\circ}\text{C}</math>, <math>s = 0.05^{\circ}\text{C}</math></p> <p>Discharge gauge pressure <math>x = 1310.6</math> kPa, <math>s = 3.5</math> kPa  Corrected absolute pressure = <math>1418.1</math> kPa, <math>t_c = 36.79^{\circ}\text{C}</math>, <math>s = 0.09^{\circ}\text{C}</math></p> <p>Motor current <math>x = 76.8</math> Amps, <math>s = 0.9</math> Amps</p>
<p>Compressor 2</p> <p>Suction gauge pressure <math>x = 288.6</math> kPa, <math>s = 0.8</math> kPa  Corrected absolute pressure = <math>391.1</math> kPa, <math>t_e = -2.41^{\circ}\text{C}</math>, <math>s = 0.05^{\circ}\text{C}</math></p> <p>Discharge gauge pressure <math>x = 1337.1</math> kPa, <math>s = 3.5</math> kPa  Corrected absolute pressure = <math>1417.6</math> kPa, <math>t_c = 36.80^{\circ}\text{C}</math>, <math>s = 0.09^{\circ}\text{C}</math></p> <p>Motor current <math>x = 77.2</math> Amps, <math>s = 0.9</math> Amps</p>
<p>Plate heat exchanger</p> <p>Water temperature in <math>x = 10.49^{\circ}\text{C}</math>, <math>s = 0.03^{\circ}\text{C}</math>, Corrected value = <math>10.39^{\circ}\text{C}</math>  Water temperature out <math>x = 1.53^{\circ}\text{C}</math>, <math>s = 0.05^{\circ}\text{C}</math>, Corrected value = <math>1.12^{\circ}\text{C}</math></p> <p>Water flow rate <math>x = 126.5</math> l/s, <math>s = 1.5</math> l/s, Corrected value = <math>144.3</math> l/s  (based on <math>238.8</math> mm change in cold dam level @ <math>314.63</math> l/mm, the increase in flow is <math>238.8 \times 314.63/3600 = 20.9</math> l/s i.e. <math>125.2 + 20.9 = 146.1</math> l/s)</p>
<p>Bulk air cooler</p> <p>Water temperature in <math>x = 10.39^{\circ}\text{C}</math>, <math>s = 0.11^{\circ}\text{C}</math>, Corrected value = <math>10.19^{\circ}\text{C}</math>  Water temperature out <math>x = 1.47^{\circ}\text{C}</math>, <math>s = 0.06^{\circ}\text{C}</math>, Corrected value = <math>1.19^{\circ}\text{C}</math>  Wet bulb temperature out <math>x = 3.01^{\circ}\text{C}</math>, <math>s = 0.07^{\circ}\text{C}</math>, Corrected value = <math>3.35^{\circ}\text{C}</math></p> <p>Water flow rate <math>x = 119.2</math> l/s, <math>s = 0.8</math> l/s, Corrected value = <math>125.2</math> l/s</p>
<p>Ambient conditions</p> <p>Wet and dry bulb temperatures = <math>17.7/33.3^{\circ}\text{C}</math>  Barometric pressure = <math>98.5</math> kPa</p>
<p>Condenser inlet wet bulb temperatures</p> <p>The inlet air wet bulb temperatures were between <math>0</math> and <math>1.6^{\circ}\text{C}</math> higher than the ambient wet bulb temperature and averaged <math>0.67^{\circ}\text{C}</math> higher.</p> <p>Only 5 condensers operational</p>

Table 4.21 - North mine simulation model : Predicted values, 11/03/92

SUB indata	
nep = 159	'number of cassettes in the evaporator phe
qac = 68.8	'condenser air flow rate
hfe = 4.0	'evaporator fouling factor
hfc = 5.0	'condenser fouling factor
ecf = .745	'evaporative condenser factor
ff = .85	'condenser airflow factor
qbc = 125	'bulk air cooler airflow rate
fombc = .75	'bulk air cooler factor of merit
fankw = 74	'condenser fan power
pumpkw = 4.9	'condenser pump power
amp1 = 76.8	'compressor 1 motor current
amp2 = 77.2	'compressor 2 motor current
cdt = .7	'condenser recirculation wet bulb
END SUB	
2 Compressor(s) operating - ambient wet bulb = 17.7	
*****	
Evaporator duty = 5670.04	Evaporating temperature = -2.39
Condenser duty = 6957.09	Condensing temperature = 32.63
Evaporator water temperatures - in 10.35 - out 1.10	
Evaporator water flow rate = 146.36	
Bulk cooler water flow rate = 125.20	Air flow rate = 125.00
Bulk cooler duty = 4845.56	Wet bulb out = 3.17
Power requirements	
Compressor 1 load = 86.47%	Load power factor = 1.057
Compressor 2 load = 87.04%	Load power factor = 1.056
Compressor 1 input power = 641.89	
Compressor 2 input power = 645.05	
Evaporator pump power = 10.30	
Condenser fan and pump power = 100.69	
Total input power = 1397.93	
Total evaporator duty = 5670.04	
Overall power to cooling ratio = 4.0560	
Evaporator details	
Number of cassettes = 159	Fouling factor = 4
Condenser details	
Airflow rate = 117	Fouling factor = 5

## 4.6 Mount Isa U62 bulk air cooler

### 4.6.1 General

The second phase of the Mount Isa 3000 ore bodies refrigeration plan requires that a 12 MWR surface bulk air cooler should be installed at U62 shaft. The timing coincides with the end of the pre-production development period and the build up in production to 2.0 million tonnes per year and is required to be operational in October 1993.

Tenders for the stage 2 refrigeration system were received from three companies. Essentially each prospective supplier provided two main proposals where the plant either operated as a batch process with storage dams or continuously without storage dams. For each proposal an alternative using either evaporative condensers or closed plate heat exchangers and cooling towers was provided.

Supplier 1 proposed the most integrated systems with the compressors connected to common evaporators and condensers. Supplier 3 opted for parallel circuits with both the refrigerant and chilled water circuits being independent of each other. The system proposed by Supplier 2 had an integrated water circuit and separate refrigeration circuits. In general, the greater the amount of integration the lower the initial cost and the higher the power requirements.

The refrigeration plant is required to operate over a wide range of ambient climatic conditions consequently a technical assessment of the plant should evaluate performance and input power requirements at "off" design conditions. The method used follows closely that employed to evaluate the Mount Isa stage 1 plant performance and the North mine surface plant described in sections 4.4 and 4.5.

The refrigerant used in all proposals is ammonia and the properties relevant to plant evaluation are summarised section 2.2.3. All prospective suppliers proposed different compressors (Howden, Stal and Sabroe) and the characteristic curves of adiabatic head and efficiency against compressor inlet refrigerant flow rate are summarised in section 3.1.

Heat rejection for all proposals comprised of either modular and packaged evaporative condensers or closed plate heat exchangers and cross flow cooling towers. The performance assessment of the evaporative condensers is summarised in section 3.2.3 and was based on the rated performance data provided by the three main manufacturers of this equipment.

For the closed plate heat exchanger and condenser cooling tower alternatives, all suppliers based their proposals on Alfa-Laval plate heat exchangers and Baltimore Aircoil cross flow cooling towers.

The plant provides chilled water to a bulk air cooler which handles intake air. Evaporator fouling is therefore considered to be relatively low and controllable with either slipstream filtration or bleed off and make up water. It was therefore not essential to provide open evaporators at a higher cost. The performance of the Alfa Laval closed plate evaporators proposed by all prospective suppliers is summarised in section 3.3.3.

The performance of the bulk air cooler is probably the most critical aspect of the different proposals. Suppliers 1 and 3 proposed to use a Baltimore Aircoil design similar to the North mine surface plant. The rated performance of this tower is summarised in Table 4.22 (factor of merit averaging 0.84) and was higher than would be expected for this type of counter flow cooling tower. The tests on a similar tower installed at North Mine in Broken Hill indicated a factor of merit of 0.75 after correcting some air and water distribution problems.

Supplier 2 co-operated with Sulzer (supplier of the Mount Isa stage 1 pre-cooling tower) to optimise the refrigeration plant and bulk air cooler arrangement. The Sulzer tower rated performance is summarised in Table 4.23 and drops significantly when surface wet bulb temperature is less than 16°C. This is almost certainly a result of conservative data presentation at low temperatures.

For surface wet bulb temperatures above 18°C, the mean factor of merit is 0.78. This decreases to an average of 0.75 when the performance at surface wet bulb temperatures down to 14°C are included. A value of 0.78 was used in the overall performance assessment.

A total of twelve simulations were developed (four for each supplier) and used in the "off design performance analysis". The simulations for the full load and part load alternatives for the Supplier 2 proposals are given in Appendix 4 and are illustrative of the range of simulations developed.

#### 4.6.2 Supplier 1 proposals

Supplier 1 originally provided two main proposals with the plant located adjacent to R63 plant (section 4.2). Both proposals used closed plate heat exchangers and cross flow cooling towers for condensing. Alternatives using evaporative condensers were subsequently supplied when requested. In proposal 1, the chiller sets operate as a batch process with storage dams used as a thermal flywheel. Proposal 2 eliminated the storage dams and had the compressors unloading to match the bulk air cooler demand.

A general arrangement of the equipment for proposal 1 is given in figure 4.33. The overall performance analysis is summarised for the two condenser alternatives in Table 4.24. With the reduction in

Table 4.22 - Mount Isa U62 plant : Rated performance of the Baltimore Air Coil Tower

Supplier 1 proposals											
Alternative 1 - 6.1 m by 7.3 m cell						Alternative 2 - 6.1 m by 9.1 m cell					
$n_w$	120.0	120.0	120.0	200.0	200.0	110.0	110.0	110.0	110.0	110.0	110.0
$n_a$	129.6	129.6	150.0	218.9	218.9	155.6	156.9	158.5	162.6	160.2	168.0
$t_{vbi}$	26.00	26.00	26.00	26.00	26.00	8.00	8.00	16.00	16.00	26.00	26.00
$t_{dbi}$	36.00	36.00	36.00	36.00	36.00	18.00	18.00	26.00	26.00	36.00	36.00
$t_{wot}$	23.55	21.84	21.31	22.57	22.90	7.50	6.94	14.90	13.58	25.54	24.52
$t_{wit}$	13.56	11.83	2.00	10.00	11.15	5.94	3.78	8.56	2.00	14.61	2.00
$s_{ai}$	77.50	77.50	77.50	77.50	77.50	24.33	24.33	43.68	43.68	77.50	77.50
$s_{wi}$	37.19	32.94	12.75	28.94	31.60	20.12	15.97	25.51	12.75	39.92	12.75
$n_w$	.8030	.7064	.8046	.7856	.7913	.7573	.7480	.8518	.8268	.9593	.9385
R	1.057	1.089	1.097	1.114	1.098	1.194	1.223	1.012	1.090	.7698	.8978
y	1.306	1.273	1.664	1.714	1.591	2.540	2.967	1.072	1.748	.1555	.3907
z	-4.750	-2.8021	-5.453	-4.943	-4.920	-5.150	-5.278	-5.979	-6.447	-7.283	-8.808
F	0.826	0.737	0.845	0.832	0.831	0.837	0.841	0.857	0.866	0.879	0.898

The calculated factor of merit based on the suppliers rated values varies between 0.74 and 0.90 with an average value of 0.84.

Supplier 3 Proposals											
$n_w$	110.0	116.0	177.0	159.0	143.0	127.4	113.0	98.4	82.6	71.9	55.0
$n_a$	196.3	197.9	199.5	201.0	202.6	204.1	205.7	207.2	208.8	210.3	98.2
$t_{vbi}$	26.00	24.00	22.00	20.00	18.00	16.00	14.00	12.00	10.00	8.00	26.00
$t_{dbi}$	36.00	34.00	32.00	30.00	28.00	26.00	24.00	22.00	20.00	18.00	36.00
$t_{wot}$	25.00	22.40	15.90	15.10	14.20	13.20	12.10	10.80	9.40	7.70	25.00
$t_{wit}$	2.00	2.00	2.00	2.00	2.00	2.00	2.00	2.00	2.00	2.00	2.00
$s_{ai}$	78.22	70.26	62.93	56.15	49.88	44.06	38.66	33.64	28.94	24.55	78.22
$s_{wi}$	12.89	12.89	12.89	12.89	12.89	12.89	12.89	12.89	12.89	12.89	12.89
$n_w$	.9583	.9273	.6950	.7278	.7625	.8000	.8417	.8800	.9250	.9500	.9583
R	.8612	.9405	1.484	1.377	1.278	1.173	1.071	.9581	.8254	.7364	.8612
y	.2385	.5686	-9.665	-115.0	9.286	3.249	1.601	.7649	.3171	.1664	.2385
z	-9.727	-9.258	-	-	-8.845	-7.258	-6.849	-6.286	-6.091	-6.018	-9.732
F	0.907	0.903	-	-	0.898	0.879	0.873	0.863	0.859	0.858	0.907

The calculated factor of merit based on the suppliers rated values varies between 0.86 and 0.91 with an average value of 0.88.

Table 4.23 - Mount Isa U62 plant : Rated performance of the Sulzer cooling Tower

$m_w$	96.0	96.0	167.0	183.0	137.0	110.0	96.0	96.0	96.0	183.0	183.0
$m_a$	188.5	190.0	191.6	193.0	194.5	196.0	136.7	137.7	138.8	188.5	190.0
$t_{wbi}$	26.00	24.00	22.00	20.00	18.00	16.00	14.00	12.00	10.00	26.00	24.00
$t_{dbi}$	36.00	34.00	32.00	30.00	28.00	26.00	24.00	22.00	20.00	36.00	34.00
$t_{wot}$	23.30	22.90	13.90	11.40	12.50	12.60	8.20	5.70	2.70	19.50	16.50
$t_{wit}$	1.00	1.00	1.00	1.00	1.00	1.00	1.00	1.00	1.00	7.80	5.00
$S_{ai}$	78.22	70.26	62.93	56.15	49.88	44.06	38.66	33.64	28.94	78.22	70.26
$S_{wi}$	11.14	11.14	11.14	11.14	11.14	11.14	11.14	11.14	11.14	24.12	18.46
$n_w$	.8920	.9522	.6143	.5474	.6765	.7733	.5538	.4273	.1889	.6429	.6053
R	.7940	.8223	1.480	1.675	1.293	1.070	1.388	1.426	1.463	1.366	1.478
y	.3702	.2203	4.230	5.431	2.587	1.313	1.928	1.466	1.121	2.936	3.741
z	-4.400	-7.870	-3.518	-3.083	-3.591	-4.005	-1.930	-1.035	-0.287	-3.331	-3.228
F	0.815	0.887	0.779	0.755	0.782	0.800	0.659	0.509	0.223	0.769	0.764
$m_w$	183.0	183.0	183.0	140.0	91.0	91.0	91.0	91.0	91.0	91.0	91.0
$m_a$	191.6	193.0	194.5	196.0	106.0	106.8	107.7	108.5	109.3	110.2	111.0
$t_{wbi}$	22.00	20.00	18.00	16.00	26.00	24.00	22.00	20.00	18.00	16.00	14.00
$t_{dbi}$	32.00	30.00	28.00	26.00	36.00	34.00	32.00	30.00	28.00	26.00	24.00
$t_{wot}$	13.10	11.40	10.30	9.20	21.50	18.50	15.50	13.40	11.00	9.60	8.50
$t_{wit}$	1.30	1.00	1.70	2.20	10.30	7.40	4.10	3.10	2.80	1.60	2.40
$S_{ai}$	62.93	56.15	49.88	44.07	78.22	70.26	62.93	56.15	49.88	44.07	38.66
$S_{wi}$	11.66	11.14	12.36	13.25	29.62	23.29	16.74	14.88	14.33	12.19	13.61
$n_w$	.5700	.5474	.5276	.5072	.7134	.6687	.6369	.6095	.5395	.5556	.5259
R	1.614	1.675	1.711	1.339	1.161	1.260	1.371	1.437	1.489	1.561	1.576
y	5.389	5.431	4.844	1.535	1.666	2.100	2.858	3.146	2.342	3.350	2.771
z	-3.321	-3.083	-2.752	-1.422	-3.373	-3.135	-3.214	-3.032	-2.040	-2.574	-2.122
F	0.769	0.755	0.734	0.587	0.771	0.758	0.763	0.752	0.671	0.720	0.680



Figure 4.33 - Mount Isa U62 plant : General arrangement for Supplier 1 proposals

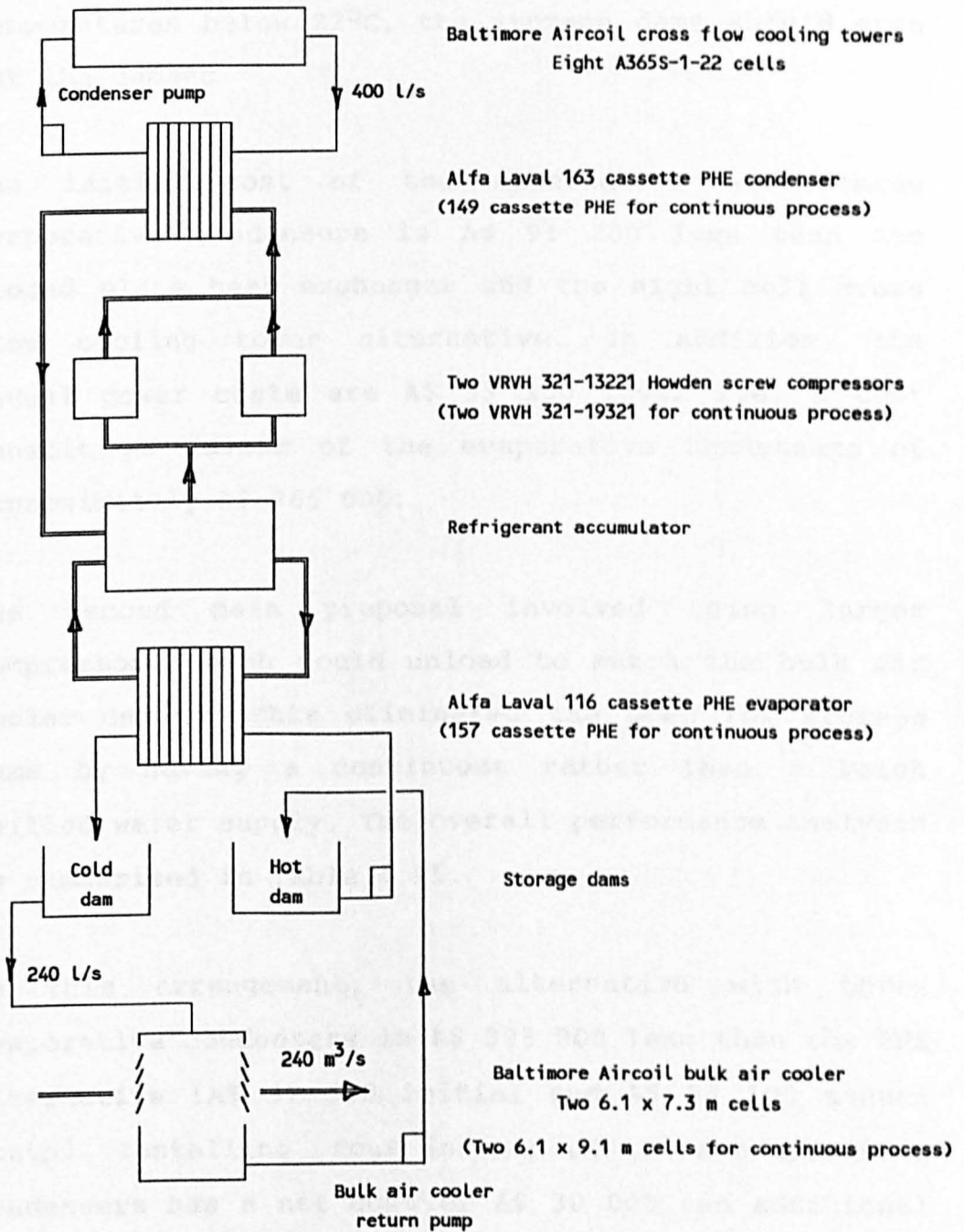

Alternative condenser - Baltimore Aircoil evaporative condensers : 3 or 4 VX1060 units.

rated bulk air cooler performance, the plant cannot actually meet the demand when the surface wet bulb temperature is above 22°C. Providing that the hottest days have the same number of hours with night time temperatures below 22°C, the storage dams should even out the demand.

The initial cost of the alternative with three evaporative condensers is A\$ 91 200 less than the closed plate heat exchanger and the eight cell cross flow cooling tower alternative. In addition, the annual power costs are A\$ 53 100 lower i.e. a cost benefit in favour of the evaporative condensers of approximately A\$ 265 000.

The second main proposal involved using larger compressors which could unload to match the bulk air cooler demand. This eliminated the need for storage dams by having a continuous rather than a batch chilled water supply. The overall performance analysis is summarised in Table 4.25.

In this arrangement, the alternative with three evaporative condensers is A\$ 395 000 less than the PHE alternative (A\$ 91 200 initial and A\$ 93 100 annual costs). Installing four instead of three evaporative condensers has a net cost of A\$ 30 000 (an additional initial cost of A\$ 125 000 and an annual operating saving of A\$ 29 000).

Based on the evaporative condenser alternatives, operating the plant as a batch process (proposal 1) rather than continuous without dams (proposal 2) has an increase in initial costs of A\$ 195 000 and a saving in power costs of A\$ 75 000 per year i.e. a cost benefit in favour of the batch process proposal using storage dams of A\$ 50 000.

#### 4.6.3 Supplier 2 proposals

Supplier 2 originally provided two main proposals (batch or continuous process) with evaporative condensers only. Closed plate heat exchangers with cross flow cooling towers for heat rejection were subsequently provided as alternatives. For the batch process (proposal 1) the larger Stal S93 screw compressor were selected. The smaller Stal S75E compressor with an economiser was proposed for the continuous process without dams (proposal 2).

A general arrangement of the equipment proposed by Supplier 2 for the batch process with dams is given in figure 4.34. The original proposal was based on Muller (Evapco design) evaporative condensers as given in the figure. Two arrangements were given for the closed plate heat exchanger and cross flow cooling tower alternatives.

The first attempted to match the initial cost of the evaporative condenser by minimising the closed plate

**Table 4.24(a) - Supplier 1, Proposal 1 : Full load compressor operation,  
Plate heat exchanger and cooling towers**

Wet bulb	No of hours	Evap. flow	Bulk flow	Bulk water		Bulk air	Plant power	
				in	out		COP	kWhx10 <sup>6</sup>
26	120	225.4	240.0	11.8	21.8	15.0	4.735	0.252
24	912	209.7	240.0	9.1	19.1	12.0	4.653	1.937
22	1080	219.7	240.0	7.8	17.0	10.2	4.695	2.099
20	1296	248.8	240.0	7.3	15.3	9.3	4.806	2.166
18	1272	291.9	240.0	7.0	13.7	8.6	4.917	1.797
16	1200	350.8	240.0	6.7	12.3	7.9	4.984	1.414
14	984	442.5	240.0	6.5	10.9	7.4	4.933	0.956
12	864	334.1	240.0	6.4	9.6	7.0	5.365	0.558
10	552	233.7	120.0	2.5	6.5	3.1	6.023	0.230

Total power requirements are  $11.362 \times 10^6$  kWh/year which results in an annual operating cost of A\$ 943 000 per year.

**Table 4.24(b) - Supplier 1, Proposal 1 : Full load compressor operation,  
Evaporative condensers**

Wet bulb	No of hours	Evap. flow	Bulk flow	Bulk water		Bulk air	Plant power	
				in	out		COP	kWhx10 <sup>6</sup>
26	120	243.1	240.0	12.5	22.0	15.6	5.420	0.227
24	912	211.9	240.0	9.1	19.1	12.0	5.152	1.749
22	1080	221.5	240.0	7.8	17.0	10.2	5.117	1.926
20	1296	250.2	240.0	7.3	15.3	9.3	5.161	2.019
18	1272	292.7	240.0	7.0	13.7	8.6	5.198	1.703
16	1200	350.8	240.0	6.7	12.3	7.9	5.181	1.362
14	984	441.3	240.0	6.5	10.9	7.4	5.039	0.937
12	864	329.0	240.0	6.4	9.6	7.0	5.165	0.576
10	552	232.1	120.0	2.5	6.5	3.1	5.547	0.222

Total power requirements are  $10.722 \times 10^6$  kWh/year which results in an annual operating cost of A\$ 889 900 per year.

**Table 4.25(a) - Supplier 1, Proposal 2 : Part load compressor operation,  
Plate heat exchanger and cooling towers**

Wet bulb	No of hours	Evap. flow	Bulk flow	Bulk water in	Bulk water out	Bulk air	Plant power COP kWhx10 <sup>6</sup>		% Load
26	120	200.0	200.0	8.4	20.4	12.1	3.933	0.305	84
24	912	200.0	200.0	5.5	17.4	8.9	3.856	2.365	93
22	1080	200.0	200.0	4.4	15.3	7.3	3.922	2.533	87
20	1296	200.0	200.0	4.3	13.9	6.6	4.132	2.509	74
18	1272	200.0	200.0	4.4	12.5	6.2	4.313	2.005	61
16	1200	200.0	200.0	4.5	11.2	5.9	4.874	1.379	96
14	984	200.0	200.0	4.8	10.1	5.9	4.931	0.878	73
12	864	200.0	200.0	5.2	9.0	5.9	5.392	0.513	52
10	552	200.0	200.0	5.7	8.1	6.2	4.256	0.259	32

The total power requirements are  $12.747 \times 10^6$  kWh/year which results in an annual operating cost of A\$ 1 058 000.

**Table 4.25(b) - Supplier 1, Proposal 2 : Part load compressor operation,  
3 or 4 Evaporative condensers**

Wet bulb	No of hours	Evap. flow	Bulk flow	Bulk water in	Bulk water out	Bulk air	Plant power COP kWhx10 <sup>6</sup>		% Load
26	120	200.0	200.0	8.4	20.3	12.1	4.707	0.255	82
24	912	200.0	200.0	5.5	17.4	8.9	4.477	2.037	91
22	1080	200.0	200.0	4.4	15.3	7.3	4.459	2.228	86
20	1296	200.0	200.0	4.3	13.9	6.6	4.585	2.261	74
18	1272	200.0	200.0	4.4	12.5	6.2	4.652	1.859	61
16	1200	200.0	200.0	4.5	11.2	5.9	5.172	1.299	96
14	984	200.0	200.0	4.8	10.1	5.9	5.231	0.828	73
12	864	200.0	200.0	5.2	9.0	5.9	5.017	0.551	52
10	552	200.0	200.0	5.7	8.1	6.2	3.598	0.307	32
<b>Four evaporative condensers</b>									
26	120	200.0	200.0	8.4	20.3	12.1	4.902	0.245	81
24	912	200.0	200.0	5.5	17.4	8.9	4.662	1.956	90
22	1080	200.0	200.0	4.4	15.3	7.3	4.653	2.135	85
20	1296	200.0	200.0	4.3	13.9	6.6	4.783	2.168	73
18	1272	200.0	200.0	4.4	12.5	6.2	4.838	1.788	60

Three evaporative condensers - The total power requirements are  $11.625 \times 10^6$  kWh/year which results in an annual operating cost of A\$ 964 900.

Four evaporative condensers - The total power requirements are  $11.276 \times 10^6$  kWh/year which results in an annual operating cost of A\$ 935 900.

heat exchanger and cooling tower sizes. This resulted in excessive condensing temperatures (over 40°C) and was not considered in detail any further. The alternative used for comparison had the same size cooling towers as proposed by Supplier 1 and two 107 cassette plate heat exchangers.

The overall performance analysis is summarised for the two condenser alternatives in Tables 4.26. The initial cost of the alternative with the plate heat exchangers and the cross flow cooling towers is A\$ 127 000 higher than that using the evaporative condensers. This could be reduced to A\$ 16 000 by using a 130 cassette plate heat exchanger, however, the condensing temperatures were over 40°C.

The annual power costs for the alternative using the evaporative condensers was A\$ 79 500 less than that using the closed plate heat exchangers, resulting in a cost benefit in favour of the evaporative condensers of approximately A\$ 385 000. The low initial cost plate heat exchanger alternative used a single 130 cassette plate heat exchanger (as compared to two 104 cassette heat exchangers) with the same condenser water flow rate of 500 l/s and the A365S-1-22 cross flow cooling towers.

The general arrangement for the continuous compressor operation process is very similar to the batch process proposal. The differences are that there are no

storage dams and that the Stal S75E screw compressor was to be used instead of the S93 compressors. The economiser associated with the smaller compressor increased its evaporator duty by approximately 9% when operating at full load.

This compressor arrangement cannot quite meet the peak demand when the wet bulb temperature is above 24°C although the shortfall is of the order of only 1%. The S93 compressor arrangement is far more flexible and was used in the performance assessment. The overall performance analysis is summarised for the two condenser alternatives in Table 4.27. As for proposal 1, the initial cost of the alternative with the closed plate heat exchangers and the cross flow cooling towers is A\$ 127 000 higher than that for evaporative condensers.

The annual power costs for the alternative using the evaporative condensers was A\$ 71 700 less than that using the closed plate heat exchangers, resulting in a cost benefit in favour of the evaporative condensers of approximately A\$ 360 000. Based on the evaporative condenser alternatives, operating the refrigeration plant as a batch process rather than continuous without dams has an increase in both initial and operating costs of A\$ 195 000 and A\$ 43 300/year respectively i.e. the cost benefit in favour of the continuous process is approximately A\$ 335 000.

Figure 4.34 - Mount Isa U62 plant : General arrangement for the Supplier 2 proposals

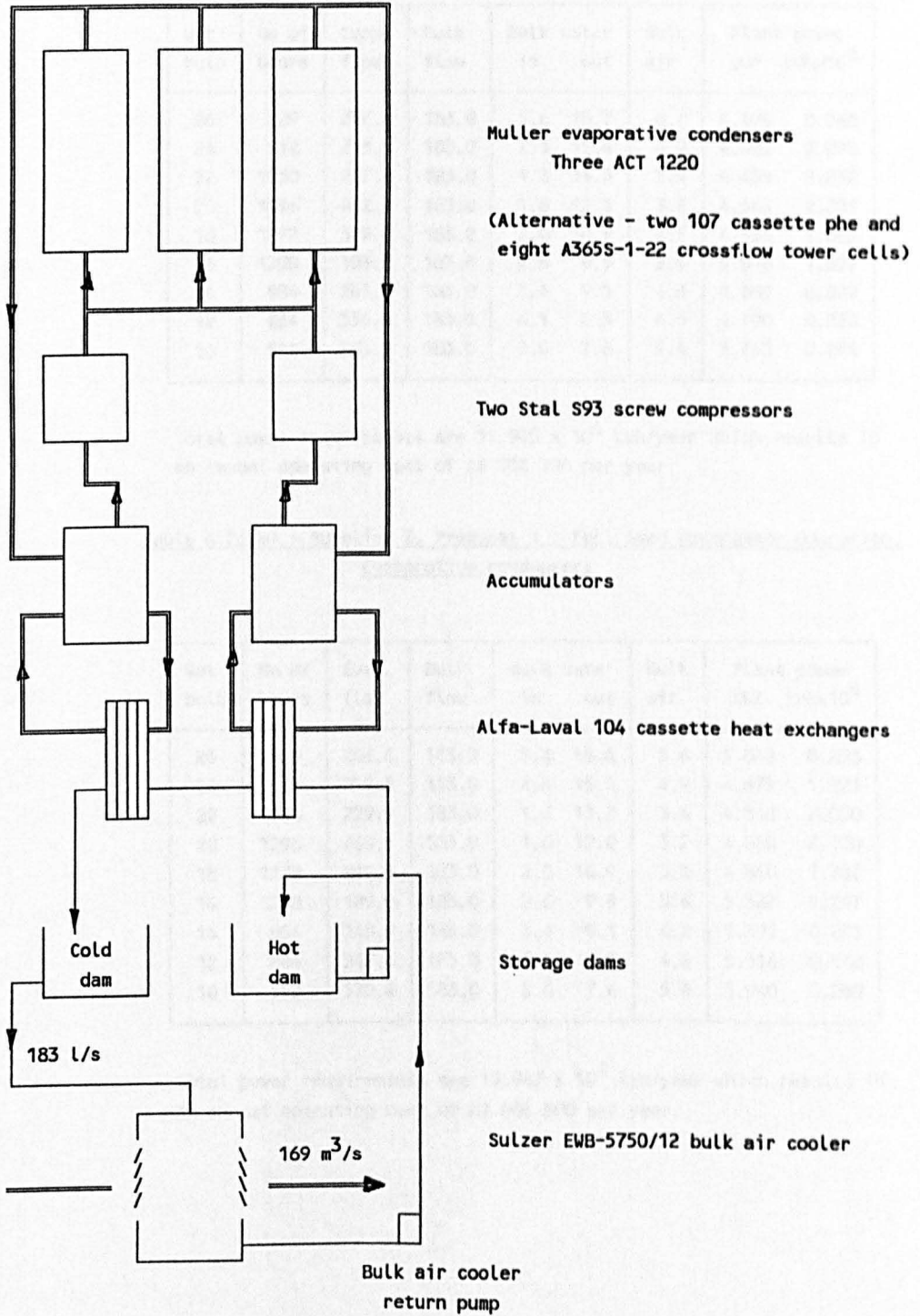



Table 4.26(a) - Supplier 2, Proposal 1 : Full load compressor operation,  
Plate heat exchanger and cooling towers

Wet bulb	No of hours	Evap. flow	Bulk flow	Bulk water in	Bulk water out	Bulk air	Plant power COP kWhx10 <sup>6</sup>	
26	120	237.9	183.0	5.6	18.7	8.7	4.479	0.268
24	912	215.9	183.0	2.3	15.4	4.9	4.406	2.070
22	1080	227.0	183.0	1.3	13.3	3.4	4.451	2.232
20	1296	262.1	183.0	1.6	12.1	3.3	4.545	2.281
18	1272	309.8	183.0	2.0	10.9	3.3	4.588	1.885
16	1200	183.2	183.0	2.6	9.9	3.6	4.810	1.397
14	984	241.5	183.0	3.4	9.1	4.2	4.869	0.889
12	864	336.6	183.0	4.1	8.3	4.6	4.700	0.588
10	552	553.5	183.0	5.0	7.6	5.4	3.753	0.294

Total power requirements are  $11.905 \times 10^6$  kWh/year which results in an annual operating cost of A\$ 988 100 per year.

Table 4.26(b) - Supplier 2, Proposal 1 : Full load compressor operation,  
Evaporative condensers

Wet bulb	No of hours	Evap. flow	Bulk flow	Bulk water in	Bulk water out	Bulk air	Plant power COP kWhx10 <sup>6</sup>	
26	120	242.6	183.0	5.6	18.6	8.6	5.048	0.238
24	912	219.5	183.0	2.3	15.4	4.9	4.875	1.871
22	1080	229.9	183.0	1.3	13.3	3.4	4.846	2.050
20	1296	263.1	183.0	1.6	12.0	3.2	4.868	2.130
18	1272	311.5	183.0	2.0	10.9	3.3	4.840	1.787
16	1200	189.9	183.0	2.6	9.9	3.6	5.387	1.247
14	984	249.9	183.0	3.4	9.1	4.2	5.393	0.803
12	864	347.6	183.0	4.1	8.3	4.6	5.116	0.540
10	552	570.4	183.0	5.0	7.6	5.4	3.940	0.280

Total power requirements are  $10.947 \times 10^6$  kWh/year which results in an annual operating cost of A\$ 908 600 per year.

Table 4.27(a) - Supplier 2, Proposal 2 : Part load compressor operation,  
Plate heat exchanger and cooling towers

Wet bulb	No of hours	Evap. flow	Bulk flow	Bulk water in	Bulk water out	Bulk air	Plant power COP kWhx10 <sup>6</sup>		% Load
26	120	183.0	183.0	5.6	18.7	8.7	4.670	0.257	74
24	912	183.0	183.0	2.3	15.4	5.0	4.445	2.052	83
22	1080	183.0	183.0	1.3	13.3	3.5	4.546	2.185	79
20	1296	183.0	183.0	1.6	12.1	3.3	4.823	2.149	67
18	1272	183.0	183.0	2.1	10.9	3.4	5.017	1.724	61
16	1200	183.0	183.0	2.6	9.9	3.6	4.811	1.397	100
14	984	183.0	183.0	3.3	9.1	4.1	5.302	0.817	73
12	864	183.0	183.0	4.2	8.3	4.7	5.650	0.489	50
10	552	183.0	183.0	5.0	7.7	5.4	5.069	0.218	29

Total power requirements are  $11.289 \times 10^6$  kWh/year which results in annual operating costs of A\$ 937 000.

Table 4.27(b) - Supplier 2, Proposal 2 : Part load compressor operation,  
Evaporative condensers

Wet bulb	No of hours	Evap. flow	Bulk flow	Bulk water in	Bulk water out	Bulk air	Plant power COP kWhx10 <sup>6</sup>		% Load
26	120	183.0	183.0	5.6	18.6	8.6	5.307	0.226	73
24	912	183.0	183.0	2.3	15.4	4.9	4.943	1.845	82
22	1080	183.0	183.0	1.3	13.3	3.4	4.965	2.001	78
20	1296	183.0	183.0	1.5	12.0	3.2	5.162	2.008	67
18	1272	183.0	183.0	2.0	10.9	3.3	5.272	1.641	56
16	1200	183.0	183.0	2.6	9.9	3.6	5.384	1.248	96
14	984	183.0	183.0	3.4	9.1	4.2	5.775	0.750	71
12	864	183.0	183.0	4.1	8.3	4.7	5.774	0.479	49
10	552	183.0	183.0	5.0	7.6	5.4	4.862	0.227	29

Total power requirements are  $10.425 \times 10^6$  kWh/year which results in annual operating cost = A\$ 865 300.

#### 4.6.4 Supplier 3 proposals

The original proposal for supplier 3 was based on a continuous process without storage dams and offered both evaporative and closed plate heat exchangers with cooling towers for heat rejection as condenser alternatives. The same equipment was used in a batch process arrangement in order to provide a basis for comparison.

A general arrangement of the equipment proposed by Supplier 3 (closed plate heat exchanger and cross flow cooling tower alternative) and arranged as a batch process with storage dams is given in figure 4.35. The condenser water flow rate through each of the closed plate heat exchangers is 260 l/s and the design flow rate in each cross flow cooling tower cell is 130 l/s. When only one compressor is operating, the number of cooling tower cells operational is determined by the requirement to maintain a minimum condensing temperature of 20°C.

The overall performance analysis for the batch process equipment arrangement and the two condenser alternatives is summarised in Table 4.28. The initial cost of the alternative with the two 88 cassette plate heat exchangers and the four cell cross flow cooling tower is A\$ 128 000 higher than that using the seven Auscon evaporative condensers.

The annual power costs for the alternative using the evaporative condensers was A\$ 60 200 less than that using the closed plate heat exchangers, resulting in a cost benefit in favour of the alternative using the evaporative condensers of approximately A\$ 325 000.

The general arrangement for the continuous compressor operation process is very similar to the batch process proposal with the main difference being that there are no storage dams. The overall performance analysis is summarised for the two condenser alternatives in Table 4.29. As for proposal 1, the initial cost of the alternative with the plate heat exchangers and the cross flow cooling towers is A\$ 128 000 higher than that using the evaporative condensers.

The annual power costs for the alternative using the evaporative condensers was A\$ 32 400 less than that using the closed plate heat exchangers, resulting in a cost benefit in favour of the evaporative condensers of approximately A\$ 235 000.

Based on the evaporative condenser alternatives, operating the refrigeration plant as a batch process (proposal 1) rather than continuous without storage dams (proposal 2) has an increase in initial costs of A\$ 225 000 and savings in annual operating power costs of A\$ 44 300 respectively i.e. there is a cost benefit of A\$ 81 000 in favour of the continuous process.

#### 4.6.5 Summary of proposals

Based on the initial costs of equipment given in the tenders and the operating power costs obtained from the simulations, the overall cost for each proposal is summarised in Table 4.30 (operating costs discounted at 30% over 10 years).

Although the batch process proposals of Supplier 1 had the lowest overall costs, they were not technically feasible with the equipment proposed. They were included to give an indication of the low operating costs that could be expected by optimising the plant design using modelling. It can be concluded from the costs summarised in Table 4.30 that no one prospective supplier had a clear cost advantage and, where initial costs were kept low, the penalty of higher operating power costs offset this.

The refrigeration simulations are being used in conjunction with Supplier 2 to optimise the individual component selection.

Figure 4.35 - Mount Isa U62 plant : General arrangement for the Supplier 3 proposals

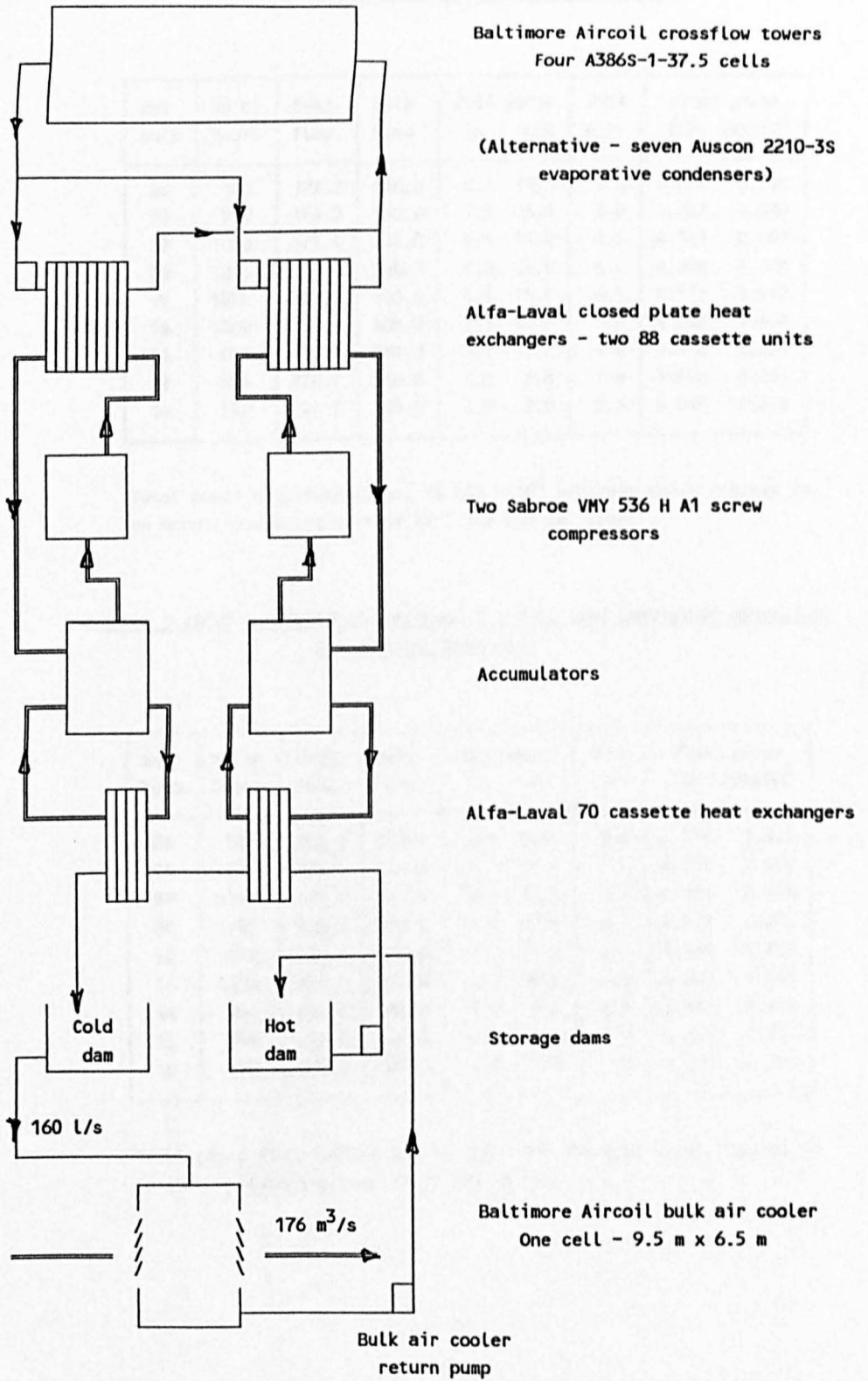

Table 4.28(a) - Supplier 3, Proposal 1 : Full load compressor operation,  
Plate heat exchanger and cooling towers

Wet bulb	No of hours	Evap. flow	Bulk flow	Bulk water in	Bulk water out	Bulk air	Plant power COP	kWhx10 <sup>6</sup>
26	120	177.3	160.0	4.4	19.3	9.6	4.091	0.293
24	912	164.0	160.0	1.5	16.4	6.2	4.032	2.262
22	1080	171.4	160.0	0.5	14.2	4.5	4.129	2.407
20	1296	201.0	160.0	1.0	12.9	4.2	4.346	2.386
18	1272	241.5	160.0	1.6	11.7	4.1	4.523	1.912
16	1200	299.9	160.0	2.3	10.7	4.3	4.622	1.454
14	984	195.7	160.0	3.1	9.7	4.6	4.492	0.964
12	864	276.7	160.0	4.0	8.8	5.0	3.996	0.692
10	552	276.7	160.0	4.9	7.9	5.6	3.996	0.276

Total power requirements are  $12.646 \times 10^6$  kWh/year which results in an annual operating cost of A\$ 1 049 600 per year.

Table 4.28(b) - Supplier 3, Proposal 1 : Full load compressor operation,  
Evaporative condensers

Wet bulb	No of hours	Evap. flow	Bulk flow	Bulk water in	Bulk water out	Bulk air	Plant power COP	kWhx10 <sup>6</sup>
26	120	180.9	160.0	4.4	19.3	9.6	4.597	0.261
24	912	166.6	160.0	1.5	16.4	6.2	4.428	2.060
22	1080	173.5	160.0	0.5	14.2	4.5	4.428	2.244
20	1296	202.8	160.0	1.0	12.9	4.2	4.562	2.273
18	1272	242.9	160.0	1.6	11.7	4.1	4.654	1.859
16	1200	300.7	160.0	2.3	10.7	4.3	4.669	1.439
14	984	202.2	160.0	3.1	9.7	4.6	4.943	0.876
12	864	285.4	160.0	4.0	8.8	5.0	4.257	0.649
10	552	276.7	160.0	4.9	7.9	5.6	4.257	0.259

Total power requirements are  $11.920 \times 10^6$  kWh/year which results in an annual operating cost of A\$ 989 400 per year.

**Table 4.29(a) - Supplier 3, Proposal 2 : Part load compressor operation,  
Plate heat exchanger and cooling towers**

Wet bulb	No of hours	Evap. flow	Bulk flow	Bulk water in	Bulk water out	Bulk air	Plant power COP kWhx10 <sup>6</sup>		% Load
26	120	160.0	160.0	4.4	19.4	9.6	3.931	0.305	87
24	912	160.0	160.0	1.6	16.4	6.2	3.973	2.296	96
22	1080	160.0	160.0	0.5	14.2	4.5	4.293	2.314	91
20	1296	160.0	160.0	1.0	12.9	4.2	4.366	2.375	77
18	1272	160.0	160.0	1.6	11.7	4.1	4.339	1.994	63
16	1200	160.0	160.0	2.3	10.7	4.3	3.946	1.703	50
14	984	160.0	160.0	3.1	9.7	4.6	5.341	0.811	76
12	864	160.0	160.0	4.0	8.8	5.0	5.200	0.532	52
10	552	160.0	160.0	5.0	7.9	5.6	3.094	0.357	32

Total power requirements are  $12.844 \times 10^6$  kWh/year which results in annual operating cost of A\$ 1 066 100.

**Table 4.29(b) - Supplier Proposal 2 : Part load compressor operation,  
Evaporative condensers**

Wet bulb	No of hours	Evap. flow	Bulk flow	Bulk water in	Bulk water out	Bulk air	Plant power COP kWhx10 <sup>6</sup>		% Load
26	120	160.0	160.0	4.4	19.3	9.6	4.456	0.269	89
24	912	160.0	160.0	1.6	16.4	6.2	4.342	2.100	97
22	1080	160.0	160.0	0.5	14.2	4.5	4.005	2.481	92
20	1296	160.0	160.0	1.0	12.9	4.2	4.176	2.483	77
18	1272	160.0	160.0	1.6	11.7	4.1	4.330	1.998	63
16	1200	160.0	160.0	2.3	10.7	4.3	4.236	1.586	49
14	984	160.0	160.0	3.1	9.7	4.6	4.803	0.901	79
12	864	160.0	160.0	4.0	8.8	5.0	5.074	0.545	53
10	552	160.0	160.0	5.0	7.9	5.6	4.435	0.249	30

Total power requirements are  $12.455 \times 10^6$  kWh/year which results in annual operating cost = A\$ 1 033 700.



Table 4.30 - Stage 2 refrigeration plant cost summary

Plant arrangement	Supplier 1	Supplier 2	Supplier 3
<u>Batch process</u>			
Phe and cooling tower	5 486 000	5 954 000	5 741 000
Evaporative	5 156 000	5 582 000	5 683 000
<u>Continuous process</u>			
Phe and cooling tower	5 587 000	5 571 000	5 567 000
Evaporative	5 205 000	5 223 000	5 595 000

## 5 SUMMARY AND RECOMMENDATIONS

### 5.1 Summary of the research

The increasing scarcity of minerals of a mineable grade at shallow depths and the acceptance that there are significant decreases in productivity when working in adverse thermal environmental conditions have resulted in an almost exponential increase in mine refrigeration in the last 25 years. As a consequence, ventilation and increasingly refrigeration, are taking a greater proportion of the resources used in mining.

The optimum amount of refrigeration required on a mine is a balance between the initial and operating costs of the plant relative to the benefit of improving the thermal environmental conditions and increasing employee productivity. Climatic variations and the effect of cyclic mining operations complicate the optimisation by introducing a complex load profile and variable thermal acceptance criteria.

Variations in employee productivity result from both the natural reduction in physical work rate in adverse thermal environmental conditions and the application of a shortened shift to control the occurrence of heat stress conditions. The cost of low productivity will depend on the ability of the mine infrastructure and organisation to adapt to changing labour demands and the revenue potential of the ore being mined.

The three main elements of a refrigeration system are the chiller subsystem, the heat rejection subsystem and the load subsystem all of which interact. Each subsystem usually comprises of several elements which also interact and a solution requires a relatively complex iterative procedure. The design of a plant with a complex load profile therefore requires that the system should be modelled and the effect of design changes simulated and then assessed.

Although modelling and computer simulations of the refrigeration processes has been developing over the last 15 years in both the air conditioning and mining industries, most of the work has been directed at the chiller subsystem and in particular those using centrifugal compressors. Modelling the performance of the central element, the compressor, has usually relied on general compressor curves using theoretical flow and head coefficients.

A method using empirical compressor performance curves based on the evaporator duty and input power to the compressor has been found to be of greater general application and not restricted to a single compressor type. Compressor performance is expressed in terms of adiabatic head and efficiency against inlet volume flow rate for a given refrigerant. The simulations have been extended to include fully the heat rejection and load subsystems and are based on steady state rather than dynamic conditions.

For the five refrigeration system models considered, two types of compressor (nine different models), four types of evaporator, three types of condenser, two types of cooling tower and five types of cooling appliance were used. The thermal performance of each was considered and the method of analysis defined and compared to actual performance measurements where these were available.

The five refrigeration systems modelled have a similar structure and method of converging to a solution which allowed a modular approach to be taken. The chiller subsystem comprised of the evaporator, condenser and compressor modules and, for given temperatures of the water into the evaporator and condenser, allowed the evaporator and condenser duties to be determined. From these values, the outlet water temperatures for the evaporator and condenser were established.

The condenser interfaces with the heat rejection subsystem and, by introducing this module, a balance can be achieved between the condenser duty and the heat rejected. The evaporator interfaces with the load subsystem which could be a straightforward single surface bulk air cooler or a complex sequence of heat exchangers of different types used both in parallel and in series circuits. The module analysis follows the same form with the distributional structure becoming more complex as more elements are introduced into the system.

The overall system operation modules link the three subsystems and incorporate the plant control strategy and the set operating configuration. Balancing the evaporator duty with the load subsystem by adjusting the evaporator water temperatures is the most critical element where the method of adjustment has a profound effect on the rate of convergence of the simulation. Although a universal method of adjustment that always converged rapidly was not found, trial and error methods always allowed a solution to be determined.

The five refrigeration system simulations described, demonstrate both the universal nature of the method used to structure and to solve the models and the varied applications for the simulations. The Mount Isa R63 plant using centrifugal compressor chiller sets was the first to be simulated and it was demonstrated that refrigeration plants with complex load systems could be modelled with an acceptable accuracy.

Modelling of the North mine underground refrigeration system extended the modelling to screw compressors and showed that the effects design aberrations (such as excessive refrigerant pressure losses) could be incorporated in the models. Despite a complex chiller set arrangement and an extensive load system, the model predictions in comparison with the measured values was acceptable. The effects of modifications to the plant could be simulated and any deficiencies in plant performance identified.

The Mount Isa surface plant models were initially used to determine the optimum refrigeration system control strategy. By correcting aspects of the model resulting from testing elements of the refrigeration plant, the simulation can be used to analyse the measurements obtained from the monitoring system. This analysis is then used to identify where corrective maintenance is necessary such as cleaning heat exchanger surfaces.

This diagnostic use for the simulations was further developed in the models of the North mine surface plant in addition to assessing the systems proposed by different suppliers and determining the optimum control system. Each of the system elements has been tested and the model adjusted to reflect the actual plant performance including part load operation of the compressors based on motor current readings.

Part load operation of compressors, the optimisation of system elements and the determination of optimum control strategies was further developed in the models used to analyse the proposals for the Mount Isa U62 surface bulk air cooler plant.

## 5.2 Recommendations for further work

A mine refrigeration system is part of an overall mine system which is dynamic in that the mining processes are causing continuous changes as does the surface climate which determines the refrigeration load. Fortunately the rate of change is slow or dampened and the system can be adequately represented by a steady state model. A future development of the modelling is its extension to fully control all the system elements including the load subsystem.

This will require an understanding of the relationship between surface and the underground conditions which influence the load subsystem. Since most refrigeration systems are batch processes supplying a continuous but varying load, the time element and the extent of dampening is a necessary part of any control strategy. Initially, the underground load subsystem will need to be monitored and historical time trends established and analysed.

Although the simulation models are initially based on the theoretical performance of the heat transfer equipment, the actual performance can be significantly different as a result of operating aberrations such as the water level in low profile evaporative condensers. More test work on operating equipment is therefore required to identify potential problems and to relate these to the theoretical simulations.

For a simulation to be used to control the operation of a refrigeration plant, the monitoring system must adequately reflect the true operating conditions. Further work is required with respect to the type, location and calibration of sensors within the plant. Although complex load systems can be simulated, there are practical limitations when considering the full control of these systems in the most cost effective manner. These limits need to be explored and related to the potential "waste" of cooling by having less sensitive controls.

The compressor is the central element of the model and further work relating its performance with different refrigerants is desirable.



## 9 REFERENCES

- ACGIH. (1986). Adopted threshold limit values for heat stress. In *Threshold limit values and biological exposure indices*. (Cincinnati: American Conference of governmental Industrial Hygienists), 66-72.
- Allen R.F. (1975). Ventilation of the 110 ore body at the Mount Isa Mine. In *Proceedings international mine ventilation congress, Johannesburg*, Hemp R. and Lancaster F.H. eds (Johannesburg: Mine Ventilation Society of South Africa, 1976), 365-374.
- ASHRAE. (1972). Heat transfer. In *Handbook of fundamentals*. (American Society of Heating, Refrigerating and Air Conditioning Engineers, New York), 31-62.
- Bailey-McEwan M. and Shone R.D.C. (1984). The specification and performance of water chillers for mine refrigeration installations. In *Third international mine ventilation congress, Harrogate*, Howes M.J. and Jones M.J. Eds (London: Institution of Mining and Metallurgy, 1984), 265-276.
- Bailey-McEwan M. and Penman J.C. (1987). An interactive computer programme for simulating the performance of water chilling installations on mines. In *Proceedings of the 20th international symposium on the application of computers and mathematics in the mineral industries*. (Johannesburg: S. Afr. Inst. Mining and Metallurgy), 291-305.
- Baker-Duly H.C.L. (1984). Control of refrigeration and ventilation systems in a South African gold mine. In *Third international mine ventilation congress, Harrogate*, Howes M.J. and Jones M.J. Eds (London: Institution of Mining and Metallurgy, 1984), 259-264.
- Baker-Duly H.C.L., Brouwer G. and Shaw J. (1988) Design of a large flexible underground refrigeration installation. In *Fourth international mine ventilation congress, Brisbane*. Gillies A.D.S. ed. (Melbourne: Australasian Institute of Mining and Metallurgy, 1988), 443-449.
- Barua D.I. and Nixon C.A.N. (1988). Ventilation and refrigeration design for the access and ore production decline to the deep copper ore body at Mount Isa. In *Fourth international mine ventilation congress, Brisbane*. Gillies A.D.S. ed. (Melbourne: Australasian Institute of Mining and Metallurgy, 1988), 465-471.
- Bidelot R and Ledent P. (1950). The air conditioning installation at the Charbonnages des Liegeois at Zwartberg. *Rev. Univer. des Mines*. 9th series, VI, Number 7.
- Bluhm S.J. (1980). Predicting performance of spray chambers for cooling air. *Heating Air Condition. Refrig.* 13, N<sup>o</sup> 2, Nov. 1980, 27-39.

Bluhm S.J. (1982). Development of an in line water spray cooler - Contribution. *J. Mine Vent. Soc. S Afr.* 35, 36-39.

Braun J.E. and others. (1987). Models for variable speed centrifugal chillers. In *ASHRAE transactions : technical and symposium papers.* (New York) 1794-1813.

Clark D.R. (1985). Centrifugal chiller model: preliminary documentation. US Department of Commerce, National Bureau of Standards.

Collison B.V. (1982). Cooling underground workings at North Broken Hill Limited - case study. In *Underground operators' conference, West Coast, Tasmania.* (Parkville, Vict: Australasian Institute of Mining and metallurgy), 71-82. (Symp. Series 31).

COM. (1987). Chiller - version 1. *Chamber of Mines Research Organisation.* (Johannesburg).

Cooke H.M. and others (1961). The effects of heat on the performance of work underground. *J. Mine Vent. Soc. S Afr.* 14, 177-188.

Davies E. (1922). Air cooling plant, Morro Velho Mine, Brazil. *Trans. Inst. Min. Engrs.* 63, 326-341.

Davis F.T. and Corripio A.B. (1974). Dynamic simulation of variable speed centrifugal compressors. In *Instrumentation in the chemical and petroleum industries.* Volume 10, ISA, Pittsburgh, USA, 15-24.

Du Pont. (1965). Thermodynamic properties of Freon 11. E.I. du Pont de Nemours, Wilmington, USA.

Ellison R.D. and Creswick F.A. (1978). A computer simulation of steady state performance of air to air heat pumps. *ORNL/CON-16 report.* (Oak ridge, TN: Oak Ridge national Laboratory).

Flower J.E. (1978). Analytical modelling of heat pump units as a design aid and for performance prediction. *UCRL-52618 report.* (Livermore, CA: Lawrence Livermore laboratory).

Freeman T.L. and others (1975). Computer modelling of heat pumps and the simulation of solar heat pump systems. *ASME paper 75-WA/Sol 3.* (New York: American Society of Mechanical Engineers).

Gorges R.A. (1952). Conditioning mine air and some experiments with deep level ventilation. *Bull. Mine Vent. Soc. South Africa.* 5, Numbers 10 and 11.

Graveling R.A., Morris L.A. and Graves R.J. (1988). Working in hot conditions in mining: a literature review. *HSE contract research report 10/1988.* (Bootle: Health and Safety Executive).

Grollius H. and others. (1986). Computer modelling of performance of centrifugal water chillers in mine refrigeration installations. In *Frigair '86 Symposium*. (Council for Scientific and Industrial Research, Pretoria), Volume 1, Mine Cooling.

Hamm E. (1979). Central refrigerating plants for air conditioning in the mines of Ruhrkohle AG. In *Second international mine ventilation congress, Reno, NV*, Mousset-Jones P. ed (New York: Society of Mining Engineers of AIME, 1980), 635-648.

Hemp R. (1981). The assessment and prediction of cooling plant performance *J. Mine Vent. Soc. S Afr.* 34, 81-118.

Hemp R. (1982). Sources of heat in mines. In *Environmental engineering in South African mines*. Burrows J. ed. (Marshalltown, S. Afr.: Mine Ventilation Society of South Africa. Chapter 22, 569-612.

Hemp R. (1986). Computer analysis of underground refrigeration plant performance *J. Mine Vent. Soc. S Afr.* 39, 77-85.

Hiller C.C. and Glickman L.R. (1976). Improving heat pump performance via compressor capacity control - analysis and test. *Heat transfer laboratory Report 24525-96*. (Cambridge, MA: Massachusetts Institute of Technology).

Howes M.J. (1975). A review of current mine cooling practice in South African gold mines. In *Proceedings international mine ventilation congress, Johannesburg*, Hemp R. and Lancaster F.H. eds (Johannesburg: Mine Ventilation Society of South Africa, 1976), 289-298.

Howes M.J. (1978a). The development of a functional relationship between productivity and the thermal environment. *J. Mine Vent. Soc. S Afr.* 31, 21-38.

Howes M.J. (1978b). Ventilation and refrigeration planning at Unisel Gold Mine Ltd. In *Proceedings of the eleventh Commonwealth mining and metallurgical congress, Hong Kong*. Jones M.J. ed. (London: Institute of Mining and Metallurgy, 1979), 729-740.

Howes M.J. (1979a). Mine ventilation and refrigeration planning. *J. Mine Vent. Soc. S Afr.* 32, 225-235.

Howes M.J. and Green N. (1979b). The design of a surface refrigeration plant at Unisel mine. *J. Mine Vent. Soc. S Afr.* 32, 85-98.

Howes M.J. (1983). Application of refrigeration in mines. *Trans. Inst. Min. Metall. (Section A: Mining industry)*, 92, A69-A79.

Howes M.J. (1988). Heat and moisture exchange in mine airways. In *Fourth international mine ventilation congress, Brisbane*. Gillies A.D.S. ed. (Melbourne: Australasian Institute of Mining and Metallurgy, 1988), 257-264.

Howes M.J. (1990). Review of ventilation and refrigeration in deep, hot and mechanised mines in Australia. *Trans. Inst. Min. Metall. (Section A: Mining industry)* 99, A73-A84.

Hwang B.C. and others (1986). Modelling and simulation of a naval shipboard heat pump. *International Journal of Modelling and Simulation*. June 1986.

IIR. (1981). Thermodynamic and physical properties of R22. International Inst. of Refrigeration. Paris 1981.

Jackson W.L., Chen F.C. and Hwang B.C. (1987). The simulation and performance of a centrifugal chiller. In *ASHRAE annual meeting, Report Conf-870620-9*. (Nashville, TN: American Society of Heating Refrigeration and Air Conditioning Engineers).

James R.W. and Marshall S.A. (1973). Dynamic analysis of a refrigeration system. *Proc. Inst. Refrigeration*. 70, 13-24.

James K.A. and James R.W. (1987). Transient analysis of thermostatic expansion valves for refrigeration system evaporators using mathematical models. *Trans. Inst. of Measurement and control*. 9, 198-205.

Lambrechts J. de V. (1967). Optimisation of ventilation and refrigeration in deep mines. *J. Mine Vent. Soc. S Afr.* 20, 57-64.

MacWilliam K.J. and McIntyre J.T. (1937). Surface refrigeration at Robinson Deep. *J. Chem. Met. Min. Soc. South Africa*. 37, 438-457.

McPherson R.K. (1960). Physiological responses to hot environments. *Med. Res. Council. Spec. Rep.* (London). Number 268.

Mew R.H. (1977). Ventilation at depth at North Broken Hill Limited. In *Underground operators' conference, Broken Hill*. (Parkville, Vict: Australasian Institute of Mining and metallurgy), 135-140. (Symp. Series 17)

Moreby R.G. (1988). Thermodynamic network simulation incorporating airway heat and moisture transfer. In *Fourth international mine ventilation congress, Brisbane*. Gillies A.D.S. ed. (Melbourne: Australasian Institute of Mining and Metallurgy, 1988), 265-272.

Morrison J.F. and others (1968). Energy expenditure in mining tasks and the need for the selection of labour. *J. S. Afr. Inst. Min. Metall.* 69, 185-191.

Murray-Smith A.I. (1987). The effect of clothing on heat stress in mining environments. *J. Mine Vent. Soc. S. Afr.*, 40, 37-39.

Nadira R. and Schick I.C. (1987). Modelling and simulation of an HVAC refrigeration system. In *Proceedings of the SCS simulators conference*. Simulation series 18, 175-181.

Nixon C.A.N., Gillies A.D.S. and Howes M.J. (1992). Analysis of heat sources in a large mechanised development end at Mount Isa Mine. In *Fifth international mine ventilation congress, Johannesburg*, Hemp R. ed. (Johannesburg: Mine Ventilation Society of South Africa, 1992).

Park C., Clark D.R. and Kelly G.E. (1986). HVACSIM building systems and equipment simulation program: building loads calculation. Report NBSIR 86-3331. US Department of Commerce, National Bureau of Standards.

Perry R.H. and Chilton C.H. (1973). Thermodynamic properties. In *Chemical engineers' handbook*. McGraw Hill, USA, Section 3, 155-158.

Ramsden R. (1981) The performance of cooling coils. *J. Mine Vent. Soc. S. Afr.*, 34, 145-154.

Ramsden R. and Bluhm. S.J. (1984). Air cooling equipment used in South African gold mines. In *Third international mine ventilation congress, Harrogate*, Howes M.J. and Jones M.J. Eds (London: Institution of Mining and Metallurgy, 1984), 243-251.

Ramsden R. (1990). Mine cooling towards the 21st century. *J. Mine Vent. Soc. S. Afr.*, 43, 162-168.

Reuther E.U. and Dauber C. (1984). Large capacity cooling equipment in German coal mines. In *Third international mine ventilation congress, Harrogate*, Howes M.J. and Jones M.J. Eds (London: Institution of Mining and Metallurgy, 1984), 253-258.

Rosenow W.M. and Choi H.Y. (1961). Heat exchangers. In *Heat, mass and momentum transfer*. (Prentice Hall, New York), 303-331.

Rice C.K. and others (1981). Design optimisation and the limits of steady state heating efficiency for conventional single speed air source heat pumps. ORNL/CON-63 report. (Oak ridge, TN: Oak Ridge national Laboratory).

Shone R.D.C. and Sheer T.J. (1988). An overview of research into the use of ice for cooling deep mines. In *Fourth international mine ventilation congress, Brisbane*. Gillies A.D.S. ed. (Melbourne: Australasian Institute of Mining and Metallurgy, 1988), 407-413.

Spalding J and Parker T.W. (1940). Air conditioning plant at Ooregum Mine, Kolar Goldfield. *J. Chem. Met. Min. Soc. South Africa*. 41, 1-42.

Stapff M. (1925). Versuche mit Kunstlicher Grubenkuhlung auf der Zeche Radbod. *Gluckauf*.

Stephan K. (1972). Boiling heat transfer. In *Handbook of fundamentals*. (American Society of Heating, Refrigerating and Air Conditioning Engineers, New York), 45-46.

Stewart J.M. (1981). Heat transfer and limiting physiological criteria as a basis for the setting of heat stress limits. *J. S. Afr. Inst. Min. Metall.* 81, 239-251.

Stewart J.M. (1982). Fundamentals of human heat stress. In *Environmental engineering in South African mines*. Burrows J. ed. (Marshalltown, S. Afr.: Mine Ventilation Society of South Africa. Chapter 20, 495-533.

Stroh R.M., Gebler W.F. and Van Deventer J.J. (1984). Performance of an integrated surface refrigeration system on Vaal Reefs. In *Third international mine ventilation congress, Harrogate*, Howes M.J. and Jones M.J. Eds (London: Institution of Mining and Metallurgy, 1984), 283-287.

Vost K.R. (1980). The reduction in amplitude and change in phase of the diurnal temperature variations of ventilation air. *J. S. Afr. Inst. Min. Metall.* 80, 210-214.

Whillier A. (1977). Predicting the performance of forced draught cooling towers. *J. Mine Vent. Soc. S. Afr.*, 30, 2-25.

Wyndham C.H. (1966). A survey of research by the Chamber of Mines into clinical aspects of heat stroke. *Proc. Mine Med. Officers Ass. S. Afr.* 46, 68-80.

Wyndham C.H. and others (1967). Assessing the heat stress and establishing the limits for work in a hot mine. *Brit. J. Ind. Med.* 24, 255-271.

Wyndham C.H. (1974). The physiological and psychological effects of heat. In *The ventilation of South African gold mines*. Burrows J. ed. (Marshalltown, S. Afr.: Mine Ventilation Society of South Africa. Chapter 7, 93-137.

Yaglou C.P. (1926). The thermal index of atmospheric conditions and its application to sedentary and industrial life. *J. Ind. Hyg.* 8, 5-19.

APPENDIX 1 - CALCULATION OF COOLING POWER

```

DECLARE SUB psychrometry ( )
DECLARE SUB coolingpower ( )
' COOLING POWER CALCULATION
COMMON SHARED wb, db, p, v, e, cpc, mhgr
CLS
PRINT " Enter wet bulb, dry bulb and pressure"
INPUT wb, db, p
PRINT " Enter air velocity"
INPUT v
mhgr = 500 : trad = db
CALL psychrometry
CALL coolingpower
PRINT " cooling power = "; cpc

END

SUB coolingpower
DO
    IF mhgr > 240 THEN tskin = 40.33 - mhgr / 42
    IF mhgr < 240 THEN tskin = 36.65 - mhgr / 118
    qrad = (trad / 2 + 291) ^ 3 * (tskin - trad) * .17 / 1000 ^ 2
    qconv = .858 * (p * (.72 - .003 * db) * v) ^ .6 * (tskin - db)
    k = 273.16 + tskin
    eskin = 100 * 10 ^ (28.5905 - 8.2 * LOG(k) / LOG(10) + k / 403.16 - 3142.3 / k)
    qeu = (eskin - e) (p * (.72 - .003 * db) * v) ^ .6 * 1363 / (p - e) ^ 2
    IF qeu > 300 THEN qevap = .65 * qeu + 95
    IF qeu < 300 AND qeu > 190 THEN qevap = .59528 * qeu ^ 1.085
    IF qeu < 190 THEN qevap = .929855 * qeu
    cpnx = INT(v) + 1
    cp = qrad + qconv + qevap
    cp1 = (cp + cpnx * mhgr) / (cpnx + 1)
    dcp = ABS(mhgr - cp)
    IF dcp > .01 THEN mhgr = cp1
LOOP UNTIL dcp < .01
    IF cp < 125 THEN cpc = cp
    IF cp > 125 THEN cpc = cp / 2 + 62.5
END SUB

SUB psychrometry
k = 273.16 + wb
eswb = 100 * 10 ^ (28.5905 - 8.2 * LOG(k) / LOG(10) + k / 403.16 - 3142.3 / k)
pf = 1 + (db ^ 2 / 178 + 10.3 - .04 * db + .3375 * p) / 10000
rswb = .621962 * eswb / (p - pf * eswb)
hao = 1.005 * wb: hai = 1.005 * db
hwl = wb ^ 3 / 158730 - wb ^ 2 / 1376 + 4.2058 * wb + .03
hwo = 1.8375 * wb + 2500.83 - wb ^ 3 / 151057 - wb ^ 2 / 5155
hwi = 1.8375 * db + 2500.83 - db ^ 3 / 151057 - db ^ 2 / 5155
r = (rswb * (hwo - hwl) - (hai - hao)) / (hwi - hwl)
e = r / (.621962 * pf + r * pf)
ra = .28703 * (1 - ((p / 188430 + 1 / 105374) - (p / 12322860 + 1 / 357910) * db))
asv = ra * (273.16 + db) / (p - e)
td = (1 + r) / asv : h = hai + r * hwi : s = h - r * hwl
END SUB

```

APPENDIX 2 - PRODUCTIVITY ANALYSIS

```

DECLARE SUB start ()
DECLARE SUB tcalc ()
DECLARE SUB tsum ()
DECLARE SUB profile ()
DECLARE SUB psychrometry ()
DECLARE SUB coolingpower ()
DECLARE SUB worktemp ()
DECLARE SUB productivity ()
DECLARE SUB probability ()
DECLARE SUB wbatdev ()
'refrigeration optimisation costs
COMMON SHARED wb, db, p, v, e, cpc, mhgr
COMMON SHARED swb, mw, tecf, mwt, tpa
COMMON SHARED x, a, propstop, propsix
COMMON SHARED nday, cstop, csix, ctecf
CLS
PRINT "Enter production rate in million tonnes and refrigeration in MW"
INPUT tpa, mwt
mw = (mwt - 6.7) * 1.2 / tpa + 2.7
swb = 26
CALL start
DO
CALL tcalc
CALL tsum
swb = swb - 2
swb = INT(swb)
LOOP UNTIL swb < 7
PRINT " "
PRINT " Weighted stop work jobs = "; cstop / 365
PRINT " Weighted six hour jobs = "; csix / 365
PRINT " Weighted productivity = "; ctecf / 365
ns = tpa * 33333
xns = ns * (.65 * cstop / 36500 + .35 * csix / 36500) + (365 / ctecf - 1) * ns
PRINT " Additional shifts = "; xns
PRINT " "
END

SUB psychrometry
k = 273.16 + wb
eswb = 100 * 10 ^ (28.59051 - 8.2 * LOG(k) / LOG(10) + k / 403.16 - 3142.3 / k)
pf = 1 + (db ^ 2 / 178 + 10.3 - .04 * db + .3375 * p) / 10000
rswb = .621962 * eswb / (p - pf * eswb)
hao = 1.005 * wb: hai = 1.005 * db
hwl = wb ^ 3 / 158730 - wb ^ 2 / 1376 + 4.2058 * wb + .03
hwo = 1.8375 * wb + 2500.83 - wb ^ 3 / 151057 - wb ^ 2 / 5155
hwi = 1.8375 * db + 2500.83 - db ^ 3 / 151057 - db ^ 2 / 5155
r = (rswb * (hwo - hwl) - (hai - hao)) / (hwi - hwl)
e = r / (.621962 * pf + r * pf)
ra = .28703 * (1 - ((p / 188430 + 1 / 105374) - (p / 12322860 + 1 / 357910) * db))
asv = ra * (273.16 + db) / (p - e)
td = (1 + r) / asv : h = hai + r * hwi : s = h - r * hwl
END SUB

```



APPENDIX 2 - PRODUCTIVITY ANALYSIS

```
SUB coolingpower
trad = db
DO
  IF mhgr > 240 THEN tskin = 40.33 - mhgr / 42
  IF mhgr < 240 THEN tskin = 36.65 - mhgr / 118
  qrad = (trad / 2 + 291) ^ 3 * (tskin - trad) * .17 / 1000 ^ 2
  qconv = .858 * (p * (.72 - .003 * db) * v) ^ .6 * (tskin - db)
  k = 273.16 + tskin
  eskin = 100 * 10 ^ (28.59051 - 8.2 * LOG(k) / LOG(10) + k / 403.16 - 3142.3 / k)
  qeu = (eskin - e) * (p * (.72 - .003 * db) * v) ^ .6 * 1363 / (p - e) ^ 2
  IF qeu > 300 THEN qevap = .65 * qeu + 95
  IF qeu < 300 AND qeu > 190 THEN qevap = .59528 * qeu ^ 1.085
  IF qeu < 190 THEN qevap = .929855 * qeu
  cpx = INT(v) + 1
  cp = qrad + qconv + qevap
  cp1 = (cp + cpx * mhgr) / (cpx + 1)
  dcp = ABS(mhgr - cp)
  IF dcp > .01 THEN mhgr = cp1
LOOP UNTIL dcp < .01
  IF cp < 125 THEN cpc = cp
  IF cp > 125 THEN cpc = cp / 2 + 62.5
END SUB

SUB probability
n1 = 0 : sig = 0 : fra = x
DO
  sig = sig + fra
  n1 = n1 + 1
  fra = -fra * x ^ 2 * (2 * n1 - 1) / (n1 * (2 * n1 + 1)) / 2
LOOP UNTIL ABS(fra) < .000001
a1 = .39894228# * sig
IF x > 0 THEN a = (1 - (a1 + .5))
IF x < 0 THEN a = .5 - a1
IF x = 0 THEN a = .5
END SUB

SUB productivity
t1 = (cpc - 50) * .25 / 200
t2 = (cpc - 50) * .25 / 150
t3 = (cpc - 50) * .2 / 100
t4 = (cpc - 50) * .3 / 75
  IF t1 > .25 THEN t1 = .25
  IF t2 > .25 THEN t2 = .25
  IF t3 > .2 THEN t3 = .2
  IF t4 > .3 THEN t4 = .3
tecf = t1 + t2 + t3 + t4
END SUB

SUB worktemp
wb = (18.64853 - .01223087# * mw ^ 2 - .01189804# * mw) * (1.023449 + .00001058148#
* mw ^ 2 - .0002314548# * mw) ^ svb
END SUB
```

APPENDIX 2 - PRODUCTIVITY ANALYSIS

SUB profile

```
IF swb = 26 THEN nday = 5
IF swb = 24 THEN nday = 38
IF swb = 22 THEN nday = 45
IF swb = 20 THEN nday = 54
IF swb = 18 THEN nday = 53
IF swb = 16 THEN nday = 50
IF swb = 14 THEN nday = 41
IF swb = 12 THEN nday = 36
IF swb = 10 THEN nday = 23
IF swb = 8 THEN nday = 20
```

END SUB

SUB start

```
PRINT " Base refrigeration load = "; mw; " MW"
PRINT " "
PRINT " Surf wb      cp      U/G wb  stop job      six hour      tecf"
PRINT " "
cstop = 0 : csix = 0 : ctecf = 0
```

END SUB

SUB tcalc

```
CALL worktemp
db = wb + 10 : p = 113 : v = .5 : mhgr = 500
CALL psychrometry
CALL coolingpower
CALL productivity
CALL wbstdev
```

END SUB

SUB tsum

```
CALL profile
xstop = propstop * 100
cstop = cstop + xstop * nday
six = (propsix - propstop) * 100
csix = csix + six * nday
ctecf = ctecf + tecf * nday
PRINT TAB(3); swb; TAB(10); cpc; TAB(20); wb; TAB(30); xstop; TAB(45); six;
```

TAB(60); tecf

END SUB

SUB wbstdev

```
sdwb = 5.9486 - .12794 * wb
wbdstop = 31.67 - wb
x = wbdstop / sdwb
CALL probability
propstop = a
wbdsix = 30.27 - wb
x = wbdsix / sdwb
CALL probability
propsix = a
```

END SUB

APPENDIX 3 - BROKEN HILL SURFACE PLANT SIMULATION

1 Main programme

```

DECLARE SUB dout1a ( )
DECLARE SUB dout2a ( )
DECLARE SUB outdata1 ( )
DECLARE SUB outdata1a ( )
DECLARE SUB wettemp (asl, pl, wbl)
DECLARE SUB bulkcooler ( )
DECLARE SUB power1 ( )
DECLARE SUB power2 ( )
DECLARE SUB dout1 ( )
DECLARE SUB dout2 ( )
DECLARE SUB indata ( )
DECLARE SUB initial ( )
DECLARE SUB start ( )
DECLARE SUB opset1 ( )
DECLARE SUB opset2 ( )
DECLARE SUB set1 ( )
DECLARE SUB set2 ( )
DECLARE SUB compressor1 (hl, vl, il, te, tc)
DECLARE SUB compressor2 (h, v, i, te, tc)
DECLARE SUB cpart1 ( )
DECLARE SUB cpart2 ( )
DECLARE SUB cpart ( )
DECLARE SUB refproperties (hl, vl, il, tel, tcl)
DECLARE SUB condenser1 ( )
DECLARE SUB condenser2 ( )
DECLARE SUB evaporator1 ( )
DECLARE SUB wetdrytemp (asl, srl, pl, wbl, dbl)
DECLARE SUB psychrometry (wbl, dbl, pl, e, r, s, h, td, asv)
'Howden proposal with fixed bulk cooler waterflow
COMMON SHARED adiah1, estadi1, qe1, qe2, qc1, compin1, ua
COMMON SHARED adiah2, estadi2, compin2
COMMON SHARED twoe, twie, le, te, nep, hfe
COMMON SHARED twoc, twic, lc, tc, ecf, hfc
COMMON SHARED invol1, idpcr1, compip1, h, v, i
COMMON SHARED invol2, idpcr2, compip2
COMMON SHARED surfvb, surfdb, surfp
COMMON SHARED qac, ff, fankv, pumpkv, cdt
COMMON SHARED tout, ncomp, fp, pif, fp1, fp2, pif1, pif2
COMMON SHARED evapip, condip
COMMON SHARED powert, opcr, qe, qc, amp1, amp2
COMMON SHARED qbc, fombc, wbbco, lbc, twot, kvbc, vbout, kvmax
CLS
CALL start
CALL initial
IF ncomp = 1 THEN CALL opset1 ELSE CALL opset2
IF ncomp = 1 THEN CALL dout1a ELSE CALL dout2a
PRINT " Enter 0 for print out and 1 for continue"
INPUT xout
IF xout = 1 GOTO 1000
IF ncomp = 1 THEN CALL dout1 ELSE CALL dout2
1000
END

```

APPENDIX 3 - BROKEN HILL SURFACE PLANT SIMULATION

2 Input data

```

SUB start
  CALL indata
  PRINT "  Enter ambient wet and dry bulb temperatures and pressure"
  INPUT surfwb, surfdb, surfp
  PRINT "  Enter number of compressors operating - 1 or 2"
  INPUT ncomp
  PRINT "  Enter water temperature in - use 0 for default from bulk air cooler"
  PRINT "  and required water temperature leaving the evaporator"
  INPUT twie, tout
  IF twie = 0 THEN twie = surfwb ^ 2 / 748 + surfwb * .895 + 2.6
END SUB

```

```

SUB indata
  nep = 159           'number of cassettes in the evaporator pha
  qac = 68.8         'condenser air flow rate
  hfe = 4            'evaporator fouling factor
  hfc = 5            'condenser fouling factor
  ecf = .745         'evaporative condenser factor
  ff = .85           'condenser airflow factor
  qbc = 125          'bulk cooler airflow rate
  fombc = .75        'bulk cooler factor of merit
  fankv = 89         'condenser fan power
  pumpkv = 4.9       'condenser pump power
  amp1 = 76.8 : amp2 = 77.2 'compressor motor current
  cdt = .7           'condenser recirculation wet bulb
END SUB

```

```

SUB initial
  te = -2: tc = 38
  qe1 = 3000: qe2 = 3000: compip1 = 700: compip2 = 700
  le = 130: lbc = 125.2: qe = qe1 + qe2
END SUB

```

3 Compressor operation

```

SUB compressor1 (h, V, i, te, tc)
  CALL refproperties(h, V, i, te, tc)
  adiah1 = h: invol1 = V: idpcr1 = i
  compin1 = invol1 * qe1
  IF compin1 > .98893 * fp1 THEN compin1 = .98893 * fp1
  estad11 = 5538 * fp1 - 5600 * compin1
  compeff1 = 361.111 * compin1 / fp1 - 188.8889 * (compin1 / fp1) ^ 2 - 171.797
  compip1 = pif1 * idpcr1 * qe1 / compeff1
END SUB

```

```

SUB compressor2 (h, V, i, te, tc)
  CALL refproperties(h, V, i, te, tc)
  adiah2 = h: invol2 = V: idpcr2 = i
  compin2 = invol2 * qe2
  IF compin2 > .98893 * fp2 THEN compin2 = .98893 * fp2
  estad12 = 5538 * fp2 - 5600 * compin2
  compeff2 = 361.111 * compin2 / fp2 - 188.8889 * (compin2 / fp2) ^ 2 - 171.797
  compip2 = pif2 * idpcr2 * qe2 / compeff2
END SUB

```

APPENDIX 3 - BROKEN HILL SURFACE PLANT SIMULATION

4 Condenser operation

```

SUB condenser1
  'evaporative condenser - one compressor
  qc = qe1 + compip1
  DO
    uac = ecf * ff ^ .8 / (1 / 1851 + 1 / (1000 * hfc))
    eair = .6105 * EXP(17.27 * (surfwb + cdt) / (237.3 + surfwb + cdt))
    esat = .6105 * EXP(17.27 * tc / (237.3 + tc))
    qest = uac * (esat - eair)
    tfact = qc / uac + eair
    tfactc = LOG(tfact / .6105)
    tc = 237.3 * tfactc / (17.27 - tfactc)
  LOOP UNTIL ABS(qc - qest) < .1
  tc = 1.019 * tc - .41
END SUB

```

```

SUB condenser2
  'evaporative condenser - two compressors
  qc = qe1 + compip1 + qe2 + compip2
  DO
    uac = ecf * ncomp * ff ^ .8 / (1 / 1851 + 1 / (1000 * hfc))
    eair = .6105 * EXP(17.27 * (surfwb + cdt) / (237.3 + surfwb + cdt))
    esat = .6105 * EXP(17.27 * tc / (237.3 + tc))
    qest = uac * (esat - eair)
    tfact = qc / uac + eair
    tfactc = LOG(tfact / .6105)
    tc = 237.3 * tfactc / (17.27 - tfactc)
  LOOP UNTIL ABS(qc - qest) < .1
  tc = 1.019 * tc - .41
END SUB

```

5 Evaporator operation

```

SUB evaporator1
  'closed plate evaporator
  DO
    twoe = twie - qe / 4.185 / le
    DO
      dt1 = twie - te: dt2 = twoe - te
      IF dt2 < 0 THEN te = twoe - .5
    LOOP WHILE dt2 < 0
    lmtd = (dt1 - dt2) / LOG(dt1 / dt2)
    rhaw = 1 / (16.9 * nep ^ .2 * le ^ .8 * (1 + .0075 * (twie + twoe)))
    rhar = 1 / (4.46 * qe ^ .5 * nep ^ .5)
    xrka = 1 / (86.7 * nep)
    rhfa = 1 / (3.193 * nep * hfe)
    ua = 1 / (rhaw + rhar + xrka + rhfa)
    qest = ua * lmtd
    estlmtd = qe / ua
    tfactc = EXP((twie - twoe) / estlmtd)
    te = (twie - twoe * tfactc) / (1 - tfactc)
    IF (twoe - te) < 0 THEN qe = qe * .9
  LOOP WHILE ABS(qe - qest) > .1
  te = 1.074 * te - .31
END SUB

```

APPENDIX 3 - BROKEN HILL SURFACE PLANT SIMULATION

6 Bulk air cooler

```

SUB bulkcooler
  twit = twoe : wb = twit: db = twit: p = surfp
  CALL psychrometry(wb, db, p, e, r, s, h, td, asv)
  swit = s : wb = surfwb: db = surfdb
  CALL psychrometry(wb, db, p, e, r, s, h, td, asv)
  sait = s
  rt = 4.185 * lbc * (surfwb - twit) / qbc / td / (sait - swit)
  nt = (fombc / (1 - fombc)) * (1 / rt) ^ .4
  nwt = (1 - EXP(-nt * (1 - rt))) / (1 - rt * EXP(-nt * (1 - rt)))
  twot = twit - nwt * (twit - surfwb)
  kwbc = (twot - twit) * 4.185 * lbc
  s = sait - kwbc / td / qbc : ss = s
  CALL wettemp(ss, p, wb)
  wbbco = wb
END SUB

```

7 Plant operation

```

SUB opset1
  'one compressor only operating
  DO
    DO
      CALL set1
      le = le * ((twie - twoe) / (twie - tout)) ^ 1.5
      LOOP UNTIL ABS(twoe - tout) < .001
      CALL bulkcooler
      dret = twie - twot : twie = (twie + twot) / 2
      LOOP UNTIL ABS(dret) < .001
    DO
  END SUB

SUB opset2
  'two compressors operating
  DO
    DO
      CALL set2
      le = le * ((twie - twoe) / (twie - tout)) ^ 1.5
      LOOP UNTIL ABS(twoe - tout) < .001
      CALL bulkcooler
      dret = twie - twot : twie = (twie + twot) / 2
      LOOP UNTIL ABS(dret) < .001
    DO
  END SUB

SUB set1
  DO
    CALL cpart
    CALL evaporator1
    CALL condenser1
    CALL compressor1(h, V, i, te, tc)
    test1 = adiah1 - estadi1 : PRINT "          test1 = "; test1
    IF ABS(test1) > 270 THEN adiah1 = 1
    estcomp1 = (5538 * fp1 - adiah1) / 5600
    IF surfwb > 20 THEN nf1 = .2 ELSE nf1 = 1
    qe1 = qe1 * (estcomp1 / compin1) ^ nf1
    LOOP UNTIL ABS(test1) < .1
  DO
END SUB

```

APPENDIX 3 - BROKEN HILL SURFACE PLANT SIMULATION

```

SUB set2
DO
  DO
    CALL cpart
    CALL evaporator1
    CALL condenser2
    CALL compressor1(h, V, i, te, tc)
    test1 = adiah1 - estadi1 : PRINT "          test1 = "; test1
    IF ABS(test1) > 270 THEN adiah1 = 1
    estcomp1 = (5538 * fp1 - adiah1) / 5600
    IF surfwb > 20 THEN nf1 = .2 ELSE nf1 = 1
    qe1 = qe1 * (estcomp1 / compin1) ^ nf1
  LOOP UNTIL ABS(test1) < .1
  CALL compressor2(h, V, i, te, tc)
  test2 = adiah2 - estadi2 : PRINT "          test2 = "; test2
  IF ABS(test2) > 270 THEN adiah2 = 1
  estcomp2 = (5538 * fp2 - adiah2) / 5600
  IF surfwb > 20 THEN nf2 = .2 ELSE nf2 = 1
  qe2 = qe2 * (estcomp2 / compin2) ^ nf2
  qe = qe1 + qe2
LOOP UNTIL ABS(test2) < .1
END SUB

SUB cpart
  CALL cpart1
  IF ncomp = 2 THEN CALL cpart2
END SUB

SUB cpart1
  fp = amp1 / 84
  pc = 428.28 + 16 * tc + .23193 * tc ^ 2 + .0017368 * tc ^ 3
  pe = 428.28 + 16 * te + .23193 * te ^ 2 + .0017368 * te ^ 3
  rp = pc / pe
  DO
    fp1 = fp
    pif1 = rp * (.808 * fp1 ^ 2 - .288 * fp1 ^ 3 - .812 * fp1 + .292) +
      (6.8625 * fp1 ^ 2 - 3.0521 * fp1 ^ 3 - 5.0394 * fp1 + 2.229)
    fp = amp1 / 84 / pif1
  LOOP WHILE ABS(fp - fp1) > .00002
END SUB

SUB cpart2
  fp = amp2 / 84
  pc = 428.28 + 16 * tc + .23193 * tc ^ 2 + .0017368 * tc ^ 3
  pe = 428.28 + 16 * te + .23193 * te ^ 2 + .0017368 * te ^ 3
  rp = pc / pe
  DO
    fp2 = fp
    pif2 = rp * (.808 * fp2 ^ 2 - .288 * fp2 ^ 3 - .812 * fp2 + .292) +
      (6.8625 * fp2 ^ 2 - 3.0521 * fp2 ^ 3 - 5.0394 * fp2 + 2.229)
    fp = amp2 / 84 / pif2
  LOOP WHILE ABS(fp - fp2) > .00002
END SUB

```

APPENDIX 3 - BROKEN HILL SURFACE PLANT SIMULATION

**8 Properties**

```

SUB psychrometry (wb, db, p, e, r, s, h, td, asv)
  k = 273.16 + wb
  eswb = 100 * 10 ^ (28.59051 - 8.2 * LOG(k) / LOG(10) + k / 403.16 - 3142.3 / k)
  pf = 1 + (db ^ 2 / 178 + 10.3 - .04 * db + .3375 * p) / 10000
  rswb = .621962 * eswb / (p - pf * eswb)
  hao = 1.005 * wb: hai = 1.005 * db
  hwl = wb ^ 3 / 158730 - wb ^ 2 / 1376 + 4.2058 * wb + .03
  hwo = 1.8375 * wb + 2500.83 - wb ^ 3 / 151057 - wb ^ 2 / 5155
  hwi = 1.8375 * db + 2500.83 - db ^ 3 / 151057 - db ^ 2 / 5155
  r = (rswb * (hwo - hwl) - (hai - hao)) / (hwi - hwl)
  e = r / (.621962 * pf + r * pf)
  ra = .28703*(1 - ((p / 188430 + 1 / 105374) - (p / 12322860 + 1 / 357910)*db))
  asv = ra * (273.16 + db) / (p - e) : td = (1 + r) / asv
  h = hai + r * hwi : s = h - r * hwl
END SUB

SUB reproperties (h, V, i, te, tc)
  'properties of ammonia R717
  h = 1.17 - 4.6621*te + .03051*te^2 + (4.5963 - .03042*te + te^2 / 4922.7) * tc
  V = ((230.07 + .75653 * tc + tc ^ 2 / 165.1) - ((8.6295 + tc / 33.872 + tc ^ 2 / 4359.8) * te) + ((.1887 + tc / 1424 + tc ^ 2 / 219766) * te ^ 2)) / 1000000
  I = (1 / 536.6 - te / 263.4 + te ^ 2 / 34095) + ((1 / 282.79 - te / 31108 - te ^ 2 / 1898.9 ^ 2) * tc) + ((1 / 54245 - te / 1648.3 ^ 2 + te ^ 2 / 8610.8 ^ 2) * tc ^ 2)
END SUB

SUB wetdrytemp (ss, sr, p, wb, db)
  swb = (1 / (.22651 ^ -.39331)) * LOG((ss + (11.5618 * p ^ .23193)) / (49.328 - 2.9887 * LOG(p) / LOG(10)))
  wbest = swb
  FOR hx = 1 TO INT(wbest / 10)
    htd = ((wbest / 73.32 - 1 / 3.05) ^ 2 + .9822) ^ (1 / 3)
    wbest = swb / htd
  NEXT hx
  hwl = wbest ^ 3 / 158730 - wbest ^ 2 / 1376 + 4.2058 * wbest + .03
  heat = ss + sr * hwl : dbeat = (heat - 2501 * sr) / (1.005 + 1.8 * sr)
  DO
    wb = wbest: db = dbeat
    CALL psychrometry(wb, db, p, e, r, s, h, td, asv)
    serr = ss - s : wbeadd = wbest + 1 : wb = wbeadd: db = dbeat
    CALL psychrometry(wb, db, p, e, r, s, h, td, asv)
    wbest = wbeat + serr / (s - ss)
    hwl = wbest ^ 3 / 158730 - wbest ^ 2 / 1376 + 4.2058 * wbest + .03
    heat = ss + sr * hwl : dbeat = (heat - 2501 * sr) / (1.005 + 1.8 * sr)
  DO
    wb = wbest: db = dbeat
    CALL psychrometry(wb, db, p, e, r, s, h, td, asv)
    herr = h - heat : rerr = sr - r : dbeat = dbeat - 2500 * rerr
  LOOP UNTIL ABS(rerr) < .0000001#
  LOOP UNTIL ABS(herr) < .00001
  wb = wbest: db = dbeat
END SUB

```



APPENDIX 3 - BROKEN HILL SURFACE PLANT SIMULATION

```

SUB wettemp (ss, p, wb)
  swb = (1 / (.22651 ^ -.39331)) LOG((ss + (11.5618 * p ^ .23193)) /
(49.328 - 2.9887 * LOG(p) / LOG(10)))
  wbest = swb
  FOR hx = 1 TO INT(wbest / 10)
    htd = ((wbest / 73.32 - 1 / 3.05) ^ 2 + .9822) ^ (1 / 3)
    wbest = swb / htd
  NEXT hx
  wb = wbest
END SUB

```

9 Output statements

```

SUB dout1
  CALL power1
  LPRINT " "
  LPRINT " "; ncomp; " compressor(s) operating - ambient wet bulb temperature =
"; surfwb
  LPRINT " *****"
  LPRINT " "
  LPRINT " Evaporator duty = "; qe; "      Evaporating temperature = "; te
  LPRINT " Condenser duty = "; qc; "      Condensing temperature = "; tc
  LPRINT " Evaporator water temperatures - in "; twie; " - out "; twoe
  LPRINT " Evaporator water flow rate = "; le
  LPRINT " Bulk cooler water flow rate = "; lbc; " air flow rate = "; qbc
  LPRINT " Bulk cooler duty = "; kwbc; " Wet bulb out = "; wbbco
  LPRINT " "
  LPRINT " Power requirements"
  LPRINT " "
  LPRINT " Compressor load = "; fp1 * 100; "% Load power factor = "; pif1
  LPRINT " Compressor input power = "; compip1
  LPRINT " Evaporator pump power = "; evapip
  LPRINT " Condenser fan and pump power = "; condip
  LPRINT " Total input power = "; power1
  LPRINT " Total evaporator duty = "; qe
  LPRINT " Overall power to cooling ratio = "; opcr
  CALL outdata1
END SUB

```

```

SUB dout1a
  CLS
  CALL power1
  PRINT " "
  PRINT " "; ncomp; " compressor(s) operating - ambient wet bulb temperature =
"; surfwb
  PRINT " *****"
  PRINT " Evaporator duty = "; qe; "      Evaporating temperature = "; te
  PRINT " Condenser duty = "; qc; "      Condensing temperature = "; tc
  PRINT " Evaporator water temperatures - in "; twie; " - out "; twoe
  PRINT " Evaporator water flow rate = "; le
  PRINT " Bulk cooler water flow rate = "; lbc; " Air flow rate = "; qbc
  PRINT " Bulk cooler duty = "; kwbc; " Wet bulb out = "; wbbco
  PRINT " "
  PRINT " Power requirements"

```

APPENDIX 3 - BROKEN HILL SURFACE PLANT SIMULATION

```

PRINT " Compressor Load      = "; fp1 * 100; "% Load power factor = "; pif1
PRINT " Compressor input power    = "; compip1
PRINT " Evaporator pump power      = "; evapip
PRINT " Condenser fan and pump power = "; condip
PRINT " Total input power           = "; powert
PRINT " Total evaporator duty       = "; qe
PRINT " Overall power to cooling ratio = "; oprc
CALL outdata1
END SUB

SUB dout2
CALL power2
LPRINT " "
LPRINT " "; ncomp; " compressor(s) operating - ambient wet bulb temperature = "; surfwb
LPRINT " *****"
LPRINT " "
LPRINT " Evaporator duty = "; qe; " Evaporating temperature = "; te
LPRINT " Condenser duty = "; qc; " Condensing temperature = "; tc
LPRINT " Evaporator water temperatures - in "; twie; " - out "; twoe
LPRINT " Evaporator water flow rate = "; le
LPRINT " Bulk cooler water flow rate = "; lbc; " air flow rate = "; qbc
LPRINT " Bulk cooler duty = "; kwbc; " Wet bulb out = "; wbbco
LPRINT " "
LPRINT " Power requirements"
LPRINT " "
LPRINT " Compressor 1 load = "; fp1 * 100; "% load power factor = "; pif1
LPRINT " Compressor 2 load = "; fp2 * 100; "% load power factor = "; pif2
LPRINT " Compressor 1 input power = "; compip1; " Compressor 2 input power = "; compip2
LPRINT " Evaporator pump power = "; evapip
LPRINT " Condenser fan and pump power = "; condip
LPRINT " Total input power = "; powert
LPRINT " Total evaporator duty = "; qe
LPRINT " Overall power to cooling ratio = "; oprc
CALL outdata1
END SUB

SUB dout2a
CALL power2
PRINT " "
PRINT " "; ncomp; " compressor(s) operating - ambient wet bulb temperature = "; surfwb
PRINT " *****"
PRINT " Evaporator duty = "; qe; " Evaporating temperature = "; te
PRINT " Condenser duty = "; qc; " Condensing temperature = "; tc
PRINT " Evaporator water temperatures - in "; twie; " - out "; twoe
PRINT " Evaporator water flow rate = "; le
PRINT " Bulk cooler water flow rate = "; lbc; " Air flow rate = "; qbc
PRINT " Bulk cooler duty = "; kwbc; " Wet bulb out = "; wbbco
PRINT " "
PRINT " Power requirements"

```

APPENDIX 3 - BROKEN HILL SURFACE PLANT SIMULATION

```
PRINT " Compressor 1 load  = "; fp1 * 100; "% Load power factor = "; pif1
PRINT " Compressor 2 load  = "; fp2 * 100; "% Load power factor = "; pif2
PRINT " Compressor 1 input power      = "; compip1; " Compressor 2 input power
= "; compip2
PRINT " Evaporator pump power          = "; evapip
PRINT " Condenser fan and pump power = "; condip
PRINT " Total input power              = "; powert
PRINT " Total evaporator duty         = "; qe
PRINT " Overall power to cooling ratio = "; opr
CALL outdata1a
END SUB

SUB outdata1
  LPRINT " "
  LPRINT " Evaporator details"
  LPRINT "      Number of cassettes = "; nep; "      Fouling factor = "; hfe
  LPRINT " Condenser details"
  LPRINT "      Airflow rate          = "; (qac * ff * ncomp); "      Fouling factor
= "; hfc
  LPRINT " "
END SUB

SUB outdata1a
  PRINT " Evaporator details"
  PRINT "      Number of cassettes = "; nep; "      Fouling factor = "; hfe
  PRINT " Condenser details"
  PRINT "      Airflow rate          = "; (qac * ff * ncomp); "      Fouling factor
= "; hfc
END SUB

SUB power1
  evapip = (54 * (le / nep) ^ 2) * le / 650
  condip = (fankw * ff ^ 3 + pumpkw) * ncomp
  powert = compip1 + evapip + condip
  opr = qe / powert
END SUB

SUB power2
  evapip = (54 * (le / nep) ^ 2) * le / 650
  condip = (fankw * ff ^ 3 + pumpkw) * ncomp
  powert = compip1 + compip2 + evapip + condip
  opr = qe / powert
END SUB
```

APPENDIX 4 - MOUNT ISA SURFACE PLANT SIMULATION

1 Main programme

```

DECLARE SUB wettemp (ss1, pl, wbl)
DECLARE SUB power1 ( )
DECLARE SUB power2s ( )
DECLARE SUB outdata1 ( )
DECLARE SUB outdata2s ( )
DECLARE SUB dout1 ( )
DECLARE SUB dout2s ( )
DECLARE SUB dout2p ( )
DECLARE SUB indata ( )
DECLARE SUB initial ( )
DECLARE SUB start ( )
DECLARE SUB opset2parallel ( )
DECLARE SUB opset2series ( )
DECLARE SUB opset1 ( )
DECLARE SUB evaporator1 ( )
DECLARE SUB evaporator2 ( )
DECLARE SUB compressor1 (hl, vl, il, te1, tc1)
DECLARE SUB compressor2 (hl, vl, il, te2, tc2)
DECLARE SUB set2 ( )
DECLARE SUB set1 ( )
DECLARE SUB refproperties (hl, vl, il, te1, tc1)
DECLARE SUB condenser1 ( )
DECLARE SUB condenser2 ( )
DECLARE SUB bulkcooler ( )
DECLARE SUB wetdrytemp (ss1, srl, pl, wbl, dbl)
DECLARE SUB psychrometry (wbl, dbl, pl, e, r, s, h, td, asv)
DECLARE SUB bcout ( )
DECLARE SUB dout ( )
DECLARE SUB dout1a ( )
DECLARE SUB dout2sa ( )
DECLARE SUB dout2pa ( )
'Supplier 2, Continuous operation - evaporative condensers
COMMON SHARED adiah1, estadi1, qe1, qc1, compin1, ua1, twoe1, twie1, le1, te1
COMMON SHARED tc1, ecf1, hfc1, qac1, ff1, invol1, idpcr1, compip1, h, v, i
COMMON SHARED adiah2, estadi2, qe2, qc2, compin2, ua2, twoe2, twie2, le2, te2
COMMON SHARED tc2, ecf2, hfc2, qac2, ff2, invol2, idpcr2, compip2, nap1, hfe1
COMMON SHARED surfvb, surfdb, surfp, tout, ncomp, config, ncond, nap2, hfe2
COMMON SHARED evapip1, evapip2, condip1, condip2, powert, opcr, qe, resistbc
COMMON SHARED qbc, fombc, wbbco, lbc, twot, kvbc, wbout, twit, headbc, bacip
COMMON SHARED acomp, acomp1, acomp2, bcomp, bcomp1, bcomp2, twoe
COMMON SHARED load1, load2, pif1, pif2, pout
CALL start
CALL initial
IF ncomp = 1 THEN CALL opset1
IF ncomp = 2 AND config = 1 THEN CALL opset2series
IF ncomp = 2 AND config = 2 THEN CALL opset2parallel
IF ncomp = 1 THEN CALL dout1a
IF ncomp = 2 AND config = 1 THEN CALL dout2sa
IF ncomp = 2 AND config = 2 THEN CALL dout2pa
PRINT " enter 1 for hard copy or 0 for skip"
INPUT pout
IF pout = 1 THEN CALL dout
IF pout = 1 THEN CALL bcout
END

```

APPENDIX 4 - MOUNT ISA SURFACE PLANT SIMULATION

2 Input data

```

SUB start
  CALL indata
  PRINT "  Enter ambient wet and dry bulb temperatures and pressure"
  INPUT surfwb, surfdb, surfp
  PRINT "  Enter set operating configuration"
  PRINT "  Enter number of compressors operating - 1 or 2"
  PRINT "  Enter 1 for series and 2 for parallel operation"
  INPUT ncomp, config
  IF ncomp = 1 THEN config = 1
  PRINT "  Enter water temperature in - use 0 for default from bulk air cooler"
  PRINT "  and required water temperature leaving the evaporator"
  INPUT twie1, tout
  IF twie1 = 0 THEN twie1 = surfwb - 3
END SUB

```

```

SUB indata
  nep1 = 104: nep2 = 104           'number of cassettes in phe
  qac1 = 95.8: qac2 = 95.8       'condenser air flow rate
  hfe1 = 7.5: hfe2 = 7.5        'evaporator fouling factor
  hfc1 = 7.5: hfc2 = 7.5        'condenser fouling factor
  ecf1 = 1.15: ecf2 = 1.15     'evaporative condenser factor
  ff1 = 1: ff2 = 1              'condenser airflow factor
  lc1 = 151: lc2 = 151         'condenser waterflow rate
  ncond = 3                     'number of evaporative condensers
  qbc = 169                     'bulk air cooler airflow
  fombc = .78                   'bulk air cooler factor of merit
  lbc = 183                     'bulk air cooler water flow rate
  resistbc = .009              'bulk air cooler air resistance
  headbc = 6.5                 'bulk air cooler pump head
  acomp1 = 1936.54 : acomp2 = 1936.54 'compressor constant
  bcomp1 = 1191.71 : bcomp2 = 1191.71 'compressor variable
END SUB

```

```

SUB initial
  te1 = 5: te2 = 0: tc1 = 40: tc2 = 40
  qe1 = 7000: qe2 = 5000: compip1 = 1000: compip2 = 1000
  twic1 = surfwb + 3: twic2 = surfwb + 3
  le = 120 / config : le1 = le: le2 = le
END SUB

```

3 Condenser operation

```

SUB condenser1
  'evaporative condenser
  qc1 = qe1 + compip1
  DO
    uac1 = ecf1 * (ncond / ncomp) * ff1 ^ .8 / (1 / 1851 + 1 / (1000 * hfc1))
    eair1 = .6105 * EXP(17.27 * surfwb / (237.3 + surfwb))
    esat1 = .6105 * EXP(17.27 * tc1 / (237.3 + tc1))
    qest1 = uac1 * (esat1 - eair1)
    tfact1 = qc1 / uac1 + eair1
    tfactc1 = LOG(tfact1 / .6105)
    tc1 = 237.3 * tfactc1 / (17.27 - tfactc1)
  LOOP UNTIL ABS(qc1 - qest1) < .1
END SUB

```

APPENDIX 4 - MOUNT ISA SURFACE PLANT SIMULATION

```

SUB condenser2
  'evaporative condenser
  qc2 = qe2 + compip2
  DO
    uac2 = ecf2 * (ncond / ncomp) * ff2 ^ .8 / (1 / 1851 + 1 / (1000 * hfc2))
    eair2 = .6105 * EXP(17.27 * surfwb / (237.3 + surfwb))
    esat2 = .6105 * EXP(17.27 * tc2 / (237.3 + tc2))
    qest2 = uac2 * (esat2 - eair2)
    tfact2 = qc2 / uac2 + eair2
    tfactc2 = LOG(tfact2 / .6105)
    tc2 = 237.3 * tfactc2 / (17.27 - tfactc2)
  LOOP UNTIL ABS(qc2 - qest2) < .1
END SUB

```

4 Compressor operation

```

SUB compressor1 (h, v, i, te1, tc1)
  'stal S93 compressor operation
  te = te1 : tc = tc1
  CALL refproperties(h, v, i, te, tc)
  adiah1 = h: invol1 = v: idpcr1 = i
  compin1 = invol1 * qe1
  IF compin1 > acomp1 / bcomp1 THEN compin1 = acomp1 / bcomp1
  estadi1 = acomp1 - bcomp1 * compin1
  load1 = acomp1 / acomp
  IF load1 > 1 THEN load1 = 1
  compeff1 = 72.489 * (compin1 / load1) - 24.444 * (compin1 / load1)^ 2 - 52.949
  sucpl = 428.28 + 16 * te + .23193 * te ^ 2 + .0017368 * te ^ 3
  disp1 = 428.28 + 16 * tc + .23193 * tc ^ 2 + .0017368 * tc ^ 3
  prat1 = disp1 / sucpl
  apart1 = 6.8625 * load1 ^ 2 - 3.0521 * load1 ^ 3 - 5.0394 * load1 + 2.229
  bpart1 = .808 * load1 ^ 2 - .288 * load1 ^ 3 - .812 * load1 + .292
  pif1 = apart1 + bpart1 * prat1
  compip1 = pif1 * idpcr1 * qe1 / compeff1
END SUB

SUB compressor2 (h, v, i, te2, tc2)
  'stal S93 compressor operation
  te = te2 : tc = tc2
  CALL refproperties(h, v, i, te, tc)
  adiah2 = h: invol2 = v: idpcr2 = i
  compin2 = invol2 * qe2
  IF compin2 > acomp2 / bcomp2 THEN compin2 = acomp2 / bcomp2
  estadi2 = acomp2 - bcomp2 * compin2
  load2 = acomp2 / acomp
  IF load2 > 1 THEN load2 = 1
  compeff2 = 72.489 * (compin2 / load2) - 24.444 * (compin2 / load2)^ 2 - 52.949
  sucpl2 = 428.28 + 16 * te + .23193 * te ^ 2 + .0017368 * te ^ 3
  disp2 = 428.28 + 16 * tc + .23193 * tc ^ 2 + .0017368 * tc ^ 3
  prat2 = disp2 / sucpl2
  apart2 = 6.8625 * load2 ^ 2 - 3.0521 * load2 ^ 3 - 5.0394 * load2 + 2.229
  bpart2 = .808 * load2 ^ 2 - .288 * load2 ^ 3 - .812 * load2 + .292
  pif2 = apart2 + bpart2 * prat2
  compip2 = pif2 * idpcr2 * qe2 / compeff2
END SUB

```

APPENDIX 4 - MOUNT ISA SURFACE PLANT SIMULATION

```

5 Evaporator operation  SUB evaporator1
    DO
        twoe1 = twie1 - qe1 / 4.185 / le1
    DO
        dt1 = twie1 - te1: dt2 = twoe1 - te1
        IF dt2 < 0 THEN te1 = twoe1 - .5
    LOOP WHILE dt2 < 0
        lmtd1 = (dt1 - dt2) / LOG(dt1 / dt2)
        rhaw1 = 1 / (16.9 * nep1 ^ .2 * le1 ^ .8 * (1 + .0075 * (twie1 + twoe1)))
        rhar1 = 1 / (4.46 * qe1 ^ .5 * nep1 ^ .5)
        xrka1 = 1 / (86.7 * nep1) : rhfa1 = 1 / (3.193 * nep1 * hfe1)
        ua1 = 1 / (rhaw1 + rhar1 + xrka1 + rhfa1)
        qest1 = ua1 * lmtd1: estlmtd1 = qe1 / ua1
        tfacte1 = EXP((twie1 - twoe1) / estlmtd1)
        te1 = (twie1 - twoe1 * tfacte1) / (1 - tfacte1)
        IF (twoe1 - te1) < 0 THEN qe1 = qe1 * .9
    LOOP WHILE ABS(qe1 - qest1) > .01#
END SUB

SUB evaporator2
    DO
        twoe2 = twie2 - qe2 / 4.185 / le2
    DO
        dt1 = twie2 - te2: dt2 = twoe2 - te2
        IF dt2 < 0 THEN te2 = twoe2 - .5
    LOOP WHILE dt2 < 0
        lmtd2 = (dt1 - dt2) / LOG(dt1 / dt2)
        rhaw2 = 1 / (16.9 * nep2 ^ .2 * le2 ^ .8 * (1 + .0075 * (twie2 + twoe2)))
        rhar2 = 1 / (4.46 * qe2 ^ .5 * nep2 ^ .5)
        xrka2 = 1 / (86.7 * nep2) : rhfa2 = 1 / (3.193 * nep2 * hfe2)
        ua2 = 1 / (rhaw2 + rhar2 + xrka2 + rhfa2)
        qest2 = ua2 * lmtd2: estlmtd2 = qe2 / ua2
        tfacte2 = EXP((twie2 - twoe2) / estlmtd2)
        te2 = (twie2 - twoe2 * tfacte2) / (1 - tfacte2)
        IF (twoe2 - te2) < 0 THEN qe2 = qe2 * .9
    LOOP WHILE ABS(qe2 - qest2) > .01#
END SUB

6 Bulk air cooler  SUB bulkcooler
    twit = tout: wb = twit: db = twit: p = surfp
    CALL psychrometry(wb, db, p, e, r, s, h, td, asv)
    swit = s: wb = surfwb: db = surfdb
    CALL psychrometry(wb, db, p, e, r, s, h, td, asv)
    sait = s
    rt = 4.185 * lbc * (surfwb - twit) / qbc / td / (sait - swit)
    nt = (fombc / (1 - fombc)) * (1 / rt) ^ .4
    nwt = (1 - EXP(-nt * (1 - rt))) / (1 - rt * EXP(-nt * (1 - rt)))
    twot = twit - nwt * (twit - surfwb)
    kwbc = (twot - twit) * 4.185 * lbc
    s = sait - kwbc / td / qbc: ss = s
    CALL wettemp(ss, p, wb)
    wbbco = wb
END SUB

```

APPENDIX 4 - MOUNT ISA SURFACE PLANT SIMULATION

7 Plant operation

```

SUB opset1
  'one set only operating
DO
  DO
    DO
      CALL set1
      le = le1 * ((twie1 - twoe1) / (twie1 - tout)) ^ 1.5
      le1 = le: le2 = le
      LOOP UNTIL ABS(twoe1 - tout) < .001
      CALL bulkcooler
      dret = twie1 - twot
      twie1 = (twie1 + twot) / 2: twoe = twoe1
      LOOP UNTIL ABS(dret) < .001
      qe = qe1 : acomp1 = acomp1 * (kwbc / qe)
    LOOP UNTIL ABS(kwbc - qe) < 10
  END SUB

SUB opset2parallel
DO
  DO
    DO
      CALL set1
      le = le1 * ((twie1 - twoe1) / (twie1 - tout)) ^ 1.5
      le1 = le: le2 = le
      LOOP UNTIL ABS(twoe1 - tout) < .001
      CALL bulkcooler
      dret = twie1 - twot
      twie1 = (twie1 + twot) / 2: twoe = twoe1
      LOOP UNTIL ABS(dret) < .001
      qe = qe1 * 2 : acomp1 = acomp1 * (kwbc / qe)
    LOOP UNTIL ABS(kwbc - qe) < 10
    qe2 = qe1: qc2 = qc1: te2 = te1: tc2 = tc1
    twie2 = twie1: twoe2 = twoe1: twic2 = twic1: twoc2 = twoc1
    compip2 = compip1: twoe = twoe1
  END SUB

SUB opset2series
DO
  DO
    DO
      CALL set1
      twie2 = twoe1
      CALL set2
      le = le1 * ((twie1 - twoe2) / (twie1 - tout)) ^ 1.5
      le1 = le: le2 = le
      LOOP UNTIL ABS(twoe2 - tout) < .001
      CALL bulkcooler
      dret = twie1 - twot
      twie1 = (twie1 + twot) / 2: twoe = twoe2
      LOOP UNTIL ABS(dret) < .001
      qe = qe1 + qe2 : acomp1 = acomp1 * (kwbc / qe) : acomp2 = acomp2 * (kwbc / qe)
    LOOP UNTIL ABS(kwbc - qe) < 1
  END SUB

```



APPENDIX 4 - MOUNT ISA SURFACE PLANT SIMULATION

```

SUB set1
  'refrigeration set operation
  DO
    CALL evaporator1
    CALL condenser1
    CALL compressor1(h, v, i, te1, tc1)
    test1 = adiah1 - estad11
    estcomp1 = (acomp1 - adiah1) / bcomp1
    qe1 = qe1 * estcomp1 / compin1
  LOOP UNTIL ABS(test1) < .1
END SUB

```

```

SUB set2
  'refrigeration set operation
  DO
    CALL evaporator2
    CALL condenser2
    CALL compressor2(h, v, i, te2, tc2)
    test2 = adiah2 - estad12
    estcomp2 = (acomp2 - adiah2) / bcomp2
    qe2 = qe2 * estcomp2 / compin2
  LOOP UNTIL ABS(test2) < .1
END SUB

```

8 Properties of air and refrigerant

```

SUB psychrometry (wb, db, p, e, r, s, h, td, asv)
kelvin = 273.16 + wb
eswb = 100 * 10^(28.59051 - 8.2 * LOG(kelvin) / LOG(10) + kelvin / 403.16 - 3142.3 / kelvin)
pf = 1 + (db ^ 2 / 178 + 10.3 - .04 * db + .3375 * p) / 10000
rawb = .621962 * eswb / (p - pf * eswb)
hao = 1.005 * wb; hai = 1.005 * db
hwL = wb ^ 3 / 158730 - wb ^ 2 / 1376 + 4.2058 * wb + .03
hwo = 1.8375 * wb + 2500.83 - wb ^ 3 / 151057 - wb ^ 2 / 5155
hwi = 1.8375 * db + 2500.83 - db ^ 3 / 151057 - db ^ 2 / 5155
r = (rawb * (hwo - hwL) - (hai - hao)) / (hwi - hwL)
e = r / (.621962 * pf + r * pf)
ra = .28703 * (1 - ((p / 188430 + 1 / 105374) - (p / 12322860 + 1 / 357910) * db))
asv = ra * (273.16 + db) / (p - e)
td = (1 + r) / asv
h = hai + r * hwi; s = h - r * hwL
END SUB

```

```

SUB reproperties (h, v, i, te, tc)
  'properties of ammonia R717
  h = 1.17 - 4.6621 * te + .03051 * te^ 2 + (4.5963 - .03042 * te + te^ 2 / 4922.7) * tc
  v = ((230.07 + .75653 * tc + tc ^ 2 / 165.1) - ((8.6295 + tc / 33.872 + tc ^ 2 / 4359.8) * te) + ((.1887 + tc / 1424 + tc ^ 2 / 219766) * te ^ 2)) / 1000000
  i = (1 / 536.6 - te / 263.4 + te ^ 2 / 34095) + ((1 / 282.79 - te / 31108 - te ^ 2 / 1898.9 ^ 2) * tc) + ((1 / 54245 - te / 1648.3 ^ 2 + te ^ 2 / 8610.8 ^ 2) * tc ^ 2)
END SUB

```

APPENDIX 4 - MOUNT ISA SURFACE PLANT SIMULATION

```

SUB wtdrytemp (ss, sr, p, wb, db)
  swb = (1 / (.22651 ^ -.39331)) LOG((ss + (11.5618 * p ^ .23193)) /
    (49.328 - 2.9887 * LOG(p) / LOG(10)))
  wbest = swb
  FOR hx = 1 TO INT(wbest / 10)
    htd = ((wbest / 73.32 - 1 / 3.05) ^ 2 + .9822) ^ .333 : wbest = swb / htd
  NEXT hx
  hwl = wbest ^ 3 / 158730 - wbest ^ 2 / 1376 + 4.2058 * wbest + .03
  heat = ss + sr * hwl: dbest = (heat - 2501 * sr) / (1.005 + 1.8 * sr)
DO
  wb = wbest: db = dbest
  CALL psychrometry(wb, db, p, e, r, s, h, td, asv)
  serr = ss - s: wbadd = wbest + 1: wb = wbadd: db = dbest
  CALL psychrometry(wb, db, p, e, r, s, h, td, asv)
  wbest = wbest + serr / (s - ss)
  hwl = wbest ^ 3 / 158730 - wbest ^ 2 / 1376 + 4.2058 * wbest + .03
  heat = ss + sr * hwl: dbest = (heat - 2501 * sr) / (1.005 + 1.8 * sr)
DO
  wb = wbest: db = dbest
  CALL psychrometry(wb, db, p, e, r, s, h, td, asv)
  herr = h - heat: rerr = sr - r: dbest = dbest - 2500 * rerr
  LOOP UNTIL ABS(rerr) < .0000001#
  LOOP UNTIL ABS(herr) < .00001
  wb = wbest: db = dbest
END SUB

```

```

SUB wtemp (ss, p, wb)
  swb = (1 / (.22651 ^ -.39331)) LOG((ss + (11.5618 * p ^ .23193)) /
    (49.328 - 2.9887 * LOG(p) / LOG(10)))
  wbest = swb
  FOR hx = 1 TO INT(wbest / 10)
    htd = ((wbest / 73.32 - 1 / 3.05) ^ 2 + .9822) ^ .333 : wbest = swb / htd
  NEXT hx
  wb = wbest
END SUB

```

9 Plant power

```

SUB power1
  evapip1 = (14 * (le1 / nep1) ^ 2) * le1 / 650
  condip1 = (2.175 * qac1 - 167.5 + lc1 / 13) * ncond
  bacip = (resistbc * qbc ^ 3) / 700 + headbc * 1.5 * lbc / 65
  powert = compip1 + evapip1 + condip1 + bacip
  qe = qe1: opcr = qe / powert
END SUB

SUB power2s
  evapip1 = (14 * (le1 / nep1) ^ 2) * le1 / 650
  condip1 = (2.175 * qac1 - 167.5 + lc1 / 13) * ncond / 2
  bacip = (resistbc * qbc ^ 3) / 700 + headbc * 1.5 * lbc / 65
  evapip2 = (14 * (le2 / nep2) ^ 2) * le2 / 650
  condip2 = (2.175 * qac2 - 167.5 + lc2 / 13) * ncond / 2
  powert = compip1 + evapip1 + condip1 + compip2 + evapip2 + condip2 + bacip
  qe = qe1 + qe2: opcr = qe / powert
END SUB

```

APPENDIX 4 - MOUNT ISA SURFACE PLANT SIMULATION

10 Output statements

```

SUB bcout
  LPRINT " Bulk cooler water in = "; twit; " Bulk cooler water out = "; twot
  LPRINT " Water quantity = "; lbc; " Air quantity = "; qbc
  LPRINT " Bulk cooler factor of merit = "; fombc
  LPRINT " Air wet bulb leaving the bulk cooler = "; wbbco
  LPRINT " Bulk cooler duty = "; kwbc

```

END SUB

```

SUB dout1
  CALL power1
  LPRINT " One compressor operating - ambient wet bulb temperature = "; surfwb
  LPRINT " *****"
  LPRINT " "
  LPRINT " Evaporator duty = "; qe1; "      Evaporating temperature = "; te1
  LPRINT " Condenser duty = "; qc1; "      Condensing temperature = "; tc1
  LPRINT " Evaporator water temperatures - in "; twie1; " - out "; twoe1
  LPRINT " Evaporator water flow rate = "; le1
  LPRINT " "
  LPRINT " Power requirements"
  LPRINT " Compressor load           = "; load1 * 100; " %"
  LPRINT " Compressor input power      = "; compip1
  LPRINT " Evaporator pump power       = "; evapip1
  LPRINT " Condenser fan and pump power = "; condip1
  LPRINT " BAC fan and pump power      = "; bacip
  LPRINT " Total input power           = "; powert
  LPRINT " Total evaporator duty       = "; qe
  LPRINT " Overall power to cooling ratio = "; opr

```

CALL outdata1

END SUB

```

SUB dout1a
  CLS
  CALL power1
  PRINT " One compressor operating - ambient wet bulb temperature = "; surfwb
  PRINT " *****"
  PRINT " "
  PRINT " Evaporator duty = "; qe1; "      Evaporating temperature = "; te1
  PRINT " Condenser duty = "; qc1; "      Condensing temperature = "; tc1
  PRINT " Evaporator water temperatures - in "; twie1; " - out "; twoe1
  PRINT " Evaporator water flow rate = "; le1
  PRINT " "
  PRINT " Power requirements"
  PRINT " Compressor load           = "; load1 * 100; " %"
  PRINT " Compressor input power      = "; compip1
  PRINT " Evaporator pump power       = "; evapip1
  PRINT " Condenser fan and pump power = "; condip1
  PRINT " BAC fan and pump power      = "; bacip
  PRINT " Total input power           = "; powert
  PRINT " Total evaporator duty       = "; qe
  PRINT " Overall power to cooling ratio = "; opr
  'CALL outdata1

```

END SUB

APPENDIX 4 - MOUNT ISA SURFACE PLANT SIMULATION

```

SUB dout2p
  CALL power2s
  LPRINT " "
  LPRINT " Two compressors in parallel - ambient wet bulb temperature = ";
surfwb
  LPRINT " *****"
  LPRINT " "
  LPRINT " Evaporator duty = "; qe1; "      Evaporating temperature = "; te1
  LPRINT " Condenser duty = "; qc1; "      Condensing temperature = "; tc1
  LPRINT " Evaporator water temperatures - in "; twie1; " - out "; twoe1
  LPRINT " Evaporator water flow rate = "; le1
  LPRINT " "
  LPRINT " Total evaporator water flow rate = "; (le1 + le2)
  LPRINT " "
  LPRINT " Power requirements"
  LPRINT " "
  LPRINT " Compressor load = "; load1 * 100; " %"
  LPRINT " Compressor input power - No 1 = "; compip1; " No 2 = "; compip2
  LPRINT " Evaporator pump power - No 1 = "; evapip1; " No 2 = "; evapip2
  LPRINT " Condenser fan and pump - No 1 = "; condip1; " No 2 = "; condip2
  LPRINT " BAC fan and pump power = "; bacip
  LPRINT " Total input power = "; powert
  LPRINT " Total evaporator duty = "; qe
  LPRINT " Overall power to cooling ratio = "; oper
  CALL outdata2s
END SUB

SUB dout2ps
CLS
  CALL power2s
  PRINT " "
  PRINT " Two compressors in parallel - ambient wet bulb temperature = "; surfwb
  PRINT " *****"
  PRINT " "
  PRINT " Evaporator duty = "; qe1; "      Evaporating temperature = "; te1
  PRINT " Condenser duty = "; qc1; "      Condensing temperature = "; tc1
  PRINT " Evaporator water temperatures - in "; twie1; " - out "; twoe1
  PRINT " Evaporator water flow rate = "; le1
  PRINT " "
  PRINT " Total evaporator water flow rate = "; (le1 + le2)
  PRINT " "
  PRINT " Power requirements"
  PRINT " "
  PRINT " Compressor Load = "; load1 * 100; " %"
  PRINT " Compressor input power - No 1 = "; compip1; " No 2 = "; compip2
  PRINT " Evaporator pump power - No 1 = "; evapip1; " No 2 = "; evapip2
  PRINT " Condenser fan and pump - No 1 = "; condip1; " No 2 = "; condip2
  PRINT " BAC fan and pump power = "; bacip
  PRINT " Total input power = "; powert
  PRINT " Total evaporator duty = "; qe
  PRINT " Overall power to cooling ratio = "; oper
  'CALL outdata2s
END SUB

```

APPENDIX 4 - MOUNT ISA SURFACE PLANT SIMULATION

```

SUB dout2s
  CALL power2s
  LPRINT " "
  LPRINT " Two compressors in series - ambient wet bulb temperature = "; surfwb
  LPRINT " *****"
  LPRINT " "
  LPRINT " First stage operation - compressor load = "; (load1 * 100); " %"
  LPRINT " "
  LPRINT " Evaporator duty = "; qe1; "      Evaporating temperature = "; te1
  LPRINT " Condenser duty = "; qc1; "      Condensing temperature = "; tc1
  LPRINT " Evaporator water temperatures - in "; twie1; " - out "; twoe1
  LPRINT " Evaporator water flow rate = "; le1
  LPRINT " "
  LPRINT " Second stage operation - compressor load = "; (load2 * 100); " %"
  LPRINT " "
  LPRINT " Evaporator duty = "; qe2; "      Evaporating temperature = "; te2
  LPRINT " Condenser duty = "; qc2; "      Condensing temperature = "; tc2
  LPRINT " Evaporator water temperatures - in "; twie2; " - out "; twoe2
  LPRINT " Evaporator water flow rate = "; le2
  LPRINT " "
  LPRINT " Power requirements"
  LPRINT " "
  LPRINT " Compressor input power - No 1 = "; compip1; " No 2 = "; compip2
  LPRINT " Evaporator pump power - No 1 = "; evapip1; " No 2 = "; evapip2
  LPRINT " Condenser fan and pump - No 1 = "; condip1; " No 2 = "; condip2
  LPRINT " BAC fan and pump power = "; bacip
  LPRINT " Total input power = "; powert
  LPRINT " Total evaporator duty = "; qs
  LPRINT " Overall power to cooling ratio = "; opr
  CALL outdata2s

```

END SUB

SUB dout2sa

CLS

```

  CALL power2s
  PRINT " "
  PRINT " Two compressors in series - ambient wet bulb temperature = "; surfwb
  PRINT " *****"
  PRINT " "
  PRINT " First stage operation - compressor load = "; (load1 * 100); " %"
  PRINT " Evaporator duty = "; qe1; "      Evaporating temperature = "; te1
  PRINT " Condenser duty = "; qc1; "      Condensing temperature = "; tc1
  PRINT " Evaporator water temperatures - in "; twie1; " - out "; twoe1
  PRINT " Evaporator water flow rate = "; le1
  PRINT " "
  PRINT " Second stage operation - compressor load = "; (load2 * 100); " %"
  PRINT " Evaporator duty = "; qe2; "      Evaporating temperature = "; te2
  PRINT " Condenser duty = "; qc2; "      Condensing temperature = "; tc2
  PRINT " Evaporator water temperatures - in "; twie2; " - out "; twoe2
  PRINT " Evaporator water flow rate = "; le2
  PRINT " "
  PRINT " Power requirements"

```

APPENDIX 4 - MOUNT ISA SURFACE PLANT SIMULATION

```
PRINT " Compressor input power - No 1 = "; compip1; " No 2 = "; compip2
PRINT " Evaporator pump power - No 1 = "; evapip1; " No 2 = "; evapip2
PRINT " Condenser fan and pump - No 1 = "; condip1; " No 2 = "; condip2
PRINT " BAC fan and pump power = "; bacip
PRINT " Total input power = "; powert
PRINT " Total evaporator duty = "; qe
PRINT " Overall power to cooling ratio = "; opr
END SUB

SUB outdata1
LPRINT " "
LPRINT " Evaporator details"
LPRINT " Number of cassettes = "; nep1; " Fouling factor = "; hfe1
LPRINT " Condenser details"
LPRINT " Airflow rate = "; (qac1 * ff1); " Fouling factor = "; hfc1
LPRINT " "
END SUB

SUB outdata2s
LPRINT " "
LPRINT " Evaporator details"
LPRINT " No 1 Number of cassettes = "; nep1; " Fouling factor = "; hfe1
LPRINT " No 2 Number of cassettes = "; nep2; " Fouling factor = "; hfe2
LPRINT " Condenser details"
LPRINT " No 1 Airflow rate = "; (qac1 * ff1); " Fouling factor = "; hfc1
LPRINT " No 2 Airflow rate = "; (qac2 * ff2); " Fouling factor = "; hfc2
LPRINT " "
END SUB
```

APPENDIX 4 - MOUNT ISA SURFACE PLANT SIMULATION

11 Main programme

```

DECLARE SUB pcondenser1 ()
DECLARE SUB pcondenser2 ()
DECLARE SUB wettemp (ssl, pl, wbl)
DECLARE SUB power1 ()
DECLARE SUB power2s ()
DECLARE SUB outdata1 ()
DECLARE SUB outdata2s ()
DECLARE SUB dout1 () DECLARE SUB dout1a ()
DECLARE SUB dout2s () DECLARE SUB dout2sa ()
DECLARE SUB dout2p () DECLARE SUB dout2pa ()
DECLARE SUB indata ()
DECLARE SUB initial ()
DECLARE SUB start ()
DECLARE SUB opset2parallel ()
DECLARE SUB opset2series ()
DECLARE SUB opset1 ()
DECLARE SUB evaporator1 ()
DECLARE SUB evaporator2 ()
DECLARE SUB compressor1 (hl, vl, il, te1, tc1)
DECLARE SUB compressor2 (hl, vl, il, te2, tc2)
DECLARE SUB set1 ()
DECLARE SUB set2 ()
DECLARE SUB refproperties (hl, vl, il, te1, tc1)
DECLARE SUB bulkcooler ()
DECLARE SUB wetdrytemp (ssl, srl, pl, wbl, dbl)
DECLARE SUB psychrometry (wbl, dbl, pl, e, r, s, h, td, asv)
DECLARE SUB bcout () DECLARE SUB dout ()
DECLARE SUB tower1 () DECLARE SUB tower2 ()
'Supplier 2, Batch operation - PHE condensers and condenser towers
COMMON SHARED adiah1, estadi1, qe1, qc1, compin1, ua1, h, v, i
COMMON SHARED twoc1, twie1, le1, te1, nep1, hfe1, twoc1, twic1, lc1, tc1
COMMON SHARED qairt1, fomt1, twot1, twit1, ncell1, qcell1, ncp1, hfe1
COMMON SHARED invol1, idpcr1, ocomp1, invol2, idpcr2, compip2, surfwb
COMMON SHARED adiah2, estadi2, qe2, qc2, compin2, ua2, surfdb, surfp
COMMON SHARED twoc2, twie2, le2, te2, nep2, hfe2, twoc2, twic2, lc2, tc2
COMMON SHARED qairt2, fomt2, twot2, twit2, ncell2, qcell2, ncp2, hfe2
COMMON SHARED tout, ncomp, config, ncond, evapip1, evapip2, condip1, condip2
COMMON SHARED powert, opcr, qe, qbc, fombc, wbbco, lbc, twot, kwbc, wbcout
COMMON SHARED resistbc, headbc, bacip, twoc, load1, load2, pif1, pif2, pout
COMMON SHARED acomp1, acomp2, bcomp, bcomp1, bcomp2, twit
CALL start
CALL initial
IF ncomp = 1 THEN CALL opset1
IF ncomp = 2 AND config = 1 THEN CALL opset2series
IF ncomp = 2 AND config = 2 THEN CALL opset2parallel
IF ncomp = 1 THEN CALL dout1a
IF ncomp = 2 AND config = 1 THEN CALL dout2sa
IF ncomp = 2 AND config = 2 THEN CALL dout2pa
PRINT " enter 1 for hard copy or 0 for skip"
INPUT pout
IF pout = 1 THEN CALL dout
IF pout = 1 THEN CALL bcout
END

```

APPENDIX 4 - MOUNT ISA SURFACE PLANT SIMULATION

12 Input data

```

SUB indata
nep1 = 104: nep2 = 104      'number of cassettes in evaporator phe
ncp1 = 107: ncp2 = 107    'number of cassettes in condenser phe
hfe1 = 7.5: hfe2 = 7.5    'evaporator fouling factor
hfc1 = 7.5: hfc2 = 7.5    'condenser fouling factor
fomt1 = .61: fomt2 = .61  'condenser tower factor of merit
ncell1 = 4: ncell2 = 4    'number of cells in condenser tower
lcell1 = 62.5: lcell2 = 62.5 'condenser tower water flow per cell
qcell1 = 55: qcell2 = 55  'condenser tower airflow per cell
lc1 = ncell1 * lcell1: lc2 = ncell2 * lcell2
qairt1 = ncell1 * qcell1: qairt2 = ncell2 * qcell2
qbc = 169                  'bulk air cooler airflow
fombc = .78               'bulk air cooler factor of merit
lbc = 183                 'bulk air cooler water flow rate
resistbc = .009          'bulk air cooler air resistance
headbc = 6.5             'bulk air cooler pump head
acomp1 = 1936.54 : acomp2 = 1936.54 'compressor constant
bcomp1 = 1191.71 : bcomp2 = 1191.71 'compressor variable
END SUB

```

13 Condenser operation

```

SUB pcondenser1
'closed plate condenser
DO
qc1 = qe1 + compip1
IF qc1 < 2000 THEN qc1 = 2000
twoc1 = twic1 + qc1 / 4.185 / lc1
DO
dt1 = tc1 - twic1: dt2 = tc1 - twoc1
IF dt2 < 0 THEN tc1 = twoc1 + .5
LOOP UNTIL dt2 > 0
lmtd1 = (dt1 - dt2) / LOG(dt1 / dt2)
rhaw1 = 1 / (16.9 * ncp1 ^ .2 * lc1 ^ .8 * (1 + .0075 * (twic1 + twoc1)))
rhar1 = 1 / (21.6 * ncp1 * EXP(tc1 / 65))
xrka1 = 1 / (86.7 * ncp1) : rhfa1 = 1 / (3.22 * ncp1 * hfc1)
ua1 = 1 / (rhaw1 + rhar1 + xrka1 + rhfa1)
qest1 = ua1 * lmtd1 : estlmtd1 = qc1 / ua1
tfactc1 = EXP((twoc1 - twic1) / estlmtd1)
tc1 = (twic1 - twoc1 * tfactc1) / (1 - tfactc1)
LOOP WHILE ABS(qc1 - qest1) > .01#
END SUB

```

SUB tower1

```

'crossflow condenser cooling tower operation
twit1 = twoc1: wb = twit1: db = twit1: p = surfp
CALL psychrometry(wb, db, p, e, r, s, h, td, asv)
swit1 = s: wb = surfwb: db = surfdb
CALL psychrometry(wb, db, p, e, r, s, h, td, asv)
sait1 = s
rt1 = 4.185 * lc1 * (twit1 - surfwb) / qairt1 / td / (swit1 - sait1)
nt1 = (fomt1 / (1 - fomt1)) * (1 / rt1) ^ .4
nwt1 = (1 - EXP(-nt1 * (1 - rt1))) / (1 - rt1 * EXP(-nt1 * (1 - rt1)))
twot1 = twit1 - nwt1 * (twit1 - surfwb)

```

END SUB



APPENDIX 4 - MOUNT ISA SURFACE PLANT SIMULATION

```

SUB pcondenser2
  'closed plate condenser
  DO
    qc2 = qe2 + compip2
    IF qc2 < 2000 THEN qc2 = 2000
    twoc2 = twic2 + qc2 / 4.185 / lc2
    DO
      dt1 = tc2 - twic2: dt2 = tc2 - twoc2
      IF dt2 < 0 THEN tc2 = twoc2 + .5
    LOOP UNTIL dt2 > 0
    lmtd2 = (dt1 - dt2) / LOG(dt1 / dt2)
    rhaw2 = 1 / (16.9 * ncp2 ^ .2 * lc2 ^ .8 * (1 + .0075 * (twic2 + twoc2)))
    rhar2 = 1 / (21.6 * ncp2 * EXP(tc2 / 65))
    xrka2 = 1 / (86.7 * ncp2) : rhfa2 = 1 / (3.22 * ncp2 * hfc2)
    ua2 = 1 / (rhaw2 + rhar2 + xrka2 + rhfa2)
    qest2 = ua2 * lmtd2
    estlmtd2 = qc2 / ua2
    tfactc2 = EXP((twoc2 - twic2) / estlmtd2)
    tc2 = (twic2 - twoc2 * tfactc2) / (1 - tfactc2)
  LOOP WHILE ABS(qc2 - qest2) > .01#
END SUB

```

```

SUB tower2
  'crossflow condenser cooling tower operation
  twit2 = twoc2: wb = twit2: db = twit2: p = surfp
  CALL psychrometry(wb, db, p, e, r, s, h, td, asv)
  swit2 = s: wb = surfwb: db = surfdb
  CALL psychrometry(wb, db, p, e, r, s, h, td, asv)
  sait2 = s
  rt2 = 4.185 * lc2 * (twit2 - surfwb) / qairt2 / td / (swit2 - sait2)
  nt2 = (fomt2 / (1 - fomt2)) * (1 / rt2) ^ .4
  nwt2 = (1 - EXP(-nt2 * (1 - rt2))) / (1 - rt2 * EXP(-nt2 * (1 - rt2)))
  twot2 = twit2 - nwt2 * (twit2 - surfwb)
END SUB

```

14 Plant operation

```

SUB opset1
  'one set only operating
  DO
    DO
      DO
        CALL set1
        CALL tower1
        test = twic1: twic1 = twot1
        LOOP UNTIL ABS(test - twot1) < .001
        le = le1 * ((twie1 - twoe1) / (twie1 - tout)) ^ 1.5
        le1 = le: le2 = le
      LOOP UNTIL ABS(twoe1 - tout) < .001
      CALL bulkcooler
      dret = twie1 - twot
      twie1 = (twie1 + twot) / 2
      twie = twie1
    LOOP UNTIL ABS(dret) < .001
  END SUB

```

APPENDIX 4 - MOUNT ISA SURFACE PLANT SIMULATION

```

SUB opset2parallel
  DO
    DO
      CALL set1
      le = le1 * ((twie1 - twoe1) / (twie1 - tout)) ^ 1.5
      le1 = le: le2 = le
      LOOP UNTIL ABS(twoe1 - tout) < .001
      CALL bulkcooler
      dret = twie1 - twot : twie1 = (twie1 + twot) / 2: twoe = twoe1
      LOOP UNTIL ABS(dret) < .001
      qe2 = qe1: qc2 = qc1: te2 = te1: tc2 = tc1
      twie2 = twie1: twoe2 = twoe1: twic2 = twic1: twoc2 = twoc1
      compip2 = compip1: twoe = twoe1
    END SUB
  END SUB

```

```

SUB opset2series
  DO
    DO
      DO
        CALL set1
        CALL tower1
        test = twic1: twic1 = twot1
        LOOP UNTIL ABS(test - twot1) < .001
        twie2 = twoe1
      DO
        CALL set2
        CALL tower2
        test = twic2: twic2 = twot2
        LOOP UNTIL ABS(test - twot2) < .001
        le = le1 * ((twie1 - twoe2) / (twie1 - tout)) ^ 1.5
        le1 = le: le2 = le
        LOOP UNTIL ABS(twoe2 - tout) < .001
        CALL bulkcooler
        dret = twie1 - twot : twie1 = (twie1 + twot) / 2: twie = twie2
        LOOP UNTIL ABS(dret) < .001
      END SUB
    END SUB
  END SUB

```

15 Plant power

```

SUB power1
  evapip1 = (15 * (le1 / nep1) ^ 2) * le1 / 650
  condip1 = (7.5 * (lc1 / ncp1) ^ 2 + 50) * lc1 / 650 + 240 * qairt1 / 650
  bacip = (resistbc * qbc ^ 3) / 700 + headbc * 1.5 * lbc / 65
  powert = compip1 + evapip1 + condip1 + bacip : qe = qe1: opr = qe / powert
END SUB

```

```

SUB power2s
  evapip1 = (15 * (le1 / nep1) ^ 2) * le1 / 650
  condip1 = (7.5 * (lc1 / ncp1) ^ 2 + 50) * lc1 / 650 + 240 * qairt1 / 650
  bacip = (resistbc * qbc ^ 3) / 700 + headbc * 1.5 * lbc / 65
  evapip2 = (15 * (le2 / nep2) ^ 2) * le2 / 650
  condip2 = (7.5 * (lc2 / ncp2) ^ 2 + 50) * lc2 / 650 + 240 * qairt2 / 650
  powert = compip1 + evapip1 + condip1 + compip2 + evapip2 + condip2 + bacip
  qe = qe1 + qe2: opr = qe / powert
END SUB

```