

Reps, Jenna Marie (2014) Detecting adverse drug reactions in the general practice healthcare database. PhD thesis, University of Nottingham.

Access from the University of Nottingham repository:

<http://eprints.nottingham.ac.uk/14360/1/thesis.pdf>

Copyright and reuse:

The Nottingham ePrints service makes this work by researchers of the University of Nottingham available open access under the following conditions.

- Copyright and all moral rights to the version of the paper presented here belong to the individual author(s) and/or other copyright owners.
- To the extent reasonable and practicable the material made available in Nottingham ePrints has been checked for eligibility before being made available.
- Copies of full items can be used for personal research or study, educational, or not-for-profit purposes without prior permission or charge provided that the authors, title and full bibliographic details are credited, a hyperlink and/or URL is given for the original metadata page and the content is not changed in any way.
- Quotations or similar reproductions must be sufficiently acknowledged.

Please see our full end user licence at:

http://eprints.nottingham.ac.uk/end_user_agreement.pdf

A note on versions:

The version presented here may differ from the published version or from the version of record. If you wish to cite this item you are advised to consult the publisher's version. Please see the repository url above for details on accessing the published version and note that access may require a subscription.

For more information, please contact eprints@nottingham.ac.uk

Detecting Adverse Drug Reactions in the General Practice Healthcare Database



Jenna Marie Reps

School of Computer Science

University of Nottingham

A thesis submitted for the degree of

Doctor of Philosophy

2014

Acknowledgements

I would like to acknowledge and thank my supervisors Professor Jonathan Garibaldi and Professor Uwe Aickelin, whos guidance made this thesis possible, my family for their continued support during my PhD and my friends for helping to keep me motivated.

Abstract

The novel contribution of this research is the development of a supervised algorithm that extracts relevant attributes from The Health Improvement Network database to detect prescription side effects. Prescription drug side effects are a common cause of morbidity throughout the world. Methods that aim to detect side effects have historically been limited due to the data available, but some of these limitations may be overcome by incorporating longitudinal observational databases into pharmacovigilance. Existing side effect detecting methods using longitudinal observational databases have shown promise at becoming a fundamental component of post marketing surveillance but unfortunately have high false positive rates. An extra step is required to further analyse and filter the potential side effects detected by existing methods due to their high false positive rates, and this reduces their efficiency. In this thesis a novel methodology, the supervised adverse drug reaction predictor (SAP) framework, is presented that learns from known side effects, and identifies patterns that can be utilised to detect unknown side effects. The Bradford-Hill causality considerations are used to derive suitable attributes as inputs into a learning algorithm. Both supervised and semi-supervised techniques are investigated due to the limited number of definitively

known side effects. The results showed that the SAP framework implementing a random forest classifier outperformed the existing methods on The Health Improvement Network longitudinal observational database, with AUCs ranging between 0.812-0.937, an overall MAP of 0.667, precision values between 0.733-1 and a false positive rate ≤ 0.013 . When applied to the standard reference the SAP framework implementing a support vector machine obtained a MAP score of 0.490, an average AUC of 0.703 and a false positive rate of 0.16. The false positive rate is lower than that obtained by existing methods on the standard reference.

Contents

| | |
|--|-----------|
| Contents | iv |
| List of Figures | ix |
| Nomenclature | xv |
| 1 Introduction | 1 |
| 1.1 Background & Motivation | 2 |
| 1.2 Aims & Objectives | 6 |
| 1.2.1 Hypotheses | 7 |
| 1.2.2 Objectives | 8 |
| 1.3 Thesis Organisation | 9 |
| 1.4 Contribution to Knowledge | 11 |
| 2 Literature Review | 13 |
| 2.1 Current Pharmacovigilance | 13 |
| 2.1.1 Introduction | 13 |
| 2.1.2 Causality | 17 |
| 2.1.3 Spontaneous Reporting Databases | 19 |
| 2.1.3.1 Overview | 19 |
| 2.1.3.2 Causality | 25 |
| 2.1.3.3 Limitations | 27 |
| 2.1.3.4 Summary | 28 |
| 2.1.4 Longitudinal Observational Databases | 29 |

| | | |
|----------|--|-----------|
| 2.1.4.1 | Introduction | 29 |
| 2.1.4.2 | Methods | 33 |
| 2.1.4.3 | Causality | 42 |
| 2.1.4.4 | Limitations | 43 |
| 2.1.4.5 | Summary | 43 |
| 2.1.5 | Combining Multiple Databases | 44 |
| 2.1.5.1 | Overview | 44 |
| 2.1.5.2 | Summary | 50 |
| 2.1.6 | Pharmacovigilance Summary | 50 |
| 2.2 | Pattern Recognition | 53 |
| 2.2.1 | Supervised Learning | 55 |
| 2.2.1.1 | Introduction | 55 |
| 2.2.1.2 | Classifiers | 61 |
| 2.2.1.3 | Ensemble Methods | 69 |
| 2.2.1.4 | Supervised Learning Summary | 73 |
| 2.2.2 | Semi-Supervised Learning | 74 |
| 2.2.2.1 | Introduction | 74 |
| 2.2.2.2 | Semi-Supervised Clustering | 79 |
| 2.2.2.3 | Metric Learning | 80 |
| 2.2.2.4 | Semi-Supervised Learning Summary | 82 |
| 2.2.3 | Pattern Recognition Summary | 83 |
| 2.3 | Literature Review Summary | 84 |
| 3 | Existing Methods Comparison | 87 |
| 3.1 | Introduction | 87 |
| 3.2 | Motivation | 88 |
| 3.3 | Existing Methods | 91 |
| 3.3.1 | TPD | 91 |
| 3.3.2 | MUTARA & HUNT | 92 |
| 3.3.3 | ROR | 92 |
| 3.4 | Determining Labels | 93 |
| 3.4.1 | ADR Labels | 93 |

| | | |
|----------|----------------------------------|------------|
| 3.4.1.1 | Online | 93 |
| 3.4.1.2 | SIDER | 93 |
| 3.4.2 | Noise Labels | 94 |
| 3.5 | Measures | 94 |
| 3.5.1 | Natural Thresholds | 95 |
| 3.5.2 | Ranking Ability | 96 |
| 3.6 | General Comparison | 98 |
| 3.6.1 | Method | 98 |
| 3.6.2 | Results | 99 |
| 3.6.3 | Discussion | 101 |
| 3.7 | Specific Comparison | 104 |
| 3.7.1 | Method | 104 |
| 3.7.2 | Results and Discussion | 105 |
| 3.8 | Summary | 108 |
| 4 | Incorporating Causation | 110 |
| 4.1 | Introduction | 110 |
| 4.2 | Motivation | 111 |
| 4.2.1 | Data Cleansing | 113 |
| 4.2.2 | Data Extraction | 113 |
| 4.2.2.1 | Formulation | 113 |
| 4.2.2.2 | Extraction | 115 |
| 4.2.3 | Data Derivation | 119 |
| 4.2.3.1 | Association Strength | 121 |
| 4.2.3.2 | Temporality | 123 |
| 4.2.3.3 | Specificity | 124 |
| 4.2.3.4 | Biological Gradient | 126 |
| 4.2.3.5 | Experimentation | 127 |
| 4.2.3.6 | Other Criteria | 128 |
| 4.2.3.7 | THIN Specific | 128 |
| 4.2.3.8 | A Note on Dependency | 130 |
| 4.2.4 | Data Description | 131 |

| | | |
|----------|---|------------|
| 4.2.5 | Data Transformation | 131 |
| 4.2.5.1 | Continuous Attributes | 131 |
| 4.2.5.2 | Discrete Attributes | 132 |
| 4.2.6 | Feature Selection | 133 |
| 4.3 | Summary | 135 |
| 5 | Developing The ADR Learning Framework | 136 |
| 5.1 | Introduction | 136 |
| 5.2 | Motivation | 137 |
| 5.3 | Algorithms | 139 |
| 5.3.1 | Supervised ADR Predictor | 139 |
| 5.3.1.1 | Training Stage | 141 |
| 5.3.1.2 | Prediction Stage | 142 |
| 5.3.1.3 | Results and Analysis | 142 |
| 5.3.1.4 | Summary | 147 |
| 5.3.2 | Semi-Supervised ADR Predictor | 148 |
| 5.3.2.1 | Self Training Random Forest | 149 |
| 5.3.2.2 | Semi-supervised Clustering | 151 |
| 5.3.2.3 | Results and Analysis | 152 |
| 5.3.2.4 | Summary | 158 |
| 5.4 | Summary | 158 |
| 6 | Evaluating The ADR Learning Framework | 160 |
| 6.1 | Introduction | 160 |
| 6.2 | Motivation | 161 |
| 6.3 | Evaluation using the Standard Reference | 162 |
| 6.3.1 | Method | 163 |
| 6.3.2 | Results | 163 |
| 6.3.3 | Discussion | 164 |
| 6.4 | Specific Comparison | 166 |
| 6.4.1 | Method | 166 |
| 6.4.2 | Results | 166 |

CONTENTS

| | | |
|----------|--|------------|
| 6.4.2.1 | Nifedipine | 166 |
| 6.4.2.2 | Ciprofloxacin | 168 |
| 6.4.2.3 | Ibuprofen | 170 |
| 6.4.2.4 | Budesonide | 172 |
| 6.4.2.5 | Naproxen | 173 |
| 6.4.3 | Discussion | 175 |
| 6.5 | Summary | 181 |
| 7 | Conclusions | 183 |
| 7.1 | Contributions | 184 |
| 7.2 | Future Work | 190 |
| 7.3 | Dissemination | 193 |
| 7.3.1 | Journal Papers | 193 |
| 7.3.2 | Conference papers | 194 |
| A | The THIN Database | 196 |
| B | Drugs | 205 |
| C | Software Details and Preliminary Work | 211 |
| C.1 | Software Details | 211 |
| C.2 | Wrapper Feature Selection | 212 |
| C.3 | Preliminary Work | 213 |
| D | SAP Result Tables | 219 |
| | References | 268 |

List of Figures

| | | |
|-----|--|----|
| 2.1 | Illustration of data contained in SRS databases. | 20 |
| 2.2 | An example entity relationship diagram for an SRS database based on the FAERS database. | 21 |
| 2.3 | The online form for submitting suspected ADRs via the Yellow Card Scheme in the UK. | 22 |
| 2.4 | Illustration of patients' longitudinal data contained in the THIN database. | 31 |
| 2.5 | Illustration of the counterfactual theory of causation. | 33 |
| 2.6 | Illustration of the disproportionality methods. | 34 |
| 2.7 | Illustration of the TPD method. | 35 |
| 2.8 | Illustration of the MUTARA and HUNT methods. | 40 |
| 2.9 | Illustration of a classifier partitioning the attribute space. Using the training data (blue dots are labelled as ADR and red as non-ADR) a function is trained to partition the space into ADR sections and non-ADR sections. This can then be used to predict whether a new data-point is an ADR or non-ADR based on where the data point lies in the attribute space. | 56 |

LIST OF FIGURES

| | | |
|------|---|-----|
| 2.10 | Illustration of the maximum number of points separable in every possible way by a linear classifier. | 60 |
| 2.11 | Example of a decision tree to classify drug-medical event pairs as ADRs or non-ADRs. | 61 |
| 2.12 | Illustration of the support vector machine classifier. The hyperplane separating the classes is positioned such that the distance between the hyperplane and the closest data points from either class is maximised. | 67 |
| 3.1 | The ROC plots for the different methods. The black line is the line $x=y$ | 100 |
| 3.2 | AP results for each method applied for each drugs. | 102 |
| 3.3 | The ROC plots for the specific comparison. The figure on the left is the whole specificity range, the figure on the right is for the specificity within the interval $[0.9, 1]$. The orange, red, yellow, green and blue curves correspond to $MUTARA_{180}$, $HUNT_{180}$, TPD_1 , TPD_2 and the ROR_{05} respectively. | 106 |
| 4.1 | Illustration of filtering done during data extraction. | 117 |
| 4.2 | Illustration of determining risk drug-medical event pairs. | 118 |
| 4.3 | Illustration of combining drug records and medical event records. | 120 |
| 5.1 | The framework implemented to train the four different classifiers using a variety of n drugs with known side effects. These general classifiers are then used to predict the class for unlabelled data. | 140 |

LIST OF FIGURES

| | | |
|-----|---|-----|
| 5.2 | The ROC curves for the different classifiers used to predict the ADRs of the drugs. The red curve represents the random forest classifier, the orange curve represents the support vector machine classifier, the green curve represents the logistic regression classifier and the blue curve represents the Naive Bayes classifier. | 144 |
| 5.2 | Continuation of the ROC plots. | 145 |
| 5.3 | The AUC and $AUC_{[0.9,1]}$ values for the SAP algorithm implementing each of the classifiers when applied for the drugs Nifedipine, Ciprofloxacin and Ibuprofen. | 146 |
| 5.4 | The framework for the Semi-Supervised ADR Predictor algorithm. This algorithm uses labelled and unlabelled data for the drug of interest only during training. The technique applied depends on the percentage of labelled data. | 150 |
| 5.5 | The ROC curves for the SSAP framework at 6 different values of <i>crit</i> when applied to the different drugs. The black, blue, red, orange, yellow and green curve correspond to <i>crit</i> values of 0.9, 0.7,0.5,0.3,0.1 and 0.05 respectively. | 154 |
| 5.6 | The ROC curves for the SSAP framework at 6 different values of <i>crit</i> when applied to Ibuprofen. The black, blue, red, orange, yellow and green curve correspond to <i>crit</i> values of 0.9, 0.7,0.5,0.3,0.1 and 0.05 respectively. Left Plot: Self Training, Right Plot: Clustering. | 155 |
| 5.7 | The ROC curves for the SSAP framework repeated multiple times for the drug Ibuprofen at a <i>crit</i> value of 0.1 to investigate consistency. Left Plot: Self Training, Right Plot: Clustering. | 156 |

LIST OF FIGURES

| | | |
|-----|--|-----|
| 5.8 | The AUC for the ROC plots obtained by applying the semi-supervised clustering and the self training classification within the SSAP framework to the different drugs at varied <i>crit</i> values. | 157 |
| 6.1 | The ROC plots for the SAP algorithm, implementing a random forest (black) and the existing methods MUTARA ₁₈₀ (orange), HUNT ₁₈₀ (red), TPD (green) and <i>ROR</i> ₀₅ (blue). | 176 |
| 6.1 | The ROC plots for the SAP algorithm, implementing a random forest (black) and the existing methods MUTARA ₁₈₀ (orange), HUNT ₁₈₀ (red), TPD (green) and <i>ROR</i> ₀₅ (blue). | 177 |
| 6.1 | The ROC plots for the SAP algorithm, implementing a random forest (black) and the existing methods MUTARA ₁₈₀ (orange), HUNT ₁₈₀ (red), TPD (green) and <i>ROR</i> ₀₅ (blue). | 178 |
| A.1 | An entity relationship diagram of the THIN database. | 197 |
| A.2 | A screen shot of the patient table contained within the THIN database. | 199 |
| A.3 | A screen shot of the therapy table contained within the THIN database. | 199 |
| A.4 | A screen shot of the medical table contained within the THIN database. | 200 |
| A.5 | An example of the branch of the THIN READ code tree. | 200 |
| A.6 | An example of the branch of the British National Formulary (BNF) tree. | 202 |

Nomenclature

| | |
|---|--|
| (α, β) | denotes a drug-medical event pair, where the drug is α and the medical event is β . |
| ADE | Adverse drug event. |
| ADR | Adverse drug reaction. |
| AUC | Area under the ROC curve: a measure of general signalling ability. |
| DOI | Drug of interest. |
| HOI | Health outcome of interest. |
| HUNT | Highlighting UTARs Negating TARs: a method for signalling ADRs using LODs. |
| IC | Information component: the measure of association used by the TPD method. |
| IC_{Δ} | A measure of association change over time used by the TPD method. |
| KNN | K-nearest neighbour. |

LIST OF FIGURES

| | |
|---------------|---|
| LOD | Longitudinal observational database. |
| LR | Logistic regression. |
| MAP | Mean average precision. |
| MUTARA | Mining Unexpected Temporal Association Rules given the Antecedent: a method for signalling ADRs using LODs. |
| NB | Naive Bayes. |
| OMOP | Observational Medical Outcomes Partnership. |
| pAUC | Area under the partial ROC curve: a measure of signalling ability for a defined specificity interval. |
| RF | Random forest. |
| RME | Risk medical events: the set of medical event that are observed for at least one patient within a month of being prescribed the drug of interest. |
| ROC | Receiver operating characteristic: an illustration of the performance of a binary classifier. |
| ROR | Reporting odds ratio: a measure of association. |
| SAP | Supervised ADR predictor: the novel framework for signalling ADRs developed through this thesis. |
| SIDER | A side effect resource containing drug-medical event pairs corresponding to ADRs. |

LIST OF FIGURES

| | |
|-------------|---|
| SRS | Spontaneous reporting system. |
| SSAP | Semi-supervised ADR predictor: a novel framework for signalling ADRs developed throughout this thesis. |
| SVM | Support vector machine. |
| THIN | The Health Improvement Network. |
| TPD | Temporal Pattern Detection: an ADR signalling method developed for LODs that looks for temporal changes in the association strength between and drug and medical event. |
| WHO | World Health Organization. |

Chapter 1

Introduction

The occurrence of negative side effects due to prescribed medication is a health issue that occurs worldwide. The early detection of side effects is imperative for the prevention of unnecessary morbidities or mortalities. Two types of electronic healthcare databases are frequently used to extract data for the detection of side effects, the spontaneous reporting system (SRS) databases and the longitudinal observational databases (LODs). Many methods have been developed for the SRS databases but these databases have a limited perspective and do not contain the data required to detect all side effects. This has prompted the focus towards using the LODs, but the proposed methods tend to be unsupervised. In this thesis, supervised and semi-supervised techniques capable of detecting side effects by utilising the data contained in LODs are investigated. The first part of this chapter focuses on the research background and motivation, this is followed by the aims and objectives. The chapter concludes with the thesis organisation that provides the outline of each chapter.

1.1 Background & Motivation

All prescribed drugs have side effects under certain conditions [170]. A negative effect following the ingestion of a drug is referred to as an Adverse Drug Event (ADE) and is defined as ‘any untoward medical occurrence that may present during treatment with a medicine but which does not necessarily have a causal relationship with the treatment’ [206]. When an ADE has been linked to a specific drug it becomes an Adverse Drug Reaction (ADR). An ADR is defined by the World Health Organization as a response to a medicine which is noxious and unintended, and which occurs at doses normally used in humans from the prophylaxis, diagnosis or therapy of disease, or for the modification of physiological function [182].

As ADRs can lead to patient morbidity or mortality, their early discovery is essential. As a consequence, the safety of a new drug is extensively analysed throughout its development. Unfortunately, the ability to analyse a drug’s toxicity is limited by the clinical study designs. The pre-clinical studies of a drug’s development, involving animal testing, are done to initially assess a drug’s toxicity [25], however, the ability to infer ADRs is limited by the inability of animal testing to be completely informative for effects on humans [133]. If a drug passes the initial toxicity analysis, it is then tested on humans during phases i–iii, with the trial population size increasing incrementally after each phase. Phase i will often involve testing the drug by giving it to healthy individuals under unrealistic conditions (i.e., the individuals cannot smoke, drink alcohol, exercise excessively and may have food limitations enforced) [38]. It is also widely known that clinical trials can be biased towards certain demographics, for example the majority

of individuals tested during phase i trials are white males [38]. Clinical trials involve testing the drug on a limited population size, with the largest population size used during phase iii, but this generally only contains up to 3000 individuals [38]. Due to numerous reasons, including the limited trial population size and the unrealistic conditions of the trials, many ADRs are undetectable during phase i-iii studies and can only be identified after the drug is marketed [11]. It is also clear that ADRs that result from polypharmacy (i.e., when multiple drugs are prescribed at the same time) will be difficult to detect. The reason is, due to the limited population being tested, it is impossible to investigate all the different drug combinations.

Studies investigating the prevalence of ADRs have provided evidence that many ADRs are not discovered prior to marketing. The results indicate that up to 6.5% of UK hospital admissions are due to ADRs [135] with similar rates also being observed in the US hospitals (6.7%) [103]. Another study found a similar prevalence within a UK paediatric hospital (4%) [62]. Research suggests ADRs are more common in geriatric patients (older than sixty five), in females and in patients taking more than one drug [17]. It has also been highlighted that the lack of efficient means to detect ADRs causes a burden in terms of cost and quality of life. Furthermore, this burden appears to be getting worse. It has been reported that ADRs could cost the UK £637 million each year [43], with £466 million being due to ADR hospital admissions and £171 million being due to ADRs during hospitalisation. These estimates do not take into consideration additional medical costs or loss of earning while in hospital due to an ADR. A study by Wu *et al.* (2010) compared the frequency of ADRs as the cause of hospital admission over 1999 to 2009 and showed the number of people admitted to hospital due to

ADRs has increased over the ten years at a greater rate than the rate of hospital admission [207]. Further, they found 26,399 people died in hospital in the UK over the ten years as a result of an ADR [207]. This corresponded to a probability of almost one in twenty ADRs resulting in death. One explanation for the increase in the number of ADRs over the years is due to polypharmacy [112].

This highlights the importance of continuous post-marketing surveillance of drugs and motivates the requirement of new methods that can identify ADRs efficiently. When a new potential ADR association is detected, the potential ADR is referred to as being signalled. The majority of current post-marketing surveillance techniques make use of the SRS databases. These databases contain records of suspected ADRs, that were originally restricted to submissions made by medical practitioners and coroners, but it is becoming increasingly common for them to enable the general public to submit reports. The SRS databases have many limitations that prevent them signalling ADRs efficiently and they cannot be used to quantify ADR risks [57], nor can they be used to consistently identify risk factors. It is widely known that the majority of ADRs signalled by the existing methods applied to SRS databases do not correspond to ADRs [172]. Retrospective studies have confirmed their inability to efficiently signal all ADRs, as the methods applied to SRS databases were unable to signal some ADRs before they were discovered by other means [3]. This has prompted the demand for better surveillance techniques [43] [207] and to use other forms of data to complement drug safety using SRS.

An alternative approach for signalling ADRs, that has recently surfaced, is to use data contained within LODs. The LODs are not restricted to a specific period of time around the drug prescription and can contain patient medical histories

spanning decades. These databases may present to opportunity to efficiently discover new ADRs [198] and enable ADR risks to be quantified. Their importance for future post-marketing surveillance has been expressed [203]. The existing methods proposed for the LODs are unsupervised and many are derived from the SRS methods [216] but new methods have been presented that are based on epidemiology techniques [156]. Unfortunately, these methods have been shown to have a high false positive rate [156], due to the difficulty distinguishing between association and causation, and this may reduce their signalling efficiency. The majority have been developed for a common data model [115; 131] (the integration of multiple LODs into a general database) rather than specific databases. Not all data can be converted into the common model [214], so information may be lost. Therefore, it is of interest to also develop methods that are specific to a single database, as new information may be revealed. It may be possible to develop a method with a low false positive rate by considering the Bradford-Hill causality consideration [19], as these are often used within extensive post marketing investigations to confirm causality .

The Health Improvement Network (THIN) database is an example of a LOD that contains approximately 6% of the general practice records within the UK. The THIN database contains complete medical records and prescription records (while the patient is registered) for all registered patients at participating practices. The THIN database contains heterogeneous data and has hierarchal structures embedded within it. An example of one of the hierarchal structures contained in the database is the recording of the medical events (i.e., administrative events, illnesses, symptoms, laboratory tests/results and medical history). The medical events are recorded via READ codes, these codes have five levels of

specificity and follow a tree structure. Little work to date has focused on using the THIN database for general postmarketing surveillance and no ADR signalling method has been specifically developed. Research has suggested that the THIN database potentially holds a wealth of information [105]. If its complex structure can be dealt with, then its integration into post-marketing surveillance may enable ADRs to be signalled efficiently.

1.2 Aims & Objectives

As this research is interdisciplinary it has both a clinical and technical aim. The overall clinical aim of this project is to develop a data-mining algorithm for a specific LOD, the THIN database, that can detect ADRs and discover new information to improve current post marketing drug surveillance. The technical aim is to develop an algorithm that can classify a pair consisting of a drug and medical event (drug-medical event pair) as a causal relationship or non-causal relationship. The algorithm must have a low false positive rate and a sufficiently high true positive rate. This algorithm has multiple applications as it can identify causation in databases containing discrete information. One such example is using databases containing customer shopping histories to identify items that when purchased influence a different item being purchased in the future. Another useful implementation of the algorithm using market data could be to identify the impact of promotions and find what purchases are caused by the promotion. The advantage over sequential pattern mining is that the algorithm does not require the events to be common.

1.2.1 Hypotheses

The THIN database potentially contains a wealth of information but this is hidden within a magnitude of heterogeneous data containing many underlying hierarchal structures. The abilities of the existing ADR signalling methods developed for LODs are likely to be impacted by the structure of the THIN database and also by their inability to distinguish between association and causation. These limiting factors may prevent the extraction of all the information that is potential available by mining the THIN database. To extract all the possible information and utilise the full potential of the THIN database, novel supervised/semi-supervised methods may need to be developed. It is therefore hypothesised that,

- H1** Current ADR signalling algorithms developed for LODs are not suitable for ADR detection when they are implemented on the THIN database.
- H2** Novel ADR signalling algorithms applied to the THIN database will be able to consistently perform better than existing LOD ADR signalling algorithms if they 1) deal with the hierarchal structures within the THIN database, 2) incorporate new attributes essential for determining causality and 3) use known ADR knowledge.
- H3** Novel ADR signalling algorithms applied to the THIN database will outcompete existing methods developed for the Observational Medical Outcomes Partnership (OMOP) common model when considering the specified drug and health outcomes of interest [141].
- H4** Novel ADR signalling algorithms applied to the THIN database will be able to generate new ADR signals.

1.2.2 Objectives

To address the research hypotheses the following research objectives are proposed, with the hypothesis they are linked to indicated in brackets.

1. Determine the benchmark for signalling ADRs using the THIN database and identify limitations (**H1**).
2. Propose suitable attributes for each drug-medical event pair that may help separate association from causation or that are specific to the THIN database (**H2.1-H2.2**).
3. Develop a novel supervised/semi-supervised ADR signalling algorithm for implementation on the THIN database that can accurately signal ADRs (**H2.3**). The requirements are,
 - (a) A low false positive rate.
 - (b) To be efficient.
 - (c) To be robust.
4. Evaluate the novel algorithm on the THIN database.
 - (a) Compare the general signalling ability of the novel ADR signalling algorithm and the existing methods applied to the THIN database (**H2**).
 - (b) Evaluate the novel ADR signalling algorithm's ability on the OMOP specified drug and health outcomes of interest (**H3**).
 - (c) Generate new ADR signals (**H4**).

Chapters 3-6 focus on Objectives 1-4 respectively.

1.3 Thesis Organisation

The continuation of this thesis is organised as follows. Chapter 2 presents the literature review that is split into a pharmacovigilance section and a pattern recognition section. The pharmacovigilance section presents an overview of the current techniques and the recent advances. The Bradford-Hill causality considerations are discussed, as ADRs represent a causal relationship and the criteria may present the opportunity to distinguish ADRs from non-ADRs. The existing methods developed for different healthcare databases are summarised, with their connection to the Bradford-Hill causality considerations evaluated. The final part of the pharmacovigilance section focusses on the new initiatives currently taking place that aim to improve the way ADRs are signalled. The pattern recognition part presents the statistical learning theory view of supervised and semi-supervised learning. The main supervised and semi-supervised algorithms, that are used during the later chapters of the thesis, are summarised.

In Chapter 3, the benchmark for the ADR signalling ability of the THIN database is determined by applying a selection of the existing methods to the THIN database. As there is no perfect gold standard for signalling ADRs, two different comparisons were applied. The first comparison involved analysing all the possible drug-medical event pairs for a set of specific drugs and considering only the drug-medical event pairs listed as known ADRs on the website NetDoctor [176] to be ADRs and all other pairs to be non-ADRs. This enabled the evaluation of the methods when there is a large number of non-ADRs, but the comparison was limited due to the possibility of ADRs listed on NetDoctor being incorrect and due to unknown ADRs. The second comparison, termed the

specific comparison, only evaluated the drug-medical event pairs corresponding to ADRs listed on drug packaging or definitively known non-ADRs. The specific comparison enabled a more realistic evaluation and highlighted methods that are non-consistent.

In Chapter 4, attributes that are suitable inputs for a learning algorithm to distinguish ADRs and non-ADRs were proposed. The attributes included values from existing method, novel attributes derived from the Bradford-Hill causality criteria or novel attributes derived by considering the structure of the THIN database. The technique for extracting and cleansing the data are described and mathematical formula for calculating each attribute are presented.

In Chapter 5, the learning algorithm is developed and tentative results are presented. The first part of the chapter proposes a novel supervised technique that learns from a mixture of drugs and, once learned, can be applied to any drug. In the second part, a novel semi-supervised technique is presented that uses the limited number of known ADRs for a drug of interest to generate a model that is specific to the drug. Both the supervised and semi-supervised models are evaluated on a selection of drugs. The evaluation suggests that a supervised model trained on multiple drugs will outperform a semi-supervised model trained on a single drug. This is advantageous, as the supervised model can be trained on drugs that have been marketed for years and can be applied to newly marketed drugs that have limited toxicity knowledge.

In Chapter 6 the novel supervised algorithm is applied to more drugs and compared with a selection of existing methods using the specific comparison technique. The results showed that the novel supervised algorithm was often significantly better and had a better mean average precision (MAP) score and

lower false positive rate than existing methods. An additional evaluation was conducted by investigating the novel supervised algorithm’s ability when considering the health outcomes of interest (HOIs) and drugs of interest (DOIs) specified by the OMOP. The evaluation showed that the novel supervised algorithm obtains a lower false positive rate than existing methods (0.16) and is able to signal a high proportion of definitively known ADRs. Therefore, the novel supervised algorithm has the potential to extract new pharmacovigilance knowledge and may help signal ADRs shortly after new drugs are marketed.

The final chapter of the thesis contains the conclusion that highlights the key results of the research and answers the research questions proposed in the introduction. Areas of future work are proposed, such as the modification of the algorithm to return quantitative information about the risk of each ADR signalled. The journal and conference contributions derived from this research are presented at the end of Chapter 7.

1.4 Contribution to Knowledge

This research has presented the first supervised and semi-supervised methods for signalling ADRs using LODs. New techniques for generating labels that are essential for supervised/semi-supervised algorithms have been presented and novel attributes that can distinguish between association and causation were proposed.

The research also highlighted the current limitations with evaluating the methods, as restricting the evaluation to a small number of definitively known drug-medical event pairs may prevent an accurate evaluation due to ignoring the numerous drug-medical event pairs that are associated due to confounding but

including more pairs into the evaluation may introduce error due to unknown ADRs.

This research has contributed to four journal papers (two published, one in print and one under review) and four conference papers. A full list of the journal and conference papers produced during this research is presented at the end of Chapter 7.

Chapter 2

Literature Review

‘Prevention is the next frontier for pharmacovigilance,
beyond simply generating alerts.’

N. MOORE [121]

2.1 Current Pharmacovigilance

2.1.1 Introduction

In 1961 a link was discovered between pregnant mothers ingesting the drug Thalidomide and then giving birth to infants with congenital malformations [167]. This widespread incident highlighted the importance of drug safety and prompted the start of systematic approaches to monitor the safety of marketed medications [29]. The research into medication safety is commonly referred to as pharmacovigilance. This involves the detection, assessment and prevention of ADRs for any marketed drug. The aim of pharmacovigilance is to identify ADRs, study relevant data and then investigate each ADR to assess risk factors. This knowl-

edge can then be used to help prevent ADRs that would otherwise lead to patient morbidity or mortality; helping to improve healthcare.

The process of identifying new ADRs involves signalling sets consisting of one or many drugs and an adverse event that may correspond to an ADR. There are different definitions for the term ADR signal in the context of pharmacovigilance but generally it means there is information to suggest a previously unknown causal relationship between some medication and an adverse event. The World Health Organization's (WHO) definition of an ADR signal is 'reported information on a possible causal relationship between an adverse event and a drug, the relationship being unknown or incompletely documented previously. Usually, more than a single report is required to generate a signal, depending on the seriousness of the event and quality of the information' [53; 111]. Almenoff *et al.* (2005) interpret this as being able to 'view a signal as any information, qualitative or quantitative, that prompts further investigation on the relationship between a drug and an event' [1].

Once an ADR signal is generated, the medication and adverse event are studied further with more stringent statistical tests to confirm whether the signal is true, meaning there is sufficient evidence to confirm a causal relationship between the medication and the adverse event. Conversely, if there is not sufficient evidence, then the signal is false. In effect, ADR signalling is a way of filtering all the possible combinations of drug and adverse event pairs so that only the combinations that are most likely to correspond to ADRs remain to be investigated further. This is important as it is not possible to efficiently investigate the thousands or even millions of possible combinations of drugs and suspected ADRs in fine detail.

Overall, the process of identifying an ADR (a causal relationship between a drug and medical event) requires three steps [136];

1. **Signal generation/detection**- this step involves analysing all drug-medical event pairs representing a possible ADR and highlighting the ones that are most suspicious.
2. **Signal refinement**- after signals are generated in step 1 for some drug-medical events pairs these drug-medical event pairs are actively surveyed to look for more evidence that they may correspond to an ADR.
3. **Signal evaluation**- this is when a single in depth investigation (formal epidemiological study) is performed to determine if there is causality between a drug and a medical event that has been signalled in step 1 and refined in step 2.

Early pharmacovigilance depended on professionals manually investigating hard copies of reports detailing suspected ADRs. These professionals would then identify commonly occurring suspected ADRs or highly noxious suspected ADRs as signals [113; 145]. The limitations with this methodology was that collaboration was difficult prior to the World Wide Web so the reports were only collected from a segment of the population and less obvious ADRs may never have been suspected and reported or may have been difficult to identify. With the advances in technology enabling rapid communication between borders and helping pool large quantities of data together, many of the original limitations are beginning to disappear [198]. Using the large collections of electrically stored data, we are now presented with the opportunity to apply data mining methods and generate ADR signals more efficiently [35], as less time is required before there is a

sufficient number of ADR incidences reported to enable the signal generation [158].

The majority of existing pharmacovigilance methods that use large databases for ADR signal detection are applied to the SRS databases. The SRS databases are readily available electronic databases that contain a collection of voluntary reports of suspected ADRs, often containing millions of reports. This type of database has been used to successfully signal many ADR signals, but the signals cannot be considered definitive [119]. There are also well documented limitations with using SRS databases for ADR signalling, due to these databases relying on people recognising and reporting suspected ADRs [63; 79; 168]. It has been suggested that these limitations may prevent the detection of rare ADRs [79] or lead to delays in generating ADR signals [93]. The standard procedure for automating the generation of ADR signals in SRS databases relies on calculating a measure of disproportionality corresponding to how often the adverse event is reported after a specific drug compared to a baseline determined by how often it is reported after any drug within an SRS database [119]. As there is no gold standard for ADR signal detection, each country tends to have a different preference for the choice of disproportionality method applied to his SRS database. The main disproportionality methods applied to the SRS databases and their limitations are detailed in Chapter 2.1.3.

Recently the LODs have caught the attention of pharmacovigilance researches as it offers a unique perspective for ADR signal generation and is starting to become more readily available [180]. The LODs suitable for pharmacovigilance contain timestamped medical records and timestamped prescription records for patients over large periods of time. Rather than relying on people suspecting

ADRs like the SRS databases, potential ADRs can be inferred using temporal relationships between the medical and prescription records for a patient. This may enable the detection of rare ADRs or ADRs with a high background rate [180] that can not be identified by mining the SRS databases. Additionally, as generating ADR signals by mining the LODs does not require people noticing potential ADRs, it may be possible to generate ADR signals earlier than by mining the SRS databases. In Chapter 2.1.4, the current ADR signalling methods developed for the LODs are described, along with their limitations.

The continuation of the pharmacovigilance section of the literature review includes a section summarising causality, and the frequently applied Bradford-Hill causality considerations [19]. This is followed by a description of the current methodologies for detecting ADRs by mining the SRS databases and the new advances into mining ADRs using LODs. The final section summarises the current pharmacovigilance initiatives and highlights how this field of research may change with the integration of multiple electronic healthcare databases.

2.1.2 Causality

The definition of a statistical association is ‘a relationship between two measured quantities that renders them statistically dependent’ [183]. Whereas the term causality is defined as ‘a relationship between two events, the cause (or incidence) event and effect (or consequent) event, where the effect event is dependent on the cause event’ [169]. Therefore a causal relationship is also an association but not all associations are causal. It is clear that an ADR represents a causal relationship, as the adverse event is a result of a patient ingesting a specific drug and would

not have occurred if the patient did not have the drug. The first step in current ADR discovery, namely signal generation, finds drug-medical event pairs that are associated and the later two steps, signal refinement and evaluation, aim to determine if the found association is also a causal relationship.

A common method to assess causality between an antecedent and consequence is to use the Bradford-Hill causality considerations [19] that proposes nine factors that need to be considered,

1. **Strength**- how much do the antecedent and consequence appear to be associated? A high association would suggest causation however a low association does not mean there is no causation.
2. **Consistency**- has the relationship been observed in different patients and situations? (In the context of ADRs, has it been reported in multiple patients and databases?).
3. **Specificity**- is the relationship specific (e.g., there are few other associations containing the antecedent or consequence). This factor has limitations as many ADRs are the result of multiple causes. An alternative interpretation is whether the population experiencing the relationship is specific (e.g., old, young or female).
4. **Temporality**- the order of the antecedent and consequence (e.g., did the medical event make the patients more prone to the drug or did the drug cause the medical event?).
5. **Biological Gradient**- is there an increasing monotonic relationship between the frequency/amount of the antecedent and the frequency of the

consequence (e.g., does a higher dosage of the drug increase the medical event frequency?).

6. **Plausibility**- does it make sense? However, this is not a necessary feature as plausibility depends on current knowledge and even the improbable could be true.
7. **Coherence**- does the relationship conflict with known facts? (e.g., Do we know drug-medical events pairs that are definitely not ADRs?).
8. **Experimentation**- does changing the antecedent change the consequence? (e.g., Does the medical event start when the drug starts and stop when it stops?).
9. **Analogy**-are there similarities with known causal relationships (e.g., does the ADR exist for a similar drug)?.

The more Bradford-Hill causality factors covered by a method, the more likely it is to correctly identify causal relations and therefore identify ADRs. In Chapters 2.1.3.2 and 2.1.4.3 the range of Bradford-Hill causality factors considered by each of the existing ADR signalling methods are determined.

2.1.3 Spontaneous Reporting Databases

2.1.3.1 Overview

The SRS databases were one of the first resources to contain vast quantities of pharmacovigilance data and enable an aggregated analysis [152]. Their presence in the field of pharmacovigilance has aided the discovery of many ADRs [106],

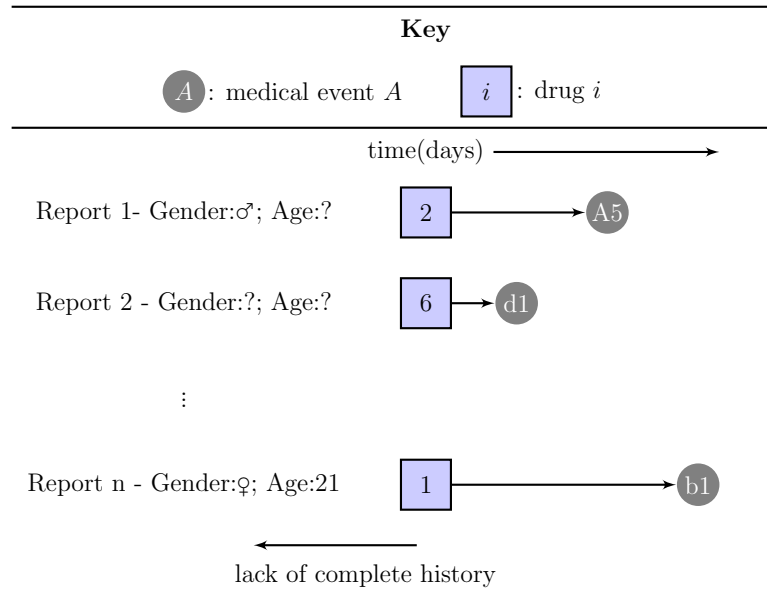

Figure 2.1: Illustration of data contained in SRS databases.

but their application is limited [63; 172]. The databases contain linked drug and medical event records. Each link represents that the drug was a suspected cause of the medical event. In addition to the linked drug and medical records, there are also details specifying information about the patient that experienced the suspected ADR. An illustration of the data contained in SRS database is presented in Figure 2.1, where drugs are represented by squares and medical events are represented by circles. An example of the database design for an SRS database can be seen in Figure 2.2. The records in the database are submitted voluntarily by medical practitioners or the general public [118]. Two common examples of SRS databases are the Food and Drug Administration (FDA) Adverse Event Reporting System (AERS) [77; 184] in the USA and the Yellow Card Scheme SRS [118] run by the Medicines and Healthcare products Regulatory Agency (MHRA) and the Commission on Human Medicines (CHM) in the UK.

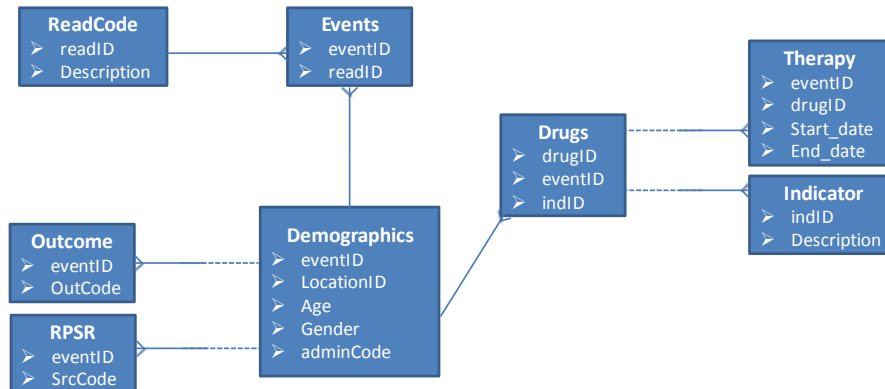

Figure 2.2: An example entity relationship diagram for an SRS database based on the FAERS database.

The general process involved in reporting a suspected ADR into an SRS database is for a patient or doctor to fill out a form detailing the drug/drugs prescribed, the adverse event experienced, some information about the patient and information about the person making the report. An example of a typical SRS report submitted online via the yellow card scheme in the UK can be seen in Figure 2.3. The majority of fields in the form are not required and the entries are not validated during submission. This causes limitations as it is common for SRS databases to contain missing or incorrect data [137]. It is also known that SRS databases suffer for bias reporting [173], especially under reporting [79]. Another issue is underascertainment, when the ADRs is not noticed (e.g., ADRs corresponding to medical events with a high background rate or rare ADRs may never be suspected) [173].

The SRS methods determine the association strength between a drug-medical event pair and pairs with a high association are signalled. The generated signals require further analysis as association does not imply causation [1]. This has

1. Reporter Details 2. Whose Side Effect 3. About the Medicines 4. Side Effects 5. Additional Details 6. Overview

1. Reporter Details

i You are completing this report as a Member of the public

i We are sorry to hear that you or someone that you know has had a side effect to the medicine they were taking. The information that you provide when you report the experience to us can help us in our work to identify previously unrecognised side effects, and thereby improve the safe use of medicines.

We would appreciate if you could please provide your contact details below so we can follow up for further information about your report if necessary.

Fields that you must complete are marked with this symbol: **required**

Title **required**

Miss

First name

|

Surname **required**

Williams

Contact Method

i Please provide a postal address, email address or both.

Address

House Number or Name

1

Address line 1

Made up street

Address line 2

Town/City

London

County

Postcode

Sn1 4FG

Telephone Number

e.g. 01622 e.g. 123123 e.g. 998

Area Code Number Extension

Email address

Step 1: Reporter Details Cancel Continue

Figure 2.3: The online form for submitting suspected ADRs via the Yellow Card Scheme in the UK.

prompted researches to state that the SRS methods are ‘initial filters’ for identifying ADR associations [8] and are not capable of generating definitive signals. Once the SRS methods generate a signal, it is then refined and finally evaluated. This means the causal relationship is not confirmed until much later in time than when the original signal occurred.

The SRS databases generally have a fixed point in time perspective, as limited past and present medical knowledge for each patient is known [12], the lack of historical data is illustrated in Figure 2.1. The actual rate that a drug is prescribed and the rate that a medical event occurs is unknown [172], as SRS databases only contain data on the drug prescriptions that may have resulted in an ADR. Consequently, the SRS methods estimate the baseline rate that a medical event occurs by finding out how often the medical event is reported with any drug in the database. Medical events that are reported disproportionately more often with the drug of interest compared to all the other drugs in the database are then ranked highly as suspected ADRs. The methods make use of a contingency table, see Table 2.1, summarising the number of reports that contain (or do not contain) the drug and event of interest. Each method estimates the baseline rate differently, by using different combinations of the values in Table 2.1. Unfortunately, the estimation of the background rate, by using other drug reports, can limit the signals that are generated [76] and prevent some ADRs (e.g., those with a high background rate) being identified. In addition, both over-reporting and under-reporting can lead to skewed estimates for the background rates and influence the signalling ability.

Initially, the disproportionality methods relied on calculating measures linked to standard epidemiology statistical values such as the Reporting Odds Ratio

Table 2.1: A sample contingency table used by the disproportionality methods applied to the SRS databases.

| | Event Y | Other Event | Total |
|------------|---------|-------------|---------|
| Drug X | a | b | a+b |
| Other Drug | c | d | c+d |
| Total | a+c | b+d | a+b+c+d |

Table 2.2: The different SRS methods and the measures they implement to calculate the association between a drug-medical event pair. ¹

| Method | Measure | Probabilistic Interpretation [75] | Approach |
|------------|--|---|----------|
| ROR | $\frac{a/b}{c/d}$ | $\frac{P(AE Drug)/P(notAE Drug)}{P(AE notDrug)/P(notAE notDrug)}$ | F |
| PRR | $\frac{a/(a+b)}{c/(c+d)}$ | $\frac{P(AE Drug)}{P(AE notDrug)}$ | F |
| NPRR | $\frac{a/(a+c)}{b/(b+d)}$ | $\frac{P(Drug AE)}{P(Drug notAE)}$ | F |
| BPCNN (IC) | $\log_2\left(\frac{a(a+b+c+d)}{(a+c)(a+b)}\right)$ | $\log_2\left(\frac{P(AE Drug)}{P(AE)}\right)$ | B |
| EBGM (RR) | $\frac{a(a+b+c+d)}{(a+c)(a+b)}$ | $\frac{P(AE Drug)}{P(AE)}$ | B |

(ROR) [9] and Proportional Reporting Ratio (PRR) [185]. In [196] the authors propose a novel PRR (NPRR) method, that takes a slightly different perspective, and they suggested that both the PRR and NPRR should be used to generate a signal. More recently, methods have been implemented that are based on artificial neural networks, such as the Bayesian Propagation Confidence Neural Network (BPCNN) [10], or Bayesian modelling, such as the Empirical Bayesian Geometric Mean (EBGM) [50]. Table 2.2 summarises the different methods and displays their probabilistic derivations. The SRS signal generation methods are split between frequentist statistical approaches (ROR, PRR) and Bayesian statistical approaches (EBGM, BPCNN). The frequentist statistical methods assume that the parameters for a model are fixed and they consider that the data comes from

¹In the approach column, F represents frequentist and B represents Bayesian.

a repeatable random sample. These methods do not require prior knowledge of a model and are computationally cheap. It follows that the advantage of frequentist methods for signal detection is that they are fast, which is an important factor due to the large quantities of data available. Conversely, the Bayesian statistical methods assume that the data are fixed and the parameters are unknown but described by a probabilistic distribution. These methods require some prior knowledge and can be computationally costly. The advantage of using Bayesian methods for signal detection is that, due to the parameters being non-fixed, they can adapt over time when changes in the drug prescription habits may differ, such as when doctors change the prescription rates of drugs or prescribe drugs to patients for a non-standard indication.

The methods all have signalling criteria, see Table 2.3. The frequentist methods generate a signal for a drug-medical event pair when there are three or more case reports and the lower 95% confidence interval is greater than one. Their standard errors, displayed in Table 2.4, are estimated using the woolf logit method [205], a method that approximates the distribution of the $\ln(\text{ROR})$ and $\ln(\text{PRR})$ as being normal. The EBGGM generates a signal for a drug-medical event pair when the lower bound of the 90% credibility interval, EB05, is greater than two. The BPCNN signals a drug-medical event pair when its IC value minus two standard deviations changes from negative to positive.

2.1.3.2 Causality

The SRS methods all work out the association strength between a drug and medical event based on the disproportionality measure. As the SRS databases sometimes contain the patient details such as age and gender it is possible for

Table 2.3: The signalling criteria for the different SRS methods [50; 185] .

| Method | Signal Criteria | Shrinkage |
|--------|---|-----------|
| ROR | $\exp[\ln(ROR) - 1.96SE(\ln(ROR))] > 1$ | No |
| PRR | $\exp[\ln(PRR) - 1.96SE(\ln(PRR))] > 1$ | No |
| NPRR | $\exp[\ln(NPRR) - 1.96SE(\ln(NPRR))] > 1$ | No |
| EBGM | $EB05 \geq 2$ | Yes |
| BPCNN | $IC - 2SD > 0$ | Yes |

Table 2.4: The standard errors for the frequentist methods [185; 196].

| Method | Standard Errors |
|--------|--|
| ROR | $SE(\ln(ROR)) = \sqrt{\frac{1}{a} + \frac{1}{b} + \frac{1}{c} + \frac{1}{d}}$ |
| PRR | $SE(\ln(PRR)) = \sqrt{\frac{1}{a} - \frac{1}{a+b} + \frac{1}{c} - \frac{1}{c+d}}$ |
| NPRR | $SE(\ln(NPRR)) = \sqrt{\frac{1}{a} - \frac{1}{a+c} + \frac{1}{b} - \frac{1}{b+d}}$ |

the SRS algorithms to deal with the specificity criteria, but none of the existing methods does and the problem of missing values may make this difficult. The methods do not cover the consistency criteria when they are only applied to one SRS database and they do not deal with the biological gradient as they do not take into consideration the dosage of the drug. The SRS methods estimate the background risk of a medical event based on all other drugs rather than restricting themselves to estimating the risk of the medical event based on similar drugs, therefore they do not consider the analogy criterion. Due to their restricted perspective, they cannot cover the experimentation factor as this requires observing what happens when the drug stops and starts. The temporality, plausibility and coherence criteria are indirectly covered as people should only submit a report when a drug is suspected to have caused an ADR, and any suspected ADR would have occurred after the drug is taken and must be plausible and coherent otherwise it would not be suspected. However, people may make mistakes when

Table 2.5: The Bradford-Hill causality considerations covered by each method. ¹

| Criteria | ROR | PRR | EBGM | BPCNN |
|---------------------|-----|-----|------|-------|
| Strength | ✓ | ✓ | ✓ | ✓ |
| Consistency | × | × | × | × |
| Specificity | × | × | × | × |
| Temporality | • | • | • | • |
| Biological Gradient | × | × | × | × |
| Plausibility | • | • | • | • |
| Coherence | • | • | • | • |
| Experimentation | × | × | × | × |
| Analogy | × | × | × | × |

reporting a suspected ADRs or may not know information that would otherwise make them reconsider that the medical event is a suspected ADR.

The criteria that could be covered by SRS methods, but are not currently, are the consistency, analogy and possibly the specificity. The consistency criteria could be covered by using other SRS databases as a cross reference to see if there is evidence in other databases for the signals generated by the SRS methods. The analogy could be covered by comparing a drug of interest against drugs in the same family and using knowledge about existing ADRs for similar drugs and the specificity could be covered by comparing the drug and event disproportionalities between different groups of the population, such as the old or young. This information is summarised in Table 2.5.

2.1.3.3 Limitations

The main limitations with signal generation using the disproportionality methods applied to SRS databases are due to database issues. The databases are known to contain missing or duplicated data and suffer from inconsistent reporting such as

¹• represents indirectly covered.

under-reporting or over-reporting for new drugs or more serious adverse events [9]. It is often common for the SRS databases to be plagued by inconsistencies due to changes in medical terminology over time or variance in the level of detail recorded for the medical event depending on the person making the report [9]. Bate *et al.* (2009) state that ‘disproportionality methods do not estimate reporting rates’, as the reporting rate calculation requires the knowledge of drug usage and this is not contained in the SRS databases [9]. The effect of this is that specific adverse events will not be found, such as when a drug causes all events to increase or when an adverse event is common for many drugs. The two major consequences of the under-reporting are that there may be a large time lag between when a rare ADR is first reported and when it is signalled, or it is possible that rare ADRs may never be detected. One retrospective study found that 19.6% of known ADRs were signalled by the PRR after other pharmacovigilance methods and 26.9% of known ADRs had not been signalled during the study period [3]. The SRS methods cannot be used for signal refinement or evaluation due to the limitation of not knowing the actual background rates that medical events occur or drug are prescribed. Therefore, it is not possible to develop a method capable of definitively identifying ADRs that only uses the SRS databases, instead, other types of databases are required for the signal refinement and evaluation once signals have been generated by mining the SRS databases.

2.1.3.4 Summary

Mining the SRS databases has aided new ADR discoveries, but the signals generated by mining the databases require further evaluation and the majority of signals do not lead to ADR discovery [172]. A recent study provided evidence

to suggest that limitations due to how the SRS data are collected may make it difficult for the disproportionality methods to identify ADRs with a high background rate [70]. Furthermore, as a consequence of the the limited perspective of the SRS databases, they cannot be used to quantify ADR risks [119], nor can they be used to identify risk factors.

2.1.4 Longitudinal Observational Databases

2.1.4.1 Introduction

The LODs are databases containing temporal medical data [12] on thousands or millions of patients, often spanning over many patient years. An example of an LOD is The Health Improvement Network (THIN) database, see appendix A, that is an electronic database containing the data stored in over 500 UK general practices [65]. The data consists of patient details such as their year of birth, gender, family links and timestamped medical and prescription records. It has been found to be a suitable representation of the UK [15] and it is not common to find duplicated or missing data due to validation procedures. Researchers have assessed the validity of using the THIN database for pharmacovigilance by investigating whether known associations can be found using the data and concluded that its use is valid [105]. The database contains records of every medical event for a patient that the doctor has been informed of, as the data is extracted directly from the local GP databases and doctors must record all the relevant medical details each time a patient visits [85]. Unfortunately under-reporting is still possible in these types of databases, as some drugs can be bought rather than being prescribed and patients may not inform their doctor of all the

medical events that they experience. It is also possible for LODs such as the THIN database to have inconsistencies in data recording between practices [78]. The THIN database also has issues with patients changing practices, as each patient is given an anonymous ID within their practice but when they change practices they will receive a new ID, and there are no links between the two IDs to identify them as representing the same patient [104].

The LODs offer a unique perspective for discovering ADRs as, unlike the SRS databases, they do not have direct links between drugs and medical events that are potential ADRs [161] but potential ADRs can be inferred using the temporal information. For example, if investigating ADRs that occur immediately after taking a drug, all the medical events that occur within 30 days of taking the drug can be flagged as potential ADRs. The advantage of generating ADR signals using the LODs compared to the SRS databases are they contain patients' medical histories and include patients that did not experience adverse events after taking a drug [71]. Therefore they contain the background rates that a drug is prescribed or a medical event occurs [216] and are less prone to bias reporting due to not relying on voluntary reports. As the LODs are not restricted to finding ADRs that occur shortly after taking a drug, they could be used to find ADRs that are not present till many years after taking a drug. Furthermore, the vast quantities of data contained in LODs makes them more suitable for detecting drug-drug interaction ADRs or child specific ADRs. Figure 2.4 illustrates the data contained in LODs, and shows that the drug-medical event pairs that are potential ADRs can be found by investigating the $[t_0, t_1]$ period around each prescription. Another advantage of the LODs is that they have frequently been used for signal refinement and evaluation [31], so all three steps of detecting an ADR can be implemented

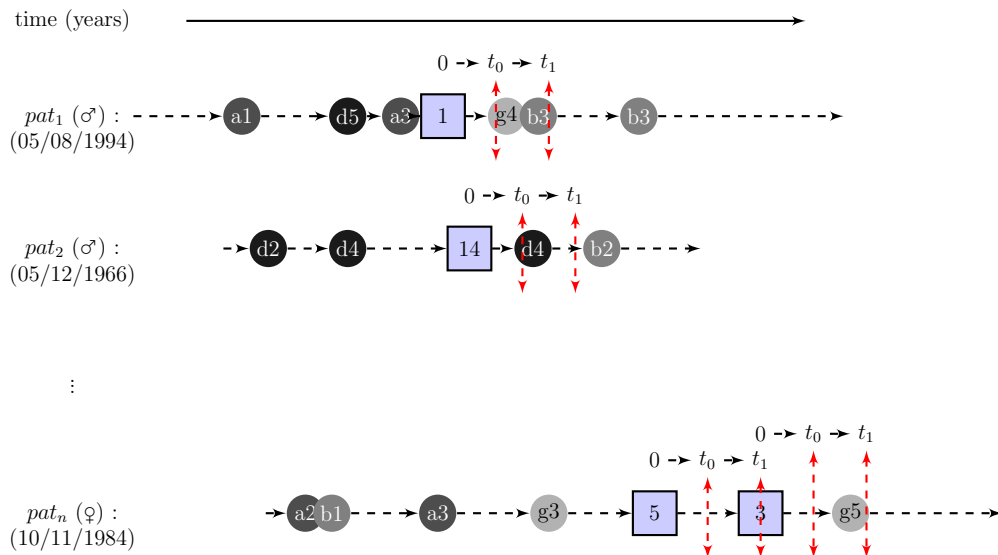

Figure 2.4: Illustration of patients' longitudinal data contained in the THIN database.

on a single LOD, making it possible to develop an efficient algorithm capable of definitively detecting ADRs. Although, there may be issues with performing signal evaluation on the same data used to generate the signal.

Numerous approaches have been suggested to signal ADR using LODs [26; 83; 90; 128; 216], but there is currently no algorithm that has been developed specifically for the THIN database. The methods tend to calculate a measure of association between each medical event and drug. This is calculated by comparing the risk of the medical event for the drug taking population within a defined time interval after the drug is prescribed with the risk of the medical event in some substituted population. These methods are based on the counterfactual theory of causality, where the observed risk of the medical event in the drug taking population is compared with the risk that would have been observed had the patients not taken the drug [122]. Once the patients take the drug, the second

situation (i.e., patients not taking the drug) is counterfactual and unobservable, so an observable substitution is used instead to approximate the second risk. If the substitution does not match the counterfactual, then confounding is introduced and the measure of association differs from the measure of causation [66].

An example of the counterfactual theory of causation is presented in Figure 2.5. It can be seen that the patient 1 given treatment 1 experienced medical event A but would not have experienced it if treatment 0 was given, so medical event A was caused by being given treatment 1 rather than treatment 0. However, it is impossible to observe patient 1 taking only treatment 1 and only treatment 0 at the same time, therefore an observable substitution is used to estimate causality. Association is determined by observing patient 2 taking treatment 0 and comparing the outcome with patient 1 taking treatment 1. Unfortunately, as the patients are different, the observed outcome over $[t_0, t_1]$ for patient 2 taking treatment 0 is different to what would have been observed for patient 1 given treatment 0 and the substitution comparison indicates that both medical event A and medical event B are associated with treatment 1. However, only medical event A is caused by treatment 1, the medical event B association is due to confounding introduced by the substitution.

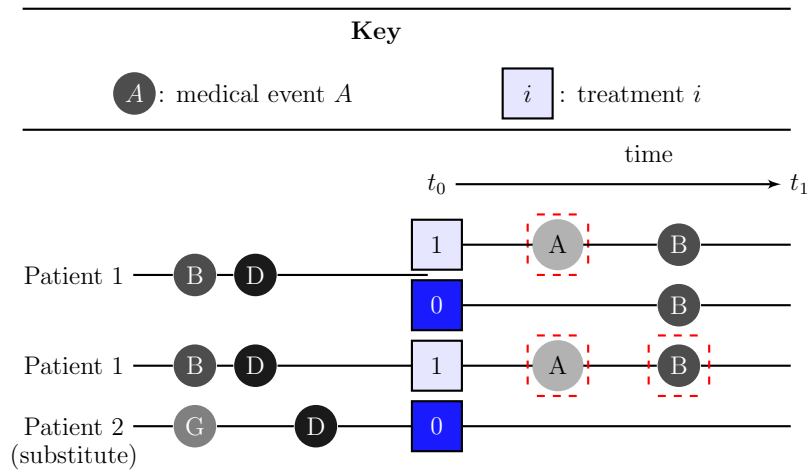

Figure 2.5: Illustration of the counterfactual theory of causation.

2.1.4.2 Methods

Disproportionally Methods

The disproportionality methods, such as modified SRS [216] and Temporal pattern Discovery (TPD) [128], compare the risk during the time interval $[t_0, t_1]$ centred around the drug of interest prescriptions with the risk during the time interval $[t_0, t_1]$ centred around all drug prescriptions, so the substituted population is the patients taking any drug. This is illustrated in Figure 2.6. The TPD also looks for temporal changes in the measure of association, as this reduces the effect of confounding by indication (i.e., when differences arise between the patients taking the drug and those not taking the drug), as illustrated in Figure 2.7. Justification for using all other drug reports as a substitution, but keeping the same time interval of interest, is that medical events are not reported uniformly over time [128], and it is common for the majority of medical events to be reported shortly after a prescription. By investigating the same period of time relative to the prescription, the potential bias caused by non-uniform reporting

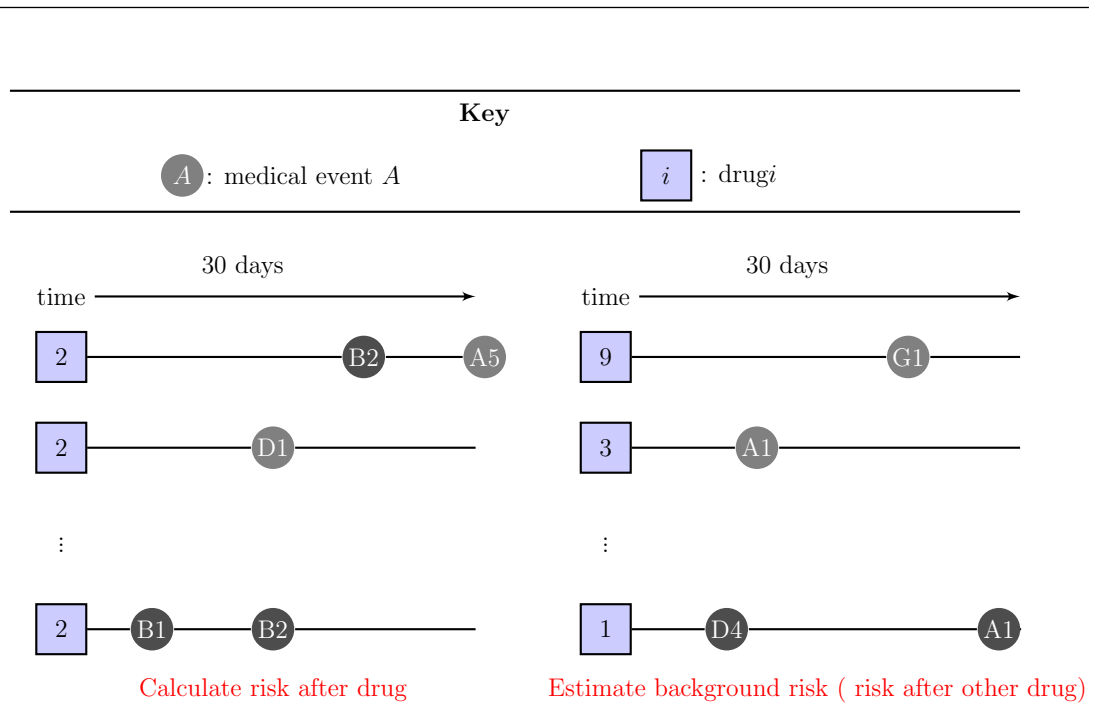

Figure 2.6: Illustration of the disproportionality methods.

is removed.

To apply the standard SRS methods, described in Chapter 2.1.3, the contingency tables need to be determined using the LOD data. In [216], the authors presented three different proposals for calculating the contingency tables for a specific drug x and medical event y using LODs. The spontaneous reporting system (SRS) and modified-spontaneous reporting system (modified-SRS) approaches performed similarly and both outperformed the distinct patient approach. Referring to the set time period after the drug of interest is prescribed as the drug hazard period, the SRS approach calculates the $a-d$ values in Table 2.1 as, a is the number of distinct times event y occurs during any x hazard period, b is the number of distinct times any non- y event occurs during any x hazard period, c is the number of distinct times event y occurs in any non- x hazard period and d is the number of distinct times any non- y event occurs within any non- x hazard

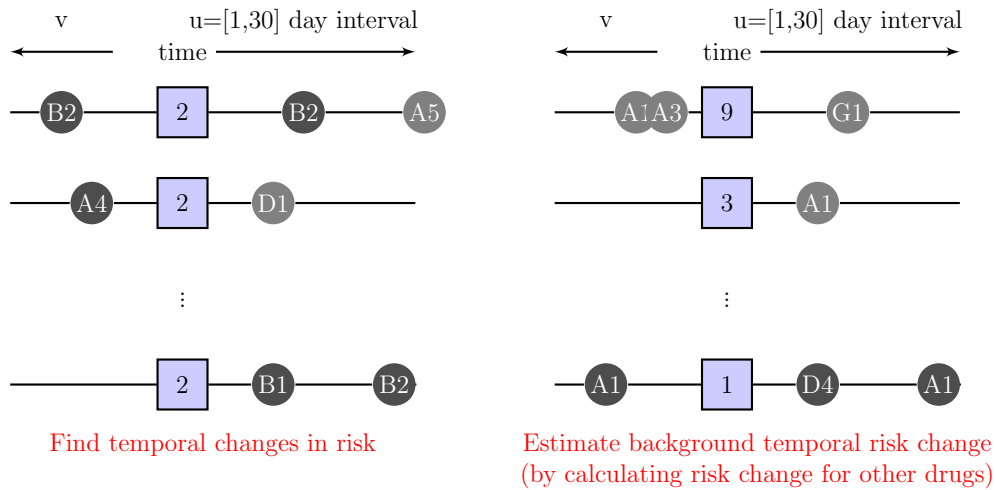

Figure 2.7: Illustration of the TPD method.

period. The modified-SRS approach is similar but considers the prescriptions that do not have medical events recorded. Therefore, b becomes the number of distinct times any non- y event occurs during any x hazard period plus the number of x hazard periods that have no medical event recorded and d becomes the number of distinct times any non- y event occurs within a non- x hazard period plus the number of non- x hazard periods that have no medical event recorded plus the number of distinct times non- y events are reported outside of a hazard period.

The TPD method [128] compares the amount of patients that have the first prescription of drug x in thirteen months followed by event y within a set time t relative to the expected number of patients if drug x and event y were independent. The background rates that a medical event occurs is calculated based on how often it occurs within the hazard period for any drug. Letting,

$n_{.y}^t$ denote the number of patients that are prescribed any drug for the first time in 13 months and have event y within time t .

$n_{x.}^t$ denote the number of patients that have drug x for the first time in 13 months and are registered for any period over time t

$n_{..}^t$ denote the number of patients that have any other drug for the first time in 13 months and are registered for some period over time t .

n_{xy}^t denotes the number of patients that have drug x for the first time in 13 months and event y occurs within time t after.

The expected number of patients that have drug x and then event y in a time period t is then,

$$E_{xy}^t = n_{x.}^t \frac{n_{.y}^t}{n_{..}^t} \quad (2.1)$$

If for a given drug, the event occurs more than expected, the ratio between the observed and expected will be greater than one. By taking the \log_2 of the ratio, a positive values suggests an interesting association between a drug and event. Modifying the equation to prevent the problem of rare events or drugs resulting in a small expectation that can cause volatility, a statistical shrinkage method is applied.

$$IC = \log_2 \frac{n_{xy}^t + 1/2}{E_{xy}^t + 1/2} \quad (2.2)$$

The shrinkage adds a bias for the IC towards zero when an event or drug is rare. The credibility intervals for the IC are the logarithm of the solution to equation 2.3 with $q = 0.025$ and $q = 0.975$.

$$\int_0^{\mu_q} \frac{(E_{xy}^t + 1/2)^{n_{xy}^t + 1/2}}{\Gamma(n_{xy}^t + 1/2)} u^{(n_{xy}^t + 1/2) - 1} e^{-(n_{xy}^t + 1/2)u} du = q \quad (2.3)$$

The above can find possible drug and event associations of interest for a given

t , however, the authors suggest that general temporal patterns can be found by comparing the IC of two different time periods. The follow-up period of primary interest is denoted by u and the control time period by v . This removes event and drug relationships that just happen to occur more in certain sub-populations. The different between the IC for both time periods is,

$$\log_2 \frac{n_{xy}^u}{E_{xy}^u} - \log_2 \frac{n_{xy}^v}{E_{xy}^v} \quad (2.4)$$

re-arranging and adding a shrinkage term gives,

$$IC_{\Delta} = \log_2 \frac{n_{xy}^u + 1/2}{E_{xy}^{u*} + 1/2} \quad (2.5)$$

where

$$E_{xy}^{u*} = \frac{n_{xy}^v}{E_{xy}^v} \cdot E_{xy}^u \quad (2.6)$$

As it was observed that medical events related to the cause of the drug are often assigned a high IC value after the prescription but also prior to the time the drug is prescribed, the TPD algorithm includes a filter that ignores medical events that have a higher IC value on the day of prescription or a month before the prescription relative to the month after the prescription.

Methods that calculate association tend to suffer from confounding as association does not imply causation, so many of the medical events signalled due to a high association value may not be ADRs. One method that has been presented to counteract the problem of confounding is the ROR Regression (RORR) method [72]. The RORR effectively filters the drugs that are signalled as ADRs by the

ROR by determining whether the association may be due to confounding. The method applies two regression models, the first model does not consider the effect of covariates, letting y represent the medical event, and x_1 represent the drug, then the log odds of medical event y is,

$$\log\left(\frac{P(y|x_1)}{1 - P(D|x_1)}\right) = b_0 + b_1x_1 \quad (2.7)$$

where b_0 is the background log odds ratio of medical event y . The second model considers the effects of the covariates, $x_i, i > 1$, and the log odds of y is calculated as,

$$\log\left(\frac{P(y|x_1, x_2, \dots, x_k)}{1 - P(D|x_1, x_2, \dots, x_k)}\right) = b_0 + \sum_{i=1}^k b_i x_i \quad (2.8)$$

For each drug with a high ROR, the regression model only considering the drug, equation (2.7), and the regression model considering all the covariates, equation (2.8), are both applied and drugs that have similar b_1 values for both models are considered to be causes of medical event y . Unfortunately, its application on the THIN database is currently limited due to the requirement of choosing the appropriate covariates for each signal. This requires manual expert input for each signal, which would be time consuming.

Sequential Pattern Methods

Methods based on sequential pattern mining include Mining Unexpected Temporal Association Rules given the Antecedent (MUTARA) [91] and Highlighting UTARs Negating TARs (HUNT) [90]. These methods calculate the standard sequential patterning mining measure known as leverage [134] that subtracts the expected proportion of all sequences that contain the drug followed by the medical event within a defined time interval from the observed proportion. The expecta-

tion is derived by calculating the risk within a randomly selected time interval for the population of patients never prescribed the drug. In effect, this is similar to a retrospective cohort study as the cohorts are the patients exposed or non-exposed to the drug.

The authors of MUTARA and HUNT refer to the patients prescribed the drug as users and patients never prescribed the drug as non-users. Both methods first restrict their attention to subsequences of the user and non-user sequences. For each user sequence, the T_h constrained subsequence of interest is the subsequence of length T_h days starting from the day the drug is first prescribed. The value of T_h differs between users depending on whether the user has a repeat prescription within T_e days after the first prescription. If the user does not have a repeat prescription within T_e days of the first prescription then $T_h = T_e$, whereas if the second prescription of the drug occurs s days after the first prescription where $s \leq T_e$ then $T_h = s + T_e$. For each non-user, the T_c constrained subsequence of interest is a subsequence of length T_c days that is randomly chosen from the non-user's sequence. An illustration of this can be seen in Figure 2.8.

Defining tot as the number of users and non-users, the $supp(x \xrightarrow{T} y)$ is defined as the number of user T_h constrained subsequences containing the medical event y divided by tot , the $supp(x \xrightarrow{T})$ is the number of users divided by tot and $supp(\xrightarrow{T} y)$ is the number of user T_h constrained subsequences that contain the medical event y divided by tot plus the number of non-user T_c constrained subsequences that contain the medical event y divided by tot . The leverage is calculated as,

$$Leverage = supp(x \xrightarrow{T} y) - supp(x \xrightarrow{T}) \times supp(\xrightarrow{T} y) \quad (2.9)$$

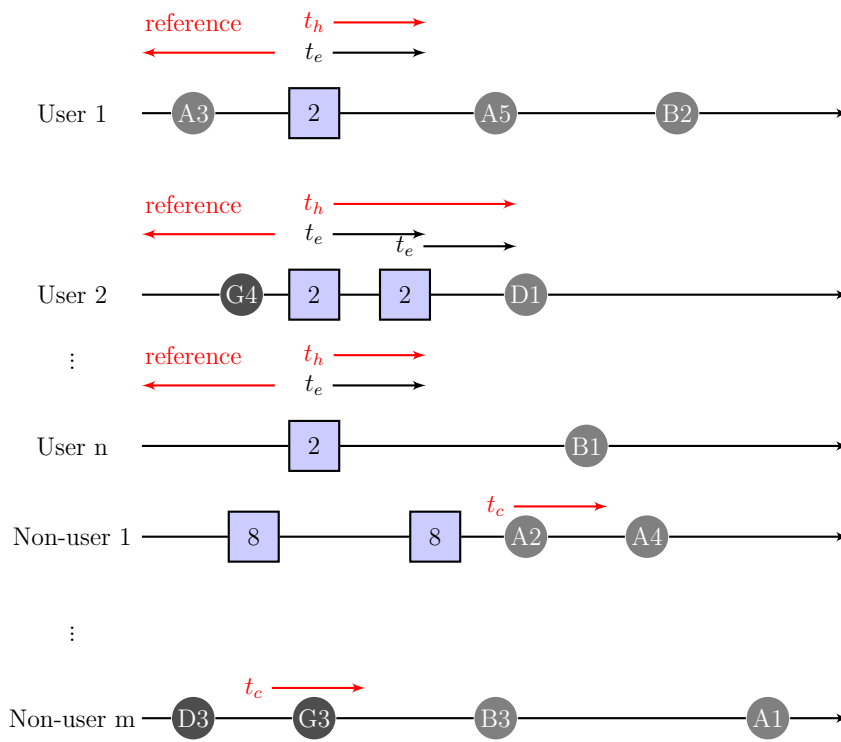

Figure 2.8: Illustration of the MUTARA and HUNT methods.

In addition to calculating the standard leverage, a new measure called unexpected-leverage is also calculated. The unexpected-leverage (*unexlev*) makes use of a user’s history to filter repeated medical events from the users’s T_h constrained subsequence as these are ‘predictable’ and unlikely to be ADRs. This is done by investigating a reference period prior to the first prescription within the user’s sequence and filtering medical events from the user’s T_h subsequence if they occurred during the reference period. Defining $\text{supp}(x \xrightarrow{T} y)$ as the number of users who’s T_h constrained subsequence contains medical event y but who do not have medical event y within the reference period divided by *tot* and $\text{supp}(\xrightarrow{T} y)$ as the total of the number of users whose T_h constrained subsequence contains medical event y but who do not have medical event y within the reference period plus the number of non-user T_c constrained subsequences that contain the medical event y all divided by *tot*, the unexpected leverage is calculated as,

$$\text{unexlev} = \text{supp}(x \xrightarrow{T} y) - \text{supp}(x \xrightarrow{T} y) \cdot \text{supp}(\xrightarrow{T} y) \quad (2.10)$$

MUTARA returns medical events ordered by *unexlev* and HUNT returns medical events in descending order of the ratio between the leverage rank and the unexpected-leverage rank,

$$\text{RankRatio} = \frac{\text{medical event rank based on leverage}}{\text{medical event rank based on unexpected-leverage}} \quad (2.11)$$

Other Methods

Other methods for signalling ADRs using LODs that have been proposed include fuzzy logic methods [89], calculating the log likelihood over time [26], applying a

Table 2.6: The different LOD ADR signalling algorithms and the causality criteria each of them covers. ¹

| Criteria | MUTARA | HUNT | TPD | Modified SRS | RORR |
|---------------------|--------|------|-----|--------------|------|
| Strength | ✓ | ✓ | ✓ | ✓ | ✓ |
| Consistency | × | × | × | × | × |
| Specificity | × | × | × | × | * |
| Temporality | ✓ | ✓ | ✓ | × | × |
| Biological Gradient | × | × | × | × | * |
| Plausibility | × | × | × | × | ✓ |
| Coherence | × | × | × | × | × |
| Experimentation | × | × | × | × | × |
| Analogy | × | × | × | × | × |

sequential version of the self controlled case series [83] or adapted epidemiology based approaches, see Chapter 2.1.5. These methods tend to suffer from confounding effects and are likely to have a high false positive rate. However, it is worth noting that the self controlled case series is resilient to any fixed in time confounding. Very few of these methods have been implemented on a range of LODs, so their robustness is unexplored.

2.1.4.3 Causality

The LOD ADR signalling algorithms all cover the strength criteria as they calculated the dependancy of the occurrence of a medical event on the occurrence of a drug being prescribed. The filtering in the MUTARA/HUNT and the TPD algorithms means they cover the temporality criteria as medical events that occur before the drug are generally filtered. The modified SRS and RORR algorithms do not apply a filter, so they do not cover the temporality criteria. In effect, the RORR covers plausibility by filtering out drug-medical event pairs that are asso-

¹* means that the factor could be incorporated but is currently not.

ciated due to other causes, so the remaining drug-medical event pairs are more plausible ADRs. Additionally, it would be possible to include dosage and personal attributes into the regression model used by the RORR, so the specificity and biological gradient could be included. The other causality criteria are not covered by the LOD algorithms. This is likely to be the reason why the existing LOD algorithms frequently signal medical events linked to the cause of taking the drug or medical events that are just common in the drug taking population.

2.1.4.4 Limitations

The LOD databases have presented the opportunity to signal ADRs without the limitations associated with the SRS databases, but research has shown they have their own limitations [100; 131]. The main limitation is the effect of confounding factors[198], as many drug-medical event pairs that are associated do not correspond to ADRs. The existing methods that signal drug-medical event pairs based on association do not consider the eight other Bradford-Hill factors, but some of these could be integrated by utilising the data available in the LODs. The RORR method has the potential to cover the most Bradford-Hill causality factors, but it is a signal refinement method rather than a signal generating method, as it requires a signal generating method such as the ROR to identify which drug-medical event pairs to apply the regression models on. Therefore, the RROR is limited by any limitations with the signal generating method it incorporates.

2.1.4.5 Summary

The LOD algorithms show promise at becoming an integral part of pharmacovigilance in the future due to the wealth of information they potentially hold [198].

Although numerous methods have been developed for generating ADR signals using LODs, they have not been robustly analysed. Their theoretical foundations would suggest that they are likely to signal many non-ADRs due to the reliance on association. The RORR method, presented to identify confounding, requires initial drug-medical event pair signals to be generated, so it is a signal refinement method. There has been no method that combines signal generating and refinement into one, but such a method could signal drug-medical event pairs more efficiently and obtain a lower rate of signalling non-causal relationships.

2.1.5 Combining Multiple Databases

2.1.5.1 Overview

There has been a recent initiative to integrate multiple electronic healthcare data sources into one. Examples include the Mini-Sentinel [136], that will eventually become Sentinel, a US Congress mandated pharmacovigilance system that contains medical data for more than 125 million Americans [124], the Exploring and Understanding Adverse Drug Reactions (EU-ADR) project [34], a European initiative set up in 2008 that contains data on over 30 million patients and the Observational Medical Outcomes Partnership (OMOP) that has a network of databases containing over 200 million patients. Numerous researchers have expressed the significance of large pharmacovigilance sources in aiding the ability to discover ADRs efficiently [144]. The initiatives may bridge gaps in the current pharmacovigilance, such as lack of knowledge concerning drug safety for minority groups [34].

The OMOP was formed to analyse the methodologies for pharmacovigilance

using longitudinal data. The partnership have developed a common data model that enables the combination of different databases by transforming them into a general format [115; 131]. The OMOP have presented a magnitude of different techniques specifically for signalling ADRs using longitudinal data, including cohort studies [107], disproportionality methods [216], case series methods [71], case control methods [71], case crossover methods [160] and propensity score based methods [159]. To enable an analysis of the methods, an approximate gold standard consisting of 53 ‘ground truth’ drug-medical event pairs (i.e., drug-medical event pairs that are known to be ADRs or non-ADRs) have been identified [141]. The ability of the methods to generate correct signals for these ‘ground truths’, at their natural threshold, has been investigated [156].

The standardised ‘ground truths’ only consider a selection of medical events, referred to as Health Outcomes of Interest (HOI) and a small subset of drugs known as Drugs Of Interest (DOI). Tables 2.7-2.8 display the OMOP’s proposed HOIs and DOIs. Unfortunately, there are few studies investigating the methods abilities in generating signals when a large number of drug-medical event pairs are studied, however this is more realistic [143].

The OMOP methods tend to be based on standard epidemiological studies that aim to identify associations between drugs and medical events by finding medical event that have a greater incidence after a drug compared to the medical event’s estimated background incidence. Many methods have been presented and the seven that have been extensively investigated as described below. The first method, the High-throughput Screening by Indiana University (HSIU), is

¹READ codes do not exist for the exact medical event, so GI ulcer READ codes are given.

²READ codes do not exist for the exact medical event, so mortality due to cardiac or patient died READ codes are given.

Table 2.7: The Health Outcomes of Interest defined by the OMOP [80] and their corresponding THIN READ codes.

| Medical event | THIN READ code |
|--|---|
| Angioedema | SN51. |
| Aplastic anemia | D20.., D2011, D201., D2012, D2012, D204., D202., Dyu2. |
| Acute liver injury | J6000, J6357 |
| Bleeding | J68.., J68z., J68z0, J68z1, J68z2, J68zz |
| GI ulcer hospitalization ¹ | J11.., J110's |
| Hip fracture | S30.., S30y. |
| Hospitalization | 8H2.., 8H2z., 8H7a., 8Hd., 8HJ., 9144. |
| Acute myocardial infarction | G30.., G30's |
| Mortality after myocardial infarction ² | G5751, 22J.. |
| Acute renal failure | K04.., K04y., K04z., Kyu20, K043. |

a cohort approach [80]. A cohort study follows a group of patients that have a common attribute or event (such as a drug prescription) and assesses outcome risk factors [178]. The Observation Screening method [155] calculates the screening rate within the drug population (the frequency of a outcome divided by the total risk time) and normalises this by dividing it by an estimate for the background screening rate. This is either the screening rate in a non-risk period (frequency in a pre-exposure period divided by the total pre-exposure time period) or the screening rate in a control group. The third method, the Disproportionality Analysis (DP) [216], identifies associations by comparing the rate that a medical event occurs within the drug population relative to the rate it occurs within some other population, similar to the SRS methods in Chapter 2.1.3.

The Univariate Self-control Case Series (USCCS), based on the method developed in [54], can be considered a cohort based study but where the exposed and non-exposed patients are the same. The approach partitions the cases' timelines

Table 2.8: The Drugs of Interest defined by the OMOP, table from [80].

| DOI Drug Name | DOI Description |
|--|--|
| OMOP ACE Inhibitor | ACE inhibitors: benazepril, captopril, enalapril, fosinopril, lisinopril, quinapril, and ramipril; restricted to oral form |
| OMOP Amphotericin B | parenteral Amphotericin B |
| OMOP Antibiotics: erythromycins, sulfonamides, and tetracyclines | Antibiotics: erythromycins, sulfonamides, and tetracyclines; restricted to oral and injectable |
| OMOP Antiepileptics: carbamazepine, phenytoin | Antiepileptics: carbamazepine, phenytoin: restricted to oral and injectable |
| OMOP Benzodiazepines | Benzodiazepines: alprazolam, chlordiazepoxide, clonazepam, clorazepate, diazepam, estazolam, flurazepam, halazepam, lorazepam, oxazepam, prazepam, quazepam, temazepam, or triazolam |
| OMOP Beta blockers | Beta blockers: propranolol, metoprolol, atenolol; restricted to oral form |
| OMOP Bisphosphonates | Bisphosphonates: alendronate |
| OMOP Tricyclic antidepressants | Tricyclic antidepressants: restricted to oral and injectable |
| OMOP Typical antipsychotics | Typical antipsychotics: Chlorpromazine, chlorprothixene, levomepromazine, flupentixol, Fluphenazine decanoate, Fluphenazine enanthate, Fluphenazine hcl, Haloperidol, Haloperidol decanoate, Loxapine hcl, Loxapine succinate, melperon, Mesoridazine, Molindone, Perphenazine, amitriptyline hcl/perphenazine, Pimozide, pipamperone, promazine, Prochlorperazine edisylate, periciazine, Prochlorperazine maleate, Promazine, Propiomazine, Thioridazine, Thiothixene, Trifluoperazine, zuclopenthixol |
| OMOP Warfarin | Warfarin |

into hazard and non-hazard periods and compares the incidence in the hazard periods with the incidence in the non-hazard periods [200]. Fixed in time confounding is overcome within the USCCS by using the same patients as the exposed and non-exposed. The Multi-Set Case Control Estimation (MSCCE) method is a case control approach that selects cases based on the occurrence of a specified condition and selects control that do not have the condition and are active over the required observation period (i.e., have events reported before and after the period) [217]. The Bayesian Logistic Regression (BLR) [87] method applies a logistic regression approach using prior knowledge to initialise the coefficients that determine the weight that each covariate has on the final output. The final method is the Information Component Temporal Pattern Discovery (ICTPD), summarised in Chapter 2.1.4.2.

The seven methods only cover the Bradford-Hill association strength consideration and some incorporate filters to cover the temporality. Consistency is indirectly incorporated due to the combination of multiple data sources. Some of the methods, such as the BLR, remove confounding by adjusting for covariates or apply stratification to reduce confounding by age and gender.

The seven OMOP methods described above were applied in the Non-Specific Association (NSA) experiment, whereby the ten DOIs were paired with all possible outcomes and the signals generated by each method at their natural thresholds were determined [80]. The majority of methods have many parameters that determine their performance and the study applied the methods over a range of parameter values to identify the optimal performance. This shows that additional work is required to tune these existing methods depending on the database being used. The performance of the seven OMOP methods during the NSA ex-

Table 2.9: The OMOP methods NSA experiment results.

| Method | Optimal Scores over the NSA experiment | | | |
|--------|--|--------|--------|--------|
| | AUC | MAP | P(10) | FPR |
| HSIU | 0.7342 | 0.1408 | 0.42 | 0.2658 |
| OS | 0.7138 | 0.0942 | 0.22 | 0.2862 |
| DP | 0.6741 | 0.0622 | 0.23 | 0.3259 |
| USCCS | 0.7342 | 0.1408 | 0.4200 | 0.2658 |
| MSCCE | 0.603 | 0.032 | 0.05 | 0.397 |
| BLR | 0.6329 | 0.0316 | 0.03 | 0.3671 |
| ICTPD | 0.6695 | 0.0591 | 0.1 | 0.3305 |

periment is presented in Table 2.9. It can be observed that all seven methods had False Positive Rates (FPRs) greater than 0.25 and Mean Average precision (MAP) scores less than 0.015. The AUC values ranged from 0.6 – 0.735, as the AUC corresponds to the probability that an ADR is ranked above a non-ADR (rank 1 being the highest) [20], there is still approximately 30%-40% chance than a non-ADR will be ranked higher than an ADR.

A recent study investigated potential loss from mapping the raw THIN data into the common data model [214]. A few existing methods were applied to both the raw THIN database and the THIN database mapped to the common data model. The results of the study suggested that the existing methods performed equally well on the raw and mapped data when considering the signals generated for the 53 ground truths. However, the study showed that 55% of drug codes and 25% of medical events codes could not be mapped from THIN into the common model [214], and this is likely to have detrimental effects when more than the 53 ground truths are considered. This highlights the important of developing database specific methods, in addition to the common model methods, that can utilise all the data available and present an alternative perspective for ADR

discovery. When improvements in the mapping to the common data model are developed, then any method developed for THIN could also be modified for implementation on the THIN mapped to the common data model (or any other common data model mapped database).

2.1.5.2 Summary

Combining the databases means that it may be possible to generate signals efficiently [3]. However, the combination requires the data to be transformed and normalised and this has the potential to lose information and can negatively impact the efficiency of signalling ADRs. It was demonstrated in [214] that many of the raw THIN data cannot be incorporated into the common data model, motivating the development of methods that are specific to certain databases. Comparisons of existing OMOP methods have shown that they perform moderately on the common data model [156] and there is no optimal method. In addition, the methods had a high false positive rate, even when the number of drug-medical event pairs being investigated is controlled. It is likely that the methods will be further hindered when applied to determine a drug's complete set of side effects as there will be a surplus number of drug-medical event pairs corresponding to non-ADRs.

2.1.6 Pharmacovigilance Summary

Adverse drug reactions are becoming an increasing burden on the NHS [166]. Existing post-marketing surveillance of drugs is limited by underlying issues associated with SRS databases [79]. Many ADRs are only being found years after the drugs are marketed and as a result, many patients suffer serious health issues

that could be avoided with improved ADR knowledge. Rare ADRs that are hard to identify, ADRs corresponding to medical events with a high background rate or less serious ADRs may never be detected by data-mining algorithms applied to SRS databases [173]. As a result there has been a recent demand for improved post-marketing surveillance [129; 190].

One recent solution has been to develop data-mining algorithms for LODs or to combine multiple electronic healthcare databases as a resource for ADR detection. Unfortunately the current methods developed for LODs have a high false positive rate [156] and have not been extensively investigated due to a lack of a complete ‘gold standard’ [33]. The high false positive rate is probably due to confounding caused by the countless number of possible covariates. Integrating the Bradford-Hill causality considerations into a signalling method is one possible consideration to reduce the negative impact of confounding factors and therefore reduce the number of false positive signals. The Bradford-Hill causality considerations have been used to help distinguish between associations that are causal, and those that are not. As confounding causes the associations that are non-causal, the Bradford-Hill causality considerations must be able to indirectly identify some confounding. The majority of existing methods only cover a few of the Bradford-Hill causality considerations, however, there is potential to extract data from the LODs to enable novel methods that cover more of the criteria. This could then reduce the number of false positives.

The THIN database is a LOD that contain medical data for over 10 million patients, often spanning decades of years per patient. The general benchmark for the THIN database is unknown, as only a few methods have been investigated by considering the signals generated for a small set of 54 ‘ground truth’ drug-medical

event pairs [214]. A specific method to signal ADR using the THIN database may generate novel signals that cannot be generated using the common data model nor the SRS databases. There are inconsistencies in the recording of data into the THIN database [78], but this may be overcome by developing a novel method that takes this into account.

2.2 Pattern Recognition

In the previous part of the literature review the existing pharmacovigilance techniques that tend to signal ADRs by calculating an estimate for the relative risk of each drug-medical event pair were summarised. The medical events with a large estimated relative risk are then signalled, or alternatively ‘classified’, as potential ADRs. These methods can be considered unsupervised learning algorithms, algorithms that infer hidden structure without being taught [2], as they do not use knowledge of existing ADRs to learn intrinsic differences between ADRs and non-ADRs. Rather, they use a single attribute such as the relative risk estimate to distinguish between ADRs and non-ADRs. The limitation with relying on a single attribute, such as the relative risk, is that confounding can occur and cause many non-ADRs to have a high relative risk estimate. This results in the techniques having high false positive rates and reduces the efficiency in detecting ADRs.

There has been no research to date that extracts attributes for drug-medical event pairs from LODs and then uses known ADRs as a means to learn the unknown ADRs based on their attributes, although in [113] the authors use chemical knowledge and learn from known ADRs. This type of learning is called supervised learning [74]. During the training stage, supervised learning requires attributes that describe each data-point and knowledge of the ‘classes’ that the data-points belong to. In the context of ADR signalling each drug-medical event pair would represent a data-point and their attributes would correspond to values that could be used to distinguish between ADRs and non-ADRs. Examples of suitable attributes include the risk of the medical event within a defined time period after

taking the drug or the average age of the patients experiencing the medical event after the drug. Labels need to be assigned to each data-point (i.e., each drug-medical event pair) to define their class, for example the pair ciprofloxacin and tendon rupture would be in the class ADR whereas the pair ciprofloxacin and normal menopause are in the class non-ADR. In the pharmacovigilance field this has been unexplored in general due to the uncertainty with knowing what medical events are definitely ADRs or non-ADRs of a drug . If a sufficient number of labelled data-points could be generated then a supervised algorithm could be trained. This would enable classification of any drug-medical event pair whose ADR status is unknown, as an ADR or non-ADR. If suitable attributes were chosen so that it was possible to distinguish between medical events linked to drugs due to confounding factors and true ADRs, then a supervised algorithm could offer significant improvement over existing ADR signalling methods .

In the following section the theory behind supervised learning and the main algorithms applied are described. This is followed by a summary on semi-supervised learning, the technique developed to deal with the situation of having labels that are difficult to generate [30]. Due to the conundrum that applying supervised learning for signalling ADRs imposes, requiring knowledge of ADRs to extract knowledge of ADRs, it may be impossible to generate the required number of labeled data-points and a semi-supervised algorithm may be more appropriate.

2.2.1 Supervised Learning

2.2.1.1 Introduction

Supervised learning is the process of learning from examples to infer the relationship between inputs and outputs. A training set consisting of inputs (also known as attributes) and their corresponding outputs are used to ‘supervise’ the training of a function that is capable of generalising the mapping between input and output. The trained function can then be used to predict the output of any unseen input coming from the same distribution as the training set inputs. When the outputs are discrete they are referred to as classes or labels and the supervised learning is known as classification. Alternatively, when the output is continuous the supervised learning is known as regression [37]. For example, if the odds ratio (OR) and risk difference (RD) attributes are known for a thousand different drug-medical event pairs and for each pair their class (ADR or non-ADR) is also known, then supervised learning could be applied to partition the attribute space into areas likely to correspond to ADRs and areas likely to correspond to non-ADRs, see Fig 2.9 illustrating the ideal situation where ADRs and non-ADRs are separable in the space determined by the OR and RD.

Formalising the previous statement, the training set A_n is a collection of inputs $\mathbf{x}_i \in X$ and corresponding outputs $y_i \in Y$ pairs,

$$A_n = \{(\mathbf{x}_1, y_1), (\mathbf{x}_2, y_2), \dots, (\mathbf{x}_n, y_n)\} \quad (2.12)$$

Where each pair (\mathbf{x}_i, y_i) are assumed to be independent identically distributed samples from an unknown joint probability distribution P . In general, $X \subset \mathbb{R}^m$

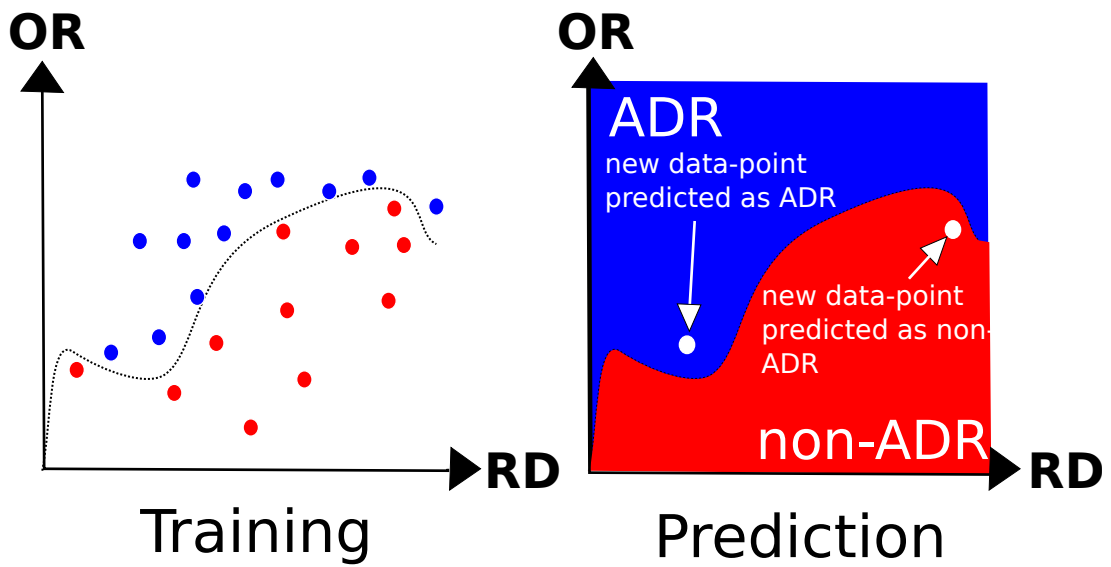

Figure 2.9: Illustration of a classifier partitioning the attribute space. Using the training data (blue dots are labelled as ADR and red as non-ADR) a function is trained to partition the space into ADR sections and non-ADR sections. This can then be used to predict whether a new data-point is an ADR or non-ADR based on where the data point lies in the attribute space.

and $Y \subset \mathbb{R}$ for regression or $Y = \{-1, 1\}$ for binary classification. The task of supervised learning is to find a function $f : X \rightarrow Y$, where $f \in H$ (a class of functions).

As the training data is considered to consist of n independently identically distributed samples from an unknown joint probability distribution $P(\mathbf{x}, y)$, then the task of supervised learning is to develop a function f that models the dependency within the joint distribution. There are two different approaches for producing machine learning models, the discriminative model and the generative model. The discriminative model aims to determine the conditional distribution of the class label given the input, $P(y|\mathbf{x})$, by using a parametric model and determining the model's parameter values with the aid of the training set [102]. The generative method calculates the joint probability distribution, $P(\mathbf{x}, y)$, and makes use of this distribution to predict the conditional distribution [102]. In general, if the training set is sufficiently large (depending on the complexity of the model), discriminative models have been shown to perform better [92], however, generative models have the advantage of being able to incorporate unlabelled data [102]. This is advantageous when generating labels becomes costly.

To find the optimal function $f \in H$ for mapping the inputs to their outputs it is necessary to evaluate each functions performance. This is calculated by a non-negative loss function, $L : Y \times Y \rightarrow \mathbb{R}^+$, that determines a measure of error between the predicted output $f(\mathbf{x}_i)$ and the real output y_i . Various loss functions have been proposed, examples for binary classification [150] include,

- Square Loss: $L(f(\mathbf{x}), y) = (1 - f(\mathbf{x})y)^2$
- Hinge Loss: $L(f(\mathbf{x}), y) = |1 - f(\mathbf{x})y|_+$

-
- Logistic Loss: $L(f(\mathbf{x}), y) = (\ln 2)^{-1} \ln(1 + e^{-f(\mathbf{x})y})$

The choice of the loss function that is implemented should be chosen based on the specific classification problem [4]. The integral of the model's loss function over the joint probability distribution gives the generalisation error, or risk,

$$R(f) = \int L(f(\mathbf{x}), y) dP(\mathbf{x}, y) \quad (2.13)$$

The Bayes estimator, g^* , is the function that minimises the risk,

$$R(g^*) = \inf_f R(f) \quad (2.14)$$

The goal of a discriminative learning algorithm is to find the function within a class of possible functions, $f^* \in H$, that minimises the risk, $f^* = \arg \min_{f \in H} R(f)$. Unfortunately it is often the case that the Bayes estimator does not belong to the class of possible functions. Methods that aim to determine the function that minimises the risk include empirical risk minimisation [123], structural risk minimisation [187], regularisation [18] and normalised regularisation [18].

Empirical risk minimisation is a simple and generally efficient means to determine a suitable function. The empirical risk measures the difference between the predicted output values and the true output values by calculating the average of the loss function over each data-point in the training set,

$$R_{emp}(f, A_n) = \frac{1}{n} \sum_{i=1}^n L(f(\mathbf{x}_i), y_i) \quad (2.15)$$

The empirical risk minimisation method then identifies the function f from a

model of possible functions H that minimises the empirical risk,

$$f^* = \arg \min_{f \in H} R_{emp}(f)$$

It is clear that the choice of model that determines the possible functions has a direct impact on the results returned by the empirical risk minimisation method.

The idea behind the structural risk minimisation is to pick a sequence of models, $\{H_s | s \in \mathbb{N}\}$, that increase in size and find the argument that minimises a trade off between the empirical risk and a penalty that penalises large models (models with a large capacity),

$$f^* = \arg \min_{f \in H_s, s \in \mathbb{N}} R_{emp}(f) + pen(s, n) \quad (2.16)$$

where n is the size of the training data. As the empirical risk only estimates the actual risk, it is of interest to find bounds on the difference between the actual and empirical risk, as this gives an indication into the predictive suitability of any functions that are determined using a supervised learning model. Extensive analysis by [187] managed to show that the actual risk is bounded by the empirical risk and an additional term that corresponds to the complexity of the model. With probability $1 - \eta$ the following holds,

$$R(f) \leq R_{emp}(f) + \sqrt{\frac{h(\log(2n/h) - \log(\eta/4))}{n}} \quad (2.17)$$

where h is the VC dimension of the class of functions H , this is a measure of their complexity. The VC dimension of a class of functions is the maximum number of points that can be separated in every possible way by those functions over a

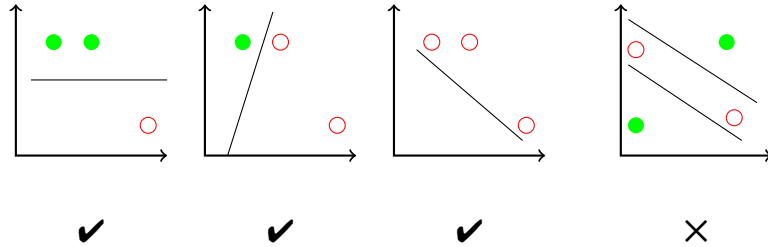

Figure 2.10: Illustration of the maximum number of points separable in every possible way by a linear classifier.

defined space [189]. A visual example demonstrating that a linear classifier has a VC dimension of 3 can be seen in Figure 2.10. It can be seen that 3 non-collinear points can be separated by a line in every possible way, but this is not the case for 4 points, as the far right graph shows two lines are required.

In general the bound can be represented as,

$$\text{Test error} \leq \text{Training error} + \text{Complexity of set of models} \quad (2.18)$$

Training a highly complex model may lead to overfitting, where the training error is minimised but the model is not generalised and performs poorly on the testing data. On the other hand, a less complex model is likely to have a high training error. Therefore, the perfect model determines a function that has a low training error but is also as simple as possible.

The complexity of the model depends on H , the class of functions, and this is determined by the classifier being applied. The most widely applied classifiers are the Decision Tree [81], Naive Bayes [101], Logistic Regression [84], Support Vector Machine [39] and K-Nearest Neighbours (KNN) [56]. Each of these have different model assumptions and are briefly summarised in the following section.

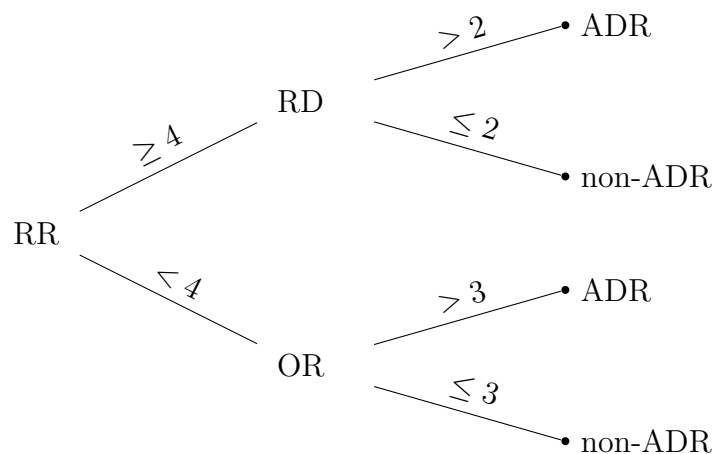

Figure 2.11: Example of a decision tree to classify drug-medical event pairs as ADRs or non-ADRs.

2.2.1.2 Classifiers

Decision Tree

The decision tree classifier is a directed tree that recursively partitions the attribute space into sub-spaces. An illustration of a hypothetical decision tree can be seen in Figure 2.11. A decision tree is non-parametric [116], self explanatory [116] and has the advantage of being unaffected by heterogeneous data or different features that have varied ranges. This means that the data does not need to be extensively processed before applying the classifier. Unfortunately, it has been described as 'greedy' as noise or irrelevant attributes in the training set can greatly impede its performance [139].

The decision tree can be constructed with a bottom-up [95] or top-down [149] approach. Generally speaking, the algorithm uses a splitting measure to calculate how well an available partitioning of the space separates the classes. During each iteration in the top-down approach, the optimal partitioning is applied to the current subspace, or the subspace stops being partitioned when the splitting

measures shows there is no possible partition that can lead to a sufficient gain or the stopping criterion is satisfied. In general, the splitting criteria is only based on a single attribute during each iteration. This is known as univariate splitting [116] and the measures are often based on impurity based criteria such as the Gini index [21] or information gain [138].

The information gain takes its origin from information theory and measures the change in the entropy value that is caused by partitioning the space. The entropy value corresponds to the uncertainty within a set. Considering the binary classification problem where there are two class, let p_1 and p_2 represent the proportion of the data-points within the set S that are in class 1 or -1 respectively, then the entropy is,

$$E(S) = - \sum_{i=1}^2 p_i \log_2 p_i \quad (2.19)$$

If the data-points in a set are all from one class, without loss of generality, assume they are from class 1, then $p_1 = 1$ ($\log_2 p_1 = 0$) and $p_2 = 0$ so $E = 0$, the lowest possible value. If the data-points in a set are spread equally between the two classes, $p_1 = p_2 = 0.5$, then the entropy is the highest possible value $E = 1$. It is clear that choosing a partitioning with the highest information gain minimises the entropy and leads to a final partitioning of the space into numerous subspaces that are dense in a single class. The main limitations of using information gain as the splitting measure for a decision tree classifier is that there is a bias towards partitioning based on attributes with large ranges [201] that can lead to overfitting and it is common for the space to be fragmented into a surplus number of small subspaces.

The Gini index is another splitting measure frequently implemented. The

Gini index is calculated for a set S by,

$$Gini(S) = 1 - \sum_{i=1}^2 p_i^2 \quad (2.20)$$

The Gini index is minimised when the majority of the data-points within set S belong to one class. In this case, one of the p_i values will be close to one and the others will be small. The square term in the Gini index calculation puts more emphasis on larger values. Squaring the p_i value close to one has little effect, whereas the closer a p_i value is to zero, the more it becomes reduced when squared. So a set S containing data-points spread between different classes will have a small value for $\sum_{i=1}^2 p_i^2$ and therefore a Gini index close to 1.

The average Gini index is the weighted average of the Gini index based on partitioning the set S into subsets S_i using the values of a single attribute A , where $|S|$ corresponds to the number of elements in the set S ,

$$Gini(S, A) = \sum_i \frac{|S_i|}{|S|} Gini(S_i) \quad (2.21)$$

The decision tree is generated by finding the partitions that minimise the average Gini index. Research comparing the different univariate splitting measures has often concluded that the choice has little effect on the decision tree as there does not appear to be an overall superior measure [116].

Naive Bayes

The Naive Bayes classifier uses the training set to determine the distribution of the class label, $P(Y)$, and the conditional distribution of the input attributes

given the class label, $P(X_i|Y)$ for $i \in [1, n]$, and then use these combined with Bayes rules and a conditional independence assumption to find the most probable class for any future inputs. The conditional independence assumption is used to simplify the number of parameters required by the model and enables an efficient calculation of the distribution $P(Y|X)$.

Consider three random variables, X , Y and Z . It is defined that X is conditionally independent of Y given Z if, $P(X|Y, Z) = P(X|Z)$. Assuming that the input features are conditionally independent given the class label, then,

$$\begin{aligned} P(X_1, X_2, \dots, X_n|Y) &= P(X_1|X_2, \dots, X_n, Y)P(X_2|X_3, \dots, X_n, Y)\dots P(X_n|Y) \\ &= P(X_1|Y)P(X_2|Y)\dots P(X_n|Y) \\ &= \prod_{i=1}^n P(X_i|Y) \end{aligned}$$

Using Bayes rule,

$$P(Y = y_k|X_1, \dots, X_n) = \frac{P(Y = y_k)P(X_1, \dots, X_n|Y = y_k)}{\sum_j P(Y = y_j)P(X_1, \dots, X_n|Y = y_j)} \quad (2.22)$$

and using the conditional independence the expression for the conditional probability of the class label given the input data is,

$$P(Y = y_k|X_1, \dots, X_n) = \frac{P(Y = y_k) \prod_i P(X_i|Y = y_k)}{\sum_j P(Y = y_j) \prod_i P(X_i|Y = y_j)} \quad (2.23)$$

As the denominator in equation (2.23) is independent of the choice of class label, it can be ignored. The classifier simply determines the most probable class label

for an input by,

$$Y = \arg \max_{y_k} P(Y = y_k) \prod_i P(X_i|Y = y_k) \quad (2.24)$$

The classifier, although limited by its unrealistic assumption of conditional independence, has performed well for some real life classification problems [47]. In [146] the authors state that a known limitation of the Naive Bayes classifier is that it does not perform optimally when the classes are non-linearly separable.

Logistic Regression

Logistic regression is a discriminative model so it assumes a distribution for $P(Y|X)$ and uses the training data to determine the parameter values. Logistic regression is applied when the classification is binary and does not required the inputs to be normally distributed, have equal variance within each class nor be linearly related [27]. The main disadvantage with the classifier is that it uses maximum likelihood to determine the parameter values and this requires larger training sizes than for linear regression. It is suggested that a minimum of 50 cases per predictor are used [27].

The logistic regression model is based on the assumption that the log odds of a data-point belonging to a class given its n attributes can be expressed as a linear combination of the data-points attributes. Under this assumption the log odds is expressed as,

$$\ln(P(Y|\mathbf{X})/(1 - P(Y|\mathbf{X}))) = w_0 + \sum_{i=1}^n w_i X_i$$

by taking the exponential and re-arranging, the conditional model used by logistic regression for the two class problem is,

$$P(Y = 0|X) = \frac{\exp(w_0 + \sum_{i=1}^n w_i X_i)}{1 + \exp(w_0 + \sum_{i=1}^n w_i X_i)}$$

$$\begin{aligned} P(Y = 1|X) &= 1 - P(Y = 0|X) \\ &= \frac{1}{1 + \exp(w_0 + \sum_{i=1}^n w_i X_i)} \end{aligned}$$

As the classifier assigns the class for an input \mathbf{x} based on $\arg \max_{y_k} P(Y = y_k | X = \mathbf{x})$, it is clear that class 0 is assigned when $1 < \exp(w_0 + \sum_i w_i X_i)$ (or equivalently $0 < w_0 + \sum_i w_i X_i$) and class 1 is assigned otherwise.

Support Vector Machine

The Support vector machine (SVM) classifier is a parametric model that aims to find the hyperplane that separates the classes while maximising the distance between the data-points and the hyperplane, see Figure 2.12. For the two class problem, the SVM works by finding two parallel hyperplanes such that they separate the two classes and there are no points between the two hyperplanes. The equations of two hyperplanes are $\mathbf{w} \cdot \mathbf{x}_i + b = 1$ and $\mathbf{w} \cdot \mathbf{x}_i + b = -1$. The bit in-between the hyperplanes is referred to as the ‘margin’. This is what needs to be maximised to ensure the classes are separated as much as possible. As the distances between the two hyperplanes is $2/||w||$, by minimising $||w||$ we can find the maximum separation between the classes. Previously in Chapter 2.2.1.1 it was shown that the actual risk of a classifier is bounded by the empirical risk and a term that depends on the capacity/complexity of the set of decision functions

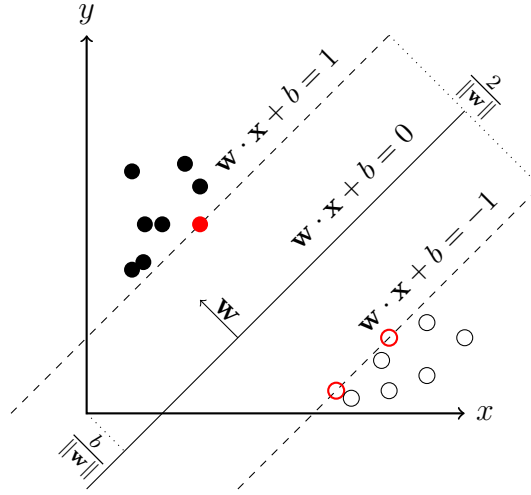

Figure 2.12: Illustration of the support vector machine classifier. The hyperplane separating the classes is positioned such that the distance between the hyperplane and the closest data points from either class is maximised.

defined by the classifier. The decision functions used by the SVM classifier are the hyperplanes $\mathbf{w} \cdot \mathbf{x} + b$. It has been proven that for the set of hyperplanes $(\mathbf{w} \cdot \mathbf{x}) = 0$ such that $\min_i |\mathbf{w} \cdot \mathbf{x}_i| = 1$ for $\mathbf{x}_i \in X$ the set of decision functions $f_w(\mathbf{x}) : X \rightarrow \{-1, 0, 1\}; f_w(\mathbf{x}) = \text{sgn}(\mathbf{w} \cdot \mathbf{x})$ satisfying $\|\mathbf{w}\| < A$ has a bounded VC dimension [188],

$$h \leq R^2 A^2 \quad (2.25)$$

where R is the radius of the smallest ball centred at the origin that covers the set X . This defines an upper bound on the capacity/complexity of the SVM classifier. In the separable case this motivates finding the parameters \mathbf{w} and b such that $\|\mathbf{w}\|^2$ is minimised and,

$$\begin{aligned} (\mathbf{w} \cdot \mathbf{x}_i + b) &\geq 1 && \text{if } y_i = 1; \\ (\mathbf{w} \cdot \mathbf{x}_i + b) &\leq -1 && \text{if } y_i = -1. \end{aligned} \quad (2.26)$$

as this results in a zero empirical risk and minimises the capacity of the model. When the data is non-separable (i.e. there is no hyperplane that can cleanly split the classes), slack variables are introduced to enable the misclassification of some data-points. The aim is to maximise the margin while minimising the degree of misclassification. The optimisation problem becomes minimise:

$$\|\mathbf{w}\|^2 + C \sum_{i=1}^m \sigma_i$$

subject to:

$$y_i(\mathbf{w} \cdot \mathbf{x}_i + b) \geq 1 - \sigma_i, \sigma_i \geq 0$$

An addition to the optimisation problem includes incorporating kernel functions that map the data-points into a space where they are separable [125].

K-Nearest Neighbour

The K-nearest neighbour (KNN) classifier is non-parametric, this means it does not assume the data come from a specific distribution. The classifier is described as a lazy algorithm as it does not use the training data to generalise (generate a probabilistic distribution) [199], this makes the training state highly efficient, but can cause the testing step to become costly.

The classifier requires the data to come from a metric space, but the measure of distance can be any suitable metric. The classifier works by taking the majority vote of the k nearest neighbours, where distance is determined by the defined metric. If the set $N_k(\mathbf{x})$ is the set of indices corresponding to the K nearest

neighbours of \mathbf{x} , then,

$$f_{KNN}(\mathbf{x}) = \begin{cases} 1 & \text{if } \sum_{i \in N_k(\mathbf{x})} y_i \geq 0; \\ -1 & \text{if } \sum_{i \in N_k(\mathbf{x})} y_i < 0. \end{cases}$$

For example, if $k = 7$, and for an input \mathbf{x} three of its neighbours are class -1 and four are class 1 then the input would be assigned the class 1 . The algorithm can be modified to use the distance of the neighbours as weights so that closer neighbours have more influence [49].

2.2.1.3 Ensemble Methods

An ensemble classifier considers the outputs from multiple trained classifier to determine the class of a data-point [130]. In general, the method combines multiple diverse ‘weak learners’ to produce a ‘strong learner’. The motivation behind an ensemble classifier is to reduce the bias that can occur when considering single classifiers and to reduce the variance than can occur due to the choice of data used during training [23].

There exists a magnitude of options for generating diverse classifiers including building models from different samples of the data [22], using different models [51] or building models that use different subsets of attributes [82]. There are also different ways to combine the predictions from the classifiers, such as determining the class by voting that returns the modal class or weighted voting that incorporates the confidence of the classifiers or error estimations as weights to produce a weighted sum of the votes. Another method, known as stacking, is to use the outputs of the classifiers as inputs into a new meta classifier that does

the final classification [177].

The most widely implemented ensemble methods that use sampling of the training data set are known as bagging [22] and boosting [60]. Bagging involves iteratively generating classifiers that are built on different training sets and returning the class with the highest number of votes based on these classifiers. The different training subsets are produced by drawing with replacement from the whole training set. Bagging has a statistical basis and can be considered similar to averaging as it reduces the classifier's variance [23; 130]. The advantage of bagging is that it is resistant to noise, however, experiments have shown that with a little noise present it is not as accurate as other methods such as boosting [46].

Boosting has its foundations in learning theory and the general aim is to produce a sequence of classifiers that are used to generate a weighted vote for the overall class. The misclassifications of the previous classifiers in the sequence have an influence on the weights assigned during classification in the later sequence classifiers. The most widely used boosting classifier is the AdaBoost classifier developed by Freund and Schapire [61] that generates a sequence of simple classifiers ($h_m \in H$, where H is a class of simple classifiers) and weights ($\lambda_m \in \mathbb{R}$) by giving more importance to data-points that were misclassified by the simple classifiers earlier in the sequence. The final classification makes use of the weighted majority vote $\text{sgn}(\sum_{m=1}^M \lambda_m h_m(x))$. Considering $(X_i, Y_i), i \in [1, n]$ to be i.i.d. samples where $Y_i \in \{-1, 1\}$ and $X_i \in x$ then the sequence is determined by,

0. Let $c_1 = c_2 = \dots = c_n = 1$, and set $m = 1$.

1. Find $h_m = \arg \max_{h \in H} \sum_{i=1}^n c_i h(X_i) Y_i$. Set

$$\lambda_m = \frac{1}{2} \log\left(\frac{\sum_{i=1}^n c_i + \sum_{i=1}^n c_i h_m(X_i) Y_i}{\sum_{i=1}^n c_i - \sum_{i=1}^n c_i h_m(X_i) Y_i}\right) = \frac{1}{2} \log\left(\frac{\sum_{h_m(X_i)=Y_i} c_i}{\sum_{h_m(X_i) \neq Y_i} c_i}\right) \quad (2.27)$$

2. Set $c_i \leftarrow c_i \exp(-\lambda_m h_m(X_i) Y_i)$, and $m \leftarrow m + 1$, If $m \leq M$, return to step 1.

In step 1 the algorithm finds the simple classifier in H that has the smallest weighted misclassification and then calculates the corresponding lambda based on the ratio of correct classifications to misclassifications. The weights that determine the importance of correctly classifying each datapoint are then updated in step 2. If the simple classifier misclassified datapoint i then $-\lambda_m h_m(X_i) Y_i$ will be positive and therefore the weight given to it will increase, alternatively if the classifier was correct the weight will decrease. Boosting has been shown to often work well but it has been hypothesised that results by boosting may be impeded when there is noise present in the training set [46; 59].

The random forest is a non-parametric ensemble classifier that produces a ‘forest’ containing multiple decision trees and determines the class based on majority voting whereby each tree in the forest is given one vote [24]. Each decision tree is built on a different random sample of the training set, where sampling is done with replacement.

Let the training set $D_n = \{(\mathbf{X}_1, Y_1), (\mathbf{X}_2, Y_2), \dots, (\mathbf{X}_n, Y_n)\}$ consists of n i.i.d. pairs of random variables sampled from the joint distribution (\mathbf{X}, Y) where $X = \mathbb{R}$ and $Y = \{0, 1\}$. We represent the marginal distribution of X by $\mu(x) = P\{X = x\}$ and the posteriori probability by $\eta(x) = P\{Y = 1|X = x\}$. The probability

of a classifier g_n misclassifying is,

$$L(g_n) = P\{g_n(X, D_n) \neq Y\}$$

It has been shown that the Bayes classifier, $g^*(x) = \mathbb{1}_{\{\eta(x) \geq 1/2\}}$, minimises the probability of error [45] and this probability of error for the Bayes classifier $L(g^*)$ is referred to as the Bayes risk. A sequence of classifiers ($\{g_n\}$) is consistent for the distribution (\mathbf{X}, Y) if $\forall \epsilon > 0 \exists N \in \mathbb{N}$ s.t. $\forall n \geq N |L(g^*) - L(g_n)| < \epsilon$.

A randomised classifier $g_n(X, \theta, D_n)$ uses a random variable θ to determine its prediction, where θ takes its values from some measurable space. The probability of error for the randomised classifier can be calculated as,

$$L(g_n) = P\{g_n(X, \theta, D_n) \neq Y | D_n\}$$

Given m identically distributed draws from the random variable θ , $\theta^m = (\theta_1, \dots, \theta_m)$ where each of the θ_i s are considered independent conditionally on X, Y and D_n , the random forest classifier is constructed such that it takes the majority vote of m decision trees by,

$$g_n^{(m)}(x, \theta^m, D_n) = \begin{cases} 1 & \text{if } \frac{1}{m} \sum_{j=1}^m g_n(X, \theta_j, D_n) \geq \frac{1}{2} \\ 0 & \text{else} \end{cases} \quad (2.28)$$

In [13], they prove that if the sequence of random classifiers is consistent then so is the voting classifier. This result implies that if the sequence of random decision trees generated by the random forest is consistent then the probability of error of the random forest tends to the Bayes risk as the number of random

trees increases. One example of the randomisation procedure used to generate the random classifiers by the random forest is to use bagging. In this case each decision trees is built on a random sample of the training data. Another common method is to randomly sample from the attributes available in the training data and train each tree on a difference set of attributes. Some random forest classifiers incorporate the randomness by generating decision trees that interactively pick a random attribute to partition the attribute space until each partition only contains a single data-point from the training set, and then the class returned for a new data-point is the class of the training data-point corresponding the the subspace that the new data-point is in [24]. This method has been shown to have similarities with the nearest neighbour classifier [110].

2.2.1.4 Supervised Learning Summary

In this section the statistical learning theory undermining supervised learning was summarised and the main supervised classifiers currently implemented were presented. It is clear that given sufficient historical data it is possible to learn underlying patterns within the data that can be used to form future predictions. As the THIN database contains a large quantity of historical data, supervised learning techniques can be applied with the aim of inferring medical information that can help improve current healthcare. In the later parts of this section the ensemble classifiers, that make use of multiple classifiers with the aim of improving the classifying accuracy on average, were discussed. In particular, the focus was aimed towards the random forest as this classifier can be applied to heterogeneous data and by incorporating bagging it can be more resilience to noise. These are the two key issues associated with the THIN database, suggesting the random

forest may have excellent performance when applied to classify ADRs using the THIN database.

The majority of existing algorithms for signalling ADRs using electronic health-care databases are unsupervised as they do not include known ADR labels when detecting patterns and instead find general structures of interest within the data. The reason few supervised algorithms exist is due to the lack of known ADRs preventing the ability to have sufficient quantities of labelled data. However, if these labels can be discovered then a supervised algorithm, with appropriate attributes, may significantly outperform its unsupervised counterpart. Due to clinical trials and knowledge gained over the time that a drug is actively prescribed, some ADRs are definitively known and could be used as labels. If there are some labels but not enough, then an alternative method would be to apply semi-supervised learning. Semi-supervised learning is a mixture of supervised and unsupervised learning techniques. It involves the inclusion of unlabelled data-points into the training stage of an algorithm when there is a small number of labelled data-points [30]. It is often observed that including unlabelled data-points during training can lead to an improvement in performance of the algorithm [30]. This is discussed further in the next section.

2.2.2 Semi-Supervised Learning

2.2.2.1 Introduction

Supervised classification was previously introduced, where the aim is to find a function that approximates the joint distribution between the random variables \mathbf{X} and Y when given n random i.i.d. samples. Unfortunately, it is not always

possible to observe both \mathbf{X} and Y together a sufficient number of times as the label Y can be scarce or costly to determine [30]. When the number of labelled samples in the training set is low, any classifier trained on the data is likely to perform poorly [140].

When the number of labelled data-points are scarce but unlabelled data-points are readily observable, under certain assumptions, knowledge of the marginal distribution can result in an improvement in the function that approximates the joint distribution. Semi-supervised learning algorithms make use of unlabelled data-points to learn the marginal distribution and incorporate this in addition to the labelled data-points when inferring the joint distribution. Formally, given both labelled ($\{(\mathbf{X}_i, Y)\}_{i=1}^l$) and unlabelled ($\{\mathbf{X}_i\}_{i=l+1}^{l+u}$) data the aim of the supervised learner is to infer the joint probability distribution $P(\mathbf{X}, Y)$ where the labelled data-points are i.i.d. samples from the joint distribution and the unlabelled data-points are i.i.d. from the marginal distribution $P(\mathbf{X})$. In general there are more unlabelled data-points, $l \ll u$

In the remainder of this introduction, the main semi-supervised techniques are summarised and the limitations associated to the assumptions they make to enable the incorporation of unlabelled data are discussed.

Self-training Algorithm

The self-training algorithm [40] trains a classifier on the labelled data and then applies the trained classifier on the unlabelled data to predict their class. The algorithm then assumes that some of the predicted classes of the unlabelled data-points are true and moves these from the unlabelled dataset into the labelled dataset. The algorithm continues until the unlabelled dataset is empty. Gener-

ally the algorithm considers the model predictions for the unlabelled data-points with the greatest prediction confidences to be true, however, this is not always the case when the classes are non-separable [215]. Consequently, the self-training algorithm can perform poorly when the classes are non-separable. Early mistakes can have huge impacts as misclassifications will be incorporated into the training of the classifiers in future iterations, potentially leading to further misclassifications.

Probability Generating Models

The aim of each classifier is to identify the most probable class given the input, $\arg \max_Y p(Y|\mathbf{X})$, and this can be determined using a generative model. The generative model makes use of Bayes rule to show that $\arg \max_Y p(Y|\mathbf{X}) = \arg \max_Y p(\mathbf{X}|Y)p(Y)$ and this implies that the class can be determined when the conditional distribution $p(\mathbf{X}|Y)$ and marginal distribution $p(Y)$ are known. If the conditional distribution and marginal distributions are assumed to come from a specified model then given the training data D , the most likely parameter value θ is,

$$\hat{\theta} = \arg \max_{\theta} p(D|\theta) = \arg \max_{\theta} \log p(D|\theta) \quad (2.29)$$

and

$$\begin{aligned} \log p(D|\theta) &= \log \left(\prod_{i=1}^l p(\mathbf{X}_i, Y_i|\theta) \prod_{i=l+1}^{l+u} p(\mathbf{X}_i|\theta) \right) \\ &= \sum_{i=1}^l \log p(Y_i|\theta) p(\mathbf{X}_i|Y_i, \theta) + \sum_{i=l+1}^{l+u} \log p(\mathbf{X}_i|\theta) \end{aligned}$$

The Expectation Maximisation (EM) algorithm [120] can find the value of θ that

locally maximises $p(D|\theta)$. The limitations with the probability generating models are that the probabilistic model needs to be defined and an incorrect model will lead to inaccurate results [215]. It can be difficult to determine the conditional distribution if the number of labelled data-points is small [215]. This technique is more appropriate if there is additional knowledge about the data (e.g., the distribution the data come from is known).

Co-training

The semi-supervised method of co-training [16] is when two different classifiers are trained, in a similar style to self-training except they learn from each other and unlabelled data is iteratively added to each classifier's labeled data based on the predictions of the other classifier. The process of co-training at learning speed k is,

1. Initially let the training sample be $L_1 = L_2 = \{(\mathbf{X}_1, Y_1), \dots, (\mathbf{X}_l, Y_l)\}$.
2. Repeat until unlabelled data is used up:
 1. Training a view-1 classifier $f^{(1)}$ from L_1 and a view-2 classifier $f^{(2)}$ from L_2 .
 2. Classify the remaining unlabelled data with $f^{(1)}$ and $f^{(2)}$ separately.
 3. Add $f^{(1)}$'s top k most-confident predictions $(\mathbf{X}, f^{(1)}(\mathbf{X}))$ to L_2 .
Add $f^{(2)}$'s top k most-confident predictions $(\mathbf{X}, f^{(2)}(\mathbf{X}))$ to L_1 .
Remove these from the unlabelled data.

In effect, the algorithm forces the two classifiers, using different views, to agree on the prediction of the unlabelled data, and the chance of overfitting is reduced.

The co-training algorithm assumes that the data can be partitioned into two different views but how this is done is not always obvious. One limitation of this algorithm is that it requires the two views to be conditionally independent given the class [41],

$$P(\mathbf{X}^{(1)}|Y, \mathbf{X}^{(2)}) = P(\mathbf{X}^{(1)}|Y)$$
$$P(\mathbf{X}^{(2)}|Y, \mathbf{X}^{(1)}) = P(\mathbf{X}^{(2)}|Y)$$

Although in [6] the authors argue that the conditional independence can be relaxed. They suggested that co-training can be applied as long as the two views are not highly correlated. However, many situations are likely to violate this assumption. For example, in the context of classifying a drug-medical event pair as a side effect, if one view uses the knowledge of when the drug occurs relative to the medical event and the other view uses association strength, these views are likely to be highly correlated. If the drug is only observed before the medical event occurs and not after then this will probably mean there is also a strong association between the drug and medical event.

In Chapter 2.2.1.1, the error of a classifier was shown to be bounded by the training error and the term that corresponds to the complexity of the model. It is known that a complex model that minimises the training error may not generalise well to unseen data as it may over-fit. Co-training aims to reduce the complexity of a model by restricting the function space, and therefore reduces the error [215].

2.2.2.2 Semi-Supervised Clustering

When there are no labelled data available, unsupervised techniques such as clustering are applied to find intrinsic patterns within the data [88] without learning from labelled data. Examples include the k-means clustering that initially assigns each data-point into a random cluster and then iteratively moves each data-point into the cluster that is closest [73]. The distance between the data-point and each cluster is based on the cluster centre, the average of the data-points within that cluster. Recent semi-supervised techniques have involved the incorporated of a small number of labelled data to bias the clustering [7]. For example, in [7] the authors use the labelled data to determine the initial centres in the k-means clustering algorithms and fix the labelled data-points into one cluster. Alternative approaches to improving clustering with additional knowledge has involved using must or cannot be in the same cluster constraints [191] or interactive clustering [32], where the semi-supervised clustering algorithm adapts based on feedback.

If the labels are given, the seed-constrained K-means clustering algorithms, developed in [7] improves the unsupervised k-means algorithm by using the labels data to determine the initial cluster centres and then applies the k-means algorithm while fixing the labelled data to their known cluster. The set of data-points input into the seed-constrained K-means algorithm is the set $\{\mathbf{x}_1, \mathbf{x}_2, \dots, \mathbf{x}_n\}$, the value of K input is k (the maximum number of classes in the labelled data) and the initial seeds are $S_l = \{\mathbf{x}_i : \mathbf{x}_i \text{ is labelled as class } l\}$. The seed-constrained k-means algorithm is described in Algorithm 1.

As there will be labels rather than constrains for the ADR detection problem, the seed-constrained K-means algorithm presents a simple and efficient solution

Input : Set of data-points $X = \{\mathbf{x}_1, \mathbf{x}_2, \dots, \mathbf{x}_n\}$, $\mathbf{x}_i \in \mathbb{R}^d$, number of clusters K , the set $S = \cup_{l=1}^K S_l$ of initial seeds.

Output: Disjoint K partitioning $\{X_l\}_{l=1}^K$ of X such that the KMeans objective function is optimised.

Initialization: $\boldsymbol{\mu}_h^{(0)} \leftarrow \frac{1}{|S_h|} \sum_{\mathbf{x} \in S_h} \mathbf{x}$, for $h = 1, \dots, K$; $t \leftarrow 0$

repeat

For $\mathbf{x} \in S$, if $\mathbf{x} \in S_h$ assign \mathbf{x} to the cluster h (i.e., set X_h^{t+1}). For $\mathbf{x} \notin S$, assign \mathbf{x} to the cluster h^* (i.e., set $X_{h^*}^{t+1}$), for $h^* = \operatorname{argmin}_h \|\mathbf{x} - \boldsymbol{\mu}_h^{(t)}\|^2$

$$\boldsymbol{\mu}_h^{(t+1)} \leftarrow \frac{1}{|X_h^{(t+1)}|} \sum_{\mathbf{x} \in X_h^{(t+1)}} \mathbf{x}$$

$t \leftarrow (t + 1)$

until convergence;

Algorithm 1: The seed-constrained K-means algorithm developed in [7]

if the number of labelled data are low. A common problem with clustering is that the measure of distance this is most suitable for a given problem is generally unknown [210]. The Euclidean distance metric is the standard one implemented, but this treats each attribute equally and assumes the attributes are independent [208]. For many clustering problems these assumptions are unrealistic. This has prompted researchers to develop methods that use the limited number of labelled data available for semi-supervised learning to learn the optimal metric space. By learning the suitable metric space, clustering techniques can be improved [208].

2.2.2.3 Metric Learning

An area of recent research is using additional knowledge to determine the optimal metric, see [99] for a summary. As clustering looks for closely connected communities within the data, the measure of ‘closeness’ will impact the results, and the standard Euclidean distance may not be most suitable [208]. In [211] the authors proposed learning the metric prior to clustering, whereas in [14] the metric learning is embedded into the clustering and gets applied during each iteration.

In [211], the authors proposed a metric learning algorithm that uses knowledge of constraints (i.e. labelled data-points that are in the same cluster as must-link and data-points that are in different clusters as cannot-link) to learn a mapping from the original attribute space into a new space that maximises the distance between data-points in different clusters while adding a constraint to the maximum distance that data-points in the same cluster can be apart. The algorithm applies eigenvalue optimisation and is highly efficient.

The known constraints are used to determine S , representing the set of all index pairs for data-points that are similar (e.g., $(1, 3) \in S$ means that data-point 1 and data-point 3 are known to be in the same cluster), and D , representing the set of index pairs for data-points that are different (e.g., $(1, 5) \in S$ means that data-point 1 and data-point 5 are known to be in different clusters). The inner product of two $d \times n$ real valued matrices, $A, B \in \mathbb{R}^{d \times n}$, is denoted by $\langle A, B \rangle := \mathbf{Tr}(A^T B)$, where $\mathbf{Tr}(A)$ means the trace of the matrix A and the cone of positive semidefinite matrices is denoted by S_+^d .

Given a pair of data-points $\mathbf{x}_i, \mathbf{x}_j \in X_L^{D_i}$, the matrix $X_{ij} = (\mathbf{x}_i - \mathbf{x}_j)(\mathbf{x}_i - \mathbf{x}_j)^T$. If $\tau = (i, j)$ is an index pair, then $X_\tau \equiv X_{ij}$. The matrix X_S is defined by $X_S = \sum_{(i,j) \in S} X_{ij}$ and $\tilde{X}_\tau = X_S^{-1/2} X_\tau X_S^{-1/2}$. The authors calculated that $\nabla f_\mu(S_t^\mu) = \frac{\sum_{\tau \in D} e^{-\langle \tilde{X}_\tau, S \rangle / \mu} \tilde{X}_\tau}{\sum_{\tau \in D} e^{-\langle \tilde{X}_\tau, S \rangle / \mu}}$. The metric learning process, that uses these matrices, is presented in Algorithm 2.

The must-link and cannot-link constraints can be determined when some labelled drug-medical event pairs are known. The must-link pairs are all combinations consisting of any two of the known ADRs pairs or all combinations consisting of any two of the known non-ADRs pairs. The cannot-link pairs are all the possible combinations consisting of one of the known ADR pairs and one of the known

Input :

- smoothing parameter $\mu > 0$ (e.g., 10^{-5})
- tolerance value tol (e.g., 10^{-5})
- step sized $\{\alpha_t \in (0, 1) : t \in \mathbb{N}\}$

Output: $d \times d$ matrix $S_t^\mu \in S_+^d$

Initialization: $S_1^\mu \in S_+^d$ with $\mathbf{Tr}(S_1^\mu) = 1$

for $t = 1, 2, 3, \dots$ **do**

$Z_t^\mu = \operatorname{argmax}\{f_\mu(S_t^\mu) + \langle Z, \nabla f_\mu(S_t^\mu) \rangle : Z \in S_+^d, \mathbf{Tr}(Z) = 1\}$, that is,
 $Z_t^\mu = \boldsymbol{\nu}\boldsymbol{\nu}^T$ where $\boldsymbol{\nu}$ is the maximal eigenvector of the matrix $\nabla f_\mu(S_t^\mu)$
 $S_{t+1}^\mu = (1 - \alpha_t)S_t^\mu + \alpha_t Z_t^\mu$
if $|f_\mu(S_{t+1}^\mu) - f_\mu(S_t^\mu)| < tol$ then **break**

end

Algorithm 2: The distance metric learning algorithm from [211]

non-ADR pairs. It is then possible to apply the metric learning described by Algorithm 2 to efficiently learn the optimal metric space.

2.2.2.4 Semi-Supervised Learning Summary

In this section the frequently applied semi-supervised techniques have been summarised. The semi-supervised techniques can, under certain assumptions, improve classification/clustering by incorporating the unlabelled data when the number of labelled data are scarce [30]. Out of the semi-supervised classification techniques discussed (i.e, self-training, co-training and probability generating), the self-training algorithm is most applicable for classifying ADRs due to the probability generating algorithm requiring prior knowledge of the distributions [215], of which is unknown, and the difficulty with determining the non-correlated views required by the co-training algorithm.

Alternatively, the most suitable semi-supervised clustering technique is the

seed-constrained k-means [7] algorithm as this is efficient and takes advantage of the labelled data available. However, as discussed previously, clustering can be improved by applying metric learning [208]. As the ADR classification/clustering is required to be efficient, a suitable metric learning algorithm to apply to improve the clustering and ensure efficiency is the one presented in [211]. The choice of semi-supervised classification or semi-supervised clustering will need to be determined.

2.2.3 Pattern Recognition Summary

Statistical learning theory is a field of research that aims to learn or identify intrinsic patterns within data. These patterns can then be applied to make future predictions, and in the medical context, they can be used to aid decision making such as what drug to prescribe to a patient. When there are a sufficient number of labelled data, supervised learning can be applied whereby a general function is learned that accurately maps the input into the output. Numerous methods have been proposed that can produce a function that has a minimal training error but will also perform well on future data [39; 56; 81; 84; 101]. Ensemble methods have been presented that are able to combine multiple classifiers to reduce the variance and can improve the classification accuracy. Unfortunately, issues arise when using real life data. Such examples include the introduction of noise, difficulties generating labels or the presence of missing data. Ongoing research aims to develop methods that can produce an accurate function when there are issues present. In the case of insufficient labels, semi-supervised techniques have been proposed that make use of unlabelled data [215]. However, there is no guarantee

that semi-supervised algorithms will outperform their supervised counterpart [30]. Nonetheless, semi-supervised techniques have been successfully implemented on real life problems [108] and may be suitable for determining ADRs when there is a lack of known ADRs.

2.3 Literature Review Summary

The first section of the literature review focussed on the current techniques being applied by the pharmacovigilance community. The literature is full of techniques for signalling ADRs using LODs, but no method has been presented that was developed specifically for the THIN database and few studies have applied a range of methods on the THIN database. Therefore, there has been no extensive analysis of applying ADR signalling methods on the THIN database and a benchmark is unknown. The current research does highlight the inherent difficulties in accurately determining current benchmarks for ADR signalling techniques, and this will need to be addressed in order to find the THIN benchmark.

The majority of existing methods for signalling ADRs using LODs rely on measures of association strength or temporality and do not cover the seven other Bradford-Hill causality considerations [19]. Furthermore, they do not take into consideration attributes specific to the database being used, but database specific attributes may offer a unique insight into causality. As a consequence, the existing ADR signalling methods tend to be affected by confounding and this causes them to generate many false positives [156]. It may be possible to reduce the negative effects of confounding by generating attributes for each drug-medical event pair based on the remaining seven Bradford-Hill causality considerations

or by generating attributes specific to the database. The justification is that the Bradford-Hill causality considerations help distinguish between association and causation, something that is currently lacking within the existing methods. This may then result in a low false positive rate.

The existing ADR signalling techniques developed for LODs are unsupervised, as they do not learn from drug-medical event pairs that are known ADRs or non-ADRs. The reasoning being that it is difficult to obtain a large number of drug-medical event pairs with definitive ADR or non-ADR labels. However, if a sufficient number of ADR and non-ADR pairs were determined, then supervised or semi-supervised techniques could be applied, using suitable attributes, to identify new ADRs. The semi-supervised techniques may be advantageous when the number of labelled drug-medical event pairs are limited, for example in the case when a drug is rarely prescribed, then its ADRs may be generally unknown and the number of labelled data will be small.

A supervised or semi-supervised technique that uses attributes based on the Bradford-Hill causality considerations or specific to the THIN database may be able to reduce the negative effects of confounding by identifying and utilising patterns linked to ADRs or non-ADRs. The random forest ensemble algorithm is a suitable classifier to apply when there is a sufficient number of labelled data due to its ability to handle heterogeneous data and its resilience to noise. When the number of labelled data is low, a self-training algorithm or a semi-supervised clustering algorithm may yield improved results. If such an algorithm signalled ADRs with a low false positive rate, then a larger number of drug-medical event pairs likely to correspond to ADRs could be evaluated extensively by rigorous epidemiological studies, and this is likely to result in new ADRs being discovered

efficiently. In addition, the supervised/semi-supervised technique that considers more than just the association strength and temporality factors of the Bradford-Hill causality considerations (and may reduce the effects of confounding) is likely to outperform the existing ADR signalling methods on the THIN database and on the OMOP standard reference.

Chapter 3

Existing Methods Comparison

‘One result from the DOI-HOI experiment was a number of reproducibly high false positive rates across methods and data sources.’

DUBEY ET AL. [48]

3.1 Introduction

So far in this thesis, the research hypotheses and aims have been defined and the current research within the field has been summarised. Numerous ADR signalling methods, specific for LODs, have been proposed, but few have been applied directly on the THIN database. As there has been no extensive application of existing methods applied on the THIN data, the general benchmark is unknown. As the aim of this research is to develop a suitable ADR signalling algorithm specifically for the THIN data, it is necessary to determine the current benchmark (i.e., the suitability of the existing methods on the THIN database).

In this chapter, the motivation for choosing two different types of comparison is given and followed by a description of the existing method implementations. The methodology used to determine the ‘true’ labels for each drug-medical event pair is proposed, as the signals generated by each method will be compared with the ‘truth’. The various measures used to analyse each method’s signalling ability are then presented and the comparisons are conducted. The chapter ends with a summary of the key results of both comparisons and the ADR signalling benchmark values for the THIN data are presented.

3.2 Motivation

ADRs are a consequence of multiple factors, for example, an ADR may only occur when the patient is a certain age and gender, eats a specific diet or has certain ongoing illnesses [94]. As a consequence, ADRs are difficult to identify and it is common for many ADRs to be unknown [147]. This means there is no extensive gold standard, as there is no complete list of definitive ADRs for any drug, and this makes it difficult to accurately benchmark ADR signalling algorithms. Motivated by the lack of gold standard, in [179], the authors developed a list of drug-medical event pairs known to represent ADRs or non-ADRs, but, although the list is expanding over time [70], it initially only considered four medical events. Further research has focused on producing a larger reference standard [33] containing drug-medical event pairs with definitive labels, but the number of drug-medical pairs is still often less than a hundred.

In previous studies, on non-THIN data, the authors have used the HOI-DOI reference standard containing 53 drug-medical event pairs with definitive labels,

3. Existing Methods Comparison

and applied the existing methods to these pairs to determine how they compare and set an approximate benchmark [156]. In [156] the TPD and ROR₀₅ signalled 16 drug-medical event pairs out of a possible 53, with 6 and 4 known ADRs being signalled respectively. The benchmarks, over a range of electronic healthcare databases, for the TPD were an AUC of 0.73 and AP of 0.41 and for ROR₀₅ an AUC of 0.68 and an AP of 0.2. The study also concluded that the existing methods obtain a similar performance and the existing methods have a high false positive rate, this was also evident in [162]. In the later study, the benchmark AUC obtained was 0.83.

A previous study determined the benchmark for the signalling ability of existing methods on the THIN database using the HOI-DOI reference standard [214]. The paper applied three existing methods, including the PRR and USCCS, to the THIN database mapped into the common data model and the raw THIN database. The results of the study, on the HOI-DOI reference standard, showed that the PRR and USCCS returned sensitivity values of 0.67 and 78 respectively and specificity values of 0.68 and 59 respectively on the mapped THIN database. Similar values were obtained by applying the PRR on the raw THIN data. Unfortunately, as the HOI-DOI reference standard restricts the analysis to a small subset of drug-medical event pairs, the impact of false positives is likely to be reduced (as there are less pairs to generate false positive on). This comparison may also add bias due to the choice of HOIs and DOIs included in the analysis. For example, the known ADRs included in the HOI-DOI reference standard have generally been signalled by numerous sources and may be easier to signal. Unfortunately, there has been no analysis of existing methods on the THIN database that includes a larger set of drug-medical event pairs, but this may be a more

3. Existing Methods Comparison

realistic analysis.

To enable an extensive analysis of the signalling ability of the existing methods on the THIN database, additional comparisons with different perspectives and bias are required. The first perspective, referred to as the general comparison, generates signals using the existing methods for all the drug-medical event pairs satisfying the condition that the medical event occurs for at least one patient during the month after the drug. The true label for each drug-medical event pair is determined using current knowledge of ADRs, where only drug-medical event pairs currently known to be ADRs are considered true ADRs. Unfortunately, the known ADR status of each drug-medical event pair is not definitive, as some ADRs may be unknown, so this introduces error into the general comparison. The second perspective, referred to as the specific comparison, is similar to comparisons previously conducted [156], as it only analyses drug-medical event pairs that are either definitively non-ADRs or listed on drug packages as ADRs. However, the specific comparison considers a larger number of drug-medical event pairs than the HOI-DOI reference standard, so there may be less bias. The specific comparison is less affected by a lack of ADR knowledge than the general comparison, but may have errors due to drug package listed ADRs being potentially incorrect, due to the difficulty in determining causality.

In summary, as there is no gold standard, numerous comparisons need to be conducted to determine an extensive benchmark for the existing methods signalling ability on the THIN database. The HOI-DOI reference standard benchmark has been determined but this benchmark is limited due to potential bias caused by non-randomly selecting drug-medical event pairs. The general comparison will evaluate the methods without the selection bias, but will introduce

bias due to a lack of ADR knowledge. Finally, the specific comparison is a trade off between the previous comparisons and potentially contains bias from both non-random selection and a lack of ADR knowledge, but both types of bias are relatively reduced.

3.3 Existing Methods

To enable a fair comparison the TPD, MUTARA, HUNT and modified ROR methods, described in Chapter 2.1.4.2 were applied to investigate the one to thirty day period after the drug is prescribed (i.e., the month after). If each method used a different time period, the comparison would be biased.

3.3.1 TPD

In this study the TPD was implemented as described in [128], with IC value over the time period corresponding to the 30 days after the first prescription in 13 months ($u = [0, 30]$) contrasted with the IC value over the time period corresponding to the 27 to 21 months prior to prescription ($v = [-822, -639]$), but two different filters were investigated:

- The TPD is applied and medical events with an *IC* value the month prior to prescription or an *IC* value on the prescription day greater than the *IC* value during the month after the prescription are filtered (TPD 1).
- The TPD is applied and medical events with an *IC* value the month prior to prescription greater than the *IC* value during the month after the prescription are filtered (TPD 2).

The justification for choosing two filters is due to the possibility that ADRs can occur and be reported to doctors on the same day as the prescription, so filtering events with an IC value on the day of prescription greater than the IC value during the month after the prescription may prevent detection of some ADRs.

3.3.2 MUTARA & HUNT

Two different lengths for the reference period were investigated as the length of the reference period determines the per patient filter stringency and the optimal stringency is unknown for the THIN database. The reference period for $MUTARA_{60}$ and $HUNT_{60}$ is set to be the time period starting from two months prior to the prescription and ending the day before the prescription. The reference period for $MUTARA_{180}$ and $HUNT_{180}$ is set to be the time period starting from six months prior to the prescription and ending the day before the prescription. The reference periods are chosen to end the day before the prescribed as this gave better preliminary results. The other parameter values used are: $T_c = T_e = 30$, as this corresponds to the time period of a month after the drug prescription.

3.3.3 ROR

The ‘Spontaneous reporting system’ style transformation [216] is applied, where SRS style reports consisting of a patient, drug prescription and possible ADR are inferred from the LOD by discovering all the medical events that occur within 30 days of a drug prescription. Signals are only generated for medical events that have been reported with the drug of interest a minimum of 3 times.

3.4 Determining Labels

3.4.1 ADR Labels

The drug-medical event pair (α, β) , consisting of a drug α and a medical event β , that correspond to an ADR were found using the online medical website NetDoctor [176] or using SIDER [98], a side effect resource containing side effects mined from drug packaging.

3.4.1.1 Online

The online medical website, NetDoctor, lists known ADRs for the majority of drugs available. The ADR strings for a general drug α were mined from the website. A string match was then applied to find the corresponding READ codes (e.g, `SELECT READcode FROM Drugcodes WHERE description like '%ADR string%'`), and each of the READ codes (β_i s) that matched the NetDoctor listed ADRs were paired to the drug α and added to the set $\Psi^{\hat{A}}$,

$$\Psi^{\hat{A}} = \{(\alpha, \beta) | \beta \text{ is listed as an ADR to } \alpha \text{ on NetDoctor} \}$$

3.4.1.2 SIDER

The SIDER side effect resource contains information on drugs' ADRs and indications that were obtained by applying text mining to drug packaging. In total, the resource contains 996 drugs, 4192 ADRs and 99423 drug-medical event pairs corresponding to ADRs. The drug-medical event pairs, (α, β) , corresponding to

ADRs were extracted from SIDER to generate the set Ψ^A ,

$$\Psi^A = \{(\alpha, \beta) | \beta \text{ is listed as an ADR to } \alpha \text{ in SIDER}\}$$

3.4.2 Noise Labels

The noise labels were manually extracted by examining the THIN READ code tree. READ codes corresponding to irrelevant events such as ‘Family history’, ‘Nationality’, ‘Job type’, ‘Chronic illnesses’ (as this research is focusing on acute immediately occurring ADRs) or ‘administrative events’ were extracted and paired with all the drugs in the THIN database to generate the set Ψ^N ,

$$\Psi^N = \{(\alpha, \beta) | \beta \text{ is irrelevant, } \alpha \in \text{THIN}\}$$

3.5 Measures

For each drug, α , and medical event, β , the existing algorithms determine a measure of association between α and β . The TPD uses the $IC_{\Delta 05}(\alpha, \beta)$, MUTARA uses $unexlev(\alpha, \beta)$, HUNT uses the rank ratio, rank in descending order of $lev(\alpha, \beta)$ divided by rank in descending order of $unexlev(\alpha, \beta)$, and the modified SRS used the $ROR_{05}(\alpha, \beta)$ (reporting odds ratio lower 95% confidence interval). This measure of association is referred to as the rank score in the remainder of this chapter.

3. Existing Methods Comparison

Table 3.1: The signalling criteria of the existing methods

| Method | Rank Score | Signal Criteria |
|--------------|---|----------------------|
| TPD | $IC_{\Delta 05}$ | $IC_{\Delta 05} > 0$ |
| MUTARA | $unexlev$ | $unexlev > 0$ |
| HUNT | $\text{Rank}_{lev}/\text{Rank}_{unexlev}$ | - |
| modified SRS | ROR_{05} | $ROR_{05} > 1$ |

Table 3.2: A worked example of comparing the existing methods signals and the known truth.

| | | Known Truth | |
|-----------|-----|-------------------------------|--------------------------------|
| | | ADR | Non-ADR |
| Signalled | Yes | True Positive $(TP) = 10$ | False Positive $(FP) = 200$ |
| | No | False Negative $(FN) = 12$ | True Negative $(TN) = 500$ |

3.5.1 Natural Thresholds

The existing methods generate signals at their natural threshold, indicated in Table 3.1. The methods performances at their natural thresholds are generally uninformative as the natural threshold is an arbitrary cut off. However, in this thesis I will present the methods performances at their natural thresholds to enable comparison with existing work that has used these thresholds. To determine the method’s ability to signal ADRs, the signals at the natural threshold are compared with the known truth. If a signalled drug-medical event pair is a true ADR then it’s a True Positive, else it’s a False Positive, conversely, if a non-signalled drug-medical event pair is a true ADR then it’s a False Negative, else it’s a True Negative, as summarised in Table 3.2. The measures of interest for the natural threshold can then be calculated as;

$$\text{Sensitivity} = TP / (TP + FN) \tag{3.1}$$

3. Existing Methods Comparison

Table 3.3: An example of the medical event list associated to a specific drug and ordered by an existing method's rank score.

| Medical Event | Rank Score | Known ADR | $y_{(i)}$ |
|---------------|------------|-----------|----------------------------|
| Event 1 | 2.34 | No | $y_{(1)} = 0$ |
| Event 5 | 2.12 | Yes | $y_{(2)} = 1$ $P(2) = 1/2$ |
| Event 4 | 1.75 | Yes | $y_{(3)} = 1$ $P(3) = 2/3$ |
| Event 2 | 1.74 | No | $y_{(4)} = 0$ |
| Event 3 | 0.68 | No | $y_{(5)} = 0$ |

$$\text{Specificity} = TN / (TN + FP) \tag{3.2}$$

So, using the example in Table 3.2, the Sensitivity is $10 / (10 + 12)$ and the specificity is $500 / (500 + 200)$.

3.5.2 Ranking Ability

To determine the general ranking ability, each existing method is applied and returns a ranked list of the drug-medical event pairs being investigated in descending order of the rank score. Table 3.3 shows an example of the output of a method when considering the ranking of the medical events paired to the same drug. The function y_i , known as the truth, is 1 if the i^{th} ranked medical event is a known ADR and 0 otherwise. The precision of each method at cutoff K , denoted $P(K)$, is defined as the fraction of known ADRs that occur in the top K events of the list returned by each method for a specific drug, see Eq. (3.3).

$$P(K) = \frac{\sum_{i=1}^K y_{(i)}}{K} \tag{3.3}$$

3. Existing Methods Comparison

Table 3.4: An example of the medical event list for all the drugs and ordered by one of the algorithms.

| Drug | Medical Event | Rank Score | Known ADR | $y_{(i)}$ |
|---------|---------------|------------|-----------|---------------|
| Drug 10 | Event 7 | 2.34 | No | $y_{(1)} = 0$ |
| Drug 10 | Event 5 | 2.12 | Yes | $y_{(2)} = 1$ |
| Drug 2 | Event 56 | 1.75 | Yes | $y_{(3)} = 1$ |
| Drug 9 | Event 7 | 1.74 | No | $y_{(4)} = 0$ |
| Drug 2 | Event 16 | 0.68 | No | $y_{(5)} = 0$ |

The average precision (AP) is a measure that can be used to determine how well a method generally ranks the medical events associated to a drug. This measure has previously been applied to compare methods implemented on the common data model [156]. The AP is calculated by finding the average $P(K)$ for each K corresponding to a known ADR,

$$\text{AP} = \frac{\sum_{K:y_{(K)}=1} P(K)}{\sum_i y_{(i)}} \quad (3.4)$$

Using Table 3.3 as an example, as there are two known ADRs returned ($\sum_i y_{(i)} = 2$) and the known ADRs in the table are ranked second and third we have $\{K : y_{(K)} = 1\} = \{2, 3\}$, so the AP score is,

$$\text{AP} = \frac{P(2) + P(3)}{2} = \frac{1/2 + 2/3}{2} = \frac{7}{12} \quad (3.5)$$

To give a general measure of the ranking ability of each algorithm over all the drugs investigated, the receiver operating characteristic (ROC) curves are computed. The ROC plots were generated by combining all the results for each method, as illustrated in Table 3.4. The ROC curves are formed by plotting the *sensitivity* against $(1 - \text{specificity})$. The Area Under the Curve (AUC) [28], was

approximated using the trapezoidal rule for a range of *specificity* values ($AUC_{[a,b]}$ corresponds to the partial AUC [193] when only considering the *specificity* within the interval $[a, b]$). To compare the AUCs of various methods DeLong's test at a 5% significance level is implemented [44].

3.6 General Comparison

3.6.1 Method

For the general comparison the method was as follows.

Step 1: Find the set of drug-medical event pairs such that the medical event is recorded within a $[1, 30]$ day time period after the drug for any patient.
 $G = \{(\alpha, \beta) | \beta \text{ occurs within the } [1, 30] \text{ day time interval centred around the day of the prescription of drug } \alpha \text{ for any patient } \}$.

Step 2: Determine the ground truth for each drug-medical event pair $((\alpha, \beta) \in G)$,

$$\text{Truth}(\alpha, \beta) = \begin{cases} \text{ADR}, & \text{if } (\alpha, \beta) \in \Psi^A \\ \text{non-ADR}, & \text{otherwise} \end{cases} \quad (3.6)$$

Step 3: For each drug-medical event pair $((\alpha, \beta) \in G)$, calculate the method's rank score.

Step 4: • Natural threshold- Determine signals using rank score and signal criteria. If (α, β) is signalled and $\text{Truth}(\alpha, \beta)$ is ADR then this is a TP, otherwise it is a FP. Conversely, if (α, β) is not signalled and $\text{Truth}(\alpha, \beta)$ is ADR then this is a FN, otherwise it is a TN.

3. Existing Methods Comparison

Table 3.5: The specificity and sensitivity at the natural thresholds for the different algorithms (3dp).

| Algorithm | Signals | Sens | Spec | Precision |
|-----------------------|---------|-------|-------|-----------|
| HUNT ₆₀ | 7785 | 0.179 | 0.903 | 0.0541 |
| HUNT ₁₈₀ | 7785 | 0.193 | 0.903 | 0.058 |
| MUTARA ₆₀ | 67624 | 0.933 | 0.109 | 0.032 |
| MUTARA ₁₈₀ | 65435 | 0.914 | 0.136 | 0.032 |
| TPD 1 | 1893 | 0.090 | 0.953 | 0.057 |
| TPD 2 | 3557 | 0.107 | 0.926 | 0.043 |
| ROR ₀₅ | 37729 | 0.312 | 0.726 | 0.031 |

- General Ranking - Plot the ROC curves and calculate the AUCs using the rank scores and Truth for each drug-medical event pair. The AP is also calculated on the list of medical events for each drug that are ordered in descending order of the assigned rank score, see Table 3.3.

The existing methods were applied to 27 drugs for 6 drug families, for information about the drugs investigated, see Appendix B.

3.6.2 Results

Table 3.5 shows the *specificity* and *sensitivity* for the different methods at their natural thresholds and the number of signals generated. As HUNT does not have a natural threshold, the top 10% of medical events were considered to be signalled.

The $AUC_{[0,1]}$ ranged between 0.546 (ROR₀₅) to 0.597 (MUTARA₁₈₀), the $AUC_{[0.7,1]}$ ranged between 0.048 (ROR₀₅) to 0.076 (MUTARA₆₀) and the $AUC_{[0.9,1]}$ ranged between 0.005 (ROR₀₅) to 0.011 (HUNT₁₈₀ and HUNT₆₀), as presented in Table 3.6. Figures 3.1a and 3.1b show the ROC plots for the different methods.

Figure 3.2a shows the AP scores for the different methods over the range

3. Existing Methods Comparison

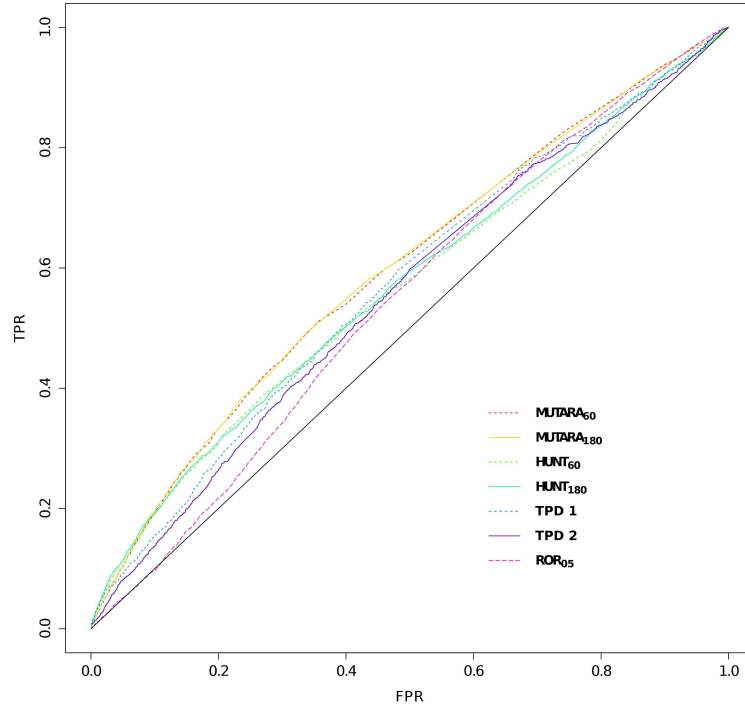

(a) Whole specificity range

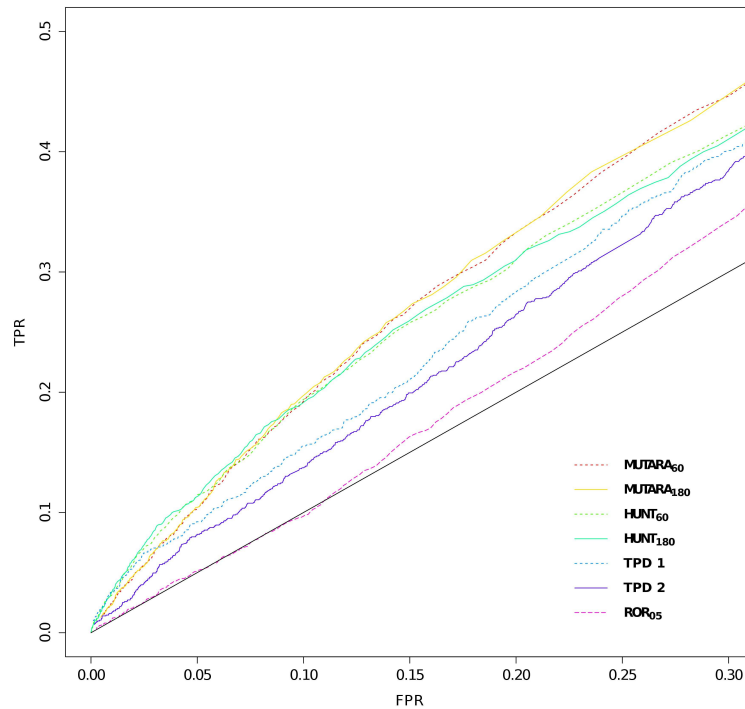

(b) Section of specificity greater than 0.7

Figure 3.1: The ROC plots for the different methods. The black line is the line $x=y$.

3. Existing Methods Comparison

Table 3.6: The AUC results for the different algorithms (3dp).

| Algorithm | $AUC_{[0,1]}$ | $AUC_{[0.7,1]}$ | $AUC_{[0.9,1]}$ |
|-----------------------|---------------|-----------------|-----------------|
| HUNT ₆₀ | 0.566 | 0.072 | 0.011 |
| HUNT ₁₈₀ | 0.570 | 0.071 | 0.011 |
| MUTARA ₆₀ | 0.596 | 0.076 | 0.010 |
| MUTARA ₁₈₀ | 0.597 | 0.069 | 0.010 |
| TPD 1 | 0.570 | 0.065 | 0.009 |
| TPD 2 | 0.557 | 0.060 | 0.007 |
| ROR ₀₅ | 0.546 | 0.048 | 0.005 |

of drugs investigated. The family of drugs that the methods perform worse on overall were the sulphonylureas with AP scores ranging from 0.0088–0.0687. The algorithms all performed well on the calcium channel blockers, with AP scores ranging from 0.0236–0.1988, but the ROR₀₅ performed worse for all the calcium channel blockers investigated. The methods also performed well for the tricyclic antidepressants with AP scores ranging between 0.0499–0.1670. It can be seen in Figure 3.2a that generally the methods perform similarly between the same drugs of the same class, apart from the methods performing much better for benzylpenicillin sodium compared to the other penicillin drugs.

The box plots of the AP scores for the different methods seen in Figure 3.2b show overall the TPDs, MUTARAs and HUNTs perform equally and outperform the ROR₀₅. The MUTARA algorithm has the highest median AP score over all the drugs and is more consistent, whereas the performance of the TPD and HUNT varies more between the drugs.

3.6.3 Discussion

The results show that the methods' natural thresholds operate at different stringencies. The most stringent method was the TPD 1 that returned 1893 signals,

3. Existing Methods Comparison

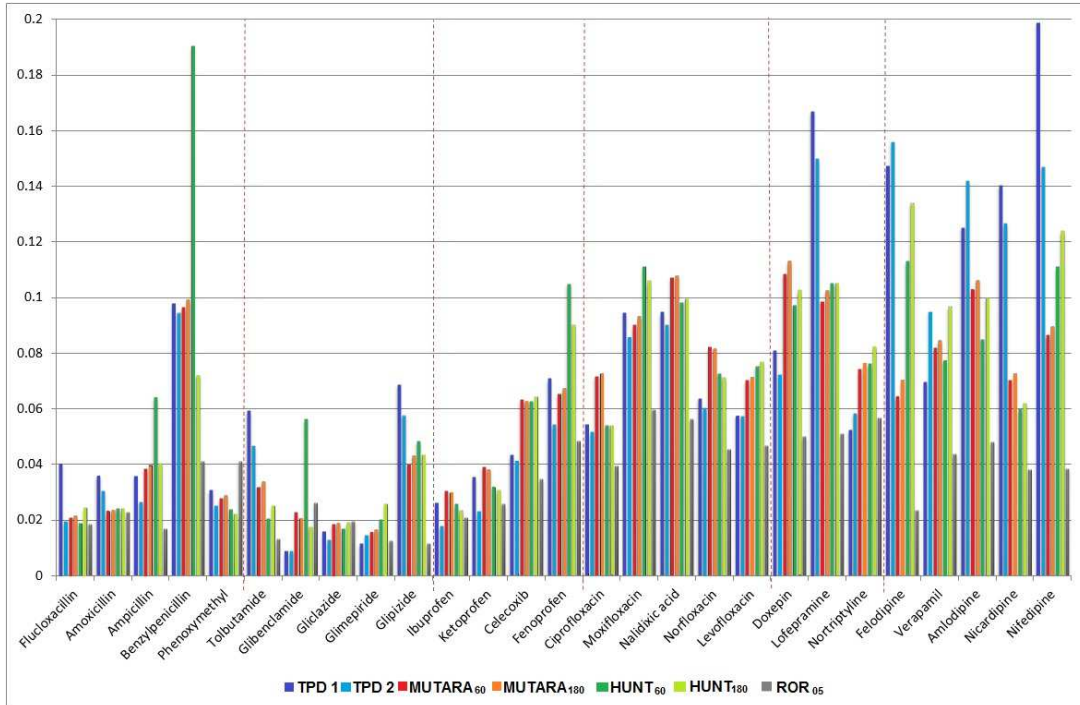

(a) Bar chart of the AP scores for each drugs.

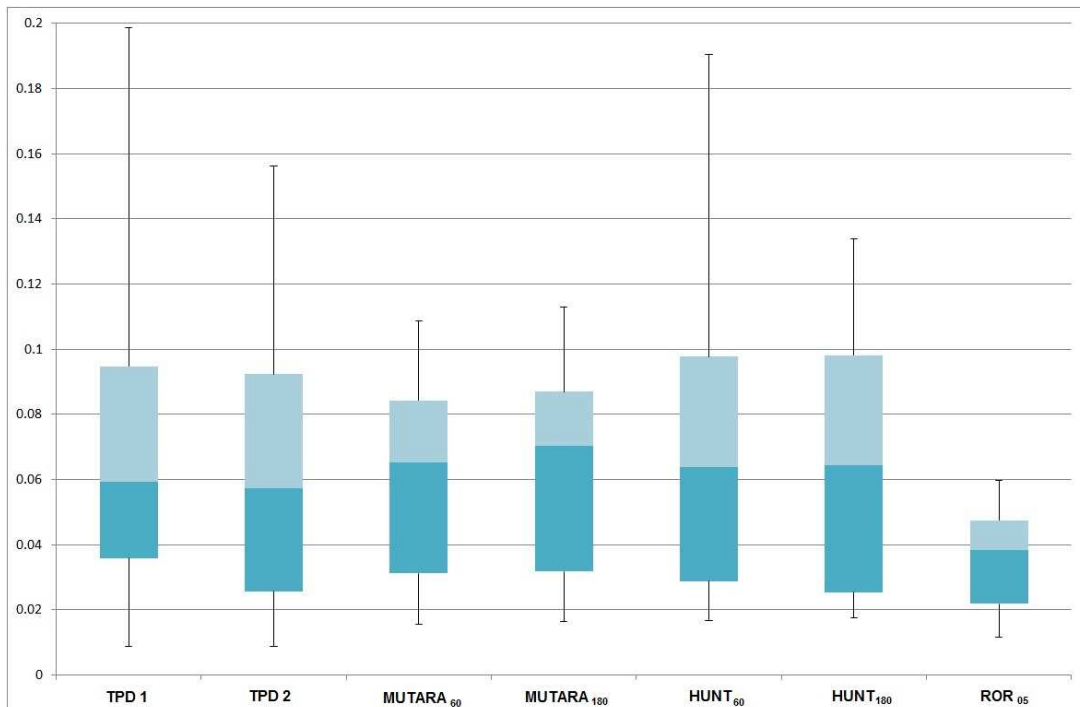

(b) Box plot showing the median, quartiles and minimum/maximum AP scores.

Figure 3.2: AP results for each method applied for each drugs.

3. Existing Methods Comparison

the lowest out of all the methods, with a high specificity of 0.953 and low sensitivity of 0.09, whereas the less stringent was the MUTARA₆₀ that returned 67624 signals with a high sensitivity of 0.933 and a low specificity of 0.109. This was not unexpected as the TPD threshold used the lower confidence interval value rather than the actual IC_{Δ} value and the TPD applied a statistical shrinkage. The results also show that none of the methods was able to signal the known ADRs without being swamped by false positives signals.

The AUC results show that the methods perform similarly and no method had a higher partial AUC for all three restricted specificity intervals studied ($AUC_{[0,1]}$, $AUC_{[0.7,1]}$ and $AUC_{[0.9,1]}$). Overall no method consistently outperformed the others over all the drugs investigated in this study, however, either the TPD 1 or HUNT had the highest AP score for the majority of the drugs studied. The ROR_{05} generally performed the worse, but still had a higher AP score than the other methods for the drug phenoxymethylpenicillin.

The results obtained in this study were consistent with previous results as the $P(10)$ for MUTARA and HUNT averaged 0.065 and 0.122 respectively in this study and were 0.1 and 0.1 – 0.3 respectively in previous work [91][90]. The $P(10)$ for the TPD method applied to Nifedipine in this study was 0.7, the same as on the UK IMS Disease Analyzer database [128]. However, there was deviation between the AP score of the ROR_{05} in this study (0.01 – 0.06) and in the study by Zorych *et al.* [216] (0.1-0.15), this is probably due to this study using real data with redundant READ codes and Zorych *et al.* using simulated data. The general comparison also demonstrated that the existing methods generate a large number of false positive signals.

The main limitation of this comparative study was the assumption that if

3. Existing Methods Comparison

a drug pair (α, β) is not in the set of known ADRs, Ψ^{A_1} , then it is a non-ADR. This is not true, as some pairs may be unknown ADRs, as there is no definitive complete list of ADRs for any drug. The consequence of this is that the true *sensitivity*, *specificity* and AP scores may be different to that the values obtained. However, the methods should be able to correctly rank the known ADRs and these are likely to be more common and obvious than the unknown ones. Therefore, if the method is unable to correctly rank the known ADRs above other events (and obtain a low AP in this study) then it is unlikely to identify the unknown ADRs, so the AP scores determined in this study still give insight into the methods abilities to detect ADRs. Another limitation was the READ code redundancy. The negative effect of noise may get amplified due to the redundancy causing there to be a larger number of noise READ codes. It may be the case that the methods would have higher AP scores if there was a way to group READ codes corresponding to the same medical event.

3.7 Specific Comparison

3.7.1 Method

Due to similar results being obtained in the general comparison by the MUTARA and HUNT methods implemented with different reference periods, only the MUTARA₁₈₀ and HUNT₁₈₀ were applied for the specific comparison. The method for the specific comparison is as follows.

Step 1: Find the definitive non-ADRs drug-medical event pairs corresponding to the drug of interest α or the drug-medical event pairs listed as ADRs on

3. Existing Methods Comparison

α 's drug packaging, $G = \{(\hat{\alpha}, \beta) \in \Psi^N \cup \Psi^A | \hat{\alpha} = \alpha\}$.

Step 2: Define the truth for each drug-medical event in G ,

$$\text{Truth}(\alpha, \beta) = \begin{cases} \text{ADR}, & \text{if } (\alpha, \beta) \in \Psi^A \\ \text{non-ADR}, & \text{if } (\alpha, \beta) \in \Psi^N \end{cases} \quad (3.7)$$

Step 3: For each drug-medical event pair $((\alpha, \beta) \in G)$, calculate the method's rank score.

Step 4:

- Natural threshold- Determine signals using rank score and signal criteria. If (α, β) is signalled and $\text{Truth}(\alpha, \beta)$ is ADR then this is a TP, otherwise it is a FP. Conversely, if (α, β) is not signalled and $\text{Truth}(\alpha, \beta)$ is ADR then this is a FN, otherwise it is a TN.
- General Ranking - Plot the ROC curves and calculate the AUCs using the rank scores and Truth for each drug-medical event pair. The AP is also calculated on the list of medical events for each drug that are ordered in descending order of the rank score assigned by the existing method.

The existing methods were applied for five drugs, Nifedipine, Ciprofloxacin, Ibuprofen, Budesonide and Naproxen, see Appendix B.

3.7.2 Results and Discussion

For the specific comparison, MUTARA performed better at general ranking than the other methods, with greater AUC, $\text{AUC}_{[0.9,1]}$ and AP values, see Table 3.7. This result contradicts the general comparison results, that showed none of the

3. Existing Methods Comparison

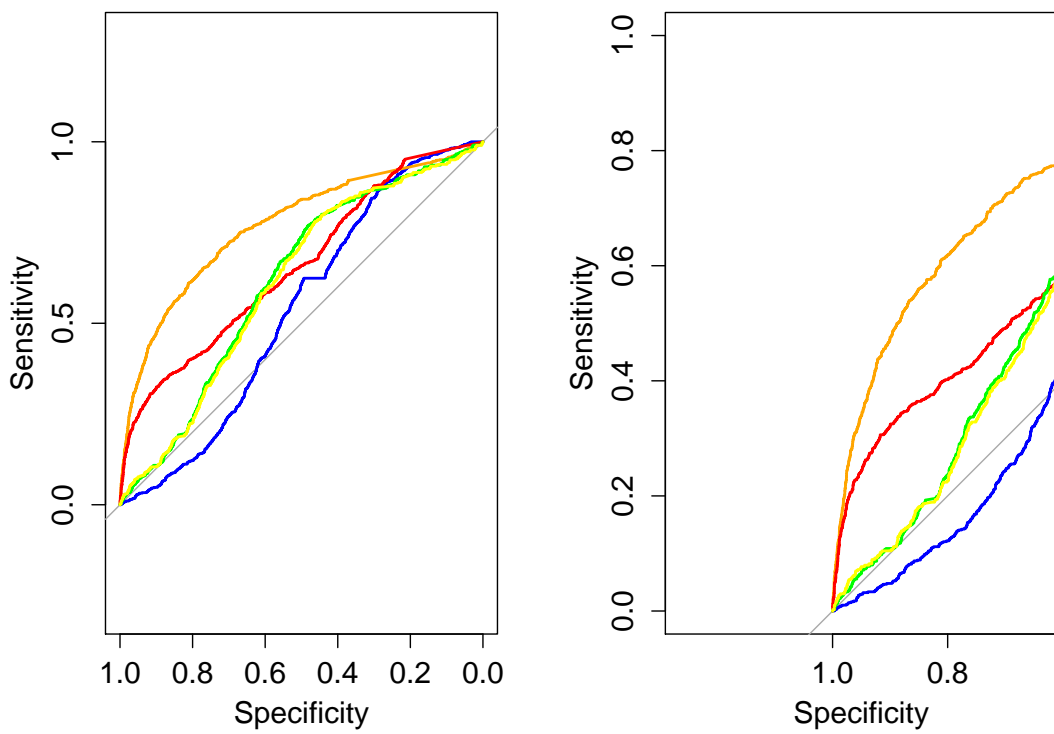

Figure 3.3: The ROC plots for the specific comparison. The figure on the left is the whole specificity range, the figure on the right is for the specificity within the interval $[0.9, 1]$. The orange, red, yellow, green and blue curves correspond to $MUTARA_{180}$, $HUNT_{180}$, TPD_1 , TPD_2 and the ROR_{05} respectively.

3. Existing Methods Comparison

Table 3.7: The ranking ability of the existing methods obtained in the specific comparison.

| Method | AUC | AUC _[0.9,1] | AP |
|--------------------------|--------|------------------------|-------|
| <i>ROR</i> ₀₅ | 0.5374 | 0.003 | 0.072 |
| MUTARA ₁₈₀ | 0.770 | 0.032 | 0.315 |
| HUNT ₁₈₀ | 0.678 | 0.023 | 0.222 |
| TPD ₁ | 0.6149 | 0.007 | 0.095 |
| TPD ₂ | 0.6197 | 0.006 | 0.094 |

Table 3.8: The signals returned by the existing methods at their natural thresholds. The natural threshold used for HUNT was the rank ratio greater than 1.

| Method | TP | FP | FN | TN | Sensitivity | Specificity | Precision |
|--------------------------|-----|------|-----|------|-------------|-------------|-----------|
| <i>ROR</i> ₀₅ | 258 | 3197 | 429 | 4140 | 0.376 | 0.564 | 0.075 |
| MUTARA ₁₈₀ | 614 | 4648 | 73 | 2689 | 0.894 | 0.366 | 0.117 |
| HUNT ₁₈₀ | 466 | 4006 | 221 | 3331 | 0.678 | 0.454 | 0.104 |
| TPD ₁ | 42 | 302 | 645 | 7035 | 0.061 | 0.959 | 0.122 |
| TPD ₂ | 49 | 392 | 638 | 6945 | 0.071 | 0.947 | 0.111 |

existing methods outperforms any other when considering the overall ranking. However, the TPD was the method that returned the least number of false positives and obtained the greatest precision, 0.122. In agreement to previously obtained results, the specific comparison showed that the existing methods signal many false positives at their natural thresholds, see Table 3.8.

To identify why the TPD’s ranking performance decreased relative to MUTARA for the specific comparison, the ranked list of drug-medical events pairs returned by the TPD was manually investigated. Interestingly, the manual investigation showed that the READ code redundancy was to blame, as the TPD did not assign a consistent $IC_{\Delta 05}$ for READ codes corresponding to the same medical event, and the READ codes matching the SIDER ADR strings tended to have lower $IC_{\Delta 05}$ values than other READ codes corresponding to known ADRs but

3. Existing Methods Comparison

not exactly matching the SIDER ADR string (e.g. If a SIDER ADR string was ‘vomiting’ , then the THIN READ code with a description ‘vomiting’ would be labelled as an ADR, but ‘O:E vomiting’ or ‘[D] vomiting’ would not be labelled). However, this does highlight that the TPD is not consistent and, although its performance may improve if different labels were used, it still struggles to assign a high $IC_{\Delta 05}$ to all READ codes corresponding to known ADR medical events . Previous studies have also identified inconsistency with the TPD [80].

The specific comparison appears to be a better way to compare the methods as the results are not limited by unknown ADRs. The potential bias introduced by only considering a subset of drug-medical event pairs has the advantage of highlighting methods that are not consistent. It can be argued that a perfect method would assign a similar rank score to READ codes corresponding to the same medical event, so methods unable to do this may be flawed.

3.8 Summary

In this chapter, four existing LOD ADR signalling methods were compared by applying them to the THIN database for a range of drugs. The comparisons measured how well they ranked the known ADRs or signalled known ADRs at their natural thresholds. As there is no golden standard, two different comparisons were applied. The first comparison compared the methods on a wide range of drug-medical event pairs but introduced bias by assuming there are no unknown ADRs, whereas the second comparison removed the bias of assuming there are no unknown ADRs but incorporated bias by only investigating a selection of drug-medical events pairs and by assuming drug packaging listed ADRs are correct.

3. Existing Methods Comparison

The results highlight the issue of comparing existing methods without a golden standard. If a golden standard existed (i.e., for one drug all the ADRs were known), the methods could be applied to all the drug-medical event pairs for the specific drug and accurate measures could be obtained. However, when there is no gold standard, then bias is introduced and the results obtained may not be a true reflection of the methods abilities.

Nonetheless, considering the results of both comparisons and previous studies, the limitations of the existing methods were determined. The general comparison showed that no method was superior over all the drugs considered, however the specific comparison indicated that MUTATA is more consistently than the TPD. The main conclusion is that, for both comparisons, the existing methods failed to signal known ADRs without signalling a superfluous quantity of non-ADRs, resulting in a low precision benchmark of 0.122 for the specific comparison and 0.058 for the general comparison. The general ranking benchmarks for the general comparison are an AP of 0.2, an AUC of 0.597, an $AUC_{[0.9,1]}$ of 0.011 and an $AUC_{[0.7,1]}$ of 0.076. The benchmarks for the specific comparison are an AP of 0.315, an AUC of 0.770 and an $AUC_{[0.9,1]}$ of 0.032. Future methods should aim for higher scores.

Chapter 4

Incorporating Causation

‘The application of Austin Bradford-Hill’s criteria for evaluation causal associations in pharmacovigilance and pharmacoepidemiology is very useful.’

SAAD A.W. SHAKIR [163]

4.1 Introduction

So far in this thesis, the current research focus was summarised and the existing pharmacovigilance methodologies were presented. In the previous chapter the benchmark measures were determined by applying the current ADR signalling methods on the THIN database and it was concluded that they have a high false positive rate. In this chapter the processes implemented to generate and transform the data extracted from the THIN database are described. The main focus is the proposal of suitable attributes that offer insight into causality. The aim is to use these attributes as inputs into a learning algorithm that will be

trained to signal ADRs with a low false positive rate.

4.2 Motivation

The main limitation of ADR signal detecting using LODs is the abundance of confounding factors [68] [174]. The majority of medical events that occur after a drug are related to pre-existing illnesses, but these are still strongly associated to the drug. The existing methods can be considered unsupervised methods that aim to approximate the measure of causation between a drug-medical event pair. This is done by comparing the risk of the medical event after the drug compared with a substitute, such as the risk in a control population [91] or the risk when considering every other prescription [128]. Unfortunately, this only measures association as the choice of substitute introduces confounding [117], for example, as argued in [114], the choice of drug treatment may be influenced by the patient’s medical history and the doctors preferences. To reduce the number of signals corresponding to medical events that are related to the drug cause, some authors have developed filters, such as ignoring medical events that occur more often before the drug than after [128; 161]. The consistently high false positive rate that occurs when the methods are applied to LODs suggests that these filters are still unable to removed all the effects of confounding and this hinders the effectiveness of the existing methods. The signals they generate require further analysis [148] and rare ADRs may not be signalled [143].

To develop an improved ADR signalling algorithm, it is important to identify a way to distinguish between association and causation in observational data. Such an algorithm would have a reduced false positive rate as it would be resilient

against confounding effects. Causality is often determined using a randomised controlled experiment [154], where treatments and controls are randomly assigned to control confounding [153]. This cannot be implemented using observational data, as there is no control over who is assigned a treatment. In [67], the authors highlight the issues associated with using observational data for causal inference. A common technique to identify causality using observational data is to apply a supervised algorithm with additional knowledge that incorporates confounding factors, such as fitting a regression model that incorporates parameters based on confounding [58]. In [132] and [42] the authors manually investigated causality between a single drug and a single medical event by investigating suitable measures of the Bradford-Hill causality considerations that can be derived from pharmacovigilance data. The Bradford-Hill causality considerations are often used when determining causation [164] and researchers have discussed the importance of applying these considerations within pharmacovigilance [52]. In this thesis, the idea is expanded by removing the requirement of a manual inspection. Instead, an algorithm is implemented that learns to determine causality between each drug-medical event pair based on Bradford-Hill causality derived attributes, as this will increase efficiency and enable a wider search. The novel idea is to train a supervised algorithm using attributes based on latent variables (not directly observed), derived from the Bradford-Hill causality considerations, rather than observable variables. In this chapter, the attributes that add insight on causality, derived from a selection of the Bradford-Hill causality considerations, are proposed and explored.

4.2.1 Data Cleansing

The THIN database contains validation fields indicating the integrity of each record. Only records that are valid are extracted from the database and records corresponding to patients with a missing date of birth or gender are deleted. Any records containing an invalid age such as a negative number or greater than one hundred and twenty years are also removed.

Patients whom are newly registered present a problem in the THIN database as they often come to the practice with a magnitude of historical and existing conditions that get recorded during their first few visits even when the conditions initially occurred years previously. This is often referred to as ‘registration event dropping’. Studies have shown that the probability of ‘registration event dropping’ is significantly reduced after a patient has been registered at the same practice for a year [104]. To prevent this biasing the results the medical records that were recorded within the first year of each patient being registered are deleted from the THIN database. The last month of prescription records for patients are also ignored to prevent under-reporting, as implemented in [143].

4.2.2 Data Extraction

4.2.2.1 Formulation

Denoting the cleansed THIN data by $\Omega = \{\Omega^P, \Omega^E\}$, where Ω^P is the set of valid drug prescription reports and Ω^E is the set of valid medical event reports contained in the THIN database. Throughout this thesis, the i^{th} element of the vector \mathbf{x} is represented by x_i . Each prescription record, $\omega \in \Omega^P \subset \mathbb{R}^8$, is a vector containing the details about the prescription, where $\omega \in \mathbb{R}^8$ and,

4. Incorporating Causation

- ω_1 : is the corresponding record's patient ID (who had the prescription).
- ω_2 : is the corresponding record's prescribed drug.
- ω_3 : is the corresponding record's gender (1 if male, 0 if female).
- ω_4 : is the corresponding record's date of prescription (when the prescription was issued).
- ω_5 : is the corresponding record's patient's age (time in days between the patients date of birth and when the prescription was issued).
- ω_6 : is the corresponding record's dosage (dosage of the drug issued).
- ω_7 : is the corresponding record's British National Formulary (BNF) code (a code specifying the general family of the drug).
- ω_8 : is the corresponding record's noise value (the total number of drugs prescribed within the $[-30, 30]$ day time interval centred around the prescription date).

Each medical event record in the complete THIN database, $\psi \in \Omega^E \subset \mathbb{R}^5$, is a vector containing the medical event report details, where $\psi \in \mathbb{R}^5$ and,

- ψ_1 : is the corresponding record's patient ID (who had the medical event).
- ψ_2 : is the corresponding record's READ code (corresponding to medical event).
- ψ_3 : is the corresponding record's date of recording (when the medical event was reported).
- ψ_4 : is a binary value representing if a READ code with the same Level 3 READ code parent as the record has been recorded for the patient before. If it is the first time the value is 1, otherwise it is 0.
- ψ_5 : is a binary value representing if a READ code with the same Level 4 READ code parent as the record has been recorded for the patient before. If it is the first time the value is 1, otherwise it is 0.

As it can be seen, each medical event is recorded via a READ code. The READ codes have a tree structure with five levels of specificity, as described in Appendix A. Therefore, the term drug-medical event pair is analogous to the term drug-READ code pair. For clarity, the drug-medical event pair corresponding to drug α and READ code β is denoted by (α, β) . Unfortunately, the READ codes are redundant, and multiple READ codes can correspond to the same medical event but with slight variance in the description. For example, the READ code ‘91a..’ may represent ‘had a chat with patient’ and the READ code ‘91b..’ may represent ‘discussion with patient at his request’, both these READ codes correspond to the medical event of talking to the patient, but differ slightly.

4.2.2.2 Extraction

For a given drug, α , it is possible to extract prescription records of interest in three different ways. The first method extracts all the records containing the drug α (where ω_2 was previously denoted as the drug prescribed in therapy record ω),

$$\Omega^{P_\alpha} := \{\omega \in \Omega^P | \omega_2 = \alpha\} \tag{4.1}$$

In the latter part of this chapter the prescription records in the set Ω^{P_α} are used to find a rough measure of association, by investigating the medical events that occur shortly before the drug compared with the medical events that occur shortly after a drug. As there is no restriction on how far apart the prescription records in the set Ω^{P_α} are for the same patient, some prescriptions, for the same patient, may be recorded in short succession. This may cause bias when investigating the medical events that occur shortly before one prescription, as they may be caused

by the previous prescription.

To reduce this bias a second method to extract reports containing drug α is proposed. For two therapy records, $\omega, \omega^* \in \Omega^{P_\alpha}$, the records correspond to the same patient when both patient IDs are the same, $\omega_1 = \omega_1^*$, and correspond to the same drug when $\omega_2 = \omega_2^*$. The second method only extracts reports if the drug was not previously prescribed, to the same patient, within the previous 13 months,

$$\hat{\Omega}^{P_\alpha} := \{\omega \in \Omega^{P_\alpha} \mid \{\omega^* \in \Omega^{P_\alpha} \setminus \omega \mid \omega_1 = \omega_1^*, \omega_2 = \omega_2^*, t_m(\omega_4, \omega_4^*) \in [0, 13]\} = \emptyset\}$$

Where the function $t_m(a, b) : \text{Date} \times \text{Date} \rightarrow \mathbb{Z}$ denotes the time in months from date a to date b . As different drugs from the same family are often prescribed, due to the first drug not being effective or the patient reacting badly, there can still be bias when using $\hat{\Omega}^{P_\alpha}$. To further reduce the bias, only prescription records where there has been no previous prescription of a similar drug within the previous 13 months are considered,

$$\bar{\Omega}^{P_\alpha} := \{\omega \in \Omega^{P_\alpha} \mid \{\omega^* \in \Omega^P \setminus \omega \mid \omega_1 = \omega_1^*, \omega_7 = \omega_7^*, t_m(\omega_4, \omega_4^*) \in [0, 13]\} = \emptyset\}$$

Figure 4.1 is a graphic representation of the different filtering that is implemented to extract the data, where a drug is considered filtered if it is surrounded by a red square. Each line represents the sequence of drug records ordered by time, where drug 1 and 2 are from the same drug family (have the same BNF code). The top line represents no filtering, so all drug records are included in the analysis, the middle line represents filtering a drug if the same drug was recorded

4. Incorporating Causation

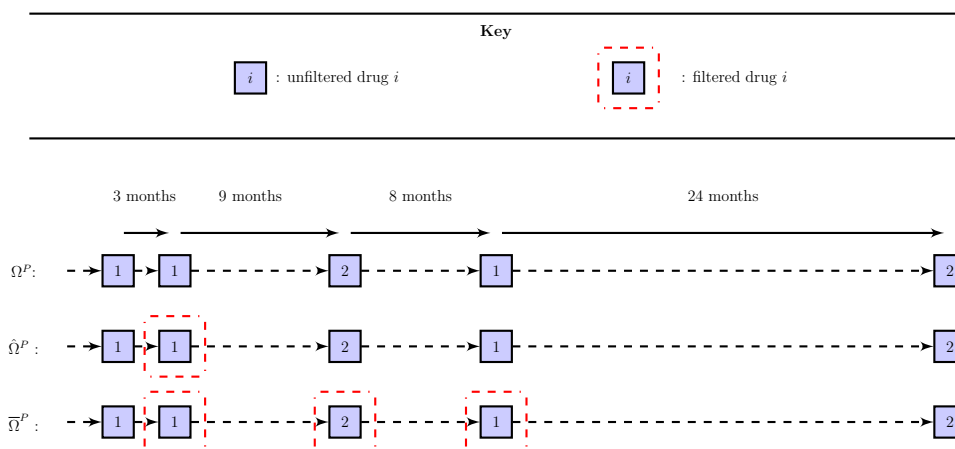

Figure 4.1: Illustration of filtering done during data extraction.

within 13 months previously, and the bottom line represents filtering a drug if a drug in the same family was recorded within the 13 months previously. Using the prescription record subsets for the drug α , it is possible to determine the ‘risk’ drug-READ code pairs that correspond to potential acutely occurring ADRs by finding all the READ codes that occur within 30 days of any prescription of α , see Equation 4.2. Figure 4.2 illustrates how the ‘risk’ drug-READ code pairs corresponding to drug 1 are determined, where the medical events represented by circles are paired with drug 1 if they occur between the square representing drug 1 and the red line. A short time period is used as the focus of this research is on discovering ADRs that occur immediately after ingesting a drug. It was determined that investigating the 30 days after a drug is prescribed was the best trade off between having a sufficiently large period of time after the prescription to allow patients time to report the medical event while not having the time period too large that many erroneous medical events will be reported.

$$RME^\alpha = \{\psi_2 | \psi \in \Omega^E, \exists \omega \in \Omega^{P^\alpha} \text{ where } \omega_1 = \psi_1, t_d(\omega_4, \psi_3) \in [1, 30]\} \quad (4.2)$$

4. Incorporating Causation

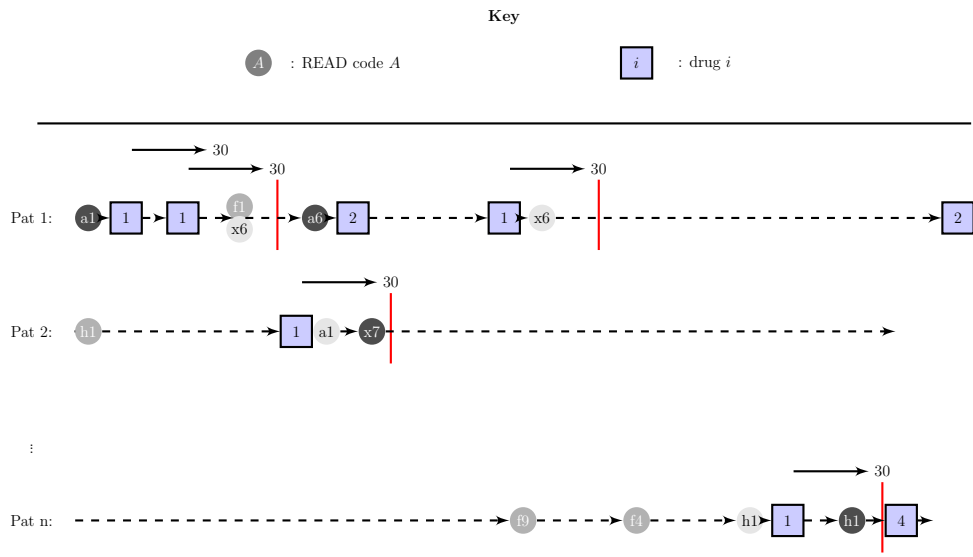

Figure 4.2: Illustration of determining risk drug-medical event pairs.

where the function $t_d(a, b) : \text{Date} \times \text{Date} \rightarrow \mathbb{Z}$ represents the time in days from date a to date b . One suitable approach to determine ADRs to drug α using LODs is to combine medical event reports with prescription reports containing α when the medical event report occurs within a set time frame around the prescription report. Let $\Omega^{[u,v],P_\alpha}$ be a relationship between the prescription records of drug α (Ω^{P_α}) and the medical event records (Ω^E) defined by the records having the same patient ID ($\omega_1 = \psi_1$) and the medical event report occurring within the set time period around the date of the prescription report ($t_d(\omega_4, \psi_3) \in [u, v]$),

$$\Omega^{[u,v],P_\alpha} = \{(\boldsymbol{\omega}, \boldsymbol{\psi}) \in \Omega^{P_\alpha} \times \Omega^E \mid \omega_1 = \psi_1, t_d(\omega_4, \psi_3) \in [u, v]\} \quad (4.3)$$

As illustrated in Equation (4.3), each element in the set $\Omega^{[u,v],P_\alpha}$ contains the combined prescription reports containing α and medical event reports of interest, where the medical event report occurred with the $[u, v]$ day interval around the

prescription record. For each combined record, $\boldsymbol{\kappa} = (\boldsymbol{\omega}, \boldsymbol{\psi}) \in \Omega^{[u,v],P_\alpha}$, the first eight elements correspond to the prescription record ($\kappa_i = \omega_i, i \in [1, 8]$) and the last five elements correspond to the medical event record ($\kappa_i = \psi_{i-8}, i \in [9, 13]$). Similarly, the set of combined reports of interest can be calculated when only considering the first time prescriptions in 13 months of drug α or the prescriptions of drug α that have no similar drug prescribed within the previous 13 months by substituting the set Ω^{P_α} with the set $\hat{\Omega}^{P_\alpha}$ or $\bar{\Omega}^{P_\alpha}$ respectively,

$$\hat{\Omega}^{[u,v],P_\alpha} = \{(\boldsymbol{\omega}, \boldsymbol{\psi}) \in \hat{\Omega}^{P_\alpha} \times \Omega^E | \omega_1 = \psi_1, t_d(\omega_4, \psi_3) \in [u, v]\} \quad (4.4)$$

$$\bar{\Omega}^{[u,v],P_\alpha} = \{(\boldsymbol{\omega}, \boldsymbol{\psi}) \in \bar{\Omega}^{P_\alpha} \times \Omega^E | \omega_1 = \psi_1, t_d(\omega_4, \psi_3) \in [u, v]\} \quad (4.5)$$

The aim of this thesis is to develop a classifier such that, for each ‘risk’ drug-READ code pair containing drug α , ($\alpha, \beta \in RME^\alpha$), the pair is classified as either an ADR or non-ADR. To develop such a classifier requires generating suitable attributes for each pair and learning from pairs that are known ADRs and non-ADR. In the next section the proposed attributes based on the Bradford-Hill causality considerations and THIN structures are derived.

4.2.3 Data Derivation

After cleansing and extracting the data of interest, the data can now be transformed into suitable attributes. The set of combined reports containing READ code β that occur within the $[u, v]$ time interval centred around the prescription

4. Incorporating Causation

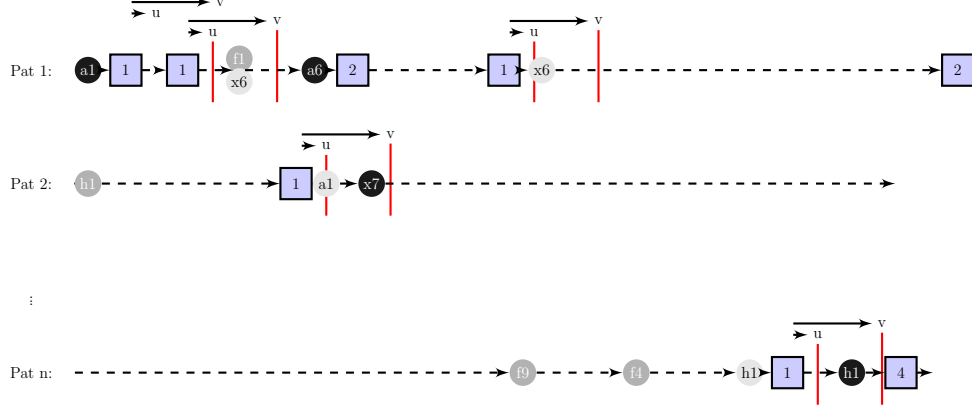

Figure 4.3: Illustration of combining drug records and medical event records.

of drug α is,

$$\Omega^{[u,v],P_\alpha E_\beta} = \{\boldsymbol{\kappa} \in \Omega^{[u,v],P_\alpha} \mid \kappa_{10} = \beta\} \quad (4.6)$$

The equivalent sets when only considering the prescriptions of drug α for the first time in 13 months or prescriptions of drug α when a similar family drug has not been prescribed within the last 13 months are,

$$\hat{\Omega}^{[u,v],P_\alpha E_\beta} = \{\boldsymbol{\kappa} \in \hat{\Omega}^{[u,v],P_\alpha} \mid \kappa_{10} = \beta\} \quad (4.7)$$

and

$$\bar{\Omega}^{[u,v],P_\alpha E_\beta} = \{\boldsymbol{\kappa} \in \bar{\Omega}^{[u,v],P_\alpha} \mid \kappa_{10} = \beta\} \quad (4.8)$$

respectively.

This is graphically illustrated in Figure 4.3, where the medical event reports are represented by circles and the drugs are represented by squares. For each prescription of drug 1, the time interval $[u, v]$ centred around the prescription is investigated, and any medical event report occurring within the interval is combined with the report to produce a new combined report.

Table 4.1: Contingency table calculations for the epidemiological association measures.

| | | |
|---|--|---|
| | READ code β | not READ code β |
| Drug α | $ \Omega^{[1,30],P_\alpha E_\beta} $ | $ \Omega^{[1,30],P_\alpha} - \Omega^{[1,30],P_\alpha E_\beta} $ |
| $\bigcup_{\gamma \neq \alpha} \text{Drug}_\gamma$ | $\sum_{\gamma \neq \alpha} \Omega^{[1,30],P_\gamma E_\beta} $ | $\sum_{\gamma \neq \alpha} \Omega^{[1,30],P_\gamma} - \sum_{\gamma \neq \alpha} \Omega^{[1,30],P_\gamma E_\beta} $ |

4.2.3.1 Association Strength

‘Prospective inquiries into smoking have shown that the death rate for cancer of the lung in cigarette smokers is nine to ten times the rate in non-smokers’ - **Bradford-Hill** [19].

The association strength criterion concentrates on how associated the READ code and drug are [19]. Previously implemented measures of association derived from LODs are the IC_Δ used by the TPD algorithm [128], see Chapter 2.1.4.2, or the $IC_{\Delta 05}$. These values measure the association between the READ code and drug during the ‘hazard’ period that occurs after the prescription relative to some ‘non-hazard’ time period.

$$x_1^{\alpha\beta} = IC_\Delta \tag{4.9}$$

$$x_2^{\alpha\beta} = IC_{\Delta 05} \tag{4.10}$$

Alternative measures are the risk ratio (RR), odds ratio (OR) and risk different (RD) that are frequently used in epidemiological studies to measure the association between an exposure and disease [194]. These measures contrast the rate of disease in a population that is exposed to some risk with the rate of the disease in a population not exposed. In [151] the author states that, if there are other (non-drug) sufficient causes of a medical event, then the frequency of these

has a greater impact on the medical event and drug's risk ratio measure than the risk difference measure. So the measures can generate varying strengths of association for the same drug-READ code pair.

The RD investigates the additive difference between the risk of having the READ code after the drug of interest is prescribed compared to the risk of having the READ code after any other drug prescription [181]. Using Table 4.1 the RD can be calculated by,

$$\begin{aligned}
 x_3^{\alpha\beta} &= (|\Omega^{[1,30],P_\alpha E_\beta}|/|\Omega^{[1,30],P_\alpha}|) - \left(\sum_{\gamma \neq \alpha} |\Omega^{[1,30],P_\gamma E_\beta}| / \sum_{\gamma \neq \alpha} |\Omega^{[1,30],P_\gamma}|\right) \\
 x_4^{\alpha\beta} &= (|\hat{\Omega}^{[1,30],P_\alpha E_\beta}|/|\hat{\Omega}^{[1,30],P_\alpha}|) - \left(\sum_{\gamma \neq \alpha} |\hat{\Omega}^{[1,30],P_\gamma E_\beta}| / \sum_{\gamma \neq \alpha} |\hat{\Omega}^{[1,30],P_\gamma}|\right) \\
 x_5^{\alpha\beta} &= (|\bar{\Omega}^{[1,30],P_\alpha E_\beta}|/|\bar{\Omega}^{[1,30],P_\alpha}|) - \left(\sum_{\gamma \neq \alpha} |\bar{\Omega}^{[1,30],P_\gamma E_\beta}| / \sum_{\gamma \neq \alpha} |\bar{\Omega}^{[1,30],P_\gamma}|\right)
 \end{aligned} \tag{4.11}$$

The RR estimates the risk of having the READ code in the month after the drug of interest is prescribed divided by the risk of having the READ code in the month after any other drug, the measure has been incorporated to signal ADRs in SRS databases [9]:

$$\begin{aligned}
 x_6^{\alpha\beta} &= (|\Omega^{[1,30],P_\alpha E_\beta}|/|\Omega^{[1,30],P_\alpha}|) / \left(\sum_{\gamma \neq \alpha} |\Omega^{[1,30],P_\gamma E_\beta}| / \sum_{\gamma \neq \alpha} |\Omega^{[1,30],P_\gamma}|\right) \\
 x_7^{\alpha\beta} &= (|\hat{\Omega}^{[1,30],P_\alpha E_\beta}|/|\hat{\Omega}^{[1,30],P_\alpha}|) / \left(\sum_{\gamma \neq \alpha} |\hat{\Omega}^{[1,30],P_\gamma E_\beta}| / \sum_{\gamma \neq \alpha} |\hat{\Omega}^{[1,30],P_\gamma}|\right) \\
 x_8^{\alpha\beta} &= (|\bar{\Omega}^{[1,30],P_\alpha E_\beta}|/|\bar{\Omega}^{[1,30],P_\alpha}|) / \left(\sum_{\gamma \neq \alpha} |\bar{\Omega}^{[1,30],P_\gamma E_\beta}| / \sum_{\gamma \neq \alpha} |\bar{\Omega}^{[1,30],P_\gamma}|\right)
 \end{aligned} \tag{4.12}$$

The OR calculates the ratio between the odds that a READ code occurs in the

drug of interest group and the odds that a READ code occurs in any other drug group. There has been much debate into the usefulness of this measure, in [165] the authors state that the OR should not be used in place of the RR although in [194] they argue that the OR and RR are different measures and as long as the OR is not considered on the same scale as the RR then it is worthwhile:

$$\begin{aligned}
 x_9^{\alpha\beta} &= \left(\frac{|\Omega^{[1,30],P_\alpha E_\beta}|}{[|\Omega^{[1,30],P_\alpha}| - |\Omega^{[1,30],P_\alpha E_\beta}|]} \right) / \left(\frac{\sum_{\gamma \neq \alpha} |\Omega^{[1,30],P_\gamma E_\beta}|}{[\sum_{\gamma \neq \alpha} |\Omega^{[1,30],P_\gamma}| - \sum_{\gamma \neq \alpha} |\Omega^{[1,30],P_\gamma E_\beta}|]} \right) \\
 x_{10}^{\alpha\beta} &= \left(\frac{|\hat{\Omega}^{[1,30],P_\alpha E_\beta}|}{[|\hat{\Omega}^{[1,30],P_\alpha}| - |\hat{\Omega}^{[1,30],P_\alpha E_\beta}|]} \right) / \left(\frac{\sum_{\gamma \neq \alpha} |\hat{\Omega}^{[1,30],P_\gamma E_\beta}|}{[\sum_{\gamma \neq \alpha} |\hat{\Omega}^{[1,30],P_\gamma}| - \sum_{\gamma \neq \alpha} |\hat{\Omega}^{[1,30],P_\gamma E_\beta}|]} \right) \\
 x_{11}^{\alpha\beta} &= \left(\frac{|\bar{\Omega}^{[1,30],P_\alpha E_\beta}|}{[|\bar{\Omega}^{[1,30],P_\alpha}| - |\bar{\Omega}^{[1,30],P_\alpha E_\beta}|]} \right) / \left(\frac{\sum_{\gamma \neq \alpha} |\bar{\Omega}^{[1,30],P_\gamma E_\beta}|}{[\sum_{\gamma \neq \alpha} |\bar{\Omega}^{[1,30],P_\gamma}| - \sum_{\gamma \neq \alpha} |\bar{\Omega}^{[1,30],P_\gamma E_\beta}|]} \right)
 \end{aligned}
 \tag{4.13}$$

4.2.3.2 Temporality

‘Does a particular diet lead to disease or do the early stages of the disease lead to those peculiar dietetic habits?’ - **Bradford-Hill** [19].

The temporality criteria concerns itself with the direction of the relationship between the READ code and drug. This is an important factor, and has been highlighted in other criteria for causation [86]. It measures if the READ code occurs after the drug, or the other way round. If the READ code and drug are associated but the READ code frequently occurs before the drug, then this may suggest the medical event corresponding to the READ code causes the drug and not the other way round.

The first values of interest are the after and before ratios (AB ratios). The

AB ratios calculate how many prescriptions of α have the READ code β recorded between 1 and 30 days after the prescription divided by how many have the READ code β recorded between 1 and 30 days before the prescription, this is a basic implementation of the self controlled cross-over method.

$$\begin{aligned}
 x_{12}^{\alpha\beta} &= |\Omega^{[1,30],P_\alpha E_\beta}| / |\Omega^{[-30,-1],P_\alpha E_\beta}| \\
 x_{13}^{\alpha\beta} &= |\hat{\Omega}^{[1,30],P_\alpha E_\beta}| / |\hat{\Omega}^{[-30,-1],P_\alpha E_\beta}| \\
 x_{14}^{\alpha\beta} &= |\bar{\Omega}^{[1,30],P_\alpha E_\beta}| / |\bar{\Omega}^{[-30,-1],P_\alpha E_\beta}|
 \end{aligned} \tag{4.14}$$

Other suitable attributes for the temporality criterion are the filters that have been implemented by existing LOD ADR signalling algorithms, where $x_{15}^{\alpha\beta}$ and $x_{16}^{\alpha\beta}$ correspond, respectively, to the TPD Filter 1 and the TDP Filter 2, the modified versions of the TPD filter applied initially in [128] and adapted in [143]. The final attribute, $x_{17}^{\alpha\beta}$, is the output of the LEOPARD algorithm described in [161].

4.2.3.3 Specificity

‘If the association is limited to specific workers and to particular sites and types of disease and there is no association between the work and other modes of dying, then clearly that is a strong argument in favour of causation’ - **Bradford-Hill** [19].

The third Bradford-Hill consideration is how specific an association is. In general, specificity is interpreted as the drug only causes a single, specific, ADR [67]. Consequently, many researchers, including [151] and [67], argue this is not very informative, as many drugs cause multiple ADRs. Other researchers have

suggested modifying the interpretation of the specificity criteria [197]. Weiss argues that an association is specific when both the outcome and the exposure are specific or when only specific people that are exposed have the outcome.

This prompts the novel specificity attributes proposed in this thesis. The first considers how specific the READ code is, justification for this is that general outcomes are likely to occur by chance as they probably have a high background rate, but if a specific READ code occurs frequently after the drug of interest is prescribed then this may give reason to suspect it as an ADR. The first specificity attribute uses the READ code hierarchal level,

$$x_{18}^{\alpha\beta} = i, \text{ where } \beta \text{ corresponds to a level } i \text{ READ code} \quad (4.15)$$

If the drug and READ code association is only found in a certain subpopulation then this may also be suggestive of an ADRs. Therefore attributes are developed based on the age and gender of the patients experiencing the READ code after the drug compared to all the patients who are prescribed the drug. A suitable method to measure if a specific age group experience β after α is to compare the average age of the patients who experience β within 1 to 30 days after α with the

average age of the patients prescribed α .

$$\begin{aligned}
 x_{19}^{\alpha\beta} &= \left(\sum_{\kappa \in \Omega^{[1,30], P_\alpha E_\beta}} \kappa_5 / |\Omega^{[1,30], P_\alpha E_\beta}| \right) / \left(\sum_{\kappa \in \Omega^{[1,30], P_\alpha}} \kappa_5 / |\Omega^{[1,30], P_\alpha}| \right) \\
 x_{20}^{\alpha\beta} &= \left(\sum_{\kappa \in \hat{\Omega}^{[1,30], P_\alpha E_\beta}} \kappa_5 / |\hat{\Omega}^{[1,30], P_\alpha E_\beta}| \right) / \left(\sum_{\kappa \in \hat{\Omega}^{[1,30], P_\alpha}} \kappa_5 / |\hat{\Omega}^{[1,30], P_\alpha}| \right) \\
 x_{21}^{\alpha\beta} &= \left(\sum_{\kappa \in \bar{\Omega}^{[1,30], P_\alpha E_\beta}} \kappa_5 / |\bar{\Omega}^{[1,30], P_\alpha E_\beta}| \right) / \left(\sum_{\kappa \in \bar{\Omega}^{[1,30], P_\alpha}} \kappa_5 / |\bar{\Omega}^{[1,30], P_\alpha}| \right)
 \end{aligned} \tag{4.16}$$

Justified by a similar argument, it is also useful to calculate a measure to compare the ratio of patients that experience β within 1 and 30 days of α that are male relative to the ratio of patients who are prescribed α and are male.

$$\begin{aligned}
 x_{22}^{\alpha\beta} &= \left(\sum_{\kappa \in \Omega^{[1,30], P_\alpha E_\beta}} \kappa_3 / |\Omega^{[1,30], P_\alpha E_\beta}| \right) / \left(\sum_{\kappa \in \Omega^{[1,30], P_\alpha}} \kappa_3 / |\Omega^{[1,30], P_\alpha}| \right) \\
 x_{23}^{\alpha\beta} &= \left(\sum_{\kappa \in \hat{\Omega}^{[1,30], P_\alpha E_\beta}} \kappa_3 / |\hat{\Omega}^{[1,30], P_\alpha E_\beta}| \right) / \left(\sum_{\kappa \in \hat{\Omega}^{[1,30], P_\alpha}} \kappa_3 / |\hat{\Omega}^{[1,30], P_\alpha}| \right) \\
 x_{24}^{\alpha\beta} &= \left(\sum_{\kappa \in \bar{\Omega}^{[1,30], P_\alpha E_\beta}} \kappa_3 / |\bar{\Omega}^{[1,30], P_\alpha E_\beta}| \right) / \left(\sum_{\kappa \in \bar{\Omega}^{[1,30], P_\alpha}} \kappa_3 / |\bar{\Omega}^{[1,30], P_\alpha}| \right)
 \end{aligned} \tag{4.17}$$

4.2.3.4 Biological Gradient

‘The fact that the death rate from cancer of the lung rises linearly with the number of cigarettes smoked daily, adds a very great deal to the simple evidence that cigarette smokers have a higher death rate than non-smokers.’ - **Bradford-Hill** [19].

The biological gradient criterion in the context of ADR detection considers the

dosage of the drug. Often, but not always the case, an ADR is more likely to occur when the drug is ingested at a high dosage compared to a low dosage [36]. In [192] the authors used the Pearson's correlation and logistical regression to measure the biological gradient. However, in [142], it was shown that the Pearson's correlation was difficult to calculate using data from the THIN database. Therefore different measures are required.

The proposed novel biological attribute, calculated below, contrasts the average drug dosage for the patients that experience β within 1 to 30 days of α with the average drug dosage for all the patients prescribed α ,

$$x_{25}^{\alpha\beta} = \left(\sum_{\kappa \in \bar{\Omega}^{[1,30],P_\alpha E_\beta}} \kappa_6 / |\bar{\Omega}^{[1,30],P_\alpha E_\beta}| \right) / \left(\sum_{\kappa \in \bar{\Omega}^{[1,30],P_\alpha}} \kappa_6 / |\bar{\Omega}^{[1,30],P_\alpha}| \right) \quad (4.18)$$

4.2.3.5 Experimentation

‘Because of an observed association some preventative action is taken,
Does it in fact prevent?’ - **Bradford-Hill** [19].

The final Bradford-Hill causality consideration investigated is experimentation. There is deviation between the meaning behind experimentation, some authors assume it relates to intervention (i.e. if the drug stops does the medical event, if the drug restarts does the medical event follow?) [175], whereas others believe it corresponds literally to experiments that have been conducted and their results [64].

In this thesis we adopt the intervention interpretation and apply a retrospective investigation to find instances where a patient stopped taking the drug for a while and then restarted, and refer to this as a retrospective intervention. Unfor-

tunately, few patients experience retrospective interventions and this limits the experimentation attribute's usefulness. If a patient has two or more independent prescriptions of the drug, it can be observed whether the medical event often occurs shortly after the prescriptions but never shortly before. If this is the case, then this is a very strong implication that the medical event is an ADR.

Equation 4.19 shows the calculation for the proposed novel attributes based on the Bradford-Hill experimentation causality consideration. It is determined by finding the number of patients that have READ code β within 1 to 30 days of two or more independent prescriptions of α but never within 1 to 30 days before any prescriptions of α divided by the number of patients that have two or more independent prescriptions of α .

$$x_{26}^{\alpha\beta} = \frac{|\{\kappa_1 | \exists \kappa, \kappa^* \in \overline{\Omega}^{[1,30], P_\alpha, E_\beta}, \kappa_4 \neq \kappa_4^*, \kappa_1 = \kappa_1^*\} \cap \{\kappa_1 | \kappa \notin \overline{\Omega}^{[-30, -1], P_\alpha, E_\beta}\}|}{|\{\kappa_1 | \exists \kappa, \kappa^* \in \overline{\Omega}^{[1,30], P_\alpha}, \kappa_4 \neq \kappa_4^*, \kappa_1 = \kappa_1^*\}|} \quad (4.19)$$

4.2.3.6 Other Criteria

The consistency, plausibility and coherence require additional resources for their calculation and are not tackled in this thesis. The analogy factor is indirectly incorporated by using a supervised algorithm, as attributes similarities for the drug-READ code pairs corresponding to known ADRs are learned and used to infer new ADRs.

4.2.3.7 THIN Specific

The attributes specific to the THIN database make use of the READ code structure and additional information available that might help distinguish between an

4. Incorporating Causation

ADR and non-ADR. The first attribute gives a measure of how much noise there is present for the READ code β and drug α as it is harder to classify drug-READ code pairs with a large measure of noise as the attribute values are likely to be misleading. To determine the level of noise, the average number of prescriptions that occur within the two month interval centred around the prescription of α is calculated for all patients and compared with the average number of prescriptions that occur within the two month time interval centred around the prescription of drug α for the patients that also experienced READ code β within 1 to 30 days.

$$x_{27}^{\alpha\beta} = \left(\sum_{\kappa \in \bar{\Omega}^{[-30,30],P_\alpha E_\beta}} \kappa_8 / |\bar{\Omega}^{[-30,30],P_\alpha E_\beta}| \right) / \left(\sum_{\kappa \in \bar{\Omega}^{[-30,30],P_\alpha}} \kappa_8 / |\bar{\Omega}^{[-30,30],P_\alpha}| \right) \quad (4.20)$$

The next attribute investigates whether, for each READ code β that occurs within 1 and 30 days of a prescription of α , the patient has previously experienced β (or its level 3 parent). If many patients have previously experienced a more general version of β but not β itself, then this is a sign that β is not an ADR to drug α . The reason is that β is likely to have occurred due to an illness progression rather than it being caused by the drug. This prompts,

$$x_{28}^{\alpha\beta} = \left(\sum_{\kappa \in \Omega^{[1,30],P_\alpha E_\beta}} \kappa_{12} \right) / \left(\sum_{\kappa \in \Omega^{[1,30],P_\alpha, E_\beta}} \kappa_{13} \right) \quad (4.21)$$

The final THIN specific attributes use the READ code structure to help distinguish between associations that are causal and associations that are due to illness progressions. These attributes calculate the AB ratio when only considering the more general versions of all the READ codes. Therefore, if the association has occurred due to the illness progression, the AB ratio for the more general versions

of the READ codes should be small, even if the AB ratio for the actual READ code is large.

Letting Φ_3^β denote the set of READ codes that have the same level 3 parent as β , then the AB ratio is calculated on the transformed data,

$$x_{29}^{\alpha\beta} = \left| \bigcup_{\beta^* \in \Phi_3^\beta} \Omega^{[1,30],P_\alpha,E_{\beta^*}} \right| / \left| \bigcup_{\beta^* \in \Phi_3^\beta} \Omega^{[-30,-1],P_\alpha,E_{\beta^*}} \right| \quad (4.22)$$

Similarly, Φ_4^β denotes the set of READ codes that have the same level 4 parent as β and the AB ratio is calculated,

$$x_{30}^{\alpha\beta} = \left| \bigcup_{\beta^* \in \Phi_4^\beta} \Omega^{[1,30],P_\alpha,E_{\beta^*}} \right| / \left| \bigcup_{\beta^* \in \Phi_4^\beta} \Omega^{[-30,-1],P_\alpha,E_{\beta^*}} \right| \quad (4.23)$$

4.2.3.8 A Note on Dependency

Many of the attributes derived from the same Bradford-Hill causality considerations may have some statistical dependency but also give slightly different perspectives. The statistical dependency is unlikely to have any negative consequences on the future classifiers as either feature selection is applied to remove any redundancy or the methods are unaffected by statistical dependency. The random forest is a decision tree based classifier; decision trees partition the attribute space based on measures such as entropy. At each iteration the decision tree will simply pick the partitioning of an attribute space based on how well it separates the classes, dependency of two attributes will not have any negative effect on this process. For the other classifier used throughout this research, feature selection will be performed prior to training. Feature selection will choose a

subset of attributes to be used by the classifier that maximises its performance. If two dependant attributes negatively affect the classifier then the optimal feature subset will only contain a maximum of one of them.

4.2.4 Data Description

The attribute vector for a drug-READ code pair (α, β) is $\hat{\mathbf{x}}^{\alpha\beta} = (x_1^{\alpha\beta}, x_2^{\alpha\beta}, \dots, x_{30}^{\alpha\beta}) \in \mathbb{R}^{30}$. The set $\hat{X}^\alpha = \{\hat{\mathbf{x}}^{\alpha\beta_i}, \beta_i \in RME^\alpha\}$ contains all the (α, β_i) corresponding Bradford-Hill causality consideration derived attribute vectors for the drug α and each of its ‘risk’ READ codes β_i (the READ codes recorded within 1 to 30 days from any prescription of α).

4.2.5 Data Transformation

4.2.5.1 Continuous Attributes

The importance of processing the data has been stressed in [127], one vital stage in processing is to ensure each attribute is treated equally by a classifier. This is done by normalising the data. Normalisation scales the nominal attribute data between two values [96], this ensures the optimal performance of some learning algorithms [127]. The three frequently implemented normalisation techniques are,

N1 (z-score Normalisation, useful if data bounds are unknown)

$$f : X \rightarrow X; f_{z-score}(x) = (x - \bar{X})/(\sigma_X)$$

N2 (Min Max Normalisation, data are scale into the range [0, 1])

$$f : X \rightarrow X; f_{MinMax}(x) = (x - min_X)/(max_X - min_X)$$

Table 4.2: The results of KNN with leave one out cross validation when the different normalisations are applied to the data, k=8 (preliminary results showed this was optimal).

| Normalisation | TP | FP | FN | TN | AUC |
|---------------|-----|-----|------|------|--------|
| None | 684 | 443 | 1080 | 7746 | 0.7885 |
| N1 | 674 | 246 | 1090 | 7943 | 0.8055 |
| N2 | 698 | 387 | 1066 | 7802 | 0.7567 |
| N3 | 673 | 349 | 1091 | 7840 | 0.7561 |

N3 (Decimal Scaling Normalisation, data are scale into the range $[-1, 1]$)

$$f : X \rightarrow X; f_{decimal}(x) = x/10^j, j = \min\{j \in \mathbb{N} | \forall_{x_i \in X} |x_i/10^j| < 1\}$$

Table 4.2 shows the results when a KNN algorithm was applied with leave one out cross validation on labelled data for 25 drugs with the data transformations N1-N3 and no transformation. The optimal solution was obtained when the N1 transformation was applied, as the AUC was the greatest. Therefore, the N1 transformation will be used to transform any continuous attributes prior to any learning algorithm in the remainder of this thesis.

4.2.5.2 Discrete Attributes

The discrete attributes, $x_{15}^{\alpha\beta} - x_{18}^{\alpha\beta}$ are not normalised. The binary attributes do not require any transformation, but the non-binary discrete attribute $x_{18}^{\alpha\beta}$ corresponding to the READ code hierarchal level does. As described in [127], dummy attributes (binary attributes corresponding to the each value of the discrete attribute) are generated for $x_{18}^{\alpha\beta}$, see Table 4.3 for an example. Due to the linear dependancy between $x_{18}^{\alpha\beta}$'s dummy attributes, one can be discarded, so only four of the dummy attributes are used. If we denote the z-score normalisation of the continuous attributes and the creation of dummy attributes for the discrete at-

Table 4.3: Example of how a discrete attribute is transformed into its dummy attributes.

| Original READ code lv | Dummy Attributes | | | | |
|--------------------------|------------------|-----|-----|-----|-----|
| | lv1 | lv2 | lv3 | lv4 | lv5 |
| 1 | 1 | 0 | 0 | 0 | 0 |
| 2 | 0 | 1 | 0 | 0 | 0 |
| 3 | 0 | 0 | 1 | 0 | 0 |
| 4 | 0 | 0 | 0 | 1 | 0 |
| 5 | 0 | 0 | 0 | 0 | 1 |
| 3 | 0 | 0 | 1 | 0 | 0 |

tributes by the mapping $f : \mathbb{R}^{30} \rightarrow \mathbb{R}^{33}$, then this leads to the transformed data $X^\alpha = \{f(\mathbf{x}), x \in \hat{X}^\alpha\}$.

4.2.6 Feature Selection

In preliminary work I investigated the usefulness of different Bradford-Hill causality considerations based attributes for predicting ADRs. A multivariate filter known as the Correlation-based Feature Selection (CFS) algorithm [69] was applied to a range of attributes. This feature selection technique aims to find a subset of attributes such that each individual attribute in the subset is more correlated to the label/class than it is to other attributes in the subset. Therefore, only attributes that offer new insight for predicting the label/class are included, the others will be removed, as they are generally redundant. The paper detailing this preliminary work can be found in appendix C. However, in the actual framework proposed within this work, I will use wrapper feature selection prior to the classification (except for random forest) as wrapper feature selection chooses the attribute subset based on how well the classifier performs when trained using only the subset of attributes, this is more useful than a multivariate filter as it

considers the classifier performance rather than just relying on correlations.

A wrapper approach to feature selection implements a heuristic search through the power set of the attributes. It aims to find the attribute subset that, when used as input into a classifier, maximises the classifiers performance. For example, consider the attribute set $\{x_1, x_2, x_3\}$, the power set of these attributes is $\{\{\}, \{x_1\}, \{x_2\}, \{x_3\}, \{x_1, x_2\}, \{x_1, x_3\}, \{x_2, x_3\}, \{x_1, x_2, x_3\}\}$. A wrapper that performs an exhaustive search will apply the classification using every possible subset of attributes (all the power set) and choose the subset for which the classifier performed the best.

In general it is not suitable to perform an exhaustive search and a local optimal subset (hopefully with a good performance) will be found instead. A forward search starts with one attribute and iteratively investigates the addition of a single attribute at a time until there is no further improvement possible. A backwards search starts with all the attributes and iteratively investigates the removal of a single attribute at a time until there is no further improvement possible. These searchers described above are referred to as ‘greedy’ as the process of adding (or removing) an attribute cannot be reversed once done. This leads to the searchers finding local optimal subsets rather than global optimal ones.

In the future work I will implement a greedy backwards feature selection algorithm named ‘rfe’ available in the R caret package. This algorithm requires inputting the size of the attribute subset desired. It iteratively removes attributes based on their ranking of importance by the naive Bayes classifier until the attribute subset is reduced to the desired size. I will search for the subsets of size 5, 10, 15, 20, 25, 30 and 33. I will then select the subset out of these seven that maximises the classifier performance (prediction accuracy). Naive Bayes was chosen

as this classifier assumes conditional independence, so it is more likely to be negatively affected by attributes' dependencies. Details about the chosen attributes returned by wrapper feature selection throughout this research can be found in appendix [C.2](#).

4.3 Summary

In this chapter methods to generate thirty-three attributes for each drug-READ code pair have been proposed. These attributes may help identify causal relationships as they are derived from the Bradford-Hill causality considerations [19] that has been used frequently to investigate causality between a single drug-medical event pair. In addition, THIN specific attributes were presented with the aim of preventing issues that arise due to the hierarchal READ code structure. The attributes were explored and it was determined that z-score normalisation should be applied to transform the continuous data and optimise the results of any learning algorithms applied. The foundations have been set to enable the development of a novel framework for ADR signalling that incorporates causal knowledge and the THIN data structure.

In Chapter 5, the attributes proposed in this chapter and their transformations will be used as inputs into a learning algorithm which will be trained, using the knowledge of known ADRs and non-ADRs, to distinguish between causal and non-causal relationships.

Chapter 5

Developing The ADR Learning Framework

‘Our evaluation showed that the phenotypic information (when available) largely improved the performance of ADR prediction models. ’

M. Liu [113]

5.1 Introduction

In the previous chapter suitable attributes based on the Bradford-Hill causality considerations and specific to the THIN database were proposed, with the aim of being used as inputs into a learning algorithm capable of identifying causality and hence, able to signal ADRs. This was the first step toward testing the main hypothesis being investigated in this thesis, that a framework that incorporates attributes that give insight into causality and attributes specific to the THIN database into a learning algorithm that uses knowledge of existing ADRs will

signal ADRs without a high false positive rate. The second step is determining which learning algorithm is optimal.

In this chapter the focus is on developing an algorithm for detecting ADRs by applying supervised and semi-supervised techniques that utilised knowledge of existing ADRs and non-ADRs. The sub question answered in this chapter is what will yield a better ADR signalling algorithm, a supervised approach that is trained on labelled data corresponding to a variety of drugs, or a semi-supervised approach that uses the labelled and non-labelled data for a single drug?

5.2 Motivation

Generally ADR signalling methods using data contained in SRS databases and LODs have been unsupervised, however, numerous supervised algorithms have been presented to classify ADR using chemical structures and known ADRs. One of the first algorithms that used chemical structures to infer ADRs was developed for a specific group of drugs known as the CEPT inhibitors [209]. This idea was expanded to simultaneously identify multiple ADRs [5] where the authors proposed two novel algorithms that incorporate knowledge of chemical structures and known ADRs, extracted from SIDER [98], to infer new ADRs. The first algorithm learns associations between drug attributes and known ADRs and uses this knowledge to infer new ADRs. The second algorithm, based on a method of predicting disease-causing genes [186], uses a diffusion process that incorporates the similarities between drugs and the similarities between ADRs. The overall measure of how likely a drug causes an ADR was calculated using a combination of the values returned by the two algorithms. More recent methods have utilised target

5. Developing The ADR Learning Framework

protein information in addition to chemical structure and ADR knowledge, and used these to generate attributes that are fed into a predictive model [109; 212] or included biological and phenotypic (e.g., indications and known ADRs) based attributes [113]. In [113] the presented framework detected ADRs with a precision of 66.17% and a recall of 63.06% and it was shown that including attributes based on known ADRs improves the ability of the classifier and increases the recall and precision. This is a key result, as it shows that incorporating knowledge of known ADRs into an algorithm for signalling ADRs may decrease the false positive rate.

ADR signalling algorithms applied to LODs have exceptional potential to identify new ADRs [204], but are currently limited by the high number of false positives [156]. An ADR signalling algorithm that generates attributes based on LODs, but also incorporates known ADR labels may reduce the number of false positives and should outperform the existing unsupervised algorithms. As an ADR represents a causal relationship, any attributes used by a learning algorithm to distinguish between ADRs and non-ADRs need to contain information about causality. In Chapter 4 suitable attributes for each drug-medical event pair based on the strength, temporality, specificity, biological gradient and experimentation factors of the Bradford-Hill causality considerations were investigated, as well as attributes specific to the THIN database. These attributes are suitable inputs into a causality learning algorithm as they are frequently implemented by researchers to determine causal relations [42]. In Chapter 3.4, labels were extracted from the SIDER resource for known ADRs, and noise medical events were extracted using the READ code tree. Using the generated attributes and the known labels it may be possible to learn areas of the attribute space that suggest a drug-medical event pair represent an ADR. It is hypothesised that such an algorithm would

reduce the time required to definitively identify ADRs and enable a wider search for ADRs. Overall, this would improve current healthcare.

5.3 Algorithms

After the THIN data has been processed, as described in Chapter 4, for each drug of interest α , we can assign class labels to some of the drug-READ code pairs (class ADRs or class non-ADRs). Therefore, the set of Bradford-Hill causality consideration attribute vectors X^α is partitioned into labelled data, $(X_L^\alpha, Y_L^\alpha) = \{(\mathbf{x}, y) | \mathbf{x} \in X^\alpha \text{ and } y \text{ is the known label}\}$, and unlabelled data, $X_U^\alpha = \{(\mathbf{x}, y) | \mathbf{x} \in X^\alpha \text{ and the label is unknown}\}$. The aim of the learning algorithms is to determine a predictive function $f : X \rightarrow Y$, using the labelled data and the unlabelled data, that can then be applied to the attributes of a new drug-medical event pair, (α^*, β^*) , to predict the pair's class.

5.3.1 Supervised ADR Predictor

Supervised methods only use the labelled data (X_L^α, Y_L^α) . The Supervised ADR Predictor (SAP) framework signals ADRs by applying a classifier that is trained on n drugs to a drug not used to train the classifier. Using a sufficiently large value for n ensures that there is an adequate number of labels. In this study the value of n used is 24 as this corresponded to approximately 10,000 labelled data-points. As the drug being investigated is not used in the training, no knowledge of existing ADRs for that drug is required, so the SAP framework can be applied to newly marketed drugs. The framework is illustrated in Figure 5.1.

5. Developing The ADR Learning Framework

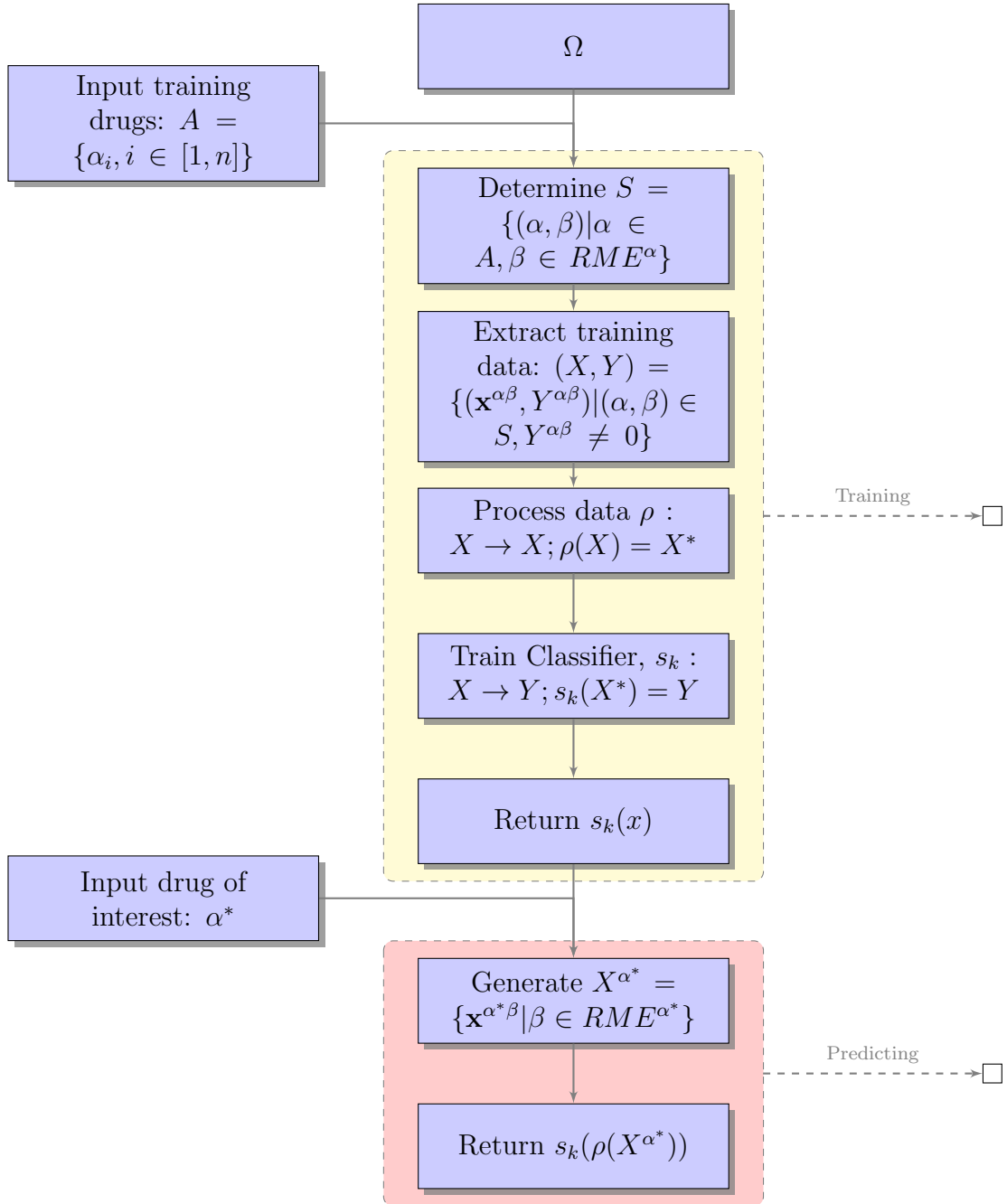

Figure 5.1: The framework implemented to train the four different classifiers using a variety of n drugs with known side effects. These general classifiers are then used to predict the class for unlabelled data.

5.3.1.1 Training Stage

Starting with the THIN data, Ω , and the set of training drugs, $A = \{\alpha_i, i \in [1, 24]\}$, the first step is determining the ‘risk’ drug-medical event pairs for each of the training drugs. These are all the medical event and drugs pairs, (α_i, β) , where the medical event β is observed to be recorded, for at least one patient, within 30 days after a training drug α_i was recorded. The set containing all these ‘risk’ drug-medical event pairs where the drug is a training set drug is denoted by S .

Next, the Bradford-Hill causality consideration based attributes and the THIN specific attributes are extracted for each pair in S with a corresponding label that is ± 1 . The labels are determined (using the sets Ψ^A and Ψ^N defined in Chapter 3.4) by,

$$Y^{\alpha\beta} = \begin{cases} 1 & \text{if } (\alpha, \beta) \in \Psi^A; \\ -1 & \text{if } (\alpha, \beta) \in \Psi^N. \\ 0 & \text{else.} \end{cases} \quad (5.1)$$

So, the extracted labelled data is, $(X, Y) = \{(\mathbf{x}^{\alpha\beta}, Y^{\alpha\beta}) | (\alpha, \beta) \in S, Y^{\alpha\beta} \neq 0\}$. Before the labelled data is used to train the classifier, it is processed according to the chosen classifier being implemented. The processing step is represented by the function $\rho : X \rightarrow X$. For the random forest classifier, ρ is the z-score normalisation function, $\rho(\mathbf{x}) = (\mathbf{x} - \mu)/\sigma$, where μ is the mean of X and σ is the standard deviation of X . For the SVM, Naive Bayes and Logistic Regression, ρ represents z-score normalisation and wrapper feature selection (see appendix C.2) [157].

The final step is using the processed labelled data to train and return the clas-

5. Developing The ADR Learning Framework

sifier, $s_k : X \rightarrow Y$, using leave one out cross-validation. The classifier is trained so that $s_k(\mathbf{x}^{ab}) = 1$ represents drug a causing medical event b and $s_k(\mathbf{x}^{ab}) = -1$ represents drug a not causing medical event b . The trained random forest classifier is represented by $s_1 : X \rightarrow Y$, the SVM is represented by $s_2 : X \rightarrow Y$, the Logistic regression is represented by $s_3 : X \rightarrow Y$ and the Naive Bayes classifier is represented by $s_4 : X \rightarrow Y$.

5.3.1.2 Prediction Stage

Once the classifier, $s_k : X \rightarrow Y$, is trained, the SAP algorithm can then be applied to any drug α^* not used in training. The set of attribute vectors, $X^{\alpha^*} = \{\mathbf{x}^{\alpha^*\beta} | \beta \in RME^{\alpha^*}\}$, corresponding to ‘risk’ drug-medical event pairs containing the drug being investigated are extracted and processed. The trained classifier is then applied to each of the data-points, $\mathbf{x}^{\alpha^*\beta} \in X^{\alpha^*}$, to predict whether the drug α^* and medical event β correspond to an ADR. The final output for classifier k is the set of medical events that correspond to the signalled drug-medical event pairs containing drug α^* , $\{\beta | s_k(\mathbf{x}^{\alpha^*\beta}) = 1, \mathbf{x}^{\alpha^*\beta} \in X^{\alpha^*}\}$.

5.3.1.3 Results and Analysis

To analyse the SAP algorithm a set of 25 drugs were chosen, $D = \{\alpha_i, i \in [1, 25]\}$. For each drug, $\alpha_i \in D$, the SAP algorithm was trained on the set of drugs in D excluding α_i and then validated by being applied to α_i . The inputs into the SAP framework were, $A = \{\alpha_j \in D | j \neq i\}$ and $\alpha^* = \alpha_i$. The predictions of the classifiers on each labelled data-point (not used during training), $s_k(\mathbf{x}^{\alpha_i\beta})$, are then compared with the truth, $Y^{\alpha_i\beta}$, to measure the ability of the classifier. Using the validation set, $(X^{\alpha_i}, Y^{\alpha_i}) = \{(\mathbf{x}^{\alpha_i\beta}, Y^{\alpha_i\beta}) | \beta \in RME^{\alpha_i}, Y^{\alpha_i\beta} \neq 0\}$, the

5. Developing The ADR Learning Framework

Table 5.1: The results of the different classifiers at their natural thresholds for three drugs, Nifedipine, Ciprofloxacin and Ibuprofen.

| Drug | Algorithm | TP | FN | FP | TN | Sensitivity | Specificity |
|---------------|-----------|----|----|----|-----|-------------|-------------|
| Nifedipine | RF | 22 | 41 | 8 | 604 | 0.349 | 0.987 |
| Ciprofloxacin | RF | 13 | 42 | 0 | 385 | 0.236 | 1 |
| Ibuprofen | RF | 22 | 53 | 2 | 784 | 0.293 | 0.997 |
| Nifedipine | NB | 14 | 49 | 6 | 606 | 0.222 | 0.990 |
| Ciprofloxacin | NB | 6 | 49 | 5 | 380 | 0.109 | 0.987 |
| Ibuprofen | NB | 9 | 66 | 16 | 770 | 0.120 | 0.980 |
| Nifedipine | SVM | 25 | 38 | 9 | 603 | 0.397 | 0.985 |
| Ciprofloxacin | SVM | 12 | 43 | 0 | 385 | 0.218 | 1 |
| Ibuprofen | SVM | 24 | 51 | 9 | 777 | 0.32 | 0.989 |
| Nifedipine | LR | 6 | 57 | 2 | 610 | 0.095 | 0.997 |
| Ciprofloxacin | LR | 6 | 52 | 6 | 379 | 0.103 | 0.984 |
| Ibuprofen | LR | 12 | 63 | 7 | 779 | 0.16 | 0.991 |

number of true positives (TP), false positives (FP), false negatives (FN) and true negatives (TN), for each classifier s_k , are calculate as,

- $TP = |\{s_k(\mathbf{x}_j) = y_j | (\mathbf{x}_j, y_j) \in (X^{\alpha_i}, Y^{\alpha_i}), y_i = 1\}|$
- $FP = |\{s_k(\mathbf{x}_j) = 1 | (\mathbf{x}_j, y_j) \in (X^{\alpha_i}, Y^{\alpha_i}), y_i = -1\}|$
- $FN = |\{s_k(\mathbf{x}_j) = -1 | (\mathbf{x}_j, y_j) \in (X^{\alpha_i}, Y^{\alpha_i}), y_i = 1\}|$
- $TN = |\{s_k(\mathbf{x}_j) = y_j | (\mathbf{x}_j, y_j) \in (X^{\alpha_i}, Y^{\alpha_i}), y_i = -1\}|$

Table 5.1 presents the results of the classifiers at their natural threshold and Figure 5.2 presents the ROC plots and partial ROC plots of the classifiers, respectively.

Bar charts of the AUC and $AUC_{[0.9,1]}$ values returned by the classifier for the three drugs are displayed in Figure 5.3. The random forest classifier had significantly greater $AUC_{[0.9,1]}$ s for all three drugs investigated at a 5% significance level. However, the random forest's AUC was only significantly greater for

5. Developing The ADR Learning Framework

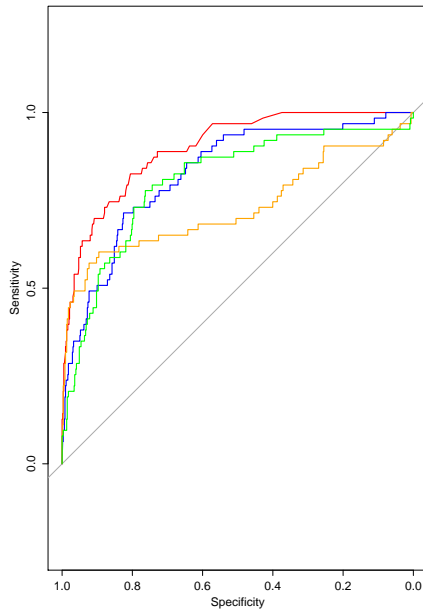

(a) Nifedipine: all specificity

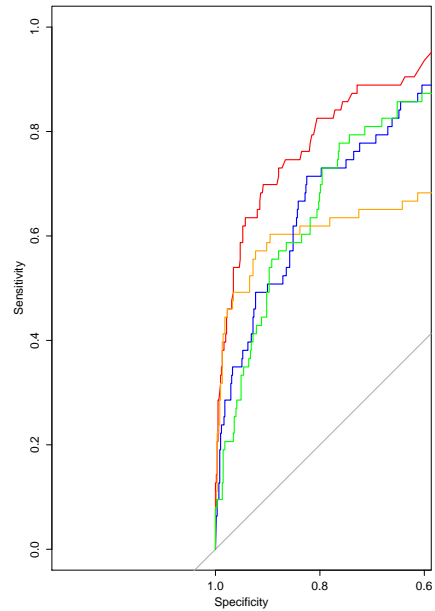

(b) Nifedipine: high specificity

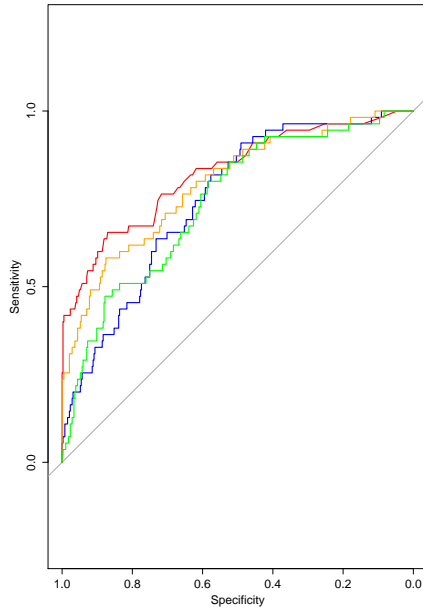

(c) Ciprofloxacin: all specificity

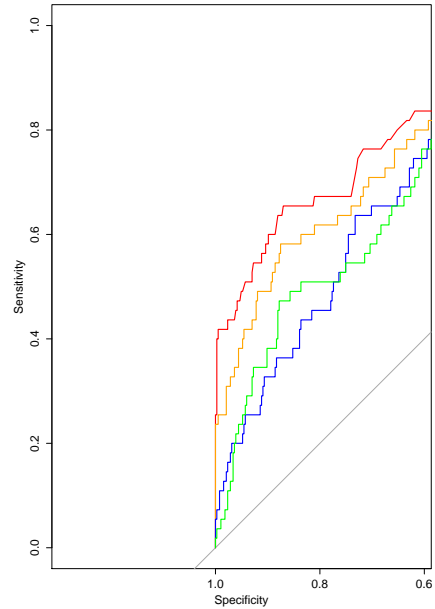

(d) Ciprofloxacin: high specificity

Figure 5.2: The ROC curves for the different classifiers used to predict the ADRs of the drugs. The red curve represents the random forest classifier, the orange curve represents the support vector machine classifier, the green curve represents the logistic regression classifier and the blue curve represents the Naive Bayes classifier.

5. Developing The ADR Learning Framework

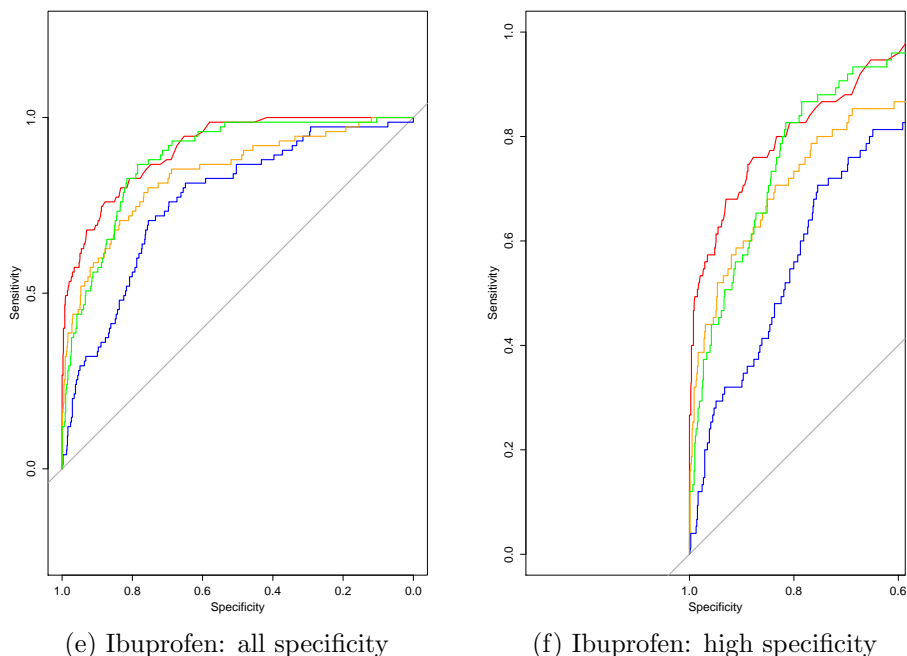

Figure 5.2: Continuation of the ROC plots.

Nifedipine (p-value: 0.0002) and not for Ciprofloxacin nor Ibuprofen (p-values 0.164 and 0.052 respectively). The AUC for the random forest classifier was in the range $[0.823, 0.912]$, indicating excellent performance. The other classifiers also performed well with the lowest AUC value of 0.730 obtained by the SVM for Nifedipine.

The random forest and SMV were able to signal between 24% – 35% and 22% – 40% of the known ADR READ codes for the three drugs respectively. Interestingly, the classifiers all managed to keep the number of false positives low, aggregating over the three drugs, 85%, 77%, 52% and 62% of the signals returned by the random forest, SVM, Naive Bayes and logistic regression classifiers, respectively, were known ADRs. Consequently, although only approximately 30% of known ADRs were signalled by the random forest classifier at its natural thresh-

5. Developing The ADR Learning Framework

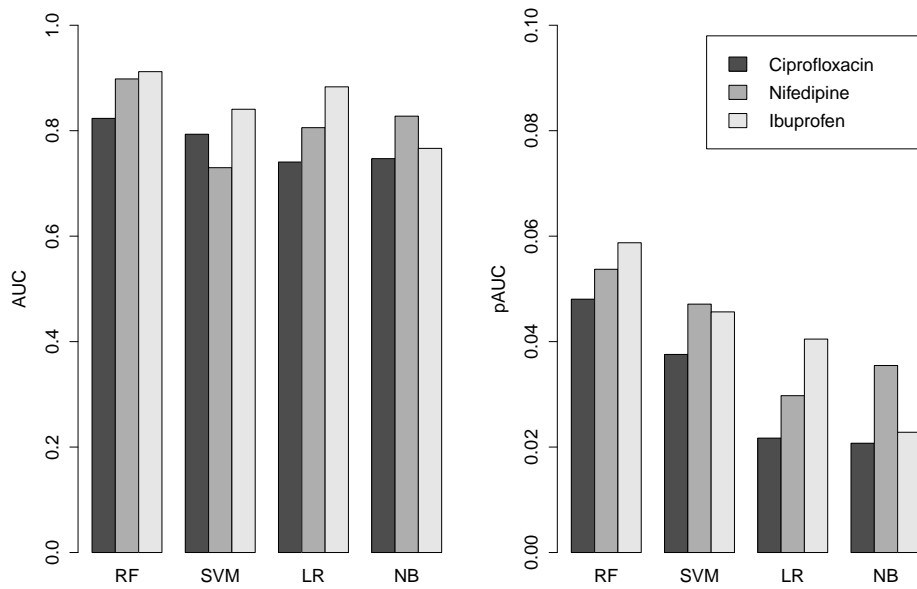

Figure 5.3: The AUC and $AUC_{[0.9,1]}$ values for the SAP algorithm implementing each of the classifiers when applied for the drugs Nifedipine, Ciprofloxacin and Ibuprofen.

5. Developing The ADR Learning Framework

old, the majority of signals were true, so no additional filtering would have been required to further validate the signals. This is an improvement over the existing methods (see Chapter 3).

When investigating the signal overlap between the classifiers, in general the SVM returned the greatest number of unique signals (6 for Ibuprofen, 6 for Nifedipine and 2 for Ciprofloxacin) although the random forest also had some unique ones (4 for Ibuprofen, 2 for Nifedipine and 4 for Ciprofloxacin). This suggests it may be of interest to investigate applying an ensemble technique that integrates the results obtained from all four classifiers.

5.3.1.4 Summary

The classifiers that use the Bradford-Hill causality consideration based and THIN specific attributes and additional knowledge of known ADRs and non-ADRs show excellent promise at effectively signalling ADRs. These classifiers are trained on drugs that are not investigated, so there is no requirement of known ADRs for the drugs investigated and the classifiers had a high specificity and sensitivity. Out of the four classifier investigated, the random forest returned significantly better results and was also the classifier that required the least amount of pre-processing, making it highly efficient. All four classifiers obtained a sufficiently high specificity in addition to constraining the number of false positives. The benchmark AUC for the supervised classifiers is set at 0.91 and the benchmark $AUC_{[0.9,1]}$ are set at 0.048 for Ciprofloxacin, 0.059 for Ibuprofen and 0.053 for Nifedipine.

5.3.2 Semi-Supervised ADR Predictor

In the previous section a general classifier was proposed but the combinations of attribute values that suggest a drug-medical event pair corresponds to an ADR may vary for each drug, so information may be lost by combining the labelled data for a variety of drugs. However, it is difficult to determine a specific classifier with a high accuracy as the number of known ADRs per drug is generally less than a hundred or so, but the number of ‘risk’ drug-medical event pairs are often in the thousands. When there is only a small number of labelled data, but surplus unlabelled data, it has been shown that semi-supervised techniques may yield more accurate results [126]. In this section a novel semi-supervised framework is proposed.

A frequently implemented example of a semi-supervised technique is the self-training wrapper algorithm, summarised in Chapter 2.2.2.1. This algorithm trains a classifier on labelled data and then gets the classifier to ‘teach’ itself by applying the trained classifier on the unlabelled data and adding any unlabelled data-point and its prediction to the labelled data, if the classifier is confident of the prediction [215]. In [195], the authors showed that the performance of a self-training approach and supervised approach is comparable by applying self-training using a tree based classifier to a natural language classification problem. This motivates the investigation of a self-training approach that incorporates a random forest to learn from the labelled and unlabelled data. Unfortunately, the self-training approach requires a sufficient number of initial labelled data, as classifiers perform poorly when trained on a small set of data [55], and an incorrect initial model will get interactively worse. When the size of the initial labelled data is

5. Developing The ADR Learning Framework

small, a semi-supervised clustering algorithm may be more appropriate as a small number of labels can be used to aid clustering by adding bias [7]. Therefore, in this Section, two semi-supervised algorithms are presented to signal ADRs using labelled and unlabelled data corresponding to one drug; a self-training random forest and a semi-supervised k-means clustering.

The framework for Semi-Supervised ADR Predictor (SSAP), that contains both the self-training algorithm and the semi-supervised clustering, is presented in Figure 5.4. The value $crit_*$ represents the critical value that is used to determine whether the self-training or semi-supervised clustering is applied during the SSAP framework, based on the fraction of total data that is labelled. This value will be determined by investigating the performance of both semi-supervised techniques when applied to data with a range of labelled data sizes.

5.3.2.1 Self Training Random Forest

The self training random forest iteratively trains a random forest on the labelled data for drug α , $(X_L^\alpha, Y^\alpha) = \{(\mathbf{x}^{\alpha\beta}, Y^{\alpha\beta}) | \beta \in RME^\alpha, Y^{\alpha\beta} \neq 0\}$, but after each random forest is built, it is applied to the unlabelled data $X_U^\alpha = \{\mathbf{x}^{\alpha\beta} | \beta \in RME^\alpha, Y^{\alpha\beta} = 0\}$ and any unlabelled data point assigned a predicted class with a confidence greater than 0.9 is removed from the unlabelled set and added to the labelled set. The self training stops when the stopping criteria is met, either all the originally unlabelled data-points are moved into the labelled set or the iteration has run for twenty times. In detail, the self train process is:

Once the final random forest is trained, the final iteration model $\hat{s} : X \rightarrow Y$, is applied to the unlabelled data X_U^α . The algorithm returns the predicted class of the unlabelled data, $\hat{s}(\mathbf{x})$, $\mathbf{x} \in X_U^\alpha$, or the confidence of the data point being in

5. Developing The ADR Learning Framework

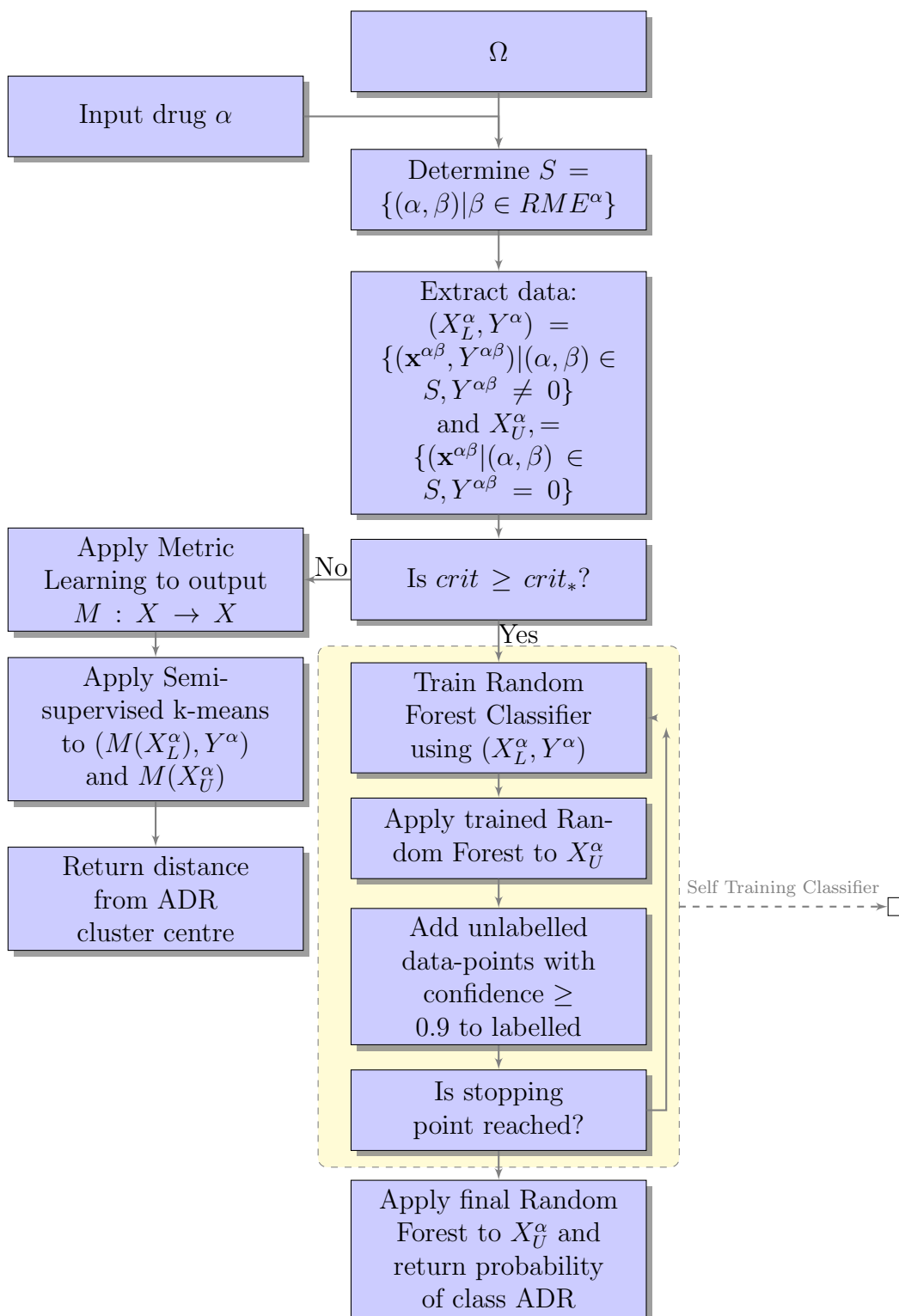

Figure 5.4: The framework for the Semi-Supervised ADR Predictor algorithm. This algorithm uses labelled and unlabelled data for the drug of interest only during training. The technique applied depends on the percentage of labelled data.

5. Developing The ADR Learning Framework

Input : Labelled data: (X_L^α, Y^α) , Unlabelled data: X_U^α and Iteration limit: n

Output: Final random forest applied to unlabelled data, $s^i(X_U^\alpha)$

Initialization: $L^1 = \emptyset, U^1 = X_U^\alpha$

for $i = 1, 2, 3, \dots$ **do**

- Train random forest, $s^i : X \rightarrow Y$, on labelled data $(X_L^\alpha, Y^\alpha) \cup L^i$.
- Apply to unlabelled data $s^i(U^i)$, Set:
- $L^{i+1} = L^i \cup \{(\mathbf{x}^{\alpha\beta}, s^i(\mathbf{x}^{\alpha\beta})) \mid \mathbf{x}^{\alpha\beta} \in U^i, \text{ confidence of prediction} \geq 0.9\}$
- $U^{i+1} = \{\mathbf{x}^{\alpha\beta} \mid \mathbf{x}^{\alpha\beta} \in U^i, \text{ confidence of prediction} < 0.9\}$
- if $i \geq n$ or $U^{i+1} = \emptyset$ then **break**

end

Algorithm 3: The self train random forest algorithm

the ADR class.

5.3.2.2 Semi-supervised Clustering

The semi-supervised clustering technique is proposed for replacing the self-training random forest when there is insufficient number of labelled data. The semi-supervised clustering method has two steps, the first step applies metric learning [211] using the labelled data, X_L^α , to learn a mapping, $M : X \rightarrow X$, of the attribute space that minimises the distance between data-points in the same class while adding a constraint to keep data-points from different classes sufficiently far apart. The second step is the application of the seed-constrained k-means clustering algorithm [7] to determine the clusters using the mapped data, $M(X^\alpha)$, where $X^\alpha = X_U^\alpha \cup X_L^\alpha$. The k-means algorithm uses the labelled data to determine the initial centres of the clusters and fixes the labelled data to a cluster, the unlabelled data-points are then iteratively assigned to the cluster with the closest centre until convergence. Both the metric learning and the semi-supervised k-means algorithm are described in Chapter 2.2.2.1. In detail, the process is:

5. Developing The ADR Learning Framework

1. Apply metric learning with $\mu = 10^{-5}$, $tol = 1 - 10^{-5}$ and $\alpha_t = 0.02$, where:

- $X = X_L^\alpha \cup X_U^\alpha$
- $S = \{(i, j) | (\mathbf{x}_i, y_i), (\mathbf{x}_j, y_j) \in (X_L^\alpha, Y^\alpha), y_i = y_j\}$
- $D = \{(i, j) | (\mathbf{x}_i, y_i), (\mathbf{x}_j, y_j) \in (X_L^\alpha, Y^\alpha), y_i \neq y_j\}$

To output the metric space mapping $M : X \rightarrow X$

2. Apply seed-constrained k-means to $M(X)$, where:

- $K = 2$
- $S_1 = \{M(\mathbf{x}_i) | (\mathbf{x}_i, y_i) \in (X_L^\alpha, Y^\alpha), y_i = 1\}$
- $S_2 = \{M(\mathbf{x}_i) | (\mathbf{x}_i, y_i) \in (X_L^\alpha, Y^\alpha), y_i = -1\}$

To output the final cluster or the distance from the final ADR centre, $\|M(\mathbf{x}_i) - \mu_1\|$, where μ_1 is the centre of the ADR cluster.

The algorithm returns the predicted cluster of the unlabelled data-points or the distance between the data point and the ADR cluster centre.

5.3.2.3 Results and Analysis

The self-training random forest algorithm and semi-supervised clustering algorithm implemented the SSAP framework were both applied to the drugs Nifedipine, Ciprofloxacin and Ibuprofen to analyse the results. For each drug, α_i , the labelled data was extracted, $(X^{\alpha_i}, Y^{\alpha_i}) = \{(\mathbf{x}^{\alpha_i\beta}, Y^{\alpha_i\beta}) | \beta \in RME^{\alpha_i}, Y^{\alpha_i\beta} \neq 0\}$, and randomly partitioned into disjoint training, $(X_L^{\alpha_i}, Y_L^{\alpha_i})$, and validation, $(X_U^{\alpha_i}, Y_U^{\alpha_i})$, sets.

$$(X^{\alpha_i}, Y^{\alpha_i}) = (X_L^{\alpha_i}, Y_L^{\alpha_i}) \cup (X_U^{\alpha_i}, Y_U^{\alpha_i})$$

5. Developing The ADR Learning Framework

$$(X_L^{\alpha_i}, Y_L^{\alpha_i}) \cap (X_U^{\alpha_i}, Y_U^{\alpha_i}) = \emptyset$$

The data input into the algorithms as labelled data was $(X_L^{\alpha_i}, Y_L^{\alpha_i})$ and the data input into the algorithms as unlabelled data was $X_U^{\alpha_i}$. The algorithms were analysed by investigating the ROC plots determined by comparing their predictions on the validation data $\hat{s}(\mathbf{x}), \mathbf{x} \in X_U^{\alpha_i}$ with the truth $Y_U^{\alpha_i}$. Both algorithms were applied for varying values of $crit = |X_L^{\alpha_i}|/|X^{\alpha_i}|$, to investigate if there is an obvious threshold value of $crit$ that can be used to determine which semi-supervised algorithm to apply when the SSAP framework is implemented (i.e., does the self-training algorithm always outperform the semi-supervised clustering when $crit \geq crit_*$?).

Figure 5.8 displays the AUC of the ROC plots obtained by applying the semi-supervised clustering or self-train classifier to the drugs Nifedipine, Ciprofloxacin, and Ibuprofen. The AUCs varied between 0.55–0.88 and 0.53–0.84 for the semi-supervised clustering and self-train classifier respectively. For Nifedipine, both algorithms performed their respective best, with AUCs of 0.80 and 0.88 for the clustering and self-train respectively, when 90% of the data was labelled, whereas for Ibuprofen, both algorithms performed their respective best when only 5% of the data was labelled. This shows that the semi-supervised techniques did not always improve in performance when the value of $crit$ was increased, this is further evident in Figures 5.5-5.6. Furthermore, this suggests that the SSAP framework does not require a large number of labelled data, as, in general, the performance seems to be similar for low and high values of $crit$, but the performance depends on the quality of labelled data.

To investigate how much the initial labels affect the performance, both semi-

5. Developing The ADR Learning Framework

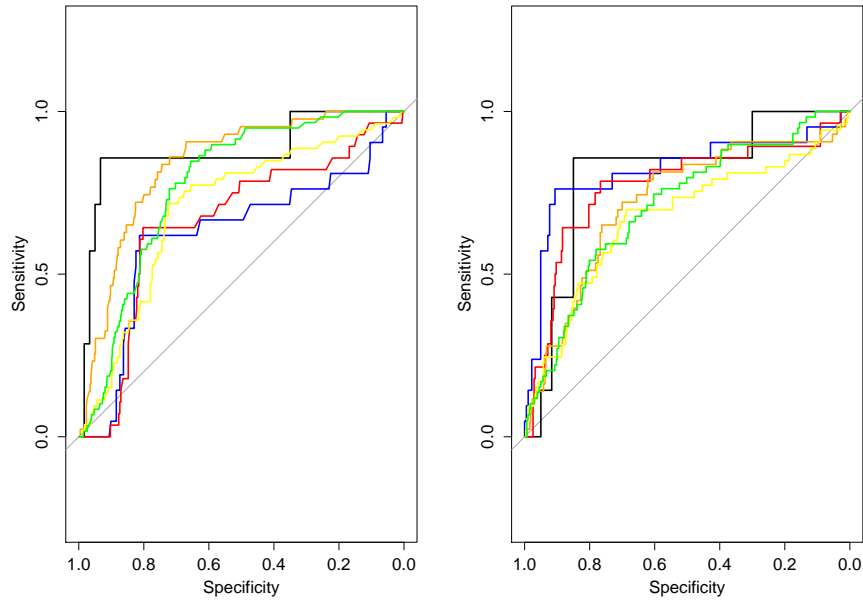

(a) Nifedipine -Left Plot: Self Training, Right Plot: Clustering

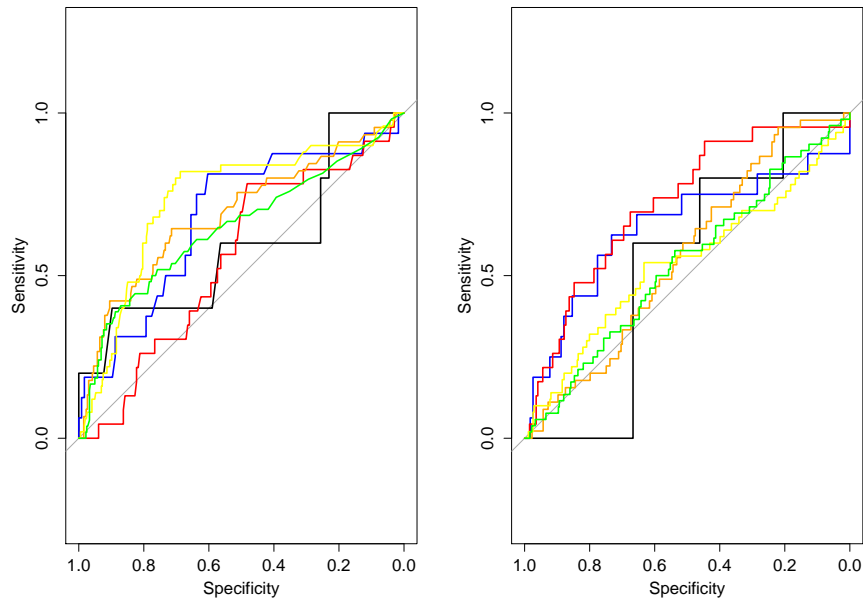

(b) Ciprofloxacin - Left Plot: Self Training, Right Plot: Clustering

Figure 5.5: The ROC curves for the SSAP framework at 6 different values of *crit* when applied to the different drugs. The black, blue, red, orange, yellow and green curve correspond to *crit* values of 0.9, 0.7, 0.5, 0.3, 0.1 and 0.05 respectively.

5. Developing The ADR Learning Framework

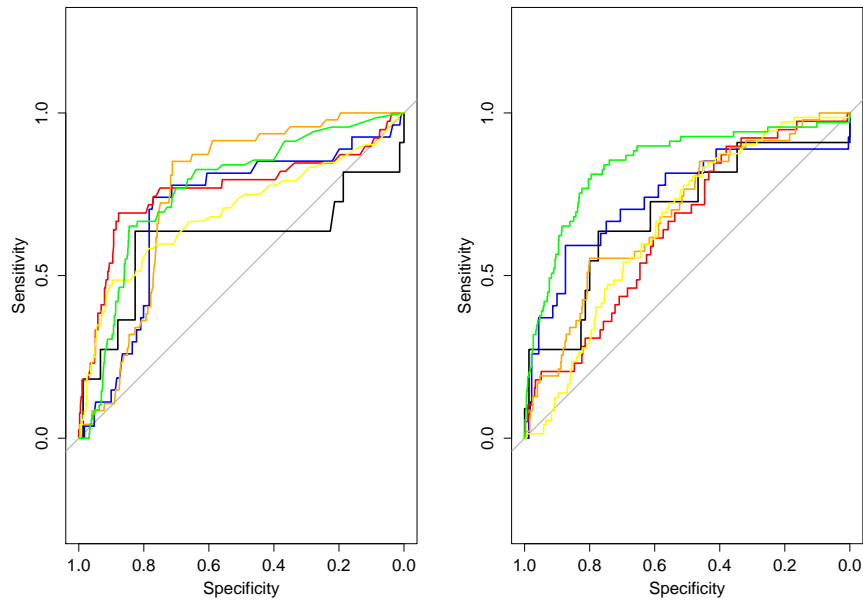

Figure 5.6: The ROC curves for the SSAP framework at 6 different values of *crit* when applied to Ibuprofen. The black, blue, red, orange, yellow and green curve correspond to *crit* values of 0.9, 0.7, 0.5, 0.3, 0.1 and 0.05 respectively. Left Plot: Self Training, Right Plot: Clustering.

5. Developing The ADR Learning Framework

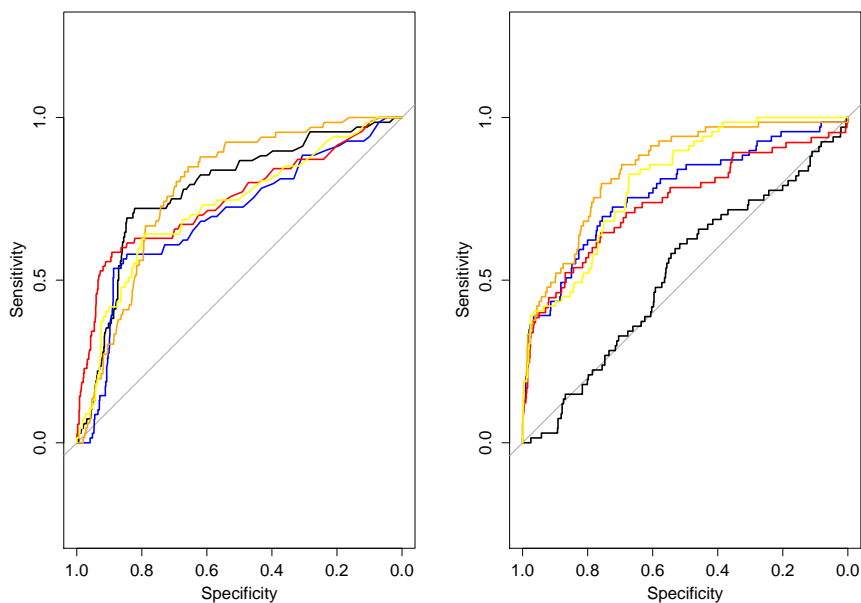

Figure 5.7: The ROC curves for the SSAP framework repeated multiple times for the drug Ibuprofen at a *crit* value of 0.1 to investigate consistency. Left Plot: Self Training, Right Plot: Clustering.

supervised techniques were applied multiple times with a *crit* value of 0.1, but the initial labels were varied. The results are displayed in Figure 5.7. It can be seen that the performance varied each time, and although the semi-supervised clustering produced good results four out of the five times, one time it performed very poorly, worse than random guessing when considering a high specificity. This is probably due to bad initial labels resulting in a poor model that then gets worse as the unlabelled data are incorporated. This is not ideal, as there is no control on the labelled data available, and applying one of the semi-supervised techniques may yield poor results for certain labelled data.

There does not appear to be an optimal value for $crit_*$ so, rather than only applying one of the algorithms, it may be optimal to apply both the semi-supervised clustering and self-trained classifier, and generate signals based on both values.

5. Developing The ADR Learning Framework

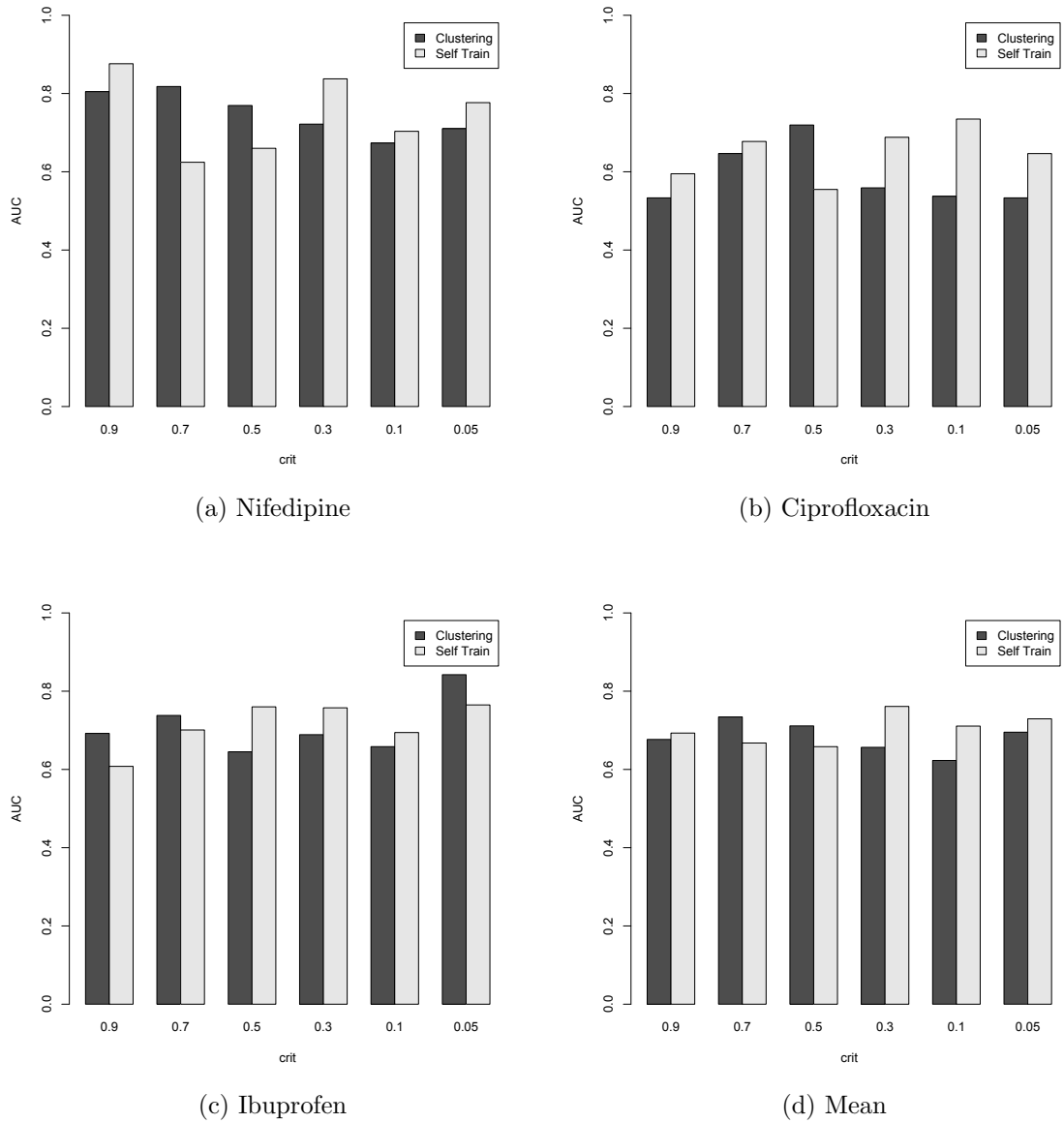

Figure 5.8: The AUC for the ROC plots obtained by applying the semi-supervised clustering and the self training classification within the SSAP framework to the different drugs at varied *crit* values.

5.3.2.4 Summary

The results show that a semi-supervised approach that only uses data for the drug of interest generally performs well but the performance can be affected by initial errors in the self training or metric learning. The consequence is that the SSAP framework is not as consistent as the SAP framework, and although it may occasionally produce better results (depending on the initial labelled data), it may also perform very poorly. It was observed that the SAP algorithm, with the random forest classifier, had a greater AUC than either of the semi-supervised algorithms for all the *crit* values investigated for all three drugs.

Overall, the SAP algorithm produced better and more consistent results. It also has the additional benefit of not requiring knowledge of existing labels for the drug being investigated, unlike the SSAP algorithm.

5.4 Summary

In this chapter two different frameworks were proposed to signal ADRs. The frameworks were then applied to data, where the truth was known, and measures were calculated to determine the suitability of each framework. The first framework implemented a supervised algorithm and was trained using labelled data corresponding to a selection of drugs not being investigated. The second framework used a semi-supervised approach and was train using the labelled and unlabelled data for the drug of interest.

The ROC plots show that the SAP framework, using a random forest classifier, consistently generates superior results. Interestingly, using the labelled data for the drug of interest generally leads to a worse performance. Therefore, the

5. Developing The ADR Learning Framework

conclusion of this chapter is that a general model, that uses Bradford-Hill causality consideration attributes and THIN specific attributes, trained on independent drugs yields the optimal solution. The tentative results suggest such a framework is capable of signalling ADRs with a low false positive rate. It is now of interest to determine how this general model compares with existing ADR signalling algorithms and investigate if it is robust.

Chapter 6

Evaluating The ADR Learning Framework

‘As there is no true gold standard, prospective evaluation of signal detection methods remains a challenge.’

P. M. Coloma[33]

6.1 Introduction

In the previous chapters, a novel idea of automating the application of the Bradford-Hill causality considerations for mass signalling of ADRs was developed. In Chapter 4 the attributes derived from the Bradford-Hill causality considerations were presented, and used as inputs into a learning algorithm in Chapter 5. The tentative results of the novel learning algorithm, named the SAP framework, suggest that training a general classifier using knowledge of existing ADRs on attributes based on the Bradford-Hill causality considerations and THIN specific

6. Evaluating The ADR Learning Framework

attributes may present the opportunity to signal ADRs with a high precision and sufficiently high specificity. In this chapter, the SAP framework is evaluated by applying the specific comparison used in Chapter 3 and also by determining the frameworks ability on the HOI-DOI reference standard, as this enables a general comparison with previous and future work.

As it was hypothesised that the SAP framework will be able to generate new signals that can not be generated by existing methods, the framework will also be applied to the drug-medical event pairs for a selection of drugs that are not definitively known as ADRs or non-ADRs. The signals generated will be presented as this offers another perspective into the effectiveness of the SAP framework and may highlight new ADRs.

6.2 Motivation

The existing methods are known to suffer from the high false positive rate [156] and this means that further investigation needs to be applied to the signals that are generated. If the SAP framework has a low false positive rate, then this additional investigation will not be required, increasing the efficiency of ADR signalling. As the high false positive rate is due to signalling strong associations that are non-causal but occur due to confounding effects, the SAP framework should be more resilient to a high false positive rate as the Bradford-Hill causality considerations should help distinguish between associations due to confounding, and associations due to causation [19].

Evaluating the SAP framework on the standard reference [80] will enable other researchers to readily compare their methods with the SAP framework

6. Evaluating The ADR Learning Framework

and the SAP framework can be compared with previous results. However, this standard reference may be biased due to only considering a selection of HOIs. Therefore, the specific comparison is also applied to evaluate the SAP framework and determine the false positive rate when a larger number of drug-medical event pairs are analysed. If the SAP framework is shown to have a low false positive rate, but this does not inhibit its general ability, then this would be a step forward for pharmacovigilance.

6.3 Evaluation using the Standard Reference

A recent standard reference set has been introduced to enable a fair comparison between methods applied to different databases. The standard reference contains ten DOIs and nine HOIs (discussed in Chapter 2.1.5), and consists of 53 definitively known ADR or non-ADR drug-medical event pairs (9 ADRs and 44 non-ADRs). The SAP framework was applied for each of the 53 drug-medical event pairs on the THIN database and the signals generated by the framework were compared with the known truth.

Previously, the benchmark measures over all the methods and a variety of databases are an AUC of 0.77 and an AP of 0.49, the method obtaining these values had a sensitivity of 0.56, a specificity of 0.82 and a positive predictive value of 0.38 [156]. The previous comparisons have all concluded that existing methods have a high false positive rate (≥ 0.18 [156]). On the THIN database the benchmark values were a sensitivity of 0.67, a specificity of 0.68 and a precision of 0.33 [214].

6.3.1 Method

The SAP framework was evaluated by generating signals for each DOI after training the SAP framework on the other nine DOIs. As some of the DOIs have drugs in common, the drugs used during training were always excluded from the validation to prevent bias. Due to the limited number of drug-medical event pairs available for training, the random forest classifier was found to perform poorly on the reference standard, so the SAP framework with a support vector machine classifier embedded was used instead. It was also found, due to the limited training size, that feature selection was required to reduce the number of attributes used by the SAP framework. The attributes not used were the TPD filter 1 ($x_{15}^{\alpha\beta}$) and TPD filter 2 ($x_{16}^{\alpha\beta}$), LEOPARD ($x_{17}^{\alpha\beta}$), experimentation ($x_{26}^{\alpha\beta}$) and the risk different ($x_4^{\alpha\beta}$ - $x_5^{\alpha\beta}$), risk ratio ($x_7^{\alpha\beta}$ - $x_8^{\alpha\beta}$) and odds ratio ($x_{10}^{\alpha\beta}$ - $x_{11}^{\alpha\beta}$) when only considering the first time the drug is prescribed in 13 months or the first time any drug in the same family is prescribed in 13 months.

6.3.2 Results

Table 6.1 presents the results of the signals generated using the SAP framework for the standard reference. The number of TPs was 6, the number of FPs was 7, the number of FNs (excluding the pair antibiotics and acute liver failure as that was not experienced by any patients in the subsection of the THIN database used) was 2 and the number of TNs was 37. Therefore, at its natural threshold, the SAP framework had a sensitivity of 0.75, a specificity of 0.84, a precision of 0.46 and a false positive rate of 0.16.

The general raking ability measures were a MAP (average AP) score of 0.490,

6. Evaluating The ADR Learning Framework

Table 6.1: The results of the SAP framework with the support vector machine classifier on the 53 standard reference set of DOIs and HOIs.

| | Angi- odema | Aplastic anemia | Acute liver injury | Bleed-GI ing | Hip frac- ture | MI | Death after MI | Renal Fail- ure |
|--------------------------------|----------------|--------------------|--------------------------|-----------------|----------------------|----|----------------------|-----------------------|
| ACE inhibitors | TP | TN | | FP | TN | | | |
| Ampotericin | TN | TN | TN | | TN | | TN | TP |
| Antibiotics | | TN | NO ¹ | TN | | FP | | TN |
| Antiepileptics | TN | FN | | TN | | | TN | TN |
| Benzodiazapine | FP | TN | TN | FP | | TP | FP | FP |
| Beta Blockers | TN | TN | TN | | TN | TN | | TN |
| Bisphosphonates | | TN | TN | | FN | | TN | TN |
| Tricyclic An- tidepressants | | TN | TN | TN | | | TP | TN |
| Typical An- tipsycotics | | | | TN | | | TP | FP |
| Warfarin | TN | TN | | TP | | TN | | TN |

an average AUC of 0.703 and an average P(10) of 0.2875. The DOIs antibiotics and betablockers were not used in the previous calculation due to them having no positive drug-medical event pairs, so the measures are undefined.

6.3.3 Discussion

Previous benchmarks for existing methods using the common data model on the standard reference set were an AP ranging between 0.25 – 0.49 an AUC ranging between 0.59–0.77 and a false positive rate ranging between 0.18–0.89 [156]. The false positive rate of 0.16 returned by the SAP framework was lower than existing methods obtained in previous studies, but the general ranking measures were comparable with the optimal existing methods. Therefore, the results of the SAP framework using the THIN database for the standard reference set show that the

¹This DOI-HOI pair was Not Observable (NO) using the THIN database

6. Evaluating The ADR Learning Framework

SAP framework is able to generate signals as well as the existing methods applied to the common data model but it has a lower false positive rate. This provides evidence to support the hypothesis that generating methods for specific database rather than the common data model may enable new signals to be generated and supports the hypothesis that incorporating knowledge of existing methods and attributes based on causation will reduce the number of false positives generated by the method.

The SAP framework was limited in this evaluation due to the small number of DOIs and HOIs resulting in a small training set. This shows that the SAP framework has even more potential, as when the training size increases, the ability of the classifier will increase and the SAP framework is likely to perform better. As the SAP framework's performance was as good, or maybe better, than existing methods when the training set was small, it is likely to significantly outperform the methods when more DOIs and HOIs are used to train the classifier. The evaluation also highlighted how adaptable the framework it, as it can use any classifier within it, so the most suitable classifier can be chosen based on the situation. Furthermore, the SAP framework only requires the classifier to be tuned and feature selection to be applied, so the number of parameters is relatively low compared to many of the existing methods, making its application more efficient.

6. Evaluating The ADR Learning Framework

| Method | Signal Criteria | Ranking Criteria |
|-----------------------|---|---|
| SAP Framework | Class with most votes | Confidence of class ADR |
| ROR ₀₅ | $ROR_{05} > 1$ | ROR ₀₅ |
| MUTARA ₁₈₀ | $unexlev > 0$ | $unexlev$ |
| HUNT ₁₈₀ | $(unexlev \text{ rank}) / (lev \text{ rank}) > 1$ | $(unexlev \text{ rank}) / (lev \text{ rank})$ |
| TPD | $IC_{\Delta 05} > 0$ | $IC_{\Delta 05}$ |

Table 6.2: The signalling and ranking criteria of the methods.

6.4 Specific Comparison

6.4.1 Method

The specific comparison, as conducted in Chapter 3.7, was repeated for the drugs Nifedipine, Ciprofloxacin, Ibuprofen, Budesonide and Naproxen and including the SAP framework as an additional method. The different criteria used by each method to generate signals or rank the pairs are described in Table 6.2. The specific comparison was chosen to be implemented in addition to evaluating the SAP on the standard reference as this enables a more rigorous evaluation of the SAP’s ability to generate signals with a low false positive rate.

An additional investigating is implemented by applying the SAP framework to the ‘risk’ drug-medical event pairs that are not definitively known as non-ADRs or listed as ADRs on the drug packaging (i.e., the unlabelled drug-medical event pairs). This will enable potentially new ADRs to be discovered.

6.4.2 Results

6.4.2.1 Nifedipine

Natural Thresholds

Table 6.3 displays the ADR signalling methods abilities at their natural thresh-

6. Evaluating The ADR Learning Framework

Table 6.3: The results of the signals generated by the different ADR signalling methods applied to Nifedipine at their natural thresholds.

| Method | TP | FN | FP | TN | Sensitivity | Specificity | Precision | F-Score |
|-----------------------|----|----|-----|-----|-------------|-------------|-----------|---------|
| SAP | 22 | 41 | 8 | 604 | 0.349 | 0.987 | 0.733 | 0.473 |
| ROR ₀₅ | 44 | 36 | 164 | 448 | 0.550 | 0.732 | 0.212 | 0.306 |
| MUTARA ₁₈₀ | 54 | 9 | 267 | 345 | 0.857 | 0.564 | 0.168 | 0.281 |
| HUNT ₁₈₀ | 42 | 21 | 248 | 364 | 0.667 | 0.595 | 0.145 | 0.238 |
| TPD ¹ | 5 | 58 | 11 | 601 | 0.079 | 0.982 | 0.313 | 0.127 |

Table 6.4: The general ranking, Area Under the Curve (AUC), partial AUC ($AUC_{[0.9,1]}$) and Average Precision (AP), results of the different ADR signalling methods applied to Nifedipine.

| Method | AUC | $AUC_{[0.9,1]}$ | AP |
|-----------------------|-------|-----------------|-------|
| SAP | 0.889 | 0.054 | 0.596 |
| ROR ₀₅ | 0.691 | 0.010 | 0.129 |
| MUTARA ₁₈₀ | 0.833 | 0.053 | 0.562 |
| HUNT ₁₈₀ | 0.743 | 0.031 | 0.326 |
| TPD | 0.716 | 0.012 | 0.170 |

old. The existing methods MUTARA₁₈₀, SRS and HUNT₁₈₀ signalled the greatest number of known ADRs, 54, 44 and 42 respectively. However, these methods also incorrectly signalled many non-ADR and had low precision values (0.145–0.212). The SAP framework had the highest precision, 0.733, specificity, 0.987 and F-score, 0.473. This was due to the low number of false positives.

General Ranking

Table 6.4 displays the AUC, $AUC_{[0.9,1]}$ and AP values for the five ADR signalling methods. The SAP framework had the highest AUC, $AUC_{[0.9,1]}$ and AP, with values 0.889, 0.054 and 0.596 respectively. The AUC of the SAP framework was not significantly greater than the AUC for MUTARA₁₈₀ (p-value 0.093), neither

¹The TPD result presented was the optimal result when both the TPD₁ and TPD₂ were applied.

6. Evaluating The ADR Learning Framework

Table 6.5: The results of the signals generated by the different ADR signalling methods applied to Ciprofloxacin at there natural thresholds.

| Method | TP | FN | FP | TN | Sensitivity | Specificity | Presicion | F-Score |
|-----------------------|----|----|-----|-----|-------------|-------------|-----------|---------|
| SAP | 13 | 42 | 0 | 385 | 0.236 | 1.000 | 1.000 | 0.382 |
| ROR ₀₅ | 19 | 36 | 71 | 314 | 0.345 | 0.816 | 0.211 | 0.262 |
| MUTARA ₁₈₀ | 55 | 0 | 327 | 58 | 1.000 | 0.151 | 0.144 | 0.252 |
| HUNT ₁₈₀ | 49 | 6 | 257 | 128 | 0.891 | 0.332 | 0.160 | 0.271 |
| TPD | 4 | 51 | 14 | 371 | 0.073 | 0.964 | 0.222 | 0.110 |

was the $AUC_{[0.9,1]}$ (p-value 0.471). The ROC plots are presented in Figure 6.1.

The worse performing method was the ROR₀₅, with an AUC of 0.691 and an AP of 0.129.

Unlabelled Data Signals

Out 6489 unlabelled drug-medical event pairs containing Nifedipine, 233 were signalled as ADRs by the SAP framework and are displayed in Appendix D. The signals (and the number of patients experiencing them 30 days after the drug) included itching/pruritus (≥ 1976), psoriasis (579), rash (≥ 836), olecranon bursitis (483), depression (≥ 3082), joint pain/arthritis (≥ 3023), appetite loss (203), tiredness (1848), excessive thirst (36), torticollis (71), dizziness (2585) and benign essential tremor (91). There were also heart related signals such as unstable angina (120) and acute myocardial infarction (114).

6.4.2.2 Ciprofloxacin

Natural Thresholds

The methods had variable sensitivities, ranging from 0.073 for HUNT₁₈₀ to 1 for MUTARA₁₈₀ and specificities, ranging from 0.0151 for MUTARA₁₈₀ to 1 for the SAP framework. This suggests their natural thresholds act at varying

6. Evaluating The ADR Learning Framework

Table 6.6: The general ranking, Area Under the Curve (AUC), partial AUC ($AUC_{[0.9,1]}$) and Average Precision (AP), results of the different ADR signalling methods applied to Ciprofloxacin.

| Method | AUC | $AUC_{[0.9,1]}$ | AP |
|-----------------------|-------|-----------------|-------|
| SAP | 0.812 | 0.048 | 0.614 |
| ROR ₀₅ | 0.713 | 0.007 | 0.190 |
| MUTARA ₁₈₀ | 0.851 | 0.042 | 0.547 |
| HUNT ₁₈₀ | 0.716 | 0.033 | 0.406 |
| TPD | 0.713 | 0.011 | 0.140 |

stringencies. The SAP framework was able to signal approximately 25% of the known ADRs and did not signal any non-ADRs. MUTARA₁₈₀ signalled all the 55 known ADRs but also signalled 327 non-ADRs. The TPD performed the worse for Ciprofloxacin, with the lowest F-score of 0.110 compared to the others that ranged from 0.252 – 0.382.

General Ranking

For the drug Ciprofloxacin, MUTARA₁₈₀ had the greatest AUC, 0.851 but the SAP framework performed better when only considering a low specificity, with a $AUC_{[0.9,1]}$ of 0.048. The SAP framework also had the greatest AP value, 0.614 compared to the APs of the other methods (0.140 – 0.547). The AUC of MUTARA₁₈₀s ROC curve was not significantly greater than the AUC of the SAP framework ROC curve (p-values 0.241), neither was the $AUC_{[0.9,1]}$ of the ROC curve for the SAP framework compared to the $AUC_{[0.9,1]}$ of MUTARA₁₈₀s ROC curve (p-value 0.235). The ROC plots for the methods applied to signalled ADRs of Ciprofloxacin can be seen in Figure 6.1.

Unlabelled Data Signals

6. Evaluating The ADR Learning Framework

Table 6.7: The results of the signals generated by the different ADR signalling methods applied to Ibuprofen at there natural thresholds.

| Method | TP | FN | FP | TN | Sensitivity | Specificity | Presicion | F-Score |
|-----------------------|----|----|-----|-----|-------------|-------------|-----------|---------|
| SAP | 23 | 52 | 3 | 783 | 0.307 | 0.996 | 0.885 | 0.455 |
| ROR ₀₅ | 16 | 59 | 242 | 544 | 0.213 | 0.692 | 0.062 | 0.096 |
| MUTARA ₁₈₀ | 69 | 6 | 538 | 248 | 0.92 | 0.316 | 0.114 | 0.202 |
| HUNT ₁₈₀ | 51 | 24 | 522 | 264 | 0.68 | 0.336 | 0.089 | 0.157 |
| TPD | 3 | 72 | 41 | 745 | 0.04 | 0.948 | 0.068 | 0.050 |

Table 6.8: The general ranking, Area Under the Curve (AUC), partial AUC ($AUC_{[0.9,1]}$) and Average Precision (AP), results of the different ADR signalling methods applied to Ibuprofen.

| Method | AUC | $AUC_{[0.9,1]}$ | AP |
|-----------------------|-------|-----------------|-------|
| SAP | 0.903 | 0.057 | 0.654 |
| ROR ₀₅ | 0.473 | 0 | 0.076 |
| MUTARA ₁₈₀ | 0.845 | 0.045 | 0.498 |
| HUNT ₁₈₀ | 0.595 | 0.020 | 0.196 |
| TPD | 0.654 | 0.002 | 0.102 |

The signals generated by the SAP framework applied to the drug Ciprofloxacin are listed in Appendix D. Out of 3574 unlabelled drug-medical event pairs containing Ciprofloxacin, 125 pairs were signalled as corresponding to ADRs. Some of the interesting signals include hypothyroidism (324), depressed mood (625), oral aphthae (285), muscle injury/strain (46), congestive heart failure (542), Incoordination symptom (807), candidal balanitis (67), confused (434), achilles tendinitis (130), left ventricular failure (318) and panic disorder (192).

6.4.2.3 Ibuprofen

Natural Thresholds

The results of the methods applied to Ibuprofen at their natural threshold are presented in Table 6.7. It can be seen that MUTARA₁₈₀ was able to signal the

6. Evaluating The ADR Learning Framework

majority of known ADRs (69/75) at its natural threshold but it also signalled 538 non-ADRs. The SAP framework signalled less, approximately 30% of the known ADRs (23/75), but managed to only signal 3 non-ADRs, this resulted in the SAP framework obtaining the greatest precision, 0.885 and F-score, 0.455.

General Ranking

The SAP framework had the greatest AUC, 0.903, and $AUC_{[0.9,1]}$, 0.057, and these were significantly greater than the AUC and $AUC_{[0.9,1]}$ corresponding to the second best method MUTARA₁₈₀, with an AUC value of 0.845 and a $AUC_{[0.9,1]}$ of 0.045 (p-values 0.037 and 0.044 respectively). The SAP framework also had the greatest AP value, 0.654 compared with 0.498, 0.196, 0.102 and 0.076 corresponding to MUTARA₁₈₀, HUNT₁₈₀, TPD and the ROR₀₅ respectively. These general ranking measures are contained in Table 6.8. The ROR₀₅ actually performed worse than random guessing, with an AUC value under 0.5 and was unable to signal any known ADRs at a high specificity as its $AUC_{[0.9,1]}$ was 0.

Unlabelled Data Signals

When the SAP framework was applied to unlabelled data corresponding to Ibuprofen, there was a total of 200 signals out of a possible 7700. The signalled pairs included the medical events Nausea (3084), rash (≥ 6155), tiredness symptom (2937), Gout (3709), essential hypertension (7883), Candidiasis (3488), Cough (1180), palpitations (1860), shortness of breath (2489), vomiting (170), patient's condition improved (22539) and myalgia (2246). A complete list of signals is contained in Appendix D.

6. Evaluating The ADR Learning Framework

Table 6.9: The results of the signals generated by the different ADR signalling methods applied to Budesonide at there natural thresholds.

| Method | TP | FN | FP | TN | Sensitivity | Specificity | Presicion | F-Score |
|-----------------------|----|----|-----|-----|-------------|-------------|-----------|---------|
| SAP | 26 | 26 | 0 | 535 | 0.5 | 1 | 1 | 0.667 |
| ROR ₀₅ | 23 | 29 | 360 | 175 | 0.442 | 0.327 | 0.060 | 0.106 |
| MUTARA ₁₈₀ | 49 | 3 | 308 | 227 | 0.942 | 0.424 | 0.137 | 0.240 |
| HUNT ₁₈₀ | 38 | 14 | 258 | 277 | 0.731 | 0.518 | 0.128 | 0.218 |
| TPD | 1 | 51 | 12 | 523 | 0.019 | 0.978 | 0.077 | 0.031 |

Table 6.10: The general ranking, Area Under the Curve (AUC), partial AUC ($AUC_{[0.9,1]}$) and Average Precision (AP), results of the different ADR signalling methods applied to Budesonide.

| Method | AUC | $AUC_{[0.9,1]}$ | AP |
|-----------------------|-------|-----------------|-------|
| SAP | 0.937 | 0.070 | 0.767 |
| ROR ₀₅ | 0.705 | 0.002 | 0.059 |
| MUTARA ₁₈₀ | 0.855 | 0.052 | 0.544 |
| HUNT ₁₈₀ | 0.707 | 0.025 | 0.232 |
| TPD | 0.696 | 0.003 | 0.105 |

6.4.2.4 Budesonide

Natural Thresholds

Table 6.9 displays the results of the signals generated for Budesonide by the methods at their natural threshold. The SAP framework did not signal the most known ADRs, MUTARA₁₈₀ signalled 49 out of 52 known ADRs, but it was able to signal 50% and all the signals were correct (0 false positives). MUTARA₁₈₀ signalled 308 false positives, so only 49 out of the 357 signals generated by MUTARA₁₈₀ correspond to known ADRs. The TPD generated the least number of signals, 13 in total, and only 1 corresponded to a known ADRs, making it the wore performing method. The F-score of the SAP framework, 0.667, was over double the other methods' F-scores, in the range [0.031, 0.240].

6. Evaluating The ADR Learning Framework

General Ranking

The SAP framework performed excellently on the drug Budesonide with an AUC of 0.937, a $AUC_{[0.9,1]}$ of 0.070 and a AP of 0.767. Both the AUC and the $AUC_{[0.9,1]}$ of the SAP framework was significantly greater than the AUC and the $AUC_{[0.9,1]}$ of MUTARA₁₈₀ (p-values 0.0126 and 0.022 respectively), the second best performing method with an AUC of 0.855 and a $AUC_{[0.9,1]}$ of 0.0524. The results for all the methods are presented in Table 6.10. The methods that obtained the lowest ranking performance were the TPD and ROR₀₅, although their AUC values were approximately 0.7, suggesting all the methods performed well for Budesonide.

Unlabelled Data Signals

There were a total of 206 signals out of a possible 5219 generated by the SAP framework when applied to unlabelled drug-medical events pairs containing Budesonide. A selection of the interesting medical events signalled as ADRs to Budesonide are micturition frequency (892), constipation (2650), pain/backache (2397), accidental falls (1513), incoordination symptom (1407), dermatitis (≥ 1739), dead (125), heartburn (634), impotence (607), essential hypertension (2258), appetite loss (82), bloating (71), drug and other substances-adverse effects in therapeutic use (281), alopecia unspecified (100), tremor (201) and patient's condition worsened (927). For a list of all the signalled medical events see Appendix D.

6.4.2.5 Naproxen

Natural Thresholds

The SAP framework was able to signal approximately 40% of the known ADRs and out of the signals generated, 89% corresponded to known ADRs and only 11%

6. Evaluating The ADR Learning Framework

Table 6.11: The results of the signals generated by the different ADR signalling methods applied to Naproxen at there natural thresholds.

| Method | TP | FN | FP | TN | Sensitivity | Specificity | presicion | F-Score |
|-----------------------|----|----|-----|-----|-------------|-------------|-----------|---------|
| SAP | 31 | 49 | 4 | 446 | 0.388 | 0.991 | 0.886 | 0.539 |
| ROR ₀₅ | 25 | 55 | 182 | 268 | 0.313 | 0.596 | 0.121 | 0.174 |
| MUTARA ₁₈₀ | 72 | 8 | 293 | 157 | 0.9 | 0.349 | 0.197 | 0.324 |
| HUNT ₁₈₀ | 54 | 26 | 274 | 176 | 0.675 | 0.391 | 0.165 | 0.265 |
| TPD | 6 | 74 | 15 | 435 | 0.075 | 0.967 | 0.286 | 0.119 |

Table 6.12: The general ranking, Area Under the Curve (AUC), partial AUC ($AUC_{[0.9,1]}$) and Average Precision (AP), results of the different ADR signalling methods applied to Naproxen.

| Method | AUC | $AUC_{[0.9,1]}$ | AP |
|-----------------------|-------|-----------------|-------|
| SAP | 0.883 | 0.055 | 0.700 |
| ROR ₀₅ | 0.510 | 0.000 | 0.136 |
| MUTARA ₁₈₀ | 0.793 | 0.036 | 0.503 |
| HUNT ₁₈₀ | 0.628 | 0.020 | 0.325 |
| TPD | 0.706 | 0.008 | 0.209 |

corresponded to non-ADRs. MUTARA₁₈₀ was able to signal 90% of the known ADRs, but only 20% of the total signals corresponded to ADRs, the remaining 80% were non-ADRs. The SAP framework had the greatest F-score, 0.539, with the other methods obtaining 0.324, 0.265, 0.174 and 0.119 for MUTARA₁₈₀, HUNT₁₈₀, the ROR₀₅ and TPD respectively. These results are presented in Table 6.11 and the ROC plots are displayed in Figure 6.1.

General Ranking

The general ranking performance of the methods varied when applied to Naproxen, this can be seen in Table 6.12. The SAP framework and MUTARA₁₈₀ performed well, obtaining AUC values of 0.883 and 0.793 respectively and $AUC_{[0.9,1]}$ values of 0.055 and 0.036 respectively. The SAP framework's AUC was significantly greater

6. Evaluating The ADR Learning Framework

than MUTARA₁₈₀'s AUC (p-value 0.012), as was its $AUC_{[0.9,1]}$ (p-value 0.007). The SAP frameworks' AP was greater than the other methods, 0.7, compared with the other methods ranging from 0.136 (ROR₀₅) to 0.503 (MUTARA₁₈₀). The ROR₀₅ performed poorly, with an AUC of 0.51, not much improvement on random guessing, and a $AUC_{[0.9,1]}$ of 0, showing it was not able to signal any known ADRs when the specificity is high.

Unlabelled Data Signals

When the SAP framework was applied to the 4540 unlabelled drug-medical event pairs containing the drug Naproxen, a total of 302 pairs were signalled as corresponding to ADRs. For a list of all the medical events contained in these drug-medical event pairs see Appendix D. The medical events of interest are depression (1677), abdominal pain (1077), acquired hypothyroidism (588), anxiety states (707), breathlessness (873), hoarse (172), nausea present (232), constipation (308), unstable angina (24), vomiting (38), left ventricular failure (230), obstructive jaundice (13), acute retention of urine (13), acute non-ST segment elevation myocardial infarction (27), ocular hypertension (147), drug stopped-medical advice (529), spasms (14), congestive heart failure (368) and atria flutter (20).

6.4.3 Discussion

The SAP framework had a greater AUC value for four out of the five drugs investigated and a greater $AUC_{[0.9,1]}$ for all five drugs, compared to the existing methods. The AUC and $AUC_{[0.9,1]}$ was significantly greater, at a 5% significance

6. Evaluating The ADR Learning Framework

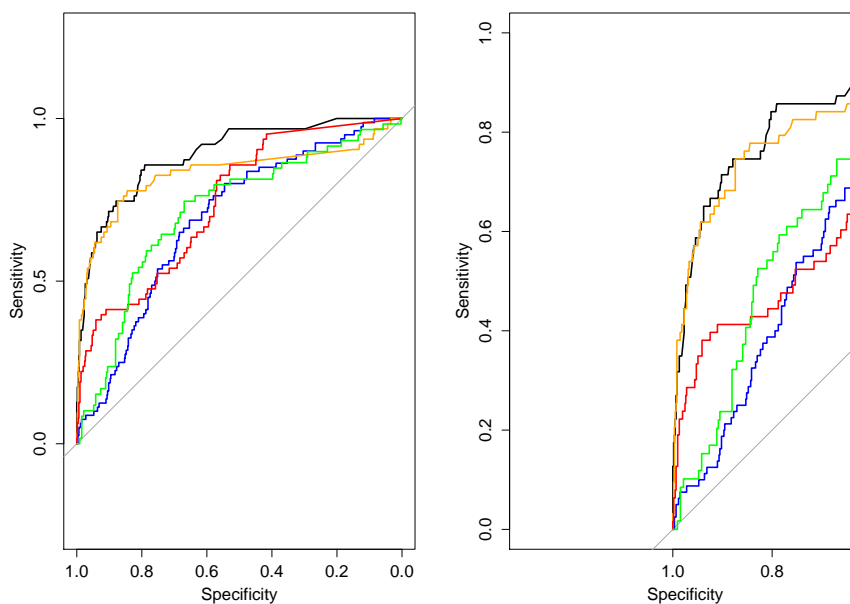

(a) Nifedipine

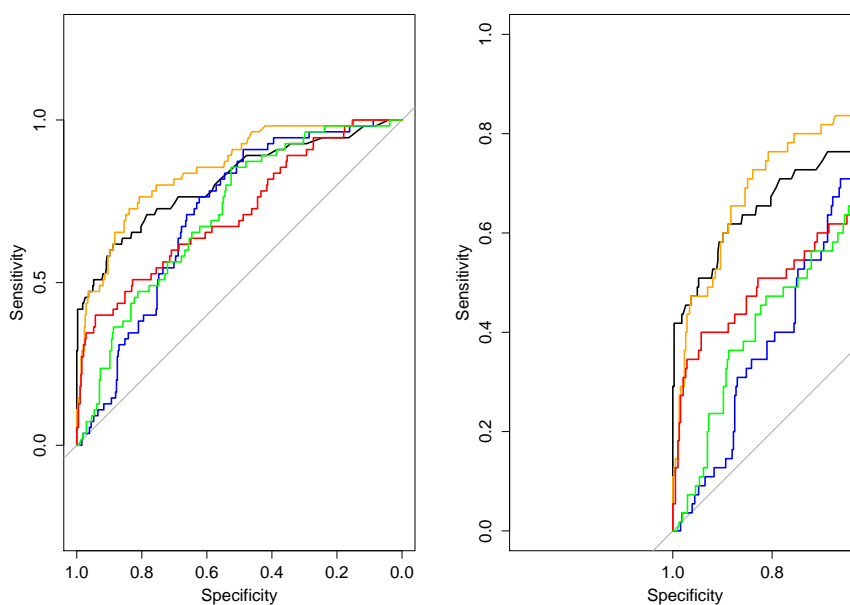

(b) Ciprofloxacin

Figure 6.1: The ROC plots for the SAP algorithm, implementing a random forest (black) and the existing methods MUTARA₁₈₀ (orange), HUNT₁₈₀ (red), TPD (green) and ROR₀₅ (blue).

6. Evaluating The ADR Learning Framework

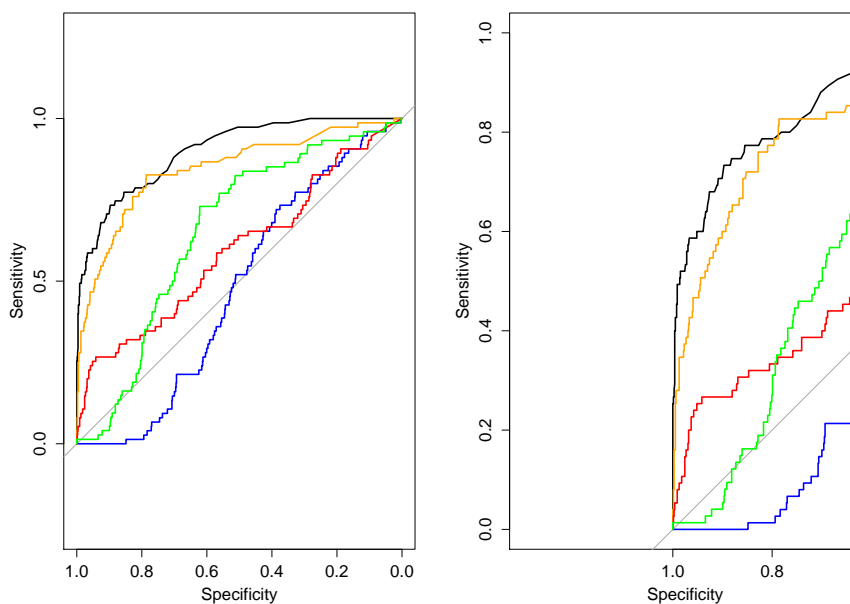

(c) Ibuprofen

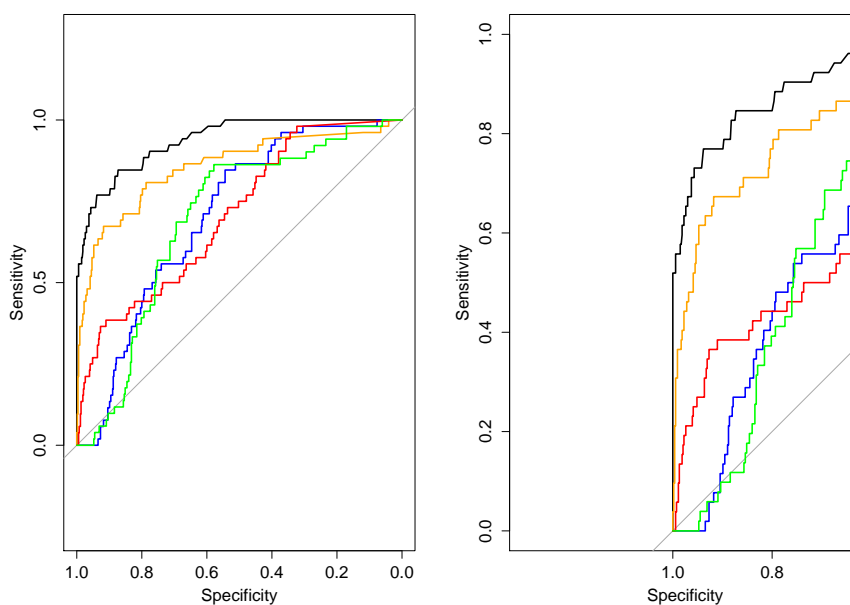

(d) Budesonide

Figure 6.1: The ROC plots for the SAP algorithm, implementing a random forest (black) and the existing methods MUTARA₁₈₀ (orange), HUNT₁₈₀ (red), TPD (green) and ROR₀₅ (blue).

6. Evaluating The ADR Learning Framework

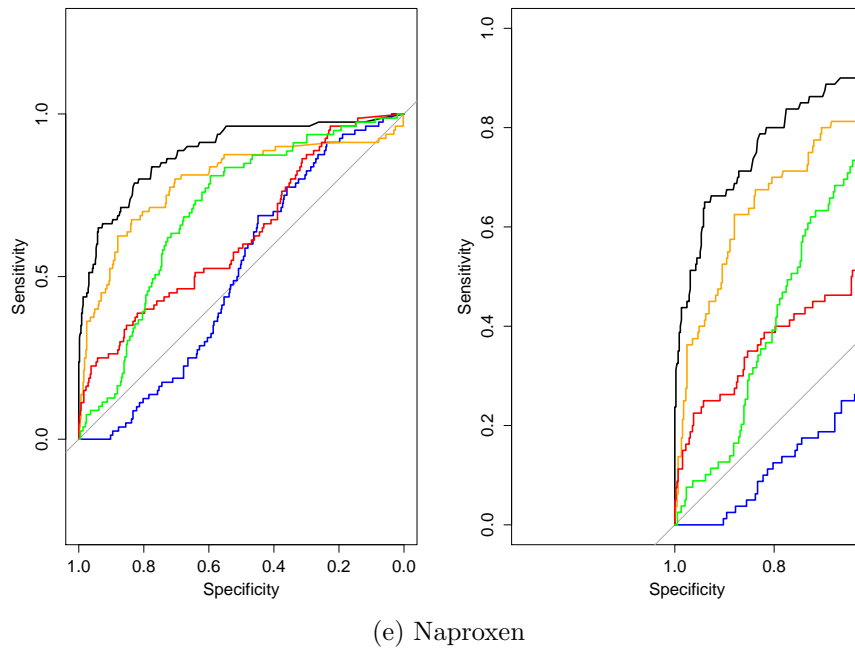

Figure 6.1: The ROC plots for the SAP algorithm, implementing a random forest (black) and the existing methods MUTARA₁₈₀ (orange), HUNT₁₈₀ (red), TPD (green) and ROR₀₅ (blue).

6. Evaluating The ADR Learning Framework

level, for three of the five drugs (Ibuprofen, Budesonide and Naproxen). This suggests that the SAP framework is overall better at ranking ADRs. As the SAP framework's $AUC_{[0.9,1]}$, the AUC when the specificity is high and the false positive rate is low, was always greater than the existing methods, this shows that the SAP framework is able to signal ADRs more precisely. This is also evident by the AP score of the SAP framework being greater than the existing methods for all five drugs, resulting in an overall Mean Average Precision (MAP) score of 0.667 compared to 0.531, 0.297, 0.145 and 0.118 corresponding to MUTARA₁₈₀, HUNT₁₈₀, TPD and ROR₀₅ respectively.

The SAP framework was able to signal a high percentage of ADRs while maintaining a low number of false positives. Although MUTARA₁₈₀ signalled more ADRs, it also signalled many false positives. Over all five drugs, the number of SAP and MUTARA₁₈₀ signals that were true positives were 115 and 299 respectively, but the number of false positives were 15 and 1733 respectively. Therefore, 88.5% of the SAP framework signals are likely to correspond to ADRs, while only 14.7% of MUTARA₁₈₀'s signals are likely to be ADRs. This means MUTARA₁₈₀'s natural threshold signals probably need additional filtering, whereas this is not necessary when the SAP framework is implemented.

Overall, the SAP framework managed to signal 115 out of the 325 ADRs. This corresponds to a minimum of 35.4% of the ADRs being identified, as READ code redundancy may mean that some of the 64.6% remaining non-signalled ADRs READ codes may correspond to the same medical event as the signalled READ codes. This value may be further improved by training the SAP framework on more drugs, or by adding additional attributes based on the remaining Bradford-Hill causality considerations (consistency, plausibility and coherence). The SAP

6. Evaluating The ADR Learning Framework

framework was also able to signal medical events that had a low frequency during the 30 day period after the drug, and medical events with a high background rate such as depression and myocardial infarction. These medical events are often difficult to signal by the existing SRS methods [70] as the association strength is often very weak.

The TPD, HUNT₁₈₀ and ROR₀₅ performed worse than the SAP framework and MUTARA₁₈₀. The methods were unable in general to signal ADRs without being swamped by false positives and obtained MAP scores of less than 0.5, suggesting their general ranking ability was poor on the drug-medical event pairs investigated. The TPD method may have been inhibited as it only analyses patients that have a long medical history, due to it investigating the 27 months to 21 month time period prior to the prescription. Therefore, the amount of data available for the TPD algorithm may have been smaller relative to other methods. The natural threshold of HUNT₁₈₀ > 1 appeared to act at a similar stringency as MUTARA₁₈₀ suggesting this is a good threshold to apply.

It is clear that the SAP framework was consistent over the drugs investigated and did not perform poorly on any instance. MUTARA₁₈₀ also returned consistent results, however, the other three existing methods returned mixed results. They performed poorly for Naproxen and Ibuprofen, with the ROR₀₅ being worse than random guessing and TDP performing little better.

When the SAP framework was applied to the unlabelled data corresponding to the five drugs it was able to signal many suspected ADRs and highlighted some potentially new ADRs. The results obtained from the unlabelled data were very promising but require further evaluation to confirm causality. The SAP framework successfully signalled known ADRs with obscure descriptions, and

this is additional evidence to support its ability.

6.5 Summary

The results of the SAP framework applied on the standard reference set of 53 drug-medical event pairs provide evidence that the SAP framework is able to signal ADRs with a low false positive rate. The results of applying the SAP framework on a subset of the THIN database and the results of applying existing method to the common data model are comparable. This is impressive as the common data model contains more data than the subset of the THIN database used through this research. The results provide evidence to support the argument that methods should be developed for specific databases to utilise the whole data, as it is known that information can be lost when transforming LODs into the common data model [214]. It is also clear that single databases in their raw form are useful sources for pharmacovigilance. The results also show that introducing attributes based on the Bradford-Hill causality considerations to tackle the problem of confounding can reduce the number of false positives signals.

The results of the specific comparison show that the novel SAP framework outperforms the existing methods evaluated in this thesis (MUTARA₁₈₀, HUNT₁₈₀, ROR₀₅ and TPD) and signalled ADRs with a low false positive rate. The SAP framework appears to be the first ADR signalling technique that has manage to signal a sufficient number of ADRs using LODs while obtaining a low false positive rate. This is an improvement over current pharmacovigilance techniques applied to LODs and may increase the efficiency in discovering ADRs. Possible

6. Evaluating The ADR Learning Framework

reasons for the SAP framework's performance are the inclusion of Bradford-Hill causality consideration attributes and attributes specific to the THIN database or its ability to learn from known ADRs.

The SAP framework was able to generate new ADR signals, but further analyse needs to be performed before the the signals can be confirmed as true or not. The benefit of the SAP framework is that prior results can be used to update the framework as the signals it generates are confirmed as ADRs or non-ADRs. The SAP framework's performance should increase over time as the number of known definitive ADRs or non-ADRs increases.

Chapter 7

Conclusions

This thesis has focused on developing an ADR signalling framework, specifically for the THIN database, that can identify ADRs with a low false positive rate. It was determined that the current ADR signalling techniques, applied to the THIN database, had a high false positive rate and the majority of signals were non-ADRs. The plausible reasons for this were that the existing methods cannot distinguish between causation and association and they do not take into account the hierarchal structures embedded within the THIN database.

To overcome this issue of the methods signalling ADRs based on the strength of association rather than causation, a generalisation of the technique of considering the Bradford-Hill causality considerations to determine signals was proposed. The technique was generalised by calculating attributes based on five of the Bradford-Hill causality considerations (association strength, temporality, biological gradient, specificity and experimentation), using the THIN database, and then using knowledge of existing ADRs to find patterns embedded within the attribute values that could be used to signal ADRs. By applying a learning technique, a sixth Bradford-Hill factor, analogy, is also indirectly incorporated. Furthermore, attributes that incorporated knowledge of the THIN hierarchal structures were

also proposed and used as attributes into the learning algorithm. These attributes helped identify medical events that occurred before the drug was taken but then progressed or were recorded inconsistently.

It was shown that the SAP framework, a classifier trained using data consisting of Bradford-Hill causality considerations and THIN specific attributes corresponding to drug-medical event pairs that are known ADRs or non-ADRs, can be applied to a different drug-medical event pair to determine if the pair is an ADR or not with an specificity of 0.75 and a sensitivity of 0.84. The natural threshold false positive rate was lower than existing methods, showing that the SAP framework overcomes the current limitation of a high false positive rate that plagues the existing ADR signalling methods for LODs.

In the continuation of this chapter the contributions of this work are summarised, and suggestions are made for future directions of work to follow on from this research. The dissemination of this research is reported in the conclusion of this chapter.

7.1 Contributions

This thesis has made the following contributions:

- **Determined the benchmark for the existing methods on the THIN database**

There is no golden standard for signalling ADRs [179] due to the lack of definitive knowledge of existing ADRs for each drug. In [214], the authors applied a selection of ADRs signalling techniques to the raw THIN database and a mapped version of the database to determine if signals are lost during

the mapping. This was the first example of the THIN database being investigated for ADR signal detection. Benchmarks for the standard reference using the raw THIN database were determined, but the authors did not apply an extensive analysis and the standard reference may contain bias.

In Chapter 3, an extensive analysis was conducted by applying a selection of existing ADR signalling methods (Reporting Odds Ratio, Temporal Pattern Discovery, Mining Unexpected Temporal Association Rules given the Antecedent and Highlighting Unexpected temporal association rules Negating Temporal association rules) to the THIN database and analysing the signals with two different perspectives. The ROR and TPD had been compared with other methods in numerous studies [156] [80] and the authors concluded that the methods performed similarly, so rather than applying all the existing methods, only these two were chosen. MUTARA and HUNT had not be incorporated in any previous comparison, so they were also added to the investigation. The previous comparisons had concluded that the methods had a high false positive rate [156] and this limited there ability.

The comparisons conducted in this research showed, consistent with previous results, that the four existing method had a high false positive rate. An interesting result was that their performance deteriorated when the number of drug-medical event pairs being investigated increased, although this may be partially due to the effect of unknown ADRs causing their results to seem worse than they are. When considering a smaller subset the drug-medical event pairs, where only definitively known ADRs or non-ADRs are

included, the benchmark AUC, $AUC_{[0.9,1]}$, AP, were 0.770, 0.032, 0.315 respectively. The sensitivity and specificity ranged between 0.061 – 0.894 and 0.0366 – 0.959 respectively.

The comparison suggested that the existing ADR signalling methods are unsuitable for signalling ADRs using the THIN database due to the large number of false positive signal generated. It would be difficult to extensively investigate each signal generated and the majority of them would be false.

- **Proposed suitable attributes to distinguish association from causation**

The THIN database is a LOD containing prescription and medical histories for millions of patients. It offers the potential to infer temporal causal relationships between drugs and medical events, but no ADR signalling technique had been developed specifically for the THIN database. Existing methods, developed for alternative databases, determine the association strength between a drug-medical pair and signal the pairs with the greatest association. This causes a high false positive rate, as many medical events can be highly associated to a drug due to non-causal reasons. When investigating a single drug-medical event pair, researchers have often considered the Bradford-Hill causality considerations to draw conclusions [164]. As the THIN database contains data that can be used in consideration of many Bradford-Hill causality considerations, in this work, a generalisation and automation of this idea was proposed by extracting Bradford-Hill causality considerations based attributes from the THIN database. The attributes were then used as inputs into a learning algorithm. This is the

first attempt of such an approach.

The attributes proposed in Chapter 4 are a mixture of existing and novel calculations to cover five of the Bradford-Hill causality considerations, namely, association strength, temporality, specificity, biological gradient and experimentation. The association strength based attributes and the majority of the temporality attributes were extracted from existing pharmacovigilance methods. The specificity, biological gradient, experimentation and temporality BA ratios are all novel attributes that were developed in this work. As this work was focussing on a ADR signalling technique, specifically for the THIN database, novel attributes were also presented in Chapter 4 to deal with the hierarchal structure within the THIN data. It was concluded in Chapter 3 that the existing methods struggle with illness progressions or redundancy within the THIN database. By using the THIN medical event hierarchy, attributes were proposed that identify medical events that are more detailed or similar to medical events that were reported before the drug. Different attributes may be required for different healthcare databases, depending on any database specific issues that are identified.

- **Developed a novel supervised/semi-supervised technique for causal inference using THIN**

After proposing the novel learning algorithm for signalling ADRs, the focus fell on what would be better, to develop a supervised classifier that is trained on labelled data corresponding to a collection drugs or to apply a semi-supervised algorithm that is trained on both labelled and unlabelled data for the drug being investigated?

In previous work, [5] and [113], researchers have trained classifiers to signal ADRs using chemical data and known ADRs. It was shown that these techniques attained a high recall and precision and the results provided evidence that incorporating knowledge of ADRs into models improves performance. The existing methods for signalling ADRs using LODs are unsupervised and do not incorporate knowledge of existing ADRs.

In Chapter 5, two learning algorithm frameworks, that use the attributes derived from the THIN data (described Chapter 4), were presented. The supervised technique, the SAP framework, applied a classifier that is trained on labelled data corresponding to various drugs. The semi-supervised technique, the SSAP framework, applied either a self-train random forest or a semi-supervised clustering technique to both the unlabelled and labelled data of a single drug. It was concluded that the SAP framework outperformed the SSAP self-train and semi-supervised approach and the SAP framework returned consistent results. This was the first attempted of implementing supervised or semi-supervised techniques to infer ADRs using a LOD.

The SAP framework consistently returned a low false positive rate, even when the training set was small. As the consuming element of the SAP framework is the training aspect, the SAP framework is highly efficient once trained and training rarely needs to occur. The SAP framework was also shown to be robust, as it was consistently able to signal ADRs with a low false positive rate over a range of drugs.

- **Evaluated the SAP framework on the THIN database**

In Chapter 6 the SAP framework was compared with the TPD, ROR, MUTARA and HUNT methods for a range of drugs using the THIN database. The results confirmed that the SAP framework, using Bradford-Hill causality considerations and THIN specific attributes and learning from known ADRs, was able to signal ADRs with a low false positive rate, unlike the existing methods. The SAP framework obtained a greater Average Precision and $AUC_{[0.9,1]}$ for all the drugs investigated. The current benchmarks, set by the SAP framework, for ADR signalling methods using the THIN database are a MAP of 0.667, a sensitivity of 0.354 and a precision of 0.885. These results provided evidence to confirm the second hypothesis, that novel ADR signalling algorithms applied to the THIN database will outperform existing methods if they deal with the hierarchical structures in the THIN database, incorporate causality based attributes and learn from existing ADRs.

The SAP framework was able to generate new ADRs signals when it was applied to unlabelled drug-medical event pairs. This supports the third hypothesis. Unfortunately, additional analysis is required to confirm if the signals are true or false.

The SAP framework's ability on the OMOP DOI-HOI standard reference containing ten DOIs and nine HOIs was limited by the training size available. However, the SAP framework's ability to generate ADR signals using the THIN database was comparable to the existing methods' ability using the common data model. This is an impressive result as the common data model contains more data, and the SAP framework obtained a lower

false positive rate than existing methods. The performance of the SAP framework is likely to improve as the training size increases, so the SAP framework is likely to outcompete the existing methods when a larger standard reference set is developed. Therefore, the fourth hypothesis, that the SAP framework will outcompete the existing methods when considering the standard reference, cannot be currently confirmed but the results do provide limited evidence to support it.

7.2 Future Work

The areas of research that follow on from this research are now presented.

- **Generating attributes for the remaining Bradford-Hill causality considerations**

In Chapter 4, attributes were developed that cover five of the nine Bradford-Hill causality considerations. The sixth, analogy, was indirectly incorporated due to using a supervised technique that looks for patterns within ADRs. The remaining considerations are consistency, plausibility and coherence. Future work could aim to generate new attributes to cover these remaining considerations. Possible suggestions for suitable attributes are, to calculate the strength of association in different databases, such as SRS databases, for the consistency factor or to incorporate attributes relating to chemical structure knowledge, such as in [113], for the coherence factor. There are two possible ideas to determine attributes for plausibility. The first idea is to mine the web, such as medical forums, and identify if the drug-medical event pair have been frequently mentioned as corresponding

to a possible ADR. In [202], the authors have used text mining techniques to identify ADRs and this idea could be adapted. The second idea is to indirectly tackle plausibility by ruling out other possibilities, this could be done by applying sequential pattern mining and filtering the explainable medical events (medical events that have progress from a prior illness).

- **Combining the SAP and SSAP frameworks using an ensemble**

In this research a supervised framework and a semi-supervised framework were proposed in Chapter 5. Four classifiers, support vector machine, random forest, naive Bayes and logistic regression and two semi-supervised algorithms, self-trained random forest and semi-supervised k-means were applied to the data and analysed. The results showed that the random forest classifier performed the best, so this was selected and used in Chapter 6, although when the training set was small, the support vector machine classifier performed better. Future work could involve investigating an ensemble technique that uses the prediction of all the learning algorithms developed in Chapter 5 to get a final aggregated prediction.

- **Quantifying the ADRs**

This research has produced a framework that can efficiently and precisely signal ADRs. Using this framework to signal the ADRs, the signalled ADRs could then be investigated and the additional risk of having the medical event due to taking the drug could be determined. This follow up work would add accurate quantitative information to ADRs, something that is currently lacking [171].

- **Identifying risk factors corresponding to the ADRs**

In addition to quantifying the ADRs, the signals could also be investigated to determine risk factors. Possible methods of achieving this would be to apply association rule mining [213] to the patients' sets of medical history for all the patients taking the drug and all the patients taking the drug and experiencing the ADRs, and then identify the rules that occur more frequently in the patients experiencing the ADR.

- **Make the SAP framework run in realtime**

The causal based attributes for each drug-medical event pair could be stored such that when new therapy and medical records are added to the database the attributes are updated. The SAP framework could then be applied to determine if the signal status of any drug-medical event pair has changed. The learning model used within the SAP framework could also be re-trained after a sufficient amount of new data is added, and could incorporate new labels as addition ADR knowledge is gained.

- **Removing the redundancy in the READ codes**

The READ code structure has redundancy and there are multiple READ codes for the same medical event. This causes issues when trying to aggregate how frequently a medical event occurs after the drug of interest for the same population as the redundancy partitions the medical event and these partitions have smaller frequencies than if they were all grouped together. If future work aimed to develop an algorithm that could group the READ codes that correspond to the same medical event together, the results of the ADR signalling algorithms on the THIN database would improve.

- **Adapting the framework to identify drug-drug interactions**

Many researchers have identified the requirement of identifying drug-drug interactions ADRs. The THIN databases contains data that may be used to signal drug-drug interaction ADRs and the SAP framework can readily be adapted. Future work could aim to identify when a patient is taking two drugs within a similar time interval and then, for drug A, drug B and medical event 1, generate the attributes developed in Chapter 4 for three different prescription situations, the first would be patients only taking drug A, the second would be for patients only taking drug B and the third would be patients taking both drugs. The three sets of attributes could be combined into one data-point corresponding to drug A, drug B and the medical event 1.

7.3 Dissemination

A list of publications that have been the result of this research are listed below.

7.3.1 Journal Papers

Submitted

- **Jenna M. Reps, Jonathan M. Garibaldi, Uwe Aickelin, Daniele Soria, Jack E. Gibson and Richard B. Hubbard.** *A Bradford-Hill causality criteria based side effect signalling framework* . Submitted to IEEE Transactions on Knowledge and Data engineering.

Accepted

-
- **Jenna M. Reps, Jonathan M. Garibaldi, Uwe Aickelin, Daniele Soria, Jack E. Gibson and Richard B. Hubbard.** Signalling paediatric side effects using an ensemble of simple study designs. *Drug Safety*, 2014.
 - **Jenna M. Reps, Jonathan M. Garibaldi, Uwe Aickelin, Daniele Soria, Jack E. Gibson and Richard B. Hubbard.** *A novel semi-supervised algorithm for rare prescription side effect discovery.* *IEEE Journal of Biomedical and Health Informatics*, 2013.
 - **Jenna M. Reps, Jonathan M. Garibaldi, Uwe Aickelin, Daniele Soria, Jack E. Gibson and Richard B. Hubbard.** *Comparison of algorithms that detect drug side effects using electronic healthcare databases.* *Soft Computing*, 2013.

7.3.2 Conference papers

- **Jenna M. Reps, Jonathan M. Garibaldi, Uwe Aickelin, Daniele Soria, Jack E. Gibson and Richard B. Hubbard.** *Attributes for causal inference in electronic healthcare databases.* In proceedings of the 26th IEEE International Symposium on Computer-Based Medical Systems (CBMS), 2013.
- **Jenna M. Reps, Jonathan M. Garibaldi, Uwe Aickelin, Daniele Soria, Jack E. Gibson and Richard B. Hubbard.** *Comparing data-mining algorithms developed for longitudinal observational databases.* In Proceedings of the 12th Annual Workshop on Computational Intelligence (UKCI), 2012.

-
- **Jenna M. Reps, Jonathan M. Garibaldi, Uwe Aickelin, Daniele Soria, Jack E. Gibson and Richard B. Hubbard.** *Discovering sequential patterns in a UK general practice database.* In proceedings of the 1st IEEE-EMBS International Conference on Biomedical and Health Informatics (BHI), 2012.
 - **Jenna Reps, Jan Feyereisl, Jonathan M. Garibaldi, Uwe Aickelin, Jack E. Gibson, Richard B. Hubbard.** *Comparing data-mining algorithms developed for longitudinal observational databases.* In Proceedings of the 11th Annual Workshop on Computational Intelligence (UKCI), 2011.
 - **Feng Gu, Jan Feyereisl, Robert Oates, Jenna Reps, Julie Green-smith, Uwe Aickelin.** *Quiet in Class: Classification, Noise and the Dendritic Cell Algorithm.* In Proceedings of the 10th International Conference on Artificial Immune Systems (ICARIS 2011), 2011.

Appendix A

The THIN Database

Introduction

The THIN database is a longitudinal resource containing temporal medical data corresponding to over 3.5 million active patients and 11.5 million total patients. The data are anonymously extracted from each individual general practice's Vision clinical system, validated and combined to generate the THIN database. The current database is 326Gb and covered 6.05% of the UK in 2012, with over 0.6 billion medical records (i.e., entries detailing an instance of a medical event such as an illness, observation or laboratory event) and approximately 1 billion therapy records (i.e., entries detailing an instance of a drug prescription). There is a slightly higher relative proportion of female patients than male patients in the database, with 47.7% of a patients being male and 52.3% being female, whereas the 2011 census suggests the UK population is 49.1% male and 50.9% female. The number of general practices included within the database is expanding over time, with 12 new practices recruited during the first three quarters of 2013.

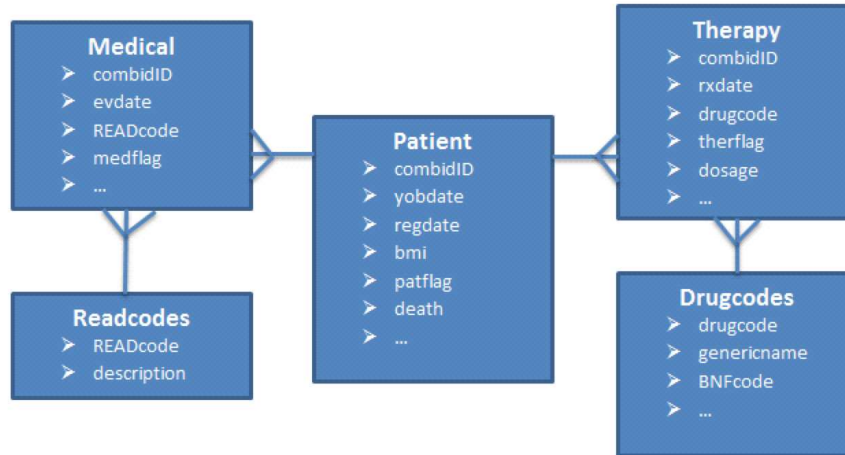

Figure A.1: An entity relationship diagram of the THIN database.

The database is also expanding due to recently occurring records from registered practices being added over time.

Structure

The structure of the main THIN database is illustrated in Figure A.1, there are additional tables not included into the diagram due to them not being incorporated within this research. The three main tables are the patient table, the therapy table and the medical table, see Figures A.2-A.4. Each patient within the THIN database is represented by a unique anonymous patient id, named the *combid*, and the patient table contains the attributes of each patient (e.g., their year of birth, their body mass index, their smoking habits, the year they registered and the date of death if they have died). The medical table stores the temporal data regarding the patients' medical events. Each entry in the medical table contains a *combid* that refers to the patient experiencing the medical event,

a READ code that corresponds to a medical event and the date that the medical event occurred. The READ codes are there due to database normalisation, but one advantage of using the READ codes rather than string descriptions to represent a medical event is that they have a hierarchical structure that may be useful when applying data analysis. The READ codes and their structure are discussed in greater detail further in this Chapter. The therapy table contains records regarding drug prescriptions. Each therapy record contains the combid referring to the patient being prescribed the drug, a drugcode corresponding to the drug being prescribed and the prescription date. The drugcode is also introduced due to database normalisation. The drugcode does not have an obvious structure but each drugcode is linked to up to three British National Formulary (BNF) codes corresponding to the main chemical components that make up the drug. The BNF codes do have a hierarchical structure and can be used to identify similar groups of drugs. The BNF codes are also discussed in greater detail in the latter section of this Chapter.

READ Codes

The READ codes are a clinical terminology thesaurus used for recording medical events within General Practice databases. Each medical event is encoded into a READ code, and the READ code consists of five elements from the alphabet $\{1-9, a-z, A-Z, \bullet\}$. The READ codes have a hierarchical tree structure with five levels. The medical events become more specific as the level increases, so the child READ codes correspond to the same medical event as their parent READ code but are more specific. The level of a READ code $\mathbf{x} = x_1x_2x_3x_4x_5$ is calculated

| | combid | prac | patid | patflag | yobstring | hh | sex | regdate | regreal | xferdate | xferreal | regrea | deatl |
|----|-----------|-------|-------|---------|-----------|--------|-----|----------|-------------------------|----------|-------------------------|--------|-------|
| 1 | h998101AD | h9981 | 01AD | A | 19830000 | 001455 | 1 | 19880921 | 1988-09-21 00:00:00.000 | 19890727 | 1989-07-27 00:00:00.000 | 03 | 0000 |
| 2 | h998101aD | h9981 | 01aD | A | 19420000 | 003428 | 1 | 20001227 | 2000-12-27 00:00:00.000 | 00000000 | NULL | 00 | 0000 |
| 3 | h998101ad | h9981 | 01ad | A | 19710000 | 001646 | 1 | 19901017 | 1990-10-17 00:00:00.000 | 19940518 | 1994-05-18 00:00:00.000 | 02 | 0000 |
| 4 | h998101ae | h9981 | 01ae | A | 19470000 | 001646 | 1 | 19901017 | 1990-10-17 00:00:00.000 | 20020123 | 2002-01-23 00:00:00.000 | 03 | 0000 |
| 5 | h998101af | h9981 | 01af | A | 19830000 | 001646 | 1 | 19901017 | 1990-10-17 00:00:00.000 | 20020123 | 2002-01-23 00:00:00.000 | 03 | 0000 |
| 6 | h998101aG | h9981 | 01aG | A | 19140000 | 001189 | 2 | 19950501 | 1995-05-01 00:00:00.000 | 20001010 | 2000-10-10 00:00:00.000 | 03 | 0000 |
| 7 | h998101ag | h9981 | 01ag | A | 19730000 | 002868 | 1 | 19901017 | 1990-10-17 00:00:00.000 | 00000000 | NULL | 00 | 0000 |
| 8 | h998101Ah | h9981 | 01Ah | A | 19480000 | 000717 | 1 | 19950222 | 1995-02-22 00:00:00.000 | 20040521 | 2004-05-21 00:00:00.000 | 01 | 2000 |
| 9 | h998101ah | h9981 | 01ah | A | 19480000 | 001646 | 2 | 19901017 | 1990-10-17 00:00:00.000 | 20020123 | 2002-01-23 00:00:00.000 | 03 | 0000 |
| 10 | h998101ai | h9981 | 01ai | A | 19360000 | 001360 | 1 | 19880111 | 1988-01-11 00:00:00.000 | 19950203 | 1995-02-03 00:00:00.000 | 03 | 0000 |
| 11 | h998101Aj | h9981 | 01Aj | A | 19490000 | 003003 | 2 | 19980710 | 1998-07-10 00:00:00.000 | 20041105 | 2004-11-05 00:00:00.000 | 02 | 0000 |
| 12 | h998101aj | h9981 | 01aj | A | 19140000 | 001267 | 1 | 19880113 | 1988-01-13 00:00:00.000 | 19890210 | 1989-02-10 00:00:00.000 | 01 | 1980 |
| 13 | h998101ak | h9981 | 01ak | A | 19170000 | 001267 | 2 | 19871221 | 1987-12-21 00:00:00.000 | 20070717 | 2007-07-17 00:00:00.000 | 27 | 0000 |
| 14 | h998101Al | h9981 | 01Al | A | 19000000 | 000076 | 1 | 19820825 | 1982-08-25 00:00:00.000 | 19920331 | 1992-03-31 00:00:00.000 | 02 | 0000 |
| 15 | h998101Am | h9981 | 01Am | A | 19150000 | 000927 | 1 | 19820705 | 1982-07-05 00:00:00.000 | 19900331 | 1990-03-31 00:00:00.000 | 01 | 1980 |
| 16 | h998101aM | h9981 | 01aM | A | 19170000 | 001442 | 2 | 19880818 | 1988-08-18 00:00:00.000 | 19940124 | 1994-01-24 00:00:00.000 | 02 | 0000 |
| 17 | h998101am | h9981 | 01am | A | 19360000 | 002869 | 2 | 19971009 | 1997-10-09 00:00:00.000 | 20040112 | 2004-01-12 00:00:00.000 | 27 | 0000 |
| 18 | h998101AO | h9981 | 01AO | A | 19280000 | 000899 | 2 | 19590511 | 1959-05-11 00:00:00.000 | 20060206 | 2006-02-06 00:00:00.000 | 03 | 0000 |
| 19 | h998101AP | h9981 | 01AP | A | 19960900 | 002994 | 1 | 19980619 | 1998-06-19 00:00:00.000 | 19981202 | 1998-12-02 00:00:00.000 | 02 | 0000 |
| 20 | h998101ap | h9981 | 01ap | A | 19420000 | 003457 | 1 | 20010323 | 2001-03-23 00:00:00.000 | 20091104 | 2009-11-04 00:00:00.000 | 27 | 0000 |
| 21 | h998101aS | h9981 | 01aS | A | 19690000 | 000051 | 2 | 19830708 | 1983-07-08 00:00:00.000 | 19881212 | 1988-12-12 00:00:00.000 | 03 | 0000 |

Figure A.2: A screen shot of the patient table contained within the THIN database.

| | combid | prac | patid | rxdate | rxdatereal | drugcode | therflag | doscode | rxqty | rxdays | private | staffid | rxtype | opno |
|----|-----------|-------|-------|----------|-------------------------|----------|----------|---------|-----------|--------|---------|---------|--------|----------|
| 1 | a6732010h | a6732 | 010h | 19990707 | 1999-07-07 00:00:00.000 | 93619997 | Y | 0000472 | 56.00000 | 000 | N | 0008 | 1 | 00000.00 |
| 2 | a6732010h | a6732 | 010h | 19990707 | 1999-07-07 00:00:00.000 | 86989998 | Y | 0000200 | 56.00000 | 000 | N | 0008 | 1 | 00000.00 |
| 3 | a6732010h | a6732 | 010h | 19990707 | 1999-07-07 00:00:00.000 | 96277997 | Y | 0012382 | 1.0000000 | 000 | N | 0009 | 1 | 00000.00 |
| 4 | a6732010h | a6732 | 010h | 19990707 | 1999-07-07 00:00:00.000 | 98776998 | Y | 0000929 | 112.00000 | 000 | N | 0009 | 1 | 00000.00 |
| 5 | a6732010h | a6732 | 010h | 19990707 | 1999-07-07 00:00:00.000 | 96940997 | Y | 0000200 | 56.00000 | 000 | N | 0003 | 1 | 00000.00 |
| 6 | a6732010h | a6732 | 010h | 19990707 | 1999-07-07 00:00:00.000 | 93619996 | Y | 0000472 | 56.00000 | 000 | N | 0008 | 1 | 00000.00 |
| 7 | a6732010h | a6732 | 010h | 19990729 | 1999-07-29 00:00:00.000 | 98815990 | Y | 0000001 | 1.0000000 | 000 | N | 0009 | 1 | 00000.00 |
| 8 | a6732010h | a6732 | 010h | 19990729 | 1999-07-29 00:00:00.000 | 96940997 | Y | 0000200 | 56.00000 | 000 | N | 0003 | 1 | 00000.00 |
| 9 | a6732010h | a6732 | 010h | 19990811 | 1999-08-11 00:00:00.000 | 96277997 | Y | 0012382 | 1.0000000 | 000 | N | 0009 | 1 | 00000.00 |
| 10 | a6732010h | a6732 | 010h | 19990824 | 1999-08-24 00:00:00.000 | 86990998 | Y | 0000200 | 56.00000 | 000 | N | 0008 | 1 | 00000.00 |
| 11 | a6732010h | a6732 | 010h | 19990824 | 1999-08-24 00:00:00.000 | 93619997 | Y | 0000472 | 56.00000 | 000 | N | 0008 | 1 | 00000.00 |
| 12 | a6732010h | a6732 | 010h | 19990824 | 1999-08-24 00:00:00.000 | 96940997 | Y | 0000200 | 56.00000 | 000 | N | 0003 | 1 | 00000.00 |
| 13 | a6732010h | a6732 | 010h | 19991027 | 1999-10-27 00:00:00.000 | 96329998 | Y | 0000447 | 112.00000 | 000 | N | 0009 | 1 | 00000.00 |
| 14 | a6732010h | a6732 | 010h | 19991112 | 1999-11-12 00:00:00.000 | 93619997 | Y | 0000472 | 56.00000 | 000 | N | 0008 | 1 | 00000.00 |
| 15 | a6732010h | a6732 | 010h | 19991112 | 1999-11-12 00:00:00.000 | 98776998 | Y | 0000929 | 112.00000 | 000 | N | 0009 | 1 | 00000.00 |
| 16 | a6732010h | a6732 | 010h | 19991112 | 1999-11-12 00:00:00.000 | 96940997 | Y | 0000200 | 56.00000 | 000 | N | 0003 | 1 | 00000.00 |
| 17 | a6732010h | a6732 | 010h | 19991210 | 1999-12-10 00:00:00.000 | 89385998 | Y | 0000200 | 28.00000 | 000 | N | 0008 | 1 | 00000.00 |
| 18 | a6732010h | a6732 | 010h | 19991210 | 1999-12-10 00:00:00.000 | 86990998 | Y | 0000200 | 56.00000 | 000 | N | 0008 | 1 | 00000.00 |
| 19 | a6732010h | a6732 | 010h | 19991210 | 1999-12-10 00:00:00.000 | 86990998 | Y | 0000200 | 56.00000 | 000 | N | 0008 | 1 | 00000.00 |
| 20 | a6732010h | a6732 | 010h | 20000124 | 2000-01-24 00:00:00.000 | 96940997 | Y | 0000200 | 56.00000 | 000 | N | 0003 | 1 | 00000.00 |
| 21 | a6732010h | a6732 | 010h | 20000124 | 2000-01-24 00:00:00.000 | 86990998 | Y | 0000200 | 56.00000 | 000 | N | 0008 | 1 | 00000.00 |

Figure A.3: A screen shot of the therapy table contained within the THIN database.

| | combid | prac | patid | evdate | evdatereale | enddate | enddatereale | dtype | medcode | medflag | staffid | source | episode | nhsspe |
|----|-----------|-------|-------|----------|-------------------------|----------|--------------|-------|---------|---------|---------|--------|---------|--------|
| 1 | a670600?? | a6706 | 0??? | 20061227 | 2006-12-27 00:00:00.000 | 00000000 | NULL | 01 | ZZZZZ00 | R | 0004 | 0 | 0 | 000 |
| 2 | a670600?? | a6706 | 0??? | 20061228 | 2006-12-28 00:00:00.000 | 00000000 | NULL | 01 | ZZZZZ00 | R | 000C | 0 | 0 | 000 |
| 3 | a670600?? | a6706 | 0??? | 20061228 | 2006-12-28 00:00:00.000 | 00000000 | NULL | 01 | ZZZZZ00 | R | 000C | 0 | 0 | 000 |
| 4 | a670600?? | a6706 | 0??? | 20061228 | 2006-12-28 00:00:00.000 | 00000000 | NULL | 01 | ZZZZZ00 | R | 000C | 0 | 0 | 000 |
| 5 | a670600?? | a6706 | 0??? | 20061228 | 2006-12-28 00:00:00.000 | 00000000 | NULL | 01 | ZZZZZ00 | R | 000C | 0 | 0 | 000 |
| 6 | a670600?? | a6706 | 0??? | 20080725 | 2008-07-25 00:00:00.000 | 00000000 | NULL | 01 | ZZZZZ00 | R | 000b | 0 | 0 | 000 |
| 7 | a670600?? | a6706 | 0??? | 20080725 | 2008-07-25 00:00:00.000 | 00000000 | NULL | 01 | ZZZZZ00 | R | 000b | 0 | 0 | 000 |
| 8 | a670600?? | a6706 | 0??? | 20080725 | 2008-07-25 00:00:00.000 | 00000000 | NULL | 01 | ZZZZZ00 | R | 000b | 0 | 0 | 000 |
| 9 | a670600?? | a6706 | 0??? | 20080725 | 2008-07-25 00:00:00.000 | 00000000 | NULL | 01 | ZZZZZ00 | R | 000b | 0 | 0 | 000 |
| 10 | a670600?? | a6706 | 0??? | 20080901 | 2008-09-01 00:00:00.000 | 00000000 | NULL | 01 | 9N36.00 | R | 000L | 0 | 4 | 000 |
| 11 | a670600?? | a6706 | 0??? | 20080915 | 2008-09-15 00:00:00.000 | 00000000 | NULL | 01 | 9N36.00 | R | 000L | 0 | 4 | 000 |
| 12 | a670600?? | a6706 | 0??? | 20080915 | 2008-09-15 00:00:00.000 | 00000000 | NULL | 11 | G65.00 | R | 0004 | 0 | 0 | 000 |
| 13 | a670600?? | a6706 | 0??? | 20080915 | 2008-09-15 00:00:00.000 | 00000000 | NULL | 01 | G65.00 | R | 0004 | 0 | 4 | 000 |
| 14 | a670600?? | a6706 | 0??? | 20080923 | 2008-09-23 00:00:00.000 | 00000000 | NULL | 01 | 66X.00 | R | 0004 | 0 | 4 | 000 |
| 15 | a670600?? | a6706 | 0??? | 20080923 | 2008-09-23 00:00:00.000 | 00000000 | NULL | 01 | 9N36.00 | R | 000L | 0 | 4 | 000 |
| 16 | a670600?? | a6706 | 0??? | 20080926 | 2008-09-26 00:00:00.000 | 00000000 | NULL | 01 | 9N25.00 | R | 0002 | 0 | 4 | 000 |
| 17 | a670600?? | a6706 | 0??? | 20081020 | 2008-10-20 00:00:00.000 | 00000000 | NULL | 01 | 9N36.00 | R | 000L | 0 | 4 | 000 |
| 18 | a670600?? | a6706 | 0??? | 20081223 | 2008-12-23 00:00:00.000 | 00000000 | NULL | 01 | 9N36.00 | R | 000L | 0 | 4 | 000 |
| 19 | a670600?? | a6706 | 0??? | 20090228 | 2009-02-28 00:00:00.000 | 00000000 | NULL | 01 | 9NL.00 | R | 000H | 0 | 4 | 000 |
| 20 | a670600?? | a6706 | 0??? | 20090731 | 2009-07-31 00:00:00.000 | 00000000 | NULL | 01 | 1M10.00 | R | 0004 | 0 | 4 | 000 |
| 21 | a670600?? | a6706 | 0??? | 20090827 | 2009-08-27 00:00:00.000 | 00000000 | NULL | 01 | 9N0M.00 | R | 000D | 0 | 4 | 000 |

Figure A.4: A screen shot of the medical table contained within the THIN database.

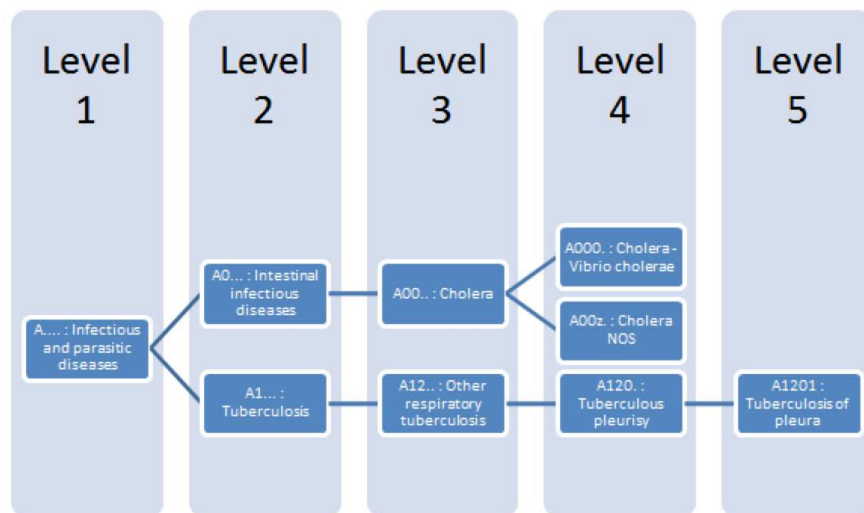

Figure A.5: An example of the branch of the THIN READ code tree.

as,

$$Lv(\mathbf{x}) = \begin{cases} \arg \min_i \{(i - 1) | x_i = \bullet\} & \text{if } \exists i \text{ s.t. } x_i = \bullet \\ 5 & \text{otherwise.} \end{cases} \quad (\text{A.1})$$

An example of a branch in the READ codes is,

A●●●● Infectious and parasitic diseases (level 1)

A1●●● Tuberculosis (level 2)

A12●● Other respiratory tuberculosis (level 3)

A120● Tuberculosis pleurisy (level 4)

A1201 Tuberculosis of pleura (level 5)

where it can be seen that all the READ codes above are infections and the infection represented by the READ code becomes more detailed as the level increases.

A graphical illustration of this section of the READ code tree can be seen in [Figure A.5](#).

Unfortunately, the READ codes have redundancies and a single medical event may have multiple corresponding READ codes found in widely varying branches of the READ code tree. This can lead to issues during data analysis as it is difficult to aggregate the data for the READ codes corresponding to the same medical event, and the partitioning can result in a lower confidence in the results that are obtained. There are also problems with inconsistent READ code usage by medical staff. For example, some staff may frequently enter high level specific READ codes while others may have a tendency to enter low level READ codes that are less specific. Furthermore, it is common to find ‘temporal READ code progressions’, where a low level READ code is initially recorded and shortly in

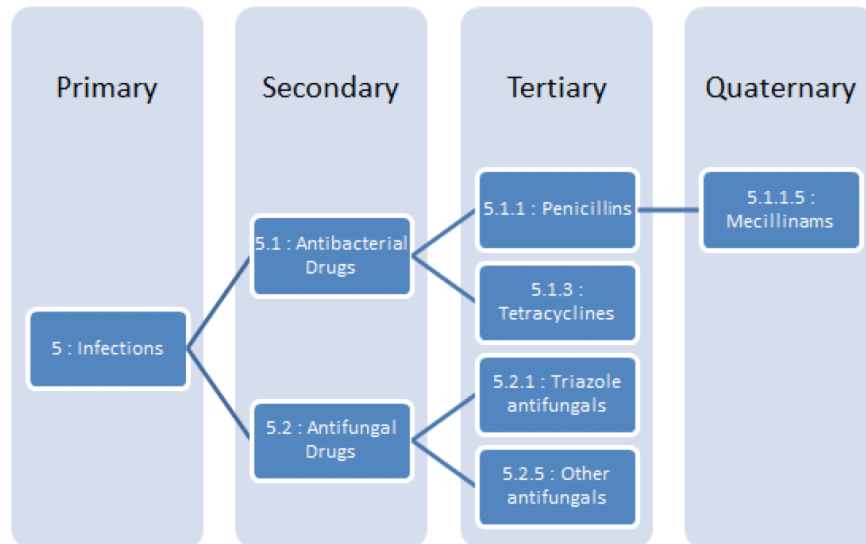

Figure A.6: An example of the branch of the British National Formulary (BNF) tree.

time afterwards a child or grand-child READ code is recorded due to additional knowledge being obtained.

BNF Codes

The BNF codes are based on BNF sections. They have a hierarchal tree structure linking drugs that are prescribed for the similar indication (i.e., the reason for being given the drug), and drugs with the same BNF code are from the same drug family. Figure A.6 illustrates a branch of the BNF code tree. If we consider each BNF code to be represented by $\mathbf{y}_i = y_{i1} \cdot y_{i2} \cdot y_{i3} \cdot y_{i4}$, where each element is in the alphabet $\{1 - 15, 00\}$, then y_{i1} is the primary category, y_{i2} is the secondary category, y_{i3} is the tertiary category and y_{i4} is the quaternary category. There are 15 different primary categories, these primary categories relate to the the most general description of the drug indication. The similarity between two BNF codes

| y_{i1} | Category |
|----------|--|
| 1 | Gastro-intestinal system |
| 2 | Cardiovascular system |
| 3 | Respiratory system |
| 4 | Central nervous system |
| 5 | Infections |
| 6 | Endocrine system |
| 7 | Obstetrics, gynaecology, and urinary-tract disorders |
| 8 | Malignant disease and immunosuppression |
| 9 | Nutrition and blood |
| 10 | Musculoskeletal and joint diseases |
| 11 | Eye |
| 12 | Ear, nose, and oropharynx |
| 13 | Skin |
| 14 | Immunological products and vaccines |
| 15 | Anaesthesia |

can be calculated as,

$$S(\mathbf{y}_i, \mathbf{y}_j) = \frac{|\{y_{ik} | y_{ik} = y_{jk}\}|}{\max(|\{k | y_{ik} \neq 00\}|, |\{k | y_{jk} \neq 00\}|)} \quad (\text{A.2})$$

where the similarity measure is 1 if and only if the two BNF codes are the same, and greater than zero if and only if the BNF codes correspond to drugs prescribed for a similar indication.

Issues & Validation

There are known issues with the database including concept drift and problems with the level of time stamp detail. In general, the data is validated during extraction and additional fields are added into the tables to indicate the integrity of each record, so problematic records can be excluded from the study.

Data Collection Issues

One of the main limitations of the THIN data is changes in the way data is collected or the type of data collected over time may lead to concept drift. Over time the READ codes that are actively used may change, new READ codes may get added and old READ codes may be removed. For example, it is common for old records to contain the READ code 'ZZZZZ' corresponding to an unmappable medical event. The drug prescription rate is unlikely to stay constant over time, as new knowledge of suspected ADRs or new studies detailing the effectiveness of a drug can impact a General Practitioner's decision to prescribe a drug. It is also common for new drugs to be introduced.

Time Stamps

Each record in the medical and therapy table contains a time stamp. These time stamps are the day that the doctors entered the event of prescription into the database. As the time stamp is only in days, it is not possible to determine the order for the medical events and prescriptions within one day. When a medical event and prescription are recorded for the same patient on the same day it may be possible that the patient was prescribed the medication due to the medical event or that the medical event is an adverse drug reaction of the medication.

To address the uncertainty of the order of events with the same timestamp for the same patient, the medical events recorded on the day a drug is prescribed are often ignored from the calculation of association between a drug and medical event.

Appendix B

Drugs

Drugs Investigated

NSAIDs

The drugs Ibuprofen, Ketoprofen, Fenoprofen and Celecoxib used in this study are all from the same drug family known as non-steroidal anti-inflammatory drugs (NSAIDs). These drugs are typically prescribed for continuous pain associated with inflammation and have a variety of common side effects including gastrointestinal disturbances, hypersensitivity reactions and depression. Rarer side effects include congestive heart failure, renal failure and hepatic failure. Elderly patients are more prone to side effects associated with NSAIDs. In this study the the drugs tended to be prescribed slightly more to females with the male proportion ranging from 0.335 – 0.405 and to older patients, although Ibuprofen was prescribed to younger patients more than the other NSAID drugs. The NSAID drug prescribed the most was Ibuprofen with over a million first in 13 month

Table B.1: Information about the NSAID drugs investigated in this paper. Total is the number of times the drug is prescribed for the first time in 13 months, age is the average age of the patients who are prescribed the drug for the first time in 13 months and male proportion is the number of patients that are male divided by the total number of patients who are prescribed the drug for the first time in 13 months.

| Drug | Total | TPD | MUTARA | ROR | Age | male proportion |
|------------|---------|---------|--------|--------|-------|-----------------|
| celecoxib | 68036 | 62946 | 62100 | 63416 | 62.49 | 0.335 |
| ibuprofen | 1178163 | 1012555 | 858819 | 903415 | 45.56 | 0.405 |
| ketoprofen | 72946 | 65718 | 61710 | 63536 | 58.17 | 0.375 |
| fenoprofen | 1255 | 1008 | 975 | 1036 | 56.29 | 0.404 |

prescriptions, whereas Fenoprofen was only prescribed 1225 times for the first time in 13 months, see Table B.1.

Quinolones

The quinolones are a class of drugs used to treat bacterial infections such as respiratory track infections and urinary-track infections. Ciprofloxacin, levofloxacin, moxifloxacin, nalidixic acid and norfloxacin are drugs from the quinolone family that are investigated in this paper. The quinolones have many side effects, including tendon rupture. The average age of the patients prescribed the quinolones for the first time in 13 months was similar between all the drugs, around the late fifties. The male proportion shows that females are prescribed quinolones more than males, but this was more obvious for norfloxacin and nalidixic acid. Ciprofloxacin was the most prescribed quinolone and moxifloxacin was the least common, with only 1465 prescriptions. Table B.2 shows the information on the drugs from the THIN database.

Table B.2: Information about the Quinolone drugs investigated in this paper. Total is the number of times the drug is prescribed for the first time in 13 months, age is the average age of the patients who are prescribed the drug for the first time in 13 months and male proportion is the number of patients that are male divided by the total number of patients who are prescribed the drug for the first time in 13 months.

| Drug | Total | TPD | MUTARA | ROR | Age | male proportion |
|----------------|--------|--------|--------|--------|-------|-----------------|
| ciprofloxacin | 280011 | 250158 | 227739 | 235420 | 55.64 | 0.440 |
| levofloxacin | 7662 | 7028 | 6775 | 6928 | 60.55 | 0.43 |
| norfloxacin | 14876 | 13224 | 12220 | 12625 | 56.83 | 0.262 |
| moxifloxacin | 1465 | 1347 | 1343 | 1371 | 62.09 | 0.419 |
| nalidixic acid | 4273 | 3646 | 3620 | 3787 | 55.63 | 0.127 |

Table B.3: Information about the tricyclic drugs investigated in this paper. Total is the number of times the drug is prescribed for the first time in 13 months, age is the average age of the patients who are prescribed the drug for the first time in 13 months and male proportion is the number of patients that are male divided by the total number of patients who are prescribed the drug for the first time in 13 months.

| Drug | Total | TPD | MUTARA | ROR | Age | male proportion |
|---------------|-------|-------|--------|-------|-------|-----------------|
| doxepin | 6752 | 6029 | 5908 | 6104 | 56.69 | 0.316 |
| lofepramine | 45532 | 38565 | 37642 | 39517 | 51.39 | 0.285 |
| nortriptyline | 11775 | 10519 | 10307 | 10650 | 54.43 | 0.286 |

Tricyclic Antidepressants

Tricyclic antidepressant drugs are a family of drugs used to treat depression and are known to cause, among others, cardiovascular and central nervous system side effects. The three drugs, doxepin, lofepramine and nortriptyline were selected in this paper. The tricyclic antidepressants investigated are prescribed to patients with similar ages and genders and tend to be prescribed more often to older females. The main difference between the drugs is that doxepin is only prescribed to 6752 patients whereas the other two drugs are prescribed to more than 10000 patients, see Table B.3.

Table B.4: Information about the calcium channel blocker drugs investigated in this paper. Total is the number of times the drug is prescribed for the first time in 13 months, age is the average age of the patients who are prescribed the drug for the first time in 13 months and male proportion is the number of patients that are male divided by the total number of patients who are prescribed the drug for the first time in 13 months.

| Drug | Total | TPD | MUTARA | ROR | Age | male proportion |
|-------------|--------|--------|--------|--------|-------|-----------------|
| nifedipine | 125491 | 112715 | 112499 | 115823 | 65.29 | 0.453 |
| verapamil | 24334 | 22000 | 21896 | 22513 | 65.01 | 0.405 |
| felodipine | 69534 | 65093 | 64036 | 65202 | 67.46 | 0.454 |
| amlodipine | 270918 | 251316 | 249972 | 254876 | 66.68 | 0.494 |
| nicardipine | 2796 | 2510 | 2511 | 2593 | 65.91 | 0.481 |

Calcium Channel Blockers

The drugs nifedipine, nicardipine, amlodipine, felodipine and verapamil are all calcium channel blocker that are used to treat high blood pressure and raynaud’s phenomenon. It is common for the calcium channel blockers to be prescribed with other drugs and applying the existing algorithms to detect side effects on the calcium channel blockers will investigate the effect of confounding due to multiple prescriptions. The drug nifedipine was previously used to investigate the TPD applied to the UK IMA Disease Analyzer, so investigating the calcium channel blockers will also give insight into how robust the TPD is when applied to different electronic healthcare databases. The calcium channel blockers are generally prescribed for the first time in 13 months to patients around 65 years old. Amlodipine and nicardipine are prescribed only slightly more to females than males, whereas the other calcium channel blockers investigated are prescribed even more often to females. Amlodipine and nifedipine have been prescribed over 100000 times for the first time in 13 months in the THIN database, but nicardipine has only been prescribed 2796 times, see Table B.4.

Table B.5: Information about the sulphonylurea drugs investigated in this paper. Total is the number of times the drug is prescribed for the first time in 13 months, age is the average age of the patients who are prescribed the drug for the first time in 13 months and male proportion is the number of patients that are male divided by the total number of patients who are prescribed the drug for the first time in 13 months.

| Drug | Total | TPD | MUTARA | ROR | Age | male proportion |
|---------------|-------|-------|--------|-------|-------|-----------------|
| glibenclamide | 11874 | 10356 | 10377 | 10768 | 65.12 | 0.540 |
| gliclazide | 45824 | 41626 | 40537 | 41612 | 65.02 | 0.546 |
| glimepiride | 10957 | 10156 | 9882 | 10081 | 64.20 | 0.534 |
| glipizide | 5315 | 4856 | 4614 | 4731 | 66.50 | 0.535 |
| tolbutamide | 3113 | 2758 | 2793 | 2894 | 69.40 | 0.487 |

Sulphonylureas

The sulphonylurea drug family includes tolbutamide, glibenclamide, gliclazide, glimepiride and glipizide. They are a class of antidiabetic drugs used for the management of type 2 diabetes mellitus. The sulphonylureas are prescribed for the first time in 13 months to older patients will an average age around 65 years old and all the sulphoylureas investigated except tolbutamide are prescribed more often to males, with approximately equal male proportions. Glipizide and tolbutamide are the less frequently prescribed sulphonylurea drugs. The general information about each of the sulphonylurea drugs can be seen in [Table B.5](#).

Penicillins

The last drug family is the Penicillin drugs amoxicillin, ampicillin, flucloxacillin, benzylpenicillin and phenoxymethlypenicillin. These drugs are used to treat bacterial infections. The number of times the drugs are recorded as being prescribed in the THIN database varies between 2000 to over two million. There is also a divergence between the average age of the patients prescribed each of the drugs,

Table B.6: Information about the penicillin drugs investigated in this paper. Total is the number of times the drug is prescribed for the first time in 13 months, age is the average age of the patients who are prescribed the drug for the first time in 13 months and male proportion is the number of patients that are male divided by the total number of patients who are prescribed the drug for the first time in 13 months.

| Drug | Total | TPD | MUTARA | ROR | Age | male proportion |
|------------------|---------|---------|---------|---------|-------|-----------------|
| amoxicillin | 2795759 | 2321098 | 1593874 | 1718875 | 38.84 | 0.427 |
| benzylpenicillin | 2071 | 1610 | 1840 | 1972 | 31.79 | 0.471 |
| flucloxacillin | 971174 | 834017 | 729967 | 765428 | 41.42 | 0.456 |
| phenoxymethly | 55397 | 45941 | 45679 | 48142 | 29.67 | 0.396 |
| ampicillin | 80655 | 63458 | 64827 | 69381 | 39.18 | 0.423 |

with the penicillins generally being prescribed to younger patients than many of the other drugs families investigated in this paper. The male proportion is fairly similar between the different penicillin drugs, with females being prescribed the drug more often than males, see Table B.6.

Appendix C

Software Details and Preliminary Work

C.1 Software Details

The data were stored in MS SQL server and the data manipulation (generation of the Bradford Hill causality consideration attributes) was performed using SQL. The classification was performed using the function ‘train’ and the feature selection used to pre-process the data prior to classification for all the classifiers except random forest was the function ‘rfe’ within the ‘caret’ package [97] in the open source software R. The ‘rfe’ function found the subset of attributes that maximised the accuracy of the classification. The ‘train’ function trained the various classifiers based on maximising the AUC performance measure using a parameter grid search.

C.2 Wrapper Feature Selection

Table C.1: The features selected and their rank of importance based on applying naive Bayes wrapper for the analysis performed in Chapter 5.

| Attribute | Nifedipine | Ciprofloxacin | Ibuprofen |
|----------------------------------|------------|---------------|-----------|
| Subset Size | 25 | 30 | 30 |
| TPD IC delta (x_1) | ✓(17) | ✓(14) | ✓(7) |
| TPD IC delta 95% CI (x_2) | ✓(22) | ✓(2) | ✓(18) |
| RD all (x_3) | × | ✓(1) | ✓(3) |
| RD first drug (x_4) | ✓(19) | ✓(3) | ✓(1) |
| RD first BNF (x_5) | × | ✓(6) | ✓(2) |
| RR all (x_6) | ✓(21) | ✓(29) | ✓(10) |
| RR first drug (x_7) | ✓(10) | ✓(27) | ✓(5) |
| RR first BNF (x_8) | ✓(5) | ✓(24) | ✓(12) |
| OR all (x_9) | ✓(25) | ✓(30) | ✓(9) |
| OR first drug (x_{10}) | ✓(9) | ✓(28) | ✓(6) |
| OR first BNF (x_{11}) | ✓(4) | ✓(25) | ✓(11) |
| AB month all (x_{12}) | ✓(16) | ✓(23) | ✓(19) |
| AB month first drug (x_{13}) | ✓(7) | ✓(16) | ✓(25) |
| AB month first BNF (x_{14}) | ✓(3) | ✓(20) | ✓(27) |
| TPD filter 1 (x_{15}) | ✓(15) | × | ✓(29) |
| TPD filter 2 (x_{16}) | × | × | × |
| LEOPARD (x_{17}) | × | ✓(18) | ✓(26) |
| Read code Lv 5 (x_{18}) | ✓(18) | ✓(21) | ✓(28) |
| Age all (x_{19}) | ✓(8) | ✓(7) | ✓(15) |
| Age first drug (x_{20}) | ✓(2) | ✓(5) | ✓(8) |
| Age first BNF (x_{21}) | ✓(1) | ✓(4) | ✓(4) |
| Gender all (x_{22}) | × | ✓(11) | × |
| Gender first drug (x_{23}) | ✓(11) | ✓(12) | ✓(17) |
| Gender first BNF (x_{24}) | ✓(6) | ✓(13) | ✓(21) |
| Dosage (x_{25}) | ✓(13) | ✓(26) | ✓(20) |
| Experimentation (x_{26}) | × | ✓(17) | ✓(13) |
| Noise (x_{27}) | ✓(24) | ✓(19) | ✓(14) |
| Illness progression (x_{28}) | × | ✓(15) | ✓(24) |
| AB month Lv 3 (x_{29}) | ✓(23) | ✓(9) | ✓(16) |
| AB month Lv 4 (x_{30}) | ✓(14) | ✓(22) | ✓(23) |
| Read code Lv 4 (x_{31}) | ✓(12) | ✓(10) | × |
| Read code Lv 3 (x_{32}) | ✓(20) | ✓(8) | ✓(22) |
| Read code Lv 2 (x_{33}) | × | × | ✓(30) |

C.3 Preliminary Work

The following is extracted from my conference paper title ‘Attributes for causal inference in longitudinal observational databases’:

Feature Selection

In this study we apply a multivariate filter, the Correlation-based Feature Selection (CFS) algorithm [69], as this algorithm is not dependent on a specific classifier. The CFS algorithm finds the optimal feature subset based on the trade-off between how correlated the class labels are to the feature subset and how intercorrelated the features of the subset are.

The feature selection was applied to the attributes described in Tables C.2-C.3. The data used in this study are extracted from The Health Improvement Network database (www.thin-uk.com) and can be found at: <http://www.ima.ac.uk/reps>.

Results

Table C.4 shows that the optimal attribute subset to use for ADR discovery is LEOPARD, RD_{13BNF} , ABratio Level 3, Gender Ratio and Read Code Level. The temporal and strength attributes had the greatest correlation with the class labels, whereas 75% of the dosage attributes has a zero correlation measure.

Discussion

The results show that the temporal and strength attributes are key for signalling ADRs as these had the highest correlation with the class labels but the specificity attributes Gender Ratio and Read Code level offered potentially new in sight than

Table C.2: Attribute Summary Table

| Feature | Criterion | Description |
|--------------------------------------|-------------|---|
| RR, RD, OR | Strength | The Risk Ratio, Risk Difference and Odds Ratio for all prescriptions. |
| $RR_{13d}, RD_{13d}, OR_{13d}$ | Strength | The Risk Ratio, Risk Difference and Odds Ratio for drugs prescribed for the first time in 13 months. |
| $RR_{13BNF}, RD_{13BNF}, OR_{13BNF}$ | Strength | The Risk Ratio, Risk Difference and Odds Ratio for drugs corresponding to a bnf that has not been prescribed in the last 13 months. |
| IC_{Δ} | Strength | The TPD Information Component as calculated in [128] |
| $lowerIC_{\Delta}$ | Strength | The lower 95% interval of the Information Component as calculated in [128] |
| Age STDEV | Specificity | Standard deviation of patient's age who experience medical event after drug divided by standard deviation of the ages for all the patients. |
| Gender Ratio | Specificity | Male proportion of patients experiencing the medical event within 30 days of the drug divided by male proportion of patients prescribed the drug. |
| RR drug / RR bnf | Specificity | The RR of the drug divided by the RR for all the drugs in the same family. |
| Read Code Level | Specificity | The specificity level of the medical event: general (level 1)- specific (level 5). |
| ABratio Level 2 | Temporality | How often the level 2 version of the medical event is recorded after the prescription compared to before. |
| ABratio Level 3 | Temporality | How often the level 3 version of the medical event is recorded after the prescription compared to before. |
| LEOPARD [161] | Temporality | 1 if the drug is prescribed significantly more after the medical event than before, 0 otherwise. |
| OE_{filt1} [128] | Temporality | 1 if the IC_{Δ} is greater the month before the drug than the month after, 0 otherwise. |
| OE_{filt2} [128] | Temporality | 1 if the IC_{Δ} is greater on the day of prescription compared to the month after, 0 otherwise. |

Table C.3: Attribute Summary Table

| Feature | Criterion | Description |
|------------------------|------------|--|
| Dosage Ratio | Dosage | Average dosage of patients experiencing the medical event within 30 days of the drug divided by average dosage of patients prescribed the drug. |
| High Low Ratio | Dosage | Proportion of patients given the highest dosage that experience the medical event (within 30 days) divided by the proportion of patients given the lowest dosage that experience the medical event (within 30 days). |
| Spearman's rank | Dosage | The Spearman's rank correlation coefficient between the patient dosage and $\{0, 1\}$ indicating if the patient experienced the medical event within 30 days. |
| Pearson product-moment | Dosage | The Pearson product-moment correlation coefficient between the patient dosage and $\{0, 1\}$ indicating if the patient experienced the medical event within 30 days. |
| Repeat ₁ | Experiment | Number of patients that have medical event in at least two distinct hazard periods and not in their non-hazard periods divided by the number of patients that have at least two distinct hazard periods and have medical event in one hazard period. |
| Repeat ₂ | Experiment | Number of patients that have medical event in two distinct hazard periods and not in their non-hazard periods divided by the occurrence in the non-hazard periods. |

available via the temporal and strength attributes. The experiment and dosage attributes investigated in this paper did not offer sufficient additional information than what could be gained from the RD_{13BNF} or the LEOPARD attributes, although there does appear to be some correlation between the class labels and both the Pearson's correlation rank attribute and the Repeats attributes.

The reason the dosage attributes did not have a greater correlation with the class labels may be due to a limiting factor of comparing different measurement types. The dosages can be recorded via different measurement types for example 'mg', '%', 'mm x cm xcm' or the measure type may be missing. As it is difficult to determine if x quantity of 'mg' is greater than y quantity of '%', the dosage attributes were calculated only considering prescriptions measured in 'mg' (as this was the most popular). Unfortunately this resulted in occasional issues due to 'mg' measured prescriptions of some drugs investigated always being the same quantity or many prescriptions of a drug not being included in the dosage attribute calculations. The experiment attributes were also limited if the drug investigated was rarely repeated. Furthermore, the experiment attributes may have been biased in this study due to using known ADRs, as if an ADR is known and a patient experiences the ADR after the drug then the doctor is likely to notice this and not prescribe the drug to that patient in the future. One possible way to overcome this issue would be to use only newly discovered ADRs in the data as the medical records may be more likely to have patients, who at the time unknowingly experienced the ADRs, having a repeat prescription.

Table C.4: The results of the CFS algorithm ordered by the measure of correlation with the class labels. Attributes not selected by the CFS algorithm have the attribute they are most correlated to listed in the CFS rank column.

| Attribute | Class Correlation | CFS Rank |
|---------------------------------------|-------------------|---------------------|
| LEOPARD | 0.3238 | 1 |
| OE _{filt1} | 0.2637 | LEOPARD |
| OE _{filt2} | 0.2618 | LEOPARD |
| RD _{13BNF} | 0.2347 | 2 |
| RD _{13d} | 0.2248 | LEOPARD |
| RD | 0.2231 | RD _{13BNF} |
| ABratio Lv3 | 0.2231 | 3 |
| ABratio Lv2 | 0.1755 | ABratio Lv3 |
| RR _{13d} | 0.1593 | RD _{13BNF} |
| OR _{13d} | 0.1593 | RD _{13BNF} |
| RR _{13BNF} | 0.1514 | RD _{13BNF} |
| OR _{13BNF} | 0.1514 | RD _{13BNF} |
| RR | 0.1408 | RD _{13BNF} |
| OR | 0.1408 | RD _{13BNF} |
| lowerIC _Δ | 0.135 | RD _{13BNF} |
| Pearson rank | 0.1029 | RD _{13BNF} |
| Gender Ratio | 0.0663 | 4 |
| Repeats ₁ | 0.0651 | LEOPARD |
| Repeats ₂ | 0.0651 | LEOPARD |
| IC _Δ | 0.0608 | RD _{13BNF} |
| Read Code Lv | 0.0279 | 5 |
| RR _{Drug} /RR _{BNF} | 0 | - |
| Dosage Ratio | 0 | - |
| High Low Ratio | 0 | - |
| Age STDEV | 0 | - |
| Spearman's' rank | 0 | - |

Conclusion

In this paper we have applied feature selection to attributes we generated based on the Bradford Hill causality criteria to determine suitable attributes to be used by a general learning algorithm to identify side effects in LODs. This is the first time suitable attributes for identifying causal relations between prescribed drugs and medical events have been explored and the results now present the opportunity to develop novel learning algorithms. We have found that the specificity attributes offer additional information for ADR signalling and it would be advantageous to include them into ADR signalling algorithms. Unfortunately the experiment and dosage attributes were not very correlated with the class labels but this is likely to be due to current limitations.

Possible future work could focus on developing a way to compare prescriptions with different measurement types so all the prescription data can be used for calculating the dosage attributes or involve developing attributes that cover the remaining Bradford Hill causality criteria (plausibility, coherence, consistency and analogy).

Appendix D

SAP Result Tables

ADR Signalling Framework Results

The signals generated by the SAP framework on the unlabelled data for the drugs Nifedipine, Ciprofloxacin, Ibuprofen, Budesonide and Naproxen.

Nifedipine

| Read Code | Medical Event | Frequency |
|-----------|----------------------------|-----------|
| N131. | Cervicalgia - pain in neck | 3659 |
| D00.. | Iron deficiency anaemias | 1281 |
| 81H.. | Dressing of wound | 7674 |
| K15.. | Cystitis | 3156 |
| 461.. | Urine exam. - general | 1482 |
| R090. | [D]Abdominal pain | 2520 |
| H00.. | Acute nasopharyngitis | 1037 |

| | | |
|-------|---|-------|
| 1C9.. | Sore throat symptom | 2749 |
| 1D13. | C/O: a pain | 5013 |
| 16C2. | Backache | 2527 |
| M18z. | Pruritus NOS | 1976 |
| 413.. | Laboratory test requested | 6064 |
| H05z. | Upper respiratory infection NOS | 6865 |
| M0z.. | Skin and subcut tissue infection NOS | 454 |
| G84.. | Haemorrhoids | 1494 |
| 1972. | Epigastric pain | 1537 |
| 1M10. | Knee pain | 2690 |
| M2yz. | Other skin and subcutaneous tissue disease NOS | 2102 |
| A53.. | Herpes zoster | 1549 |
| M01.. | Furuncle - boil | 342 |
| K190z | Urinary tract infection, site not specified NOS | 5167 |
| M12z1 | Eczema NOS | 2785 |
| 16C6. | Back pain without radiation NOS | 2385 |
| 2.... | Examination / Signs | 2845 |
| R021z | [D]Rash and other nonspecific skin eruption NOS | 2875 |
| H33.. | Asthma | 2792 |
| N142. | Pain in lumbar spine | 4225 |
| 8HQ1. | Refer for X-Ray | 2421 |
| H06z0 | Chest infection NOS | 14291 |
| H27z. | Influenza NOS | 678 |
| 1C14. | Blocked ear | 994 |

| | | |
|-------|---|-------|
| 2D82. | O/E - wax in auditory canal | 1939 |
| 892.. | Informed consent for procedure | 1976 |
| M03z0 | Cellulitis NOS | 2326 |
| 856.. | Acupuncture | 597 |
| 1625. | Abnormal weight loss | 581 |
| M101. | Seborrhoeic dermatitis | 803 |
| M2z0. | Skin lesion | 931 |
| ZV583 | [V]Attention to surgical dressings or sutures | 347 |
| ZV681 | [V]Issue of repeat prescription | 2994 |
| 8BMC. | Prescription collected by pharmacy | 1206 |
| 1922. | Sore mouth | 476 |
| H02.. | Acute pharyngitis | 1055 |
| 8C1B. | Nursing care blood sample taken | 10786 |
| 2516. | Abdomen examined - NAD | 902 |
| AB0.. | Dermatophytosis including tinea or ringworm | 1051 |
| 8H5B. | Referred to urologist | 975 |
| M0... | Skin and subcutaneous tissue infections | 963 |
| 8CA.. | Patient given advice | 5746 |
| E2B.. | Depressive disorder NEC | 3082 |
| N094K | Arthralgia of hip | 2466 |
| 1A... | Genitourinary symptoms | 1313 |
| 41B1. | Blood test due | 2474 |
| 8H77. | Refer to physiotherapist | 1952 |
| F587. | Otalgia | 1047 |

| | | |
|-------|---|------|
| K190. | Urinary tract infection, site not specified | 3347 |
| 8E... | Physiotherapy/remedial therapy | 2474 |
| 2F13. | O/E - dry skin | 2055 |
| Z4A.. | Discussion | 4065 |
| AB2.. | Candidiasis | 1156 |
| TC... | Accidental falls | 4253 |
| SP255 | Postoperative wound infection, unspecified | 568 |
| 25Q.. | O/E - rectal examination done | 484 |
| 22L.. | O/E - wound healing | 325 |
| H26.. | Pneumonia due to unspecified organism | 382 |
| M180. | Pruritus ani | 568 |
| D21z. | Anaemia unspecified | 1690 |
| M21z1 | Skin tag | 474 |
| N2471 | Leg cramps | 1915 |
| 8BAA. | Pain relief | 1455 |
| F502z | Otitis externa NOS | 1962 |
| 1J4.. | Suspected UTI | 1551 |
| 1.... | History / symptoms | 1610 |
| 1C... | Ear/nose/throat symptoms | 287 |
| 58D.. | Ultrasound scan | 259 |
| AB01. | Dermatophytosis of nail | 939 |
| M07z. | Local infection skin/subcut tissue NOS | 986 |
| J43.. | Other non-infective inflammatory gastroenteritis and colitis | 719 |

| | | |
|-------|------------------------------|-------|
| 67I.. | Advice | 1789 |
| 22J.. | O/E - dead | 231 |
| F501. | Infective otitis externa | 1395 |
| 8B3A1 | Medication increased | 3450 |
| N094. | Pain in joint - arthralgia | 1243 |
| M161z | Psoriasis NOS | 599 |
| R062. | [D]Cough | 959 |
| 176.. | C/O - catarrh | 370 |
| 8B314 | Medication review | 15307 |
| M111. | Atopic dermatitis/eczema | 1320 |
| 1C3.. | Earache symptoms | 383 |
| 1CA2. | Hoarse | 430 |
| 1C12. | Hearing difficulty | 704 |
| J520z | Constipation NOS | 965 |
| 2128. | Patient's condition the same | 5198 |
| F1310 | Benign essential tremor | 91 |
| 2227. | O/E - rash present | 836 |
| 8C9.. | Reassurance given | 671 |
| A781. | Viral warts | 420 |
| J50zz | Intestinal obstruction NOS | 134 |
| C2621 | Vitamin B12 deficiency | 323 |
| 8H9.. | Planned telephone contact | 809 |
| 1D14. | C/O: a rash | 3294 |
| N143. | Sciatica | 2510 |

| | | |
|-------|---|-------|
| M12z0 | Dermatitis NOS | 1143 |
| K28y6 | Epididymal cyst | 185 |
| M262. | Sebaceous cyst - wen | 659 |
| 67E.. | Foreign travel advice | 1570 |
| 73050 | Irrigation of external auditory canal for removal of wax | 9722 |
| 8B21. | Drug prescription | 637 |
| 2315. | Resp. system examined - NAD | 1622 |
| 1D15. | C/O: itching | 715 |
| 4K... | General pathology | 1119 |
| 85D.. | Injection given | 737 |
| F51.. | Nonsuppurative otitis media + eustachian tube disorders | 94 |
| 8B3H. | Medication requested | 16644 |
| 16C5. | C/O - low back pain | 1507 |
| H060. | Acute bronchitis | 2569 |
| 19EA. | Change in bowel habit | 812 |
| 8P... | Removal of surgical material and sutures | 230 |
| M230. | Ingrowing nail | 521 |
| E112. | Single major depressive episode | 328 |
| R0300 | [D]Appetite loss | 203 |
| R0040 | [D]Dizziness | 2585 |
| 7G223 | Removal of suture from skin NEC | 809 |
| J082. | Oral aphthae | 645 |

| | | |
|-------|---|-------|
| 1C8.. | Nasal symptoms OS | 301 |
| 6896. | Depression screening using questions | 12687 |
| 16C.. | Backache symptom | 451 |
| M244. | Folliculitis | 402 |
| R021. | [D]Rash and other nonspecific skin eruption | 520 |
| 7NB16 | [SO]Toe NEC | 20 |
| 19FZ. | Diarrhoea symptom NOS | 374 |
| ZV49z | [V]Unspecified limb or other problem | 1398 |
| 1739. | Shortness of breath | 1856 |
| F4E51 | Xanthelasma | 31 |
| 1832. | Ankle swelling | 1681 |
| 8BAD. | Chemotherapy | 236 |
| 1982. | Nausea present | 440 |
| H17.. | Allergic rhinitis | 504 |
| M12.. | Contact dermatitis and other eczemas | 316 |
| 2D... | Ear, nose + throat examination | 610 |
| 5882. | Spirometry | 386 |
| M036z | Cellulitis and abscess of leg NOS | 534 |
| 8H21. | Admit medical emergency unsp. | 470 |
| 68M.. | Spirometry screening | 381 |
| 70560 | Carpal tunnel release | 346 |
| 8HP2. | Refer for microbiological test | 285 |
| Eu32z | [X]Depressive episode, unspecified | 832 |
| 1AG.. | Recurrent urinary tract infections | 294 |

| | | |
|-------|--|-------|
| J1544 | Helicobacter gastritis | 15 |
| ZGB62 | Advice about side effects of drug treatment | 55 |
| M05.. | Impetigo | 242 |
| 2G5.. | O/E - foot | 5012 |
| ZGB64 | Advice to start drug treatment | 112 |
| 8B35. | Drug Rx stopped-medical advice | 1671 |
| J530. | Anal fissure | 173 |
| C3541 | Hypercalcaemia NEC | 113 |
| N2133 | Olecranon bursitis | 483 |
| R1057 | [D]Glucose, blood level abnormal | 318 |
| F4Kz1 | Eye pain NOS | 522 |
| Z1B13 | Change of dressing | 348 |
| 6A... | Patient reviewed | 37926 |
| Eu410 | [X]Panic disorder [episodic paroxysmal anxiety] | 13 |
| F4D0. | Blepharitis | 1266 |
| 7K6WS | Arthroscopic acromioplasty | 23 |
| 165.. | Temperature symptoms | 217 |
| 2FD.. | O/E - skin cyst | 360 |
| G3111 | Unstable angina | 120 |
| 73130 | Myringotomy and insertion of short term grom- met | 26 |
| 1BK.. | Worried | 329 |
| 8B41. | Repeated prescription | 6599 |
| N30z8 | Bone infection NOS, of other specified site | 70 |

| | | |
|-------|--|------|
| 8B3A2 | Medication decreased | 1337 |
| N0946 | Arthralgia of the lower leg | 3023 |
| F52z. | Otitis media NOS | 624 |
| E2003 | Anxiety with depression | 790 |
| G57y9 | Supraventricular tachycardia NOS | 99 |
| M03z1 | Abscess NOS | 157 |
| G581. | Left ventricular failure | 1154 |
| M01z. | Boil NOS | 182 |
| 8C1.. | Nursing care | 2782 |
| G57y7 | Sinus tachycardia | 57 |
| J5730 | Rectal haemorrhage | 1424 |
| R0350 | [D]Excessive thirst | 36 |
| ZV700 | [V]Routine health checkup | 152 |
| 8C15. | Nursing care - dressing | 1557 |
| G30.. | Acute myocardial infarction | 1145 |
| R0734 | [D]Bloating | 107 |
| H041. | Acute tracheitis | 541 |
| 1BE1. | Problem situation | 238 |
| E2C01 | Anger reaction | 10 |
| 168.. | Tiredness symptom | 1848 |
| J521. | Irritable colon - Irritable bowel syndrome | 848 |
| 5.... | Radiology/physics in medicine | 706 |
| F504. | Impacted cerumen (wax in ear) | 4067 |
| 7N511 | [SO]Prostate | 57 |

| | | |
|-------|---|-------|
| 8HQ2. | Refer for ultrasound investign | 403 |
| 8B24. | Prescription given no examination of patient | 907 |
| SD... | Superficial injury | 446 |
| 7L143 | Intravenous blood transfusion NEC | 303 |
| ZV411 | [V]Other eye problems | 420 |
| AB200 | Candidiasis of mouth | 445 |
| 1B1X. | Behavioural problem | 3 |
| ZGB17 | Advice to stop treatment | 18 |
| 8B316 | Medication changed | 2761 |
| ZGB67 | Advice about drug dosage | 208 |
| 4JK21 | High vaginal swab culture negative | 7 |
| H170. | Allergic rhinitis due to pollens | 768 |
| 7L172 | Blood withdrawal for testing | 12960 |
| 7H2B0 | Paracentesis abdominis for ascites | 6 |
| ZV6D5 | [V]Person consulting for explanatn of investiga- tion findings | 232 |
| 22Q.. | Wound observation | 237 |
| N2179 | Plantar fasciitis | 789 |
| R090B | [D]Groin pain | 651 |
| M07yz | Other spec local skin/subc infection NOS | 646 |
| ZV720 | [V]Examination of eyes and vision | 114 |
| R1320 | [D]Echocardiogram abnormal | 28 |
| G83.. | Varicose veins of the legs | 752 |
| 7K6Z2 | Injection of therapeutic substance into joint | 372 |

| | | |
|-------|-------------------------------------|------|
| 1B5.. | Incoordination symptom | 2893 |
| AB20. | Candidiasis of mouth and oesophagus | 368 |
| 79294 | Insertion of coronary artery stent | 64 |
| A7811 | Verruca plantaris | 123 |
| A7814 | Plain wart | 151 |
| F4Kz4 | Redness of eye NOS | 282 |
| Z1823 | Chaperone refused | 44 |
| N135z | Torticollis NOS | 71 |
| 195.. | Indigestion symptoms | 365 |
| 1M... | Pain | 634 |
| M12z2 | Infected eczema | 186 |
| 7G2E3 | Dressing of skin NEC | 731 |
| 1BT.. | Depressed mood | 908 |
| S64.. | Intracranial injury NOS | 290 |
| 196.. | Type of GIT pain | 437 |

Table D.1: The medical events signalled by the SAP framework with the random forest classifier for the drug Nifedipine. The medical events are ranked by the confidence returned by the classifier for the medical event belonging to the ADR class.

Ciprofloxacin

| Read Code | Medical Event | Frequency |
|-----------|-------------------------|-----------|
| 1BT.. | Depressed mood | 625 |
| 2227. | O/E - rash present | 329 |
| E2B.. | Depressive disorder NEC | 779 |

| | | |
|-------|---|------|
| A53.. | Herpes zoster | 364 |
| 892.. | Informed consent for procedure | 513 |
| Z4A.. | Discussion | 2861 |
| 66R5. | Rep.presc. treatment changed | 515 |
| C04.. | Acquired hypothyroidism | 324 |
| 32... | Electrocardiography | 363 |
| D00.. | Iron deficiency anaemias | 468 |
| R021z | [D]Rash and other nonspecific skin eruption NOS | 658 |
| 168.. | Tiredness symptom | 1006 |
| 8E... | Physiotherapy/remedial therapy | 686 |
| D00y1 | Microcytic hypochromic anaemia | 164 |
| J082. | Oral aphthae | 285 |
| Eu32. | [X]Depressive episode | 139 |
| 1D14. | C/O: a rash | 1310 |
| F4430 | Anterior uveitis | 9 |
| 8C1B. | Nursing care blood sample taken | 3263 |
| E2741 | Transient insomnia | 164 |
| 81H.. | Dressing of wound | 4336 |
| J520z | Constipation NOS | 433 |
| R0720 | [D]Difficulty in swallowing | 90 |
| E200. | Anxiety states | 573 |
| R090B | [D]Groin pain | 468 |
| J5730 | Rectal haemorrhage | 465 |
| R0608 | [D]Shortness of breath | 1143 |

| | | |
|-------|---|------|
| 7L172 | Blood withdrawal for testing | 3209 |
| R021. | [D]Rash and other nonspecific skin eruption | 176 |
| ZV57C | [V]Palliative care | 260 |
| ZV682 | [V]Expert advice request | 43 |
| G5y34 | Ventricular hypertrophy | 22 |
| G5yy9 | Left ventricular systolic dysfunction | 11 |
| S5yz1 | Muscle injury / strain | 46 |
| 2127. | Patient's condition worsened | 1099 |
| 8B311 | Medication given | 2556 |
| 1D13. | C/O: a pain | 1931 |
| 8H77. | Refer to physiotherapist | 602 |
| G580. | Congestive heart failure | 542 |
| 8B313 | Medication commenced | 929 |
| Z1B13 | Change of dressing | 247 |
| Z1K13 | Removal of suture from skin | 15 |
| Z4G1B | Giving encouragement to continue treatment | 7 |
| M18z. | Pruritus NOS | 576 |
| 8H9.. | Planned telephone contact | 581 |
| E112. | Single major depressive episode | 87 |
| Eu32z | [X]Depressive episode, unspecified | 356 |
| ZV681 | [V]Issue of repeat prescription | 806 |
| 8H21. | Admit medical emergency unsp. | 340 |
| K2710 | Balanitis | 77 |
| 22C2. | O/E - oedema of ankles | 383 |

| | | |
|-------|--|------|
| R060A | [D]Dyspnoea | 397 |
| 70652 | Nerve conduction studies | 18 |
| 8BAA. | Pain relief | 782 |
| R0300 | [D]Appetite loss | 88 |
| 8C15. | Nursing care - dressing | 981 |
| 681.. | Screening - general | 905 |
| 771Qz | Diagnostic rigid sigmoidoscopic exam of sigmoid colon NOS | 134 |
| ZV583 | [V]Attention to surgical dressings or sutures | 121 |
| N145. | Backache, unspecified | 387 |
| 7G2E3 | Dressing of skin NEC | 351 |
| Ryu8A | [X]Hyperglycaemia, unspecified | 22 |
| G84.. | Haemorrhoids | 487 |
| R0700 | [D]Nausea | 59 |
| 2315. | Resp. system examined - NAD | 988 |
| N2470 | Swelling of limb | 328 |
| AB200 | Candidiasis of mouth | 501 |
| 1B13. | Anxiousness | 700 |
| 313B. | Audiogram | 86 |
| ZZZZZ | converted code | 4445 |
| 1982. | Nausea present | 428 |
| 1M10. | Knee pain | 685 |
| 7C032 | Unilateral total orchidectomy - unspecified | 39 |
| 8C1.. | Nursing care | 1124 |

| | | |
|-------|--|------|
| 173.. | Breathlessness | 2023 |
| 677B. | Advice about treatment given | 1826 |
| M1535 | Perioral dermatitis | 17 |
| 761Fz | Diagnostic fiberoptic endoscopic exam upper GI tract NOS | 158 |
| 7L17. | Blood withdrawal | 2638 |
| 70560 | Carpal tunnel release | 77 |
| 8H8.. | Follow-up arranged | 1439 |
| C3652 | Dehydration NEC | 90 |
| 1B5.. | Incoordination symptom | 807 |
| 423.. | Haemoglobin estimation | 70 |
| AB220 | Candidal balanitis | 67 |
| 2841. | Confused | 434 |
| 8B3A3 | New medication commenced | 293 |
| R0420 | [D]Swelling in head or neck | 45 |
| 7L171 | Venesection | 610 |
| ZV680 | [V]Issue of medical certificate | 1019 |
| E2001 | Panic disorder | 192 |
| ZL233 | Under care of district nurse | 55 |
| H17.. | Allergic rhinitis | 158 |
| 8B316 | Medication changed | 727 |
| G581. | Left ventricular failure | 318 |
| E2003 | Anxiety with depression | 254 |
| 41D0. | Blood sample taken | 1984 |

| | | |
|-------|---|-----|
| R0073 | [D]Lethargy | 157 |
| 8HB2. | Medical follow-up | 533 |
| 21262 | Asthma resolved | 106 |
| ZV6D6 | [V]Alcohol abuse counselling and surveillance | 4 |
| N2174 | Achilles tendinitis | 130 |
| 7L185 | Intramuscular injection of vitamin B12 | 724 |
| 7G2A6 | Insertion of hormone implant | 54 |
| J4101 | Ulcerative colitis | 103 |
| C3661 | Fluid retention | 94 |
| S6460 | Minor head injury | 6 |
| A3B11 | Meticillin resistant staphylococcus aureus | 73 |
| M1616 | Guttate psoriasis | 17 |
| 7N522 | [SO]Epididymis | 31 |
| 8H4B. | Referred to rheumatologist | 132 |
| 68... | Screening | 724 |
| 8H76. | Refer to dietician | 150 |
| ZV700 | [V]Routine health checkup | 48 |
| R1057 | [D]Glucose, blood level abnormal | 82 |
| H51y7 | Malignant pleural effusion | 15 |
| R1100 | [D]Albuminuria | 27 |
| Z174L | Skin care | 36 |
| J50zz | Intestinal obstruction NOS | 102 |
| C11y3 | Impaired fasting glycaemia | 45 |
| 44120 | Urea and electrolytes normal | 24 |

| | | |
|-------|---|----|
| Eu410 | [X]Panic disorder [episodic paroxysmal anxiety] | 7 |
| F4C71 | Subconjunctival haemorrhage | 90 |
| A3A0. | Gas gangrene | 13 |
| 7G2EA | Two layer compression bandage for skin ulcer | 31 |

Table D.2: The medical events signalled by the SAP framework with the random forest classifier for the drug Ciprofloxacin. The medical events are ranked by the confidence returned by the classifier for the medical event belonging to the ADR class.

Ibuprofen

| Read Code | Medical Event | Frequency |
|-----------|---|-----------|
| D00.. | Iron deficiency anaemias | 1876 |
| 198.. | Nausea | 3084 |
| K190z | Urinary tract infection, site not specified NOS | 5945 |
| 461.. | Urine exam. - general | 1842 |
| M28.. | Urticaria | 1268 |
| 81H.. | Dressing of wound | 10761 |
| 2227. | O/E - rash present | 1717 |
| D21z. | Anaemia unspecified | 2089 |
| 16E.. | Feels unwell | 2129 |
| 8H9.. | Planned telephone contact | 1386 |
| H33.. | Asthma | 3253 |
| M0z.. | Skin and subcut tissue infection NOS | 599 |
| K190. | Urinary tract infection, site not specified | 4806 |
| H06z0 | Chest infection NOS | 17499 |

| | | |
|-------|---|------|
| 22L.. | O/E - wound healing | 600 |
| 1B5.. | Incoordination symptom | 3824 |
| R021z | [D]Rash and other nonspecific skin eruption NOS | 3253 |
| SP255 | Postoperative wound infection, unspecified | 887 |
| Z4A.. | Discussion | 8370 |
| 1D14. | C/O: a rash | 6155 |
| 1982. | Nausea present | 987 |
| 168.. | Tiredness symptom | 2937 |
| 535.. | Standard chest X-ray | 1465 |
| R090. | [D]Abdominal pain | 4220 |
| 67I.. | Advice | 3408 |
| 1922. | Sore mouth | 794 |
| 7G2E3 | Dressing of skin NEC | 817 |
| 8HB2. | Medical follow-up | 2143 |
| J5730 | Rectal haemorrhage | 1473 |
| 66R5. | Rep.presc. treatment changed | 2890 |
| H1y1z | Nasal cavity and sinus disease NOS | 907 |
| M0... | Skin and subcutaneous tissue infections | 1766 |
| AB2.. | Candidiasis | 3488 |
| 1J4.. | Suspected UTI | 2814 |
| 1A... | Genitourinary symptoms | 1976 |
| 2315. | Resp. system examined - NAD | 2992 |
| C34.. | Gout | 3709 |
| 66R.. | Repeat prescription monitoring | 3230 |

| | | |
|-------|---|-------|
| H30.. | Bronchitis unspecified | 1682 |
| G20.. | Essential hypertension | 7883 |
| 4131. | Blood test requested | 2484 |
| 1C14. | Blocked ear | 1257 |
| 2F13. | O/E - dry skin | 2790 |
| 8B314 | Medication review | 13074 |
| AB200 | Candidiasis of mouth | 681 |
| E2B.. | Depressive disorder NEC | 5162 |
| R062. | [D]Cough | 1180 |
| J520z | Constipation NOS | 1422 |
| M230. | Ingrowing nail | 1016 |
| 1BT.. | Depressed mood | 2678 |
| F4D0. | Blepharitis | 1298 |
| M07z. | Local infection skin/subcut tissue NOS | 1685 |
| Eu32z | [X]Depressive episode, unspecified | 2044 |
| G66.. | Stroke and cerebrovascular accident unspecified | 919 |
| ZV720 | [V]Examination of eyes and vision | 147 |
| 8C1.. | Nursing care | 4083 |
| 8C15. | Nursing care - dressing | 2028 |
| 1AG.. | Recurrent urinary tract infections | 500 |
| 196.. | Type of GIT pain | 984 |
| 1737. | Wheezing | 1553 |
| 181.. | Palpitations | 1860 |
| 67E.. | Foreign travel advice | 3206 |

| | | |
|-------|---|-------|
| 182.. | Chest pain | 10791 |
| 413.. | Laboratory test requested | 7598 |
| 1B321 | Weakness of leg | 177 |
| 8C1L. | Wound care | 884 |
| 23... | Examn. of respiratory system | 1535 |
| ZV681 | [V]Issue of repeat prescription | 3691 |
| 81H5. | Change of dressing | 635 |
| 8B41. | Repeated prescription | 6877 |
| R021. | [D]Rash and other nonspecific skin eruption | 894 |
| F51y0 | Eustachian tube dysfunction | 742 |
| F502z | Otitis externa NOS | 2593 |
| E112. | Single major depressive episode | 569 |
| 1Y... | Patient feels well | 2684 |
| AB20. | Candidiasis of mouth and oesophagus | 513 |
| K28y8 | Pain in testis | 258 |
| 2841. | Confused | 1066 |
| D00y1 | Microcytic hypochromic anaemia | 618 |
| 1.... | History / symptoms | 2793 |
| M05.. | Impetigo | 1098 |
| 6A... | Patient reviewed | 70321 |
| 7G2E. | Dressing of skin or wound | 1255 |
| 1739. | Shortness of breath | 2489 |
| 8CA.. | Patient given advice | 9574 |
| N2133 | Olecranon bursitis | 919 |

| | | |
|-------|---|-------|
| 73050 | Irrigation of external auditory canal for removal of wax | 9848 |
| A07y0 | Viral gastroenteritis | 355 |
| 8HQ2. | Refer for ultrasound investign | 857 |
| 1D13. | C/O: a pain | 12907 |
| 8C1B. | Nursing care blood sample taken | 12573 |
| H02.. | Acute pharyngitis | 2993 |
| E200. | Anxiety states | 2845 |
| AD30. | Scabies | 554 |
| 8H76. | Refer to dietician | 698 |
| N20.. | Polymyalgia rheumatica | 2441 |
| Z1B13 | Change of dressing | 498 |
| M03z. | Cellulitis and abscess NOS | 1473 |
| G65.. | Transient cerebral ischaemia | 1212 |
| 662.. | Cardiac disease monitoring | 17235 |
| J0250 | Dental abscess | 909 |
| 1B8.. | Eye symptoms | 1863 |
| 7M0G1 | Aspiration of other lesion of organ NOC | 65 |
| 8H8.. | Follow-up arranged | 4686 |
| 8H5B. | Referred to urologist | 1159 |
| J64.. | Cholelithiasis | 544 |
| 7NB00 | [SO]Shoulder NEC | 60 |
| 81HZ. | Wound dressing NOS | 1866 |
| R012z | [D]Gait abnormality NOS | 155 |

| | | |
|-------|--|-------|
| 2D82. | O/E - wax in auditory canal | 2078 |
| ZV680 | [V]Issue of medical certificate | 4916 |
| M18z. | Pruritus NOS | 2310 |
| 892.. | Informed consent for procedure | 3444 |
| TGyz3 | Accidental injury NOS | 70 |
| D41yz | Other specified disease of blood or blood forming organ NOS | 148 |
| 1D131 | C/O - pain in hallux | 256 |
| S2420 | Fracture of scaphoid | 83 |
| R0701 | [D]Vomiting | 170 |
| H060. | Acute bronchitis | 3311 |
| G33.. | Angina pectoris | 3241 |
| R0222 | [D]Lump, localized and superficial | 517 |
| 212.. | Patient examined | 3042 |
| 7G2B1 | Injection of therapeutic substance into skin | 183 |
| 41D0. | Blood sample taken | 8004 |
| 2128. | Patient's condition the same | 14124 |
| N30z8 | Bone infection NOS, of other specified site | 275 |
| G30.. | Acute myocardial infarction | 629 |
| 4K... | General pathology | 1181 |
| 8BAA. | Pain relief | 4430 |
| 7G22. | Removal of repair material from skin | 1713 |
| F501. | Infective otitis externa | 2790 |
| AB0.. | Dermatophytosis including tinea or ringworm | 1382 |

| | | |
|-------|--------------------------------------|-------|
| 173B. | Nocturnal cough / wheeze | 492 |
| 1C9.. | Sore throat symptom | 8963 |
| N2243 | Ganglion unspecified | 216 |
| 8C9.. | Reassurance given | 1597 |
| 2126. | Patient's condition improved | 22539 |
| M15y1 | Intertrigo | 1556 |
| M0203 | Paronychia of finger | 249 |
| Z1B.. | Dressing of skin or wound | 677 |
| 7L172 | Blood withdrawal for testing | 13906 |
| AB220 | Candidal balanitis | 102 |
| A53.. | Herpes zoster | 2338 |
| C3652 | Dehydration NEC | 117 |
| 8H7R. | Refer to chiropodist | 941 |
| 7G251 | Drainage of lesion of skin NEC | 189 |
| H00.. | Acute nasopharyngitis | 1627 |
| ZV49z | [V]Unspecified limb or other problem | 3605 |
| F1382 | Spasmodic torticollis | 118 |
| ZL146 | Under care of deputising GP | 245 |
| R0052 | [D]Insomnia NOS | 2374 |
| 246.. | O/E - blood pressure reading | 7872 |
| 7G0C1 | Biopsy of lesion of skin NEC | 35 |
| N2410 | Myalgia unspecified | 2246 |
| SN52. | Drug hypersensitivity NOS | 251 |
| M03z0 | Cellulitis NOS | 3272 |

| | | |
|-------|--|-------|
| 8HQ1. | Refer for X-Ray | 7376 |
| F4Kz4 | Redness of eye NOS | 282 |
| ZV583 | [V]Attention to surgical dressings or sutures | 550 |
| R0400 | [D]Facial pain | 568 |
| 7L171 | Venesection | 1946 |
| 7L11y | Other specified injection of therapeutic substance | 66 |
| 173.. | Breathlessness | 3310 |
| M101. | Seborrhoeic dermatitis | 1018 |
| R065z | [D]Chest pain NOS | 195 |
| H26.. | Pneumonia due to unspecified organism | 489 |
| 19FZ. | Diarrhoea symptom NOS | 728 |
| 677B. | Advice about treatment given | 6676 |
| 8B311 | Medication given | 8307 |
| 19B.. | Flatulence/wind | 629 |
| 32... | Electrocardiography | 2209 |
| SN530 | Allergic reaction | 110 |
| ZV6D5 | [V]Person consulting for explanation of investigation findings | 283 |
| 7L17. | Blood withdrawal | 11641 |
| 1B320 | Weakness of arm | 68 |
| M244. | Folliculitis | 773 |
| R0608 | [D]Shortness of breath | 2053 |
| F4G01 | Orbital cellulitis | 56 |

| | | |
|-------|---|-------|
| N23y4 | Spasm of muscle | 597 |
| E2001 | Panic disorder | 933 |
| 1954. | Indigestion | 1326 |
| 4617. | MSU = abnormal | 173 |
| ZGB62 | Advice about side effects of drug treatment | 75 |
| SP2y2 | Postoperative pain | 289 |
| 1D15. | C/O: itching | 1097 |
| D00zz | Iron deficiency anaemia NOS | 52 |
| N2241 | Ganglion of joint | 115 |
| R082. | [D]Retention of urine | 440 |
| N2457 | Shoulder pain | 1446 |
| R0043 | [D]Vertigo NOS | 1898 |
| C2943 | Iron deficiency | 130 |
| ZZZZZ | Converted code | 21209 |
| 1A7.. | Vaginal discharge symptom | 1047 |
| 585.. | Other diagnostic ultrasound | 412 |
| 4618. | Urine dipstick test | 1090 |
| 704A0 | Therapeutic lumbar epidural injection | 121 |
| M12.. | Contact dermatitis and other eczemas | 580 |
| F586. | Otorrhoea | 286 |
| 7G090 | Cauterisation of lesion of skin NEC | 230 |
| M200z | Corns NOS | 127 |

Table D.3: The medical events signalled by the SAP framework with the random forest classifier for the drug Ibuprofen. The medical events are ranked by the confidence returned by the classifier for the medical event belonging to the ADR class.

Budesonide

| Read Code | Medical Event | Frequency |
|-----------|---|-----------|
| R090. | [D]Abdominal pain | 1436 |
| K190z | Urinary tract infection, site not specified NOS | 1626 |
| N245. | Pain in limb | 5360 |
| 1A1.. | Micturition frequency | 892 |
| 892.. | Informed consent for procedure | 1286 |
| D00.. | Iron deficiency anaemias | 670 |
| 413.. | Laboratory test requested | 3881 |
| 8C9.. | Reassurance given | 540 |
| 19C.. | Constipation | 2650 |
| A53.. | Herpes zoster | 703 |
| 1D14. | C/O: a rash | 2553 |
| 2227. | O/E - rash present | 601 |
| N142. | Pain in lumbar spine | 2397 |
| 1B8.. | Eye symptoms | 875 |
| 1B8Z. | Eye symptom NOS | 352 |
| 1M10. | Knee pain | 1999 |
| N131. | Cervicalgia - pain in neck | 2365 |
| Z4A.. | Discussion | 3827 |
| K190. | Urinary tract infection, site not specified | 1513 |
| TC... | Accidental falls | 1528 |
| R021z | [D]Rash and other nonspecific skin eruption NOS | 1396 |
| 16C2. | Backache | 1185 |

| | | |
|-------|---|------|
| M244. | Folliculitis | 394 |
| 1A... | Genitourinary symptoms | 760 |
| AB0.. | Dermatophytosis including tinea or ringworm | 645 |
| M03z0 | Cellulitis NOS | 1236 |
| 16C5. | C/O - low back pain | 1189 |
| 461.. | Urine exam. - general | 518 |
| K15.. | Cystitis | 1687 |
| 2F13. | O/E - dry skin | 1066 |
| F501. | Infective otitis externa | 1082 |
| M0z.. | Skin and subcut tissue infection NOS | 272 |
| 1B5.. | Incoordination symptom | 1407 |
| 8H77. | Refer to physiotherapist | 1176 |
| 8B24. | Prescription given no examination of patient | 524 |
| ZV583 | [V]Attention to surgical dressings or sutures | 233 |
| M12z0 | Dermatitis NOS | 514 |
| 16C6. | Back pain without radiation NOS | 1831 |
| 81H.. | Dressing of wound | 3827 |
| M07z. | Local infection skin/subcut tissue NOS | 736 |
| 1BT.. | Depressed mood | 1238 |
| 1J4.. | Suspected UTI | 1133 |
| 41D0. | Blood sample taken | 3193 |
| 8B4.. | Previous treatment continue | 5212 |
| D21z. | Anaemia unspecified | 561 |
| 1D15. | C/O: itching | 494 |

| | | |
|-------|--|------|
| 2D82. | O/E - wax in auditory canal | 762 |
| 8H9.. | Planned telephone contact | 664 |
| E2001 | Panic disorder | 432 |
| 7L172 | Blood withdrawal for testing | 6199 |
| 8C1B. | Nursing care blood sample taken | 4453 |
| M101. | Seborrhoeic dermatitis | 438 |
| N143. | Sciatica | 1198 |
| 7L17. | Blood withdrawal | 4396 |
| M02z. | Cellulitis and abscess of digit NOS | 254 |
| 6A5.. | Ongoing review | 273 |
| 8B41. | Repeated prescription | 3431 |
| 22J.. | O/E - dead | 125 |
| N0946 | Arthralgia of the lower leg | 1112 |
| J155. | Gastritis unspecified | 324 |
| 8CA.. | Patient given advice | 4064 |
| N094K | Arthralgia of hip | 1182 |
| 66R.. | Repeat prescription monitoring | 1212 |
| E2B.. | Depressive disorder NEC | 1434 |
| AB01. | Dermatophytosis of nail | 574 |
| 16E.. | Feels unwell | 789 |
| 16C.. | Backache symptom | 314 |
| M2yz. | Other skin and subcutaneous tissue disease NOS | 986 |
| E200. | Anxiety states | 1170 |
| J520z | Constipation NOS | 471 |

| | | |
|-------|---|-------|
| 6A... | Patient reviewed | 28334 |
| 2516. | Abdomen examined - NAD | 557 |
| 677B. | Advice about treatment given | 2990 |
| 2126. | Patient's condition improved | 8208 |
| H06z0 | Chest infection NOS | 20537 |
| 1955. | Heartburn | 634 |
| 8C1.. | Nursing care | 1349 |
| 7G22. | Removal of repair material from skin | 668 |
| F59.. | Hearing loss | 653 |
| E2273 | Impotence | 607 |
| F502z | Otitis externa NOS | 783 |
| M0... | Skin and subcutaneous tissue infections | 634 |
| G20.. | Essential hypertension | 2258 |
| N0945 | Arthralgia of the pelvic region and thigh | 519 |
| M12.. | Contact dermatitis and other eczemas | 223 |
| 1C3.. | Earache symptoms | 556 |
| 4618. | Urine dipstick test | 355 |
| R0300 | [D]Appetite loss | 82 |
| M111. | Atopic dermatitis/eczema | 1739 |
| R090B | [D]Groin pain | 358 |
| 2.... | Examination / Signs | 3388 |
| M12z1 | Eczema NOS | 2033 |
| 424.. | Full blood count - FBC | 451 |
| 1C9.. | Sore throat symptom | 3604 |

| | | |
|-------|---|------|
| 8C15. | Nursing care - dressing | 771 |
| 7.... | Operations, procedures, sites | 259 |
| ZV725 | [V]Radiological examination NEC | 63 |
| 22L.. | O/E - wound healing | 182 |
| 8E... | Physiotherapy/remedial therapy | 1413 |
| 58D.. | Ultrasound scan | 205 |
| 8BAA. | Pain relief | 890 |
| 1.... | History / symptoms | 1628 |
| 8BI.. | Other medication review | 448 |
| M2z0. | Skin lesion | 454 |
| 22C2. | O/E - oedema of ankles | 577 |
| M12z2 | Infected eczema | 276 |
| J0931 | Coated tongue | 33 |
| R0734 | [D]Bloating | 71 |
| 16Z3. | Recurrence of problem | 499 |
| Z1B.. | Dressing of skin or wound | 252 |
| N2132 | Lateral epicondylitis of the elbow | 570 |
| J5730 | Rectal haemorrhage | 516 |
| J521. | Irritable colon - Irritable bowel syndrome | 787 |
| 4131. | Blood test requested | 1374 |
| 73050 | Irrigation of external auditory canal for removal of wax | 3217 |
| F301z | Trigeminal neuralgia NOS | 65 |
| 2128. | Patient's condition the same | 3380 |

| | | |
|-------|--|------|
| 662.. | Cardiac disease monitoring | 6147 |
| K3110 | Gynaecomastia | 40 |
| SP255 | Postoperative wound infection, unspecified | 244 |
| M161z | Psoriasis NOS | 265 |
| 1C14. | Blocked ear | 523 |
| 1AA.. | Prostatism | 298 |
| N145. | Backache, unspecified | 682 |
| 6896. | Depression screening using questions | 5625 |
| 6A2.. | Coronary heart disease annual review | 758 |
| K20.. | Benign prostatic hypertrophy | 390 |
| N094. | Pain in joint - arthralgia | 764 |
| R0902 | [D]Colic NOS | 37 |
| M01.. | Furuncle - boil | 244 |
| C34.. | Gout | 741 |
| M03z1 | Abscess NOS | 161 |
| M03z. | Cellulitis and abscess NOS | 339 |
| N2470 | Swelling of limb | 362 |
| TJ... | Drugs and other substances-adverse effects in therapeutic use | 281 |
| N135z | Torticollis NOS | 78 |
| 19FZ. | Diarrhoea symptom NOS | 250 |
| 1A53. | Lumbar ache - renal | 405 |
| F4Kz1 | Eye pain NOS | 207 |
| 7K36. | Diagnostic arthroscopy of knee | 129 |

| | | |
|-------|---|------|
| 8B21. | Drug prescription | 309 |
| K271. | Balanoposthitis | 98 |
| J0854 | Angular stomatitis and cheilitis | 170 |
| 8B314 | Medication review | 6558 |
| G65.. | Transient cerebral ischaemia | 325 |
| 2G5.. | O/E - foot | 1275 |
| 196.. | Type of GIT pain | 369 |
| R0081 | [D]Excessive sweating | 80 |
| 36150 | Gastroscopy abnormal | 22 |
| AB200 | Candidiasis of mouth | 1042 |
| 33C.. | Circulatory function tests | 274 |
| 67E.. | Foreign travel advice | 1578 |
| 32... | Electrocardiography | 789 |
| 4.... | Laboratory procedures | 521 |
| M180. | Pruritus ani | 308 |
| F51y0 | Eustachian tube dysfunction | 388 |
| R021. | [D]Rash and other nonspecific skin eruption | 364 |
| M2400 | Alopecia unspecified | 100 |
| 246.. | O/E - blood pressure reading | 1966 |
| J64.. | Cholelithiasis | 249 |
| 16ZZ. | General symptom NOS | 377 |
| F340. | Carpal tunnel syndrome | 399 |
| 2D... | Ear, nose + throat examination | 659 |
| 41B1. | Blood test due | 1127 |

| | | |
|-------|-------------------------------------|------|
| 7M07z | Cryotherapy to organ NOC NOS | 184 |
| 46... | Urine examination | 294 |
| R0103 | [D]Tremor NOS | 201 |
| SE... | Contusion (bruise) with intact skin | 223 |
| K4211 | Vulvitis unspecified | 88 |
| 1D131 | C/O - pain in hallux | 70 |
| N2133 | Olecranon bursitis | 256 |
| E2003 | Anxiety with depression | 528 |
| 212.. | Patient examined | 1243 |
| N2410 | Myalgia unspecified | 527 |
| AD30. | Scabies | 197 |
| 1B321 | Weakness of leg | 44 |
| J573. | Haemorrhage of rectum and anus | 231 |
| J0250 | Dental abscess | 322 |
| 1M11. | Foot pain | 349 |
| 8H4B. | Referred to rheumatologist | 239 |
| 8H5B. | Referred to urologist | 430 |
| K28y8 | Pain in testis | 70 |
| K10y0 | Pyelonephritis unspecified | 23 |
| N0940 | Arthralgia of unspecified site | 255 |
| 15C.. | Vaginal irritation | 135 |
| F504. | Impacted cerumen (wax in ear) | 1240 |
| M05.. | Impetigo | 452 |
| C2943 | Iron deficiency | 76 |

| | | |
|-------|---|------|
| ZV700 | [V]Routine health checkup | 64 |
| 8H8.. | Follow-up arranged | 1847 |
| C3652 | Dehydration NEC | 28 |
| F52z. | Otitis media NOS | 1426 |
| 8CAK. | Patient given telephone advice out of hours | 570 |
| R0904 | [D]Abdominal cramps | 43 |
| 893.. | Post operative monitoring | 130 |
| J10y4 | Oesophageal reflux without mention of oesophagi- tis | 1108 |
| 535.. | Standard chest X-ray | 914 |
| 1J... | Suspected condition | 651 |
| Z1B13 | Change of dressing | 191 |
| ZV411 | [V]Other eye problems | 204 |
| D00y1 | Microcytic hypochromic anaemia | 233 |
| F4D0. | Blepharitis | 499 |
| G3... | Ischaemic heart disease | 781 |
| 8A... | Monitoring of patient | 199 |
| 2127. | Patient's condition worsened | 927 |
| N2452 | Pain in leg | 656 |

Table D.4: The medical events signalled by the SAP framework with the random forest classifier for the drug Budesonide. The medical events are ranked by the confidence returned by the classifier for the medical event belonging to the ADR class.

Naproxen

| Read Code | Medical Event | Frequency |
|-----------|---|-----------|
| E2B.. | Depressive disorder NEC | 1677 |
| R090. | [D]Abdominal pain | 1077 |
| D00.. | Iron deficiency anaemias | 627 |
| K190z | Urinary tract infection, site not specified NOS | 1507 |
| 1C9.. | Sore throat symptom | 1707 |
| R021z | [D]Rash and other nonspecific skin eruption NOS | 1034 |
| 1BT.. | Depressed mood | 858 |
| 535.. | Standard chest X-ray | 402 |
| H06z0 | Chest infection NOS | 4417 |
| G84.. | Haemorrhoids | 541 |
| C04.. | Acquired hypothyroidism | 588 |
| H02.. | Acute pharyngitis | 640 |
| 8H9.. | Planned telephone contact | 392 |
| D21z. | Anaemia unspecified | 797 |
| 413.. | Laboratory test requested | 3664 |
| 461.. | Urine exam. - general | 445 |
| 892.. | Informed consent for procedure | 1173 |
| Z4A.. | Discussion | 2371 |
| H05z. | Upper respiratory infection NOS | 2634 |
| 1A... | Genitourinary symptoms | 530 |
| 81H.. | Dressing of wound | 2969 |
| M230. | Ingrowing nail | 372 |

| | | |
|-------|---|------|
| 1D14. | C/O: a rash | 1456 |
| 66R.. | Repeat prescription monitoring | 797 |
| H00.. | Acute nasopharyngitis | 380 |
| 2315. | Resp. system examined - NAD | 547 |
| H30.. | Bronchitis unspecified | 514 |
| K190. | Urinary tract infection, site not specified | 902 |
| M07z. | Local infection skin/subcut tissue NOS | 574 |
| H060. | Acute bronchitis | 823 |
| AB2.. | Candidiasis | 801 |
| E200. | Anxiety states | 707 |
| 173.. | Breathlessness | 873 |
| 66R5. | Rep.presc. treatment changed | 911 |
| M18z. | Pruritus NOS | 638 |
| M244. | Folliculitis | 247 |
| 2F13. | O/E - dry skin | 590 |
| 2227. | O/E - rash present | 337 |
| 7L17. | Blood withdrawal | 4328 |
| H1y1z | Nasal cavity and sinus disease NOS | 286 |
| 1Z... | History/symptom NOS | 632 |
| 1CA2. | Hoarse | 172 |
| 16E.. | Feels unwell | 411 |
| 7G22. | Removal of repair material from skin | 497 |
| 8B4.. | Previous treatment continue | 2945 |
| 662.. | Cardiac disease monitoring | 5045 |

| | | |
|-------|--|------|
| R0608 | [D]Shortness of breath | 556 |
| G20.. | Essential hypertension | 2348 |
| 8H76. | Refer to dietician | 199 |
| G66.. | Stroke and cerebrovascular accident unspecified | 232 |
| H06z1 | Lower resp tract infection | 867 |
| SP255 | Postoperative wound infection, unspecified | 278 |
| 1982. | Nausea present | 232 |
| 761Fz | Diagnostic fiberoptic endoscopic exam upper GI tract NOS | 146 |
| 1B5.. | Incoordination symptom | 902 |
| 8B41. | Repeated prescription | 1709 |
| J10y4 | Oesophageal reflux without mention of oesophagitis | 466 |
| 7L172 | Blood withdrawal for testing | 5052 |
| 1737. | Wheezing | 395 |
| 1922. | Sore mouth | 196 |
| 8C1.. | Nursing care | 721 |
| 8C17. | Nursing care - injections | 388 |
| M05.. | Impetigo | 226 |
| 196.. | Type of GIT pain | 184 |
| F4D0. | Blepharitis | 318 |
| 19EA. | Change in bowel habit | 234 |
| E2273 | Impotence | 628 |
| M180. | Pruritus ani | 243 |

| | | |
|-------|--|-------|
| 1739. | Shortness of breath | 571 |
| 22L.. | O/E - wound healing | 147 |
| 2516. | Abdomen examined - NAD | 326 |
| J1011 | Reflux oesophagitis | 189 |
| 4618. | Urine dipstick test | 296 |
| AD30. | Scabies | 106 |
| 8B314 | Medication review | 3576 |
| M2300 | Ingrowing great toe nail | 166 |
| J520z | Constipation NOS | 308 |
| ZV681 | [V]Issue of repeat prescription | 1485 |
| E2001 | Panic disorder | 231 |
| E2003 | Anxiety with depression | 440 |
| N2133 | Olecranon bursitis | 361 |
| 7L18. | Intramuscular injection | 1066 |
| M12z1 | Eczema NOS | 764 |
| Z174N | Wound care | 63 |
| 8C15. | Nursing care - dressing | 539 |
| M0... | Skin and subcutaneous tissue infections | 488 |
| F4Kz1 | Eye pain NOS | 160 |
| G3111 | Unstable angina | 24 |
| R060A | [D]Dyspnoea | 233 |
| M2yz. | Other skin and subcutaneous tissue disease NOS | 645 |
| 6A... | Patient reviewed | 21724 |
| D00y1 | Microcytic hypochromic anaemia | 197 |

| | | |
|-------|---|------|
| 8B3R. | Drug therapy discontinued | 534 |
| 36140 | Gastroscopy normal | 21 |
| 1J4.. | Suspected UTI | 702 |
| K28y6 | Epididymal cyst | 75 |
| 23... | Examn. of respiratory system | 272 |
| 7G2E3 | Dressing of skin NEC | 263 |
| 8BL.. | Other medication review | 301 |
| 1972. | Epigastric pain | 800 |
| 4.... | Laboratory procedures | 342 |
| R0701 | [D]Vomiting | 38 |
| 41D0. | Blood sample taken | 3007 |
| 7C242 | Standard circumcision | 33 |
| 8CA.. | Patient given advice | 2562 |
| 4142. | Blood sample -¿ Haematol Lab | 426 |
| 1Y... | Patient feels well | 765 |
| E112. | Single major depressive episode | 107 |
| ZV583 | [V]Attention to surgical dressings or sutures | 149 |
| G5y34 | Ventricular hypertrophy | 19 |
| 73050 | Irrigation of external auditory canal for removal of wax | 2577 |
| 7L064 | Amputation below knee | 4 |
| J3030 | Unilateral inguinal hernia - simple | 56 |
| G30.. | Acute myocardial infarction | 162 |
| J5747 | Anal pain | 65 |

| | | |
|-------|--|------|
| R0700 | [D]Nausea | 35 |
| K2414 | Acute epididymitis | 54 |
| 8H5B. | Referred to urologist | 319 |
| 677B. | Advice about treatment given | 1684 |
| Eu431 | [X]Post - traumatic stress disorder | 31 |
| 7P051 | Ultrasound of abdomen | 31 |
| 2126. | Patient's condition improved | 6857 |
| 8CAL. | Smoking cessation advice | 1621 |
| ZZZZZ | Converted code | 4290 |
| 7G2A9 | Subcutaneous injection of hormone antagonist | 87 |
| G581. | Left ventricular failure | 230 |
| M15y1 | Intertrigo | 441 |
| 7H220 | Exploratory laparotomy | 35 |
| 8B311 | Medication given | 2296 |
| J66y6 | Obstructive jaundice NOS | 13 |
| 8H21. | Admit medical emergency unsp. | 115 |
| F587. | Otalgia | 510 |
| 44121 | Urea and electrolytes abnormal | 48 |
| R090F | [D]Acute abdomen | 12 |
| 8B42. | Previous treatment repeat | 1333 |
| 8B24. | Prescription given no examination of patient | 293 |
| 1B8Z. | Eye symptom NOS | 274 |
| 7701z | Other excision of appendix NOS | 26 |
| SK160 | Other hip injuries | 31 |

| | | |
|-------|---|------|
| M111. | Atopic dermatitis/eczema | 444 |
| ZL233 | Under care of district nurse | 20 |
| 2841. | Confused | 203 |
| 7G2E. | Dressing of skin or wound | 324 |
| R062. | [D]Cough | 284 |
| G3... | Ischaemic heart disease | 641 |
| AB0.. | Dermatophytosis including tinea or ringworm | 421 |
| Z1779 | Outpatient care | 30 |
| M161z | Psoriasis NOS | 244 |
| 32... | Electrocardiography | 579 |
| R047. | [D]Epistaxis | 226 |
| M271. | Non-pressure ulcer lower limb | 980 |
| 4131. | Blood test requested | 969 |
| R0822 | [D]Acute retention of urine | 13 |
| G65.. | Transient cerebral ischaemia | 282 |
| 79360 | Implantation of intravenous cardiac pacemaker system | 15 |
| 8H7R. | Refer to chiropodist | 260 |
| 1968. | Abdominal discomfort | 185 |
| ZV680 | [V]Issue of medical certificate | 1629 |
| R0905 | [D]Epigastric pain | 52 |
| E2900 | Grief reaction | 65 |
| 22C2. | O/E - oedema of ankles | 434 |
| 2G5.. | O/E - foot | 920 |

| | | |
|-------|---|------|
| 1B321 | Weakness of leg | 33 |
| M270. | Decubitus (pressure) ulcer | 161 |
| 7L185 | Intramuscular injection of vitamin B12 | 686 |
| R0733 | [D]Abdominal distension, gaseous | 19 |
| Z1B13 | Change of dressing | 166 |
| 173B. | Nocturnal cough / wheeze | 94 |
| 7NB13 | [SO]Lower leg NEC | 98 |
| 7G2EA | Two layer compression bandage for skin ulcer | 14 |
| R021. | [D]Rash and other nonspecific skin eruption | 172 |
| M0z.. | Skin and subcut tissue infection NOS | 149 |
| 7G251 | Drainage of lesion of skin NEC | 58 |
| G3071 | Acute non-ST segment elevation myocardial in- farction | 27 |
| 8BAA. | Pain relief | 1332 |
| F4504 | Ocular hypertension | 147 |
| 22Q.. | Wound observation | 164 |
| 7B2A. | Diagnostic cystoscopy | 293 |
| A3Ay2 | Clostridium difficile infection | 17 |
| K3110 | Gynaecomastia | 30 |
| 8C1L. | Wound care | 190 |
| 2128. | Patient's condition the same | 3954 |
| 7G2E1 | Dressing of burnt skin NEC | 44 |
| H03.. | Acute tonsillitis | 544 |
| 8HB2. | Medical follow-up | 851 |

| | | |
|-------|--|------|
| J50zz | Intestinal obstruction NOS | 46 |
| 7L1H0 | Direct current cardioversion | 10 |
| 7L123 | Myocardial perfusion scan | 13 |
| J5031 | Faecal impaction | 16 |
| N2243 | Ganglion unspecified | 74 |
| 8HQ1. | Refer for X-Ray | 2396 |
| 7G033 | Excision of lesion of skin NEC | 146 |
| Eu32z | [X]Depressive episode, unspecified | 488 |
| N094M | Arthralgia of knee | 322 |
| 81HZ. | Wound dressing NOS | 497 |
| M1610 | Psoriasis unspecified | 416 |
| 7B2Az | Diagnostic cystoscopy NOS | 115 |
| F4E51 | Xanthelasma | 28 |
| ZGB66 | Advice to stop drug treatment | 35 |
| A0745 | Helicobacter pylori gastrointestinal tract infection | 10 |
| 7G2B1 | Injection of therapeutic substance into skin | 17 |
| K10y0 | Pyelonephritis unspecified | 14 |
| G831. | Varicose veins of the leg with eczema | 315 |
| 1.... | History / symptoms | 695 |
| 761F1 | Diagnostic gastroscopy NEC | 74 |
| 44120 | Urea and electrolytes normal | 68 |
| 7G223 | Removal of suture from skin NEC | 363 |

| | | |
|-------|--|------|
| 782Gz | Diagnostic endosc retrograde exam bile+pancreatic ducts NOS | 15 |
| 77352 | Injection of sclerosing substance into haemor- rhoid | 29 |
| 8B35. | Drug Rx stopped-medical advice | 529 |
| M07z1 | Infection toe | 95 |
| F5611 | Benign paroxysmal positional vertigo or nystag- mus | 232 |
| 8CA40 | Pt advised re wt reducing diet | 171 |
| SK150 | Other finger injuries, unspecified | 89 |
| Ryu8A | [X]Hyperglycaemia, unspecified | 7 |
| Eu411 | [X]Generalized anxiety disorder | 15 |
| C3540 | Hypocalcaemia NEC | 16 |
| R0102 | [D]Spasms NOS | 14 |
| F4005 | Eye infection | 11 |
| 1C14. | Blocked ear | 325 |
| R082. | [D]Retention of urine | 103 |
| R0400 | [D]Facial pain | 141 |
| R1100 | [D]Albuminuria | 14 |
| G2... | Hypertensive disease | 1284 |
| F4200 | Background diabetic retinopathy | 78 |
| C11y3 | Impaired fasting glycaemia | 96 |
| C2621 | Vitamin B12 deficiency | 103 |
| G57y7 | Sinus tachycardia | 12 |

| | | |
|-------|---|------|
| 8C9.. | Reassurance given | 291 |
| 761Fy | Diagnostic fiberoptic endoscopic exam upper GI tract OS | 15 |
| R0043 | [D]Vertigo NOS | 534 |
| Z4G1B | Giving encouragement to continue treatment | 23 |
| 7M05z | Laser therapy to organ NOC NOS | 11 |
| 8B3A1 | Medication increased | 956 |
| Z1K13 | Removal of suture from skin | 22 |
| ZV57C | [V]Palliative care | 84 |
| SD... | Superficial injury | 202 |
| TE640 | Insect bite NOS | 130 |
| 246.. | O/E - blood pressure reading | 2878 |
| M0212 | Paronychia of toe | 62 |
| 8BAB. | Pain control | 461 |
| 78105 | Endoscopic cholecystectomy | 63 |
| 42QE0 | INR - international normal ratio normal | 3 |
| 7M371 | Radiotherapy NEC | 145 |
| SN52. | Drug hypersensitivity NOS | 78 |
| 19FZ. | Diarrhoea symptom NOS | 140 |
| 2D82. | O/E - wax in auditory canal | 472 |
| K253. | Phimosis | 37 |
| G73z0 | Intermittent claudication | 209 |
| 4K1.. | Histology | 149 |
| 8A... | Monitoring of patient | 91 |

| | | |
|-------|--|------|
| 1AG.. | Recurrent urinary tract infections | 107 |
| 2127. | Patient's condition worsened | 861 |
| R090z | [D]Abdominal pain NOS | 39 |
| ZL146 | Under care of deputising GP | 34 |
| R0904 | [D]Abdominal cramps | 27 |
| 68... | Screening | 1200 |
| N2470 | Swelling of limb | 342 |
| ZV49z | [V]Unspecified limb or other problem | 1085 |
| ZV654 | [V]Other counselling NEC | 93 |
| M03z0 | Cellulitis NOS | 828 |
| 7B2B5 | Insertion of urethral catheter | 4 |
| R1431 | [D]Electrocardiogram (ECG) abnormal | 12 |
| K20.. | Benign prostatic hypertrophy | 390 |
| 31340 | Audiogram bilateral abnormality | 7 |
| 1B13. | Anxiousness | 582 |
| 1C8.. | Nasal symptoms OS | 166 |
| 77282 | Examination of rectum under anaesthetic | 11 |
| R0901 | [D]Abdominal colic | 79 |
| 72550 | Trabeculectomy | 29 |
| F563. | Labyrinthitis | 193 |
| TJ... | Drugs and other substances-adverse effects in therapeutic use | 422 |
| H33zz | Asthma NOS | 26 |
| R0720 | [D]Difficulty in swallowing | 63 |

| | | |
|-------|---|------|
| 6791. | Health ed. - smoking | 2170 |
| M2y45 | Epidermal cyst | 35 |
| F501. | Infective otitis externa | 600 |
| 7NB16 | [SO]Toe NEC | 20 |
| NyuBC | [X]Osteopenia | 132 |
| G5730 | Atrial fibrillation | 283 |
| G580. | Congestive heart failure | 368 |
| 7M0G1 | Aspiration of other lesion of organ NOC | 20 |
| Z1745 | Ear care | 19 |
| M01.. | Furuncle - boil | 225 |
| 679.. | Health education - subject | 188 |
| F4Ey4 | Cyst of eyelid NOS | 20 |
| 7717z | Other excision of colon NOS | 8 |
| Z174O | Post-surgical wound care | 16 |
| N0810 | Loose body in joint, unspecified joint | 19 |
| K272z | Other penile inflammatory disorder NOS | 5 |
| M1271 | Sunburn | 39 |
| 8HB20 | Medical follow-up - normal | 69 |
| G20z. | Essential hypertension NOS | 201 |
| ZV6D5 | [V]Person consulting for explanatn of investiga- tion findings | 149 |
| 7G2AC | Insertion of gonadorelin analogue implant | 21 |
| G5731 | Atrial flutter | 20 |
| 7M340 | Local anaesthetic nerve block | 36 |

| | | |
|-------|--|-----|
| R012z | [D]Gait abnormality NOS | 26 |
| AB200 | Candidiasis of mouth | 181 |
| R1103 | [D]Microalbuminuria | 41 |
| 8BA.. | Other misc. therapy | 174 |
| 7920y | Saphenous vein graft replacement of coronary artery OS | 7 |

Table D.5: The medical events signalled by the SAP framework with the random forest classifier for the drug Naproxen. The medical events are ranked by the confidence returned by the classifier for the medical event belonging to the ADR class.

References

- [1] J. Almenoff, J. M. Topping, A. L. Gould, and et al. Perspectives on the use of data mining in pharmacovigilance. *Drug Safety*, 28(11):981–1007, 2005. [14](#), [21](#)
- [2] E. Alpaydin. *Introduction to machine learning*. MIT press, 2004. [53](#)
- [3] Y. Alvarez, A. Hidalgo, F. Maignen, and J. Slattery. Validation of statistical signal detection procedures in EudraVigilance post-authorization data. *Drug Safety*, 33(6):475–487, 2010. [4](#), [28](#), [50](#)
- [4] J. Andrés-Ferrer, D. Ortiz-Martínez, I. García-Varea, and F. Casacuberta. On the use of different loss functions in statistical pattern recognition applied to machine translation. *Pattern Recognition Letters*, 29(8):1072–1081, 2008. [58](#)
- [5] N. Atias and R. Sharan. An algorithmic framework for predicting side effects of drugs. *Journal of Computational Biology*, 18(3):207–218, 2011. [137](#), [188](#)
- [6] M.-F. Balcan, A. Blum, and K. Yang. Co-training and expansion: Towards

REFERENCES

- bridging theory and practice. In *Advances in Neural Information Processing Systems*, pages 89–96, 2004. [78](#)
- [7] S. Basu, A. Banerjee, and R. Mooney. Semi-supervised clustering by seeding. In *Proceedings of 19th International Conference on Machine Learning (ICML)*, 2002. [79](#), [80](#), [83](#), [149](#), [151](#)
- [8] A. Bate. Bayesian confidence propagation neural network. *Drug Safety*, 30(7):623–625, 2007. [23](#)
- [9] A. Bate and S. J. W. Evans. Quantitative signal detection using spontaneous ADR reporting. *Pharmacoepidemiology and Drug Safety*, 18(6):427–436, 2009. [24](#), [28](#), [122](#)
- [10] A. Bate, M. Lindquist, I. R. Edwards, S. Olsson, R. Orre, A. Lansner, and R. M. De Freitas. A bayesian neural network method for adverse drug reaction signal generation. *European Journal of Clinical Pharmacology*, 54(4):315–321, 1998. [24](#)
- [11] J. A. Berlin, S. C. Glasser, and S. S. Ellenberg. Adverse event detection in drug development: recommendations and obligations beyond phase 3. *American Journal of Public Health*, 98(8):1366–1371, 2008. [3](#)
- [12] J. M. Bernardo, M. J. Bayarri, J. O. Berger, A. P. Dawid, D. Heckerman, A. F. M. Smith, and M. West. Bayesian methods in pharmacovigilance. pages 421–438. Oxford University Press, 2011. [23](#), [29](#)
- [13] G. Biau, L. Devroye, and G. Lugosi. Consistency of random forests and

- other averaging classifiers. *The Journal of Machine Learning Research*, 9:2015–2033, 2008. [72](#)
- [14] M. Bilenko, S. Basu, and R. J. Mooney. Integrating constraints and metric learning in semi-supervised clustering. In *Proceedings of the 21st International Conference on Machine Learning (ICML)*, page 11. ACM, 2004. [80](#)
- [15] B. T. Blak, M. Thompson, H. Dattani, and A. Bourke. Generalisability of The Health Improvement Network (THIN) database: demographics, chronic disease prevalence and mortality rates. *Informatics in Primary Care*, 19(4):251–255, 2011. [29](#)
- [16] A. Blum and T. Mitchell. Combining labeled and unlabeled data with co-training. In *Proceedings of the 11th Annual Conference on Computational Learning Theory*, pages 92–100. ACM, 1998. [77](#)
- [17] F. T. Bourgeois, M. W. Shannon, C. Valim, and K. D. Mandl. Adverse drug events in the outpatient setting: an 11-year national analysis. *Pharmacoepidemiology and Drug Safety*, 19(19):901–910, 2011. [3](#)
- [18] O. Bousquet, S. Boucheron, and G. Lugosi. Introduction to statistical learning theory. In *Advanced Lectures on Machine Learning*, pages 169–207. Springer, 2004. [58](#)
- [19] A. Bradford-Hill. The environment and disease: Association or causation? *Proceedings of the Royal Society of Medicine*, 58:295–300, 1965. [5](#), [17](#), [18](#), [84](#), [121](#), [123](#), [124](#), [126](#), [127](#), [135](#), [161](#)

REFERENCES

- [20] A. P. Bradley. The use of the area under the ROC curve in the evaluation of machine learning algorithms. *Pattern Recognition*, 30(7):1145–1159, 1997. [49](#)
- [21] L. Breiman, J. Friedman, R. Olshen, and C. Stone. *Classification and regression trees*. Wadsworth International Group, 1984. [62](#)
- [22] L. Breiman. Bagging predictors. *Machine Learning*, 24(2):123–140, 1996. [69](#), [70](#)
- [23] L. Breiman. Bias, variance, and arcing classifiers. 1996. [69](#), [70](#)
- [24] L. Breiman. Random forests. *Machine Learning*, 45(1):5–32, 2001. [71](#), [73](#)
- [25] T. Brodniewicz and G. Gryniewicz. Preclinical drug development. *Acta Poloniae Pharmaceutica*, 67(6):578–585, 2010. [2](#)
- [26] J. S. Brown, M. Kulldorff, K. A. Chan, R. L. Davis, D. Graham, P. T. Pettus, S. E. Andrade, M. A. Raebel, L. Herrinton, D. Roblin, et al. Early detection of adverse drug events within population-based health networks: application of sequential testing methods. *Pharmacoepidemiology and Drug Safety*, 16(12):1275–1284, 2007. [31](#), [41](#)
- [27] R. P. Burns and R. Burns. *Business research methods and statistics using SPSS*. Sage, 2008. [65](#)
- [28] R. Caruana and A. Niculescu-Mizil. Data mining in metric space: an empirical analysis of supervised learning performance criteria. In *Proceedings of the 10th International Conference on Knowledge Discovery and Data Mining (KDD)*, pages 69–78, 2004. [97](#)

- [29] O. Caster and I. R. Edwards. Reflections on attribute and decision in pharmacovigilance. *Drug Safety*, 33(10):805–809, 2010. [13](#)
- [30] O. Chapelle, B. Schölkopf, A. Zien, et al. *Semi-supervised learning*, volume 2. MIT press Cambridge, 2006. [54](#), [74](#), [75](#), [82](#), [84](#)
- [31] Z. Clancy, S. W. Keith, C. Rabinowitz, M. Ceccarelli, J. J. Gagne, and V. Maio. Statins and colorectal cancer risk: a longitudinal study. *Cancer Causes & Control*, pages 1–6, 2013. [30](#)
- [32] D. Cohn, R. Caruana, and A. McCallum. Semi-supervised clustering with user feedback. *Constrained Clustering: Advances in Algorithms, Theory, and Applications*, 4(1):17–32, 2003. [79](#)
- [33] P. Coloma, P. A. P, F. Salvo, M. Schuemie, C. Ferrajolo, A. Pariente, A. Fourier-Rglat, M. Molokhia, V. Patadia, J. van der Lei, M. Sturkenboom, and G. Trifirò. A reference standard for evaluation of methods for drug safety signal detection using electronic healthcare record databases. *Drug Safety*, 31(1):13–23, 2013. [51](#), [88](#), [160](#)
- [34] P. M. Coloma, M. J. Schuemie, G. Trifirò, R. Gini, R. Herings, J. Hippisley-Cox, G. Mazzaglia, C. Giaquinto, G. Corrao, L. Pedersen, et al. Combining electronic healthcare databases in europe to allow for large-scale drug safety monitoring: the EU-ADR project. *Pharmacoepidemiology and Drug Safety*, 20(1):1–11, 2011. [44](#)
- [35] P. M. Coloma, G. Trifirò, M. J. Schuemie, R. Gini, R. Herings, J. Hippisley-Cox, G. Mazzaglia, G. Picelli, G. Corrao, L. Pedersen, et al. Electronic

REFERENCES

- healthcare databases for active drug safety surveillance: is there enough leverage? *Pharmacoepidemiology and Drug Safety*, 21(6):611–621, 2012. [15](#)
- [36] A. Coppen, M. Abou-Saleh, P. Milln, J. Bailey, and K. Wood. Decreasing lithium dosage reduces morbidity and side-effects during prophylaxis. *Journal of Affective Disorders*, 5(4):353–362, 1983. [127](#)
- [37] M. Cord and P. Cunningham. *Machine learning techniques for multimedia: case studies on organization and retrieval*. Springer, 2008. [55](#)
- [38] O. P. Corrigan. A risky business: the detection of adverse drug reactions in clinical trials and post-marketing exercises. *Social Science & Medicine*, 55(3):497–507, 2002. [2](#), [3](#)
- [39] C. Cortes and V. Vapnik. Support-vector networks. *Machine Learning*, 20(3):273–297, 1995. [60](#), [83](#)
- [40] M. Culp and G. Michailidis. An iterative algorithm for extending learners to a semi-supervised setting. *Journal of Computational and Graphical Statistics*, 17(3):545–571, 2008. [75](#)
- [41] S. Dasgupta, M. L. Littman, and D. McAllester. Pac generalization bounds for co-training. *Advances in Neural Information Processing Systems*, 1:375–382, 2002. [78](#)
- [42] T. M. Davidson and W. M. Smith. The bradford hill criteria and zinc-induced anosmia: a causality analysis. *Archives of Otolaryngology – Head & Neck Surgery*, 136(7):673–676, 2010. [112](#), [138](#)

REFERENCES

- [43] E. C. Davies, C. F. Green, S. Taylor, P. R. Williamson, D. R. Mottram, and M. Pirmohamed. Adverse drug reactions in hospital in-patients: a prospective analysis of 3695 patient-episodes. *Public Library of Science one*, 4(2):e4439, 2009. 3, 4
- [44] E. R. DeLong, D. M. DeLong, and D. L. Clarke-Pearson. Comparing the areas under two or more correlated receiver operating characteristic curves: a nonparametric approach. *Biometrics*, pages 837–845, 1988. 98
- [45] L. Devroye, L. Györfi, and G. Lugosi. *A probabilistic theory of pattern recognition*, volume 31. Springer, 1996. 72
- [46] T. G. Dietterich. An experimental comparison of three methods for constructing ensembles of decision trees: Bagging, boosting, and randomization. *Machine Learning*, 40(2):139–157, 2000. 70, 71
- [47] P. Domingos and M. Pazzani. On the optimality of the simple bayesian classifier under zero-one loss. *Machine Learning*, 29(2-3):103–130, 1997. 65
- [48] A. K. Dubey, V. M. Castro, W. Mahamaneerat, S. Goryachev, T. D. Wang, C. D. Herrick, V. S. Gainer, and S. N. Murphy. Investigating OMOP false positives with i2b2. <http://omop.org/sites/default/files/Investigating%20MOP%20False%20Positives%20with%20i2b2%20Final%20Report%20November%202012.pdf>. Access: 2012-12-20. 87
- [49] S. A. Dudani. The distance-weighted k-nearest-neighbor rule. *IEEE Transactions on Systems, Man and Cybernetics*, 6(4):325–327, 1976. 69

-
- [50] W. DuMouchel. Bayesian data mining in large frequency tables, with an application to the FDA spontaneous reporting system. *The American Statistician*, 53(3):177–190, 1999. [24](#), [26](#)
- [51] S. Džeroski and B. Ženko. Is combining classifiers with stacking better than selecting the best one? *Machine Learning*, 54(3):255–273, 2004. [69](#)
- [52] I. R. Edwards. Considerations on causality in pharmacovigilance. *The International Journal of Risk & Safety in Medicine*, 24(1):41–54, 2012. [112](#)
- [53] I. R. Edwards and C. Biriell. Harmonisation in pharmacovigilance. *Drug Safety*, 10(2):93–102, 1994. [14](#)
- [54] C. P. Farrington. Relative incidence estimation from case series for vaccine safety evaluation. *Biometrics*, 51(1):228–235, 1995. [46](#)
- [55] R. L. Figueroa, Q. Zeng-Treitler, S. Kandula, and L. H. Ngo. Predicting sample size required for classification performance. *BioMed Central Medical Informatics and Decision Making*, 12(1):8, 2012. [148](#)
- [56] E. Fix and J. L. Hodges. Discriminatory analysis. nonparametric discrimination: Consistency properties. *International Statistical Review/Revue Internationale de Statistique*, 57(3):238–247, 1989. [60](#), [83](#)
- [57] P. B. Fontanarosa, D. Rennie, and C. D. DeAngelis. Postmarketing surveillance—lack of vigilance, lack of trust. *The Journal of the American Medical Association*, 292(21):2647–2650, 2004. [4](#)
- [58] D. Freedman. From association to causation via regression. *Advances in Applied Mathematics*, 18(1):59 – 110, 1997. [112](#)

REFERENCES

- [59] Y. Freund. An adaptive version of the boost by majority algorithm. *Machine Learning*, 43(3):293–318, 2001. [71](#)
- [60] Y. Freund, R. Schapire, and N. Abe. A short introduction to boosting. *Japanese Society For Artificial Intelligence*, 14(5):771–780, 1999. [70](#)
- [61] Y. Freund and R. E. Schapire. A decision-theoretic generalization of on-line learning and an application to boosting. In *Computational Learning Theory*, pages 23–37. Springer, 1995. [70](#)
- [62] R. Gallagher, K. Bird, J. Mason, M. Peak, P. Williamson, A. Nunn, M. Turner, M. Pirmohamed, and R. Smyth. Adverse drug reactions causing admission to a paediatric hospital: a pilot study. *Journal of Clinical Pharmacy and Therapeutics*, 36(2):194–199, 2011. [3](#)
- [63] S. A. Goldman. Limitations and strengths of spontaneous reports data. *Clinical Therapeutics*, 20:C40–C44, 1998. [16](#), [20](#)
- [64] K. J. Goodman and C. V. Phillips. *Hill's criteria of causation*. Wiley Online Library, 2005. [127](#)
- [65] R. L. Grant, V. M. Drennan, G. Rait, I. Petersen, and S. Iliffe. First diagnosis and management of incontinence in older people with and without dementia in primary care: A cohort study using The Health Improvement Network primary care database. *Public Library of Science Medicine*, 10(8):e1001505, 2013. [29](#)
- [66] S. Greenland and H. Morgenstern. Confounding in health research. *Annual Review of Public Health*, 22(1):189–212, 2001. [32](#)

REFERENCES

- [67] D. A. Grimes and K. F. Schulz. Bias and causal associations in observational research. *The Lancet*, 359(9302):248–252, 2002. [112](#), [124](#)
- [68] K. Haerian, D. Varn, S. Vaidya, L. Ena, H. Chase, and C. Friedman. Detection of pharmacovigilance-related adverse events using electronic health records and automated methods. *Clinical Pharmacology & Therapeutics*, 92(2):228–234, 2012. [111](#)
- [69] M. A. Hall. *Correlation-based feature selection for machine learning*. PhD thesis, The University of Waikato, 1999. [133](#), [213](#)
- [70] R. Harpaz, W. DuMouchel, P. LePendou, A. Bauer-Mehren, P. Ryan, and N. H. Shah. Performance of pharmacovigilance signal-detection algorithms for the FDA Adverse Event Reporting System. *Clinical Pharmacology & Therapeutics*, 93(6):539–546, 2013. [29](#), [88](#), [180](#)
- [71] R. Harpaz, W. DuMouchel, N. H. Shah, D. Madigan, P. Ryan, and C. Friedman. Novel data-mining methodologies for adverse drug event discovery and analysis. *Clinical Pharmacology & Therapeutics*, 91(6):1010–1021, 2012. [30](#), [45](#)
- [72] R. Harpaz, K. Haerian, H. S. Chase, and C. Friedman. Mining electronic health records for adverse drug effects using regression based methods. pages 100–107, 2010. [37](#)
- [73] J. A. Hartigan and M. A. Wong. Algorithm AS 136: A k-means clustering algorithm. *Journal of the Royal Statistical Society. Series C (Applied Statistics)*, 28(1):100–108, 1979. [79](#)

REFERENCES

- [74] T. Hastie, R. Tibshirani, and J. J. H. Friedman. *The elements of statistical learning*, volume 1. Springer New York, 2001. 53
- [75] M. Hauben and A. Bate. Data mining in pharmacovigilance. *Pharmaceutical Data Mining: Approaches and Applications for Drug Discovery*, 6:341, 2009. 24
- [76] M. Hauben, D. Madigan, C. M. Gerrits, L. Walsh, and E. P. Van Puijenbroek. The role of data mining in pharmacovigilance. *Expert Opinion on Drug Safety*, 4(5):929–948, 2005. 23
- [77] M. Hauben, L. Reich, and S. Chung. Postmarketing surveillance of potentially fatal reactions to oncology drugs: potential utility of two signal-detection algorithms. *European Journal of Clinical Pharmacology*, 60(10):747–750, 2004. 20
- [78] K. Haynes, W. B. Bilker, T. R. TenHave, B. L. Strom, and J. D. Lewis. Temporal and within practice variability in The Health Improvement Network. *Pharmacoepidemiology and Drug Safety*, 20(9):948–955, 2011. 30, 52
- [79] L. Hazell and S. A. Shakir. Under-reporting of adverse drug reactions. *Drug Safety*, 29(5):385–396, 2006. 16, 21, 50
- [80] P. HealthCare, S. N. Murphy, V. Castro, J. Colecchi, A. Dubey, V. Gainer, C. Herrick, and M. Sordo. Partners healthcare OMOP study report. http://omop.fnih.org/sites/default/files/PHCS_Final_OMOP_StudyReport.pdf, 2011. Accessed: 2013-01-18. 46, 47, 48, 108, 161, 185

REFERENCES

- [81] E. G. Henrichon Jr and K.-S. Fu. A nonparametric partitioning procedure for pattern classification. *IEEE Transactions on Computers*, 100(7):614–624, 1969. [60](#), [83](#)
- [82] T. K. Ho. The random subspace method for constructing decision forests. *IEEE Transactions on Pattern Analysis and Machine Intelligence*, 20(8):832–844, 1998. [69](#)
- [83] M. N. Hocine, P. Musonda, N. J. Andrews, and C. Paddy Farrington. Sequential case series analysis for pharmacovigilance. *Journal of the Royal Statistical Society: Series A (Statistics in Society)*, 172(1):213–236, 2009. [31](#), [42](#)
- [84] D. W. Hosmer Jr, S. Lemeshow, and R. X. Sturdivant. *Applied logistic regression*. Wiley. com, 2013. [60](#), [83](#)
- [85] R. Hubbard, S. Lewis, J. West, C. Smith, C. Godfrey, L. Smeeth, P. Farrington, and J. Britton. Bupropion and the risk of sudden death: a self-controlled case-series analysis using The Health Improvement Network. *Thorax*, 60(10):848–850, 2005. [29](#)
- [86] D. Hume. *A treatise of human nature. Second edition*. Oxford: Oxford University Press, 1978. [123](#)
- [87] T. Jaakkola and M. Jordan. A variational approach to bayesian logistic regression models and their extensions. In *Proceedings of the 6th International Workshop on Artificial Intelligence and Statistics*. Citeseer, 1997. [48](#)

REFERENCES

- [88] A. K. Jain, M. N. Murty, and P. J. Flynn. Data clustering: a review. *ACM Computing Surveys (CSUR)*, 31(3):264–323, 1999. [79](#)
- [89] Y. Ji, H. Ying, J. Tran, P. Dews, A. Mansour, and R. Massanari. A method for mining infrequent causal associations and its application in finding adverse drug reaction signal pairs. *IEEE Transactions on Knowledge and Data Engineering*, 25(4), 2012. [41](#)
- [90] H. Jin, J. Chen, H. He, C. Kelman, D. McAullay, and C. M. O’Keefe. Signalling potential adverse drug reactions from administrative health databases. *IEEE Transactions on Knowledge and Data Engineering*, 22(6):839–853, 2010. [31](#), [38](#), [103](#)
- [91] H. Jin, J. Chen, C. Kelman, H. He, D. McAullay, and C. M. O’Keefe. Mining unexpected associations for signalling potential adverse drug reactions from administrative health databases. In *Proceedings of the 10th Pacific-Asia Conference on Advances in Knowledge Discovery and Data Mining (PAKDD)*, pages 867–876. Springer, 2006. [38](#), [103](#), [111](#)
- [92] A. Jordan. On discriminative vs. generative classifiers: A comparison of logistic regression and naive bayes. pages 841–848, 2002. [57](#)
- [93] R. A. Kamtane and V. Jayawardhani. Knowledge, attitude and perception of physicians towards adverse drug reaction (ADR) reporting: A pharmacoepidemiological study. *Asian Journal of Pharmaceutical and Clinical Research*, 5(3):210–214, 2012. [16](#)
- [94] J. C. Kando, K. A. Yonkers, and J. O. Cole. Gender as a risk factor for adverse events to medications. *Drugs*, 50(1):1–6, 1995. [88](#)

- [95] M. J. Kearns and Y. Mansour. A fast, bottom-up decision tree pruning algorithm with near-optimal generalization. In *Proceeding of the 15th International Conference on Machine Learning (ICML)*, volume 98, pages 269–277. Citeseer, 1998. [61](#)
- [96] S. B. Kotsiantis, D. Kanellopoulos, and P. E. Pintelas. Data preprocessing for supervised learning. *International Journal of Computer Science*, 1(2):111–117, 2006. [131](#)
- [97] M. Kuhn. Building predictive models in R using the caret package. *Journal of Statistical Software*, 28(5):1–26, 2008. [211](#)
- [98] M. Kuhn, M. Campillos, I. Letunic, L. J. Jensen, and P. Bork. A side effect resource to capture phenotypic effects of drugs. *Molecular Systems Biology*, 6(1):343–349, 2010. [93](#), [137](#)
- [99] B. Kulis. Metric learning: A survey. *Machine Learning*, 5(4):287–364, 2012. [80](#)
- [100] R. Kunz and A. D. Oxman. The unpredictability paradox: review of empirical comparisons of randomised and non-randomised clinical trials. *British Medical Journal*, 317(7167):1185, 1998. [43](#)
- [101] P. Langley, W. Iba, and K. Thompson. An analysis of bayesian classifiers. In *Proceeding of the 10th National Conference on Artificial Intelligence (AAAI)*, volume 90, pages 223–228, 1992. [60](#), [83](#)
- [102] J. A. Lasserre, C. M. Bishop, and T. P. Minka. Principled hybrids of generative and discriminative models. In *Proceeding of the 19th IEEE Computer*

REFERENCES

- Society Conference on Computer Vision and Pattern Recognition (CVPR)*, volume 1, pages 87–94. IEEE, 2006. [57](#)
- [103] J. Lazarou, B. H. Pomeranz, and P. N. Corey. Incidence of adverse drug reactions in hospitalized patients. *The Journal of the American Medical Association*, 279(15):1200–1205, 1998. [3](#)
- [104] J. D. Lewis, W. B. Bilker, R. B. Weinstein, and B. L. Strom. The relationship between time since registration and measured incidence rates in the general practice research database. *Pharmacoepidemiology and Drug Safety*, 14(7):443–451, 2005. [30](#), [113](#)
- [105] J. D. Lewis, R. Schinnar, W. B. Bilker, X. Wang, and B. L. Strom. Validation studies of the health improvement network (THIN) database for pharmacoepidemiology research. *Pharmacoepidemiology and Drug Safety*, 16(4):393–401, 2007. [6](#), [29](#)
- [106] J. Lexchin. Is there still a role for spontaneous reporting of adverse drug reactions? *Canadian Medical Association Journal*, 174(2):191–192, 2006. [19](#)
- [107] X. Li, S. Hui, P. Ryan, M. Rosenman, and M. Overhage. Statistical visualization for assessing performance of methods for safety surveillance using electronic databases. *Pharmacoepidemiology and Drug Safety*, 22(5):503–509, 2013. [45](#)
- [108] Y. Li, C. Guan, H. Li, and Z. Chin. A self-training semi-supervised SVM algorithm and its application in an EEG-based brain computer interface speller system. *Pattern Recognition Letters*, 29(9):1285–1294, 2008. [84](#)

REFERENCES

- [109] H. Liang-Chin, W. Xiaogang, and Y. C. Jake. Predicting adverse drug reaction profiles by integrating protein interaction networks with drug structures. *Proteomics*, 13(2):313–324, 2013. [138](#)
- [110] Y. Lin and Y. Jeon. Random forests and adaptive nearest neighbors. *Journal of the American Statistical Association*, 101(474):578–590, 2006. [73](#)
- [111] M. Lindquist, I. R. Edwards, A. Bate, H. Fucik, A. M. Nunes, and M. Ståhl. From association to alerta revised approach to international signal analysis. *Pharmacoepidemiology and Drug Safety*, 8(S1):S15–S25, 1999. [14](#)
- [112] M. O. Little and A. Morley. Reducing polypharmacy: Evidence from a simple quality improvement initiative. *Journal of the American Medical Directors Association*, 14(3):152–156, 2013. [4](#)
- [113] M. Liu, M. E. Matheny, Y. Hu, and H. Xu. Data mining methodologies for pharmacovigilance. *ACM SIGKDD Explorations Newsletter*, 14(1):35–42, 2012. [15](#), [53](#), [136](#), [138](#), [188](#), [190](#)
- [114] Z. Lu. Information technology in pharmacovigilance: Benefits, challenges, and future directions from industry perspectives. *Drug, Healthcare and Patient Safety*, 1:35–45, 2009. [111](#)
- [115] D. Madigan and P. Ryan. Commentary: What can we really learn from observational studies?: The need for empirical assessment of methodology for active drug safety surveillance and comparative effectiveness research. *Epidemiology*, 22(5):629–631, 2011. [5](#), [45](#)

REFERENCES

- [116] O. Z. Maimon and L. Rokach. *Data mining and knowledge discovery handbook*. Springer, 2005. [61](#), [62](#), [63](#)
- [117] G. Maldonado and S. Greenland. Estimating causal effects. *International Journal of Epidemiology*, 31(2):422–429, 2002. [111](#)
- [118] D. J. McLernon, C. M. Bond, P. C. Hannaford, M. C. Watson, A. J. Lee, L. Hazell, and A. Avery. Adverse drug reaction reporting in the uk. *Drug Safety*, 33(9):775–788, 2010. [20](#)
- [119] J.-L. Montastruc, A. Sommet, H. Bagheri, and M. Lapeyre-Mestre. Benefits and strengths of the disproportionality analysis for identification of adverse drug reactions in a pharmacovigilance database. *British Journal of Clinical Pharmacology*, 72(6):905–908, 2011. [16](#), [29](#)
- [120] T. K. Moon. The expectation-maximization algorithm. *IEEE Signal Processing Magazine*, 13(6):47–60, 1996. [76](#)
- [121] N. Moore. The past, present and perhaps future of pharmacovigilance: homage to folke sjoqvist. *European Journal of Clinical Pharmacology*, 69(1):33–41, 2013. [13](#)
- [122] S. L. Morgan and C. Winship. *Counterfactuals and causal inference: Methods and principles for social research*. Cambridge University Press, 2007. [31](#)
- [123] S. Mukherjee, P. Niyogi, T. Poggio, and R. Rifkin. Learning theory: stability is sufficient for generalization and necessary and sufficient for consistency

-
- of empirical risk minimization. *Advances in Computational Mathematics*, 25(1-3):161–193, 2006. [58](#)
- [124] A. Mullard. Unleashing the mini-sentinel. *Nature Reviews Drug Discovery*, 11(4):255–257, 2012. [44](#)
- [125] K.-R. Muller, S. Mika, G. Ratsch, K. Tsuda, and B. Scholkopf. An introduction to kernel-based learning algorithms. *IEEE Transactions on Neural Networks*, 12(2):181–201, 2001. [68](#)
- [126] K. Nigam, A. K. McCallum, S. Thrun, and T. Mitchell. Text classification from labeled and unlabeled documents using EM. *Machine Learning*, 39(2-3):103–134, 2000. [148](#)
- [127] R. Nisbet, J. Elder, and G. Miner. *Handbook of Statistical Analysis & Data Mining Applications*. Elsevier Incorporation, 2009. [131](#), [132](#)
- [128] N. Norén, J. Hopstadius, A. Bate, K. Star, and I. R. Edwards. Temporal pattern discovery in longitudinal electronic patient records. *Data Mining and Knowledge Discovery*, 20(3):361–387, 2010. [31](#), [33](#), [35](#), [91](#), [103](#), [111](#), [121](#), [124](#), [214](#)
- [129] J. L. Oliveira, P. Lopes, T. Nunes, D. Campos, S. Boyer, E. Ahlberg, E. M. Mulligen, J. A. Kors, B. Singh, L. I. Furlong, et al. The EU-ADR Web Platform: delivering advanced pharmacovigilance tools. *Pharmacoepidemiology and Drug Safety*, 22(5):459–467, 2013. [51](#)
- [130] D. Opitz and R. Maclin. Popular ensemble methods: An empirical study. *Journal of Artificial Intelligence Research*, 11:169–198, 1999. [69](#), [70](#)

REFERENCES

- [131] J. M. Overhage, P. B. Ryan, C. G. Reich, A. G. Hartzema, and P. E. Stang. Validation of a common data model for active safety surveillance research. *Journal of the American Medical Informatics Association*, 19(1):54–60, 2012. [5](#), [43](#), [45](#)
- [132] M. Perrio, S. Voss, and S. A. W. Shakir. Application of the bradford hill criteria to assess the causality of cisapride-induced arrhythmia. *Drug Safety*, 30(4):333–346, 2007. [112](#)
- [133] T. S. Peters. Do preclinical testing strategies help predict human hepatotoxic potentials? *Toxicologic Pathology*, 33(1):146–154, 2005. [2](#)
- [134] G. Piatetsky-Shapiro. Discovery, analysis, and presentation of strong rules. *Knowledge Discovery in Databases*, pages 229–238, 1991. [38](#)
- [135] M. Pirmohamed, S. James, S. Meakin, C. Green, A. K. Scott, T. J. Walley, K. Farrar, B. K. Park, and A. M. Breckenridge. Adverse drug reactions as cause of admission to hospital: prospective analysis of 18 820 patients. *British Medical Journal*, 329(7456):15–19, 2004. [3](#)
- [136] R. Platt and R. Carnahan. The US food and drug administration’s mini-sentinel program. *Pharmacoepidemiology and Drug Safety*, 21(S1):1–303, 2012. [15](#), [44](#)
- [137] E. Poluzzi, E. Raschi, U. Moretti, and F. De Ponti. Drug-induced torsades de pointes: data mining of the public version of the fda adverse event reporting system (aers). *Pharmacoepidemiology and Drug Safety*, 18(6):512–518, 2009. [21](#)

REFERENCES

- [138] J. R. Quinlan. Simplifying decision trees. *International Journal of Man-Machine Studies*, 27(3):221–234, 1987. [62](#)
- [139] J. R. Quinlan. *C4. 5: programs for machine learning*, volume 1. Morgan Kaufmann, 1993. [61](#)
- [140] S. J. Raudys and A. K. Jain. Small sample size effects in statistical pattern recognition: Recommendations for practitioners. *IEEE Transactions on Pattern Analysis and Machine Intelligence*, 13(3):252–264, 1991. [75](#)
- [141] C. Reich, P. B. Ryan, P. E. Stang, and M. Rocca. Evaluation of alternative standardized terminologies for medical conditions within a network of observational healthcare databases. *Journal of Biomedical Informatics*, 45(4):689–696, 2012. [7](#), [45](#)
- [142] J. M. Reps, J. M. Garibaldi, U. Aickelin, D. Soria, J. Gibson, and R. Hubbard. Attributes for causal inference in electronic healthcare databases. 2013. [127](#)
- [143] J. M. Reps, J. M. Garibaldi, U. Aickelin, D. Soria, J. Gibson, and R. Hubbard. Comparison of algorithms that detect drug side effects using electronic healthcare databases. *Soft Computing*, pages 1–17, 2013. [45](#), [111](#), [113](#), [124](#)
- [144] M. J. Rho, S. R. Kim, S. H. Park, K. S. Jang, B. J. Park, and I. Y. Choi. Development common data model for adverse drug signal detection based on multi-center EMR systems. In *Proceedings of 4th International Conference on Information Science and Applications (ICISA)*, pages 1–7. IEEE, 2013. [44](#)

REFERENCES

- [145] R. L. Richesson et al. *Pharmacovigilance*, pages 367–387. Springer, 2012. [15](#)
- [146] I. Rish. An empirical study of the naive bayes classifier. In *Proceeding of the 17th International Joint Conference on Artificial Intelligence (IJCAM) Workshop on Empirical Methods in Artificial Intelligence*, volume 3, pages 41–46, 2001. [65](#)
- [147] T. RJ and H. MH. Safety of newly approved drugs: Implications for prescribing. *The Journal of the American Medical Association*, 287(17):2273–2275, 2002. [88](#)
- [148] M. A. Robb, J. A. Racoosin, R. E. Sherman, T. P. Gross, R. Ball, M. E. Reichman, K. Midthun, and J. Woodcock. The US food and drug administration’s sentinel initiative: Expanding the horizons of medical product safety. *Pharmacoepidemiology and Drug Safety*, 21(S1):9–11, 2012. [111](#)
- [149] L. Rokach and O. Maimon. Top-down induction of decision trees classifiers—a survey. *IEEE Transactions on Systems, Man, and Cybernetics, Part C: Applications and Reviews*, 35(4):476–487, 2005. [61](#)
- [150] L. Rosasco, E. De Vito, A. Caponnetto, M. Piana, and A. Verri. Are loss functions all the same? *Neural Computation*, 16(5):1063–1076, 2004. [57](#)
- [151] K. J. Rothman, S. Greenland, and T. L. Lash. *Modern epidemiology*. Wolters Kluwer Health, 2008. [121](#), [124](#)
- [152] E. Roux, F. Thiessard, A. Fourrier, B. Begaud, P. Tubert-Bitter, et al. Spontaneous reporting system modelling for data mining methods evalu-

-
- ation in pharmacovigilance. In *Preceding of the AIME Workshop on Intelligent Data Analysis in Medicine and Pharmacology (IDAMAP)*, 2003. [19](#)
- [153] D. B. Rubin. Estimating causal effects of treatments in randomized and nonrandomized studies. *Journal of Educational Psychology*, 66(5):688–701, 1974. [112](#)
- [154] D. B. Rubin. Bayesian inference for causal effects: The role of randomization. *The Annals of Statistics*, 6(1):34–58, 1978. [112](#)
- [155] P. B. Ryan, G. E. Powell, E. N. Pattishall, and K. J. Beach. Performance of screening multiple observational databases for active drug safety surveillance. In *Proceedings of the 25th International Conference on Pharmacoepidemiology & Therapeutic Risk Management (ICPE)*, 2009. [46](#)
- [156] P. B. Ryan, D. Madigan, P. E. Stang, J. Marc Overhage, J. A. Racoosin, and A. G. Hartzema. Empirical assessment of methods for risk identification in healthcare data: results from the experiments of the observational medical outcomes partnership. *Statistics in Medicine*, 31(30):4401–4415, 2012. [5](#), [45](#), [50](#), [51](#), [84](#), [89](#), [90](#), [97](#), [138](#), [161](#), [162](#), [164](#), [185](#)
- [157] Y. Saeys, I. Inza, and P. Larraaga. A review of feature selection techniques in bioinformatics. *Bioinformatics*, 23(19):2507–2517, 2007. [141](#)
- [158] S. Schneeweiss. Developments in post-marketing comparative effectiveness research. *Clinical Pharmacology & Therapeutics*, 82(2):143–156, 2007. [16](#)
- [159] S. Schneeweiss, J. A. Rassen, R. J. Glynn, J. Avorn, H. Mogun, and M. A.

REFERENCES

- Brookhart. High-dimensional propensity score adjustment in studies of treatment effects using health care claims data. *Epidemiology*, 20(4):512–522, 2009. [45](#)
- [160] S. Schneeweiss, T. Stürmer, and M. Maclure. Case–crossover and case–time–control designs as alternatives in pharmacoepidemiologic research. *Pharmacoepidemiology and Drug Safety*, 6(S3):S51–S59, 1997. [45](#)
- [161] M. J. Schuemie. Methods for drug safety signal detection in longitudinal observational databases: LGPS and LEOPARD. *Pharmacoepidemiology and Drug Safety*, 20(3):292–299, 2011. [30](#), [111](#), [124](#), [214](#)
- [162] M. J. Schuemie, P. M. Coloma, H. Straatman, R. Herings, G. Trifirò, J. N. Matthews, D. Prieto-Merino, M. Molokhia, L. Pedersen, R. Gini, F. Innocenti, G. Mazzaglia, G. Picelli, L. Scotti, J. van der Lei, and M. Sturkenboom. Using electronic health care records for drug safety signal detection: A comparative evaluation of statistical methods. *Medical Care*, 50(10):890–897, 2012. [89](#)
- [163] S. A. W. Shakir. *Causality and correlation in pharmacovigilance*, pages 329–343. John Wiley & Sons Limited, 2005. [110](#)
- [164] S. A. W. Shakir and D. Layton. Causal association in pharmacovigilance and pharmacoepidemiology. *Drug Safety*, 25(6):467–471, 2002. [112](#), [186](#)
- [165] J. C. Sinclair and M. B. Bracken. Clinically useful measures of effect in binary analyses of randomized trials. *Journal of Clinical Epidemiology*, 47(8):881–889, 1994. [123](#)

REFERENCES

- [166] R. Sirriyeh, S. McClean, and V. Robins. *Introducing Patient Safety: Theory, Policy and Practice*, volume 1357, chapter 1, pages 3–20. SAGE Publications, 2012. [50](#)
- [167] A. L. Speirs. Thalidomide and congenital abnormalities. *The Lancet*, 279(7224):303–305, 1962. [13](#)
- [168] W. P. Stephenson and M. Hauben. Data mining for signals in spontaneous reporting databases: proceed with caution. *Pharmacoepidemiology and Drug Safety*, 16(4):359–365, 2007. [16](#)
- [169] A. Stevenson. *Oxford dictionary of English*. Oxford Reference Online Premium. OUP Oxford, 2010. [17](#)
- [170] N. L. Story. Sexual dysfunction resulting from drug side effects. *Journal of Sex Research*, 10(2):132–149, 1974. [2](#)
- [171] B. H. Stricker and B. M. Psaty. Detection, verification, and quantification of adverse drug reactions. *British Medical Journal*, 329(7456):44–47, 2004. [191](#)
- [172] B. L. Strom. Potential for conflict of interest in the evaluation of suspected adverse drug reactions. *Journal of the American Medical Association*, 292(21):2643–2646, 2004. [4](#), [20](#), [23](#), [28](#)
- [173] B. L. Strom and J. L. Carson. Use of automated databases for pharmacoepidemiology research. *Epidemiologic Reviews*, 12(1):87–107, 1990. [21](#), [51](#)

REFERENCES

- [174] M. Suling and I. Pigeot. Signal detection and monitoring based on longitudinal healthcare data. *Pharmaceutics*, 4(4):607–640, 2012. 111
- [175] M. Susser. What is a cause and how do we know one? a grammar for pragmatic epidemiology. *American Journal of Epidemiology*, 133(7):635–648, 1991. 127
- [176] The National Magazine Company Ltd. NetDoctor.co.uk - the UK’s leading independent health website. <http://www.netdoctor.co.uk>. Accessed: 04-02-2012. 9, 93
- [177] K. M. Ting and I. H. Witten. Issues in stacked generalization. *Journal of Artificial Intelligence Research*, 10:271–289, 1999. 70
- [178] M. J. Titulaer, L. McCracken, I. Gabilondo, T. Armangué, C. Glaser, T. Iizuka, L. S. Honig, S. M. Benseler, I. Kawachi, E. Martinez-Hernandez, et al. Treatment and prognostic factors for long-term outcome in patients with anti-NMDA receptor encephalitis: an observational cohort study. *The Lancet Neurology*, 12(2):157–165, 2013. 46
- [179] G. Trifirò, A. Pariente, P. Coloma, , J. Kors, G. Polimeni, G. Miremont-Salam, M. Catania, F. Salvo, A. David, N. Moore, A. Caputi, M. Sturkenboom, M. Molokhia, J. Hippisley-Cox, C. Acedo, J. van der Lei, and A. Fourrier-Reglat. Data mining on electronic health record databases for signal detection in pharmacovigilance: which events to monitor? *Pharmacoepidemiol Drug Safety*, 18(12):1176–1184, 2009. 88, 184
- [180] G. Trifirò, V. Patadia, M. J. Schuemie, P. M. Coloma, R. Gini, R. Herings, J. Hippisley-Cox, G. Mazzaglia, C. Giaquinto, L. Scotti, et al. EU-ADR

- healthcare database network vs. spontaneous reporting system database: preliminary comparison of signal detection. *Studies in Health Technology and Informatics*, 166:25–30, 2011. 16, 17
- [181] G. Tripepi, K. Jager, F. Dekker, C. Wanner, and C. Zoccali. Measures of effect: relative risks, odds ratios, risk difference, and ‘number needed to treat’. *Kidney International*, 72(7):789–791, 2007. 122
- [182] Uppsala Monitoring Centre. Glossery of terms used in pharmacovigilance. <http://www.who-umc.org/graphics/15338.pdf>, 2000. Accessed: 2013-04-04. 2
- [183] G. Upton and I. Cook. *A dictionary of statistics second edition*. Oxford University Press, 2006. 17
- [184] US Food and Drug Administration. Center for Drug Evaluation and Research. Adverse events reporting system (AERS). <http://www.fda.gov/cder/aers/default.htm>. Accessed: 2012-11-23. 20
- [185] E. P. van Puijenbroek, A. Bate, H. G. Leufkens, M. Lindquist, R. Orre, and A. C. Egberts. A comparison of measures of disproportionality for signal detection in spontaneous reporting systems for adverse drug reactions. *Pharmacoepidemiology and Drug Safety*, 11(1):3–10, 2002. 24, 26
- [186] O. Vanunu and R. Sharan. A propagation-based algorithm for inferring gene-disease associations. pages 54–52, 2008. 137
- [187] V. Vapnik. *The nature of statistical learning theory*. springer, 2000. 58, 59

REFERENCES

- [188] V. Vapnik and O. Chapelle. Bounds on error expectation for support vector machines. *Neural Computation*, 12(9):2013–2036, 2000. [67](#)
- [189] V. Vapnik, E. Levin, and Y. Le Cun. Measuring the vc-dimension of a learning machine. *Neural Computation*, 6(5):851–876, 1994. [60](#)
- [190] M. Wadman. Experts call for active surveillance of drug safety. *Nature*, 446(7134):358–359, 2007. [51](#)
- [191] K. Wagstaff, C. Cardie, S. Rogers, and S. Schrödl. Constrained k-means clustering with background knowledge. In *Proceedings of the 18th International Conference on Machine Learning (ICML)*, volume 1, pages 577–584, 2001. [79](#)
- [192] E. K. Wai, D. M. Roffey, P. Bishop, B. K. Kwon, and S. Dagenais. Causal assessment of occupational bending or twisting and low back pain: results of a systematic review. *The Spine Journal*, 10(1):76–88, 2010. [127](#)
- [193] S. D. Walter. The partial area under the summary ROC curve. *Statistics in Medicine*, 24(13):2025–2040, 2005. [98](#)
- [194] S. D. Walter. Choice of effect measure for epidemiological data. *Journal of Clinical Epidemiology*, 53(9):931–939, 2000. [121](#), [123](#)
- [195] B. Wang, B. Spencer, C. Ling, and H. Zhang. Semi-supervised self-training for sentence subjectivity classification. In S. Bergler, editor, *Advances in Artificial Intelligence*, volume 5032 of *Lecture Notes in Computer Science*, pages 344–355. Springer Berlin Heidelberg, 2008. [148](#)

REFERENCES

- [196] J.-X. Wei, M. Li, Y.-H. Sun, Y. Lu, and H.-M. Xu. A novel method for signal detection of adverse drug reactions based on proportional reporting ratios. *Pharmacy World & Science*, 32(5):658–662, 2010. [24](#), [26](#)
- [197] N. S. Weiss. Can the ‘specificity’ of an association be rehabilitated as a basis for supporting a causal hypothesis? *Epidemiology*, 13(1):6–8, 2002. [125](#)
- [198] B. Wettermark. The intriguing future of pharmacoepidemiology. *European Journal of Clinical Pharmacology*, 69(1):43–51, 2013. [5](#), [15](#), [43](#)
- [199] D. Wettschereck, D. W. Aha, and T. Mohri. A review and empirical evaluation of feature weighting methods for a class of lazy learning algorithms. *Artificial Intelligence Review*, 11(1-5):273–314, 1997. [68](#)
- [200] H. J. Whitaker, C. Paddy Farrington, B. Spiessens, and P. Musonda. Tutorial in biostatistics: the self-controlled case series method. *Statistics in Medicine*, 25(10):1768–1797, 2006. [48](#)
- [201] A. P. White and W. Z. Liu. Technical note: Bias in information-based measures in decision tree induction. *Machine Learning*, 15(3):321–329, 1994. [62](#)
- [202] R. W. White, N. P. Tatonetti, N. H. Shah, R. B. Altman, and E. Horvitz. Web-scale pharmacovigilance: listening to signals from the crowd. *Journal of the American Medical Informatics Association*, 20(3):404–408, 2013. [191](#)
- [203] R. A. Wilke, H. Xu, J. C. Denny, D. M. Roden, R. M. Krauss, C. A. McCarty, R. L. Davis, T. Skaar, J. Lamba, and G. Savova. The emerging role

REFERENCES

- of electronic medical records in pharmacogenomics. *Clinical Pharmacology & Therapeutics*, 89(3):379–386, 2011. 5
- [204] A. M. Wilson, L. Thabane, and A. Holbrook. Application of data mining techniques in pharmacovigilance. *British Journal of Clinical Pharmacology*, 57(2):127–134, 2004. 138
- [205] B. Woolf. On estimating the relation between blood group and disease. *Annals of Human Genetics*, 19(4):251–253, 1955. 25
- [206] World Health Organization. Safety monitoring of medical products. guidelines for setting up and running a pharmacovigilance centre. <http://apps.who.int/medicinedocs/en/d/Jh2934e/>. Accessed: 2013-04-04. 2
- [207] T. Y. Wu, M. H. Jen, A. Bottle, M. Molokhia, and et al. Ten-year trends in hospital admission for adverse drug reactions in england 1999-2009. *Journal of the Royal Society of Medicine*, 103(6):239–250, 2010. 4
- [208] S. Xiang, F. Nie, and C. Zhang. Learning a mahalanobis distance metric for data clustering and classification. *Pattern Recognition*, 41(12):3600–3612, 2008. 80, 83
- [209] L. Xie, J. Li, and P. Bourne. Drug discovery using chemical systems biology: identification of the protein-ligand binding network to explain the side effects of cetp inhibitors. *Public Library of Science Computational Biology*, 5(5):e1000387, 2009. 137
- [210] E. P. Xing, M. I. Jordan, S. Russell, and A. Ng. Distance metric learning

- with application to clustering with side-information. In *Advances in Neural Information Processing Systems*, pages 505–512, 2002. [80](#)
- [211] Y. Ying and P. Li. Distance metric learning with eigenvalue optimization. *The Journal of Machine Learning Research*, 13:1–26, 2012. [80](#), [81](#), [82](#), [83](#), [151](#)
- [212] Y. Yoshihiro, P. Edouard, and K. Masaaki. Drug side-effect prediction based on the integration of chemical and biological spaces. *Journal of Chemical Information and Modeling*, 52(12):3284–3292, 2012. [138](#)
- [213] C. Zhang and S. Zhang. *Association rule mining: models and algorithms*. Springer-Verlag, 2002. [192](#)
- [214] X. Zhou, S. Murugesan, H. Bhullar, Q. Liu, B. Cai, C. Wentworth, and A. Bate. An evaluation of the THIN database in the OMOP common data model for active drug safety surveillance. *Drug Safety*, 36(2):119–134, 2013. [5](#), [49](#), [50](#), [52](#), [89](#), [162](#), [181](#), [184](#)
- [215] X. Zhu and A. B. Goldberg. Introduction to semi-supervised learning. *Synthesis Lectures on Artificial Intelligence and Machine Learning*, 3(1):1–130, 2009. [76](#), [77](#), [78](#), [82](#), [83](#), [148](#)
- [216] I. Zorych, D. Madigan, P. Ryan, and A. Bate. Disproportionality methods for pharmacovigilance in longitudinal observational databases. *Statistical Methods in Medical Research*, 22(1):39–56, 2013. [5](#), [30](#), [31](#), [33](#), [34](#), [45](#), [46](#), [92](#), [103](#)
- [217] I. Zorych, P. Ryan, and D. Madigan. *Observational Medical Outcomes*

REFERENCES

Partnership multi-set case-control estimation specification. Foundation for the National Institutes of Health, 2009. [48](#)