



Vilisaar, Janek (2012) The induction and effects of Substance P and its receptor in human immune cells and neurons: potential relevance in multiple sclerosis. DM thesis, University of Nottingham.

Access from the University of Nottingham repository:

http://eprints.nottingham.ac.uk/12663/1/Thesis_Final.pdf

Copyright and reuse:

The Nottingham ePrints service makes this work by researchers of the University of Nottingham available open access under the following conditions.

- Copyright and all moral rights to the version of the paper presented here belong to the individual author(s) and/or other copyright owners.
- To the extent reasonable and practicable the material made available in Nottingham ePrints has been checked for eligibility before being made available.
- Copies of full items can be used for personal research or study, educational, or not-for-profit purposes without prior permission or charge provided that the authors, title and full bibliographic details are credited, a hyperlink and/or URL is given for the original metadata page and the content is not changed in any way.
- Quotations or similar reproductions must be sufficiently acknowledged.

Please see our full end user licence at:

http://eprints.nottingham.ac.uk/end_user_agreement.pdf

A note on versions:

The version presented here may differ from the published version or from the version of record. If you wish to cite this item you are advised to consult the publisher's version. Please see the repository url above for details on accessing the published version and note that access may require a subscription.

For more information, please contact eprints@nottingham.ac.uk

The University of Nottingham

School of Clinical Sciences

Division of Clinical Neurology

**THE INDUCTION AND EFFECTS OF SUBSTANCE P
AND ITS RECEPTOR IN HUMAN IMMUNE CELLS
AND NEURONS: POTENTIAL RELEVANCE IN
MULTIPLE SCLEROSIS**

Janek Vilisaar

Thesis submitted for the degree of Doctor of Medicine

Nottingham

2011

Abstract

INTRODUCTION: Substance P (SP) has well-established roles in neurogenic inflammation and pain transmission, however recently, a number of SP immunomodulatory effects have been shown. In this thesis SP and its neurokinin-1-receptor (NK1R) role in autoimmune inflammation was investigated with an applicability to multiple sclerosis (MS). In the four experimental chapters the role of SP and its receptor was studied in human immune cells and neurons with a focus on the relationship with Th17 and Th1 pathways as the main pro-inflammatory arms in autoimmune pathology.

AIMS: To quantify the effects of SP on inflammatory cytokine induction in peripheral blood mononuclear cells (PBMC); to measure Th17 and Th1 pathway effects on SP and NK1R expression in T cells and NT2 neurons; to compare NK1R expression and relevant parameters in peripheral immune cells of relapsing-remitting MS patients and healthy controls.

METHODS: Real-time PCR, flow cytometry, ELISA, Western blotting and promoter studies were used to measure the expression of target genes under different stimulation conditions. Cells were isolated from consented healthy controls, relapsing-remitting MS patients, or differentiated as specified.

RESULTS: In PBMC, treatment with SP significantly increased the relative quantity of IL-12/IL-23 subunit p40, IL-23 p19 and IL-12 p35 mRNA showing that SP can signal induction of IL-12 and IL-23. As part of the reciprocal mechanism in T cells, NK1R and SP expression was strongly upregulated by Th17 cytokines and significantly less by Th1 cytokines. These effects for NK1R were confirmed at promoter and protein levels. The Th17 effects were prevalent at earlier stages compared to the Th1 effects. As a novel finding, IL-17 (IL-17A) had direct effects on neurons via its functionally expressed receptor. Neuronal NK1R mRNA-level expression was subject to regulation by IL-17, whereas SP precursor was considerably less upregulated by IL-17. In MS patients in a relapse NK1R mRNA in peripheral immune cells was strongly downregulated as compared to controls. This finding is likely associated with the inflammatory activity in an acute MS relapse.

CONCLUSIONS: Mutual interactions exist between SP and Th17, Th1 responses with SP showing involvement in Th17 and less in Th1 pathway effects. This supports NK1R role in mediating autoimmune activity as occurs in an acute MS relapse. The results also show direct neuronal involvement in immune interactions involving SP and Th17 pathway.

Table of Contents

1	Introduction.....	1
2	Literature Review	4
2.1	Substance P and its receptor	4
2.1.1	Historical background.....	4
2.1.2	Chemical properties of SP	6
2.1.3	Expression of SP	7
2.1.4	Genetics of SP.....	8
2.1.5	SP synthesis and metabolism.....	10
2.1.6	TK receptors.....	11
2.1.7	Genetics of TK receptors	13
2.1.8	Receptor binding and signalling	14
2.1.9	Receptor agonists	17
2.1.10	NK1R antagonists	18
2.1.11	SP and neurogenic inflammation.....	20
2.1.12	SP in immunogenic inflammation	21
2.2	Multiple sclerosis	25
2.2.1	General features of MS	25
2.2.2	MS clinical presentation	25
2.2.3	Etiological factors in MS	26
2.2.4	Immunoactivation in MS	27
2.2.5	Cellular immune responses and BBB penetration	27
2.2.6	Inflammatory cascade in the CNS	29

2.2.7	Role of humoral responses	29
2.2.8	Propagation of lesions and direct neuronal injury	30
2.2.9	Neurodegenerative features of MS	31
2.2.10	MS animal models targeting SP role	31
2.3	Aims	33
3	The induction of inflammatory cytokines by substance P in human peripheral blood mononuclear cells	34
3.1	Introduction	34
3.2	Methods	38
3.2.1	Cell preparations and cultures	38
3.2.2	Stimulation of cell cultures	39
3.2.3	Flow cytometric bead array for IL-1 β , IL-6, IL-8, IL-10, IL- 12p70, TNF- α	40
3.2.4	ELISA for IL-12 and IL-23 subunits on PBMC culture supernatants	40
3.2.5	Total RNA extraction from stimulated cells	41
3.2.6	Reverse transcription	41
3.2.7	Quantitation of IL-23p19, IL-12p40 and IL-12p35 transcripts	42
3.2.8	Agarose gel electrophoresis on the amplification product	43
3.2.9	Statistical analysis	44
3.3	Results	44
3.3.1	CBA for IL-12, IL-1 β , IL-6, IL-8, IL-10 and TNF α protein level induction by SP	44

3.3.2	Flow cytometry on PBMC stimulated with LPS and CP-96345/CP-96344	46
3.3.3	ELISA for protein level induction of IL-12 and IL-23 by SP.....	48
3.3.4	mRNA-level expression of IL-12 and IL-23 subunits in PBMC on stimulation with SP	51
3.4	Discussion	53
4	IL-12 and IL-23 differential effects on substance P and its receptor expression in human T cells.....	60
4.1	Introduction.....	60
4.2	Methods.....	63
4.2.1	Cell preparations and cultures.....	63
4.2.2	Stimulation of cell cultures	63
4.2.3	Flow cytometry for protein level expression of NK1R in T cell blasts	64
4.2.4	ELISA for SP in T cell blasts.....	65
4.2.5	Total RNA extraction and reverse transcription	66
4.2.6	Quantitation of TAC1 and NK1R mRNA transcripts.....	66
4.2.7	Cloning of the NK1R promoter-luciferase expression vector	67
4.2.8	Transfection of Jurkat cells with NK1R promoter-reporter construct and luciferase reporter assay	69
4.2.9	Statistical analysis	70
4.3	Results.....	70
4.3.1	Protein level induction of NK1R in T cell blasts.....	70
4.3.2	Protein level induction of SP in T cell blasts.....	72

4.3.3	Induction of SP and NK1R mRNA in T cells.....	73
4.3.4	NK1R promoter construct activation in Jurkat cells.....	77
4.4	Discussion.....	78
5	Upregulation of substance P and its receptor in human NT2 neurons via functional IL-17 receptor.....	85
5.1	Introduction.....	85
5.2	Methods.....	90
5.2.1	Preparation of undifferentiated NT2 (NT2U) cultures.....	90
5.2.2	Differentiation of NT2U into mature post-mitotic neurons.....	90
5.2.3	Stimulation of cell cultures.....	91
5.2.4	Total RNA extraction.....	92
5.2.5	Reverse transcription.....	92
5.2.6	Quantitation of IL-17A, IL-17RA, NK1R, PPT mRNA transcripts.....	93
5.2.7	Agarose gel electrophoresis.....	94
5.2.8	Western blotting.....	94
5.2.9	Subcellular fractionations of NT2 cells.....	95
5.3	Results.....	96
5.3.1	IL-17R mRNA level expression in neurons.....	96
5.3.2	Upregulation of neuronal SP and NK1R by IL-17 and IFN- γ	98
5.3.3	Upregulation of neuronal gene expression by SP.....	100
5.3.4	Western blotting for IL-17R and NF κ B proteins in NT2 neurons	101
5.4	Discussion.....	103

6	Downregulation of NK1R in peripheral immune cells of multiple sclerosis patients in a relapse	109
6.1	Introduction.....	109
6.2	Methods.....	112
6.2.1	Subjects and sample collection	112
6.2.2	Extraction of total-RNA from whole blood.....	113
6.2.3	Reverse transcription	114
6.2.4	Quantitation of NK1R and TAC1 mRNA transcripts.....	115
6.2.5	Collection of medical data	115
6.2.6	Statistical analysis.....	116
6.3	Results.....	116
6.4	Discussion.....	120
7	Conclusions.....	126
8	Bibliography	135
9	Appendices.....	163
9.1	Appendix A. Data analysis for real-time qPCR experiments	163
9.2	Appendix B. The McDonald Criteria (2010) for Diagnosis of MS	168
9.3	Appendix C. The Ethics Committee approval for patient recruitment	169

Vilisaar, J.

Declaration

I declare that this dissertation is my own work, and the research contained herein is original. The work described was undertaken at the Division of Clinical Neurology, University of Nottingham between March 2005 and December 2008, and as part of it in October 2008 at the Department of Neurology, University of Pennsylvania, USA. No portion of this work has been submitted for an application for any other degree.

Janek Vilisaar

October, 2010

Acknowledgements

I am indebted to a number of people whose help have made this work possible. Above all, I would like to thank MS patients and healthy volunteers who agreed to take part in the study. I am grateful to my supervisor Prof Cris Constantinescu for his advice, support and encouragement, Dr Angela Fahey and Ms Manjit Braitch for guiding me through the majority of experimental techniques used in the thesis, Dr Julie Swales and Dr Adrian Robins for their expertise advice in flow cytometry.

I would like to thank Dr Kiyokazu Kawabe, Ms Manjit Braitch, and Dr Lucie Jean-Gilles for their input to the experiments in Chapters 3 and 6.

I would also like to thank Dr Dennis Kolson, Ms Patricia Vance, Ms Stephanie Cross, Ms Lin Zhou, Dr Xu Wang, Prof Wen-Zhe Ho from the University of Pennsylvania, USA, for contributing to Chapter 5 of the thesis, teaching me the techniques used, and kindly hosting me in their laboratories. In particular, I would like to thank Ms Patricia Vance and Ms Stephanie Cross for additional Western blot and signalling experiments for Chapter 5.

I am grateful to Multiple Sclerosis International Federation (www.msif.org) for the Jacqueline du Pre Grant that helped funding the exchange with the University of Pennsylvania, USA.

Abbreviations

aa	Aminoacids
ADNF	Activity-Dependent Neuroprotective Factor
APC	Antigen Presenting Cell
BBB	Blood-Brain Barrier
β 2MG	β 2-microglobulin
BDNF	Brain-Derived Neurotrophic Factor
bp	base pairs
BSA	Bovine Serum Albumin
CBA	Cytometric Bead Array
CCR5	C-C Chemokine Receptor type 5
CD	Cluster of Differentiation
cDNA	Complementary DNA
CGRP	Calcitonin Gene-Related Peptide
CNS	Central Nervous System
CSF	Cerebrospinal Fluid
DAG	Diacylglycerol
DMEM	Dulbecco's Modified Eagle Medium
DMF	Dimethyl Fumarate
DMT	Disease Modifying Treatment
DNA	Deoxyribonucleic Acid
dNTPs	Deoxynucleotide Triphosphates
EAE	Experimental Autoimmune Encephalomyelitis
EC	Extracellular

EDSS	Expanded Disability Status Scale
EK	Endokinin (e.g EKA – Endokinin A)
ELISA	Enzyme-Linked Immunosorbent Assay
ERK	Extracellular Signal-Regulated Kinase
FACS	Fluorescence-Activated Cell Sorting
FBS	Fetal Bovine Serum
FCS	Fetal Calf Serum
GAPDH	Glyceraldehyde-3-Phosphate Dehydrogenase
Gd	Gadolinium
GDP	Guanosine diphosphate
GM-CSF	Granulocyte Macrophage-Colony Stimulating Factor
GTP	Guanosine triphosphate
HBSS	Hank's Balanced Salt Solution
hHK-1	Human Hemokinin-1
HLA	Human Leukocyte Antigen
IC	Intracellular
IFN	Interferon
Ig	Immunoglobulin
I κ B	Inhibitor of κ B
IL	Interleukin
IL-17R	IL-17 receptor
IL-17RA	IL-17 receptor subtype A
IP3	Inositol triphosphate
IVMP	Intravenous Methylprednisolone

kb	Kilobase
LFA-1	Lymphocyte Function- Associated Antigen-1
LPS	Lipopolysaccharide
MAG	Myelin-Associated Glycoprotein
MAPK	Mitogen-Activated Protein Kinase
MCP	Monocyte Chemoattractant Protein-1
mRNA	messenger RNA
MBP	Myelin Basic Protein
MI	Mitotic Inhibitors
miRNA	micro RNA
MIP	Macrophage Inflammatory Protein
MMLV	Moloney Murine Leukaemia Virus
MOG	Myelin-Oligodendrocyte Glycoprotein
MRI	Magnetic Resonance Imaging
MS	Multiple Sclerosis
NA	Not Applicable
NF κ B	Nuclear Factor- κ B
NEP	Neutral endopeptidase
NKA	Neurokinin A
NKB	Neurokinin B
NK1R	Neurokinin-1 receptor
NK1R-T	Truncated Neurokinin-1 receptor
NO	Nitric Oxide
NPK	Neuropeptide K

NP γ	Neuropeptide γ
NTC	No Template Control
NT2	Neuroteratocarcinoma (NTera2) cells
NT2N	Neuroteratocarcinoma post-mitotic neurons
NT2U	Undifferentiated NTera2 cells
OCB	Oligoclonal Bands
PAGE	Polyacrylamide Gel Electrophoresis
PARP	Poly-(ADP-Ribose) Polymerase
PBA	Phosphate Buffered Albumin
PBL	Peripheral Blood Lymphocytes
PBMC	Peripheral Blood Mononuclear Cells
PC7	Phycoerythrin Cyanin 7
PCR	Polymerase Chain Reaction
PE	Phycoerythrin
PHA	Phytohemagglutinin
PKC	Protein Kinase C
PLL	Poly-L-lysine
PLP	Proteolipid Protein
PIU	Patient Investigation Unit
PPMS	Primary Progressive Multiple Sclerosis
PPT	Preprotachykinin
P/S	Penicillin/Streptomycin
qPCR	Quantitative Polymerase Chain Reaction
RA	Retinoic Acid

Vilisaar, J.

RNA	Ribonucleic Acid
RRMS	Relapsing-remitting Multiple Sclerosis
RT-PCR	Reverse Transcriptase Polymerase Chain Reaction
SD	Standard Deviation
SEM	Standard Error of the Mean
SP	Substance P
SPMS	Secondary Progressive Multiple Sclerosis
TAC	Tachykinin precursor gene
Tc	T cytotoxic cell
Th	T helper cell
TGF	Transforming Growth Factor
TK	Tachykinin
TLR	Toll-like Receptor
TM	Transmembrane
TNF	Tumour Necrosis Factor
Tr	Regulatory T cell
US	Unstimulated
WB	Western Blotting
WBC	White Blood Cell

1 Introduction

Substance P (SP) belongs to one of the largest and most abundantly found peptide families within a living organism, known as tachykinins (TKs). SP has been mainly regarded as a neuropeptide present both in the central nervous system (CNS) as well in peripheral nerves. It has a well-established role in pain transmission and neurogenic inflammation, including effects of vasodilatation and plasma extravasation. With its effects on smooth muscle, SP is known to be involved in motility of different organ tracts as well as stimulation of glandular secretion and modulating autonomic reflexes (Harrison et al. 2001; Hokfelt et al. 2001).

Recently, however, its conventional meaning as a neuropeptide has been challenged as SP has been found in various non-neuronal cells and having a role in intercellular signalling. Its expression particularly in immune cells, such as lymphocytes, macrophages, dendritic cells, eosinophils and its immunoregulatory effects on them have caused it to be rather characterized as an immunomodulatory neuropeptide (O'Connor et al. 2004). Along with other neuropeptides, SP is found to be involved in neuroimmune interactions revealing increasing overlap between these systems as well as challenging definitions of a neurotransmitter and a cytokine (Reinke et al. 2006; Franco et al. 2007; Levite 2008).

Vilisaar, J.

SP acts primarily via neurokinin-1 receptor (NK1R) and exerts its inflammatory activity with various effects on immune cells. It has been shown to stimulate lymphocyte proliferation and antibody production, inflammatory cytokine secretion in immunocytes and release of various other inflammatory agents, including oxygen free radicals, arachidonic acid metabolites and histamine from these cells (Harrison et al. 2001). Via release of these mediators or by SP directly inflammatory effects of SP are implemented.

In addition to SP role in various neurogenic inflammatory conditions, its involvement has been shown in a number of primarily immunogenic inflammatory diseases. Elevated levels of SP and upregulated NK1R have been reported in inflammatory bowel disease and rheumatoid arthritis (O'Connor et al. 2004). There is evidence of its role in multiple sclerosis (MS) murine model experimental autoimmune encephalomyelitis (EAE), showing suppression of the disease by NK1R antagonists and in NK1R knockout phenotype (Nessler et al. 2006; Reinke et al. 2006). In humans, SP-immunoreactive astrocytes have been found in MS lesions, suggesting SP role in MS lesion formation (Kostyk et al. 1989). Additionally, SP precursor encoding TAC1 gene has been highlighted in genome-wide linkage studies as a possible susceptibility gene for MS (Vandenbroeck et al. 2002; Cunningham et al. 2005).

SP is a widely expressed peptide with a variety of functions yet only a few of them have been clearly characterized. The modulating role of SP in autoimmune inflammation still remains largely unknown, particularly with regards to the recently uncovered Th17 pathway. Moreover, SP interactions with the pro-inflammatory Th1 and Th17 pathways have not been investigated in humans. The roles and regulatory potential of SP in inflammation within the CNS, where it is abundantly expressed, is also poorly understood. Very little is known to date about its messenger role in neuroimmune intersystem communication.

Resulting from above, the current thesis focuses on the role of this peptide in immunogenic inflammation, with an emphasis on MS. In the literature review topics on SP and MS will be covered. Further information on Th1 and Th17 pathways, different cell types and interactions relevant to the thesis is provided in individual chapter introductions. In the following literature review all the effects are referred to the human species, unless indicated differently.

2 Literature Review

2.1 Substance P and its receptor

2.1.1 Historical background

SP was first described in alcoholic extracts of equine brain and intestine by von Euler and Gaddum in 1931 (Hokfelt et al. 2001; Severini et al. 2002) and was found to have potent hypotensive and smooth muscle contractile properties (Euler et al. 1931). Gaddum and Schild (Gaddum et al. 1934) named the new agent substance P, referring to the “Preparation” obtained after the extraction procedure (Page 2004). It was first postulated by Lembeck that SP could function as a neurotransmitter associated with pain transmission as it was found in high concentrations in dorsal roots of the spinal cord (Harrison et al. 2001). Otsuka and Konishi (Otsuka et al. 1976) showed later that SP immunoreactivity increased in the perfusate taken from isolated spinal cord of newborn rats after application of electrical stimuli.

The amino acid (aa) sequence of SP was determined by Chang and Leeman in 1970 (Lecci et al. 2006). It was found to be an undecapeptide having the following sequence Arg¹-Pro²-Lys³-Pro⁴-Gln⁵-Gln⁶-Phe⁷-Phe⁸-Gly⁹-Leu¹⁰-Met¹¹-NH₂ (Harrison et al. 2001) (Fig 2.1).

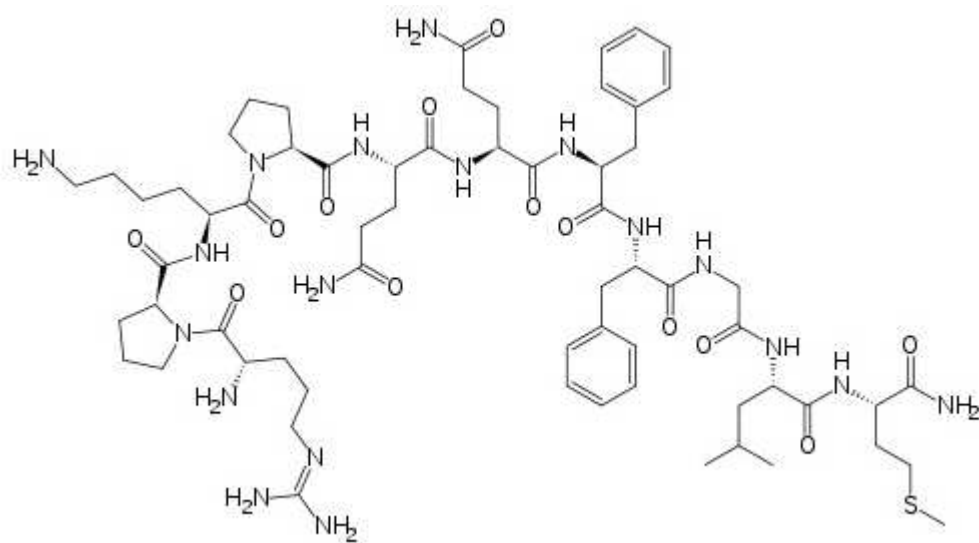

Figure 2.1. Chemical structure of SP with a molecular formula $C_{63}H_{98}N_{18}O_{13}S$ and a molecular weight 1347.63 g/mol (Substance P Compound Summary - CID 36511, 2010) (PubChem 2010).

Later SP was classified as part of the tachykinin (TK) family having over 40 members identified in vertebrates and invertebrates (Severini et al. 2002). In addition to SP, currently known human TKs include neurokinin A (NKA) with its elongated forms neuropeptide K (NPK) and neuropeptide- γ (NP γ), neurokinin B (NKB), and more recently identified human hemokinin-1 (hHK-1) with its two known elongated forms endokinin A (EKA) and EKB (Lecci et al. 2006).

2.1.2 Chemical properties of SP

SP conformation appears to be strongly dependent upon the solvent. For instance, in methanol the structure contains the mixture of β -turn conformations, whereas in water there is an extended chain structure (Sumner et al. 1990). The following features appear to be characteristic of SP in all media: α -helical core from Pro⁴ to Phe⁸ which is stabilized by two hydrogen bonds between Phe⁷-NH/Lys³-CO, Phe⁸-NH/Pro⁴-CO; an extended highly flexible N-terminal Arg¹-Pro²-Lys³; and a central turn on the Gly⁹, bringing the C-terminal amide in contact with the γ -carbonyl O-atom of both of the glutamines (Lavielle et al. 1988; Regoli et al. 1994).

By definition TKs all share the same conserved hydrophobic C-terminal region, Phe-X-Gly-Leu-Met-NH₂, where X is always hydrophobic, that is either an aromatic or a β -branched aliphatic amino acid (Page 2004). Aromatic phenylalanine or tyrosine in this location is considered indicative of NK1R binding affinity (Page 2004). In contrast, at their N-terminals they possess divergent and hydrophilic regions believed to convey receptor specificity (Ingi et al. 1991). The C-terminal end of SP is naturally amidated without which a great deal of SP activity is lost. This has been explained mainly due to its ionicity (negative charge) near physiological pH, amide hydrogen involvement in conformational interactions, and lack of stability i.e. toward different peptidases and synthetases (Escher et al. 1982).

Vilisaar, J.

Due to methionine residue, SP is very susceptible to oxidation. In aqueous solutions SP quickly loses its activity. For storage in liquid form it is advised to keep it at acidic pH (e.g. 0.05 M acidic acid) or by using oxygen free water (Sigma 1998). Addition of bovine serum albumine (1%) increases solution stability. Crude solutions are stable below pH 8 but are rapidly destroyed above pH 8 (Merck 1989). Solutions are advised to be stored frozen at -20 to -70 C in small aliquots with repeated freeze-thaw cycles avoided (Sigma 1998).

2.1.3 Expression of SP

SP is expressed widely in the central and peripheral nervous system and beyond. SP is produced by several cell types, including neurons, astrocytes, microglia (Michel et al. 1986; Barker et al. 1992) as well as endothelial cells (Barker et al. 1992) and lymphocytes (Lai et al. 1998), monocytes, macrophages (Ho et al. 1997), eosinophils (Metwali et al. 1994) and endocrine cells (Page 2004). In the CNS, SP immunoreactivity has been shown in a wide variety of structures also developmentally, including telencephalon, basal ganglia, hippocampus, amygdala, septal areas, hypothalamus, mesencephalon, metencephalon, myelencephalon, spinal cord (Shults et al. 1984; Lee et al. 1985). For example, SP fibres originating in the striatum and projecting in the midbrain have been shown to modulate the activity of dopaminergic neurons (Reid et al. 1990; Chen et al. 2004). SP is present in dorsal root ganglia and sensory nerves,

mediating pain transmission, and both in central and peripheral components of the autonomic systems (Dun et al. 1981). The recently discovered EKA/B, that may crosstalk with SP, are abundantly expressed in peripheral non-neuronal tissues (Page 2004).

2.1.4 Genetics of SP

Three genes encoding TKs have been identified in humans: TAC1 (or PPT-I or PPT-A), TAC3 (or PPT-II or PPT-B) and TAC4 (or PPT-C) (Tab 2.1). TAC1 consists of seven exons, the sequence that encodes SP is contained in exon 3. Alternative splicing of TAC1 transcript gives four distinct α , β , γ and δ forms of messenger ribonucleic acid (mRNA) (Fig 2.2). α -TAC1 and δ -TAC1 encode SP, β -TAC1 encodes SP, NKA and NPK, and γ -TAC1 encodes SP, NKA and NP γ (Nawa et al. 1984). The most frequently expressed isoforms of TAC1 mRNA in human T cells has been shown to be β and γ isoforms in healthy subjects (Cantalupo et al. 2008). A relative shift in β/γ ratio has been shown in MS patients in a relapse (Cantalupo et al. 2008).

The TAC3 gene transcribes three forms of mRNA (α , β , γ) of which only the α - and β -TAC3 are translated into NKB (Hokfelt et al. 2001). The TAC4 gene can be transcribed into α , β , γ and δ mRNA isoforms of which the α one has two variants: α -TAC4v1, encoding EKA and EKC, and α -TAC4v2 encoding EKB and EKC.

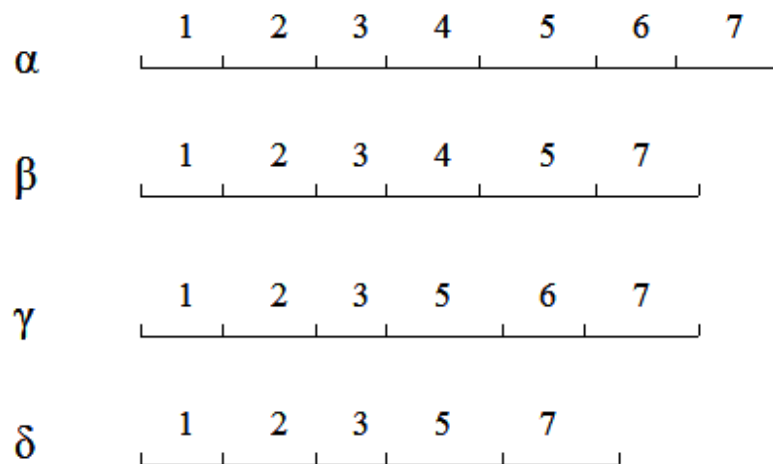

Figure 2.2. Schematic diagram showing combinations of exons in alternative splicing of TAC1 transcripts. The numbers refer to the same exons encoding four different forms of mRNA.

The EKC has a C-terminal Leu-NH₂ and cannot be properly considered a TK. It also lacks significant activity at TK receptors. The β -TAC4 mRNA is translated into EKB and EKD, the latter which like EKC, has a modified C-terminal sequence. Both γ - and δ -TAC4 code for EKB only (Page 2004).

SP is released from its precursor by the actions of proteases called convertases. Cleavage points for the convertases on the SP precursor are doublets of cationic residues (Harrison et al. 2001). Typical cleavage points are Lys-Arg, Arg-Arg, and Arg-Lys doublets (Steiner et al. 1992). This is followed by C-terminal amidation by the action of peptidyl-Gly- α -amidating monooxygenase (Lembeck 1953).

Gene	Chromosome position	mRNA transcript	cDNA transcript length (bp)	Precursor protein length (aa)	Peptides predicted on precursor	Accession number
TAC1	7q21-q22	α TAC1	1048	111	SP	NM_013996
		β TAC1	1102	129	SP,NKA, NP γ	NM_003182
		γ TAC1	1057	114	SP,NKA, NPK	NM_013997
		δ TAC1	1003	96	SP	NM_013998
TAC3	12q13-q21	α TAC3	902	135	NKB	AF537115
		β TAC3	785	121	NKB	AF537118
		γ TAC3	731	103	NA	AF537121
TAC4	17q21.33	TAC4	225	68	hHK-1, hHK-1(4-11)	AF521560
		α TAC4v1	675	113	EKA, EKC	AF515828
		α TAC4v2	657	107	EKB, EKC	AY471574
		β TAC4	624	96	EKB, EKD	AF515829
		γ TAC4	597	87	EKB	AF515830
δ TAC4	564	76	EKB	AF515831		

Table 2.1. Human tachykinins (adapted from Page NM, 2004).

2.1.5 SP synthesis and metabolism

In neuronal cells synthesis of SP occurs in ribosomes and is confined to the pericaryon (Harmar et al. 1980). SP is then packed into storage vesicles (Plenderleith et al. 1990) and transported axonally to terminal endings for final enzymatic processing (Brimijoin et al. 1980). SP seems to be the most easily inactivated by proteolytic enzymes compared to other tachykinins

(Severini et al. 2002). A number of enzymes seem to be involved in the metabolism of SP, including: neutral endopeptidase (NEP), SP-degrading enzyme (SP-DE), angiotensin-converting enzyme (ACE), dipeptidyl-aminopeptidase IV (DPIV), post-proline endopeptidase (PEP), cathepsin-D and cathepsin-E. Although all of these enzymes cleave SP in vitro, due to their specific cellular localization it is probably NEP and ACE that are most commonly involved in the cleavage of SP in the periphery (Nadel 1991). NEP has been demonstrated to be involved in the metabolism of SP in the brain (Hooper et al. 1987), spinal cord (Sakurada et al. 1990) and in peripheral tissues (Di Maria et al. 1998), whereas ACE is known to degrade SP in plasma (Wang et al. 1991) and cerebrospinal fluid (Harrison et al. 2001). Both NEP and ACE catalyze the hydrolysis of Phe⁸-Gly⁹ or Gly⁹-Leu¹⁰ bonds of SP, leaving the peptide lacking the C-terminal regions required to bind to the tachykinin receptors (Skidgel et al. 1987). The N-terminal fragments of SP, particularly SP (1-4) (Joshi et al. 2001) and SP (1-7) (Zhou et al. 2002) are biologically active SP metabolites and the formation of these products can be blocked by the action of specific endopeptidase inhibitors (Sakurada et al. 1999).

2.1.6 TK receptors

TKs exert their effects on target cells through the TK receptor family. These receptors consist of seven hydrophobic transmembrane domains, connected by extra- and intracellular loops and coupled to G-proteins

Vilisaar, J.

(Regoli et al. 1989; Gerard et al. 1991; Gerard et al. 1993). There are three main types of neurokinin receptors NK1, NK2 and NK3 exhibiting preferences for substance P, neurokinin A and neurokinin B respectively (Regoli et al. 1994). In summary, the affinities of these peptides as ligands to NK1 receptor (NK1R) can be expressed as follows: SP>NKA>NKB, that to NK2R as NKA>NKB>SP and to NK3R as NKB>NKA>SP (Harrison et al. 2001). All TKs show some degree of cross-reactivity among TK receptors as their affinity is dictated by common C-terminal amino acid (aa) sequence.

Two isoforms of NK1R exist in humans with a different length of the C-terminal end: a full-length NK1R (also referred to as NK1R-F) consisting of 407 aa (Fig 2.3) and a truncated isoform NK1R-T consisting of 311 aa (Fong et al. 1992; Lai et al. 2008; Chernova et al. 2009). The latter has been found in peripheral tissues whereas NK1R is abundant in the CNS (Caberlotto et al. 2003; Lai et al. 2008). In this thesis “NK1R” has been used to refer to NK1R-F.

It has been shown for NK1R that the receptor can be easily internalised, helping to regulate the receptor response e.g. after noxious stimuli and SP binding; its density on a cell membrane can be restored quickly (on average within 30 min) after a stimulus (Mantyh et al. 1995).

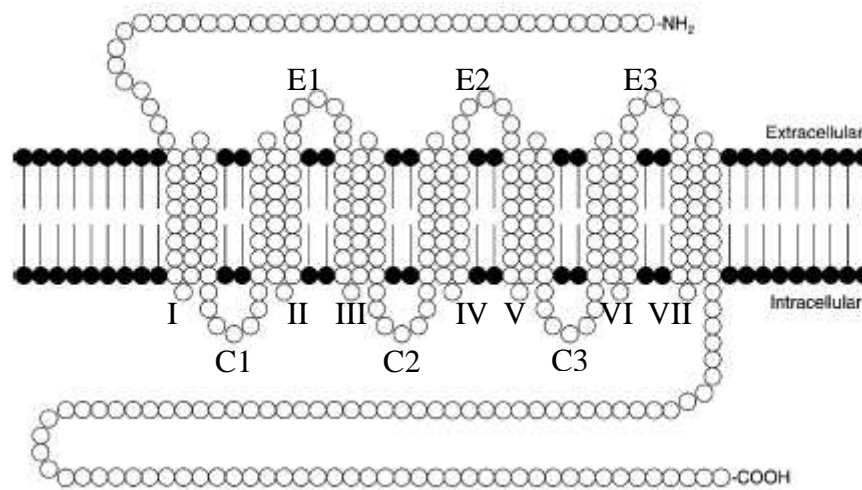

Figure 2.3. Diagram of human full-length NK1R with a relative molecular mass of 46 kDa. The second and third transmembrane (TM) domains are involved in agonist/antagonist binding, the third cytoplasmic loop is responsible for G-protein interaction. Roman numerals indicate the number of TM domains, E1-3 and C1-3 designate extracellular and cytoplasmic loops respectively (adapted from O'Connor et al 2004).

Different conformations for NK1R and NK2R have been demonstrated that may be conditioned by the ligand with subsequent activation of different G-proteins (Palanche et al. 2001).

2.1.7 Genetics of TK receptors

The gene for NK1R, TACR1, is located on human chromosome 2, spans 45-60 kb and is contained in 5 exons (Gerard et al. 1991). The gene is known to provide two splice variants that differ in the length of the cytoplasmic C-terminal tail by approximately 8 kDa (Li et al. 1997). The long isoform of NK1R, prevalent in the brain, and the truncated isoform,

mainly in peripheral tissues (Caberlotto et al. 2003), show differences in the signal transduction and desensitisation rates (Li et al. 1997).

NK2R encoding gene TACR2 also yields two splice variants: the α -isoform is the “classic” NK2R, whereas the β -isoform lacks the long amino acid sequence forming E III and C II loops and a TM domain IV (Lecci et al. 2006). TKs have not been found to bind to this receptor isoform, however, other ligands have not been described (Lecci et al. 2006). The gene encoding NK3R has been defined as TACR3, the claimed existence of NK3R subtypes has not been confirmed (Lecci et al. 2006).

2.1.8 Receptor binding and signalling

The C-terminal region is central to the activation of each of the three TK receptors (Page 2004). Radiolabelled mapping and mutagenesis studies have shown that SP inserts itself into the hydrophobic ligand binding pocket (TM II, III and VII) between the transmembrane domain and extracellular surface and the centre bilayer (Huang et al. 1994; Rosenkilde et al. 1994). The remainder of the SP molecule interacts with amino acids on the extracellular surface of the receptor. (Fig 2.4)

Human NK1R has been found to stimulate multiple second messenger systems and to couple to several members of the G- protein family (Gq/11, Gas, G α 0) (Macdonald et al. 1996; Roush et al. 1998). G-proteins are

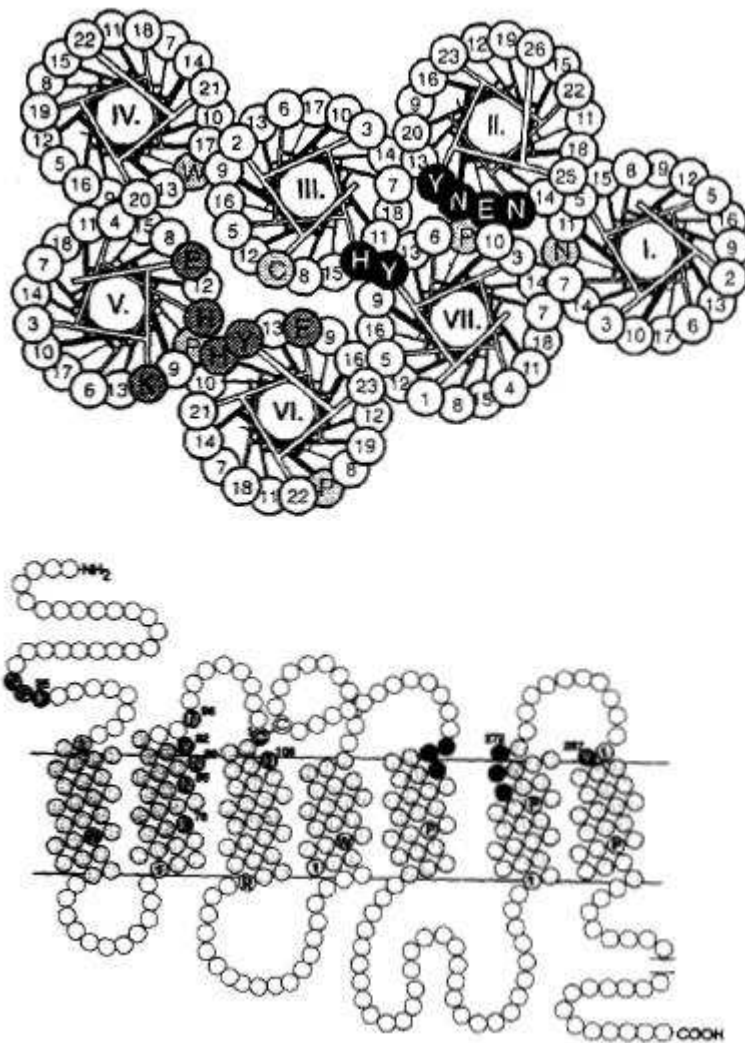

Figure 2.4. Diagrams of the human NK1R binding of SP and the non-peptide antagonist CP-96345. The upper diagram shows the extracellular part of the receptor from an outside-inward view and the lower diagram depicts transectional view through the cell membrane. Residues suggested to be involved in SP binding are shown in white on black (TM domains II, III and VII), residues involved in CP-96345 binding are shown in black on grey (TM V and VI). Although the binding sites are spatially different the binding is competitive due to interchange in allosteric conformations of the receptor (Rosenkilde et al, 1994).

coupled to the third cytoplasmic loop of the NK1R (O'Connor et al. 2004). Upon receptor-ligand interaction conformational changes within the receptor cause exchange of guanosine diphosphate (GDP) with guanosine triphosphate (GTP) that activates the attached G-protein. The α subunit of the G-protein dissociates from the β and γ subunits and activates the intracellular effectors (Khawaja et al. 1996), such as members of the mitogen-activated protein kinase (MAPK) cascade, including extracellular signal-regulated kinases 1 and 2 (ERK1/2) and p38MAPK (DeFea et al. 2000; Fiebich et al. 2000). ERK1/2 translocate into the nucleus and mediate phosphorylation of transcription factors such as NF κ B, widely involved in cytokine expression (Lieb et al. 1997; Tokuda et al. 2005). p38MAPK subfamily comprises kinases functioning as a signal transduction pathway independent of NF κ B. This pathway also has been shown to mediate SP-induced inflammatory cytokine expression, such as IL-6 (Fiebich et al. 2000).

Another effector of G-protein activation is phospholipase C β (PLC β) that hydrolyses phosphatidyl inositol biphosphate (PIP₂) into two second messenger molecules inositol triphosphate (IP₃) and diacylglycerol (DAG). IP₃ acts on specific receptors to release intracellular stores of calcium from the sarcoplasmic reticulum. DAG acts via protein kinase C (PKC) to open calcium channels in the plasma membrane. The increase in [Ca²⁺] leads to the tissue responses. One of such NK1R mediated responses dependent on

Vilisaar, J.

PKC activation and extracellular calcium is arachidonic acid release (Garcia et al. 1994).

TK receptor activation can be coupled via G-proteins also to adenylyl cyclase activation (Khawaja et al. 1996) that converts ATP into cAMP. The second messenger cAMP acts via different effectors and is able to inhibit the proliferation of many cell types but stimulate proliferation of others. The mechanisms for this differential regulation involve cross-talk between different signalling pathways (Dumaz et al. 2005).

NK1R-T has not been shown to induce Ca²⁺ mobilisation independently, but as a result of crosstalk with co-receptor mediated responses, such as chemokine receptor CCR5. ERK1/2 pathway has been suggested in NK1R-T downstream signalling (Chernova et al. 2009).

2.1.9 Receptor agonists

Natural agonists for neurokinin receptors are relatively nonselective, examples include aforementioned members of the TK family. In developing synthetic agonists, modifications in amino acid sequences of the parent peptide have been used, particularly at the common C-terminal. (Regoli et al. 1989). Several selective synthetic agonists have resulted ([pGlu⁶,Pro⁹]SP(6-11), [Sar⁹Met(O₂)¹¹]SP, [Nle¹⁰]NKA(4-10),

[MePhe⁷]NKB etc) that have been used in characterizing the neurokinin receptors and elucidating their physiological function (Regoli et al. 1989).

2.1.10 NK1R antagonists

Antagonists for the SP receptor were first recognised in 1960s with analogues of nonmammalian TK eledosin, containing a D-amino acid (Schroder et al. 1964). Resulting from this, several other peptide antagonists were synthesized that lacked oral bioavailability and penetration into the CNS (Harrison et al. 2001).

A breakthrough was observed with NK1R antagonists following the discovery of CP-96345 (Snider et al. 1991), the first non-peptide tachykinin receptor (NK1R) antagonist (Fig 2.5).

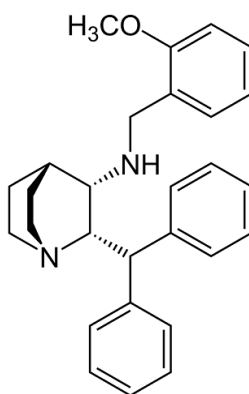

Figure 2.5. CP-96345, chemically as (2S,3S)-cis-2-(diphenylmethyl)-N-([2-methoxyphenyl]-methyl)-1-azabicyclo(2.2.2)-octan-3-amine.

Vilisaar, J.

Both CP-96345 and CP-99994 (another NK1 selective antagonist) readily crossed the BBB (Snider et al. 1991). These compounds contained a benzyl group with an ortho- (and ortho-methoxy-) substitution on the benzyl ring which enhanced the binding and affinity for the receptor (Lowe et al. 1992).

Additional non-peptide NK1R antagonists have been synthesized, such as RP-67580 or SR-140333 (Emonds-Alt et al. 1993). It is noteworthy, that many of the selective NK1R antagonists demonstrate species-related variation in affinity. CP-96345 is a more potent antagonist in human, guinea-pig and rabbit tissue, whilst RP-67580 is a better antagonist in rat and mouse preparations (Snider et al. 1991). These slight variations are often linked to the change of a single mutation of the amino-acid sequence of the receptor (Harrison et al. 2001).

Binding sites for these competitive nonpeptide antagonists and SP have been analyzed. It was discovered that the peptide is binding at the extracellular ends of the transmembrane helices and especially in the extracellular loops of the receptor, whereas the small hydrophobic, nonpeptide antagonists are binding more deeply inbetween the transmembrane segments. CP-96345 has been shown to interact specifically with residues 183-196 (TM V) and 271-276 (TM VI) (Gether et al. 1993), a glutamine residue 165 (TM IV) (Fong et al. 1994), and histidine 265 (TM VI) of NK1R (Zoffmann et al. 1993). There appears to be very little overlap in the binding sites for CP-96345 and SP, although

Vilisaar, J.

they are competitive binders (Fig 2.4). This is due to these receptors functioning as allosteric molecules, where agonists and antagonists are believed to stabilize different conformations (Hokfelt et al. 2001).

Several other selective NK1R antagonists have been derived, some of which have been successful in clinical trials. MK-869 is an orally available and long-acting NK1R antagonist which have been shown useful in major depressive disorders (Kramer et al. 1998), CP-99994 ameliorating post-operative pain after dental extraction (Dionne et al. 1998) and L-7540303 having anti-emetic effects (Harrison et al. 2001).

2.1.11 SP and neurogenic inflammation

The function of SP and other neuropeptides in sensory nerves is not confined to mediating sensation. TK-containing sensory nerves innervate most of the organs, including the viscera, and are highly represented also near cerebral arteries (Edvinsson et al. 1983). Neuropeptides can be released from these nerves in response to noxious and inflammatory stimuli (Oku et al. 1987). The immediate effects of SP, released from the peripheral nerve endings, are particularly prominent on the vasculature where SP induces vasodilatation of the arterioles (together with calcitonin gene-related peptide, CGRP) (Fiscus et al. 1992), plasma extravasation in post-capillary venules (entirely mediated by tachykinins) (Piedimonte et al. 1993) and leukocyte adhesion to endothelial cells of venules (Nakanishi

1987). SP stimulates mast cells and basophils to release histamine and other mediators, such as leukotriens (Harrison et al. 2001), whose releasing activity of SP can further contribute to plasma extravasation and oedema (Severini et al. 2002). The consequence of neurogenic inflammation is also pain and that can positively feedback the above effects (Severini et al. 2002).

2.1.12 SP in immunogenic inflammation

Bi-directional effects as above are responsible also for neuroimmunoregulatory interactions. TK-containing afferent nerve fibres innervate immune organs and tissues, including thymus, spleen, bone marrow and lymph nodes (Severini et al. 2002; Steinman 2004). This can provide means via which neural control over immune responses is maintained. TK receptors in these tissues indicate receptive function and are present on most immune cells. Importantly, immune cells themselves express SP and other neuropeptides and their receptors (Levite 2008).

Immunoregulatory effects of neuropeptides are exerted to a great extent through their modulation of cytokine production by different types of cells. SP has been shown to stimulate cytokine secretion including IL-1, IL-6, IL-8, IL-10, IL-12, TNF- α from monocytes and macrophages (Lotz et al. 1988; Laurenzi et al. 1990; Ho et al. 1996; Kincy-Cain et al. 1997), IL-2, IFN- γ , IL-4 and IL-10 from T cells (Calvo et al. 1992; Blum et al. 1993).

Vilisaar, J.

SP has been shown to stimulate inflammatory cytokine IL-6 and IL-1 production also in astrocytes and microglia (Martin et al. 1992; Martin et al. 1993; Gitter et al. 1994; Lieb et al. 1998). IL-12 induction by SP has not been investigated in humans (except for our preliminary results) and the relationship between SP and IL-23 has previously not been investigated.

The indirect effect of IL-12 on IFN- γ production could conceivably be mediated by SP. In murine models, IL-12 has been shown to induce SP precursor mRNA in macrophages via STAT4 pathway (Arsenescu et al. 2005) and NK1R expression by both IL-12 and IL-18 stimulation via NF κ B (Weinstock et al. 2003). Recently, IL-12 and IL-23 have been found to induce SP synthesis in murine T cells and macrophages which can be regulated by IL-10 and TGF- β respectively (Blum et al. 2008). In turn, SP enhances IFN- γ production in different inflammatory models (Blum et al. 1993; Blum et al. 2001) and as part of the IL-12 immune regulatory circuit may be important in promoting Th1 responses (Arsenescu et al. 2005).

Other effects of SP include stimulating proliferation of T and B cells (Raffa 1998). SP is known to act as a B cell differentiation co-factor and have effects on immunoglobulin production (Bost et al. 1992). SP enhances cell-mediated cytotoxicity of Tc and natural killers (Wozniak et al. 1993) as well as phagocytosis in macrophages (Bar-Shavit et al. 1980). It induces oxidative burst in macrophages with release of oxygen radicals,

Vilisaar, J.

arachidonic acid derivatives that are involved in tissue injury and indirectly stimulate recruitment of immune cells (Raffa 1998).

The mechanisms of chemotaxis by SP are not clear; evidence exists that chemotactic activity may reside in its C-terminal amino acid sequence (O'Connor et al. 2004). Loss of chemoattractant effect of SP on neutrophils has been described in NK1R knock-out mice (Ahluwalia et al. 1998). SP has been also found to induce macrophage inflammatory protein-1 β expression in human T cells (Guo et al. 2002). Lately, it has been found that SP promotes CCR5-mediated chemotaxis of human monocytes. This has been shown implemented via crosstalk between CCR5 and NK1R-T on monocytes (Chernova et al. 2009).

SP is involved in leucocyte adhesion to endothelial cells and has been reported to induce the expression of endothelial-leucocyte adhesion molecule-1 on human small vessel endothelium, increase the expression of the leucocyte integrin CD11b on human neutrophils, and enhance the expression of intercellular adhesion molecule-1 and leucocyte function-associated antigen-1 on murine endothelial cells and lymphocytes (Matis et al. 1990; Vishwanath et al. 1996).

SP influences host responses in both viral and bacterial infections. In infections, increased expression of SP and its receptor have been reported (Jacoby et al. 2000; Tripp et al. 2000; Kwan et al. 2001). Antagonism of

Vilisaar, J.

NK1R limits Th1 responses during salmonellosis with decreased IFN- γ mRNA expression in mucosal tissues (Kincy-Cain et al. 1996), NK1R deficient mice show reduced granuloma formation and IFN- γ production in infection with *Schistosoma mansoni* (Blum et al. 1998; Blum et al. 1999). Increased viral or bacterial burden and accelerated disease progression with impaired natural killer activity have been described in several studies with impaired SP response (Svensson et al. 2005).

2.2 Multiple sclerosis

2.2.1 General features of MS

MS is an autoimmune disease of the CNS characterised by multifocal inflammatory demyelination and neuronal loss. The disease affects predominantly younger people with an onset usually in the third or fourth decade. Like other autoimmune conditions it is preponderant in females with a female/male ratio of 3/2 to 2/1 (Confavreux et al. 1980). The main target of inflammation is myelin and myelin-producing oligodendrocytes that enclose and insulate axons. The inflammatory breakdown of myelin leads to impairment in nerve conduction which results in clinical symptoms and signs.

2.2.2 MS clinical presentation

MS presents with an abrupt onset of neurological symptoms, usually for weeks, followed by a complete or partial recovery. Symptoms and signs depend on the tracts affected and the location of the lesion. MS manifests frequently in the optic nerve and sensory disturbances (numbness, paraesthesiae, pain), motor findings (weakness, spasticity) and cerebellar features (ataxia, tremor), bladder and bowels dysfunction and commonly with generalized fatigue. The diagnosis is based on evidence for at least two demyelinating events at different sites, separated in time (for

diagnostic criteria please see Appendix B) (Polman et al. 2011). In 80% of patients MS presents as a relapsing-remitting (RR) type, which in a majority of cases advances into the secondary progressive stage (Compston et al. 2002; Compston et al. 2008). Approximately 15 % of patients present from the onset with primary progressive MS (PPMS) and about 5% have a benign form of MS which does not progress (Compston et al. 2002). Pathologically, these clinical types of MS reflect different combinations of acute inflammatory and chronic neurodegenerative processes.

2.2.3 Etiological factors in MS

MS has been considered a polygenic disease, however until date, no major susceptibility genes have been identified. Association with the haplotype DR2 (Ebers et al. 1995) and coexistence of other alleles of the human leucocyte antigen (HLA) class II (Frohman et al. 2005) have been found, having implications in antigen presentation. There is also evidence of MS being linked to environmental factors, the prevalence of MS increasing with latitude (Kurtzke 1980). Associations with several intracellular pathogens have been suggested in MS pathogenesis, such as measles, rubella, mumps, parainfluenza, HTLV-I, herpes simplex and Epstein-Barr viruses, *Chlamydia pneumoniae* (Wingerchuk et al. 2001). Nevertheless, no clear causal relationship between any of these infections and MS has been consistently confirmed. Recently, associations of increased risk for

Vilisaar, J.

the disease have been found with low 1,25-dihydroxyvitamin D3 levels and smoking (Ascherio et al.; Smolders et al.; Jafari et al. 2009).

2.2.4 Immunoactivation in MS

The effect of infectious agents seems important in activating cellular immune responses with 10% of infections being followed by a relapse in patients with defined MS and 30% of first presentations being related to a preceding infection (Compston et al. 2002). The latter can be explained by immune system activation via the mechanism of molecular mimicry in genetically susceptible individuals. In molecular mimicry immune cells of the body become activated towards myelin components that structurally resemble foreign antigens. In the course of the disease epitope spreading may as well be involved making the inflammatory response more myelin specific. The target antigens in MS are not proven; proteolipid protein (PLP), myelin basic protein (MBP), myelin-oligodendrocyte glycoprotein (MOG) and myelin-associated glycoprotein (MAG) epitopes have been suggested based on MS animal models and on indirect evidence on humans (Mokhtarian et al. 1984; Satoh et al. 1987; van der Veen et al. 1989; Kuchroo et al. 1991; Kerlero de Rosbo et al. 1993).

2.2.5 Cellular immune responses and BBB penetration

Inflammation in MS is driven mainly by cell mediated immunity. Autoreactive T cells against myelin epitopes are present physiologically

and believed to be controlled by naturally occurring as well as induced subgroup of T cells known as regulatory T cells (Tr). Immunoregulatory defects of Tr found in MS are believed to result in activation and proliferation of autoreactive T cells (Baecher-Allan et al. 2006). The latter attach themselves to the lining of cerebral venules, allowed by upregulation of adhesion molecules such as α 4-integrin on them and induction of VCAM-1 and ICAM-1 (Pober et al. 1986; May et al. 1992; Arnason 1996) reciprocally on CNS endothelia (Vajkoczy et al. 2001; Frohman et al. 2005). Previously, SP role in ICAM-1, VCAM-1 expression (Nessler et al. 2006) and leukocyte-endothelial cell adhesion have been shown (Harrison et al. 2001). Release of matrix metalloproteinases enables breakdown and penetration of the blood-brain barrier (BBB). Additionally, modulatory role of SP in BBB integrity has been proposed (Kostyk et al. 1989; Cioni et al. 1998). Recently, the role of mast cells, located perivascularly, has been implicated in developing autoimmune inflammation, whereas SP has been shown an important role as a mediator in this function (Theoharides et al. 2008). Several SP effects in mast cells have been established, such as inducing degranulation, histamine, serotonin and inflammatory cytokine release that contribute to the cascade damaging the BBB (O'Connor et al. 2004). Mast cells can stimulate activated T cells coming in contact with them at the BBB, e.g. after stimulation with myelin basic protein or SP (Theoharides et al. 2008).

2.2.6 Inflammatory cascade in the CNS

In the CNS, autoreactive T cells activate microglia and astrocytes (Frohman et al. 2005) that act as local antigen presenting cells (APC) representing the antigen of myelin to T cells. Activated T cells and APC release cytokines that lead to the propagation of inflammation and recruitment of other immune cells via secretion of chemokines (RANTES, MCPs, MIPs, IL-8). The recruited monocytes, differentiating into macrophages, are the main effector cells degrading myelin. They phagocytose myelin lamellae with release of different proteolytic enzymes, NO, free radicals, H₂O₂ and cytokines (Traugott et al. 1983). Another group, CD8⁺ T cells (Tc), may have a suppressor function in MS with secretion of IL-4, IL-10 and TGF- β , but have also been implicated as potentially pathogenic. They are more abundant than CD4⁺ helper cells (Th) in MS lesions (Crawford et al. 2004). The immune pathways involving Th subsets Th17, Th1, and Th2 determine the balance of the inflammatory arms and mediate autoimmune damage to myelin. Neuropeptides, including SP, have been shown to modulate Th phenotype commitment (Levite 1998).

2.2.7 Role of humoral responses

B cells and plasma cells are also activated in MS and have been found in and near MS lesions (Arnason 1996). IL-4, released by Th2 cells, has the main role in facilitating humoral responses (Arnason 1996). Oligoclonal

IgG is present in plaques and found as oligoclonal bands (OCB) in cerebrospinal fluid (CSF) electrophoresis in more than 90% of MS patients, indicating local oligoclonal activation. Activation of complement in active lesions has been demonstrated (Compston et al. 1989; Storch et al. 1998) which by causing opsonisation of myelin antigens stimulates and focuses the autoimmune attack (Mosley et al. 1996).

2.2.8 Propagation of lesions and direct neuronal injury

The above phenomena result in lesions of both white and grey matter. In the brain, they frequently show periventricular distribution. Lesions start as perivenous infiltration of lymphocytes, activated macrophages and microglia, followed by proliferation of astrocytes that prevail at later stages leading to gliosis. Oligodendrocyte and myelin damage by macrophages exposes neurons impairing their conduction and enabling direct injury. Effector cells and released cytokines, proteinases, free radicals, NO as well as glutamate can all contribute to neuronal injury. It is plausible that on neuronal injury, SP may be released, which in turn is involved in stimulating and maintenance of inflammation. Interstitial oedema is evident in acute stages with a possible neurogenic role of SP (Brenner et al. 1994). Heterogeneity in pathogenic mechanisms of MS has been observed and distinction of four major pathological patterns has been suggested (Lucchinetti et al. 2000)

2.2.9 Neurodegenerative features of MS

Pathological evidence and magnetic resonance imaging (MRI) have shown that neurodegeneration with damage to axons and neuronal cell bodies is present from the earliest stages of the disease (Ferguson et al. 1997; Trapp et al. 1998; Bitsch et al. 2000; Kornek et al. 2000; Kuhlmann et al. 2002). This is accompanied by reparative processes and remyelination commencing in the acute inflammatory phase. Activated T cells, monocytes, astrocytes and microglia produce various neurotrophic factors, such as brain-derived neurotrophic factor (BDNF), activity-dependent neuroprotective factor (ADNF) (Braitch et al.; Kerschensteiner et al. 1999; Kerschensteiner et al. 2003) that support neuronal survival, regeneration, synaptogenesis as well as remyelination (Coyle 2005). There is also evidence of SP involvement in neuronal survival as part of the protective arm of inflammation (Barker 1986; Salthun-Lassalle et al. 2005; Amadoro et al. 2007).

2.2.10 MS animal models targeting SP role

In vivo evidence on SP role in CNS demyelination comes from studies on EAE mice using NK1R antagonists or NK1R knockout model. NK1R antagonist CP-96345 administered before the disease onset has been shown to considerably ameliorate the clinical and histological signs in T cell transfer EAE (Nessler et al. 2006). The protective effect of CP-96345 was attributed to a reduced expression of adhesion molecules ICAM-1 and

Vilisaar, J.

VCAM-1 on CNS endothelia (Nessler et al. 2006) and reduced secretion of pro-inflammatory (Th1) cytokines in treated animals (Nessler et al. 2006). Milder clinical presentation has been shown in NK1R deficient mice with also decreased numbers of LFA-1 high CD4+ T cells and MOG-specific, IFN- γ producing CD4+ cells (Reinke et al. 2006). NK1R antagonist SR140333 administered during the chronic phase of EAE has proved insufficient ameliorating EAE symptoms (Reinke et al. 2006). In humans suggestions on SP involvement in MS come from linkage studies that have highlighted TAC1 association with MS (Vandenbroeck et al. 2002; Cunningham et al. 2005).

2.3 Aims

The primary aims of the study are as follows:

1. To determine the role of NK1R mediated effects on the expression of various inflammatory cytokines, such as IL-23, IL-12 IL-1 β , IL-6, IL-8, IL-10, TNF α in PBMC from normal controls.
2. To investigate the expression of SP and its receptor in T cells in a normal state and on stimulation with the main Th17 and Th1 cytokines, i.e. IL-23, IL-17, IL-12, IFN- γ .
3. To study the possible intermediary roles of IL-17 and IFN- γ in the IL-23 and IL-12 effects respectively in the induction of SP and NK1R in T cells from healthy controls.
4. To investigate the expression of SP and its receptor in human NT2 neurons as an effect of IL-17, as part of the Th17 response, in comparison with IFN- γ as part of the Th1 pathway.
5. To determine NK1R expression in peripheral blood cells in an unstimulated state comparatively in RRMS patients and healthy volunteers.

3 The induction of inflammatory cytokines by substance P in human peripheral blood mononuclear cells

3.1 Introduction

The induction of inflammatory cytokines is one of the main mechanisms by which SP exerts its immunomodulatory effects. In this chapter we have studied SP-induced inflammatory cytokine expression on both protein and mRNA-level. The cells used for this purpose are peripheral blood mononuclear cells (PBMC) that refer collectively to a population of monocytes, lymphocytes and antigen-presenting cells. PBMC cultures represent a good experimental setup for studying this regulation as these cells represent the main source of inflammatory cytokines in the circulation. Additionally, immune interactions between these cells *in vivo* are important determining the type of immune responses.

In the context of MS the inflammatory pathways associated with the created cytokine profiles can be characterized by means of three main subtypes of Th responses: Th1, Th2 and Th17. The main role responsible for inflammatory activity in MS is currently attributed to the recently uncovered Th17 cells (Harrington et al. 2005; Hofstetter et al. 2005; Komiyama et al. 2006). The effects and co-effects of cytokines secreted and engagement of the inflammatory pathways governs further differentiation of the cells and determines the balance of the inflammatory

arms. The three subtypes of Th responses are known to antagonise each other on a cytokine and likely also on a transcription factor level (Korn et al. 2007). This reflects their interdependency of each other and enables to maintain the created immunological profile.

It has been shown that Th17 cells with strong pro-inflammatory effects are differentiated mainly by the co-effect of TGF- β and IL-6 and at the later stage maintained by IL-23 via signal transducer and activator of transcription (STAT)3 and the orphan nuclear receptor ROR γ (Ivanov et al. 2006). Th1 population with mainly pro-inflammatory features is driven by IL-12 and IFN- γ via STAT1, STAT4 and T-box transcription factor T-bet. Th2 cells with anti-inflammatory effects are induced by IL-4 via STAT6 and subsequently by the zinc-finger transcription factor GATA3 (Murphy et al. 2002) (Fig 3.1). It has been shown that neuropeptides, such as SP, can modulate Th phenotype commitment (Levite 1998).

Th1 cells are known to activate macrophages and other immune cells via secretion of pro-inflammatory cytokines including IFN- γ , TNF- β , IL-1, IL-2 (Roitt et al. 2001), however recently it has been found they may also exhibit autoimmune inflammation limiting effects (Iwakura et al. 2006; McKenzie et al. 2006). The effects of Th2 cells, in MS context, via secretion of IL-4, IL-5, IL-10, IL-13, IL-25, include mainly downgrading activity of immune cells (i.e. cell-mediated immunity), as well as antibody

generating function. Th17 effects include secretion of IL-17A, IL-17F, IL-21, IL-22 and to a lesser extent TNF and IL-6 (Bettelli et al. 2007). Depending on the stimulatory effects, populations of PBMC produce a combination of inflammatory cytokines.

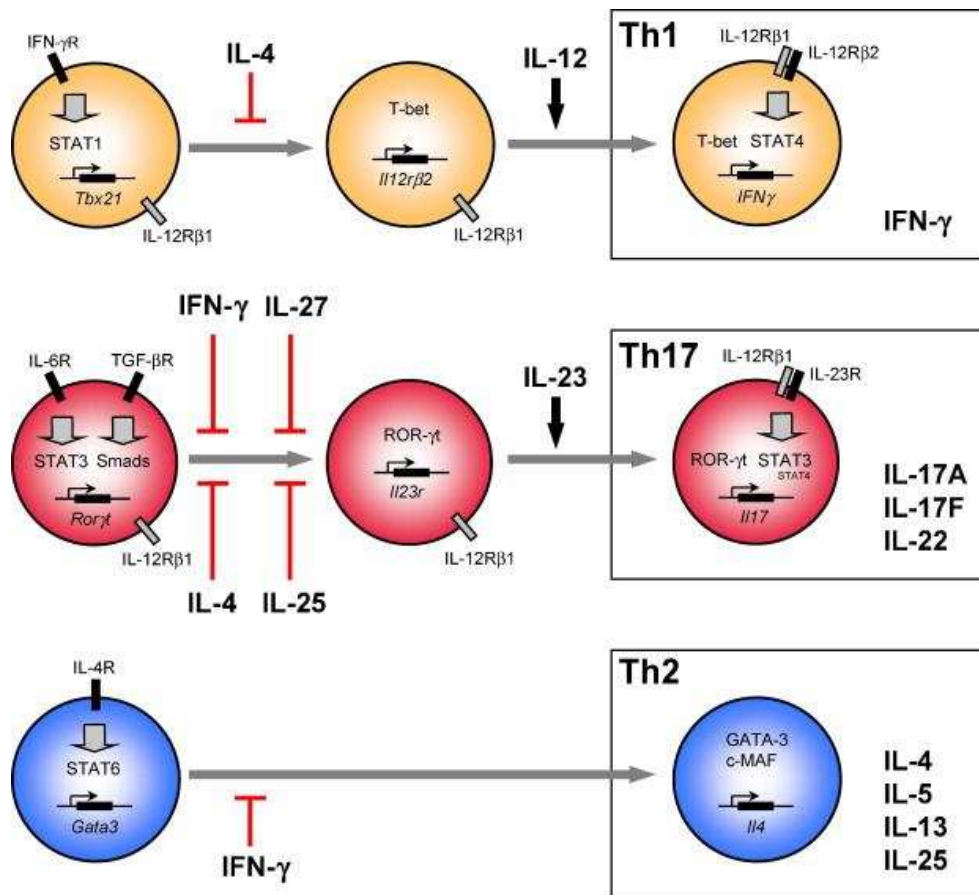

Figure 3.1. Differentiation and characteristics of CD4+ cells representing three main effector phenotypes (⊥ - inhibitory effects, ↓ - stimulatory effects) (Korn et al 2007).

Different co-effects and so called chain effects exist in induction of the studied cytokines. For example IL-12, secreted largely by APC, such as

macrophages, dendritic cells, and in the CNS also by microglia (Gran et al. 2004), is known to exert its effects either directly or via inducing production of IFN- γ . IFN- γ , secreted predominantly by Th1 cells, has potent pro-inflammatory effects. Similarly IL-23, a relatively newly discovered pro-inflammatory cytokine sharing the same p40 subunit, β 1 receptor chain and some of the signalling steps as IL-12 (Hoeve et al. 2006), can exert its effects directly or via promoting IL-17 production by Th17 cells (Aggarwal et al. 2003). IL-17 has various actions, including induction of IL-1 β , TNF, IL-6, several chemokines, colony-stimulating factors, matrix metalloproteinases from a series of different cell types (Kolls et al. 2004).

There has been a lot of discussion about the kinetics and interaction of the two pro-inflammatory pathways in the pathogenesis of MS. The importance of IL-23 versus IL-12 role in autoimmune demyelination has been extensively studied *in vivo*. In EAE model IL-23 but not IL-12 requirement in autopathogenic T cell response implicates the central role for IL-23/IL-17 axis. Both IL-23 and IL-17 knockout and therapeutic neutralisation experiments in EAE have supported resistancy to EAE or amelioration of the disease course (Hofstetter et al. 2005; Langrish et al. 2005; Chen et al. 2006; Komiyama et al. 2006). However, it seems Th17 responses may have a role earlier compared to Th1 cells which may be recruited by Th17 effects and have a role at later stages of inflammation.

Vilisaar, J.

SP effects on autoimmune inflammation and cytokine induction relevant to this chapter have been explained above (please see section 2.1.12). As a result from previous studies, SP has been found to induce activation of the pro-inflammatory pathways. Using PBMC cultures we will elucidate the net effects of SP, objectivised in our case by the expression of the inflammatory cytokines, such as IL-12, IL-23, IL-1, IL-6, IL-10, IL-8, TNF α . In particular we have been focussing on IL-12 and IL-23 induction as the key cytokines in Th1 and Th17 pathways respectively.

As an acknowledgement for work contributing to this chapter, a portion of ELISA and qPCR experiments were done by Dr K Kawabe and Ms M Braitch.

3.2 Methods

3.2.1 Cell preparations and cultures

PBMC were isolated by standard gradient centrifugation. Blood was obtained on venepuncture from healthy volunteers. 10 ml of whole blood was diluted with an equal volume of RPMI 1640 medium (Sigma-Aldrich, UK) with 6 ml of Histopaque 1077 (Sigma-Aldrich, UK) layered underneath blood and media. The solution was centrifuged for 20 minutes at 715 \times g. PBMC were isolated at the interface between the medium and the Histopaque. Harvested cells were washed twice, first with 20 ml of 2 % Fetal Calf Serum (FCS, Sigma-Aldrich, UK) in RPMI (consisting of 2 mM

Vilisaar, J.

Glutamine, 20 mM Hepes, 0.1 mg/ml Penicillin and Streptomycin) and centrifuged at $715 \times g$ for 15 minutes, and subsequently with 10ml of 2 % FCS in RPMI and centrifuged at $400 \times g$ for 10 minutes. Cells were resuspended in 5ml of 10% FCS in RPMI and aliquotted in 1:1 dilution with 0.4% Trypan blue (Sigma-Aldrich, UK) for cell counting and viability check. Cells were counted using a haemocytometer (Marinfeld Laboratory Glassware, Germany). PBMC were diluted with 10% FCS in RPMI to the concentration of 10^6 cells/ml, plated on 24 well plates 1ml/well and stimulated.

3.2.2 Stimulation of cell cultures

PBMC at a concentration 10^6 /ml were stimulated for 24 h and 48 h with 10^{-6} - 10^{-12} M SP (Sigma-Aldrich, UK) with and without the presence of following agents: NK1R antagonist CP-96345 (Pfizer, UK) 10^{-3} M - 10^{-6} M; an inactive enantiomer of the latter CP-96344 (Pfizer, UK) 10^{-3} M - 10^{-6} M; anti-NK1R antibody (Chemicon International Inc) 1:500 or 1:1000; lipopolysaccharide (LPS, E. coli serotype 0111:B4, Sigma-Aldrich, UK) 1 μ g/ml. After cell culture stimulations the supernatants were removed and stored at -80°C .

For stimulations SP as an acetate salt hydrate (SigmaAldrich, UK) was dissolved in distilled water and stored at -20°C (see also section 2.1.2), CP-96345 and CP-96344 were dissolved in distilled water.

Vilisaar, J.

3.2.3 Flow cytometric bead array for IL-1 β , IL-6, IL-8, IL-10, IL-12p70, TNF- α

For Cytometric Bead Array (CBA) on Fluorescence-Activated Cell Sorting (FACS) commercial CBA Inflammatory Kits (BD Biosciences Pharmingen, USA) were used according to the manufacturer's Culture Supernatant Assay procedure. The following two modifications to the procedure were made:

1. One extra standard for higher and smaller concentrations were added, 10,000 pg/ml and 10 pg/ml respectively;
2. Samples were incubated with capture beads as two separate subsamples. The first subsample of 5/6 of the total sample volume was incubated with the mixture of IL-1 β , IL-6, IL-10, IL-12p70, TNF- α beads, and the second subsample diluted 1:50 (due to high concentrations of IL-8) and of 1/6 total sample volume accordingly with IL-8 beads. After washing, the subsamples were added and treated per protocol.

For analysis EPICS Altra flow cytometer (Beckman Coulter) and WinMDI 2.9 software were used.

3.2.4 ELISA for IL-12 and IL-23 subunits on PBMC culture supernatants

Concentrations of different IL-12 and IL-23 subunits in stimulated PBMC culture supernatants were measured using commercial ELISA (Enzyme-Linked Immunosorbent Assay) kits. IL-12p40 (Diacclone, USA), IL-12p70 (eBioscience, USA) and IL-23 p19/p40 (eBioscience, USA) kits were used

Vilisaar, J.

following the manufacturer's instructions. The assay sensitivities were specified as follows: below 20 pg/ml for IL-12p40, below 15 pg/ml for IL-23 p19/p40 and 4 pg/ml for IL-12p70.

3.2.5 Total RNA extraction from stimulated cells

This step was carried out by column extraction method using commercial RNeasy® kit (Qiagen GmbH, Germany) according to the manufacturer's protocol. The homogenization step was performed using needle homogenisation method. Total RNA concentration was measured using NanoDrop® ND-1000 spectrophotometer (NanoDrop Technologies, USA). Purity was assessed by measuring 260/280 nm ratio, only samples within the range 1.70-1.95 were used.

3.2.6 Reverse transcription

First strand cDNA synthesis was initiated from the same amount of total RNA in each sample using random hexamers. To denature the secondary structure and anneal oligonucleotide primers to the RNA 0.3-0.5 µg total RNA was incubated with 1 µl of random primers (Promega, USA) (0.5 µg/µl) in a final volume of 15 µl, made up with nuclease-free water (Sigma-Aldrich, UK), at 70 °C for 5 minutes. Until the next step the microcentrifuge tubes with the above mixture were kept on ice. The following components of the total volume of 10 µl were added to each tube: 5 µl 5x MMLV (Moloney Murine Leukemia Virus) Reverse Transcriptase Buffer (Promega, USA), 1.25 µl dNTPs (10mM dATP, dCTP, dGTP,

Vilisaar, J.

dUTP) (Promega, USA), 0.5 µl of Ribonuclease Inhibitor (Promega, USA), 1 µl MMLV Reverse Transcriptase (Promega, USA) and 2.25 µl nuclease-free water (Sigma-Aldrich). The reverse transcription was carried out by incubating the mixture at 42 °C for 1 hour. The resultant cDNA was diluted with 75 µl of nuclease-free water for real-time PCR or stored at –20 °C.

3.2.7 Quantitation of IL-23p19, IL-12p40 and IL-12p35 transcripts

Quantification of transcripts was carried out using real-time PCR and the relative standard curve method as described by Applied Biosystems (AppliedBiosystems 1997). For the set of standards equal aliquots of undiluted cDNA from each sample were pooled together and serially diluted 1:2, 1:5, 1:10, 1:20. For each sample 12.5 µl of SYBRGreen Mastermix (Stratagene, USA), 6 µl nuclease-free water (Sigma-Aldrich, UK), 0.75 µl forward and 0.75 µl of reverse primers (10 pmol/µl) were mixed with 5 µl target cDNA/standard/water per tube. The real-time PCR reactions were carried out in triplicates on multiplex qPCR system Mx4000® (Stratagene, USA). The following conditions were used: 10 mins at 95 °C to denature the secondary structure followed by 40 cycles of alternating 95 °C for 15 sec and 54-62 °C (depending on T_m of primers) for 1 min. For dissociation curves the additional incubation at 95 °C for 1 minute and subsequent 40 cycles each with 1 °C increment in temperature from 55 to 95 °C every 30 seconds were added. Dissociation curves were

used routinely for each reaction to assess product homogeneity. The following primer sequences were used for IL-23p19 sense: 5'ctcctgatagccctgtg3', antisense: 5'gactgaggcttggaaatct3'; for IL-12p40 sense: 5'ggagtaccctgacacctg3', antisense: 5'agatgacctggctgagg3'; for IL-12p35 sense: 5'ccactccagaccaggaatg3', antisense: 5'gacggcctcagcaggt3' (Lee et al. 2004). For standardisation β 2-microglobulin (β 2MG) gene was used as an internal standard relative to which the ratios of the reaction products were taken. The primers used for β 2MG were as follows: sense: 5'ctccgtggccttagctgtg3', antisense: 5'tggatgaaaccagacacatag3'. The reaction efficiency was optimal with template in 1:5 dilution and primer concentrations 10 pmol/ μ l for all of the above reactions. The product size was confirmed on agarose gel electrophoresis. Further information about data analysis of the qPCR step is provided in Appendix A.

3.2.8 Agarose gel electrophoresis on the amplification product

Agarose gel electrophoresis was used to optimise conditions for reactions to all three subunits as well as for confirmation of the product size. 1.6 % agarose gel (Bioline, UK) was prepared in 1xTBE buffer (Tris, Boric acid, EDTA). 5 μ l PCR product with 1 μ l loading buffer and a 100 bp DNA ladder (Sigma-Aldrich, UK) were run at 100 V for 50-60 min. The gel was stained with ethidium bromide (0.2 μ g/100 ml) for 25 minutes and visualised under the UV-light (260 nm).

3.2.9 Statistical analysis

For statistical analysis Friedman and Wilcoxon tests were used in SPSS 16.0 software. Non-parametric tests are used for analysis throughout the thesis due to non-Gaussian distribution of the results.

3.3 Results

3.3.1 CBA for IL-12, IL-1 β , IL-6, IL-8, IL-10 and TNF α protein level induction by SP

SP-induced production of the above inflammatory cytokines by PBMC was measured on PBMC culture supernatants. CBA did not show significant stimulatory effects of SP in these assays neither at 24h nor 48h. There was a trend for IL-8 and IL-6 induction in some individual samples on stimulation with SP 10^{-6} M and 10^{-12} M in a concentration-dependent fashion which was more pronounced at 24 hours than after 48 hours. SP showed additive effects on co-stimulation with LPS on IL-8 and IL-6 production (Fig 3.2), however, statistically these were not significant.

No induction of IL-12 in response to SP was detected. LPS 1 μ g/ml neither in this IL-12 assay showed stimulatory effects on IL-12 production. Interestingly, CP-96345 at concentrations 10^{-4} M or higher showed inhibitory effects on LPS-stimulated and SP and LPS co-stimulated cells

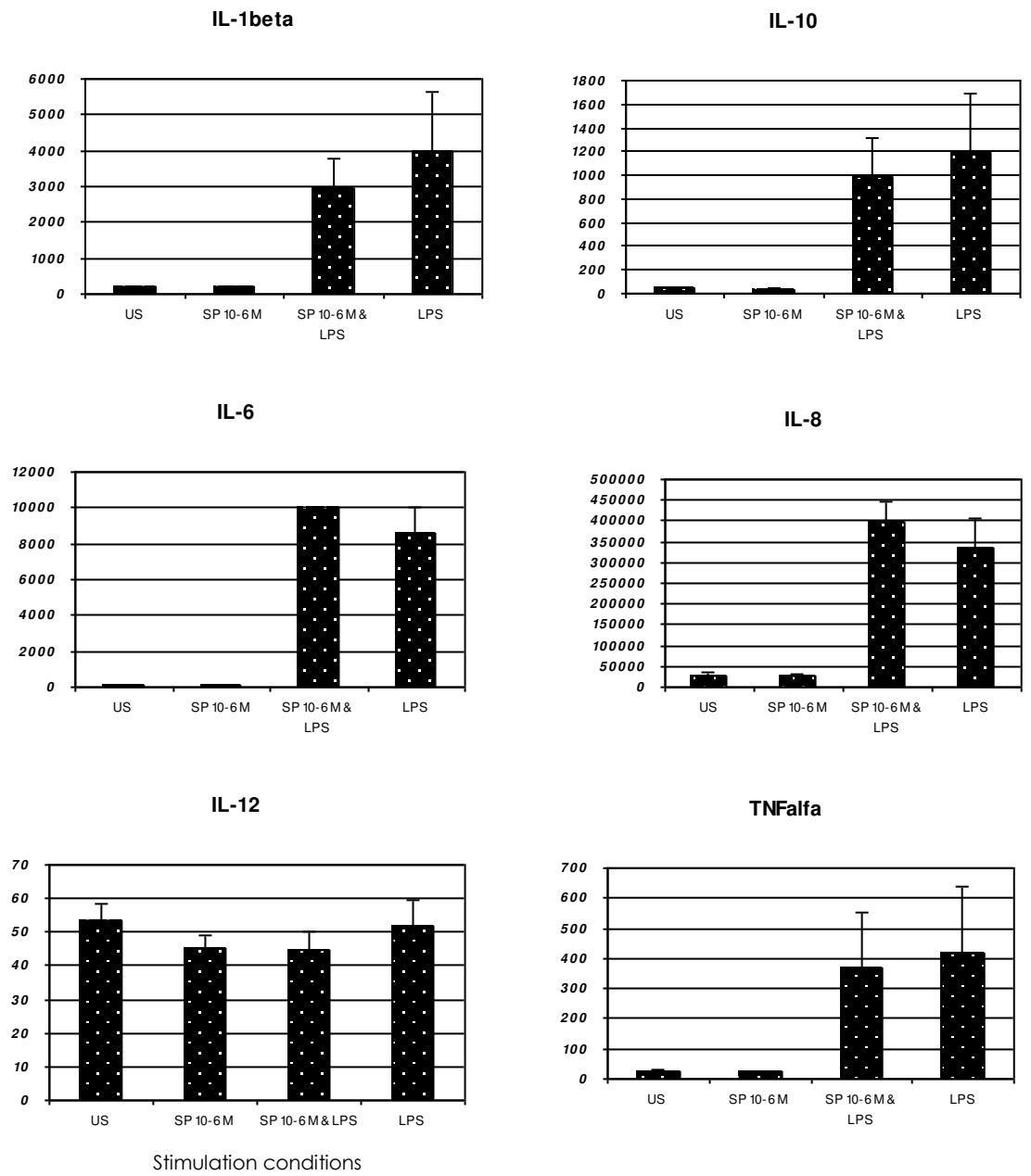

Figure 3.2. CBA-detected inflammatory cytokine concentrations (pg/ml) in cell culture supernatants of PBMC stimulated with SP 10⁻⁶ M and/or LPS 1 µg/ml. Results represent means of 6 experiments from different subjects +/- SEM.

on IL-1 β , TNF- α , IL-6, IL-8 and IL-10 production which will be discussed below (data not shown).

3.3.2 Flow cytometry on PBMC stimulated with LPS and CP-96345/CP-96344

The above described finding with CP-96345 reducing the effect of LPS was further investigated with different concentrations of CP-96345, its inactive isomer CP-96344 and antibodies to NK1R at two different concentrations 1:500 and 1:1000. The effect of CP-96345 was dose-dependent and marked with the highest concentration of 10^{-3} M (Fig 3.3). Similar effects were seen with CP-96344 but not with NK1R antibody. This showed that the effect was not mediated via NK1R binding, however, interaction of SP with CD14/TLR4/MD2 complex, that the results led to hypothesize, could not be ruled out. The cells incubated with CP-96345 for 24 hours at concentrations 10^{-6} , 10^{-5} , 10^{-4} , 10^{-3} M and stained with propidium iodide (of final concentration 0.5 $\mu\text{g/ml}$) showed an increasing population of dead cells on flow cytometry from a concentration 10^{-4} M upwards suggesting toxicity of CP-96345 and CP-96344 at higher concentrations. In the following experiments CP-96345 and CP-96344 concentrations of 10^{-6} M were used.

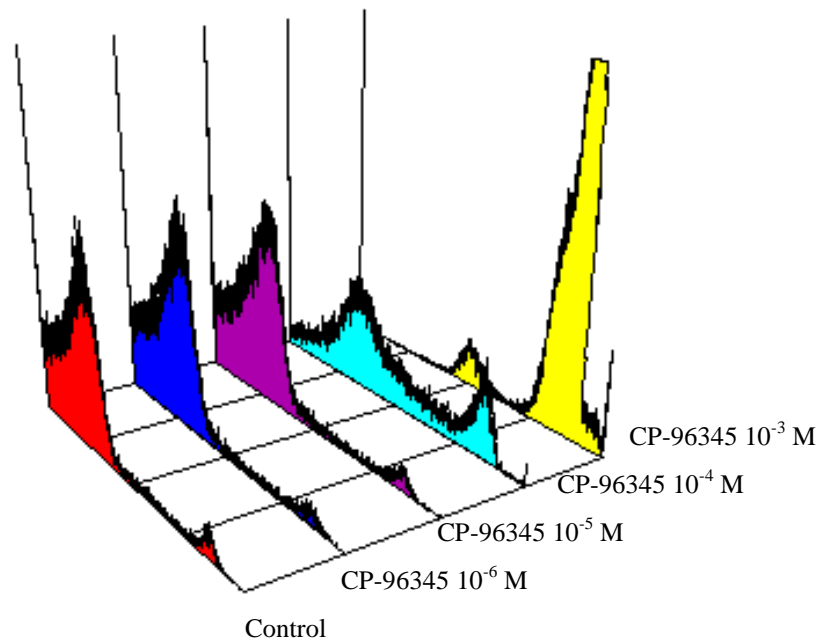
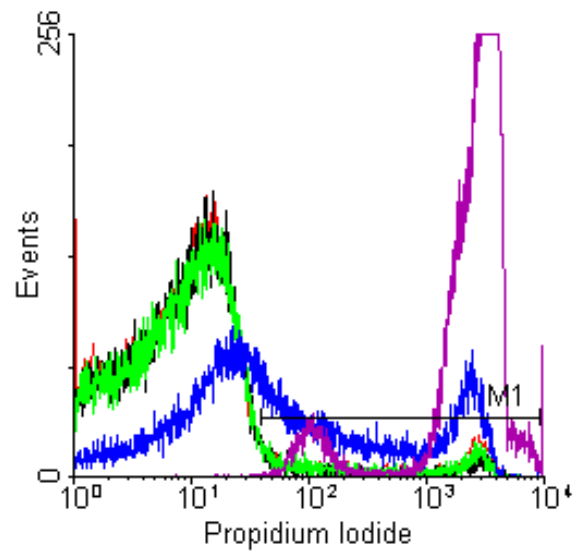

Figure 3.3. Flow cytometry histograms on propidium iodide staining of PBMC after exposure to different concentrations of CP-96345 (10^{-6} M, 10^{-5} M, 10^{-4} M, 10^{-3} M). The results represent a single experiment with cells isolated from one control subject.

3.3.3 ELISA for protein level induction of IL-12 and IL-23 by SP

Three different subunit ELISAs were used to study IL-12 and IL-23 expression in PBMC. IL-12/23p40 ELISA on PBMC culture supernatants showed no significant induction of p40 by SP at 10^{-6} M or 10^{-12} M neither at 24 h nor 48h (Fig 3.4).

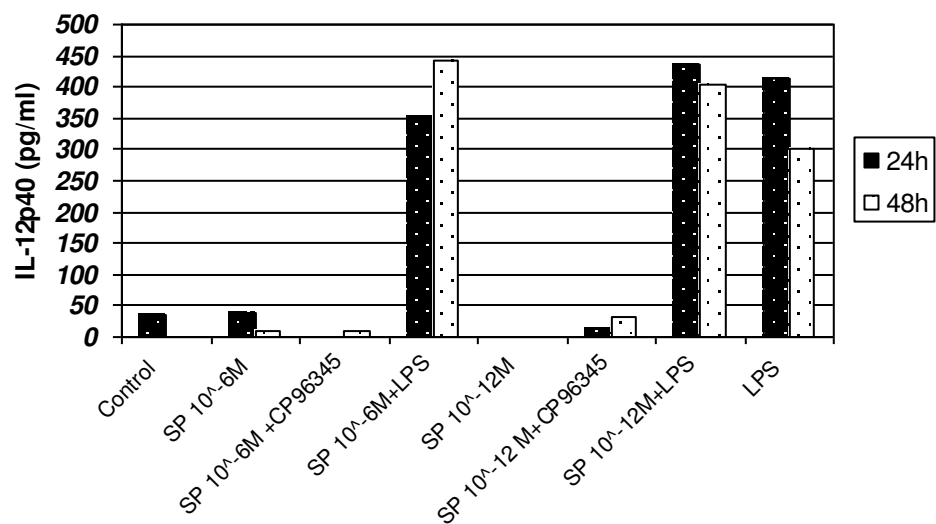

Figure 3.4. A representative example of one IL-12p40 ELISA on tissue culture supernatants of PBMC stimulated with SP with two different concentrations 10^{-6} M and 10^{-12} M for 24h and 48h. Similar results were obtained in 2 additional assays.

Relying on the sensitivity of ELISA compared to other methods we have tested different concentrations of SP including 10^{-6} , 10^{-8} , 10^{-10} , 10^{-12} M using IL-12p40 assay. A small concentration-dependent effect was

Vilisaar, J.

observed with SP 10^{-6} M giving the best response, additionally some dose-dependent additive effects were seen in some sets on co-stimulation with SP and LPS. The experiments were repeated using three different IL-12p40 kits. The only significant results were seen on stimulation with LPS 1 $\mu\text{g/ml}$ and on co-stimulation with LPS 1 $\mu\text{g/ml}$ and SP at 10^{-6} M and 10^{-12} M. The differences between SP 10^{-6} M and 10^{-12} M were not significant, nor was significant the additional effect of SP added to LPS as compared to LPS only.

On IL-12p70 and IL-23p19/p40 assays SP failed to upregulate p70 and p40 both at 24h and 48h (see Fig 3.5 and Fig 3.6). The only positive result was again seen on stimulation with LPS. LPS-induced expression of IL-12p70 was inhibited by both CP-96345 10^{-6} M and CP-96344 10^{-6} M, whereas SP antagonist and pseudo-antagonist had no effect on LPS upregulation of IL-23p19/p40. The effects for IL-23 induction by LPS were clearly more pronounced at 24h compared to 48h, this difference between 24h and 48h was not evident for IL-12.

Pre-stimulation experiments with LPS were additionally tested in which isolated PBMC were pre-stimulated with LPS (1 $\mu\text{g/ml}$) and incubated for 24 h at 37 °C, 5% CO₂ alongside with non-LPS-pretreated cells, and subsequently stimulated with the usual conditions as above. The experiment was repeated twice on PBMC from two different subjects.

Neither IL-12p70 nor IL-23p19/p40 ELISA showed significant differences from LPS pre-treatment.

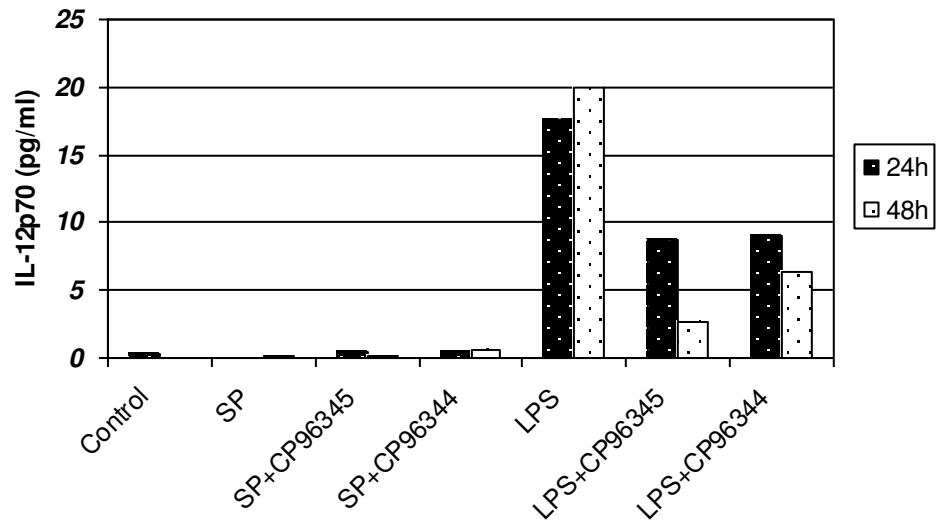

Figure 3.5. IL-12p70 concentrations in PBMC culture supernatants as detected by ELISA comparatively after 24 h and 48 h stimulation.

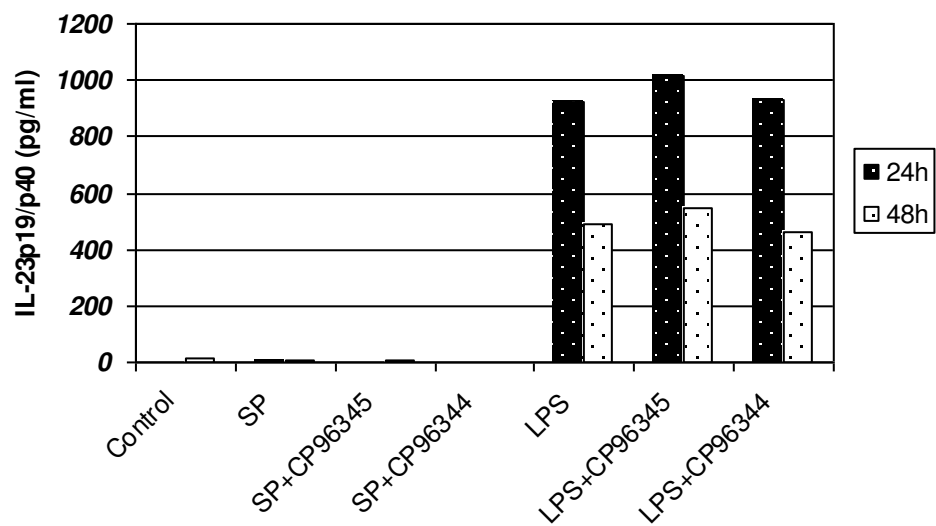

Figure 3.6. ELISA results on IL-23p19/p40 concentrations in PBMC culture supernatants after 24 h and 48 h stimulation.

3.3.4 mRNA-level expression of IL-12 and IL-23 subunits in PBMC on stimulation with SP

These experiments with a 24-hour induction with SP were done on PBMC from 5 healthy volunteers. The expression of the three IL-12 and IL-23 subunits showed a similar response to stimulation with SP and suppression by CP-96345, but not by CP-96344. SP strongly upregulated the expression of the subunits in a similar degree to LPS (Figs 3.7, 3.8, 3.9).

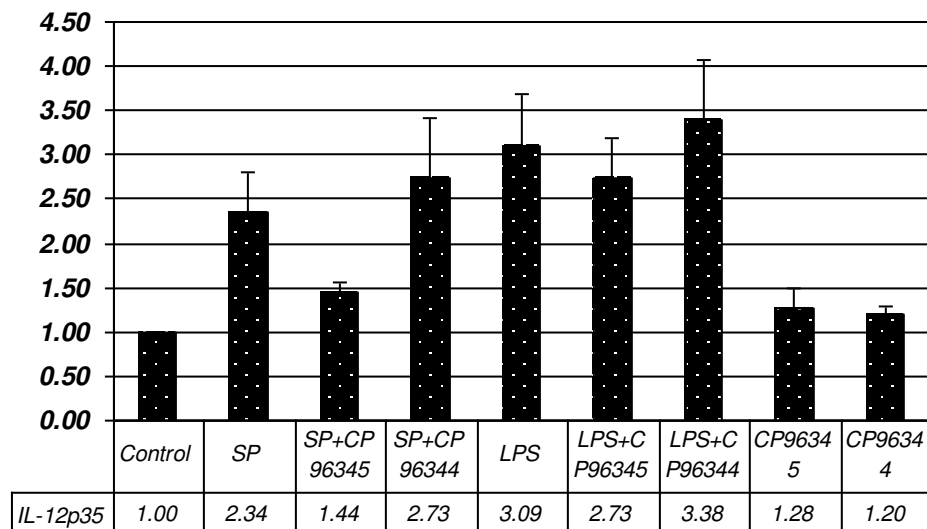

Figure 3.7. IL-12p35 mRNA abundance in PBMCs in response to a 24h incubation with different stimuli. The values represent arbitrary units after normalisation with β 2MG as an internal standard. The results are based on 5 different controls, error bars represent SEM.

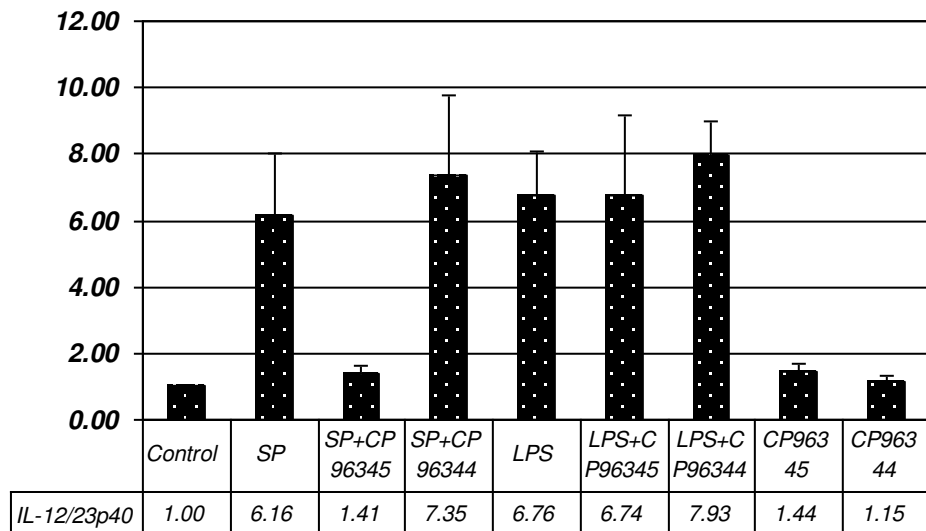

Figure 3.8. IL-12/23p40 mRNA abundance in PBMCs stimulated for 24 h, normalised with β 2MG. The values represent averages of 5 different controls +/- SEM.

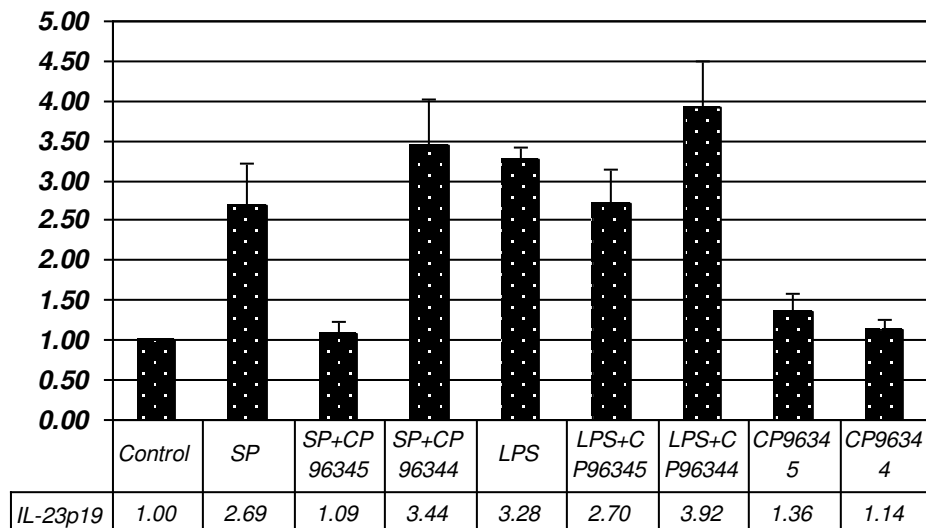

Figure 3.9. IL-23p19 mRNA abundance in PBMCs after 24h stimulation, normalised with β 2MG. Results are presented as averages of 4 different controls +/- SEM.

Vilisaar, J.

The induction of the p40 subunit by SP was the greatest with a 6.2-fold increase ($p=0.043$), followed by p19 and p35 induction with a 2.7-fold ($p=0.068$) and 2.3-fold ($p=0.043$) increase in the level of their expression respectively.

The previously observed phenomenon of CP-96345 and CP-96344 blocking LPS effects were showing a similar trend in these experiments only with CP-96345, particularly in IL-12p35 and IL-23p19 series.

The product homogeneity and size for each of the conditions were confirmed on agarose gel electrophoresis with a product size of 131 bp for IL-12/23p40, 62 bp for IL-12p35, 109 bp for IL-23p19, and 148 bp for β 2MG.

3.4 Discussion

The protein-level expression of the inflammatory cytokines on CBA did not show significant induction by SP. Additionally, IL-12 could not be induced with LPS using IL-12 p70 beads suggesting low sensitivity of the assay. Other cytokine bead assay sensitivities were sufficient as assessed by the positive control stimulus. Our results in CBA set apart trends in induction of IL-6 and IL-8 as a concentration-dependent response to SP. Additionally, additive effects in IL-6 and IL-8 induction were observed on co-stimulation with SP and LPS. This may support the presence of some effect of SP in the assay. Adding CP-96345 at a concentration 10^{-4} M or higher to SP and LPS stimulated samples significantly reduced the

stimulatory effects for IL-1 β , TNF- α , IL-6, IL-8 and IL-10 production. The latter aspect of CP-96345 findings will be further discussed below.

The comparison of previously published studies reveals contradictory results on the above effects of SP. For example, Lotz has shown production of IL-1, TNF- α , IL-6 from human blood monocytes by SP (Lotz et al. 1988) which is contradicted by Derocq not confirming the ability of SP to induce IL-1 β , IL-6, IL-8, TNF- α in human PBMC (Derocq et al. 1996), and Lieb who also failed to demonstrate IL-1 and IL-6 induction in human monocytes (Lieb et al. 1996). Synergistic effects, however, were reported on stimulation with LPS and SP on IL-6 production (Lieb et al. 1996) as were also observed in our experiments. A great variability of IL-1 response to SP in human monocytes has been previously reported (Laurenzi et al. 1990). Wide contradictions in these studies may indicate that preferentially activated cells may respond to SP (Laurenzi et al. 1990). However, the comparison of results in these cases is difficult due to the variety of commercial assays used in the studies.

NK1R specific antagonist CP-96345 was used to study NK1R mediated effects. Previously published CP-96345 concentrations 10^{-3} M (Wang et al. 2004) and 10^{-4} M (Kincy-Cain et al. 1997) have shown clearly toxic dose-dependent effects in our study. Similar effects were seen with its inactive isomer CP-96344 at the same concentrations. Although CP-96345 10^{-5} M appeared not toxic to the cells, caution is needed in drawing conclusions

also at lower concentrations. Based on the above findings we have used CP-96345 and CP-96344 concentrations of 10^{-6} M for further experiments with still some reduction in LPS effects that is not necessarily due to toxicity. This is supported by the fact that CP-96345 at 10^{-6} M was not producing more dead cells than a negative control on propidium iodide staining. Interaction of CP-96345 and CP-96344 with LPS on receptor binding level cannot be excluded. Structural analysis for possible binding interactions is extraneous to the aims of the study and this was not further investigated.

IL-12 and IL-23 protein-level expression was studied further with different ELISAs detecting IL-12 and IL-23 subunits. In these assays both IL-12 and IL-23 concentrations were indeed low despite a strong positive control. On the p40 ELISA neither SP at 10^{-6} M nor 10^{-12} M was effective at 24 h and 48 h. Only LPS and co-stimulation with LPS and SP mounted an induction. Higher concentrations of SP were not included due to these not being physiological. In subsequent IL-12p70 and IL-23p19/p40 assays SP 10^{-6} M failed to upregulate p70 and p19/p40 both at 24 h and 48 h. The positive result was seen only on stimulation with LPS, whereas SP and LPS co-stimulation in these assays was not included. The effect for IL-23 induction by LPS being greater at 24 h than at 48 h is suggestive for IL-23 role earlier than that of IL-12.

Vilisaar, J.

On ELISAs reductions in p40 production were noticeable when adding CP-96345 at concentrations 10^{-6} M to the cultures stimulated with LPS and both SP and LPS. This phenomenon, as explained above, cannot be attributed to CP-96345 toxicity. Both CP-96345 and CP-96344 at 10^{-6} M inhibited the LPS-induced expression of IL-12p70, whereas they had no effect on LPS upregulation of IL-23p19/p40. This may suggest that CP-96345 and CP-96344 interactions with LPS may not necessarily be due to receptor binding as this finding distinguishes p70 and p19/p40 differences at some point downstream of the receptor level. To test additionally the possible role of receptor level interactions pre-stimulation experiments with LPS were included. Here neither IL-12p70 nor IL-23p19/p40 ELISA showed significant differences from LPS non-pre-treated cells hence not fully supporting the idea of CP-96345 interaction with the CD14/TLR4/MD2 complex or LPS itself.

Subsequently, mRNA-level expression of the individual subunits was studied in which clear induction of all subunits was detectable. The highest values were seen with p40 which is consistent with the role of p40 as part of IL-12 and IL-23. The common p40 is also found in free form and known to yield homodimers in the mouse immune system. The mRNA abundance of both IL-12p35 and IL-23p19 was lower but comparable with slightly higher levels of p19. This induction could not be shown on the protein level, nevertheless, the results suggest that the molecular mechanisms for induction of IL-12 and IL-23 by SP are present. This likely involves

Vilisaar, J.

distinct signalling pathways for IL-12 and IL-23, as also described in the literature review (Goodridge et al. 2003). There may be other factors downstream regulating the expression of the subunits on a translational level and in post-translational processing for p35 (Murphy et al. 2000). Alternatively, assay-related problems remain, although less likely, a possibility explaining no or little expression of the subunits on the protein level.

From the literature IL-12 induction by SP has been previously shown in a single mRNA level study on murine macrophages (Kincy-Cain et al. 1997). In the study SP agonist concentrations with which the effects could be elicited were as low as 10^{-9} M. We have used concentrations as high as 10^{-6} M in our series. In the above study both IL-12p40 and IL-12p35 mRNA was potently induced, IL-12p70 expression was not increased. On the protein level at 24h IL-12p40 was induced, however no detectable secretion of p70 occurred (Kincy-Cain et al. 1997). We have not tested p70 in our series. Additive effects of SP on LPS in IL-12 induction were observed as were also seen in our experiments on PBMC. No studies, except this one, have been published showing IL-12 protein-level induction by SP. Moreover, studies on IL-23 induction by SP have not been published and in humans neither IL-12 nor IL-23 induction has been previously shown.

Vilisaar, J.

Monocytes, which are part of the PBMC population, have been recently reported to express NK1R-T (Chernova et al. 2009). The latter may require co-stimulation, such as has been shown for NK1R-T and CCR-5 (Chernova et al. 2009). This crosstalk of receptors is likely needed to elicit signalling events. To better characterize SP effects on various cell types, the receptor isoforms would need determining in cell populations. Additionally, for SP to mount a pro-inflammatory response, the requirement of co-stimulation with other mediators, such as RANTES, need to be elucidated. This aspect may also explain some inconsistencies and poor protein level results as co-signalling may be required for downstream events. It is possible that the expression of different receptor isoforms and the presence of other mediators may dictate the response of SP in a particular inflammatory setting.

With regards to the previously observed peculiar effects of CP-96345 and CP-96344, the LPS stimulation of all subunits showed inhibition on the mRNA-level only with CP-96345. This was done at a concentration 10^{-6} M for both CP-96345 and CP-96344 as our experiments initially suggested. On the contrary, CP-96344 was behaving similarly to SP showing synergistic effects with LPS on the mRNA-level. Additionally CP-96344, when co-stimulated with SP, gave consistent additive effects suggesting agonistic features of CP-96344. Despite strong trends the effects with SP antagonist and pseudo-antagonist did not reach the significance level mainly due to low numbers of the experiments in which the conditions

were additionally added. If these findings are true, however, they show an interesting pattern that may require further studies with larger number of experiments to allow more definite conclusions.

The results represent net cytokine responses on all subpopulations of PBMC. As both IL-12 and IL-23 were induced by SP on the mRNA level it can be concluded that both Th17 and Th1 responses are inducible with slightly more preponderance to Th17 responses. This supports SP effects in pro-inflammatory arm of autoimmune inflammation. As we used a cell culture model comprising many different cell types, several effects can interact and interfere with the net response, constituting the main limitation of the experiments in this chapter. On the mRNA level there are generally less factors influencing the expression of the subunits and the results can be considered more targeted compared to the protein-level expression where also post-transcriptional and post-transcriptional regulation influence the outcome. However, at present it is difficult to stipulate exactly why the responses on the protein-level were low as measured by the cytokine concentrations.

4 IL-12 and IL-23 differential effects on substance P and its receptor expression in human T cells

4.1 Introduction

In the previous chapter we looked at the effects of SP on induction of inflammatory cytokines in PBMC. In this chapter we have studied the opposite regulation - whether SP and its receptor expression is dependent on inflammatory stimuli in T cells as important regulatory and effector units in autoimmune inflammation. We have been focussing on the effects of main Th1 and Th17 cytokines, in particular the effects of IL-12 and IL-23.

T cells play a central role in autoimmune disorders characterized by delayed type hypersensitivity. They display CD3, a number of subclasses are further distinguished, such as CD4+ T helper cells (Th), CD8+ T cytotoxic cells (Tc), CD4+CD25+ T regulatory cells (Tr). Other markers exist that distinguish and characterize groups more specifically. They are subclassified by the secreted cytokine profiles when activated into a particular lineage. Th1, Th2, Th17 represent the main subpopulations of Th cells responsible for different types of immune functions (Bettelli et al. 2007). In our experimental setup we have also employed Jurkat cells that are human lymphoblast-like cell line derived from an acute T-

Vilisaar, J.

lymphoblastic leukaemia (Schneider et al. 1977). Jurkat cells are effectively used for transfection experiments and studying T cell activation.

IL-12 and IL-23 have some overlapping and some distinct functions. Both are capable of inducing proliferation and IFN- γ production by T cells, but whereas IL-12 preferentially acts on naïve T cells, IL-23 is involved in activation and maintenance of memory T cells (Hoeve et al. 2006). Additional distinctions exist such as their autocrine effects on dendritic cells. IL-23 is known to specifically induce the production of IL-17 that is suppressed by IL-12 (Hoeve, Savage et al. 2006). IL-17 has been shown to have important effector activities in autoimmune inflammation, whilst IFN- γ has been recently attributed a modulatory function, limiting Th17 responses (Harrington, Hatton et al. 2005; Park, Li et al. 2005; Nakae, Iwakura et al. 2007).

NF κ B is a transcription factor involved primarily in regulation of cell proliferation and apoptosis, immune and inflammatory functions (expression of cytokines, chemokines and their receptors, inflammatory enzymes, acute phase proteins, adhesion molecules etc). It is a heterodimeric protein complex consisting of subunits p65 and p50 with other variants. NF κ B is found inactive in the cytosol bound to inhibitory proteins I κ Bs. Signalling activates I κ B kinases that degrade I κ B, allowing NF κ B activation (Perkins 2007). Activated NF κ B translocates into the nucleus and binds to DNA targets, such as promoters and enhancers,

Vilisaar, J.

inducing transcription. NFκB is involved in cellular responses to a number of inflammatory and infectious stimuli. Among other pathways, SP signalling via NFκB has been shown (Takahashi et al. 1992; Lieb et al. 1997), additionally, human NK1R promoter region has a functional NFκB binding site (Takahashi et al. 1992; Simeonidis et al. 2003) and NFκB has been shown responsible for mediating NK1R expression (Simeonidis et al. 2003). In this chapter we have used NFκB signalling helping to substantiate the effects of some of the cytokines.

From the literature, SP mRNA induction has been previously reported by IL-12 via STAT4 in murine macrophages (Arsenescu et al. 2005) and NK1R upregulation by IL-12 and IL-18 via NFκB activation in murine T cells (Weinstock et al. 2003). The significance of IL-23/IL-17 axis on SP and NK1R has not been investigated. The above effects have not been studied in humans. Here we are investigating the responses of SP and NK1R to Th1 and Th17 pathways in the human system both on the mRNA and protein level using T blasts, CD4+ cells and CD3 and CD28 costimulated T cells. Additionally, NK1R induction on the promoter level is studied in Jurkat cells.

4.2 Methods

4.2.1 Cell preparations and cultures

PBMC from healthy donors were isolated by standard gradient centrifugation as described above (section 3.2.1). For T cell differentiation, PBMC were cultured for 72 hours with 10 µg/ml phytohemagglutinin (PHA-P, Sigma-Aldrich, UK) in 10% FCS/RPMI media (consisting of 2mM glutamine, 20mM HEPES, 0.1 mg/ml penicillin and streptomycin) at 37 °C, 5% CO₂. Following PHA-induced proliferation and media change cells were stimulated with 1000 U/ml IL-2 (PeproTech EC, UK) at 37 °C 5% CO₂ for 24 h.

CD4⁺ cells were isolated using RosetteSep Human CD4⁺ T cell Enrichment Cocktail following the manufacturer's protocol (StemCell Technologies, Canada).

Jurkat T cell line (kindly donated by Professor David Heery, School of Pharmacy, University of Nottingham) was used for NK1R promoter-reporter assay.

4.2.2 Stimulation of cell cultures

Subsequent stimulations with cytokines were carried out at specified final concentrations. Cultured cells 10⁶/ml/well in 10% FCS/RPMI were stimulated with 10ng/ml IL-12 (R&D Systems, UK) with and without 2.5 µg/ml anti-IFN-γ antibody (PeproTech EC, UK), 10 ng/ml IL-23 (R&D Systems) with and without 2.5 µg/ml anti-IL-17 antibody (PeproTech), 10

Vilisaar, J.

ng/ml IL-17 (PeproTech), 10 ng/ml IFN- γ (PeproTech) for 8 and 24 h for mRNA-level and 24 and 48 h for protein-level expression.

Anti-CD3 and anti-CD28 stimulation of CD4⁺ cells was carried out on 24-well plates that were prepared as follows. Wells of the 24-well plate were precoated with 500 μ l/well of the mixture consisting 0.5 μ g/ml anti-CD3 (Beckman Coulter) and 2.5 μ g/ml anti-CD28 (Beckman Coulter, USA) in PBS, and kept overnight at room temperature. Wells were washed with 1ml RPMI. Subsequently, 10⁶ CD4⁺ cells/ml (isolated as in 4.2.1) were transferred to each precoated well and stimulated with IL-12 10 ng/ml or IL-23 10ng/ml for 24 hours.

4.2.3 Flow cytometry for protein level expression of NK1R in T cell blasts

Stimulated T cell blasts were washed twice with PBA (Phosphate Buffered Albumin, containing 0.5% bovine serum albumin, 0.1% sodium azide in phosphate buffered saline), stained with polyclonal primary NK1R antibody (Abcam, UK) in 1:50 dilution and incubated in the dark at room temperature for 30 mins. Cells were washed twice with PBA and subsequently stained with conjugated antibodies: secondary anti-rabbit IgG-PE (Abcam, UK) 1:50 and CD3-PC7 (Beckman Coulter, USA) in the dark at room temperature for 30 min. Cells were washed twice with PBA, fixed with 0.5 ml of 0.5% formaldehyde and analysed.

For intracellular staining, stimulated and PBA washed PHA/IL-2 induced T cell blasts were incubated in the dark at room temperature with conjugated anti-CD3-PC7 (Beckman Coulter) for 40 min and fixed with 2% formaldehyde for 5 min. Thereafter cells were washed with PBA and treated twice with PBA/saponin (0.4 g/l saponin, 50mM glucose in PBA) and 10% FCS/saponin (10% FCS in PBA/saponin) buffers and stained with primary NK1R antibody 1:50 for 1.5 hours in the dark on ice. Cells were washed with PBA/saponin buffer and subsequently incubated with PE-conjugated secondary NK1R antibody 1:50 for 30 min on ice, washed with PBA/saponin and fixed with 0.5 ml 0.5% formaldehyde. T blasts were evaluated on EPICS Altra flow cytometer (Beckman Coulter, USA) and the results analysed with WinMDI 2.9 software.

4.2.4 ELISA for SP in T cell blasts

Supernatants of T blast cultures stimulated for 12 and 24 h for the above FACS experiments were frozen promptly after collection and stored in -80 °C. On the day of the assay samples were thawed and analysed using the Parameter™ SP ELISA kit (R&D Systems, USA) according to the manufacturer's instructions. Additional serial dilutions were included with the lowest standards diluted down to 9.75 pg/ml. The mean minimum detectable dose of SP as specified by the manufacturer in these assays was

Vilisaar, J.

31.5 pg/ml. Paired stimulation sets for 24 h and 48 h were simultaneously analysed on the same plate.

4.2.5 Total RNA extraction and reverse transcription

Total-RNA was extracted by column extraction using RNeasy Miniprep Kit® (Qiagen) following the kit protocol. The homogenization step was performed by needle homogenization. The total RNA concentration was determined at 260nm using NanoDrop® ND-1000 spectrophotometer (NanoDrop Technologies). For reverse transcription the same amount of total RNA per extraction within the range of 0.3-0.5 µg was incubated with 1 µl of random primers (0.5 µg/µl) in a final volume of 15µl with nuclease-free water (Sigma-Aldrich) at 70 °C for 5 min. The following components with the total volume of 10 µl were added to each tube: 5 µl 5xMMLV reverse transcriptase buffer (Promega), 1.25 µl nucleotides (10 mM dATP, dCTP, dGTP, dUTP), 0.5 µl ribonuclease inhibitor, 1 µl MMLV reverse transcriptase (Promega), 2.25 µl nuclease-free water, and the mixture incubated at 42 °C for 1 h. The resultant cDNA was diluted with 75 µl of nuclease-free water for real time PCR and storage.

4.2.6 Quantitation of TAC1 and NK1R mRNA transcripts

Quantitative real-time PCR was used to assess TAC1 and NK1R mRNA abundance. For real-time PCR reaction 12.5 µl SYBR Green Mastermix (Stratagene), 6 µl nuclease-free water, 0.75 µl forward and 0.75 µl reverse

Vilisaar, J.

primers (10 pmol/ μ l) were mixed with 5 μ l target cDNA/water per tube. The reaction was carried out in triplicates on multiplex qPCR system Mx4000 (Stratagene) with the following conditions: 10 minutes at 95°C, followed by 40 cycles of alternating 95°C for 15 seconds and 57-60°C (depending on T_m of primers) for 1 minute. Dissociation curves were included for each reaction. For primer design Primer 3 software was used. The following oligonucleotides were designed for NK1R: sense 5'gaatgaggacagtgcgaac3', antisense 5'tgtggaactgcagtagaac3'; for TAC1: sense 5'tcaatgggcaatgacagga3', antisense 5'tccgcagtagctgacacaac3' (primer orders from MWG Biotech, Germany). For internal standardization with β 2-microglobulin the primers were designed as follows: sense 5'ctccgtggccttagctgtg3', antisense 5'ttggagtacgctggatagcct3'. For TAC1 reaction the concentration of primers 2 pmol/ μ l and 1:5 template dilutions were used for optimal efficiency. For quantitation of transcripts the relative standard curve method (AppliedBiosystems 1997) was used.

4.2.7 Cloning of the NK1R promoter-luciferase expression vector

The vector for the NK1R promoter activation assay was prepared by transforming E coli DH5 α -T1 competent cells (Invitrogen) with human NK1R gene promoter 1,837-bp fragment cloned into luciferase expression vector pGL3-Basic (Promega, Fig 4.1) (Simeonidis et al. 2003).

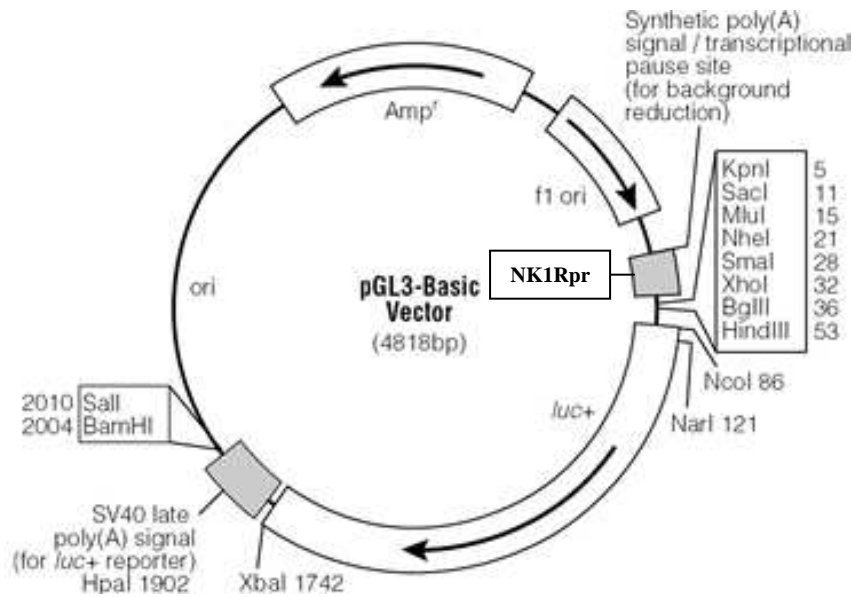

Figure 4.1. pGL3-Basic Vector Circle Map. Description: *luc+*, cDNA encoding modified firefly luciferase; Amp^r, gene conferring ampicillin resistance in *E. coli*; f1 ori, origin of replication derived from filamentous phage; ori, origin of replication in *E. coli*; NK1Rpr, 1837 bp NK1R promoter region. Arrows within *luc+* and Amp^r gene indicate the direction of transcription; the arrow in the f1 ori indicates the direction of ssDNA strand synthesis (adapted from Promega Product Catalogue, Promega Corporation, USA).

1 µg of the construct (generously provided by C Pothoulakis, Beth Israel Deaconess Medical Center, Boston, USA) was propagated into 100 µl of *E. coli* cells with a 2-min 42°C heatshock. The cells were grown on an Ampicillin (1µg/ml) selective agar plate overnight at 37 °C. A single colony was isolated and cultured in 2ml of LB media in a shaking incubator at 37 °C for 8 h and thereafter transferred into 200ml LB media

Vilisaar, J.

with Ampicillin (1µg/ml) and left shaking overnight. The suspension was centrifuged and DNA extracted using Genelute HP Plasmid Maxiprep kit as specified by the manufacturer (Sigma-Aldrich). The concentration of plasmid DNA was measured by NanoDrop® ND-1000 spectrophotometer. To confirm transformation, restriction digest by endonucleases Kpn1 (Roche) and BglII (Roche) were used. The promoter construct was incubated with 1 U of enzyme per 1µg DNA in 25µl corresponding buffer system (Roche) for 1 h at 37°C. On gel electrophoresis two fragments sized approximately 1.8 Kb and 4.8 Kb (corresponding to the NK1R promoter region and the pGL3-Basic vector respectively) were separated in the digested extract as compared to the 6.6 Kb undigested control.

4.2.8 Transfection of Jurkat cells with NK1R promoter-reporter construct and luciferase reporter assay

For incorporation of the vector into Jurkat cells, 2×10^7 cells/400µl ice-cold PBS were transferred into each electroporation cuvette (Invitrogen) and kept on ice for 10 mins. Subsequently 3 µg prepared NK1R promoter-reporter plasmid (containing Photinus pyralis luciferase) and 0.3 µg Renilla reniformis luciferase reporter vector (Promega) as an incorporation control were added per cuvette and pulsed on Gene Pulser X cell™ (Biorad) with 250 V and 950 µF. After electroporation cells were kept in 10% FCS/RPMI overnight at 37°C, 5% CO₂.

Vilisaar, J.

Following stimulation of transfected cells with cytokines as above for 24 h, cells were washed with PBS and transferred into Röhren tubes (Sarstedt). Cells were passively lysed according to the Dual-Luciferase Reporter Assay protocol (Promega) whilst kept on a shaker for 15 min. The luciferase activities of each lysate were sequentially read on TD-20/20 single-sample luminometer (Turner Designs) by adding initiation/stop reagents (Promega) per protocol. Background luminescence of non-transfected control was subtracted from individual sample values and ratios of Photinus/Renilla luciferase signals were calculated.

4.2.9 Statistical analysis

For statistical analysis Friedman and Wilcoxon tests, and SPSS 16.0 software were used.

4.3 Results

4.3.1 Protein level induction of NK1R in T cell blasts

NK1R expression on a protein level was studied by flow cytometry using surface staining of stimulated PHA/IL-2 blasts; intracellular staining for NK1R was tested but in our experiments there was little differential staining between samples.

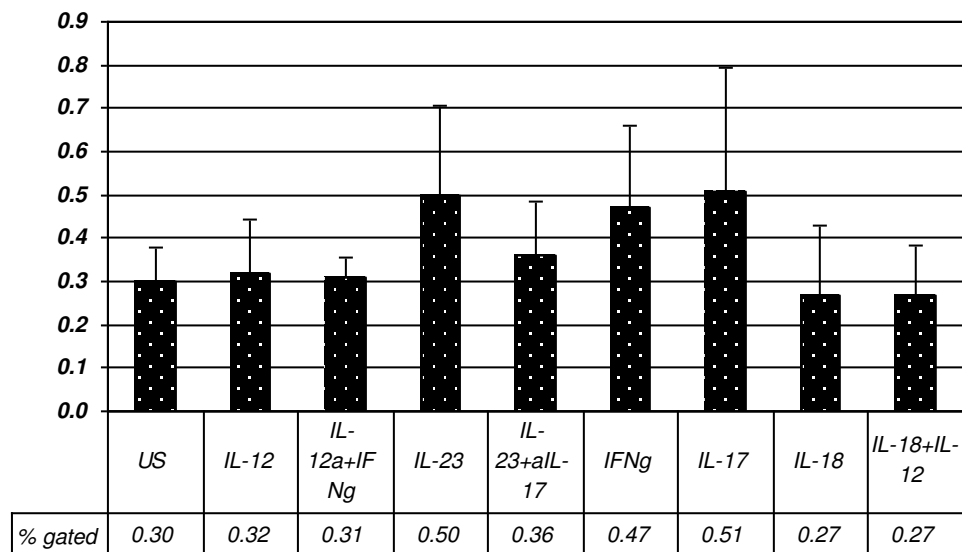

Figure 4.2. NK1R surface expression of T cell blasts: mean percentage of T blasts surface staining for NK1R from three healthy subjects after 48 h stimulation +/- SEM.

The results showed that IL-23 is a relatively strong stimulus with a slightly greater effect at 24h than at 48 h. IL-12 effects appeared to be marginally stronger after 48 h compared to 24 h. IL-17 proved to be a more effective stimulus after 48 h compared to 24 h. IFN- γ was a moderately strong inducer throughout but is not considerable in mediating IL-12 effects. None of the results yielded a statistically significant value.

Regarding the Th1 pathway effects, the combination of IL-12 10 ng/ml and IL-18 10 ng/ml was additionally used in this experiment. Overall, IL-18 and IL-18/ IL-12 co-stimulation did not show any significant effects.

4.3.2 Protein level induction of SP in T cell blasts

Two separate ELISAs were run on supernatants of stimulated T blasts from 5 control subjects. Both ELISAs were from R&D with the same sensitivity. Protein level SP expression showed a great deal of variability between subjects.

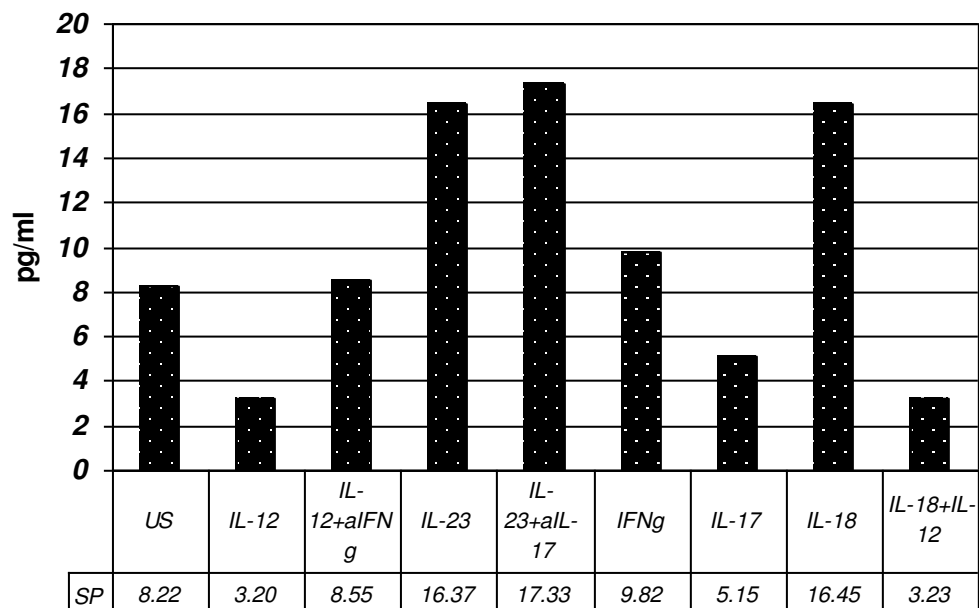

Figure 4.3. A representative example of SP ELISA on one control subject: SP concentrations (pg/ml) in T blast culture supernatants following a 24 h stimulation.

Overall, IL-23 was a relatively weak stimulus and appeared no more potent than IL-12, compared both at 24 h and 48 h. Anti-IL-17 did not show blocking effects of IL-23 in these experiments as has also been observed on the same individual sets in our flow cytometry data for NK1R.

IL-18 appeared a stronger stimulus than IL-12 in these experiments, whereas IL-18 and IL-12 co-stimulation did not show any additive effects. The samples had generally low levels of SP, extrapolation below the sensitivity threshold was avoided. None of the stimulation conditions in the experiments gave a statistically significant result.

4.3.3 Induction of SP and NK1R mRNA in T cells

The effects of Th1 and Th17 stimuli on SP precursor and NK1R expression on the mRNA level were studied in T cell blasts from 10 healthy volunteers. IL-23 significantly upregulated both NK1R ($p=0.041$) and TAC1 transcripts ($p=0.022$).

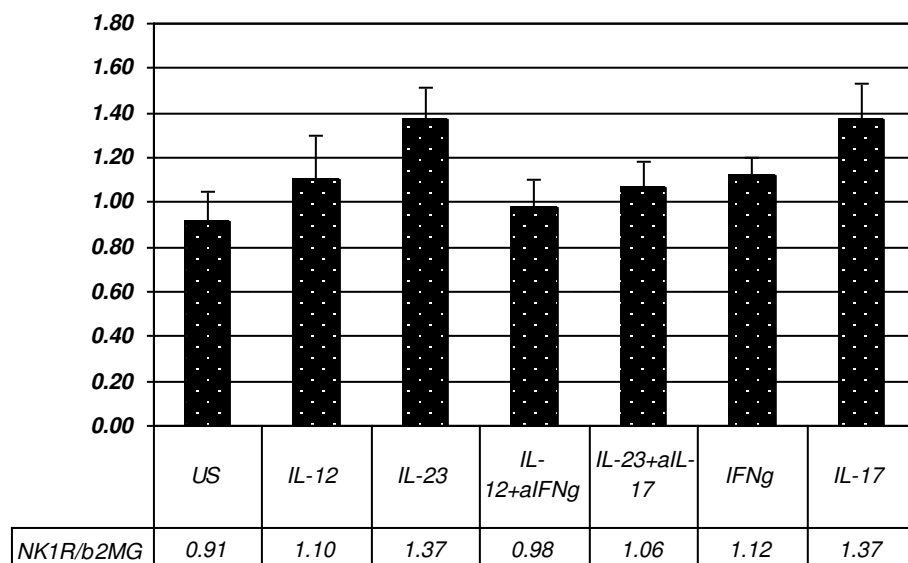

Figure 4.4. mRNA-level expression of NK1R relative to the internal standard β 2MG in T blasts: mean ratios of stimulation assays from 10 healthy controls +/- SEM.

There was a trend with IL-12 upregulating TAC1 and NK1R but this did not reach the significance level (Figs 4.4, 4.5). NK1R ($p=0.037$) but not TAC1 ($p=0.203$) expression was significantly upregulated also by IL-17. Interestingly, anti-IL-17 abolished the effects of IL-23 in our assays to induce TAC1 ($p=0.041$), whereas this effect was not significant with NK1R ($p=0.262$) (Fig. 4.5).

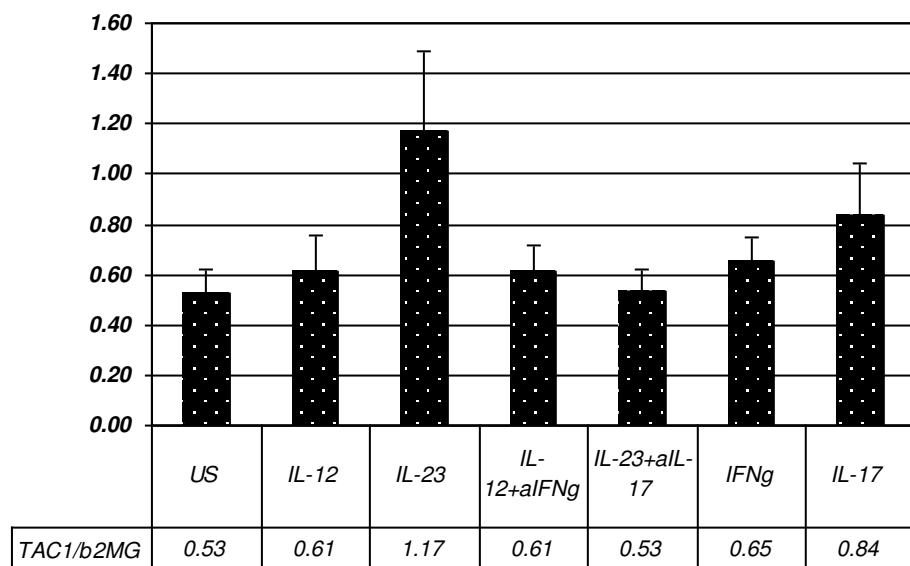

Figure 4.5. mRNA-level expression of TAC1 relative to the internal standard β 2MG in T blasts from 10 healthy controls: mean ratios of 10 stimulation assays +/- SEM.

On the other hand, anti-IFN- γ did not show significant blocking effects in IL-12 stimulated samples. There was a trend for IFN- γ to upregulate TAC1 and NK1R but these effects were not significant.

Vilisaar, J.

In CD4⁺ cells and anti-CD3/anti-CD28 activated cells stimulation with IL-12 and IL-23 showed similar results upregulating NK1R and SP precursor on the mRNA level.

The above effects were studied over different stimulation periods as it has been suggested that IL-12 and IL-23 responses may prevail at different stages of inflammation (Thakker et al. 2007). Stimulation for 8 and 24 h was used as possible induction of secondary cytokines to IL-12 and IL-23 stimuli may take time to initiate, however, no differences were found in T blasts between 8 h and 24 h. The results from a 4 hour-stimulation as used by Weinstock et al (Weinstock et al. 2003) and Arsenescu et al (Arsenescu et al. 2005) were also not significantly different from the effects at 8 and 24 h. However, in CD4⁺ cells a marginally greater tendency for NK1R induction by IL-12 was seen at 24 h compared to 8 h (Fig. 4.6), and in SP induction by IL-23 at 8 h as opposed to 24 h (Fig. 4.7). NK1R induction by IL-23 in CD4⁺ cells was significant ($p= 0.043$), whereas induction by IL-12 was not, despite a strong trend ($p=0.063$). TAC1 did not show a significant induction neither by IL-23 or IL-12 using non-parametric tests.

With regards to multiple splice variants of TAC1 that have caused difficulties in designing primers and optimising reaction conditions, we have designed primers inside TAC1 exon 7 (present in all splice variants) for the reported results. Real-time PCR dissociation curves were routinely

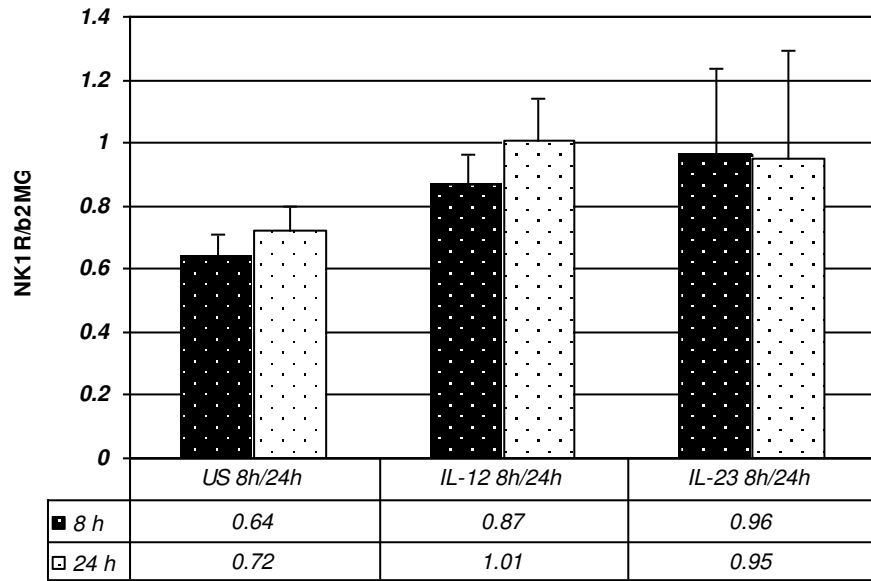

Figure 4.6. Mean ratios of NK1R/b2MG mRNA-level expression in CD4+ cells at 8h and 24 h: mean ratios of 4 controls +/- SEM.

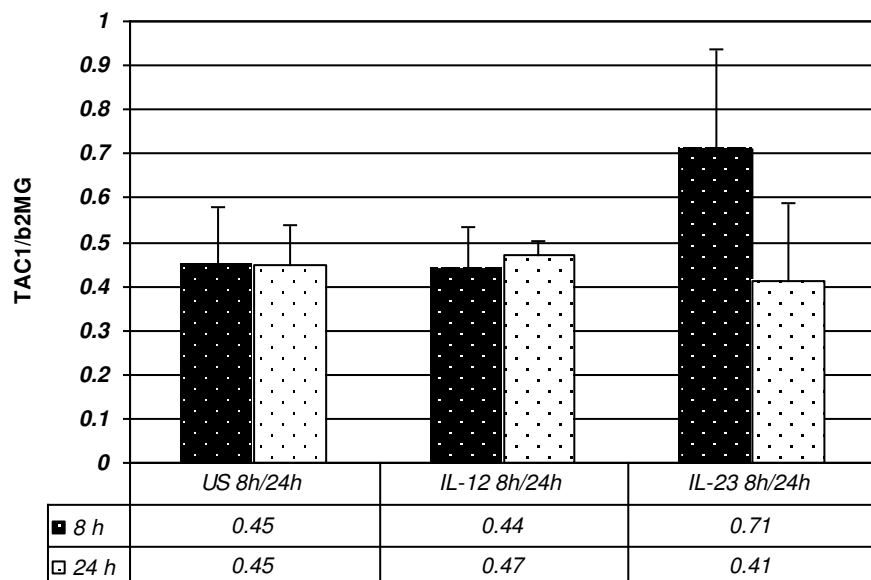

Figure 4.7. Mean ratios of TAC1/b2MG mRNA-level expression +/-SEM of 4 CD4+ cell stimulation assays for 8 h and 24 h.

included for each reaction to detect genomic DNA amplification. On agarose gel electrophoresis homogenous product with the expected size 288bp was detected and the no reverse transcriptase control did not yield a band suggesting there was no genomic DNA contamination.

4.3.4 NK1R promoter construct activation in Jurkat cells

Two experiments were carried out in which IL-23 appears to be an inducer of the NK1R promoter region with a 6-fold increase in the reporter signal ratio compared to the unstimulated cells. In both of these experiments anti-IL-17 in IL-23 stimulated samples showed strong reduction of NK1R expression compared to the IL-23 stimulus alone (Fig. 4.8).

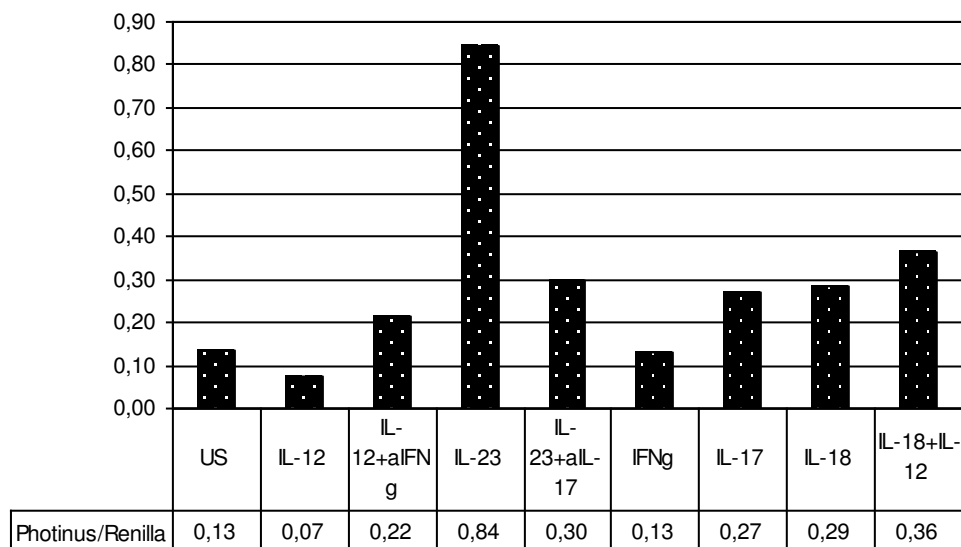

Figure 4.8. Dual-luciferase reporter assay with activation of NK1R promoter-reporter construct in Jurkat cells. The results represent mean ratios of Photinus/Renilla luminescence of two experiments after 24 h stimulation.

IL-12 and IFN- γ showed no activation in these assays. IL-17, IL-18 and the combination of IL-12 and IL-18 showed moderate effects with 2.1, 2.3 and 2.8-fold increase from the baseline respectively.

As a general comment to the results in this chapter, overall a great deal of variability was observed in induction of SP and its receptor. The results show marked interindividual variability of SP and NK1R response to inflammatory stimuli. There appear to be different responses to IL-12 and IL-23 between individuals, more marked with IL-12.

4.4 Discussion

IL-23 upregulates both NK1R and SP mRNA and appears to be a much stronger stimulus than IL-12 in human T cells. Whereas IL-12 can act on both naïve and activated cells, mainly activated cells are considered responsive to IL-23 (Parham et al. 2002). Our results can be interpreted in the view of this preference to IL-23/IL-17 axis in activated cells, however, this hypothesis was tested in a population of CD4⁺ cells with similar tendencies (please see below). IL-17 stimulus was significant for NK1R but not for SP induction and this effect was also seen on the protein level with positive induction of NK1R showing a stronger effect at 48 h. Regarding SP response to IL-17, IL-2 used to provide growth and survival for T blasts has been found to abolish IL-17 production and induce IFN- γ

production (Veldhoen et al. 2006). Despite a strong trend, IFN- γ induction did not reach the significance level either for NK1R or SP. The results showed high unstimulated baseline values which can decrease sensitivity and may, however, indicate some dependence of this induction on the level of T cell activation.

The above effects studied in CD4⁺ population and in anti-CD3/anti-CD28 activated cells showed no significant differences compared to T blasts, apart from some reduction in TAC1 response to IL-23 after 48 h. A relatively smaller proportion of CD4⁺ cells in the IL-12 stimulated cultures were probably driven towards Th1 phenotype compared to IL-23 stimulated samples where Th17 responses initially were prevalent. Stimulation with CD3 and CD28 was additionally used as TCR/CD3 complex and CD28 costimulation has been reported to be optimal for NF κ B activation leading to activation of T cells and transcription of different inflammatory mediators (Bettelli et al. 2007). However, costimulation by CD28 itself has been shown to have only mild enhancing effect on IL-23/IL-17 axis (Liu et al. 2005).

Hence, the level of cell activation is not a fully convincing explanation for our results with relatively poor Th1 pathway effects. Another possible explanation may transpire from our results with CD4⁺ cells and NK1R surface staining. As seen in 48 h NK1R protein-level induction, IL-12 may have a slightly greater effect at 48 h and IL-23 may be more important in

the initial response as has been also described previously. However, the combination of IL-12 and IL-18 used in the protein level experiments did not show any increased or additive effects in our assays at any time-point as has previously been reported (Weinstock et al. 2003). Nevertheless, with regards to the Th1 pathway with IFN- γ showing some induction in NK1R flow cytometry results may still indicate a positive feedback mechanism in which SP stimulates IFN- γ (Blum et al. 1993) and IFN- γ in turn upregulates SP receptor in T cells.

In protein-level experiments SP did not show consistent induction by the used cytokines. The blocking effects in IL-23 and IL-12 stimulated samples by anti-IL-17 and anti-IFN- γ respectively were not clearly evident. As anti-IFN- γ abolishes IFN- γ anti-proliferative effects, the increased values seen in IL-12 and anti-IFN- γ co-stimulated samples may result from increased cell numbers in these wells. IL-18 showed induction only in SP ELISA. However, in the rest of the conditions SP and NK1R expression agree with each other suggesting that both SP and its receptor are simultaneously upregulated. This was confirmed by analysing the same sets both for NK1R surface staining and for SP production on ELISA. However, it is not worth attributing too much reliability on detected SP concentrations in cell culture supernatants as SP is quickly inactivated in aqueous solutions near a physiological pH. Low actual concentrations of SP are also not surprising as T cells are not a major source of SP. The

discrepancies between the protein and mRNA level induction will be discussed below.

Particularly in mRNA-level experiments unstimulated samples showed relatively high baseline values and a great deal of variability was observed between individual assays from different subjects. Although 10 different assays were compared for mRNA-level expression, high baseline values may be one of the reasons why some of the conditions showing a strong trend, such as IL-12, proved insignificant. To optimise the protocol, starving of cells overnight with RPMI without antigenic stimuli of FCS was tested. This did not show major differences compared to unstarved cells. Higher IL-12 and IL-23 concentrations of 100 ng/ml as opposed to 10 ng/ml also showed no significant differences in results and were suggesting 10 ng/ml as being optimal. With β 2MG as an internal standard similar pattern was observed with uniformly high values in unstimulated samples and throughout the stimulation conditions as expected, however, the variation was less between individual assays. This suggests that the regulation of TAC1 and NK1R transcripts is variable.

Individual variations were found similarly with NK1R and TAC1, however, they were more pronounced with the latter. This is expected as there are more factors involved in TAC1 transcriptional and post-transcriptional regulation providing a source for variation. These factors include also recently uncovered transcriptional silencers repressing TAC1 transcription

in non-neuronal cells (Greco et al. 2007). From the literature, much of this regulation at the transcription level has not yet been elucidated. Within exon 1 in TAC1 promoter region, adjacent to NF κ B site, two RE-1 silencer of transcription (REST) binding sites have been identified (Greco et al. 2007). Additionally RNA-binding proteins and microRNAs (miRNAs) have been shown to regulate SP synthesis (Greco et al. 2007; Murthy et al. 2008). Although TAC1 mRNA is found ubiquitously in human non-neuronal tissues (Pinto et al. 2004), some recent studies suggest the importance of preconditioning non-neuronal cells with inflammatory stimuli for TAC1 expression. Recently, IL-1 α has been shown to induce TAC1 and particularly SP translation in non-neuronal cells (Greco et al. 2007). The above findings can explain the lesser degree of protein-level expression in our experiments compared to the promoter and mRNA-level results as well as contribute to the variability.

Both NK1R and TAC1 promoter regions have NF κ B binding sites that suggests their activation by immune mediators and role in inflammation. The dependence of SP and NK1R expression on Th17 and Th1 stimuli further supports SP role in autoimmune inflammation. Here we are showing that NK1R promoter is activated by IL-23 and, as suggestive by anti-IL-17 blocking effects, also by IL-17. Both IL-23 and IL-17 are known to signal via NF κ B, consistent with our promoter-level findings. Additionally, IL-18 showed similar moderate effects as IL-17 on the promoter level. In the work by Weinstock (Weinstock et al. 2003) and

Vilisaar, J.

Arsenescu (Arsenescu et al. 2005) NK1R expression was induced by IL-12 and IL-18 in murine T cells via NFκB, whereas SP induction in murine macrophages was responsive only to IL-12 via STAT4. In our study, the effects of IL-18 and co-stimulation of IL-12 and IL-18 activating NK1R promoter were nearly 2.5 fold less than the effects by IL-23. IL-12 alone gave no activation of NFκB-containing NK1R promoter whilst known to act via STAT4. SP synthesis has been previously shown to be STAT4 independent (Blum et al. 2008). These findings support SP involvement in the Th17 pathway.

Regarding other published studies, IL-12 has been shown to induce SP which can mediate IFN-γ production potentiating IL-12 effects in murine cells (Blum et al. 1993; Blum et al. 2001). Also due to the described effects above SP has been so far suggested to be part of Th1 pathway. In the recent study IL-12 was shown to induce SP in murine T cells whereas IL-23 induced SP in macrophages (Blum et al. 2008). In our study IL-12 induction of SP nor NK1R was significant in human T cells. As evidence suggests from our experiments, this induction of SP by IL-12 is likely not additionally mediated by IFN-γ. As part of the IL-12 immune regulatory circuit SP has been also shown to induce IFN-γ in antigen-driven T cells in murine schistosomiasis (Blum et al. 1993). In our work the speculative positive feedback effect by IFN-γ inducing SP itself, was not confirmed. Importantly, also in the above-mentioned work by Weinstock (Weinstock et al. 2003) and Arsenescu (Arsenescu et al. 2005) the effects in murine

Vilisaar, J.

cells were dependent on the presence of *Schistosoma mansoni* in the inflammatory model. NK1R upregulation has also been demonstrated by IL-1 β and TNF α via NF κ B in murine macrophages (Simeonidis et al. 2003) which in our study was not investigated. IL-1 β via NF κ B has also been shown to upregulate NK1R in astrocytes (Guo et al. 2004).

On the basis of our similar results in T blasts as well as anti-CD3/anti-CD28 activated cells one can conclude that SP and its receptor in T cells respond to Th17 stimuli and less so to Th1-type signals. Additionally, IL-23 potent activation of NK1R promoter region was shown in Jurkat cells. IL-23 effects as part of the Th17 response may be particularly relevant in the early inflammatory response whereas IL-12 as part of the Th1 cascade may be more important at later stages. IL-23 strong effect is likely a co-effect accomplished via involvement of Th17 population with IL-17 production that additionally mediates IL-23 effects. IL-12 effects in human T cells did not prove to be mediated by IFN- γ . The results support SP and its receptor involvement in IL-23/IL-17 axis responses that have been shown important in the inflammatory model of EAE.

5 Upregulation of substance P and its receptor in human NT2 neurons via functional IL-17 receptor

5.1 Introduction

Human NTera2 (NT2) cells are neuronally differentiated teratocarcinoma-derived cells that are among very few available neuronal cell lines with the terminal phenotype virtually identical to mature primary neurons. NT2 cells are differentiated into post-mitotic neurons (NT2N) involving treatment with retinoic acid (RA) (Andrews 1984). Exposure of NT2 cells to RA over a 6-week period downregulates neuro-epithelial markers and upregulates neuronal markers on them (Pleasure et al. 1992; Pleasure et al. 1993). Further exposure to mitotic inhibitors (MI) produces 99% pure population of terminally differentiated NT2N (Lee 1986). They produce outgrowth processes and form functional synapses, express all three classes of neurofilaments (Lee 1986), microtubule associated proteins type 1 and 2, tau protein, synaptophysin (Pleasure et al. 1992) as features characteristic of CNS neurons. Immunocytochemically terminally differentiated NT2N do not divide and maintain their neuronal phenotype over long time periods (Pleasure et al. 1993).

Evidence exists on SP role in CNS immune regulation and modulation of neuronal functions related to immune activities in the CNS (Li et al. 2003). Multiple cell types in the CNS express NK1R, such as neurons, astrocytes,

microglia, oligodendrocytes which produce cytokines in response to SP (Martin et al. 1993; Gitter et al. 1994; Luber-Narod et al. 1994; Li et al. 2003)(Marriott 2004). Neuroimmune interactions involving SP may be particularly relevant in inflammation-induced neuronal injury as occurs in an acute MS relapse. SP expression in neurons has been shown downregulated in neuronal injury (Hokfelt et al. 1994), at the same time SP receptor binding sites are highly expressed in glia in vivo after neuronal injury (Mantyh et al. 1989). This and SP immunoreactivity found in MS plaques (Kostyk et al. 1989) may suggest possible SP regulation of glial response to injury. Signalling of NK1R has been shown to lead to NF κ B activation in the CNS and upregulation of inflammatory mediators (Lieb et al. 1997; Wang et al. 2004).

The expression of SP and NK1R has been previously confirmed in NT2N (Li et al. 2003). Transcripts for both SP precursor and NK1R mRNA have been shown to be present in NT2N with increase in their expression during NT2 differentiation (Li et al. 2003). On the protein-level, NK1R has been confirmed in NT2N cell membranes, and SP demonstrated intracellularly by immunohistochemical and immunofluorescent staining techniques (Li et al. 2003). Levels of SP expression have been found higher in NT2N compared to human monocytes, peripheral blood lymphocytes and microglia (Li et al. 2003). NK1R functional expression in NT2N has been previously confirmed with SP induction of macrophage inflammatory protein-1 β (MIP-1 β) (Li et al. 2003). SP has been shown to activate NF κ B

promoter in NT2N (Wang et al. 2004), the mechanism that may explain regulation of chemotaxis and a variety of other pro-inflammatory gene functions by SP.

NT2N represent a good model for studying neuronal gene expression in response to inflammatory stimuli, and substantial evidence exists on neurons and NT2N being involved in inflammatory responses. Several inflammatory mediators and their receptors have been demonstrated on NT2N. In addition to MIP-1 β (Li et al. 2003), NT2N are also known to produce MCP-1 and express functional receptors for a range of chemokines including CCR1, CCR2, CCR5, CXCR1, CXCR2, CXCR3, CXCR4 (Hesselgesser et al. 1997; Coughlan et al. 2000; Valerio et al. 2004; Lu et al. 2005). IL-8, MCP-1, RANTES and IP-10 production by NT2N have been reported on hypoxia and subsequent reoxygenation (Froyland et al. 2006). Additionally, IL-1 β has been shown to stimulate MIP-1 α and -1 β production by NT2N (Guo et al. 2003), and IL-1 β and TNF- α have shown effects on GM-CSF production in NT2N (Dame et al. 2002).

IFN- γ , an important Th1 cytokine in MS pathogenesis, has established reception and effects on NT2N. IFN- γ effects have been shown to implement in the CNS via IFN- γ receptor and alpha-amino-3-hydroxy-5-methyl-4-isoxazolepropionic (AMPA) receptor subunit GluR1 complex (Mizuno et al. 2008). Activation of this receptor complex leads to JAK1,2

and STAT1 pathway activation. Previously demonstrated neurotoxic effects of IFN- γ have been shown both mediated via microglial reaction, and directly on neurons. IFN- γ effects on neurons have, however, been reported contradictory, inducing retrograde dendritic retraction, inhibiting synapse formation (Kim et al. 2002) as well as promoting neurite outgrowth and survival of neuronal cells (Barish et al. 1991; Song et al. 2005). In mouse cortical neurons IFN- γ has shown direct induction of neuronal dysfunction with dendritic bead formation and enhancing glutamate neurotoxicity via AMPA receptors (Mizuno et al. 2008). It has been proposed that the direct mechanism of IFN- γ neuronal excitotoxicity could contribute to neuronal dysfunction in inflammatory and neurodegenerative diseases.

Much less is known about Th17 effects on neurons and neuronal response to Th17 in CNS inflammation. IL-17 (IL-17A) as the main effector cytokine in Th17 responses in MS lesions has various effects and target functions. However, no studies have yet shown IL-17 direct effects on neurons, which may have important implications, including inflammatory neurodegeneration. IL-17 binds to both IL-17A receptor (IL-17RA) and IL-17RC that form oligomeric IL-17 receptor (IL-17R) complexes. IL-17R has been shown to consist of at least two IL-17RA subunits and at least one IL-17RC, however, the precise stoichiometry of the receptor complex has not been determined (Shen et al. 2008). IL-17R expression on neurons has not been shown unequivocally. Limited evidence is available to date about

Vilisaar, J.

IL-17R downstream signalling, in which NF κ B is most frequently implicated alongside with MAPK, less so JAK-STAT and other pathways (Shen et al. 2008). The main proportion of IL-17 signal regulated target genes involve different inflammatory mediators, often regulated synergistically with other cytokines (Shen et al. 2008). No reports have been made on IL-17 effects on SP or NK1R expression.

In this chapter we have been studying the regulation of SP and NK1R expression in neurons in response to inflammatory stimuli as an aspect of autoimmune inflammation in the CNS. Considering different expression of SP and NK1R in the CNS compared to peripheral immune cells, as well as co-effects with other mediators, SP immunogenic effects in the CNS may be different. We have previously shown that SP and NK1R are upregulated in human T cells differentially by Th17 and Th1 stimuli. Here we studied some of these effects on NT2N. We measured IL-17 functional effects on SP and its receptor expression in these cells and compared them with the well-established stimulus of IFN- γ . To substantiate IL-17 direct effects we additionally addressed the IL-17R expression on NT2N. We have also studied the effects of SP on neuronal expression of IL-17RA, IL-17 and NK1R. As part of studying SP and NK1R expression in NT2N, we are investigating with this approach also direct neuronal response to IL-17, as a key cytokine in CNS inflammation. TAC1 has also been used previously as a target in studying general questions of neuronal gene expression (Greco et al. 2007).

I would like to acknowledge the work of Ms P Vance and Ms S Cross at the Department of Neurology, University of Pennsylvania, for additional Western Blot and signalling experiments.

5.2 Methods

5.2.1 Preparation of undifferentiated NT2 (NT2U) cultures

Frozen stock of NT2U teratocarcinoma cells were thawed, immediately added to 10 ml of warm DMEM (Dulbecco's Modified Eagle Medium, Invitrogen, USA) with 10% FBS (Fetal Bovine Serum), 1% Penicillin/Streptomycin (P/S) and centrifuged for 7 min at 2000 rpm. Cell pellet was resuspended in 6 ml DMEM with 10% FBS, 1% P/S and incubated in T25 tissue flasks at 37°C, 5% CO₂. When confluent, cells were washed with 5ml Versene (8g NaCl, 0.2g KCl, 1.15g Na₂HPO₄ 0.2 EDTA, 0.1 g Phenol Red), treated with 2 ml of 0.25% Trypsin (Invitrogen, USA) in PBS and incubated in T75 flasks in a total of 18 ml of DMEM with 10% FBS, 1% P/S, and maintained by twice weekly passages.

5.2.2 Differentiation of NT2U into mature post-mitotic neurons

2.7×10^6 NT2U cells were replated into 10 μ M retinoic acid (RA) in a total of 18 ml DMEM with 10% FBS, 1% P/S per T75 flask for a 5-week incubation with twice weekly replating and RA media change. At week 5

cells were replated into mitotic inhibitors (MI, 10 μ M 5-fluoro-2'-deoxyuridine, 10 μ M uridine, 1 μ M cytosine- β -D-arabino furanoside) with weekly MI media change and replating in either of the following two ways:

1. The total number of cells from one T75 flask were incubated in MI media on 6-well tissue culture plates (7 in total) for 4 weeks to reach full maturity. This method is slower, allowing neurons to grow on the bed of existing background cells, but is more consistent in methodology;
2. Alternatively, contents of one T75 flask was cultured in 10 cm Petri dishes (9 in total) in MI media for 6-9 days. Cells were washed twice with HBSS 1x (Hank's Balanced Salt Solution, Mediatech Inc, USA), treated with 2 ml trypsin to break cell adhesions and suspension centrifuged. Cell pellets were triturated 15-20 times through a Pasteur pipette, cells counted and cultured 10^6 cells in 2ml of MI media on 35 mm Matrigel covered dishes for terminal differentiation for 1-2 days. This method is faster yielding a 95-98% pure population of differentiated neurons in a relatively short time using an artificially provided extracellular matrix substrate (Matrigel).

5.2.3 Stimulation of cell cultures

Cells were assessed under confocal microscopy for differentiation, viability and cell density. MI media overlying terminally differentiated

Vilisaar, J.

NT2N neurons on 6 well plates was measured and reduced to 2ml. Cell cultures were stimulated with/without human IL-17 (R&D Systems) 10 ng/ml or 100ng/ml, IFN- γ 10 ng/ml or 100 ng/ml, and SP (Sigma-Aldrich) 10^{-5} or 10^{-6} M and incubated at 37 °C, 5% CO₂ for 24h or 48h. To confirm IL-17R mediated effects negative controls with heat inactivated (95°C for 10 min) IL-17 100 ng/ml and anti-IL-17RA were additionally used.

5.2.4 Total RNA extraction

Media on stimulated cells were removed and cells washed twice with HBSS. Wells were subsequently covered with 200 μ l of Trypsin and the plates tapped to detach neurons (2-3 min) assessing under a confocal microscope. 1 ml of DMEM media was immediately added and cell suspension transferred into eppendorfs. Total-RNA extraction was performed using RNeasy Miniprep Kit® (Qiagen) according to the manufacturer's instructions. Extracted total-RNA amounts were quantified using BioPhotometer 6131 (Eppendorf AG, Germany). Purity was assessed by measuring the 260/280 nm ratio, samples within range 1.0-2.5 range were used.

5.2.5 Reverse transcription

0.5 μ g of total RNA was incubated with 1 μ l of random primers (0.5 μ g/ μ l) in a final volume of 15 μ l with nuclease-free water at 70 °C for 5 min. For reverse transcriptase step 5 μ l 5x MMLV reverse transcriptase buffer

Vilisaar, J.

(Promega), 1.25 µl of nucleotides (10mM dATP, dCTP, dGTP, dUTP), 0.5µl ribonuclease inhibitor (Promega), 1µl MMLV reverse transcriptase (Promega) and 2.25 µl nuclease free water as a mixture was added into each of the microcentrifuge tubes, whilst on ice. The tubes were incubated at 42 °C for 1 h. At this stage cDNA was diluted to 100 µl with nuclease free water for the subsequent real-time PCR step.

5.2.6 Quantitation of IL-17A, IL-17RA, NK1R, PPT mRNA transcripts

Quantitative real-time PCR was used to assess mRNA abundance for the above genes and 18S RNA as a housekeeping gene for internal standardisation. For a real-time PCR reaction 12.5 µl SYBR Green Mastermix (Stratagene), 6 µl nuclease-free water, 0.75 µl forward and 0.75 µl reverse primers (2 pmol/µl) were mixed with 5 µl target cDNA/water per tube. The reaction was carried out in triplicates on multiplex qPCR system Mx4000 (Stratagene) with the following conditions: 10 minutes at 95°C, followed by 40 cycles of alternating 95°C for 15 seconds and 57-68°C (depending on T_m of primers) for 1 minute. The following primers were used: NK1R sense 5'gaatgaggacagtgcgaac3', antisense 5'tgtggaactgcagtagaac3'; TAC1 sense 5'tcaatgggcaatgacagga3', antisense 5'tccgcagtagctgacacaac3'; IL-17RA sense 5'caccgtggagaccctggaggc3', antisense 5'gtctgggcgaggtatgtgg3'; IL-17A sense 5'gcacaaactcatcatccc3', antisense 5'gtgattcctgccttactatg3'; 18S RNA sense 5'cggtaccacatccaaggaa3', antisense 5'gctggaattaccgcgct3'.

Vilisaar, J.

For quantitation of transcripts the relative standard curve method was used. For optimal efficiency of the reaction template dilutions 1:5 were used. Dissociation profiles were included for each reaction to assess product homogeneity. Product sizes were confirmed on agarose gel electrophoresis.

5.2.7 Agarose gel electrophoresis

2.0% agarose gel was prepared with ethidium bromide and samples run at 100V for 50 min alongside with 100 bp DNA Ladder (Promega, USA) to determine product size.

5.2.8 Western blotting

Differentiated NT2 cells were washed twice and lysed with 1x RIPA buffer (50mM Tris-HCl pH 7.4, 150mM NaCl, 1% NP40, 0.25% Na-deoxycholate, 1mM PMSF, 1x Roche complete protease inhibitor cocktail, 1x Pierce phosphatase inhibitor cocktail), lysate was collected and transferred into eppendorfs. Protein was quantified with Lowry assay (Bio-Rad Protein Quantification Assay, Bio-Rad, USA) and read at 750 nm on Microplate reader 680 (Bio-Rad). Standard curve (BSA standards in range 0.25- 2.0 mg/ml) was plotted and total protein concentration determined. After denaturing the lysates for 10 min at 95°C, 10 µg of total protein was run on 7% acrylamide gel in TGS buffer with Prestained SDS-PAGE standards (BioRad). Macrophage and CD4+ cell lysates as positive controls and NT2U lysates for comparison were treated and run accordingly. Following electrophoresis the gel was transferred onto PVDF

Vilisaar, J.

membrane (Bio-Rad) and run overnight at 30-35 V, at 4 °C. The membrane was washed, incubated with 5% Blotting Grade Blocker Non-Fat Dry Milk (Bio-Rad) in PBS-Tween for 1h and incubated with 1 µg/ml primary mouse antibody (monoclonal) to human IL-17RA (FabGennix Inc, USA) in PBS-Tween-5% powdered milk overnight rocking at 4°C. The membrane was washed and stained with a secondary goat anti-mouse HRP conjugated antibody (Thermo Scientific, USA) 10ng/ml in PBS-Tween-5% powdered milk rocking for 1h at room temperature. The membrane was washed 5x10 mins and treated for 2 min with chemoluminescent SuperSignal® West Dura Substrate (ThermoScientific, USA) according to the manufacturer's instructions. The membranes were exposed for 1-60 sec in the dark and developed.

5.2.9 Subcellular fractionations of NT2 cells

For whole-cell lysate collection, cells were rinsed twice with ice-cold PBS, lysed in 75 mM Tris-HCl (pH 6.8), 15% glycerol, 3.75 mM EDTA, and 3% SDS, and supplemented with Complete Protease Inhibitor Cocktail (Roche Applied Science, USA) and PhosSTOP phosphatase inhibitor mixture (Roche).

To assess for nuclear translocation of NFκB proteins, differentiated cells were treated with DMF for 24 h, exposed to TNF-α (1 ng/ml) for 10 min, and fractionated. To prepare nuclear extracts, cells were rinsed twice in ice-cold PBS and lysed on ice for 10min in 10mM HEPES (pH 7.9), 10

Vilisaar, J.

mM KCl, 10 mM EDTA, 1 mM DTT, and 0.4% Nonidet P-40 supplemented with protease and phosphatase inhibitors. Nuclei were pelleted for 3 min at $16000 \times g$ and the supernatant (cytoplasmic fraction) was collected and stored at $-20\text{ }^{\circ}\text{C}$. The nuclear pellet was resuspended in 20 mM HEPES (pH 7.9), 400 mM NaCl, 1 mM EDTA, 10% glycerol, 1 mM DTT and protease and phosphatase inhibitors and incubated at $4\text{ }^{\circ}\text{C}$ on a rocking platform at 200 rpm for 2 h. After centrifugation at $16000 \times g$ for 5 min, supernatants (nuclear fractions) were collected and stored at $-20\text{ }^{\circ}\text{C}$. Protein concentrations were determined and cell lysates were subjected to SDS-PAGE as above (Cross et al. 2011).

5.3 Results

5.3.1 IL-17R mRNA level expression in neurons

The mRNA level expression of IL-17RA gene was confirmed in response to various stimuli, including IL-17, IFN- γ and SP. IL-17RA appears to be relatively equally upregulated by IL-17 and IFN- γ . The strongest signal according to the real-time PCR results, as also evidenced on gel electrophoresis, was seen with IL-17 (Fig 5.1). IL-17 at 10 ng/ml gave a 2.3-fold increase as compared to a 1.9-fold increase with IFN- γ 10 ng/ml. IL-17 10 ng/ml appeared more effective than 100 ng/ml and the effects of IL-17 were greater at 24h than at 48h. The product homogeneity and size was confirmed on gel electrophoresis as shown in Fig 5.1.

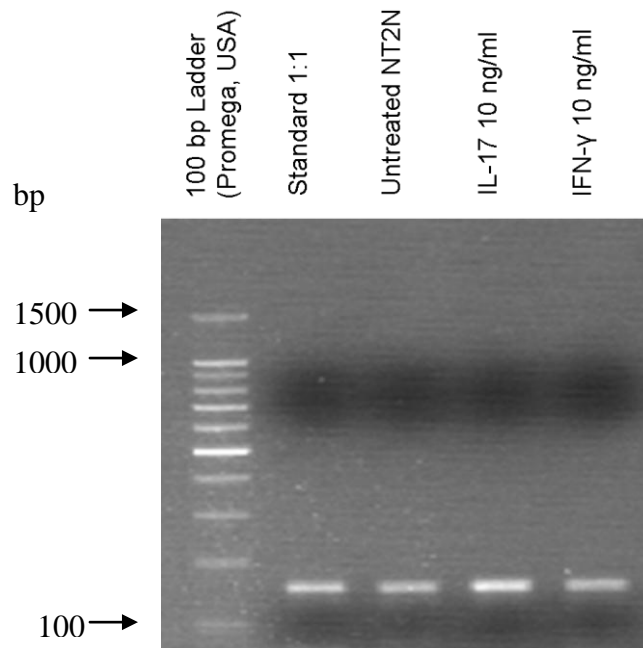

Figure 5.1. Gel electrophoresis confirming homogeneous real-time PCR product corresponding to 149 bp IL-17RA amplicon from NT2N under different stimulation conditions. Arrows indicate steps of 100 bp DNA ladder (Promega, USA).

SP showed a dose dependent effect on IL-17RA expression with $SP10^{-5}$ M giving a 2.3-fold increase from the baseline (Fig 5.2), whereas $SP10^{-6}$ M showed a downregulating effect on IL-17RA mRNA abundance. Due to wide baseline variations the results are presented as separate experiments. Similar results were obtained in 3 additional experiments.

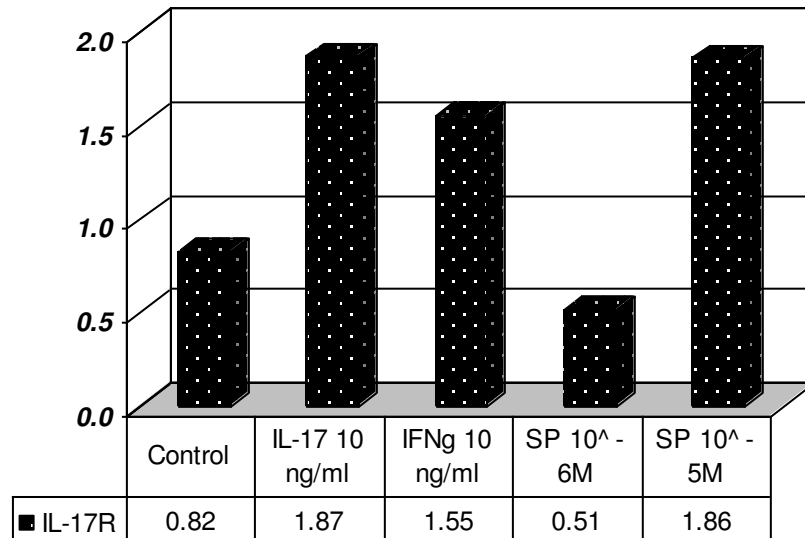

Figure 5.2. Representative experiment showing IL-17RA mRNA abundance standardised with 18S RNA (arbitrary units) in response to different stimuli in a 24h stimulation experiment of NT2N. Similar results were shown in 3 additional experiments.

5.3.2 Upregulation of neuronal SP and NK1R by IL-17 and IFN- γ

As an initial control experiment to confirm the specificity of the IL-17RA binding, heat-inactivated IL-17 100 ng/ml and monoclonal anti-IL-17RA (R&D Systems) 2 μ g/ml together with IL-17 100 ng/ml in a 24h-stimulation were tested as negative controls (Fig 5.3).

IL-17 in this experiment clearly upregulated mRNA level expression 2.4-fold for NK1R, 1.5-fold for TAC1, and 2.8-fold for IL-17RA, whereas heat-inactivated IL-17 effects were comparable with the baseline values. IL-17 strongly upregulated its own expression in these cells giving a 5.4-fold increase.

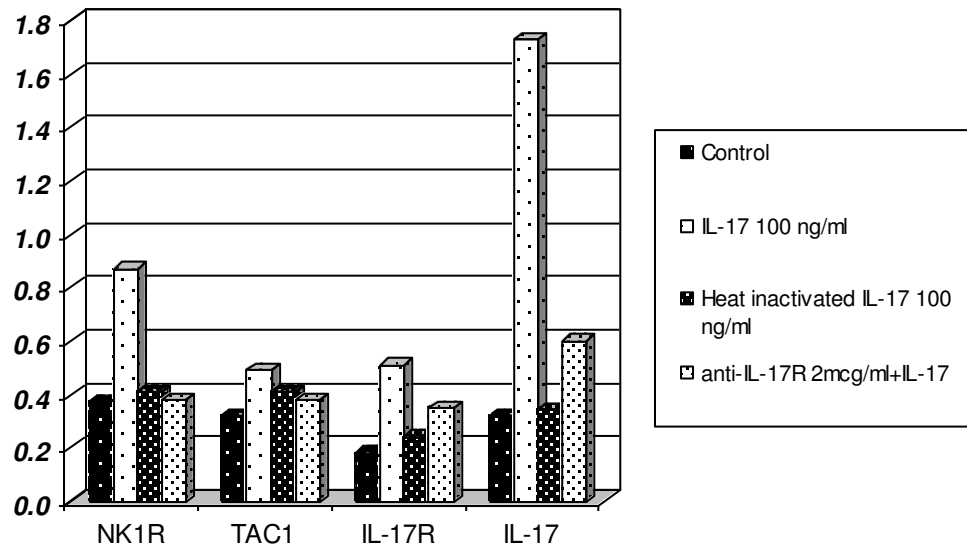

Figure 5.3. Specificity of IL-17 effects on NK1R, TAC1, IL-17RA and IL-17 expression in NT2N on the basis of one real-time PCR experiment. The effects were measured by mRNA abundance and standardised with 18S RNA (arbitrary units).

Anti-IL-17RA showed blocking effects on the above expression suggesting that the effects were mediated via IL-17RA binding.

18S RNA was used as an housekeeping gene in NT2N experiments due to β 2MG expression showing upregulation by IFN γ in NT2N.

On studying TAC1 and NK1R mRNA level expression, IL-17 and IFN- γ stimuli at different concentrations were used in comparison. Both IL-17 and IFN- γ at 10 ng/ml had stronger effects than at 100 ng/ml. The effects were more marked for NK1R (Fig 5.4).

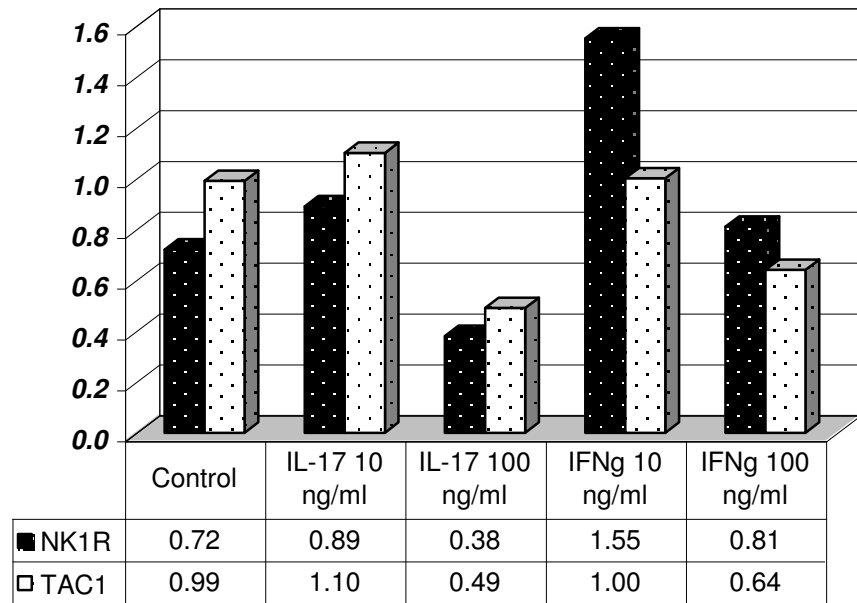

Figure 5.4. Effects of different doses of IL-17 and IFN- γ on NK1R and TAC1 expression in NT2N: averages of two 24h stimulation sets standardised with 18S RNA (arbitrary units).

IL-17 effects were stronger at 24h, whereas IFN- γ showed trend towards greater effect at 48h (data not shown). IFN- γ in this series appeared a stronger stimulus than IL-17 at the same concentration.

5.3.3 Upregulation of neuronal gene expression by SP

The effects of SP were studied using two different concentrations i.e. 10^{-6} M and 10^{-5} M of SP. Interestingly, SP stimulus at 10^{-6} M showed a tendency for downregulation of all studied genes, as opposed to SP 10^{-5} M that strongly upregulated IL-17RA, IL-17 and its own expression in

neurons, but not NK1R expression (Fig 5.5). SP appeared an equally strong stimulus both at 24h and 48h.

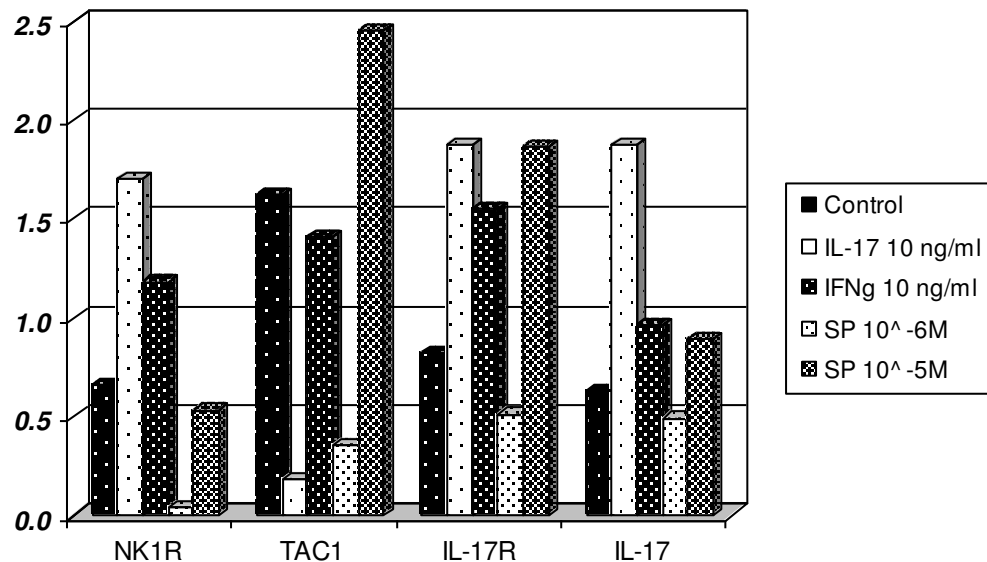

Figure 5.5. Effects of different stimuli on NT2N mRNA level expression (arbitrary units) of NK1R, TAC1, IL-17R and IL-17, normalised with 18S RNA; representative results of one 24 h stimulation experiment.

5.3.4 Western blotting for IL-17R and NF κ B proteins in NT2 neurons

On WB the product size around the expected 106 kDa, corresponding to the IL-17RA, was not convincingly detected. WB was run for both NT2N and NT2U cells for comparison. CD4⁺ T cell and macrophage lysates, treated according to the same lysis protocol, were included as positive controls. As a positive immunoblot control the membranes were stained for β -actin 1:2000 as a primary antibody giving a strong signal after one-second exposure.

As WB results for IL-17RA were not convincing, we have studied NFκB as a putative marker for IL-17RA signaling. NT2N fractionation for NFκB nuclear versus cytoplasmic localisations was carried out after 24h stimulation with 100 ng/ml IL-17. IL-17 did not affect total levels of NFκB proteins (p105, p50, p65) or alter their nuclear/cytoplasmic ratios as assessed by WB (Fig. 5.6). We have also used TNFα alone and in addition to IL-17 on NT2N that neither affected the amount of nuclear NFκB proteins. Thus, no evidence has been found to support NFκB signalling in neurons as part of the IL-17RA receptor response, nor in response to TNFα, as an exploratory experiment. It is possible that IL-17 may signal in neurons via other pathways, such as ERK1/2.

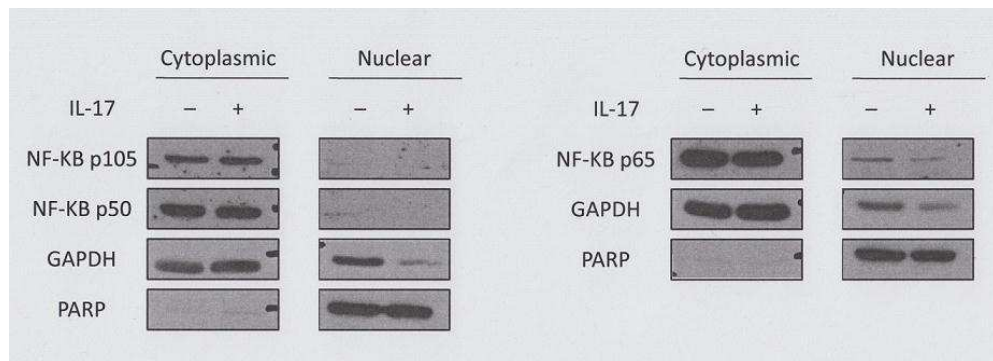

Figure 5.6. Nuclear fractionation of NT2N and Western blotting. IL-17 treatment did not induce nuclear entry of NFκB p65 and NFκB p50 proteins. GAPDH and PARP serve as positive controls showing good fractionation and localisation in cytoplasmic and nuclear compartments respectively.

As a general comment to this section, no differences in results were seen from cells grown on Matrigel plates compared to the ones grown on 6-well plates.

5.4 Discussion

In this chapter we have focussed on the expression of SP and its receptor in NT2 cells in response to IL-17 as the main effector cytokine in MS pathogenesis. The response of SP and NK1R expression to autoimmune inflammation in peripheral immune cells could be similar in neurons, however, little is known to date on direct neuronal response to inflammatory stimuli. Neuronal mechanisms initiating changes in gene expression, resulting in sequelae, including inflammatory neurodegeneration, are largely unknown. Although previous studies have shown Th1 effects on neurons, no studies to date have demonstrated IL-17 direct effects on neurons. In our study we have addressed the latter mainly by studying changes in gene expression comparatively in response to IL-17 and other stimuli. The effects of IL-17 on SP and NK1R expression is of relevance as SP in the setting of CNS inflammation may serve as an important modulator of immune responses.

A number of inflammatory and excitotoxic agents released by immune and glial cells in acute MS lesions are known to cause toxic neuronal injury and inflammation. As part of Th17 effects on neurons, cytolytic activity by

granzyme B, secreted mostly by CD8⁺ cells, has previously been shown (Kebir et al. 2007). The receptor for IL-17 in MS lesions is known to be expressed in addition to the immune cells also on astrocytes, thus in vivo the effects of IL-17 can be both direct on neurons, and indirect involving astrocytes. IL-17 immunoreactivity has also previously been shown on astrocytes in MS brain (Tzartos et al. 2008). The current study was designed to look at IL-17 effects on pure neuronal population to allow more straightforward conclusions on the direct effects. We have addressed the expression of IL-17R on these cells, as although there is previous suggestion of its presence on neurons (Kebir et al. 2007), it has not been confirmed.

IL-17RA mRNA-level expression was confirmed in stimulation experiments which showed upregulation of the gene by IL-17, IFN- γ and SP. IFN- γ upregulating IL-17RA mRNA shows credible evidence of neuronal response to an established stimulus of IFN- γ and may explain how IFN- γ facilitates and enhances Th17 effects in some experimental situations (O'Connor et al. 2008). IL-17 upregulating IL-17RA supports the importance of Th17 effects and signal reception in neurons. WB was additionally used to study protein level expression of IL-17RA on NT2N, however, the results were not convincing, despite different stainings used for IL-17RA comparing NT2N, NT2U, macrophages and CD4⁺ cells. Generally, our experiments showed little and nonspecific binding for IL-17RA as one of the receptor subtypes together with IL-17RC for which IL-

Vilisaar, J.

IL-17 is a known ligand. To demonstrate that the observed effects of IL-17 were indeed implemented via IL-17RA, control stimulations were performed with heat-inactivated IL-17 and monoclonal anti-IL-17RA that supported the effects via IL-17RA.

Signalling mechanisms of IL-17 receptors are largely unknown. IL-17 has been reported to signal via different pathways, most commonly via NF κ B. The latter has been preliminarily tested in our study in an attempt to further support intracellular effects of IL-17 by means of signalling. Nuclear versus cytoplasmic fractionation of NF κ B proteins with subsequent WB was used with no significant activation by IL-17. TNF α , that has an established functional receptor on NT2N, was tested additionally as IL-17 effects are known to be synergized by TNF α . Surprisingly, TNF α treatment did not induce nuclear localization of p65 in NT2N, whereas in macrophages TNF α treatment strongly increases the amount of nuclear NF κ B. The results suggest that TNF α may not regulate NF κ B nuclear import in NT2N. As neither of these cytokines seemed to activate NF κ B in NT2N it is likely that they act via other pathways, such as ERK1/2. Further studies are needed to confirm the structural presence and signalling of IL-17RA in neurons, however, as being beyond the aims of this project, this was not further elucidated.

Representing a Th1 response, stimulation with IFN- γ was included throughout the experiments for comparison with IL-17 effects and

validation of NT2N functional response. IFN- γ as an important Th1 cytokine in MS pathology has well-characterised effects on neurons (Wong et al. 1984; Benveniste 1998; Munoz-Fernandez et al. 1998; Rottenberg et al. 2002). In our experiments the effects of IL-17 and IFN- γ were comparable, supporting the role of both cytokines on neurons in inflammatory settings. In T cells IFN- γ has been shown to inhibit IL-17 expression (Harrington et al. 2005; Park et al. 2005). However, in other experimental situations it was shown to increase IL-17R expression, and Th1 cells have been shown to facilitate entry of the Th17 into the CNS (O'Connor et al. 2008). Also, the subset of T cells co-expressing IFN- γ and IL-17 are thought to be the most potent inflammatory cells in both EAE and MS (Edwards et al.). The suppression of IL-17 by IFN- γ was not observed in neurons, on the contrary, in our study IFN- γ upregulated IL-17 mRNA. Neurons as neuroectodermal cells, may be expected to express IL-17 and its expression by a variety of neoplastic cells has been reported (Kebir et al. 2007). Therefore it is plausible that adult neurons or NT2N express IL-17 and that NT2U express higher levels. Based on our results, IFN- γ could have a role in upregulating SP and its receptor in the CNS.

The effects of IL-17 on NT2N were more marked for NK1R than for TAC1 expression. This indicates that in inflammation IL-17 upregulates NK1R, rather than SP, which may be present at high concentrations in these settings. Both IL-17 and IFN- γ had stronger effects at 10 ng/ml, whereas at 100ng/ml IFN- γ was generally a stronger stimulus than IL-17.

Vilisaar, J.

Interestingly, the response to IL-17 was greater with 10 ng/ml at 24h and 100 ng/ml at 48 h. This could suggest that IL-17 does not necessarily act in a dose-dependent fashion. The fact that IL-17 effects were more marked at 24 h suggests the role of Th17 earlier compared to Th1 effects. IL-17 also upregulated its own expression in NT2N which suggests a positive feedback mechanism.

Stimulations with SP were additionally included to study reciprocal effects on IL-17 and its receptor expression as well as regulation of NK1R by SP. This can reflect a setting in the CNS upon neuronal injury during acute inflammation. From our previous results in T cells, SP expression is not as significant as NK1R upregulation on stimulation with Th17 and Th1 cytokines. Neurons in this setting could be a significant source of SP that can influence inflammatory and immune effects, and in turn, upregulate the expression of IL-17R and IL-17 in neurons and other cells in MS lesions. Indeed, upregulation of IL-17R and IL-17 in NT2N by SP was confirmed. In our series SP 10^{-5} M upregulated IL-17RA, IL-17, and TAC1 whereas SP at 10^{-6} M resulted in reduced expression compared to the baseline values. SP at lower concentrations may indeed have a downregulatory effect on certain components of inflammation, whereas at high concentrations SP may be pro-inflammatory.

The effects described above are examples of neuronal gene expression subject to regulation by IL-17. The main limitation of NT2N model in our

Vilisaar, J.

study is difficulty assessing neurotoxic effects of IL-17 in NT2N due to greater resistance of these cells to toxic stimuli. Cell viability was assessed by confocal microscopy with no differences observed in cell survival between stimulation conditions. This aspect of possible neurotoxic effects of IL-17 would need addressing in primary neuronal cultures. It may be additionally useful to study inflammatory mechanisms and neuronal survival in neuron-astrocyte co-cultures. Except for a few peculiarities, the above effects in NT2N have many similarities with the pattern of expression in peripheral blood mononuclear cells. The latter could serve as a more convenient experimental set-up for extrapolating aspects of immunological regulation in neurons.

6 Downregulation of NK1R in peripheral immune cells of multiple sclerosis patients in a relapse

6.1 Introduction

MS is an autoimmune disease characterized by CNS inflammatory demyelination and neuronal loss. Inflammation in MS is believed to be governed by Th17 and Th1 responses creating a cytokine and chemokine milieu that directs cellular mechanisms and feedbacks inflammation. This leads to perivascular infiltration of lymphocytes and macrophages and subsequent axonal demyelination. Local CNS cells (microglia, oligodendrocytes, astrocytes, neurons) play a role in developing inflammatory lesions as well as in remyelination. SP and other neuropeptides are involved in modulation of neuroimmune interactions by engaging with the inflammatory pathways. Recently, axonal loss has been regarded as an important hallmark of the disease present from the earliest stages.

In MS, the state of the peripheral immune system is important in triggering relapses and determining disease activity. Peripheral immune cells directly invade the CNS in an acute MS relapse via breakdown of BBB. However, immune responses may also be propagated within the CNS itself by previously infiltrating and chronically activated peripheral immune cells

and/or chronically activated CNS resident cells, such as microglia (Bar-Or 2008). In this case the inflammation becomes compartmentalized in the CNS and relatively independent of peripheral events (Bar-Or 2008). However, particularly in the early course of the disease and RR phase peripheral immune cells often guide CNS inflammatory responses, thus studying peripheral immune cell functions helps to elucidate processes in CNS inflammation.

Immune status of MS patients can be influenced by a number of factors. Infections that induce cellular responses may trigger MS relapses, whereas for instance allergic states and parasitic infections activate Th2 responses and may appear protective. Trivial infections in MS patients, such as urinary tract infections, can trigger MS relapses, or like fever / high ambient temperature, can just worsen existing MS symptoms, termed pseudo-relapses. A thorough clinical assessment, excluding infections, assessing EDSS change etc, is important in relapse evaluation. Additionally, MS patients presenting with other co-morbidities or autoimmune diseases, the aspects of which influence the peripheral immune status, alter susceptibility to MS relapses. There are several other physiological and non-physiological factors, such as hormonal changes, that influence the occurrence of relapses.

The immune status of MS patients can be influenced by several treatments that nowadays are becoming increasingly effective controlling relapse rate

and disease progression. At the time of this study, disease modifying treatments (DMT) mainly for RR type of the disease included β -interferons and glatiramer acetate. For severe and worsening disease, immunosuppressant regimens were used with mitoxantrone as a first-line treatment. For treatment of acute relapses high dose (1g/day) intravenous methylprednisolone (IVMP) is used. For IVMP treatment patients usually attend the Patient Investigation Unit (PIU) for 3 consecutive days; other dosing schemes may be used. Assessment prior IVMP treatment is important, infections are excluded by laboratory workup and Expanded Disability Status Scale (EDSS) determined on the basis of physical examination. An MS relapse as part of this study was defined as one or more new or previously observed neurological abnormalities consistent with the CNS demyelinating event for at least 24h.

SP immunomodulatory role has been recently brought into attention as a potential target influencing immune responses in MS. There are several lines of evidence showing roles for SP in CNS demyelinating disease, however, in the mechanistic context of MS, the interactions of the main inflammatory pathways with SP are currently sparse and the evidence remains limited. An overview of the main pathologic features of MS and suggested roles for SP in MS have been covered in more detail in the literature review (section 2.2). Additional aspects of inflammatory mechanisms and cytokine networks have been covered in the introductory sections of the above experimental chapters.

The work in this chapter focusses on SP receptor in MS, measuring its expressional differences on the mRNA level in relapsing-remitting MS (RRMS) patients in a relapse and healthy controls. For this purpose peripheral whole blood cells were utilised. NK1R expression reflects the importance of SP signal and its receptive allowance in these cells enabling an indirect estimation of the role of SP as its primary ligand. As evidenced from previous chapters, the expression of SP itself would be more difficult to detect due to the variability of its expression, whereas NK1R expression is more reliable. We are comparing the experimental results with the patients' clinical data with the help of which are seeking explanations to the findings. The expression of NK1R in MS has not been previously studied.

As an acknowledgement for contribution to this chapter, part of the sample processing and RNA isolation was performed by Ms L Jean-Gilles.

6.2 Methods

6.2.1 Subjects and sample collection

Patients for a donation of a blood sample were recruited solely at the Queen's Medical Centre, Nottingham University Hospitals NHS Trust, Nottingham (Ethics Committee Approval NS090102, valid for 10 years - please see Appendix C). 10 healthy controls and 11 relapsing-remitting MS

Vilisaar, J.

(RRMS) patients diagnosed with clinically definite MS according to the McDonald (2001, 2005) and Poser (1983) criteria were consented for the study. RRMS patients were recruited in a relapse when attending the PIU for IVMP treatment. They were assessed and consented for the study on PIU, a blood sample was obtained prior to the first dose of IVMP. No patient or control was recruited with a suspicion of a concurrent infection. Some patients were on DMT which was specified individually. No patient had received systemic corticosteroids or other course of immunosuppressants 6 months prior to the donation of a blood sample. Consent for blood donation was also obtained from healthy volunteers. The control and patient groups were age and sex matched.

Upon meeting the study criteria a single blood sample from the consented subjects was collected via venepuncture into PAXgene™ Blood RNA tubes (PreAnalytix GmbH, UK) for stabilisation of intracellular RNA in peripheral whole blood. Tubes were kept at room temperature in an upright position for 4-6 h to allow stabilisation before transferring them to -20 °C for 24 h and subsequently storing at -80 °C.

6.2.2 Extraction of total-RNA from whole blood

On the day of extraction PAXgene™ tubes were thawed in a wire rack at ambient temperature (18 °C...25 °C) for approximately 2 h. Blood samples were processed following the instructions of the PAXgene™ Blood RNA

Vilisaar, J.

Kit (PreAnalytix GmbH, UK) for isolation and purification of intracellular RNA from whole blood.

Briefly, after centrifuging PAXgene™ tubes, pellets were washed with RNase-free water, resuspended in buffer (BR1) and incubated for 10 min with a binding buffer (BR2) and proteinase K at 55 °C. The lysate was processed through Shredder spin columns, absolute ethanol was added to the flow-through fraction which was then processed through PAXgene™ RNA spin columns. Flow-through was discarded and processing columns were washed through with the washing buffer (BR3), thereafter treated with DNase I in the DNA digestion buffer (RDD) and washed again. RNA was collected by treating spin columns with the elution buffer (BR5). The elute was incubated at 65 °C for 5 min to denature the RNA for downstream applications.

The RNA concentration was determined at 260 nm by NanoDrop® ND-1000 spectrophotometer (Nanodrop Technologies, USA). Purity was assessed by measuring the 260/280 nm ratio, only samples in the range 1.70-1.95 were used.

6.2.3 Reverse transcription

The first step of reverse transcriptase reaction was initiated on 0.5 µg of total RNA (0.1 µg/µl) incubated with 1 µl of random hexamers (0.5 µg/µl) (Promega, USA) in a volume of 15 µl with nuclease-free water at 70 °C for 5 min. The microcentrifuge tubes were kept on ice until the following

Vilisaar, J.

reverse transcription step whilst adding 5 μ l 5x MMLV reverse transcriptase buffer (Promega, USA), 1.25 μ l nucleotides (10 mM dATP, dCTP, dGTP, dUTP) (Promega), 0.5 μ l RNasin® ribonuclease inhibitor (Promega), 1 μ l MMLV reverse transcriptase (Promega) and 2.25 μ l nuclease-free water (Sigma-Aldrich, UK) to a final volume of 25 μ l. The mixture was incubated at 42 °C for 1 hour, subsequently diluted to 100 μ l with nuclease-free water for the qPCR step or storage at –20 °C.

6.2.4 Quantitation of NK1R and TAC1 mRNA transcripts

Quantitative real-time PCR was carried out to assess NK1R and TAC1 mRNA abundance using the SYBR Green fluorescence method as specified by the manufacturer (Stratagene, USA). Relative standard curve method (AppliedBiosystems 1997) was used with standards obtained by pooling equal aliquots of undiluted cDNA from each sample. The primers for NK1R, TAC1, internal standard β 2MG, and the reaction conditions were used as in section 4.2.6. For all reactions, dissociation profiles were obtained to ensure that genomic amplification products were not detected.

6.2.5 Collection of medical data

Patient medical records were used to obtain the following information: demographics, onset of first MS symptoms, time of diagnosis, OCB presence, distinct features on MRI (lesion distribution, T2 lesion load and Gd+ lesions), routine autoantibody panel (including anti-nuclear, anti-thyroid peroxidase, anti-mitochondrial, anti-gastric parietal cell, anti-

Vilisaar, J.

smooth muscle and anti liver kidney microsomal antibodies) with positive titres, other positive serum or CSF immunology, history and severity of neuropathic pain, medications used, last course of steroids or other immunosuppressants prior to the blood sample, previous relapse prior to the current presentation, other relevant medical history. For disability assessment Kurtzke EDSS was used. EDSS training and certification was obtained via Neurostatus, Basel, Switzerland, e-Test at <http://www.neurostatus.net> (Level C). The following scale was used for assessing neuropathic pain levels: 0 - no pain, 1 – mild pain, 2 – moderate pain, 3 – severe pain. Pain belonging to any of the neuropathic pain categories (definite, probable, possible) was rated as above.

Throughout the study Data Protection Act 1998 was followed. Additionally, in the subsequent analysis data processing was run anonymously. Experimental data was kept blinded from the medical data until the final data analysis step.

6.2.6 Statistical analysis

For the analysis Mann-Whitney, Kruskal-Wallis tests, chi-squared statistics and Spearman ρ correlation were used.

6.3 Results

The summary of the descriptive data of MS patients and controls is presented in Table 6.1.

	MS Patients	Controls
Number of subjects	11	10
Mean age +/- SD ⁱ	42.8 +/- 8.7	40.6 +/- 10.6
Female/Male ratio	8/3	7/3
Mean Time from onset of first symptoms	4.3 +/- 4.9	NA
Mean EDSS ⁱⁱ +/- SD	3.6 +/- 2.0	NA
Number of patients on DMT ⁱⁱⁱ	2	NA
Neuropathic pain present	9	NA

ⁱ Standard Deviation

ⁱⁱ Expanded Disability Status Scale

ⁱⁱⁱ Disease Modifying Treatment

Table 6.1. The summary of the main characteristics of the patient and control groups compared in the study.

The relative expression NK1R/ β 2MG in peripheral whole blood cells was compared in RRMS patients and healthy controls. NK1R in the peripheral blood was significantly less expressed in the MS group than in the control group. The mean NK1R/ β 2MG mRNA ratio was 1.483 +/- 3.249 in MS patients as compared to 23.686 +/- 24.604 in healthy volunteers (p=0.000) (Fig 6.1).

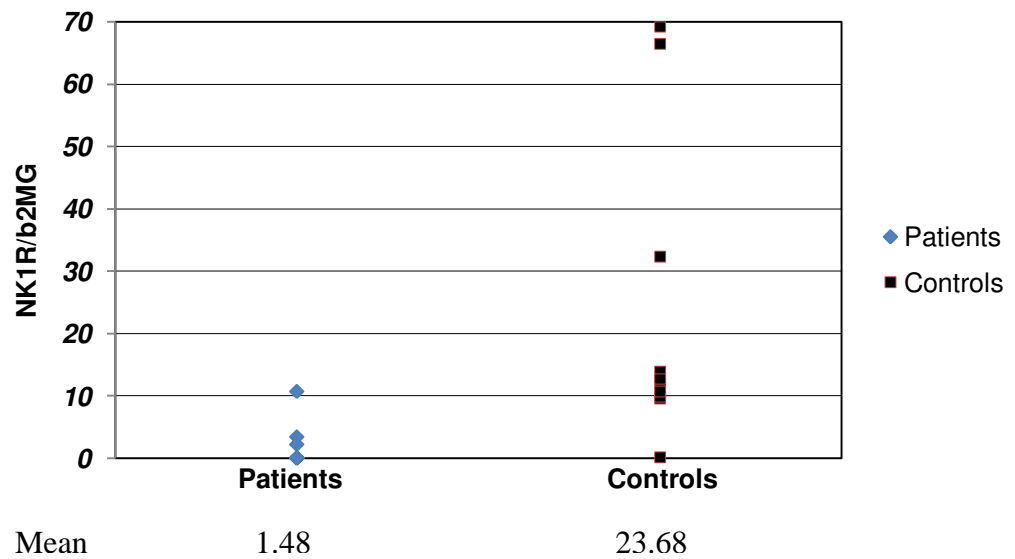

Figure 6.1. NK1R mRNA abundance normalised with β 2MG (arbitrary units) in peripheral whole blood cells from 11 RRMS patients and 10 healthy controls.

Age was not significantly associated with NK1R expression neither in patients nor in controls, despite the strong trend in the latter ($p=0.058$) with downregulation of NK1R with increasing age. No gender-related differences were found in NK1R expression, however, in the control group there was some tendency for less NK1R expression in females. With regards to clinical features, no differences were found in NK1R expression between OCB positive (OCB+) and OCB- patients and the autoantibody positive and negative patients. NK1R expression did not correlate with the disease duration and no correlation was found between NK1R expression and disability. For descriptive purposes of the RRMS subgroups it should be noted that no significant differences were seen between OCB+ and

OCB- patients with regards to EDSS and other clinical characteristics. Comparison of patients with a normal autoantibody screen with patients with other positive autoantibodies (at least one positive autoantibody titre) showed no distinction in other clinical features or NK1R expression. In the autoantibody positive group a slight trend was seen towards higher disability, assessed by the EDSS. Importantly, NK1R expression did not correlate with the level of neuropathic pain in MS. Two of the 11 RRMS patients were on DMT at the time and in these two cases NK1R mRNA-level expression was similar to other patients showing no different tendencies.

Exploratory experiments were also conducted to study TAC1/ β 2MG mRNA level expression in 3 patients and 3 controls in order to assess the differences in NK1R and TAC1 expression. The results show distinct downregulation of NK1R in these 3 patients, whereas TAC1 expression was low in both patient and control groups (Fig 6.2). Only a small difference can be observed in TAC1 expression between MS patients and healthy controls, however, at present this cannot be attributed any significance.

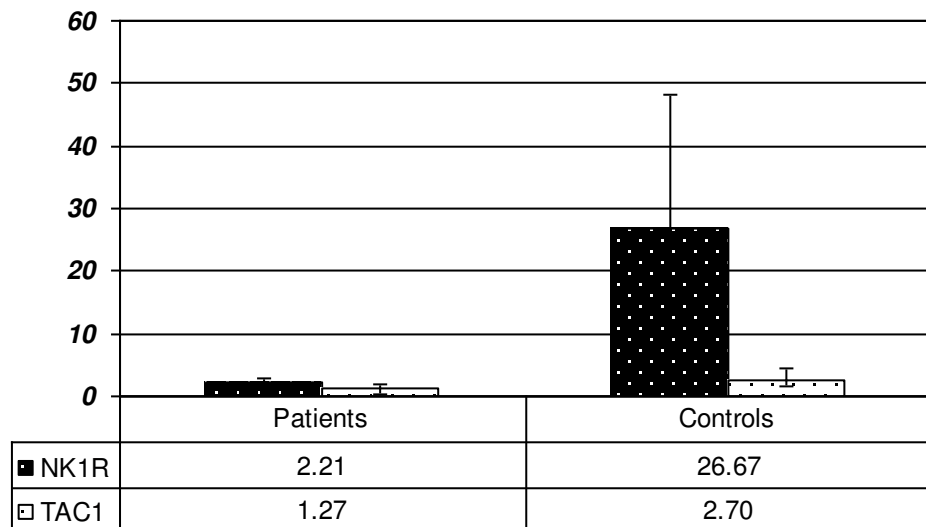

Figure 6.2. NK1R and TAC1 mRNA abundance normalised to β 2MG (arbitrary units) in peripheral whole blood cells of 3 MS patients and 3 healthy controls +/- SEM.

6.4 Discussion

The results refer to the whole population of cells in peripheral blood and thus may raise questions about whether they reflect a targeted cell function. Among other constituents, the whole blood includes leukocytes, virtually the only nucleated cells in human peripheral blood, of which approximately 50-60 % are neutrophils and 25-30% lymphocytes. Although SP is also involved in neutrophil activation, when comparing whole blood of MS patients and healthy controls, the main differences are expected to arise from the lymphocyte population. Particular care has been

taken not to include patients and controls with any suspected infection. No *ex vivo* stimulation conditions as additional variables are used in this method. Analogous experiments addressing SP or NK1R expression in human peripheral whole blood have not been published to date. Additionally, no studies have been published on NK1R expression in MS patients.

NK1R expression in peripheral blood immune cells can be considered more informative than SP expression for reasons specified in Chapter 4. The results show highly significant differences in NK1R mRNA abundance between patients and controls with strong downregulation of NK1R in an MS relapse. TAC1 was much less expressed in both groups, which is expected as peripheral blood cells are not a major source of SP. SP is the main ligand for NK1R, however, other tachykinins as alternatives for NK1R binding may play a role. Focussing on NK1R also reflects reception of other tachykinins, such as hHK-1, which is another recently uncovered NK1R ligand, particularly in lymphocytes and cells of monocyte lineage. Although TAC1 exon 7 encodes other tachykinins originating from alternative splicing of TAC1 gene, the issue of not addressing other tachykinins in this thesis is one of the main limitations of the study.

It is important to address the issue of drawing conclusions on the results considering the role of SP in MS. Assumptions allowing conclusions on SP

role in MS are based on evidence of its role in demyelinating disease, such as demonstrated in direct in vivo studies in EAE. As another aspect, NK1R expression in lymphocytes and cells of monocyte lineage in peripheral blood is likely different compared to the CNS, where different cell types express SP and higher amounts of SP are available. The model does not fully reflect the role of SP in peripheral immune cell function applicable in the CNS setting, where additionally the immunological role of SP could be different, including possible SP concentration-dependence, as seen in the previous chapter, and various co-effects with other mediators. Additionally, SP receptor isoform expression has been shown different in these tissues (Caberlotto et al. 2003). Thus, studying NK1R expression in peripheral whole blood as an aspect of CNS inflammation only allows limited conclusions. Nevertheless, some indirect conclusions are possible on the immune cell perspective in an acute MS relapse which results in invasion of these cells into the CNS.

The mechanism for NK1R downregulation in MS is not clear. Decreased NK1R expression in blood of MS patients may represent an effect of specific inflammatory cytokines upregulated in MS. Our results are consistent with a single published study showing reduced NK1R expression in IFN- γ , IL-1 β , TNF- α stimulated macrophages (Berger et al. 2007). These pro-inflammatory cytokines which play a role in MS pathogenesis may have a role in downregulating NK1R also in our patients. The inflammatory mechanism is one of the most likely explanations to our

findings in an acute MS relapse. Additionally in Chapter 4, our NK1R promoter level results in Jurkat cells are consistent with the findings by Berger with IL-12 and IFN- γ showing no activation of the promoter, but rather a tendency for NK1R downregulation. Also IL-18 alone exerted a downregulatory effect in NK1R surface staining results in T blasts. However, further experiments would be necessary to test these inflammatory effects on NK1R expression.

Our findings refer to SP regulation that could be important in MS pathogenesis. Th1 cytokines have been shown in the past to be pro-inflammatory, however, their recently uncovered inflammation limiting properties may be important in regulation of SP effects. Th1 cytokines downregulating NK1R may be one of the mechanisms limiting SP pro-inflammatory effects at high SP concentrations, such as may occur upon neuronal injury. On the contrary, Th17 cytokines appear important in upregulating NK1R as seen in Chapter 4. That in fact, may contribute to the acute inflammation in the early stages when Th17 responses are prevalent. At lower concentrations, without neuronal injury, SP may exhibit immunosuppressive (Chen et al. 1996) and neuroprotective effects (Raffa 1998; Amadoro et al. 2007) and upregulation of NK1R in these settings may be beneficial. This supposition would require further studies.

It can be stated that there is a difference in NK1R expression in RRMS and healthy controls, however, it is not possible to confirm whether it is due to

inflammatory activity, although it seems the likely explanation. To address this question additional experiments would be needed looking at NK1R expression in different types of MS and RRMS comparatively in a relapse and remission. Larger numbers of recruitment are necessary to elucidate these differences. For the validity of the method (uniformity of the study groups, reducing other variables) and due to time constraints only RRMS patients in an acute relapse were used in this study. Based on the inflammatory role of SP, NK1R downregulation would be expected to be less significant in progressive types of MS. In the current study, no inflammatory and immune markers allowed associations with differences in NK1R expression within the relapsing patient group which can be due to inflammatory activity.

Other explanations, besides those directly inflammatory, could be found for NK1R downregulation in MS. NK1R as a G-protein coupled receptor is easily internalised and the expression rapidly downregulated after receptor activation. One such consideration for the receptor response in MS patients is the presence of neuropathic pain as a common symptom in MS. It is a theoretical possibility that higher pain levels may have downregulated substance P receptor. Neuropathic pain mechanisms are complex, in MS they usually arise as a direct consequence of demyelinating lesions in somatosensory pain pathways (Treede et al. 2008). Additionally being very subjective, pain levels are variable in MS and are not associated with the disease activity. Nociceptive pains, resulting from activation of peripheral

afferents, may often co-exist. Nevertheless, no stress hormones or other agents have been previously demonstrated in association with pain affecting NK1R expression in peripheral blood.

To address the issue about peripheral blood NK1R expression and pain being possibly associated, we have compared NK1R expression with the severity of neuropathic pain in the patient group. The current results were homogeneous with regards to NK1R expression as different levels of pain were not affecting peripheral blood NK1R expression. An association of NK1R with the level of pain thus appears a less likely explanation in peripheral immune cells, supporting the inflammatory mechanism in NK1R downregulation. It may, however, be the case that in the context of acute inflammatory activity that distinction cannot be reliably made. Additionally age and gender related differences in the MS group may not have been apparent due to prevailing inflammatory activity. Hence, in the future studies pain levels are an important consideration in the study design.

7 Conclusions

Cytokine-like properties of SP and its role in immunogenic inflammation is a recent recognition on which still limited evidence is available and very little has been published on humans. SP effects in immunogenic inflammation can be shown as modulatory, implemented by a number of mechanisms, including inflammatory cytokine induction. Reciprocal interactions exist in expression and effects of SP and its receptor with various other inflammatory mediators and their pathways. In this thesis we have been studying SP and NK1R role from the perspective of autoimmune inflammation of MS. We have focussed on SP role particularly in relation to Th17 and Th1 pathways, as the main drive of SP pro-inflammatory properties. In the four experimental chapters we covered induction of inflammatory cytokines by SP in PBMC (Chapter 3), dependence of SP and NK1R expression on inflammatory stimuli in T cells (Chapter 4) and NT2N (Chapter 5), and the expression of NK1R in RRMS patients and controls (Chapter 6). The main findings of these chapters are concluded below.

In Chapter 3, we studied the expression of various inflammatory cytokines in response to SP in PBMC. In particular, we focussed on SP induction of IL-12 and IL-23 as the key cytokines in Th1 and Th17 pathways respectively. Treatment of PBMC with SP showed marked increase in the

relative quantity of IL-12/IL-23p40, IL-23p19 and IL-12p35 mRNA in these cells indicating that SP receptor can signal IL-23 and IL-12 subunit induction. Protein-level results were not confirmatory as protein level expression may require activated cells or additional co-activating factors. The findings support SP ability to enhance Th17 and Th1 responses with a favour to Th17 induction. As an additional finding that would bear importance in further studies is toxicity of CP-96345 and CP-96344 at concentrations 10^{-4} M and higher. We also observed interesting interactions of CP-96345 and CP-96344 with LPS effects that would need further elucidation. In particular, the relationship between SP and TLR will need to be further explored.

In Chapter 4 we investigated the opposite – the regulation of SP and its receptor expression by Th17 and Th1 cytokines in T cells. IL-23 significantly upregulated both TAC1 and NK1R on the mRNA level, whereas induction by IL-12 was not significant. These effects on NK1R were confirmed on a protein level with NK1R surface staining, and promoter studies in which IL-23 differential effects compared to IL-12 were most pronounced. IL-23 effects were partially mediated via induction of IL-17, whereas IFN- γ did not mediate IL-12 effects. NK1R was significantly upregulated also by IL-17, while IFN- γ had no significant effects. We saw that IL-23 effects were prevalent at earlier stages than the effects by IL-12. Th17 stimuli in our series were important inducers of NK1R and TAC1 supporting dependence of SP and NK1R expression in T

Vilisaar, J.

cells on inflammatory stimuli. The findings suggest SP involvement in Th17 and less in Th1 pathway effects.

As part of Chapter 5 we showed that neuronal NK1R expression was subject to regulation by IL-17; TAC1 was considerably less upregulated. IL-17 and IFN- γ effects were comparable both showing optimal effects at 10 ng/ml. IL-17 effects are likely more important earlier at 24h compared to IFN- γ prevailing trend at 48h. SP 10^{-5} M upregulated IL-17R, IL-17 and TAC1 but not its own receptor in NT2N. With these results we demonstrated that IL-17 can regulate NT2N gene expression via its receptor, having shown effects via IL-17RA functional expression in these cells. Further studies are needed for structural confirmation and elucidating signalling of IL-17R in NT2N. The above effects have important implications in neuroinflammatory conditions, however, IL-17 possible neurotoxicity would need addressing in primary neurons. The findings indicate that neurons are involved in immune interactions involving SP and Th17 pathway.

In Chapter 6, we compared relapsing RRMS patients with healthy volunteers to study differences in NK1R mRNA-level expression between the groups. NK1R was significantly downregulated in peripheral blood of RRMS as compared to healthy controls. Experiments on TAC1 expression showed much lower levels in relative quantity of SP precursor mRNA in both patients and controls with no significant differences between the

groups. The most likely explanation for NK1R downregulation in the patient group is the inflammatory mechanism. No immune and other inflammatory markers allowed distinctions in expression of NK1R, which can be explained with the inflammatory activity in an acute relapse. Further studies are needed to investigate NK1R expression differences between different types of MS and RRMS in relapse and remission. Pain was not associated with the level of NK1R expression, nevertheless, in future study design this has to be considered.

As one of the concluding findings in our study, SP pro-inflammatory activity is associated with the Th17 pathway. This is a novel association as previously SP has been shown to be linked with Th1 activities, which may be explained by the relatively recently uncovered Th17 role. As previous studies were done in murine models it is unclear how Th17 would compare with Th1 in mice in these experimental settings. According to our findings, Th17 and Th1 cytokines in humans seem to have differential effects on expression of SP and NK1R both in peripheral immune cells and less in NT2N. In neurons NK1R expression is more dependent on inflammatory stimuli than SP expression. Although Th1 cytokines are having mild effects in our experiments, Th17 far outweigh Th1 effects in T cells. Th17 pro-inflammatory pathway is communicated by SP by NF κ B signalling. Hence, as results from this thesis suggest, a proportion of SP pro-inflammatory properties are implemented via Th17 pathway activation and less so via Th1. As a limitation to this, we have not tested all Th1

cytokines, thus final conclusions need to be cautious. For example, it is not possible to compare how the cytokines used in our study compare with IL-1 effects which also acts via NF κ B and has been previously reported to induce SP and NK1R protein-level expression (Guo et al. 2004). Of note, IL-1 may also be a T cell cytokine and in our previous experiments has been induced by SP in PMA/ionomycin activated T cells (Chopra and Constantinescu, unpublished observations).

Reciprocal interactions of SP with other cytokine networks is one of the other important findings of the study. As studied in the first two experimental chapters, mutual regulation is evident in relation to the Th17 pathway. Previously, IFN- γ immunoregulatory circuit and other SP paracrine and autocrine interactions involving mainly Th1 pathway have been demonstrated (Pascual et al. 1990; Blum et al. 1993; Castagliuolo et al. 1997; Cioni et al. 1998; Weinstock et al. 1998). In our studies little evidence for the induction of Th1 cytokines and their reciprocal induction of SP was seen in the human system. On occasions, Th1 cytokines even seemed to exert limiting effects. It is possible that SP pro-inflammatory interactions with Th17 pathway prevail in humans. However, prior studies focussing mainly on Th1, predominantly in murine models, allows limited conclusions on circuits involving Th17 versus Th1. For the future studies it would be of interest testing SP induction of cytokines, such as IL-17 and IFN- γ , in parallel. Bi-directional induction seen in our results serves

feedback mechanisms and supports SP role modulating propagation of immune responses.

Preconditioning of cells is important for optimal SP effects, and similarly, priming of cells with SP has been shown important for different cytokine effects. Pre-activation seems to change responsiveness of cells to particular inflammatory stimuli, in some circumstances co-activation is needed for eliciting downstream signalling events. Conditioning of cells has been shown in a number of different inflammatory models previously. For example, LPS preactivated monocytes have been shown to have increased response to SP (Laurenzi et al. 1990), SP has been shown to mediate and enhance release of different cytokines from macrophages and other immune cells (Blum et al. 1993; Berman et al. 1996; Castagliuolo et al. 1997), enhance TNF α secretion from pre-activated neuroglial cells (Luber-Narod et al. 1994), IL-2 release from activated T cells (Calvo et al. 1992) etc. This partly also explains inconsistencies in protein- and mRNA-level expression as additional factors and co-factors downstream, regulating post-transcriptional events seem important. This suggests how SP protein-level induction is controlled in inflammatory settings.

The effects of SP may be concentration dependent, i.e. at high concentrations SP may be pro-inflammatory, whereas at low concentrations it may show anti-inflammatory effects. There are some suggestions for the latter also from earlier reports (Chen et al. 1996). Hints

to SP dichotomic effects were seen in Chapter 5 and Chapter 3. We found that the effects on IL-12 subunit production with SP 10^{-12} M as compared to 10^{-6} M was occasionally lower than baseline in PBMC, and SP 10^{-6} M has shown downregulatory effects compared to 10^{-5} M on various genes in NT2N. This may suggest that in neurons the effects by SP are possibly different than in PBMC, which can be contributed by higher concentrations of SP in the CNS and expression of different SP receptor isoforms in these tissues. The effects in NT2N on IL-17 and IL-17RA downregulation are pointing to inflammation limiting effects, whereas in PBMC the effects are more distinct with Th1 and Th17 cytokines. These effects of SP may prove important in CNS inflammatory settings, however, as the observations are statistically not significant, it currently remains on a speculative basis. Additionally, no evidence was presented in our study on SP neuroprotective features as these were not possible to study in NT2N. Nevertheless, we did not note a difference in NT2N survival ability in different neuronal culture conditions. Hence SP, classically known for its pro-inflammatory effects, may function as a cytokine that helps to regulate the balance of the inflammatory arms also limiting autoimmune damage. The possible dual nature of SP in inflammation would need further studies.

As a novel finding from the thesis, neurons react actively to Th17 stimuli which regulates their SP and NK1R expression. The finding assumes expression of IL-17R on them through which these effects are mediated. Functional evidence is supporting this, however, further experiments on

the protein level are necessary to confirm IL-17R structurally. The findings indicate that neurons participate actively in immune responses and may modulate these by neuroimmune feedback. SP has a role communicating these interactions. The results support the importance of SP immunomodulatory role in CNS inflammation. Th17 responses seen in neurons reveal a different perspective on neuronal response to autoimmune inflammation. Further studies are needed to elaborate the findings and study signalling pathways. The results have also important implications with regards to sequelae leading to inflammatory neurodegeneration and possible targets for neuroprotection.

As a general comment to the findings, being aware of other tachykinins, such as hemokinin-1, acting on NK1R, is important. This is particularly relevant in peripheral immune cell function. This thesis has focussed mainly on the role of SP as the NK1R primary ligand. No experiments were done where intermediary steps were used that depended on subsequent induction of SP or other tachykinins. TAC1 gene gives rise to different tachykinins as a result of four different splice variants, whereas exon 7 is included in all of these. Hence, our TAC1 mRNA-level results reflect also the expression of other tachykinins. However, this is important to consider in transferring conclusions to in vivo settings. This may also account for possible differences in role of SP on immune function in peripheral blood and in the CNS. Thus, focussing only on SP may appear not that informative than studying NK1R expression in these settings, and

Vilisaar, J.

NK1R does not reflect only on SP reception. Not testing comparatively other tachykinins can be considered one of the limitations of the study, however, for reasonable experimental design and aims purposes this was inevitable.

As a conclusion, our study has attempted to shed light on involvement of SP in autoimmune inflammation with the focus on the human system and CNS inflammation. Pertinent to these settings, the role of SP can be best summarized as of a pleiotropic immune regulator. SP has probably underrecognized role in CNS inflammation where it serves as a neuroimmune regulator. In vivo evidence has previously shown SP and NK1R pathogenic role in EAE. In humans, SP participates in a range of pro-inflammatory cytokine networks, particularly in Th17 pathway interactions. Its modulation of immune activities is characterized by mutual regulation and co-effects with other mediators. SP release with both its neurogenic and immunogenic actions may serve as an amplification mechanism that perpetuates the inflammatory cascade (Bozic et al. 1996). Its signalling involves activation of NF κ B, which is behind the regulation of various inflammatory genes, explaining SP regulation of chemotaxis and other inflammatory mechanisms. The overall picture involving SP roles, however, is complex and its multiple facets yet remain to be elucidated.

8 Bibliography

- Ahluwalia, A., C. De Felipe, J. O'Brien, S. P. Hunt and M. Perretti (1998). "Impaired IL-1beta-induced neutrophil accumulation in tachykinin NK1 receptor knockout mice." British Journal of Pharmacology **124**(6): 1013-5.
- Andrews, P. (1984). "Retinoic acid induces neuronal differentiation of a cloned human embryonal carcinoma cell line in vitro." Dev Biol **103**: 285-293.
- AppliedBiosystems (1997). User Bulletin #2 ABI PRISM 7700 Sequence Detection System. Foster City, CA, Applied Biosystems.
- Arnason, B. G. (1996). "Interferon beta in multiple sclerosis." Clinical Immunology & Immunopathology **81**(1): 1-11.
- Arsenescu, R., A. M. Blum, A. Metwali, D. E. Elliott and J. V. Weinstock (2005). "IL-12 induction of mRNA encoding substance P in murine macrophages from the spleen and sites of inflammation." J Immunol **174**: 3906-3911.
- Arsenescu, R., A. M. Blum, A. Metwali, D. E. Elliott, J. V. Weinstock, R. Arsenescu, A. M. Blum, A. Metwali, D. E. Elliott and J. V. Weinstock (2005). "IL-12 induction of mRNA encoding substance P in murine macrophages from the spleen and sites of inflammation." Journal of Immunology **174**(7): 3906-11.
- Ascherio, A., K. L. Munger and K. C. Simon "Vitamin D and multiple sclerosis." Lancet Neurology **9**(6): 599-612.

- Baecher-Allan, C. and D. A. Hafler (2006). "Human regulatory T cells and their role in autoimmune disease." Immunological Reviews **212**: 203-16.
- Bar-Or, A. (2008). "The immunology of multiple sclerosis." Seminars in Neurology **28**(1): 29-45.
- Bar-Shavit, Z., R. Goldman, Y. Stabinsky, P. Gottlieb, M. Fridkin, V. I. Teichberg and S. Blumberg (1980). "Enhancement of phagocytosis - a newly found activity of substance P residing in its N-terminal tetrapeptide sequence." Biochemical & Biophysical Research Communications **94**(4): 1445-51.
- Barker, R. and A. Larner (1992). "Substance P and multiple sclerosis." Medical Hypotheses **37**(1): 40-3.
- Berger, A., A. H. Tran, C. J. Paige, A. Berger, A. H. Tran and C. J. Paige (2007). "Co-regulated decrease of Neurokinin-1 receptor and Hemokinin-1 gene expression in monocytes and macrophages after activation with pro-inflammatory cytokines." Journal of Neuroimmunology **187**(1-2): 83-93.
- Berman, A. S., C. Chancellor-Freeland, G. Zhu and P. H. Black (1996). "Substance P primes murine peritoneal macrophages for an augmented proinflammatory cytokine response to lipopolysaccharide." Neuroimmunomodulation **3**(2-3): 141-9.
- Betelli, E., T. Korn and V. K. Kuchroo (2007). "Th17: the third member of the effector T cell trilogy." Current Opinion in Immunology **19**(6): 652-657.
- Betelli, E., M. Oukka and V. K. Kuchroo (2007). "T(H)-17 cells in the circle of immunity and autoimmunity." Nature Immunology **8**(4): 345-50.
- Betelli, E., M. Oukka and V. K. Kuchroo (2007). "T(H)-17 cells in the circle of immunity and autoimmunity." Nat Immunol **8**: 345-50.

Vilisaar, J.

- Bitsch, A., J. Schuchardt, S. Bunkowski, T. Kuhlmann and W. Bruck (2000). "Acute axonal injury in multiple sclerosis. Correlation with demyelination and inflammation." Brain **123**(Pt 6): 1174-83.
- Blum, A., T. Setiawan, L. Hang, K. Stoyanoff and J. V. Weinstock (2008). "Interleukin-12 (IL-12) and IL-23 Induction of Substance P Synthesis in Murine T Cells and Macrophages Is Subject to IL-10 and Transforming Growth Factor {beta} Regulation." Infect. Immun. **76**(8): 3651-3656.
- Blum, A. M., A. Metwali, G. Cook, R. C. Mathew, D. Elliott and J. V. Weinstock (1993). "Substance P modulates antigen-induced, IFN-gamma production in murine Schistosomiasis mansoni." Journal of Immunology **151**(1): 225-33.
- Blum, A. M., A. Metwali, G. Cook, R. C. Mathew, D. Elliott and J. V. Weinstock (1993). "Substance P modulates antigen induced IFN-gamma production in murine Schistosomiasis mansoni." J immunol **151**: 225-233.
- Bost, K. L. and D. W. Pascual (1992). "Substance P: a late-acting B lymphocyte differentiation cofactor." American Journal of Physiology **262**(3 Pt 1): C537-45.
- Brenner, T., D. Soffer, M. Shalit, F. Levi-Schaffer, T. Brenner, D. Soffer, M. Shalit and F. Levi-Schaffer (1994). "Mast cells in experimental allergic encephalomyelitis: characterization, distribution in the CNS and in vitro activation by myelin basic protein and neuropeptides." Journal of the Neurological Sciences **122**(2): 210-3.

Brimijoin, S., J. M. Lundberg, E. Brodin, T. Hokfelt and G. Nilsson (1980).

"Axonal transport of substance P in the vagus and sciatic nerves of the guinea pig." Brain Research **191**(2): 443-57.

Caberlotto, L., Y. L. Hurd, P. Murdock, J. P. Wahlin, S. Melotto, M. Corsi, R.

Carletti, L. Caberlotto, Y. L. Hurd, P. Murdock, J. P. Wahlin, S. Melotto, M. Corsi and R. Carletti (2003). "Neurokinin 1 receptor and relative abundance of the short and long isoforms in the human brain." European Journal of Neuroscience **17**(9): 1736-46.

Calvo, C. F., G. Chavanel and A. Senik (1992). "Substance P enhances IL-2

expression in activated human T cells." Journal of Immunology **148**(11): 3498-504.

Cantalupo, L., C. Cioni and P. Annunziata (2008). "Expression of

preprotachykinin-A mRNA isoforms and substance P production in T lymphocytes of human healthy subjects." Neuroscience Letters **434**(2): 191-194.

Cantalupo, L., C. Cioni, L. D. Santi and P. Annunziata (2008). "Expression

pattern of substance P gene isoforms and peptide production in T-lymphocytes of multiple sclerosis patients." Journal of Neurology **255**: P451.

Castagliuolo, I., A. C. Keates, B. Qiu, C. P. Kelly, S. Nikulasson, S. E. Leeman

and C. Pothoulakis (1997). "Increased substance P responses in dorsal root ganglia and intestinal macrophages during Clostridium difficile toxin A enteritis in rats." Proceedings of the National Academy of Sciences of the United States of America **94**(9): 4788-93.

Vilisaar, J.

Chen, J., S. Li, Y. Liu, S. Wu and H. Ji (1996). "[The role of substance P in the spinal dorsal horn in the pathogenesis of autoimmune diseases]." Chung-Kuo i Hsueh Ko Hsueh Yuan Hsueh Pao Acta Academiae Medicinae Sinicae **18**(3): 183-8.

Chen, J., S. Li, Y. Liu, S. Wu, H. Ji, J. Chen, S. Li, Y. Liu, S. Wu and H. Ji (1996). "[The role of substance P in the spinal dorsal horn in the pathogenesis of autoimmune diseases]." Chung-Kuo i Hsueh Ko Hsueh Yuan Hsueh Pao Acta Academiae Medicinae Sinicae **18**(3): 183-8.

Chen, L. W., K. K. L. Yung and Y. S. Chan (2004). "Neurokinin peptides and neurokinin receptors as potential therapeutic intervention targets of basal ganglia in the prevention and treatment of Parkinson's disease." Current Drug Targets **5**(2): 197-206.

Chernova, I., J.-P. Lai, H. Li, L. Schwartz, F. Tuluc, H. M. Korchak, S. D. Douglas and L. E. Kilpatrick (2009). "Substance P (SP) enhances CCL5-induced chemotaxis and intracellular signaling in human monocytes, which express the truncated neurokinin-1 receptor (NK1R)." Journal of Leukocyte Biology **85**(1): 154-64.

Cioni, C., D. Renzi, A. Calabro and P. Annunziata (1998). "Enhanced secretion of substance P by cytokine-stimulated rat brain endothelium cultures." Journal of Neuroimmunology **84**(1): 76-85.

Compston, A., A. Coles, A. Compston and A. Coles (2002). "Multiple sclerosis.[erratum appears in Lancet 2002 Aug 24;360(9333):648]." Lancet **359**(9313): 1221-31.

- Confavreux, C., G. Aimard and M. Devic (1980). "Course and prognosis of multiple sclerosis assessed by the computerized data processing of 349 patients." Brain **103**(2): 281-300.
- Coyle, P. K. (2005). Controlling neurodegeneration and slowing progression of disability with glatiramer acetate: the evidence. Drugs in Focus. Paris.
- Crawford, M. P., S. X. Yan, S. B. Ortega, R. S. Mehta, R. E. Hewitt, D. A. Price, P. Stastny, D. C. Douek, R. A. Koup, M. K. Racke, N. J. Karandikar, M. P. Crawford, S. X. Yan, S. B. Ortega, R. S. Mehta, R. E. Hewitt, D. A. Price, P. Stastny, D. C. Douek, R. A. Koup, M. K. Racke and N. J. Karandikar (2004). "High prevalence of autoreactive, neuroantigen-specific CD8+ T cells in multiple sclerosis revealed by novel flow cytometric assay." Blood **103**(11): 4222-31.
- Cross, S. A., D. R. Cook, A. W. S. Chi, P. J. Vance, L. L. Kolson, B. J. Wong, K. L. Jordan-Sciutto and D. L. Kolson (2011). "Dimethyl Fumarate, an Immune Modulator and Inducer of the Antioxidant Response, Suppresses HIV Replication and Macrophage-Mediated Neurotoxicity: A Novel Candidate for HIV Neuroprotection." Journal of Immunology **187**: 000-000.
- Cunningham, S., C. C. Patterson, G. McDonnell, S. Hawkins and K. Vandebroek (2005). "Haplotype analysis of the preprotachykinin-1 (TAC1) gene in multiple sclerosis." Genes & Immunity **6**(3): 265-70.
- DeFea, K. A., Z. D. Vaughn, E. M. O'Bryan, D. Nishijima, O. Dery and N. W. Bunnell (2000). "The proliferative and antiapoptotic effects of substance P are facilitated by formation of a beta -arrestin-dependent scaffolding

Vilisaar, J.

complex." Proceedings of the National Academy of Sciences of the United States of America **97**(20): 11086-91.

Derocq, J. M., M. Segui, C. Blazy, X. Emonds-Alt, G. Le Fur, J. C. Brelire and P. Casellas (1996). "Effect of substance P on cytokine production by human astrocytic cells and blood mononuclear cells: characterization of novel tachykinin receptor antagonists." FEBS Letters **399**(3): 321-5.

Di Maria, G. U., S. Bellofiore and P. Geppetti (1998). "Regulation of airway neurogenic inflammation by neutral endopeptidase.[see comment]." European Respiratory Journal **12**(6): 1454-62.

Dionne, R. A., M. B. Max, S. M. Gordon, S. Parada, C. Sang, R. H. Gracely, N. F. Sethna and D. B. MacLean (1998). "The substance P receptor antagonist CP-99,994 reduces acute postoperative pain." Clinical Pharmacology & Therapeutics **64**(5): 562-8.

Dumaz, N., R. Marais, N. Dumaz and R. Marais (2005). "Integrating signals between cAMP and the RAS/RAF/MEK/ERK signalling pathways. Based on the anniversary prize of the Gesellschaft fur Biochemie und Molekularbiologie Lecture delivered on 5 July 2003 at the Special FEBS Meeting in Brussels." FEBS Journal **272**(14): 3491-504.

Dun, N. J. and S. Minota (1981). "Effects of substance P on neurones of the inferior mesenteric ganglia of the guinea-pig." Journal of Physiology **321**: 259-71.

Ebers, G. C., A. D. Sadovnick and N. J. Risch (1995). "A genetic basis for familial aggregation in multiple sclerosis. Canadian Collaborative Study Group." Nature **377**(6545): 150-1.

- Edvinsson, L., S. Rosendal-Helgesen and R. Uddman (1983). "Substance P: localization, concentration and release in cerebral arteries, choroid plexus and dura mater." Cell & Tissue Research **234**(1): 1-7.
- Edwards, L. J., R. A. Robins and C. S. Constantinescu "Th17/Th1 phenotype in demyelinating disease." Cytokine **50**(1): 19-23.
- Emonds-Alt, X., J. D. Doutrèmeuich, M. Heaulme, G. Nèliat, V. Santucci, R. Steinberg, P. Vilain, D. Bichon, J. P. Ducoux, V. Proietto and et al. (1993). "In vitro and in vivo biological activities of SR140333, a novel potent non-peptide tachykinin NK1 receptor antagonist." European Journal of Pharmacology **250**(3): 403-13.
- Escher, E., R. Couture, C. Poulos, N. Pinas, J. Mizrahi, D. Theodoropoulos and D. Regoli (1982). "Structure-activity studies on the C-terminal amide of substance P." Journal of Medicinal Chemistry **25**(11): 1317-21.
- Euler, U. S. v. and J. H. Gaddum (1931). "An unidentified depressor substance in certain tissue extracts." Journal of Physiology **72**: 74-87.
- Ferguson, B., M. K. Matyszak, M. M. Esiri and V. H. Perry (1997). "Axonal damage in acute multiple sclerosis lesions." Brain **120**(Pt 3): 393-9.
- Fiebich, B. L., S. Schleicher, R. D. Butcher, A. Craig and K. Lieb (2000). "The neuropeptide substance P activates p38 mitogen-activated protein kinase resulting in IL-6 expression independently from NF-kappa B." Journal of Immunology **165**(10): 5606-11.
- Fiscus, R. R., D. R. Gross, H. Hao, X. Wang, W. A. Arden, R. H. Maley and R. K. Salley (1992). "N omega-nitro-L-arginine blocks the second phase but not the first phase of the endothelium-dependent relaxations induced by

Vilisaar, J.

substance P in isolated rings of pig carotid artery." Journal of Cardiovascular Pharmacology **20 Suppl 12**: S105-8.

Fong, T. M., S. A. Anderson, H. Yu, R. R. C. Huang and C. D. Strader (1992).
Differential activation of intracellular effector by two isoforms of human neurokinin-1 receptor, Molecular Pharmacology. 41 (1) (pp 24-30), 1992.
Date of Publication: 1992.

Fong, T. M., H. Yu, M. A. Cascieri, D. Underwood, C. J. Swain and C. D. Strader (1994). "Interaction of glutamine 165 in the fourth transmembrane segment of the human neurokinin-1 receptor with quinuclidine antagonists." Journal of Biological Chemistry **269**(21): 14957-61.

Franco, R., R. Pacheco, C. Lluís, G. P. Ahern and P. J. O'Connell (2007). "The emergence of neurotransmitters as immune modulators." Trends in Immunology **28**(9): 400-7.

Gaddum, J. H. and H. O. Schild (1934). "Depressor substances in extracts of intestine." Journal of Physiology **83**: 1-14.

Garcia, M., K. Sakamoto, M. Shigekawa, S. Nakanishi and S. Ito (1994). "Multiple mechanisms of arachidonic acid release in Chinese hamster ovary cells transfected with cDNA of substance P receptor." Biochemical Pharmacology **48**(9): 1735-41.

Gerard, N. P., L. A. Garraway, R. L. Eddy, Jr., T. B. Shows, H. Iijima, J. L. Paquet and C. Gerard (1991). "Human substance P receptor (NK-1): organization of the gene, chromosome localization, and functional expression of cDNA clones." Biochemistry **30**(44): 10640-6.

- Gether, U., T. E. Johansen, R. M. Snider, J. A. Lowe, 3rd, S. Nakanishi and T. W. Schwartz (1993). "Different binding epitopes on the NK1 receptor for substance P and non-peptide antagonist." Nature **362**(6418): 345-8.
- Gitter, B. D., D. Regoli, J. J. Howbert, A. L. Glasebrook and D. C. Waters (1994). "Interleukin-6 secretion from human astrocytoma cells induced by substance P." Journal of Neuroimmunology **51**(1): 101-8.
- Greco, S. J., P. Rameshwar, S. J. Greco and P. Rameshwar (2007). "Enhancing effect of IL-1alpha on neurogenesis from adult human mesenchymal stem cells: implication for inflammatory mediators in regenerative medicine." Journal of Immunology **179**(5): 3342-50.
- Greco, S. J., S. V. Smirnov, R. G. Murthy, P. Rameshwar, S. J. Greco, S. V. Smirnov, R. G. Murthy and P. Rameshwar (2007). "Synergy between the RE-1 silencer of transcription and NFkappaB in the repression of the neurotransmitter gene TAC1 in human mesenchymal stem cells." Journal of Biological Chemistry **282**(41): 30039-50.
- Guo, C.-J., S. D. Douglas, Z. Gao, B. A. Wolf, J. Grinspan, J.-P. Lai, E. Riedel and W.-Z. Ho (2004). "Interleukin-1 β upregulates functional expression of neurokinin-1 receptor (NK-1R) via NF- κ B in astrocytes." Glia **48**(3): 259-266.
- Guo, C. J., J. P. Lai, H. M. Luo, S. D. Douglas, W. Z. Ho, C. J. Guo, J. P. Lai, H. M. Luo, S. D. Douglas and W. Z. Ho (2002). "Substance P up-regulates macrophage inflammatory protein-1beta expression in human T lymphocytes." Journal of Neuroimmunology **131**(1-2): 160-7.

- Harmar, A., J. G. Schofield and P. Keen (1980). "Cycloheximide-sensitive synthesis of substance P by isolated dorsal root ganglia." Nature **284**(5753): 267-9.
- Harrington, L. E., R. D. Hatton, P. R. Mangan, H. Turner, T. L. Murphy, K. M. Murphy and C. T. Weaver (2005). "Interleukin 17-producing CD4+ effector T cells develop via a lineage distinct from the T helper type 1 and 2 lineages.[see comment]." Nature Immunology **6**(11): 1123-32.
- Harrison, S. and P. Geppetti (2001). "Substance p." International Journal of Biochemistry & Cell Biology **33**(6): 555-76.
- Ho, W. Z., J. P. Lai, X. H. Zhu, M. Uvaydova and S. D. Douglas (1997). "Human monocytes and macrophages express substance P and neurokinin-1 receptor." Journal of Immunology **159**(11): 5654-60.
- Hoeve, M. A., N. D. L. Savage, T. d. Boer, D. M. Langenberg, R. d. W. Malefyt, T. H. M. Ottenhoff and F. A. W. Verreck (2006). "Divergent effects of IL-12 and IL-23 on the production of IL-17 by human T cells." Eur J Immunol **36**: 661-670.
- Hokfelt, T., B. Pernow and J. Wahren (2001). "Substance P: a pioneer amongst neuropeptides." Journal of Internal Medicine **249**(1): 27-40.
- Hooper, N. M. and A. J. Turner (1987). "Isolation of two differentially glycosylated forms of peptidyl-dipeptidase A (angiotensin converting enzyme) from pig brain: a re-evaluation of their role in neuropeptide metabolism." Biochemical Journal **241**(3): 625-33.

- Huang, R. R., H. Yu, C. D. Strader and T. M. Fong (1994). "Interaction of substance P with the second and seventh transmembrane domains of the neurokinin-1 receptor." Biochemistry **33**(10): 3007-13.
- Ingi, T., Y. Kitajima, Y. Minamitake and S. Nakanishi (1991). "Characterization of ligand-binding properties and selectivities of three rat tachykinin receptors by transfection and functional expression of their cloned cDNAs in mammalian cells." Journal of Pharmacology & Experimental Therapeutics **259**(3): 968-75.
- Ivanov, I. I., B. S. McKenzie, L. Zhou, C. E. Tadokoro, A. Lepelley, J. J. Lafaille, D. J. Cua and D. R. Littman (2006). "The Orphan Nuclear Receptor ROR[gamma] Directs the Differentiation Program of Proinflammatory IL-17+ T Helper Cells." Cell **126**(6): 1121-1133.
- Jafari, N., I. A. Hoppenbrouwers, W. C. J. Hop, M. M. B. Breteler and R. Q. Hintzen (2009). "Cigarette smoking and risk of MS in multiplex families." Multiple Sclerosis **15**(11): 1363-7.
- Joshi, D. D., A. Dang, P. Yadav, J. Qian, P. S. Bandari, K. Chen, R. Donnelly, T. Castro, P. Gascon, A. Haider and P. Rameshwar (2001). "Negative feedback on the effects of stem cell factor on hematopoiesis is partly mediated through neutral endopeptidase activity on substance P: a combined functional and proteomic study." Blood **98**(9): 2697-706.
- Kebir, H., K. Kreymborg, I. Ifergan, A. Dodelet-Devillers, R. Cayrol, M. Bernard, F. Giuliani, N. Arbour, B. Becher and A. Prat (2007). "Human TH17 lymphocytes promote blood-brain barrier disruption and central nervous system inflammation." Nature Medicine **13**(10): 1173-5.

Vilisaar, J.

Khawaja, A. M. and D. F. Rogers (1996). "Tachykinins: receptor to effector." International Journal of Biochemistry & Cell Biology **28**(7): 721-38.

Kincy-Cain, T. and K. L. Bost (1996). "Increased susceptibility of mice to Salmonella infection following in vivo treatment with the substance P antagonist, spantide II." Journal of Immunology **157**(1): 255-64.

Kincy-Cain, T. and K. L. Bost (1997). "Substance P-induced IL-12 production by murine macrophages." Journal of Immunology **158**(5): 2334-9.

Kolls, J. K. and A. Linden (2004). "Interleukin-17 family members and inflammation." Immunity **21**(4): 467-76.

Korn, T., M. Oukka, V. Kuchroo and E. Bettelli (2007). "Th17 cells: effector T cells with inflammatory properties." Seminars in Immunology **19**(6): 362-71.

Kornek, B., M. K. Storch, R. Weissert, E. Wallstroem, A. Stefferl, T. Olsson, C. Linington, M. Schmidbauer and H. Lassmann (2000). "Multiple sclerosis and chronic autoimmune encephalomyelitis: a comparative quantitative study of axonal injury in active, inactive, and remyelinated lesions." American Journal of Pathology **157**(1): 267-76.

Kostyk, S. K., N. W. Kowall and S. L. Hauser (1989). "Substance P immunoreactive astrocytes are present in multiple sclerosis plaques." Brain Research **504**(2): 284-8.

Kramer, M. S., N. Cutler, J. Feighner, R. Shrivastava, J. Carman, J. J. Sramek, S. A. Reines, G. Liu, D. Snavey, E. Wyatt-Knowles, J. J. Hale, S. G. Mills, M. MacCoss, C. J. Swain, T. Harrison, R. G. Hill, F. Hefti, E. M. Scolnick, M. A. Cascieri, G. G. Chicchi, S. Sadowski, A. R. Williams, L. Hewson, D.

Vilisaar, J.

Smith, E. J. Carlson, R. J. Hargreaves and N. M. Rupniak (1998). "Distinct mechanism for antidepressant activity by blockade of central substance P receptors.[see comment]." Science **281**(5383): 1640-5.

Kuhlmann, T., G. Lingfeld, A. Bitsch, J. Schuchardt, W. Bruck, T. Kuhlmann, G. Lingfeld, A. Bitsch, J. Schuchardt and W. Bruck (2002). "Acute axonal damage in multiple sclerosis is most extensive in early disease stages and decreases over time." Brain **125**(Pt 10): 2202-12.

Kurtzke, J. F. (1980). "Epidemiologic contributions to multiple sclerosis: an overview." Neurology **30**(7 Pt 2): 61-79.

Lai, J.-P., S. Lai, F. Tuluc, M. F. Tansky, L. E. Kilpatrick, S. E. Leeman and S. D. Douglas (2008). "Differences in the length of the carboxyl terminus mediate functional properties of neurokinin-1 receptor." Proceedings of the National Academy of Sciences of the United States of America **105**(34): 12605-10.

Lai, J. P., S. D. Douglas and W. Z. Ho (1998). "Human lymphocytes express substance P and its receptor." Journal of Neuroimmunology **86**(1): 80-6.

Laurenzi, M. A., M. A. Persson, C. J. Dalsgaard and A. Haegerstrand (1990). "The neuropeptide substance P stimulates production of interleukin 1 in human blood monocytes: activated cells are preferentially influenced by the neuropeptide." Scandinavian Journal of Immunology **31**(4): 529-33.

Lecci, A., A. Capriati, M. Altamura, C. A. Maggi, A. Lecci, A. Capriati, M. Altamura and C. A. Maggi (2006). "Tachykinins and tachykinin receptors in the gut, with special reference to NK2 receptors in human." Autonomic Neuroscience-Basic & Clinical **126-127**: 232-49.

Vilisaar, J.

Lee, V., Andrews PW (1986). "Differentiation of NTERA-2 clonal human embryonal carcinoma cells into neurons involves the induction of all three neurofilament proteins." J Neurosci **6**: 514-521.

Lee, Y., Y. Kawai, S. Shiosaka, K. Takami, H. Kiyama, C. J. Hillyard, S. Girgis, I. MacIntyre, P. C. Emson and M. Tohyama (1985). "Coexistence of calcitonin gene-related peptide and substance P-like peptide in single cells of the trigeminal ganglion of the rat: immunohistochemical analysis." Brain Research **330**(1): 194-6.

Lembeck, F. (1953). "Zur Frage der Zentralen Übertragung afferenter Impulse II. Mitteilung. Das Vorkommen und die Bedeutung der Substanz P in den dorsalen Wurzeln des Rückenmarks." Arch Exp Pathol Pharmacol **219**: 197-213.

Levite, M. (2008). "Neurotransmitters activate T-cells and elicit crucial functions via neurotransmitter receptors." Current Opinion in Pharmacology **8**(4): 460-71.

Li, H., S. E. Leeman, B. E. Slack, G. Hauser, W. S. Saltzman, J. E. Krause, J. K. Blusztajn and N. D. Boyd (1997). "A substance P (neurokinin-1) receptor mutant carboxyl-terminally truncated to resemble a naturally occurring receptor isoform displays enhanced responsiveness and resistance to desensitization." Proceedings of the National Academy of Sciences of the United States of America **94**(17): 9475-80.

Li, Y., S. D. Douglas, D. E. Pleasure, J. Lai, C. Guo, P. Bannerman, M. Williams and W. Ho (2003). "Human neuronal cells (NT2-N) express functional

Vilisaar, J.

substance P and neurokinin-1 receptor coupled to MIP-1 beta expression."

Journal of Neuroscience Research **71**(4): 559-66.

Lieb, K., B. L. Fiebich, M. Berger, J. Bauer and K. Schulze-Osthoff (1997). "The neuropeptide substance P activates transcription factor NF-kappa B and kappa B-dependent gene expression in human astrocytoma cells." Journal of Immunology **159**(10): 4952-8.

Lieb, K., B. L. Fiebich, M. Busse-Grawitz, M. Hull, M. Berger and J. Bauer (1996). "Effects of substance P and selected other neuropeptides on the synthesis of interleukin-1 beta and interleukin-6 in human monocytes: a re-examination." Journal of Neuroimmunology **67**(2): 77-81.

Lieb, K., H. Schaller, J. Bauer, M. Berger, K. Schulze-Osthoff and B. L. Fiebich (1998). "Substance P and histamine induce interleukin-6 expression in human astrocytoma cells by a mechanism involving protein kinase C and nuclear factor-IL-6." Journal of Neurochemistry **70**(4): 1577-83.

Liu, X. K., J. L. Clements and S. L. Gaffen (2005). "Signaling through the murine T cell receptor induces IL-17 production in the absence of costimulation, IL-23 or dendritic cells." Mol Cells **20**: 339-47.

Lotz, M., J. H. Vaughan and D. A. Carson (1988). "Effect of neuropeptides on production of inflammatory cytokines by human monocytes." Science **241**(4870): 1218-21.

Lowe, J. A., 3rd, S. E. Drozda, R. M. Snider, K. P. Longo, S. H. Zorn, J. Morrone, E. R. Jackson, S. McLean, D. K. Bryce, J. Bordner and et al. (1992). "The discovery of (2S,3S)-cis-2-(diphenylmethyl)-N-[(2-methoxyphenyl)methyl]-1-azabicyclo[2.2.2]-octan-3-amine as a novel,

Vilisaar, J.

nonpeptide substance P antagonist. [erratum appears in *J Med Chem* 1992 Dec 11;35(25):4768]." *Journal of Medicinal Chemistry* **35**(14): 2591-600.

Luber-Narod, J., R. Kage and S. E. Leeman (1994). "Substance P enhances the secretion of tumor necrosis factor-alpha from neuroglial cells stimulated with lipopolysaccharide." *Journal of Immunology* **152**(2): 819-24.

Lucchinetti, C., W. Bruck, J. Parisi, B. Scheithauer, M. Rodriguez and H. Lassmann (2000). "Heterogeneity of multiple sclerosis lesions: implications for the pathogenesis of demyelination." *Annals of Neurology* **47**(6): 707-17.

Macdonald, S. G., J. J. Dumas and N. D. Boyd (1996). "Chemical cross-linking of the substance P (NK-1) receptor to the alpha subunits of the G proteins Gq and G11." *Biochemistry* **35**(9): 2909-16.

Marriott, I. (2004). "The role of tachykinins in central nervous system inflammatory responses." *Front Biosci* **9**: 2153-65.

Martin, F. C., P. A. Anton, J. A. Gornbein, F. Shanahan and J. E. Merrill (1993). "Production of interleukin-1 by microglia in response to substance P: role for a non-classical NK-1 receptor." *Journal of Neuroimmunology* **42**(1): 53-60.

Martin, F. C., A. C. Charles, M. J. Sanderson and J. E. Merrill (1992). "Substance P stimulates IL-1 production by astrocytes via intracellular calcium." *Brain Research* **599**(1): 13-8.

Matis, W. L., R. M. Lavker and G. F. Murphy (1990). "Substance P induces the expression of an endothelial-leukocyte adhesion molecule by

Vilisaar, J.

microvascular endothelium." Journal of Investigative Dermatology **94**(4): 492-5.

Merck (1989). Merck Index: 1398.

Metwali, A., A. M. Blum, L. Ferraris, J. S. Klein, C. Fiocchi and J. V. Weinstock (1994). "Eosinophils within the healthy or inflamed human intestine produce substance P and vasoactive intestinal peptide." Journal of Neuroimmunology **52**(1): 69-78.

Murphy, F. J., M. P. Hayes, P. R. Burd, F. J. Murphy, M. P. Hayes and P. R. Burd (2000). "Disparate intracellular processing of human IL-12 preprotein subunits: atypical processing of the P35 signal peptide." Journal of Immunology **164**(2): 839-47.

Murphy, K. M. and S. L. Reiner (2002). "The lineage decisions of helper T cells." Nat Rev Immunol **2**(12): 933-944.

Nadel, J. A. (1991). "Neutral endopeptidase modulates neurogenic inflammation." European Respiratory Journal **4**(6): 745-54.

Nakanishi, S. (1987). "Substance P precursor and kininogen: their structures, gene organizations, and regulation." Physiological Reviews **67**(4): 1117-42.

Nawa, H., H. Kotani and S. Nakanishi (1984). "Tissue-specific generation of two preprotachykinin mRNAs from one gene by alternative RNA splicing." Nature **312**(5996): 729-34.

Nessler, S., C. Stadelmann, A. Bittner, K. Schlegel, F. Gronen, W. Brueck, B. Hemmer, N. Sommer, S. Nessler, C. Stadelmann, A. Bittner, K. Schlegel, F. Gronen, W. Brueck, B. Hemmer and N. Sommer (2006). "Suppression of autoimmune encephalomyelitis by a neurokinin-1 receptor antagonist--a

Vilisaar, J.

putative role for substance P in CNS inflammation." Journal of Neuroimmunology **179**(1-2): 1-8.

O'Connor, T. M., J. O'Connell, D. I. O'Brien, T. Goode, C. P. Bredin, F. Shanahan, T. M. O'Connor, J. O'Connell, D. I. O'Brien, T. Goode, C. P. Bredin and F. Shanahan (2004). "The role of substance P in inflammatory disease." Journal of Cellular Physiology **201**(2): 167-80.

Oku, R., M. Satoh and H. Takagi (1987). "Release of substance P from the spinal dorsal horn is enhanced in polyarthritic rats." Neuroscience Letters **74**(3): 315-9.

Otsuka, M. and S. Konishi (1976). "Release of substance P-like immunoreactivity from isolated spinal cord of newborn rat." Nature **264**(5581): 83-4.

Page, N. M. (2004). "Hemokinins and endokinins." Cellular & Molecular Life Sciences **61**(13): 1652-63.

Palanche, T., B. Ilien, S. Zoffmann, M. P. Reck, B. Bucher, S. J. Edelstein and J. L. Galzi (2001). "The neurokinin A receptor activates calcium and cAMP responses through distinct conformational states." Journal of Biological Chemistry **276**(37): 34853-61.

Parham, C., M. Chirica, J. Timans, E. Vaisberg, M. Travis, J. Cheung, S. Pflanz, R. Zhang, K. P. Singh, F. Vega, W. To, J. Wagner, A. M. O'Farrell, T. McClanahan, S. Zurawski, C. Hannum, D. Gorman, D. M. Rennick, R. A. Kastelein, R. d. W. Malefyt and K. W. Moore (2002). "A receptor for the heterodimeric cytokine IL-23 is composed of IL-12Rbeta1 and a novel cytokine receptor subunit, IL-23R." Immunol **168**: 5699-708.

Vilisaar, J.

- Park, H., Z. Li, X. O. Yang, S. H. Chang, R. Nurieva, Y.-H. Wang, Y. Wang, L. Hood, Z. Zhu, Q. Tian and C. Dong (2005). "A distinct lineage of CD4 T cells regulates tissue inflammation by producing interleukin 17.[see comment]." Nature Immunology **6**(11): 1133-41.
- Pascual, D. W. and K. L. Bost (1990). "Substance P production by P388D1 macrophages: a possible autocrine function for this neuropeptide." Immunology **71**(1): 52-6.
- Perkins, N. D. (2007). "Integrating cell-signalling pathways with NF-[kappa]B and IKK function." Nat Rev Mol Cell Biol **8**(1): 49-62.
- Piedimonte, G., C. Bertrand, P. Geppetti, R. M. Snider, M. C. Desai and J. A. Nadel (1993). "A new NK1 receptor antagonist (CP-99,994) prevents the increase in tracheal vascular permeability produced by hypertonic saline." Journal of Pharmacology & Experimental Therapeutics **266**(1): 270-3.
- Pinto, F. M., T. A. Almeida, M. Hernandez, P. Devillier, C. Advenier, M. L. Candenias, F. M. Pinto, T. A. Almeida, M. Hernandez, P. Devillier, C. Advenier and M. L. Candenias (2004). "mRNA expression of tachykinins and tachykinin receptors in different human tissues." European Journal of Pharmacology **494**(2-3): 233-9.
- Pleasure, S. J. and Lee (1993). "NTera2 cells: a human cell line which displays characteristics expected of a human committed neuronal progenitor cell." J Neurosci Res **35**: 585-602.
- Pleasure, S. J., C. Page and V. M. Lee (1992). "Pure, postmitotic, polarized human neurons derived from NTera 2 cells provide a system for

Vilisaar, J.

expressing exogenous proteins in terminally differentiated neurons."

Journal of Neuroscience **12**(5): 1802-15.

Plenderleith, M. B., C. J. Haller and P. J. Snow (1990). "Peptide coexistence in axon terminals within the superficial dorsal horn of the rat spinal cord."

Synapse **6**(4): 344-50.

Polman, C. H., S. C. Reingold, B. Banwell, M. Clanet, J. A. Cohen, M. Filippi, K. Fujihara, E. Havrdova, M. Hutchinson, L. Kappos, F. D. Lublin, X.

Montalban, P. O'Connor, M. Sandberg-Wollheim, A. J. Thompson, E.

Waubant, B. Weinshenker and J. S. Wolinsky (2011). "Diagnostic criteria for multiple sclerosis: 2010 revisions to the McDonald criteria." Annals of

Neurology **69**(2): 292-302.

PubChem, P. C. D. (2010). "Substance P - Compound Summary (CID 36511)."

Retrieved 30.11.2010, 2010, from

<http://pubchem.ncbi.nlm.nih.gov/summary/summary.cgi?cid=36511>.

Raffa, R. B. (1998). "Possible role(s) of neurokinins in CNS development and neurodegenerative or other disorders." Neuroscience & Biobehavioral

Reviews **22**(6): 789-813.

Regoli, D., A. Boudon and J. L. Fauchere (1994). "Receptors and antagonists for substance P and related peptides." Pharmacological Reviews **46**(4): 551-99.

Regoli, D., S. Dion, N. E. Rhaleb, N. Rouissi, C. Tousignant, D. Jukic, P. D'Orleans-Juste and G. Drapeau (1989). "Selective agonists for receptors

of substance P and related neurokinins." Biopolymers **28**(1): 81-90.

Reid, M. S., M. Herrera-Marschitz, T. Hokfelt, N. Lindfors, H. Persson and U.

Ungerstedt (1990). "Striatonigral GABA, dynorphin, substance P and

Vilisaar, J.

neurokinin A modulation of nigrostriatal dopamine release: evidence for direct regulatory mechanisms." Experimental Brain Research **82**(2): 293-303.

Reinke, E. and Z. Fabry (2006). "Breaking or making immunological privilege in the central nervous system: the regulation of immunity by neuropeptides." Immunology Letters **104**(1-2): 102-9.

Reinke, E. K., M. J. Johnson, C. Ling, J. Karman, J. Lee, J. V. Weinstock, M. Sandor, Z. Fabry, E. K. Reinke, M. J. Johnson, C. Ling, J. Karman, J. Lee, J. V. Weinstock, M. Sandor and Z. Fabry (2006). "Substance P receptor mediated maintenance of chronic inflammation in EAE." Journal of Neuroimmunology **180**(1-2): 117-25.

Roitt, I., J. Brostoff and D. Male (2001). Immunology. Edinburgh, Mosby.

Rosenkilde, M. M., M. Cahir, U. Gether, S. A. Hjorth and T. W. Schwartz (1994). Mutations along transmembrane segment II of the NK-1 receptor affect substance P competition with non-peptide antagonists but not substance P binding, Journal of Biological Chemistry. 269 (45) (pp 28160-28164), 1994. Date of Publication: 11 Nov 1994.

Roush, E. D. and M. M. Kwatra (1998). "Human substance P receptor expressed in Chinese hamster ovary cells directly activates G(alpha q/11), G(alpha s), G(alpha o)." FEBS Letters **428**(3): 291-4.

Sakurada, C., C. Watanabe, S. Sakurada, K. Tan-No and T. Sakurada (1999). "Major metabolites of substance P degraded by spinal synaptic membranes antagonize the behavioral response to substance P in rats." Journal of Pharmaceutical Sciences **88**(11): 1127-32.

Vilisaar, J.

Sakurada, T., K. Tan-No, T. Yamada, S. Sakurada and K. Kisara (1990).

"Phosphoramidon potentiates mammalian tachykinin-induced biting, licking and scratching behaviour in mice." Pharmacology, Biochemistry & Behavior **37**(4): 779-83.

Schneider, U., H. Schwenk and G. Bornkamm (1977). "Characterization of EBV-

genome negative "null" and "T" cell lines derived from children with acute lymphoblastic leukemia and leukemic transformed non-Hodgkin lymphoma." Int J Cancer **19**: 621–6.

Schroder, E. and K. Lubke (1964). "[On peptide synthesis. C-terminal partial

sequences of eledoisins and eledoisin analogs]." Experientia **20**(1): 19-21.

Severini, C., G. Improta, G. Falconieri-Erspamer, S. Salvadori, V. Erspamer, C.

Severini, G. Improta, G. Falconieri-Erspamer, S. Salvadori and V. Erspamer (2002). "The tachykinin peptide family." Pharmacological Reviews **54**(2): 285-322.

Shen, F. and S. L. Gaffen (2008). "Structure-function relationships in the IL-17

receptor: implications for signal transduction and therapy." Cytokine **41**(2): 92-104.

Shults, C. W., R. Quirion, B. Chronwall, T. N. Chase and T. L. O'Donohue (1984).

"A comparison of the anatomical distribution of substance P and substance P receptors in the rat central nervous system." Peptides **5**(6): 1097-128.

Sigma (1998). Substance P Acetate Salt Hydrate. Product Information CAS#

137348-11-9.

Simeonidis, S., I. Castagliuolo, A. Pan, J. Liu, C.-C. Wang, A. Mykoniatis, A.

Pasha, L. Valenick, S. Sougioultzis, D. Zhao and C. Pothoulakis (2003).

Vilisaar, J.

"Regulation of the NK-1 receptor gene expression in human macrophage cells via an NF-kappa B site on its promoter." Proceedings of the National Academy of Sciences of the United States of America **100**(5): 2957-62.

Simeonidis, S., I. Castagliuolo, A. Pan, J. Liu, C. Wang, A. Mykoniatis, A. Pasha, L. Valenick, S. Sougioultzis, D. Zhao and C. Pothoulakis (2003).

"Regulation of the NK-1 receptor gene expression in human macrophage cells via an NF-κB site on its promoter." Proc Natl Acad Sci **100**: 2957-62.

Skidgel, R. A. and E. G. Erdos (1987). "Cleavage of peptide bonds by angiotensin I converting enzyme." Agents & Actions - Supplements **22**: 289-96.

Smolders, J. and J. Damoiseaux "Vitamin D as a T-cell modulator in multiple sclerosis." Vitamins & Hormones **86**: 401-28.

Snider, R. M., K. P. Longo, S. E. Drozda, J. A. Lowe, 3rd and S. E. Leeman (1991). "Effect of CP-96,345, a nonpeptide substance P receptor antagonist, on salivation in rats." Proceedings of the National Academy of Sciences of the United States of America **88**(22): 10042-4.

Steiner, D. F., S. P. Smeekens, S. Ohagi and S. J. Chan (1992). "The new enzymology of precursor processing endoproteases." Journal of Biological Chemistry **267**(33): 23435-8.

Steinman, L. (2004). "Elaborate interactions between the immune and nervous systems." Nature Immunology **5**(6): 575-81.

Sumner, S. C., K. S. Gallagher, D. G. Davis, D. G. Covell, R. L. Jernigan and J. A. Ferretti (1990). "Conformational analysis of the tachykinins in solution: substance P and physalaemin." Journal of Biomolecular Structure & Dynamics **8**(3): 687-707.

Vilisaar, J.

Svensson, A., J. Kaim, C. Mallard, A. Olsson, E. Brodin, T. Hokfelt, K. Eriksson, A. Svensson, J. Kaim, C. Mallard, A. Olsson, E. Brodin, T. Hokfelt and K. Eriksson (2005). "Neurokinin 1 receptor signaling affects the local innate immune defense against genital herpes virus infection." Journal of Immunology **175**(10): 6802-11.

Takahashi, K., A. Tanaka, M. Hara and S. Nakanishi (1992). "The primary structure and gene organization of human substance P and neuromedin K receptors." European Journal of Biochemistry **204**(3): 1025-33.

Thakker, P., M. W. Leach, W. Kuang, S. E. Benoit, J. P. Leonard and S. Marusic (2007). "IL-23 is critical in the induction but not in the effector phase of experimental autoimmune encephalomyelitis." J Immunol **178**: 2589-98.

Theoharides, T. C., D. Kempuraj, T. Kourelis and A. Manola (2008). "Human mast cells stimulate activated T cells: implications for multiple sclerosis." Annals of the New York Academy of Sciences **1144**: 74-82.

Tokuda, M., R. Miyamoto, T. Sakuta, S. Nagaoka, M. Torii, M. Tokuda, R. Miyamoto, T. Sakuta, S. Nagaoka and M. Torii (2005). "Substance P activates p38 mitogen-activated protein kinase to promote IL-6 induction in human dental pulp fibroblasts." Connective Tissue Research **46**(3): 153-8.

Trapp, B. D., J. Peterson, R. M. Ransohoff, R. Rudick, S. Mork and L. Bo (1998). "Axonal transection in the lesions of multiple sclerosis." New England Journal of Medicine **338**(5): 278-85.

Treede, R. D., T. S. Jensen, J. N. Campbell, G. Cruccu, J. O. Dostrovsky, J. W. Griffin, P. Hansson, R. Hughes, T. Nurmikko and J. Serra (2008).

Vilisaar, J.

"Neuropathic pain: redefinition and a grading system for clinical and research purposes.[see comment]." Neurology **70**(18): 1630-5.

Vandenbroeck, K., P. Fiten, S. Heggarty, A. Goris, E. Cocco, S. A. Hawkins, C. A. Graham, M. G. Marrosu, G. Opdenakker, K. Vandenbroeck, P. Fiten, S. Heggarty, A. Goris, E. Cocco, S. A. Hawkins, C. A. Graham, M. G. Marrosu and G. Opdenakker (2002). "Chromosome 7q21-22 and multiple sclerosis: evidence for a genetic susceptibility effect in vicinity to the protachykinin-1 gene.[see comment]." Journal of Neuroimmunology **125**(1-2): 141-8.

Veldhoen, M., R. J. Hocking, C. J. Atkins, R. M. Locksley and B. Stockinger (2006). "TGFbeta in the context of an inflammatory cytokine milieu supports de novo differentiation of IL-17-producing T cells." Immunity **24**: 179-89.

Vishwanath, R. and R. Mukherjee (1996). "Substance P promotes lymphocyte-endothelial cell adhesion preferentially via LFA-1/ICAM-1 interactions." Journal of Neuroimmunology **71**(1-2): 163-71.

Wang, L. H., S. Ahmad, I. F. Benter, A. Chow, S. Mizutani and P. E. Ward (1991). "Differential processing of substance P and neurokinin A by plasma dipeptidyl(amino)peptidase IV, aminopeptidase M and angiotensin converting enzyme." Peptides **12**(6): 1357-64.

Wang, X., S. D. Douglas, K. G. Commons, D. E. Pleasure, J. Lai, C. Ho, P. Bannerman, M. Williams, W. Ho, X. Wang, S. D. Douglas, K. G. Commons, D. E. Pleasure, J. Lai, C. Ho, P. Bannerman, M. Williams and W. Ho (2004). "A non-peptide substance P antagonist (CP-96,345) inhibits

Vilisaar, J.

morphine-induced NF-kappa B promoter activation in human NT2-N neurons." Journal of Neuroscience Research **75**(4): 544-53.

Weinstock, J. V., A. Blum, A. Metwali, D. Elliott, R. Arsenescu, J. V. Weinstock, A. Blum, A. Metwali, D. Elliott and R. Arsenescu (2003). "IL-18 and IL-12 signal through the NF-kappa B pathway to induce NK-1R expression on T cells." Journal of Immunology **170**(10): 5003-7.

Weinstock, J. V., A. Blum, A. Metwali, D. Elliott and A. R (2003). "IL-18 and IL-12 signal through the NFκB pathway to induce NK-1R expression on T cells." J Immunol **170**: 5003-5007.

Weinstock, J. V. and D. Elliott (1998). "The substance P and somatostatin interferon-gamma immunoregulatory circuit." Annals of the New York Academy of Sciences **840**: 532-9.

Wingerchuk, D. M., C. F. Lucchinetti and J. H. Noseworthy (2001). "Multiple sclerosis: current pathophysiological concepts." Laboratory Investigation **81**(3): 263-81.

Wozniak, A., W. H. Betts, G. McLennan and R. Scicchitano (1993). "Activation of human neutrophils by tachykinins: effect on formyl-methionyl-leucyl-phenylalanine- and platelet-activating factor-stimulated superoxide anion production and antibody-dependent cell-mediated cytotoxicity." Immunology **78**(4): 629-34.

Zhou, Q., F. Nyberg, Q. Zhou and F. Nyberg (2002). "Injection of substance P (SP) N-terminal fragment SP(1-7) into the ventral tegmental area modulates the levels of nucleus accumbens dopamine and dihydroxyphenylacetic acid in

Vilisaar, J.

male rats during morphine withdrawal." Neuroscience Letters **320**(3): 117-20.

Zoffmann, S., U. Gether and T. W. Schwartz (1993). "Conserved HisVI-17 of the NK-1 receptor is involved in binding of non-peptide antagonists but not substance P." FEBS Letters **336**(3): 506-10.

9 Appendices

9.1 Appendix A. Data analysis for real-time qPCR experiments

The experiments employed Mx4000® multiplex qPCR instrument (Stratagene, USA) and SYBR Green detection system (Stratagene, USA). The experiments were performed as two-step quantitative reverse transcriptase PCR reactions, i.e. the reverse transcriptase and qPCR steps were run as separate reactions. The following analysis was routinely performed for each qPCR experiment.

Following qPCR data collection raw fluorescence values and amplification plots were analyzed, any outliers were excluded. “No template control” (NTC) plots, three of which were included in each experiment, were screened for contamination, primer dimer formation, other non-specific increase in the fluorescence signal. For amplification plots the baseline was set such that linear contributions to the fluorescence were subtracted (only range of cycles giving exponential growth of signal contributed). The threshold cycle (Ct) was adjusted as necessary to the exponential or near-exponential phase of all samples.

Standard curve

Relative standard curve method was used as described by Applied Biosystems (AppliedBiosystems 1997). As specified in the experimental chapters, the standard curve was constructed based on Ct values of serial dilutions (usually 1:1, 1:2, 1:5, 1:10, 1:20) from the pool of cDNA made up of equal aliquots from each analyzed sample.

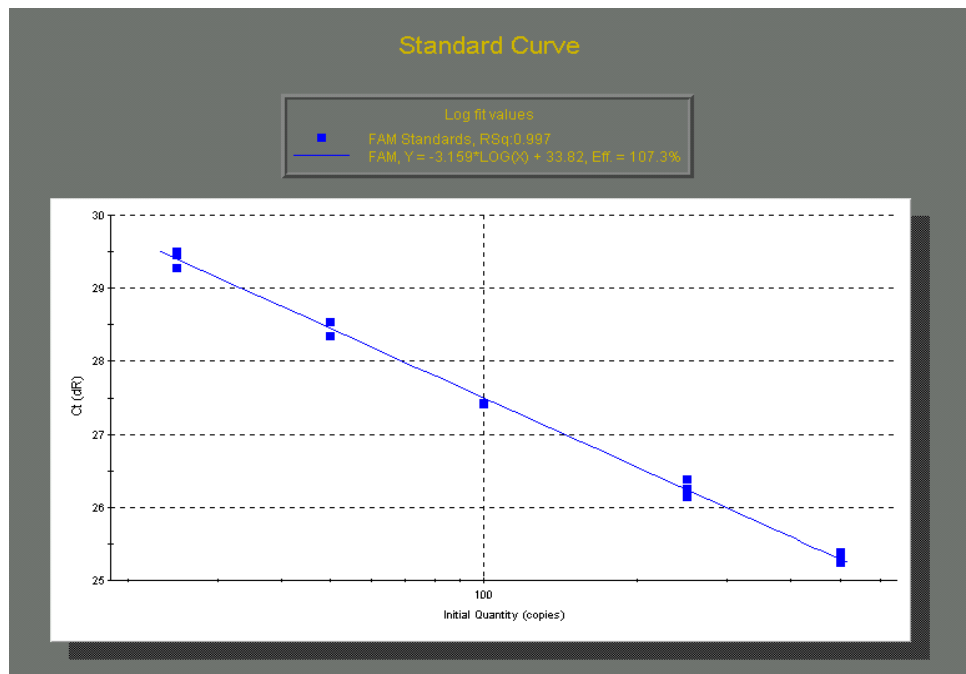

Fig A1. Example of the standard curve output graph. Ct values of the standards are plotted against log of the initial template quantity. The linearity is expressed as Rsq (R^2 or Pearson Correlation Coefficient), the efficiency (E) is derived $E = 10^{(-1/slope)} - 1$. Rsq= 0.997, E= 107.3%.

Vilisaar, J.

Example of standard calculations for finding mRNA abundance for samples

For the above example in Fig A1 the standard curve equation can be expressed as follows:

$$Y = -3.159 \log X + 33.82$$

where Y is the Ct value of an individual sample; X is the mRNA abundance of the transcript (arbitrary units).

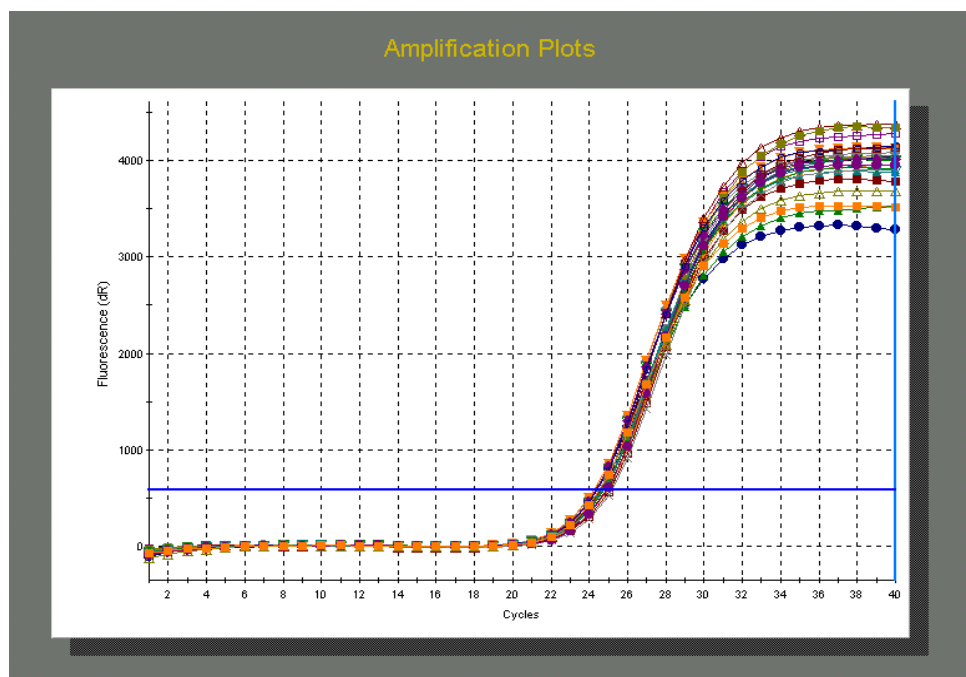

Figure A2. Amplification plots of the unknowns. Ct value correlates to the amount of starting concentration of the target mRNA which can be derived from the standard curve and after normalization can be compared between different stimulation conditions.

Vilisaar, J.

For the qPCR all samples of cDNA were loaded in triplicates for both standards and unknowns and the three Ct values for each standard/unknown were averaged. Using the above standard curve the mean Ct value was applied in the formula to find the mRNA abundance of the unknowns:

$$\log X = \frac{Y - 33.82}{-3.159}$$

Additionally, dissociation curve analysis was included in each experiment to exclude genomic DNA amplification and formation of primer dimers. This is particularly important with SYBR Green system due to non-specific binding of the dye to a double-stranded product. Special care was taken to ensure that single melting curves at right temperatures were obtained for each sample.

The values of individual mRNA abundance were standardized with the corresponding values of the housekeeping gene as specified in the chapters. For the above example of NK1R expression, β 2-microglobulin gene was used as an housekeeping gene. The same procedure as described above was run for the housekeeping gene on the same plate and the ratios of the gene of interest/ housekeeping gene transcribed mRNA abundance were calculated.

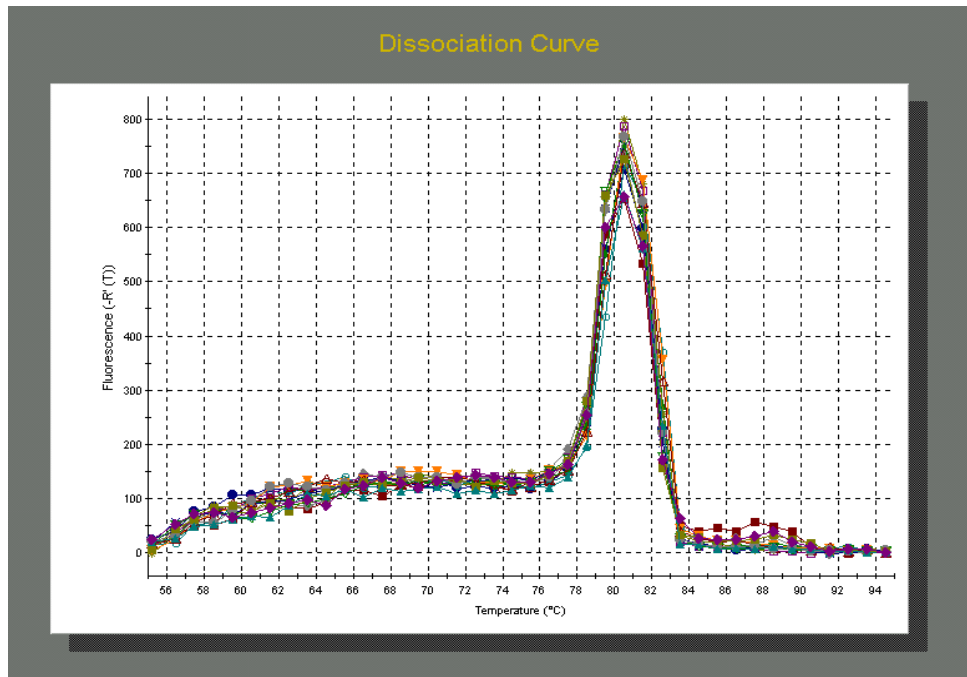

Fig A3. Dissociation curve, as in an example for NK1R, depicts the negative first derivative of raw fluorescence plotted against increasing temperature. Single homogeneous melting curves for each well were obtained, indicating specific amplification.

The final results, expressed in ratios, were comparable between stimulation conditions allowing control for differences in RNA isolation, reverse transcription reaction efficiency and other sample to sample and experiment to experiment technical variability.

9.2 Appendix B. The McDonald Criteria (2010) for Diagnosis of MS

Clinical Presentation	Additional Data Needed for MS Diagnosis
≥2 attacks ^a ; objective clinical evidence of ≥2 lesions or objective clinical evidence of 1 lesion with reasonable historical evidence of a prior attack ^b	None ^c
≥2 attacks ^a ; objective clinical evidence of 1 lesion	Dissemination in space, demonstrated by: ≥1 T2 lesion in at least 2 of 4 MS-typical regions of the CNS (periventricular, juxtacortical, infratentorial, or spinal cord) ^d ; or Await a further clinical attack ^a implicating a different CNS site
1 attack ^a ; objective clinical evidence of ≥2 lesions	Dissemination in time, demonstrated by: Simultaneous presence of asymptomatic gadolinium-enhancing and nonenhancing lesions at any time; or A new T2 and/or gadolinium-enhancing lesion(s) on follow-up MRI, irrespective of its timing with reference to a baseline scan; or Await a second clinical attack ^a
1 attack ^a ; objective clinical evidence of 1 lesion (clinically isolated syndrome)	Dissemination in space and time, demonstrated by: For DIS: ≥1 T2 lesion in at least 2 of 4 MS-typical regions of the CNS (periventricular, juxtacortical, infratentorial, or spinal cord) ^d ; or Await a second clinical attack ^a implicating a different CNS site; and For DIT: Simultaneous presence of asymptomatic gadolinium-enhancing and nonenhancing lesions at any time; or A new T2 and/or gadolinium-enhancing lesion(s) on follow-up MRI, irrespective of its timing with reference to a baseline scan; or Await a second clinical attack ^a
Insidious neurological progression suggestive of MS (PPMS)	1 year of disease progression (retrospectively or prospectively determined) plus 2 of 3 of the following criteria ^e : 1. Evidence for DIS in the brain based on ≥1 T2 lesions in the MS-characteristic (periventricular, juxtacortical, or infratentorial) regions 2. Evidence for DIS in the spinal cord based on ≥2 T2 lesions in the cord 3. Positive CSF (isoelectric focusing evidence of oligoclonal bands and/or elevated IgG index)

If the Criteria are fulfilled and there is no better explanation for the clinical presentation, the diagnosis is "MS"; if suspicious, but the Criteria are not completely met, the diagnosis is "possible MS"; if another diagnosis arises during the evaluation that better explains the clinical presentation, then the diagnosis is "not MS."

^aAn attack (relapse; exacerbation) is defined as patient-reported or objectively observed events typical of an acute inflammatory demyelinating event in the CNS, current or historical, with duration of at least 24 hours, in the absence of fever or infection. It should be documented by contemporaneous neurological examination, but some historical events with symptoms and evolution characteristic for MS, but for which no objective neurological findings are documented, can provide reasonable evidence of a prior demyelinating event. Reports of paroxysmal symptoms (historical or current) should, however, consist of multiple episodes occurring over not less than 24 hours. Before a definite diagnosis of MS can be made, at least 1 attack must be corroborated by findings on neurological examination, visual evoked potential response in patients reporting prior visual disturbance, or MRI consistent with demyelination in the area of the CNS implicated in the historical report of neurological symptoms.

^bClinical diagnosis based on objective clinical findings for 2 attacks is most secure. Reasonable historical evidence for 1 past attack, in the absence of documented objective neurological findings, can include historical events with symptoms and evolution characteristic for a prior inflammatory demyelinating event; at least 1 attack, however, must be supported by objective findings.

^cNo additional tests are required. However, it is desirable that any diagnosis of MS be made with access to imaging based on these Criteria. If imaging or other tests (for instance, CSF) are undertaken and are negative, extreme caution needs to be taken before making a diagnosis of MS, and alternative diagnoses must be considered. There must be no better explanation for the clinical presentation, and objective evidence must be present to support a diagnosis of MS.

^dGadolinium-enhancing lesions are not required; symptomatic lesions are excluded from consideration in subjects with brainstem or spinal cord syndromes.

MS = multiple sclerosis; CNS = central nervous system; MRI = magnetic resonance imaging; DIS = dissemination in space; DIT = dissemination in time; PPMS = primary progressive multiple sclerosis; CSF = cerebrospinal fluid; IgG = immunoglobulin G.

(Polman et al. 2011)

Vilisaar, J.

9.3 Appendix C. The Ethics Committee approval for patient recruitment

Queen's Medical Centre Nottingham 
University Hospital NHS Trust

Please ask for:
Linda Ellis, Administrative Assistant
Ext 41049. E-mail: linda.ellis@mail.qmguh-tr.trent.nhs.uk

Trust Headquarters
Research and Development
Queen's Medical Centre
University Hospital NHS Trust
Nottingham
NG7 2UH

Tel: 0115 970 9049
Fax: 0115 8493295

Our Reference: NS090102

30th November 2001

Dr C S Constantinescu
Department of Neurosciences
D Floor
West Block
UHN

Dear Dr Constantinescu

Re: Inflammatory Mediators/Biological Markers In The Cerebrospinal Fluid And Serum Of Multiple Sclerosis Patients

The Ethics Committee met on 5th November 2001 and approved the project subject to your providing of some information, or clarification. We are now in receipt of this, and the project is now fully approved, including the protocol version 1, patient information sheet dated 26/11/01 and consent form.

The Ethics Committee requires that:

- i) Serious adverse reaction/events, which occur during the course of the project, are reported to the Committee.
- ii) Changes in the protocol are submitted as project amendments to the Committee.
- iii) Yearly reports and a final report on the project to be submitted. (Forms will be sent to Lead Investigator for completion).

Kind regards

Yours sincerely



Dr I M Holland
Honorary Secretary
Ethics Committee

Mr E F Cantle, Chairman Mr J A MacDonald, Chief Executive
Queen's Medical Centre, Nottingham, University Hospital NHS Trust, Nottingham NG7 2UH