

Saikayasit, Rossukorn (2011) The influence of communication modality and shared visual information on collaboration in virtual teams. PhD thesis, University of Nottingham.

Access from the University of Nottingham repository:

http://eprints.nottingham.ac.uk/12068/1/Corrections_final_printed2.pdf

Copyright and reuse:

The Nottingham ePrints service makes this work by researchers of the University of Nottingham available open access under the following conditions.

- Copyright and all moral rights to the version of the paper presented here belong to the individual author(s) and/or other copyright owners.
- To the extent reasonable and practicable the material made available in Nottingham ePrints has been checked for eligibility before being made available.
- Copies of full items can be used for personal research or study, educational, or not-for-profit purposes without prior permission or charge provided that the authors, title and full bibliographic details are credited, a hyperlink and/or URL is given for the original metadata page and the content is not changed in any way.
- Quotations or similar reproductions must be sufficiently acknowledged.

Please see our full end user licence at:

http://eprints.nottingham.ac.uk/end_user_agreement.pdf

A note on versions:

The version presented here may differ from the published version or from the version of record. If you wish to cite this item you are advised to consult the publisher's version. Please see the repository url above for details on accessing the published version and note that access may require a subscription.

For more information, please contact eprints@nottingham.ac.uk

Abstract

The rise of the internet coupled with advancements in computing technology has contributed to the increasing popularity of virtual team working. Virtual teams rely heavily upon the use of mediated communication as face-to-face interaction is limited. Many off-the-shelf collaborative technologies with multiple features are widely accessible in the market to support virtual collaboration. These technologies are being adopted to support uni- and multi-modal interaction in various workplace settings. However the influence of these technologies is often domain specific and is dependent on the type of tasks and teams, thus selecting the most appropriate tool to support a specific collaborative task is difficult.

This thesis investigated the use and influence of communication modality when used to accompany shared workspaces in virtual collaboration, particularly in the design and engineering domain. Empirical studies were conducted in laboratory and field settings to evaluate the effects of modality and shared workspaces on collaboration. Novel and off-the-shelf technologies were examined at different development stages (i.e. from user requirements elicitation, to prototype evaluation, to workplace implementation and evaluation of off-the-shelf technologies). The focus of these studies was to compare audio, audio-visual, text-only and text with additional audio communication within the context of shared workspaces. The purpose was to identify whether these modalities have different effects when used in synergy with shared workspaces for collaboration on spatial and non-spatial tasks. The first series of studies investigated how these modalities were adopted in the workplace individually and/or to supplement other tools in collaborative work. Findings from these studies contributed to the understanding of how modalities are selected to support different aspects of various collaborative tasks. A field study was conducted to evaluate the implementation of an 'always-on' audio-visual feed to provide shared visual information in the workplace suggested that providing shared visual information for remote users could help maintain team awareness. The results suggested that a careful consideration is required to ensure that the context of use, technical constraints and the quality of the audio-visual feed satisfied the end user needs. Finally, to further extend this understanding, laboratory studies were conducted to compare these modalities. The findings suggested that audio-only compared to audio-visual had no influence on collaboration, while text-only communication required no additional audio to support a virtual design task, given that a shared workspace or screen sharing is provided in both settings. Shared workspaces reduce the necessity for virtual team members to verbalise lexically complex information, thus allowing users to concentrate on the core activities of collaborative tasks.

Acknowledgements

I owe my deepest gratitude to my supervisors, Dr. Sarah Sharples, Dr. Harshada Patel and Professor John Wilson for their excellent supervision, guidance, patience and support they gave me over the past 4 years.

I would also like to thank CoSpaces and EPSRC for sponsoring this PhD research. My particular thanks go to the CoSpaces end users for their time and for all the volunteered participants in the studies. In addition, thanks to Dr. Holger Schnädelbach for inviting me to be a part of the field study.

Thanks to everyone at the Human Factors Research Group for their kindness and support. Many thanks also to Nastaran Dadashi, Kirstie Dane, Tamsyn Edwards, Anne Floyde and Laura Millen and for helping out with my experiments.

My eternal thanks to my family for everything they have done for me throughout this long endeavour. My special thanks to my sister Grace Saikayasit. Thanks to all my friends for their constant support, especially Francesca Cheney, Susannah Drummond-Moray, Nyan Kyaw, Newton Li, Jan Sriviroj, E Feng Tan-Loh, Gibb Tungtavaprasith and Eva Yung.

Finally, special thanks to Glyn Lawson for his limitless reserves of encouragement, help and motivation.

Table of Contents

ABSTRACT	I
ACKNOWLEDGEMENTS	II
CHAPTER 1 - INTRODUCTION.....	1
1.1 BACKGROUND	1
1.2 THESIS OVERVIEW	5
CHAPTER 2 - LITERATURE REVIEW	8
2.1 CHAPTER SUMMARY.....	8
2.2 INTRODUCTION TO COLLABORATION.....	8
2.3 CO-LOCATED AND DISTRIBUTED COLLABORATION.....	10
2.4 TECHNOLOGIES USED IN VIRTUAL COLLABORATION	19
2.5 QUALITATIVE AND QUANTITATIVE METHODS IN COLLABORATION STUDIES.....	53
2.6 IDENTIFYING THE RESEARCH AREA.....	60
CHAPTER 3 - EVALUATING THE USE OF QUALITATIVE AND QUANTITATIVE METHODS IN MEASURING COLLABORATION	64
3.1 CHAPTER SUMMARY.....	64
3.2 INTRODUCTION.....	66
3.3 PURPOSE OF CHAPTER 3.....	71
3.4 INTERVIEWS	71
3.5 EXPERT PRIORITY ELICITATION EXERCISE	81
3.6 QUESTIONNAIRES.....	89
3.7 CASE STUDY.....	109
3.8 DISCUSSION	114
3.9 KEY FINDINGS FROM CHAPTER 3	116
CHAPTER 4 - EVALUATING A COLLABORATIVE TECHNOLOGY ENABLING A SHARED VIRTUAL ENVIRONMENT IN THE WORKPLACE – A CASE STUDY	120
4.1 CHAPTER SUMMARY.....	120
4.2 INTRODUCTION.....	121
4.3 PURPOSE OF CHAPTER 4.....	121
4.4 THE COMPANY	122
4.5 MIXED REALITY ARCHITECTURE.....	123
4.6 METHOD.....	126
4.7 RESULTS: PRE-INSTALLATION QUESTIONNAIRES AND INTERVIEWS.....	129
4.8 RESULTS: EXPECTATION OF THE MRA.....	137

4.9	MRA INSTALLATIONS	138
4.10	RESULTS: INTERIM EVALUATION	140
4.11	RESULTS: EXIT EVALUATION	145
4.12	RESULTS AND DISCUSSION	148
4.13	KEY FINDINGS FROM CHAPTER 4	153
CHAPTER 5 - INVESTIGATING THE INFLUENCE OF SHARED VISUAL INFORMATION AND THE USE OF AUDIO-VISUAL COMMUNICATION ON VIRTUAL COLLABORATION.....		158
5.1	CHAPTER SUMMARY.....	158
5.2	INTRODUCTION.....	158
5.3	PURPOSE OF CHAPTER 5.....	164
5.4	METHOD.....	165
5.5	ANALYSIS	178
5.6	RESULTS.....	184
5.7	DISCUSSION.....	199
5.8	KEY FINDINGS FROM CHAPTER 5	203
CHAPTER 6 - INVESTIGATING THE IMPACT OF A SHARED APPLICATION AND THE USE OF INSTANT MESSENGER AND INTERNET PHONE ON VIRTUAL DESIGN TEAMS		208
6.1	CHAPTER SUMMARY.....	208
6.2	INTRODUCTION.....	208
6.3	PURPOSE OF CHAPTER 6.....	210
6.4	METHOD.....	212
6.5	PROCEDURE.....	229
6.6	ANALYSIS	230
6.7	RESULTS.....	235
6.8	DISCUSSION.....	251
6.9	KEY FINDINGS FROM CHAPTER 6	254
CHAPTER 7 - DISCUSSION		258
7.1	DISCUSSION OF RESEARCH FINDINGS	259
7.2	STRENGTHS AND LIMITATIONS OF RESEARCH	274
CHAPTER 8 - CONCLUSIONS.....		277
8.1	RECOMMENDATIONS FOR CoSPACES END USERS.....	278
8.2	FUTURE RESEARCH.....	279
8.3	SUMMARY.....	281
REFERENCES.....		282
APPENDICES.....		294

LIST OF TABLES

Table 2-1: Summary of co-located and virtual collaboration (adapted from Olson and Olson, 2000)	12
Table 2-2: Summary of key findings on the influences of physical proximity on collaboration	19
Table 2-3: Summary of key research in the use of technologies in VTs	24
Table 2-4: Summary of key findings for audio and video information in virtual communication	29
Table 2-5: Summary of key findings on shared visual information	39
Table 2-6: Summary of key findings for text-based communication tools.....	50
Table 2-7: Summary of key findings on communication modality	53
Table 2-8: Methods used to measure collaboration	59
Table 2-9: Key aspects of collaboration investigated in this thesis	63
Table 3-1: Summary of purpose of studies and outcomes	65
Table 3-2: Critical review of research methodology in measuring collaboration.....	70
Table 3-3: Purpose of Chapter 3	71
Table 3-4: Occupations of semi-structured interview participants.....	76
Table 3-5: Skype interview prompts	76
Table 3-6: Comparing semi-structured interviews	80
Table 3-7: Expert priority elicitation question design.....	82
Table 3-8: Three questions asking participants to list and rank influential factors of collaboration and technologies	82
Table 3-9: Categorisation of responses from the expert session and the frequency of responses with descriptive statistics (i.e. the median and mode results from participants' ranking)	86
Table 3-10: Evaluation of collaborative technologies checklist.....	95
Table 3-11: Checklist layout used to evaluate DiFac technologies.....	96
Table 3-12: Summary of number of collaboration questionnaires completed for each technology	96
Table 3-13: Summary of the number of completed collaboration questionnaires for the DiFac in-house evaluation	98
Table 3-14: Summary of median ratings of questionnaire items on a 5-point Likert scale (1 = strongly disagree and 5 = strongly agree). The medians reporting strongly disagree are highlighted.	99
Table 3-15: Outlook questionnaire statements.....	104
Table 3-16: Outlook questionnaire statements with median rating shown for each statement	106
Table 3-17: What do you like about Outlook? (Category and the frequency of responses)..	107
Table 3-18: What do you dislike about Outlook? (Category and the frequency of responses)	107
Table 3-19: How has Outlook influenced your overall collaboration? (Category and the frequency of responses)	108
Table 3-20: Students' choice of collaboration methods and types of communication they support.....	113
Table 3-21: Summary of methods and further uses in the thesis	115
Table 3-22: Chapter 3 summary of key findings	119
Table 4-1: Chapter 4 – purpose of study	122
Table 4-2: Offices and staff distribution	122
Table 4-3: Summary of data collection methods used at different stages of the trial.....	126
Table 4-4: Structure of pre-installation questionnaire	127
Table 4-5: Technologies and the frequency of usage at Company X.....	134
Table 4-6: Advantages and disadvantages of email and the telephone at Company X	136

Table 4-7: Post-demo questionnaire statements and associated median rating scores.....	137
Table 4-8: MRA final installation locations and the frequency of occupation during a working week.....	139
Table 4-9: Frequency of use at the different locations.....	142
Table 4-10: Recommendations which would encourage participants to use the MRA more in future	142
Table 4-11: Statements and median responses on the influence of the MRA system at work from the interim survey.....	144
Table 4-12: The comparison of MRA with email and the telephone and the median responses from the interim survey.....	144
Table 4-13: Influence of MRA on the office environment and the median ratings from the interim survey.....	144
Table 4-14: Summary of reasons for lack of MRA usage - exit survey.....	146
Table 4-15: Statements and median responses on the influence of the MRA system at work from the exit survey.....	147
Table 4-16: The comparison of MRA with email and the telephone and the median responses from the exit survey.....	147
Table 4-17: Influence of MRA on the office environment and the median ratings from the interim survey.....	147
Table 4-18: Comparing the user ratings from the post-demo, interim and exit evaluations on the benefits of the MRA at work	149
Table 4-19: Comparing the user ratings from the interim and exit evaluations on the effectiveness of the MRA vs. the telephone.....	150
Table 4-20: Chapter 4 summary of key findings	157
Table 5-1: Summary of experimental conditions.....	158
Table 5-2: Chapter 5 - purpose of study	164
Table 5-3: Summary of participant information	166
Table 5-4: Post-task questionnaire - satisfaction ratings on performance.....	169
Table 5-5: Post-task questionnaire - subjective ratings on the experience of the task.....	170
Table 5-6: Post-task - subjective rating on the difficulty of the task	170
Table 5-7: Summary of different features provided in the six experimental conditions	177
Table 5-8: Summary of collaboration style categories and group description.....	181
Table 5-9: Summary of top three rankings of houses by four independent judges	183
Table 5-10: Summary of marks awarded to correct houses and ranking positions	183
Table 5-11: Example of scores awarded to final three houses selected (X as an option represents other choices other than A, B or C)	183
Table 5-12: Results of the 2*3 analyses of variance investigating the effects of experimental conditions on the utterances in the collaboration style categories	188
Table 5-13: Summary of post-hoc tests; Tukey HSD values indicate the significant differences in the mean utterances made in two information sharing methods	191
Table 5-14: Summary of descriptive statistics for task performance	196
Table 5-15: Summary of significant differences found on the questionnaire items rated on a 5-point rating scale and the mean ratings of each condition	198
Table 5-16: Summary of the influence of the presence of a shared screen (50% with shared screen and 50% without shared screen).....	202
Table 5-17: Comparison between the 50% without a shared screen and 100% without a shared screen conditions.....	202
Table 5-18: Chapter 5 summary of key findings	207
Table 6-1: Chapter 6 – purpose of study	211
Table 6-2: Summary of participant information	212
Table 6-3: Post-task questionnaire – satisfaction rating of final design.....	215

Table 6-4: Post-task questionnaire on aspects of collaboration	216
Table 6-5: Post-task questionnaire on the frequency of use of off-the-shelf technologies ...	217
Table 6-6: Task selection criteria	218
Table 6-7: Comparison of task scenarios	221
Table 6-8: Summary of design layout of conditions 1 and 2	228
Table 6-9: Collaboration style categories and explanations.....	231
Table 6-10: Bathroom Marking Scheme	234
Table 6-11: Overall communication (condition 1 vs. condition 2).....	235
Table 6-12: Means and standard deviations of collaboration style category utterances	236
Table 6-13: Giving verbal instructions: comparison between condition 1 (IM only) and condition 2 (IM and audio)	238
Table 6-14: Descriptive statistics for IM logs (conditions 1 and 2).....	239
Table 6-15: Post-hoc Test – condition 1 chat vs. condition 2 chat	241
Table 6-16: Condition 2 comparison of audio vs. IM chat	241
Table 6-17: Comparing communication codes - IM chat vs. audio.....	243
Table 6-18: Summary of performance scores of two conditions	244
Table 6-19: Correlation between collaboration style categories and performance score.....	246
Table 6-20: Means and standard deviations of physical behaviour for conditions 1 and 2 ...	247
Table 6-21: Physical behaviour comparison between condition 1 vs. condition 2	247
Table 6-22: Summary of correlations found between the overall level of satisfaction and aspects of collaboration.....	249
Table 6-23: Correlations between overall level of difficulty and aspects of collaboration	249
Table 6-24: Correlations between the difficulty rating of the drawing tablet and collaboration	250
Table 6-25: A summary of participants’ comments after task completion	251
Table 6-26: Chapter 6 summary of key findings	257
Table 7-1: Summary of thesis key findings	263
Table 8-1: Thesis key findings	278

List of Figures

Figure 1-1: Thesis structure	5
Figure 2-1: Topics covered in the literature review.....	8
Figure 2-2: Categories of communication technologies discussed in section 2.4	23
Figure 2-3: MRA-physical and virtual space integration.....	28
Figure 2-4: Online puzzle task (Gergle et al., 2004a; Gergle et al., 2004b)	34
Figure 2-5: Diagrams used by Veinott <i>et al.</i> (1999): Expert's map with route drawn on (left). Novice's map requiring the route to be drawn on (right)	37
Figure 2-6: The use of a whiteboard as part of a decision making task from an experiment by Dillenbourg and Traum (1999) – the diagram illustrates how participants eliminated various clues to solve the mystery during the task	38
Figure 2-7: Image of IM (taken from Windows Live Messenger)	44
Figure 3-1: Illustration of median ranking and the number of appearances of each category (median ranking 1 = most important and 10 = least important).....	87
Figure 3-2: Factory Constructor – 3D virtual factory layout (Bourguignon <i>et al.</i> , 2009).....	91
Figure 3-3: Remote Maintenance – the tool allows users to share views, annotate the shared view of the workspace and initiate text and audio chat (Bourguignon <i>et al.</i> , 2009)	92
Figure 3-4: Collaborative Product Reviewer server (Bourguignon <i>et al.</i> , 2009).....	93
Figure 3-5: Collaborative Product Reviewer - carpet design visualisation tool allowing 3D designs of a carpet to be positioned and superimposed onto a real photo (Bourguignon <i>et al.</i> , 2009).....	93
Figure 3-6: iPortal illustrating the project page and status of other users (Bourguignon <i>et al.</i> , 2009).....	94
Figure 3-7: Layout of Outlook online questionnaire on the frequency of use	103
Figure 3-8: Layout of online Outlook questionnaire (statements listed in Table 3-15).....	104
Figure 4-1: Open-plan office at Office A	123
Figure 4-2: Representation of three MRACells sharing a 3D virtual environment in an MRA system.....	124
Figure 4-3: Images of an MRACell. View from the office of the shared virtual environment (left) and view of others from the environment into the office (right) (Schnädelbach <i>et al.</i> , 2007).....	125
Figure 4-4: MRA privacy feature: open (left), semi-closed (middle), offline or unavailable (right) (Schnädelbach <i>et al.</i> , 2007).....	125
Figure 4-5: MRACell – Office A (main office)	139
Figure 4-6: MRA in the boardroom at Company X (participants were blurred to protect anonymity).....	140
Figure 4-7: How often do you typically use the MRA system for communication? (n=19)....	141
Figure 4-8: Extract from the interim questionnaire on the influence of the MRA system (the company name has been blanked for confidentiality purpose).....	143
Figure 4-9: Typical frequency of MRA use reported in the exit survey	146
Figure 4-10: Usage comparison between interim and exit surveys	149
Figure 5-1: Three steps involved in hidden profile tasks (Kerr and Murthy, 2009).....	162
Figure 5-2: Experimental setup diagram of the experiment	167
Figure 5-3: Illustration of experimental setup for conditions with a shared screen	167
Figure 5-4: Rent expressed in area shown on a map.....	173
Figure 5-5: Locations of all ten houses	174
Figure 5-6: Integrated information given to independent judges during the development of a marking scheme including locations of houses, price and crime zones (not given to participants).....	182
Figure 5-7: Total number of utterances in each condition.....	184

Figure 5-8: Means of all 11 collaboration style categories across all six experimental conditions	185
Figure 5-9: Mean comparison of audio-only and audio-visual conditions	187
Figure 5-10: Mean comparison of shared visual information	187
Figure 5-11: Illustration of performance means from the six experimental conditions	196
Figure 6-1: Paint application used as e-whiteboard	213
Figure 6-2: Unisex wheelchair-accessible toilet with corner WC and bathtub (source: Approved Document M)	223
Figure 6-3: Height restrictions for bathroom layout (source: Approved Document M)	224
Figure 6-4: Bathtub grab-rails and fittings	225
Figure 6-5: Design guidelines for bathroom layout	226
Figure 6-6: Total number of utterances (condition 1 IM-only vs. condition 2 IM and audio)	235
Figure 6-7: Mean utterances of text-only vs. text and audio conditions.....	236
Figure 6-8: Comparing the mean utterances between chat logs taken from condition 1 and condition 2	240
Figure 6-9: Comparison between the total number of utterances on audio vs. IM chat.....	242
Figure 6-10: Comparison between the mean number of utterances for IM chat and audio to communicate for each collaboration style category	242
Figure 6-11: Bathroom design of the pair of participants with the highest mark in condition 1	245
Figure 6-12: Bathroom design of the pair of participants with the highest mark in condition 2	245
Figure 6-13: IM emoticons.....	246
Figure 6-14: Mean comparison of physical behaviour between conditions	247

Chapter 1 - Introduction

1.1 Background

Research in supporting virtual teams and collaboration has become increasingly important along with the move towards globalisation. The increasing use of groupware or computer-mediated communication (CMC) tools which allow two or more users to interact with each other across time and distance has resulted from the availability of the Internet and greater bandwidth (Gutwin and Greenberg, 2000). Many commercial technologies supporting different modes of communication in remote interaction have also become more widely accessible and thus more widely used.

Many organisations have adopted the use of virtual teams, whose members work together towards common task goals across time and distance (Edwards and Wilson, 2004). The benefits of virtual team working include the ability to utilise resources, be located closer to the market and recruiting experts from all over the globe regardless of their physical locations. However, the geographical distance separating each member has altered the way in which teams collaborate by moving towards mediated communication and away from face-to-face meetings, which can often be expensive and difficult to arrange. These teams rely heavily on technologies which allow and support remote coordination, cooperation and collaboration regardless of the physical distance between team members.

Different research fields such as computer science, human factors, engineering, management, education and healthcare have examined ways to support virtual collaboration (Schmidt, 2009). Early researchers of mediated communication used their observations on face-to-face interactions to influence their theoretical hypotheses to form the view that multi-modal technologies (e.g. audio and visual) offer better solutions than uni-modal ones (e.g. audio-only) (Whittaker, 2003). This therefore led to the development of video-conferencing systems, which provide users with a video of each other as well as audio. However, the results of these studies comparing uni- and multi-modal technologies have not led to clear agreement on the influence of communication modality on collaboration or how these technologies support different types of collaborative tasks. Many of these research fields use different definitions of collaboration which consider and focus on different elements. Wilson *et al.* (2009) further suggests that supporting collaboration is dependent on many factors such as the type of task, the availability of skills and resources, team attributes and individuals involved. This adds to the difficulty of selecting collaborative technologies for

a particular task in a specific setting. Furthermore, various collaborative technologies with multiple features to support virtual interaction (e.g. audio, video-conferencing, web-seminars, shared workspaces and shared virtual environment with avatars representing users etc.) are readily available in the market, while the influence of these technologies on different collaborative tasks remains unclear.

Studies have examined and compared the use and aspects of collaborative technologies, such as modality and shared visualisation to support collaboration. Previous research directly compared either the use of communication modality (i.e. audio-only vs. audio-visual) or the presence of shared visualisation (i.e. with a shared workspace vs. without a shared workspace) but limited consideration of when they are adopted together as an integrated solution to support the same collaborative task.

This thesis aimed to investigate the influence of these technologies as an integrated solution on virtual collaboration, pattern of technology use when users are able to select between technologies, user satisfaction and task performance, particularly in design and engineering. The focus of this research thesis was motivated by and was conducted within the context of CoSpaces. CoSpaces (IST-5-034245) is a 48-month European Commission funded Integrated Project, which involves researchers, end users and developers from different institutes and organisations from 12 European countries. The project consortium worked together to achieve the overall objective of developing collaboration models and innovative collaborative workspaces to support co-located, distributed and mobile settings in engineering and design (within the automotive, aerospace and construction industries).

The work presented in this thesis was conducted independently from and mainly in parallel with the CoSpaces project. The only study conducted as part of the CoSpaces is presented in Section 3.4.2. The purpose of the work conducted in this thesis was solely to fulfil the aims and objectives of this research thesis and not that of CoSpaces. However, it should be noted that the focus and findings of the CoSpaces project inspired some of the work (i.e. experimental tasks and rationales) for studies in Chapter 5 and Chapter 6.

The main aim of this thesis was to investigate the influence of communication modality in collaborative technologies and the use of shared workspaces on supporting virtual collaboration. Laboratory and field studies were conducted to include various task contexts such as spatially orientated decision making and design tasks. As part of the investigation, the research observed the effects of technologies on collaboration (including conversational

communication and information exchange), effectiveness of collaboration (i.e. performance) and the overall satisfaction of users.

The following objectives contributed to the achievement of the overall objective of this thesis:

1: *Evaluate approaches to examine the use of technologies to support collaboration in a range of contexts*

Methods used to examine collaboration in different contexts were compared in order to inform the most appropriate data collection methods for the main studies conducted in this thesis. Various qualitative and quantitative approaches have been adopted by researchers investigating collaboration and the influence of technologies on collaborative work. A review of these methods was conducted as part of the literature review (Chapter 2). The most frequently used methods were employed in this thesis to measure collaboration and the influence of technologies in industry and university settings (Chapter 3) to identify the appropriateness of these methods in different settings.

2: *Understand and evaluate the influence of communication modality on collaborative tasks*

Empirical studies were conducted in the laboratory and in the field to investigate the effects of communication modality on supporting virtual collaborative tasks, team awareness and how communication technologies are adopted with regards to the context of use, user needs and behaviours. Synchronous and asynchronous off-the-shelf technologies used to support verbal, textual and spatial information (such as email, shared calendar, Instant Messenger and internet telephone) were examined in commercial, educational and research settings (Chapters 3 and 4). Studies compared the use and the influence of audio, video and text based technologies in the workplace (Chapter 3), on collaborative decision making (Chapter 5) and design tasks (Chapter 6). The following research questions were extracted from the literature and were used to focus the studies conducted to satisfy this objective:

- How important is it for technologies to suit user needs, context of use, task and do users alter behaviours to fit technological constraints?
- How can technology help to maintain an awareness of remote colleagues and tasks?
- Is audio the most useful communication modality in remote tasks?
- Does being able to see and hear remote colleagues enhance user satisfaction?

3: Investigate the use of shared workspaces and shared visual information when used with synchronous communication tools in collaborative tasks

The Mixed Reality Architecture system was implemented in a workspace; the system continuously connects remote offices together over a shared virtual space to provide a constant communication channel (audio and visual). The influence of this technology on collaboration was evaluated (Chapter 4). Shared visual information tools were investigated in two laboratory experiments: first to provide a shared view of the textual and spatial information space in a collaborative decision making task (Chapter 5), and second, to provide a shared drawing space for a virtual collaborative design task (Chapter 6). The findings from these studies were used to answer the following research questions which contribute to this objective:

- Is there a need for technology to support more than spoken language for planned and unplanned collaboration?
- Is a shared view of the workspace in remote collaboration more useful than a view of the remote colleague?

1.2 Thesis overview

This section presents an overview of each of the contributing chapters to the thesis. The structure of the thesis is illustrated in Figure 1-1.

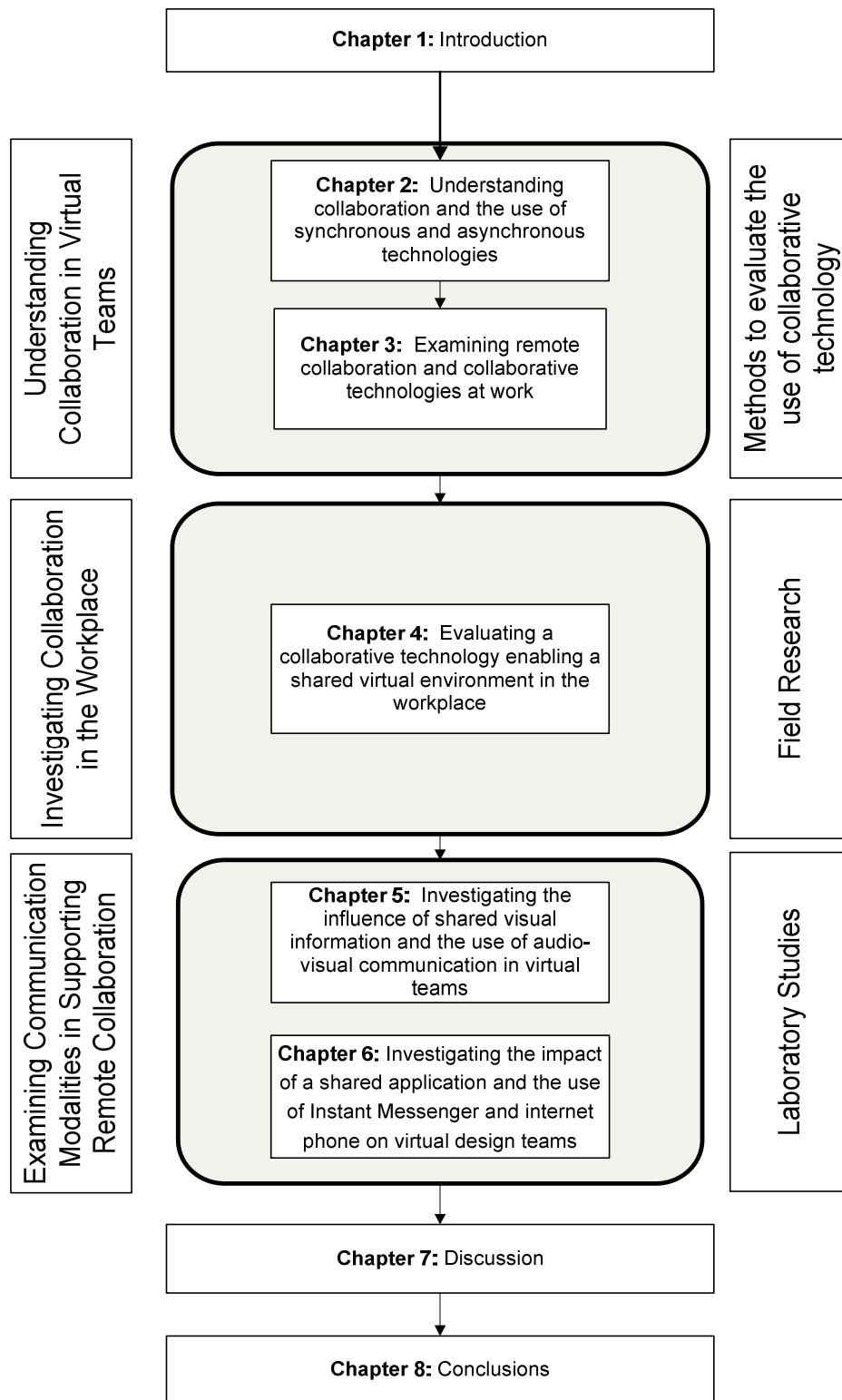

Figure 1-1: Thesis structure

Chapter 2: A literature review consolidated the understanding and requirements of virtual collaboration and mediated communication. This review covered fields such as management, human factors, engineering, psychology, computer-supported cooperative work (CSCW), computer-supported collaborative learning (CSCL) and human-computer interaction (HCI). Much research has been done in these areas and therefore this initial review was essential to fully appreciate the complexity of collaboration. Chapter 2 summarises literature from these fields.

Chapter 3: A series of small studies were conducted in order to examine the use of various qualitative and quantitative data collection methods as well as to investigate several aspects of virtual collaboration influenced by the use of communication technologies. This chapter presents six pilot studies investigating: 1) user requirements for collaborative technologies, 2) the use of internet telephone (Skype), 3) the expert prioritisation of aspects of collaboration, 4) the evaluation of novel collaborative technologies using the checklist developed in the expert prioritisation exercise, 5) the use of Microsoft Outlook's shared calendar feature, and 6) the use of communication tools in a student project. These studies employed several data collection methods: two interviews, one expert priority elicitation, two questionnaires and one case study. The findings from the expert priority elicitation were used to design a collaboration checklist to evaluate collaborative features of technologies. Furthermore, findings were also used to inform the design of the commercial case study presented in Chapter 4 and later laboratory studies (Chapters 5 and 6).

Chapter 4: This chapter describes a field study undertaken to evaluate the use of mediated communication in the form of an 'always-on' media space called the Mixed Reality Architecture (MRA). The MRA connects remote users through a shared virtual environment with a live audio and video feed. The system was adopted to complement other existing communication channels in an industrial organisation. This field study used interviews, questionnaires and focus groups to evaluate collaboration in the workplace. The company involved was a medium sized enterprise with one main head office accommodating the majority of staff and two smaller branches abroad as well as three home offices in the UK.

Chapter 5: This chapter presents a laboratory study investigating the influence of communication modality and shared visual information on a spatially oriented collaborative decision making task. The task was referred to as 'House Hunting', which required participants to work in pairs and select three out of ten given houses that they would like to rent together, according to their given conflicting criteria. This experiment examined two

modes of communication (audio-only vs. audio and video) and three information sharing methods enabling shared visual context: 1) no shared visual information – (participants in pairs were given half of the information each), 2) screen sharing enabling shared visual information – (participants could see each other's screen but were given half of the information each), and 3) participants working in pairs were both given all the required information. The experiment had six experimental conditions and 96 participants were involved.

Chapter 6: This chapter describes a laboratory experiment examining the use of a shared workspace such as a virtual whiteboard combined with different communication modes (i.e. text-only vs. text and audio) in two experimental conditions, each with 10 pairs of participants. The task developed for this study was referred to as 'Bathroom Design'. Participants were required to collaborate remotely in their pairs to design a bathroom (i.e. complete a spatially-oriented design task). Each participant in a pair was given a different half of the design guidelines.

Chapter 7: This chapter presents a general discussion of all the key findings obtained from the research studies with the aim of drawing conclusions on how to support virtual collaboration and use of collaborative technologies in different settings with regards to the tasks and user requirements.

Chapter 8: The thesis concludes with a summary of findings and recommendations for future research in the area of supporting virtual collaboration and the use of technologies in design and engineering. Recommendations for CoSpaces end users, which are drawn from the key findings of this thesis are also presented in this chapter.

Chapter 2 - Literature Review

2.1 Chapter Summary

This chapter reviews and summarises literature relevant to supporting collaboration. Much research has been done in supporting collaboration from different perspectives, such as investigating different types of technologies for use in different tasks, contexts and organisations. Collaboration exists in two main settings, referred to as co-located (when members are in the same physical space) and remote or distributed (when members are geographically dispersed). The nature of co-located and distributed collaboration are reviewed and compared in this chapter, however only the latter is further discussed in relation to supporting technologies. The structure of this chapter is represented in Figure 2-1.

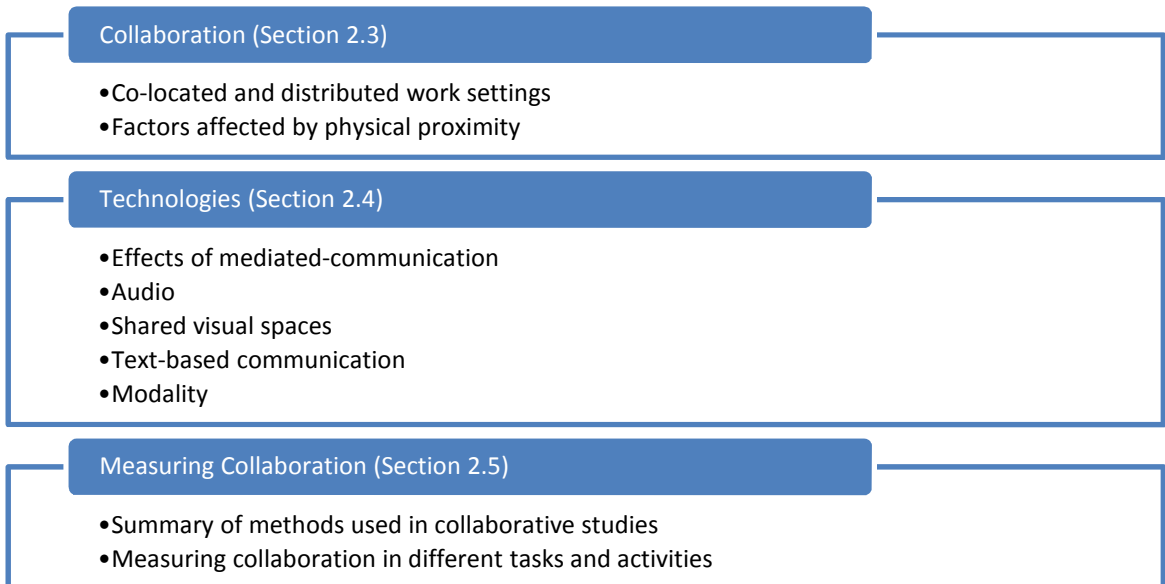

Figure 2-1: Topics covered in the literature review

2.2 Introduction to Collaboration

The first part of this chapter presents an overview of collaboration, which is a concept that has been researched in many fields including business and management, psychology, human factors, human-computer interaction, computer-supported cooperative work, engineering and design, healthcare and education (Wilson *et al.*, 2009). Researchers in these fields have investigated ways to support co-located and distributed collaboration in teams, with the latter being the newer subset of collaboration (though it has been investigated and examined for over 20 years) (Bradner and Mark, 2002). This research is more relevant now with the increasing use of computer-mediated communication tools and the increasing connectivity of

the internet, allowing organisations to adopt and rely on these tools to support teams whose members are geographically distributed to one another (Gutwin and Greenberg, 2000).

Collaboration has been described in various ways; however the main understanding from these definitions of collaboration is that it is the process which takes place when two or more people coordinate, communicate, and cooperate with each other to reach a common goal (Schrage, 1990; Klein, 2001; Weiseth *et al.*, 2006; Wilson *et al.*, 2009) by sharing information, establishing common ground and shared understanding (Clark and Brennan, 1991; Dillenbourg and Traum, 1999; Birnholtz *et al.*, 2005) as well as maintaining mutual awareness of each other (Schmidt and Bannon, 1992; Artman and Wærn, 1999; Schmidt, 2002). This definition suggests that there are interdependencies amongst team members, though each may have his/her individual goals, in addition to a common goal which all parties want to achieve (Klein, 2001).

Team coordination involves different stages and each requires different support systems. These stages as defined by Kline (2001) are: preparation, planning, direction, execution and assessment. The preparation stage requires the sharing of information and management of the availability of resources so that all participants receive appropriate and meaningful information for their tasks. The planning stages require support to allow members to establish and maintain common ground. Having clearly defined directions is crucial as this involves teams transferring their established knowledge into ways forward for themselves and their colleagues, whilst execution involves monitoring and alignment in order to maintain the ultimate level of performance, and assessment is the phase in which the team can assess how well it is doing (Klein, 2001).

Cooperation, as another aspect of collaboration, implies that members work independently, but together, in their efforts in order to achieve mutual benefits, though they may not necessarily have the same common goals (van Leeuwen and Fridqvist, 2006; Liu *et al.*, 2008). This includes sharing knowledge, expertise and experience among the team in order for members to accomplish mutual benefits (Liu *et al.*, 2008).

Face-to-face and computer-mediated collaboration has been studied widely in the fields of computer-supported cooperative work (CSCW) (Egido, 1988; Heath and Luff, 1992; Bellotti and Bly, 1996; Bannon and Bødker, 1997; Fussell *et al.*, 2000; Schmidt, 2009), computer-mediated communication (CMC) (Preece *et al.*, 2002; Whittaker, 2003; Schmidt, 2009), small group research (McGrath, 1997), Group Support Systems (GSS) (DeSanctis and Gallupe, 1987)

and computer-supported collaborative learning (CSCL) (Ocker and Yaverbaum, 1999; Lipponen, 2002; Rummel and Spada, 2005). Different terms have evolved to describe similar systems which fundamentally are computer-based communication tools or systems used to support virtual collaboration (Beranek and Martz, 2005). CSCW and CSCL have produced the most popular models to investigate team working (Leinonen *et al.*, 2005).

Mobile Virtual Work (MVW) is a concept which suggests that in many areas such as maintenance, sales, healthcare and logistics, users are becoming more mobile and are collaborating on the move instead of from a fixed location (i.e. an office) (Andriessen and Vartiainen, 2006). The increase in this type of work is driven by the competition in the markets (e.g. globalisation) as well as a cost reduction solution. The availability of technologies such as mobile phones and hand-held equipment allow users to stay connected, thus collaborate while being mobile (Andriessen and Vartiainen, 2006). In addition, collaboration can also exist amongst individuals not working as part of a team, and in some cases even with competitors in the same industry to develop better solutions, for example. This is described as mass collaboration, where some companies have adopted open-source as a way of collaborating over the internet, by taking the risk to share proprietary data to allow interested experts across the globe, who are not necessarily part of the organisation, to virtually solve problems and submit possible solutions to the company (Tapscott and Williams, 2008). MVW and mass collaboration are however beyond the scope of this thesis.

2.3 Co-located and Distributed Collaboration

The process of collaboration can happen when team members are spontaneously interacting at the same time, which is referred to as 'synchronous' collaboration. It can also take place when members are not interacting at the same time, with a delay in responses, which is referred to as 'asynchronous' collaboration. Another aspect to consider is the physical proximity of people engaged in collaboration and how this influences collaboration (Bradner and Mark, 2002) - the following section discusses this.

There are two settings of collaboration which are mainly categorised by the physical proximity of those involved in the interactions. The first is referred to as 'co-located' collaboration, where team members are located in the same office or building, referred to as 'co-present' (Clark and Brennan, 1991), and the second, is referred to as 'distributed', 'remote' or 'virtual' collaboration, when team members are geographically dispersed and interact with each other through an electronically mediated infrastructure (Olson and Olson, 2000; Edwards and Wilson, 2004). The term "virtual" is commonly used to describe the

absence or reduction of physical artefacts, and hence in distributed collaboration, the reduction of physical interactions (Wilson, 2006).

Virtual teams (VTs) are usually typified as those consisting of geographically distributed members who are involved in virtual collaboration using various types of communication tools (Hammond *et al.*, 2001; Driskell *et al.*, 2003; Huysman *et al.*, 2003; Edwards and Wilson, 2004; Martins *et al.*, 2004; Lee-Kelley and Sankey, 2008; Branson *et al.*, 2008; de Jong *et al.*, 2008), to achieve “virtual co-location” and overcome difficulties (those associated with culture, language, time and organisational boundaries) caused by a lack of physical proximity (Olson and Olson, 2000), in order to achieve competitive gains, flexibility and productivity outcomes (Hacker and Lang, 2000; Martins *et al.*, 2004; Edwards and Wilson, 2004; Beranek and Martz, 2005; Greenberg *et al.*, 2007; Bergiel *et al.*, 2008). This type of team is becoming increasingly common and fast-growing in organisations (Edwards and Wilson, 2004; Horwitz *et al.*, 2006; de Jong *et al.*, 2008), providing the benefit of recruiting experts regardless of their geographical location (Greenberg *et al.*, 2007; Bergiel *et al.*, 2008). The rise of VTs is supported by the growth, lowering costs and the availability of technology and benefits of these technologies such as to enhance cohesiveness, satisfaction and performance (e.g. productivity and work quality) (Edwards and Wilson, 2004; Horwitz *et al.*, 2006).

Historically, prior to the rise of VTs, organisational teams were constricted by geographical and temporal limitations and meetings were mainly held face-to-face, scheduled around the availability of members (Beranek and Martz, 2005). VTs can therefore be seen as a way to cut travel time, cost and effort associated with face-to-face meetings (Bergiel *et al.*, 2008).

VTs have been categorised by Edwards and Wilson (2004) as: project teams (assembled in response to a specific project brief), service teams (provide support and resources as their main function) and process teams (formed in response to an ongoing need). They further suggest that the nature of collaboration greatly depends on the type of team and their goals (Edward and Wilson, 2004).

Co-located and virtual teams often engage in both synchronous and asynchronous collaboration, which are supported by different technologies. The differences between co-located and VTs in both synchronous and asynchronous collaboration were identified by Olson and Olson (2000) and are summarised in Table 2-1.

	Co-located	Virtual
Synchronous	<ul style="list-style-type: none"> • Participants are co-present in time and space (interactions take place synchronously such as face-to-face meetings) • Members share social settings and have access to common spaces for interactions • Technologies are sometimes used in this setting such as Instant Messenger and telephony 	<ul style="list-style-type: none"> • Members are geographically dispersed in space and/or time • Distributed members communicate via mediated collaboration tools at the same time, e.g. telephone, video-conferencing system, Instant Messenger, shared applications and shared whiteboard
Asynchronous	<ul style="list-style-type: none"> • Participants are in the same place i.e. same office. However, they are unable to interact at the same instant • Technologies such as email and message boards can be used 	<ul style="list-style-type: none"> • Team members are unable to communicate in real-time whilst being geographically distributed • Email, virtual message boards and voicemail are often used to collaborate

Table 2-1: Summary of co-located and virtual collaboration (adapted from Olson and Olson, 2000)

VTs are required to overcome problems imposed by the lack of physical proximity, which influence various factors affecting the effectiveness of the overall collaboration (Olson and Olson, 2000).

People have reported a preference for face-to-face interactions when possible, especially if they are within walking distance to one another (Bellotti and Bly, 1996; Ocker and Yaverbaum, 1999; Santhanam, 2001) and are more likely to initiate a collaboration or new work projects with their co-located colleagues (Kiesler and Cummings, 2002). Furthermore, many studies also suggest that the lack of proximity negatively affects the frequency of face-to-face and mediated communication within teams (Kraut *et al.*, 1990; Whittaker *et al.*, 1994; Isaacs *et al.*, 1997; Olson and Olson, 2000; Bradner and Mark, 2002; Schmidt, 2002; Kiesler and Cummings, 2002). In addition, the lack of physical proximity also increases the difficulty of team coordination (Olson and Olson, 2000; Driskell *et al.*, 2003) whilst the lack of observation and presence of other members hinders the group decision making process and shared understanding (Kiesler and Cummings, 2002; Leinonen *et al.*, 2005). These studies suggest some degree of difficulty in virtual collaboration.

In situations where individuals have to collaborate with both co-located and distributed colleagues, Andres (2006) and Fussell *et al.* (2004) found that individuals collaborated and shared more information with their co-located team members. Furthermore, co-located colleagues who were to collaborate face-to-face formed a stronger sense of group. They often gave higher priorities to requests from their co-located colleagues than their remote

colleagues and as a result, outperformed those working remotely (Sadat Shami *et al.*, 2004). Moreover, as individuals focus more attention on their co-located collaboration when they are required to multi-task (Kiesler and Cummings, 2002; Fussel *et al.*, 2004; Gonzalez and Mark, 2005), responses to their remote colleagues are further delayed (Scupelli *et al.*, 2005).

The lack of face-to-face interactions can lead to misunderstanding; individuals often perceive their remote colleagues to be over domineering in virtual discussions. This results in negative feelings towards those perceived as dominant (Peña *et al.*, 2007). A study by Peña *et al.* (2007) compared the dominance perception between co-located and distributed settings and found that individuals rate their co-located colleague's level of dominance as close to neutral whilst the opposite is observed in distributed teams.

Physical proximity also influences other factors such as technologies used (see Section 2.4), team and task awareness (Olson and Olson, 2000; Kraut *et al.*, 2002a; Leinonen *et al.*, 2005), trust building approach (Rocco, 1998; Greenberg *et al.*, 2007), management style (Beranek and Martz, 2005; Lee-Kelly and Sankey, 2008) and communication (Kraut *et al.*, 2002a; Bergiel *et al.*, 2008; Branson *et al.*, 2008). The following sections present literature on the effects of physical proximity (i.e. whether participants are co-located or remote from one another) on the overall collaboration.

2.3.1 Awareness and Common Ground

Being co-present (Clark and Brennan, 1991) with colleagues means individuals' attention and social impact towards each other increases (Kiesler and Cummings, 2002). Individuals are able to share all visual, verbal and social cues with each other, in real-time, which allows them to process the same information during an interaction (Driskell *et al.*, 2003). These cues enable them to establish a sense of awareness of their working environment as well as equip them with crucial information to develop common ground (Schmidt, 2002; Kraut *et al.*, 2003; Neale *et al.*, 2004). Visual co-presence refers to the level of shared visual environment during collaboration (Gergle *et al.*, 2004b).

Co-located team members sharing the same environment surreptitiously monitor their colleagues' work and update themselves with a continuous flow of information including visual and audio cues. Audio cues such as 'overhearing' in co-located settings have been shown to support awareness in teams (Heath and Luff, 1992; Sharples *et al.*, 2007). These cues allow team members to adapt to dynamic changes, relying on the new information they receive. Heath and Luff (1992) studied collaborative work between co-located colleagues

within a Line Control Room of the London Underground and observed that members updated their own work or volunteered relevant information to their colleagues without direct requests, as a result of overhearing conversations. Similarly Cox *et al.* (2007) observed collaboration in air traffic control and examined how experts interacted with each other as well as the computer systems as part of their tasks. The study found that overhearing enabled team members to receive verbal instructions, which were not initially directed to them, but relevant to their work to provide them with an update of the working situation (Cox *et al.*, 2007).

Visual cues are also shared in a co-located environment, providing the inhabitants with information to promote situation awareness and helping to reduce any extra effort required to ensure that they understand each other (Kraut *et al.*, 2003). These cues include facial expressions, reactions of other colleagues, tone of voice, body position and the view of all objects involved in the discussion, which are often unavailable in distributed collaboration (Kraut *et al.*, 2003). These cues also enable members to gain an awareness of the possibility for collaboration, and awareness of the aims and process of collaboration (Leinonen *et al.*, 2005).

However, Avarahami *et al.* (2007) found that regardless of all these available cues, co-located team members often fail to estimate the interruptibility and the availability of their colleagues. The study found that a cue such as a closed office door causes others to misjudge how busy a person is and mistake this cue as 'no interruption', though individuals inside the office are often frustrated when colleague fail to notify them of important information. In contrast, colleagues believe that individuals are more interruptible when they are working on their computer when, in fact, they do not wish to be disturbed.

The availability of visual and verbal cues also influences the development of common ground. In order for collaborators to communicate effectively, they should establish common ground or mutual understanding, knowledge, attitudes, goals and beliefs (Clark and Brennan, 1991). The term grounding refers to the activity carried out to ensure that the speaker's message is received and understood appropriately by the listener. The speaker monitors the listener's reactions and expressions during the information exchange and then decides whether sufficient information has been delivered or whether to provide more information should the listener fail to understand the message (Clark and Brennan, 1991). Furthermore, the principle of 'least collaborative effort' in conversational grounding by Clark and Brennan (1991)

suggests that speakers limit their effort in elaborating their conversations for the listener if they believe that the message has already been understood.

Common ground can be established when members are in the same group and have the same joint awareness of the situation (Neale *et al.*, 2004) and shared understanding of the task and actions of those involved (Clark and Brennan, 1991). It can be further developed from verbal interaction given that participants have the same linguistic co-presence and/or physical co-presence (Fussell *et al.*, 2000; Kraut *et al.*, 2003) as well as visual co-presence (Gergle *et al.*, 2004b). Linguistic co-presence refers to when collaborators are able to construct interactions on the basis that they understand the same utterances (Kraut *et al.*, 2003). Establishing and maintaining common ground in group activities is crucial to the performance and success of the group (Clark and Brennan, 1991).

In virtual activities involving discussion or manipulation of physical objects, conversations are often focussed on the identification of the object, as part of the grounding process, to ensure that all participants understand the information related to that object correctly (Kraut *et al.*, 2003). Furthermore, if actions are carried out on the target object, participants involved are required to have an up-to-date understanding of the state of the object and the task activities, through grounding. This process is greatly influenced by the availability of visual and verbal cues which affect the level of shared awareness amongst participants (Gergle *et al.*, 2004b). In contrast, Roch and Ayman (2005) suggest that the lack of cues in distributed teams enable members to judge their performance and success of their decision making much more accurately than face-to-face teams as they are not affected or distracted by peripheral cues such as the emotions and facial expressions of others.

2.3.2 Trust

Another concept related to team working and virtual collaboration is trust (Edwards and Wilson, 2004). This includes trust in the technologies (i.e. how reliable the hardware and software are to support tasks) and trust that each team member has for one another (Wilson, 2006). Trust amongst team members is harder to establish and maintain in distributed settings (Rocco, 1998; Wilson, 2006; Greenberg *et al.*, 2007), due to the lack of face-to-face interaction (Riegelsberger *et al.*, 2003). However, it can be developed through frequent interactions during which individuals learn to share insights, interests and commonality (Holton, 2001), while enabling individuals to become familiar with each other (Kiesler and Cummings, 2002).

An experimental study by Bradner and Mark (2002) found that geographical distance in collaboration has a negative impact on the level of collaboration, persuasion and trust. Participants were required to collaborate with an experimenter acting as an unknown partner who gave standard responses leading participants to either believe that the experimenter was in the same city as them, or located far away. Participants were able to communicate with the experimenter using video-conferencing and Instant Messaging. The results suggest that participants collaborated less with a partner if they were perceived to be far away. They were also less cooperative and less persuadable initially, however this increased with the level of interaction. Furthermore, if participants believed that the experimenter was remote to them, they were less truthful or open about themselves, their backgrounds and personal details.

In VTs, trust building often takes place over mediated communication, including video-conferencing and audio tools, which may be as good as face-to-face interaction in terms of trust development, though participants communicating virtually may take slightly longer to establish trust than face-to-face teams (Bos *et al.*, 2001).

Trust in VTs is further defined as 'delayed' and 'fragile' to explain the effect of different communication mediums on the rate of trust formation and declination in remote teams. Delayed trust is developed fastest when using video-mediated communication, followed by audio and then text-only communication. Fragile trust defines the level in which trust declines after a violation by other members. Trust is more fragile in VTs than in traditional face-to-face teams, and once trust has been violated teams face a higher level of difficulty to regain that trust (Bos *et al.*, 2002).

2.3.3 Management and Training

The lack of physical co-presence means VTs require more structured management and training than face-to-face teams to equip team members with the skills they require to collaborate virtually (Kiesler and Cummings, 2002; Beranek and Martz, 2005; Wilson, 2006; Lee-Kelly and Sankey, 2008), including ways to utilise collaborative technologies appropriate to their teams and their tasks (Qureshi and Zigurs, 2001). VTs are often seen to spend more time managing team processes and much less time on information processing and decision making, even in a decision making task (Branson *et al.*, 2008). Thus by implementing a well structured management system, VTs can concentrate on their core activities.

Training is required to help VT members (who are unable to interact with each other face-to-face) to develop relational links which can lead to cohesiveness, positive perceptions of the process and satisfaction with outcomes (Beranek and Martz, 2005). Virtual members should be trained to understand and anticipate problems which may arise as part of virtual collaboration, such as common misunderstandings, ways to conduct virtual meetings, task-orientated communication, trust building and goal clarification (Bernaek and Martz, 2005), which all contribute to the development of relational links in VTs.

The level of assistance offered by the management to VTs has an impact on perceptions of the overall project, performance and other team colleagues. Horwitz *et al.* (2006) found that a lack of assistance negatively influences the perception of the overall team performance and increases the perceived level of difficulties and complications experienced by individuals within VTs.

Disagreements and conflicts are more difficult to manage in VTs due to the lack of face-to-face interaction. Moreover, in face-to-face teams, managers can be casually informed of any problems and they are able to 'sense' the working atmosphere or tension. In contrast, VT managers rely on explicit notifications by team members to be made aware of conflicts (Bergiel *et al.*, 2008). Management is also required to support individuals working remotely from other colleagues to ensure that they are not overlooked or feeling isolated (Branson *et al.*, 2008). In addition, when team members are located away from their team leaders, the level of motivation as well as performance becomes harder to evaluate and support, therefore setting clearly defined goals provides remote members with clear directions whilst ensuring they understand their responsibilities and become accountable to their actions and contributions (Bergiel *et al.*, 2008). Members should be committed to their teams and encouraged to frequently communicate with other colleagues to ensure cohesion and cooperation (Jensen *et al.*, 2000; Horwitz *et al.*, 2006), shared understanding and to reduce miscommunications (Horwitz *et al.*, 2006).

2.3.4 Communication and Knowledge Sharing

VT members often mistakenly believe that virtual communication is the same or easier than face-to-face communication (Olson and Olson, 2000; Bergiel *et al.*, 2008). However, Branson *et al.* (2008) suggest that virtual interactions often fail to convey subtle confirmatory communication which requires visual or audio support to enable users to see and hear each other's expressions (e.g. a lighter tone of voice or a smile to accompany a sarcastic comment expressing informality and playfulness). Virtual interactions therefore need to be conducted

cautiously to avoid misunderstanding between team members. The traditional hierarchical setups of organisations also require updating to better suit the nature of virtual communication in VTs (Carletta *et al.*, 2000).

Knowledge sharing is a crucial part of team working and is harder to initiate and maintain in VTs as it can be influenced by factors such as trust, technology and cultural differences (Rosen *et al.*, 2007). Members in VTs should be encouraged to share information and knowledge virtually in order for individuals to benefit from a pool of information when making decisions for the team (Finholt *et al.*, 2002; Kock, 2002).

The main effects of physical proximity are summarised in Table 2-2. Evidently, VTs need to be assisted in a different manner to traditional face-to-face teams. This type of team offers many advantages and flexibility over co-located teams, however, many factors which were naturally occurring and supported in co-located teams now require more effort to establish and maintain in VTs. Issues and difficulties emerging from geographical dispersion have to be addressed in order for VTs to be successful (Hacker and Lang, 2000).

The reliance on all available human and technological resources to achieve optimal performance is a necessity. However, only technologies designed to support virtual teams and their influence on collaboration are discussed further in this thesis.

Key Finding	Source
VTs need to overcome challenges such as cultural differences, time zones, language barriers as well as a lack of face-to-face interactions in order to collaborate effectively	Martins <i>et al.</i> (2004); Rosen <i>et al.</i> (2007); Bergiel <i>et al.</i> (2008)
Physical proximity negatively affects the frequency of communication – individuals interact more with co-located than distributed colleagues	Kraut <i>et al.</i> (1990); Whittaker <i>et al.</i> (1994); Isaacs <i>et al.</i> (1997); Olson and Olson (2000); Bradner and Mark (2002); Schmidt (2002); Kiesler and Cummings (2002); Fussell <i>et al.</i> (2004); Sadat Shami <i>et al.</i> (2004); Andres (2006); Bergiel <i>et al.</i> (2008)
People often prefer face-to-face communication which supports richer communication cues (visual/verbal)	Bellotti and Bly (1996); Santhanam (2001); Kraut <i>et al.</i> (2003)
Frequent communication helps cohesion, cooperation, develop shared understanding and reduce the effects of cultural differences.	Jensen <i>et al.</i> (2000); Horwitz <i>et al.</i> (2006)
Sharing work environment and communication helps establish and maintain awareness between team members	Heath and Luff (1992); Cox <i>et al.</i> (2007); Sharples <i>et al.</i> (2007)

Trust is harder to establish when members are geographically dispersed due to a lack of familiarity and face-to-face interactions. Therefore frequent communication is required for team trust	Holton (2001); Kiesler and Cummings (2002); Bradner and Mark (2002); Riegelsberger <i>et al.</i> (2003)
--	---

Table 2-2: Summary of key findings on the influences of physical proximity on collaboration

2.4 Technologies Used in Virtual Collaboration

The rise of networked technologies has enabled the increasing formation of VTs while computer-mediated tools have evolved and improved their services in response to the increasing trend of VTs (Beranek and Martz, 2005). These tools should allow participants to coordinate activities, share knowledge and expertise, and gather appropriate information to ground their utterances and understanding between each other in remote collaboration (Qureshi and Zigurs, 2001; Kraut *et al.*, 2003).

The term Computer-Supported Cooperative Work (CSCW) was first used in the early 1980s to describe and discuss ways of supporting collaboration with the use of computers in the workplace (Schmidt and Bannon, 1992). CSCW and computer-mediated communication (CMC) have been used to describe similar systems and environments used to support group work (Driskell *et al.*, 2003).

These systems can help to bridge the time and space gap in VTs (Liu *et al.*, 2008). However, as further investment is required to implement new systems (e.g. extra equipment and increased bandwidth) (Kraut *et al.*, 2003), it is suggested that they are not cost reduction methods (i.e. reduce travel cost for face-to-face meetings), but support systems which organisations adopt to improve collaboration for the same cost and possibly less time (Kamel and Davison, 1998).

Research in the CSCW field considers aspects of multiple individuals, different perspectives and different work settings as examples of factors affecting the design of computer systems which aim to support them (Schmidt and Bannon, 1992; Taylor, 2001). This field has been fast moving, resulting in the rapid development of technologies which offer strategies and solutions for team collaboration in different forms such as shared workspaces, information exchange, discussion mechanisms, knowledge management, and documentation and scheduling tools (Klein, 2001), whilst endeavouring to ensure that negative interactions are avoided (Kamel and Davison, 1998).

Many in the field of CSCW concentrate on the design of software that supports group work (Schmidt and Bannon, 1992; Taylor, 2001), however, Kamel and Davison (1998) suggest that

developers often fail to focus on end users and instead aim to develop highly sophisticated tools which may not suit their needs or address real life problems. Therefore the consideration of user needs, contexts of use, and task specifications is crucial to the development, selection and implementation of technologies to support successful collaboration (Clark and Brennan, 1991; Driskell *et al.*, 2003; Gergle *et al.*, 2004a; Lauche, 2005; Beranek and Martz, 2005; Andres, 2006; Bergiel *et al.*, 2008). It is important that the appropriate tools are implemented and the adoption is supported to encourage team members to feel involved and utilise the technology to provide optimal benefit for their tasks (Anderson *et al.*, 2007), while ensuring that tasks and behaviours are not being altered to fit the technological constraints (Olson and Olson, 2000).

CSCW tools implemented in VTs require users to understand and use these tools as part of their collaborative work, influencing the overall nature of collaboration (Andres, 2006) by affecting group cohesiveness, dynamics and interpersonal relations among members (Kamel and Davison, 1998). Gergle *et al.* (2004a) highlighted that a good proportion of existing communication tools primarily aim to support spoken language and fail to support other types of interaction (such as visual feedback, gestures and verbal utterances). However, these neglected cues are vital in virtual collaboration as they help to raise awareness and coordination among members (Andres, 2006).

Clark and Brennan (1991) defined media characteristics which can influence the nature of communication. These factors compare face-to-face with distributed settings and could be used to identify characteristics which are currently unsupported in technologies (Olson and Olson, 2000). These media characteristics are: 1) 'co-presence': whether they are in the same physical space 2) visibility: whether participants can see each other, 3) audibility: whether they can hear each other, 4) 'co-temporality': whether communication is received at the same time as it is sent, 5) simultaneity: whether participants can send and receive information at the same time, 6) 'sequentiality': whether participants' speaking turns stay in sequence during the communication, 7) reviewability of messages by others, and 8) 'revisability' of own messages before sending to other participants (Clark and Brennan, 1991). Olson and Olson (2000) further extended this to include: multi-channels (i.e. combinations of voice, facial expressions, gesturing), shared social context, co-reference, implicit periphery cues, and spatiality of reference.

In addition, key concepts influencing the success of a collaborative team have been identified by Olson and Olson (2000). These concepts are: common grounding, work coupling (the level

of communication amongst members in order to complete the task), collaboration readiness (the extent to which the culture within the organisation encourages or permits collaboration and information sharing) and collaboration technology readiness (the capability and openness of members to the introduction of new technologies). Clark and Brennan (1991) suggested that common grounding mechanisms during mediated collaboration differ from that of face-to-face interactions, and are affected by the medium used.

Mediated communication in itself can become a barrier to communication and knowledge sharing in VTs (Rosen *et al.*, 2007). Remote work is still difficult to support, even in the case of teams consisting of members who have been engaged in previous work together (Olson and Olson, 2000). It should be further noted that mediated communication can support interaction in one situation but disrupt interaction in other situations (Driskell *et al.*, 2003). Therefore selecting appropriate tools to suit different situations to avoid unwanted interruption can be complex, as judging the situation and availability of distributed colleagues can be difficult due to the lack of physical co-presence (Kraut *et al.*, 2003).

The 'media richness' theory suggests that different technologies used to mediate virtual collaboration have varying degree of information richness, thus tools should be selected to provide enough amount of information to reduce uncertainty, ambiguity and encourage understanding (Daft and Lengel, 1986; Workman *et al.*, 2003). High richness, such as face-to-face interaction conveys communication cues (i.e. visual and audio) as well as instantaneous feedback, allowing participants to exchange information and understanding within an appropriate time interval. It was suggested that low richness mediums with few cues and restricted feedback are less appropriate for reducing uncertainty and ambiguity (Daft and Lengel, 1986).

Nowadays teams can choose to adopt different tools from a comprehensive range in order to support their needs, whether to supplement or replace face-to-face interactions (Martins *et al.*, 2004). However it is important to realise that initial face-to-face meetings at the start of a project, or when a team is first formed, can help members establish a connection, trust and collaboration before a later reliance on mediated communication tools (Rocco, 1998). Mediated communication can reduce the necessary conversational strategies for team relationship building such as small talk (Kiesler and Cummings, 2002), thus occasional face-to-face meetings can help to establish and maintain relationships (Santhanam, 2001).

Technologies used to support distributed teams should provide low-cost communication, allow frequent and spontaneous interactions which are necessary to initiate collaboration, whilst helping to monitor and coordinate work, as well as help to manage distant relationships (Kraut *et al.*, 1990). Frequency and informality of communication can also promote positive images of colleagues in remote teams, such as likeability, intellect and trustworthiness (Kraut *et al.*, 1990; Jensen *et al.*, 2000; Kiesler and Cummings, 2002). Many currently used technologies are better at supporting prearranged meetings rather than informal or opportunistic interactions (Carletta *et al.*, 2000).

Once users have collectively adopted one type of technology or style of media to facilitate their remote collaboration and have acclimatised to the tool (Santhanam, 2001), it is unlikely that they will agree to switch to new technologies, even if they might offer better solutions (Huysman *et al.*, 2003). The term 'media stickiness' was defined by Huysman *et al.* (2003) as the degree to which users 'stick' to one type of mediated communication. Furthermore, technical failure or interruptions experienced by users often cause them to switch back to the previous media regardless of the collaboration goals and purposes of the communication (Huysman *et al.*, 2003).

Often co-located team members share a piece of technology (such as video-conferencing and shared whiteboards) in order to communicate or exchange information with their remote colleagues. It is therefore important to ensure that individuals taking part are able to contribute and the person in charge of the keyboard and controls does not dominate the session (Carletta *et al.*, 2000). The impact of technology sharing on collaboration was investigated by Anderson *et al.* (2007). In the first condition of their experiment, co-located teams were required to share a communication tool when interacting with remote colleagues. The second condition allowed individuals to use their own tools without sharing. It was found that when members shared communication tools, all interaction was directed to the person in charge of the tool, who then dominated the overall conversation. Furthermore team members who were not in charge of the technology during remote meetings tended to direct their interactions only to co-located colleagues and not their remote colleagues. Therefore the teams did not benefit from the expertise of those who were not in charge of the communication tool, because they only conversed with their co-located members during the session (Anderson *et al.*, 2007). It is essential that the facilitators or moderators in charge of virtual meetings should understand the technology being used and are able to solve technical problems to ensure effective collaboration (Mark *et al.*, 1999).

Olson and Olson (2000) produced a list of various technologies in the order in which they were adopted in different workplaces. Telephone was the first to be adopted, followed by fax, email, audio conferencing (via the telephone), email with attachments, audio and video-conferencing (via the internet), internet repositories (i.e. company sites to provide static information), shared calendars, handoff collaboration (e.g. ‘tracking changes’ option when multiple authors collaborate on the same document), and simultaneous collaboration (e.g. screen sharing, internet chat). These technologies have been categorised into three main sections: audio and video, shared visual information and text-based communication (shown in Figure 2-2).

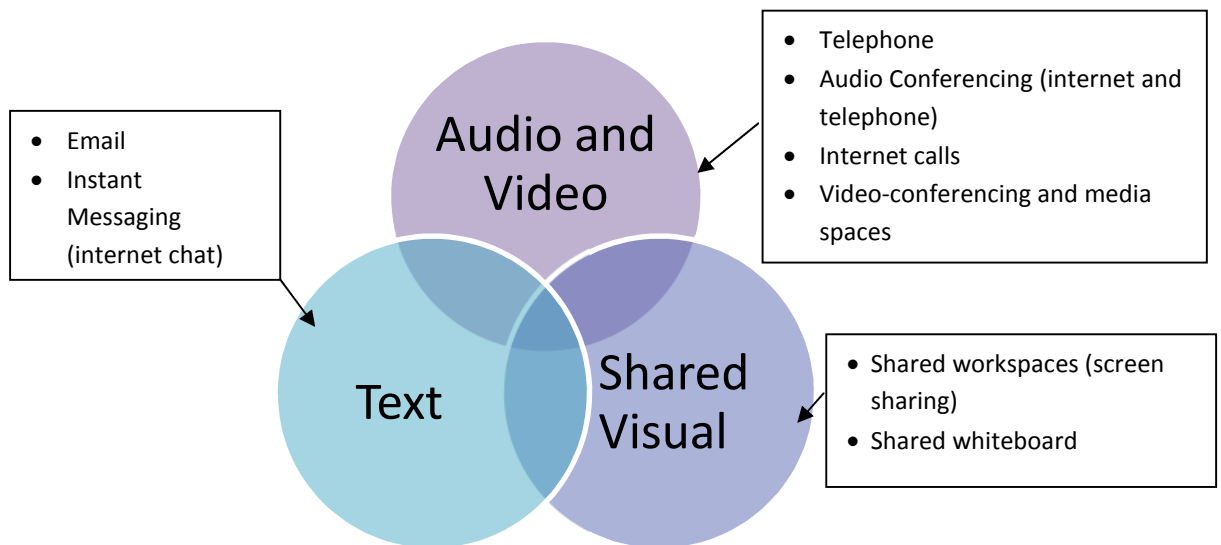

Figure 2-2: Categories of communication technologies discussed in section 2.4

A summary of key findings from this section is shown in Table 2-3. The studies discussed in this section emphasise the importance of the use of communication technologies in VTs as they determine the success of the teams as well as the way in which members interact with each other.

Key Finding	Source
Characteristics which collaborative tools are required to support are: co-presence, visibility, audibility, co-temporality, simultaneity, sequentiality, revisability, multimodality (multi-channels), shared social context, co-reference and implicit cues	Clark and Brennan, (1991); Olson and Olson, (2000)
Tools adopted should also assist collaboration in different situations depending on all parties, their availability and focus	Driskell <i>et al.</i> (2003)
Informal communication can help promote familiarity, likeability and positive images of colleagues such as intellect and trustworthiness	Jensen <i>et al.</i> (2000); Kiesler and Cummings (2002)
Even in VTs, occasional face-to-face meetings are required to help establish and maintain relationships, especially at the	Rocco, (1998); Santhanam, (2001); Kiesler and

start of a project, so team members can be introduced to each other Cummings (2002)

Table 2-3: Summary of key research in the use of technologies in VTs

2.4.1 Audio and Video in Virtual Collaboration

This section presents the literature on collaborative technologies providing audio and video communication, such as audio conferencing (via internet and telephone), internet telephone, video-conferencing, and media spaces to support virtual collaboration.

The telephone has been around to support communication for a long time and mobile phones were soon adopted by many to support their work and personal lives. Audio-conferencing can be used to support verbal communication in virtual collaboration (Scholl *et al.*, 2006). Voice over IP (VoIP) is also commonly used due to the low cost nature of these applications, many of which are free (e.g. Skype), allowing users to connect to each other and make calls over the internet (Kushman *et al.*, 2008). However, the performance of these applications relies very much on the internet bandwidth and capability - slow internet can hinder the quality of VoIP (Kushman *et al.*, 2008).

Difficulties in audio conferencing include users being unable to identify the person who is talking or what is being referred to during discussions. Furthermore, this encourages new and unnatural behaviours to occur, such as users identifying themselves before speaking and more formal protocol for turn taking (Olson and Olson, 2000).

Common linguistic background is considered to be an aspect of the common ground to be established between participants. Olson and Olson (2000) found that audio communication was perceived as easy to use during virtual collaboration if participants were of the same linguistic background. However, this medium was found to be insufficient when participants were from different linguistic backgrounds.

Video-conferencing is another method used to support collaboration (Mark *et al.*, 1999). Video-conferencing allows both audio and visual cues to be transmitted, mainly over the internet, however in most cases only two computers can be connected at a time (but co-located users can still share). It is also reported that users appreciated the use of video-conferencing tools (such as 'NetMeeting' and Skype) but only if it provided high quality video connections (Mark *et al.*, 1999). Many developers have viewed face-to-face as a true example on which to base their design of technologies to support mediated communication (Whittaker, 2003), hence the origin of 'talking heads' video-mediated tools, which are of less value when conversing about physical objects or tasks. It is important to understand the use

of video-mediated tools in virtual collaboration. The true benefits of video in virtual collaboration in different settings remain unclear (Olson and Olson, 2000).

The use of video has also been compared to face-to-face communication by O’Conaill *et al.* (1993). Face-to-face interactions are in real-time and are full duplex, i.e. participants can send and receive information at the same time (speaking and hearing others at the same time), unlike the half duplex tools, which only allow the message to either be sent or received at any one time. The study found that video-mediated communication tools which are full duplex, but have lags or delays in the system affect the behaviour of participants. Speakers are often affected by these lags in the system causing them to adopt a more formal and explicit way to manage the conversation and turn taking. In addition, the lower quality of the media channel reduces spontaneity of interactions and responses from the listeners.

People often report a higher level of satisfaction when conversing by video in remote situations than by audio alone, as this provides the feeling of “being there” (Egido, 1988) and they believe that videos add value to the interaction (Olson *et al.*, 1995). However, if only low bandwidth is available to the users, the video or live audio feed may be interrupted or delayed, and in such cases, the quality of video-conferencing is perceived to be low (Olson and Olson, 2000). Furthermore, applications such as video-conferencing may take longer for participants to familiarise themselves with due to the initial ‘awkwardness’ for some users in comparison to less obtrusive channels, such as email or the telephone (Holton, 2001). Similarly, having video interaction may give users a false sense of awareness and belief that all their performed actions will be transmitted across the video link to their remote partners (Cavallin *et al.*, 2000).

Studies have found that many of the interactions which take place in co-located work settings involve unplanned interpersonal interactions (Bellotti and Bly, 1996; Isaacs *et al.*, 1997; Herbsleb and Mockus, 2003). In contrast, video-mediated communication tools often aim to support arranged, intended and formal interactions and therefore fail to support short, informal or opportunistic communication (Whittaker *et al.*, 1994; Bellotti and Bly, 1996; Isaacs *et al.*, 1997). Indeed, many of the existing video-mediated tools are designed specifically to support formal interactions and operate on a ‘connection-based’ level, where participants make a decision on initiating interactions; unintended or impromptu interactions, which tend to lack a clearly defined opening and closing remark (Whittaker *et al.*, 1994) are often overlooked (Isaacs *et al.*, 1997).

A one-week long observation of two mobile professionals to identify characteristics of informal communication was conducted by Isaacs *et al.* (1997). They found that 80-90% of interpersonal interactions were unintended. These interactions were brief, intermittent and the frequency was dependent on their physical proximity. They further characterised six functions of informal communication with extensive content analysis of information from face-to-face interactions as well as telephone calls. The six functions were: 1) tracking people: involved gathering information to identify whereabouts, activities and plans of colleagues, 2) taking and leaving messages: involved contacting someone via a third party, 3) meeting arrangements, 4) document delivery, 5) giving or getting help: involved short question-answer exchanges and 6) reporting progress and news. It can be seen that these functions contribute to work productivity, member support and the group social system (Isaacs *et al.*, 1997).

Some researchers have investigated the use of shared virtual spaces or media spaces on collaboration in order to support informal communication as well as to increase the mobility of users within the office without having to rely purely on desktop-based tools (Bellotti and Bly, 1996).

2.4.1.1 Media Spaces

Media space is a term referring to technologically created environments (Bly *et al.*, 1993), coined back in the mid 1980s to describe attempts to integrate audio and video feeds to support formal and informal synchronous communication. Media spaces connect people across space and time, by creating a shared space which transmits audio-visual feeds, providing rich contextual information, background awareness and co-presence (Bly *et al.*, 1993; Lenman *et al.*, 2002). These systems are switched on at all times unlike video-conferencing systems (which require pre-planning prior to connection) (Bly *et al.*, 1993; Baecker *et al.*, 2008; de Vasconcelos Filho *et al.*, 2009); thus supporting informal and opportunistic interactions rather than formal meetings which are supported mainly by video-conferencing systems (Tollmar *et al.*, 2001).

The concept of media space was developed to support virtual teams by mimicking the nature of informal communication such as when colleagues have unexpected or opportunistic meetings in the hallway. The mediated connection is always there, but people are able to walk around as they would in real life, in and out of the camera shot, with no formal start or stop to such casual conversations (Mackay, 1999). Bellotti and Bly (1996) observed a team of product designers involved in virtual collaboration who could potentially benefit from media

spaces. It was found that interactions primarily took place informally whilst the nature of design activities encouraged participants to become more mobile. This was beneficial to co-located communication as participants were able to 'walkabout', which enhanced local collaboration. However, as participants were constantly away from their desks, distributed colleagues were faced with difficulties in tracking them down using desktop based tools such as email and the telephone. Therefore Bellotti and Bly (1996) believed media spaces could benefit such work settings where individuals are required to move away from their desks.

Another study by Tollmar *et al.* (2001) explored the use of media spaces in common work areas such as coffee rooms or corridors and the lobby. They aimed to facilitate informal communication amongst distributed offices which had no regular contact prior to the study. Researchers also installed a media space in a designated area called the Cafébar, where tables and chairs were provided so users could sit down and converse, socialise and relax with those in the remote office via the media space. Tollmar *et al.* (2001) found that the usage of these media spaces decreased over time. Initially, users made superficial contacts across sites to try out the system, however, they reported that social activities across sites did not take place as users were unfamiliar with each other in real life and were therefore uncomfortable with initiating activities. Users found that there was no real context or purpose for interactions and privacy issues were also encountered.

Media spaces have not been adopted as widely as predicted back when they were first developed (Baecker *et al.*, 2008). Two main problems with such systems include privacy concerns (Avrahami *et al.*, 2007) and technology limitations such as the quality of video and audio over the internet bandwidth (Baecker *et al.*, 2008; de Vasconcelos Filho *et al.*, 2009). Furthermore de Vasconcelos Filho *et al.* (2009) found that users were often self conscious about their own appearance being shown in a video feed during a videoconference or during media space communication, which may contribute to the low acceptance of such tools.

A study by Gaver (1992), found that media spaces with integrated audio and video provide limited views and functionalities and prevent movements and exploration that would be possible in a real hallway space. Therefore collaboration in media spaces is different from that in the real face-to-face setting, but not necessarily worse (Gaver, 1992).

Mixed reality has been used to combine real physical spaces or objects and virtual environments as part of supporting collaborative activities. Mixed reality boundaries allow physical spaces to be linked and shared virtually, meaning participants in one physical space

can see into the virtual space. This presents another physical space allowing people to interact with their remote colleagues through the virtual environment (Koleva *et al.*, 1999).

Mixed Reality Architecture (MRA) is an example of a system bringing together physical spaces in a virtual environment, aiming to support informal and formal communication as well as maintain awareness in VTs (Schnädelbach *et al.*, 2007). This system allows multiple offices to be represented in a shared virtual space with a live video and audio feed projected onto their MRACells. Each office is set up with an MRACell, which consists of a webcam, microphone and speaker so visual and audio information can be transmitted over the internet connection. Each MRACell is represented as a virtual 3D object, with live video and audio attached to each of the virtual objects (i.e. an office). Figure 2-3 shows two MRACells representing two offices in a shared virtual space. The position of these two cells is close enough so that the office inhabitants can see each other's live video link, but not close enough so that they can hear each other. This connection allows each office to navigate the virtual space (i.e. move their MRACells around) so that they can line their cell up with any other office to establish communication or availability for communication (Schnädelbach *et al.*, 2007). This setup allows users to explore the shared environment and interact with more than one remote office.

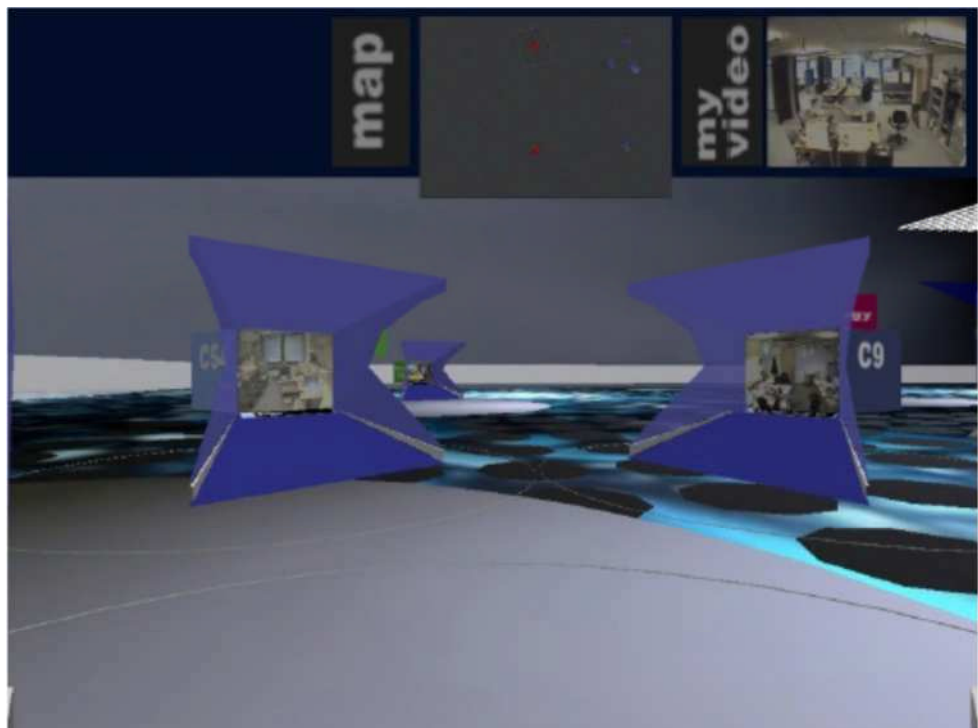

Figure 2-3: MRA-physical and virtual space integration

Key findings of the use of audio and video as well as media spaces are summarised in Table 2-4.

Key Finding	Source
Audio-only conferencing makes identifying the speaker and managing turn taking difficult when more than two participants are involved	Olson and Olson (2000)
Video-conferencing combines audio and visual information and helps participants feel closer to each other during virtual meetings; they are often more satisfied when conversing over video than by audio alone.	Egido (1988); Olson <i>et al.</i> , (1995)
Low bandwidth (causing lags in video and audio) has a negative effect on participants' perception of the overall quality of the communication	Olson and Olson (2000)
Media Spaces support informal, opportunistic interactions as well as providing background awareness	Bly <i>et al.</i> (1993); Mackay (1999); Tollmar <i>et al.</i> (2001); Lenman <i>et al.</i> (2002);
Use of media spaces decline shortly after installation. There are issues concerning privacy and low bandwidth causing poor quality connections	Avrahami <i>et al.</i> (2007); Baecker <i>et al.</i> (2008); de Vasconcelos Filho <i>et al.</i> (2009)

Table 2-4: Summary of key findings for audio and video information in virtual communication

2.4.2 Shared Visual Spaces

Researchers from different fields, especially CSCW have invented and examined different ways to support remote collaborative tasks, particularly by providing a common visual or information space to allow remote participants to collaborate effectively (for example, Schmidt and Bannon, 1992; Bannon and Bødker, 1997; Kraut *et al.*, 2003). Shared visual spaces have been used as one of the main methods to allow remote participants collaborating from multiple offices to view shared objects or environments synchronously (Gutwin and Greenberg, 2000; Kraut *et al.*, 2002b; Gergle *et al.*, 2004a). Tools such as video-conferencing, media spaces, application sharing, remote workspace sharing and shared e-whiteboards are used to provide shared visual information in remote settings. Despite their common use, Fussell *et al.* (2000) suggested that there is still a lack of understanding of the effects of visual information sharing on the quality and style of interaction as well as on collaborative performance in remote teams.

In co-located collaborative settings, participants share common workspaces and are therefore exposed to rich visual and auditory cues of three-dimensional objects, people and artefacts (e.g. shared monitors, physical timetables or work schedules, notice boards, whiteboards used for brainstorming, paperwork, records and books etc.). These cues enable individuals to form and maintain an up-to-date awareness of the changing situations around

the work environment, which further allows them to establish common ground, mutual understanding and know when their attention needs to be directed to specific artefacts, people or tasks (Heath and Luff, 1992; Bannon and Bødker, 1997; Fussell *et al.*, 2000; Kraut *et al.*, 2003; Ranjan *et al.*, 2007;).

Without the shared physical and visual spaces, distributed participants are forced to deliberately transmit important information, including auditory and visual cues in a meaningful way using available communication tools in the hope that their remote colleagues are able to appropriately understand the messages required to begin the grounding process (Bannon and Bødker, 1997). This is more important when the collaborative task involves the use of physical objects or spatial information (Kraut *et al.*, 2003) or when tasks are lexically complex, causing difficulties in expressing views or information verbally (Ranjan *et al.*, 2007).

The concept of a 'common information space' was analysed by Bannon and Bødker (1997). They examined collaborative work with the aim of investigating the way in which people, artefacts and settings are interrelated to each other in collaborative work. They emphasised that the nature of these common workspaces should be designed according to the different workplace settings and context of use. The use of shared visual spaces is often accompanied by auditory feeds to provide common workspaces. Systems that provide an appropriate view of the work area including physical objects and artefacts are likely to support situation awareness and conversational grounding (Kraut *et al.*, 2003), better than those systems which only provide a view of the remote participants.

Shared visual space is important to support and maintain an awareness of the current task and the collaborative activities being conducted in relation to the end goal. It is also important to facilitate communication and conversational grounding (Kraut *et al.*, 2002b). In addition, Schmidt and Bannon (1992) asserted that a 'shared information space' can be used as an alternative method to workflow arrangements (i.e. project planning, work scheduling, task organisation and coordination) which consist of objects and events. It can also be used as an outlet for members to engage with each other and share their joint interpretation of such information. Shared visual information can be used as part of the communication thereby reducing the need for explicit linguistic utterances (Gergle *et al.*, 2004a).

The lack of shared visual information in remote collaboration often means that participants are forced to rely only on spoken language during communication. This requires the

conversation to be more explicit and descriptive as none of the participants can see what others are seeing or the remote objects they are working on (Kraut *et al.*, 2003). In order to design tools to support shared visual information so that the overall performance is improved, it is necessary to understand the organisation of the team and the information needs so that the presence of a shared view can be used appropriately for the task (Gergle *et al.*, 2004a; Ranjan *et al.*, 2007). A study conducted by Brennan (2004) found that when pairs were able to share visual information, some conversation exchanges were completely replaced by actions as a response. Gergle *et al.* (2004a) suggested that it is important to identify how visual information and speech can influence the overall collaboration and how they can be used to replace one another.

Communication tools providing visual information also affect the process of grounding: for example if individuals are able to see the actions of remote colleagues during the collaboration, they can adjust their next set of utterances to accommodate for these observations; i.e. whether to give further instructions to further clarify the objectives and correct the actions or acknowledge that actions have already been carried out correctly (Clark and Brennan, 1991; Kraut *et al.*, 2003). In contrast, hesitation or lack of action (which is another form of visual information to the speaker) after having listened to instructions can indicate a lack of understanding (Gergle *et al.*, 2004a).

Actions performed to replace verbal exchanges can be in the form of gestures in response to the given instruction and its interpretation, or intentionally as part of the communication to ensure that their partner can see their action (Brennan, 2004). Once participants are mutually aware of the progress, verbal acknowledgement is withheld (Brennan, 2004). Shared visual information allows grounding to be done continuously and in parallel with the task and the overall communication, rather than participants having to wait for the right conversational turns to interject their information (Brennan, 2004).

Whittaker (2002) summarised that three main types of video-mediated applications have been designed in order to support 1) glance - allowing remote office inhabitants to quickly look into another office to see if their colleagues are available, 2) open-links - which provide continuous audio and video connections such as media spaces, and 3) awareness - which allows snapshots of the other office to be viewed and does not provide a continuous video feed.

2.4.2.1 Shared Workspaces

Shared workspace applications support virtual collaboration by allowing users to remotely manipulate visible tools and/or task artefacts (such as viewing and annotating on a shared drawing, editing a shared document or multi-player gaming) (Gutwin and Greenberg, 2000). Seven main activities observed in shared workspaces were identified by Gutwin and Greenberg (2000), which include: 1) explicit communication (i.e. remote members intentionally exchanging communication verbally, textually or by referring to the shared artefacts), 2) consequential communication (i.e. members exchanging information unintentionally), 3) coordination of action (i.e. some tasks may require actions to happen in particular orders, which require some level of coordination to avoid duplication etc.), 4) planning (i.e. task division amongst team members), 5) monitoring (i.e. gather information about who is in the workspace and what they are doing), 6) assistance (i.e. formal or opportunistic assistance to others within the workspace, and 7) protection (i.e. preventing others from accidentally overwriting their work).

Video-mediated communication tools have been adopted and examined as an option to provide remote participants with shared visual spaces (Nardi *et al.*, 1993; Kraut *et al.*, 2003; Ranjan *et al.*, 2007). Nardi *et al.* (1993) suggested that most previous studies have examined video feeds during communication as a method to enhance telepresence - participants were represented as 'talking heads', while failing to show other information such as the workspace or tasks being carried out locally. Therefore the use of 'video-as-data' instead of 'talking heads' allows images of the workspace and work objects relevant to the collaborative task to be seen by remote users (Whittaker, 2002). This is especially useful when participants are required to refer to objects, as a lack of visual information means making physical references or 'deixis' (e.g. referring to artefacts as 'this one' whilst pointing to the object to accompany the utterance) becomes difficult due to the lack of a shared environment (Whittaker, 2002). However, many studies investigating shared workspaces have failed to report effects on improved performance in different tasks especially those requiring the use of spatial information or manipulation of physical objects, but have reported higher user satisfaction (Veinott *et al.*, 1999; Whittaker, 2003) and shared mental models of the task (Bolstad and Endsley, 1999).

An ethnographic study conducted by Nardi *et al.* (1993) found that shared workspaces (supported by live video and an audio feed) enhanced task performance in neurosurgery, thus supporting fast-paced collaboration. A live video feed was shown on screen monitors

located within the operating room as well as in offices of remote experts, providing an up-to-date status of the task from the same viewpoint as the surgeon performing the operation. This allowed supporting nurses within the operating room to monitor the surgery, anticipate the situation and provide support and the appropriate instruments without verbal requests from the surgeon. Furthermore, the live video and audio feed shown on remote monitors also allowed other specialists and experts to watch the video from their offices within the hospital and decide when their presence was needed in the operating room.

The effect of shared display on shared mental models and awareness in distributed teams was examined in the laboratory by Boldstad and Endsley (1999). Sixteen pairs of participants were required to complete two rounds of the same experimental task. The spatial task required both participants to collaborate within a pair but each assumed different roles. In the first condition, eight pairs were allowed to use the shared display facility (i.e. they were able to view their partner's monitor) during the task in the first round. However, this facility was revoked in the second round of the task. In contrast, in the second experimental condition, eight pairs of participants completed their first round of the task without the use of a shared display, and then used a shared display in the second round of the task. The results showed pairs who were able to use the shared display facility in their first round of the task were able to form a better understanding of the task and were able to perform better in their second round. They also performed better than the experimental condition without a shared display. In addition, the experiment found that participants who were exposed to the shared display facility were able to perform exceptionally even when that shared display facility was removed. This suggests that shared visual display can also be used to enhance awareness and shared mental models (Boldstad and Endsley, 1999).

The results from various studies investigating the use of shared visual communication (e.g. via video feeds) have been inconsistent with regards to the actual benefits (Fussell *et al.*, 2000). Fussell *et al.* (2000) proposed that this could be due to the diversity of the collaborative tasks adopted in the experiments (e.g. remote assistance, problem-solving, remote assemblies) and the differing way in which video was used from study to study, even though they all focussed on spatial tasks. Therefore research into the use of shared visual spaces is still ongoing. Studies of different tools to support shared visual information in remote collaboration are discussed further in this section.

Several studies have evaluate shared visual spaces provided by a live video feed for remote maintenance or remote assembly scenarios, where one participant completes the physical or

virtual task whilst the other participant acts as the expert monitoring the process and offering guidance and instructions (Fussell *et al.*, 2000; Kraut *et al.*, 2003; Ou *et al.*, 2003; Gergle *et al.*, 2004a; Ranjan *et al.*, 2007). The participants acting as experts were provided with a live video feed of their novice partners' workspaces, showing the task being conducted as they instructed them. With the help of experts, novice participants manipulated either physical or virtual objects such as bicycle parts (Fussell *et al.*, 2000; Kraut *et al.*, 2003), or participated in Lego puzzle tasks (Ou *et al.*, 2003; Ranjan *et al.*, 2007).

Gergle *et al.* (2004a) examined how actions can be used to replace explicit verbal communication such as instructions and explanation in a shared visual workspace in an online puzzle solving task. Shared workspaces were provided to support a remote collaborative task where two participants worked together in order to ensure the finished puzzle matched that of the given target picture. However, the target picture was only given to one of the participants who then acted as the 'Helper', while the other acts as a 'Worker', manipulating the puzzle according to the Helper's guidance. There were two experimental conditions – participants either performed the task with or without the use of a shared workspace. In both conditions participants were unable to see each other during the task, and the Worker participants were required to carry out the task on the computer as instructed by their Helper partners (i.e. puzzles were manipulated using a mouse with the image shown on the computer screen). In the condition where a shared workspace was available, the Helper was able to see a copy of the Worker's screen alongside the target picture given. Worker participants were able to see all the available parts of the puzzle which they could use during the task in the 'staging area' (see Figure 2-4).

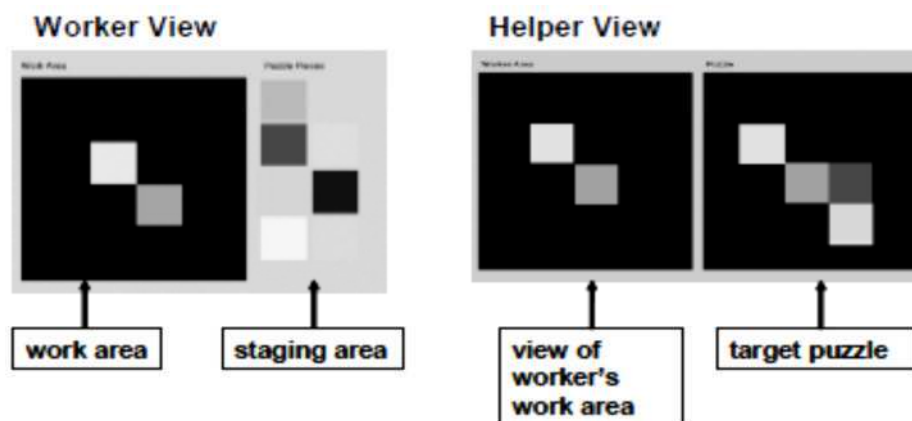

Figure 2-4: Online puzzle task (Gergle *et al.*, 2004a; Gergle *et al.*, 2004b)

The results of this study indicated that participants adapted their communication to the presence or absence of the shared visual workspace. The shared visual workspace reduced

the acknowledgement of utterances as Workers let their actions 'speak' by carrying out the instructions instead of describing the current state of the task (Gergle *et al.*, 2004a). The results of this study supported the principle of 'least collaborative effort' proposed by Clark and Brennan (1991), i.e. partners adapt their communication to reduce collaborative effort when the media provide enough visual information on the current activity (Gergle *et al.*, 2004a). Moreover, the study suggested that even low-bandwidth video feeds could be adequate and useful when supporting such spatial tasks as they provide a representation of the workspace and schematic feedback rather than the face or body of the collaborators (Gergle *et al.*, 2004a).

The use of a head-mounted video in a remote bicycle repair task was examined by Kraut *et al.* (2003). The study compared three experimental conditions: 1) participants were able to use a head-mounted video to provide shared visual information, 2) remote participants relied on audio only communication during the task and 3) participants were co-located during the task. The effect of side-by-side guidance (with both expert and novice in the same room) and remote guidance (expert and novice in different rooms) was compared on influencing performance and conversational grounding. The side-by-side pairs were able to complete the task in a shorter period of time, with fewer utterances because the shared visual space ensured that both the expert and novice could effectively construct their conversations and were adjusting themselves to the continuously changing state of the task. This was similar to the video condition and showed that visual information influenced conversations and dialogues. The presence of video also allowed participants to rely on the ability to gesture and the use of deictic and short-hand expressions such as 'this one', knowing that their partners were able to see the target object, which contributed to effective grounding of conversations. Participants in the audio-only condition were forced to be more explicit and detailed with their descriptions (Kraut *et al.*, 2003).

Another study by Ranjan *et al.* (2007) investigated the use of a video-mediated collaboration tool on a Lego puzzle task. They compared the use of automatic and static cameras as a means of providing shared visual information to remote experts to complete tasks of differing complexity during the task. The static camera remained still during the experiment and hence the field of vision was restricted unless the camera was manually adjusted by the novice. In contrast, the automatic camera was guided in part by tracking the novice's hand position, allowing the remote experts to monitor the task states regardless of any movements and changes. The results showed that the automatic camera supported performance of the

complex task but not the simpler task, thus participants with the automatic camera in the complex task finished faster with a lower number of errors than those with the static camera only (Ranjan *et al.*, 2007). Kirk and Stanton Fraser (2006) examined how remote gesturing in collaborative physical tasks could be used to improve task performance. The study compared a combination of different gesture formats (i.e. what is being projected to convey remote gesture, such as hands only, hands and sketching and digital sketching only), and the location of the gesture output (i.e. whether the gesture is being projected in the task space or on a separate window, both using a live video feed). Participants worked in pairs to complete a Lego assembly task, where one participant was provided a diagrammatic instruction manual, and thus acted as the expert, giving instruction to his/her partner during the task. The data obtained from this study suggested that the gesture format, which allowed remote users to view the hand gesture (i.e. unmediated hand) led to quicker task performance than the pen-based gesturing (i.e. physical and digital sketching).

The use of video in addition to audio and text-based communication in a collaborative decision making task was examined by Baker (2002). Participants were required to work on strategies together to ensure the team completed the Prisoner's Dilemma task most effectively whilst satisfying individual goals (participants were required to collaborate with all individuals in the group to achieve optimal goals). The results showed that video improved the overall collaboration, though the addition of video to text-based communication did not improve the quality of teams' decisions.

The effect of live video streaming to support non-native speakers in synchronous remote collaboration was examined by Veinott *et al.* (1999). The experimental task was similar to remote assistance, with one participant being given the target spatial information while the other was asked to replicate the information without being able to view the details directly. Within pairs, one participant was required to explain a fictional map route to his or her partner whose task was to draw this given route on a map (see Figure 2-5).

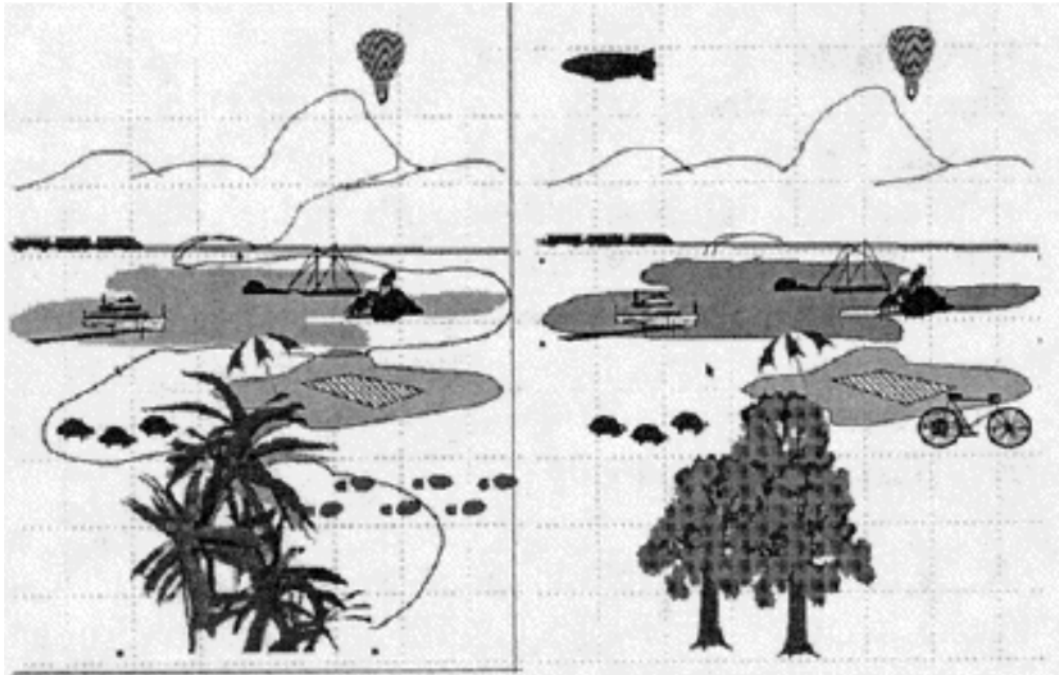

Figure 2-5: Diagrams used by Veinott *et al.* (1999): Expert's map with route drawn on (left). Novice's map requiring the route to be drawn on (right)

Both maps given to the novice and expert within a pair were similar, but not identical, to ensure that participants were required to ground their information by collaborating. This study compared the effect of video and an audio-only setup on performance and communication. Half of the participants were native speakers and the other half were non-native speakers from different linguistic backgrounds. By manipulating how participants were paired with each other, the researchers were able to control the base level of common ground prior to the experiment (i.e. non-native pairs lacked linguistic co-presence). The results showed that native speakers performed better than non-native speakers. However the performance of non-native pairs improved with the presence of video instead of audio-only, though this had no effect on the native pairs.

2.4.2.2 Shared Whiteboard

Applications or tools which support visibility, information sharing and mutual knowledge can have a positive impact on mutual understanding in remote collaboration (Clark and Brennan, 1991). Features which allow greater visibility of the task or target object used during collaboration help reduce the effort required to verbalise all available information in conversational grounding (Dillenbourg and Traum, 1999). Therefore, application sharing is considered one of the most valuable features of collaborative tools (Taylor, 2001).

Application sharing allows one user to view and manipulate an application on his computer screen, which is also connected to a remote colleague's computer over the internet.

Depending on the software as well as the setup, remote users can be granted remote access to the local computer, allowing both users to see and manipulate the same view on their computer screens in real-time (Bowman, 2001). Application sharing can allow software such as Microsoft Office, Whiteboard, Paint or graphic software and Computer-Aided Design (CAD) tools to be shared amongst remote users.

A shared virtual whiteboard can be used to share information during remote interactions. Information (including problems and different solutions) presented on the board can be seen and manipulated by all members (Dillenbourg and Traum, 1999). Applications such as a shared whiteboard may be used to complement other media such as Instant messenger during synchronous collaboration as visual information on its own can sometimes cause ambiguities (Dillenbourg and Traum, 1999). A laboratory study conducted by Dillenbourg and Traum (1999) involved 20 pairs of participants who played a mystery game where they both acted as detectives, sharing information and collaborating in order to make a joint decision virtually. The task was described as complex with a large amount of information from which the pairs derive solutions. The scenario was set in a virtual environment in which participants were able to navigate through different virtual rooms to gather information. They were also able to use an electronic whiteboard which supported drawings and text in order to store and share information. The results showed that participants used the whiteboard to organise text-based information amongst themselves (illustrated in Figure 2-6) and a few used the graphical features of the whiteboard during the task (Dillenbourg and Traum, 1999).

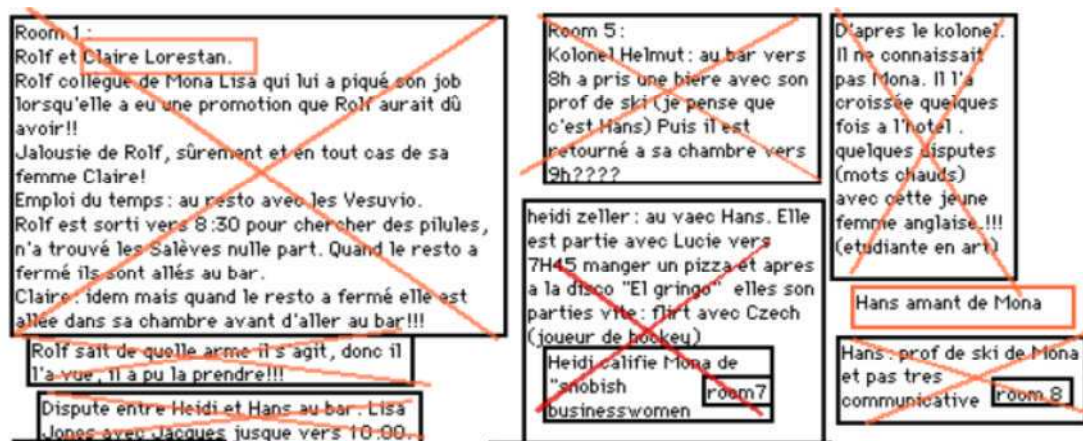

Figure 2-6: The use of a whiteboard as part of a decision making task from an experiment by Dillenbourg and Traum (1999) – the diagram illustrates how participants eliminated various clues to solve the mystery during the task

A study conducted by Whittaker *et al.* (1991) examined the use of an electronic shared whiteboard in remote collaboration. The whiteboard allowed participants to type, write or draw by using a keyboard or a mouse simultaneously. They were able to select whether they

wanted to type, write, or sketch at anytime throughout the session. Participants were asked to complete two tasks: first they were to create a list of criteria of important features to look for when buying a house and rank them in order of priority, and second, they were asked to arrange a two-hour meeting with each other by coordinating their calendars. The study found that a shared whiteboard was useful to plan and organise their activity as well as share the content of communication. Furthermore, if speech was available during communications, participants still used the shared whiteboard to construct the content of their communication while speech was used to coordinate the process of communication.

Key findings of shared visual information research have been summarised in Table 2-5. These studies suggest that video can reduce the need for explicit verbal communication and improve grounding as the video image projects enough information to support the awareness of those involved in tasks such as remote maintenance or ‘physical collaborative tasks’ involving spatial information and manipulation of objects (Nardi *et al.*, 1993; Kraut *et al.*, 2003; Gergle *et al.*, 2004a).

Key Finding	Source
The lack of visual information forces conversations to be more explicit and descriptive	Kraut <i>et al.</i> (2003)
The availability of shared visual information alters conversations with participants, replacing verbal responses with actions. This also affects conversational grounding	Clark and Brennan, (1991); Kraut <i>et al.</i> (2003); Brennan (2004); Gergle <i>et al.</i> (2004a)
Shared workspaces or visual information can help establish and maintain awareness	Nardi <i>et al.</i> , (1993); Kraut <i>et al.</i> (2003); Gergle <i>et al.</i> (2004a)
Shared workspaces help remote users perform more quickly and accurately	Kraut <i>et al.</i> (2002b)
Shared visual information helps performance in complex tasks but has no effect on simpler tasks, and is more beneficial to non-native speakers	Veinott <i>et al.</i> (1999); Kraut <i>et al.</i> (2002b); Ranjan <i>et al.</i> (2007)

Table 2-5: Summary of key findings on shared visual information

2.4.3 Text-based Communication

Text-based communication has been used in the form of letters, fax with email, online discussion boards and Instant Messaging (IM). IM is becoming more and more popular in the workplace (Handel and Herbsleb, 2002; Avrahami and Hudson, 2004; Çakir *et al.*, 2007), allowing users to exchange information synchronously and asynchronously. These methods are used by co-located and distributed colleagues in order to exchange relevant information, coordinate tasks and effort, check each other’s availability, initiate or negotiate meetings,

conduct formal and informal interactions as well as make social contact (Handel and Herbsleb, 2002; Fussell *et al.*, 2004; Avrahami and Hudson, 2004; Scholl *et al.*, 2006).

The ease of use of these applications encourages and supports collaboration within and between sites, however it also means that users are often bombarded with a large amount of incoming communication, which may be received at inappropriate times or be an unwelcomed interruption. Users may be forced to judge the cost of either postponing their current task to respond to communication or the consequences of delaying their replies (Avrahami *et al.*, 2008).

A study conducted by Straus and McGrath (1994) compared face-to-face teams with those communicating via a text-only tool on three different tasks: an idea-generation task (to generate as many ideas as possible for a given scenario), an intellectual task (to solve complex logic questions as a group) and a judgement task (to judge a bribery case and generate a list of disciplinary actions according to the different scenarios). They found that face-to-face teams were able to complete more of the task in the given time compared to the text-only teams. The results showed little difference in the quality of the work completed by the two types of teams (Straus and McGrath, 1994). However, the text-based communication method was inappropriate for the judgement task - participants felt more negative towards the tool and were less involved in the task than the face-to-face teams.

The following sections present research on the use of text-based communication tools such as email and IM, which are popular text-only communication methods in the workplace.

2.4.3.1 Email

Email is one of the most common computer-mediated communication tools adopted for both co-located and distributed work teams (Whittaker, 2005; Dabbish *et al.*, 2005; Lancaster *et al.*, 2007). It is mainly considered an asynchronous form of communication - there is little expectation that the reader will retrieve the message and reply immediately (Handel and Herbsleb, 2002; Whittaker, 2005). Email is a primary channel for information exchange in distributed teams and is considered one of the most useful mediated tools developed (Whittaker, 2005; Whittaker *et al.*, 2007). Furthermore, with the increasing number of virtual teams, email is crucial in supporting coordination and awareness (Brush and Borning, 2005; Siu *et al.*, 2006). Even with the increasing use of other media (such as IM) to support communication, email is still one of the primary methods used in organisations for information exchange (Dabbish *et al.*, 2005; Siu *et al.*, 2006).

Many email applications now support multiple tasks such as task management, calendar systems (which help users organise work schedules), sending and receiving attachments other than text files, storing contact information and setting reminders in addition to the fundamental information exchanging feature (Whittaker and Sidner, 1996; Whittaker *et al.*, 2005; Bellotti *et al.*, 2003; Fisher *et al.*, 2006; Whittaker *et al.*, 2007). Dabbish *et al.* (2005) summarised four main tasks carried out over email, which include task and project management, information exchange, scheduling and social interaction. People use email to communicate socially with their friends and family as well as their work colleagues (Dabbish *et al.*, 2005).

Email is also considered to be a low cost method of communication - a message is able to reach a lot of people in a short period of time assuming they check their inboxes regularly, making email an effective medium for updating colleagues and team members on task status (Brush and Borning, 2005). The asynchrony of email allows users to concentrate on other primary tasks (Siu *et al.*, 2006), without being interrupted by more intrusive means such as the telephone.

Dabbish *et al.* (2005) suggest that people may reply to emails relatively quickly regardless of the level of importance of the message, due to the ease of use of the application. This is particularly true when responding to non-work related or social messages. In contrast, highly important messages often take longer to respond to as they may require more work and more attention than a social message (Dabbish *et al.*, 2005). Factors such as time, workload, features provided by their email software (e.g. saving and archiving features), and characteristics of the messages further determine the way in which users attend to their email messages (Dabbish *et al.*, 2005; Whittaker *et al.*, 2007). Some emails may be responded to immediately, but others may take longer from hours to even days (Bellotti *et al.*, 2003).

Over the past two decades, users have increased their archive size and many have organised their messages into more folders (Fisher *et al.*, 2006). In addition, the overall volume of email has also increased, resulting in large inbox sizes which can be difficult to cope with (Fisher *et al.*, 2006; Whittaker *et al.*, 2007). Many email tasks are mainly coordination or collaborative tasks, which are iterative and require multiple exchanges causing many users to experience high volumes of messages in their inboxes (Whittaker, 2005), which may also include irrelevant spam (Whittaker *et al.*, 2005). Users can feel overloaded with emails due to the number of ongoing threads they are involved in as this can generate a high volume of incoming messages (Bellotti *et al.*, 2003). In addition, email encourages more communication

and can be time consuming (Kiesler and Cummings, 2002). Moreover, a positive correlation was found between the number of times users checked their inboxes and the perceived importance of work messages and hence they were less likely to delete messages (Dabbish and Kraut, 2006).

Users are left with outstanding tasks while they await replies from colleagues about a specific task. This delay can add to the general workload as the user has to keep the 'task in mind' (Bellotti *et al.*, 2003); many users attempt to remind themselves of outstanding tasks by copying themselves in on their original messages, which causes further email overload (Whittaker, 2005). The problem of managing emails results in further problems in 'personal information management', causing users to lose or forget important information and responsibilities (Whittaker *et al.*, 2007). However, users still prefer using emails to serve as a reminder instead of other external applications providing a 'to-do' list (Whittaker *et al.*, 2007). Email flow is also regarded as a part of users' task management strategies instead of a background activity to support awareness (Siu *et al.*, 2006). However some users send 'today' messages to team members as a means of updating each other on the task they have completed on a particular day in order to enhance awareness in teams; these can be used to replace status meetings (Brush and Borning, 2005). However, email is already seen as another task which is dealt with multiple times a day and many spend more time on email than on their core work (Czerwinski *et al.*, 2004; Dabbish *et al.*, 2005; Bellotti *et al.*, 2003).

Collating and identifying specific messages can be difficult in large inboxes as users visually scan different emails whilst having to remember to scroll back and forth for earlier or later messages (Whittaker, 2005; Whittaker *et al.*, 2007). Whilst search features are available in email applications, it requires users to know information such as the date received, subject and sender information, for example (Whittaker *et al.*, 2007). Another email management problem is caused by the fact that many inboxes still present messages of different priorities in almost the same way unless the sender marks them as important or the receiver manually marks the otherwise undifferentiated messages (Whittaker *et al.*, 2005). Bellotti *et al.* (2003) found that integrating features to help task management directly into email inboxes can improve problems such as difficulties in tracking messages and outstanding tasks. Some existing interfaces can group messages into relevant conversations to a certain extent, allowing users to follow replies to threads, but most, by default, present messages in chronological order, regardless of the content (Venolia and Neustaedter, 2003).

There is an increasing trend to support the use of real-time communication technologies such as synchronous messaging applications, which allow opportunistic, informal and unstructured communication in the workplace and promote team situation awareness (Handel and Herbsleb, 2002; Fussell *et al.*, 2004; Scholl *et al.*, 2006). Whilst there are benefits to synchronous communication, it is argued that email gives users the power to decide what action to take in response to a message, when to reply and when the conversation can continue, in contrast to synchronous messaging applications (Siu *et al.*, 2006). However the use of text-based tools such as email can negatively affect the level of collaboration and trust in a VT when members have not met face-to-face prior to initiating remote communication (Rocco, 1998).

Face-to-face communication is often found to be more satisfactory than asynchronous communication methods in terms of users being more satisfied with the quality of discussion and interactions (Ocker and Yaverbaum, 1999). However, the overall performance and performance satisfaction appears to be the same for face-to-face and asynchronous methods of communication (Ocker and Yaverbaum, 1999).

2.4.3.2 Instant Messaging

'Instant Messaging' (IM) or 'chat' was first introduced to the public in 1996 (Lancaster *et al.*, 2007). These applications have been widely adopted in workplaces to support communication (Handel and Herbsleb, 2002; Avrahami and Hudson, 2004; Scholl *et al.*, 2006), providing an interactive text-based channel for internet users (Herbsleb *et al.*, 2002).

Much research has been done on the use of IM in both work and social settings (Birnholtz *et al.*, 2005). Chat applications support synchronous and asynchronous interactions (Handel and Herbsleb, 2002) as well as semi-synchronous communication (Avrahami *et al.*, 2008). This means that IM messages can be sent and received instantly allowing participants to have synchronous or near-synchronous communication, as they wish, depending on the speed of the internet network transmission (Nardi *et al.*, 2000; Avrahami and Hudson, 2006; Avrahami *et al.*, 2008;). It has been found that over 60% of IM interactions at work are work related whilst just over 20% of the interactions were used to offer information or make announcements (Isaacs *et al.*, 2002b).

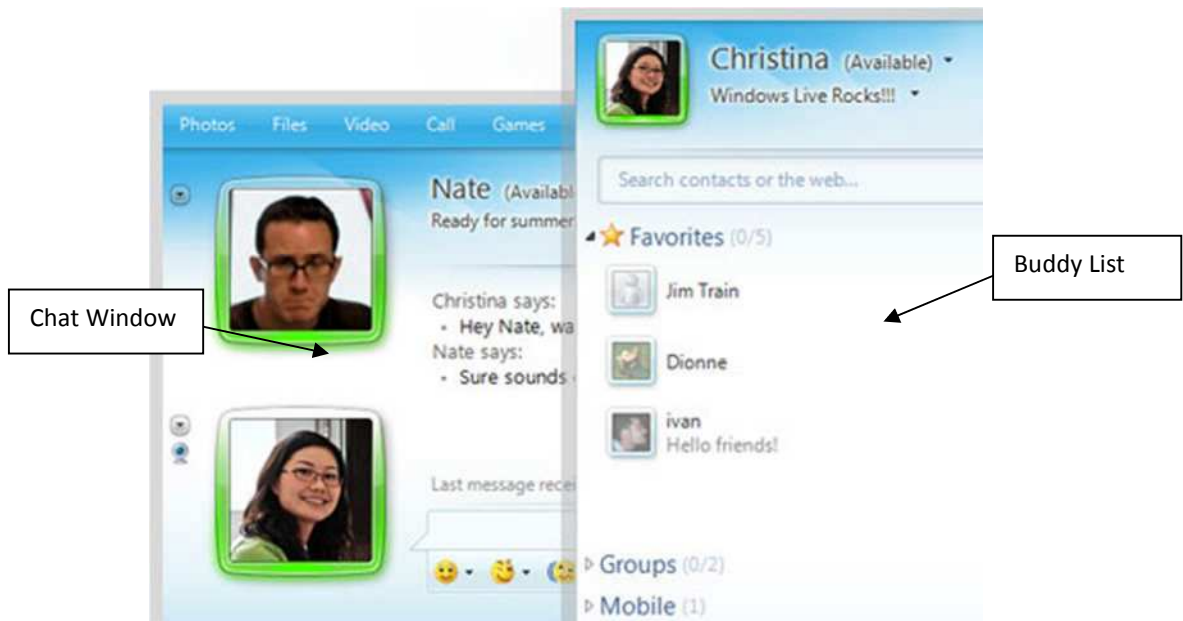

Figure 2-7: Image of IM (taken from Windows Live Messenger)

IM has different features which allow users to control who is allowed on their 'buddy list', i.e. people who are accepted by the individual for communication, who are able to see when they are online and available to chat (see Figure 2-7) (Nardi *et al.*, 2000; Herbsleb *et al.*, 2002). Users can also change and update their online status from 'available' to 'busy' indicating their availability for communication to those on their buddy list. They are able to select whether to have one-to-one conversations, or multi-party chat with two or more people (Nardi *et al.*, 2000).

IM is also considered an important medium for informal, casual, opportunistic and intermittent communications (Nardi *et al.*, 2000; Herbsleb *et al.*, 2002; Scholl *et al.*, 2006), such as quick questions and clarifications, coordination of social impromptu face-to-face meetings and to negotiate availability (Nardi *et al.*, 2000; Fussell *et al.*, 2004) – this is one of the benefits of IM over email (Fussell *et al.*, 2004). Isaacs *et al.* (2002b) categorised two types of users: those who 'work together' over IM, discussing complex work issues, with intense conversations including many short exchanges over a short period of time; and those who use IM for 'coordination' as the main purpose, using messages which are often shorter in length with formal endings to conversations.

A feature called 'Project View IM' could be integrated to IM to help users to manage their work and attention on multiple projects (Scupelli *et al.*, 2005). This feature provides reminder and awareness functions, linking active projects to related files and members online. A

preliminary study compared work with or without Project View IM and found that users with Project View IM reported lower workload (Scupelli *et al.*, 2005).

A survey study with college students conducted by Lancaster *et al.* (2007) found that IM is seen as easier to use than email, and helps convey emotions through the use of 'emoticons'. These emoticons are provided as part of the application allowing users to send symbols or characters to convey emotions, such as a smile, as substitute facial expressions (Lancaster *et al.*, 2007). More than 50% of the respondents in this survey indicated that IM is more effective at building friendships compared to email. Results also indicated that users preferred to use IM with friends and family whilst email was preferred in a working context (which was perceived as being more secure) (Lancaster *et al.*, 2007).

Many IM providers also allow a history of conversations to be kept, which is useful when updating members who are unavailable during a discussion (Handel and Herbsleb, 2002). IM can be used as an initial mode of communication to arrange further meetings using other media (Nardi *et al.*, 2000; Isaacs *et al.*, 2002a), however users rarely switch media mid-conversation (Isaacs *et al.*, 2002a).

'Explicit referencing' was defined by Cherubini and Dillenbourg (2007) as the attempt to link an object or a specific point in a shared visual space to a particular utterance in remote discussions, by considering the conversation context and task context. This means users relate utterances to previous utterances or objects. They further described conversation context as utterances which participants use to interpret forthcoming or new utterances in a conversation whilst task context is the set of objects or environment being referred to (Cherubini and Dillenbourg, 2007). The influence of explicit referencing in a collaborative problem solving task via synchronous IM to negotiate spatial information on a shared map was examined by Cherubini and Dillenbourg, (2007). The task required participants to allocate facilities (e.g. parking, toilets, concert stages) on a shared map, however, they were unable to view each other's screen and were forced to coordinate different positions verbally. Participants worked in pairs and did not know each other prior to the study. Four experimental conditions compared the use of explicit referencing (linking messages visually to different points on the map or messages during the discussion) and the ability to view message history on problem solving as follows:

- 1) Previous chat messages exchanged in sequential order
- 2) Previous chat messages shown on the shared map
- 3) Previous chat messages in sequential order and use of the explicit referencing feature

4) Previous chat messages shown on the shared map and use of the explicit referencing feature

The results showed that participants in the condition which allowed linking IM messages to different points on the map or even the previous message, sequentially in the chat history (condition 3) scored the highest in terms of correctly allocating facilities (Cherubini and Dillenbourg, 2007).

Similarly, Gergel *et al.* (2004b) conducted a laboratory study to investigate the effect of different numbers of previous messages available in a chat client history when used to support remote problem solving. The study compared a chat client showing only two previous messages with another showing 12 previous messages. The results showed that having a longer dialogue history helped participants to communicate more effectively, contributing to a better performance especially when the spatial requirement of the task was complex (Gergel *et al.*, 2004b).

However, when compared to face-to-face communication less interaction was seen over such text-based communication in terms of quantity, which could be due to the effort required for typing instead of direct verbal communication (Straus and McGrath, 1994; Nardi *et al.*, 2000). Isaacs *et al.* (2002a) found that partners who frequently interact with each other tend to have longer interactions than those who rarely communicate with each other on IM. They also found that the faster pace and shorter conversational turns are usually the result of greater experience with IM as well as greater familiarity with the interaction partner (Isaacs *et al.*, 2002a). Frequent interaction with the same members on their buddy lists also allows users to have more informal exchanges with each other (Nardi *et al.*, 2000).

Unlike fully synchronous interactions such as face-to-face interactions or telephone calls, IM allows users to multitask between conversational turns or breaks in conversations, or even participate in multiple conversations at once due to its semi-synchronous nature (Avrahami *et al.*, 2008); and messages can be attended to at a convenient time (Avrahami and Hudson, 2004). Nardi *et al.* (2000) also found that for frequent coordination and scheduling tasks, users prefer IM for its immediacy thus avoiding formal emails or lengthy telephone conversations.

IM is easier to install and set up compared to audio/video mediated tools; an additional benefit of using chat over audio communication is that it can be easier for those communicating in a second language (Scholl *et al.*, 2006). However, the adoption of such

systems needs to be fully supported so that all members in a collaborative team are encouraged and trained to benefit from their use (Herbsleb *et al.*, 2002).

Incoming messages are made visible on IM - new messages flash up at the bottom of the computer screen and remain highlighted as an opened window; this constant visual alert is there to ensure participants are aware of new messages, even if the audio alert has been switched off. This is efficient for tasks which require immediate responses, so are better than emails (which sometimes require users to log in via internet portals or web access to check their accounts – and others may have no flashing visual alerts and hence are less noticeable if the audio alert is switched off) or voicemail (which requires users to look away from their computer to notice the visual alert if the audio alert is switched off) (Nardi *et al.*, 2000). However incoming IM messages may distract or interrupt the current work in progress (Czerwinski *et al.*, 2000; Cutrell *et al.*, 2000; Avrahami and Hudson, 2004), especially when users do not want to be interrupted (Nardi *et al.*, 2000). IM distractions during evaluation tasks cause users much difficulty in going back to the task having been disturbed by the message alert, especially if the incoming message is unrelated to their current task (Cutrell *et al.*, 2000; Czerwinski *et al.*, 2000). Even so, users still consider this tool more discreet and less disruptive compared to telephone or face-to-face interactions (Scholl *et al.*, 2006). Moreover, when the use of audio or verbal communication could disturb those working around them, (i.e. too much noise may distract other colleagues), users were more willing to converse via IM (Scholl *et al.*, 2006).

Messages are sent at the sender's convenience to initiate a conversation, but it may be undesirable and disruptive to the receiver when received at an inappropriate time as IM provides limited awareness of the receiver's current work activities (Avrahami and Hudson, 2006). The inability to interpret the availability of others may cause misunderstanding and negative feelings between members (Avrahami and Hudson, 2004; Avrahami and Hudson, 2006). In contrast, Nardi *et al.* (2000) found that the buddy lists and online status of members provide partial awareness of whether other users are available, and many messages sent by initiators are often in the form of preambles, where the sender tries to establish whether the receiver is ready to converse at that moment, i.e. whether the receiver would reply straight away. Users may choose to ignore new messages until they are ready to respond (Nardi *et al.*, 2000), however the lack of responsiveness can be portrayed as impoliteness to the sender who may be expecting immediate replies due to other users being online (Avrahami and Hudson, 2004). In contrast, Nardi *et al.* (2000) claimed that IM provides 'plausible deniability'

where many users believe they can ignore messages without offending senders as they believe senders may not always assume that they are at their desks to receive the messages in the first instance. IM also allows receivers to judge the level of urgency of the incoming messages and decide whether to respond, which is less distracting than the telephone (Nardi *et al.*, 2000).

It would be useful for members to be able to predict the timeframe in which they could accurately expect a reply to their messages, or the responsiveness, to prevent breakdowns in communication (Avrahami and Hudson, 2006). It has been found that different message characteristics affect responsiveness, for example messages including questions usually mean that senders tend to be waiting for replies and therefore an answer is normally sent back faster, whilst users are usually slower to respond if the message includes links to other websites or information (Avrahami *et al.*, 2008).

Avrahami and Hudson (2004) developed the first version of a tool called "QnA", which can be used as an addition to commercial IM clients already available on the market. This tool can help participants to identify messages which need attending to, such as those containing questions. Once a question is detected by the tool, the message is flagged and the software automatically alerts the user to the incoming question. This is to avoid disrupting users with less urgent messages. One of the main problems found with this tool and other mediated text-based tools is that users are often relaxed in their use of grammar, spelling and punctuation (Nardi *et al.*, 2000; Avrahami and Hudson, 2004), therefore detecting questions from statements automatically can be difficult (Avrahami and Hudson, 2004).

IM allows conversations to include more than one recipient and provides a place for members to interact in real-time, with short conversational turns (Santhanam, 2001; Handel and Herbsleb, 2002). However, exchanging information with a large group of participants during a chat session may hinder participants from distinguishing known authority figures as the chat window updates spontaneously and messages can get lost or overlooked (Birnholtz *et al.*, 2005). Users also prefer to use IM in parallel with other media during a group discussion, such as a telephone conference, to establish and maintain a social link with other participants (Nardi *et al.*, 2000). IM is unsuitable to support tasks which require users to reference the conversation over a period of time as newer messages sent and received are usually displayed at the bottom of the window, whilst older messages move up the screen and eventually disappear off the screen (Çakir *et al.*, 2007).

A study by Fussell *et al.* (2004) found that participants working with co-located as well as remote colleagues often give higher priority to their co-located colleagues. This study investigated the use of IM in task management and the division of labour in remote collaboration on four web design tasks. Each participant was required to work with two colleagues on the same team simultaneously (one co-located and one distributed). All communication to remote partners was via IM. The results showed that the use of IM compared to face-to-face interactions had no effect on the sequence in which activities were conducted, but participants still favoured co-located tasks. However, participants did not feel that the quality of teamwork or the overall performance of their co-located projects was higher than that of their remote projects conducted via IM (Fussell *et al.*, 2004).

Another empirical study was conducted by Handel and Herbsleb (2002) investigating how six distributed teams engaged in remote collaboration used IM in their workplace to facilitate communication between remote sites. They found that the tool was adopted to support synchronous communication, but only in bursts. Participants only used IM a few times to leave asynchronous messages for each other - the content of conversations was mainly work related, or investigating the whereabouts and availability of each other. Participants also used IM to share some non-task related interactions such as humour; however this was very rare in comparison with work discussions.

Table 2-6 summarises key research for text-based communication tools (both email and IM). Even with the increasing availability of audio and video communication tools, IM and email are both useful mediums for communication and therefore will not become obsolete in the future (Scholl *et al.*, 2006).

Key Finding	Source
Email is mainly regarded as an asynchronous tool – users expect delays in replies	Handel and Herbsleb, (2002); Whittaker (2005)
The perceived importance, current workload, characteristics of the message and availability determine how soon users reply to email messages	Dabbish <i>et al.</i> (2005); Whittaker <i>et al.</i> (2007)
Many email tasks are mainly collaborative tasks, which require multiple exchanges causing many users to experience high volumes of messages in their inboxes, which can be time consuming to organise	Kiesler and Cummings (2002); Whittaker (2005)
IM is regarded as synchronous as well as semi-synchronous communication – depending on the speed of the internet network. Users often prefer IM for immediacy thus avoiding formal emails or telephone calls	Nardi <i>et al.</i> (2000); Handel and Herbsleb (2002); Avrahami <i>et al.</i> (2008);
When compared to email, IM was reported to be easier to use and helps convey emotions through the use of ‘emoticons’. It is	Lancaster <i>et al.</i> (2007)

found to be more effective at building friendships than email	
IM helps support explicit referencing, which in turns improves performance in a spatial task	Cherubini and Dillenbourg (2007)
Using IM with audio/video tools makes communication easier for non-native speakers	Scholl <i>et al.</i> (2006)
IM can be a source of distraction as messages are often sent at the sender's convenience and not the recipient's	Avrahami and Hudson (2006)

Table 2-6: Summary of key findings for text-based communication tools

2.4.4 Modality

Since the start of CSCW, much has been done to compare face-to-face meetings with mediated communication, however limited research has been done to compare different mediated tools available to support distributed work (Baker, 2002; Martins *et al.*, 2004). A wide range of technologies support more than one mode of communication channel (i.e. audio, text, visual representation) - this is referred to as multimodality. This section presents the use of different modes of communication and how they can supplement each other in various contexts in VTs.

It is suggested that the separate definitions contrasting VTs and traditional face-to-face teams are becoming less important as the degree of 'virtualness' or 'team virtuality' is considered more relevant (Kock, 2002; Martins *et al.*, 2004; Kirkman and Mathieu, 2005; de Jong *et al.*, 2008). Team virtuality is the extent to which team members interact by using mediated tools. This includes the level of synchronisation and the presence of non-verbal cues, which are transmitted virtually (Martins *et al.*, 2004; Kirkman and Mathieu, 2005). For example, video-conferencing provides a higher level of virtuality enabling participants to converse synchronously while receiving nonverbal cues. In contrast, text-based methods such as email and fax provide much less virtuality as participants are unable to predict when to expect responses - delays are often anticipated and information about the receiver's reaction to their messages is limited.

Overall, the degree of virtualness is affected by the technology adopted to support virtual collaboration. The adoption of the technology is, however, influenced by the tasks (e.g. spatial, decision making, information exchange), the user preferences (whether users prefer text-based methods or synchronous means such as the telephone), the time constraints and the availability of technology as well as skills of the users (Martins *et al.*, 2004). Teams with higher levels of task virtuality have less task conflicts (de Jong *et al.*, 2008).

Technologies offered to VTs have different affordances, which determine or constrain the way in which the technology is used, how behaviour is affected and how interactions are

supported (Whittaker, 2002). These affordances are the modes which the technology supports (i.e. audio and/or visual) and the interactivity (whether participants are able to receive feedback from the partners they are communicating with) (Whittaker, 2002).

Complex multimodal technologies offer better support for virtual collaboration, particularly when the collaborative task involves participants viewing or using physical objects (Whittaker, 2003). Subsequently, relying only on one mode of communication, especially text-based communication, can deprive team members of the additional non-verbal cues which exist in face-to-face interactions, such as the tone of voice, facial expression, shared visual context (i.e. of objects or artefacts), body language and personal demeanour, which can enhance verbal information (Branson *et al.*, 2008).

The following subsections present studies comparing communication modes such as audio, video and shared visual representation (i.e. shared whiteboard), and text-based communication.

2.4.4.1 Audio-only vs. Shared Visual Information

This section reviews and compares the use of audio-only tools such as the telephone or internet phone with shared visual information technologies.

Previous research in CSCW summarised by Whittaker (2003) suggests that when remote communications involve the need for people to refer to physical objects without being able to interact face-to-face, speech alone is sufficient and effective for simple tasks. However, it is still more important to provide and share visual information of objects being discussed rather than of other participants involved. However, disjointed or interrupted visual information can undermine communication processes (Whittaker, 2003).

The 'bandwidth hypothesis' was initially used to develop mediated tools so that they support interaction as close to that of face-to-face by integrating visual and auditory information to improve communication efficiency (Whittaker, 2002). This hypothesis suggests that the more information transmitted and supported over mediated collaboration, the more effective the technology. However, studies such as Kraut *et al.* (2003) and Fussell *et al.* (2000) found no evidence to support this hypothesis. Whittaker (2002) summarised that speech is the most crucial part of tasks such as remote assistance and the additional visual information may not contribute towards the effectiveness of the communication unless it is to support social cues during interaction.

Face-to-face communication, audio-only and video enhanced communication in a remote collaborative task was examined by Olson *et al.* (1995). All participants were able to use a simple text editor during the task; some were allowed to directly converse face-to-face with their team members and others relied on video (speech and visual) and a final group used speech only. The task required participants to produce a design document together, but did not involve participants dealing with spatial information (such as sketches or manipulation of physical objects). The performance of participants in the video condition was as good as those in the face-to-face condition. However, participants in the audio-only condition reported poor quality of discussion, lower satisfaction and a higher difficulty in communication.

Audio alone is considered inefficient when supporting turn taking in remote conversations as users often rely on visual information to track others' attention (e.g. eye gaze) (Whittaker, 2002). Isaacs and Tang (1994) established that users find managing remote conversations easier when they are able to rely on the additional video feed as well as audio.

2.4.4.2 Text vs. Audio

A combination of modes such as IM and audio can be used in conjunction with each other (Fussell *et al.*, 2004; Scholl *et al.*, 2006). Scholl *et al.* (2006) showed that users mainly communicated via audio for formal meetings with distributed colleagues; however, the telephone is also used with co-located colleagues for an extended conversation usually initiated through IM.

Text-only and audio-only communication tools were compared in a collaborative decision making task in VTs by Baker (2002). This study found that there was no difference in performance between the two modes of communication. It is suggested that as long as text-based tools are capable of supporting the appropriate level of linguistics required for the remote collaborative task, text alone is sufficient.

One difference between telephone interaction and email interaction is the way email can reach and include more recipients and allow an ongoing information exchange involving all members (Santhanam, 2001). A study by Santhanam (2001) compared how email, face-to-face interaction and or the telephone were adopted by users to support structured collaborative tasks (required users to develop a prototype to a given set of specifications) and unstructured collaborative tasks (required participants to produce a report on their choice of topic from a list). Results showed a positive correlation between the level of email usage and

the overall task outcome, i.e. the higher the level of email interaction, the higher the task score achieved by VTs. Conversely, a negative correlation was found between the use of fax and the telephone and the attraction (i.e. the perceived likeability of other participants) within groups. In addition, the level of interruption caused by text chat or email is considerably lower than that of voice information such as from the telephone; for example, email contributes to only 3% of users switching tasks while telephone accounts for 14% (Czerwinski *et al.*, 2004).

Voice-only communication can positively affect the level of perceived intellect of team members as well as promote cooperation and trust between members compared to text-only communication (Jensen *et al.*, 2000). However, IM can be used to help overcome audio problems in remote collaboration (Scholl *et al.*, 2006), while audio can be distracting especially if the task requires processing of visual information as users have difficulty switching their focus to different modes of information (Weisz and Kiesler, 2008).

The goal of the studies discussed was to compare different modalities as well as identify how different types of communication can be used to supplement each other in various collaborative tasks and settings. Key findings on different modality communication have been summarised in Table 2-7.

Key Finding	Source
Complex multimodal technologies offer better support when tasks involve remote collaboration involving physical objects	Whittaker (2003)
Speech alone is sufficient when participants are not required to interpret social cues – the additional visual information for such tasks has no effect on performance	Fussell <i>et al.</i> (2000); Whittaker (2002); Kraut <i>et al.</i> (2003)
Audio-alone is inefficient to support turn taking as users rely on visual information such as eye gaze to track others' attention	Isaacs and Tang (1994); Whittaker (2002)
In a remote collaborative decision making task, text-only or audio-only tools have no difference on performance	Baker (2002)
A positive correlation was found between the use of email and task outcome, while a negative correlation was found between the use of the telephone or fax and the group members' attraction to each other	Santhanam (2001)
Text-based communication (IM/email) causes less interruption to the current task compared to voice communication	Czerwinski <i>et al.</i> (2004)

Table 2-7: Summary of key findings on communication modality

2.5 Qualitative and Quantitative Methods in Collaboration Studies

In order to gain a better understanding of the use of collaborative tools, it is necessary to examine individuals' actions, usage and reasons for using technology in a collaborative task (Liu *et al.*, 2008). However, it is difficult to measure collaboration which involves more than

two people acting independently of each other whilst coordinating and cooperating on necessary tasks in complex settings, and maintain validity, generalisability and control (Neale *et al.*, 2004; Anderson *et al.*, 2007).

Different approaches have been adopted to investigate the influence and impact of technologies, physical proximity, workplace settings and other factors on the overall communication and collaboration (Liu *et al.*, 2008). These methods include laboratory studies, field studies, interviews, observations, questionnaires and ethnography (Whittaker, 2002).

Laboratory studies have investigated the use of mediated communication in multidisciplinary teams working on different tasks, and using different combinations of media modalities, by gathering subjective and objective data including conversations that have taken place (Whittaker, 2002). Laboratory studies allow researchers to control important variables but may sacrifice ecological validity by removing users from their usual, natural work settings to perform laboratory tasks over a short period of time (Anderson *et al.*, 2007). However, investigations carried out in the field have little power to control settings and variables - the manipulation of these variables is considered important at different stages of development of new communication technologies (Whittaker, 2002). Thus simulated tasks are often designed to examine collaboration or to create clean measurable outcomes, which may be too complex to observe in real life tasks. Roch and Ayman (2005) argued that in real life situations, decision making tasks do not always yield correct answers, rather members work towards achieving what they perceive to be the best solution, which is no different from a simulated task. Therefore simulated tasks to a certain extent can be used to encourage decision making processes in laboratory studies, especially during the development and evaluation phases of a technology to examine the initial influences, prior to further examinations in the field.

In order to best compromise between controlled laboratory studies and field observations, Anderson *et al.* (2007) conducted a field observation in order to identify important features which influence remote collaboration in real workplaces before designing a semi-controlled laboratory simulation involving real end users in different experimental conditions performing a real task. The factors constituting a team's perceived performance has not been clearly defined, though measures are often taken in both laboratory and field studies to assess performance (e.g. subjective measures such as satisfaction in field studies, and

objective measures such as productivity of teams in laboratory studies) (Andres, 2006; de Jong *et al.*, 2008).

Interviews and surveys are often used to gather information from real work settings, such as how technologies are used in the workplace (Siu *et al.*, 2006; Liu *et al.*, 2008). They can be used to measure the frequency of usage, and attitudes and behaviours towards technologies. However, these techniques rely on self-reports which can be inaccurate and often fail to capture the contextual dynamic of the technology usage (Siu *et al.*, 2006; Liu *et al.*, 2008).

Ethnography is time consuming and one of the main weaknesses is the lack of generality as it is often conducted on a small number of users over a long period of time, although it yields extensive qualitative data on user behaviours and usage of technologies within a particular context (Whittaker, 2002).

The research studies discussed in this chapter adopted different methods of data collection, tasks, contexts, team compositions and variables (dependent and independent) to examine virtual collaboration. The last part of this section summarises some of the different techniques adopted (see Table 2-8).

Methods	Studies	Participants	Task/Duration	Measures	Additional Methods
Observation	Isaacs and Tang (1994)	5 software engineers (on 3 different sites)	6 interactions were observed (2 desktop video conferences, 2 face-to-face and 2 telephone conferences)	Videotapes of interactions to examine: 1) non-verbal information (gesturing), 2) expression of attitudes (posture and facial expression), and 3) managing pauses	
	Isaacs <i>et al.</i> (1997)	2	One week long observation of participants' communication at work	Formal and informal communication in the workplace	
	Bellotti and Bly (1996)	4 end users (engineers and designers)	40 person-hours of close observation	1) Description of work, and 2) individuals' day-to-day work and the nature of collaboration in the workplace	1) Interviews, 2) brainstorming with users, and 3) researchers attended meetings for observation
	Scholl <i>et al.</i> (2006)	10 (observations) 66 (questionnaires)	Observed the use of software (chat, audio, whiteboard) - using a data collection tool for 3 months	Context of use of software (observation – audio and chat logs) Questionnaire: student feedback on remote tutoring sessions as part of class (subjective 7-point Likert scale)	Observed participants were also interviewed
	Anderson <i>et al.</i> (2007)	70 participants in total (9 groups of 4-7 individuals in teams and the rest worked individually)	Scenario of automotive collaboration between different teams – 40 min task: discussion and problem solving	1) Video/audio recordings: transcribed and coded, and 2) group performance (one researcher marked all against criteria of effective solution)	
	Olson <i>et al.</i> (1995)	36 groups of 3 professionals (had worked together before)	3-hour tasks (2 sessions) on collaborative design	1) Quality of product, 2) participants' satisfaction with the process, and 3) process of design and coordination (transcript/coding)	Questionnaire
Laboratory Experiments	Veinott <i>et al.</i> (1999)	38 pairs of student participants	Instructor/follower scenario: one participant had to try and redraw routes on a fictional map with directions given by his/her remote partner	1) Performance, 2) subjective ratings of satisfaction, and 3) communication patterns	Questionnaire
	Huysman <i>et al.</i> (2003)	34 students (12 different groups, which formed 6 teams)	6 different tasks (each group only carried out one task)	Email traffic monitoring	1) Weekly communication diaries, and 2) observation of pattern of media use

Straus and McGrath (1994)	72 groups of 3 people	3 tasks (idea-generation, intellectual task and judgement task). Each task was 12-min long. 2 experimental conditions (face-to-face vs. text editor)	Performance: idea-generation task – the quality of these ideas were judged by 2 raters; intellectual task – objective marking and judgement task – specially developed scoring system	Questionnaire: satisfaction with media and task outcome
Jensen <i>et al.</i> (2000)	66 participants randomly assigned into pairs	Prisoner's Dilemma (participants required to collaborate so each would gain optimal benefit). 4 experimental conditions (no communication, text chat, text-to-speech and voice) – high scores were awarded with prizes	1) Performance (scores), and 2) level of contribution (collaboration)	Post-study questionnaire: Subjective rating of others in their teams (likeability, trustworthiness, intelligence)
Baker (2002)	64 groups (of 3-4 members: worked with each other before)	Prisoner's Dilemma (4 experimental conditions: text-only, text-video, audio-only, audio-video)	Performance (based on decision making)	
Fussell <i>et al.</i> (2000)	25 undergraduate students	Remote assistance task on bicycle repair	1) Performance (completion time, no. of tasks completed and quality), 2) real-time recordings (trained observers rated work quality and communication quality), and 3) video and audio recordings (transcribed/coded)	Post-task questionnaire
Andres (2006)	48 student participants (teams of 4)	2.5 hours; software design task	1) Video recordings (2 observers), 2) team productivity, and 3) group process satisfaction (5-point Likert scale)	1) Observation and 2) group style questionnaire
Cutrell <i>et al.</i> (2000)	9 participants	Performed 2-part task 1) web search task, 2) a cursory analysis of graphic design quality	1) Time to switch task as cause of IM message, 2) time spent on message before returning to task, and 3) time to resume the search task after leaving the message	
Avrahami and Hudson (2006)	58 participants (did not know each other before)	4-hour block (6 sessions) of simulation games. Participants needed to maximise their own scores as well as the company they were assigned to	Performance (scores of individual)	Observation of communication but no audio/verbal recordings

	Cherubini and Dillenbourg (2007)	60 pairs (120 students)	Collaboratively solve given problem using IM – 45 mins session	1) Eye-gaze, 2) performance scores and 3) conversation structure (no. of words, utterances, turn taking)	
	Fussell <i>et al.</i> (2004)	88 participants (4 per group)	4 web design tasks to be completed collaboratively within an hour	1) Transcribed audio, 2) subjective ratings, 3) key stroke analysis of activities over IM, and 4) subjective task performance rating	Questionnaire (demographic and subjective ratings)
	Whittaker <i>et al.</i> (1991)	18 participants (6 groups of 3)	1) List and prioritise criteria to meet when buying a house 2) Arrange a meeting by coordinating availability and calendars		
	Gergle <i>et al.</i> (2004a)	12 pairs of undergraduate students	1 hour online puzzle solving task (1 participant acts as Worker, guided by another participant acting as Helper).	1) Utterances (length and time), and 2) physical actions	Sequential analysis (verbal exchanges and physical actions) and chat content analysis
	Gergle <i>et al.</i> (2004b)	16 pairs of professionals and students	1 hour online puzzle solving task (1 participant acts as Worker, guided by another participant acting as Helper).	1) Completion time (performance measure), and 2) conversational efficiency of communication (length of utterances, number of words, conversational structure)	Chat content analysis
Questionnaires /Surveys	de Jong <i>et al.</i> (2008)	49 teams (172 members) of various professions	The nature of team communication and the use of communication media in general	1) Perceived team performance, 2) relationships, 3) tasks and process conflicts, and 4) level of team virtuality	
	Lancaster <i>et al.</i> (2007)	545 surveys given to university students	Investigate the usage difference/ preferences of email and IM	69 questions on IM and email covering: 1) emotion, 2) relationship, 3) usage, and 4) reliability	
	Leinonen <i>et al.</i> (2005)	1 global team (19 members)	Data collected over 3 months	Pre- and post-questionnaires on user experience, perception	Log files of shared virtual workspace
Interviews	Whittaker and Sidner (1996)	21 end users (office workers)	Study of email and database usage. 1-2 hours of semi-structured interviews	1) Usage of technologies, 2) functions, and 3) benefits and problems	Content analysis (20 different databases)
	Nardi <i>et al.</i> (2000)	20 participants	Interviewed to study the usage of IM in the workplace	Audio recording of interviews (transcribed)	Additional observation and IM logs
Content Analysis	Handel and Herbsleb (2002)	4 teams of end users (from 4-28 members)	17 months of data collection with real end users – understand functionality of	Analysis of log-files; calculated number of logins, status changes. Chat logs were analysed	1) Semi-structured interviews, and 2) small focus group

IM at work					
Diary Studies	Czerwinski <i>et al.</i> (2004)	11 participants	1-week; participants were given electronic spreadsheet with pre-designed columns to document their activities	1) Explore users' definitions of 'task'; no. and types of task, 2) observe the 'start' and 'finish' time and duration of task, and 3) capture difficulties of task switching	
Ethnography	Whittaker <i>et al.</i> (1994)	2 participants	1-week long observation; informal interactions in workplace	1) Audio and video data were analysed to examine the nature of informal communication; i.e. types of tasks, and 2) analysis of documents exchanged	Remote shadowing was used (i.e. videos were set up in participants' rooms and participants wore wireless audio recorder)
	Nardi <i>et al.</i> (1993)	Approximately 35 participants (study was ongoing and different participants were observed depending on their work-shifts)	14-person weeks of observation, including formal meetings, informal lunch breaks (observation and informal 'chat' with participants)	1) The use of video-as-data to transmit live video feeds from the operating room, and 2) recorded and analysed over 500 pages of transcripts to examine the influence of video	Shadowing, observation, audio analysis, semi-structured interviews and informal interactions

Table 2-8: Methods used to measure collaboration

2.6 Identifying the Research Area

Collaboration is one of the most important factors contributing to the success of virtual teams, influencing the overall team performance, cohesion and satisfaction (Frost and Sullivan, 2006; Horwitz *et al.*, 2006). However, collaboration is complex as it is influenced by many factors, including the type of collaborative task, teams, individuals involved and the technology used, all of which are composed of further subsets (Wilson *et al.*, 2009). It also takes place in many settings and is studied broadly in many fields such as medicine and healthcare, management, technology, computer science, education, gaming and cognitive ergonomics (Wilson *et al.*, 2009). In addition to an examination of the multiple settings of collaboration, the interpersonal relationships, the task goals and the team characteristics also varied in existing empirical research, thus many definitions of collaboration have emerged in these different research fields, contributing to the difficulty of studying virtual collaboration.

Adopting all existing definitions of collaboration identified in the literature for further examination in this PhD thesis was impractical. Therefore a definition was selected, which best described collaboration in the context of this thesis, i.e. when two or more people coordinate, communicate, and cooperate with each other to reach a common goal (Schrage, 1990; Klein, 2001; Weiseth *et al.*, 2006; Wilson *et al.*, 2009) by sharing information, establishing common ground and shared understanding (Clark and Brennan, 1991; Dillenbourg and Traum, 1999; Birnholtz *et al.*, 2005) as well as maintaining mutual awareness of each other (Schmidt and Bannon, 1992; Artman and Wærn, 1999; Schmidt, 2002).

The collaboration discussed in the literature review chapter of this thesis was mainly observed amongst team members, working together and who knew each other (i.e. they have had previous face-to-face interaction) prior to the virtual collaboration or had 'met' each other virtually (i.e. introduced over email or the telephone) during the course of collaboration. The terms distributed teams and virtual teams are often used interchangeably in the literature to describe teams whose geographically distributed members interact and collaborate with each other electronically. However, distributed collaboration may not always imply the same level of team virtuality (i.e. team members may work separately in different locations, but meet face-to-face to collaborate during the day). It is therefore important to emphasise that this thesis focussed mainly on virtual collaboration, where virtual team members collaborate on specific tasks using mediated technologies and have limited face-to-face communication.

This thesis was funded by the European Project, CoSpaces, the main focus of the research was greatly influenced by the aim of this project, which was to develop technologies to support collaboration within the context of design and engineering (i.e. in the aerospace, automotive and construction industries). CoSpaces is part of the 10-year Future_Workspaces roadmap project with the aim to support Collaborative Working Environments (CWEs), to identify end users' vision for future collaborative work and provide ways to optimise collaboration, which is seen as a way to increase competitiveness of European companies. This shows a strong European objective to support collaboration in multiple industries. This PhD thesis was therefore grounded in recognition to improve EU industry by supporting collaboration and by identifying the influence of collaborative technologies especially in design and engineering.

Virtual teams rely heavily on the use of technologies to allow members to collaborate effectively. A good proportion of existing tools primarily aim to support spoken language and fail to support other types of interaction (Gergle *et al.*, 2004a), while the literature indicates that the majority of the research has evaluated communication modality on its own or in direct comparison with other technologies (i.e. audio-only vs. audio-visual, shared workspace vs. no shared workspace), but not as an integrated solution.

Recent research began to identify the conditions in which visual information is beneficial in virtual collaboration (Kraut *et al.*, 2002b) and studies suggest that video communication (which provides audio-visual information of remote colleagues during collaboration) has no significant effect on overall task performance but enhanced user satisfaction compared to audio communication alone. In contrast, if the video communication provides a view of the physical workspace, allowing remote users to see physical objects or systems being worked on (i.e. video-as-data), performance was better compared to audio communication alone (Nardi *et al.*, 1993; Veinott *et al.*, 1999, Kraut *et al.*, 2003). Whittaker (2003) suggested that complex multimodal technologies offer better support for virtual collaboration, particularly when the task involves viewing or using physical objects.

Despite findings from the previous studies, there is still a lack of understanding on how shared visual workspaces improve performance and how they benefit different types of virtual collaborative tasks. Kraut *et al.* (2002b) suggested that there is still the need for more research to supplement these studies, which is still true to date, as shown in the literature review. Moreover,

it is important to identify how visual information influence collaboration and how it can be used to replace other modes of communication (i.e. speech) in different settings (Gergle *et al.*, 2004a).

The use of shared visual spaces is often accompanied by auditory feeds to provide common workspaces (Kraut *et al.*, 2003), though limited literature was found to compare the effectiveness of other communication modality (i.e. visual and text-based) in supporting shared workspaces. Furthermore, limited literature was found on the combined influence of communication modality and shared workspaces on virtual collaboration or how users select between modality in virtual engineering and design tasks, which involve spatial information. These gaps were therefore identified as appropriate areas of research and were used to determine the overall aim and objectives of this thesis.

Audio, video and IM tools have been highly adopted in workplaces therefore it is essential to understand the fundamental impact and influence of these technologies on supporting virtual collaboration. This is of particular importance when collaboration involves the use of spatial information, which is considered lexically complex to describe when colleagues are distributed from one another, thus are unable to rely on deictic references. The importance of supporting the exchange of spatial information in virtual collaboration was identified and addressed by the CoSpaces project, which developed technologies to support shared co-located and distributed workspaces. This allowed users within the same room to share a view of the virtual object being projected onto their individual laptop screen as well as on a large screen in the room. Users are able to pass control of the 3D objects and make changes or annotations during the meeting, which are seen by all members on the large screen as well as on their own laptops. This enables users to seamlessly communicate spatial information with the use of shared workspaces and virtual annotation. The technology could also be set up to include distributed members to remotely see the shared objects. The technology aimed to support collaborative design and was seen as a solution to support the use of spatial information.

This PhD thesis aimed to examine the influence of communication modality combined with shared workspaces or shared visualisation on conversational communication, performance and user satisfaction in virtual teams. Furthermore, the findings within the virtual team setting will contribute to an understanding of virtual collaboration in design and engineering. The work presented in this thesis on investigating the use of shared visual information and shared

workspaces was conducted in parallel with CoSpaces and was grounded in the importance of shared workspaces.

As collaboration can be difficult to measure due to its complex nature which may differ across different domains as it is highly influenced by context, there is limited understanding of collaboration and how best to support it in different contexts (Wilson, 2006). Therefore for practical reasons, only a few aspects of collaboration were selected from the literature for study as not all could have been evaluated as part of this thesis. The selected aspects, as shown in the literature review, are important but the degree to which they are important to collaboration may be case specific. However they were selected for further examination as part of this PhD thesis as they sit coherently within the main investigations on the influence of modality and shared workspaces on collaboration. Thus these aspects were used to compare and focus the key findings across all studies conducted in this thesis. These key aspects of collaboration investigated to satisfy the objectives of this thesis are summarised in Table 2-9. The comparison of the key findings from different studies conducted in this thesis is presented in Chapter 7.

Key aspects of collaboration	Relevant thesis objective	Relevant chapters
How important is it for technologies to suit user needs, context of use and task? Do users alter behaviours to fit technological constraints?	1	Chapters 3 and 6
How can technology help to maintain an awareness of remote colleagues and tasks?	1	Chapters 4 – 6
Is audio the most useful communication modality in remote tasks?	1	Chapters 3 – 6
Does being able to see and hear remote colleagues enhance user satisfaction?	1	Chapters 4 and 6
Is there a need for technology to support more than spoken language for planned and unplanned collaboration?	2	Chapters 4 – 6
Is a shared view of the workspace in remote collaboration more useful than a view of the remote colleague?	2	Chapters 3 – 6

Table 2-9: Key aspects of collaboration investigated in this thesis

Finally, limited literature was found to guide the selection of specific methods for data collection, with many studies measuring performance, user satisfaction and the amount of communication in order to understand collaboration. Therefore a part of this thesis aimed to compare the most frequently adopted methods for measuring collaboration in various contexts.

Chapter 3 - Evaluating the Use of Qualitative and Quantitative Methods in Measuring Collaboration

3.1 Chapter Summary

This chapter is composed of a series of empirical studies conducted to examine the influence of technologies on collaboration in various workplaces (in industry and research settings) and the use of different data collection methods to measure collaboration.

One of the studies presented in this chapter was conducted within the CoSpaces project and thus the full results are not presented in this thesis (see Section 3.4.2). Another study was conducted within the DiFac project (described in Section 3.6.2), however the author designed the questionnaire to collect data for this study thus the results are presented in this chapter. The rest of the studies presented in this chapter were conducted solely to satisfy the aims of this thesis and were independent of other research projects.

The results of each study as well as the strengths and weaknesses of the data collection methods gathered from these studies are presented in this chapter. The findings from this chapter were used to inform the design of the laboratory and field studies of this thesis, presented in Chapters 4, 5 and 6.

It should be noted that these studies took place in different orders to that presented in this thesis. However they were grouped by methodology so that each qualitative and quantitative method could be best presented and evaluated in the context of measuring collaboration.

The description of study, the order they were conducted as well as the aims and outcomes of studies and their impact on further studies conducted in this thesis are summarised in Table 3-1.

Methods	Context of use	Order conducted	Purpose of study	Description of studies	Participants	Outcomes and contributions to overall thesis
Interviews	CoSpaces interviews	1	1) CoSpaces user requirements elicitation 2) Evaluate the current collaborative work practices of the CoSpaces end users 3) Evaluate the use of pre-design interview template	Semi-structured interviews conducted as part of CoSpaces user requirement elicitation	15 CoSpaces end users (engineers and designers)	1) Informed content, methods and skills used for interview sessions at Company X (Chapter 4) 2) Understanding of collaborative design tasks used to inform experimental design (Chapter 6)
	Skype interviews	5	1) Examine the use of Skype as a text and audio communication tool in real workplaces 2) Assess the use of semi-structured interview	Semi-structured interviews conducted to examine the use of Skype at work	7 (researchers, architects, analyst and manager)	1) The understanding of the way Skype is adopted at work influenced the use of Skype in a virtual design task (Chapter 6) 2) Informed the content of Company X pre-installation questionnaire regarding text and audio communication (Chapter 4)
Expert Priority Elicitation Exercise	Expert priority elicitation	2	1) Identify and prioritise factors of collaboration 2) Examine how a structured group prioritising session can be used	Experts were asked to list and rank different factors regarding collaboration	11 human factors researchers	1) Factors emerged from the session were used to develop a checklist examining collaborative features of a technology for the DiFac project (Chapter 3)
Questionnaire	Checklist for DiFac technology evaluation	3	1) Evaluate collaborative technologies developed in the DiFac project 2) Examine the use of short checklist in studying collaboration	Checklist developed from the outcome of the expert priority elicitation exercise to evaluate collaborative features of DiFac technologies	20 of DiFac consortium (researchers, developers and end-user representatives)	1) The use of checklist is adopted to record physical behaviours during laboratory experiment investigating virtual collaborative design (Chapter 6) 2) The outcomes used as feedback to the DiFac technology developers and were used to inform the content of questionnaire and interviews at Company X (Chapter 4)
	Outlook questionnaire	4	1) Examine the use of Outlook calendar in an academic research office 2) Evaluate the success and ease of use of online questionnaire as a method of data collection	Online questionnaire to examine the use of Microsoft Outlook calendar in the a research group	12 researchers	1) Online questionnaire method was adopted for use in Company X (Chapter 4)
Case Study	Student project case Study	6	1) Examine the use of collaborative technologies in a student group design project	Students reports on communication technologies used within their coursework groups	58 engineering students	1) A case study was conducted in the field study (Chapter 4) 2) The results informed the use of Skype and Instant Messenger for the design experiment (Chapter 6)

Table 3-1: Summary of purpose of studies and outcomes

These methods are discussed individually in this chapter, with brief descriptions of the design of the study, data collection, results and the practical implications of each method. The final section of this chapter (Section 3.8) summarises how these studies have directed the selection of the methods used in the laboratory and field studies presented in Chapters 4-6 of this thesis.

3.2 Introduction

It was seen in the literature (see Chapter 2, Section 2.5) that various methods have been adopted by researchers in order to examine collaboration which is facilitated by using a wide range of technologies in different tasks and contexts.

Collaboration involves two or more people interacting with each other and communication is therefore often more than two-way (i.e. with many speakers and listeners in a group discussion or during telephone conferencing); thus the overall collaboration process becomes difficult to capture and process, especially in complex work settings (Anderson *et al.*, 2007). Collaboration can still occur without direct communication especially when participants are able to gather physical or visual cues to gain and/or maintain awareness of each other's activities (Heath and Luff, 1992; Sharples *et al.*, 2007). This aspect of collaboration is therefore even more difficult to examine than direct communication (this type of collaboration is beyond the scope of this thesis). However, due to the limited understanding of different types of collaboration and how people collaborate in different settings, studying collaboration is complex (Gutwin and Greenberg, 2000).

Methods of measuring collaboration have not been standardised or evaluated as different methods can be appropriate in different situations depending on the setup of teams, cultures, organisations, individuals, tasks as well as the shared goals (Gutwin and Greenberg, 2000). However the main methods used in collaboration research include laboratory studies, field studies and ethnography which employ the use of interviews, observation and questionnaires (Whittaker, 2002). All methods of data collection have strengths and weaknesses and are more suitable for different stages of the development of the technology as well as of the implementation at work, such research into collaborative work is not straightforward, hence more than one method is often adopted in a study (Wilson, 2006).

In order to study collaboration and the way in which it could be improved upon, the research should focus on investigating and analysing current collaborative systems to identify the

fundamental impact of these technologies in different situations (Wilson, 2006). The data collection methods selected for each study are often determined on the basis of the development stage of the collaborative system (i.e. from prototypes to end products) as well as other factors such as the number of end users involved and the type of organisation in which it is employed. Thus different methods are used to study the collaborative technology during the concept development stage and when it is already implemented at work.

Therefore the studies conducted in this chapter investigated collaborative work practices in different settings, which investigated real life collaboration involving real end users. Studies examined different development stages of several collaboration technologies (i.e. from user requirement elicitation to prototypes evaluation and off-the-shelf technologies). The studies presented in this chapter can be regarded as a series of pilot studies which were used to evaluate different methodologies and their appropriateness in various settings of collaborative work.

The interview sessions conducted for the CoSpaces user requirements elicitation (Section 3.4.2) aimed to investigate current work practices and gather user needs in order to develop new collaborative technologies to appropriately support these needs. The CoSpaces interviews were conducted as part of the CoSpaces project and can therefore be considered background work to this thesis, where the author contributed to the study alongside other researchers. In contrast, the Skype interviews, which were conducted solely by the author for the purpose of this thesis was aimed to examine the use of a multi-modal technology, such as Skype at work (Section 3.4.3).

The work presented in this chapter also includes the evaluation work conducted with another EU project, DiFac. DiFac was a three-year, EU funded project (IST-5-035079). The project aimed to develop a 'Collaborative Manufacturing Environment' (CME) for digital manufacturing including product design (virtual product design, development and review), manufacturing (factory layout and simulation), and a virtual training simulation for workers. The three fundamental elements of the CME include presence, ergonomics and collaboration, which were used to underpin the technologies developed within DiFac. The project included research institutes, developers, and real users from industries all over Europe. The author was invited to take part in this project to develop a method of evaluating collaborative features in the DiFac technologies. As no existing questionnaire was found in the literature, the author conduct an expert priority elicitation session with a group of human factors experts in order to elicit important features in which a

collaborative technology should support (see Section 3.5). The results from this expert priority elicitation session were used to develop the checklist used in the DiFac evaluation (see Section 3.6.2). As this chapter aimed to evaluate the use of data collection methods for collaborative work, an online questionnaire was also conducted to evaluate the use of Microsoft Outlook calendar at work (see Section 3.6.3).

Finally, an opportunistic study was conducted to evaluate the use of collaborative technologies in student projects (Section 3.7.1). This study explored the way in which existing (and many off-the-shelf) collaborative technologies were adopted by students to support various collaborative tasks.

Studies conducted in the field with real users have ecological validity as behaviours are examined in their natural settings, such as in a real workplace. However, laboratory studies can be used to examine fundamental human-computer interaction to provide a theoretical understanding of the influence of these technologies on collaboration, prior to further investigation in the field with many uncontrollable variables.

The overall purpose of the studies presented in this chapter was to provide new insights into different collaborative workplaces which can be used to generate ideas for future research (Robson, 2002), as well as to assess the suitability of such methods for certain settings and development stages, and the depth of the data yield.

3.2.1 Review of Methodology

Several methods were adopted by different researchers in different contexts of use while evaluating different aspects of collaboration (See Chapter 2, Section 2.5). No previous evaluation or guideline on how each method should be adopted to measure the use and the influence of technology on collaboration was found in the literature. This further suggests that collaboration is a multi-factorial notion and because different studies aimed to evaluate different specific aspects of collaboration, no standardised method was seen across all these studies.

Not all methods seen in the literature were adopted in this thesis as some were labour and resource intensive and were considered more exploratory for the scope of this thesis (i.e. methods such as ethnography and diary study).

This section presents a review of these methods and their relevance, appropriateness, adaptability and practicality to studies conducted in this thesis. A summary and the critical review of methods used by other researchers to evaluate collaboration and their influence on studies conducted in Chapters 4-6 are shown in Table 3-2.

Method	Context of use in literature	Relevance to context of use in the thesis
Observation	Adopted to evaluate formal and informal communication, context of use of technology, non-verbal communication and collaboration.	Observation is useful in different contexts and the richness of the data depends on the purpose and measure of the study. However, a full workplace observation can be difficult to arrange and requires a lot of resources in terms of the time required for data gathering as well as analysis of rich video data. Field observation can also be difficult to arrange in the context of collaboration as communication can be planned, spontaneous and serendipitous. Therefore observation is required to be conducted over a long period of time to capture specific interactions. This is especially difficult in virtual collaboration where participants can be geographically distributed. Observation is not evaluated in this chapter, but is adopted in part by focusing in specific aspects and as a complement to other methods, in Chapter 4 (i.e. workplace observation), Chapter 5 (i.e. for further qualitative information) and Chapter 6 (i.e. physical behaviour observation).
Laboratory experiment	Participants are often given a collaborative task to finish while the measurements taken include performance, subjective responses and verbal communication	Collaboration in different laboratory experiments have been measured using different methods, and the findings can be task or setting specific. However, certain aspects of collaboration can be difficult to capture in the field and thus the use of laboratory experiments help isolate the effects of specific technological features on collaboration. This method is seen as an important means to gather data for this thesis, thus laboratory studies are conducted in Chapters 5 and 6.
Questionnaires/ surveys	Questionnaires have been adopted in many studies independently and/or to complement other data gathering methods such as laboratory experiments and observation. However there are no standard questionnaires to measure the way in which collaboration is influenced by technologies and modalities. Furthermore, studies in the literature have designed specific questionnaires to evaluate different aspects of collaboration ranging from the frequency of use of technologies, the nature of communication, the use of email and IM, relevant to their own focus	Questionnaire as a method is evaluated in this chapter in order to assess the usefulness, pros and cons of paper and online questionnaire when measuring the use and the influence of technologies on different aspects of collaboration. No standard questionnaire has been developed to measure the presence of different collaborative features in technologies, therefore a checklist specific to this purpose is developed and adopted in Section 3.6.2. Questionnaires were adopted to complement other methods in the field and laboratory studies in Chapters 4-6.
Interviews	Interviews are often adopted to complement other methods such as content analysis or additional observation and activity logs. The studies adopting interviews often investigated the nature of use of technologies or how collaboration is conducted in a specific workplace.	There is no guideline as to how interviews should be conducted in the context of collaboration, i.e. structured, semi-structured or whether it should be conducted as a group interview or on a one-on-one basis. The analysis is often difficult and lengthy, depending on the length of the interviews as most sessions are audio recorded and thus need to be transcribed prior to analysis. Therefore this chapter evaluated interviews in the context of collaboration. This method was further adopted to gather data in the field study in Chapter 4.

Table 3-2: Critical review of research methodology in measuring collaboration

3.3 Purpose of Chapter 3

The main purpose of this chapter (see Table 3-3) was to identify the influence of technologies on collaboration in various context and to evaluate the appropriateness of the use of different data collection methods to further inform the design of the laboratory and field studies in this thesis (Chapters 4, 5 and 6).

Purpose of Chapter 3:

1. To identify factors affecting collaboration with regards to the use of various collaboration technologies in different contexts.
2. To examine the use of qualitative and quantitative methods to gather information with respects to collaboration at work; and to conduct a case study on student projects to inform methods adopted in further studies.
3. To develop and gain transferable skills required for the administration and execution of different methods in preparation for laboratory and field studies.

Table 3-3: Purpose of Chapter 3

3.4 Interviews

The two semi-structured interview studies are presented in this section. The first interview aimed to elicit user requirements for the CoSpaces project while the second was to examine the use of Skype at work.

For the CoSpaces user requirements elicitation, five semi-structured interview sessions were conducted face-to-face with two to three interviewees at a time. Seven semi-structured interviews were also conducted for the Skype survey, four of which were face-to-face and three sessions were conducted over the telephone.

3.4.1 Purpose of Interview Studies

The overall purpose of these two pilot studies was to assess the use of interviews to examine collaboration and the influence of collaborative technologies in the workplace. Furthermore, as the interview sessions were conducted at the initial research stage of this thesis they helped to develop interviewing skills to benefit the later studies.

The semi-structured interview sessions were used as part of the CoSpaces user requirements elicitation process to gather information regarding collaborative processes at the end user partner sites. The key findings were submitted to the project consortium for use in technology

development and later evaluation. CoSpaces aimed to produce collaborative technologies to support collaboration in co-located, distributed and mobile work settings. Users were asked to select a specific work scenario to describe how collaboration was currently taking place at their organisation and a future scenario of how the technologies developed in the CoSpaces project could be used to support and improve their collaborative practices.

The second semi-structured interviews were used to evaluate the use of Skype as an Instant Messenger and internet telephone at work.

3.4.2 Semi-structured CoSpaces Interviews

Five interview sessions were conducted with end-users from the automotive industry (results presented in Wilson *et al.* 2007a). The author attended, transcribed and analysed the data gathered in all five sessions as well as conducting two of the sessions. Another six interviews were conducted with the user partners in construction and aerospace, which the author did not attend. The demographic information of the interviewees from the interview sessions was not taken as part of the study.

On average, there were three interviewees (mainly non-native English speaking engineers) present in each session. However, as the interviews were conducted in English, there was usually one main speaker who responded to questions or translated questions to the rest of the group.

3.4.2.1 Method

The structure of the interviews was designed by researchers, without the author's involvement at the University of Nottingham for the CoSpaces project, prior to the interview sessions. A scenario development template was used which listed information which was required from all the interviews, in order to standardise the types of information elicited from the three industries.

The scenario template was used for all the interview sessions, with detailed headings and information required presented in a structured table to allow corresponding answers to be recorded (see Appendix 1 and 2).

The scenario template included space to record information about current practices and future visions with regards to the functions and processes of the interviewees' specific work area, goals, user profiles, work setting, task description and technologies used. As part of the interview,

participants were asked to describe their roles, their day-to-day work and how they currently collaborate with their colleagues (Wilson *et al.* 2007b).

An electronic copy of the scenario template was sent to all the interviewees prior to the interview session to ensure that participants were able to identify a work scenario to focus on during the interview. They were also asked to initially formulate responses to questions in the different sections of the template in advance. This helped the interviewer to gain a basic understanding of the work scenario prior to the interview which helped the interviews to flow more smoothly.

Two interviewers (researchers) were involved in all the interviews; one was responsible for asking questions whilst the other was responsible for completing the structured template to incorporate the responses. Each interview was audio recorded and lasted between one to two hours. These recordings were later transcribed and the content of the structured tables was updated after reviewing the transcripts.

3.4.2.2 Discussion and conclusion on CoSpaces user requirements

The results of this interview study are not published in this thesis as the work was done as part of the CoSpaces project and the scenario templates were designed by other researchers.

The author attended all five interview sessions with the CoSpaces end users in the automotive industry and conducted two of the interviews. The author also conducted the primary analysis of all the data from the five sessions, which allowed the author to gain an understanding of collaborative work and the several types of technologies used by the real end users in the automotive industry.

The need for a shared visualisation technology to support virtual collaborative design processes to enable remote users to view and share the same object during discussions was prominently discussed with the end users in the automotive industry. This finding also emerged from the interviews with the users from the other two industries (aerospace and construction). This was therefore the main driving force for the CoSpaces technology development to focus on shared visualisation and manipulation of 3D objects, which further influenced the studies conducted in this thesis (Chapters 4 – 6).

One of the problems reported in the automotive industry was with regards to the virtual design process. At the initial design stage, end users from one of the organisations interviewed reported emailing 3D drawings with comments to other colleagues prior to holding a telephone conversation regarding the drawings. They reported that no real-time tool was being used to support shared visualisation during a remote conference call, causing difficulty when conveying technical and spatial information verbally. To overcome this problem, staff from this organisation preferred face-to-face design meetings instead of meetings over the telephone.

The information gathered from this particular interview supported the literature presented in Chapter 2, regarding the importance of the use of shared visualisation of workspaces and objects. The results indicated that engineering and design users require a way to support virtual collaboration and discussion especially for spatial information which can be complex to verbalise without being able to interact with their colleagues face-to-face. This finding was used to design the task development and the experimental setup for the laboratory studies in both Chapters 5 and 6.

The data collected for the longer CoSpaces project interviews were transcribed. As the interviews were on average 90 minutes each, the transcription process took the author between seven to ten hours per interview depending on the complexity of the interview content, which included technical terms and abbreviations used in engineering. The interviewees did not speak English as their first language, hence the language barrier and accents added further complexity to the transcription process. Once all audio recordings were transcribed, the responses were used to complete the scenario template created prior to the interview sessions.

The results taken from the five interview sessions, showed that the responses between organisations varied depending on the work scenario selected by each company. As the overall aim of the user requirements elicitation was to gather information regarding user needs, current practices and their vision for technological support in the future, this method was considered appropriate as interviewees were able to concentrate on one chosen aspect of a collaborative process.

However, if a particular aspect of collaboration was required to be examined, then the selection of differing scenarios would mean that information gathered from different interview sessions might not be comparable (depending on the level of similarity of the scenarios). If the scenario

was kept constant and the interviewees were only from one organisation, then their responses could be directly compared. The semi-structured design of the scenario template provided the focus for the interviews though allowed interviewers to adopt a more conversational style to complete the template than if interview questions were predefined. Participants were encouraged to elaborate or clarify their original responses in different sections of the scenario template. However, this approach limited the information elicited to consider only the topics listed in the scenario template. This method is useful to gather detailed information to satisfy predetermined categories.

Findings from the CoSpaces interviews were valuable in terms of providing information on real-world collaboration. Furthermore, the findings also suggest that the purpose of use of a methodology (i.e. the interview templates and questions) affect the type of data gathered. The same interview templates were used across all three of the user partner industries and thus the data gather can be generalised across these three industries.

The opportunity of interviewing and gathering information regarding real life collaboration from the real end users has considerably contributed to the author's understanding of collaborative work. This has also allowed the author to further investigate the way in which shared workspaces influence virtual collaboration, bearing in mind the feedback from these interview sessions in the laboratory experiments conducted in Chapters 5 and 6.

3.4.3 Semi-structured Skype interviews

The semi-structured interviews were conducted to investigate the use of internet telephones and IM provided by Skype to support audio communication (including audio conferencing and chat) at work. In contrast to the CoSpaces project interview, these interviews were short and informal, and participants were not required to do any prior preparation themselves. However a list of questions was prepared prior to the interview sessions which were used as prompts to guide the interviews.

3.4.3.1 Participants

Seven participants were interviewed on their usage of Skype at work (male = 4, female = 3; mean age = 30). Four participants were interviewed face-to-face and three were interviewed over the telephone. Their occupations are shown in Table 3-4.

Occupation	No. of participants
Researchers	3
Architects (part-time)	2
Environmental Analyst	1
Manufacturing Manager	1

Table 3-4: Occupations of semi-structured interview participants

On average, participants reported using Skype 3–4 times a week, with each call lasting approximately 10 minutes.

The researchers regularly used Skype to support audio calls with colleagues outside of the UK. Two participants were part-time architects who used Skype as well as IM to support collaboration when they worked away from the office; one participant was an Environmental Analyst based in London who collaborated with a colleague in New York; and the last participant worked in the manufacturing industry where she was required to contact suppliers abroad. All participants were selected for the interviews as they reported using Skype on a regular basis.

3.4.3.2 Method

A short list of key questions on the use of Skype was prepared prior to the interview sessions. These questions were used to ‘probe’ or encourage participants to explain different uses of Skype at work, with the possibility and flexibility for interviewers to prompt participants to expand on novel feedback. The interviewer documented all answers during the session, and a Dictaphone was used to record sessions, each of which lasted between 10-15 minutes. No transcription was required, whilst the audio recordings were used to provide supplementary quotes.

The questions used to encourage discussion relating to Skype usage are shown in Table 3-5. These questions were asked when participants were required to provide more detailed information during the interview.

1. Please describe your typical usage of Skype at work.	5. Why do you choose to use Skype over the telephone?
2. Who do you talk to on Skype? Where are your colleagues located?	6. What do you like and dislike about Skype?
3. How often do you use Skype for audio calls in a typical week?	7. Have you tried any other internet phone providers?
4. How many people are usually involved in your Skype conference?	8. Do you use any other communication technologies in conjunction with Skype during an audio call?

Table 3-5: Skype interview prompts

At the start of each interview session, participants were asked to briefly describe their roles and responsibilities at work, and the current project or task they were mainly involved in. Then participants were asked to describe their typical usage of Skype at work.

3.4.3.3 Discussion and conclusion on Skype interviews

All participants reported that they sign-in onto Skype as part of their daily work routine every day even though they may not use Skype to communicate that day. They further report that Skype was used by all their colleagues at work and being online was an indirect way of showing their availability for work-related communication. One participant said:

"Signing in is like letting my boss and colleagues know that I am in the office already. Sometimes I check my Skype contact list in the morning to see if the colleague I want to speak to is online yet. If he is, then it's very likely that he's in the office or somewhere in the building if he's not at his desk."

Three participants reported having arranged meetings on Skype, with a set start time and an agenda of issues to discuss. These arranged meetings often involved more than two participants, with Skype being used as an audio conference facility. Pre-arranged audio conferences often lasted longer than impromptu interactions.

One participant reported using Skype to collaborate on a project with her colleague in New York who was originally co-located in her London office prior to moving to the New York branch. The participant reported regularly using the IM feature on Skype with this colleague who is offering her distance training on software programming. She mentioned that the real-time feedback on Skype allowed her to 'cut' and 'paste' software code to her colleague when she required his assistance. They usually continue to communicate textually through IM however, if the issues discussed were complex, the conversations were frequently followed up by a long distance telephone call. When asked why the participant preferred to use the telephone instead of internet calling, she further explained that Skype would have been preferred instead of costly telephone calls, she said:

"It's quite embarrassing actually, but we haven't got our microphones and headphones yet. We're still waiting for them to be delivered. Once they are, we will probably use Skype instead of the telephone."

The participant further reported that her company has purchased a licence to use web-conferencing to conduct audio-conferencing, meetings and seminar sessions once all the

headphones and microphones have been delivered. She reported that her company often hold audio-conferencing with clients who were interested in online presentations to reduce travelling. The web-conferencing tool allows remote attendees to participate via either the telephone or a computer.

Spontaneous conversations were also reported - these were often initiated in chat. Participants often employed chat to ascertain each other's availability before an audio conversation. Spontaneous calls often involved only two participants. There was some indication that Skype was used to clarify information, which was often sent in advance by email (e.g. text documents such as Word files, 3D models and design sketches).

"People at my office use Skype all the time, so it's very easy to talk to anyone when I'm working from home. We have to talk about our CAD models quite a lot, so we end up emailing our models back and forth, and we'll discuss them over Skype or chat, make changes to the model there and then, then we'll email again; or if the file isn't too large or confidential, we can sometimes send them over the file transfer on Skype as well."

Three participants also reported using Skype with co-located colleagues with one participant reporting:

"It usually starts off very quickly on Skype. Often I send a one-line greeting to my colleague, just to check his availability and see if he was free, at his desk and OK to talk. If he is, and we're both in the office, I sometimes say 'right I'm coming to see you now', if we don't continue our conversation on Skype."

Participants suggested that Skype was easier to use when supporting impromptu interactions as it merely required one mouse click to get connected to a colleague. Furthermore, as all Skype to Skype calls are free, it is also preferable to use over the telephone, especially when people are located in different countries.

However, the quality of the audio conversation over Skype is often determined by the quality of the internet of those involved in the Skype calls. Slow bandwidth causes interferences, interruptions and delays in communication resulting in participants speaking over each other, especially in audio conferencing involving more than two users. One participant noted that when calling abroad, some countries provide different internet speeds and bandwidth which highly affect the call quality, making Skype difficult to use, therefore they often switch to the telephone when conversations could not be continued smoothly.

Five participants only used Skype with colleagues who were located abroad; otherwise they preferred to use the telephone to communicate with UK colleagues. The two architects however, used Skype mainly with their UK colleagues when they were working from their home offices. Only one interviewee reported the use of webcam during Skype conversations (i.e. video-conferencing), with one other Skype user. Skype does not yet support more than two-way video conferencing.

The semi-structured interviews produced comprehensive information. Questions were used as probes during the interviews rather than to structure the conversation, with the interviewer listening and asking spontaneous questions in response to what the interviewees were saying.

The field of interest of the semi-structured interviews was narrowed down only to focus on the use of Skype at work and therefore this type of interview was considered effective. It also required less design and data analysis time and effort when compared to the semi-structured interview method adopted for CoSpaces user requirements elicitation.

However, the information gathered in the short interviews did not capture other aspects of collaborative tasks which the users were involved in, or the use of other technologies to support them other than Skype. Participants mentioned the use of email at work, which was not further explored during the interview.

Interview sessions were audio recorded but were not fully transcribed in order to examine whether taking notes during the interview was as effective as relying on the recordings. The audio recordings were later reviewed to extract appropriate interview quotes. As these interview sessions were short and only focussed on one aspect of collaboration, taking notes during the interview was considered appropriate and the data gathered was comprehensive. However, if the interview sessions were longer and less focussed, audio recordings could be transcribed to ensure that no vital information was missed.

3.4.4 Interview Conclusions

Findings from the CoSpaces and Skype interviews suggest that users who worked with spatial information were required to send and receive files containing models and sketches by email or file transfer, without being able to share the same view as their remote colleagues. Similarly to the findings from the CoSpaces requirements interviews, users were emailing their models to each other prior to discussing them over Skype chat, or phone calls.

Skype was seen as an acceptable office tool to support communication with co-located and distributed colleagues, with users reporting that colleagues within their organisations were all using Skype. The online contact list provided by Skype which allows users to view the online status of other users acts as an awareness tool which allowed users to indirectly check the availability of each other. Similar to Instant Messenger (described in Chapter 2, Section 2.4.3.2), users are able to set their online status to 'available', 'busy', 'away' and 'invisible' to indicate their availability.

Overall, the use of interviews as a method of data collection produces comprehensive qualitative data. This is a useful method to gather subjective data such as user attitudes and user perceptions towards their team members, the organisation or towards use of technology.

This method also relied on good interview skills as the interviewer was required to encourage the flow of conversation whilst listening, taking notes and using questions to probe for further clarification. These interviews took place at the start of this PhD research and therefore they were also seen as a means of training, allowing the author to experience conducting interviews in real workplaces and interacting with real end users.

A summary of the key findings on semi-structured interviews as a data collection method is shown in Table 3-6. The structure of the interview should be designed to suit the level of detail required and the purpose of the study.

Interview	Context of use	Advantages/Disadvantages
CoSpaces interviews	<ul style="list-style-type: none"> • Examining daily use of collaboration technologies at work • Understanding users' roles and working relationships with others 	<ul style="list-style-type: none"> + Comprehensive data + Greater understanding of work processes and collaboration - Difficult to organise as requires longer user participation - Significant effort required to design the interview structure and to transcribe and analyse data
Skype interviews	<ul style="list-style-type: none"> • Use of specific technology • Perception and attitudes towards a specific use of the technology 	<ul style="list-style-type: none"> + Information gathered is concise due to shorter interviews focussing on Skype + Easy to recruit volunteers due to the informality and short sessions + Information can be easy to process - Not enough information was generated from the Skype interviews for coding - This interview did not consider the working process as a whole

Table 3-6: Comparing semi-structured interviews

The two interview studies influenced the interview style used to examine collaboration practices and working relationships between various departments at Company X (see Chapter 4). The use of screen sharing for spatial information is evaluated in Chapters 5 and 6, while Skype was adopted to provide audio communication in conjunction with another IM tool in Chapter 6.

3.5 Expert Priority Elicitation Exercise

The expert priority elicitation exercise was conducted as a structured brainstorming and group discussion with human factors experts who were required to produce and rank a list of factors influencing different aspects of collaboration. The purpose of this study was to elicit expert knowledge in identifying and prioritising factors influencing collaboration, both positive and negative, as well as features which collaborative technologies should support. Furthermore, this study was conducted to examine how a structured brainstorming session and group discussions could be employed to gather data on user needs for collaborative technologies.

3.5.1 Method

Eleven Human Factors experts (male = 4, female = 7), including lecturers and researchers volunteered to take part in the one-hour session. This session was conducted as a structured priority elicitation session. As part of the experimental design process, several questions were considered (shown in Table 3-7), but due to the time restriction, these questions were combined to form the three most important questions.

Purpose	Possible questions	Comment	Contribution to final questions	Final Questions
To identify good technologies and their features that support collaboration	1) What technologies do you use to support collaboration in your day to day work? 2) What type of tasks do you use collaborative technologies for?	This aimed to investigate how different technologies were used and adopted by different people. However, the same technology can be used differently depending on the user's preference as well as his/her team's preference	Instead of asking participants to state their usage of collaborative technologies, it was more appropriate to focus on what they perceived to be good technological features to support collaboration, without being specific to one type of tool	Question 1: List up to 10 key functions which collaborative technologies should support and rank them in order of importance

To identify factors influencing successful or effective collaboration	1) List your experiences of successful collaboration 2) What makes effective collaboration?	This question aimed to identify contributing factors for effective collaboration without having to identify one key area; it was therefore up to participants to brainstorm and cover different aspects.	It was ensured that this question was not only technology specific	Question 2: List up to 10 factors which may result in effective collaboration and rank them in order of significance
To identify factors contributing to poor collaboration	List your experiences of poor/inefficient collaboration	This question encouraged participants to explain why these negative experiences happened in the first place (i.e. the causes). Possible answers could involve examples or experiences of undesirable collaboration	The question selected for the group exercise was not specific to describing negative experiences	Question 3: List up to 10 factors which may result in ineffective collaboration and rank them in order of significance

Table 3-7: Expert priority elicitation question design

At the start of the session, participants were seated around a meeting table and the experimenter proceeded to explain the purpose of the session. Participants were instructed that there were no right or wrong answers as the exercise aimed to gather different views and definitions of collaboration and collaborative technologies.

During the session, participants were given three questions (shown in Table 3-8). These questions were shown on PowerPoint slides, one at a time and participants were given time to record their responses individually. Participants were given between 10 – 15 minutes to complete each question.

1. List up to 10 key functions which collaborative technologies should support and rank them in order of importance
2. List up to 10 factors which may result in effective collaboration and rank them in order of significance
3. List up to 10 factors which may result in ineffective collaboration and rank them in order of significance

Table 3-8: Three questions asking participants to list and rank influential factors of collaboration and technologies

After the participants were given enough time to formulate their answers to each of the questions, they were asked to discuss different aspects of collaboration in their day-to-day tasks prompted by the questions listed in Table 3-7. The experimenter took note of the discussion. The answer sheets were collected at the end of the session.

3.5.2 Results

Once all the answer sheets were analysed, responses were grouped into 14 emerging categories. These categories, example responses and additional comments and the descriptive statistics are summarised in Table 3-9. The frequency of response shown in Table 3-9 represents the number of responses in that category. The majority of participants responded to the three questions (see Table 3-8) by listing one-word answers or requirements which they believe contribute to the success or failure of collaboration. The frequency of response and median ranking of each category are further illustrated in Figure 3-1.

Categories	Explanation of categories summarised from participants' responses	Example responses	Frequency of responses	Mode and median ranking out of 10 (1 = most important and 10 = least important)
Accessibility	Access to resources or database which are available/shared between team members	<ul style="list-style-type: none"> • <i>Remote access</i> • <i>Freedom of accessing appropriate information</i> 	2	Mode = 8 Median = 8
Application and file sharing	Feature allowing more than one person to view the same resources or views (asynchronously and synchronously)	<ul style="list-style-type: none"> • <i>More than one individual working on same document</i> • <i>Share views of pictures</i> 	14	Mode = 2 Median = 4
Asynchronous communication	Non-real time communication, where participants can pick up messages and documents sent by his/her colleague in his/her own time	<ul style="list-style-type: none"> • <i>Email</i> • <i>Ability to share documents but not at the same time</i> 	4	Mode = 1 and 2 Median = 2
Awareness	Awareness of other colleagues working within the team. Most of the participants indicated awareness issues with distributed teams rather than co-located teams	<ul style="list-style-type: none"> • <i>Manage turn-taking</i> • <i>Know who can see my work</i> 	11	Mode = 10 Median = 6
Customisation	The ability to customise the workspace to suit the users and tasks	<ul style="list-style-type: none"> • <i>Customising workspace and tools according to preferences</i> 	1	Mode = 6 Median = 6

Categories	Explanation of categories summarised from participants' responses	Quotes taken from participants' responses	Frequency of responses	Mode and median ranking out of 10 (1 = most important and 10 = least important)
Knowledge management	This allows knowledge which has been accumulated during the project or by individuals within the teams to be shared among members	<ul style="list-style-type: none"> • <i>Central information store for all users</i> • <i>Ability to search for specific information on the project</i> 	2	Mode = 1 and 5 Median = 3
Planning/reminder	Reminding participants of meetings and other work schedules	<ul style="list-style-type: none"> • <i>Ability to let people know the urgency of communication</i> • <i>Reminding members of meeting schedules</i> 	3	Mode = 5,6,7 Median = 6
Presence	The presence of other members in distributed communication, such as how social presence is supported by collaborative technologies	<ul style="list-style-type: none"> • <i>Similar to face-to-face feedback and presence</i> 	1	Mode = 8 Median = 8
Privacy	Privacy of users when communicating and sharing resources with other members online	<ul style="list-style-type: none"> • <i>Controlling who can see my data</i> • <i>Controlling own status</i> 	3	Mode = 4,6,8 Median = 6
Support various interactive devices	Support connections to other mobile or input devices	<ul style="list-style-type: none"> • <i>PDA's</i> • <i>Use of mouse and joystick as input</i> 	5	Mode = 8,9 Median = 8

Categories	Explanation of categories summarised from participants' responses	Quotes taken from participants' responses	Frequency of responses	Mode and median ranking out of 10 (1 = most important and 10 = least important)
Support existing software	Support existing software packages in use in the workplace	<ul style="list-style-type: none"> • <i>Compatibility with CAD software</i> • <i>Allowing other members to view models on CAD</i> 	4	Mode = 7 Median = 7
Synchronous communication	Real-time communication and connectivity with other members within the team, remotely and in co-located workspaces	<ul style="list-style-type: none"> • <i>Voice and visual communication</i> • <i>Live text chat</i> 	22	Mode = 1 and 4 Median = 5
Traceability	The ability to track changes and work updates in shared documents or databases as well as to ensure traceability of the communication (i.e. records of the information exchanged)	<ul style="list-style-type: none"> • <i>Search by time</i> • <i>Monitor changes in documents</i> 	12	Mode = 6 Median = 6
Usability	Design and usability of the technologies	<ul style="list-style-type: none"> • <i>Good interface</i> • <i>System feedback</i> 	10	Mode = 1 and 3 Median = 3

Table 3-9: Categorisation of responses from the expert session and the frequency of responses with descriptive statistics (i.e. the median and mode results from participants' ranking)

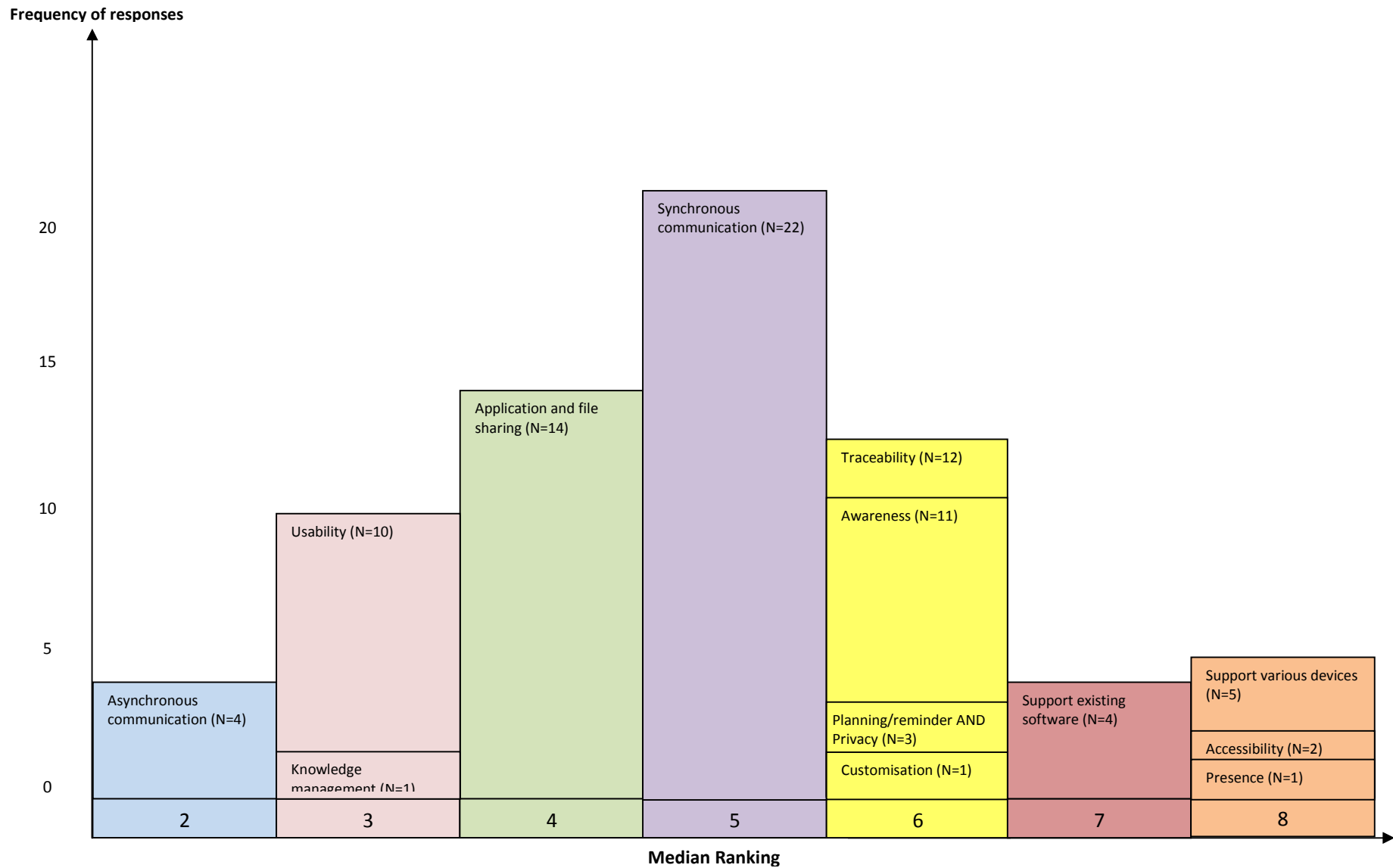

Figure 3-1: Illustration of median ranking and the number of appearances of each category (median ranking 1 = most important and 10 = least important)

3.5.3 Discussion and conclusion on the expert elicitation session

This exercise was conducted with human factors experts to identify and compare various factors affecting collaboration in the workplace; these experts were also end users of many collaborative technologies.

This session was simpler to conduct than the CoSpaces user requirements elicitation sessions (described in Section 3.4.2) in terms of preparation and analysis. However the information gathered was less comprehensive and there was no focus on the context of use of different technologies or aspects of collaboration considered. Similarly to the CoSpaces user requirements elicitation, the group discussion highlighted factors which influence overall collaboration beyond the use of technologies, such as the behaviours and attitudes of colleagues.

The information gathered from this prioritisation exercise was used to formulate a checklist to benchmark features which collaborative tools should encompass in order to satisfy fundamental needs (described in Section 3.6.2).

Overall, the method produced informative data and was easy to conduct, but in order to validate and standardise collaborative practices across different industries, this exercise should be repeated to involve users from different backgrounds and professions in order to establish their collaboration practices. However, this study aimed to examine the use of brainstorming and semi-structured group discussion and not produce a complete model of collaboration practices in different contexts. Therefore the results gathered were sufficient for the aim and the study was not repeated with end users from industry or commercial settings.

Ideally, it would have been useful to repeat the expert elicitation exercise with CoSpaces end users in order to compare the data while ensuring that the use and the context of use of these technologies were appropriate (i.e. outside of research and academia). However, this expert elicitation session took place after the CoSpaces initial interviews presented in Section 3.4.2 and therefore the author could no longer get access to the CoSpaces end users. In addition, this elicitation exercise was not repeated with the DiFac end users due to the lack of evaluation time, which only allowed for short paper based questionnaires to be administered (Section 3.6.2).

3.6 Questionnaires

Two styles of questionnaires were examined and are presented in this section: a short checklist and an online questionnaire. The short paper-based checklist was used to evaluate various collaborative technologies and the online questionnaire evaluated the use of Microsoft Outlook at work.

Questionnaires are considered a low cost method, which are relatively easy to administer to a large number of participants in order to gather information (Sinclair, 2005). However, problems involving the use of questionnaires include poor reliability, validity, response rates, misunderstanding and misinterpretation of the questions, which can further cause unreliable results (Sinclair, 2005). Therefore it is important to examine the advantages and disadvantages of this method against the aims and purpose of the data collection.

3.6.1 Purpose of Questionnaire Studies

The overall aim was to examine the use of questionnaires in different formats. The checklist, which was developed based on results from the expert priority elicitation exercise (see Section 3.5), formulated a list of items regarding features of a collaborative technology. The purpose of this checklist was to evaluate collaborative features of novel collaborative technologies. It was also to produce a method of data gathering which was quick and easy to administer as well as easy to complete by participants. This checklist was adopted to evaluate collaborative features of technology prototypes developed within the DiFac project (see Section 3.6.2).

The purpose of the online questionnaire was to investigate the use of Microsoft Outlook to provide email and a shared calendar in a co-located setting. The online questionnaire was also used in order to examine the response rate and the willingness to answer open-ended questions in a working environment where participants were able to easily access the internet.

3.6.2 Checklist: Evaluation of Collaborative Technologies

The results from the expert priority elicitation exercise (discussed in Section 3.5) were used to develop a checklist to evaluate how a collaborative technology supports different aspects of collaboration. The checklist was adopted to examine the effectiveness of collaboration features in novel technology prototypes developed in the Digital Factory for Human-Oriented Production System (DiFac) project. The results from this evaluation session were used to formulate a list of

recommendations for the software developers based on the performance of their prototypes and the collaboration features of their tools.

A total of eight technologies were developed as part of the DiFac project, however, only four technology prototypes were evaluated as part of this study as these technologies were predominantly collaborative technologies. These four technologies were: 'Factory Constructor', 'Remote Maintenance', 'Collaborative Product Reviewer' and 'iPortal'.

The first technology was the Factory Constructor (see Figure 3-2) which allows more than one user to collaborate, visualise and plan the layout of a factory in a 3D virtual environment. The purpose of this tool was to enable designers to evaluate their designs virtually in order to assess their efficiency and effectiveness and identify potential problematic areas throughout the design development. This was to eliminate costly corrections once the design has been physically constructed. This tool allows multiple designers to view and manipulate designs synchronously. Designers are able to move 3D models of machines as part of their design layout. The Factory Constructor was developed alongside another DiFac technology (not part of this study), which was able to simulate the level of productivity influenced by the factory layout, thus allowing designers to further assess their design.



Figure 3-2: Factory Constructor – 3D virtual factory layout (Bourguignon *et al.*, 2009)

The second technology was the Remote Maintenance tool (see Figure 3-3) which was considered part of the training aspect of DiFac. The tool enables engineers to carry out maintenance activities on real machines at remote sites with Augmented Reality (AR) instructions loaded onto their laptops and the DiFac software. Onsite engineers carry a web camera attached to a laptop on which the Remote Maintenance tool operates. Special barcodes attached to each machine allow the Remote Maintenance tool to identify the machinery (the web camera transfers the unique barcode to the Remote Maintenance tool). Once the machine has been identified, the Remote Maintenance tool loads the maintenance instruction of that machine onto the engineer's laptop, which demonstrates the maintenance procedures in the form of AR, imposed onto the real image of the machine captured by the web camera.

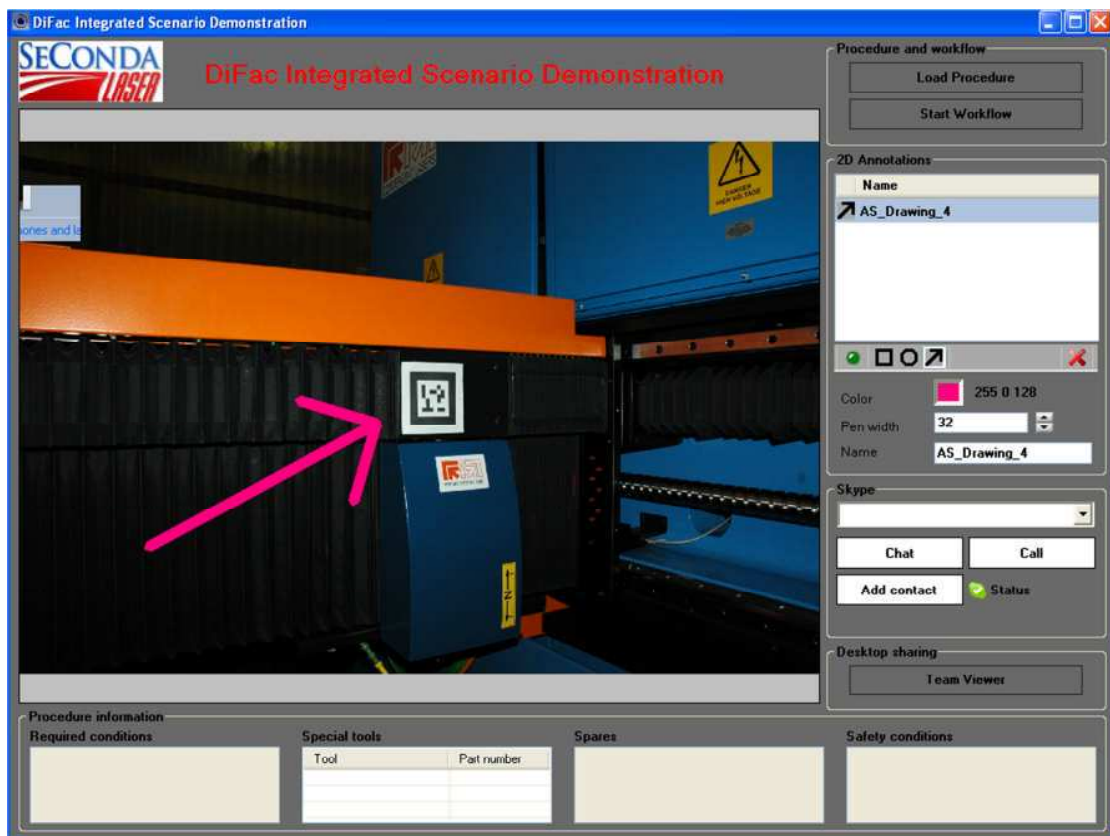

Figure 3-3: Remote Maintenance – the tool allows users to share views, annotate the shared view of the workspace and initiate text and audio chat (Bourguignon *et al.*, 2009)

This tool also enables onsite engineers to remotely contact other experts in the head office for assistance by using the incorporated audio and text chat facility while sharing the same view of the workspace (i.e. the machine). Users are also able to annotate (such as drawing an arrow, see Figure 3-3) on the shared view indicating a specific part of the machine for which they require assistance.

The third DiFac technology was the Collaborative Product Reviewer, which integrates the use of AR and VR in product design, enabling designers, engineers and customers to share visualisation synchronously and remotely. Designers and engineers can open and share an online archive of a project, exchange information and messages (see Figure 3-4). A feature of this tool allows customers to specify designs of a carpet online, using AR and VR. The customers are able to upload a photo of the room and superimpose a 3D design of a carpet on the photo to aid visualisation (Figure 3-5).

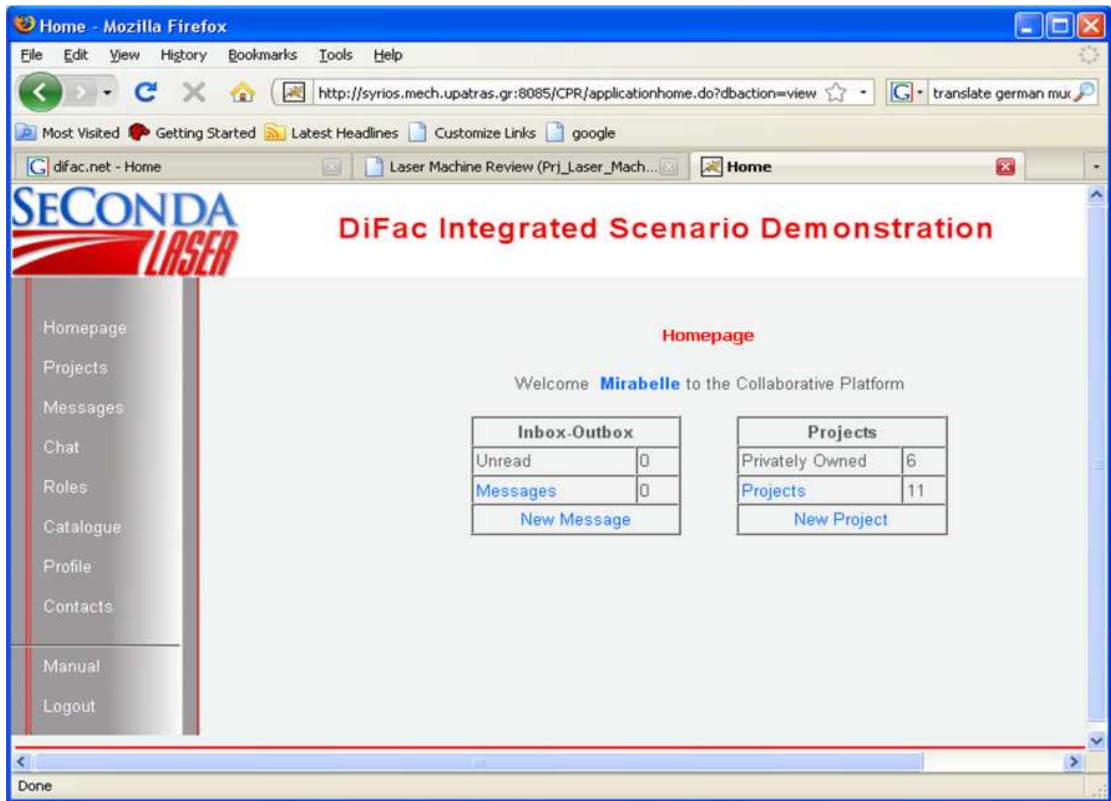

Figure 3-4: Collaborative Product Reviewer server (Bourguignon *et al.*, 2009)



Figure 3-5: Collaborative Product Reviewer - carpet design visualisation tool allowing 3D designs of a carpet to be positioned and superimposed onto a real photo (Bourguignon *et al.*, 2009)

The final technology evaluated was the 'iPortal' which was developed as an internet portal to integrate all tools developed in DiFac including the Remote Maintenance, Collaborative Product Reviewer and Factory Constructor. The iPortal also enables users to check the status of collaborative projects, access the shared applications, view project documents as well as member

information (including contact details, roles, Skype online status and events calendar) (see Figure 3-6).

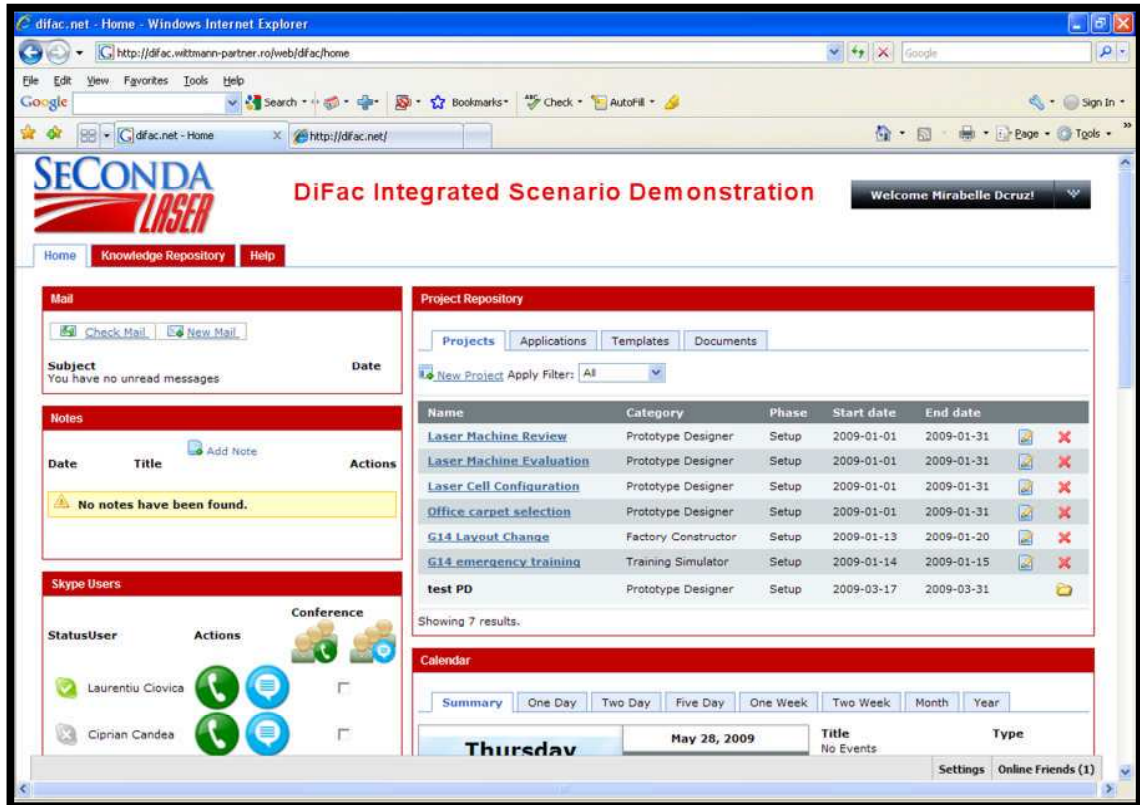

Figure 3-6: iPortal illustrating the project page and status of other users (Bourguignon *et al.*, 2009)

These four technology prototypes were evaluated as part of the DiFac evaluation session using the collaboration checklist developed in this thesis chapter. Only these four technologies are referred to as the DiFac technologies for the purpose of this study as the other four (which were not predominantly collaboration technologies) were not evaluated.

3.6.2.1 Collaboration Checklist Development

Seven categories of factors influencing collaboration with the highest number of appearances and median ratings (from the expert priority elicitation results, see Section 3.5) were selected to form 11 items for the checklist (see Table 3-10 for the list of items). Other features such as the hardware, and behaviours or attitudes of other colleagues were beyond the scope of this checklist. Usability of the technology was assessed using the System Usability Scale (SUS) (Brooke, 1996) and therefore was not the main focus of this checklist.

The collaboration checklist was design by the author specifically to evaluate collaborative features in collaborative technologies. Statements were designed to incorporate the factors identified by experts (based on frequency and responses gathered) during the priority elicitation session. The most highly rated categories from the expert priority elicitation exercise were selected and statements were designed to represent these categories. These statements were used to evaluate whether the collaborative technology supports important aspects of collaboration.

A 5-point Likert scale (1 = strongly disagree, 2 = disagree, 3 = neutral, 4 = agree and 5 = strongly agree) was assigned to each of the statements, allowing participants to use the checklist to rate different aspects of a collaborative technology. Eleven statements and their related categories are shown in Table 3-10. These 11 statements can be seen and identified within the expert priority elicitation results. The layout of the checklist is illustrated in Table 3-11.

Items	Related Statements
Application sharing and synchronous	The system allowed me to view files together with other users
Application sharing and synchronous	It was easy to indicate to other remote users where I was looking when viewing the same file together
Asynchronous	The system allowed me to effectively communicate offline with other users
Awareness and synchronous	The system allowed me to identify other users easily
Awareness and synchronous	The system allowed me to locate other users easily
Awareness and traceability	I was aware of what other people were doing on the system
Privacy and synchronous	I could set my online status to protect my privacy from other users
Privacy and traceability	The system allowed me to protect my own work from being edited by others
Synchronous	The system allowed me to effectively communicate in real-time with other users
Traceability	The system allowed me to see changes and updates made by other users
Usability	It was easy to contact other users via the system

Table 3-10: Evaluation of collaborative technologies checklist

	<i>Strongly Disagree</i>	<i>Disagree</i>	<i>Neutral</i>	<i>Agree</i>	<i>Strongly Agree</i>
1. The system allowed me to locate other users easily					
2. The system allowed me to identify other users easily					

Table 3-11: Checklist layout used to evaluate DiFac technologies

3.6.2.2 First DiFac Evaluation

By arrangement with the DiFac project consortium, the author acted as an analyst and observed the demonstration sessions and was responsible for the collaboration evaluation of the technologies. The checklist was piloted at an evaluation session organised by the DiFac consortium where end-user representatives were invited to watch demonstrations of the DiFac technologies. A total of 24 members of the project consortium were present at the evaluation (male = 19, female = 5), nine of whom were end-user representatives.

During the evaluation session, all developers were able to demonstrate their prototypes simultaneously and participants were able to move around from one prototype to the next according to their interests. If participants were interested, they were able to interact with the system and could complete a list of tasks, developed for each prototype, to evaluate features of the technology. These tasks were developed by the technology developers and were therefore specific to each of the DiFac technologies. Once they had completed the task, participants were asked to complete questionnaires assessing aspects such as presence, ergonomics and collaborative elements of the technology.

As participants were able to move freely around all of the DiFac technologies and were not obliged to complete the tasks or the evaluation questionnaires, the response rate was considered low. A total of 12 collaboration questionnaires were completed for the four DiFac technologies evaluated for collaboration (see Table 3-12).

Technology	No. of completed questionnaires
Factory Constructor	4
Remote Maintenance	2
Product Reviewer	4
iPortal	2

Table 3-12: Summary of number of collaboration questionnaires completed for each technology

The number of responses for each of the technologies during the first DiFac evaluation session was low and therefore the results were inconclusive. However, this low response rate suggested that these prototypes were required to be evaluated systematically.

From this first evaluation session, which was considered a pilot study for the collaboration checklist, the Remote Maintenance was the only technology to receive low median scores (i.e. strongly disagree) for four elements of the questionnaire ('the system allowed me to locate other users easily', 'the system allowed me to identify other users easily', 'it was easy to contact other users via the system', and 'I could set my online status to protect my privacy from other users'). The Remote Maintenance was designed to be used in conjunction with other technologies such as Skype or the telephone to facilitate synchronous communication and therefore these features were not included in the technology. This was highlighted in this evaluation session and the results regarding these four elements for the Remote Maintenance are expected to remain the same in the second DiFac evaluation.

The iPortal was the only technology that received a 'strongly disagree' to the statement 'The system allowed me to protect my own work from being edited by others'. This could indicate that the system fails to allow users to protect their work, which should be an important feature as the iPortal provides a virtual space where users are able to archive and share their work with each other. Being able to protect work from being edited by others was seen as an important aspect of virtual collaboration by the experts during the priority elicitation session (see Section 3.5). Due to the low response rate, further evaluation was required. However, the use of this collaboration questionnaire allowed collaborative features which were not easily highlighted to be assessed and focussed on allowing early feedback and recommendations to support the final integrated solution (D'Cruz *et al.*, 2009).

3.6.2.3 Second DiFac evaluation

An in-house evaluation session was conducted at the University of Nottingham, adopting the same set of presence, ergonomics and collaboration questionnaires used in the first evaluation session (full results see Lawson and D'Cruz, 2009). Only the collaboration evaluation is presented in this section. In the second DiFac evaluation session, the author's role was to collect and analyse the collaboration checklist results and provide a feedback to the technology developers. However, the in-house experiment was conducted by the DiFac evaluation management, who was based in the University of Nottingham.

A total of 20 participants were recruited, 10 from within the Human Factors Research Group (researchers, postgraduate research students and administrative personnel), and 10 were recruited from a DiFac partner organisation (including researchers and end-user representatives).

As part of the evaluation, participants were required to complete the same lists of tasks as the first evaluation session, which were compiled by the developers in order to assess the main features and functionalities of each DiFac technology prototype. Participants were invited to the session individually, on a one-to-one basis with the DiFac Evaluation Manager who conducted all the sessions involving participants from the University of Nottingham. Participants from the DiFac organisation took part in an independent session.

Participants evaluated all eight of the DiFac technologies, however due to various reasons such as time constraints and technical difficulty, not all 20 participants completed their evaluation sessions with all the technologies. Only the results from the four collaboration technologies (i.e. Factory Constructor, Remote Maintenance, Product Reviewer and iPortal) are presented in this study.

The researcher conducting the evaluation session demonstrated the technology to the participant, who was then required to complete the given tasks and complete questionnaires regarding the technology they had experienced. This was repeated for all the technologies. Participants were able to request assistance from the experimenter during the task.

The full results of all the DiFac technologies and the presence, ergonomics and collaboration evaluations are presented in Lawson and D’Cruz (2009). The number of completed collaboration questionnaires for each of the four technologies is presented in Table 3-13.

Technology	No. of completed questionnaires
Factory Constructor	10
Remote Maintenance	19
Product Reviewer	9
iPortal	18

Table 3-13: Summary of the number of completed collaboration questionnaires for the DiFac in-house evaluation

The median responses were calculated for each of the collaboration questionnaire items – summarised in Table 3-14.

	Factory Constructor	Remote Maintenance	Product Reviewer	iPortal
1. The system allowed me to locate other users easily	4	2	4	4
2. The system allowed me to identify other users easily	4.5	2	4	4
3. It was easy to contact other users via the system	4	3	4	4
4. The system allowed me to view files together with other users	4	4	3	3
5. The system allowed me to see changes and updates made by other users	4	3	4	3
6. I was aware of what other people were doing on the system	3.5	2	3	2
7. It was easy to indicate to other remote users where I was looking when viewing the same file together	2	4	1	2
8. The system allowed me to protect my own work from being edited by others	1	2	3	3
9. I could set my online status to protect my privacy from other users	1	2.5	1	3
10. The system allowed me to effectively communicate in real-time with other users	4	4	1	4
11. The system allowed me to effectively communicate offline with other users	1	1	4	4

Table 3-14: Summary of median ratings of questionnaire items on a 5-point Likert scale (1 = strongly disagree and 5 = strongly agree). The medians reporting strongly disagree are highlighted.

The results from this evaluation session were used to generate a list of recommendations for the developers of each of the DiFac technologies. The results indicated that the four technologies performed differently on different aspects of collaboration as shown in Table 3-14.

Factory Constructor was rated poorly on the item ‘the system allowed me to protect my own work from being edited by others’, as the system allows more than one user to synchronously design a layout on a shared space. This feature was seen as important from the results gathered in the expert priority elicitation session (Section 3.5) to ensure that shared work could not be adjusted or overwritten without discussion or consent, intentionally or unintentionally. This finding, which was highlighted from this checklist, was part of a list of recommendations for the developers of this technology. This technology was only designed to support synchronous

(online) collaboration and therefore received low ratings with regards to the asynchronous aspects of collaboration.

Remote Maintenance was poorly rated by participants for the checklist statements: 'the system allowed me to locate other users easily' and 'the system allowed me to identify other users easily', compared to the other three technologies. This which may be because this technology is used as an integrated solution coupled with external tools such as internet telephone/IM (i.e. Skype) or the telephone. In contrast, the Remote Maintenance received the highest score for one of the checklist statements, 'it was easy to indicate to other remote users where I was looking when viewing the same file together', compared to the other three technologies.

Product Reviewer which aimed to allow remote users to view or share the same design of a product scored relatively highly for the first six items of the checklist regarding synchronous interactions with other remote users. However, this technology was rated poorly for being unable to indicate to other users where they were looking (i.e. for the statement, 'it was easy to indicate to other remote users where I was looking when viewing the same file together'). Similarly this was also considered an important aspect in the expert priority elicitation session, particularly when supporting remote collaboration and discussion of spatial information. This finding was given to the developers as one of the recommendations for improving the technology.

Overall, iPortal achieved high scores for nine out of the 11 statements. The aim of this technology was to act as an access to all resources, such as project files, documents, schedules as well as other DiFac technologies, to support the overall collaboration and information sharing. The only two aspects of the checklist which were rated low were 'I was aware of what other people were doing on the system' and 'It was easy to indicate to other remote users where I was looking when viewing the same file together'. It was recommended to the developers that allowing participants to see what each other were doing on the system (i.e. accessing a particular file) would support awareness in remote colleagues.

3.6.2.4 Discussion and conclusion on the collaborative technology evaluation checklist

It was observed that some features of collaboration from all four technologies were rated less favourably on the checklist. This may have been because these four technologies aimed to support different collaborative tasks or aspects of collaboration. In hindsight, participants could

have been asked to rate the importance of each of the 11 checklist items for each technology before rating the effectiveness of these features (i.e. using a similar checklist layout, with a 5-point rating scale, 1 = least important and 5 = most important). Furthermore, some of the collaborative features were unavailable during the prototype stage and there was no real collaboration during the evaluation (i.e. one participant was required to evaluate the system at a time), and therefore this could affect the perceived effectiveness of some features.

The checklist was easy to administer and the results collected from the evaluation session were simple to process, allowing comparisons between different technologies to be made. The checklist was adopted as a standard questionnaire to evaluate systems which have different collaborative features. However, it was found that not all the statements listed in the checklist were specifically applicable to the technologies developed to support remote collaboration specific to this evaluation session - all the five systems were greatly different from one another and focussed on supporting different manufacturing stages. This therefore indicated an initial difficulty with designing a standardised checklist to evaluate multiple collaboration technologies.

Furthermore, the primary results gathered from the priority elicitation exercise (which the checklist was based on) mainly focussed on basic collaborative technologies (e.g. email, application sharing), however the five systems evaluated in this pilot study (see Chapter 6) include 3D plant layout and simulation systems including Augmented Reality, which were not considered in the priority elicitation exercise. Another disadvantage of this checklist was a lack of consideration of the overall effects of the collaborative technology in supporting workplace collaboration.

The method was favourable for use in situations where participants have limited time to respond as there were only a few straightforward statements to be rated. The checklist was more appropriate for evaluating a holistic collaborative system, such as the iPortal, but less effective when assessing specialised technologies aiming to support specific aspects of collaboration. Therefore this checklist was not adopted for further use in this thesis. However, by being in charge of the collaboration evaluation of the DiFac project, the author was given the opportunity to examine novel technologies which were greatly varied from one another as well as other existing tools. Therefore this awareness contributed to the way in which different industries and organisations within the EU are trying to support and improve different aspects of collaboration.

3.6.3 Online Questionnaire: the evaluation of Microsoft Outlook

The use of online questionnaires is increasingly popular along with the increasing use of the internet at work. In contrast to paper-based questionnaires, online questionnaires are relatively easy to administer and results can be collected regardless of the location of the respondents. Participants only need to receive the online link or website address to the questionnaire which allows them to respond from their office using their own computers, in their own time without the concerns of returning a paper copy.

3.6.3.1 Microsoft Outlook

Within the past four years, the University of Nottingham switched their email server and ensured that everyone connected move from the old email tool to the new Microsoft Outlook, which allows activities such as arranging meetings, checking other team members' calendars and schedules, in the hope to help everyone synchronise with each other.

Microsoft Outlook was considered a new technology for the whole university as well as the Human Factors Research Group (HFRG), where this study took place. The HFRG includes researchers working on various projects, with co-located members as well as with other research institutes from all over the UK and Europe. Researchers were unfamiliar with using the Calendar feature on Outlook to arrange joint meetings and check colleagues' availability on their calendars, therefore a meeting was held to encourage participants to use this tool to organise meetings. Researchers were encouraged to use this feature for a month on a trial basis.

The questionnaire was developed to examine the use and influence of the Calendar aspect of Outlook, which was used to arrange meetings and establish the availability of other users. This shared calendar allows users to view other individuals' calendars once permission is granted. One of the main advantages of this feature is that it aids collaboration and awareness. For example, one user can view another user's calendar to see if he/she is in the office that day, or whether he/she would be free for a meeting next week. Meeting invitations can also be sent via Outlook; participants can choose to accept, amend or reject the meeting, bearing in mind that the host (person initiating the meeting) would have been able to see the invitees' calendars before sending out invitations. This can raise privacy concerns among users who may feel they are being monitored, which can affect team trust, for example. Therefore it is important to try and understand the implications of the deployment of such collaborative technologies in the workplace.

All staff members within the HFRG office have their own workstation and computer. The majority of their work was also conducted electronically on their computer. All members within the department were invited to complete the questionnaire, which evaluated how the Outlook calendar feature was used within a medium sized department to aid co-located and distributed collaboration.

3.6.3.2 Participants

A total of 12 complete responses (male = 5, female = 7, median age group = 30-39) were collected at the end of the study. The group was composed of 15 full-time researchers, lecturers and postgraduate students at the time of the study. The response rate was 80%.

3.6.3.3 Method

A list of questions was developed to gather information about the use of Outlook and the participants' perceptions of the software, and specifically the shared calendar facility.

Participants were asked to rate their agreement with some statements on a 5-point Likert scale (1 = strongly disagree, 2 = disagree, 3 = neutral, 4 = agree and 5 = strongly agree) as well as a 5-point rating scale to indicate satisfaction with other statements (1 = extremely dissatisfied, 2 = dissatisfied, 3 = neutral, 4 = satisfied and 5 = extremely satisfied). There were also open-ended questions for participants to provide comments and feedback on the use of Outlook and other aspects which were not covered by the questionnaire.

Participants were asked to rate how often they used their Outlook calendar within the week of completing the online questionnaire (see Figure 3-7), this question was specifically about the calendar function to set the tone for the rest of the questionnaire.

1. How often did you use Outlook calendar this week?

<input type="radio"/> More than 4 times a day	<input type="radio"/> 2-3 times a week
<input type="radio"/> 4 times a day	<input type="radio"/> Once a week
<input type="radio"/> 3 times a day	<input type="radio"/> Less than once a week
<input type="radio"/> Twice a day	<input type="radio"/> Never
<input type="radio"/> Once a day	

Figure 3-7: Layout of Outlook online questionnaire on the frequency of use

The questionnaire statements were influenced by factors from the priority elicitation exercise (see Section 3.5), such as awareness, privacy and usability. All statements used in the online questionnaire are shown in Table 3-15.

Statements used in online questionnaire	
This week, I have used Outlook calendar as part of my day-to-day work	I have used Outlook to arrange virtual meetings (e.g. Skype, telephone conference)
Using Outlook has made me more aware of activities taking place within my own research group	Other methods such as email and telephones are used to confirm meetings arranged by Outlook
I feel like I need to be careful with my calendar entries	Outlook makes it easier for me to plan my day around work schedules
I have used Outlook to arrange face-to-face meetings with colleagues from the same building	I like colleagues being able to see my calendar entries
I have used Outlook to arrange face-to-face meetings with colleagues from different buildings	It is useful to be able to see my colleagues' calendars
I dislike sharing my calendar with my colleagues	Outlook is my main work calendar
Outlook is easy to use	Outlook is effective at arranging meetings
I dislike using Outlook	Outlook has been beneficial to my work

Table 3-15: Outlook questionnaire statements

One of the priorities of this questionnaire was to ensure that it was easy to understand and complete. Selected statements with their associated 5-point Likert scale were presented on one page, the layout is shown in Figure 3-8. At the bottom of the page, participants were able to leave other comments if they wished.

2. Please rate the following statements

	Strongly disagree	Disagree	Neutral	Agree	Strongly Agree
This week, I have used Outlook calendar as a part of my day-to-day work	<input type="radio"/>	<input type="radio"/>	<input type="radio"/>	<input type="radio"/>	<input type="radio"/>
Outlook is easy to use	<input type="radio"/>	<input type="radio"/>	<input type="radio"/>	<input type="radio"/>	<input type="radio"/>
Outlook has been beneficial to my work	<input type="radio"/>	<input type="radio"/>	<input type="radio"/>	<input type="radio"/>	<input type="radio"/>
Using Outlook has made me more aware of activities taking place within HFRG	<input type="radio"/>	<input type="radio"/>	<input type="radio"/>	<input type="radio"/>	<input type="radio"/>
I dislike using Outlook	<input type="radio"/>	<input type="radio"/>	<input type="radio"/>	<input type="radio"/>	<input type="radio"/>

Figure 3-8: Layout of online Outlook questionnaire (statements listed in Table 3-15)

The last section of the questionnaire included three open-ended questions as follows:

- What did you like about using Outlook?
- What did you dislike about using Outlook?
- How has Outlook affected your overall collaboration with colleagues?

These three questions were not made compulsory for participants to answer. However these questions were put at the end in an attempt to gather more information which could yield richer results and supporting evidence than the rating scale provided.

The online questionnaire was piloted on three participants who were not part of the research group and therefore were not involved in the trial. This was to ensure that all statements were easy to understand and that the questionnaire could be completed within 5-10 minutes.

An introduction page was attached to the start of the questionnaire, which explained the aims and purpose of the study. Participants were assured that all responses would be treated anonymously and analysed confidentially. All personnel and students within the department were sent an email explaining the aims of the questionnaire study and a link to the online questionnaire website. Another reminder was sent two weeks after this first email to ensure that all participants received a copy of the email and had completed the questionnaire.

Once a questionnaire was completed, they were automatically collected on the web server, ready for analysis. Participants were given three weeks to complete the questionnaires. The final date of collection was stated in the initial and the reminder email. After this closing date, all the data were collected and analysed.

3.6.3.4 Results

Participants were asked to rate how often they used Microsoft Outlook on a typical day during the week prior to the questionnaire. All participants reported using Outlook at least once a day and the median was “3 times a day” and “4 times a day”. In addition, 33% of the participants also reported a high usage of Outlook of “more than 4 times a day”.

Table 3-16 shows the median responses of all the statements in the questionnaire which participants were asked to rate on a 5-point Likert scale.

Statements	Median
This week, I have used Outlook calendar as a part of my day-to-day work	Strongly Agree
Outlook is easy to use	Agree
Outlook has been beneficial to my work	Agree
Using Outlook has made me more aware of activities taking place within HFRG	Neutral
I dislike using Outlook	Disagree
I have used Outlook to arrange face-to-face meetings with colleagues from the same building	Agree
I have used Outlook to arrange face-to-face meetings with colleagues from different buildings	Agree
I have used Outlook to arrange virtual meetings (e.g. Skype, telephone conference)	Strongly Disagree
Other methods such as telephone or email are used to confirm meetings arranged by Outlook	Disagree
Outlook is effective at arranging meetings	Agree
Outlook makes it easier for me to plan my day around work schedules	Agree
I dislike sharing my calendar with my colleagues	Disagree
I feel I am compromising my privacy by sharing my calendar with colleagues	Disagree
I feel like I need to be careful with my calendar entries	Disagree
I like colleagues being able to see my calendar entries	Neutral
It is useful to be able to see my colleagues' calendars	Agree

Table 3-16: Outlook questionnaire statements with median rating shown for each statement

In addition to the rating scale questions in this section, participants were able to leave comments with regards to the use of Outlook at work. This section of the questionnaire offered participants the opportunity to further express their views on Outlook in open-ended, non-compulsory questions. Eleven participants responded to the open-ended questions, the following quotes were taken from the responses on using Outlook at work:

“I have used Outlook in previous workplaces and have always found it a very useful tool provided that its use is made compulsory for all staff members. Concerns over privacy can be addressed by staff being made aware of the 'privacy' option for calendar entries and by the benefits of use being made obvious.”

“As I don't have a portable synchronised Outlook calendar it is difficult to arrange meetings when I am not online.”

“I don't confirm with email or phone, BUT I often suggest a meeting on phone/email/face-to-face and then confirm this with an Outlook invite. It also depends on how much explanation of the meeting is needed. Here, I tend to do this pre-arranging, but in my last job (where people always used Outlook and wouldn't turn up to meetings unless they had received an Outlook invite) it was typical to explain the purpose of the meeting etc. just in the text of the Outlook invite, especially if you knew the person well and they had a general idea of the context. Also,

even if someone isn't on Outlook, I will still place the meeting in the calendar for my own benefit, just as a reminder."

"I also use a paper diary which is my main point of reference. I mainly use Outlook for recording things others should know about such as when I'm not going to be in the office (e.g. on holiday or when I'm attending meetings). For my own personal use, I still prefer to use my paper diary which I have with me at all times (I don't have internet access at home)."

The responses of 11 participants who answered this question were further summarised into categories shown alongside the frequency of responses for each category (see Table 3-17).

Responses	Frequency of responses
Helps organise meetings	3
Check and update availability of other colleagues	3
Easy to use	2
Overview of own appointments and task schedules	1
Show others my availability	1
Accessible over the internet regardless of physical location	1
Appropriate for the job	1

Table 3-17: What do you like about Outlook? (Category and the frequency of responses)

Participants were further asked to comment on factors they disliked about using Outlook. The answers from the nine participants who responded to this question were categorised and are shown in Table 3-18. Two participants mentioned there was nothing they disliked about using Outlook.

Responses	Frequency of responses
Synchronising Outlook diary with paper or other devices, e.g. phone	2
Colleagues who failed to make their own diaries available to others or keep an accurate or up-to-date diary	2
Diary-sharing only applies to those using the university network	1
Cannot access Outlook without being online	1
Reliability of the technology	1
Some features of Outlook are still complicated (interface/usability issues)	2
There is nothing I dislike about Outlook	2

Table 3-18: What do you dislike about Outlook? (Category and the frequency of responses)

The last open-ended question in the questionnaire asked how Outlook had influenced the overall collaboration process within the workplace. Eleven participants responded to this question and again, the responses were categorised and are shown in Table 3-19.

Responses	Frequency of responses
Effective and easy to arrange meetings with colleagues from the same (internal) network	6
Easy and useful to check availability of colleagues	3
Outlook helps promote awareness of my work schedules and availability shown in my diary	1
Outlook can be used as a reminder to help people remember their appointments (e.g. reminder set to alert before meeting starts; confirmed appointments are shown and synchronised in diary)	1
Outlook has made little difference to the overall collaboration	4

Table 3-19: How has Outlook influenced your overall collaboration? (Category and the frequency of responses)

The majority of respondents suggested that Outlook can be used to effectively arrange meetings and other resources (such as booking rooms and equipment) for meetings. They further commented on the usefulness of the Calendar sharing feature which enabled them to view each other’s availability online. When asked about the influence of Outlook on collaboration, one participant wrote:

“Totally – having used it extensively in my last few commercial jobs, the combination of email/calendar/invites is indispensable.”

Four participants responded to this question by stating Outlook had not altered their overall collaboration process, but three participants suggested that the ability to view other colleagues’ availability was a useful feature for awareness and further meeting arrangements. Only one participant suggested that using Outlook has no effect on collaboration:

“It hasn’t. A piece of software doesn’t actually influence collaboration”.

The overall results of the questionnaire indicate that the majority of the participants had no objections to using Outlook or sharing their calendar entries with other colleagues. Participants were asked to rate whether using Outlook to share their Calendar was compromising their privacy - the median of the 5-point rating scale was “Disagree”. Furthermore, participants expressed in the open-ended questions that having this feature was useful when arranging meetings with each other.

3.6.3.5 Discussion and conclusion on the Outlook online questionnaire

This pilot study examined the use of an online questionnaire to investigate the use of a specific collaborative tool – Microsoft Outlook. The online questionnaire had a high response rate,

however it should also be considered that the participants were highly cooperative, which might not be true outside of the research group.

The online questionnaire was easy to administer and the design of the questionnaire was kept on the online database. This can be useful as it can be re-administered again in the future to examine changes in responses.

The structure of the questionnaire included questions to yield both qualitative and quantitative responses. The additional comments offered by the respondents were comprehensive, which could be used to illustrate the quantitative results gathered by the questionnaire. The last three sections of the questionnaire were open-ended questions. The space available for the responses was adjustable (i.e. as the participant begins to add his/her response, the space available expands to accommodate the amount of text input).

The use of online questionnaires would only be efficient if the target respondents are able to access the internet at their own convenience in order to respond to the questionnaires. In addition, the participants involved in this pilot study were able to type and are familiar with using computers as part of their roles, therefore no additional effort was required to physically input their responses. If the participants were unable to access the internet or are in professions where a computer was not readily available to them, then online questionnaires would have been inappropriate.

3.7 Case Study

Many organisations have now adopted different off-the-shelf technologies in order to aid communication in teams. Skype, which was originally a social internet telephone tool, is also used in workplaces as the quality of the service has improved in recent years. The cost of such technologies is considered minimal as the service itself allows one participant to call another from PC to PC regardless of their countries of origin as long as they are both online synchronously. Many other tools such as IM and video-conferencing software which provide free services have also been adopted alongside email and telephones.

This case study investigated students' preferences and usage of different collaborative tools during a group project. The group project was part of the students' course requirement (Module MM4HCI, in 2009). As part of the assignment, each group was asked to design an information kiosk for university visitors. Each group was then required to present their project findings and

design of the kiosk, which was assessed by a panel of four markers made up of the module convener, two lecturers and the author. As part of their presentation, students were required to present an evaluation and preferences of collaborative technologies they used to support collaboration within their group, during the project.

As this case study was focussed on the use of collaborative technologies in student projects, the results were gathered from the students' presentations. The marks awarded to students were not reported in this study as their performance was judged on their designs of the kiosk, which was the main task of the coursework. However, students were also asked to report the use of technologies they adopted to support their in-group collaboration during the coursework, which was the data obtained for this study.

A total of 58 students (12 groups) of mainly engineering and Human Factors students completed this group coursework as part of their module. The overall demographic information of each student was not recorded.

On average, there were five students in a group. Students were able to form their own groups in order to complete the coursework. Students were either in their penultimate or final year of undergraduate study. The coursework given for this module contributed to their degree results.

3.7.1 Purpose of the Case Study

The overall purpose of this study was to observe the use of various off-the-shelf collaborative technologies in student projects to inform the experimental design and selection of technologies for further laboratory experiments.

3.7.2 Method

Students were able to select their own groups to complete a design task. They were required to design an information system or kiosk for university visitors as well as existing students and staff. This assignment was given over the holiday period and as part of the assignment they were asked to evaluate and record the technologies they used to collaborate over the holiday.

They were asked to present their design, their user centred design method (i.e. for data collection such as questionnaires and interview, the analysis and their design development) and their evaluation of the collaborative technologies used during the task. They were asked to report the different technologies they used to enable them to collaborate in co-located and

distributed settings with their colleagues. These requirements were set by the module convener. However, for the purpose of this study, this was seen as an opportunity to observe the use of technologies; therefore the student presentations were used to obtain results for this study. The data collection was done by analysing presentation slides submitted by the students at the end of their presentations.

3.7.3 Results

The number of times each group reported using different collaborative technologies or methods was recorded. All of the 12 groups reported that they used more than one technology and/or method over the period of their assignment.

As this was a group project, students were required to divide the workload and coordinate their time and effort as a group in order to deliver the final report and presentation on time. This assignment was given to them over the Easter holiday and therefore students were unable to arrange face-to-face meetings constantly as team members may no longer be located in the same place. Therefore there was a mix between co-located and distributed collaboration during the coursework.

Eight main methods were observed, one being face-to-face communication. Different existing tools were selected by different teams; similar tools were categorised into the same group. For example, the majority of the groups opted for internet telephone, some with webcam; the tools selected included Skype, Google Talk, Windows Live Messenger and Oovoo. These tools offer more than one feature and the use of these tools has therefore been categorised by functionality rather than the brand of the tool itself.

Internet telephone and mobile telephones were selected by 11 out of 12 groups. Ten groups also used Short Message Service (SMS) or mobile text messaging as a way of communicating with their team members. Ten groups opted for online shared workspaces, which allowed real-time collaboration and sharing of documents as well as live editing between members. These tools included Google Groups, Huddle and WebCT. These tools also support project management. Members can send group announcements to each other, arrange meetings as well as view or edit the same documents at the same time on their shared workspace.

Interestingly two out of ten groups did not have face-to-face meetings during the group project. This could be due to differing geographical locations of all the members during the coursework

period. Other reasons could be the availability of technologies, the way each member works or prefers to be contacted as well as any cultural differences (the majority of the students taking the module were international students from outside the UK). Two groups of students reported that some of the group members did not have access to the internet over the Easter holiday and therefore could not receive emails. A group of students also used an interactive whiteboard which allowed them to view and edit ideas and images on the same whiteboard to aid their face-to-face collaboration.

Nine groups used IM as part of their collaboration process. Email was also chosen by nine groups of students as a means of communication with their teams in order to share files and documents as well as updates and announcements, regardless of their locations and time zones.

The social network, Facebook, was also used by five teams. All the students who selected Facebook already had an existing account prior to the start of the coursework. These groups used Facebook in a similar way to those using a shared workspace. Even though the social network site does not specifically support project management, it allows messages and files to be shared among those on the participant's contacts or friends list. Participants were also able to send out invites to meetings via Facebook. Account holders have the option of whether they would like to receive notifications of invites to events and meetings in their normal e-mail account. However, if they did not opt for this option, then this method relies solely on participants checking the social network site regularly to pick up messages and announcements.

The number of groups selecting different communication technologies and methods to support their group collaboration in both co-located and distributed meetings and the types of communication supported are summarised in Table 3-20.

Methods	No. of groups (out of 12)	Types of communication
Internet phones and webcam (e.g. Google Talk, Skype, Oovoo, Windows Live Messenger)	11	Synchronous audio/video
Mobile telephone call	11	Synchronous audio
Mobile text messaging (SMS)	10	Semi-synchronous/ asynchronous text
Online shared workspaces/portals (e.g. Google Groups, Huddle, WebCt)	10	Semi-synchronous/ asynchronous text

Face-to-face	10	Synchronous
Instant Messenger (e.g. Windows Live Messenger, Skype)	9	Semi-synchronous text/ asynchronous text
Email	9	Asynchronous
Social Network (Facebook)	5	Semi-synchronous/ asynchronous text

Table 3-20: Students' choice of collaboration methods and types of communication they support

3.7.4 Discussion and conclusion on the case study

This case study illustrated the different technologies and methods of collaboration adopted by students when carrying out a group project. The teams were formed by the students themselves and they were asked to complete the whole project within the given time of two months. This time period included the Easter holiday during which team members could have been distributed (e.g. travelled home on holiday). During the two month period, students were able to meet as they were co-located during term time when the coursework was assigned.

This was not an in depth study and therefore the organisation and project management of each group were not recorded, however these may have influenced the way in which group members collaborated. It was found that 11 (out of 12) groups selected internet telephone and mobile telephone, which allow real-time audio and some video communication as their preferred methods of communication. Internet telephone such as Skype allows more than two participants to be connected in a telephone conference. Oovoo allows more than two participants to have a video conference call, whilst Skype and other tools only allow a two-way video conference. However, only one group used Oovoo, possibly because this software is still new in comparison to Skype and Windows Live Messenger.

The majority of the collaborative methods allowed participants to communicate synchronously, or in real-time, using mainly audio and text. However, depending on the situation, some of the synchronous tools such as Instant Messenger can also be seen as asynchronous (i.e. when a message was sent to someone who was online but not in front of his/her computer and therefore the message was not received or read and replied to immediately).

This case study showed the adoption and use of different communication technologies by undergraduate students in a group project. The main technologies used were email, the

telephone and internet phone and lastly the use of social networking websites (which may be uncommon in workplace settings).

3.8 Discussion

This section summarises the possible uses of the methods discussed in this chapter in order to measure various aspects of collaboration in the studies conducted in this thesis as well as presents key findings emerged from the pilot studies.

Each method is appropriate for use in a wide range of situations and therefore possible contexts of use for each, alongside the practical implications, are presented in Table 3-21. In addition, the way in which some methods have been adopted for further use in the main thesis studies is also listed.

Method	Context of future use	Implications and practicality	Further uses in thesis (influences on selected methods)
Interviews	<ul style="list-style-type: none"> Used to understand current collaboration practices and technology use with wide range of tasks Collect extensive views and subjective information on influences of technologies on collaboration in the workplace Suitable to use as part of a field study 	<ul style="list-style-type: none"> Detailed interviews require audio recordings and transcription with high time and effort cost Participant recruitment for a long session can be difficult Produces qualitative data with rich quotes Coding can be done to quantify data gathered 	<p>Chapter 4 – Company X</p> <ul style="list-style-type: none"> Semi-structured, group interviews were conducted to gather information on current collaboration practices prior to the introduction of a new collaborative technology at Company X Method was selected to produce rich qualitative data to understand the company's functions, attitudes, roles and relationships of staff in different departments, including the way they interact Interviews were audio recorded and transcribed with responses summarised into categories (tabulated results)
Expert priority elicitation exercise	<ul style="list-style-type: none"> Gathers information on usage and perception of specific technology Suitable to use as part of a field study 	<ul style="list-style-type: none"> Data can be difficult to record; requires transcription due to multiple participants Group discussions can be conducted followed by a short questionnaire to ensure the collection of relevant data 	<p>Chapter 4 – Company X</p> <ul style="list-style-type: none"> Group discussions were conducted after demonstrations of a new technology: participants were able to express their views and attitudes towards a new technology A short questionnaire was administered after the focus group with rating scales to document perceptions of the technology

Online questionnaire	<ul style="list-style-type: none"> • Repeated use to record changes in attitudes; collects information on usage and effectiveness of collaborative technologies 	<ul style="list-style-type: none"> • Produces qualitative and quantitative data • Easy to administer • Appropriate only if target respondents have easy access to internet at their convenience and are familiar with computer/typing 	<p>Chapter 4 – Company X</p> <ul style="list-style-type: none"> • Online questionnaires were used in Chapter 4 as part of the interim and exit evaluation (same questionnaire) to evaluate the influence of a new technology on the overall collaboration process at Company X. The same questionnaire was repeated half way through the trial period and again at the end of the trial to evaluate the changes in responses <p>Paper questionnaires were administered at the start of the Company X study, prior to meeting the participants face-to-face (completed questionnaires were collected at the first meeting with participants)</p> <p>Chapters 5 and 6 (laboratory studies)</p> <ul style="list-style-type: none"> • Paper questionnaires were adopted for the laboratory studies (Chapters 5 and 6) for ease of completion
Checklist	<ul style="list-style-type: none"> • Quick method of evaluation (e.g. of technology usage) 	<ul style="list-style-type: none"> • Statements require standardisation and validation • Rating scale results are easy to process when comparing more than one condition/technology 	<p>Chapter 5 – laboratory study</p> <ul style="list-style-type: none"> • Adapted in the form of an observational checklist used as a method for quick data recording of users’ physical behaviours during an experimental study • A list of physical movements/behaviour was formulated prior to the experiment. Experimenters then recorded the behaviour every 5 seconds to document the physical state of the participants
Case Study	<ul style="list-style-type: none"> • Real-world or laboratory studies • Examines specific use of technology in a given context 	<ul style="list-style-type: none"> • Produces qualitative and quantitative data • Produces context specific data to allow understanding and evaluation of collaboration 	<p>Chapters 5 and 6 (laboratory studies)</p> <ul style="list-style-type: none"> • Adopted in the form of experimental studies where each study required participants to conduct a collaborative task using the given technology

Table 3-21: Summary of methods and further uses in the thesis

3.9 Key findings from Chapter 3

The studies presented in chapter 3 compared qualitative and quantitative methods for collaborative studies and the use of technologies to support collaboration. This section summarises the key findings on the use of technologies and their influence different aspects of virtual collaboration.

1) How important is it for technologies to suit user needs, context of use and task? Do users alter behaviours to fit technological constraints?

Both CoSpaces and DiFac projects aimed to support collaboration in an industry context by developing appropriate software to suit user needs after having conducted thorough user requirements elicitation with interviews and questionnaires. This indicates the importance of ensuring the compatibility between the users, tasks, skills, preferences and software implementation.

Users appeared to change their behaviours to best optimise available technologies to support their remote collaboration. The availability of these technologies at work is further influenced by factors including the organisation (i.e. resources, awareness of and investment in technologies), and preferences of users and colleagues, especially authority figures of the company. Interviewees in the CoSpaces and Skype interviews mentioned that when dealing with non-spatial tasks remotely, users often send their spatial information back and forth while discussing over the telephone, Skype, chat or email, instead of meeting face-to-face and collaborating over a physical drawing which all participants can share. In remote collaboration, once participants finish their discussions, changes are implemented in the design drawings and send them electronically to colleagues again.

The Outlook survey showed that the majority of the participants adopted the use of the online shared calendar system (i.e. to arrange meetings), however some responses indicated that the reliance on having a computer and the internet is an additional difficulty as users were unable to access their calendar without the internet. Furthermore, users were required to synchronise their paper-based diaries and other devices with the Outlook system manually. This suggests that the technology alters the behaviour of users (i.e. there is an additional administrative task of synchronising diaries).

The student case study suggested that different groups adopted different collaboration methods even when conducting the same task. Their selection could have been based on their preferences and other factors such as the availability of technology or the internet as well as the location of their colleagues, for example. Students reported the use of mostly off-the-shelf technologies during their coursework.

The results from these studies suggest that even though off-the-shelf technologies are widely accessible, real users in industry from the CoSpaces and DiFac projects are still searching for tools to better fit their needs. The importance of the user requirements elicitation conducted by both EU funded projects indicates that end users are more proactive to ensure that technologies are designed to support important aspects of collaboration, often specific to their use cases. Therefore it can be summarised that collaborative technologies which appropriately satisfy the user needs and context of use have a greater chance of successful implementation and thus are more likely to contribute to successful virtual collaboration.

2) Is audio the most useful communication modality in remote tasks?

Participants report the use of audio (such as Skype or the telephone) and chat with remote colleagues in the CoSpaces and Skype interviews, and only one participant interviewed regarding the use of Skype at work reported the use of a webcam to facilitate video-conferencing to support virtual collaboration. However, the chat feature of Skype was mentioned as a way to send synchronous/semi-synchronous textual messages to co-located and remote colleagues. Participants also reported having used chat on Skype to check colleagues' availability as well as for sending programming codes (i.e. non-spatial). However, follow up telephone or Skype calls are often required when the discussion becomes too complex to continue on chat.

The DiFac technologies examined did not aim to support audio communication within the system; these systems mainly provide a shared view of the workspace, including live text chat, and on-screen annotation. These technologies were designed to be used in conjunction with external software such as Skype and the telephone.

The results from the expert priority elicitation session indicated that synchronous communication including audio, visual and text chat is considered important in supporting collaboration. In addition, students from the case study reported the highest use of internet telephone and mobile telephones to support collaboration during their student project. The

coursework assignment required students to conduct qualitative and quantitative data collection to gather user requirements as part of their user-centred design approach. Therefore some stages of the task were considered non-spatial. However, the results from this case study did not indicate the frequency of use, but only the number of groups adopting such methods to support their team collaboration.

The results from these studies indicate that in all cases, users adopt more than one method of collaboration and many initiate their contacts with text-based communication (i.e. IM or mobile telephone text messaging, file transfer and email). Possibly due to the cost of long distance telephone calls, audio was adopted as a follow up method over complex collaborative tasks. Therefore the results suggest that audio communication may not be the most useful modality in remote tasks, however further examination is required to assess whether heavily spatially oriented tasks will rely more on audio than text-only communication.

3) Is a shared view of the workspace in remote collaboration more useful than a view of the remote colleagues?

Apart from the reported use of internet telephone and webcams to support virtual collaboration in the student projects, no other results suggest the importance or the usefulness of seeing remote colleagues in virtual collaboration.

Interviews conducted for the CoSpaces user requirements elicitation and the use of Skype at work suggest that being able to share information (i.e. spatial and textual) has benefits in supporting remote discussion. The technologies developed in the DiFac project also aimed to support a shared view of the workspace instead of a view of the remote colleagues, especially when supporting spatial tasks. In addition, being able to share a view of the workspace was also reported as 'application sharing' in the expert elicitation session. This indicates the value of being able to view the same workspace during collaboration. In addition, students also reported the use of online shared workspaces and portals to support their group project. Therefore results suggest shared workspaces in remote collaboration are more useful than being able to see a view of the remote colleague.

3.9.1 Summary

Although limited, these studies were conducted as series of short studies to investigate several aspects of collaboration and the type of technologies adopted or required by users in different work settings. The results gathered from the CoSpaces and DiFac project, as well as some of the Skype interviews were from real industrial users in situ, which was a rare opportunity for research in collaborative work. A summary of key findings how these findings contribute to further studies are presented in Table 3-22.

	Chapter 3 key findings	What next?
<i>How important is it for technologies to suit user needs, context of use and task? Do users alter behaviours to fit technological constraints?</i>	<ul style="list-style-type: none"> • Technologies should fit user and task needs (e.g. DiFac technologies to support design tasks). • User preferences, tasks and availability of other colleagues influence technologies selected. • Users adapt their behaviours such as recording meetings on Outlook as well as in personal paper diaries to fit the requirement to share work calendar. 	<ul style="list-style-type: none"> • What are the effects of implementing a new technology in the workplace? (Chapter 4) • How does suiting user needs, context of use and task influence the success of implementation? (Chapter 4)
<i>Is audio the most useful communication modality in remote tasks?</i>	<ul style="list-style-type: none"> • Audio and text-based communication modalities are both frequently used to support collaboration, and these two modalities are often used to complement each other. • Text-based communication is often adopted and complex conversations are followed up by audio communication. 	<ul style="list-style-type: none"> • How crucial is the always-on audio when supporting remote non-spatial tasks? (Chapter 4) • How useful is audio when used with screen sharing applications in spatial task? (Chapters 5 and 6)
<i>Is a shared view of the workspace in remote collaboration more useful than a view of the remote colleagues?</i>	<ul style="list-style-type: none"> • A shared view of the workspace is supported by design technologies developed in DiFac. • Participants in the expert elicitation session perceived application sharing as a necessity when supporting collaboration • No results reported the usefulness or importance of viewing remote colleagues during collaboration. 	<ul style="list-style-type: none"> • How does a shared view of the working environment and a view of the remote colleagues influence collaboration? (Chapter 4) • A further examination of video-conferencing together with a shared workspace to support virtual collaboration (Chapter 5) • How does a shared view of the workspace support audio and text communication? (Chapter 6)

Table 3-22: Chapter 3 summary of key findings

Chapter 4 - Evaluating a Collaborative Technology Enabling a Shared Virtual Environment in the Workplace – A Case Study

4.1 Chapter Summary

This chapter presents a field study evaluating collaboration and the implementation of the Mixed Reality Architecture (MRA) system in the workplace to support virtual teams.

The study reported in this chapter is part of a six-month case study conducted in an organisation with 25 staff located in five offices (of different sizes). However, for the purpose of this study, only three main offices and two home offices were included. Two of the offices are in the UK (one being the main head office) and a third in Europe. The company's structure means team members virtually collaborate with each other as part of their work.

During the six-month case study, a lot of time was dedicated to the technical setups at the start of the project. The technical focus of the MRA system is beyond the scope of this thesis, thus the installation phase of this project (i.e. the first three months) is not reported in this chapter.

The aim of this chapter was to evaluate the impact of a new collaboration technology in a real work place. The evaluation stage started approximately three months after the project started and the focus of this chapter is on the three-month evaluation work, conducted by the author, just before the MRA was operating through to the end of the project.

To examine current collaborative practices and a description of work within the organisation, a pre-installation questionnaire was administered to employees and interviews were conducted prior to the MRA was fully introduced to the participants. The pre-installation evaluation was conducted one week before the MRA system was fully functional at the company.

Once the MRA was installed, participants were invited to join demonstration sessions where they were able to discuss their perceptions and expectations of the system (prior to the actual usage) and complete a post-demo questionnaire. An interim-questionnaire was administered three weeks after the installation to examine the initial usage of the MRA system. This questionnaire was re-administered as part of the exit-evaluation, 10 weeks after the system was installed. Results from the different stages of evaluation were analysed and are discussed in this chapter.

4.2 Introduction

Collaborative technologies have been researched and evaluated to discover how they can best support virtual collaboration in real workplaces. Various communication tools (such as the telephone, email, telephone or audio conferencing, IM, internet telephone and remote application sharing) have seen successful adoption into organisations.

Factors influencing the selection, implementation and deployment of tools include users, tasks, goals, organisational structure, preference, resources available (skills, expertise, training) and the cost of implementation (which is considered an investment) (Martins *et al.*, 2004). Organisations seek to adopt tools which they believe would support and improve collaboration in their workplace, and hence improve the overall performance, effectiveness, team relationships and user satisfaction (Kamel and Davison, 1998; Ocker and Yaverbaum, 1999).

The use of computer-mediated tools is very common today with the rise of VTs. These tools have enabled such teams to function allowing cheap and frequent mediated communication without relying on face-to-face interaction alone. However, as users become more familiar and comfortable with using technologies, they become more proficient at selecting tools which they believe would support them with their tasks (Gutwin and Greenberg, 2000). Even though users are becoming less techno-phobic, they are often resistant to using new tools once they are comfortable with their existing tool (Grudin *et al.*, 2005), and hence the term ‘media stickiness’ (Huysman *et al.*, 2003).

4.3 Purpose of Chapter 4

The purpose of this case study was to examine the use of collaboration tools within an active organisation that had a need to support their VTs. Information was obtained regarding the relationship between the selection of these tools and the type of tasks they are used to support. Specifically, this case study evaluated the organisation’s adoption of a new tool, the MRA system, which management believed would be beneficial to assist their current collaboration.

As the system had not been tested with end users prior to this study (Schnädelbach *et al.*, 2006; Schnädelbach *et al.*, 2007) user feedback and recommendations which emerged from this study was used to provide a feedback to the system designers for future improvements. A summary of the purpose this study is presented in Table 4-1.

Purpose of Chapter 4:

1. Understand the nature of the company and the tasks carried out by the main VTs
2. Investigate current collaboration practices in the organisation
3. Evaluate the collaboration before and after the installation of the MRA system
4. Compile recommendations and feedback which can be used to aid further development of the system

Table 4-1: Chapter 4 – purpose of study

4.4 The Company

To ensure the anonymity of the company involved in this case study, it is referred to as Company X. The real locations of different offices are also not reported in this chapter and different offices are referred to by their arbitrary names (i.e. Office A).

Company X provides IT services to customers based in the UK and Europe. Twenty-five people were employed at the time of this study, working in three main offices of various sizes. These offices are referred to as Office A, B and C. Both offices A and B are located in the same country, but different cities, while Office C is located in another European country. Thus the company structure allows for a great level of virtual work between teams.

Office A is the largest office consisting of different departments of the whole organisation, where all the main commercial and technical activities take place, whilst Office B works closely with Office A. Employees in Office C mainly act as a point of contact for customers outside of the UK while liaising with those in Office A. In addition, the two directors of the company tele-work from their respective homes at least once a week.

Location	Team Size	No. of Departments
Office A	17	6
Office B	2	2
Office C	3	2
Home office (1)	1	1
Home office (2)	1	1

Table 4-2: Offices and staff distribution

In Office A, employees are all grouped into their department within an open-plan office (see Figure 4-1).



Figure 4-1: Open-plan office at Office A

4.5 Mixed Reality Architecture

Mixed Reality Architecture (MRA) was adopted as a media space system to support collaboration in remote teams. This system is still in development and has only been evaluated in an academic setting ever since the early stages (Schnädelbach *et al.*, 2006; Schnädelbach *et al.*, 2007). This is therefore the first time the MRA system has been used in a commercial organisation with real end users.

This media space system is used to support different types of communication (formal, informal and arranged) as well as to serve as an awareness tool in VTs, enabling local inhabitants to see into the remote offices of their distributed team members. More than two offices can be connected to the system and share the same virtual space with each other, which is private to the organisation as it runs on its own main server, connected to the internet.

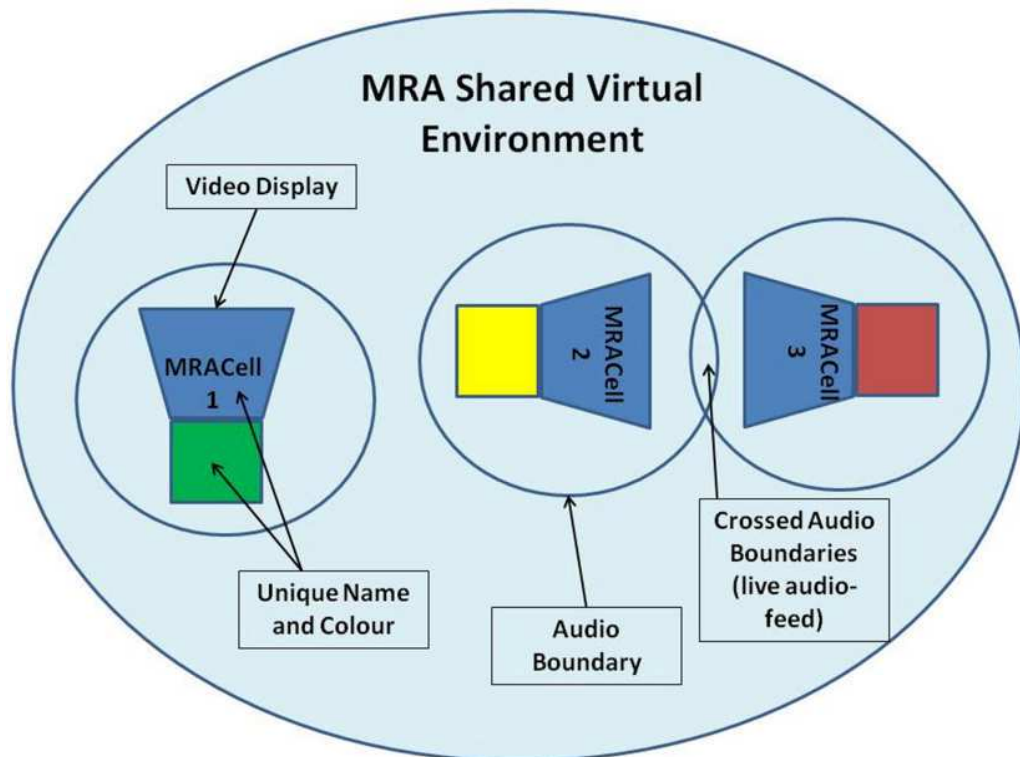

Figure 4-2: Representation of three MRACells sharing a 3D virtual environment in an MRA system

The MRA system is illustrated in Figure 4-2. An office connected to the MRA system is allocated an MRACell, which is a representation of that office in the 3D virtual space, providing a live audio-visual feed to other remote offices in the same environment. Each 3D MRACell is clearly labelled with the names of their offices and are shown in their unique colours in a shared environment so that they can be identified easily. Names of the inhabitants can also be shown on their MRACell, underneath the video-feed.

An MRACell consists of a computer, which runs the programme, a camera, a microphone, a joystick or a mouse (to control their hub around the virtual space), a speaker and a monitor (or a screen and a projector). The setup of an MRACell is shown in Figure 4-3 (left image).

Users are able to move their own MRACell around the shared virtual space, allowing them to search for another 3D MRACell belonging to their virtual colleagues and establish a communication or check their availability. Each MRACell has its own audio boundary which determines whether they can hear audio-feeds from other MRACells. Once one MRACell enters an audio boundary of another cell, the live audio feeds from the two offices come within range and hence the inhabitants from both offices can hear each other (see Figure 4-2). The closer one

MRACell is to another, the louder the audio and the clearer the visual feed, similar to the real life relationship between cues and physical proximity. A view of their own video (as seen by others) and a map of the virtual space showing locations of other MRACells are provided to the local inhabitant, at the top of their MRA screens (shown in Figure 4-3 - right image).



Figure 4-3: Images of an MRACell. View from the office of the shared virtual environment (left) and view of others from the environment into the office (right) (Schnädelbach *et al.*, 2007)

Three MRACells can come near enough to each other, by forming a triangle, so that inhabitants in all three offices can see and hear each other over the audio-visual feed. Users have complete control of their audio setting, allowing them to switch the microphone and speakers on and off from their local MRACell controls. In addition, they are also able to change their online status to protect their privacy by updating their video settings, as shown in Figure 4-4. The MRACell status can be set to semi-close, (other MRACells from afar can no longer see the video link of the local office but can still come through the 'curtain' to see the video if required), or they can go offline.

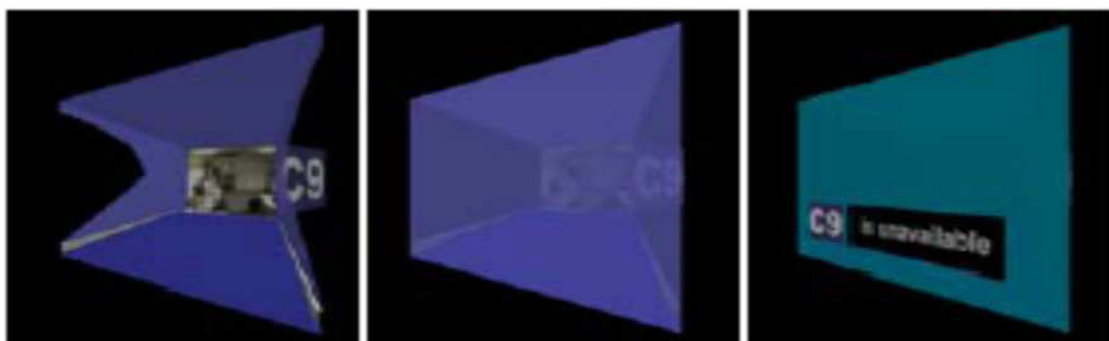

Figure 4-4: MRA privacy feature: open (left), semi-closed (middle), offline or unavailable (right) (Schnädelbach *et al.*, 2007)

4.6 Method

To understand the company’s settings and collaborative practices and to examine the changes caused by the implementation of the MRA system, a number of qualitative and quantitative measures were employed. The measures taken before the installation, during and after the trial are summarised in Table 4-3.

Entry-evaluation	Post demo-evaluation	Interim-evaluation	Exit-evaluation
Pre-installation questionnaire	Informal group discussions	Informal feedback	Informal feedback
Group interviews (by department) including telephone interview with Office C	Short questionnaire (expectations of the MRA)	Online questionnaire (3 weeks after installation)	Online questionnaire (10 weeks after installation)
Workplace observation (Office A)	Workplace observation (Office A)		

Table 4-3: Summary of data collection methods used at different stages of the trial

4.6.1 Pre-installation Questionnaire

In order to evaluate the current collaboration practices, the needs for collaboration as well as the relationships between departments within the organisation, a pre-installation questionnaire was designed and administered to participants at the organisation prior the MRA system was fully functional. There were five sections to the pre-installation questionnaire, which took approximately 10 minutes to complete. The structure and questions in each of the sections are summarised in Table 4-4 (see Appendices).

Sections	Comments	Example questions
Introductory details	This section included demographic information and information about the respondent’s roles at Company X	<ul style="list-style-type: none"> • What is your main role? • How long have you been with the company?
Communication	This section consists of 11 statements (5-point Likert rating scale) regarding the nature of the respondents’ communication as part of their roles at work	See Appendix 2 for statements
Team communication	Questions in this section were regarding the type of communication which takes place between participants and their colleagues within and outside of their own departments	<ul style="list-style-type: none"> • How often do you have an arranged face-to-face meeting with your co-located colleagues? • How were you introduced to your team members?
Technologies	Participants were presented with a list of	Rating on 5-point scale,

	various technologies and were asked to rate how often they used different tools for co-located and distributed communication. Furthermore, they were asked to rate their perception on the reliability of each technology when used to support collaboration	technologies included, telephone, email, videophone, video-conferencing, audio-conferencing, file sharing and IM
Trust building	This section focussed on the methods used for trust building between co-located and distributed colleagues. Participants were asked to rate the importance and preference of different methods to support trust building	Rating on 5-point scale aspects included formal face-to-face meetings, informal face-to-face meetings, telephone, email, video-conferencing and IM

Table 4-4: Structure of pre-installation questionnaire

Questions included in the questionnaire were influenced by the user requirements elicitation work done in the CoSpaces project (see Chapter 3). Paper questionnaires were administered to the participants based at the Offices A and B while an electronic copy of the same questionnaire was sent to Office C. Two of the directors were also involved in this study. At the time this questionnaire was administered, participants were unaware of the type of technology or the functionality of the MRA system or the purpose of the implementation. The results of the pre-installation questionnaires are presented in section 4.7 of this chapter.

4.6.2 Pre-installation Interviews

A series of semi-structured group interviews were conducted with all participants located at Offices A and B as well as the two directors who took part in the study. Participants at Office A were interviewed in groups of two or three, depending on the size of their department. The participants located abroad were individually interviewed by the telephone. Both of the directors were interviewed separately to allow other participants to express their views freely without having a figure of authority in the room. Seven interview sessions were conducted at Office A. The interview sessions lasted approximately 45 minutes to one hour. All interview sessions were voice recorded and later transcribed for further analysis. However, to ensure anonymity, quotes from these interview sessions are not reported in this thesis.

At the start of the interview session, participants were asked to describe the role of their departments within the organisation, and their individual roles and contribution towards the department. They were also asked to explain the working relationships of their departments with others; this was in order to identify collaboration needs within the organisation. Participants were asked about their previous experiences with technologies and the history of various

communication tools which were implemented at the company to support their collaboration needs. The sub-categories of questions they were asked are shown as follows:

- **Department and Organisational Structure:** including functions and processes in the department
- **Technologies:** the use of different technologies for different scenarios (i.e. with co-located or distributed contacts, with other departments and any external contacts); preferences of these technologies
- **Co-located and distributed collaboration:** collaboration with co-located colleagues in different scenarios and relationships with their colleagues from other departments
- **Work meetings:** the nature of formal and informal collaboration at work
- **New colleagues:** how new co-located or distributed colleagues are introduced into the group (including colleagues abroad, taking into consideration the cultural and language differences)
- **Perception:** what participants thought of communication methods in their organisation; what could be improved and what they would like to remain the same

4.6.3 Post-Demonstration Questionnaire

After the demonstration session, where participants were encouraged to interact with the system and take part in the group discussion, they were asked to complete a short questionnaire regarding their expectations of the MRA. This questionnaire required the participants to rate ten statements regarding their expectations of the MRA on a 4-point Likert rating scale (1 = strongly disagree, 2 = disagree, 3 = agree and 4 = strongly agree). The ten statements of the questionnaire are presented in Section 4.8.

4.6.4 Interim and Exit Online questionnaire

An online survey was used for the interim and exit evaluations. The online survey was chosen over the use of a paper-based survey to promote the ease of distribution, ease of response and collection. A link to an online survey was sent via email to the two directors who forwarded the link to all the participants involved in the trial. The short online survey required approximately 10 minutes to complete. Participants were given one week to respond to the questionnaire and an email reminder was forwarded to participants in the middle of the week to encourage more responses.

Three weeks after the installation of the MRA system at the company, an online survey was distributed to all participants to evaluate the usage and the influence of the system on collaboration within the organisation (i.e. interim evaluation). After the interim evaluation, participants were able to use the MRA system in the workplace as part of their everyday process. The trial finished 10 weeks after the initial installation. The same online survey used was delivered to the participants at the end of the trial (i.e. exit evaluation). This was to ensure that the data collected during the exit evaluation could be directly compared with the interim evaluation.

The first part collected some demographic data from the respondents. The second part investigated whether the participants used the MRA system in their office in general and some questions examined the usage specific to the week prior to the survey. This section included open-ended questions allowing participants to describe the usage pattern if they wished. The third part of the survey examined the perceived influence of the MRA implementation on the overall collaboration, attitudes and environment in the workplace on a 5-point Likert rating scale (strongly disagree, disagree, neutral, agree and strongly agree). At the end of the survey, participants were able to add further comments regarding the use of the system.

4.7 Results: Pre-installation Questionnaires and Interviews

As the pre-installation questionnaires and interviews were used to complement each other and produce rich qualitative and quantitative data, the results have been combined and discussed alongside each other in this section. These questionnaires were collected at the Office A one week after they were delivered to the company.

4.7.1 Participants

4.7.1.1 Pre-installation Questionnaire

A total of 20 questionnaires were sent to the company (18 to Office A and B, and 2 were sent electronically to Office C). Nineteen (male = 14, female = 5; median age group = 25-34) completed the questionnaires. Sixteen of the respondents were from Office A, one from Office B and two from Office C. Just over half of the respondents had been in their current position between one to five years (52%). The company was established in 2001 (the case study was conducted at the end of 2007), which meant that only a few people had been at Company X longer than five years, since the start of the company.

4.7.1.2 Interviews

A total of 18 participants were interviewed following the questionnaire, including two directors. As this project was enthusiastically championed by these two directors of the company, their interview sessions were analysed separately to allow views from employees or the main end users to be illustrated clearly.

4.7.2 Organisation at Company X

Employees as well as the two directors indicated the company has a flat hierarchical structure and in keeping with this both directors have their desks within the open-plan layout at Office A located with the other employees. The two directors suggested in their interviews that they believe in this flat organisational structure to promote a friendly working environment where they were approachable by all their employees. The layout in Office A allows easy communication as desks were within a close proximity of each other.

Participants perceived the physical office layout of Company X to be friendly. The informal culture of the organisation as well as the open-plan layout enables employees to benefit from informal or spontaneous meetings. Conversations which took place at work were mostly work related (63%, n=19) and 68% (n=19) of the questionnaire respondents agreed that these conversations were often case specific. Furthermore, it was suggested in several interviews that the open-plan layout of Office A allowed the majority of the employees to collaborate informally with each other.

4.7.3 Building trust between team members

Building trust between distributed team members can be a difficult challenge and this can be exacerbated by the unfamiliarity between remote colleagues. The two directors indicated that they understood the difficulty imposed by the geographical separation of the virtual offices and therefore they try to rectify this problem by ensuring that the employees are invited to the main head office, two or three times a year for work meetings as well as for the company's parties.

Interestingly, interviewees from Office A suggested they believe that their colleagues abroad can feel isolated as they are located far away from the rest of the organisation. However, the participants abroad suggested they enjoyed their independence and were happy with the level of support and the response rate of colleagues from other offices.

Participants rated informal meetings very highly for building trust. 42% (n=19) of distributed team members thought that informal gatherings are an important mechanism for building trust, while 79% (n=19) thought this was important for co-located team members. When new employees join the office abroad, they are invited to spend a week at Office A, to allow them to meet other colleagues within Company X. This also ensured an opportunity for new staff to be trained at the head office. In addition, employees based abroad often attend one-day formal meetings with the two directors.

4.7.4 Collaboration

Various departments in the organisation are required to collaborate with their co-located colleagues on a regular basis and fewer departments collaborate with distributed colleagues frequently.

Occasionally the two directors work from their home offices which means employees are required to remotely collaborate with them at their home offices. Several of the departments based in Office A work with each other, however the majority of the work is intra-department, thus much of the collaboration at Company X is co-located. In addition, four (out of six departments) at Office A collaborate on a regular basis with staff in Offices B and C.

4.7.5 Co-located Collaboration

4.7.5.1 Co-located Meetings

Questionnaire responses indicated that 79% (n=19) of participants strongly agreed that effective communications were essential to their work while 63% (n=19) agreed that most work conversations took place informally with their co-located colleagues. Consequently, there is rarely a need to *arrange* face-to-face meetings (only 5% do). It was identified that co-located teams preferred spontaneous meetings and rarely opt for pre-arranged or formal meetings. Although the boardroom is available at Office A for all employees to use for meetings, it is rarely used. A smaller number of interviewees from Office A suggested that they try to organise regular bi-weekly or monthly meetings in the boardroom with other departments to discuss various issues. In the past, they have also held an audio conference with staff located abroad, in the boardroom.

Three departments who often work with each other in Office A were reported to have an arranged face-to-face meeting every month in order to discuss performance and promotional material.

Results from the interviews suggested that staff located in Office A, with the open-plan layout rely on the shared office or shared spaces with their colleagues to accommodate for flexible meeting arrangements.

4.7.5.2 Customer Support

In order to ensure that all products supplied to customers by Company X operate effectively, the company provides after-sale technical support to ensure that customers can overcome any technical difficulties. Customers in the UK contact the team in Office A, while those abroad contact their representatives in Office C. Employees in Office C then create a problem log file on the company's internal system, which is monitored by those in Office A. Advice from the Office A is input into the log file for employees in Office C to translate and forward to clients. This system allows the organisation to provide support to clients in different countries while overcoming problems such as language barriers, which may cause misunderstandings.

This internal logging system allows the staff in Office C to log a case file (reference number, customer's account number, details of the problem), which provides enough information to those in Office A with sufficient details of the assistance required. However, the nature of asynchronous text-based communication supported by this system can result in delays in responses or further misunderstanding of the specific problems, therefore it was reported in interviews that staff in Offices A and C often telephone each other when they need clarifications.

Employees at Office A suggested in their interviews that they felt it was much easier for them to get help from their co-located colleagues compared to those in Office C. In urgent cases, colleagues can often walk up to each other's desks and ask for help, while those abroad rely on the internet support system which is dealt with on a first-come-first-serve basis. Often, customers telephoning Office A get transferred to speak to specific departments directly, whereas this is not an option for customers abroad due to the time difference and the language barrier. This indicates that employees in Office A believed they benefited from being located in the same office as other departments as they were able to establish immediate communications with their colleagues face-to-face.

4.7.6 Distributed Collaboration

Some departments located in Office A are required to remotely collaborate with Office C on a regular basis, while others are also working closely with Office B. However, employees at Office B visit Office A regularly, whereas those in Office C visit the other two offices less frequently.

The questionnaire results showed that 74% (n=19) of the respondents reported that as part of their roles at the company, they were required to work with external companies. Participants were further asked which communication methods were used when contacting external organisations - 100% (n=19) agreed that email was frequently used as a method of communication and 57% agreed that the telephone was frequently used. This nature of collaboration with external organisations was not investigated further in this study.

4.7.6.1 Collaboration outside of the UK

Company X is required to deal with different time zones when collaborating outside of the UK, thus employees suggested that sometimes, due to the vast time difference between some countries, they were required to take it in turns to look after a mobile phone which was referred to as the 'Hotline' to provide support for urgent cases outside of the UK working hours.

The main communication methods with those outside of the UKs are email and the telephone. In urgent cases, the telephone is used primarily; however, this is often followed up by an email to ensure that all important details are documented.

The language barrier was also reported as one of the difficulties in communication in some of the interviews. As the Company X also has customers abroad, requests from these customers are therefore required to be translated into English, before being forwarded to specific departments, which can take longer.

Even though email is reported as a primary method of communication with distributed colleagues, some disadvantages of email were revealed in interview sessions. This included the long windedness of email communication as well as the fact that text communication can be prone to misinterpretation. However, it was further added that these misunderstandings were easily solved by a telephone conversation. It was suggested that email was often used in conjunction with the telephone in order to ensure clarity and rectify misunderstanding in communication. Telephone calls are often followed up with an email to reiterate the points made and actions required. These precautions are taken to avoid misunderstandings and delays.

4.7.7 Communication Technologies

The pre-installation questionnaires asked several questions about the current usage of technology at the company including what technologies they are currently using to support co-located and distributed collaboration. This section summarises the use of technologies at Company X before the installation of the MRA system.

A list of possible technologies were presented and participants were asked to rate the frequency of use for each technology on a 5-point rating scale (1 = never used and 5 = frequently used, as the only two anchor cues). The list of technologies included those shown in Table 4-5 as well as several others such as electronic whiteboard, video-conferencing and videophones; however, only those adopted by the company are presented in Table 4-5.

Technology	Co-located %	Frequently used (co-located)%	Distributed %	Frequently used (distributed) %
E-mail	100	79	100	95
Telephone	89	37	100	53
Wikis	84	21	68	11
IM	84	26	53	0
Shared drives/folders	58	11	32	0
Internet phone	47	0	42	0
Fax	26	0	37	5
Audio conferencing	16	0	26	0

Table 4-5: Technologies and the frequency of usage at Company X

All respondents reported a high usage of email as well as the telephone and Wikis with both co-located and distributed colleagues.

It was mentioned several times in different interview sessions that Company X was continuously seeking and trying new technologies to support collaboration. In the past, they have tried videophone and video-conferencing over the internet (by Skype and Windows Live Messenger) to communicate with their distributed colleagues. However it was found that the poor audio and video quality of these technologies led to a reliance on the telephone and email.

All participants were allocated their own telephone and computers when they started at the company. Email was used very frequently to communicate with co-located team members (79%, n = 19, of the participants strongly agreed). In addition, 95% (n=19) used email to communicate with their distributed colleagues. A further investigation by interviews revealed that participants mainly used email to predominantly exchange files and documents such as invoices,

programming codes and product specifications. During the interviews, most participants claimed that email was their first method of communication in an ordinary situation.

In addition, 37% of the questionnaire respondents reported that telephone is very frequently used for co-located communication. This was because all the telephone calls to Office A are answered by one department, who would then either transfer the calls to relevant departments or telephone other departments regarding a customer's enquiry, while putting the customer on-hold. This was therefore reported as telephone communication with co-located colleagues.

Some departments also reported that they use Wikis to collaborate with each other during the product development phase (84% of the participants have agreed they have used Wiki to with co-located colleagues; 10% used Wikis frequently with co-located colleagues). They further explained that Wiki allows them to create a shared page with information on the new product. This page is then viewed and edited collaboratively by those involved from both departments. Participants reported that it was useful to be able to view and update information on a continuous basis throughout the development phase without sending email updates to everyone all the time. Important information is also included on the Wiki.

They further reported that Wikis enabled the two departments to make changes to ideas, the layout and functionality of the new products being developed without much effort. A notification email is sometimes sent to those involved urging them to view the updates on the shared Wiki space.

An internal version of Instant Messenger (IM) is also used at Company X ensuring security and confidentiality of information exchanged between staff within the organisation. Employees were encouraged to adopt this system instead of using or installing other free software such as Windows Live Messenger. Results from the questionnaire indicated that 84% (n=19) of the employees used this for co-located communication, however only 26% used this very frequently. Employees at the head office reported that they preferred to walk over to their colleagues rather than use IM. In addition, as IM is adopted less than email, not all employees are logged on and available for interaction all the time.

Furthermore, departments within the organisation also have access to their own shared folder, specific to each department, which is not accessible by the rest of the company.

It can be seen from both the questionnaire and interviews that email and the telephone are the main methods of communication within the company, for both co-located and distributed settings. The advantages and disadvantages of both email and the telephone gathered from interview sessions are summarised in Table 4-6.

Technology	Advantages	Disadvantages
Email	<ul style="list-style-type: none"> • Messages can be sent conveniently even if the receivers may not receive them straight away • Enable traceability • Used as a summary of telephone calls to ensure all important points were discussed • Used as a method to send confirmation messages • Less intrusive than telephone • If the person they are trying to contact is busy, then an email is a better way to supply the information before they follow up with a telephone call • Can help language problem as the writer can take more time to review the message before it is sent 	<ul style="list-style-type: none"> • The rate of response cannot be determined • Urgent messages can be forgotten or ignored • Prone to misunderstanding/ misinterpretation • Long winded communication • Language barrier highlighted by email communication • Time difference aggravates delays in email communication • Multiple or group emails can be difficult to keep track of (especially when multiple people reply to the same email) • Takes a long time to write a comprehensive email
Telephone	<ul style="list-style-type: none"> • Often easier to make a telephone call than write an email 	<ul style="list-style-type: none"> • Hard to accommodate for a large time difference • Telephone is insufficient when helping the Office C team solve computer problems where visual information is required

Table 4-6: Advantages and disadvantages of email and the telephone at Company X

To summarise, the technology use at Company X can be described as follows:

- In combination, email and the telephone are the core communication tools used when participants are not in the same location and therefore cannot communicate face-to-face casually i.e. by walking over to a colleague’s desk. These two technologies would work less well in separation, as the telephone is used for speed and to avoid the long-windedness of email, while email is used to back up information discussed in telephone calls.
- The company is open to new technologies to overcome perceived deficiencies in communication. Wikis used as a shared persistent application to discuss ideas have proven successful, while the use of IM is less successful and they have given up using Skype.

4.8 Results: Expectation of the MRA

This section presents results from the group discussions and questionnaire surveys administered after the demonstration sessions at Office A.

Two MRACells were to be installed at Office A and once these two were fully operating after the interview sessions, demonstrations sessions were conducted allowing the employees to experience the system for the first time. The MRACells at the other offices were later installed by the Company X and therefore those employees did not participate in the demonstration sessions provided by the developers from The University of Nottingham. However the directors were asked to demonstrate the system to employees in Offices B and C once their MRACells were installed.

4.8.1 Demonstration sessions

The demonstrations aimed to show how the system operates and allow staff to interact and experience the system. There were three sessions of two to five participants. A total of 10 participants from Office A took part.

Participants were also encouraged to try the system and ask questions during the session. Short group discussions which took place after the demonstrations allowed the participants to express their views and reactions to the system. They were also asked to fill in a short questionnaire at the end of the session on their expectations of the system and how they believed the system could affect their current methods of communication within the organisation. The ten statements rated and the associated medians are shown in Table 4-7.

Statement	Median
I enjoyed the Demo session	Agree
I am looking forward to using the MRA	Agree
I will be using the MRA as much as other communication mediums	Disagree
I dislike distributed members being able to see me on the MRA	Disagree
MRA will be beneficial to my work at Company X	Agree
MRA will help build trust between distributed colleagues	Agree
MRA will help make my actions more accountable	Agree
MRA will strengthen personal relationships between distributed colleagues	Agree
MRA will help me exchange information with colleagues	Agree
MRA will make communication within Company X more efficient	Agree

Table 4-7: Post-demo questionnaire statements and associated median rating scores

Results from post-demonstration questionnaires showed that 80% (n=10) of participants disagreed with the statement “I dislike distributed members being able to see me on the MRA”, indicating that the respondents were open to the idea of their distributed colleagues being able to see them on the webcam. It was also reported that 70% (n=10) of the participants perceived the MRA would be beneficial to their work. All 10 participants indicated that they looked forward to using the system and thought that it would help the efficiency of communication, information exchange and would strengthen relationships and 90% (n=10) thought it would help build trust between distributed colleagues.

The group discussions after the demonstration sessions indicated that most participants thought the concept of the MRA would help them to keep in touch with other offices. Whilst the company already encouraged team building and social gatherings of employees as discussed above, they thought the MRA would help them ‘feel closer’ to their remote colleagues in other offices.

Questions participants asked during the demo sessions included technical concerns such as the battery life of the joystick. Locations of MRACells were also discussed as members of staff wondered where the cells should be installed and whether the one which was being used for the demonstration in the meeting room, would stay in the meeting room.

In conclusion, the feedback taken from the group discussions and post-demonstration questionnaires showed positive attitudes towards the use of the system.

4.9 MRA Installations

This section presents the final installation of the MRA at various sites of the organisation. Initially, two MRACells were to be installed in the main open-plan space of Office A, one at either end of the office. However, further discussions with the participants after the demonstration sessions suggested that one of the MRACells should be moved to the meeting room to provide a quiet space for private meetings without disturbing others working in the open-plan (see Table 4-8 for installation locations).

Location	Days occupied in a working week
Office A (main office area)	5
Office A (meeting room)	Only used for meetings – no permanent inhabitant
Office B	3

Office C	5
Home office (1)	1-2
Home office (2)	1-2

Table 4-8: MRA final installation locations and the frequency of occupation during a working week

The two MRACells installed at Office A had a 40" monitor screen. Both systems were positioned on a mobile stand, which could be physically moved around the office depending on the reach of the cables (see Figure 4-5 and Figure 4-6). Once the maximum range of the cables was reached, the system could be shut-down and plugged in elsewhere, and hence both systems were mobile. The other MRACells were comprised of smaller screens (22"-24") and were not positioned on mobile stands like the ones located in Office A.



Figure 4-5: MRACell – Office A (main office)



Figure 4-6: MRA in the boardroom at Company X (participants were blurred to ensure anonymity)

4.10 Results: Interim Evaluation

4.10.1 Participants

Twenty participants, from various departments responded to an interim online questionnaire. However, one participant only completed the first section of the survey and was therefore removed from the analysis leaving a total of 19 participants (male = 14, female = 5, median age group = 25-34); the response rate was 95%.

4.10.2 MRA Usage

The first question in the MRA usage section was with regards to the general frequency of use since the MRA was implemented at the organisation. Participants were asked to select the appropriate frequency representing their typical usage of the system.

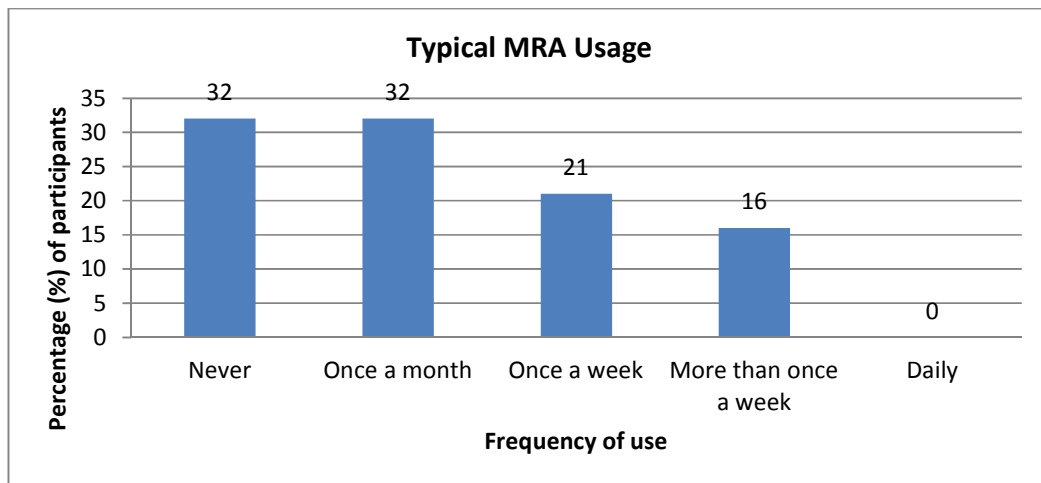

Figure 4-7: How often do you typically use the MRA system for communication? (n=19)

It can be seen from Figure 4-7 that the majority of respondents selected ‘Never’ or ‘Once a month’ to represent their typical frequency of use of the MRA - the median lies at ‘Once a month’. None of the participants reported daily usage of the system, three weeks after the initial installation and demonstration sessions at the Office A.

Participants were also asked to select MRACells representing other offices in the virtual environment which they typically communicated with using the MRA system. Participants were required to state which office they were based in and rate the frequency of communication over the MRA with other offices within the organisation.

The results showed that six out of 19 respondents (32%) used the MRA system during the week prior to the survey. Four of those respondents were based in Office A, one participant was based in Office C and finally one of the directors who was contacting his colleagues from his home office. MRA connections were mainly established between Offices A, B C and one of the home offices. Participants were also asked to rate the frequency of use or connection to various sites within the organisation on a 3-point rating scale (never, infrequently and frequently). The results are summarised in Table 4-9. There was no activity reported from the other home office. It could also be seen that the initial use by Office C was possibly to explore the system after it was installed rather than initiating a work-related communication.

Origin	No. of Participants	Location	Further Comments
Office A	4	Infrequently contacted Offices B, C and one of	<ul style="list-style-type: none"> Departmental meetings and updates between Offices A and C

		the home offices	<ul style="list-style-type: none"> • Meetings between offices A and B • One clarification instance between one employee from Office A and one of the directors at the home office
Office C	1	Infrequently contacted Offices A, B and one of the home offices	Just to say 'hello'
Home office (1)	1	Frequently contacted Offices A, C and the home office	General conversations

Table 4-9: Frequency of use at the different locations

Participants who did not use the MRA system at work on the week prior to the survey were also able to express their reasons for lack of usage. Seven of the participants who reported that they did not use the system explained that they mainly work with co-located colleagues and there was no need to use the system. One participant explained that it was inappropriate to discuss confidential issues over the MRA as they could be overheard. In addition, some participants offered suggestions for improvements which they thought would encourage them to use the system in the future (see summary in Table 4-10).

Suggestions	No. of Participants	Quotes
Improve sound quality	4	"Better sound quality as it's difficult to hear the other party" "The sound needs to better. Currently you always feel like you're shouting to make yourself heard over the background noise of the office."
More privacy	1	-
Better location	1	-

Table 4-10: Recommendations which would encourage participants to use the MRA more in future

4.10.3 Influence of the MRA system

The next part of the survey examined participants' perceptions of the MRA in the workplace. In this section, participants were asked to rate whether they agreed or disagreed with a series of statements (see Figure 4-8).

11) Please rate the following statements according to the influence you believe the MRA has had on your work

	Strongly disagree	Disagree	Neutral	Agree	Strongly agree
MRA is beneficial to my work at [redacted]	<input type="radio"/>	<input type="radio"/>	<input type="radio"/>	<input type="radio"/>	<input type="radio"/>
MRA helps build trust between colleagues who are located in different offices	<input type="radio"/>	<input type="radio"/>	<input type="radio"/>	<input type="radio"/>	<input type="radio"/>
MRA helps make my actions more accountable	<input type="radio"/>	<input type="radio"/>	<input type="radio"/>	<input type="radio"/>	<input type="radio"/>
MRA makes me more aware of activities taking place within [redacted]	<input type="radio"/>	<input type="radio"/>	<input type="radio"/>	<input type="radio"/>	<input type="radio"/>
MRA helps strengthen personal relationships between colleagues who are located in different offices	<input type="radio"/>	<input type="radio"/>	<input type="radio"/>	<input type="radio"/>	<input type="radio"/>
MRA helps me exchange information with colleagues	<input type="radio"/>	<input type="radio"/>	<input type="radio"/>	<input type="radio"/>	<input type="radio"/>
MRA makes communication within [redacted] more efficient	<input type="radio"/>	<input type="radio"/>	<input type="radio"/>	<input type="radio"/>	<input type="radio"/>

Figure 4-8: Extract from the interim questionnaire on the influence of the MRA system (the company name has been blanked for confidentiality purpose)

A total of 22 statements were rated by the respondents. The medians responses are summarised in Table 4-11 to Table 4-13.

Participants agreed that the implementation of the MRA system influenced the interpersonal relationships between distributed colleagues. They agreed that the system made them feel close to colleagues from other offices, helped build trust and finally helped strengthen personal relationships. However, they neither agreed nor disagreed with whether the MRA was beneficial to their work, or whether it could help exchange information or make communication more effective. The median ratings of these statements are summarised in Table 4-11.

Statements	Median
MRA makes me feel closer to colleagues from other offices	Agree
MRA is beneficial to my work at Company X	Neutral
MRA helps build trust between colleagues in different offices	Agree
MRA helps make my actions more accountable	Neutral
MRA makes me more aware of activities taking place within Company X	Neutral
MRA helps strengthen personal relationships between colleagues in	Agree

different offices	
MRA helps me exchange information	Neutral
MRA makes communication more efficient	Neutral

Table 4-11: Statements and median responses on the influence of the MRA system at work from the interim survey

Similarly, participants were asked to rate the MRA compared to email and the telephone, which were reported to be their primary and secondary methods of communication prior to the installation of the MRA system. The results showed that, overall, participants disagreed that the MRA was easier or more comfortable to use than email and the telephone and therefore they did not use the MRA as much as the other communication technologies. The results are summarised in Table 4-12.

Statements	Median
MRA is easier to use than Email	Disagree
MRA is more effective than Email	Neutral
Email is more comfortable to use than MRA	Agree
MRA is easier to use than phone	Disagree
MRA is more effective than phone	Neutral
Phone is more comfortable to use than MRA	Agree
I use MRA as much as any other technologies	Disagree

Table 4-12: The comparison of MRA with email and the telephone and the median responses from the interim survey

The last part of this section concentrated on the office environment after the installation of the MRA (results summarised in Table 4-13). Participants indicated that the MRA made the office noisier than before. They liked that their colleagues from other offices were able to see them over the MRA. In addition, participants did not feel negatively about other potential drawbacks such as intrusiveness and privacy, or the MRA as a surveillance system in the workplace.

Statements	Median
MRA helps make the office friendlier	Neutral
MRA makes the office noisier	Agree
MRA has allowed informal chats with those from other offices	Neutral
MRA makes me feel like I'm being watched	Neutral
MRA makes me need to be careful with what I say in the office	Neutral
I like colleagues from other offices being able to see me	Agree
MRA is intrusive	Neutral

Table 4-13: Influence of MRA on the office environment and the median ratings from the interim survey

4.10.4 Conclusions from the Interim Evaluation

The MRA usage reported in the interim evaluation did not meet the initial expectations shown by the participants after the demonstration sessions. All participants who took part in the demonstration sessions agreed that they looked forward to using the MRA system, but the

interim evaluation highlighted that in practice the system was infrequently used. Furthermore, after the demonstration, participants initially believed that MRA would be beneficial to their work at the company and thought that the system would help improve the effectiveness of their overall communication. However, this view slightly changed three weeks into the trial with participants neither agreeing nor disagreeing with regards to the benefits of the MRA.

4.11 Results: Exit Evaluation

It was hoped that using the same online survey would encourage and maintain a high response rate by using a questionnaire format which participants were already familiar with. The survey included questions on the general usage of the MRA, the use of the system specifically on the week prior to completing the survey, the influence of interpersonal relationships between distributed colleagues, the working environment and atmosphere and finally the comparison of the MRA system with other technologies such as email and the telephone.

Twenty participants Company X responded to the final exit survey (male = 15, female = 5, median age group = 25-34).

4.11.1 MRA Usage

The survey was distributed on the week after the end of the trial (i.e. at the time of the survey, the system had been disconnected). The first section of the survey regarding the usage during the previous working week, which indicated that only one participant reported having used the MRA, and that was only to check if the system was running. The results also showed a decline in the overall usage level of the system. Half the participants reported that they did not use the MRA system and the median lies at 'Never' (see Figure 4-9). Nineteen participants offered reasons for the lack of usage (see Table 4-14).

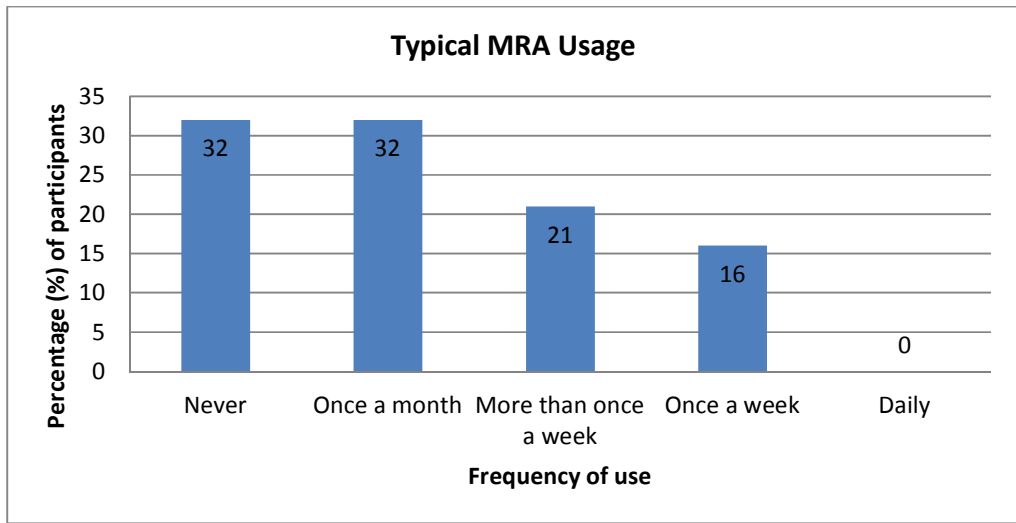

Figure 4-9: Typical frequency of MRA use reported in the exit survey

Reasons for lack of MRA usage	Comments	No. of Participants
No requirement to use MRA	Participants working only with co-located colleagues	12
Inappropriate to task	<ul style="list-style-type: none"> • MRA inappropriate when discussing confidential information • Already have other systems such as customer support system 	3
Poor audio	<ul style="list-style-type: none"> • Too slow to speak over the MRA • Audio was poor, could not hear each other 	2
Other	Participants were away from the office	2

Table 4-14: Summary of reasons for lack of MRA usage - exit survey

One participant reported that the two times he tried to use the MRA system to contact his colleagues in a different office but he failed to attract their attention and no one came to the monitor to converse causing him to revert back to the use of email and the telephone. An explanation for this could be that the speakers in the other office was switched off during the day, meaning they could not hear that their remote colleagues were trying to establish a communication.

4.11.2 Influence of the MRA system

Participants’ perceptions regarding the influence of the MRA system at work were investigated and the median ratings showed that the majority of the participants neither agreed nor disagreed with most of the questionnaire items (see Table 4-15).

Statements	Median
MRA makes me feel closer to colleagues from other offices	Neutral
MRA is beneficial to my work at Company X	Neutral
MRA helps build trust between colleagues in different offices	Neutral
MRA helps make my actions more accountable	Disagree
MRA makes me more aware of activities taking place within Company X	Neutral
MRA helps strengthen personal relationships between colleagues in different offices	Neutral and Agree*
MRA helps me exchange information	Neutral
MRA makes communication more efficient	Neutral

Table 4-15: Statements and median responses on the influence of the MRA system at work from the exit survey

It can be seen in Table 4-16 that the participants mainly disagreed that the MRA system was easier, more comfortable or more effective to use than email or the telephone in the workplace. This further provides reasons for the decline in the typical usage reported earlier.

Statements	Median
MRA is easier to use than Email	Disagree
MRA is more effective than Email	Disagree
Email is more comfortable to use than MRA	Agree
MRA is easier to use than phone	Disagree
MRA is more effective than phone	Disagree
Phone is more comfortable to use than MRA	Agree
I use MRA as much as any other technologies	Disagree

Table 4-16: The comparison of MRA with email and the telephone and the median responses from the exit survey

It was indicated that the use of the MRA in the workplace neither affected the overall working environment in a positive or negative way (see Table 4-17). In the previous interim survey, participants agreed that the MRA made the office noisier, however, they neither agreed nor disagreed to this same statement in the exit questionnaire, which could be due to the reduced usage of the MRA system.

Statements	Median
MRA helps make the office friendlier	Neutral
MRA makes the office noisier	Neutral
MRA has allowed informal chats with those from other offices	Neutral
MRA makes me feel like I'm being watched	Neutral
MRA makes me need to be careful with what I say in the office	Neutral
I like colleagues from other offices being able to see me	Neutral
MRA is intrusive	Neutral

Table 4-17: Influence of MRA on the office environment and the median ratings from the interim survey

Throughout the trial, the MRA was always running in the background, (i.e. the webcam and the shared virtual space were always operating), however there was no indication that potential drawbacks such as the lack of privacy again affected the participants negatively.

4.11.3 Conclusions from the Exit Evaluation

The exit evaluation found that the overall usage of the MRA declined since the initial installation and the interim evaluation. Only one participant reported to have used the system in the week prior to the disconnection and that was only to check whether the system was operating rather than to communicate with other remote offices. The results also identified that participants preferred the use of email and the telephone over the MRA for various reasons such as privacy, in appropriateness for task and the poor audio quality. However, the majority of the participants reported that it was unnecessary to use the MRA system as they mainly collaborated with co-located colleagues.

4.12 Results and Discussion

4.12.1 Comparison of Usage and Perception

This section compares the usage trends, attitudes and perception of the MRA at work throughout the trial.

Initially, all participants were enthusiastic about the MRA and many thought the system would support the company's overall collaboration. However, as the trial progressed, the subjective data from both interim and exit surveys indicated that the majority of the participants did not need to use the MRA as they mainly collaborated with those who were co-located to them. A significant difference in the overall level of use was found between the interim evaluation (median = 'Once a month') and the exit evaluation (median = 'Never') ($U_{(19,20)} = 130$, 2-tailed, $p < 0.05$). The usage was reported to be higher in the interim survey (see Figure 4-10).

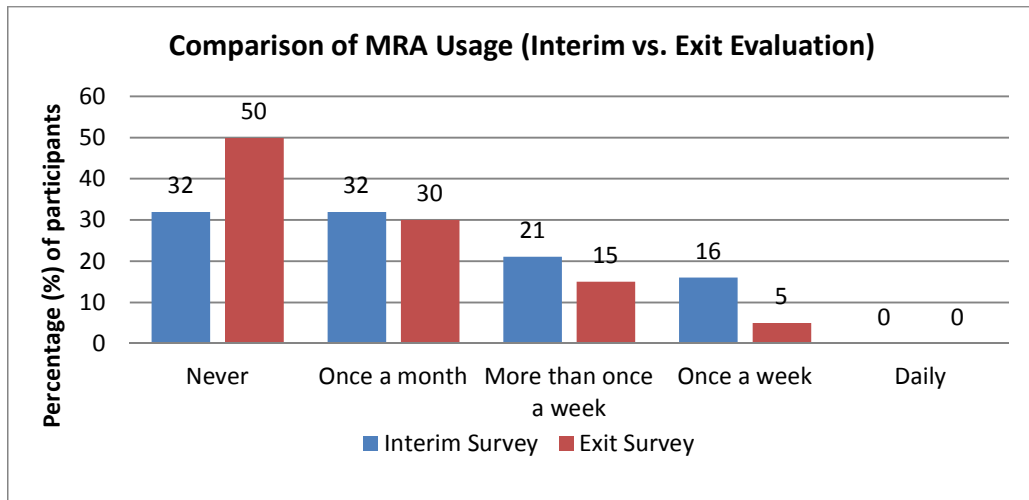

Figure 4-10: Usage comparison between interim and exit surveys

All responses for statements used in the interim and exit surveys were compared in order to observe whether there were any significant changes over the period of the trial - only two significant differences were found. One significant difference was found when comparing the data collected from the post-demonstration sessions, the interim survey and the exit survey regarding participants' views of whether the MRA system was beneficial to their work at Company X ($\chi^2 = 20.04$, $df=2$, $p < 0.01$). The questionnaire results collected after the post-demonstration sessions indicated that participants unanimously selected 'Agree' when asked if they thought the MRA would be beneficial to their work. However, this perspective changed over time and the range of the responses became larger (see Table 4-18), even though the medians from the interim and exit statement remained the same ('Neutral').

Statements	Post-demo	Interim	Exit
MRA is beneficial to my work at Company X	<ul style="list-style-type: none"> • Mean = 4 • SD = 0 • Range = 0 • Median = Agree 	<ul style="list-style-type: none"> • Mean = 3.32 • SD = 0.48 • Range = 1 • Median = Neutral 	<ul style="list-style-type: none"> • Mean = 2.75 • SD = 0.95 • Range = 3 • Median = Neutral

Table 4-18: Comparing the user ratings from the post-demo, interim and exit evaluations on the benefits of the MRA at work

Another significant difference was found for whether participants thought the MRA was more effective than the telephone, by comparing the results taken from the interim and exit evaluations ($U_{19,20} = 185$, 2-tailed, $p < 0.05$). This statement was not asked in the post-demonstration survey as in order to gain a clear perspective, participants were required to use the system as part of their daily task. It can be observed that the median changed from 'Neutral' to 'Disagree' indicating that over the period of the trial, participants found the MRA system was

not more effective than the telephone. It can be seen that both the usage and some of the beliefs about the MRA declined throughout the trial (see Table 4-19). The decreasing usage could therefore have influenced the overall attitudes towards the system or vice versa.

Statements	Interim	Exit
MRA is more effective than phone	<ul style="list-style-type: none"> • Mean =2.84 • SD = 1.07 • Range = 3 • Median = Neutral 	<ul style="list-style-type: none"> • Mean =2.20 • SD = 0.77 • Range = 3 • Median = Disagree

Table 4-19: Comparing the user ratings from the interim and exit evaluations on the effectiveness of the MRA vs. the telephone

4.12.2 Declining Usage

This section discusses possible causes of the decline in use of the MRA system over the trial. A few main causes were reported such as the poor audio quality, functionality and privacy, and in addition, many participants reported that they mainly worked with co-located colleagues. Summaries of different aspects which could influence the overall acceptability and use of the MRA are presented in the following sections, with quotes taken from the surveys administered throughout the trial.

4.12.3 Audio and Video Quality

The poor quality of the communication through the MRA system affected the level of usage negatively

As with many organisations, participants at Company X have already established a primary method of communication with tools such as email and the telephone. In order for the MRA to support or improve the existing collaboration effectively, the system was required to reduce the effort of communication with remote colleagues by providing an easy to use communication channel. As the majority of participants in Office A reported their preference for face-to-face and informal communication, the ‘always-on’ element of the MRA system should have allowed this nature of communication to extend to their remote colleagues; i.e. allowing users from to simply walk up to their remote colleagues and converse over the MRA as they would do in a co-located setting. However, the poor audio quality over the internet meant users often found that the communications were interrupted and unclear. Instead of reducing the communication effort, participants were required to speak loudly in order to communicate, however this was unnecessary on the telephone or when using email.

4.12.4 Live Audio-visual Information

Live audio-visual connections between distributed offices was not seen as too intrusive

The live video feed provided by the MRA system could be used to support awareness between virtual offices. However, there was no result to suggest that participants believed the system was intrusive. This could be influenced by the fact that many of the employees at Company X are familiar with the open-plan office layout, thus they have always been able to see and overhear other colleagues at work. Participants further suggested in their informal feedback and exit survey responses, that it was nice to be able to see other remote offices for the first time over the MRA.

When asked to rate whether the MRA was an intrusive communication tool, the majority of the respondents selected 'Neutral' in both the interim and exit surveys.

4.12.5 Overall functionality

The shared 3D environment of the MRA system was viewed as adding difficulty to the communication

The shared 3D environment of the MRA system allows virtual offices to view each other's MRACells in the same space and allows them to navigate around in order to select which other virtual office(s) they wanted to initiate communication with. However, as Company X only have two main offices (Offices A and C) which were fully occupied all the time within a working week (i.e. Monday-Friday), participants thought the 3D environment made it difficult to establish a quick informal connection because these two MRACells were not always aligned or positioned near each other within the virtual space. Therefore in order to communicate with each other, the users were required to navigate the virtual space to find the other MRACell, line both of them up using a joystick so that the two cells were close enough to see and hear each other clearly. This was viewed as extra effort which prevented participants from engaging in short contact with each other.

The 3D shared space would have been more appropriate if there were more than two frequently occupied virtual offices online and participants were able to navigate around to visit different offices. The time taken to navigate might have been more acceptable in such situations.

4.12.6 User Requirements

The technology should only be implemented if it supports the current tasks

Participants consistently suggested in the interim and exit surveys that many of them were not required to collaborate with remote colleagues and therefore did not need to use the system. In the pre-installation interviews, it was clear that mainly two of the departments at Office A work closely with Office C. However, it was further reported after the installation that the current file logging system was sufficient to support the task without the need for the MRA system.

Users should be able to control the privacy settings appropriate for the required tasks

The MRA system allows any offices close enough to each other to hear an audio-feed, even without seeing each other (i.e. when two MRACells of two offices are lined up back-to-back in the 3D environment). This therefore allows private or confidential conversations to be overheard. Hence users suggested that the MRA system did not support the right level of privacy for certain tasks. Furthermore, during an established conversation between two MRACells, another office can navigate their MRACell near enough so that the noise from that office distracts the conversation going on in the other two offices.

Another useful suggestion about the system was with regards to mobility of the users. Two users reported that they have become more mobile as part of their job and have relied on their mobile phones which also allows access to their email when they are away from the office. The MRA system is primarily a desktop-based technology connecting virtual offices together and does not currently support such mobility. However, participants suggested that if the MRA system could run on their mobile phone or laptops then this might have suited their tasks more.

4.12.7 Positive feedback

Even though the usage declined after the installation and both technical as well as functional problems were reported, participants still expressed that the MRA could be beneficial to support remote collaboration in the right context. However, with the current structure of Company X, many remote offices were not always fully occupied (including the home offices) and only a minority of the staff were required to collaborate remotely on a regular basis.

Participants suggested that they believe the MRA is a good tool, if remote offices were larger and were fully occupied all the time and thus the system can be used as a conference system, bringing remote offices together.

4.13 Key findings from Chapter 4

This field study was conducted to investigate the influence of a collaborative technology on collaboration at work as well as to identify the influence of different aspects of collaboration. Key findings from this study are summarised in this section.

1) How important is it for technologies to suit user needs, context of use and task? Do users alter behaviours to fit technological constraints?

In order for a new collaborative technology to be fully utilised and accepted by the workforce, many aspects require careful evaluation, including the user requirements, attitudes and willingness to adopt the changes in communication and technology.

The MRA system has been evaluated within research and academic settings prior to this study. This was the first evaluation in a commercial setting. The technology was still under development and technical constraints (i.e. the requirement of a faster internet connection and a higher bandwidth) were seen throughout the evaluation session at the user company, which caused delays in the initial installation and difficulties during the trial. However Company X initially believed that the system would be beneficial to the organisation, whose structure is composed of small virtual teams collaborating with each other.

The usage of the MRA declined over time and the user needs appeared to be one of the main reasons. Participants indicated that even though they perceived the system as being useful, there was little need to use the system as the majority of the employees located at the main head office mainly require co-located collaboration. This decline showed that the technology selected was redundant for the nature of communication within Company X considering they already have existing technologies (i.e. email and telephone). Initially users did try to use the MRA system, however as users felt the system did not contribute to their collaboration, which was already accomplished by the existing methods (telephone, email, file sharing, face-to-face meetings and their internal logging system), the initial enthusiasm declined.

In this case study, users did try to alter their behaviours and the way in which they collaborated with each other to use the MRA. However eventually the end users were unable to get the required amount of support for their communication medium or the right level of quality, which further increased their effort in communication, therefore they switched back to their original,

familiar methods of communication. Some participants indicated that collaboration at Company X was sufficiently supported by the telephone and email.

This case study highlighted the importance of adopting technologies to suit user needs and context of use a successful implementation, thus allowing users to effortlessly use the technology to collaborate to improve their current work.

2) Is there a need for technology to support more than spoken language for planned and unplanned collaboration?

The MRA system aimed to support both planned and unplanned collaboration. The nature of the always-on system allowed opportunistic collaboration such as when co-located members unexpectedly collaborate at work. The system also aimed to support awareness by providing remote colleagues with a view of each other's offices or workspace, allowing participants to judge the availability of each other prior to establishing a communication for example. Therefore it was expected that the system could support the seamless changes between remote colleagues being aware of each other's activity through to supporting unplanned collaboration.

As the quality of the audio-visual connection of the MRA was not always at its optimum, the performance of the system was compromised. Participants suggested that they felt it was unnatural to shout to be heard, hence the system failed to support spoken language for unplanned collaboration. However, little evidence was obtained from this case study to suggest that the live video feeds connecting different remote offices and thus supporting visual as well as verbal communication was necessary for the collaborative work at Company X.

3) How can technology help to maintain an awareness of remote colleagues and tasks?

The MRA system helped support awareness by allowing the always-on connection. However, as the size of the virtual space is not influenced by the number of remote offices, the remote offices may not always be facing each other and or be enough for the audio-visual feed to help support awareness. This could be rectified by the users navigating the shared virtual space to line their MRACell up with another remote office. If navigation is necessary then extra effort is required for participants to gain an awareness of their remote colleagues, which may prevent the system from being used constantly. In particular, when there are only a few MRACells in the virtual space, maybe selecting an office to communicate with by clicking on a list may have been easier than navigating a virtual space with a joystick.

4) Is audio the most useful communication modality in remote tasks?

Participants in Company X were required to complete many collaborative tasks on a daily basis. However, the majority of the tasks were done co-locatedly, by the telephone, email or through text-based communication such as file sharing, Wiki and their internal pre-established system. The way in which the audio feed was used for this study meant that other participants in the same open-plan office could easily be disturbed by conversations over the MRA or background noise from other remote offices. Therefore users were reluctant to conduct conversations over the MRA and preferred email and the telephone.

All the remote tasks conducted at Company X are supported by both text and audio communication and the method of communication is influenced by the urgency and the type of task. Therefore in this case study, limited evidence was obtained from the results to suggest that audio is the most useful communication, as users reported the reliance on both audio and text communication.

5) Is a shared view of the workspace in remote collaboration more useful than a view of the remote colleague?

The MRA could be used to provide a view of the working environment (i.e. the office) of remote colleagues as well as a view of the remote colleague during collaboration. No strong evidence from this study suggested that being to see a view of the workspace or the remote colleague was useful to virtual collaboration at Company X.

Participants reported that there was no requirement to see each other on the MRA screen and believed that audio-only and email was effective in supporting remote collaboration. However, some also reported that being able to screen share would help remote assistance (i.e. easier to show objects or another computer screen on the webcam than trying to verbalise information). As the majority of the collaborative work conducted at Company X was mainly co-located meaning those working together were already sharing the same physical workspace, with limited requirement to collaborate with remote colleagues.

The MRA does not support shared workspace in the same sense as application sharing or screen sharing software, therefore this was not directly compared in the study, but is further investigated in Chapter 5.

6) Does being able to see and hear remote colleagues enhance user satisfaction?

Being able to see colleagues in remote offices could help users feel closer to each other and less isolated as some participants have reported in the pre-installation interviews. There was limited requirement to collaborate with distributed members, therefore there was no real need for introducing a new 'always-on' technology, and hence the technology did not have an impact on user satisfaction.

In this case study, being able to see and hear remote colleagues had no influence on user satisfaction. The feeling of being isolated in remote collaboration is a difficulty which required support from technology as well as management. However, there was no real evidence to suggest that employees in smaller remote offices felt isolated from others within Company X, thus the MRA did not help improve or enhance user satisfaction.

4.13.1 Summary

A summary of key findings from this field study is presented in Table 4-20.

Chapter 4 key findings	
<i>How important is it for technologies to suit user needs, context of use and task? Do users alter behaviours to fit technological constraints?</i>	<ul style="list-style-type: none"> • The usage declined after end users tried the technology out of curiosity at the start of the trial. • The majority of collaboration was co-located and therefore there was no need to contact remote colleagues all the time.
<i>How can technology help to maintain an awareness of remote colleagues and tasks?</i>	<ul style="list-style-type: none"> • Technology should support quick glances and overhearing in remote settings, only if the audio (e.g. background noise from remote offices) does not distract users. • If participants were required to collaborate remotely then supporting awareness would allow colleagues to keep an up-to-date view of remote activities.
<i>Is audio the most useful communication modality in remote tasks?</i>	<ul style="list-style-type: none"> • During the trial, participants reported technical difficulties with the audio system resulting in users switching speakers off. The always-on audio was not seen as a useful feature of the technology. • Tasks conducted over the MRA were mainly brief verbal exchanges and therefore the presence of audio supported these quick interactions. • Participants relied on email, logging system, file sharing, Wikis all of which support the exchange of textual or spatial information. The telephone was also used to support verbal interactions.
<i>Is there a need for technology to support more than spoken language for planned and unplanned collaboration?</i>	<ul style="list-style-type: none"> • The always-on nature of the MRA allowed users to see other remote colleagues and update their awareness of remote activities without verbal communication. This was therefore a way to support more than spoken language between remote users.
<i>Is a shared view of the workspace in remote collaboration more useful than a view of the remote colleague?</i>	<ul style="list-style-type: none"> • Some participants reported there was no need to see remote colleagues during collaboration as email and the telephone were sufficient and effective enough. • However, some reported being able to screen share would help collaboration or being able to point a web camera to the screen and point with their finger to where they were looking at would help clarify conversations.
<i>Does being able to see and hear remote colleagues enhance user satisfaction?</i>	<ul style="list-style-type: none"> • There was no strong evidence to suggest that users felt being able to see remote colleagues all the time was enhancing relationships or user satisfaction.

Table 4-20: Chapter 4 summary of key findings

Chapter 5 - Investigating the influence of shared visual information and the use of audio-visual communication on virtual collaboration

5.1 Chapter Summary

This chapter presents a laboratory study investigating the effects of a shared screen facility, the amount of shared information available and the communication modality provided, on a collaborative problem solving task in virtual teams. This experiment was a between-subject design - 96 participants (48 pairs) were required to collaborate on a 'house hunting' task using spatial and textual information in order to make a joint decision at the end of a timed session. The experiment was an incomplete 2x2x2 design with the variables being the communication modes (i.e. audio vs. audio and video), the screen sharing facility (i.e. shared or no shared screen), and the amount of information given to each participant within a pair (i.e. 50% each or 100% each). As giving both participants 100% of information was a way of sharing the same visual information, the screen sharing facility was not provided in those conditions and therefore there were six experimental conditions (shown in Table 5-1).

50% of information	1. No shared screen with audio-only	3. Shared screen with audio-only
	2. No shared screen with audio and video	4. Shared screen with audio and video
100% of information	5. All information with audio-only	6. All information with audio and video

Table 5-1: Summary of experimental conditions

Audio transcriptions recorded from all sessions were analysed as were the performance and post-experiment subjective questionnaire results. All six experimental conditions are compared and discussed in this chapter.

5.2 Introduction

Communication technologies coupled with increases in bandwidth have increased the possibilities for distributed teamwork. This allows for digital transmission of text, audio and streaming images, which can facilitate collaborative work such as coordination, communication, decision making and sharing of information across time and space (Van der Kleij *et al.*, 2009). Many organisations have also adopted the use of shared publication spaces to rectify the problem of sharing restrictions in distributed workplaces. This is often in the form of a

collaborative portal which brings all project information into one central location that can be accessed anytime, anywhere very easily (Balme *et al.*, 2005). However Van der Kleij *et al.* (2009) warned that the increase in use of these groupware technologies to aid distributed teamwork also comes with possible negative effects on communication processes and team performance, caused by difficulties in communicating information, lack of awareness of other team members and failure to develop effective interpersonal relationships.

A study investigating more general effects and influences of technologies on different aspects of collaboration was conducted by Saikayasit and Sharples (2009) (summarised in section 5.2.3), which was conducted as part of the author's MSc dissertation (see Saikayasit, 2006) and was therefore considered background development to this PhD thesis. The author's MSc experiment required pairs of participants to collaborate on a task but they were unable to communicate face-to-face. The only form of communication allowed during the experiment was voice communication. This experiment compared two experimental conditions (i.e. with or without a shared screen facility). Factors such as shared mental models development, decision-making and collaboration were investigated as effects of shared representation. The results showed no significant difference in overall performance between the two experimental conditions. However, participants in the shared screen facility condition achieved a higher level of shared mental model development and satisfaction in the collaborative process.

The experiment used in the present study was developed and adapted based on the study by Saikayasit and Sharples (2009). The aim was to investigate relationships between factors influencing collaboration including the use of a shared screen facility, the amount of information available to each participant and communication modality (i.e. audio-only vs. audio and video) through the Mixed Reality Architecture (MRA) system. The factors investigated in Saikayasit and Sharples (2009) were not investigated in this experiment. The same task was used with additional experimental conditions and procedures however the method of data analysis differs in this study.

The 'House Hunting' task scenario from Saikayasit and Sharples (2009) was adopted for this laboratory study, where pairs of participants were required to derive a joint decision and select three houses to rent together based on the given information and selection criteria. This was shown to be a suitable and effective task to encourage collaboration and information sharing in

virtual collaboration. The division of information also allowed the use of a shared screen to be examined.

Findings from the CoSpaces and Skype user groups (see Chapter 3), suggest that virtual collaborative work in engineering and design involves the use, interpretation, exchange and discussion of spatial information. Users often have difficulties when collaborating with remote colleagues by not being able to making physical references to a physical drawing or object to ensure that their remote colleagues know the specific area of the drawing to look at. Therefore this laboratory study aimed to examine how users verbalise textual and spatial information to one another when they are required to share information and make collaborative decisions.

5.2.1 Shared Visual Information and Video-Conferencing

The nature of VTs often means less face-to-face communication and generally less informal awareness of their team members. However informal awareness or the naturally gained sense of understanding and awareness of who is around and what task they are currently engaged in, which is often lacking in virtual collaboration, can help make casual interaction possible (Tee *et al.*, 2009). Informal awareness is therefore easier to maintain when team members work in a co-located setting, where individuals inhabit the same shared office space allowing them to accumulate information about their environment without extra effort (Bly *et al.*, 1993). However, for distributed groups or virtual teams this could be considered problematic as team members are often unaware of who is around to contact and are unable to overhear other conversations which may update their knowledge of the task they are working on. Coordination and communication therefore have to be formally arranged (e.g. by scheduled meetings), which often means expending a relatively large amount of effort in order to maintain interaction (Tee *et al.*, 2009).

During a collaborative task, the participants involved try to establish and elaborate the mutual belief that their partner(s) has/have understood what they meant or what they were referring to. This is termed 'social grounding' (Clark and Brennan, 1991). It is therefore important for participants involved in the discussion to explicitly identify, for example, the object being referred to. This places emphasis on shared understanding within a team. Clark and Brennan (1991) also suggested the principle of least collaborative effort, implying that people do not usually like to work any harder than they have to, and should therefore try to ground with as

little combined effort as needed. In addition, they also suggested that the effort required changes dramatically with the medium used for communication.

Research has been done to evaluate the use of shared visual information by providing a video feed or a shared screen of the workspaces during a remote collaborative task which involves spatial information that can be lexically complex (Kraut *et al.*, 2003; Ranjan *et al.*, 2007; Boldstad and Endsley, 1999; Fussell *et al.*, 2000; Ou *et al.*, 2003; Gergle *et al.*, 2004a; Veinott *et al.*, 1999).

The majority of studies found in the literature required participants to assume different roles during the task, where one participant was provided with more information than his or her partner and hence the fundamental activity was translating the verbal information into meaningful verbal instructions (i.e. remote maintenance, Lego puzzle tasks). The research into the influence of video-conferencing and shared visual information is still ongoing in order to test these systems for use with different tasks and settings (Fussell *et al.*, 2000).

The laboratory study presented in this chapter investigated the use of a video-conferencing system with webcam mobility (allowing users to dictate the webcam focus) in conjunction with shared visual spaces. In previous studies found in the literature, a live video feed was either used to enable shared visual information (i.e. video-as-data) or to provide a visual image of remote participants involved in the virtual conversation (talking heads) (Whittaker, 2002), however limited literature was found to combine the two uses of video communication.

5.2.2 Shared and Unshared information

In addition to a shared visual information facility and the use of audio and video communication, this laboratory experiment examined the nature of information sharing between experimental conditions (i.e. audio vs. video and screen sharing).

Group decision making often involves individuals sharing or pooling information to combine their disparate knowledge to benefit and influence the outcome of the discussion (Stasser and Titus, 2003). Stasser and Titus (2003) further summarised that when individuals share knowledge in order to make a joint decision, their final decision is often based on common knowledge or the information they all knew prior to the discussion. This is referred to as 'hidden profile', where members involved in the discussion possessed partially informed information which is crucial to the problem solving process of the group (Stasser, 1992). Effective information sharing within teams requires individuals to acknowledge and mention unshared information during the

discussion and ensure that the information is considered by the team in the group decision making process (Stasser *et al.*, 2000). Kerr and Murthy (2009) explained three main steps involved in solving hidden profile tasks: 1) members must exchange uniquely held information, 2) individuals involved must process the given information and identify whether more information is unknown to the group or uniquely held by others, which leads to more information exchange, and 3) once members have fully shared all their information, they are able to utilise the information pool in order to solve the problem (see Figure 5-1).

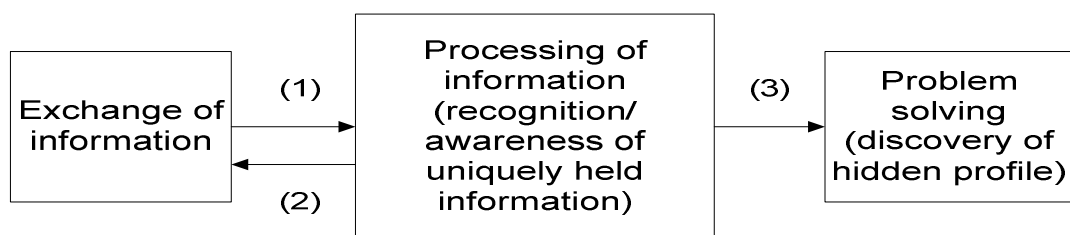

Figure 5-1: Three steps involved in hidden profile tasks (Kerr and Murthy, 2009)

An investigation into the use of synchronous communication tools compared with face-to-face interactions on hidden profile tasks was conducted by Kerr and Murthy (2009). The communication tool used was a synchronous chat tool which enabled participants to type messages to, and read messages from those in their groups. The results showed that face-to-face teams were able to share more uniquely held information and were able to solve hidden profile issues more effectively than virtual teams.

5.2.3 Shared Visual Information and Shared Mental Models

A study by Saikayasit and Sharples (2009) investigated the influence of shared visual workspaces on shared mental models development in remote teams, especially with regards to the use of spatial information as part of a decision making task. This study was considered to be background study to this thesis as it was conducted during the author's MSc research (Saikayasit, 2006). The task and methods of data collection was designed by the author for the MSc study, however several of the elements were adapted and repeated again in the laboratory presented in this chapter. This section describes the work conducted in the MSc research.

The experiment was a between-subject design with 32 participants (16 pairs), who were required to collaborate on a 'house hunting' task; each participant within the pair was given information about different houses available (i.e. hidden profiles), as well as a set of conflicting criteria which

encouraged discussion and information sharing in order for both participants to jointly select three houses (out of ten) which they believed were most suitable for their given criteria. There were two experimental conditions: 1) participants had 50% of the information each, with audio and shared screen, and 2) participants had 50% of the information each, with audio but no shared screen.

Participants working within a pair had met each other prior to the experiment. Each participant within a pair was provided with an information pack, which included half of the information about the ten houses available, their individual set of criteria for the house and PowerPoint presentation slides of all the maps of the area with locations of the houses, crime zones and road links.

All sessions were video recorded (one camera per participant), and both audio and visual information (i.e. gestures) were analysed as part of the shared mental model development evaluation. The final three houses selected by each pair were objectively marked against a marking scheme specific to this study. A post-task questionnaire was completed by all participants, collecting subjective information such as perceived difficulty of the task, satisfaction in their performance, the communication method, and their approach to the task.

The study concluded that the presence of shared visual workspaces had little effect on the overall performance and level of difficulty perceived. However, it did have an effect on shared mental models development. The shared screen facility enabled participants to view each other's PowerPoint slides during the task, encouraged individuals in this experimental condition to initiate or share strategies and evaluation more, which are behaviours contributing to shared mental model development. Those with a shared screen were also seen to debate or question their partner's views more than those who could not see their partner's screen.

Participants who were given a shared screen reported that they found it easy to direct their partner to a location compared to those who could not see their partner's screen. Participants who could not see their partner's screen agreed that they communicated with their partner more articulately compared to those with a shared screen. Gesturing also occurred more frequently in the condition where partners could not see each other's screen even though their partners were unable to see these gestures (Saikayasi and Sharples, 2009).

5.3 Purpose of Chapter 5

The use of communication modalities such as audio and video-conferencing and shared workspaces has been examined separately in the literature (see Chapter 2). However the overall purpose of this study was to investigate the influence of an integrated solution of audio and visual information of remote colleagues and a shared workspace.

This laboratory study aimed to investigate the effects of different combinations and modality of communication tools in supporting virtual collaboration and information sharing. The influence of the technology on conversational structures, satisfaction and task performance are investigated in this study (see Table 5-2).

Purpose of Chapter 5:

1. To investigate the influences of audio-only communication and video-conferencing on virtual decision making and information sharing
 2. Examine the influence of shared visual information on information sharing behaviour
 3. To assess the types of information shared during the task on the overall nature of collaboration and performance
 4. To evaluate the effects of different communication modalities and shared visual information on team performance and satisfaction
-

Table 5-2: Chapter 5 - purpose of study

In order to investigate the influence of communication modality and shared visual information on collaboration, conversations which took place during different experimental conditions were categorised and compared.

5.3.1 Research Questions

Live video feeds have been used to support distributed collaboration by providing a shared workspace during a remote collaborative task (e.g. Nardi *et al.*, 1993; Kraut *et al.*, 2003; Ranjan *et al.*, 2007), as well as to enhance the experience of collaboration such as user satisfaction (Veinott *et al.*, 1999; Whittaker, 2003). However, most studies presented in Chapter 2 have either employed live video feeds to provide a view of participants during remote conversations ('talking head') or to provide a live image of the workspace, but not both.

Some experimental conditions of this laboratory study provided participants with both the live image of their remote partner as well as a shared view of the workspace, the first two research

questions compared the influence of communication modalities (i.e. audio-only vs. audio and video) as follows:

1) Does communication modality (i.e. video-conferencing vs. audio-only) affect the information exchange and conversation structure in collaboration?

2) Does communication modality (i.e. video-conferencing vs. audio-only) affect the perceived level of task difficulty and satisfaction?

The screen sharing facility used in this experiment provided a shared view of the workspace in some of the experimental conditions. Previous studies (e.g. Kraut *et al.*, 2003; Ranjan *et al.*, 2007) suggested that a shared view of the workspace might help support collaboration, by helping participants verbalise spatial information and develop shared mental models (Bolstad and Endsley, 1999; Saikayazit and Sharples, 2009) which may support performance of lexically complex tasks (Ranjan *et al.*, 2007). Thus the research questions of this study investigated the influence of shared visual information, either by providing a shared view of the workspace or supplying participants with no uniquely held information during the task. Therefore the remaining research questions are:

3) Does the method of information sharing (i.e. shared screen vs. no shared screen and the amount of information given to participants within a pair) influence the overall performance?

4) Will the presence of a shared screen influence the subjective responses to the post-task questionnaire (including perceived level of difficulty and satisfaction) and conversation structure during the collaborative task?

5) Will the amount of information shared between team members (i.e. 100% of information per participant vs. 50% of information per participant) influence the level of information exchange?

6) Will the combination of information sharing and the communication channel influence team performance?

5.4 Method

5.4.1 Participants

The majority of participants were undergraduate students with some postgraduate students and researchers (see Table 5-3). All participants were native English speaking volunteers. Participants

were required to bring a friend to take part as a pair for the experiment and therefore all partners knew or had worked with each other (i.e. on student projects) prior to the experiment.

No. of participants	Total in each condition	Age range	Gender	Mean age	Background
96 (48 pairs)	16	18-48	M=42, F=54	24	Native English speaking students and researchers

Table 5-3: Summary of participant information

Prior to the experiment, participants were given task instructions and descriptions of the experiment as well as descriptions of the shared screen facility and the MRA as a video-conferencing system where appropriate. All of the participants had known each other and/or worked together, thus all teams were established rather than ad hoc.

Only native English speakers were able to take part in order to ensure that participants possessed the same level of linguistic co-presence, however, educational background was not considered a restriction in the recruitment process. All pairs completed the task within the given time and all volunteers were rewarded £8 for taking part.

5.4.2 Apparatus

Participants working in a pair were each located in different rooms, which were set up identically to one another throughout the experiment. Each participant was given an 'information laptop' for the 'house hunting' task which was presented on Microsoft PowerPoint. Participants were given information appropriate to the experimental condition.

Each participant was provided with a monitor, which was connected to the information laptop belonging to the participant in the other room. These monitors were switched off in the condition with no use of the shared screen facility. In the condition where they were able to see a view of their remote partner (over the video link on the MRA screen), they were provided with a movable webcam (see Figure 5-2 and Figure 5-3). In the conditions where they were unable to see a view of their remote partner over the link, the MRA screen was switched off and the webcam taken away.

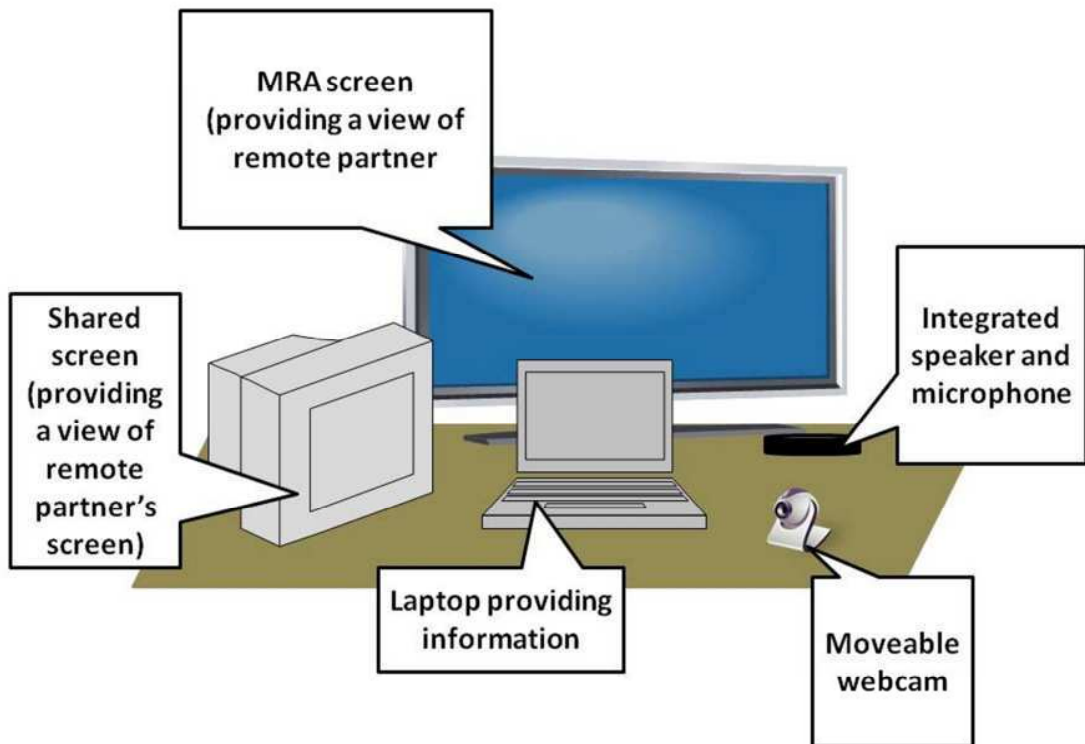

Figure 5-2: Experimental setup diagram of the experiment

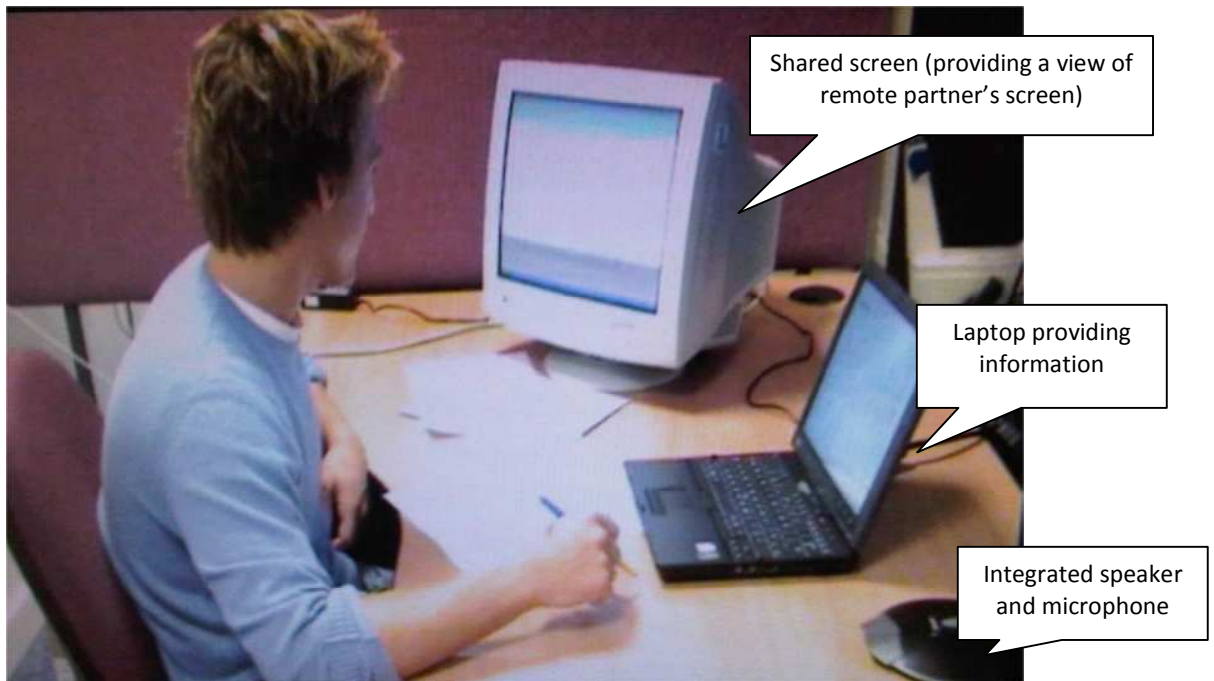

Figure 5-3: Illustration of experimental setup for conditions with a shared screen

The live audio and video feeds were provided over the MRA system, which was set up in both of the experimental rooms. This system was adopted as a video-conferencing system therefore the full functionality of the system was not used (see Chapter 4 - for the full setup and functionality of the MRA system). The video-conferencing system (MRA) consisted of a monitor, webcam, microphone and speakers. The video-conferencing monitors were switched off in the conditions in which participants were unable to see their partners during the experiment. The same specification of equipment was used in both rooms.

The video-conferencing system was set up prior to the session to provide live audio and/or video feeds during the experiment therefore participants were not required to adjust the configuration. The webcam was set up on each participant's desk and was moveable by the participants.

A video camera was set up for the experiment in each room to record all experimental sessions.

5.4.3 Materials

Prior to the start of the session, participants were asked to read an introduction to the task and sign a consent form to indicate their understanding of the purpose of the study as well as to reassure them of their anonymity.

The information pack given to participants included the task instruction, a set of criteria per participant and a list of information slides available on their laptop. One blank answer sheet was given per pair for participants to record their joint decisions on the top three houses and the corresponding reasons for their selection.

Participants were also provided with blank sheets of paper for the experiment should they wish to make notes during the task, however this was not compulsory.

After the experimental sessions, participants were required to complete a post-task questionnaire to collect individual subjective responses about their satisfaction in their communication method, their final responses and the perceived difficulty of the task etc.

No existing questionnaires appropriate for the task and the measures were available and therefore the post-task questionnaire was specifically designed for this experiment. Questionnaires were piloted before they were administered in order to ensure that all the statements were easy to understand and were unambiguous. Technical terms and complex

vocabulary were avoided. The questionnaire was composed of a series of 5-point rating scales to ensure consistency in design as well as ease of use and comprehension. Questionnaires from the author’s MSc dissertation were mainly focussed on the development of shared mental models and therefore were inapplicable to the study presented in this chapter.

As participants were required to bring a friend to take part as a pair for the experiment, the first section of the questionnaire requested information such as the length of time they had known each other, or whether they had experience in working together or in looking for a house together prior to the experiment.

In order to evaluate the level of satisfaction (in their own performance, in the available technology and their communication), participants were asked to rate six statements based on their first choice of house, on a 5-point rating scale (1 = extremely dissatisfied, 2 = dissatisfied, 3 = neutral, 4 = satisfied and 5 = extremely satisfied) as illustrated in Table 5-4. These items corresponded to the two sets of conflicting criteria given to both participants in a pair.

	Extremely Dissatisfied	Dissatisfied	Neutral	Satisfied	Extremely Satisfied
1. Location of the house	1	2	3	4	5
2. The transportation available in the area	1	2	3	4	5
3. The rent of the property	1	2	3	4	5
4. The security level of the neighbourhood	1	2	3	4	5
5. The distance to the local shop	1	2	3	4	5
6. The overall aspects of the house	1	2	3	4	5

Table 5-4: Post-task questionnaire - satisfaction ratings on performance

The next section of the questionnaire was related to the participants’ experience of completing the task. Participants were asked to rate their level of agreement with seven statements on a 5-point Likert scale (1 = strongly disagree, 2 = disagree, 3 = neutral, 4 = agree and 5 = strongly agree), shown in Table 5-5.

	Strongly Disagree	Disagree	Neutral	Agree	Strongly Agree
1. I have spent much time looking around different areas/locations of the map	1	2	3	4	5
2. I have communicated with my partner articulately	1	2	3	4	5
3. I have found it easy to discuss different locations with my partner	1	2	3	4	5
4. I have found it easy to ensure that my partner was looking at the same point on the map as me	1	2	3	4	5
5. Information was easily shared within our team	1	2	3	4	5
6. Decisions were made within a reasonable amount of time	1	2	3	4	5
7. The computer screen showing information was easy to use	1	2	3	4	5

Table 5-5: Post-task questionnaire - subjective ratings on the experience of the task

Participants were asked to rate the overall level of difficulty of the task using the scale shown in Table 5-6. The horizontal line used in this question was 100mm allowing the mark made by participants across the line to be recorded in millimetres. This method was chosen to provide a sensitive scale allowing participants to freely rate the perceived level of difficulty.

How did you find the task overall?

(Please put a cross anywhere along the horizontal line below to represent your view).

Extremely Easy Extremely Difficult

Table 5-6: Post-task - subjective rating on the difficulty of the task

The final section of the questionnaire consisted of demographic questions regarding their age, gender and so on, followed by an open-ended question allowing participants to add comments about the experiment.

The subjective data gathered from the questionnaire were analysed allowing direct comparisons between responses of participants from all six experimental conditions.

5.4.4 Design

The independent variables of the experiment were the communication modality (audio-only and video-conferencing), the level of shared information amongst teams (i.e. 50% each or 100% each) and the presence of shared visual workspaces (i.e. whether participants could see each other's screen during the task).

The dependent variables were verbal exchanges (collaboration style categories, number of utterances in each collaboration style category), subjective questionnaire responses and performance. The collaboration style categories refer to conversational communication codes which emerged from the transcript analysis, see section 5.5.1).

5.4.4.1 Task Description

The 'house hunting' task used in Saikayasi and Sharples (2009) was also used in this current study. Participants were given a choice of ten houses from which each pair was required to select three houses to rent, and rank them in order of preference. Within a pair, both participants were given conflicting criteria which they needed to satisfy.

During the CoSpaces user requirements elicitation work, end users indicated the difficulty in distributed collaboration involving spatial information, thus the task used for this experiment had a spatial aspect.

Other task scenarios were also considered in order to utilise the use of spatial and textual information including a product design evaluation task (participants in a team would evaluate given designs and technical drawings). The design evaluation scenario was considered realistic as many of the CoSpaces users were engineers and had to regularly communicate with their remote colleagues during a design progress. However, this scenario was dismissed because pre-requisite knowledge in designs and technical drawings could bias the overall performance of participants from different backgrounds. A puzzle task was also considered, requiring participants to remotely solve or manipulate virtual puzzles, similar to Gergle *et al.* (2004a). However, most of the puzzle tasks seen in the literature (see Chapter 2) required one participant to act as an expert who was given more information to guide his/her partner remotely in order to complete the task; thus the task did not require participants to make joint decisions based on the information available. Another scenario considered to address the joint decision making process was the 'survival task', where participants were required to make joint decisions based on given information. For

example, participants could be given a scenario such as the team being stranded on an island and they had to gather items which they could utilise in order to survive. As a team, they would be required to rank these items in order of their usefulness. This task is often used in team relationship assessments as well as in job recruitment programmes. Therefore some participants may have had prior experience of this task which may allow them to excel more than other participants.

A house hunting task was selected as it was simple to understand and did not require any background or technical knowledge in order to complete. It also allowed different types of information to be used and presented during the experiment, including geographical maps, text-based information such as literature and description of the houses and finally numeric information shown in tables.

The conflicting criteria were used to ensure that both participants were equal in the collaborative decision making task (i.e. no expert or novice roles were established) and to avoid one participant taking charge without consulting his/her partner. This was also to simulate a realistic collaborative scenario where team members may have the same goals but do not necessarily have the same motivations and hence discussions were necessary to achieve the best compromise. These different sets of criteria encouraged interactions, debates and problem solving amongst partners.

5.4.4.2 Development of Task Information

This section described the background work, which was conducted as part of the author's MSc dissertation in order to fully develop the 'house hunting' task.

An initial pilot study was carried out with ten volunteers who were asked to list and rank different factors affecting their decision on selecting a house to rent. The aim of the pilot study was to isolate the important information that could be given to participants during the experiment. The top five highest priorities were:

1. Price
2. Location
3. Crime rate
4. Transportation
5. Local shops

Other factors included noise, other residents in the neighbourhood and greenery. These factors were also included as part of the information given to the participants, however these were given less weighting than the top five highest priorities.

A geographic map of an area was extracted from an Ordnance Survey (OS) Mastermap. This map was selected over other maps such as A-Z maps because it allowed different layers of information about the same area to be presented (i.e. with or without roads, with or without buildings or greenery such as parks). This feature was an essential part of the experiment as different variables and information on each house could be overlaid onto different layers of the map, which could be divided between the two participants within a pair. This allowed one partner to be able to view all the road access and green areas and the other could see where the houses were, for example.

Price (see Figure 5-4), location (see Figure 5-5) and crime zones were presented to participants as spatial information. In the condition where participants within a pair were only given half of the information each (50% of information), only one participant could see the location of the houses whilst the other could see the price and crime zones. This was to ensure that participants were required to exchange and verbalise spatial information in order to complete the task (particularly in the no shared screen condition).



Figure 5-4: Rent expressed in area shown on a map



Figure 5-5: Locations of all ten houses

Information regarding the ten houses was created purposely for the experiment. Originally local areas in Nottingham were considered, however as the experiment was conducted in Nottingham, arbitrary information was adopted to prevent participants relying on background knowledge of the area on which to base their decisions.

In conditions where information was divided into parts to be given to each participant in a pair, it was ensured that information was divided equally in terms of quantity, importance and relevance, including the division of spatial information and text. Participants in these conditions were required to combine their information with their partners.

5.4.4.3 Experimental Setup

In total this experiment had six conditions and hence 48 pairs of participants were recruited, eight per experimental condition. In four out of six experimental conditions, partners within a pair were given different pieces of information and different criteria. In the last two conditions, both partners were given the same information on the houses, but different criteria.

An important aspect of the task was for participants to collaborate with each other in order to combine the information given to them and utilise that knowledge to select the three best houses to rent. In two of the four conditions where partners had different pieces of information, they were allowed to see a copy of each other's screen and hence were able to combine their

information directly. However, in the two other conditions, participants were not allowed to see each other's screens and hence were forced to verbalise their own set of information to their partner.

This section illustrates the setup of the six experimental conditions including how each of the condition differs to one another:

1. No shared screen with audio-only and 50% of information each
2. No shared screen with video-conferencing and 50% of information each
3. Shared screen with audio-only and 50% of information each
4. Shared screen with video-conferencing and 50% of information each
5. No shared screen with audio-only and 100% of information each
6. No shared screen with video-conferencing and 100% of information each

Eight pairs of participants were randomly allocated in each of the six experimental conditions.

The setup of these conditions are summarised in Table 5-7.

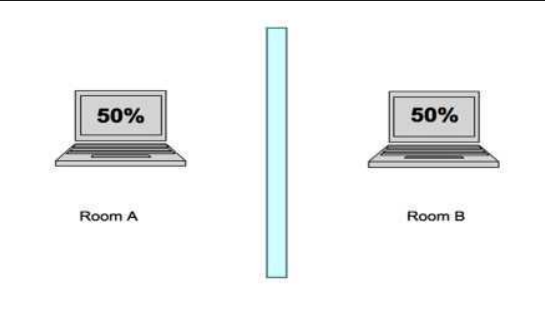
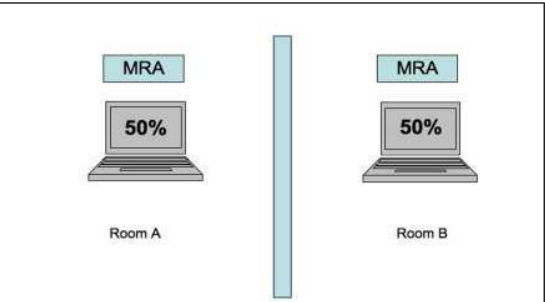
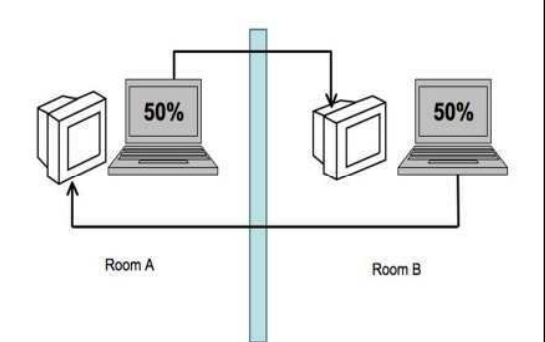
Condition	Audio	Video	Shared Screen	Amount of information each	Setup
1. No shared screen without MRA	Yes	No	No	50%	
2. No shared screen with MRA	Yes	Yes	No	50%	
3. Shared screen without MRA	Yes	No	Yes	50%	

Condition	Audio	Video	Shared Screen	Amount of information each	Setup
4. Shared screen with MRA	Yes	Yes	Yes	50%	
5. All information without MRA	Yes	No	No	100%	
6. All information with MRA	Yes	Yes	No	100%	

Table 5-7: Summary of different features provided in the six experimental conditions

5.4.5 Procedure

Participants were asked to bring along a friend or someone they knew in order to pair up and work together during the 40-minute task. Participants were given spatial, numerical and textual information on ten houses. Pairs of participants were asked to decide on three houses to let together from the selection of ten, according to a set of criteria given to each participant.

Each participant in the pair was seated in different rooms. They were asked to read and sign the consent forms before they were given a brief on the instructions and the aims of the task and their information booklet. They were informed at this stage that they were being video recorded during the experiment and that the recordings would be kept secured and would only be used for analysis purposes. Participants were also shown how to use Microsoft PowerPoint and basic controls in order to browse the given information on the laptops. In four of the conditions, participants were informed that they did not have the same slides as their partners.

Participants were also informed that they have been given blank sheets of paper have been provided can be used during the task as they wished. After the participants had understood the task and what they were required to do, they were given a few minutes to familiarise themselves with the slides and how the data were presented. They were told when to start the experiment and told that the duration of the task was 40 minutes. Each participant was videoed throughout the experiment.

During the sessions, participants were able to ask the experimenter questions related to PowerPoint, but direct help which may have influenced the team's decisions was avoided. At the end of the experiment, participants were asked to complete a post-task questionnaire.

5.5 Analysis

This section presents the development of the verbal coding and the performance marking schemes which were used in the analysis of this study. The verbal coding scheme used in Saikayasit and Sharples (2009) was focussed on investigating shared mental model development and therefore was not used in this current study.

5.5.1 Development of Collaboration Style Categories

In order to examine the construct of conversations and the level of collaborative exchange in different experimental conditions, the analysis began with developing a coding scheme (referred to as 'collaboration style categories').

The transcription process which took between 3-6 hours per pair (over 190 hours of transcription) allowed the author to observe the emergence of the collaboration patterns across all six conditions. It became apparent that the majority of the pairs followed a similar pattern of communication during the task. At the start of the experimental session, participants were mainly exchanging uniquely held information with their partners, followed by a discussion and review of the ten houses, then they eliminated houses or made their final selections based on their given criteria. In order to categorise the collaboration style, a selection of utterances were used in an open card sorting session with three human factors experts.

Two pairs of participants per experimental condition were randomly selected and statements were extracted from these 12 transcripts. This in depth understanding of the collaboration patterns gained through the transcription process allowed the author to identify and select the most representative and most frequent statements from the 12 transcripts. These statements were selected from various stages of collaboration during the task (i.e. from the start of the experiment through to the end of the session). As a result 75 utterances were selected to represent conversational communication. Due to the time constraints, not all of the utterances could be sorted.

In the open card sorting session, the three independent judges were required to jointly sort all 75 statements into categories. Judges were able to categorise the given statements into as many groups as appropriate so that each group was composed of similar utterances. The sorting of statements was done iteratively until all judges agreed with the sort. Once judges were satisfied with the sort, they were asked to collectively assign names to best represent all the categories. Eleven collaboration style categories emerged from the open card sort session. These categories are summarised in Table 5-8. These categories were used to code all the utterances in order to examine the information exchange and collaboration.

Collaboration style categories	Description
Referring to criteria	As participants in a pair were given different sets of criteria, they were required to share their criteria with their partner in order to achieve a common goal. This code refers to when participants communicated about the given criteria e.g. <i>"From my criteria, I have to be near to the bus stop because I don't have a car."</i>
Establishing information source available	In four of the conditions, participants were required to share their given information with their partner as neither participant had a complete set of information. Therefore this code refers to when participants tried to understand the sources (i.e. establishing which partner has what type of information) e.g. <i>"From my screen I can see information about rent, have you got that too?"</i>
Establishing strategy	This is when participants discussed with their partners how best to approach the task and prioritised actions required in order to complete the task e.g. <i>"Shall we start by eliminating houses?", "I think we should go through all the information first."</i>
Sharing map knowledge	This is when participants ensured that their partners were looking at the same point on the map as they were, in order to evaluate specific aspects or areas by trying to navigate their partners, using landmarks, roads, shapes and objects on the map to ensure they were looking at the same focal point. e.g. <i>"Do you see that square near the main road, I think that's a playing field."</i>
Locating houses	In two conditions only one participant within a pair was able to view the location of the houses. However, both partners needed to know the location of houses in order to evaluate different aspects of the house, therefore this code refers to interaction to communicate the location of houses. e.g. <i>"If you follow that main road, turn left at the first junction and you'll see a block of houses. House A is the 3rd house in that block."</i>
Relating criteria to house	This is when participants share information about specific houses against their criteria with their partners. e.g. <i>"I like this house because it has a parking space, where the other house hasn't. It also near the shop and bus stop."</i>
Evaluating options	This refers to the decision process participants go through with their partners in order to narrow down their options to the final three houses. e.g. <i>"House G has what we want, but it's in a very expensive price bracket, but house C can also be an option too, but it's in quite a noisy area."</i>
Referring to equipment	This is a general code to represent verbal communication about the equipment used during the experiment. e.g. <i>"I can see you on my big screen."</i>
Referring to task instructions	All participants were given instruction sheets informing them about the task and what they were required to do to complete it. This code represents a participant's discussion with their partner about the given instructions or to remind each other of the instructions. e.g. <i>"We're supposed to pick three out of ten houses and we have to pick them together."</i>
Verbal instruction	This is when one partner specifically gave a verbal instruction to their partner during the experiment. e.g. <i>"Could you repeat that again please?"</i> or <i>"Can you go to the price slide and tell me how much A is?"</i>

Non-task related utterance	Statements which were non-task related were coded into this category. This includes joking with their partners. e.g. <i>“What time is your next lecture?”</i>
-----------------------------------	--

Table 5-8: Summary of collaboration style categories and group description

The data were analysed once all the transcripts were coded and all the utterances were classified by the 11 collaboration style categories.

As part of the analysis one coder completed the coding of all utterances for all 48 pairs of participants. However, in order to examine any bias in the coding system and procedure, another independent judge was employed to code six pairs (one from each condition) to determine the inter-rater reliability for the verbal coding. The Cohen’s Kappa statistics was found by comparing ratings from the two coders ($K = 0.71$), and the outcome indicated high or ‘substantial agreement’ (Landis and Koch, 1977) – indicating that the two independent judges agreed on the verbal analysis coding.

5.5.2 Development of the Performance Measure (marking scheme)

A marking system was developed in order to award scores to participants’ choices of houses. Four independent judges were recruited to rank all the 10 houses independently, in order of preference according to both sets of criteria given to participants in a pair. Judges were provided with all the information given to participants, and extra information which integrated all the house locations, prices, crime zones and other information onto one map, providing them with all the available information required to make an informed decision (see Figure 5-6).

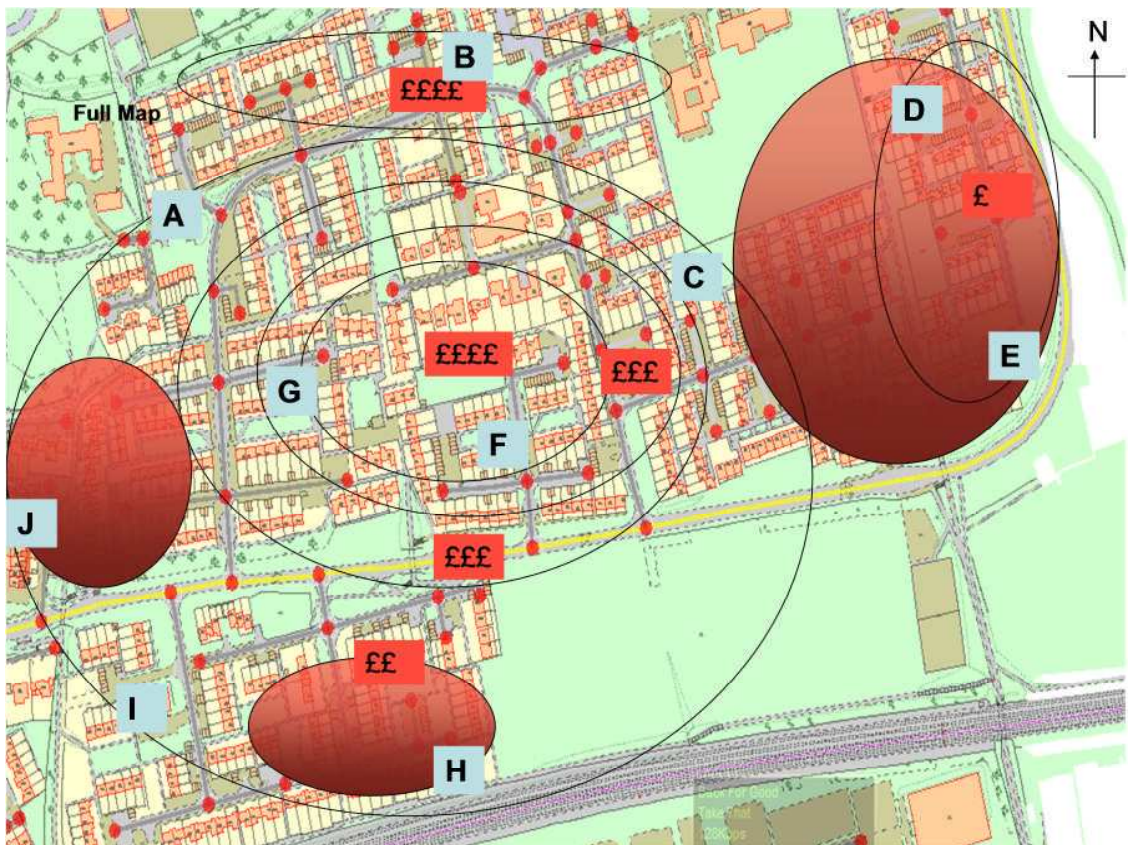

Figure 5-6: Integrated information given to independent judges during the development of a marking scheme including locations of houses, price and crime zones (not given to participants)

The Cohen's Kappa statistics test was performed to compare the responses of the four judges ($K = 0.4$), and the outcome indicated there was 'fair agreement' (Landis and Koch, 1977). However, as the judges did not perfectly agree on the ranking position of all the ten houses, only the top three choices were taken into consideration instead, as participants were only required to select their top three houses. According to Sinclair (2005), ranking can become difficult and inaccurate for nine or more items. However, participants are often able to accurately rank the first two or three ranks and then the last two or three ranks (i.e. extreme values) (Sinclair, 2005).

There was a high level of agreement amongst the four judges for the top three and the tenth rankings ($K = 0.74$, 'substantial agreement', Landis and Koch, 1977) with the top three rankings alone indicating 'substantial agreement' ($K = 0.67$). Therefore only the top three rankings taken from the judges were used to develop a marking scheme instead of developing scores for all ten houses (see Table 5-9). The results from this inter-rater reliability check indicated that the top three houses which best satisfy the given criteria were 'house A', 'house B' and 'house C'.

Rank Position	Judge 1	Judge 2	Judge 3	Judge 4
First	A	A	A	A
Second	C	C	B	C
Third	B	B	C	B

Table 5-9: Summary of top three rankings of houses by four independent judges

The marking scheme was developed on the basis of the importance of both the house choices and ranking order and therefore the scheme was composed of two parts. As the majority of the judges selected A, C and B, A was given the highest mark followed by C and B respectively. The first ranking was given the highest mark (i.e. if the participants have selected the right house and the right ranking), then second and third respectively. The marking scheme is summarised in Table 5-10.

Option	Score
A	50
B	5
C	25
First position	50
Second position	25
Third position	5

Table 5-10: Summary of marks awarded to correct houses and ranking positions

This marking system awarded participants scores for selecting the top three houses as A, B and C, however, the highest scores could only be achieved if the ranking positions satisfied the positions indicated by the judges, with an emphasis on the importance of the correct, 'most preferred', or first position house (i.e. A). The failure to select A as one of the top three choices or failure in ranking A in the first position has severe consequences in terms of points allocation. Example scores for various combinations of selections of houses are shown in Table 5-11.

Choices selected	Score awarded	Explanation
ACB	160	Correct choices in correct position
ACX	150	Selected the first two choices correctly (in correct order), but incorrect third choice
ABC	130	Selected all three correct choices, but two incorrect positions
AXC	125	Selected two correct choices, but one in incorrect order
ACX	110	Correct first two choices and correct order, but incorrect third choice
ABX	105	Selected two correct choices, but one in wrong position and wrong third choice
AXX	100	Correct first choice (correct position), but two wrong choices
XCA	100	Selected 2 correct choices, but in incorrect positions

Table 5-11: Example of scores awarded to final three houses selected (X as an option represents other choices other than A, B or C)

5.6 Results

The analysis has been divided into three main sections: verbal analysis (audio recordings), subjective responses (questionnaires) and performance (task outcomes). The audio recordings (taken from the video recordings of all sessions) were transcribed and statements were later coded into groups or collaboration style categories.

5.6.1 Verbal Communication Analysis

The total number of utterances per condition were summarised as part of the analysis. No significant difference was found between conditions (see Figure 5-7), indicating that participants in all six conditions made the same number of utterances during the task.

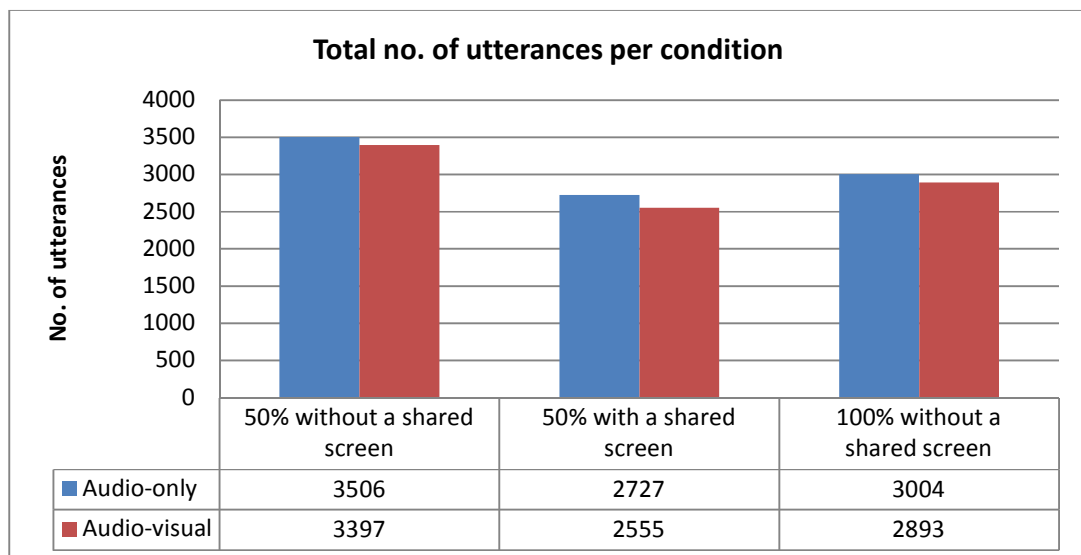

Figure 5-7: Total number of utterances in each condition

This section reports the detailed analysis of the effects of the communication modality (i.e. audio-only vs. video) on the structure of verbal communication and collaboration. Utterances from all pairs of participants were classified into 11 categories. The means of all the 11 verbal communication categories were calculated and are illustrated in Figure 5-8. The code with the highest means across all six experimental conditions was the 'relating criteria to house'. In addition, it can also be seen that participants who were unable to view or share information (i.e. conditions 1 and 2) had a higher number of utterances in 'sharing map knowledge' and 'locating houses' compared to the other four conditions.

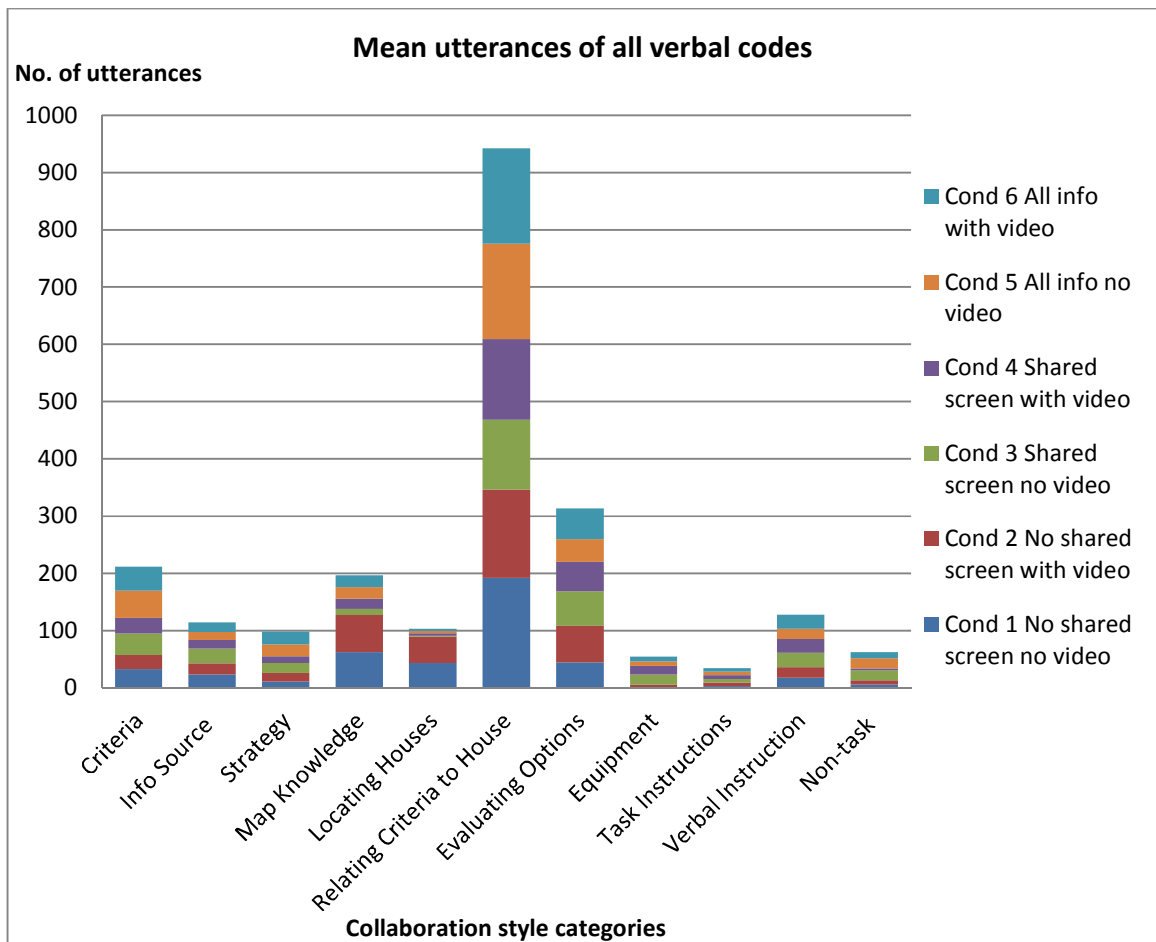

Figure 5-8: Means of all 11 collaboration style categories across all six experimental conditions

H_1 : There is a difference in the number of utterances in each of the collaboration style category, exhibited by each of the experimental condition

In order to identify whether there is a difference in the total number of utterances in each of the collaboration style category as well as a difference in each of the experimental condition, a mixed-model analysis of variance was performed. All 11 codes were treated as within subject variables and the experimental conditions were between-subject variables.

Prior to the analysis of variance test, the data were examined against the normality and homogeneity requirements. As all the 11 datasets were severely skewed, thus they were initially transformed by the reciprocal method which led to the data being more skewed, and therefore the logarithm method was applied.

Once the datasets were transformed to satisfy the assumptions, the full analysis was carried out to investigate the effects of the collaboration style categories and the experimental conditions on

the overall communication. A 6 (experimental conditions) * 11 (collaboration style categories) analysis of variance showed that there was a significant main effect of the collaboration style categories ($F = 102.85$, $p < 0.05$) and a significant interaction between the collaboration style categories and the experimental condition ($F = 6.01$, $p < 0.05$). This indicates that the mean number of utterances in each of the collaboration style categories differ according to the experimental condition. However, there was no significant main effect for the experimental conditions on the overall communication, indicating that the mean number of utterances in each of the experimental conditions did not differ from one another.

5.6.2 Effects of modality and shared visual information on Collaboration

A further analysis was conducted to investigate the interaction between the collaboration style categories and the effects of communication modality and shared visual information. The data from the six experimental conditions have been combined for further analyses in this section, as the previous section has shown that there was no significant main effect across all of the six experimental conditions.

H₂: There is a difference in the number of utterances in each of the collaboration style category depending on the available communication modality and shared visual information

In order to isolate the effects of video-conferencing and the shared visual information on communication structure, a 2 (modality: audio-only or audio and video) * 3 (shared visual information: '50% of information without shared screen', '50% of information with shared screen' and '100% of information without shared screen') analysis of variance was performed on each of the 11 collaboration style categories. This allowed the number of utterances of the audio-only pairs to be directly compared with the audio and video pairs at the same time as comparing the information sharing method and examining the combined effects of the two variables on the collaboration style categories. The mean comparisons of the modality and shared visual information setups are shown in Figure 5-9 and Figure 5-10.

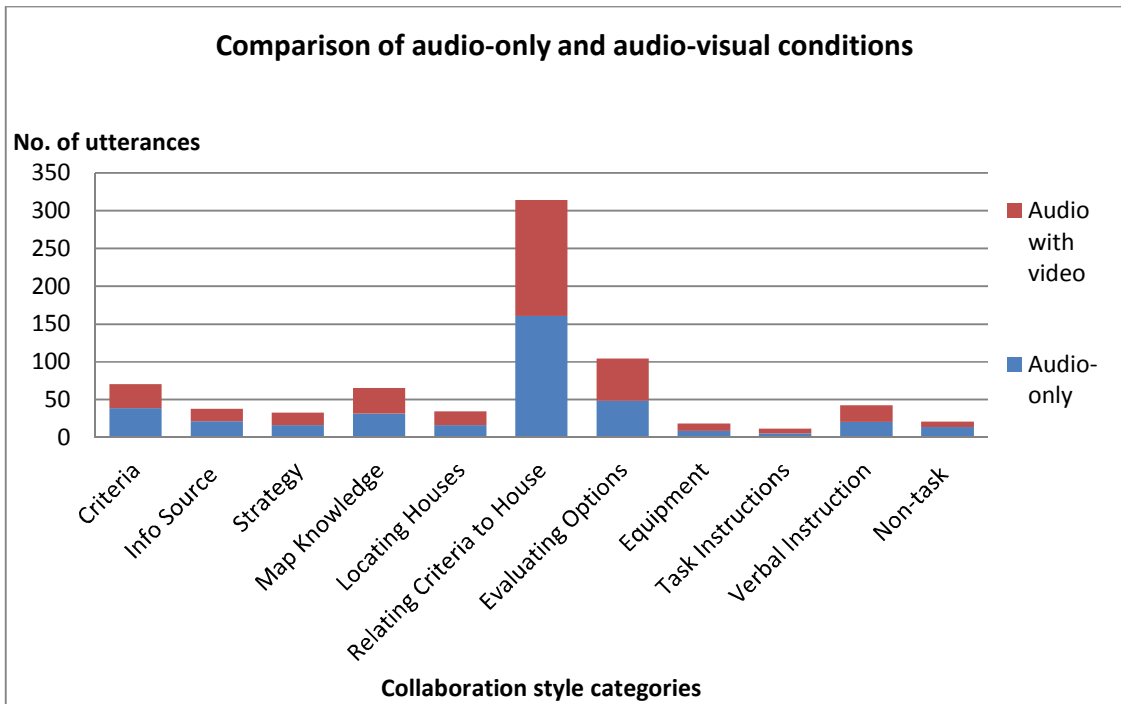

Figure 5-9: Mean comparison of audio-only and audio-visual conditions

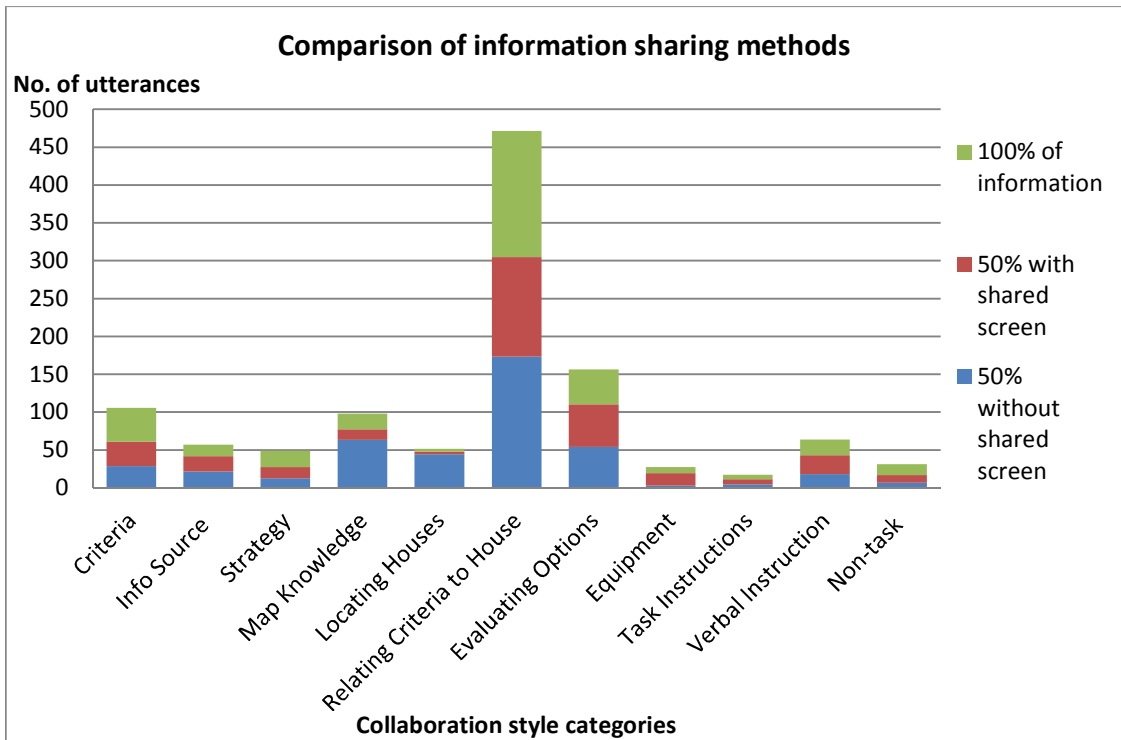

Figure 5-10: Mean comparison of shared visual information

The results of the 2*3 analysis of variance are summarised in Table 5-12; significant differences are highlighted in the table.

Collaboration style categories	Communication modality (audio-only vs. audio and video)	Visual information sharing method (screen sharing and amount of information) given	Interaction between communication modality and visual information sharing method
Referring to criteria	$F_{(1,42)} = 3.28, p > 0.05$	$F_{(2,42)} = 5.86, p < 0.05$	$F_{(2,42)} = 0.31, p > 0.05$
Establishing information source available	$F_{(1,42)} = 0.12, p > 0.05$	$F_{(2,42)} = 1.44, p > 0.05$	$F_{(2,42)} = 0.83, p > 0.05$
Establishing strategy	$F_{(1,42)} = 0.06, p > 0.05$	$F_{(2,42)} = 1.26, p > 0.05$	$F_{(2,42)} = 0.46, p > 0.05$
Sharing map knowledge	$F_{(1,42)} = 0.87, p > 0.05$	$F_{(2,42)} = 17.79, p < 0.05$	$F_{(2,42)} = 0.53, p > 0.05$
Locating houses	$F_{(1,42)} = 2.02, p > 0.05$	$F_{(2,42)} = 36.20, p < 0.05$	$F_{(2,42)} = 1.05, p > 0.05$
Relating criteria to house	$F_{(1,42)} = 0.08, p > 0.05$	$F_{(2,42)} = 2.28, p > 0.05$	$F_{(2,42)} = 1.54, p > 0.05$
Evaluating options	$F_{(1,42)} = 1.84, p > 0.05$	$F_{(2,42)} = 0.88, p > 0.05$	$F_{(2,42)} = 2.00, p > 0.05$
Referring to equipment	$F_{(1,42)} = 0.46, p > 0.05$	$F_{(2,42)} = 21.53, p < 0.05$	$F_{(2,42)} = 0.61, p > 0.05$
Referring to task instructions	$F_{(1,42)} = 2.30, p > 0.05$	$F_{(2,42)} = 1.21, p > 0.05$	$F_{(2,42)} = 0.004, p > 0.05$
Verbal instruction	$F_{(1,42)} = 0.17, p > 0.05$	$F_{(2,42)} = 3.75, p < 0.05$	$F_{(2,42)} = 0.54, p > 0.05$
Non-task related utterance	$F_{(1,42)} = 1.69, p > 0.05$	$F_{(2,42)} = 7.19, p < 0.05$	$F_{(2,42)} = 6.32, p < 0.05$

Table 5-12: Results of the 2*3 analyses of variance investigating the effects of experimental conditions on the utterances in the collaboration style categories

Significant main effects were found on some of the collaboration style categories (highlighted in Table 5-12). The communication modality did not affect the overall collaboration as none of the collaboration style categories were influenced by the additional video to the audio communication. However, the amount of uniquely held information and the availability of screen sharing influenced the amount of information participants were required to share with each other.

Several collaboration style categories were influenced by the method of information sharing and the amount of uniquely held information. These were ‘referring to criteria’ ($F_{(2,42)} = 5.86, p < 0.05$), ‘sharing map knowledge’ ($F_{(2,42)} = 17.79, p < 0.05$), ‘locating houses’ ($F_{(2,42)} = 36.20, p < 0.05$), ‘referring to equipment’ ($F_{(2,42)} = 21.53, p < 0.05$), ‘giving verbal instruction to partner’ ($F_{(2,42)} = 3.75 ; p < 0.05$) and finally ‘non-task related utterance’ ($F_{(2,42)} = 7.19, p < 0.05$). An interaction was

Chapter 5 - Investigating the influence of shared visual information and the use of audio-visual communication on virtual collaboration

also found between communication modality and visual information sharing method for 'non-task related utterance' ($F_{(2,42)} = 6.32, p < 0.05$).

Tukey HSD post-hoc tests were employed to investigate the differences between the three methods of visual information sharing ('50% no shared screen', '50% shared screen' and '100% no shared screen') on the collaboration style categories. The results summarised in Table 5-13, which includes illustrations comparing the means of different conditions which were found to be significantly different.

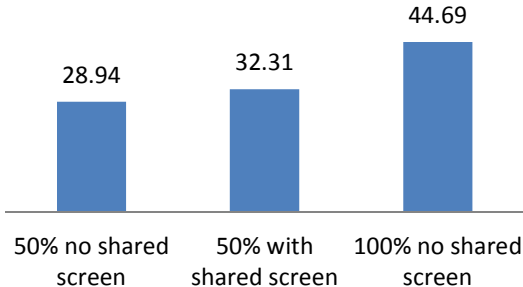
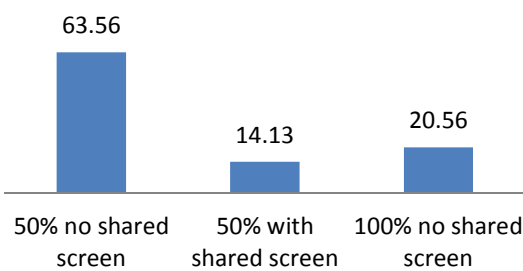
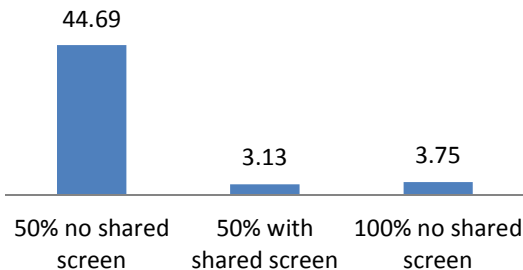
Collaboration style categories	Post-hoc test (comparing mean utterances)	Means comparison (number of utterances)	Comment								
Referring to criteria	<ul style="list-style-type: none"> '100% without a shared screen' was higher than '50% without a shared screen' (Tukey HSD = 15.75, $p < 0.01$) 	 <table border="1"> <thead> <tr> <th>Condition</th> <th>Mean Utterances</th> </tr> </thead> <tbody> <tr> <td>50% no shared screen</td> <td>28.94</td> </tr> <tr> <td>50% with shared screen</td> <td>32.31</td> </tr> <tr> <td>100% no shared screen</td> <td>44.69</td> </tr> </tbody> </table>	Condition	Mean Utterances	50% no shared screen	28.94	50% with shared screen	32.31	100% no shared screen	44.69	<p>Participants given all 100% of the information referred to the given criteria more than the 50% without a shared screen condition. The reason could be because these participants were not required to spend as much time sharing information with each other</p>
Condition	Mean Utterances										
50% no shared screen	28.94										
50% with shared screen	32.31										
100% no shared screen	44.69										
Sharing map knowledge	<ul style="list-style-type: none"> '50% without a shared screen' was higher than '50% with a shared screen' (Tukey HSD = 49.44, $p < 0.001$) '50% without a shared screen' was higher than '100% without a shared screen' (Tukey HSD = 43, $p < 0.01$) 	 <table border="1"> <thead> <tr> <th>Condition</th> <th>Mean Utterances</th> </tr> </thead> <tbody> <tr> <td>50% no shared screen</td> <td>63.56</td> </tr> <tr> <td>50% with shared screen</td> <td>14.13</td> </tr> <tr> <td>100% no shared screen</td> <td>20.56</td> </tr> </tbody> </table>	Condition	Mean Utterances	50% no shared screen	63.56	50% with shared screen	14.13	100% no shared screen	20.56	<p>Participants in the condition with uniquely held information and no shared screen were seen verbally exchanging spatial information in this collaboration style category more than participants in the other two conditions (where participants were able to see the same maps)</p>
Condition	Mean Utterances										
50% no shared screen	63.56										
50% with shared screen	14.13										
100% no shared screen	20.56										
Locating houses	<ul style="list-style-type: none"> '50% without a shared screen' was higher than '50% with a shared screen' (Tukey HSD = 41.51, $p < 0.001$) '50% without a shared screen' was higher than '100% without a shared screen' (Tukey HSD = 40.94, $p < 0.001$) 	 <table border="1"> <thead> <tr> <th>Condition</th> <th>Mean Utterances</th> </tr> </thead> <tbody> <tr> <td>50% no shared screen</td> <td>44.69</td> </tr> <tr> <td>50% with shared screen</td> <td>3.13</td> </tr> <tr> <td>100% no shared screen</td> <td>3.75</td> </tr> </tbody> </table>	Condition	Mean Utterances	50% no shared screen	44.69	50% with shared screen	3.13	100% no shared screen	3.75	<p>Participants each with 50% of information and no shared screen were found to make a higher number of mean utterances than participants in the other two conditions: 50% with a shared screen and 100% of information.</p>
Condition	Mean Utterances										
50% no shared screen	44.69										
50% with shared screen	3.13										
100% no shared screen	3.75										

<p>Referring to equipment</p>	<ul style="list-style-type: none"> • '50% with a shared screen' was higher than '50% without a shared screen' (Tukey HSD = 13.75, $p < 0.001$) • '100% without a shared screen' was higher than '50% without a shared screen' (Tukey HSD = -5.38, $p < 0.01$) • '50% with a shared screen' was higher than '100% without a shared screen' (Tukey HSD = -8.38, $p < 0.05$) 	 <table border="1"> <thead> <tr> <th>Condition</th> <th>Mean Utterances</th> </tr> </thead> <tbody> <tr> <td>50% no shared screen</td> <td>2.81</td> </tr> <tr> <td>50% with shared screen</td> <td>16.56</td> </tr> <tr> <td>100% no shared screen</td> <td>8.19</td> </tr> </tbody> </table>	Condition	Mean Utterances	50% no shared screen	2.81	50% with shared screen	16.56	100% no shared screen	8.19	<p>The equipment setup of the shared screen facility was more complex, allowing participants to see their own and their partner's monitor at the same time. Therefore participants in this condition were referring to the equipment more frequently. Participants in the 100% without a shared screen condition were also referring to the equipment more than the 50% without a shared screen</p>
Condition	Mean Utterances										
50% no shared screen	2.81										
50% with shared screen	16.56										
100% no shared screen	8.19										
<p>Verbal instruction</p>	<ul style="list-style-type: none"> • '50% with a shared screen' was higher than '50% without a shared screen' (Tukey HSD = 6.19, $p < 0.05$) 	 <table border="1"> <thead> <tr> <th>Condition</th> <th>Mean Utterances</th> </tr> </thead> <tbody> <tr> <td>50% no shared screen</td> <td>18.31</td> </tr> <tr> <td>50% with shared screen</td> <td>24.50</td> </tr> <tr> <td>100% no shared screen</td> <td>21.19</td> </tr> </tbody> </table>	Condition	Mean Utterances	50% no shared screen	18.31	50% with shared screen	24.50	100% no shared screen	21.19	<p>Verbal instruction related utterances were higher in the 50% with a shared screen condition compared to the 50% without a shared screen condition.</p>
Condition	Mean Utterances										
50% no shared screen	18.31										
50% with shared screen	24.50										
100% no shared screen	21.19										
<p>Non-task related utterances</p>	<ul style="list-style-type: none"> • '100% without a shared screen' was higher than '50% without a shared screen' (Tukey HSD = 7.75, $p < 0.05$) 	 <table border="1"> <thead> <tr> <th>Condition</th> <th>Mean Utterances</th> </tr> </thead> <tbody> <tr> <td>50% no shared screen</td> <td>6.62</td> </tr> <tr> <td>50% with shared screen</td> <td>10.25</td> </tr> <tr> <td>100% no shared screen</td> <td>14.38</td> </tr> </tbody> </table>	Condition	Mean Utterances	50% no shared screen	6.62	50% with shared screen	10.25	100% no shared screen	14.38	<p>This may suggest that, the low mean utterances in the 50% without a shared screen condition meant participants concentrated on exchanging uniquely held information more than in the conditions where both participants in a pair were given all the information available.</p>
Condition	Mean Utterances										
50% no shared screen	6.62										
50% with shared screen	10.25										
100% no shared screen	14.38										

Table 5-13: Summary of post-hoc tests; Tukey HSD values indicate the significant differences in the mean utterances made in two information sharing methods

The post-hoc test (see Table 5-13 for 'referring to criteria') indicates that participants in the 100% without a shared screen condition referred to the criteria more than those in the 50% without a shared screen. This could suggest that without the requirement to exchange information, participants in the '100% without a shared screen' condition were able to spend more time discussing the house requirements as part of their decision making process.

It was observed that the presence of a shared screen and the elimination of the uniquely held information influenced the conversational structures of participants. These participants were able to see the same information either by requesting their partners to show it to them (i.e. '50% of information with a shared screen'), or retrieving it from their own given information pack (i.e. '100% of information without a shared screen').

Participants in the '50% without a shared screen' condition were unable to view half of the given textual and spatial information. They were seen to describe spatial information which was not necessarily specific to the location of the houses, but about different areas around the map. The following extract taken from a pair of participants in the '50% without a shared screen' condition illustrates how information regarding the map layout was shared during the task:

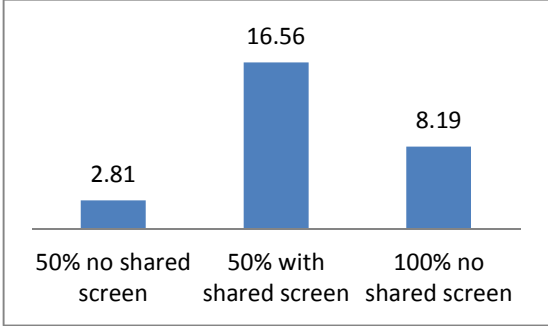
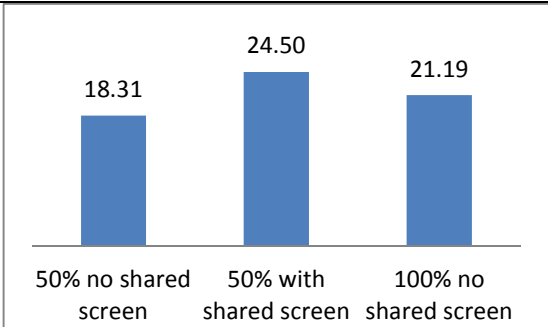
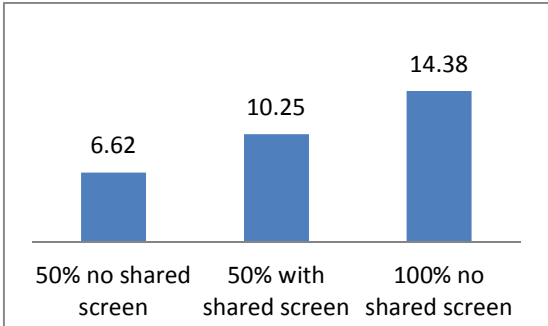
A: Yeah go up and then left a bit. Go up and left a bit...you like... you do... well count the... there's like one junction, two junctions and then on the third junction...
B: Yeah
A: If you go up there, there's like a T-junction as well afterwards I mean cross roads
B: Yeah
A: See it? Then you keep going up and you get to like a park area on the left, second park area on the left. Do you follow where I'm saying? Right there is really expensive as well, it's kind of just..
B: So there's a park area on the left, very left-hand side?
A: Not quite, it's kind of in the middle of the map. It's just off-set a bit left and a bit up it's really expensive. It's really difficult to explain.
B: On the middle of the map?
A: Yeah on the middle of the map, if you go up a tiny bit left, go a tiny bit left and a tiny bit up it's really expensive there.

The extract of the conversation between a pair of participants in the '50% without a shared screen' condition illustrates the participants' difficulty in verbalising spatial information and ensuring that they understood each other during the task (i.e. looking at the same point on the map).

This type of exchange was seen less in the conditions where participants were able to view the same information and hence the necessity of verbally describing such information was reduced.

Participants in the '50% without a shared screen' condition also exhibit higher utterances relating to 'locating houses' during the task. The following quotes were taken from different pairs in the '50% without a shared screen' condition as examples:

- *"If you look at the bottom left hand corner of that big green area, C is there."*
- *"G is the third turning off the main road, turn right and you take the second right turning off."*
- *"H is the bottom one, like middle next to the park."*

In addition, as participants were unable to see each other's screen, many participants were unable to recall the locations of houses and repeatedly asked their partners to describe these locations throughout the task.

<p><i>A: Where is A again sorry? Is it kind of left top of middle screen?</i> <i>B: It's the one on the top left next to the park.</i></p>
--

Only two pairs of participants in the 50% without a shared screen condition drew a map of the approximate locations of each house as they were verbally described by their partners on the blank sheets of paper provided in the task.

Participants in the '50% with a shared screen' condition referred to the equipment setup the most during the task. In addition, participants in this condition also gave their partners more verbal instructions than participants in the '50% without a shared screen' condition. The majority of the verbal instructions seen in the '50% with a shared screen' condition were mainly requesting partners to show or bring up specific slides onto the shared screen. The following quotes were extracted from different pairs to illustrate verbal instructions in the '50% with a shared screen' condition:

- *"Yeah, then go up to price. Go up another 2 slides."*
- *"So scroll down to your next slide, full map and crime, that's topographic line and area"*
- *"OK scroll down again, next one, next one, additional information on properties."*
- *"Oh that's my slide. Shall I bring up where it is and you can go through your slides?"*
- *"Could you show me the crime?"*

No significant difference was found when comparing the amount of verbal instructions given to partners between the '50% with a shared screen' and '100% without a shared screen' conditions. Similar instructions requesting partners to view specific information slides during discussions

were seen between these two conditions. However, more detailed instructions were also seen in the '100% without a shared screen' condition. For example, participants were able to delegate tasks as they were both able to access the same pieces of information. The following quotes were taken from two different pairs of participants who could see the same pieces of information:

- *"Right, tell you what, you look at the parking then. Like A, D and E and I'll do that for J. Ok?"*
- *"Slide 1. So if you look on all the properties. What can you see for property A?"*

Participants were able to view the given information separately and reassure each other or compare their understanding of the data as part of the collaboration, which was not seen in other experimental conditions. The following extract was taken from a pair of participants in the '100% without shared screen' condition to illustrate how participants shared their interpretations of the given information:

<p>A: <i>"OK low price, let's have a look"</i> B: <i>"So let's go to the...."</i> A: <i>"Price map"</i> B: <i>"and see the most expensive ones."</i> A: <i>"OK, the most expensive ones are B and F."</i> B: <i>"So let's..."</i> A: <i>"Am I right?"</i> B: <i>"I don't know, let me just go and check."</i> A: <i>"Just have a look."</i></p>

In addition, verbal instructions from the '100% without a shared screen' condition were more strategic and insightful than simply requesting partners to show slides, for example:

- *"OK, write down like this. Write down A – J from top to bottom. And across we can have different boxes that fit our criteria."*
- *"Oh hang on wait, position your mouse over A and then scroll down to see what about that is on the other slide."*
- *"Right shall we go back to the beginning then? We need to be a bit quicker."*

Participants in the '100% without a shared screen' condition exhibited a higher number of non-task related utterances than those in the '50% without a shared screen' condition. This may suggest that without the necessity to verbally share all the information with their partners within the same period of time, participants without uniquely held information were able to discuss their options and make decisions under less time pressure. The following extracts were taken

from two pairs of participants in the 100% without a shared screen condition to illustrate how participants were more playful during the task.

The first pair discussed the requirement of a car parking space:

A: *"Why don't you sell your car because you're not using it!" (laugh)*
B: *"Yes, shall I?"*
A & B: *(laugh)*
A: *"Yes, then you can pay the extra rent."*
B: *(laugh) "I'd be quite happy to sell my car. But you'll have to make me dinner!"*

The second pair of participants discussed the criteria stating that the house should allow them to walk their dog nearby:

A: *"Yeah, this one is nice, it's moderately priced and not too expensive. And it has a park for my dog."*
B: *(laugh) "You and your dog!"*
A: *(laugh)*
B: *"What is your dog called?" (laugh)*
A: *"I don't know! Daisy?" (laugh)*

Participants in other conditions spent more time exchanging information and concentrating on the task, especially those in the '50% without a shared screen' condition.

5.6.3 Performance

The performance measure of this experiment considered the final choice of three houses as well as their ranking order selected by pairs of participants as part of the task.

5.6.3.1 Effects of Experimental Conditions on Performance

The scores awarded to all 48 pairs of participants across the six experimental conditions were analysed in order to compare whether the conditions affected the task performance. The descriptive statistics of the performance from each experimental condition are summarised in Table 5-14 with the means further illustrated in Figure 5-11.

For the purpose of the analyses, the scores given to participants were treated as non-parametric data to accommodate for the fact that the scores were derived for the purpose of this experiment and could not be mapped on an interval scale, as the marking scheme was developed based on agreed ranking of independent judges.

Experimental condition	Mean	Standard deviation	Range	No. of pairs scoring full marks (160)
50% without shared screen and audio-only	100.00	44.56	35-160	1
50% without shared screen and video	72.50	50.85	25-150	0
50% with shared screen and audio-only	113.13	28.02	75-160	1
50% with shared screen and video	119.38	43.13	50-150	0
100% without shared screen and audio-only	127.50	29.87	75-160	1
100% without shared screen and video	143.75	19.96	100-160	2

Table 5-14: Summary of descriptive statistics for task performance

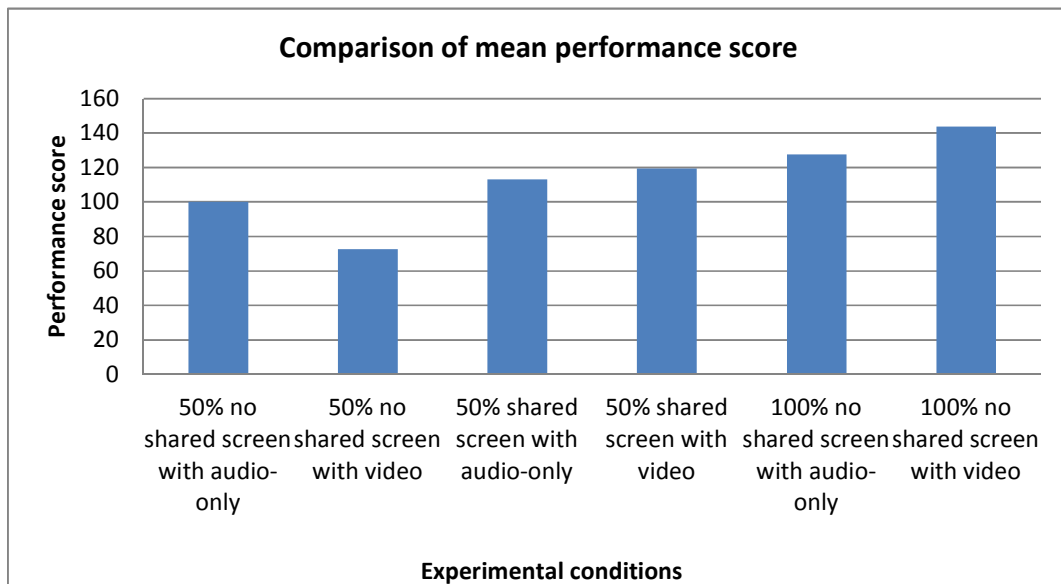

Figure 5-11: Illustration of performance means from the six experimental conditions

H₃: There is a significant difference in the level of performance across all six experimental conditions.

The Kruskal-Wallis test showed no significant difference between the scores of the six groups of participants ($\chi^2 = 10.98$; $df = 5$, $p > 0.05$).

To further isolate the influences of communication modalities and the information sharing methods, further Mann-Whitey (comparing two communication modalities) and Kruskal-Wallis (comparing three methods of information sharing) tests were performed. The results showed

that the communication modality had no significant effect on the overall scores received by participants in each of the experimental conditions ($U = 286$; $p > 0.05$). This indicates that the audio-only and audio and video groups received similar scores for their selection.

However, a significant difference was found between the three methods of information sharing ('50% with no shared screen', '50% with a shared screen' and '100% with no shared screen') was compared ($\chi^2 = 8.51$; $df = 2$, $p < 0.05$), indicating that the method of information sharing influences the overall performance. A post-hoc paired comparison test was conducted to examine the significant differences between the three types of information sharing methods. A significant difference was found between the mean performance of participants in the '50% without a shared screen' and participants in the '100% without a shared screen' conditions ($K = 3.56$, $p < 0.05$). Thus participants given 100% of the information performed better than those given 50% of information but without a shared screen.

5.6.4 Analysis of Subjective Responses (post-task questionnaire)

Participants were asked to complete a post-task questionnaire regarding various aspects of the task (see Section 5.4.3).

H₄: There is a significant difference in the level of satisfaction reported on the overall performance and collaboration as an influence of the communication modality and the method of information sharing

The responses were compared by conducting a 2 (modality: audio-only or audio and video) * 3 (information sharing: '50% no shared screen', '50% shared screen' and '100% no shared screen') analysis of variance on the 5-point ratings of different questionnaire statements (1 = strongly disagree, 2 = disagree, 3 = neutral, 4 = agree and 5 = strongly agree).

Significant differences were related to the information sharing method whilst no significant differences or interactions were found with regards to the use of the two different communication modalities. The significant differences and the means of each are summarised in Table 5-15. Tukey HSD post-hoc tests were performed to further identify the differences between each information sharing setup.

Questionnaire item	Significant differences	Information sharing method with highest mean rating	Information sharing method with 2 nd highest mean rating	Information sharing method with lowest mean rating	Tukey HSD post-hoc test results indicating significant differences between methods
"I communicated with my partner articulately"	F(2,96) = 4.45 (p < 0.05)	50% with shared screen Mean = 4.59 SD = 0.50	100 % without screen sharing Mean = 4.37 SD = 0.49	50 % without screen sharing Mean = 4.16 SD = 0.72	<ul style="list-style-type: none"> • 50% with a shared screen and 50% without a shared screen (p<0.05)
" I found it easy to discuss different locations with my partner"	F(2,96) = 14.02 (p < 0.05)	50% with shared screen Mean = 4.72 SD = 0.46	100 % without screen sharing Mean = 4.44 SD = 0.67	50 % without screen sharing Mean = 3.81 SD = 0.90	<ul style="list-style-type: none"> • 50% with shared screen and 50% without (p<0.01) • 100% without shared screen and 50% without shared screen (p<0.05)
" I found it easy to direct my partner around the maps"	F(2,96) = 20.64 (p < 0.05)	50% with shared screen Mean = 4.72 SD = 0.46	100 % without screen sharing Mean = 4.41 SD = 0.71	50 % without screen sharing Mean = 3.59 SD = 0.91	<ul style="list-style-type: none"> • 50% with shared screen and 50% without shared screen (p<0.01) • 100% without shared screen and 50% without shared screen (p<0.01)
"Information was easily shared with my partner"	F(2,96) = 4.45 (p < 0.05)	50% with shared screen Mean = 4.75 SD = 0.44	100 % without screen sharing Mean = 4.53 SD = 0.67	50 % without screen sharing Mean = 4.19 SD = 0.78	<ul style="list-style-type: none"> • 50% with shared screen and 50% without shared screen (p<0.01)
"We made the final decision within a reasonable time"	F(2,96) = 3.79 (p < 0.05)	50% with shared screen Mean = 4.62 SD = 0.66	50 % without screen sharing Mean = 4.34 SD = 0.65	100 % without screen sharing Mean = 4.16 SD = 0.72	<ul style="list-style-type: none"> • 50% with shared screen and 100% without shared screen (p<0.05)
"On-screen information was easy to use"	F(2,96) = 12.67 (p < 0.05)	50% with shared screen Mean = 4.69 SD = 0.47	50 % without screen sharing Mean = 4.22 SD = 0.91	100 % without screen sharing Mean = 3.66 SD = 0.97	<ul style="list-style-type: none"> • 50% with shared screen and 100% without shared screen (p<0.01) • 50% without shared screen and 100% without shared screen (p<0.05)

Table 5-15: Summary of significant differences found on the questionnaire items rated on a 5-point rating scale and the mean ratings of each condition

The post-hoc tests indicated that for all of the six questionnaire items shown in Table 5-15, significant differences were found between the highest mean rating conditions (i.e. '50% with shared screen') and the lowest mean rating conditions ('50% without shared screen' for the first four items and '100% without shared screen' for the last two items listed). However, significant differences were not found between the highest mean rating condition ('50% with a shared screen') and the second highest mean rating conditions ('100% without shared screen' for four of the items, and '50% without shared screen' for two of the items).

In four of the experimental conditions, participants were given 50% of the information each, but in two conditions they were provided with a shared screen facility. The post-hoc tests showed significant differences between the two screen sharing setups, indicating that participants who were unable to use the shared screen facility perceived the some aspects of the task differently than the participants using the shared screen facility, regardless of the amount of information given to participants within a pair. These aspects from the questionnaire were: 1) "I communicated with my partner articulately", 2) "Information was easily shared with my partner" and, 3) "We made the final decision within a reasonable time".

In two conditions, participants within pairs were given all the information (100%) but without the use of a shared screen facility. The post-hoc tests identified significant differences between the highest mean ratings ('50% with shared screen') and the lowest mean ratings ('100% without shared screen') for two of the questionnaire items. These two questionnaire items are "we made the final decision within a reasonable time" and "on-screen information was easy to use", suggesting that participants given 100% of the information found the larger amount of information more difficult to process which may have caused them to feel that they took more time and consideration to make their final house selection. However, it was also shown in Table 5-13 that participants in this condition ('100% without a shared screen') also exhibit high number of 'non-task related utterances', which could also indicate that participants were still able to exchange 'non-task related utterances' even though they might have felt that more time was required to complete the task.

5.7 Discussion

The verbal analysis comparing setups between the six experimental conditions as well as isolating the possible influences of the communication modalities showed no significant effects in the collaboration style categories. Furthermore, the total number of utterances, which indicate the

amount of interaction, was not affected by the experimental conditions. This suggests that the audio-only compared to video-conferencing conditions were not significantly different from one another. In addition, the communication modalities had no significant effect on participants' subjective responses or on the overall performance. Therefore it can be concluded that the communication modalities had no significant effect on overall outcome of the task and thus the following research questions were unsupported:

1) Does communication modality (i.e. video-conferencing vs. audio-only) affect the information exchange and conversation structure in collaboration?

2) Does communication modality (i.e. video-conferencing vs. audio-only) affect the perceived level of task difficulty and satisfaction?

It was observed, during the task that two pairs of participants (out of eight in the condition of 50% no shared screen with audio and video) used the web camera as a way of sharing information as part of the task. These participants were seen to point the camera to their own computer screen and hence transmit their uniquely held information to their partner over the video-conferencing system. One pair of participants in the '50% with a shared screen' with audio and video were seen to adopt this same approach during the task (to show where they were pointing on the shared screen with their finger).

Initially it was expected that more participants who were provided a webcam during the task would have adopted this approach to share their uniquely held information (i.e. as a way of creating a shared screen over the webcam), especially if their partners could not see a copy of their screen. However, very few participants adopted this approach during the task. At the start of the experiment, all pairs were told that they could use, or move the camera around during the task as they wished. However, as they were not explicitly told to use the web camera to relay the on-screen information to their partners, participants might not have thought of this technique or simply thought it was not allowed during the task.

The performance, subjective responses and collaboration style categories were compared between conditions with a shared screen ('50% with a shared screen') and conditions without ('50% without a shared screen') in order to assess the influence of this method of shared visual information. A significant difference of screen sharing was found in terms of performance (i.e. the actual scores received), when comparing the performance scores between the three

methods of information sharing ('50% with no shared screen', '50% with a shared screen' and '100% with no shared screen') and post-hoc tests indicated that participants in the '100% without a shared screen' conditions performed better than those in the '50% without a shared screen' – hence the following research question was supported:

3) Does the method of information sharing (i.e. shared screen vs. no shared screen and the amount of information given to participants within a pair) influence the overall performance?

Several differences were found between the methods of information sharing in terms of verbal analysis and subjective responses (see Table 5-16). It was observed that within the same time allowance for the collaborative task, participants without the use of a shared screen were required to share more spatial information with their partners compared to those who were able to simply view that information on the shared screen. Participants in the shared screen conditions gave more verbal instructions and referred to the available equipment more. From the verbal analysis, the type of verbal instructions exchanged between participants in the '50% with a shared screen' conditions mainly involved asking partners to manipulate their part of the information in order for the specific information slides to be shared on the shared screen (e.g. 'can you go back to that slide again?'). Furthermore, participants using the shared screen facility felt they communicated with their partners more accurately and it was easier to direct partners and discuss different locations around the maps than those without a shared screen. Finally the shared screen facility led participants to perceive that it was easier to share information with their partners compared to those without a shared screen (see Table 5-16). Therefore the following hypothesis was supported:

4) Will the presence of a shared screen influence the subjective responses to the post-task questionnaire (including perceived level of difficulty and satisfaction) and conversation structure during the collaborative task?

	Item	Condition with higher mean (no. of utterances or rating on 5-point scale) between shared screen and without shared screen
Verbal Analysis	Sharing map knowledge	50% without shared screen
	Locating houses	50% without shared screen
	Referring to equipment	50% with shared screen

	Verbal instruction	50% with shared screen
Subjective Responses	“I communicated with my partner articulately”	50% with shared screen
	“ I found it easy to discuss different locations with my partner”	50% with shared screen
	“ I found it easy to direct my partner around the maps”	50% with shared screen
	“Information was easily shared with my partner”	50% with shared screen

Table 5-16: Summary of the influence of the presence of a shared screen (50% with shared screen and 50% without shared screen)

The difference in overall performance was significant between the ‘50% of information without a shared screen’ and ‘100% of information without a shared screen’. This significant difference was used to direct other comparisons between the two methods of information sharing (see Table 5-17), including post-hoc results from the performance, verbal analysis and subjective response comparisons.

	Item	Condition with higher mean (score, no. of utterances or rating on 5-point scale) between 50% without shared screen and 100% without shared screen
Performance	Overall performance scores	100% without shared screen
Verbal Analysis	Referring to criteria	100% without shared screen
	Sharing map knowledge	50% without shared screen
	Locating houses	50% without shared screen
	Non-task related utterance	100% without shared screen
Subjective Responses	“ I found it easy to discuss different locations with my partner”	100% without shared screen
	“ I found it easy to direct my partner around the maps”	100% without shared screen
	“On-screen information was easy to use”	50% without shared screen

Table 5-17: Comparison between the 50% without a shared screen and 100% without a shared screen conditions

By comparing the proportion of verbal exchanges between participants in the two setups (‘50% without a shared screen’ and ‘100% without a shared screen’), it can be seen that the lack of shared visual information and the presence of uniquely held information led participants within pairs to spend more time ensuring that all the critical information was shared. Participants given 100% of the information referred to the given criteria to selecting houses more with less

verbalisation of information to each other. In addition, they found it easier to discuss different locations and aspects of the maps with their partners. This could have led them to outperform participants in conditions with no shared visual information as all pairs completed the task within the same amount of time – less time was spent on describing the map and more time was available to make informed decisions. However, participants given 100% of information each during the task found that the on-screen information was not as easy to use as participants only given 50% of the information. Therefore the following research question was supported:

5) Will the amount of information shared between team members (i.e. 100% of information per participant vs. 50% of information per participant) influence the level of information exchange?

The only main performance difference was found between the '50% without shared screen' and '100% without shared screen' – as the communication modality had no effect on the performance. The main influence was the method of shared visual information and therefore the following research question was unsupported as not all conditions were different, even with different methods of information sharing:

6) Will the combination of information sharing and the communication channel influence team performance?

The overall findings of this study indicated that the information sharing method was the most influential factor on the overall task collaboration, especially when spatial information exchange is required as part of collaborative decision making. The disadvantages of the lack of shared visual information (i.e. the amount of information given to participants and/or the use of screen sharing) led participants to exchange information for the majority of the allocated time, however the overall performance was not greatly affected. The task was conducted over a period of 40 minutes and participants in the conditions without the use of screen sharing reported lower agreement on the ease of discussion and information sharing aspect, which could be more pronounced in longer, more complex collaborative tasks.

5.8 Key findings from Chapter 5

The findings from the study presented in this chapter suggest that virtual teams can effectively collaborate given the use of audio communication and an appropriate method of information sharing (such as screen sharing or ensuring that all participants are given the same amount and type of information) during a decision making task. However, the use of additional video

provided no extra benefits to the overall collaboration. The results gathered from this laboratory study are summarised in this section.

1) Is there a need for technology to support more than spoken language for planned and unplanned collaboration?

In this laboratory experiment, participants were required to communicate textual and spatial information to each other in order to share their uniquely held information as part of a collaborative decision making task. As this experiment setup forced participants to collaborate remotely, they were unable to see each other face-to-face and all communication was planned and technologically mediated.

The results indicated no significant difference in the overall performance between experimental conditions. However, by supporting more than verbal communication (i.e. when participants were able to see their partner's screen or were given 100% of the information each), the construct of the spoken communication was affected. Participants who were unable to view their partner's screen or access the same pieces of information as each other were required to verbalise all their information during the task in order to exchange the uniquely held information. Participants in the '50% without a shared screen' condition were required to spend more time exchanging information than the '50% with a shared screen' and '100% without a shared screen' conditions. This suggests that by supporting remote information sharing, either by providing a shared view of the workspace or ensuring that remote colleagues are fully provided with all the information, the participants can focus on the core activity of the task, instead of verbalising all the information.

This laboratory study simulated a planned remote collaboration session where only spoken language was supported in some of the experimental conditions. The results indicated that there is a need for technology to support more than spoken language in a planned condition to reduce the need to verbally exchange information allowing participants to concentrate on other aspects of collaboration (such as matching their options to the given criteria).

2) How can technology help to maintain an awareness of remote colleagues and tasks?

By allowing participants to view their partner's screen during the task, participants were able to see what their partners were viewing and what information was being processed by their partner. This awareness allowed participants in the '50% with a shared screen' condition to direct

each other in the form of requests or verbal instructions during the task compared to those who were unable to see their partner's screen. Participants without a shared screen were seen verbally checking their partner's status or saying 'hello' during the conversation when they were unsure what their partners were doing, especially in the audio-only conditions.

This suggests that providing a visual image of the workspace and a video feed of their remote colleagues allows participants to view and anticipate their colleague's status and current activity during the task. However, having a video feed of their remote colleagues has no effect on the overall collaboration, the task outcome and user satisfaction.

Chapter 6 further investigates shared workspaces to support awareness during a design task, however without the live video feed as no results from Chapter 4 or 5 suggested any benefits of seeing remote partners.

3) Is audio the most useful communication modality in remote tasks?

This experiment compared the use of audio-only and audio-visual feeds to support a collaborative decision making task which involved interpreting, sharing and understanding textual and spatial information.

The audio-visual setup of this experiment which allowed participants to view their remote colleague during the task had no effect on the collaboration style categories, user satisfaction or performance. Audio communication was therefore the main communication modality for this experiment. This indicates the importance of audio over video in this remote collaboration task with elements of both spatial and non-spatial information.

4) Is a shared view of the workspace in remote collaboration more useful than a view of the remote colleague?

The results from this experiment suggest that being able to see their remote colleagues during a collaborative task had no influence on the overall quality of collaboration, performance and user satisfaction. However, participants who were unable to see a video of their remote partners or a shared view of the workspace appeared to ask their partners what they were doing more frequently.

However, a shared view of the workspace during the task allowed participants to share uniquely held information with their partner effectively with less proportion of the communication

dedicated to verbalising their textual and spatial information than those who were unable to view their partner's screen.

The results of this study indicated that a shared view of the workspace influenced overall collaboration and the perceived difficulty of the task, but not the overall performance. Participants with the use of a shared screen found the information sharing aspect and the manipulation of the information easier than those in the conditions without a shared workspace.

As the results from this experiment indicated that being able to view remote colleagues has no effect on the overall collaboration, the experiment presented in Chapter 5 eliminated the video feed of remote colleagues, but provided a view of the shared workspace.

5) Does being able to see and hear remote colleagues enhance user satisfaction?

Participants in some conditions were able to see and hear their remote colleagues over the video feed provided during the task. However, there was no evidence to suggest that the additional video helped to improve or enhance user satisfaction with the overall collaboration or task performance (reported in the post-task questionnaire) compared to those who were unable to see their partners during the task. This aspect is examined in Chapter 4, where an always-on video feed was provided to support collaboration in remote teams, however results suggested little improvement in terms of user satisfaction.

5.8.1 Summary

A summary of key findings and how these findings contribute to further studies are presented in Table 5-18.

Chapter 5 key findings	
<i>Is there a need for technology to support more than spoken language for planned and unplanned collaboration?</i>	<ul style="list-style-type: none"> • Supporting more than verbal communication influenced conversational structure in planned collaboration. • Being able to view/share spatial information supported the sharing of uniquely held information.
<i>How can technology help to maintain an awareness of remote colleagues and tasks?</i>	<ul style="list-style-type: none"> • Being able to view remote colleagues' screen or workspace allowed users to acknowledge the attention focus of their colleagues and what information was being seen and processed during the task.
<i>Is audio the most useful communication modality in remote tasks?</i>	<ul style="list-style-type: none"> • Compared to video-conferencing, audio alone was sufficient in supporting the task where spatial and non-spatial information was shared and interpreted by remote colleagues.
<i>Is a shared view of the workspace in remote collaboration more useful than a view of the remote colleague?</i>	<ul style="list-style-type: none"> • Being able to see a view of the remote colleague had no significant difference on collaboration, user satisfaction and performance. • The presence of the shared workspace better supported the conversational structure of collaboration especially when sharing spatial information.
<i>Does being able to see and hear remote colleagues enhance user satisfaction?</i>	<ul style="list-style-type: none"> • Being able to see as well as hear remote colleagues had no additional influence on the overall user satisfaction than being able to only hear colleagues during planned collaboration.

Table 5-18: Chapter 5 summary of key findings

Chapter 6 - Investigating the impact of a shared application and the use of Instant Messenger and Internet Phone on virtual design teams

6.1 Chapter Summary

This chapter presents a laboratory study examining the influence of application sharing in providing shared visual information during remote collaborative design. The study also aimed to evaluate the effects of the communication modality (text-only vs. text and audio) on the conversational communication in a setting where participants were provided with shared visual information.

The application sharing software allowed remote users to view and draw on the same virtual workspace synchronously. Twenty pairs of participants completed a design task in a remote setting. In the first condition, ten pairs communicated with each other via Instant Messenger (IM) (i.e. text-only). In the second condition, ten pairs of participants were able to use both IM and voice communication, provided by Skype (i.e. text and audio).

Participants collaborated on a bathroom design task, which required the basic layout of facilities including a WC, a sink, and a bathtub for wheelchair users. The design specifications regarding these facilities were divided amongst participants working in a pair to encourage collaboration and information sharing.

6.2 Introduction

One of the most common tools used in collaborative design is a whiteboard (Chen *et al.*, 2003), which allows multiple participants to view and share sketches while solving design issues. Benefits of a whiteboard to support co-located design teams include versatility and immediacy - allowing participants to share sketches, notations and diagrams formally and informally, while being easy to setup and use (Chen *et al.*, 2003).

Electronic whiteboards (e-whiteboards) have been developed to enable users to share views and objects while being able to annotate and save their sketches electronically. The use of e-whiteboards has increased in popularity in the workplace to support distributed and co-located designers in the collaborative design process as well as provide additional support to virtual meetings (Volda *et al.*, 2002; Chen *et al.*, 2003).

Application sharing can also be used to simulate an e-whiteboard amongst virtual colleagues, which is used to support 'Paint', or other modelling software. This allows greater visibility of shared objects during collaboration (Dillenbourg and Traum, 1999). This feature is considered one of the most valuable features of collaborative tools (Taylor, 2001), benefiting mutual understanding and mental models development in remote teams (Clark and Brennan, 1991; Bolstad and Endsley, 1999), and workspace awareness (Gutwin and Greenberg, 2002). By being able to view shared information, participants consequently alter conversations and conversational grounding by replacing verbal descriptions with physical actions (i.e. manipulating a shared object), knowing their responses can be seen by their remote colleagues (Clark and Brennan, 1991; Kraut *et al.*, 2003; Brennan, 2004; Gergle *et al.*, 2004a).

Workspace awareness was defined by Gutwin and Greenberg (2002) as the updated knowledge and understanding of how other individuals are currently interacting with the shared workspace, rather than awareness of the workspace itself. Simple whiteboard or group sketch WYSIWIS ('what you see is what I see') tools which allow participants to create a shared visual workspace may not provide the same level of workspace awareness to be comparable to that of face-to-face teams (Gutwin and Greenberg, 2002). Virtual colleagues often have difficulties with determining who else is in the shared workspace or their current action as gestures and people's hands are often reduced to a cursor or electronic pointer), which sometimes may not be represented or seen by remote partners (Gutwin and Greenberg, 2002). Kirk *et al.* (2007) examined the use of remote gesturing in a physical collaborative task, by providing virtual colleagues with a live video feed of each other's workspace, allowing them to see the physical objects their partners interact with during the collaboration, with the results suggesting that a shared workspace helps reduce the process of grounding.

In virtual collaborative tasks, with the low cost and high availability of the internet telephone (including voice and video), users are able to make calls over the internet alongside application sharing to support virtual collaboration (Kushman *et al.*, 2008). Users can often choose between an audio-only, text chat-only, video connection or different combinations of the communication channels to support their tasks. IM has been widely adopted in workplaces to support communication (Handel and Herbsleb, 2002; Avrahami and Hudson, 2004; Scholl *et al.*, 2006). The use of both audio feeds and chat can be adopted to provide better audio-visual support than using a WYSIWIS tool alone.

Chapter 6 - Investigating the impact of a shared application and the use of Instant Messenger and Internet Phone on virtual design teams

The quality of internet calls and live chat has increased with the increasing availability of high-speed broadband, with free access to many of the basic features, such as connecting video and audio calls between two (or more) computers. Studies presented in Chapter 3 illustrated the extent to which IM and Skype have been adopted for use to support low cost collaboration.

This chapter investigates the impact and the influence of technologies such as IM, internet phone and application sharing (i.e. e-whiteboard) on supporting a virtual design task.

6.2.1 Design Tasks

A design task is considered a creative process involving discussion of design solutions, mathematic calculations as well as drawings or models (Mangano *et al.*, 2008). Several design characteristics were identified by Mangano *et al.* (2008): 1) designers frequently shift focus: at the start of the design process, designers generate a vast amount of ideas to satisfy the design brief while shifting between these ideas until they have decided on more refined solutions; 2) designers use quick and low level of detail methods for exploration: sketches and models are used to express ideas and allow external examination of their ideas, thus tools should encourage the flow of creativity and exploration; 3) designers use ambiguous models: this is due to rough sketches made in the earlier stages as well as a strategy to ensure that their visions of the design remain broad while ambiguity supports reinterpretation of the original designs and ideas; and 4) designers use a broad range of 'languages' and technical terms to express their designs, some of these are not formally defined, and often pictorial descriptions are used instead of text. Therefore supporting a remote collaborative design process can be difficult and hence researchers have been finding ways to evaluate communication tools to best support this process (Gutwin and Greenberg, 2002; Chen *et al.*, 2003; Mangano *et al.*, 2008).

The 'house hunting' experiment described in Chapter 4 allowed users working as a team to only see their partner's screen. Thus participants were unable to manipulate the information shown on their partner's screen during the task. However for this study, participants were able to view and update the same piece of information on the same working space as his/her partner during the task.

6.3 Purpose of Chapter 6

The main purpose of this study was to investigate the combination of audio, shared workspace and text-chat applications in supporting a remote collaborative design task (see Table 6-1).

Purpose of Chapter 6:

1. To investigate the influence of text-only and audio and text communication on collaboration and the nature of information sharing in virtual design teams
 2. Examine the influence of application sharing on the users' ability to fluidly sketch and communicate ideas during a design task
 3. To evaluate the effects of the overall communication setups (i.e. text-only with shared application vs. text and audio with shared application) on team performance and satisfaction
-

Table 6-1: Chapter 6 – purpose of study

The collaboration style categories created in Chapter 4 were used in this study to code the conversational communication of information sharing and collaboration during the task.

6.3.1 Research Questions

Text-only and audio-only communication tools have been compared in the field of CSCW with the aim to best support remote collaborative tasks (e.g. Olson and Olson, 1995; Santhanam, 2001; Baker, 2002). Most of the previous studies did not specifically investigate design tasks nor did they use a shared visual information system, including real-time annotations. Furthermore, the purpose of this experiment was not to directly compare the influence of text and audio communication, but to examine the effects of combining both mediums. Thus the first set of research questions investigated the additional presence of audio to text-only communication in a design task:

- 1) Does the communication modality (i.e. text-only vs. text and audio) influence the way participants in pairs construct their conversations?*
- 2) Does the communication modality (i.e. text-only vs. text and audio) influence the overall task performance?*
- 3) Does the two types of communication setup affect the subjective ratings such as satisfaction and preference?*

In order to understand how users adopt different modes of communication for different communication purposes, the following research questions compare the use of IM and the audio connection:

Chapter 6 - Investigating the impact of a shared application and the use of Instant Messenger and Internet Phone on virtual design teams

4) Will the text and audio pairs use the IM and voice communication for different types of information exchange (collaboration styles categories)?

5) Will participants from the two experimental conditions exhibit different proportion of physical states (e.g. writing, typing, drawing, resting, reading and speaking)?

A behavioural checklist was developed to record physical states observed during the task in order to investigate the last research question.

6.4 Method

6.4.1 Participants

A summary of participant information is presented in Table 6-2.

No. of participants	Total per condition	Age range	Gender	Mean age	Background
40 (20 pairs)	20	18-35	M=36, F=4	24	Native English speaking engineering and design students with proficient typing skills

Table 6-2: Summary of participant information

Participants working in pairs had met each other prior to the experiment (50% indicated they had known each other for more than 2 years). All participants fully completed the given task and all received £12 gratuity money at the end of the experiment. All sessions took approximately one hour to one hour and 40 minutes. Participants were shown how to use Paint and the drawing tablet and were given up to 15 minutes to familiarise themselves with the equipment before taking part in the experiment.

Participants were recruited from engineering courses (e.g. mechanical, product design, manufacturing and civil engineering) - those from the architecture departments were excluded to avoid bias from those with superior background knowledge of the task.

6.4.2 Apparatus

Participants working in pairs were located in two different rooms with an identical setup. Two identical laptops were used in each room, one of which was set up as a drawing tablet and the other to provide text and audio communication. Laptops providing audio feeds were equipped with microphones and speakers. The application sharing (enabling e-whiteboard), IM and internet telephone software was installed on all the laptops. This software was connected to the

Chapter 6 - Investigating the impact of a shared application and the use of Instant Messenger and Internet Phone on virtual design teams

internet before the participants arrived. In the conditions where participants were connected via an audio feed, a voice recorder was set up to record all the conversations.

The laptops used as drawing tablets were set up so that participants were able to use the stylus provided as a pen, to draw directly onto the screen of the tablet with the pen movement being registered by the system, allowing drawings to be shown on the shared workspace (similar to a conventional pen-based whiteboard). The keyboards of the laptops which were set up as drawing tablets were hidden during the task to encourage participants to use the stylus and explore the functionality of the e-whiteboard.

Windows Live Messenger (WLM) was used to provide the chat and application sharing facilities during the task, while Skype was selected as the internet telephone software for this study. 'Paint' was installed and used to simulate an e-whiteboard illustrated in Figure 6-1.

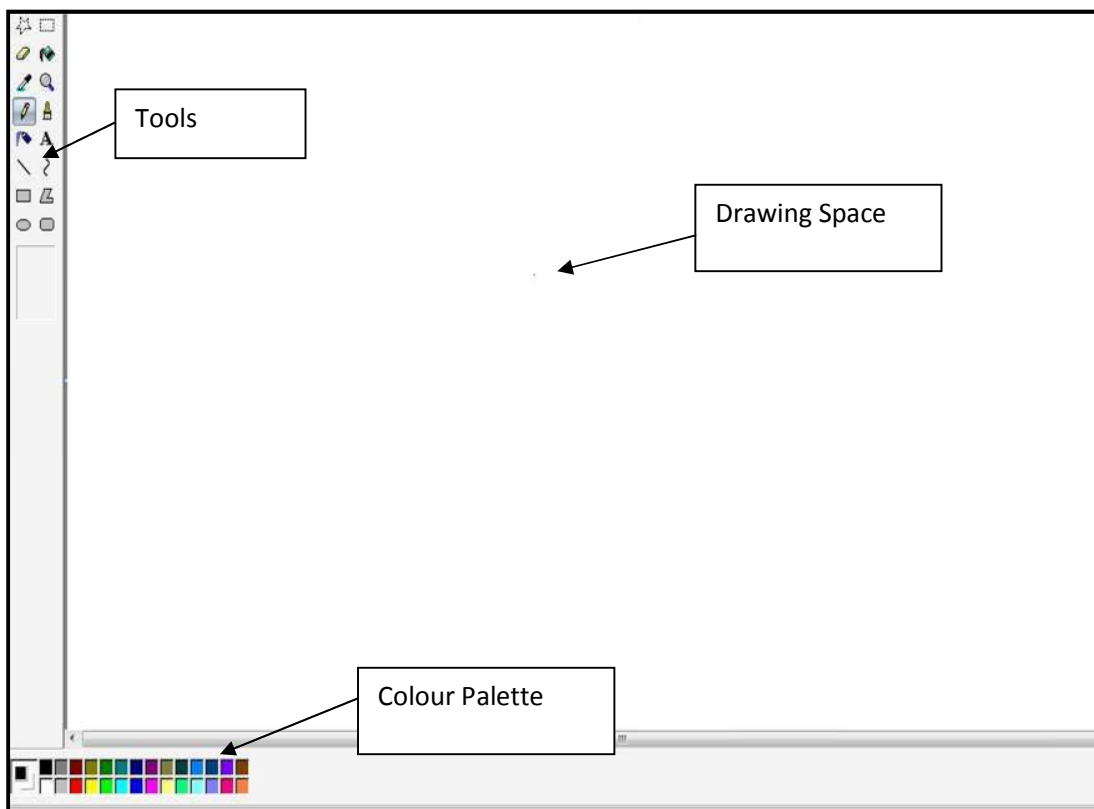

Figure 6-1: Paint application used as e-whiteboard

Participants working in pairs were able to see the same view on their laptops (i.e. the e-drawing space) at the same time (WYSIWIS).

6.4.3 Materials

A consent form was provided to notify participants of the purpose of the study and the data analysis as well as assure them of their anonymity. Participants were also given a pen, paper and a calculator to use during the task.

6.4.3.1 Instruction sheet

Participants were given instruction sheets and design guidelines explaining the task, the criteria, the required outcome and the communication channel available for each experimental condition.

6.4.3.2 Observational checklist

All sessions were observed by two experimenters, one sitting with each participant during the task. Each experimenter was given a laptop with an observation sheet template on Microsoft Excel, on which they were asked to manually record the participant's physical behaviours every five seconds.

This observation sheet was designed as a method of data collection to record the proportion of time participants spent doing various activities. This method was developed based on that of Balfe (2010) who designed an observational checklist to monitor physical states of train signallers at signal boxes. Signallers were required to carry out various tasks as part of their job including monitoring, intervening, planning, communicating and quiet time, each of which included a further 14 sub-categories (e.g. active monitoring, passive monitoring, communicating on the telephone etc.).

In the present study, all sessions were undertaken within a controlled environment, participants were restricted to only performing a small set of actions (i.e. without the interference of other external factors such as the telephone or interruptions from other colleagues), therefore the checklist was much simpler than that of Balfe (2010). The observational checklist included the following fundamental types of physical behaviours:

- Typing (on IM)
- Speaking (only in one of the conditions: speaking and speaking while drawing)
- Resting (quiet time)
- Drawing on the shared whiteboard
- Writing (on paper or on the shared whiteboard)

Chapter 6 - Investigating the impact of a shared application and the use of Instant Messenger and Internet Phone on virtual design teams

As the whiteboard required the use of a pen, participants were able to draw or write on the tablet and therefore the ‘writing’ category included two sub-categories of writing on the blank paper provided, and writing on the whiteboard to communicate with their remote partner.

6.4.3.3 Post-task questionnaire

The post-task questionnaire used for this experiment was based on the design of the previous ‘house hunting’ experiment (see Chapter 5), which incorporated both a 5-point rating scale (to indicate frequency of use of different technologies and the level of satisfaction of several decisions made during the task) and a 5-point Likert scale (for agreement rating).

At the start of the questionnaire, participants were asked to state whether they had worked with each other on a design project prior to the experiment and if so, they were asked to briefly describe that project.

As participants were required to collaboratively design a bathroom layout, this section of the questionnaire gathered information regarding their level of satisfaction with the positions of various facilities in the bathroom. These compulsory facilities included a bathtub, WC, a sink, the door and a free space large enough to accommodate wheelchair users (i.e. the turning space).

Participants were asked to rate how satisfied they were with their final design and positions of these facilities on a rating scale of 1-5 (1 = extremely dissatisfied, 2 = dissatisfied, 3 = neutral, 4 = satisfied and 5 = extremely satisfied) (shown in Table 6-3).

	Extremely Dissatisfied	Dissatisfied	Neutral	Satisfied	Extremely Satisfied
1. Position of the bath	1	2	3	4	5
2. Position of the WC	1	2	3	4	5
3. Position of the sink	1	2	3	4	5
4. Position of the door	1	2	3	4	5
5. Position of the wheelchair turning space	1	2	3	4	5
6. The overall design of the bathroom	1	2	3	4	5

Table 6-3: Post-task questionnaire – satisfaction rating of final design

A 5-point Likert scale was also used to ask participants to rate their level of agreement on various statements about the collaboration process with their partners during the task (taken from the

Chapter 6 - Investigating the impact of a shared application and the use of Instant Messenger and Internet Phone on virtual design teams

house-hunting task presented in Chapter 5); additional items were also added as shown in Table 6-4.

	Strongly disagree	Disagree	Neutral	Agree	Strongly Agree
It was easy to discuss different design issues during the task	1	2	3	4	5
I found it difficult to put my ideas across to my partner	1	2	3	4	5
Drawing on the PC tablet was difficult	1	2	3	4	5
I found it easy to use Chat to communicate with my partner	1	2	3	4	5

Table 6-4: Post-task questionnaire on aspects of collaboration

In addition, participants were asked to rate how often they used different communication technologies and tools in general. They were asked to rate each of the tools on a 5-point rating scale (1 = never used, and 5 = very frequently used) (see Table 6-5). Participants were also given space to write down any other technologies they used down which were not listed.

This additional part was to gather information about their familiarity with different off-the-shelf tools available, which have been widely adopted in the workplace (as described in Chapters 2 and 3).

	Never Used				Very frequently used
1. Telephone/Mobile	1	2	3	4	5
2. Mobile SMS (instant messaging)	1	2	3	4	5
3. E-mail	1	2	3	4	5
4. Fax	1	2	3	4	5
5. Videophone (3G)	1	2	3	4	5
6. Video-conferencing (e.g. Skype, MSN)	1	2	3	4	5
7. Audio conferencing	1	2	3	4	5
8. MSN Shared whiteboard	1	2	3	4	5
9. Online application sharing features	1	2	3	4	5
10. Document/file sharing applications	1	2	3	4	5
11. Instant messaging/chat	1	2	3	4	5

Chapter 6 - Investigating the impact of a shared application and the use of Instant Messenger and Internet Phone on virtual design teams

12. IP phones (e.g. Skype)	1	2	3	4	5
13. Other _____	1	2	3	4	5

Table 6-5: Post-task questionnaire on the frequency of use of off-the-shelf technologies

6.4.4 Design

This section describes the two experimental conditions in detail as well as the development of the task scenario used for this study.

There were two experimental conditions for this between-subject study. A total of 20 pairs of participants were recruited to take part; 10 pairs per condition. These conditions were:

1. Participants were able to use application sharing and IM (Chat) to communicate without telephone conference (text-only communication condition)
2. Participants were able to use application sharing and IM as well as telephone conference (text and audio communication condition)

Participants were asked to work in pairs to solve a given design task. All pairs in both of the experimental conditions were provided with an application sharing programme which allowed both partners (who were based in different locations) to view and manipulate objects in the same virtual space. Hence they were able to see and manipulate each other’s drawing, or writing in real-time. The shared application also allowed them to draw or write on the workspace at the same time. Both experimental conditions allowed participants to share the “Paint” application during the design task.

6.4.4.1 Task description

The task scenario used was purposely developed for this experiment. Several criteria were developed to select the most appropriate task for this study to ensure that the collaboration which took place between participants during the experiment could be observed, measured and analysed. The type of task should also encourage participants to collaborate with each other in the most natural setting that a laboratory study can simulate. Several task scenarios were considered and compared using the set of criteria (see Table 6-6).

Criteria	Explanation
Quick data gathering and analysis	The task should allow behaviour data to be quickly gathered and analysed in comparison to the previous ‘House Hunting’ task which required processing video data before further analysis. Therefore the task selected should allow and encourage different behaviours

	which can be observed during the experiment.
Participants' prior knowledge	As this is a design task, it would be more appropriate for participants to be of the right background such as engineering or design, in order to take part.
Ability to observe/hear interactions	The task should be designed so that interactions and collaboration could be monitored and observed by the experimenters.
Has real-world face value	The task selected should be designed based on existing findings from the end user requirements elicitation carried out in the CoSpaces project to allow real-world face value and realistic problems to be examined in a laboratory setting.
Inspired by CoSpaces	
Objective measures of performance	Objective marking systems should be possible for the task scenario selected to allow performance to be evaluated. In contrast to the previous 'House Hunting' experiment where performance was not objectively judged because of the subjective nature of the task, this task should minimise a reliance on subjective decision making.
Detect different methods of collaboration	Different elements of collaboration which the task should allow and encourage include collaborative design, discussion, evaluation, planning, problem solving, debate, coordination and decision making.
Spatial element of task	The task should have aspects of spatial information which is necessary for participants to solve the proposed problems. The spatial information would be shared between partners during the collaborative design task.
Requires multiple people to interact	Conflicting information could be given to prevent one partner within the pair making all the decisions without collaborating or consulting with his or her partner. Therefore the task should allow essential information to be divided equally between both partners, or allow partners to assume different roles in the decision making process.

Table 6-6: Task selection criteria

These criteria were considered important as the selection of the right task scenario was crucial to the study. The majority of the scenarios considered were design based. Six tasks were considered and compared using the task selection criteria before one was chosen. These tasks were:

- Factory layout design
- Assembly line design
- Material handling process design
- Bathroom design
- Website design
- Health and safety design

The six scenarios were compared against each other using the specified criteria from Table 6-6.

The summary of this comparison is shown in Table 6-7.

Criteria/Task	Factory layout	Assembly line design	Material handling design	Bathroom design	Website design	Health and safety design
Task details	Participants to design a factory layout by looking at different processes being carried out at the plant. Participants could each be given a production line, with different processes, which require them to collaborate and work out the best plant layout to satisfy both products.	Manufacturing assembly line of parts. This could be applied to a food assembly line such as sandwiches as well as more mechanical parts. Different products could be given to participants working together and therefore they would need to design the best line to accommodate for the different products.	Mixture of factory and assembly line design – consideration of health and safety as well as the materials being handled.	Participants to work together to design a bathroom, either domestic, public or wheelchair accessible bathrooms. Design guidelines could be divided so both participants working together need to meet their own requirements whilst compromising with his/her partner.	Different criteria given to participants to design a homepage. One participant could act as a marketing consultant and one as a usability consultant. Both would have different sub-goals and their own requirements whilst working together.	Diagrams of workplaces with health and safety issues to be identified by participants. Participants could be given information to help them. To do this, participants could then be asked to design the best solution to eliminate the hazards. Information given to participants could be divided so that both participants are given some of the hazard identification notes and some for redesigning, to encourage information sharing.
Quick data gathering	Depending on the level of detail which needs to be recorded, an observational checklist can be used. This may need more than one experimenter, i.e. one observer per participant when they are distributed. These tasks are all based on design and problem solving, so an observational checklist could be developed to suit the task.					
Participants' prior knowledge	Students who have taken the right taught modules prior to the task, preferably engineering students.	Manufacturing or mechanical engineering students. If food assembly then anyone should be able to take part.	Manufacturing students and possibly human factors students if including health and safety issues.	No prior knowledge but preferably engineering students, and no architect students as they may possess too much	Human Factors, product design or manufacturing students who have taken courses on	No prior knowledge, but preferably engineering students from manufacturing and human factors.

				architectural experience for the task.	usability and HCI.	
Ability to observer/hear interactions	Could assign participants different roles (with conflicting interests, but the same overall goal) would mean participants are required to collaboration. Information could also be given according to the department or products they are in charge of designing for, which could differ from their partners. This would encourage participants to exchange and share information which could be observed during the task.			Information about the guidelines could be divided between participants, who are then required to share this with each other instead of making decisions without collaboration	Participants could assume different roles with different interests and their own agendas. Different roles assigned could have conflicting interests, which could encourage participants to interact, compromise and discuss their decisions. These interactions could therefore be observed.	
Has real-world face value	Yes, this task could represent the early development stage such as concept design where all the information is shared and initial ideas are considered.	Food assembly line may be perceived as being too simple a task, but still has the design aspect.	Yes, similar to factory and assembly line planning.	Yes, however the task is usually done by architects. However engineering students are often involved in design tasks and should therefore be equipped with the knowledge to solve a new design problem.	Yes, but participants can only do a low profile prototype of the website to avoid using programming skills.	Yes but usually not done using diagrams - hazards are often identified by real workplace inspections. Therefore the diagrams provided may not offer the same level of task complexity.
Inspired by CoSpaces	The design aspect of the task with the use of a shared representation and annotation, links in with CoSpaces user requirements. End users were interviewed at the start of the project during the user requirements elicitation phase and many identified collaboration problems during the design phase when members were distributed, as they were required to verbalise a lot of spatial information to each other.			The CoSpaces project has created a scenario from the construction industry based on collaborative design of bathrooms for wheelchair users.	CoSpaces as a project was required to design and launch a web portal to aid collaboration. However this was an outcome of their research	CoSpaces technology aimed to provide users with a channel to share spatial information in the design process. However they aimed to provide 3D models instead of 2D spatial information.

			instead of part of the user requirements.	
Objective measures of performance	Marking scheme derived by looking at the sequence of processes and distances between stations in the layout. This usually relies on calculations at the start to obtain the best solutions, then machinery and resources could be arranged to satisfy the solution. Performance could therefore be evaluated on the new arrangement. However this required work from scratch and could take time and effort.	Wheelchair accessible bathrooms would follow strict guidelines therefore impose more restrictions on design which could be used to evaluate performance, with marks allocated to the number of criteria met.	Criteria measuring if guidelines are met, subjective aspects such as aesthetics need more consideration.	Clean measures – number of hazards spotted, however the design to rectify each hazard could be difficult to evaluate.
Detect different aspects of collaboration	Coordination, planning, debate, design, problem solving and decision making can be identified during the task as components of collaboration. The scenarios should provide opportunities for meaningful and in depth discussions about different aspects of the task. Might be useful to give participants different motivations or sub-goals when working together on the same overall goal to encourage them to make compromises.			
Spatial element of task	Spatial information produced and shared with partners during the design process.			Reference diagrams including spatial information
Requires multiple people to interact	Two or more participants can work together on the task. If more than two participants, the experimental setup, data collection and observation can be more complicated.			Task is originally for one person, so will need adaptation to suit team work.

Table 6-7: Comparison of task scenarios

6.4.4.2 Development of task information

The scenario selected for this study was bathroom design for wheelchair users. This was because this task satisfied many of the criteria specified, with one of the main reasons being that performance could be evaluated clearly.

Once the scenario was selected, the development work was carried out so that the task was suitable for the experiment. A copy of the “Approved Document M: Access to and use of buildings” (edition 2004)¹, was used to develop this scenario. This document is used by architects, which provides information regarding design specifications for access to buildings. The layout of the bathroom and the facilities available were yet to be decided at this point. The guidelines were to mainly support several types of bathrooms, for example, these were:

- WC (toilet) and sink only
- WC, sink and shower
- WC, sink and a bathtub
- WC, sink, a bathtub and a separate shower area

The guidelines provided in the architectural document show that the more facilities that are available, the more design restrictions needed to be satisfied and hence the complexity of the task increases.

The information provided in Document M was already presented in the form of diagrams (see Figure 6-2, for example) with full dimensions and specifications. However, these diagrams were not given to participants; the information was extracted and translated into textual descriptions.

The documents showing acceptable dimensions of these bathrooms did not however show the actual dimensions of each of the facilities such as a bathtub or a WC. This meant, regardless of the actual size of the bathtub, the spaces or clearances specified in Document M should still be met. Essential information such as the size of each facility to be incorporated into the design of the bathroom was researched and provided to participants.

¹ “Approved Document M: Access to and use of building”, 2004 edition, The Building Regulations 2000, http://www.planningportal.gov.uk/uploads/br/BR_PDF_ADM_2004.pdf

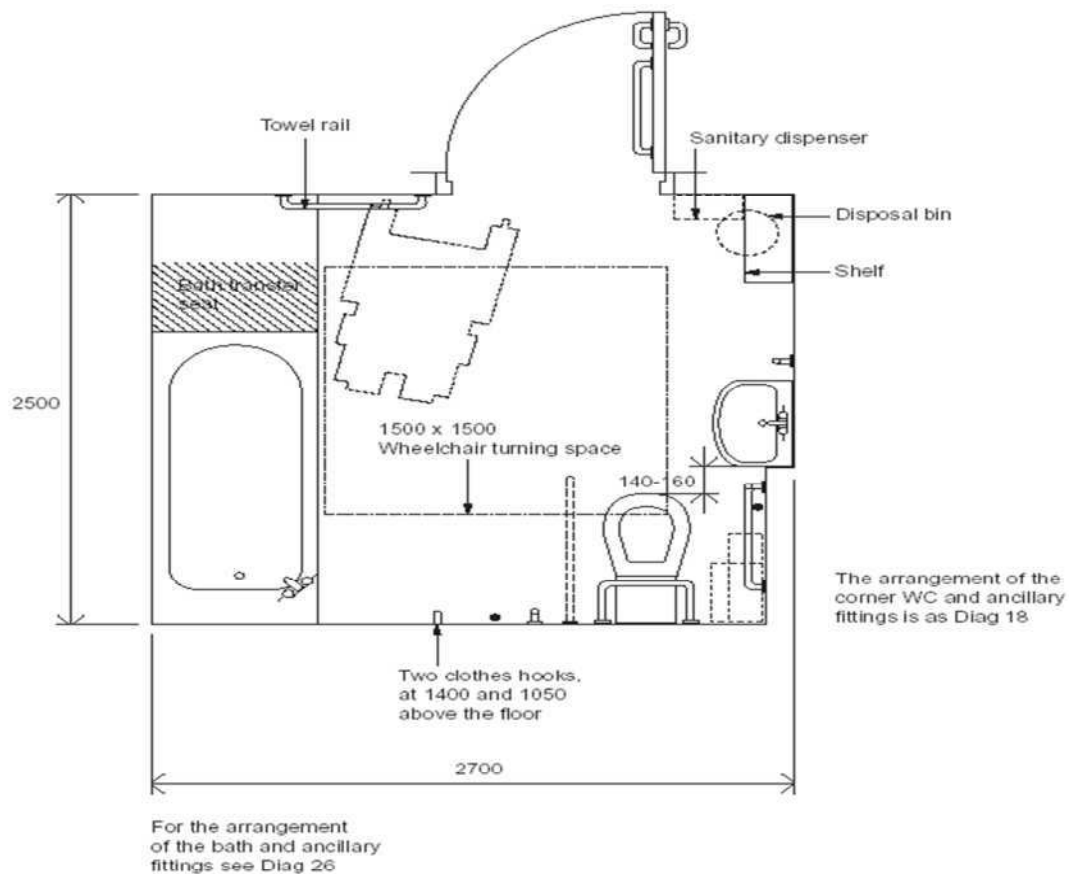

Note
Layout shown for right hand transfer to bath and WC

Figure 6-2: Unisex wheelchair-accessible toilet with corner WC and bathtub (source: Approved Document M)

As there were several layouts to select from with different levels of associated complexity, it was important to therefore select the most appropriate design for the experiment. The complexity of each layout was determined by the number of facilities incorporated into the design (i.e. additional changing area, a shower cubical etc.). The task given to participants should allow partners to communicate and collaborate but not so complex that participants fail to complete the task.

The bathroom design including a WC, sink, bathtub and a separate shower area was discarded as the diagram provided in Document M was complex, including many restrictions and translating the dimensions from the diagram into textual descriptions made the information difficult to read and understand. The dimensions provided in Document M included vertical heights as well as horizontal measurements, (i.e. 3D). Therefore the bathroom could have been much too difficult for participants to design.

Therefore the WC and sink only was considered, as the design was much less complicated with fewer restrictions. However, once the information was translated into understandable descriptions, the bathroom became too simple to design.

Finally, the WC with sink and a bathtub was selected over the WC with sink and a shower. This is because in order to provide access in and out of the bathtub, participants needed to include a facility called a transfer-seat, which allowed users to be transferred in and out of the bath, providing a few more restrictions than the shower-only bathroom. Having selected this design, it was decided that the task should be kept as a 2D design task. This is because the Paint programme given to participants mainly supports 2D drawings and sketches without any 3D support or facilities. It was also because the level of difficulty and complexity increased too much when 3D restrictions such as heights were included into the design.

Figure 6-3 shows how heights could be included in the design. However the heights shown represent the 3D aspect of this design, which complicates both the instructions to be given to participants as well as the actual design task itself. Therefore it was decided to concentrate on a 2D task only.

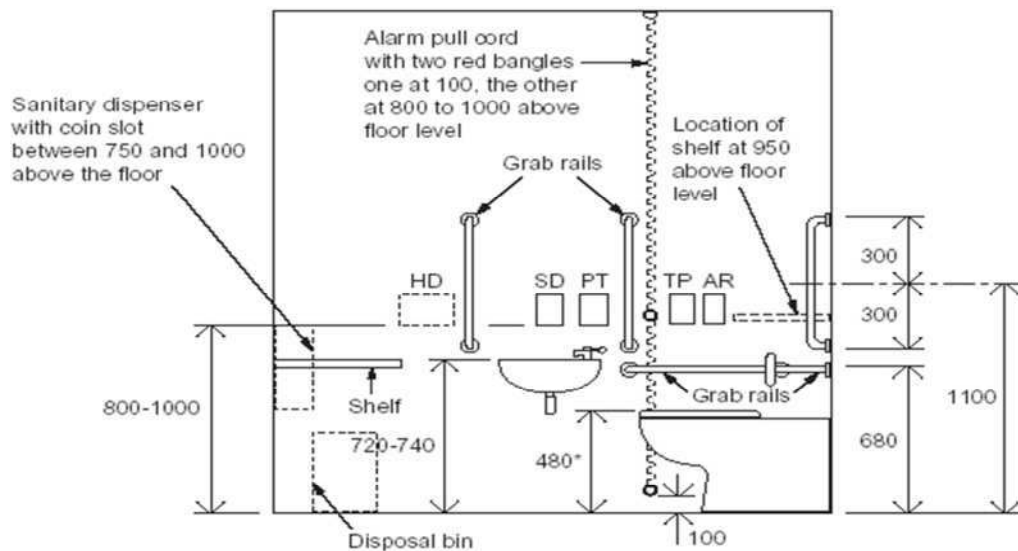

*Height subject to manufacturing tolerance of WC pan

- HD: Possible position for automatic hand dryer (see also Diag 21)
- SD: Soap dispenser
- PT: Paper towel dispenser
- AR: Alarm reset button
- TP: Toilet paper dispenser

Height of drop-down rails to be the same as the other horizontal grab rails

Figure 6-3: Height restrictions for bathroom layout (source: Approved Document M)

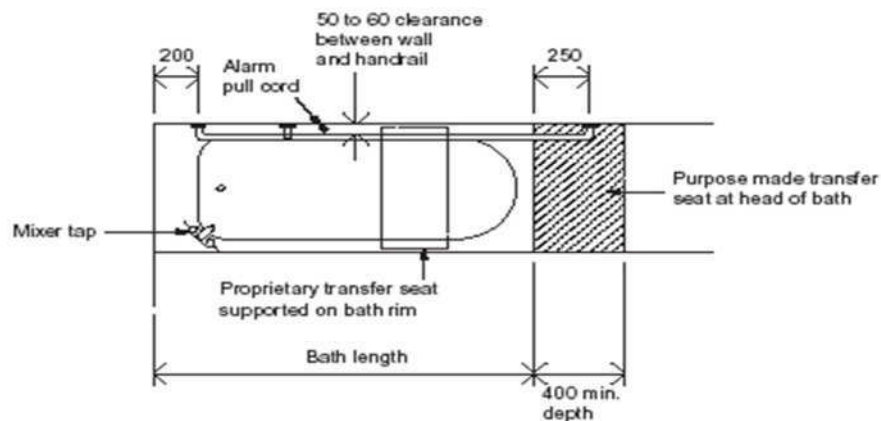

Figure 6-4: Bathtub grab-rails and fittings

Information taken from Figure 6-2 to Figure 6-4 was then used to provide instructions and directions in order to provide participants with relevant information to aid the design task for this study. The diagrams were then used to guide the marking process in order to assess the outcome or performance at the end of the task.

The design guidelines taken from these diagrams were divided into two; each partner working in a pair received half the instructions. Design specifications given to participants are shown in Figure 6-5. Participants were also advised to draw their diagrams clearly with necessary labels and dimensions.

Participant A

1. Total size of bathroom is 2500mm x 2700mm – the bathroom should contain a bathtub, a corner WC and a sink. These should be accompanied by the necessary handrails and towel rails.
2. Within the bathroom, there should be a free space or the wheelchair turning space of at least 1500mm x 1500mm.
3. The bathroom must have an outward opening door with a width of 1000mm
4. Corner WC has the dimensions shown in the diagram below. The back of the WC should be fixed to a wall.

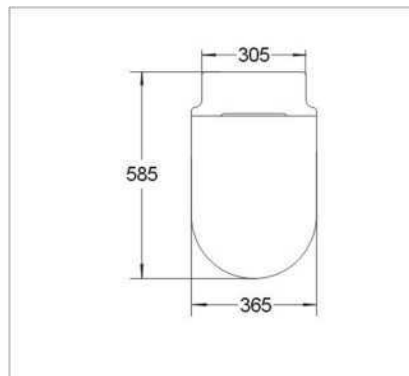

5. The centre line of the WC should be at least 500 mm from one side of the wall.

6. A wall mounted grab rail should be provided on the wall that is 500 mm from the centre line of the WC. This handrail should be parallel to the WC and should be at least 600 mm in length and at least 250 mm away from the adjacent wall (where the back of the WC is attached to).

Participant B

1. Provide a drop-down hand rail to the side of the WC where it is at least 500 mm away from the wall. This is to ensure that the user has support from both sides of the WC. This drop-down hand rail should be 320 mm from the centre line of the WC.
2. The sink should be wall mounted with the edge of the sink 140 mm to 160 mm away from the WC pan. This is to allow enough knee clearance for the user and ensure that it is within easy distance from the WC.

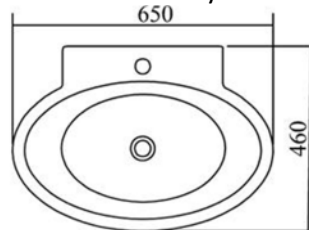

3. Two vertical grab rails should be fitted either side of the sink, they should be 200mm on either side of the sink.
4. A standard sized 1700mm x 700mm bath is to be put in the bathroom.



5. A purpose made transfer seat of 700mm x 400 mm is to be fixed at one end of the bath, preferably to the opposite end of the tap to aid the user in and out of the bath.
6. A handrail is to be fixed on the wall by the bath, stretching the whole length of the bath, i.e. from one end of the bath to reach at least 250mm from the centre line of the transfer seat at the end of the bath.
7. The following items should also be included in the bathroom: clothes hooks (x2), disposal bin (x1), toilet roll dispenser (x1), towel rail (x1), shelves (x2), mirror (x1), paper towel dispenser (x1). Please note that these items carry less marks than the WC, sink and bathtub.

Figure 6-5: Design guidelines for bathroom layout

After the task was designed, a pilot study was conducted with two participants working together to solve the design task. This was to ensure that all the design specifications were understandable and the task could be completed within or around an hour.

6.4.4.3 *Experimental setup*

This section illustrates the setup of the equipment and technologies used during the study (see Table 6-8). Participants worked in their pairs with partners located in different rooms. The PC tablets which allowed participants to draw on them directly were connected over the internet, so that participants were able to interact and had the same view of the drawing space as their partner in the other room. Participants were provided with laptops with IM feature (text-chat) and/or Skype to allow synchronous collaboration during the task.

Condition	Skype (audio)	IM (text-chat)	Shared virtual drawing space
Condition 1	No	Yes	Yes
Condition 2	Yes	Yes	Yes

Table 6-8: Summary of design layout of conditions 1 and 2

In contrast to the previous 'House Hunting' experiment, neither of the conditions allowed participants to see a video feed of their partner during the task.

The only independent variable in this study was the audio communication option, i.e. whether partners were able to communicate with each other directly over Skype using audio or audio and chat.

The dependent variables were:

- The types of communication during the task
- The physical behaviours (i.e. the proportion of time participants spent doing different activities during the task)
- Objective performance measure
- Subjective questionnaire response

6.5 Procedure

On their arrival, participants were given a brief on the task and the study and were asked to read and sign the consent form. Participants were shown how to use IM and Paint on the tablet PC. It was explained to them at this point that the tablets were connected to each other and they could both view and draw on the same working space during the task. In the condition where the participants were offered audio conferencing, they were also informed that this was already set up prior to the experiment. Participants were also notified that they would be observed by an experimenter, who would sit with them and note down their observations.

After participants were shown how to use the Paint programme, separated into different rooms for the experiment (one participant in each room). They were asked to familiarise themselves with the programme before the task began. They were also asked to carefully read their instructions and design guidelines during this period. Once participants had read and understood all the instructions, they were introduced to the experimenter who would be observing them during the experiment, following which the task began.

Participants were told they were allowed a maximum of 1 hour to complete the task. However they could leave as soon as they had finished even if they had taken less than an hour and this would not affect their payment. After participants had completed the task, they were asked to fill in the post-task questionnaire and the payment form.

6.6 Analysis

The analysis of this study was divided into five parts, influenced by the data collection methods designed; these were audio recordings (only for experimental condition 2, where participants were able to talk to each other), IM logs (which documented all the conversations which took place on IM for both conditions), questionnaire responses, physical observations during the task and finally performance based on the task completion time and scores awarded to the final drawings of the bathroom designs.

6.6.1 Communication Coding

This aspect of the task was similar to the previous 'House Hunting' task, where participants were also communicating within their pairs to interpret and share the given spatial and textual information in order to make informed decisions. In the current study, participants in one of the experimental conditions were able to select between two modes of communication (IM or audio). It was therefore necessary to capture how participants used the two modes of communication during the task, as well as the differences in content communicated over the two modes.

The audio recordings and IM chat logs gathered from the bathroom design experiment were of a similar nature to the 'House Hunting' experiment - participants were required to share the given design criteria with their partners in order to establish the complete design guidelines. During the task, it was expected that participants would follow and incorporate different aspects of these guidelines into their final design. Their collaboration could involve evaluation, giving their partners specific instructions, referring to the given design criteria, referring to the task instructions, ensuring their partners were looking at the right location on the whiteboard during discussion as well as non-task related utterances, for example. The codes established in the 'House Hunting' experiment were adopted again for this experiment to categorise different features of collaboration.

Both the bathroom design and the 'House Hunting' tasks had similar aspects such as the use of spatial information and the requirement for participants to share their criteria with each other in order to ensure the final decisions met all the criteria. The material given to participants was divided for both tasks to encourage collaboration, and both tasks involved participants verbalising and translating between text and spatial information during their communication with each other. Therefore the same coding scheme was adopted, although some changes were made such as eliminating the code 'locating houses' (see Table 6-9 for explanation of coding scheme within the context of the bathroom design task).

Collaboration style category	Explanation
Referring to criteria or design guidelines	As participants in a pair were given different sets of criteria, they were required to share their criteria with their partner in order to achieve a common goal. This code refers to when participants communicated with their partners about the criteria given.
Establishing information source available	Neither of the participants could see their partner's sheet containing the design guidelines. Therefore they often tried to establish which part of the information they both had and which they had to share with their partners, or reiterating who had the piece of information needed for that moment in time.
Establishing strategy	This is when both participants discussed how best to approach the task and prioritised actions required in order to complete the task.
Focal Point	This category was originally referred to as "sharing map knowledge" where participants give each other directions and help in navigation in order to ensure they are both looking at the same position (or location of the map in the previous experiment.) This was renamed as focal point, which still implies the same meaning. This category refers to when participants needed to ensure that their partners were looking at the same point on the drawing as they were, in order to evaluate specific aspects or areas. This was often done by participants using objects as references to get to the same focal point.
Discussing aspects of design	This is when participants tried to apply and relate the criteria to their design. This code is applicable when participants discussed different aspects of a design object such as the bathtub and how they could accommodate all the associated specifications in their drawing.
Evaluating options	This usually comes after participants have discussed different aspects of the designs and obtained all the information necessary before they could evaluate their options and discuss the best solution.
Referring to equipment	This is a general code to represent communication or utterances about the equipment used during the experiment.
Referring to task instructions	All participants were given instruction sheets informing them about the task and what they were required to do to complete the task. This category represents participant discussion with their partners about the given instructions or to remind each other of the instructions.
Verbal instruction	This is when one partner specifically gave a verbal instruction to their partner during the experiment.
Non-task related utterance	Statements which were non-task related were coded into this category. This includes joking with their partners.

Table 6-9: Collaboration style categories and explanations

One of the original codes from the 'House Hunting' experiment ('Locating Houses') was not included in this study as it was not relevant.

Ten audio files were recorded in the experiment as only half of the pairs were able to speak to their partners directly during the task. As the coding scheme was pre-established from the 'House Hunting' task, there was no need to transcribe all the sessions for analysis, instead after completion of the experiment they were coded straight away, almost in real-time. However the coder was in control of the playback speed and was able to stop and rewind the recording when necessary during coding.

This coding scheme was also used for the IM (chat) logs for all 20 pairs who took part in the experiment.

6.6.2 Performance Marking Scheme

Participants were marked on their final designs of the bathroom represented as drawings on the virtual whiteboard. One mark was awarded per pair depending on how many design criteria were satisfied and fully illustrated in their sketch. The aesthetics and quality of drawing were not judged as part of this evaluation as long as all the details of the bathroom were conveyed clearly enough. The marking scheme was based on the design criteria given to participants during the tasks (shown in Figure 6-5).

There were 13 design criteria given to the participants, six to one participant and seven to the other working in the same pair. Participants were required to combine their criteria in order to obtain a full specification for their bathroom. It was important for the marking scheme to be representative of each criterion. Some criteria were allocated more marks than others depending on their complexity. The sensitivity of the marking scheme was also important to separate different levels of ability. Each of the 13 design guidelines were divided into smaller components and each were worth one mark (see Table 6-10).

Design criteria	Marking scheme (marks awarded per point)	Total marks	Comments
1) Total size of bathroom is 2500mm x 2700mm – the bathroom should contain a bathtub, a corner WC and a sink.	(1) mark for drawing of the room (1) mark for dimensions	2	Points for the second part of this specification (for the bathroom should contain a bathtub, WC and a sink) were awarded elsewhere.
2) Within the bathroom, there should be a free space or a wheelchair turning space of at least 1500mm x 1500mm.	(1) Drawing free space – ensuring other facilities do not overlap with the free space (1) Dimensions of free space	2	

3) The bathroom must have an outward opening door with a width of 1000mm.	(1) Drawing of the door ensuring other bathroom facilities such as bathtub do not obstruct the door (1) Labelling and dimension of the door (width)	2	
4) Corner WC, has the dimensions shown in the diagram below (see Figure 6-5). The back of the WC should be fixed to a wall.	(1) Drawing of the WC with one side attached to a wall (1) Dimensioning of the WC	2	Not all dimensions of the WC are necessary as long as there are enough to help identify the width and length, for example.
5) The centre line of the WC should be at least 500 mm from one side of the wall.	(1) the centre line of the WC is shown to be of the correct distance from one wall (1) this distance should be labelled 500mm	2	If the centre line is shown to be of a certain distance from the wall, but participants failed to label the distance to be 500mm then only 1 mark was awarded.
6) A wall mounted grab rail should be provided on the wall that is 500 mm from the centre line of the WC. This handrail should be parallel to the WC and should be at least 600 mm in length and at least 250 mm away from the adjacent wall (where the back of the WC is attached to).	(1) for drawing a grab rail (1) for the rail being on the wall which is 500mm away from the WC (1) for the length being 600mm (1) for the back of the rail being 250mm from the back wall (1) for if all the dimensions were stated	5	This specification contained more elements to be considered and therefore carried more marks. If the drawing shows, for example, that participants had considered leaving a gap between the back of the rail from the adjacent wall, but failed to label the gap as being 250mm, they were rewarded a mark for this point, but would not receive a mark for dimensions.
7) Provide a drop-down hand rail to the side of the WC where it is at least 500 mm away from the wall. This is to ensure that the user has support from both sides of the WC. This drop-down hand rail should be 320 mm from the centre line of the WC.	(1) for drawing a drop down handrail (1) for the handrail to be on the other side of WC (1) for the handrail to be 320mm away from the centreline of the WC (1) For dimensioning the handrail 320mm away	4	This drop down handrail should be on the side of the WC that is away from the wall. If the handrail is a distance away from the centreline of the WC, but the participants failed to label the dimension as 320mm then participants failed to achieve the final point for dimension.
8) The sink should be wall mounted with the edge of the sink 140 mm to 160 mm away from the WC pan. This is to allow enough knee clearance for the user but on the other hand, to ensure that it is within easy distance from the WC.	(1) for drawing a sink (1) for the edge of the sink to be 140mm away from the WC (1) for all the dimensions	3	If the edge of the sink is a distance away from the WC, but the distance was not clearly labelled, then participants only received a total of 2 marks for this specification.
9) Two vertical grab rails should be fitted either side of the sink, they should be 200mm on either side of the sink.	(1) for drawing vertical grab rails – usually drawn as circles (1) if grab rails are said to be 200mm on either side of the	2	Dimensions of the grab rails were not given to participants, therefore there was no dimension mark for this specification. However they

	sink		should have labelled the 200mm gap to achieve the second mark.
10) A standard sized 1700mmx700mm bathtub is to be put in the bathroom.	(1) for drawing a bathtub – ensuring the bath fits in the space (1) for dimensioning the bathtub	2	Quick check to see if the bath would fit in the specified space in the drawing, as this was the biggest object given to participants. However, the room size given was big enough to contain all the facilities.
11) A purpose made transfer seat of 700mm x 400 mm is to be fixed at one end of the bath, preferably to the opposite end of the tap to aid the user in and out of the bath.	(1) for drawing a transfer seat (1) Seat being opposite to the tap with correct dimensions	2	No diagram of the transfer seat was given in the specification – participants were told to draw a simple box to represent the object. The seat should have been located by the end of the bathtub.
12) A handrail is to be fixed on the wall by the bath, stretching the whole length of the bath, i.e. from one end of the bath to reach at least 250mm from the centre line of the transfer seat at the end of the bath.	(1) for handrail being drawn on the wall (1) for the length being reachable across the whole length of the bath and the transfer seat (1) dimensioning the handrail to be 250mm away from the centreline of the seat	3	The actual dimension of the handrail was not given, however, participants should have labelled that the seat was 250mm away from the centre line of the transfer seat.
13) The following items should also be included in the bathroom: clothes hooks (x2), disposal bin (x1), toilet roll dispenser (x1), towel rail (x1), shelves (x2), mirror (x1), paper towel dispenser (x1).	9 items for 2 marks, therefore each item was worth 2/9 th of a mark	2	There were 9 objects in total to be incorporated. Participants were also advised that these items (without other guidelines or specifications) contained less marks than others.
TOTAL		33	

Table 6-10: Bathroom Marking Scheme

Pearson’s correlation was carried out to validate the marking scheme between two markers. In order to ensure the marking scheme was robust and unbiased, a second marker was employed to second-mark all 20 drawings according to the given marking scheme. The second independent judge was given all the necessary instructions including the complete list of design guidelines given to participants during the task as well as the task instructions. The two sets of marks were examined for a linear relationship and a significant difference was found ($r = 0.94$, $N = 20$, $p < 0.001$, 2-tailed). This showed that the marking scheme was acceptable and robust for the study.

6.7 Results

The analysis as mentioned was divided into separate stages. This section explains each of the stages such as the analysis of IM chat logs from both conditions, and the comparison of the overall trend of communication in conditions 1 and 2. Condition 2 was further analysed on its own so that the effects of IM and audio on the communication trend could be examined. Furthermore, this section compared the overall performance from the two experimental conditions and finally, the physical behaviours and subjective responses of both conditions were examined.

6.7.1 Overall Collaboration

This section investigates the overall collaboration which took place in both experimental conditions without separating the usage of IM and audio in condition 2 (see Section 6.7.2 for IM-only analysis). The number of utterances taken from condition 2 was that of the combined IM and audio interactions. The total and mean utterances from both conditions are summarised in Table 6-11 and Figure 6-6.

Condition	Total no. of utterances	Mean	Min/Max	Standard Deviation
Condition 1 (IM only)	1616	161.6	22/401	104.9
Condition 2 (IM + audio)	3328	332.8	222/441	77.02

Table 6-11: Overall communication (condition 1 vs. condition 2)

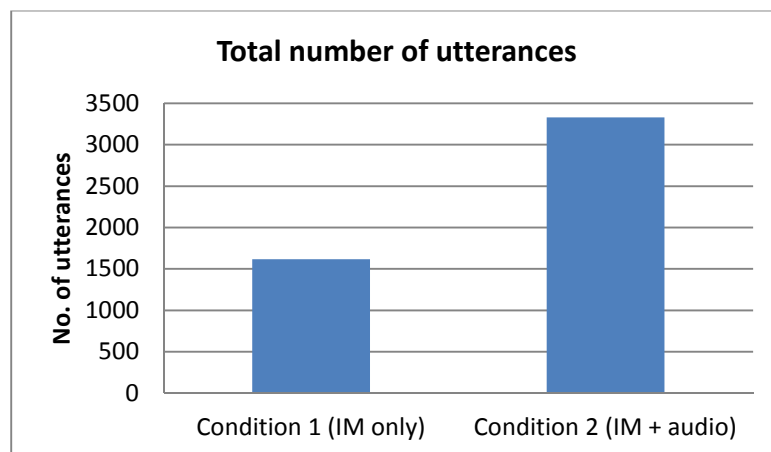

Figure 6-6: Total number of utterances (condition 1 IM-only vs. condition 2 IM and audio)

Utterances were coded into ten collaboration style categories (see Section 6.6.1) and the mean utterances from both experimental conditions (i.e. IM only vs. IM and audio) are summarised and illustrated in Table 6-12 and Figure 6-7.

Collaboration style category	Condition 1- (IM only) Mean (SD)	Condition 2 (IM and audio) Mean (SD)
Referring to criteria or design guidelines	36.60 (23.55)	63.80 (16.54)
Establishing information source available	0 (0)	6.20 (5.51)
Establishing strategy	14.10 (8.44)	15.20 (9.21)
Focal Point	8.20 (6.96)	25.60 (16.43)
Discussing aspects of design	42.80 (44.49)	85.20 (32.40)
Evaluating options	19.90 (13.44)	29.20 (20.91)
Referring to equipment	5.50 (4.30)	11.00 (4.37)
Referring to task instructions	4.30 (2.58)	3.50 (3.41)
Verbal instruction	24.60 (18.82)	84.40 (26.09)
Non-task related	5.60 (7.29)	8.70 (7.75)

Table 6-12: Means and standard deviations of collaboration style category utterances

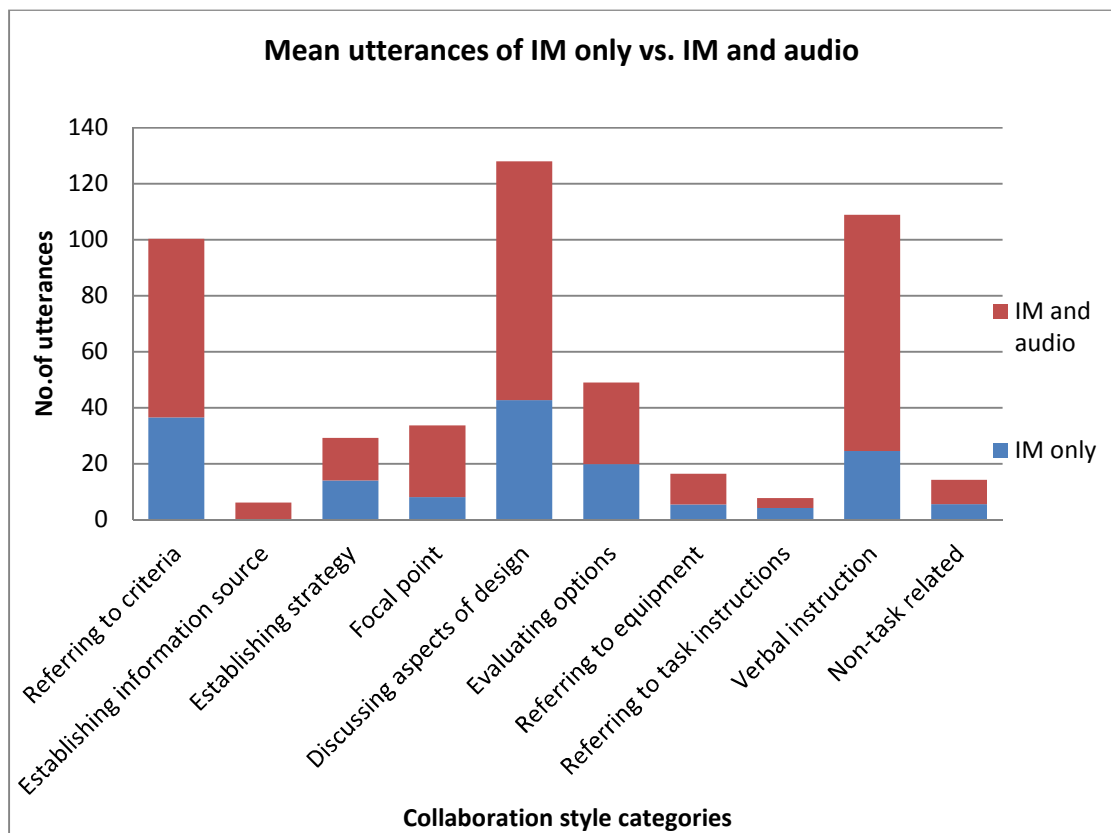

Figure 6-7: Mean utterances of text-only vs. text and audio conditions

The differences between the two experimental conditions can be observed in some of the collaboration style categories. An analysis of variance was carried out to investigate the differences between communication trends in the two conditions.

Assumptions of ANOVA for this dataset were tested before further investigation. The skewness test showed that out of the 10 data groups, three were severely skewed while one was moderately skewed ($F_{crit(10,19)} = 2.38 < F_{max} = 3211$). These datasets were then transformed to ensure the assumptions of ANOVA were satisfied, using reciprocal and square

root methods respectively. The assumptions were tested after the final transformation, whilst two sets were still severely skewed, the severity was greatly reduced.

H₁: There is a difference between the number of utterances in each of the collaboration style category and the two experimental conditions

A 2 (conditions: IM chat only vs. IM chat + audio) * 10 (communication coding) analysis of variance was conducted. This mixed-model analysis of variance analysed the communication coding as a within-subject variable whilst the experimental condition was treated as a between-subject variable. This test examines the main effects and interactions of these two variables.

Mauchly's test showed that the sphericity assumption was not met ($\chi^2 = 421.42$, $p < 0.001$). Therefore degrees of freedom were corrected using Greenhouse-Geisser estimates of sphericity ($\epsilon = 0.24$). The results show that there was a significant main effect of code ($F_{(2.18, 39.18)} = 52.72$, 2-tailed, $p < 0.001$) and condition ($F_{(1, 18)} = 15.33$, 2-tailed, $p < 0.01$). There was also an interaction between these two variables ($F_{(2.18, 39.18)} = 9.49$, 2-tailed, $p < 0.001$). The results suggest that the utterances in the collaboration style categories were different from one another and the collaboration between the two conditions differed.

Post-hoc tests showed that the overall number of utterances recorded were significantly different for both conditions ($p < 0.01$). Participants in condition 2 (with IM chat and audio) were communicating more during the task (i.e. higher number of utterances) when considering both their IM and audio communication.

A series of T-tests were performed to compare the frequency of utterances in the 10 collaboration style categories between the two experimental conditions. A Bonferroni correction was applied to compensate for the repeated use of T-tests, reducing the p-value to 0.005 (i.e. the significance is only accepted if p-value is less than 0.005).

The only significant difference found was in the 'giving verbal instructions' code ($t = 5.88$, $df = 18$, 2-tailed, $p < 0.001$). This code identified the number of utterances (i.e. one partner giving directions, order or guidance to his/her partner during the task). Table 6-13 shows that participants in condition 2 gave their partners more verbal instructions during the task compared to those in condition 1.

Collaboration style category	Significant difference	Condition 1 – IM chat	Condition 2 – IM chat and audio
Verbal instruction	P<0.001	Mean = 24.60 SD = 18.82	Mean = 84.40 SD = 26.09

Table 6-13: Giving verbal instructions: comparison between condition 1 (IM only) and condition 2 (IM and audio)

The shared whiteboard feature allowed both participants in a pair to draw at the same time as each other on the same space. However, the cursor position of their remote colleague was not shown on the shared space, therefore participants were unable to anticipate where the next object would appear on the shared screen until their remote partner had finished drawing, unless they were told. This resulted in partners drawing objects on top of each other's or accidentally deleting each other's objects during the task, thus prompting further communication.

In condition 2 (IM chat and audio), once an object was deleted accidentally, the verbal responses were usually immediate from both participants followed by a request for the deleted object to be redrawn. The following extract was taken from the verbal communication of a pair of participants in condition 2 (i.e. IM and audio), after 'Participant A' accidentally deleted an object:

A: "Oops!"
 B: "Oh no!"
 A: "Sorry"
 B: "Can you replace that? I'm drawing my box on the edge of it"
 A: "Yeah I'm on it"

The first utterance from participant A, who accidentally deleted an object, was immediate and this allowed participant B to realise that the object was deleted by mistake. However, it was observed that when the same incident occurred in condition 1 (IM only), the remote partners were initially more hesitant to make a remark once an object is deleted. They then formally asked their remote partner for their intentions regarding the missing object compared to the short utterances exchanged verbally between those in condition 2. The following extract was taken from the IM chat log of a pair of participants in condition 1, after 'Participant B' accidentally deleted an object:

A: "That should be 200mm either side of the sink....."
 "Did you delete the box?"
 B: "Sorry just meant to alter the sizing can we get that back?"
 A: "Click on edit"

This could indicate that the synchronous audio feed in condition 2 in conjunction with the shared workspace helped support awareness of remote colleagues, allowing participants to realise immediately that the object was deleted by mistake by being able to hear short utterances. Participants in condition 2 were not relying on status updates or formal questions to update their awareness on the task compared to those in the text-only condition.

6.7.2 Instant Messenger Logs

This section presents the results and findings from the analysis of all the IM logs taken during the experiment. A total of 19 out of 20 logs were analysed; one of the logs was empty as the participants in that pair did not use IM during the task. IM records showed all the exchanges which took place within pairs during the experiment. Since all exchanges were in real-time over text chat, these were coded after the experiment using the pre-developed coding scheme (see section 6.6.1).

A total of 1802 exchanges or utterances taken from 19 pairs of participants (ten from condition 1 and nine from condition 2) were coded. Table 6-14 and Figure 6-8 show a summary of the utterances on IM taken from both conditions.

Condition	Total no. of utterances	Mean	Min/Max	Standard Deviation
Condition 1 (IM only)	1616	161.6	22/401	104.9
Condition 2 (IM and audio)	186	18.6	0/40	14.6

Table 6-14: Descriptive statistics for IM logs (conditions 1 and 2)

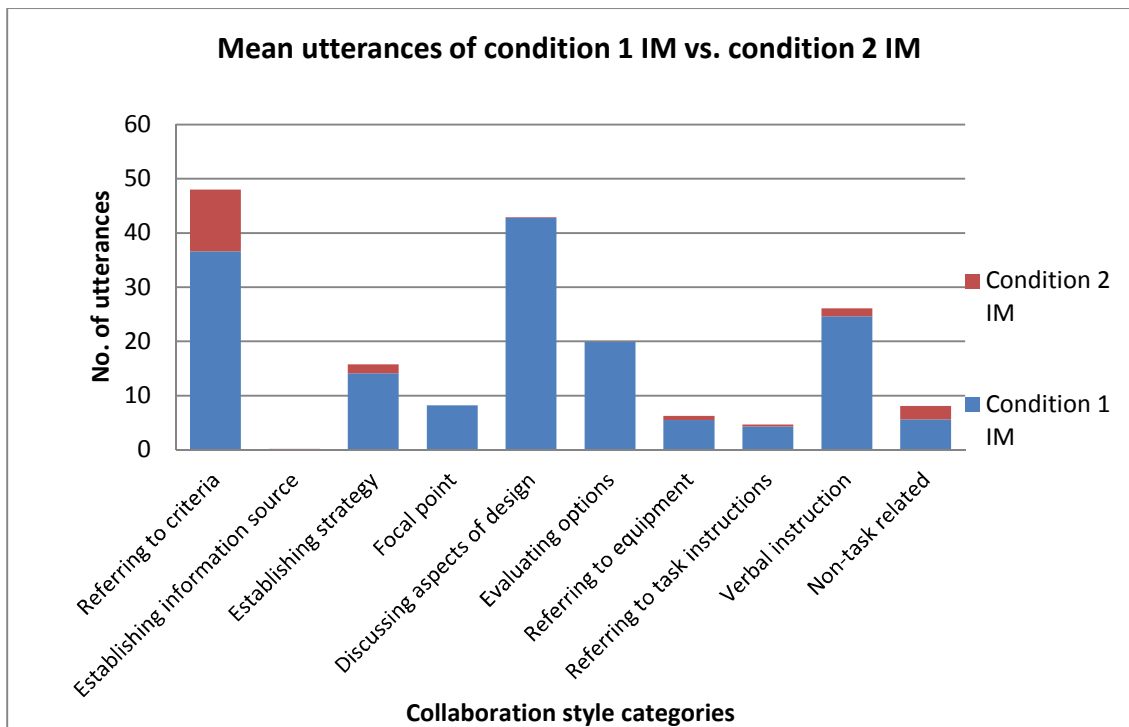

Figure 6-8: Comparing the mean utterances between chat logs taken from condition 1 and condition 2

It can be seen from Figure 6-8 that the mean utterances in from both conditions were lowest in the collaboration style categories, 'establishing information source'. Some differences between the two conditions could also be observed in Figure 6-8, however further analysis of variance tests were conducted.

The ANOVA assumptions were tested. The skewness was tested by calculating the z values for each of the codes, the homogeneity and the Hartley's F value. The results showed that out of the 10 coding groups tested, all were positively skewed ($F_{crit(10,19)} = 2.38 < F_{max} = 513.58$). The datasets were transformed logarithmically to reduce the severity of the skewness.

H₂: There is a difference between the number of chat utterances in each of the collaboration style category and the two experimental conditions

A 2 (experimental condition) * 10 (analysis codes) between-subject, mixed-model analysis of variance was conducted to identify the effects of the variables. The 10 communication codes were used across both experimental conditions and therefore were treated as a within-subject variable. Mauchly's test of sphericity assumption was also violated ($\chi^2=116.39$ $p<0.001$). Therefore Greenhouse-Geisser correction was applied to the degrees of freedom ($\epsilon = 0.47$).

For the within-subject variable, there was a significant main effect of the coding scheme ($F_{(4.25, 76.47)} = 3.50$, 2-tailed, $p<0.05$) and interaction between the coding scheme and

experimental conditions ($F_{(4.25, 76.47)} = 2.70$, 2-tailed; $p < 0.05$). There was also a significant main effect of experimental condition ($F_{(1,18)} = 47.33$, 2-tailed; $p < 0.01$), which was the between-subject variable. Post-hoc tests showed that participants in condition 1 had more communication on IM than those in condition 2 ($p < 0.001$). This was expected as IM was the communication channel provided to participants in condition 1.

Following on from the analysis of variance which showed significant main effects of both variables as well as an interaction, 10 T-tests were conducted to evaluate the differences between the means in all 10 groups of the coding scheme. Bonferroni correction was applied and the adjusted significant criterion is $p < 0.005$. Table 6-15 shows those codes with significant differences.

Collaboration style category	T value df = 18, 2-tailed	Condition 1 – IM chat	Condition 2 – IM chat
Sharing strategies	t = 7.11 ($p < 0.001$)	Mean = 14.10 SD = 8.44	Mean = 1.70 SD = 3.37
Focal Point	t = 4.31 ($p < 0.001$)	Mean = 8.20 SD = 6.96	Mean = 0 SD = 0
Discussing aspects of design	t = 8.39 ($p < 0.001$)	Mean = 42.80 SD = 44.49	Mean = 0.10 SD = 0.32
Evaluating options	t = 7.97 ($p < 0.001$)	Mean = 19.90 SD = 13.44	Mean = 0 SD = 0
Verbal instruction	t = 8.78 ($p < 0.001$)	Mean = 24.60 SD = 18.82	Mean = 1.50 SD = 2.80

Table 6-15: Post-hoc Test – condition 1 chat vs. condition 2 chat

From this section of the analysis, it can be seen that participants in condition 2, who were able to select between IM and audio as their mode of communication used IM less frequently for all the five codes shown in Table 6-15 (as reflected by the higher means in Condition 1).

6.7.3 Analysis of Chat vs. Audio

This section of the analysis examines only those within condition 2, where participants were provided with both IM and audio and were able to freely choose or switch between both modes of communication during the task. The codes of communication participants preferred to convey over the two types of technology were investigated. Table 6-16 and Figure 6-9 illustrate the total number of communication utterances recorded within condition 2.

Mode of communication	Total no. of utterances	Mean	Min/Max	Standard Deviation
Audio	3142	314.2	185/433	80.39
IM Chat	186	18.6	0/49	14.62

Table 6-16: Condition 2 comparison of audio vs. IM chat

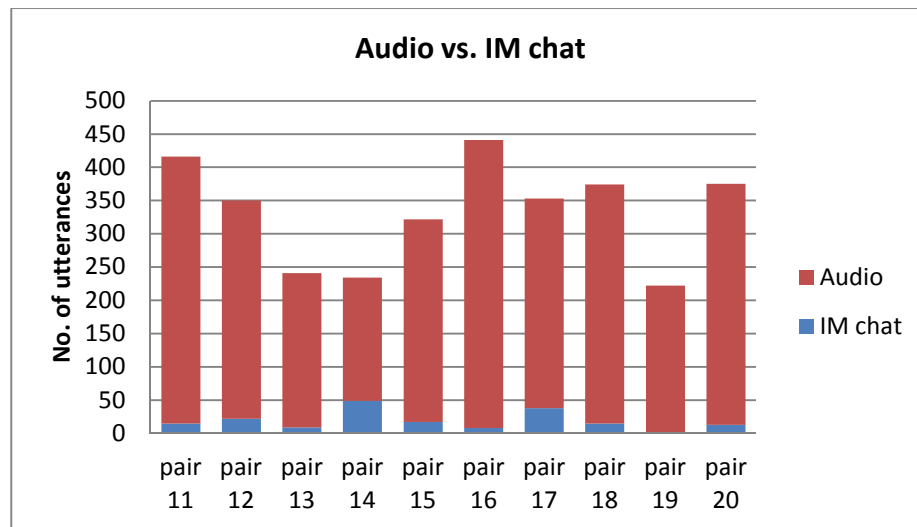

Figure 6-9: Comparison between the total number of utterances on audio vs. IM chat

It was observed that one pair of participants in this condition (i.e. pair 19) did not use IM chat during the experiment and all communication was done verbally over the audio feed provided.

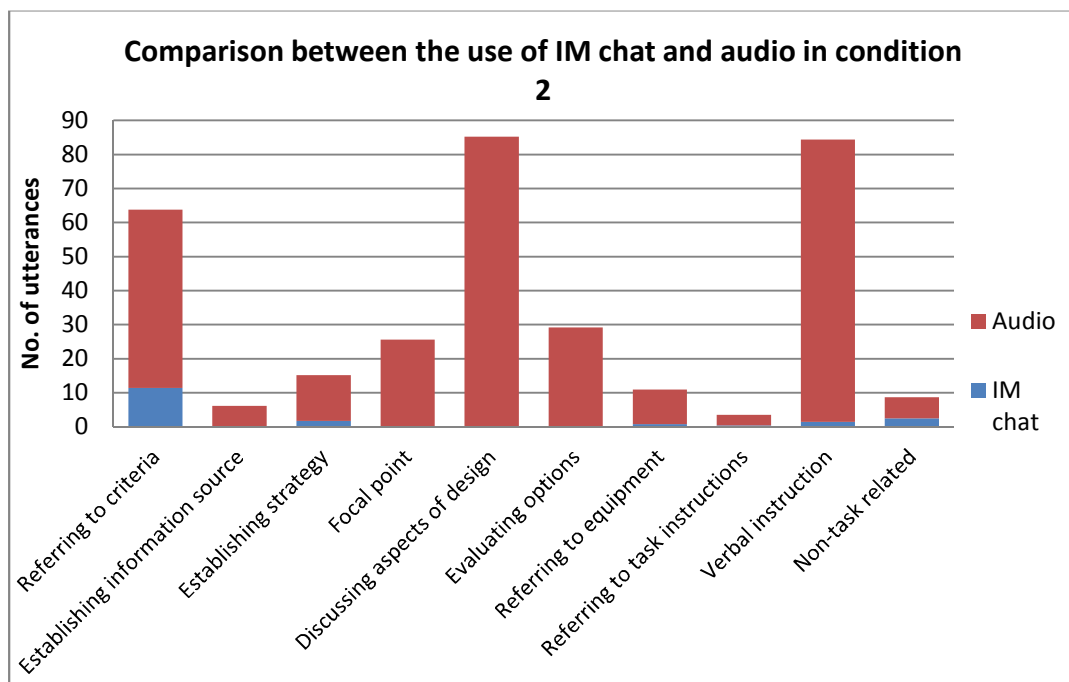

Figure 6-10: Comparison between the mean number of utterances for IM chat and audio to communicate for each collaboration style category

H₃: There is a difference between the number of utterances in each of the collaboration style category seen over audio and chat

To further analyse the use of IM and audio within this condition, a 2 (communication: chat vs. audio) * 10 (communication codes) within-subject analysis of variance was conducted to take

into account all the 10 codes. Figure 6-10 illustrates the comparison between the mean number of utterances seen on IM chat and audio for each collaboration style category.

The assumptions of ANOVA were tested and eight data groups out of 20 groups were severely skewed ($F_{crit(10,19)} = 2.38 < F_{max}$), thus logarithm was applied to normalise the data. After the data were transformed, only one data set was left severely skewed, however the severity of the skewness was reduced. Mauchly's test of sphericity showed that both of the variables violated the assumption and the degrees of freedom associated were corrected (Coding scheme: $\chi^2 = 121.89$, $p < 0.001$ and Greenhouse Geisser = 0.32).

The analysis of variance revealed a significant main effect of the code ($F_{(2.86, 25.76)} = 47.12$, $p < 0.001$, 2-tailed). Another main effect of the communication method (IM chat and audio) was also found to be of significance ($F_{(1,9)} = 117.28$, $p < 0.001$, 2-tailed). A significant interaction was found between the two variables ($F_{(3.25, 29.20)} = 33.42$, $p < 0.001$, 2-tailed). The post-hoc tests showed that participants within condition 2 spoke to their partners directly during the experiment more often than typing to each other using IM chat ($p < 0.001$).

A series of T-tests, with Bonferroni correction ($p < 0.005$), showed that some of the communication codes differed between IM chat and audio. This meant that for the communication codes in Table 6-17, participants preferred to use one mode of communication over another, i.e. audio. A summary of significant differences found between the two modes of communication is shown in Table 6-17.

Collaboration style category	t value, df = 9 (significance)	IM Chat: mean (SD)	Audio: mean (SD)
Referring to criteria	t = 4.99 (p<0.001)	11.4 (8.63)	52.4 (20)
Establishing strategy	t = 3.78 (p<0.001)	1.7 (3.37)	13.5 (10.5)
Focal point	t = 4.93 (p<0.001)	0	25.6 (16.4)
Discussing aspects of design	t = 7.97 (p<0.001)	0.1 (0.32)	85.1 (32.45)
Evaluating options	t = 4.42 (p<0.001)	0	29.2 (20.9)
Referring to equipment	t = 4.22 (p<0.001)	0.8 (1.32)	10.2 (3.61)
Verbal instruction	t = 9.80 (p<0.001)	1.5 (2.80)	82.9 (25.61)

Table 6-17: Comparing communication codes - IM chat vs. audio

It could be seen that even though the majority of exchanges were done verbally using audio, participants in this condition also used IM chat to exchange their criteria of the bathroom design. Seven out of ten pairs of participants in this condition typed their given design criteria onto the IM chat to exchange information with their partners during the task. However, zero means for 'focal point' and 'evaluating options' as well as a low mean for 'discussing aspects

of design' on IM suggest that audio was a much preferred means of communication for these collaboration style categories. Participants adopted to verbally exchange their reasons with each other over the audio feed instead of over the text chat.

6.7.4 Performance

Two independent judges awarded marks to each pair of participants based on the number of criteria participants satisfied in their final designs. Average scores of the two judges were used in the analysis in order to compare the performance of participants in the two experimental conditions.

H₄: There is a difference in the performance between the two experimental conditions

A t-test was used to examine whether the two conditions performed differently and no significant difference was found between the overall scores ($t = 1.71$, $df = 18$; 2-tailed, $p > 0.05$). Therefore it can be seen that the communication modality had no effect on the overall performance of the teams. A summary of scores taken from both conditions is shown in Table 6-18.

Condition	Mean	Standard Deviation	Range (mark out of 33)
Condition 1 (text-only)	19.56	6.48	7 - 27
Condition 2 (text and audio)	23.68	4.00	16.5 - 30

Table 6-18: Summary of performance scores of two conditions

Submitted sketches of pairs with the highest scores from both conditions are shown in Figure 6-11 and Figure 6-12.

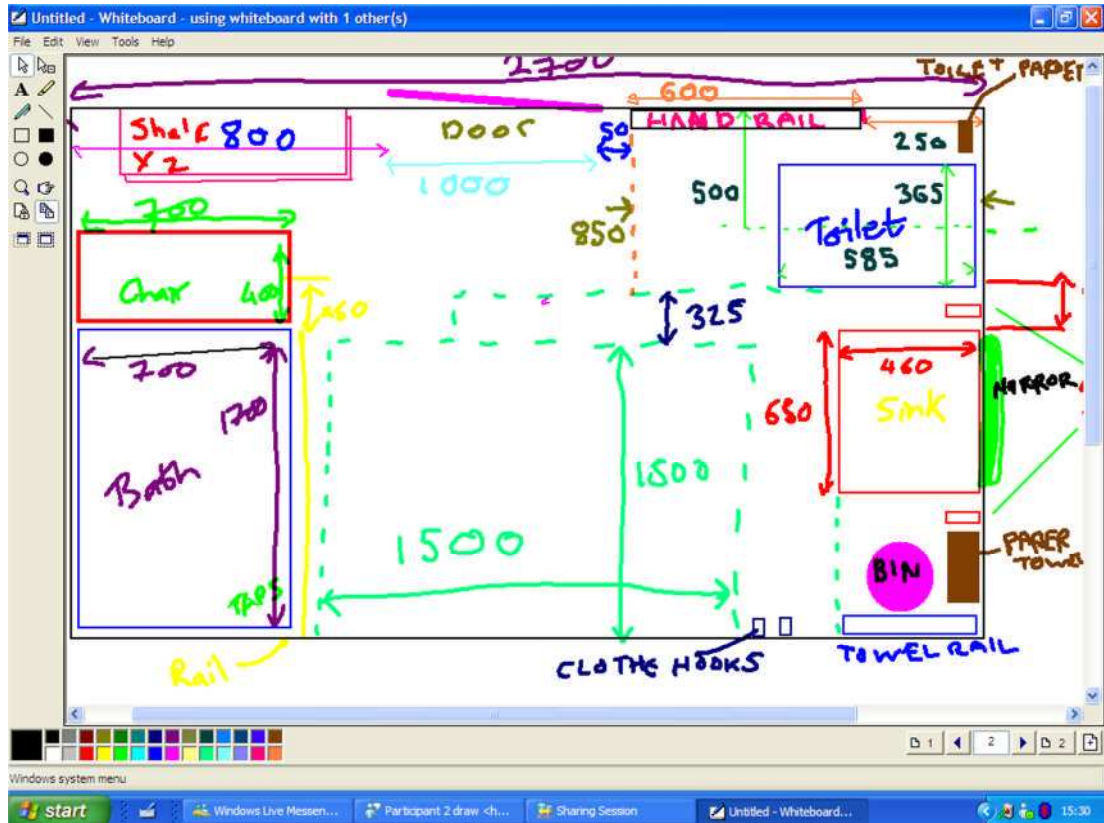

Figure 6-11: Bathroom design of the pair of participants with the highest mark in condition 1

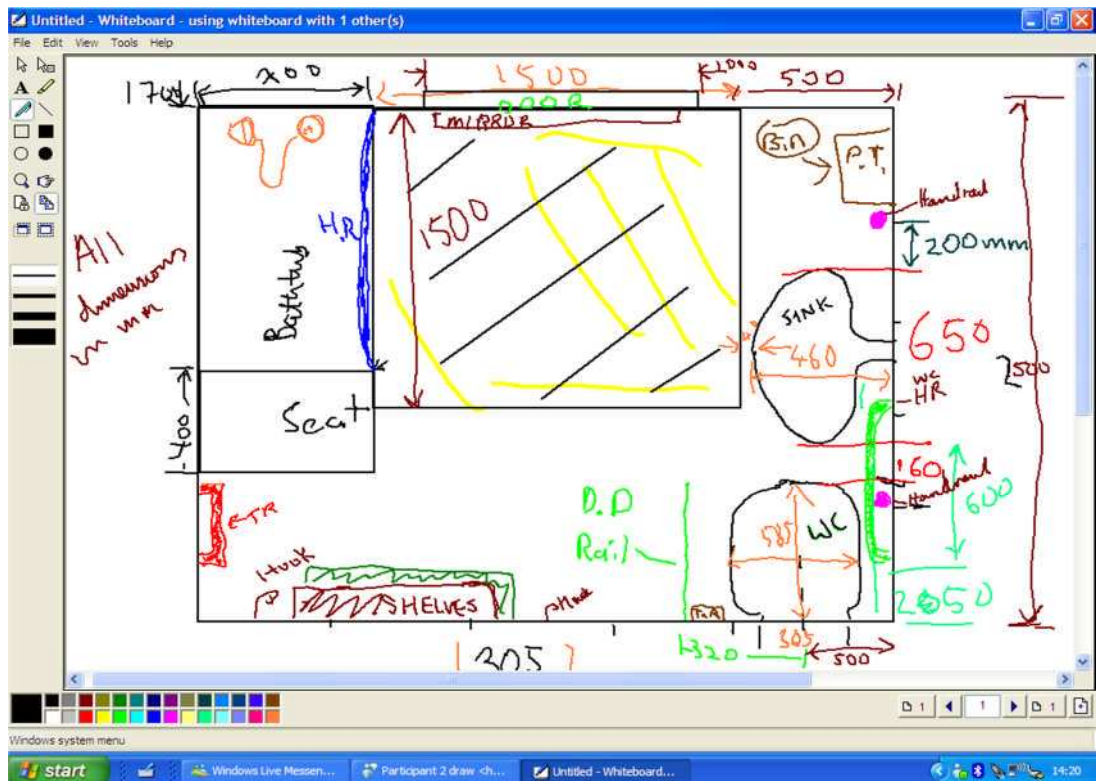

Figure 6-12: Bathroom design of the pair of participants with the highest mark in condition 2

Correlations were found when examining the relationships between the scores given to pairs and the utterances in all ten collaboration style categories for ‘referring to criteria’,

‘evaluating options’ and ‘non-task related utterances’. Correlations were calculated disregarding the experimental conditions as no significant difference was found between the overall performance of the two conditions.

Collaboration style category	Pearson correlation r-value (2-tailed) df = 18
Referring to criteria	0.56 (p<0.05)
Evaluating options	0.54 (p<0.05)
Non-task related utterances	0.58 (p<0.05)

Table 6-19: Correlation between collaboration style categories and performance score

The positive correlations between the collaboration style categories (see Table 6-19) the higher number of utterances found in ‘referring to criteria’, ‘evaluating options’ and ‘non-task related utterances’ was positively correlated to the performance score. Referring to criteria or the design guidelines and evaluating possible design options often during the task could help ensure that participants were able to form the best solution to satisfy the given guidelines.

It was further observed that a few participants used ‘emoticons’ or smiley faces provided as part of the IM feature (see Figure 6-13) mostly towards the end of the session when participants believed they had finished their task.



Figure 6-13: IM emoticons

6.7.5 Physical Observation

Each participant was observed by an experimenter who completed a physical observation checklist every five seconds during the task (see section 6.4.3.2). This physical coding was analysed and the means of each behaviour count are summarised and illustrated in Table 6-20 and Figure 6-14.

Physical Behaviour	Condition 1 (IM only)	Condition 2 (Audio and IM)
	Mean (SD)	Mean (SD)
Resting	248.95 (107.95)	229.95 (64.05)
Typing	187.00 (74.04)	35.00 (30.00)
Drawing	183.84 (91.10)	179.16 (73.05)
Writing on paper	30.37 (40.34)	3.74 (10.61)
Writing on screen (tablet)	6.42 (11.13)	0.00 (0)

Speaking	0.84 (1.58)	242.53 (89.21)
Speaking and drawing	0.00	18.74 (23.25)

Table 6-20: Means and standard deviations of physical behaviour for conditions 1 and 2

The mean of ‘speaking’ in condition 1 (IM-only) considered participants who spoke to themselves during the task, even though their partners could not hear their utterances.

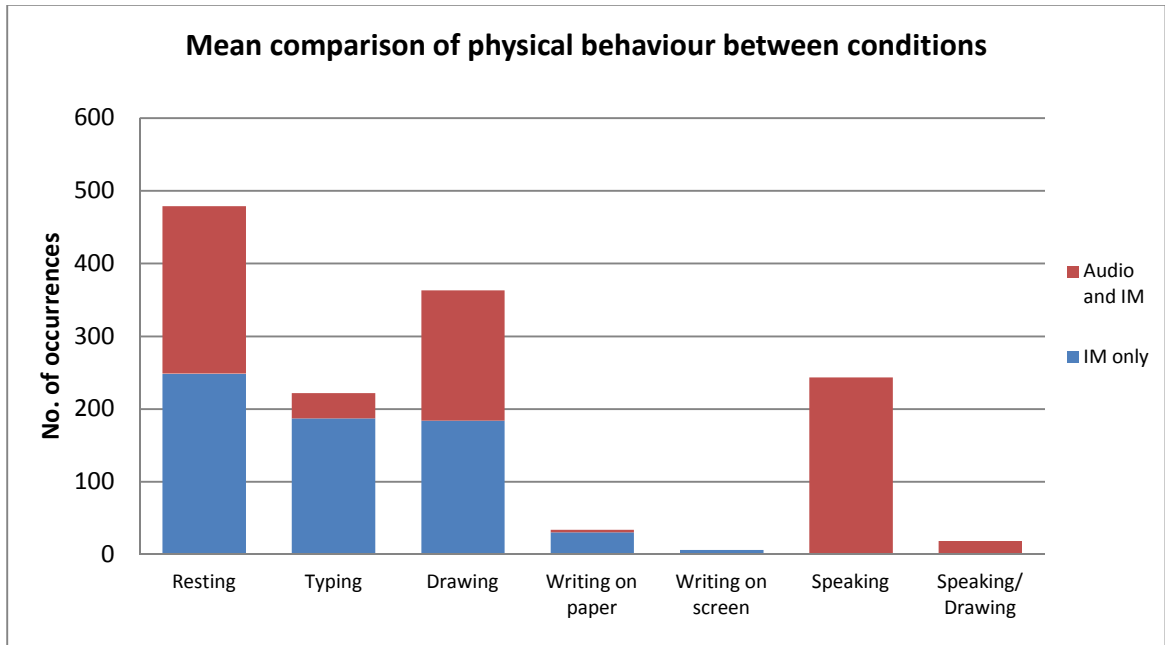

Figure 6-14: Mean comparison of physical behaviour between conditions

H₅: There is a difference between the physical behaviour exhibited between participants in the two experimental conditions

A series of t-tests were performed on the physical behaviour data observed by the experimenters during the experiment. Out of a total of seven individual physical behaviour categories (typing, speaking-only, speaking while drawing, resting, drawing, writing on paper and writing on shared whiteboard) only four significant differences were found (see Table 6-21).

Physical behaviour	Significant difference (df = 38)	Condition 1 mean (SD)	Condition 2 mean (SD)
Typing	t = 8.36, p<0.001	187 (74.05)	37.65 (30)
Writing on paper	t = 2.76, p<0.05	29.25 (40.34)	3.55 (10.61)
Speaking	t = 11.94, p<0.001	0.8 (1.58)	239 (89)
Speaking while drawing	t = 3.5, p<0.01	0 (0)	18.20 (23.25)

Table 6-21: Physical behaviour comparison between condition 1 vs. condition 2

It was expected that participants in conditions 1 and 2 would exhibit different physical behaviours, especially typing and speaking as participants in condition 1 were unable to exchange verbal communication during the task. In addition, participants in condition 1 were observed to be writing more information on blank sheets of paper during the task after

information had been given to them by their partner over IM. A chat history (i.e. exchanges between partners) could be referred to all the time during the task by scrolling to the top of their IM window. However, as all interactions took place on chat, it took longer for participants to browse and locate the specific information they required in the chat history. This might be the reason why many participants in condition 1 were seen to write more information down on paper than those in condition 2. Participants in condition 2 were able to exchange criteria by IM and continued their verbal exchanges during the task, and hence had a much shorter chat history. Some participants in condition 1 were also seen to speak to themselves during the task, even though their partners could not hear these utterances.

As participants within a pair were given a different set of criteria or design guidelines during the task, a series of T-tests were conducted to compare the physical behaviours of participants given design guideline A and participants given guideline B (see Figure 6-5). No significant difference was found between physical behaviours of participants given design criteria A or B in both conditions. No correlations were found for either experimental condition when examining the relationship between physical behaviours and the scores achieved by participants.

6.7.6 Subjective Response Analysis

Participants in both conditions were asked to rate the level of satisfaction on several aspects of their final designs (e.g. position of the door, WC, sink, bath and turning space) as well as their perception of the overall collaboration (e.g. communication, articulation and information sharing) during the task.

H_6 : There is a difference between the subjective response (i.e. satisfaction on final design and overall collaboration) between participants in the two experimental conditions

The questionnaire responses gathered from both experimental conditions were compared using a Mann-Whitney test and no significant difference was found indicating that the additional audio mode had no effect on the overall level of satisfaction on performance and collaboration. This suggests that participants who were communicating on IM only during the task felt they were able to complete the task as satisfactorily without audio.

Several correlations were found between the level of overall satisfaction (with the final design of the bathroom) rated by participants and several aspects of collaboration, regardless of the experimental condition. The results summarised in Table 6-22 indicate positive correlations between several aspects of collaboration and the overall level of satisfaction

with the final design. The last statement was a negative statement and therefore the negative correlation was expected – indicating that if participants agreed with the statement (i.e. found it difficult to share information with their partner), the overall level of satisfaction was rated lower.

Collaboration aspects which correlated with the overall level of satisfaction	Spearman's rho (p-value) N = 40
I have communicated with my partner articulately	0.60 (p<0.001)
I have found it easy to discuss different bathroom layouts with my partner	0.44 (p<0.01)
I have found it easy to ensure that my partner was looking at the same place on the drawing as me	0.58 (p<0.01)
Decisions were made within a reasonable amount of time	0.45 (p<0.01)
It was easy to discuss different design issues during the task	0.45 (p<0.01)
I found it difficult to share ideas with my partner	-0.42 (p<0.01)

Table 6-22: Summary of correlations found between the overall level of satisfaction and aspects of collaboration

In addition to the rating scale used, participants were asked to rate the overall level of difficulty of the task on a 10 mm line (they were asked to put a cross along the line to represent the perceived difficulty). A negative correlation was found between the overall level of difficulty and the overall level of design satisfaction ($r_s = -4.5$, $N = 40$, $p < 0.01$), indicating that if participants were highly satisfied with their final design, they perceived the task as being less difficult than those who were dissatisfied with their design.

Several correlations were found between the perceived level of difficulty of the overall task and several of the collaboration aspects (see Table 6-23). It can be seen by the negative correlations that the more participants in both conditions perceived that they were able to communicate with their partners - the lower they rated the level of difficulty. The last statement was a negative statement and therefore a positive correlation was expected.

Correlation between overall level of difficulty and aspects of collaboration	Spearman's rho (p-value) N = 40
I have communicated with my partner articulately	-0.66 (p<0.001)
I have found it easy to discuss different bathroom layouts with my partner	-0.66 (p<0.001)
I have found it easy to ensure that my partner was looking at the same place on the drawing as me	-0.51 (p<0.01)
Information was easily shared within the team	-0.46 (p<0.01)
Decisions were made within a reasonable amount of time	-0.60 (p<0.001)
It was easy to discuss different design issues during the task	-0.54 (p<0.001)
I found it difficult to share ideas with my partner	0.58 (p<0.01)

Table 6-23: Correlations between overall level of difficulty and aspects of collaboration

Participants were asked to rate the level of difficulty in using the drawing tablet as well as the IM text communication during the task. Correlations were also found between these two ratings regarding the communication and shared visualisation tools with several aspects contributing to collaboration. The only correlation found for IM was between the ease of use of chat and the ease of information sharing within the team ($r_s = 4.3$, $N = 40$, $p < 0.01$), but further correlations were for the drawing tablet ratings (see Table 6-24).

Collaboration aspect	Spearman's rho (p-value) for correlation with the difficulty rating of the drawing tablet N = 40
I have found it easy to discuss different bathroom layouts with my partner	-0.36 ($p < 0.05$)
I have found it easy to ensure that my partner was looking at the same place on the drawing as me	-0.38 ($p < 0.05$)
It was easy to discuss different design issues during the task	-0.49 ($p < 0.01$)
I found it difficult to share ideas with my partner	0.44 ($p < 0.01$)

Table 6-24: Correlations between the difficulty rating of the drawing tablet and collaboration

The statement regarding the use of the drawing tablet in the post-task questionnaire was a negative statement (i.e. "Drawing on the PC tablet was difficult"), therefore a strongly disagreement suggests the drawing on the tablet was easy.

Participants were able to leave comments at the end of the questionnaire. Twenty-six participants gave short comments and a summary of the responses is presented in Table 6-25. The majority of the responses were positive feedback on the task, with some suggestions that other technologies instead of the Paint application used to simulate a shared workspace would have been better for the task. However, Paint was selected instead of other drawing software (such as AutoCad, Pro/ENGINEER or Microsoft Visio) because it was easy to use and participants did not require background knowledge or training. Some participants indicated a preference for face-to-face collaboration for the task.

	Quotes taken from condition 1	Quotes taken from condition 2
Positive responses	<ul style="list-style-type: none"> • “At first there was quite a lot of information to get to grips with but once you get your head around it, it was quite easy to do. MSN was easy to use as used quite often, although never on design task. Whiteboard was very easy to use, will use again if needed. Quite enjoy the task good level of difficulty” • “Really like the whiteboard” • “Good fun, interesting to see/experience the challenges that come with not being in the same room as partner. Designing seems to be quicker and easier if together. Prefer to write and sketch by hand to get ideas across than to use interactive methods, though after this task I might give it a go! “ 	<ul style="list-style-type: none"> • “The exercise was interesting and challenging. With more practise of using the whiteboard, the design teams can work articulately even when in different locations .” • “Good experience. Communication was quite clear. The software used was accurate which made this design process go smoothly.” • “A fun and enjoyable task.”
Negative responses	<ul style="list-style-type: none"> • “Enjoyed task, but frustrating as didn't complete it. Partner was slow to respond” • “The technology was frustrating.” • “The hardest part was 2 people trying to draw on the same whiteboard without instant feedback which is obtained when able to talk to partner directly.” 	<ul style="list-style-type: none"> • “The whiteboard is hard to use.” • “Initial part of test was difficult, lots of information to relay.”
Responses on virtual collaboration	<ul style="list-style-type: none"> • “Much easier to talk about specifics in person. Good idea having virtual drawing though.” • “I would prefer to cut out object on paper and arrange them on scale drawing. Communication was unnatural” • “Hard to get points across without being face-to-face.” 	<ul style="list-style-type: none"> • “Close to being in the same room as partner.”
Suggestions on the technology	<ul style="list-style-type: none"> • “Would have been better to have Word as shared application, so can type criteria and share directly.” 	<ul style="list-style-type: none"> • “Would be easier if Skype was clearer and used other drawing tools other than Paint such as Visio instead of a whiteboard.”

Table 6-25: A summary of participants’ comments after task completion

6.8 Discussion

Verbal and textual exchanges over audio and IM in the two experimental setups were compared to investigate the influence of communication modalities on collaboration (i.e. the collaboration style categories) as well as overall performances. The overall communication was analysed and the total number of utterances during the task of the two experimental conditions were compared (combining both the audio and IM logs for condition 2). A

significant difference was found indicating that participants in condition 2 (with IM chat and audio) communicated more than participants in condition 1 (IM only), in particular participants in condition 2 gave more verbal instructions to each other during the task. Furthermore, when comparing the use of IM during the task between participants in both conditions, it was found that participants in condition 1 communicated more over IM when: sharing strategies, when giving each other directions to navigate to the same point of interest on the drawing, when discussing aspects of the drawing, when evaluating options and giving verbal instructions, than participants in condition 2.

It was observed that some participants in condition 2 were also using IM to send each other 'emoticons' or 'smiley faces' during the task and were also seen to exchange design guidelines over IM after having verbally read them out to their partner. This could indicate the use of IM to share important task information (chat history can be referred to throughout the session), allowing participants to include all the detailed descriptions of the design guidelines without having to repeatedly verbalise their information.

The influence of the communication modalities can be observed by the difference in the total number of utterances during the task. However the only significant difference in the way in which participant constructed their conversations during the task was shown by the higher level of verbal instructions given to each other in condition 2. Therefore it can be concluded for the majority of the collaboration style categories, participants in both conditions constructed their conversations similarly and hence the following research question was unsupported:

1) Does the communication modality (i.e. text-only vs. text and audio) influence the way participants in pairs construct their conversations?

The results suggest that participants in this condition 2 switched between audio and IM with some collaboration categories being communicated over IM as well as audio. The uniquely held design specifications were exchanged verbally and this was proportionally higher on IM than for the other collaboration categories. It was observed that seven out of ten pairs in condition 2 typed out their given design criteria on IM in order to exchange information with their partners during the task.

Performance between participants in the two conditions was compared and no significant difference was found, indicating that communication modality had no effect on the overall performance. Moreover, no significant difference was found when comparing the subjective

responses (i.e. satisfaction) gathered from the post-task questionnaires, thus the additional audio communication in condition 2 did not enhance or increase the level of satisfaction in performance or collaboration perceived by the participants. Therefore the following research questions were unsupported:

2) Does the communication modality (i.e. text-only vs. text and audio) influence the overall task performance?

3) Does the two types of communication setup affect the subjective ratings such as satisfaction and preference?

An analysis was conducted to investigate how participants in condition 2 used IM and audio during the task. Participants communicated more over audio and significant differences were found particularly when participants were referring to criteria, sharing strategies, describing a focal point or giving directions, discussing aspects of design, evaluating options, referring to the equipment and finally verbal instruction. Participants in this condition did not use IM at all when trying to ensure that they were looking at the same point on the drawing as their partner, or when they were evaluating design options during the task. Therefore with the availability of both modes of communication, participants in condition 2 used and utilised both modes differently, hence the following research question was supported:

4) Will the text and audio pairs use the IM and voice communication for different types of information exchange (collaboration styles categories)?

Finally the physical behaviours of participants observed during the task were compared between the two experimental conditions. Participants exhibited different proportions of the physical states during the task; those in condition 1 were typing more than those in condition 2, whilst participants in condition 2 were speaking more. Therefore the following research question was supported:

5) Will participants from the two experimental conditions exhibit different proportion of physical states (e.g. writing, typing, drawing, resting, reading and speaking)?

However, it was also observed that participants in condition 1 were writing down information sent to them by their partners over IM on paper more even though the chat history was easily accessible (i.e. by scrolling the chat page upwards, participants were able to view earlier messages throughout the task). An explanation for this could be that as IM was the only method of communication, participants were exchanging more messages, creating a

longer list of utterances during the conversation. Therefore for example, the information exchanged at the start of the 1-hour long session was pushed off the page and browsing (scrolling) to search for a specific message was difficult and more time consuming. Some participants in condition 1 were also seen to speak to themselves during the task even though their partners could not hear them.

6.9 Key findings from Chapter 6

This laboratory study conducted in this chapter aimed to examine a few aspects of virtual collaboration in order to identify ways to support a collaborative design task when participants are geographically distributed. Findings from this study are summarised in this section.

1) Is there a need for technology to support more than spoken language for planned and unplanned collaboration?

This study was conducted to simulate a planned collaboration where participants were required to virtually exchange their uniquely held information (i.e. the design guidelines) in order to complete a given design task. Participants were able to interact with each other using a real-time shared e-whiteboard, allowing them to see and draw on the same workspace as their partners. Only text-based communication was provided in the first condition while an additional audio feed was provided with the text-based tool in the second.

By analysing the IM logs taken from both conditions, it was clear that when given a choice between audio and text communication, participants in the second condition preferred audio and would only use text communication for some aspects of the collaboration (i.e. to exchange the textual design guidelines). In addition, participants also switched between audio and IM chat during the task when the quality of the audio was compromised (i.e. bad internet signals or audio connection during the task), or to clarify points in writing during the task (such as when participants were unable to hear each other because they spoke over each other). This suggests that even though the text communication was not adopted all the time, it still became useful at several instances during the collaboration, especially if the quality of the audio could not be guaranteed due to poor internet connection.

The shared workspace was also used to support collaborative design in this study. From the previous 'House Hunting' experiment, the information sharing method influenced the overall collaboration and the conversational structures, thus this feature was adopted in conjunction with the text and audio communication channel in this study. The interactive shared workspace in this task allowed participants to synchronously complete their design virtually

and remotely. Without this feature to support the spatial aspect of a design task, participants would have been required to divide the task and complete their drawings separately and then send files back and forth to each other (as reported in Chapter 3, Section 3.4.3). Therefore results from this experiment further suggest the importance of supporting more than spoken language especially if the virtual collaborative task involves the use and manipulation of spatial information.

2) How can technology help to maintain an awareness of remote colleagues and tasks?

The shared workspace provided to support virtual design allowed participants to see objects drawn by their partners during the task. However, the design of the Paint application used to simulate a virtual whiteboard does not allow users to see each other's cursors and therefore objects being drawn were not visible to their remote partners until the drawing was finished. This often meant participants were unable to anticipate where the next object would appear on the shared screen without communicating with their partner.

However, being able to view and interact with the same workspace while communicating over text and/or audio allowed participants to appreciate which part of the design or drawing their remote partners are working on. The presence of the live audio feed further supported awareness by allowing participants to hear utterances, the sound of their partner drawing on the tablet using the given stylus or when they are typing, thus updating their awareness of each other.

Technologies used in this laboratory study helped support awareness both visually (i.e. by text chat and shared workspace) as well as by audio. Participants in the text-only communication were able to type their current activity to each other (the IM feature indicates when their remote partner is typing). Awareness in this condition was supported by the technology, but users relied on each other to manually update their status when necessary. However this appeared easier when participants could hear utterances, which were incomplete sentences but were indicative enough to support awareness.

3) Is audio the most useful communication modality in remote tasks?

No significant difference was found between text-only communication and text and audio communication in terms of performance and user satisfaction; there was a difference in the overall number of utterances between the two conditions. Participants given audio as well as text communication made a higher number of utterances during the task. However the only significant difference when comparing collaboration style categories between the two conditions was in 'verbal instructions'.

In the previous 'House Hunting' task, the results suggest that audio was more valuable than the additional video feed of remote colleagues. However, in this experiment results suggest that audio (with the optional text) condition was not significantly different to the text-only communication. Therefore audio was not the most crucial communication in this laboratory study, although given the option, participants preferred to use audio more often than text.

4) Is a shared view of the workspace in remote collaboration more useful than a view of the remote colleagues?

Participants in both experimental conditions were able to view and draw in the same workspace during the task. Participants were unable to see a view of their remote colleagues. In the two conditions, with different communication modalities offered, the only constant parameter was the shared whiteboard application which was used by all participants to complete the task - performance was consistent in both conditions.

In the 'House Hunting' study, participants in some of the experimental conditions were able to see a live video feed of their remote partners during the task. However, no evidence was found to suggest that being able to a view of their remote partner had significant effect on performance or collaboration. However, the screen sharing facility, which was a mechanism to provide a shared workspace, had significant effects on the overall collaboration and the perceived difficulty of the task.

Even though the bathroom design experiment was not aimed to compare the difference between seeing a view of the remote colleague and having a shared workspace. The overall collaboration (i.e. the number of utterances in each of the collaboration style category) would have differed without the shared virtual whiteboard. Participants would have been spending more time grounding their conversations to ensure they were discussing the same part or object within their design and updating each other's status to maintain awareness without being able to see and sketch on the same drawing, which was observed in some of the experimental conditions in the 'House Hunting' task.

The results from this bathroom design experiment contributed to the findings previously presented in Chapter 5 (i.e. House Hunting), that a shared view of the workspace can be more useful especially when collaborating over spatial information.

6.9.1 Summary

A summary of key findings of how they contribute to further studies are presented in Table 6-26.

Chapter 6 key findings	
<i>Is there a need for technology to support more than spoken language for planned and unplanned collaboration?</i>	<ul style="list-style-type: none"> • There was a need to provide a shared workspace to enable synchronous collaborative design activities. • Both text and audio were adopted to support different collaboration style categories during the task. • Participants who were able to adopt both modalities switched between them during the task to accommodate different aspects of collaboration.
<i>How can technology help to maintain and awareness of remote colleagues and tasks?</i>	<ul style="list-style-type: none"> • Providing a shared workspace, audio and/or text during a remote collaborative design task helps participants to direct their attention to the point/object being discussed, check activity status and their task progress with each other. • Audio allowed participants to overhear each other. They were able to acknowledged activities with short utterances without formally asking for updates compared to text-only communication.
<i>Is audio the most useful communication modality in remote tasks?</i>	<ul style="list-style-type: none"> • No significant difference was found between text-only and text and audio communication on performance and user satisfaction. • Participants exchanged more utterances when communicating via an audio feed than communicating via text alone.
<i>Is a shared view of the workspace in remote collaboration more useful than a view of the remote colleague?</i>	<ul style="list-style-type: none"> • Participants were able to view and interact synchronously on the same virtual workspace during the task. • A shared view of the workspace was supported by text and audio communication, with results indicating there was no significant difference from one another. • Performance from both conditions was equally high and therefore not being able to see their remote colleagues did not appear to affect the overall objective of the task.

Table 6-26: Chapter 6 summary of key findings

Chapter 7 - Discussion

The overall aim of the thesis was to investigate the influence of communication modality combined with shared workspaces in virtual collaboration. The thesis examined the use of different technologies including novel (i.e. CoSpaces, DiFac and MRA) and off-the-shelf technologies (i.e. Skype and IM) and their influence on collaboration. All of the studies were conducted in various settings and at different stages of development of the technology, i.e. from the user requirement elicitation, to prototype evaluation and implementation in the real world.

This PhD research was funded by the CoSpaces project, which aimed to develop technologies to support collaboration in design and engineering. The work conducted in this thesis was grounded in the need to support designers and engineers in their virtual collaborative tasks and addressed issues which are of relevance in this type of work. The needs to understand and support collaboration are reflected on the EU funded projects, such as CoSpaces and DiFac, which aimed to improve collaboration in EU businesses in different industries to help increase their competitiveness. The CoSpaces project developed technologies to support collaborative work in co-located, distributed and mobile settings, by providing shared workspaces, while the DiFac project developed technologies to support virtual collaboration in remote maintenance, factory and product design, which incorporated shared visual information features, thus emphasising the importance of shared visual information in virtual collaboration, especially in spatially oriented tasks.

Previous research compared the use of uni- and multimodal channels such as text-based communication (i.e. email and IM) (e.g. Handel and Herbsleb, 2002; Dabbish *et al.*, 2005 and Lancaster *et al.*, 2007), audio and video-conferencing (e.g. Egido, 1988; O'Conaill *et al.*, 1993; Bellotti and Bly, 1996; Isaacs *et al.*, 1997; Mark *et al.*, 1999; Whittaker, 2003; Scholl *et al.*, 2006; Kushman *et al.*, 2008), and shared visual information (i.e. shared whiteboards and shared workspaces) (e.g. Schmidt and Bannon, 1992; Bannon and Bødker, 1997; Dillenbourg and Traum, 1999; Kraut *et al.*, 2003; Gergle *et al.*, 2004a; Ranjan *et al.*, 2007) to support virtual collaboration. Some benefits of shared workspaces have been identified in the literature (Kraut *et al.*, 2003; Gergle *et al.*, 2004a), however the design and use of shared workspaces is dependent on the workplace settings and tasks (Bannon and Bødker, 1997). Moreover, shared workspaces are often accompanied by auditory feeds but limited literature has been found to identify the differences between modalities to support shared workspaces and their combined effects, especially in design and engineering. Therefore the original

contribution of this thesis was an understanding of the differences between communication modalities when used in conjunction with shared workspaces and the overall influence of modality and shared workspaces on virtual collaboration. Several of the studies conducted in this thesis examined collaboration in real workplace settings (i.e. CoSpaces, DiFac, interviews with Skype users, and Company X), thus the findings from these studies contributed to the understanding of real world collaboration. Moreover, findings from these studies suggest that users use multiple technologies to support different aspects and stages of collaboration in real workplaces, which illustrate the importance of this thesis in investigating the combined effects of these technologies.

7.1 Discussion of Research Findings

The empirical work began with a series of studies examining collaboration in industry and in research settings to investigate the use of current collaborative technologies and their effects on collaboration in different workplaces. The technology end users took part in the majority of the studies in Chapter 3, which were also partly conducted to compare the appropriateness of different data collection methods for use in collaborative studies. Two laboratory studies were conducted to evaluate the influence of communication modality and the use of shared workspaces in collaborative tasks. Finally, a field study was undertaken to further evaluate the use of an 'always-on' technology which transmits audio-visual information across a virtual space, thus providing shared visual information of the working environment to remote colleagues. The key findings from these empirical studies are summarised in Table 7-1.

	Chapter 3	Chapter 4	Chapter 5	Chapter 6
Summary of study (Task, users and technology used)	<ul style="list-style-type: none"> • Six studies were conducted to evaluate different methodologies in different context of collaboration to further inform the designs of studies in Chapters 4 – 6 • Two interview studies were conducted. One with CoSpaces end user and another with researchers and technology end users in different workplace settings • One expert priority elicitation session was conducted to generate and prioritise features which a collaborative technology should support. This was conducted with 11 researchers • Two questionnaires were used, one was to evaluate DiFac technologies (i.e. with 20 users from the consortium) and another was an online questionnaire to evaluate the use of Outlook calendar in a research group • A case study was conducted to identify the type of technologies students preferred and adopted to support collaboration in student projects. 	<ul style="list-style-type: none"> • Field study involving real end users in a commercial setting where participants within Company X were required to collaborate with co-located and some with distributed colleagues as part of their tasks. • MRA was implemented in the real world for the first time and this study evaluated the impact of such communication technology on collaboration at Company X • No evidence was found to suggest that an always-on video-conferencing system such as the MRA was beneficial to collaboration at Company X 	<ul style="list-style-type: none"> • Laboratory study which recruited university students and staff to take part in pairs to agree on three houses they would like to let together according to the given criteria • Six experimental conditions involving the use of screen sharing, video-conferencing and audio communication • Conflicting criteria were given to each participant in a pair who were required to share this with their partner in order to compromise and make a joint decision at the end of the task • Shared screen facility used in this study only allowed participants to read and view information on the screen without being able to manipulate the on-screen objects 	<ul style="list-style-type: none"> • A laboratory experiment further investigating the use of shared screen applications where participants were able to manipulate and create on-screen objects • Engineering students were recruited to take part in the task as they were required to design a bathroom layout and submit a plan-view of the design at the end of the task • The overall design specification were divided amongst participants within a pair who were either able to communicate with their partner by text-only, or both text and audio • All pairs were able to use the shared whiteboard where they worked on their design sketches

	Chapter 3 key findings	Chapter 4 key findings	Chapter 5 key findings	Chapter 6 key findings
<i>How important is it for technologies to suit user needs, context of use and task? Do users alter behaviours to fit technological constraints?</i>	<ul style="list-style-type: none"> • User requirements and task needs influenced the use of technologies (e.g. user requirements elicitation for DiFac and CoSpaces technologies to support design tasks) • User preferences, tasks and availability of other colleagues influenced technologies selected • Users adapted their behaviours such as recording meetings on Outlook as well as personal paper diary to fit the requirement to share work calendars 	<ul style="list-style-type: none"> • The implementation was initiated and championed by the management. The majority of the participants were enthusiastic and cooperative during the evaluation • The usage declined after end users tried the technology out of curiosity at the start of the trial • The majority of collaboration was co-located and therefore there was no need to contact remote colleagues frequently • User needs did not match the technology which was reflected in the usage decline 		
<i>How can technology help to maintain an awareness of remote colleagues and tasks?</i>		<ul style="list-style-type: none"> • MRA can support quick glances and overhearing in remote settings, however the background noise transmitted over the MRA may have distracted other people within the audio range resulting in users switching audio off. Furthermore, there was no evidence to suggest that the MRA did support awareness at Company X • If participants were required to collaborate remotely then supporting awareness would allow colleagues to keep an up- 	<ul style="list-style-type: none"> • Being able to view a remote colleague's screen allow users to acknowledge their colleague's focus of attention and what information was being seen during the task, thus helped participants maintain an awareness of each other 	<ul style="list-style-type: none"> • Providing a shared workspace, audio and/or text during a remote collaborative design task helps participants to focus their attention to specific points and check each other's progress • Audio allowed participants to overhear each other. They were able to acknowledge activities with short utterances without formally asking for updates compared to text-only communication

		to-date view of remote activities		
<p><i>Is audio the most useful communication modality in remote tasks?</i></p>	<ul style="list-style-type: none"> • Audio and text-based communication modalities were highly used to support collaboration, and these two modalities were often used to complement each other 	<ul style="list-style-type: none"> • During the trial, participants reported technical difficulties with the audio system resulting in users switching speakers off • Tasks conducted over the MRA were mainly brief verbal exchanges, so the audio supported these, but was not seen as useful • Participants relied on email, logging system, file sharing and Wikis, all of which support the exchange of textual or spatial information. The telephone was also used as a supplement 	<ul style="list-style-type: none"> • Compared to video-conferencing, audio alone was sufficient in supporting the task where spatial and non-spatial information was shared and interpreted by remote colleagues in order to make collaborative decisions 	<ul style="list-style-type: none"> • No significant difference was found between text-only and text and audio communication on task performance and user satisfaction • Participants exchanged more utterances when communicating via an audio feed than communicating via text alone • No evidence was found to suggest that the additional audio feed support collaboration more effectively in this virtual design task than text-only communication
<p><i>Is there a need for technology to support more than spoken language for planned and unplanned collaboration?</i></p>	<ul style="list-style-type: none"> • The always-on nature of the MRA allowed users to see other remote colleagues and update their awareness of remote activities without verbal communication. This was seen as a way to support more than spoken language between remote users. However end users in the study did not need to collaborate with remote colleagues on a regular basis and therefore did not benefit from this • Users from Office A reported that it was nice to finally see the remote office for the first 	<ul style="list-style-type: none"> • Supporting more than verbal communication influenced conversational structure in planned collaboration • Being able to view/share spatial information supports the sharing of uniquely held information • Users were seen to verbalise spatial uniquely held information more when only spoken language was supported, thus more time was spent exchanging information 	<ul style="list-style-type: none"> • Supporting more than verbal communication influenced conversational structure in planned collaboration • Being able to view/share spatial information supports the sharing of uniquely held information • Users were seen to verbalise spatial uniquely held information more when only spoken language was supported, thus more time was spent exchanging information 	<ul style="list-style-type: none"> • There was a need to provide a shared workspace to enable synchronous collaborative design activities • Both text and audio were adopted to support different collaboration style categories during the task • Participants who were able to adopt both modalities switched between one or another during the task to accommodate different aspects of collaboration and communicated more on audio

	time over the MRA as they have never been to the Spanish office			
<i>Is a shared view of the workspace in remote collaboration more useful than a view of the remote colleague?</i>	<ul style="list-style-type: none"> • A shared view of the workspace was supported by design technologies developed in DiFac and CoSpaces • Application sharing was perceived as necessary to support collaboration by participants in the expert elicitation session • No results reported the usefulness or importance of viewing remote colleagues during collaboration 	<ul style="list-style-type: none"> • Some participants reported there was no need to see remote colleagues during collaboration as email and the telephone were sufficient and effective enough • Some reported being able to screen share would help collaboration or being able to point a web camera to the screen (creating a shared workspace) and point to where they were looking at with their finger would help clarify conversations 	<ul style="list-style-type: none"> • Being able to see a view of the remote colleague had no significant difference on collaboration, user satisfaction and performance • The presence of the shared workspace better supported the conversational structure of collaboration especially when sharing uniquely held spatial information 	<ul style="list-style-type: none"> • A shared view of the workspace was supported by text and audio communication, with results indicated no significant difference between them • Performance from both conditions was equally high and therefore not being able to see their remote colleagues did not appear to affect the overall objective of the task
<i>Does being able to see and hear remote colleagues enhance user satisfaction?</i>		<ul style="list-style-type: none"> • There was no strong evidence to suggest that users felt being able to see remote colleagues all the time was enhancing relationships or user satisfaction 	<ul style="list-style-type: none"> • Being able to see as well as hear remote colleagues had no influence on the overall user satisfaction compared to audio-only communication 	

Table 7-1: Summary of thesis key findings

7.1.1 Communication Modality

Objective 1: "Understand and evaluate the influence of communication modality on collaborative tasks"

This objective was addressed in Chapters 3, 4, 5 and 6 with a series of empirical studies to understand the current use of technologies to support collaboration and to investigate the influence of communication modality on different collaborative tasks. Furthermore, audio, text-based and video-conferencing technologies were compared in two laboratory studies and one field study. The following questions with regards to supporting virtual collaboration were investigated in these chapters:

- How important is it for technologies to suit user needs, context of use and task? Do users alter behaviours to fit technological constraints?
- Is audio the most useful communication modality in remote tasks?
- How can technology help to maintain an awareness of remote colleagues and tasks?
- Does being able to see and hear remote colleagues enhance user satisfaction?

Findings from these studies, especially those from Chapter 3, suggested that in real workplaces and academic settings, users often adopt more than one off-the-shelf and/or novel technology to support co-located and virtual collaboration. Collaborative tasks examined included spatial and non-spatial tasks. These technologies were used to facilitate communication, information sharing and help maintain an awareness of remote colleagues. Audio is often used to complement other modalities such as text and visual information (i.e. drawings and sketches). Users reported sending information to their remote colleagues in advance by email prior to a telephone conversation, or using the telephone to clarify text or spatial exchanges (i.e. by email). This allowed them to have shared visual information ready before communication.

Audio and audio-visual (video-conferencing) were examined in this thesis with regard to how they support remote collaboration especially when remote users are required to share textual and spatial information. No difference between audio and audio-visual communication was found on collaboration, user satisfaction and task performance. The results contrasted with the findings by Olson *et al.* (1995), which suggested that audio-visual was as good as face-to-face interaction in terms of performance while audio-only provided poor quality discussion, resulting in lower user satisfaction and higher perceived difficulty in communication. It was initially expected that the additional video-feed providing a view of the remote participants would help enhance the user experience as suggested by the literature (Egido, 1988; Olson *et al.*, 1995; Olson and Olson, 2000). However, the data

obtained did not support this prediction and the video-conferencing system had no additional value to the overall collaboration than audio-only communication. The findings from this thesis supported the work by Fussell *et al.* (2000), Whittaker (2002) and Kraut *et al.* (2003), which suggested that speech alone was sufficient to support virtual collaboration unless interpreting social cues was an important part of the interaction. As participants who took part in the studies in this thesis were invited to bring someone they knew to participate with them in the experiment, many brought people they knew well (i.e. friends, siblings, colleagues, and partners). The pre-established interpersonal relationships within their pairs might have reduced the importance of social cues and the level of formality in the way they communicated with each other during the task. Participants spoke casually with their partners during the task, which might not be the case if they had not known each other prior to the task. The findings could further suggest that video-conferencing does not add value to collaboration, especially when users have pre-established interpersonal relationships, thus no influence on user satisfaction. Moreover, the context of use in which audio and audio-visual was compared in this thesis was not a physical task (i.e. where physical objects were being manipulated or referenced by remote partners), therefore being able to see a view of their partners provided no further task information to the participants, as gesturing or physical movements were not essential to the task.

A video feed was provided by the MRA technology which was installed at Company X to support planned and unplanned virtual collaboration, awareness, workplace relationships and user satisfaction. However, the additional video allowing users to see into remote offices as an extension of their own office did not strongly affect or improve user perceptions of interpersonal relationships or the overall collaboration. The perceived usefulness as well as the level of use of the MRA declined shortly after installation, similar to the findings by Baecker *et al.* (2008) on the use of media spaces, however privacy or the self consciousness of being seen by virtual colleagues as suggested by Avrahami *et al.* (2007) and de Vasconcelos Filho *et al.* (2009) were not the causes of the decline. Privacy might not have been an issue at Company X due to the organisational culture of the company, where the layout of the main head office was already an open-plan office with directors sitting amongst other employees, thus participants were accustomed to being overhead, or seen by other colleagues. However, the poor quality of the audio and video was one of the reported causes of the decline in usage, similar to the findings of Baecker *et al.* (2008). The poor audio and video was partly because of the internet connectivity and this further prompted the MRA developers to

improve on the audio and video quality for the next version of the MRA, to ensure better quality audio and visual feeds.

It was concluded after the implementation at Company X that the MRA system was not yet commercially viable and some technical issues needed to be addressed (i.e. the constant requirement of a high internet bandwidth). The company was required to upgrade their internet service provider prior to the start of the MRA study to accommodate the high bandwidth requirement by the system. This suggested that potential organisations wanting to adopt the system would require a level of financial investment in order to upgrade their existing internet to accommodate the system needs. Moreover, many countries (as reported by the CoSpaces end users) do not currently provide internet infrastructure to support such high bandwidth, which may result in the MRA system being perceived as an unfeasible investment.

Initial reports of user needs for the MRA system at Company X as suggested by management were not supported or shared by the real users. Employees reported that there was no need to see their remote colleagues and that their existing collaboration at the organisation was already effectively supported. The majority of collaboration was co-located within the main head office, where most of the employees are based, thus there was little need for virtual collaboration. Employees seemed to welcome the technology in the pre-installation interviews, which could be because the installation of the MRA had already begun, thus the level of anticipation and curiosity of the technology was high or because employees were aware that the implementation of the technology was management driven, causing false reactions and acceptance of the technology. This initial enthusiasm obtained in the pre-installation data might have hidden the mismatch between the MRA functionality and user needs for virtual collaboration. Users did alter their behaviour to try and incorporate the MRA technology as part of their work after the installation. However this was not sustained as there was no need to use the technology and users reverted back to their previous methods to collaborate.

The use of the MRA was not fully supported at Company X and the technology gave no additional value in terms of supporting virtual collaboration. The findings supplemented the work by Tollmar *et al.* (2001), which suggested that users would initially use new technologies out of curiosity, however if they later find that there was no real context or purpose for interactions, the usage declines. Furthermore, the decline could also be related to the concept of 'media stickiness', as users were familiar with existing systems and thus did

not feel the need to commit to the MRA fully (Huysman *et al.* 2003). This study highlighted the importance of the consideration of user needs, context of use and task specification, supplementing the existing work in the literature (Clark and Brennan, 1991; Driskell *et al.*, 2003, Gergle *et al.*, 2004a; Lauche, 2005; Beranek and Martz, 2005; Andres, 2006, Bergiel *et al.*, 2008). However, the findings from this study, which was the first MRA evaluation outside the development and academic setting, highlighted the technical difficulties for further development.

The bathroom design task investigated the influence of text-only and a combination of text and audio communication on a collaborative design task. In this laboratory study, participants working in a pair were given half of the design guidelines each and were required to exchange the uniquely held information with each other in order to complete the design task. They were able to view and simultaneously sketch out their design on the same virtual whiteboard during the task. Participants in the first condition communicated via text-only IM whilst those in the second condition were provided with text and audio communication.

Given the choice between the two modes of communication, participants were seen to communicate more over audio than on IM. The mean number of utterances between partners during the task was higher over audio than on IM. IM was observed to be primarily used to exchange text-based design specifications while audio was used for other parts of the collaboration (e.g. discussion and evaluation). This suggests that a text-based channel is useful but is more suitable to support the exchange of textual information, when used alongside audio communication. The textual exchanges were kept short and succinct whilst the main communication was conducted verbally. This could be due to the fact that the effort required to type is higher and thus it was easier for participants in this condition to speak. Straus and McGrath (1994) and Nardi *et al.* (2000) compared text-only communication with face-to-face communication (i.e. audio-visual) and found that interaction was much less in the text-based communication in terms of quantity. It was suggested by Nardi *et al.* (2000) that users preferred to use IM to supplement other media during a group discussion (i.e. more than two participants) in order to establish and maintain a social link with others. The user behaviour observed in this study contradicted the findings of Isaacs *et al.* (2002a), which suggested that users rarely switch media mid-conversation, when participants switched between audio and text communication during the design task.

The task performance between the IM-only and the IM and audio conditions was not significantly different. This finding was similar to that of Baker (2002) who found no

difference in performance between audio-only and text-only communication. However, the results found in this thesis suggested that even though participants communicated verbally over the audio feed more when provided with a choice, they can perform equally well without this audio feed. This suggested that audio was not the most useful communication modality. This contrasted the media richness theory (Daft and Lengel, 1986) as the theory suggests that audio, which supports higher information richness than the text-only communication, should allow remote partners to exchange information and understanding more effectively in tasks with high uncertainty and ambiguity. Participants were able to rely on IM to exchange information sufficiently. However this could be due to the presence of the shared whiteboard, which allowed them to make explicit references on the drawing, which their partners could also see and interact with, thus reducing ambiguous information. This helped reduce the need for participants to verbalise spatial information; simply by drawing on the shared whiteboard and replacing communication with action.

Shared visual spaces are often accompanied by auditory feeds to provide common workspaces (Kraut *et al.*, 2003). However, limited literature was found to indicate whether audio was the most appropriate mode of communication in comparison to video and text, to support shared visual. Overall, it appears that the communication modality has no effect on the task performance or subjective responses on satisfaction. No significant difference on collaboration was found between audio-only and audio-visual, while a difference in the amount of communication was found between text-only and text and audio communication. Users communicated more when they were able to speak to each other directly when compared to the text-only communication where users were required to type. However, the presence of audio and video, which provided synchronous feedback during virtual collaboration, allowed users to update and maintain an awareness of remote colleagues with less effort than those communicating by a text-only channel.

7.1.2 Shared workspaces

Objective 2: "Investigate the use of shared workspaces and shared visual information integrated with synchronous communication tools in collaborative tasks"

This objective was accomplished through the laboratory and field studies. The use of shared workspaces was adopted to support virtual collaboration, and not as a replacement of other modalities in this thesis. The aim of providing a shared workspace was to support the use and exchange of spatial and non-spatial information important to the remote collaborative task. The following questions were addressed in these studies:

- Is there a need for technology to support more than spoken language for planned and unplanned collaboration?
- Is a shared view of the workspace in remote collaboration more useful than a view of the remote colleague?

Studies have found that a video-feed allowing users a shared view of the workspace has different effects on the overall performance of complex collaborative tasks (e.g. remote maintenance) (Veinott *et al.*, 1999; Whittaker, 2003; Ranjan *et al.*, 2007), while helping to establish and maintain awareness (Nardi *et al.*, 1993; Kraut *et al.*, 2003; Gergle *et al.*, 2004a). However, very few of the CoSpaces end users reported the current use of a shared application tool or a video-conferencing system in conjunction with other technologies to support design tasks. It was reported in the interviews that difficulties were faced by many users in different countries, especially smaller companies as these tools often require high internet bandwidth, which the companies' existing infrastructure do not support. This was also a problem at Company X, where the company was specifically required to upgrade their existing internet bandwidth prior to the installation. In addition, users reported that some colleagues, especially in design and engineering, were reluctant to use application sharing tools, which could be due to the knowledge management culture or individual concerns about confidentiality which had no actual basis in policy.

The majority of the CoSpaces interviewees reported the need for shared visualisation as not being able to synchronously share spatial information was one of the most difficult issues in virtual collaborative engineering. The lack of shared visual environment means that users are unable to make deictic references to indicate to the remote colleague which point is being discussed during a telephone or email communication and are required to verbalise spatial information to one another. This increases difficulty in conversational grounding, which further complicates collaboration (Clark and Brennan, 1991; Whittaker, 2002).

The literature reports the importance of a shared visual workspace for improving performance in complex remote spatial tasks (Nardi *et al.*, 1993; Kraut *et al.*, 2003; Brennan, 2004; Gergle *et al.*, 2004a; Ranjan *et al.*, 2007); these findings were further supported by interviews with the CoSpaces end user partners who were mainly engineers and designers, who reported the difficulties in verbalising and communicating lexically complex spatial information.

The 'House Hunting' study examined three different methods of information sharing using the hidden profile concept (i.e. 50% of information per participant in a pair without a shared

screen, 50% of information per participant in a pair with a shared screen and 100% of information without a shared screen). This simulated real life situations where virtual teams are composed of members from different backgrounds who are required to share their knowledge with each other. The differences in the number of utterances in various collaboration style categories suggest that shared visual information influenced the level of information exchanged and conversational grounding. Participants who did not see their partner's screen during the task were forced to verbalise more spatial information such as explaining where the properties were located on the map. These findings agreed with the 'least collaborative effort' concept by Clark and Brennan (1991), as those who could see their partner's screen or were given all the information explained or verbalise this information less, believing their partners could see pieces of information themselves.

Performance was also higher when participants were given all of the information compared to those with half of the information who were required to complete the task without being able to see their partner's screen. This suggested that a combination of information sharing methods and shared visual information can influence overall collaboration, performance, user satisfaction and perception of task difficulty more so than communication modality. The results from this study were similar to that of by Nardi *et al.* (1993) and Kraut *et al.* (2002b) which suggested that using video-as-data in spatial and textual task is more beneficial than providing a view of remote colleagues. The results in this study also suggested that communication modality has little influence in this context of use.

The bathroom design task adopted the use of a shared workspace as part of an integrated solution with text-only or text with additional audio communication to support a virtual design task. Participants in both of the experimental conditions were able to use the application sharing facility which provided a shared workspace during the task. However there was no significant difference between the communication modalities. This suggests that as long as the available communication channel sufficiently supports verbal exchanges or utterances, shared visual information can reduce the need for participants to verbalise spatial information, thus allowing participants to concentrate on the task. Results from the bathroom design task further suggested that having a shared workspace as well as other synchronous communication channels could help team awareness by allowing participants to have an up-to-date understanding of what their partner was doing, or which part of the drawing was being worked on, as they could see a view of the workspace.

Users at Company X had access to the MRA system which provided continuous audio-visual connections with remote offices in the same virtual space. The shared working environment between remote colleagues was facilitated by this 'always-on' connection, allowed users to see into another remote office or hear remote conversations. This provided a view of remote offices to supplement other existing communication modes (such as email, the telephone), while the video-conferencing facility of the MRA aimed to allow participants to gain a sense of togetherness, establish relationships with remote colleagues, maintain awareness and thus improve the overall collaboration within the organisation. However results indicated that within this context of use, the MRA had no influence on the overall collaboration or altered the methods of communication at the organisation. Users reverted back to their existing methods of communication and the MRA was not adopted fully to support collaboration. Collaborative tasks conducted at Company X were mainly conducted via email or the telephone prior to the implementation of the MRA system. After the initial installation and the first few weeks into the trial, users reported that they did not believe the MRA could replace email or the telephone.

Overall, results from these studies indicate that shared workspaces or shared visual information could be used to support virtual collaboration and have positive effects on spatial tasks. In addition, the presence of shared visual information in combination with other communication modes could help support awareness of remote colleagues and their activities, thus helping to reduce communication effort as suggested by the 'least collaborative effort' principle (Clark and Brennan, 1991).

Finally, the presence of a shared workspace in a spatially oriented task ensured that unimodal communication (i.e. text-only or audio-only) alone was sufficient to support virtual collaboration in the laboratory studies. Being able to view remote partner's screen, or a shared e-whiteboard help reduce uncertainty and complexity of the spatial oriented task by providing visual co-presence amongst virtual team members. Therefore audio and/or text-only could both be used to accompany shared visual information and users would adopt these available modes of communication differently, for various aspects of one continuous task, without negative effects on performance or satisfaction. However, the uniquely held information is better supported with the presence of a shared workspace than without. This suggests that in a spatially oriented context of use, users can benefit from being able to see a view of the virtual workspace (i.e. a 3D model or a drawing), during collaboration, regardless of communication modes adopted. However, the CoSpaces end users reported that security of information is important, thus the use of bespoke application sharing tools to protect the

confidentiality of information may be more appropriate than using off-the-shelf application sharing tools.

7.1.3 Approaches for collaborative studies

Objective 3: “Evaluate approaches to examine the use of technologies to support collaboration in a range of contexts”

Qualitative and quantitative approaches have been used throughout this thesis as a means of data collection and analysis to investigate collaboration and the influence of technologies on collaboration. The findings from the pilot studies conducted in Chapter 3 helped inform the design of the laboratory studies as well as the case study conducted at Company X.

This objective was initially accomplished by reviewing the methods used in the literature to measure collaboration. The most potentially suitable methods were then adopted in the pilot studies presented in Chapter 3. Empirical data collection methods such as questionnaires, interviews, expert structured brainstorming sessions, case studies and laboratory studies were used to examine collaboration in different work settings. It emerged that the nature of collaborative tasks dictates the suitability of data collection methods. Results from these studies suggested that these methods are valuable for measuring collaboration when used alone, or in combination with each other.

Collaboration itself is a complex multi-factorial notion and is difficult to examine as it can involve two or more participants interacting with each other and with technologies, remotely. Furthermore, individuals within a team do not always interact with their technologies in a similar manner as their work colleague or even share the same expectations about how these tools work, even for common ones, such as email (Thomas and Bostrom, 2005), adding to the complexity of collaborative studies. Therefore, studying the collaboration of two or more two participants in real life or in a laboratory situation requires considerable preparation and planning in terms of the data collection and analysis methods used. With this consideration, the laboratory experiments were therefore limited to two participants to ensure feasibility of data collection and equipment use as well as restricting the level of complexity of the overall collaboration.

Two types of semi-structured interviews were reported in Section 3.4 (Chapter 3), the one used in the CoSpaces was more detailed, gathering information regarding the nature of collaboration at work, tasks, teams, technologies and future visions. The second type of interview was more specific to the use of Skype. The quantity of data gathered from the CoSpaces and Skype interviews was vastly different as the CoSpaces interviews were much

longer and more detailed. However, the quality of the data gathered for both of the studies were suited to the research interest of each study and therefore this suggested that semi-structured interviews could be modified appropriately to examine collaboration in different contexts. These two interview studies contributed to the design and preparation of the interviews conducted at Company X prior to the installation process.

The interviews at Company X were more flexible, utilising a list of probing questions, while allowing participants to discuss additional issues. These interviews were conducted to understand the current collaboration, the user requirements for, as well as perceptions of, new technologies at the organisation. Other information was also gathered regarding the organisational structure, relationships between co-located and distributed colleagues, as well as positive and negative feedback of the current technologies, and on the organisation as a whole. The main problem with the interview sessions conducted at Company X prior to the installation was that, even though all the employees at the head office were not directly informed of the technology implementation, participants had been able to see some of the equipment around the office and part of the hardware installation process. In addition, the implementation was management driven, which might have lead to false acceptance and enthusiasm in the employees. By the time the interviews were conducted, many participants had already assumed a new piece of technology was being installed to support communication. This anticipation may have influenced the responses in these interviews. Many participants reported collaboration with remote colleagues abroad, even though remote collaboration did not occur frequently (which was captured by the pre-installation questionnaires). Unfortunately the enthusiasm and the level of acceptance towards new technology which came across in the interviews were not reflected in the level of use of the MRA system after the installation. It was observed from this study that the data collected in the field can often be influenced by other factors, external to the study (i.e. management pressure), thus biasing the data captured. Without being able to control variables and observe or record behaviours, measuring collaboration in the field can further be influenced other factors such as the availability of staff, time and financial support, which affect the precision of the experimental design. Ideally, the interviews or pre-installation questionnaires should have been conducted before the start of the installation process, however, due to the project time constraints as well as the time required to order equipment and upgrade the internet infrastructure, there were delays and overlaps in the different stages of the project. These factors influenced the extent to which data could be collected in the field, thus the methodology employed in the field in studies (including the CoSpaces user requirements, the

DiFac evaluation and the MRA implementation at Company X) were less controlled than laboratory studies. However the data captured from the real end users provided valuable contributions into the understanding of collaboration in the real world. However, further laboratory studies were conducted as part of the thesis to examine aspects of collaboration which could not be easily captured in the field.

Questionnaires and checklists were adopted during the data collection process in the laboratory studies. No interviews were conducted as audio and video were used to record behaviours for further analysis. It could be argued that laboratory studies may not simulate real life scenarios where participants would be subjected to external factors and disturbances during remote collaboration. However the data captured from laboratory studies were used to isolate the fundamental effects of specific dependent variables which would have been difficult to measure in the field. Therefore the laboratory studies in this thesis were used to complement findings from field studies. It is important to realise that more than one method of data collection is often required to measure collaboration in order to capture adequate information on all the factors under examination.

7.2 Strengths and Limitations of Research

This research aimed to examine the use of synchronous collaboration technologies and shared workspaces to support virtual collaboration, especially in spatially oriented tasks. One of the main strengths of this thesis was the involvement of real end users from the CoSpaces, DiFac and Company X studies, thus the data obtained were from real-life collaboration. In addition, different stages of collaborative technology development were also considered, from the user requirements elicitation stage, through to prototype evaluation and final implementation in industry. Findings from both the CoSpaces and Company X users provided insights into collaboration at work, in two different industries, both involving design and development work, but in different settings. The type of engineering design work reported by the CoSpaces users involved more 3D and spatial information compared to the software development work at Company X, which involved designing text-based computer programming codes.

Even though the information involved in these two case studies differed, the use of similar technologies such as email, file sharing and the telephone were reported. This suggested that, even though industry users have tried different alternatives to support collaboration, email and the telephone were still used the most. Users from both case studies reported the requirement for, and some existing use of, shared workspace applications. This provided

some indication that industry users are interested in being able to see a shared view of the workspace in virtual collaboration.

Results from the laboratory studies conducted in this thesis on the information sharing methods (i.e. shared workspace, and the amount of information shared amongst remote users) has contributed to the area of supporting virtual collaboration, indicating that the presence of a shared workspace has more significant value to collaboration, regardless of the communication mode available.

Collaboration is complex and there is limited literature identifying factors influencing collaboration, however it was observed that collaboration is often context specific. This means collaboration varies depending on individuals, team composition, task, members' relationships, preferences, task, urgency, the technologies used, and the organisational structure and culture. Differences between the workplace settings were identified by the results from the expert priority elicitation session (academic setting) and that of the DiFac study (commercial and engineering). Therefore more qualitative and quantitative research is required to collect different profiles of collaboration in order to examine whether the same factors influence and/or contribute to the success of virtual collaboration in different workplace settings with different types of users.

The laboratory and field studies were conducted using off-the-shelf technologies (Skype and Windows Live Messenger) as well as the MRA system. Results and key findings may differ as newer versions of these technologies become available, or indeed if different tools were adopted for further research. The usability and technical difficulties which occurred during these studies were not addressed as part of this research thesis. Similar to many technology implementations, the introduction of the MRA system at Company X was management driven. This could therefore have influenced the findings regarding the impact of the system on the organisation's collaboration.

The laboratory studies aimed to identify the influence of adopting such technologies to support collaboration and therefore methods were focussed on examining dependent variables quantitatively. The performance schemes of both of the laboratory studies were designed to evaluate performance differences, without taking into consideration participant's feedback on their perceptions of the importance of each of the given criterion. Therefore further qualitative examination could have been undertaken in order to evaluate whether participants were able to satisfy what they believed were high priority criteria, for example. In addition, participants recruited to work in pairs knew each other prior to the laboratory

experiments and this pre-established interpersonal relationship could have influenced the way in which they communicated with each other, which could have been different to those who did not know each other well. The influence of interpersonal relationship on collaboration in similar settings could further be investigated.

Due to the cost and logistics of measuring synchronous collaboration of more than two users, the experiments were restricted to only paired work with a limited number of eight pairs per experimental condition. The team combination as well as number of colleagues could be further examined to identify whether the collaboration is influenced differently. Participants in both laboratory studies were university students and staff, therefore a wider range of participants could be further examined. Longitudinal studies or tracking of a virtual team over time and focusing on the achievement of a specific collaborative task is also necessary to understand the complex nature of collaboration and user interaction with technologies.

Chapter 8 - Conclusions

Organisations are moving towards virtual teams whose members are geographically distributed while working and collaborating as part of a team to achieve common goals. The nature of these teams allows the recruitment of experts from all over the globe, without the restriction of their physical locations in order to gain from their expertise. Many organisations also benefit from strategically locating their employees away from the head office to be closer to other resources. Organisations are no longer restricted to the traditional setup where all team members are located in one place, collaborating face-to-face and travel to other locations when necessary. However, these virtual teams rely on the use of technologies to support their activities such as collaboration. Many all-in-one collaborative technologies which claim to support multiple aspects of collaboration are readily accessible on the market. However collaboration is difficult to support and limited theories were found in the literature to identify factors influencing collaboration, though much work has been done to study collaboration in different fields and contexts of use.

This research examined the influence of communication modality in combination with the use of shared workspaces on supporting virtual collaboration. Aspects such as conversational communication, performance and user satisfaction were evaluated. Furthermore, an overview of factors contributing to successful collaboration was identified in each of the studies.

This research provides a foundation for further investigation into different methods of workspace sharing in collaborative tasks. It can be concluded that workspace sharing during remote spatial tasks is one of the most important collaborative features which technology should support. Lexically complex information can be shared without users having to verbalise this to each other, therefore they can concentrate on the core activity of the collaborative task. The amount of information shared amongst colleagues in virtual collaboration also influences overall collaboration, drawing on the concept of hidden profile. The more information users have to share with each other during the task, the more the information exchange becomes the main focus of the collaboration.

The communication modality has little influence on the overall collaboration, the task performance and user satisfaction. Audio encouraged more verbal communication and can better support awareness of remote users than a text-only channel, where users were required to formally update one another on their status throughout the collaboration. However, it should be noted that audio-conferencing can be difficult to manage with a large

group of users, as turn taking and identifying the speaker without visual support can be difficult. Providing text-based communication during audio communication can ensure that when users are faced with technical difficulties (i.e. low audio quality), users can notify other remote colleagues. The key thesis findings are summarised in Table 8-1

Summary of key thesis findings	
How important is it for technologies to suit user needs, context of use and task? Do users alter behaviours to fit technological constraints?	<ul style="list-style-type: none"> • Collaborative technologies should fit users needs, tasks and preferences • If technologies do not fit needs, users will revert back to previous tools which have been proven to support collaboration in the past
How can technology help to maintain an awareness of remote colleagues and tasks?	<ul style="list-style-type: none"> • Providing an audio-visual channel can help support remote awareness and allow users to update each other's status without directly speaking or requesting information
Is audio the most useful communication modality in remote tasks?	<ul style="list-style-type: none"> • As long as users are able to express themselves and there is a shared visual information facility, then text-only communication can support collaboration as well as audio-only • When audio-only is compared to video-conferencing, audio was the most useful and video adds no additional value to performance or user satisfaction
Is there a need for technology to support more than spoken language for planned and unplanned collaboration?	<ul style="list-style-type: none"> • Supporting the exchange of spatial information during remote collaboration reduces the complexity of the spoken language as users no longer need to verbalise lexically complex spatial information
Is a shared view of the workspace in remote collaboration more useful than a view of the remote colleague?	<ul style="list-style-type: none"> • In both spatial and non-spatial tasks, participants prefer a shared view of the workspace and being able to see remote colleagues has no added value to the overall collaboration or performance
Does being able to see and hear remote colleagues enhance user satisfaction?	<ul style="list-style-type: none"> • Being able to see and hear remote colleagues has no significant difference in terms of user satisfaction

Table 8-1: Thesis key findings

8.1 Recommendations for CoSpaces End Users

Findings from the studies conducted as part of this thesis suggest that technologies should suit user needs and the context of use to encourage users to support implementation and use

technologies as part of their collaborative task, instead of perceiving usage as another job requirement. Implementation should be properly managed to ensure that users are aware of how the new technology could improve collaboration.

The majority of the design tasks reported by the CoSpaces users involve spatial information; allowing two or more remote users to see a shared view of a drawing during a design discussion helps support the information exchange and reduces the needs to verbalise complex spatial information.

Many of the CoSpaces user partners have offices in different countries therefore providing a view of the shared workspace may help with any language difficulties. Ensuring that all participants involved in the virtual collaboration are provided with all the information prior to the interaction as well as providing shared workspaces can help improve the quality of collaboration in terms of task performance and the perceived difficulty of the task. For both spatial and non-spatial tasks, users often prefer to see a shared view of the workspace (i.e. drawing or document being discussed), than a view of their remote colleague.

Performance may not be greatly influenced by communication modality, however audio supports awareness more effortlessly than text-based communication and allows participants to communicate more. It should be noted that if collaboration involves more than two participants, audio-only can cause confusion and maybe insufficient to support turn taking and thus video-conferencing may provide more support (Olson and Olson, 2000). Importantly, the quality of the audio or video connection should be efficient as low connections can result in dissatisfaction and lower perceptions of the quality collaboration.

Technologies selected to support collaboration should be able to perform optimally and be commercially viable prior to the implementation. Users are often curious with new technologies and thus the initial level of acceptance and usage can be initially high. However, if the technology was during its development stage and the technical constraints can result in low quality of interaction. Thus using the technology can be seen as additional workload, which requires more effort to operate the tool rather than effectively support existing work. This could result in users reverting back to previous tools which they have used and relied on prior to the installation.

8.2 Future Research

In order to formulate a comprehensive list of collaborative features to support virtual collaboration, expert brainstorming and group discussions should be carried out in different

work settings (similar to the session with experts in Section 3.5 in Chapter 3). This method could be used to create a profile of different workplaces and the way users in different organisations perceive the importance of various collaborative features.

Different technologies have different features and usability issues, therefore several should be evaluated in the same context as the laboratory and field studies to identify whether the findings were tool specific. Prototypes of technologies can perform very differently from the final, commercially ready products, thus user feedback throughout the development is necessary.

Further evaluation could be conducted with a wider range of participants, from different backgrounds, ages and professions to determine whether the key findings were reproducible with a wider spectrum of participants. The laboratory work completed in this thesis involved users who had known each other face-to-face prior to the start of the experiments. The nature of interpersonal relationships between friends differs from virtual colleagues meeting face-to-face a few times a year. Therefore it is important to examine how the pre-established interpersonal relationships between remote colleagues can influence the way in which they collaborate virtually. A video feed of remote partners might give additional value to participants who did not know each other well prior to the collaboration, however research has reported that users often feel self conscious and awkward on camera.

Privacy and trust issues could be addressed with respect to the use of shared workspaces. Both CoSpaces and Company X users reported that employees within their organisations had different rights to access the file sharing facility and sometimes they were required to use the company's version of communication tools (such as IM), which is more secure than off-the-shelf products. This indicates that privacy is important, thus sharing workspaces, such as allowing remote users to see the view of one's own computer screen during collaboration, may make users uncomfortable and thus reluctant to allow such access to remote colleagues.

The laboratory studies conducted to evaluate the use of shared workspaces should be repeated in the real world and in different industries to establish whether the findings are specific to virtual engineering and design teams.

Since the MRA study conducted in this thesis, MRA2 has been developed as an updated version of the MRA, incorporating the feedback from the end users at Company X. Further development is being conducted to allow the MRA to become a viable mobile technology. End users from healthcare have also expressed an interest in the MRA technology to support

collaboration between different hospital wards, as well as a mobile system to allow collaboration between emergency response units (i.e. paramedics on ambulances) and the Accident and Emergency unit located in hospitals.

8.3 Summary

This thesis has presented the research performed to investigate the influence of communication modalities when used with shared workspaces on virtual collaboration. Modalities examined include text-only, audio-only and audio-visual communication. Different stages of collaborative technology development, from the user requirements elicitation, to prototype and final product evaluation, through to the implementation in the real-world setting were considered. The research findings will help direct the design and implementation of collaborative tools to support virtual collaboration in design and engineering.

References

- Andres, H.P. (2006) The impact of communication medium on virtual team group process, *Information Resources Management Journal*, 19(2), 1-17
- Anderson, A.H., McEwan, R., Bal, J. and Carletta, J. (2007) Virtual team meetings: An analysis of communication and context, *Computers in Human Behaviour*, 23, 2558-2580
- Andriessen E. and Vartiainen M (2006) Emerging Mobile Virtual Work, J.H.E. Andriessen and M. Vartiainen (eds), *Mobile Virtual Network. A New Paradigm?* Springer, Berlin, 3-12
- Artman, H. and Wærn, Y. (1999) Distributed Cognition in an Emergency Co-ordination Center, *Cognition, Technology & Work*, 1, 237-246
- Avrahami, D. and Hudson, S.E. (2004) QnA: Augmenting an Instant Messaging client to balance user responsiveness and performance, *Proceedings of the 2004 ACM conference on Computer Supported Cooperative Work*, Chicago, Illinois, USA, 6(3), 515-518
- Avrahami, D. and Hudson, S.E. (2006) Responsiveness in Instant Messaging: Predictive Models Supporting Inter-Personal Communication, *Proceedings of the SIGCHI conference on Human Factors in Computing Systems (CHI'06)*, Quebec, Canada, 731-740
- Avrahami, D., Fogarty, J. and Hudson, S.E. (2007) Biases in human estimation of interruptibility: Effects and implications for practice, *Proceedings of the SIGCHI conference on Human factors in Computing System*, San Jose, CA, USA, 50-60
- Avrahami, D., Fussell, S.R. and Hudson, S.E. (2008) IM Waiting: Timing and responsiveness in semi-synchronous communication, *Proceedings of the ACM 2008 conference on Computer Supported Cooperative Work*, San Diego, CA, USA, 285-294
- Baecker, R., Harrison, S.R., Buxton, W., Poltrock, S.E., Churchill, E.F. (2008) Media spaces: past visions, current realities, future promise, *Proceedings of the SIGCHI conference on Human Factors in Computing Systems*, Florence, Italy, 2245-2248
- Baker, G. (2002) The effects of synchronous collaborative technologies on decision making: a study of virtual teams, *Information Resources Management Journal*, 15(4), 79-93
- Balfe, N. (2010) Appropriate automation of rail signalling systems: a human factors study, University of Nottingham, PhD thesis, Nottingham
- Balme, S. How, J., Theis, J.M. and Utzel, N. (2005) Using remote participant tools to improve collaborations, *Fusion Engineering and Design*, 74(1-4), 903-907
- Bannon, L. and Bødker, S. (1997) Constructing Common Information Spaces, *Proceedings of the 5th European Conference on Computer Supported Cooperative Work*, Lancaster, UK, 81-96
- Bellotti, V. and Bly, S. (1996) Walking away from the desktop computer: distributed collaboration and mobility in a product design team, *Proceedings of the Computer-Supported Cooperative Work*, Boston, MA, USA, 209-218
- Bellotti, V., Ducheneaut, N., Howard, M.A., and Smith, I.E. (2003) Taking email to task: the design and evaluation of a task management centered email tool, *Proceedings of the SIGCHI conference on Human factors in Computing Systems*, Fort Lauderdale, Florida, USA, 345-352

- Beranek, P.M. and Martz, B. (2005) Making virtual teams more effective: improving relational links, *Team Performance Management*, 11 (5/6), 200-213
- Bergiel, B.J., Bergiel, E.B. and Balsmeier, P.W. (2008) Nature of virtual teams: a summary of their advantages and disadvantages, *Management Research News*, 31(2), 99-110
- Birnholtz, J.P., Finholtz, T.A., Horn, D.B., Bae, S.J. (2005). Grounding needs: achieving common ground via lightweight chat in large, distributed, ad-hoc groups, *Conference Proceedings of Human Factors in Computing Systems*, Portland, Oregon, USA, 21-30
- Bly, S., Harrison, S.R., and Irwin, S. (1993) Media spaces: bringing people together in a video, audio, and computing environment, *Communications of the ACM*, 36(1), 28-46
- Bolstad, C.A. and Endsley, M.R. (1999) Shared mental models and shared displays: an empirical evaluation of team performance, *Human Factors and Ergonomics Society Annual Meeting Proceedings*, Houston, Texas, USA, 5, 213-217
- Bos, N., Gergle, D., Olson, J.S. and Olson, G.M. (2001) Being there versus seeing there: Trust via video, *Human Factors in Computing Systems*, Seattle, Washington, USA, 291-292
- Bos, N., Olson, J., Gergle, D., Olson, G. And Wright Z. (2002) Effects of four computer-mediated communications channels on trust development, *Proceedings of the SIGCHI conference on Human Factors in Computing Systems*, Gaithersburg, Maryland , USA, 135-140
- Bourguignon, D., Lawson G. and D’Cruz, M. (2009) D46 DiFac evaluation by SME user group, DiFac deliverable report, IST-5-035079
- Bowman, B (2001) Application sharing in Windows Messenger for Windows XP: My 2000 Mile Wide Conference Room.
http://www.microsoft.com/windowsxp/using/windowsmessenger/expert/bowman_august06.mspx, accessed on 14/2/2010
- Bradner, E. and Mark, G. (2002) Why Distance Matter: Effects on Cooperation, Persuasion and Deception, *Proceedings of Computer-Supported Cooperative Work*, New Orleans, Louisiana, USA, 226-235
- Branson, L., Clausen, T.S., Sung, C-H. (2008) Group Style Differences between Virtual and Face-to-face teams, *American Journal of Business*, 23(1), 65-70
- Brennan, S.E. (2004) How conversation is shaped by visual and spoken evidence, J. Trueswell and M. Tanenhaus (Eds.), *World Situated Language Use: Psycholinguistic, Linguistic and Computational Perspectives on Bridging the Product and Action Traditions*. MIT Press, Cambridge, MA, 95-130
- Brooke, J. (1996) "SUS: a "quick and dirty" usability scale", in P. W. Jordan, B. Thomas, B. A. Weerdmeester and A. L. McClelland, *Usability Evaluation in Industry*, Taylor and Francis, London
- Brush, A.J.B. and Borning, A. (2005) ‘Today’ Messages: Lightweight support for small group awareness via email, *Proceedings of the 38th Hawaii International Conference on System Sciences*, Hawaii, USA, 1, 16-26
- Çakir, M.P., Zemel, A. and Stahl, G. (2007) The organization of collaborative math problem solving activities across dual interaction spaces, *Proceedings of the 8th International Conference on Computer Supported Collaborative Learning*, Rhodes, Greece, 105-107

- Carletta, J., Anderson, A.H. and McEwan, R. (2000) The effects of multimedia communication technology on non-located teams: a case study, *Ergonomics*, 43(8), 1237 – 1251
- Cataldo, M., Wagstrom, P.A., Herbsleb, J.D. and Carley, K.M. (2006) Identification of coordination requirements: Implications for the design of collaboration and awareness tools, *Proceedings of the 2006 20th anniversary conference on Computer supported cooperative work*, Banff, Alberta, Canada, 353-362
- Cavallin, H., Fruchter, R. and Martin, W.M. (2000) To see or not to see: The role of visibility and awareness in videoconference-mediated teamwork, in, R. Fruchter, K. Roddis, F. Pena-Mora (Eds), *Proceedings of ICCCBE-VIII: 8th Conference on Computer in Building and Civil Engineering*, Stanford University, Stanford, CA, USA, 1-8
- Chen, Q., Grundy, J. and Hosking, J. (2003) An E-whiteboard application to support early design-stage sketching of UML diagrams, *Proceedings of the 2003 IEEE Symposium on Human Centric Computing Languages and Environments*, Auckland, New Zealand, 219-226
- Cherubini, M. and Dillenbourg, P. (2007) The effects of Explicit Referencing in distance problem solving over shared maps, *Proceedings of the 2007 international ACM conference on Supporting group work*, Sanibel Island, FL, USA, 331-340
- Clark, H.H. and Brennan, S.E. (1991) Grounding in Communication, L. B. Resnick, R. M. Levine and S. D. Teasley (Eds) *Perspectives on Socially Shared Cognition*, American Psychological Association, Washington, USA, 127-149
- Cox, G., Sharples, S.C., Stedmon, A.W. and Wilson, J.R. (2007) An observation tool to study air traffic control and flightdeck collaboration, A.W. Stedmon & S.C. Sharples (eds). *Applied Ergonomics: Human Factors in Technology & Society*, 38(4) 425-435
- Cutrell, E.B., Czerwinski, M. and Horvitz, E. (2000) Effects of Instant Messaging interruptions on computing tasks, *Human factors in Computing Systems*, The Hague, The Netherlands, 99-100
- Czerwinski, M., Cutrell, E. and Horvitz, E. (2000) Instant Messaging and Interruption: Influence of Task Type on Performance, *Proceedings of OZCHI 2000*, Sydney, Australia, 356—361
- Czerwinski, M., Horvitz, E. and Wilhite, S. (2004) A diary study of task switching and interruptions, *Proceedings of the SIGCHI conference on Human factors in computing systems*, Vienna, Austria, 175-182
- D’Cruz, M., Lawson, G., Redaelli, C., and Saikayasit, R. (2009) Methods for evaluating Ergonomics, Presence and Collaboration in the Digital Factory, *Proceedings of Laval Virtual*, Laval, France
- Dabbish, L., Kraut, R., Fussell, S. and Kiesler, S. (2005) Understanding Email Use: Predicting Action on a Message, *Proceedings of the SIGCHI conference on Human factors in computing systems*, Portland, Oregon, USA, 691 – 700
- Dabbish, L. and Kraut, R. (2006) Email overload at work: An analysis of factors associated with email strain, *Proceedings of the 2006 20th anniversary conference on Computer supported cooperative work*, Banff, Alberta, Canada, 431 - 440
- Daft, R.L. and Lengel, R.H. (1986) Organisational information requirements, media richness and structural design, *Management Science*, 32(5), 554-571

- DeSanctis, G. and Gallupe, R.B. (1987) A foundation for the study of group decision support systems, *Management Science*, 33(5), 589–609
- de Jong, R., Schalk, R. and Curşeu, P.L. (2008) Virtual communicating, conflicts and performance in teams, *Team Performance Management*, 14 (7/8), 364-380
- de Vasconcelos Filho, J.E., Inkpen, K.M., and Czerwinski, M. (2009) Image, appearance and vanity in the use of Media Spaces and Videoconference Systems, *Proceedings of the ACM 2009 International conference on Supporting Group work*, Sanibel Island, FL, USA, 253-262
- Dillenbourg, P. and Traum, D. (1999) Does a shared screen make a shared solution?, *Computer Support for Collaborative Learning, Proceedings of the 1999 Conference on Computer Support for Collaborative Learning*, Stanford University, Palo Alto, CA, USA, Mahwah, NJ: Lawrence Erlbaum Associates, Dec 12-15
- Driskell, J.E., Radtke, P.H., Salas, E. (2003) Virtual Teams: Effects of Technological Mediation on Team Performance, *Group Dynamics: Theory, Research and Practice*, 7(4), 297-323
- Edwards, A. and Wilson, J.R. (2004) *Implementing Virtual Teams: A guide to organisational and human factors* Gower Publishing Ltd, England
- Egido, C. (1988) Videoconferencing as a technology to support groupwork: a review of its failure, *Proceedings of the ACM Conference on Computer Supported Cooperative Work*, 13-24
- Finholt, T.A., Sproull, L. and Kiesler S. (2002) Outsiders on the inside: sharing know-how across space and time, P. Hinds, S. Kiesler (eds), *Distributed Work*, MIT Press, Cambridge, MA, 470-491
- Fisher, D., Brush, A.J., Gleave, E. and Smith, M.A. (2006) Revisiting Whittaker & Sidner's "email overload" ten years later, *Proceedings of the 2006 20th anniversary conference on Computer supported cooperative work*, 309-312
- Frost & Sullivan. (2006). Meetings around the world: The impact of collaboration on business performance [online]. A Frost & Sullivan white paper sponsored by Verizon Business and Microsoft. Available from: http://newscenter.verizon.com/kit/collaboration/MAW_WP.pdf [Accessed 21 May 2010].
- Fussell, S.R., Kraut, R.E. and Siegel, J. (2000) Coordination of Communication: effects of shared visual context on collaborative work, *Proceedings of Computer-Supported Cooperative Work*, Philadelphia, PA, USA, 21-30
- Fussell, S.R., Kiesler, s., Setlock, L.D., Scupelli, P. and Weisban, S. (2004) Effects of Instant Messaging on the management of multiple project trajectories, *Conference Proceedings of Human Factors in Computing Systems*, Vienna, Austria, 6(1), 191-198
- Gaver, W.W. (1991) Sound support for collaboration, *Proceedings of the European Conference on Computer Supported Cooperative Work*, Amsterdam, The Netherland, 293–308
- Gaver, W.W. (1992) The affordances of media spaces for collaboration, *Proceedings of the Conference on Computer-Supported Cooperative Work*, Toronto, Canada, 17-24
- Gergle, D., Kraut, R.E. and Fussell, S.R. (2004a) Action as Language in a Shared Visual Space, *Proceedings of Computer-Supported Cooperative Work*, Chicago, Illinois, USA, 6(3), 486-496

- Gergle, D., Millen, D.R., Kraut, R.E. and Fussell, S.R. (2004b) Persistence matters: Making the most of chat in tightly-coupled work, *Proceedings of the SIGCHI conference on Human factors in computing systems*, Vienna, Austria, 6(1), 431-438
- González, V.M. and Mark, G (2005) Managing currents of work: Multi-tasking among multiple collaborations, *Proceedings of the 8th European Conference of Computer-Supported Cooperative Work*, Paris, France, 143-162
- Greenberg, P.S., Greenberg, R.H. and Antonucci, Y.L. (2007) Creating and sustaining trust in virtual teams, *Business Horizons*, 50, 325-333
- Grudin, J., Tallarico, S. and Counts, S. (2005) As technophobia disappears: implications for design. *Proceedings of GROUP'05*, Sanibel Island, Florida, USA, 256-259
- Gutwin, C. and Greenberg, S. (2000). The Mechanics of Collaboration: Developing Low Cost Usability Evaluation Methods for Shared Workspace, *Proceedings of the 9th IEEE International Workshops on Enabling Technologies Infrastructure for Collaborative Enterprises*, Gaithersburg, MD, USA, 98-103
- Gutwin, C. and Greenberg S. (2002) A Descriptive Framework of Workspace Awareness for Real-Time Groupware, *Computer Supported Cooperative Work*, New Orleans, Louisiana, USA, 11, 411-446
- Hacker, M.E. and Lang, J.D. (2000) Designing a performance measurement system for a high technology virtual engineering team: a case study, *International Journal of Agile Management Systems*, 2/3, 225-232
- Hammond, J., Koubek, R.J., Harvey, C.M. (2001) Distributed collaboration for engineering design. A review and reappraisal, *Human Factors and Ergonomics in Manufacturing*, 11(1), 35-52
- Handel, M. and Herbsleb, J.D. (2002) What is Chat doing in the workplace?, *Proceedings of ACM Conference on Computer-Supported Cooperative Work*, New Orleans, Louisiana, USA 1-10.
- Heath, C. and Luff, P. (1992) Collaboration and Control: Crisis Management and Multimedia Technology in London Underground Line Control Rooms, *Journal of Computer Supported Cooperative Work*, 1(1), 24-48
- Herbsleb, J.D., Atkins, D.L., Boyer, D.G., Handel, M. and Finholt, T.A. (2002) Introducing Instant Messaging and Chat into the workplace, *Proceedings of the SIGCHI conference on Human factors in Computing Systems*, Minneapolis, Minnesota, USA, 171-178
- Herbsleb, J.D., Mockus, A. (2003) An empirical study of speed and communication in globally distributed software development, *Proceedings of the IEEE Transactions of Software Engineering*, 26(6), 481-494
- Holton, J.A. (2001) Building trust and collaboration in a virtual team, *Team Performance Management: An International Journal*, 7(3/4), 36-47
- Horwitz, F.M., Bravingtong, D. and Silvis, U. (2006) The promise of virtual teams: identifying key factors in effectiveness and failure, *Journal of European Industrial Training*, 30(6), 472-494
- Huysman, M., Steinfield C., Jang, C-Y., David, K., Huis In't Veld, M., Poot, J. and Mulder, I. (2003) Virtual teams and the appropriation of communication technology: exploring the concept of

- Media Stickiness, *Proceedings of the Eighth European Conference on Computer-Supported Cooperative Work*, Helsinki, Finland, 12(4), 411-436
- Isaacs, E., and Tang, J. (1994) What video can and can't do for collaboration: a case study, *MultiMedia Systems*, 3, 63-73
- Isaacs, E.A., Whittaker, S., Frohlich, D., and O'Conaill, B.(1997) Informal communication re-examined: New functions for video in supporting opportunistic encounters, *Video-Mediated Communication*, Finn, K.E., Sellen, A.J., and Wilbur, S.B. (Eds.), New Jersey: Lawrence Erlbaum, 459-485
- Isaacs, E.A., Kamm, C., Schiano, D.J. Walendowski, A. and Whittaker, S. (2002a) Characterizing instant messaging from recorded logs, *Human factors in computing systems*, Minneapolis, Minnesota, USA, 720-721
- Isaacs, E.A. Walendowski, A., Whittaker, S., Schiano, D.J. and Kamm, C. (2002b) The character, functions and styles of Instant Messaging in the workplace, *Proceedings of the 2002 ACM conference on Computer-Supported Cooperative Work*, New Orleans, Louisiana, USA, 11-20
- Jensen, C., Farnham, S.D., Drucker, S.M. and Kollock, P. (2000) The effects of communication modality on cooperation in online environments, *Conference Proceedings of Human Factors in Computing Systems*, The Hague, Netherlands, 2(1), 470-477
- Kamel, N.N. and Davison, R.M. (1998) Applying CSCW technology to overcome traditional barriers in group interactions, *Information & Management*, 34, 209-213
- Kerr, S.D. and Murthy U.S. (2009) The effectiveness of synchronous computer-mediated communication for solving hidden-profile problems: Further empirical evidence, *Information & Management*, 46, 83-89
- Kiesler, S. and Cummings, J.N. (2002) What do we know about proximity and distance in work groups? A legacy of research, P. Hinds, and S. Kiesler (Eds), *Distributed Work*, MIT Press, Cambridge, MA, 57-80
- Kirk, D. S., & Stanton Fraser, D. (2006) Comparing Remote Gesture Technologies for Supporting Collaborative Physical Tasks, *Proceedings of CHI Conference on Human Factors in Computing Systems*, Quebec, Canada, 1191-1200
- Kirk, D., Rodden, T. and Stanton Fraser, D. (2007) Turn It This Way: Grounding Collaborative Action with Remote Gestures, *Proceedings of CHI Conference on Human Factors in Computing Systems*, San Jose, CA, USA, 1039-1048
- Kirkman, B.L. and Mathieu, J.E. (2005) The dimensions and antecedents of team virtuality, *Journal of Management*, 31, 700-718
- Klein, G. (2001) Features of Team Coordination, M. McNeese, E. Salas and M. Endsley (Eds), *New Trends in Cooperative Activities: Understanding System Dynamics in Complex Environments*. Santa Monica, CA: Human Factors and Ergonomics Society, 68-95
- Kock, N. (2002) The effects of collaborative technologies, K-P, Mehdi (Eds), *Collaborative Information Technologies*, Idea Group Publishing, Hershey, PA, 63-81

- Koleva, B., Benford, S. and Greenhalgh, C. (1999) The Properties of Mixed Reality Boundaries, S. Bødker, M. Kyng, and K. Schmidt (Eds), *Proceedings of the 6th European Conference on Computer-Supported Cooperative Work*, Copenhagen, Denmark, 119-137
- Kraut, R.E., Egidio, C. and Galegher, J. (1990) Patterns of Contact and Communication in Scientific Research Collaboration, J. Galegher and R. E. Kraut (Eds), *Intellectual Teamwork: Social and Technological Foundations of Cooperative Work*. Hillsdale, NJ: Lawrence Erlbaum, 149-172
- Kraut, R.E., Fussell, S.R., Brennan, S. and Siegel, J. (2002a) Understanding effects of proximity on collaboration: implications for technologies to support remote collaborative work, P. Hinds, and S. Kiesler (Eds.) *Technology and Distributed Work*, MIT Press, Cambridge, MA, 137-162
- Kraut, R.E., Gergle, D. and Fussell, S.R. (2002b) The use of visual information in shared visual spaces: informing the development of virtual co-presence, *Proceedings of the 2002 ACM conference on Computer Supported Cooperative Work*, New Orleans, Louisiana, USA, 31-40
- Kraut, R.E., Fussell, S.R. and Siegel, J. (2003) Visual Information as a Conversational Resource in Collaborative Physical Tasks, *Human-Computer Interaction*, Bath, England, 18, 13-49
- Kushman, N., Kandula, S. and Katabi, D. (2008) Can you hear me now?! It must be BGP, *SIGCOMM Computer Communication Review*, 37(2), 77-84
- Lancaster, S., Yen, D.C., Huang, A.H. and Hung, S-Y (2007) The selection of instant messaging or email. College students' perspective for computer communication, *Information Management & Computer Security*, 15(1), 5-22
- Landis, J.R. and Koch, G.G. (1977) The measurement of observer agreement for categorical data, in *Biometrics*, 33(1), 159-174
- Lauche, K. (2005) Collaboration among designers: analysis an activity for system development, *European Conference on Computer Supported Cooperative Work*, Paris, France 14, 253-282
- Lawson, G. and D'Cruz, M (2009) Evaluation report: interim evaluation, DiFac (Digital Factory for Human-Oriented Production System IST-5-035079
- Lee-Kelley, L. and Sankey, T. (2008) Global Virtual teams for value creation and project success: A case study, *International Journal of Project Management*, 26(1), 51-62
- van Leeuwen, J.P. and Fridqvist, S. (2006) An information model for collaboration in the construction Industry, *Computers in Industry*, 57, 809-816
- Leinonen, P., Järvelä, S., Häkkinen, P. (2005) Conceptualising the awareness of collaboration: a qualitative study of a global virtual team, *European Conference on Computer Supported Cooperative Work*, Paris, France, 14, 301-322
- Lenman, S., Räsänen, M., and Thuresson, B. (2002) A user-oriented approach to building a video community in a distributed workplace, T. Binder, J. Gregory and I. Wagner (Eds.) *Proceedings of the Participatory Design Conference*, Malmö, Sweden, 323-327
- Lipponen, L. (2002) Exploring foundations for computer-supported collaborative learning, G. Stahl (Ed.), *Computer Support for Collaborative Learning: Foundations for a CSCL community*, *Proceedings of the Computer-supported Collaborative Learning 2002 Conference*, Maastricht, The Netherlands, 72-81

- Liu, P.-J., Laffey, J.M. and Cox, K.R. (2008) Operationalization of technology use and cooperation in CSCW, *Computer-Supported Cooperative Work*, San Diego, CA, USA, 505-514
- Mackay, W. E. (1999) "Media Spaces: Environments for Informal Multimedia Interaction", Beaudouin-Lafon (Ed.) *Computer Supported Cooperative Work*, John Wiley & Son Ltd, Chichester 55 –82
- Mangano, N., Baker, A., and van der Hoek, A. (2008) Calico: a prototype sketching tool for modeling in early design, *Proceedings of the 2008 international workshop on Models in software engineering*, Leipzig, Germany, 63-68
- Mark, G., Grudin, J., and Poltrock, S.E. (1999) Meeting at the desktop: An empirical study of virtually collocated teams, *Proceedings of the 6th European Conference on Computer-Supported Cooperative Work (ECSCW'99)*, Copenhagen, Denmark, 159-178
- Martins, L.L., Gilson, L.L. and Maynard, M.T. (2004) Virtual Teams: what do we know and where do we go from here?, *Journal of Management*, 30(6), 805-835
- McGrath, J.E. (1997). Small Group Research, That Once a Future Field: An Interpretation of the Past with an Eye to the Future, *Group Dynamics: Theory, Research and Practice*, 1(1), 7-27
- Nardi, B., Schwarz, H., Kuchinsky, A., Leichner, R., Whittaker, S. and Schlabassi, R. (1993) Turning Away from Talking Heads; The use of video-as-data in neurosurgery, *Proceedings of the Interchi 93 Conference on Human Factors in Computing Systems*, Amsterdam, The Netherlands, 327-334
- Nardi, B., Whittaker, S. and Bradner, E. (2000) Interaction and Outeraction: Instant messaging in action, *Proceedings of the 2000 ACM conference on Computer Supported Cooperative Work*, Philadelphia, PA, USA, 79-98
- Neale, D.C., Carroll, J.M. and Rosson M.B. (2004) Evaluating Computer-Supported Cooperative Work: Models and Frameworks, *Proceedings of the 2004 ACM conference on Computer-Supported Cooperative Work*, Chicago, Illinois, USA, 6(3), 112-121
- O'Conaill, B., Whittaker, S. and Wilburn, S. (1993) Conversations over video conferences: an evaluation of the spoken aspects of video-mediated communication, *Human-Computer Interaction*, Orlando, FL, USA, 8(4), 389-428
- Ocker, R.J. and Yaverbaum, G. (1999) Asynchronous computer-mediated communication verses face-to-face collaboration: results on student learning, quality and satisfaction, *Group Decision and Negotiation*, 8, 427-440
- Olson, J.S., Olson, G.M. and Meader, D.K. (1995) What mix of video and audio is useful for small groups doing remote real-time design work, *Proceedings of the SIGCHI conference on Human factors in Computing Systems*, Denver, Colorado, USA, 362-368
- Olson, G.M. and Olson, J.S. (2000) Distance matters, *Human-Computer Interaction*, Sunderland, UK, 15, 139-179
- Ou, J., Fussell, S.R., Chen, X., Setlock, L.D. and Yang, J. (2003) Gestural Communication over Video Stream: Supporting Multimodal Interaction for Remote Collaborative Physical Tasks, *Proceedings of the 5th International Conference on Multimodal Interfaces*, Vancouver, BC, Canada, 242-249

- Peña, J., Walther, J.B. and Hancock, J.T. (2007) Effects of geographic distribution on dominance perceptions in computer mediated groups, *Communication Research*, 34(3), 313-331
- Preece, J., Rogers, Y. and Sharp, H. (2002) *Interaction Design: beyond human-computer interaction*, John Wiley & Sons, Inc., NY
- Qureshi, S. and Zigurs, I. (2001) Paradoxes and prerogatives in global virtual collaboration, *Communications of the ACM*, 44(12), 85-88
- Ranjan, A., Birnholtz, J. and Balakrishnan, R. (2007) Dynamic Shared Visual Spaces: Experimenting with Automatic Camera Control in a Remote Repair Task, *Proceedings of Human Factors in Computing Systems*, San Jose, CA, USA, 1177-1186
- Riegelsberger, J., Sasse, M.A., McCarthy, J.D. (2003) The researcher's dilemma: evaluating trust computer-mediated communication, *International Journal of Human-Computer Studies*, 58, 759-781
- Robson, C. (2002) *Real world research: a resource for social scientists and practitioner – researchers*, 2nd edition, Blackwell Publishing, Oxford
- Rocco, E. (1998) Trust breaks down in electronic context but can be repaired by some initial face-to-face contact, *Proceedings of the SIGCHI conference on Human factors in computing systems*, Los Angeles, CA, USA, 496-502
- Roch, S.G. and Ayman, R. (2005) Group decision making and perceived decision success: the role of communication medium, *Group Dynamics: Theory, Research and Practice*, 9(1), 15-31
- Rosen, B., Furst, S. and Blackburn, R. (2007) Overcoming barriers to knowledge sharing in virtual teams, *Organizational Dynamics*, 36(3), 259-273
- Rummel, N. and Spada, H. (2005) Sustainable support for computer-mediated collaboration: How to achieve and how to assess it, R. Bromme, F. W. Hesse & H. Spada (Eds), *Barriers and biases in computer-mediated knowledge communication and how they may be overcome*. Dordrecht, NL: Kluwer Academic Publishers
- Sadat Shami, N. Bos, N. Wright, Z. Hoch, S. Yung Kuan, K. Olson, J. and Olson, G. (2004) An experimental simulation of multi-site software development, *Proceedings of the 2004 Conference of the Centre for Advanced Studies on Collaborative Research*, 255-266
- Saikayasit, R. (2006) The influence of shared visualisation on shared mental model development, University of Nottingham, MSc dissertation, Nottingham, UK
- Saikayasit, R., Schnädelbach, H., Pettitt, M., Patel, H., Glover T. (2008) Mixed Reality Architecture: Introducing Collaborative VR Tools into Commercial Organisations, 5th INTUITION International Conference, Turin, Italy
- Saikayasit, R. and Sharples, S. (2009) The Influence of Shared-Representation on Shared Mental Models in Virtual Teams, *Proceedings of the 8th International Conference on Engineering Psychology and Cognitive Ergonomics*, San Diego, CA, USA, 269 - 278
- Santhanam, R. (2001) The effects of communication modality by outcomes of collaborative tasks, *Information Technology and Management*, 2, 377-394
- Schmidt, K. (1991) Riding a Tiger, or Computer Supported Cooperative Work, *Computer Supported Cooperative Work*, 1-16

- Schmidt, K. and Bannon, L. (1992) Taking CSCW Seriously: Supporting Articulation Work, *Computer Supported Cooperative Work*, Toronto, Canada, 1(1), 7-40
- Schmidt, K. (2002) The Problem with 'Awareness'. Introductory Remarks on 'Awareness in CSCW', *Computer Supported Cooperative Work*, New Orleans, Louisiana, USA, 11, 285-298
- Schmidt, K. (2009) Divided by a common acronym: On the fragmentation of CSCW, *Proceedings of the 11th European Conference on Computer Supported Cooperative Work*, Vienna, Austria, 223-242
- Schnädelbach, H., Penn, A., Steadman, P., Benford, S., Koleva, B. and Rodden, T. (2006) Moving Office: Inhabiting a Dynamic Building, *Proceedings of CSCW 2006 conference*, Banff, Canada, 313-322
- Schnädelbach, H., Penn, A., and Steadman, P., (2007) Mixed Reality Architecture: A Dynamic Architectural Topology, *Proceedings of International Space Syntax Symposium 2007*, Istanbul, Turkey, 106-120
- Scholl, J., McCarthy, J., Harr, R. (2006) A comparison of chat and audio in media rich environments, *Proceedings of the 2006 20th anniversary conference on Computer supported cooperative work*, Banff, Alberta, Canada, 323-332
- Schrage, M. (1990) *Shared Minds: The New Technologies of Collaboration*. Random House, New York.
- Scupelli, P. Kiesler, S. Fussell, S.R. and Chen C. (2005) Project View IM: A tool for juggling multiple projects and teams, *Human factors in Computing Systems*, Portland, Oregon, USA, 1773 - 1776
- Sharples, S., Stedmon, A., Cox G., Nicholls, A., Shuttleworth, T. And Wilson J.R. (2007) Flightdeck and Air Traffic Control Collaboration Evaluation (FACE): Evaluating aviation communication in the laboratory and field, *Applied Ergonomics*, 38(4), 399-407
- Sinclair, M.A. (2005) Participative Assessment, in Wilson, J.R. & Corlett, E. N. (Eds.) *Evaluation of Human Work*. 3rd ed., Taylor & Francis Ltd, London, 83-111
- Siu, N., Iverson, L. and Tang, A. (2006) Going with the flow: Email awareness and task management, *Proceedings of the 2006 20th anniversary conference on Computer Supported Cooperative Work*, Banff, Alberta, Canada, 441 - 450
- Stasser, G. (1992) Information Salience and the Discovery of Hidden Profiles by Decision-Making Groups: A "Thought Experiment", *Organisational Behaviour and Human Decision Processes*, 52, 156-181
- Stasser, G., Vaughan, S.I. and Stewart D.D. (2000) Pooling Unshared Information: The Benefits of knowing How Access to Information Is Distributed among Group Members, *Organizational Behavior and Human Decision Processes*, 82 (1), 102-116
- Stasser, G. and Titus, W. (2003) Hidden Profiles: A Brief History, *Psychological Inquiry*, 14 (3&4), 304-31

- Straus, S.G. and McGrath, J.E. (1994) Does the medium matter? The interaction of task type and technology on group performance and member reactions, *Journal of Applied Psychology*, 79(1), 87-97
- Taylor, S.J.E. (2001) NetMeeting: A tool for collaborative simulation modelling, *Journal of Simulation*, 1(1-2), 59-68
- Tapscott, D. and Williams A., D. (2008) Wikinomics: How mass collaboration changes everything. Expanded edition, Penguin Group, NY
- Tee, K., Greenberg, S. and Gutwin, C. (2009) Artifact awareness through screen sharing for distributed groups, *International Journal of Human-Computer Studies*, 67(9), 677-702
- Thomas, D.M., Bostrom, R.P. (2005) Virtual team leader as technology facilitator: the missing role, *Proceedings of the 2005 Southern Association of Information Systems Conference*, Savannah, GA
- Tollmar, K. Chincholle, D., Klasson, B. And Stephanson, T. (2001) VideoCafé – exploring mediaspaces in public places within organizations, *Behaviour & Information Technology*, 20(2), 101-110
- Van de Kleij, R., Lijkwan, J.T.E., Rasker, P.C. and De Dreu, C.K.W (2009) Effects of time pressure and communication environment on team processes and outcomes in dyadic planning, *International Journal of Human-Computer Studies*, 67(5), 411-423
- Veinott, E.S., Olson, J., Olson, G.M. and Fu, X. (1999) Video Helps Remote Work: speakers who need to negotiate common ground benefit from seeing each other, *Proceedings of the SIGCHI conference on Human factors in Computing Systems*, Pittsburgh, PA, USA, 302-309
- Venolia, G.D. and Neustaedter, C. (2003) Understanding sequence and reply relationships within Email conversations: A mixed-model visualization, *Proceedings of the SIGCHI conference on Human factors in Computing Systems*, FL, USA, 361-368
- Voida, S., Mynatt, E.D., MacIntyre, B. and Corso, G.M. (2002) Integrating virtual and physical context to support knowledge workers, *Proceedings of the 2002 IEEE Symposium on Pervasive Computing*, Oakland, CA, USA, 1(3), 73-79
- Weiseth, P.E., Munkvold, B.E., Tvedte, B., Larsen, S. (2006) The Wheel of Collaboration Tools: A Typology for Analysis Within a Holistic Framework, *Proceedings of the 2006 20th anniversary conference on Computer supported Cooperative Work*, Banff, Alberta, Canada, 239-248
- Weisz, J.D. and Kiesler, S. (2008) How text and audio chat change the online video experience, *Proceeding of the 1st International conference on Designing Interactive User Experiences for TV and Video*, Silicon Valley, CA, USA, 9-18
- Whittaker, S., Brennan, S., and Clark, H. (1991) Co-ordinating activity: an analysis of computer supported cooperative work, *Proceedings of Human Factors in Computing Systems*, New Orleans, Louisiana, USA, 360-367
- Whittaker, S., Frohlich, D. and Daly-Jonest, O. (1994) Informal Workplace Communication: what is it like and how might we support it?, *Proceedings of the SIGCHI conference on Human Factors in Computing Systems*, Boston, Massachusetts, USA, 131-137

Whittaker, S. and Sidner, C. (1996) Email overload: exploring personal information management of email, *Proceedings of the SIGCHI conference on Human factors in Computing Systems*, Vancouver, British Columbia, Canada, 276-283

Whittaker, S. (2002) Theories and Methods in Mediated Communication, Graesser, A., Gernsbacher, M., and Goldman, S. (Ed.) *The Handbook of Discourse Processes*, Erlbaum, NJ, 243-286

Whittaker, S. (2003) Things to talk about when talking about things, *Human-Computer Interaction*, Bath, UK, 18(1), 149-170

Whittaker, S. (2005) Supporting Collaborative Task Management in Email, *Human-computer Interaction*, Beijing, China, 20(1), 49-88

Whittaker, S., Bellotti, V. and Moody, P. (2005) Revisiting and Reinventing Email, *Human-Computer Interaction*, Beijing, China, 20(1), 1-9

Whittaker, S., Bellotti, V. and Gwizdka, J. (2007) Everything through email, W. Jones and J. Teevan (Eds.) *Personal Information Management*, University of Washington Press, Seattle 167-189

Wilson, J.R. (2006) Collaboration in Mobile virtual Work: a Human Factors View, J.H.E. Andriessen and M. Vartiainen (eds), *Mobile Virtual Network. A New Paradigm?* Springer, Berlin, 129-151

Wilson, J.R., Patel, H., Pettitt, M., Schnädelbach, H. and Saikayasi, R. (2007a) D2 – First release of the functional specification for the *CoSpaces* distributed software framework, CoSpaces report, (IST-5-034245)

Wilson, J.R., Patel, H., Pettitt, M., Schnädelbach, H. and Saikayasi, R. (2007b) D6 – First framework for capturing and accounting for stakeholder requirements for collaborative workspaces, CoSpaces report, (IST-5-034245)

Wilson, J.R., Patel, H. and Pettitt, M. (2009) Human Factors and development of next generation collaborative engineering, P.D. Bust (Ed) *Contemporary Ergonomics 2009*, Taylor & Francis, Wiltshire, 39-48

Workman, M., Kahnweiler, W. and Bommer, W. (2003) The effects of cognitive style and media richness on commitment to telework and virtual teams, *Journal of Vocational Behaviour*, 63, 199-219

Websites

CoSpaces Project: <http://www.cospaces.org> and (for EU project fact sheet) http://cordis.europa.eu/fetch?CALLER=FP6_PROJ&ACTION=D&DOC=79&CAT=PROJ&QUERY=1170700719153&RCN=80178&DOC=1&QUERY=0126d1f254cd:7232:435ae840, accessed on 15/2/2010

Windows Live Messenger: <http://download.live.com/messenger>, accessed on 16/2/2010

Appendices

Appendix 1

CoSpaces interview template (Wilson *et al.*, 2007a)

Current practice scenarios are descriptions of work functions, processes and environments where collaboration in design or collaborative engineering work is carried out currently (with or without technical systems assistance) and which are of interest and importance to the user company, where current collaboration is deficient in some way, or where the company imagines that CoSpaces technologies may bring demonstrable improvements in the middle or far future.

Scenario Heading	Detail of current situation
1. Company(ies) – type etc. <i>Which is the company concerned, or which grouping or network of companies? What is their market position?</i>	
Vision for future; comments	
2. Area/Dept(s) <i>E.g. Design engineering, Structural testing, Architect, Client, etc.</i>	

<p>3. Function(s) and process(es)</p> <p><i>What is carried out in the focus area/dept – e.g. testing wind resistance of body profile or assessing service systems access to the building. The process could usefully be described with diagrams and a timeline based on an actual example.</i></p>		
<p>Vision for future; comments</p>		
<p>4. Goals</p> <p><i>These are the goals for the current functions and processes</i></p>	<p>Business</p> <p><i>Market position, structuring or financial etc. goals</i></p>	
	<p>Operational</p> <p><i>Goals of the function or process focused on</i></p>	
	<p>Human</p> <p><i>Goals in terms of the type,</i></p>	

	<i>contribution and support for the people involved</i>	
Vision for future; comments		
<p>5. Evaluation of current functions and processes</p> <p><i>This is probably the most important part (together with the process/function description) of the scenario and more detail is better here than less. The problems and current good points will determine where and how CoSpaces collaborative work environments may bring improvements</i></p>	<p>Needs/Problems</p> <p><i>In the current situation – these probably explain why this area, function, process, activity is the one selected as relevant to potential CWEs</i></p>	
Vision for future; comments		
	<p>Successes</p> <p><i>In the current situation what works well, what does not want to be lost in any change implementation – in terms of</i></p>	

	<i>performance, technical set ups, human factors etc.</i>	
<p>6. User profiles</p> <p><i>These are factors of the people involved that are highly relevant to the current way of doing things and to the implementation of any CWEs.</i></p>	<p>Individual factors</p> <p><i>E.g.: professional background and competency, IT literacy age if an issue, training, motivation, attitudes, physical and cognitive capabilities</i></p>	
	<p>Group factors</p> <p><i>Main variable is co-located or distributed (mobile or not); also size of group, span of control, communications, autonomy of team etc.</i></p>	
Vision for future; comments		
<p>7. Settings:</p> <p><i>These are the contextual, situational and environmental factors, which will constrain or support current and visionary future ways of</i></p>	<p>Physical</p> <p><i>Workspace, layout, lighting, climate, noise, indoor/outdoor etc.</i></p>	

<i>working</i>		
	<p>Social</p> <p><i>Quality and frequency of inter-personal contact, social relations, communications etc.</i></p>	
Vision for future; comments		
	<p>Organisational</p> <p><i>Structure of company (hierarchical, flat etc), relationships in supply chain or network (if relevant), etc.</i></p>	
	<p>Infrastructure</p> <p><i>Existing computer systems and architectures, simulators, databases, and constraints from these (i.e. what is the current organisation experience and what must CoSpaces be compatible with)</i></p>	
	<p>Business climate</p> <p><i>Strong/weak, globalisation, etc</i></p>	

	Procurement and contracting <i>Any organisation or legal influences</i>	
	Security <i>Current systems and future needs and constraints from data transfer, sharing, networking etc.</i>	
Vision for future; comments		
8. Task-level description: <i>This is a more detailed description of what is described in 2 and 3 above, to get a good idea of what the people involved are actually doing or else should be doing.</i>	Activities	
Vision for future; comments		
	Decisions	
Vision for future; comments		
	Communications	

Vision for future; comments		
	Collaborations	
Vision for future; comments		

Appendix 2

Company X Pre-installation

MRA PRE-INSTALLATION EVALUATION

This MRA Pre-Installation Evaluation Questionnaire has been distributed to all the staff to complete before the introduction of the new MRA system. This questionnaire has been designed to gather information on current work practice, the communication methods and the way in which staff work within their assigned teams and departments to accomplish common set goals.

The completed questionnaires will be collected, and are processed by the Human Factors Research Group and the Mixed Reality Lab, University of Nottingham. Therefore, anonymity for all respondents and confidentiality of data which might identify any individuals are assured.

Please take your time, read each question carefully, and answer the best you can, given your job and your views. This questionnaire should take no longer than 15 minutes to complete. I will collect completed questionnaires.

Thank you for your time

Rose Saikayait

Research Postgraduate

Epxrs7@nottingham.ac.uk

SECTION 1: INTRODUCTORY DETAILS

Please answer each question accordingly or tick relevant boxes

1.1 Please specify your department

1.2 What is your role?

1.3 Where is your main place of work?

Office A

Office B

Office C

Home offices (Please specify location)_____

1.4 What gender are you?

Male

Female

1.5 Please indicate your age group

Under 25

25 to 34

35 to 44

45 to 56

Over 56

1.6 How long have you been working in the IT industry?

Less than 1 year

1 to 5 years

6 to 10 years

11 to 19 years

20 years+

1.7 How long have you been in your current position?

Less than 1 year

1 to 5 years

6 to 10 years

11 to 19 years

20 years+

SECTION 2: COMMUNICATION

2.1 To what extent do you agree or disagree with the following statements?

Please circle the number which corresponds to your answer

	Strongly disagree	Disagree	Neutral	Agree	Strongly Agree
1. Effective communications are essential parts of my work	1	2	3	4	5
2. Most of my conversations at work are work related	1	2	3	4	5
3. Conversations at work always lead to an exchange of documents	1	2	3	4	5
4. Documents that are exchanged are usually electronic	1	2	3	4	5
5. Most conversations about work take place in arranged meetings	1	2	3	4	5
6. Most conversations about work take place informally	1	2	3	4	5
7. My colleagues are from a variety of professional backgrounds	1	2	3	4	5
8. Most of the colleagues I communicate with are from different professional backgrounds to me	1	2	3	4	5
9. During conversations the type of information regularly exchanged is:	1	2	3	4	5
a) General (e.g. asking where to get more paper etc)	1	2	3	4	5
b) Problem specific (e.g. technical discussion / problem solving activities)	1	2	3	4	5
c) Non-work related (e.g. social)	1	2	3	4	5
d) Work-social/ team related (e.g. non-work activities in office/ organisation)	1	2	3	4	5
e) Others (please specify)	1	2	3	4	5
10. The location of conversation is always appropriate for the subject matter being discussed	1	2	3	4	5

SECTION 3: YOU AND YOUR TEAM

Please tick relevant boxes

“Team: A group of two or more people with complementary skills who are committed to a common purpose, performance goals, and approach for which the team holds its members mutually accountable.” Within your company, examples of teams are the departments of Sales, Operations, Development and Finance etc.

3.1 Please indicate the size of your team

1 to 5

6 to 10

11 to 15

16 to 20

20+

3.2 How were you introduced to your team members? (please tick all that apply)

Informal meeting/gathering

Formal face-to-face team meeting

“Virtual” team meeting, using electronic means

No initial introduction (self introduced)

Other (please specify) _____

3.3 A **co-located** team refers to team members who are based within the same building or office. **If you are a member of the Operations or Development teams**, please answer the following question. Please answer the following questions based on your **co-located** team(s).

How often do you meet another member of your co-located team face-to-face?

Everyday

Every week

Every month

Other (please specify)-_____

3.4 A **distributed** team refers to team members who are **not** based in the same building or office. Please answer the following questions based on your **distributed** team(s). **If you are a member of the Finance or Sales teams**, please answer the following question.

How often do you meet another member of your distributed team face-to-face?

Everyday

Every week

Every month

Other (please specify)-_____

SECTION 4: TECHNOLOGIES

4.1 Please rate how often the following technologies are used when communicating with **co-located** colleagues (those who are located in the same office as you are)

Please circle the number which corresponds to your answer

Technologies	Never used					Very frequently used
	1	2	3	4	5	
Telephone	1	2	3	4	5	
E-mail	1	2	3	4	5	
Fax	1	2	3	4	5	
Videophone	1	2	3	4	5	
Video conferencing	1	2	3	4	5	
Audio conferencing	1	2	3	4	5	
Electronic Whiteboard	1	2	3	4	5	
File Sharing application (e.g. our shared file store or FTP servers)	1	2	3	4	5	
Wikis	1	2	3	4	5	
Instant messaging/chat	1	2	3	4	5	
IP phones (e.g. Skype)	1	2	3	4	5	
Others (please specify) _____	1	2	3	4	5	

4.2 “**Reliability** is the ability of a system to perform and maintain its functions in routine circumstances, as well as hostile or unexpected circumstances.”

Please rate the **reliability** of the following technologies which you have used when communicating with **co-located** colleagues

Please circle the number which corresponds to your answer. Please tick in the N/A box if you have not used the technology

Technologies	Never Used					Very frequently used	N/A
	1	2	3	4	5		
Telephone	1	2	3	4	5		
E-mail	1	2	3	4	5		
Fax	1	2	3	4	5		
Videophone	1	2	3	4	5		
Video conferencing	1	2	3	4	5		
Audio conferencing	1	2	3	4	5		
Electronic Whiteboard	1	2	3	4	5		
File Sharing application (e.g. our shared file store or FTP servers)	1	2	3	4	5		
Wikis	1	2	3	4	5		
Instant messaging/chat	1	2	3	4	5		
IP phones (e.g. Skype)	1	2	3	4	5		
Others (please specify) _____	1	2	3	4	5		

4.3 Please rate how often the following technologies are used when communicating with **distributed** colleagues (those who are not located in the same office as you are)

Please circle the number which corresponds to your answer.

Technologies	Never used				Very frequently used
	1	2	3	4	5
Telephone	1	2	3	4	5
E-mail	1	2	3	4	5
Fax	1	2	3	4	5
Videophone	1	2	3	4	5
Video conferencing	1	2	3	4	5
Audio conferencing	1	2	3	4	5
Electronic Whiteboard	1	2	3	4	5
File Sharing application (e.g. our shared file store or FTP servers)	1	2	3	4	5
Wikis	1	2	3	4	5
Instant messaging/chat	1	2	3	4	5
IP phones (e.g. Skype)	1	2	3	4	5
Others (please specify) _____	1	2	3	4	5

4.4 “**Reliability** is the ability of a system to perform and maintain its functions in routine circumstance, as well as hostile or unexpected circumstances.”

Please rate the **reliability** of the following technologies which you have used when communicating with **distributed** colleagues

Please circle the number which corresponds to your answer. Please tick in the N/A box if you have not used the technology

Technologies	Never Used					Very frequently used	N/A
	1	2	3	4	5		
Telephone	1	2	3	4	5		
E-mail	1	2	3	4	5		
Fax	1	2	3	4	5		
Videophone	1	2	3	4	5		
Video conferencing	1	2	3	4	5		
Audio conferencing	1	2	3	4	5		
Electronic Whiteboard	1	2	3	4	5		
File Sharing application (e.g. our shared file store or FTP servers)	1	2	3	4	5		
Wikis	1	2	3	4	5		
Instant messaging/chat	1	2	3	4	5		
IP phones (e.g. Skype)	1	2	3	4	5		
Others (please specify) _____	1	2	3	4	5		

4.5 Do you need to work with people who are from an external organisation?

Yes (please carry on with this section)

No (please go to section 5)

4.6 Please rate how often the following methods are used when communicating with people from an external organisation

Please circle the number which corresponds to your answer

Methods	Never used					Very frequently used
	1	2	3	4	5	
Telephone	1	2	3	4	5	
Face-to-face meetings	1	2	3	4	5	
Post and couriers	1	2	3	4	5	
E-mail	1	2	3	4	5	
Fax	1	2	3	4	5	
Videophone	1	2	3	4	5	
Video conferencing	1	2	3	4	5	
Audio conferencing	1	2	3	4	5	
Electronic Whiteboard	1	2	3	4	5	
File Sharing application (e.g. our shared file store or FTP servers)	1	2	3	4	5	
Wikis	1	2	3	4	5	
Instant messaging/chat	1	2	3	4	5	
IP phones (e.g. Skype)	1	2	3	4	5	
Others (please specify) _____	1	2	3	4	5	

5.1. Please rate the **importance** of the following activities for building **trust** with new **co-located** team members

Please circle the number which corresponds to your answer

	Very Important	Important	Neutral	Unimportant	Very Unimportant
1. Having an informal face-to-face meeting with the other person	1	2	3	4	5
2. Having a formal face-to-face meeting with the other person	1	2	3	4	5
3. Speaking to the other person on the phone	1	2	3	4	5
4. Emailing the other person	1	2	3	4	5
5. Reviewing a personal information sheet about the other person	1	2	3	4	5
6. Talking about social things over chat/instant messaging	1	2	3	4	5
7. Having a video conference with the other person	1	2	3	4	5
8. Information on posters and notices around the office	1	2	3	4	5

5.2. Please rate your **liking** of the following activities for building trust with new **co-located** team members

Please circle the number which corresponds to your answer

	Least liked Most liked				
1. Having an informal face-to-face meeting with the other person	1	2	3	4	5
2. Having a formal face-to-face meeting with the other person	1	2	3	4	5
3. Speaking to the other person on the phone	1	2	3	4	5
4. Emailing the other person	1	2	3	4	5
5. Reviewing a personal information sheet about the other person	1	2	3	4	5
6. Talking about social things over chat/instant messaging	1	2	3	4	5
7. Having a video conference with the other person	1	2	3	4	5
8. Information on posters and notices around the office	1	2	3	4	5

5.3 Please rate the **importance** of the following activities for building trust with new **distributed** team members

Please circle the number which corresponds to your answer

	Very Important	Important	Neutral	Unimportant	Very Unimportant
1. Having an informal face-to-face meeting with the other person	1	2	3	4	5
2. Having a formal face-to-face meeting with the other person	1	2	3	4	5
3. Speaking to the other person on the phone	1	2	3	4	5
4. Emailing the other person	1	2	3	4	5
5. Reviewing a personal information sheet about the other person	1	2	3	4	5
6. Talking about social things over chat/instant messaging	1	2	3	4	5
7. Having a video conference with the other person	1	2	3	4	5
8. Information on posters and notices around the office	1	2	3	4	5

5.4 Please rate your **preference** for the following activities for building trust with new **distributed** team members

Please circle the number which corresponds to your answer

	Most Preferred	Neutral			Least preferred
1. Having an informal face-to-face meeting with the other person	1	2	3	4	5
2. Having a formal face-to-face meeting with the other person	1	2	3	4	5
3. Speaking to the other person on the phone	1	2	3	4	5
4. Emailing the other person	1	2	3	4	5
5. Reviewing a personal information sheet about the other person	1	2	3	4	5
6. Talking about social things over chat/instant messaging	1	2	3	4	5
7. Having a video conference with the other person	1	2	3	4	5
8. Information on posters and notices around the office	1	2	3	4	5

Thank you very much for taking your time to answer these questions.

Your contribution is greatly appreciated.