

Saifaddin, Huda B. (2011) The role of procedural similarity, self-explanation and self-constructed diagrams in analogical problem solving. PhD thesis, University of Nottingham.

Access from the University of Nottingham repository:

http://eprints.nottingham.ac.uk/11997/1/Huda_Burhan_Saifaddin_thesis_July_2011.pdf

Copyright and reuse:

The Nottingham ePrints service makes this work by researchers of the University of Nottingham available open access under the following conditions.

- Copyright and all moral rights to the version of the paper presented here belong to the individual author(s) and/or other copyright owners.
- To the extent reasonable and practicable the material made available in Nottingham ePrints has been checked for eligibility before being made available.
- Copies of full items can be used for personal research or study, educational, or not-for-profit purposes without prior permission or charge provided that the authors, title and full bibliographic details are credited, a hyperlink and/or URL is given for the original metadata page and the content is not changed in any way.
- Quotations or similar reproductions must be sufficiently acknowledged.

Please see our full end user licence at:

http://eprints.nottingham.ac.uk/end_user_agreement.pdf

A note on versions:

The version presented here may differ from the published version or from the version of record. If you wish to cite this item you are advised to consult the publisher's version. Please see the repository url above for details on accessing the published version and note that access may require a subscription.

For more information, please contact eprints@nottingham.ac.uk

THE ROLE OF PROCEDURAL SIMILARITY, SELF-EXPLANATION AND
SELF-CONSTRUCTED DIAGRAMS IN ANALOGICAL PROBLEM
SOLVING

Huda Burhan Saifaddin

Thesis submitted to the University of Nottingham for the degree of
Doctor of Philosophy, July 2011

بِسْمِ اللَّهِ الرَّحْمَنِ الرَّحِيمِ

ACKNOWLEDGEMENTS

Firstly, and above all, my gratitude, thanks and humble submission to Allah The Most Beneficent and Most Merciful, without whose will and help this challenging task and any achievement or success was not possible. His guidance and enlightenment has given me the patience and tolerance to overcome moments of frustration, depression and despair.

My prayers are due to our Prophet Mohammad (Peace be upon Him) whose sayings and deeds have inspired and enriched my life and my soul.

My heartfelt thanks are due to those whose advice and assistance during this study have been invaluable. I am indebted to Professor Claire O'Malley my advisor, whose constructive comments and suggestions have stimulated me to knowledge that has given me the opportunity to obtain maximum professional grooming and develop the necessary skills to understand the complex nature of analogy. Her experience in the field and valuable remarks not only took this thesis forward, but also gave it the shape it is today.

I would also like to thank my examiners Peter Chapman and Peter Cheng for assessing my thesis and for their valuable suggestions and remarks.

My deepest gratitude to my first advisor professor Balkis Nasser Alsharif, whose academic assistance and support have helped broaden my intellectual and professional horizon. Additional thanks to my local advisor Dr. Faiqah Badr for her support and encouragement. I would also like to express my deepest appreciation to Dr. Tahra Alladin, my co advisor, who deserves a special praise for her great moral support, valuable advice, discussion, criticism, and guidance which were instrumental in the development of this research.

My thanks are also due to the staff of King Abdul Aziz University. Among them are Dr. Sami Hamdi, Dr. Rashad Damanhour (Head of the department of Psychology), Dr. Khadija Khoja, and Omaima Olagi for their support. I am also grateful to Dr. Fouad Dahlawi for his support during the stage of analysis and discussion of quantitative and qualitative data.

Several colleagues offered valuable advice, criticism, care and concern, notably among them are my dear sister Dr. Laila Al Ghalib, Dr. Khadija Mashhour, Dr. Khadija Sabban, Hafsa Raies, Nesma Alkhatib, Dr. Hassn Thabit, Dr. Mohsen Mansouri, Dr. Shehadah Fareh, Mousa Belhadif and Isa and Khadija Wada. A special thank you to certain people whose names must be recorded for their assistance and concern; Danah Dhabban, Laiala Al Mishawi, and the undergraduates at King Abdul Aziz University who have participated in this research.

Finally, I wish to dedicate this work to my family: To my most loving father (May his soul rest in peace) whose memories are still alive in my thoughts. He always encouraged me to think independently, believe in what I do and do it right.

To my invaluable and loving mother, whose prayers, love, encouragement, support, and personal sacrifice, have made my higher education possible. God bless her with long and happy life.

To all my brothers and sisters for their unconditional love, spiritual and physical support that brought security and happiness to my life; Abudulwahid, Samira, Khalid, Mohammad, Haifa, Hatim, Khadija, Haitham, Elham and Safinaz.

To my dear nephews, from Abrar and Samah to Ahmad and Hamza whose belief in my ability always raised my confidence.

I extend my thanks to all my brothers and sisters in law for their care and concern.

Last, but not least, to my dearest and loving husband, who stood by me in every moment of my life and career. Your valuable comments and moral support was an anchor that kept me steadfast on achieving this goal. Despite your busy schedule, you were always there when I needed you. No words are enough to express my gratitude. Your love, compassion, encouragement, and emotional support are invaluable and beyond repayment.

TABLE OF CONTENTS

ACKNOWLEDGEMENTS	III
LIST OF TABLES	XII
LIST OF FIGURES	XV
PREFACE	XX
ABSTRACT	XXI
CHAPTER 1: OVERVIEW OF THE THESIS	1
Introduction.....	1
Thesis Overview	4
CHAPTER 2: LITERATURE REVIEW	12
Introduction.....	12
Problem Solving	12
Insight Problem-Solving.....	16
Analogical Problem Solving	18
Theories of Analogical Problem-Solving	22
Triarchic Theory	22
Structure-Mapping Theory	26
Pragmatic and Multi-Constraint Theories	28
Overview of Theories	31
The ACME (Analogical Constraint Mapping Engine) Model	34
External Representation.....	36
Cognitive Theory of Graphical and Linguistic Reasoning	39
Pictorial Representation in Analogical Problem Solving	42
The Self-Support Methods.....	48
Self-Explanation (SE).....	48
Self-Constructed Diagrams (SCD)	53
Importance of the Thesis	61
Aim of the Thesis.....	64

CHAPTER 3: THE TASK ANALYSIS FOR PROCEDURAL SIMILARITY ..	65
Introduction.....	65
Preliminary Studies.....	72
Task Analysis.....	75
The Elephant Problem	76
Problem Building.....	80
The Salt Problem	81
Summary	87
CHAPTER 4: THE EFFECT OF SELF-EXPLANATION ON PROCEDURAL LEVEL OF SIMILARITY	89
Introduction.....	89
The Think-Aloud Protocol.....	90
Experiment 1	93
Hypotheses.....	94
Methodology	95
Participants	95
Procedure	95
Materials	98
Scoring.....	99
Statistical Analysis.....	102
Results.....	103
Quantitative Analysis.....	104
The Coding of Verbal Protocols	109
Segmentation	110
Categorization of the Protocols	113
Verbal protocols Analysis.....	128
Factors Affecting Strength of Transfer	132

Relationship between the Cognitive Processes and Strength of Transfer	133
Types of Ideas Generated	135
Discussion.....	137
Conceptual Analysis of Prediction	137
Critical analysis of the findings	145
Contributions	158
Limitations	158
Conclusion	160
CHAPTER 5: MODALITY OF REPRESENTATION AND ITS EFFECT ON TRANSFER IN PROBLEM SOLVING BY ANALOGY	163
Introduction.....	163
External Representation.....	163
Experiment 2.....	166
Hypotheses.....	167
Methodology.....	170
Participants	170
Design and Materials	170
Construction of Problem Tasks	172
Levels of Abstraction.....	174
Results.....	175
ANOVA Results	176
Solvers and Non-Solvers	177
Solvers of the source problem	180
Solvers of the Target Problem	181
Other Important Findings	182
Discussion.....	183
Critical analysis of the findings	183

Contributions and Limitations of Experiment 2	191
Conclusion	192
CHAPTER 6: THE ROLE OF SELF-CONSTRUCTED DIAGRAMS IN ANALOGICAL PROBLEM SOLVING.....	194
Introduction.....	194
The Importance of Externalizing Representation	195
Experiment 3	199
Hypotheses.....	199
Methodology	201
Participants	201
Materials	201
Design	202
Procedure:	203
Scoring.....	205
Development of the Drawing Protocol Analysis	206
Analysis of the Self-Drawings	217
Coding Scheme for the Diagram	220
Statistical Analysis.....	228
Results.....	229
Descriptive Analysis	229
ANOVA Results	237
Qualitative Analysis of Drawing Protocols	240
Inter-Coder Reliability for Diagrams.....	240
Analysis of the drawing units generated.....	241
Discussion.....	246
Contributions and limitations	256
Conclusions.....	257

CHAPTER 7: THE GENERATIVE PROCEDURAL MODEL FOR ANALOGICAL PROBLEM-SOLVING	260
Structural Mapping theory and the Multi Constraints theory	261
The Cognitive Load Theory.....	262
Cognitive Theory of Multimedia Learning.....	263
Learner-Generated Drawing Model.....	264
The Generative Procedural Model (GPM) for Analogical Problem-Solving	266
Comparison of Models	266
Description of the GPM	270
Discussion.....	307
Distinctive characteristics of the GPM	309
Limitation	315
Conclusions.....	316
CHAPTER 8: GENERAL DISCUSSION	317
Summary of the Thesis	317
Overall Discussion.....	324
Modality of Representation	325
Levels of Abstraction.....	328
The Self-Support Methods (SE, SCD).....	330
Contributions of the Study	334
Limitations of the Study	336
Overall Conclusion	340
REFERENCES	342
APPENDIX.....	353
A. MATERIAL USED IN EXPERIMENTS 1	354
B. THE CODING OF VERBAL PROTOCOL FOR PICTORIAL REPRESENTATION	357
C. MATERIALS USED IN EXPERIMENT 2& 3.....	366

D. TASK ANALYSIS FOR EXPERIMENTS 2 & 3	368
E. THE SCORING SHEET FOR SCD.....	395

LIST OF TABLES

Table 4.1	105
Number of Solvers in each Target Problem according to Performance on the Source Problem	
Table 4.2	106
Number of Participants who Solved both Source Problems according to Levels and Conditions	
Table 4.3	107
Solvers of both the Source and Target Problems according to Levels of Similarity	
Table 4.4	107
Number of Solvers in the Target Problem according to Levels and Conditions	
Table 4.5	107
Number of Participants who solved both the Target Problems according to Levels and Conditions	
Table 4.6	108
Descriptive Statistics of Performance on Target Problem according to Protocol Conditions and Levels of Similarity	
Table 4.7	126
Kappa Inter-Coder reliability for all Participants between coder A and the researcher on the salt problem	
Table 4.8	127
The coding sheet	
Table 4.9	129
The Mean and SD of the Time Spent and Number of Lines Generated by Solvers and Non-solvers in both Source and Target Problems	
Table 4.10	131
The Mean and SD of the Frequencies of Explanation and Inference Processes in both Source Problems	
Table 4.11	132
The Mean and SD of the Frequencies in the Main Processes of Explanation, Inferences, and Analogizing in the Target Problem	
Table 4.12	132
The Mean and SD of the Frequencies in the Sub-processes of Inferences, and Analogizing in the Target Problem	

Table 4.13	133
Correlations between the Main Cognitive Processes and the Strength of Transfer	
Table 4.14	133
Correlation between the Sub-processes of Inference and the Strength of Transfer	
Table 4.15	134
Correlation between the Sub-processes of Analogizing & Strength of Transfer	
Table 5.1	178
Solvers according to Level of Similarity and Type of Representation	
Table 5.2	179
Solvers of both the Source and its Target Problems	
Table 5.3	180
Solvers for Source Pictorial and Source Verbal Scores	
Table 5.4	182
Mean and SD According to Levels and Conditions	
Table 6.1	212
Form A, Judges' Analysis of the drawing protocols of participant 1	
Table 6.2	213
<i>Form A, Judges' Analysis of the drawing protocols of participant 2</i>	
Table 6.3	214
Form A, Judges' Analysis of the drawing protocols of participant 3	
Table 6.4	215
Form A, Judges' Analysis of the drawing protocols of participant 3	
Table 6.5	216
<i>The cognitive processes derived from the judges' verbal interpretations described in the previous Tables</i>	
Table 6.6	230
Correlations Inter-scorer Reliability	
Table 6.7	231
Descriptive of Time Spent on Source and Target Problems	
Table 6.8	231
Pictorial Representation	
Table 6.9	232
Verbal Representation	
Table 6.10	232
Pictorial Representation	

Table 6.11	232
Verbal Representation	
Table 6.12	234
The number of Solvers for the Pictorial and Verbal source and Target Problems in Drawing Conditions	
Table 6.13	234
Number of Solvers in both Source and Target Problem in each Level of Similarity	
Table 6.14	235
Pictorial Source and Target solvers in the Conditions of Drawing and Levels of Similarity	
Table 6.15	236
Verbal Source and Target solvers in the Conditions of Drawing and the Level of Similarity	
Table 6.16	236
Source and Target solvers in the Pictorial Representation	
Table 6.17	237
Source and Target solvers in the Verbal Representation	
Table 6.18	239
Mean Performance according to Levels of Similarity, Conditions of Drawing, and Type of Representation	
Table 6.19	240
Descriptives of Time Spent on Source and Target according to Type of Representation in SCD Condition	
Table 6.20	243
Descriptives of Number of Drawing Units and Arrows Generated	
Table 6.21	245
Cognitive Processes revealed in the Source Problems	
Table 6.22	245
The Qualitative Analysis for Cognitive Processes in the Target Problems	
Table 6.23	245
The Correlations between the Cognitive Processes and ST in the Target Problem of PS in the SCD	
Table 6.24	246
The Correlations between the Cognitive Processes and ST in the Target VS Problem	

LIST OF FIGURES

Figure 2.1: Tower of Hanoi: initial and goal state	16
Figure 2.2: The nine-dot matrix and its solution.	17
Figure 2.3: The Triarchic theory.....	24
Figure 2.4: The three components of the componential sub-theory.	24
Figure 2.5: Different representations for Tic-Tac-Toe problem (Zhang et al., 1998).	39
Figure 2.6: The conflict with relational correspondence. The two women are highly similar perceptually, but they play different roles in the scenes where cross mapping leads to a conflict of perceptual correspondences that conflict with relational correspondence (Markman and Gentner 2000).	43
Figure 2.7: The pair of diagrams used as a source analogue by Gick and Holyoak (1983).	45
Figure 2.8: The source pictorial representation for the Dunker Radiation (Target) problem (Pedone et al. 2001).	46
Figure 3.1: The representation of the various schematic models in the source problem used by Chen (2002).	73
Figure 3.2: Tools for the target Elephant problem.	78
Figure 3.3: The Principle Model (the right to left direction).	78
Figure 3.4: The right to left new spring compression model (similar strategy). ..	79
Figure 3.5: The right to left new sinking compression model (similar procedure). ..	79
Figure 3.6: Tools for the Target Salt problem.	82
Figure 3.7: The Principle model.	83
Figure 3.8: Strategy Multi-Measure Model.	83
Figure 3.9: Procedure single measure refilling method.	84
Figure 3.10: A) The initial state of the principle level. B) The goal state of the principle level: measuring out the amount of water required.	85
Figure 3.11: A) The initial state of the Strategy level. B) The goal state: required amount of water remaining in a glass.	85
Figure 3.12: The initial and goal state of the procedural level. A) The initial state Source of water, the required amount of water. B) goal state: measuring out the(tap)One large jug (empty), One glass.	86
Figure 3.13: The space theory of the solved problem	88
Figure 4.1: Estimated marginal means of both target problems according to levels and conditions. This figure shows the effect of procedural level of similarity in both VB and SE conditions. There is also a strong effect of SE on the strategy level of similarity.	109

Figure 4.2: The Cognitive Processes Model (CPM).....	114
Figure 4.3: Sub-process of Labeling in the Strategy level.....	116
Figure 4.4: Sub-process of Labeling in the procedural level.....	116
Figure 4.5: Sub-process of Combination in the strategy level.....	117
Figure 4.6: Sub-process of Combination in the procedural level.	117
Figure 4.7: Sub-process of Comparison in procedural level of similarity.	118
Figure 4.8: Sub-process of Comparison in strategy level of similarity.	118
Figure 4.9: Sub-process of Relation in the procedural level.	119
Figure 4.10: Sub-process of Relation in the strategy level.	120
Figure 5.1: The various problems used according to levels of similarity and type of representation	172
Figure 6.1: The design of the experiment: four main groups in each condition. Note. 'G': is group number.	203
Figure 6.2: categorization of drawing protocols by (Cox & Brna, 1995). A) Plan, B) Minimal plan, C) Directed graph, D) Logic, E) Set digram and F) Letters and lines.	208
Figure 6.3: This self-constructed diagram shows 4 units separated by space. Note: (A part of the sketch is encircled by the researcher to highlight a particular feature.).....	218
Figure 6.4: This diagram consists of 5 units separated by space, circles, and arrows.	218
Figure 6.5: This participant drew 4 units separated them by space; the circles show these units.	218
Figure 6.6: This participant drew 3 units separated by arrows and rectangles. ..	219
Figure 6.7: This participant produced 8 units separated by lines.	219
Figure 6.8: Labeling taken from several participants in The Almond target problem and Ball 1 source problem.	221
Figure 6.9: The sub-process of combination.	221
Figure 6.10: Comparing the two units the first is equal and the second is not equal.....	222
Figure 6.11: The sub-process of comparing.	222
Figure 6.12: The sub-process of comparing. The circles and arrows indicate the process of comparing the different units drawn by the participants.	222
Figure 6.13: The process of relation.	223
Figure 6.14: The process of relation.	223
Figure 6.15: The process of relation in the Bar2 problem.	223
Figure 6.16: The process of relation in the Jug problem.	223
Figure 6.17: The process of relation in the Jug problem.	224

Figure 6.18: The sub-process of mathematical elaboration.	224
Figure 6.19: The sub-process of mathematical elaboration.	224
Figure 6.20: The sub process of mathematical elaboration.	225
Figure 6.21: Initial state and goal state in the Jug problem.	225
Figure 6.22: Depiction of obstacles in the self-constructed diagrams.	226
Figure 6.23: Profile Plots: The Conditions * Representation * the Level of Similarity.) The estimated marginal means of the condition * representation in Figure (a) The strategy level. (b) The procedural level. There is no significant interaction in (a) and (b). There is no interaction effect between the condition and levels of similarity (c) and between the levels and the representation (d).	239
Figure 6.24: Comparison of the source and target generated diagrams in the Pictorial source representation.	251
Figure 6.25: The sketchpad of the pictorial source (Jug 2 problem).	255
Figure 6.26: The sketchpad of the target problem for the pictorial source (Jug 2).	255
Figure 6.27: Sketchpad of source verbal problem.	255
Figure 6.28: Sketchpad of the target Lab problem.	255
Figure 7.1: Gentner & Markman (1997) Model of Mapping cognitive processing	261
Figure 7.2: Mayer Model.	264
Figure 7.3: Comparing Assumptions	268
Figure 7.4: Comparing Cognitive processes	268
Figure 7.5: Comparing Methodology	269
Figure 7.6: The initial state of the model.	274
Figure 7.7: The Cognitive Process Of Labeling (1).	275
Figure 7.8: The sub-process of combination (2).	276
Figure 7.9: The sub-process of comparison (3).	276
Figure 7.10: The sub-process of math elaboration (5).	277
Figure 7.11: The cognitive sub-process of relations (4).	278
Figure 7.12: The cognitive sub-process of goal directness (6).	278
Figure 7.13: The process of integration.	279
Figure 7.14: The final state of the source problem.	279
Figure 7.15: Initial state for the target problem.	280
Figure 7.16: the cognitive sub-processes of combination (2) and encoding.	281
Figure 7.17: The process of constraining (7).	282
Figure 7.18: The sub-processes of comparison (3) and Mapping.	282
Figure 7.19: The sub-process of math elaboration (5) and Mapping.	283
Figure 7.20: The sub-processes of relations (4) and mapping.	283
Figure 7.21: The sub-process of goal directness (6) and transfer.	284

Figure 7.22: The process of integration.	284
Figure 7.23: Initial state for the verbal source problem.	285
Figure 7.24: The cognitive process of combination (2).	286
Figure 7.25: The sub-process of combination.	286
Figure 7.26: The sub-process of math elaboration.	287
Figure 7.27: The final state of the source problem case 2	287
Figure 7.28: Initial state for the target problem. The sensory memory selected some verbal elements, one or more, to construct an internal mental model.	288
Figure 7.29: The cognitive sub-process of combination and comparison.	289
Figure 7.30: The cognitive sub-process of math elaboration and mapping.	290
Figure 7.31: The cognitive sub-process of goal and mapping.	290
Figure 7.32: The final state of the target problem indicating integration (case 2)	291
Figure 7.33: Initial state for Case 3	292
Figure 7.34: The cognitive sub-process of combination.	292
Figure 7.35: The cognitive sub-process of comparison.	293
Figure 7.36: The cognitive sub-process of comparison continues.	294
Figure 7.37: Final state of the source problem (Case 3)	294
Figure 7.38: Initial state of the target problem (case 3)	295
Figure 7.39: The cognitive process of comparing	296
Figure 7.40: The cognitive process of mapping.	296
Figure 7.41: The final state of the target problem and the process of integration (case 3)	297
Figure 7.42: Integrated system of relations between the source and target problems.	298
Figure 7.43: The cognitive sub-process of labeling.	300
Figure 7.44: The cognitive sub-process of combination	301
Figure 7.45: The cognitive sub-process of comparison.	302
Figure 7.46: The cognitive sub-process of math elaboration	302
Figure 7.47: The cognitive sub-process of comparing	303
Figure 7.48: The cognitive sub-process of comparing	303
Figure 7.49: The sub-process of goal directness	304
Figure 7.50: The sub-process of goal directness	304
Figure 7.51: The process of integration.	305
Figure 7.52: The GPM is applicable to multiple SSM, levels of similarity and representation.	310
Figure 8.1: Procedural level of similarity: The refilling method	320

Figure 8.2: Problem analysis of the verbal and pictorial source problems and their verbal target.	327
Figure 8.3: Comparison of self-support methods SE and SCD	333

PREFACE

In The Name of ALLAH The most Compassionate, The most Merciful

[وَأَنْتَلُّ عَلَيْهِمْ نَبَأَ ابْنَيْ آدَمَ بِالْحَقِّ إِذْ قَرَّبَا قُرْبَانًا فَتُقْبِلَ مِنْ أَحَدِهِمَا وَآلَمْ يَقْبَلْ مِنَ الْآخَرِ قَالَ لَأَقْتُلَنَّكَ قَالَ إِنَّمَا يَتَقَبَّلُ اللَّهُ مِنَ الْمُتَّقِينَ - لَنْ بَسَطْتُ إِلَى يَدِكَ لَتَقْتُلَنِي مَا أَنَا بِبَاسِطِ يَدِي إِلَيْكَ لِأَقْتُلَنَّكَ إِنِّي أَخَافُ اللَّهَ رَبَّ الْعَالَمِينَ - إِنِّي أُرِيدُ أَنْ نَبُوءَ بِآثِمِي وَإِنَّمَا فَتَكُونُ مِنَ أَصْحَابِ النَّارِ وَتِلْكَ جَزَاءُ الظَّالِمِينَ - فَطَوَّعَتْ لَهُ نَفْسُهُ قَتْلَ أَخِيهِ فَقَتَلَهُ فَأَصْبَحَ مِنَ الْخَاسِرِينَ - فَبَعَثَ اللَّهُ غُرَابًا يَبْحَثُ فِي الْأَرْضِ لِيُرِيَهُ كَيْفَ يُورِثِي سَوْءَةَ أَخِيهِ قَالَ يُورِثُنَا أُعْجِزْتُ أَنْ أَكُونَ مِثْلَ هَذَا الْغُرَابِ فَأَوَارِي سَوْءَةَ أَخِي فَأَصْبَحَ مِنَ النَّادِمِينَ]

(27. And recite to them the story of the two sons of Adam in truth; when each offered a sacrifice, it was accepted from the one but not from the other. The latter said to the former: "I will surely, kill you." The former said: "Verily, Allah accepts only from those who have Taqwa.) (28. "If you do stretch your hand against me to kill me, I shall never stretch my hand against you to kill you, for I fear Allah; the Lord of all that exists.") (29. "Verily, I intend to let you draw my sin on yourself-as well as yours, then you will be one of the dwellers of the Fire, and that is the recompense of the wrongdoers.") (30. So the soul of the other encouraged him and made fair-seeming to him the murder of his brother; he murdered him and became one of the losers.) (31. Then Allah sent a crow who scratched the ground to show him how to hide the dead body of his brother. He said: "Woe to me! Am I not even able to be as this crow and to hide the dead body of my brother" Then he became one of those who regretted.)

The aforementioned verse, taken from the Holy Quran tells the story of Cain and Abel, the two sons of Adam, father of mankind. It illustrates the importance of learning by analogy which existed since man first walked on earth. The incident relates to the first murder that took place when Cain killed his brother Abel out of jealousy, because God accepted Abel's sacrifice of livestock, and rejected the offering of Cain; and so the first murder in a jealous rage occurred. Soon, Cain realized the magnitude of his malicious deed, and was left with a novel problem of how to deal with the situation of death. As Cain was contemplating his actions and its consequences, he saw two crows fighting. Cain watched carefully in a trance of flashbacks as one of them gets killed. The killer crow dug the earth, and buried the dead crow. Cain was quick to notice the analogy wondering at the same time why it did not occur to him. He then began to mimic the actions of the crow for burying his brother, Abel. Thus, from time in memorial beginning of time, immemorial analogies have often helped discover answers to problems that otherwise seemed to be impossible.

ABSTRACT

This study aimed to investigate the precise role of self-support methods, such as self-explanation and self-constructed diagrams, as an alternative to external methods in enhancing the cognitive processes considered crucial for effective transfer performance in analogical problem-solving that depicts a multi-step process involving source problems and target problems. This was achieved by systematically examining how type of representation (Verbal & Pictorial) and levels of similarity (Principle, Strategy, and Procedural) interact with self-support methods (Self-explanation (SE) and Self Constructed Diagrams (SCD)) in influencing transfer performance. Three experiments were conducted each addressing a set of issues related to the purpose of the study.

Experiment 1 (N = 48) was conducted to identify the cognitive processes and their sub-processes involved in analogical problem solving using pictorial representation and also investigated the specific effects of the self-explanation method on transfer process. This experiment consisted of two experimental conditions; self-explanation (SE) (experimental group) and verbalization (VB) (control group), and three levels of similarity (i.e., procedural, strategy, and principle). Procedural similarity combined with the SE method was found to have a positive significant influence on the transfer process compared to the principle and strategy levels and VB condition. However, the verbal protocols also revealed that despite the inherent advantages of SE the percentage of complete solvers was low. This was attributed to some difficulty arising from adapting information from a pictorial source to solve a verbal target.

Experiment 2 (N = 84) investigated the effect of verbal and pictorial types of representation on transfer performance in a within-subjects design, where each participant solved a pictorial source (PS) and verbal source (VS) problem, and their verbal target analogues. The mean performance of the pictorial representation was higher compared to verbal representation. Transfer performance was higher in the procedural level than the strategy level. This indicated that information from PS tends to be utilized more effectively than VS in retrieving and applying that information to the target problem. Thus having ensured that pictorial representation was an advantage in problems depicting a multistep to be implemented, Experiment 3 was conducted.

Experiment 3 (N = 160) aimed at finding whether self-constructed diagrams (SCD) are a better alternative to external support in facilitating the cognitive processes crucial for transfer in analogical problem-solving. As predicted, a significant difference was found between the experimental (SCD) and No Diagrams (ND) control groups in the transfer performance. No significant within subject difference in the transfer performance of verbal and pictorial source representations was found in the SCD condition. An interesting finding was that transfer performance was significantly higher in the verbal representation and strategy level of similarity in the SCD condition than ND. Theoretically, this suggests that because visual memory is more easily accessible than auditory memory, SCD may play a critical role in creating accessible information from the source problem for effective feedback to help solve the target problem.

It was concluded that explaining by diagrams helps in identifying the various elements of the problem that stimulate the memory and motivate the

person to recall what he drew earlier while solving the target problem. This study contributed to the field of research on the cognitive processes involved in problem-solving by analogy. The methodology employed in each of the experiments was unique in terms of coding and scoring the protocols, which generated strong and reliable results. The outcome of the study was a dynamic model “The Generative Procedural Model of Analogical Problem-solving” which contributed to our understanding of not only how information is processed from verbal and pictorial representations during problem-solving by analogy but also the potential of a self-method in optimizing the processes of noticing, retrieving, and implementing a learned solution process successfully.

CHAPTER 1: OVERVIEW OF THE THESIS

Introduction

Analogy is of paramount importance for problem-solving, learning, and creativity. Analogy is defined as a mental process of transferring information from a particular domain (i.e., the source) to another domain (i.e., the target). The success of any transfer process is contingent on the ease with which acquired information is retrieved and applied to solve similar problems. Failures in the transfer process often occur when individuals are unable to apply the solution that they previously learned. Most researchers who intended to increase transfer success in analogical reasoning, used a variety of external methods, such as hints (Chen, 2002; Gick & Holyoak, 1980, 1983; Mayer, Steinhoff, Bower, & Mars, 1995; Pedone, Hummel, & Holyoak, 2001), schema induction (Chen & Mo, 2004; Gick & Holyoak, 1983), multiple external representation (MER) (Ainsworth, 2006; Ainsworth & Van Labeke, 2002; Ainsworth & Van Labeke, 2004), and multimedia (MMR) (Mayer, 1997, 2001; Mayer, Dow, & Mayer, 2003; Mayer et al., 1995; Pedone et al., 2001). With the exception of hints, these methods often produced mixed results because learners either tended to treat each representation separately or failed to integrate information from more than one source (Ainsworth, 2006).

The current study investigated the precise role of self-support methods, such as self-explanation (SE) and self-constructed diagrams (SCD), as an alternative to external support methods, in enhancing the cognitive processes considered crucial for effective transfer performance in analogical problem-solving.

In this study, analogical problem-solving was investigated through sets of similar or isomorphic problems where the first in each set is referred to as the source problem and the second set is referred to as the target problem. The term transfer refers to the process of retrieving the principle, strategy, or procedural aspects of similarity between the source problem and applying it to the target problem. In other words, transferring the information gained in the source to the target. Successful transfer occurs when the information gained from the source problem is effectively used to solve the target problem.

The study used novel, non-domain-specific, every-day problems in both the source and target. These problems are considered novel because they do not demand any specific previous knowledge, but they do require some insight. They involved deciphering a step-by-step process of weighing large objects or measuring substances without adequate tools. As the problems involved learning a process in the source and implementing it in an isomorphic target problem, the representation of the problem in the source (in terms of the level of similarity shared between the source and target problems), and the modality of representation are important factors that determine transfer performance. The source problems were pictorially depicted at three levels of similarity, which differed in the extent to which they shared a concrete procedure with the target, ranging from “none” to “complete procedure.

Principle level of similarity refers to the abstract type of information shared between the source and the target problem to be solved. The strategy level of similarity depicts a procedure that could be used to solve a given problem by providing relevant information but not the exact procedure for deriving the target solution. On the other hand, procedural similarity which refers to the complex

multi-componential relationships between the source and the target problem, is defined as “the transformation of a general solution principle or idea into concrete operations (a sequence of actions) relevant to goal attainment” (Chen, 2002, p. 81). Therefore, an assumption that remained consistent throughout the study was that pictorial representation combined with the procedural level of similarity, between the source and the target, are important factors influencing the transfer performance.

As analogy is considered a critical tool in learning, creativity and problem-solving, this dissertation was motivated by a need for reliable, quantitative, experimentally derived data on the factors that enhance transfer performance in analogical problem-solving both in verbal and pictorial forms of representations. Although there is a plethora of research on verbal representation in learning and problem-solving, there is comparatively a lack of systematic investigation regarding analogical reasoning with diagrams. The study builds off the theoretical frameworks in the field of analogical problem-solving that guided the researcher to develop a unique methodology to understand and analyze the finer aspects of the pictorial representation and protocols generated while solving problems by analogy.

Besides, enhancing the understanding of analogical problem-solving in non-domain specific problems depicting a process diagrammatically at different levels of similarity, this study intended to provide an alternative perspective to dealing with the problem of faulty or incomplete transfer by demonstrating the potential of self-support methods (self-explanation and self-constructed diagrams) in analogical problem-solving. According to Chi, Bassok, Lewis, Reimann, and Glaser (1989), self-explanation “is a mechanism of study that

allows students to infer and explicate the conditions and consequences of each procedural step in the example, as well as apply the principles and definitions of concepts to justify them” (p. 151). Chi et al. also claimed that explanations could explore students’ understanding when applying the condition of action, the consequences, the relationship of actions to goals, and the relationship of goals and actions to natural laws and other principles of actions (Chi et al., 1989).

In sum, this dissertation aimed to find other methods that effectively overcome the problem of failure to notice relationships between the source and target problems and the retrieval of relevant information from the source. The study consisted of three experiments and generated a working model to illustrate the dynamic role of a self-support method (SSM) in optimizing the transfer performance in analogical problem-solving. The problem theme, mode (pictorial), and the levels of representation (strategy, and procedure) in the source remained consistent throughout the study to compare their effects separately and when combined with other factors such as self-explanation (Experiment 1), verbal representation (Experiment 2), and self-constructed diagrams (Experiment 3).

Thesis Overview

The thesis consists of eight chapters. Chapter 1 presents the background and the problem that this dissertation intends to examine and resolve. It provides a vivid explanation of the importance of the problem and also summarizes the seven chapters of the thesis.

Chapter 2 reviews relevant literature of analogical problem-solving. It begins by describing various kinds of problems in general and analogical problems in particular. Because analogical problem-solving involves the ability

to learn and apply knowledge, the theoretical background for the study began by reviewing the contribution of Sternberg's Componential sub-theory of Intelligence that gave a framework of the important cognitive processes underlying classical analogies. Among the more specific theories of analogical reasoning are Structural Mapping theory (Gentner, 1983) and Multi Constraints theory (Gick & Holyoak, 1983). These theories contributed immensely to our understanding of how complex analogies are represented and processed in terms of superficial and structural relations between source and target (Gentner, 1983) and goals/constraints (Gick & Holyoak, 1980, 1983). Because the external representation of a problem has a direct effect on problem-solving performance, Chapter 2 emphasizes the importance of pictorial representation in analogical problem-solving. One of the important theories that guided the understanding of representation in problem-solving is that of Stenning and Oberlander (1995) who advocated that reasoning performance is largely determined by both the logical equivalence of inferences and the implementational differences expressed in graphical or linguistic forms. Finally, as the current study is to some extent based on the work of Pedone et al. (2001) and Chen (2002), they are reviewed in more detail. Chapter 2 ends by briefly stating the aims and importance of the study.

Chapter 3 describes how the problem tasks were chosen and built to achieve the aims of the study. This chapter briefly mentions the two preliminary studies A and B undertaken to determine the suitability of the problem tasks chosen for the main study and to explore how analogical problems are generally perceived and solved by Arab participants.

The verbal target problem, "Elephant", was translated into Arabic language and its source pictorial schematic models were taken from Chen (2002).

This problem was chosen for three reasons: (a) the problem is an insight problem which does not require domain-specific information, (b) the problem describes a process that could be depicted pictorially, and (c) the problem could be represented at different levels of similarity in the source problem. These characteristics of the problem served the aims of the study.

Chapter 4 reports Experiment 1 which was conducted to investigate the specific effects of the think aloud method of self-explanation (SE) on the cognitive processes and sub-processes involved in analogical problem-solving in general and transfer performance in particular when using pictorial representation in the source. This experiment examined deeply the nature of verbal protocols produced that helped develop a coding scheme that was applied to all verbal protocols in the study.

In Experiment 1, forty-eight (48) undergraduate female students were randomly assigned to two conditions (i.e., SE and VB) and three levels of similarity (principle, strategy, and procedural). This experiment used the Elephant and the Salt problems (Appendix A). The basic theme of the problems was a multistep process of weighing heavy objects and measuring out substances without adequate tools.

Think-aloud means that participants verbalize their thought processes as strategies that they are using in tackling a specific problem. Differentiating between VB and SE, Ericsson & Crutcher (1991) and Ericsson & Simon (1993) defined the former as saying aloud anything that comes to the mind from the short-term memory (STM) while engaging in a task while the latter involves verbally recoding the contents of STM. According to these researchers, direct verbalization does not interfere with the performance of the task, and it does not

slow down the process of problem-solving. On the other hand, self-explanation was chosen because there was sufficient empirical evidence regarding its effectiveness in facilitating the learning process (Ainsworth & Loizou, 2003; Chi et al., 1989; Renkl, 1997). However, besides investigating the effectiveness of SE in analogical problem-solving this experiment also compared it to the VB method. Experiment 1 shows that self-explanation and procedural level of similarity have a significant positive effect on strength of transfer performance. Further, the results indicated a significantly higher mean performance in the SE condition than VB condition. The results also showed that the mean performance in the procedural level of similarity was significantly higher in the SE condition than the VB condition. Experiment 1 therefore concluded that procedural similarity, when combined with the SE support method, has a positive significant influence on the transfer process.

Although results revealed that the SE protocols guided the thinking process towards the goal and induced active involvement of the participant in the problem-solving process, there were only 62% complete solvers. On the basis of SE protocols this was attributed to some difficulty in mentally simulating and executing the solution process from the source to the target problem. Protocols also revealed that participants often tended to fail in integrating information or forgetting important pieces of information. Thus, as a method of self-support, SE perhaps failed, somewhat short, in providing an effective scaffold, in manipulating information of a multistep process in the working memory, while problem solving.

In Experiment 1, a verbal format was used to depict the target problem of the pictorial source to compare transfer performance across levels and conditions.

As such, it was speculated that the results could be affected by individual differences in processing pictorial information and/or the ease of transferring or adapting information from a pictorially represented source analogue to a verbal target problem. Therefore, this issue was addressed before continuing the search for an effective alternative to external support methods (such as hints) during problem-solving in this study.

Chapter 5 reports the result of Experiment 2, which aimed to investigate the effect of verbal and pictorial types of representation on transfer performance. Eighty four (84) undergraduate female students were assigned to two levels of similarity (strategy and procedural). Unlike Experiment 1, this experiment used a within-subjects design where each participant solved both pictorial (PS) and verbal (VS) source problems along with their verbal target analogues. This design was chosen to reduce the effect of individual differences while solving problems that differ in the format of representation in the source problem. In other words, this method was used to isolate some extraneous variables that may be a result of individual differences. New problems were constructed and used in this experiment. The two target problems were named (a) the Almond and (b) the Lab. Their source analogues were constructed verbally and pictorially in two levels of similarity, strategy, and procedure. The basic theme of the problems remained weighing heavy objects and measuring out substances. A pilot study (Appendix D) was conducted, for experiment 2, to establish the computational and informational equivalence of the problems as well as their reliability and validity.

Experiment 2 predicted that positive transfer will be influenced more by the pictorial representation and the procedural similarity shared between the

source analogue and target problem. A significant within-subjects main effect was revealed for the type of representation on target performance, where the mean performance of pictorial representation was higher than the verbal. A significant between-subjects main effect was also found for the levels of similarity, with transfer performance higher in the procedural level compared to strategy level. Therefore, the prediction that a pictorial type of representation combined with procedural similarity is more effective than the verbal representation in transfer performance was confirmed. This was apparently because problems that require an understanding of a multistep process and the mental manipulation of objects lend themselves more easily to a pictorial representation.

Chapter 6 reports Experiment 3, which aims at finding whether self-constructed diagrams (SCD) are a better alternative to external support methods in eliciting the cognitive processes crucial for transfer in analogical problem-solving. The mixed design of this experiment consisted of three independent variables: two levels of similarity (i.e., strategy and procedural), and two conditions of drawing (i.e., SCD and No Diagrams (ND)) as between-subjects factors and two modalities of representation (i.e., VS and PS) were the within-subjects factor. One hundred and sixty (160) female undergraduate students participated in this experiment. Each participant solved two problems (VS and PS) and their verbal target analogues (Appendix C).

Experiment 3 predicted that the condition of SCD will have a positive influence on performance (strength of transfer) more than the condition of ND and that participants in the procedural-level of similarity will perform better than the participants in the strategy level of similarity in the SCD condition. It was

also predicted that there would be no within-subjects significant difference between the performance in the two types of representations, pictorial and verbal in the SCD condition.

Experiment 3 revealed a significant difference between the experimental (SCD) and control (ND) groups in the transfer performance. A significant difference was found between the procedural and strategy levels of similarity where participants in the procedural level performed better than those in the strategy level. Also, the study revealed no significant within-subject difference in the transfer performance of verbal and pictorial source representation in the SCD condition. An interesting finding in Experiment 3 runs contrary to the findings of Experiment 2 in that transfer performance was significantly higher in the verbal representation and strategy level of similarity in the SCD condition than the ND condition.

Chapter 7 describes the outcome of the study through a model “The Generative Procedural Model of Analogical Problem-Solving” developed by the researcher. The validity of the model was demonstrated by analyzing three cases in the SCD condition and one case in the SE condition to illustrate how a representation is perceived and processed in the working memory using self-support methods of SE and SCD during problem-solving. The proposed model contributes to our understanding of not only how information is processed from verbal and pictorial representations during problem solving by analogy but also the potential of a self-support method in optimizing the processes of noticing, retrieval and successful implementation of a learned solution process. It integrates the points of view of various theories that are relevant to effective

transfer performance while solving analogical problems that involve learning and implementing a process.

Finally, in Chapter 8 an overall discussion of the study is undertaken. It also states the contributions and limitations of the study along with implications for future research. The most significant finding of the study was that the self-support methods such as self-explanation and self-constructed diagrams, the pictorial type of representation, and the procedural level of similarity were important factors positively influencing the transfer performance in solving problems by analogies that involve a multistep processes to be learned and implemented.

CHAPTER 2: LITERATURE REVIEW

Introduction

This chapter provides a theoretical and empirical background to analogical problem-solving. It begins with highlighting the different types of problems, the process of problem-solving and external representation of the problem in general and analogical problems in particular. Sternberg's Triarchic Theory of Intelligence (1987), Gentner's Structural Mapping Theory (1983), Multi-constraints (Gick & Holyoak, 1980, 1983), and Pragmatic Approach (Holyoak, 1985) along with the ACME model (Holyoak & Thagard, 1989a; 1989b;) have been discussed to provide a theoretical framework. The chapter also reviews literature on the think-aloud methods and the role of diagrams in learning and reasoning. Chen (2002) and (Chen & Mo, 2004) used schematic representations in the source at different levels of abstraction (similarity) with a verbal target problem which is also discussed here to highlight the importance of procedural similarity in problems involving a multistep process solution.

Problem Solving

Problem solving is the use of previous knowledge or new skills applied to a situation where a definite outcome is sought. Mayer (1999a) defined problem-solving as “cognitive processing directed at transforming a given situation into a goal situation when no obvious solution method is available to the problem solvers” (p. 437). This broad definition, which applies to problems ranging from mathematical problems, playing chess, to resolving a personal dilemma, consists of four basic components: mental activity (cognition), knowledge or operations, goal directed, and personal ability or skill (Mayer 1999a).

Problems have been categorized according to the variation in their nature of complexity, domain specificity, and level of structure (Jonassen, 1997). Complexity of a problem is determined by the availability of information, the degree of connectivity and the type of functional relationships among ideas, and the stability among the properties of the problem (Funke, 1991). Problem complexity necessarily affects the learner's ability, such as search activity to solve the problem, as problems that are more complex require more cognitive operations. Another important aspect of problem-solving is knowledge (domain specificity), for which the assumption is that expertise in the field enhances problem-solving. According to Sternberg (2003), experts are often differentiated from novices based on their organization and use of knowledge. The schemas of experts involve large, highly interconnected units of knowledge, which are organized according to underlying structural similarities among knowledge units and contain a great deal of procedural knowledge about problem strategies relevant to a domain. In contrast, the schemas of novices involved relatively small and disconnected units of knowledge, which are organized according to superficial similarities and consisting of relatively little procedural knowledge about problem strategies relevant to a domain.

Problems with a well-defined structure have been distinguished from an ill-defined structure according to whether they have a clear path to the solution or not (Jonassen, 1997). Problems with clear solution paths usually consist of a clear given or initial state, a clear goal state, and a clear set of rules often encountered in mathematics or science (e.g. what is the area of a playground?).

An ill-defined problem, on the other hand, lacks a clear goal and set of required operations. Everyday problems, such as estimating the cost of something

or figuring out how to obtain a key from a child who locked himself in a room, are often considered as ill defined-problems because they lack a clear path to the goal. Jonassen (2000) believed that ill-defined problems are more prevalent in everyday situations because their solutions, which are often unpredictable, are not constrained by domain content. Although information processing theories regard the processes involved to solve ill-structured problems as the same as those used to solve well-structured problems (Simon & Hayes, 1976), more recent research found some clear indications that simulation in ill-defined everyday problem-solving requires different intellectual skills, that include meta-cognition and argumentation, than well-structured problems (Jonassen & Kwon, 2001).

Researchers have focused more on well-defined problems through computer simulations, which led to the development of computer programs that could solve such problems. Newell & Simon (1972) built a theory of human problem-solving based on the computer program called the General Problem Solvers (GPS) for formalized symbolic problems, such as geometric problems and chess. The GPS program distinguished between the knowledge of a problem (understanding) from the strategy of how to solve the problem. Newell & Simon (1972) described problem-solving as a set of possible internal representations of an external task environment where the problem solver, through the activity of search, generates one or more problem spaces within which to operate. Problem space is defined as the problem solver's internal representation of the problem. It includes the move operators together with the instructions on their applications, and the set of knowledge states that are required on the way from start to goal (Newell & Simon, 1972).

Thus, according to Newell and Simon's theory (1972), the critical factors involved in solving a problem were determining the problem space in terms of the initial state, the goal state to be achieved, and the transformation rules. Newell & Simon (1972) used verbal protocols to establish that while solving a problem, a solver tends to first define objects and operations or generate heuristics, often through means-ends analysis, by focusing on the available operations. Second, the solver finds what inputs are acceptable and what outputs will be generated. Third, the solver creates sub-goals to get closer to the final goal.

Following Newell & Simon's (1972) seminal work, Simon & Hayes (1976) generated some isomorphic problems and defined two problems as isomorphic if both problems have the same structure in their problem space, such as Tower of Hanoi which is isomorphic to the Cannibal and the Missionary problem. These researchers were the first to analyze why one problem, in an isomorphic problem, may be more difficult than the other using their model of problem-solving (Simon & Hayes, 1976). Kotovsky, Hayes, & Simon (1985) assessed difficulty ratios of the problems, which led to two important findings. The first was related to the role of the move operators in determining problem difficulties and transfer, and the second was related to the discovery of a dichotomous pattern of moves. Kotovsky et al. explained the model by describing that the main idea of Tower of Hanoi was to move the disks from one situation to another by following two rules: (1), only one disk can be transferred at a time; (2), a disk can be transferred to a pole only if there are no disks or if it is placed on a larger disk (Figure 2.1).



Figure 2.1: Tower of Hanoi: initial and goal state

Problems are also described as being either routine or creative. Mayer (1999a) distinguished between routine and creative problems based on the personal experience and knowledge of the problem solvers. A problem that is routine for one person might be a creative one for another. According to Sternberg and Davidson (1999), creative problem-solving requires insight, which is a process where a problem solver suddenly progresses from a state of not knowing to knowing how to solve a problem.

Insight Problem-Solving

Sternberg and Davidson (1999) defined insight as a, “Distinctive and apparently sudden realization of strategy that aids in solving a problem, which is usually preceded by a great deal of prior thought and often involves reconceptualizing a problem or a strategy for its solution in a totally new way; it frequently emerges by detecting and combining relevant old and new information to gain a novel view of the problems or of its solution; it is often associated with finding solutions to ill-structured problems (i.e., problems for which a clear path to solution is not known)” (p. 58).

Insight in problem-solving is also often regarded as a process of association among various ideas that may lead to the discovery of the solution. However, Kaplin & Simon (1990) used think-aloud protocols to provide evidence that people used strategies and were not blindly checking for associations by trial and error in problem-solving.

Although insight is often required in well-structured problems, it is more essential for solving ill-structured problems. It occurs when problem solvers restructure their mental view of given information or redefine the problem in a new and productive way. The process of insight invariably occurs in an analogous problem when the structural relations or principles in the source problem are applied to solve the target problem (Mayer, 1999a; Sternberg & Davidson, 1999). According to MacGregor, Ormerod, & Chronicle (2001), the nine-dot problem (Maier, 1930) is one of the most difficult insight problems that had been studied. It requires problem solvers to connect all the dots in a 3 x 3 matrix by drawing four straight lines without lifting their pens from the page or retracing any lines. The key action necessary for solving the nine-dot problem is that participants should draw lines that extend beyond the dots. Further, Kershaw & Ohlsson (2004) and Kershaw, Ohlsson & Coyne (2003) explained that a reasoning which led to the likelihood of producing a key action is dependent on the cognitive factors that underlie that action. This, in the nine-dot problem, involves multiple factors of difficulty; perceptual, knowledge, and processes, that are operating where each lowers the probability of making a non-dot turn. These they refer to as classes of difficulty: Figure 2.2 presents the nine dot problem and its solution.



Figure 2.2: The nine-dot matrix and its solution.

Researchers have used explicit and implicit hints to make insight problems easier (Gick & Holyoak, 1980; Kaplan & Simon, 1990). However, Gick and Paradigm, (1989) discussed the use of diagrams as aids to analogical problem-solving when the two problems were from different domains. They observed that hints were often ignored or rejected when they are inconsistent with the approach (e.g., wrong representation) of the individual. Gick & Lockhart (1995) aptly summarized the role of insight in problem-solving as a process of three dimensions: accessing an existing representation, restructuring, and applying it where either or both of the first two dimensions involve a higher degree of difficulty.

Another important factor that determined the nature of the problem is the way it is represented, which affects how the learner perceives and represents the problem internally. Often, problems are situated in contexts that require the problem solver to select important information from irrelevant information by constructing a problem space. An important function of designing a problem is how to represent it to learners.

Analogical Problem Solving

Analogy is considered an effective cognitive tool for learning and conceptual change. The investigation of the mechanisms of analogical problem-solving has yielded a great deal of progress over the past two decades. The history of work on analogical problem-solving integrates contributions from Cognitive psychology (Chen 2002), Artificial Intelligence (Daives & Goel 2003), Educational psychology (Van meter, Aleksic, Schwartz, & Garner, 2006) and Cognitive Science (Gentner 1983), which reflect its importance. Zhang (1997) considers analogical problem-solving operations representation specific that

activate perceptual operations, such as searching for objects that have a common shape, and inspecting differences.

Studies of analogical reasoning have focused on how people use existing knowledge to draw inferences about new situations, in other words, solving a prior problem (source problem) to solve a new problem (target problem). However, people often fail to see that the two problems are analogous, that is, they can be solved through positive transfer of ideas. According to Robertson (2001), analogical reasoning is a process of effectively applying ideas or a type of solution that worked well for a particular problem or when trying to solve an analogous problem. Robertson also added that negative transfer occurs when the previous learning prevents the person from solving a new problem or at least from seeing an optimal solution. Therefore, the probability of successfully solving a problem by analogy is greatly determined by the representation of the source and target problems, the information or concepts involved, the organization of this information, and the clarity of goals and constraints. The degree of diversity (or similarity or level of abstraction) shared between the source and the target problems termed as isomorphism, determine the probability of success in problem-solving. Isomorphic problems usually involve the process of identifying the underlying structural isomorphism of problems and applying the idea or the method to solve another problem (e.g., from a textbook to a problem on a test).

Analogical reasoning has often been investigated using well-defined tasks such as Missionaries and Cannibals and Tower of Hanoi, in which the initial conditions, operating steps, and goal state are specifically stated. However, analogies typically involve representations of problems that are much less

defined. Gick and Holyoak (1980) used scenarios to explore analogical transfer between ill-defined problems (e.g., the fortress and the radiation problem) where both problems (the source and target) could be solved by using a similar but not identical strategy. Gick and Holyoak found that when participants solved the source problem, they tend to reapply the same type of solution in the target problem even if it did not work. To investigate the effect of representing the problems ranging between disparate to similar domains on analogical solutions in ill-defined problem they used a story analogy, Duncker's radiation problem. Gick and Holyoak found that the number of participants who generated a solution when no source analogue was given was far less than when they were given a dissimilar source problem. On the basis of such experiments they suggested that there are primary requirements of analogies. First, a relevant known analog must be available to the subject. Second, the target problem must be sufficiently novel and challenging so that an analogy could potentially be useful (like for example the radiation problem, due to its ill-defined nature, meets the second requirement), and third, the optimal level of representation which maximizes the degree of correspondence between causally relevant features of the analogs. The source (Fortress problem) and its target (radiation problem) are reproduced below.

The Radiation Problem

Suppose you are a doctor faced with a patient who has a malignant tumor in his stomach. It is impossible to operate on the patient, but unless the tumor is destroyed the patient will die. There is a kind of ray that can be used to destroy a tumor. If the rays reach the tumor all at once at a sufficiently high intensity, the tumor will be destroyed. Unfortunately, at that intensity the healthy tissue that the rays pass through on the way to the tumor will also be destroyed. At lower intensities the rays are harmless to healthy tissue, but they will not affect the tumor either. What type of procedure might be used to destroy the tumor with the

rays, and at the same time avoid destroying the healthy tissues? (Gick & Holyoak, 1980, pp. 307-308)

The source problem to the above target depicted an analogous story about a military situation (The General) and its solution. In the story, a general wishes to capture a fortress where a full-scale attack is impossible. The general's solution is to divide his army into small groups that converge simultaneously on the fortress.

"A small country fell under the iron rule of a dictator. The dictator ruled the country from a strong fortress. The fortress was situated in the middle of the country, and was surrounded by farms and villages. Many roads radiated outward from the fortress like spokes on a wheel. A great general emerged who raised a large army at the border and vowed to capture the fortress and free the country of the dictator. The general knew that if his entire army could attack the fortress at once it could be captured. His troops were poised at the head of one of the roads leading to the fortress, ready to attack, however a spy brought the general a disturbing report. The ruthless dictator had planted mines on each of the roads. The mines were set so that small bodies of men could pass over them safely, since the dictator needed to be able to move troops and workers to and from the fortress. However, any large troops would detonate the mines, not only would this blow up the road and render it impassable, but the dictator, would then destroy many villages in retaliation. A full-scale direct attack on the fortress therefore appeared impossible.

The General, however, was undaunted. He divided his army up into small groups and dispatched each group to the head of a different road. When all was ready he gave the signal and each group charged down a different road. All of the small groups passed safely over the mines, and the army then attacked the fortress in full strength. In this way the general was able to capture the fortress and overthrow the dictator (Gick & Holyoak, 1980, p. 351).

In the above examples of isomorphic source and target problems, the researchers used the concept of convergence solution as analogous to the radiation problem. In this case, the doctor could direct multiple low-intensity rays toward the tumor from different directions, which would destroy the tumor without harming the healthy tissue. Gick and Holyoak (1980, 1983) also used a different version of the military story at different levels of knowledge to study its effects on the type of transfer. They found that the more similar the problems

(source and target) the more effective the transfer. Chen (2002) and Chen and Mo (2004) focused on the fundamental issue of procedural similarity between the source and target problems, which involved a process to be discovered and implemented.

However, seeing analogues in problem-solving is a complex process that often involves re-representing the problems, restructuring reasoning (Cheng & Holyoak, 1985), or aligning relations (Gentner & Markman, 1997). In an effort to further our knowledge of the mechanisms and functions of analogy in problem-solving, the contributions of some influential theories are discussed here. Firstly, Sternberg's Triarchic Theory is undertaken because it explains analogical reasoning as an important aspect of information processing in the general framework of intellectual behavior. Second, the theories of Gentner's Structure Mapping and Holyoak's Multi-constraint were reviewed for their importance in addressing the representational structure and cognitive processes in analogical reasoning.

Theories of Analogical Problem-Solving Triarchic Theory

Sternberg's Triarchic Theory (1987, 2000) proposes three essential sub-theories: the componential, the experiential, and the contextual, that include various processes that affect the performing of cognitive tasks and consist of the information processing skills that drive intelligent behavior. Sternberg (1987) considered these processes as elementary information processors that operate upon internal representation of objects or symbols. The componential sub-theory is discussed in greater depth in this section as it outlines the structure and the mental mechanisms underlying analogical reasoning. This sub-theory of

information processing includes three components: meta-components, performance components, and knowledge-acquisition components.

Meta-components are higher-order mental processes that determine which performance and learning components will be used as well as the sequence in which they will be used. These components (Figure 2.3) are common for all tasks: they plan, monitor, and evaluate what one is doing. Furthermore, they activate performance and knowledge-acquisition components (Sternberg, 1987, Sternberg et al., 2000).

Performance Components are referred to as lower-order processes, which are basic processes involved in intellectual activities. They are often specific to the type of problems being solved and follow the plans laid out by the meta-components. They include processes such as encoding, combination, comparison, and response. Encoding is concerned with initial perception and storage of new information, whereas combination and comparison processes are involved in putting together or comparing information. For example, inductive reasoning tasks, such as matrices and analogies, involve a set of performance components, which include encoding, inference, mapping, application, comparison, justification, and response (Sternberg, 1987, Sternberg et al., 2000).

The Knowledge-Acquisition Components help discover what knowledge and information are needed to solve the problem. Sternberg and Davidson (1999) identified three types of selectivity involved in analogical reasoning: selective encoding, involving sifting relevant from irrelevant information; selective combination, involving combining information from isolated pieces into a unified whole; and selective comparison, involving comparing relatively newly acquired information to information acquired in the past. For example, in problem-solving

by analogy one relies on specific similarities between new information and old information, and one uses information about the similarities to understand better the new problem. Therefore, a problem solver must focus on the general structural features of the two problems rather than only on the specific responses needed to solve the problem. Thus, according to Sternberg (1987) and Sternberg et al. (2000), meta-components activate performance and knowledge-acquisition components, which in turn provide feedback to the meta-components as shown in Figure 2.4.

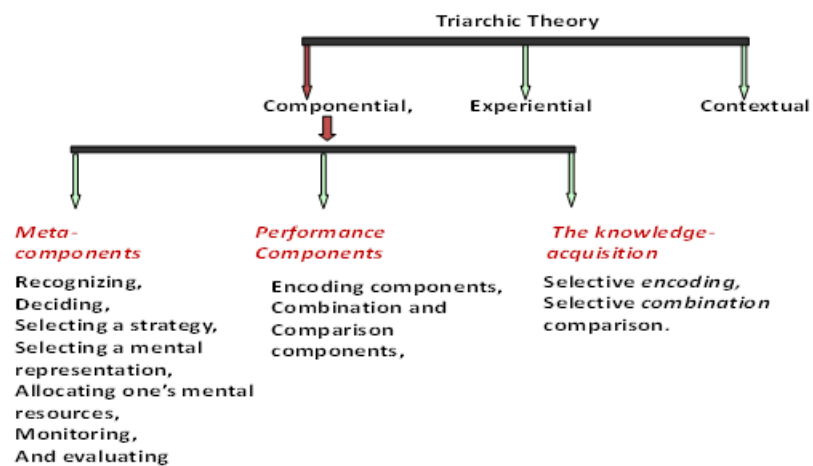

Figure 2.3: The Triarchic theory.

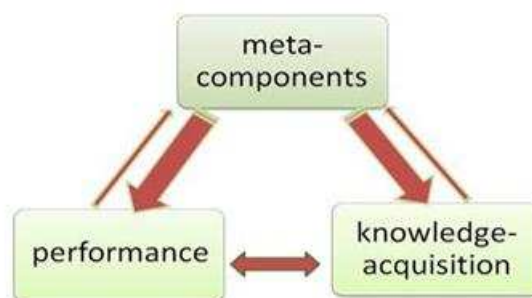

Figure 2.4: The three components of the componential sub-theory.

Furthermore, Sternberg (1987) identified eight different operations involved in problem-solving in general: (a) recognizing the existence of the

problem, (b) deciding on the nature of the problem, (c) selecting the lower-order processes that will be needed to solve the problem, (d) selecting a strategy to combine them, (e) selecting a mental representation on which the strategy can act, (f) allocating one's mental resources, (g) monitoring one's problem-solving as it is happening, and (h) evaluating one's problem-solving after it is done.

Analogical problem-solving involves four steps. First, encode or identify the defining attributes of each term in the analogy (e.g., A: B: as C: D). Second, infer a relationship between the first and the second terms in the analogy (A: B). Third, map the relationship between the first term and the third terms (A: C). Fourth, apply the relationship observed between the first and second terms (A: B) to the third and fourth terms (C: D) (Sternberg, 1986). In addition, Sternberg differentiated between mapping and inference, whereby the former is considered as the recognition of a higher-order relation between two lower-order relations, and the latter is the recognition of a relation between two different elements or within a single element. He highlighted that mapping is related to inference but differs from it by illustrating that the relation between "grey" and "elephant" requires inference, while the relation between "grey-and-elephant" on the one hand and "brown-and-grizzly bear", on the other hand, requires a mapping. Thus, Sternberg argued that mapping is essential to the solution of most kinds of analogies because analogical reasoning and problem-solving require us to see the second-order relation between two lower-order relations (Sternberg & Grigorenko, 2002).

Sternberg's (1987) componential sub-theory was briefly dealt with above as it describes the various cognitive processes underlying problem-solving and also provides a comprehensive framework for understanding how information is

processed while solving problems. As commented by Eysenck (1998), the Triarchic theory contributes greatly to bridging the gap between intelligence and research in problem-solving. However, the theory essentially analyzed analogical problem-solving as an index of intelligent behavior and not as a cognitive tool for acquiring new knowledge, which is the precise purpose of the Structure-Mapping and Multi Constraints theories of analogical reasoning discussed below.

Structure-Mapping Theory

Gentner (1983) considered the defining characteristic of analogy as alignment of relational structure. The theory essentially describes analogies in terms of how information from a source analogue is interpreted and applied to the target. Gentner viewed domains and situations in analogies as a system of objects, object attributes, and relations between objects (as cited by Keane, 1988). When an object has an attribute relative to another object in the same domain it is psychologically considered to be a relation; whereas when it has an attribute relative to an object in another domain it is considered as a real attribute (Gentner, 1989; Gentner & Markman, 1997; Gentner, Rattermann, & Forbus, 1993).

The central claim of the theory states that an analogy is characterized by the mapping of relations between the objects rather than the attributes of the objects from the source to the target problem. These mapped features are dominated by higher order relation mapping, which coincides with Sternberg's view who referred to the same idea as recognition of higher order relations between two lower order relations. Thus according to this theory, one of the important characteristics of analogy is relational focus where analogies involve

common relations that need not involve common objects (Gentner & Markman 1993).

In addition, Gentner (1983) proposed the principles of systematicity and transparency to determine which relations are mapped and how difficult the process of mapping will be. Transparency implies that close, literal similarity matches are the easiest type of mapping and least likely to cause errors (Gentner & Markman, 1997). Arguing that relational similarity has a special status in analogical reasoning, she explains the principle of systematicity which holds that a base predicate which belongs to an interconnected system of relations is more likely to be imported into the target than an isolated predicate (Gentner & Toupin, 1986; Markman & Gentner, 2000). An example of a system of relations that would be a structure linked by causal relations is cause [more-massive-than (sun-planet), revolves-around (planet, sun)]. This roughly translates into the notion that the sun is more massive than the planet, and this causes the planet to revolve around the sun (Gentner & Markman, 1993). Furthermore, the theory proposes that the process of alignment in analogical reasoning is enhanced if the representations are structurally consistent and have parallel connectivity, which means that matching relations must have matching arguments. It is also enhanced if there is a one-to-one correspondence that requires any element in one representation to match one element (at most) in the other representation (Gentner & Markman, 1997). With regard to the role of plans and goals, Gentner (1989) accepted that they can influence the analogical process but are not central to the analogical reasoning process. She argued that plans and goals influenced reasoning before and after, but not during, the analogical process. Differentiating between a structure-driven analogy (no specific or obvious goal) and a goal

driven one, she pointed out that the former allowed for the possibility of finding unexpected matches (creativity) that may contradict the main goal (Gentner, 1989).

Thus, according to the Structure Mapping theory, interpreting an analogy is fundamentally a matter of finding or noticing a common relational structure, that is, the presence of higher order relations is an important determinant of an analogy. The objects in the two domains are placed in correspondence on the basis of holding similar roles in the relational structure, and not on the basis of intrinsic attribution-related similarity. As an essential requirement of analogies is that they need to be interpreted in terms of deep and cohesive systems of relational matches rather than sets of isolated relationships therefore, the key to analogies is a common system of relations rather than the sheer number of matching predicates or overall similarity (Gentner & Markman, 1997).

While Gentner's theory held that analogies rely on the application of relationships between problems, implying that what matters in developing analogies is not the similarity of the content, but how closely their structural systems of relationships match, Holyoak and Thagard (1989a, 1995) highlighted some other equally important factors that influence analogical reasoning in their Pragmatic and Multi-constraint theories.

Pragmatic and Multi-Constraint Theories

The main thrust behind the Pragmatic approach (Holyoak, 1985; Holyoak & Thagard, 1989a) was that information transferred from a source to a target was influenced heavily by the goals and purpose of the system. Gick and Holyoak's (1980, 1983) representational assumption differed from Gentner's in that the source and target problems were thought to be represented at various levels of

abstraction. It was assumed that at an abstract level of macrostructure, an analogue was structured as a type of problem schema, consisting of hierarchically-organized components: initial state, solution plan, and outcome (Holyoak, 1984, 1985).

In Holyoak's pragmatic theory, the process of analogical problem-solving was split into a number of sub-processes, including retrieval, mapping, and induction. Retrieval refers to semantic elements, such as a relation or objects that were inferred between the target problem and a known source domain that lead to the retrieval of a known source to the problem. Once a suitable analogue was found, the mapping process is initiated. Holyoak and Thagard (1989a) characterized this process as one of spreading activation from concepts in the statement of the target problem to related concepts in a source analogue. The process of mapping took place between some components of initial states of both analogues, usually at the abstract schematic level used to produce parallel solution propositions to target problems. The components of the initial state (goal, resources, etc.) constituted the 'conditions' for the 'actions' of the solution plan that results in outcomes.

Gick and Holyoak (1983) found that when they provided participants with more than one source representation they derived a schema that highly affected the transfer performance. Gick and Holyoak referred to this as induction, which takes place when a generalization of more than one source analogue is carried out to form an abstract problem schema. They proposed that an important step in the formation of such schemata involved eliminative induction, in which the differences between source analogues are deleted and their commonalities are preserved. Holyoak (1984) distinguished between problem-solving based on a

schema and problem-solving based on analogy. The former was the application of an abstract principle to a concrete problem and the latter was the application of one problem to another at the same level, usually concrete-to-concrete or abstract-to-abstract (e.g., wave models of light and sound).

The multi-constraint theory posits that analogical mapping was a process of finding correspondence between elements of two structures. Holyoak and Thagard (1989a) also proposed that the selection and mapping of source analogues was dependent on relatively abstract, high-level information shared between the source and target problems, that is similar to Gentner's (1989) mapping of high-order relations. However, Holyoak and Thagard (1989a) differ from Gentner in how they define these abstract elements, and the emphasis on schema induction as a mean of facilitating mapping and transfer.

In addition, the multi-constraint theory elaborated on the role of different constraints (structural, semantic, and pragmatic), in the mapping process (Holyoak & Thagard, 1989a). The structural constraints of isomorphism favored the mapping process, given that the mapping is one-to-one. For structural constraints, each target element should correspond to only one element of the source. Semantic similarity is present when the elements have similar meaning that supports possible correspondences. Last, pragmatic centrality is essential to the analogist either because a particular correspondence between two elements is presumed to hold, or because an element is judged to be sufficiently central that some mapping should be found (Holyoak & Thagard, 1989a; Spellman & Holyoak, 1996).

Spellman and Holyoak (1996) proposed that pragmatic constraints interact with semantic and structural constraints within the mapping stage itself.

They distinguish between the process of mapping and other processes that occur before or after the mapping process. The pre-mapping process helped select the relevant elements that could be mapped while post-mapping processes use the corresponding elements that have been chosen in the mapping process to generate inferences about the target.

Thus, Spellman & Holyoak (1996) dealt with some important factors and issues relevant to problem-solving that were given insufficient attention in Gentner's theory (1989), such as the goals and constraints that affect the mapping process. Moreover, the processes of retrieval and induction, along with certain representational problems (e.g., levels of abstraction and the representation of the target problem) were explicitly dealt with in this theory.

Overview of Theories

Sternberg's Triarchic theory (1987, 2000) provided a general framework of information processing that contributed towards identifying the cognitive processes underlying problem-solving in general and classical analogies (A:B::C:?) in particular. However, the theory did not provide an analysis of complex analogies or how they influence the cognitive processes. On the contrary, theories of analogical problem-solving used complex tasks that provided a scope for examining how the relational structures between the source and target problems affect the mapping and transfer processes.

A central feature of both Gentner's (1983, 1989) and Holyoak's (1984, 1985) theory concerns the representational structure of the problem not considered by Sternberg. Although Gentner considers mapping the structural properties from source to target as a central and unique process involved in analogies, Holyoak emphasized the pragmatic features, such as the goal, as

inseparable from the structure of analogy in determining what structural properties of the domain will be transferred to the target. Therefore, a common argument shared by Gentner's and Holyoak's theories was that the way in which a problem was represented at the structural level would determine the effectiveness of the mapping process between the source and target domains. For example, Holyoak considered the level of abstraction or similarity shared between the source and target as important in analogical transfer, whereas Gentner and Markman (1993) refer to the similarity of correspondences between structured representations as affecting the mapping process.

Both the theories of Gentner (1983, 1989) and Holyoak (1984, 1985) also recognized that the main stages involved in analogical reasoning are encoding, retrieval, and mapping. Amongst these different stages, mapping was considered to be the crux of analogical reasoning, whereby knowledge about the source was carried over to the target. For instance, if a person was trying to solve a target problem, he or she could use a source problem for which a solution was known. If the structure of the two problems could be aligned, the solution for the source problem can be transferred to the target problem (Gentner & Markman, 1997; Holyoak & Thagard, 1997). The mapping process was more of a continuum ranging from simple one-to-one mapping all the way to analogical mapping of structural relations across different domains (Gentner, 1983).

Although most theorists acknowledge that analogical inference was influenced by goals and context, theories of analogy differ in their assumptions about whether such pragmatic constraints directly enter into the mapping process. Although the structural mapping theory was both theoretically and empirically significant, it has been criticized for not taking into account the fact that the

selection and transfer of information was largely determined by the goals, which function as a constraint. It has also been criticized for the lack of emphasis on the outcome of identifying the common features of the source and target problems on transfer, which are considered of central importance in analogical problem-solving situations (Keane 1988).

On the other hand, Holyoak's multi-constraints theory (1984, 1985) brings to notice three major processes of analogy: retrieval, mapping, and induction. The empirical evidence that pragmatic, structural, and semantic constraints interact with each other within the mapping stage itself, in addition to their influence in the pre (retrieval) and post (induction) mapping stages, contributed to our understanding of the different aspects of problem representation and their effect on transfer. Spellman and Holyoak (1996) stated that a crucial requirement for goal-directed thinking is ensuring that inferences are relevant to the goals of the solvers. A problem situation will often cue an enormous range of associated knowledge stored in the long-term memory, most of which will be irrelevant to achieving the solution. In such situations, goals are instrumental in providing more than static representational components in the mapping process.

These theories of analogy have contributed to our understanding of how new knowledge is created (i.e., something that was not known about the target is now inferred based on the comparison with the source). This feature makes analogy a powerful cognitive tool (Gentner & Markman, 1997; Holyoak & Thagard, 1995). Although there were some differences between these theories of analogy, there appeared to be a consensus that relational similarity, or noticing

the structural correspondence between the source and target, is at the core of interpreting analogies.

The ACME (Analogical Constraint Mapping Engine) Model

Because the core of analogical thinking lies in the process of mapping, which is defined as the construction of orderly correspondences between the elements of a source analog and those of a target, the ACME model was described to provide a cognitive framework for the model proposed for the study. Holyoak and Thagard (1989b) implemented the multi-constraints theory of analogical mapping, which integrates structural, semantic, and pragmatic constraints and involves the mapping process, in the connectionist computer program called ACME. The connectionist approach uses networks of units (a type of hypothesis) interconnected by links that represent constraints; such links determine the extent to which sets of hypotheses are mutually coherent. This computational program depicted how multiple constraints worked together to help interpret analogies, even when the constraints conflict, by supporting or identifying competing possibilities related to elements that can be mapped.

The structural constraint of isomorphism encourages mappings that maximize the consistency of relational correspondences between the elements of the two analogs. The constraint of semantic similarity supports mapping possibilities to the degree that mapped predicates have similar meanings. The pragmatic constraints relate to mappings that involve elements believed to be important to achieve the purpose of the analogy. According to Holyoak and Thagard (1989b), an equally important activity is parallel constraint satisfaction which identifies mapping possibilities that collectively represent the overall mapping that best fits the three interacting constraints.

Complementary to ACME is a program called ARCS (Analog Retrieval by Constraint Satisfaction), which was developed as a constraint-satisfaction model of retrieval (Thagard, Holyoak, Nelson, & Gochfeld, 1990). While ACME focused on identifying elements involving structural similarity, ARCS is dominated by semantic similarity to help find relevant analogs stored in memory.

ACME has been applied to a wide range of examples that include problem analogies, analogical arguments, explanatory analogies, story analogies, formal analogies, and metaphors. The examples presented illustrated such capabilities as finding many-to-one and one-to-many mappings, mapping dissimilar relations, identifying purely structural isomorphisms without any semantic or pragmatic information, and using pragmatic knowledge to find useful mappings in the face of misleading structural and semantic resemblances. The program was able to provide qualitative simulations of a number of experimental findings concerning human analogical reasoning. The models of the multi-constraints theory thus provide a unifying account of analogical mapping and mapping to schemas.

Although the constraint-satisfaction theory of analogical mapping appears powerful in its intended domain, many other important issues about analogy remain unsolved. Most notably, the model of mapping is considered as lacking in incorporating all phases of analogical reasoning. Among some limitations noted by Hummel and Holyoak (1997) are that the computer programs (ACME and ARCS) are considered to be based on unrealistic assumptions about working-memory capacity because they simultaneously considered all possible matches between source and target elements, and all constraints relevant to the selection of those matches that were generally not within the accepted limits of working

memory. The link between the initial spontaneous retrieval of possibly useful analogs and the subsequent mapping process had not been taken into account. It has been noted that these programs did not integrate the similarities and differences between access (available to long-term memory) and mapping (available to working memory) operating on a single representation of that knowledge (Hummel & Holyoak, 1997). Moreover, Novick (1992) pointed out that the programs did not consider the fact that human reasoning was both limited and domain-specific.

External Representation

Knowledge representation is a fundamental issue in cognitive science. Over the past few decades, a large body of research has enhanced our understanding of the nature of representations. Most studies either have focused on internal representations exclusively or did not distinguish the role of external representation from the internal one, based on the view that most cognitive tasks involve interactions with the environment, for which the cognitive processing took place in the internal model of the external environment. Thus, the importance of explicitly distinguishing external representations from internal ones has been taken up only recently.

According to Zhang (1997), external representations are defined as the "knowledge and structure in the environment, as physical symbols, objects, or dimensions (e.g., written symbols, beads of abacuses, dimensions of a graph, etc.), and as external rules, constraints, or relations embedded in physical configurations (e.g., spatial relations of written digits, visual and spatial layouts of diagrams, physical constraints in abacuses, etc.)" (p. 1). On the other hand, Zhang (1997) defined internal representation as "the knowledge and structure in

memory, as propositions, productions, schemas, neural networks, or other forms” (p. 2).

The information in internal representations has to be retrieved from the memory by cognitive processes, although the cues in external representations can sometimes trigger the retrieval processes. The nature of external representations (ER) was summarized by Zhang and Norman (1994) as memory aids that provide information that can be directly perceived and used without the need to be interpreted and formulated explicitly. ERs also can anchor and structure cognitive behavior; they may change the nature of the task, and they are an indispensable part of the representational system of any distributed cognitive task. Besides being a source of inputs and stimuli, or memory aids to the internal mind, external representations also play an important role of guiding, strengthening, and determining cognitive behavior (Zhang, 1997, 2001). Thus, the form of representation helps determine what information should be selected and how it is to be implemented.

Cox (1997) considered ERs an important part of intelligent educational systems where reasoning with ERs is central to the learning activity supported. Diagrams, graphs, and pictures are typical types of external representations used to enhance problem-solving and reasoning that are considered more beneficial than propositional or sentential representation. According to Larkin and Simon (1987) this is because diagrammatic representations help recognize the features of representation easily and make inferences faster. Tversky (2002) defined graphics as a depiction or picture of something imaginary, Tversky stated that “... the varieties of graphics humankind has produced. The prototypic graphic, of course, is a depiction of something in the world, or something imaginary that is

similar to something in the world, a picture” (p. 58). Maps and diagrams, or sketches, consist of elements or depictions that figuratively represent things arranged in space for the purpose of communication. According to Tversky, general abstract meanings, such as the concept of equivalence, can be expressed well in depictions by grouping items that are equal and spatially separating them from items that are not.

Cheng (2002) argued that there are often benefits of using diagrams over propositional or sentential representations. Different representations can dramatically affect the ease of problem-solving. External pictures can give people access to knowledge and skills that are unavailable from internal representations. In studying the nature of representational systems for problem-solving and learning in science and mathematics, Cheng introduced the concept of Law Encoding Diagrams (LEDs) as representations that capture the laws or relations in the structure of a diagram using geometric, topological, or spatial constraints, in which each diagram represents one law and depicts one phenomenon. Cheng and Shipstone (2003) defined AVOW diagrams as “a novel way of representing the properties of electric circuits which show how current, voltage, resistance and power (the Amps, Volts, Ohms and Watts) are distributed” (p.193). According to Cheng and Shipstone, these diagrams help learners develop useful concepts and a more integrated understanding of electric circuit behavior than alternative teaching methods. They used AVOW diagrams in problem-solving with A-level students, the results showed that the use of box and AVOW diagrams enhanced student learning and helped develop their abilities in solving the electric circuit problems.

According to Zhang (1998), different representations of the same task structures could generate different type of behavioral outcomes. Zhang, Johnson, and Wang (1998) studied, under the theory of distributed cognition, the effect of forms of external representations on the acquired strategy for transfer in three isomorphic representations of the Tic-Tac-Toe task (Figure 2.5). Zhang et al. found that different representations of common structure led to the discovery of different forms of a common strategy, with varying degrees of generalities. The results showed that different line, number, and color representations of the problem examined affected the processes of learning. The subjects comprehended faster from line-oriented presentation than from color-oriented presentation. It was also found that transfer across different isomorphic representations could be positive or negative as a result of the representation and not the structure of the task. A positive transfer was found from Number to Color and a negative transfer was found from Color to Line (Zhang et al. 1998; Zhang & Norman, 1994).

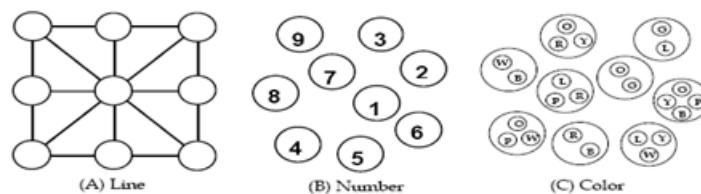

Figure 2.5: Different representations for Tic-Tac-Toe problem (Zhang et al., 1998).

Cognitive Theory of Graphical and Linguistic Reasoning

The Cognitive Theory of Graphical and Linguistic Reasoning of Stenning and Oberlander (1995) is one of the important theories that guided the understanding of representation in problem-solving. In this cognitive theory, Stenning and Oberlander advocated that reasoning performance is largely

determined by both the logical equivalence of inferences and the implementational differences expressed in graphical or linguistic forms. They compared performance on tasks that involved manipulation of external graphics (Euler's circles) with tasks that do not involve manipulation (text comprehension) and the mental performance of syllogisms to provide empirical support to their theory.

Stenning and Oberlander (1995) proposed that graphical representations, such as diagrams, limit abstraction and thereby aid in the problem-solving process because they tend to induce classification of information (specificity) by reducing arbitrary abstractions. Specificity has been defined as "the feature distinguishing graphical and linguistic representations, rather than low-level visual properties of graphics. We take specificity to be a general, logically characterizable property of representational systems, which has direct ramifications for processing efficiency" (Stenning & Oberlander, 1995) p. 98.

This cognitive theory of human reasoning held that different representational systems of a problem (graphical or linguistic) gave rise to different processing characteristics due to differences in the facility of inference. Thus, a good representation is one that provides for the effective use of a clear structure that aids the learner in extracting and processing the needed information (Stenning & Oberlander 1995).

Stenning and Oberlander (1995) also differentiated between three types of representational systems according to their expressiveness, minimal abstraction (MARS), limited abstraction (LARS), and unlimited abstraction (UARS). MARS suggests an exact model for each representation in the system under the intended interpretation, such as the color red, which has a singly property that imposed

restrictions on its possible representations. LARS suggests a single representation that conveyed more than one model or multiple sub-diagrams where each corresponded to one model, such as the tabular representation, which combined varied information. UARS suggest that the interpretation of representation is dependent on elements within or outside the representation.

Although these classes of representational systems were based on the semantic properties of a representation, the theory highlights the computational possibilities that emerged from it. It also helps us understand how rational humans calculate possibilities of combining arguments that go beyond merely assessing whether or not a feature of the representation is consistent with each argument.

Studies of human cognition have also shown that different representations affect the ease of problem-solving by reducing the cognitive load. Some common methods are worked out examples (Chi, et al., 1989; Renkl, 1997; Renkl 2005; Roy & Chi 2005); heuristics and algorithms, for example, as in the problem of missionaries and cannibals (Reed, Ernst, & Banerji, 1974); means-ends analysis, as in the Tower of Hanoi (Kotovsky et al., 1985) and problem-solving by analogical reasoning (Chen, 1996, 2002, Chen & Mo 2004; Gick & Holyoak, 1980, 1983).

The above review explicitly emphasizes the role of external representation in problem-solving. For many tasks, external representations are intrinsic because they require applying learned knowledge from one situation to solve another or reasoning by analogy.

Pictorial Representation in Analogical Problem Solving

The ability to perceive similarities and analogies is one of the most fundamental aspects of reasoning and learning, which is often tied to particular domains of knowledge, and is greatly influenced by the context in which it occurs (Vosniedo & Ortony, 1989). A general method involved in analogical problem-solving is the use of a known source analogue as a guide to the solution of a novel target problem.

Most of the studies that have used diagrams have focused more on the interpretation of diagrams that directly represent the information in the problem to be solved, rather than focusing on their role as source analogues to solve a novel target problem. For example, Markman and Gentner (2000) investigated the relation between similarity and alignment using pictures (Figure 2.6). In Figure, Markman and Gentner represented the two women as perceptually similar, but played different roles in the scenes where cross mapping leads to a conflict of perceptual correspondences that conflict with relational correspondence. Markman and Gentner used a pictorial representation to conclude that similarity judgments were sensitive to relational structures when determining the overall alignment.

Cheng (2004) demonstrated “why diagrams are sometimes six times easier than words.” Cheng used Larkin and Simon’s (1987) simple Pulley System problem with different levels of difficulty and three types of representation: diagrammatic, tabular, and sentential. The results indicated that subjects with the diagram type of representation came up with the solution six times more than the informational equivalent sentential representation.

Pictorial forms of representation were often used in educational contexts to enhance learning outcomes. Ainsworth and Loizou (2003) reported that participants with given information about the human circulatory system in diagrams comprehended more than those given texts. Students who were given diagrams also performed better than students given texts, particularly on more difficult knowledge-based inference questions. The study revealed that the process of learning is enhanced by graphical representation that helped in understanding and manipulating information. They use this evidence to claim that diagrams differentially aid learning. On the other hand, relatively few studies have used pictorial representations in analogical reasoning as source analogues; one such study was conducted by Sternberg and Ketron (1982), who used visual form in classical analogy.

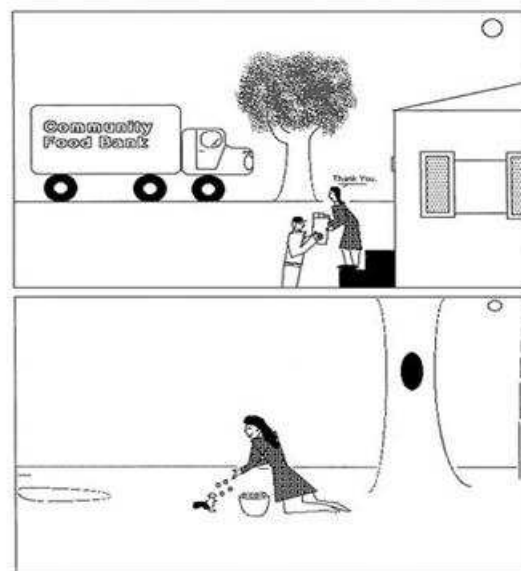

Figure 2.6: The conflict with relational correspondence. The two women are highly similar perceptually, but they play different roles in the scenes where cross mapping leads to a conflict of perceptual correspondences that conflict with relational correspondence (Markman and Gentner 2000).

In an experiment conducted by Gick and Holyoak (1980, 1983), three conditions of representation, involving text and diagrams, were used in the source analogue. Those in the analog-only condition read the analogue military story to the target Duncker radiation problem (Figure 2.7). Subjects in the analog-plus-diagrams condition also read the same story, but modified it slightly to refer to a pair of accompanying diagrams, depicting a single large arrow, representing the desirable but blocked plan of sending a large force from a single direction and several smaller converging arrows representing the alternative, successful plan. Subjects in a third condition, diagrams only, received the graphical depictions without any accompanying story. They were told that the first part of the experiment involved pattern recognition, requiring them to study the diagrams for three minutes so that they could later reproduce them. The diagrams-only condition yielded the most striking discrepancy between initial noticing and eventual application. This supported Gick and Holyoak's view that diagrams as representations in the source analogue lack semantic interpretation or semantic retrieval-cue analysis, which is essential for noticing analogies. They found that only 10% of the participants generated a solution when no source analogue was given, and about 30% gave the correct solution to a highly dissimilar source problem. However, this percentage increased to 75% after a hint was given to use the source problem. Last, when the source was given in diagrammatic form the gap between the pre-hint (10%) and post-hint (70%) was much greater.

Gick and Holyoak (1983) argued that the successful use of both verbal and diagrammatic source analogues requires the solver to: (a) retrieve the information from the source and notice its relevance to the target problem, and (b) map the analogues and identify the relational correspondences in order to

construct the analogous solution. They also discovered that the major hindrance to a successful transfer was the lack of noticing and retrieving information from the source analogue.

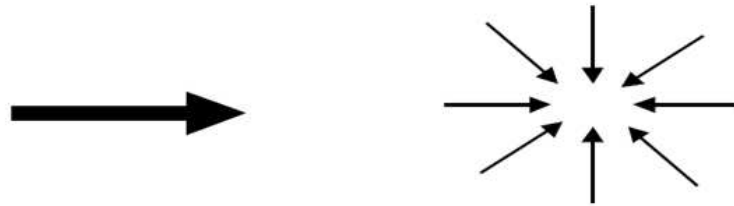

Figure 2.7: The pair of diagrams used as a source analogue by Gick and Holyoak (1983).

Later, Pedone et al. (2001) confirmed the findings of Gick and Holyoak (1983) and concluded that diagrams cannot be accessed reliably as source analogues without hints. Pedone et al. (2001) investigated the difficulties in spontaneous (without hints) retrieval and noticing of a diagrammatic source analogue (Figure 2.8). The study was based on the proposition that without semantic interpretation, diagrams are not encoded in terms of concepts that could link them to a verbal target problem. Thus, Pedone et al. focused on the impact of perceptual or visio-spatial properties of diagrams to foster encoding and spontaneous access in analogical problem-solving using the same Duncker radiation problem. They found that spontaneous retrieval and noticing increased markedly by animating displays obviously because they convey movement more clearly as shown in Figure 2.8.

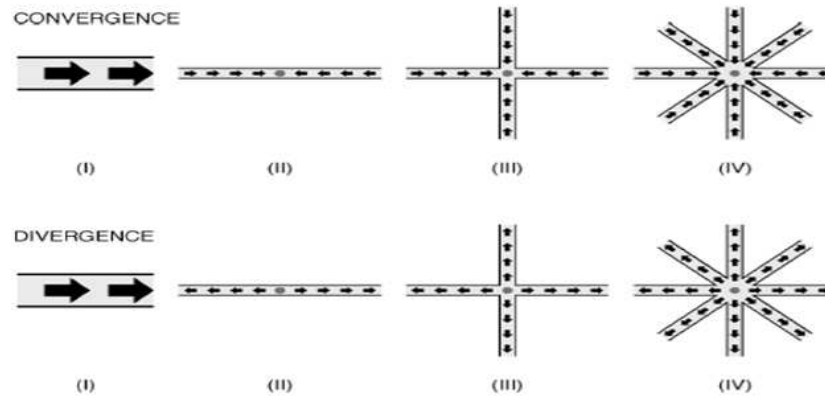

Figure 2.8: The source pictorial representation for the Dunker Radiation (Target) problem (Pedone et al. 2001).

Note: Each of the four diagrams was presented in sequence, the diagrams in the upper row were used in the convergence conditions, and those in the lower row were used in the divergence conditions. Diagrams were not numbered in displays. Note that Diagram was identical in the two sequences; the static and dynamic conditions.

In the same study, Pedone et al. (2001) added a statement as a hint to the principle of the diagrammatic source analogues to overcome the difficulty of spontaneous retrieval to facilitate the transfer. They found that the verbal support increased transfer by (50%) in both the static and dynamic convergence conditions.

Chen (2002) took the research a step further by representing the source problem at different levels of abstraction or similarity with the target problem. In his study, Chen examined the effect of diagrammatic representation depicting a process in procedural similarity, as compared to the strategy and principle levels of similarity between the source and target on transfer. These three levels of abstraction were diagrammatically represented in the source model depicting the problem of weighing large objects. Chen's study differed from those of Gick & Holyoak (1983) and Pedone et al. (2001) in two ways. First, Chen schematically represented a problem involving a process at three different levels of similarity with the target problem. Second, the source problem required the participants to

figure out and discover the underlying principle and solve it. Although, Chen found that the procedural level of similarity was more effective, he also discovered that the major barrier to successful solution in analogical problem solving involving a process was failure in the executing process; that is, failure to apply the solution discovered in the source problem to the target problem.

On the assumption that a single source analogue could cause difficulties in noticing the analogous relations between the source and the target problems, and implementing the solution, Chen and Mo (2004) also examined the processes of schema formation in problem-solving. In their study, participants experienced a series of similar tasks through which a solution principle is extracted before attempting to solve isomorphic target problems. They proposed that an abstract schema induced from multiple sources with diverse procedures would facilitate the execution process. Chen and Mo argued that because a solver who recognizes that a solution might be linked to different superficial features, may notice the analogous relations more readily than those who experience a single source.

The above review highlights that although researchers confirmed their assumptions and found the beneficial consequences of different ways of representations and abstract schema induction on the execution process, there remains the need to use hints to guide solvers. This study investigates the effects of self-support methods such as SE and SCD along with different types of external representation (pictorial and verbal) on transfer performance. A review of the interventions for improving analogical transfer performance is undertaken below.

The Self-Support Methods

Self-Explanation (SE)

Think-aloud protocol has been widely used as a research method to gather information about the cognitive processes involved while performing a mental task (Ainsworth & Loizou, 2003; Chi et al., 1989; Renkl, 1997). This method allows a researcher to study new task domains in-depth, and is recognized as a useful source of data that can provide a means for uncovering knowledge structures underlying human mental work and problem-solving activities.

According to Ericsson and Simon (1993), concurrent and retrospective verbal report protocols are a means of gaining insight into the type of knowledge and cognitive processes underlying problem-solving. Generally, concurrent verbal reports are referred to as talk-aloud, think-aloud, or thought listing techniques.

Think-aloud is verbalizing thought processes as strategies that are being used to tackle a specific problem situation. Verbal protocols are collected, recorded, transcribed, and presented to derive coding skills that suitably fit the protocol data. Verbal protocols also help in understanding the sequence of possible solutions that people explore and are open to inspection and interpretation (Ericsson & Simon, 1980, 1984, 1993).

The theory of think-aloud proposed by Ericsson and Simon (1993) asserted that there are three kinds of verbalization:

1. Type I direct verbalizations, which did not involve reporting on one's thought processes but merely stating aloud anything that comes to the mind in the short term memory (STM) while doing a task. As such, verbalization is considered not to interfere with the performance of the task nor slow down the process of problem-solving. Ericsson & Simon (1980, 1984) are of the opinion that

verbalizations are more effective in studying cognitive processes as compared to SE because there is no way of being certain that explanations reflect the processes actually used by the participants.

2. Type II verbal reports involve re-coding the contents of the STM. This type of verbalization may slow down the process of problem-solving to a certain extent as it involves processing information. Type II is used in problem-solving tasks that use graphics, as in the present experiment, where verbalization involves interpretation of images into verbal codes.
3. Type III verbal reports involve explanations where reasons for doing something are given explicitly which has a strong effect on problem-solving performance. It is not simply recording of the information in short-term memory (STM) but linking it with the information in long-term memory (LTM).

Roy and Chi (2005) defined SE as “A domain general constructive activity that engages students in active learning and insures that learners attended to the material in a meaningful way while effectively monitoring their evolving understanding. Several key cognitive mechanisms are involved in this process including generating inferences to fill in missing information, integrating information within the study materials, integrating new information with prior knowledge, and monitoring and repairing faulty knowledge (p. 272).

There is sufficient empirical evidence regarding the role of self-explanation and problem-solving. Chi et al. (1989) argued that a learner would benefit from studying a worked-out example depending upon how they explain the problem to themselves. Chi et al. conducted a study on nine participants, in which they let them study material in the domain of physics for several weeks so that they understood the basic background and gained knowledge about the subject. The participants were then given three worked-out problems followed by

test problems. Both the worked out examples and the test problems required the participants to think-aloud while solving them.

Comparison of verbal protocols between the successful and unsuccessful learners showed that the successful problem solvers spent more time studying worked out examples by generating more task relevant ideas. The other characteristics of successful learners, revealed by the protocol analysis of the study, were that they frequently elaborated on the processes related to the conditions of applications and goals of operators. Additionally, they indulged in anticipative reasoning by more frequently relating the steps of the solution to the domain principles. Moreover, the study found that successful learners did not delude themselves when they failed to comprehend something. Thus, Chi et al. (1989) found that good and poor learners differed quantitatively on learning time and qualitatively on the quality of the self-explanations generated.

Chi et al. (1989) study was taken further by Van Lehn and Jones (1993), who reanalyzed the data from the study and proposed that SE helps in three ways: the gap filling explanation, which causes participants to detect and fill the gap in their knowledge; the schema formation explanation, which causes the participants to abstract general solution procedures and associate it with the description of the problem to which it applies; and analogical enhancement explanation, which causes richer elaboration of the example for analogical problem-solving. Van Lehn and Jones found that gap filling accounts for most and analogical enhancement the least of the SE effect.

Chi et al. (2001) used self-explanations to establish the view that good students learn with understanding because they generate many explanations that refine and expand the condition for action and facilitate problem-solving. Alevon

and Koedinger (2002) explored how students explain their own solutions when they solve problems from geometry. Alevan and Koedinger are of the view that such explanations help improve students' problem-solving and SE skills and also results in transferable knowledge.

Renkl (1997) conducted a study more or less on the same lines of Chi et al. (1989). He differentiated between successful and unsuccessful learners by keeping the time constant so that the qualitative differences that are primarily due to the activity of SE could be determined. He found that the quality of SE was significantly related to the learners' outcomes even when time was kept constant. These discrepancies between successful and unsuccessful learners were attributed to the capability of the former to assign meaning to the operators by identifying the principles, classifying the goals and sub-goals, and using anticipative reasoning more. Renkl (1997) further analyzed the protocols of unsuccessful learners as passive explainers and superficial explainers, for which low SE activity was associated with the former.

Other experimental evidence about the effect of SE relates to a study conducted by Renkl, Stark, Gruber, and Mandl (1998), in which half of the participants received self-explanation training with information about its importance before the presentation of the instructional example. The other half was assigned to the VB group, which was not given any prior training. The results showed that the performance of the SE group was significantly higher in both near and far transfer.

Short, Evans, Friebert, and Schatschneider (1991) questioned the assumption that thinking aloud while problem-solving does not alter or interfere with performance when instructions are bland. On the contrary, they assumed that

think-aloud manipulation would encourage problem solvers to spend more time encoding, which helps improve performance. The study addressed two main issues: which type of task performance (verbal analogies or spatial problems) was affected by thinking aloud, and whether the effect of the protocol was similar in a variety of populations (children and adults) or not. Short et al. found that although children showed a significant improvement in performance in verbal analogies in the think-aloud condition, the results of the adult population were consistent with the assumption that thinking aloud had no significant affect on performance. They are of the opinion that thinking aloud leaves task performance unchanged and that verbal protocols obtained while thinking aloud during task performance provide a clear picture of the problem-solving processes and strategies employed by the learner. Chen (2002) also used verbal reports in analogical problem-solving to gather more evidence and a precise picture of how participants used the source analogue models in solving the target problem.

Researchers have used think-aloud protocol to investigate and analyze the cognitive processes underlying problem-solving. In addition to studying the SE effect in a wide variety of domains ranging from physics problem-solving to geometry and programming, researchers also tested the impact of type of representation on SE. Researchers have either presented material as text (Chi et al., 1994) or in text and diagrams (Alevin & Koedinger, 2002; Ainsworth & Loizou, 2003; Chi et al., 1989). Ainsworth and Loizou (2003) explored the effect of the material (text or diagrams) on SE. Half of their participants received the information about the human circulatory system in text and the other half in diagrams and were encouraged to self-explain. The results showed that students who were given diagrams performed significantly better on post-tests than

students given text, and generated significantly more SE than text students generated. The study also indicated that diagrams were more effective in learning because they reduced memory load. Therefore, there is considerable evidence to suggest that the format of information influences learning by SE.

This brief review of studies shows that SE has often been used as a meta-cognitive method to improve performance and enhance learning. Moreover, it has been mostly applied in domain specific areas, such as physics and mathematics, using a verbal representation of the problem. However, as observed by (Stenning & Oberlander, 1995), graphical external representations, by their limited ability to express abstraction, may provide more salient and vivid feedback to a comprehension-monitoring, self-explaining student than self-talk in the linguistic modality. Therefore, another self-support method that is regarded as equally effective if not more than SE is SCD.

Self-Constructed Diagrams (SCD)

Externalizing representation by drawing helped problem solvers to interpret initial internal representation into an external stimulus, which, upon re-processing, aids in finding a solution. Reisberg (1987) saw the process of constructing an external representation as a procedure for widening the context of understanding and turning ones representations into stimuli. According to Cox (1997), “external representations (ERs) are an important part of many intelligent educational systems. In some systems, reasoning with ERs is central to the learning activity supported” (p. 1). Lewis (1989) considered self-constructed diagrams as facilitating learning-by-doing and providing a channel for generating SE. To describe these facilitating effects of externalizing by drawing, Anderson and Helstrup (1993) used the term perceptual assistance for discovering and

synthesizing ideas of novel patterns from simple shapes. They investigated the effectiveness of mental imagery with and without drawing support and concluded that while mental imagery is the initial source of discovery and synthesis, drawing is useful in production and refinement of patterns. Such studies of SE during problem-solving with ERs have contributed a great deal to our understanding of externalization of representation.

Grossen and Carnine (1990) were one of the earliest researchers to demonstrate the importance of active external representation construction (constructivism) empirically in the domain of graphical reasoning. After teaching the use of Euler's circles as a method of reasoning, they compared a group of students who self-constructed their external representations with a group who used prefabricated (pre-drawn) external representations. They found that students in the condition of instruction with self-constructed diagrams scored higher on difficult problem types, and they concluded that active drawing creates deeper understanding and processing than passive diagram selection. Later, Cox and Brna (1995) studied the effects of self-re-representations on the solution to analytical problem-solving. They referred to these external representations as work scratching used by students during problem-solving and found that they helped learners derive correct inferences, even when some constructions were incorrect. They also reported a range of external representations used by subjects, which included plan diagrams, tabular representations, graphs, logic, lists, and natural language.

Cox (1997) compared subjects' performance on a diagram interpretation task (Euler's circles) with their performance on a task in which they constructed their own Euler's circle representations. He concluded that external

representation construction involved active interactions between external and mental models as the learner constructs a personal version of the presented information. Furthermore, Cox (1997) explained that some types of interpretation error often led to subsequent construction errors, which was attributed to performance differential in terms of processes associated with the externalization of cognition. These included mental representation, disambiguation, SE, and working memory offloading. Cox (1999) also found evidence in his study that creating representations may lead to better understanding of the problem situation. He emphasized that the process of constructing and interacting with an external representation is a crucial component of learning. This, he explains, is a result of a dynamic interaction between the external and internal models that takes place when a learner constructs a personal version of the presented information.

Tversky (2002, 2005) has also exhaustively studied the nature and usefulness of graphics in understanding the pragmatics of linguistic and pictorial communication. Based on research on sketch maps, graphs, and geometric analogy she found that the choice and representation of elements and the order in which they are drawn reflect the way that domain is schematized and conceptualized. Tversky explained that elements that are arranged in space, in groups, orders, or distances can be meaningful either symbolically or metaphorically, facilitating inference and conveying ideas. The order of drawing elements resembles a dialogue that problem solvers conduct with themselves that reveals their underlying mental organization or conceptual structure. Heiser, Tversky, and Silverman (2004) highlighted this characteristic by stating that “many abstract design problems can be depicted by mapping the elements and

relations of the abstract task onto visual elements and spatial relations in a sketch (p. 9). They also argued that as the amount of information that can be held in the working memory and the number of mental operations that can be applied to that information is limited, externalizing through depictions helps to reduce the limitations of memory and thinking by representing and organizing information that can be frequently inspected and altered.

Ainsworth and Iacovides (2005) investigated the benefits of drawing self-diagrams and found that learners could overcome the disadvantages of text by drawing while self-explaining and that drawing diagrams is as effective as writing SE. Van Meter (2001) studied the benefit of student-generated drawings as a learning strategy in 5th and 6th grade children. Drawing methods involved providing participants with blank paper and a pencil and instructing participants to make a picture to show the important ideas in text. Three experimental drawing conditions and a reading control tested the hypothesis that drawing is effective only when students are supported during the construction process. One group (drawing participants) constructed drawings only, whereas another (illustration comparison participants) compared drawings with a provided illustration. A third group (prompted illustration comparison [PIC] participants) answered prompting questions to guide the comparison process. Dependent measures included a free-recall and recognition posttest, drawing accuracy, on-line self-monitoring behaviors, and time on task. Participants in all drawing conditions who spent significantly more time on the task were engaged in significantly more self-monitoring events than were reading control participants. Van Meter also found that the third group, PIC participants, constructed the most accurate drawings and scored significantly higher on the free-recall posttest.

Thus, there is ample evidence to support the benefits of SCD as a kind of external representation and a cognitive tool facilitating information processing when solving a problem. Cox (1999) listed the benefits of constructing an external representation to illustrate how it assists problem-solving and involves a wide range of processes which are summarized as follows: Constructing an ER helps translate information from one type of representation to another re-ordering information in useful ways, directing attention to unsolved parts of the problem, monitoring progress, providing perceptual assistance, checking and changing what is recalled, facilitating the inference of motion (mental animation), and refining and disambiguating mental images.

In educational contexts, an increasing need for competency-based education has generated a plethora of research in multimedia learning. Some cognitive theories that lend support to the effectiveness of self-constructed diagrams in learning are briefly discussed here.

The specificity theory of Stenning & Oberlander (1995) provided grounds for predicting that effective reasoning on indeterminate problems required one to use external representations capable of expressing abstraction in complex problems. The theory also proposed that the process of translating information from a linguistic representation, such as natural language or logic, to a graphical representation (e.g., verbal to pictorial) might be more effective than translation from one representation to another within the same modality.

Mayer's (1999b, 2001) theory of multimedia learning was based on the human information processing system, which consisted of dual channels for (visual/pictorial and verbal) processing, both of which have a limited capacity for processing. Active learning, according to this theory, entails coordinating

cognitive processes in the two channels by selecting relevant words or information from the textual and pictorial formats, organizing and integrating them with prior knowledge, and generating a coherent verbal and visual representation. In the context of the effectiveness of the representations, the Cognitive Load Theory (CLT) provided guidelines for presenting information (verbally or pictorially) in a manner that stimulated learner activities to optimize intellectual performance and develop competencies that enabled learners to recognize and define new problems as well as solve them effectively (Kirschner, 2002). The CLT also proposed that working memory, which was used to organize, contrast, compare, or work on information, was limited, as it can process only two or three items of information simultaneously. As a result, there is a need to determine which methods of learning and problem-solving assured that the limits of the learner's working memory load are not exceeded when processing information, but at the same time maintain an optimal load for the information to be transferred as a learning experience to the LTM.

Van Meter et al. (2006) presented a processing model of drawing construction that was an extension of Mayer's Generative Theory of Textbook Design, a model proposed to explain learning from illustrated text (Hegarty, Mayer, & Monk, 1995; Mayer & Sims, 1994; Mayer, 2001) grounded in Paivio's (1986) and Paivio's and Clark (1991) models. In Mayer's model, readers select and organize key elements from text and illustrations to form coherent verbal and nonverbal representations. These two representations are then integrated to form a mental model that supports conceptual transfer (Mayer, 1993, 1996). Though Van Meter et al (2006). found her model consistent with Mayer's in the processes of selection, organization, and integration, they also found some important

differences with respect to the construction of the nonverbal representation and the integration of the verbal and nonverbal representations when applied to drawing. In the verbal representation, which serves as the foundation for the construction of the nonverbal representation, the selection and organization of verbal elements are crucial processes in the drawing strategy. The construction of this representation begins as the learner activates stored referential links between selected verbal elements and stored nonverbal representations of these elements. Van Meter et al. (2006) explained this process with an example of a reader who learned that the bones of a bird's wing were similar to the human arms could also activate a stored image of the human arm and use this as part of the nonverbal representation. Drawing also required the learner to represent elements for which no stored images nonverbally, or nonverbal mental representation of the element exists (Sadoski & Paivio, 2004). In these cases, Van Meter et al. (2006) explained that the learner relies on the verbal description to generate a nonverbal representation. The verbal description thus serves as the foundation for this construction. Although construction of the nonverbal representation is dependent on the verbal representation, the two influence one another. For example, when drawing a learner realizes the need to determine the spatial location of the structure and this realization leads to a recheck of the text and selection of information for inclusion in the verbal representation. Once represented verbally, this knowledge is available to the nonverbal representation and subsequently can be included in the drawing. The nonverbal representation thus serves as the internal image the learner depicts in a drawing. The entire process is a recursive one (Van Meter et al. 2006).

In summary, the Generative Theory of Drawing Construction emphasizes the process of integration as an additional benefit of SCD. When learners integrate representations, particularly across modalities, the result is a mental model defined as an elaborated representation that lends itself more easily to higher-order applications or transfer of this acquired knowledge

The prior review suggests that there is ample theoretical and empirical evidence that self-constructed diagrams are effective personal interactive external representations facilitating better understanding when learners construct a coherent mental representation from the presented material. These diagrams are also considered a more practical and easier alternative to think-aloud (SE), hints, Multiple External Representations (MER), and Multimedia Representations (MMR) for enhancing problem-solving performance.

Moreover, the literature review explicitly emphasizes the role of external representation in general, and the diagrammatic form in particular, in problem-solving. Cheng, Lowe, and Scaife (2001) reviewed the variety of cognitive science approaches in the importance of diagrammatic representation and concluded that “the study of diagram use should examine the cognitive processes involved in diagram interpretation and understanding and not just the perceptual properties of graphic displays” (p. 16).

The present study used pictorial depictions of a non-domain specific problem that involved figuring out a process represented at different levels of similarity in the source problem. It highlights the methods of constructing diagram in different levels of similarity, focusing on interpreting and understanding the processes and the procedure that diagram reflect, and analyzing

the cognitive processes by developing protocol analysis for self-constructing diagram.

Importance of the Thesis

The literature reviewed has established the important role of analogical reasoning in problem-solving in particular and intelligent behavior in general. The rapid changes in information systems demands that teaching methods include developing the ability of a learner to acquire and apply knowledge efficiently.

Multimedia, for example, has become increasingly introduced and invasive, in live and virtual forms, which makes self-skills of retrieving, combining, and referencing information a basic requirement for effective learning. At the same time, the concept of distance learning and e-learning is also gaining momentum. As this trend becomes a popular and convenient way of learning, learners may have to rely more on self learning rendering empirical research in pictorial and self-support methods increasingly important in the subsequent years.

Learning by analogy is one of the oldest methods used in the teaching and learning process. It has been used effectively in virtually all domains of knowledge. However, studies using analogy (Chen, 2002, 2007; Chen, Mo, & Honomichl, 2004; Gick & Holyoak, 1980, 1983; Novick & Bassok, 2005; Pedone et al., 2001) have indicated a lack of robust results mainly attributed to certain learner-oriented problems related to noticing, retrieving, and adapting a solution from a source to the target problem. Researchers dealt with these problems by using various external strategies, such as hints, schema induction, and MERs.

In addition, research has established the effectiveness of think-aloud methods like SE for increasing learning outcomes in specific domains such as

science (Ainsworth & Burcham, 2007; Ainsworth & Loizou, 2003; Chi et al., 1989, 1994; Cox, 1999; Renkl, 2002, 2005; Roy & Chi 2005). However, to the knowledge of the researcher, this method has not been tested formally in analogical problem-solving with non-domain-specific problems that do not require any particular knowledge but an element of insight in discovering and applying a procedure from a source to an isomorphic target problem.

Knowledge is expanding and becoming highly diverse and complex. It is imperative that a learner uses cost-effective methods (in terms of time and energy) to gain maximum advantage from a learning situation. Learning by analogy is a learner-oriented method of teaching that refines problem-solving skills helps a person develop some cognitive abilities such as drawing information from experience and adapting it to achieve new inferences, which directly affect the quality of learning.

The review of literature highlighted the cognitive processes that are crucial in analogical problem-solving such as selective encoding, combining, and comparing (Sternberg & Davidson, 1999); restructuring systematicity of relations and mapping (Gentner, 1989); adapting a procedural solution, constraints, and goals (Gick & Holyoak, 1983); effects of good representation, graphics, and text (Larkin & Simon, 1987; Pedone et al 2001); and cognitive offloading (Van Meter, 2001).

Moreover, although the importance of using diagrams has been empirically established, their use has been often limited either because of the fact that not all subjects lend themselves easily to diagrams or because of the difficulty in determining their informational and computational equivalence to textual form. In this study, it was assumed that the self-support methods will

serve a dual purpose: First, the active involvement of a person in representing or restructuring any information and second, the consequent development of a deeper understanding of the subject.

In addition, the fact that learners are often exposed to different levels of knowledge abstraction has led researchers to examine the effects of representing a source problem in various levels of similarity with the target problem. The importance of procedural similarity using diagrams in the source problem has been emphasized in problems requiring a process to be learnt and applied (Chen, 2002). Besides using different levels of similarity and pictorial representation of the source, the present study extends Chen's findings through investigating the effects of verbal representation of the source on target problem performance.

The researcher considers the methodology used in this study as unique and significant because it describes how the source problems were systematically developed and depicted pictorially in the three levels of similarity using the problem space theory and the concepts of informational and computational equivalence. It also describes a coding scheme considered by the researcher as a valuable contribution to the field of cognitive science.

Finally, the study developed the “Generative Procedural Model of Analogical Problem-Solving” (GPM) which substantially contributes to our understanding of the extent to which people use various cognitive processes (through drawing protocols) to represent and solve by analogy a verbally or diagrammatically represented problem at any level of similarity. Thus, this research rests on the assumption that in problems requiring a procedure to be understood and applied, a single representation (verbal or pictorial) at any level

of similarity along with self-support methods, such as SE and SCD, help problem solvers exploit the benefits of solving problems by analogical reasoning.

Aim of the Thesis

The present thesis draws largely on the findings of Pedone et al. (2001) and Chen (2002). The failure to notice and retrieve information from the source problem led Pedone et al. to use hints and verbal text to increase transfer performance. Chen, on the other hand, found that despite the positive effects of schematic representation and procedural similarity, the participants faced the problem of executing a process from the source to the target.

The primary aim was to find other methods, instead of hints and MERs, that could effectively overcome the problem of lack of retrieval and noticing the critical steps involved in mapping and transfer. The second aim was to determine the exact mechanisms underlying procedural representation that help implement the source analog solution in a workable procedure (execution process) to reach a goal. The study also aimed at understanding the various cognitive processes and sub-processes underlying diagrammatic forms of representation that affect the retrieval and implementation of the source solution. In a series of three experiments, non-domain specific problems depicting a process were used, which are diagrammatically represented at different levels of similarity; principle, strategy and procedural. The effect of two self-support methods, SE and SCD, on the transfer process was systematically investigated. In addition, the two types of representation, pictorial and verbal were directly compared.

CHAPTER 3: THE TASK ANALYSIS FOR PROCEDURAL SIMILARITY

Introduction

The review of literature in the previous chapter highlighted the important role of analogical reasoning on two dimensions. First, it described particular instances in which analogies provided a pedestal for problem-solving and, second, it illustrated a form of intelligent behavior. Since the importance of learning by analogy was recognized, most of the research such as the work of Gick and Holyoak (1983) and Gentner et al. (1993) has exhaustively dealt with the role of superficial and structural similarity between the source and its target analogue.

In addition, researchers have also documented the influence of different approaches in analogical problem-solving, such as hints, examples, schema induction, and think-aloud methods. These different approaches were implemented to enhance learning performance and analogical transfer. However, most of these studies have used only verbal representations in analogical reasoning (Catrambone & Holyoak, 1989) while relatively little work has explored the use of pictorial analogies (Chen, 2007; Kroger, Holyoak, & Hummel, 2004; Pedone et al., 2001).

This chapter describes two preliminary studies (A and B) undertaken to explore how analogical problems are generally perceived and solved by Arab students and also to determine the suitability of the problem tasks chosen for the main study.

The main study systematically investigated how the self-support methods (SSM) of self-explanation (SE) and self-constructed diagrams (SCD) help

learners extract the maximum amount of information from a given situation and adapt it successfully to solve an analogous problem. On a general level, it examines how the SSM influence transfer performance when an analogical problem is represented pictorially or verbally at different levels of similarity (principle, strategy, and procedural) between the source and the target problem.

Thus, as the choice and design of the problem tasks was a crucial step, in ensuring the empirical value of the study, it was selected if it adhered to the following criteria:

- The tasks should be two isomorphic (source and target) non-domain specific tasks not requiring any prior knowledge to understand or solve.
- The tasks should lend themselves easily to both pictorial and verbal representations.
- They should depict a step-by-step process or a procedure.
- It should be possible to represent the task problem in the source at three different levels of similarity with a target problem.
- The tasks should involve sufficient information processing activity to help generate SE and self-constructed diagrams.

The first criterion required the researcher to use simple insight problems that are encountered in day-to-day life and can be solved by any individual with average intelligence. Although insight problems are simple and usually contain only a small number of objects and relations, they require examining the problem from different angles and connecting the different relations in order to figure out the solution, which appears difficult at the beginning (Kershaw & Ohlsson, 2001, 2004). In addition, it has been suggested that the experience of discovering a solution by insight in the source analog may aid a deeper understanding of the problem as worked out examples, in terms of learning. This incompleteness of

source problems, as observed by Renkl (1997), is considered typical of common textbooks and everyday problems. Therefore, insight problems were chosen because they induce a learner to actively extract information that is necessary for understanding and finding the solution.

The second criterion called for the ability of the problem to be represented in both verbal and diagrammatic forms. Graphical representations can aid problem-solving by facilitating perceptual judgments of a kind, which are almost effortless for humans, and can act as triggers to the retrieval process (Larkin & Simon, 1987). However, their use was often restricted to enhance learning benefits (Ainsworth & Loizou, 2003). Diagrammatic reasoning focuses on the interpretation of pictures and diagrams that directly represent the information in the problem to be solved (e.g., by using a static picture of a pulley system to infer the direction of motion (Ferguson & Hegarty, 1995; Hegarty, 2004). Understanding pictorial information processing at different levels of similarity was considered equally important in identifying the mechanisms that optimize analogical transfer. Stenning and Oberlander (1995) propose that different representational systems of a problem (graphical or linguistic) give rise to different processing characteristics due to differences in the facility of inference.

The review of literature indicated the lack of systematic investigation regarding analogical reasoning with diagrams compared to verbal analogical reasoning. The rarity of using diagrams, particularly in analogical reasoning, was due to four reasons. First, there was a lack of a systematic method available for constructing diagrammatic source analogs. Second, it was often considered difficult to develop a single source analog diagrammatically and the added difficulty when dealing with different levels of similarity. Third, it took more

time and effort consuming to pursue such an approach. Finally, although its benefits are often emphasized for both children and adults, it was expected that most people tend to prefer traditional verbal methods, and perhaps are not readily open to schematic representations.

As an important feature of the study concerns procedural similarity, the third criterion required problems that depicted a process to be understood in the source and the knowledge used to implement a solution in the target problem. Therefore, the problems chosen for the study needed to be non-domain specific everyday problems requiring no prior knowledge and involving insightful thinking along with a concrete procedure (process solution) to solve it.

The fourth criterion of selecting the task deals with the multilevel nature of the analogical approach (Gick & Holyoak, 1980). This usually involved a process of extracting a solution principle that primarily depends on, and is guided by, the level of representation in the source problem. Gick and Holyoak differentiated between the various levels of abstraction in the representation by investigating their effect on analogical problem-solving performance. They explained that a level of abstraction was considered relatively 'low' when the two problems, source and target, share a variety of corresponding details and more 'abstract' when these two problems share higher order relations only.

In their cognitive theory of graphical and linguistic reasoning, Stenning and Oberlander (1995) proposed that a good representation is one that provided for the effective use of a clear structure that aids the learner to extract and process the needed information. They differentiated between three types of representational systems (MARS, LARS, and UARS) that corresponded to the extent of elements' dependency within or outside the representation.

Chen (1996, 2002) also focused on the multilevel characteristic of analogy and the importance of levels of similarity (abstraction), between the source and target problem, in influencing the process of deriving a solution in an analogy. Differentiating among the processes of noticing similarities between the source and target, and applying (implementing) what was comprehended, Chen, observed that those features of a source representation that increase the probability of noticing and mapping do not necessarily ensure that a solution principle will be automatically applied to the target situation. He proposed three types of similarity that reflect the relations between a source analogue and a target problem, the first two of which are superficial similarity, where the problems may be similar or different in their surface attributes, such as objects or characters in the source and target problems, and structural similarity, where the source and target may share some features, solution principle, or causal relations among the key components. These two types of similarity are commonly identified by many researchers (Gentner et al. 1993; Gick & Holyoak, 1983).

The third type is procedural similarity, referring to the complex, multi-componential relationships, and defined by Chen (2002) “as the transformation of a general solution principle or idea into concrete operations (a sequence of actions) relevant to goal attainment” (p. 81). Chen (2002) considered procedural similarity between the source and target as an important factor for facilitating the transfer of the solution process. Using a pictorial type of representation, Chen systematically analyzed and compared the effects of different levels of similarity (principle and strategy) with procedural similarity on the execution or the procedural implementation of a learned solution.

All of the four criteria mentioned above converge towards the last criterion of selecting the problems for analogical reasoning that relate directly to the main purpose of the study. The selected problems needed to be designed in a way that facilitates the effects of the SSMs on the various properties of analogies used to study the insightful non-domain specific problems represented verbally and pictorially at different levels of similarity (principle, strategy, and procedural) between the source and target problems.

Chen's (2002) study served as a useful guide in problem selection, as he effectively used general problems of analogy in schematic form. Both the theme and the representation of the target problem used (Weighing the Elephant) and its schematic source models closely met the requirements of the study. As the research draws upon Chen's (2002) work, the materials used are described here to highlight the extent to which they served and contributed to the aims of the present study.

The main characteristics of problems used by Chen were classified in the following categories:

- Everyday non-domain specific problem (involving simple methods of weighing and measuring objects) that required some insight. According to Chen, this type of problem differentiates it from ill-defined problems such as the Duncker radiation problem (Gick & Holyoak, 1980) and well-defined problems with specific domains such as physics and mathematical tasks (Bassok & Holyoak, 1989; Novick & Holyoak, 1991; Reed, 1987).
- Not very simple and neither too difficult to solve.
- Schematically depicted in three levels of similarity in the source.

- The tasks required a step by step process (procedural implementation of a solution) which helped measure transfer performance objectively.

Chen (2002) schematically represented the Elephant problem in different levels of similarity or abstraction to establish the positive effects of procedural similarity as compared to the principle and strategy levels on procedural implementation of a learned solution from a source to the target problem. The participants viewed a schematic picture as a source model, interpreted its conceptual meaning, and then attempted to solve the target problem by applying the conceptual information derived from the source model. He defined the various levels of similarity in the source as follows:

- Principle Level of Similarity: The principle only model (e.g., general idea) depicted only the super-ordinate concept in the source model such as the general relation between a large object and a set of smaller objects. No concrete information concerning how to achieve this comparison was given. (Figure 3.1a)
- The Similar Principle (seesaw balance): This also illustrates the principle of weight equivalence but relatively in more detail but without a concrete solution in terms of strategy or procedure required to solve the target (Figure 3.1b).
- The Dissimilar Strategy but Similar Principle models: This contained a specific strategy and procedure that illustrated the weight equivalence principle (e.g., seesaw balance and hanging balance in the Weighing the Elephant problem).. However, both seesaw and hanging balance models are not similar in the strategy or procedure required for solving the target problem (Figure 3.1c).
- The Strategy Level of Similarity: Figure 3.1d shows the source model in similar strategy but dissimilar procedure. (e.g., spring compression in the “Weigh the Elephant problem.”)

- The Procedural Level of Similarity: The similar procedure models (e.g., sinking compression in the Elephant problem Figure 3.1e) depict specific procedures that can be used to solve the target problem. The relations between the sinking compression model and the boat solution exemplify this condition.

The two important features of the general insight problem used by Chen were the diagrammatic representation and levels of similarity in the source. Both these features were adopted by the researcher to examine the effects of SSMS on analogical problem-solving involving diagrammatic representation at different levels of similarity between the source and target problems.

Preliminary Studies

Psychologists and cognitive scientists have always been interested in understanding causes of people's failure to solve problems when they possess all the necessary information either gained in past experience (retrieved from memory) or provided by the environment during the problem-solving process. In both cases, people can differ significantly in the degree to which they are informed about the relevance of a particular piece of information to the solving of the target problem. Therefore, it is not only theoretically but also empirically important to determine the how people from various cultures engage in analogical mapping when they are presented with a target and source analogue.

Two preliminary exploratory studies A & B preceded the main study to develop suitable tasks and a methodology for investigating the interactive effects of the procedural level of similarity, modality of representation, and the self-support methods in solving problems by analogy. As the study involved investigating the comparative effects of levels of similarities and modality of

representation, the researcher replicated the study of Chen (2000) to explore the factors that affect analogical problem-solving in Arab culture and compare the findings.

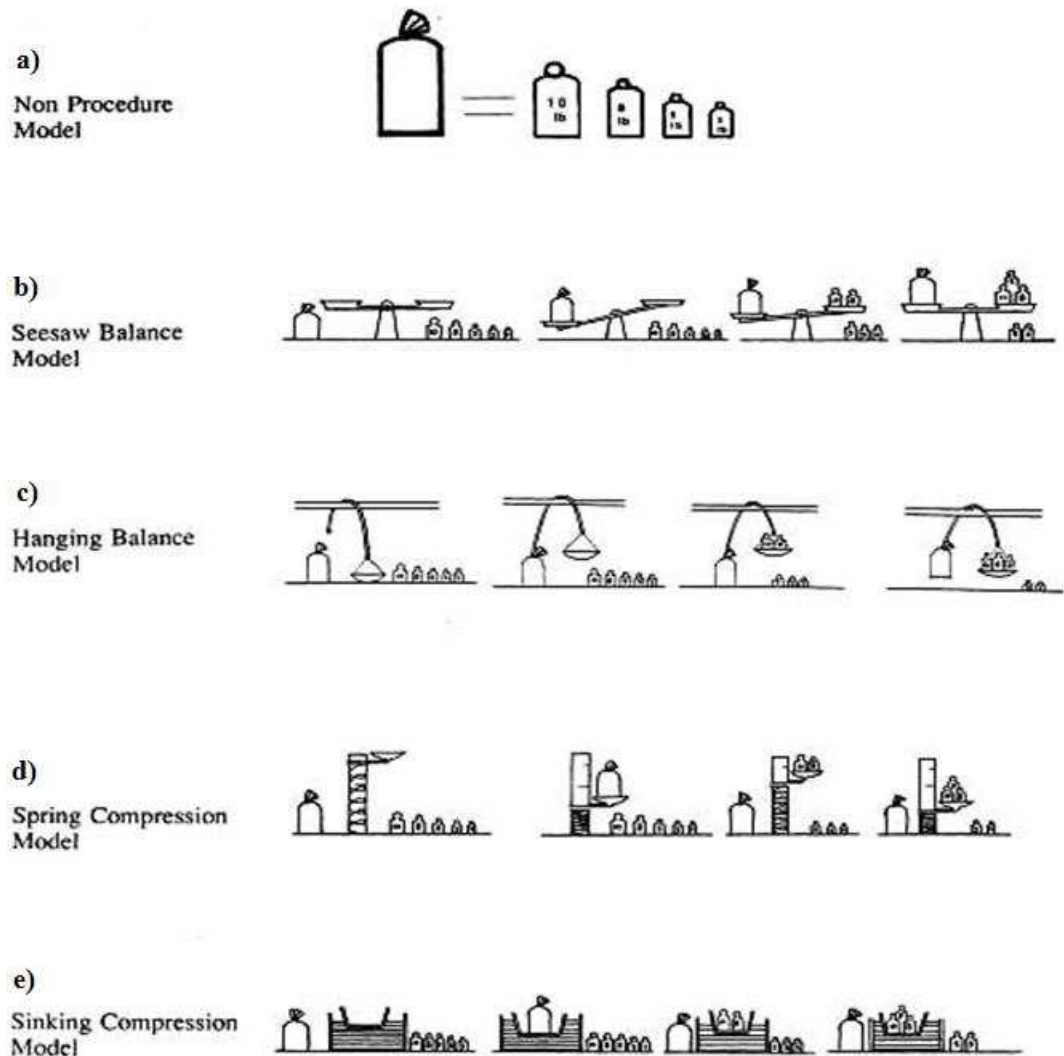

Figure 3.1: The representation of the various schematic models in the source problem used by Chen (2002).

Note: The general principle illustrates only the notion of weight equivalence without a concrete solution strategy or procedure for the target. The seesaw balance (similar principle) also illustrates the principle of weight equivalence in relatively more detail but without a concrete solution strategy or procedure for the target. The hanging balance model gives a solution strategy but which is dissimilar to the target solution. The spring compression models depict a similar strategy to the target solution that several smaller objects can push down a compressible surface to the same degree as one heavy object. The sinking compression model provides a similar procedure for the solution of the target.

Experiment (A) was conducted with 156 Arabic speaking female undergraduates from King Abdul-Aziz University, Jeddah Saudi Arabia, between the ages of 18-25 ($M = 20.1$, $SD = 1.74$). This experiment pictorially depicted a method of weighing heavy objects in the source problem at different levels of similarity with an isomorphic target problem called Elephant (Chen, 2002). It may be mentioned here that in both the preliminary studies, the researcher used three main levels of similarity instead of five used by Chen (2002). These are the principle (general idea), the similar strategy, and the similar procedure as shown in Figure 3.1 a, d & e) to represent the source for the Elephant problem.

The results of the preliminary study A showed no significant difference among the groups with regard to performance as a function of the various levels of similarity. This was mainly attributed to two factors: (a) the ambiguity of the pictures presented in the source models reported by the participants in their retrospective reports (Figure 3.1), and (b) the tendency of Arabic native speakers for reading or seeing things from right to left which reversed the perception and understanding of a step by step process described in the source problem. These two reasons that accounted for the discrepancies in the findings between experiment (A) and Chen (2002) called for examining the precise effects of clear source models represented in both L to R and R to L direction of representing the pictorial source models.

In preliminary study B, the researcher investigated whether clearer pictures at different levels of similarity and their direction, right to left and left to right (R to L or L to R), in the source problem (Appendix A) influenced transfer performance in problem-solving by analogical reasoning. Additionally, a new problem the Salt, devised by the researcher was used in this preliminary

experiment. A new group of 150 female participants (similar age group as in preliminary A) were assigned to three levels of similarity (principle, strategy, and procedure) and two conditions of direction (R to L and L to R). The findings were in line with Chen (2002), indicating a significantly high transfer performance in the procedural level of similarity in the condition of right to left direction.

Thus, these two preliminary experiments helped determine the suitability of the analogical problems chosen or devised by the researcher to depict different levels of similarity, in both verbal and diagrammatic forms, for the main experiments of this study.

Task Analysis

The theme of the problems used in the study is weight equivalence or measuring out a substance without adequate tools or measures (Chen, 2002). These problems are not considered to be domain specific although discovering the concrete process solution involves some mathematical reasoning with insight to figure out a process illustrated in the source problem for weighing heavy objects or measuring out substances. Insightful thinking, according to Kershaw and Ohlsson (2001, 2004), are simply stated problems containing a small number of objects and relations that at first glance appear to be difficult if not impossible to solve. However, once the problem is looked at from different angles, and the relationship between the objects is figured out, a logical solution is easily deduced. In order to solve the source problem a person is required to discover the underlying process (steps) by figuring out the relationship between the objects depicted in a sequence of pictures. This is based on the assumption that the experience of discovering a process may help a deeper understanding of the

problem as worked out examples in terms of learning. As also observed by Renkl (1997), the incompleteness of the source problems was considered typical of common textbooks and everyday problems. Therefore, to successfully learn from pictorial types of representations, the problem should induce a learner to actively and rationally extract information relevant to the solution process. The target problem for the source, in all levels of similarity, is stated verbally to facilitate comparisons across levels and modality of representation and also to distinguish between the process of implementing a procedure and other components of transfer, such as mapping.

The researcher used four different problems in this study. The Elephant target problem by Chen (2002) was translated into Arabic. The isomorphic schematic source problems at different levels of similarity for the Elephant target problem were modified for clarity by the researcher (Appendix A). A systematic method was applied by the researcher in building each of the three new target problems called the Salt, the Lab, and the Almond problems, and their isomorphic source problems at different levels of similarity. The Elephant problem is described first since it served as a model for developing other problems. The construction of the Salt target problem and its source analogs at three levels of similarity is described in the subsequent section while the other two problems, the Lab and the Almond, are discussed in Appendices C and D respectively.

The Elephant Problem

This target problem was adapted from a traditional Chinese tale by Chen (2002). It describes a scenario in which a boy needs to weigh an elephant but cannot find a scale big enough. The participants were asked to generate the

possible solutions for obtaining the weight of the elephant. The critical item required for the solution was a boat, which was presented along with some relevant and irrelevant items, such as a small scale, rocks, table, containers, and boxes (Figure 3.2). The elements were given to differentiate between the participants who choose the key elements from those who did not (Chen 2002). These clues helped generate the boat solution (sinking compression) as the only possible and appropriate solution of the target problem, which could be retrieved from the source analog. The steps of the boat solution are:

- Put the elephant on a boat.
- Mark the water level on the boat.
- Replace the elephant with some smaller objects (e.g., rocks or containers) so that the water level reaches the mark.
- Weigh the smaller objects separately with the small scale.
- Sum the weight of small objects to get the weight of the elephant.

The Problem

Many years ago there lived in China a young man. Wishing to further his education, he went to a wise man in a remote land. *Master,*” he said, “if you will allow me to study with you for one year, I will give you, in payment, this elephant.” And he displayed to the wise man an elephant, strong and beautiful.

The old man looked from the young man to the elephant, and asked: “How much does the elephant weigh?”

“I do not know, Master” the boy replied.

“Weigh the elephant. Come back tomorrow and we will begin to learn from each other.”

So the boy left, running through the town, looking for a scale to weigh the elephant. The largest scale he could find, however, was only scaled to 200 pounds.

“The next morning the boy sat, despondent, under a big tree, on a rocky river bank. As he watched, a boat came into view; the old man was rowing toward him. The old man got out of the boat, went to the boy and sat down.

“How much does your elephant weigh?”

“I cannot find a large scale, master.”

“It is not the elephant I am measuring, my son. It is the student’s thinking. You have everything you need to weigh the elephant. When you have done so, you may join me.” And the old man stood up and moved up the path to his school, leaving the boy with the problem.

Participants were given illustrations of objects as shown in Figure 3.2 that they could use to solve the target elephant problem.

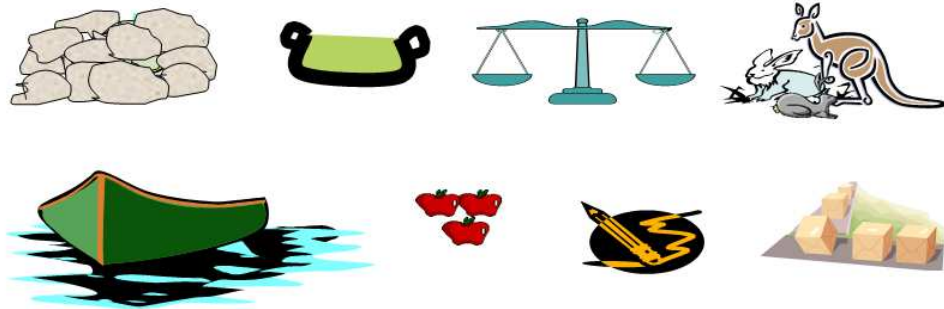

Figure 3.2: Tools for the target Elephant problem.

The Source problems for the target Elephant Problem

The source problems represented pictorially at three levels of abstraction, principle, strategy, and procedure, were modified for clarity and were represented in the right-to-left direction as shown in Figures 3.3, 3.4 and 3.5. The three levels are described and illustrated below.

The Principle Model: At the most abstract or super-ordinate level, the analogue provides a general solution orientation or principle for solving a target problem, with no concrete details for implementation of the principle. Figure 3.3 shows the general relation between a large object and a set of smaller objects where one large object is equal to a sum of small objects in the Elephant problem.

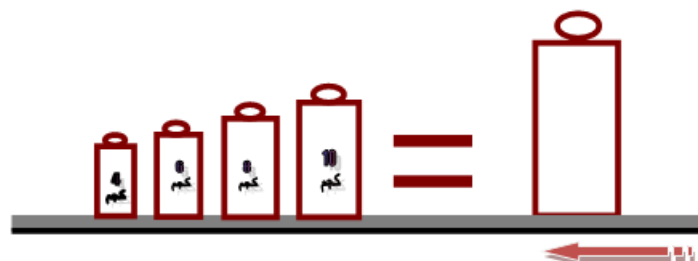

Figure 3.3: The Principle Model (the right to left direction).

The Strategy Model: At an intermediate level, the source and target problems share not only a general principle but also a more concrete strategy to implement it. However, they still differ in the most concrete operational details. They are illustrated to depict an alternative procedure that can be used to solve the target problem. Here, no procedure is given that could be applied directly. The strategy for the Elephant is depicted by illustrating the spring compression method of weighing large objects (Figure 3.4).

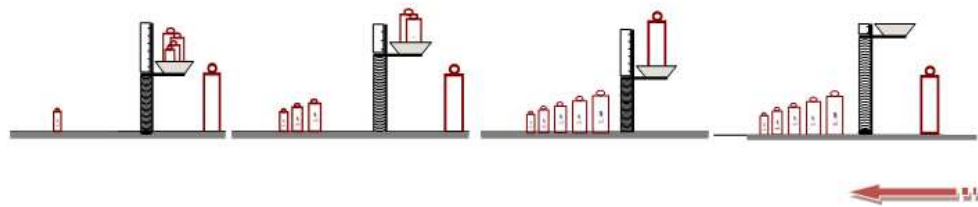

Figure 3.4: The right to left new spring compression model (similar strategy).

The Procedural Model: At the most specific level, the source and target problems share a similar solution in their concrete procedural details. Therefore, the similar procedure models describe the exact method that can be directly applied to solve the target problem. For the Elephant problem, the sinking compression model depicted a specific procedure of using a container immersed in water and measuring the amount of water that is displaced as a result of the weight that it contains as shown in Figure 3.5(Chen, 2002).



Figure 3.5: The right to left new sinking compression model (similar procedure).

Problem Building

A systematic method was applied for building analogous problems using the following steps:

- Selecting or developing the target problem: All the target problems were in verbal format to compare the transfer performance across modality of representation (verbal or pictorial) and different levels of similarity provided in the source problem.
- Analyzing the target problem: The Problem Space Theory was applied to identify the various steps involved in solving the target problem (Newell & Simon, 1972). The initial state, procedural steps and the goal state along with the constraints present in the problem were highlighted to indicate the solution path.
- Building the source problems: Analyzing the target problem was followed by developing its isomorphic source problems. Successful transfer depended on the level of information shared between the two problems (the source and the target). Procedural similarity is the focus of the study and is differentiated from other types of similarity (namely principle and strategy) in terms of the extent to which the solution illustrated in the source analogue is similar to that required to solve the target problem. The pictorially depicted source problems required a person to discover both the process and its underlying principle. The source problems were built in three levels of similarity. First, a source problem at the procedural level of similarity was built depicting the exact step-by-step method required (direct information) for the target problem but differing in the objects depicting the procedure. Second, the source for the strategy level was developed which depicted a different procedure with different objects (indirect information) that could guide a person to solve the target. Last, the source problem at the principle level was devised that gave no procedure, but only the minimum information in terms of a general principle or idea that could help solve the target. How this

method was applied in building one of the problems is illustrated below.

The Salt Problem

This problem was adapted from Sternberg (1996) and translated to Arabic to be used as a target. Its isomorphic source problems have been adapted from Luchins' (1942) classic water jugs problem. A systematic method was used for building the source analogs pictorially at three levels of similarity and two directions R to L and L to R for the target Salt problem.

First, the steps required to solve the Salt target problem are described. It required the participant to measure out a specific amount of substance without an exact measuring tool. The critical items were an 11g (gram) spoon, a 4g spoon and a container of salt. Pictures of these objects, along with some irrelevant items (e.g., containers and boxes), are shown in Figure 3.6.

The Salt Target Problem

A cook needs 1 g of salt to season a special meat he is cooking. When he opens the drawer to get a measuring spoon, he finds out that he has only an 11 g measuring spoon and a 4-g measuring spoon. How can the cook measure out exactly 1 g of salt using nothing but these two spoons and not guessing at the amount?

Task Analysis

- Initial State: meat and salt
- Goal State: Required amount 1g of salt.
- Resources: an 11g measuring spoon and a 4g measuring spoon
- Constraints: No guessing.



Figure 3.6: Tools for the Target Salt problem.

The solution steps of the Salt problem:

- First: fill the 4g spoon.
- Empty it into the 11g spoon.
- Repeat the same process once more so that the salt in the larger spoon now amounts to 8g of salt.
- Fill the 4g spoon for the third time.
- Empty it into the 11g spoon which will now hold only 3g of salt
- 1g of salt remains in the 4g spoon, which is exactly the required amount.

The Source Problems for the Salt problem

The source problems were designed pictorially for each of the three levels of similarity: principle, strategy, and procedure. No numerical information (e.g., adding and subtracting) to obtain a required amount of salt was given as shown in Figures 3.7 to 3.9.

The Principle Level: This subtraction model is the most abstract level where the analogue provides a general solution orientation or principle for solving a target problem without any concrete process details. The general relation between a large full object, a smaller empty object, and a half-full object, provides a general way for measuring out a required amount of substance as shown in Figure 3.7.

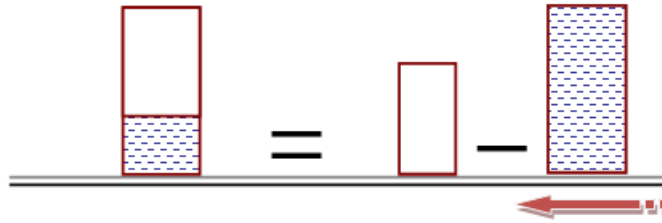

Figure 3.7: The Principle model.

The Strategy or Multi-Measures Model: Although the source analogue and target problem share a concrete strategy that can be implemented, they still differ in the exact operational or procedural details that could be applied directly. In the Salt problem, the strategy is depicted using more than one tool (multi-measures) for conveying an idea that can be used for measuring substances with containers of different sizes as shown in Figures 3.8.

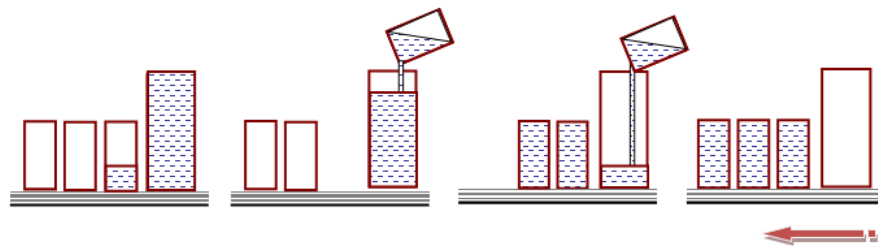

Figure 3.8: Strategy Multi-Measure Model.

The Similar Procedure or the Single Measure Refilling Model: The source and target share a similar solution in the concrete procedural details. It describes the exact method that can be directly applied to solve the Salt target problem. Moreover, it depicts a specific procedure of using big and small containers that can be used several times to measure the exact amount of water, which could be applied to the target problem, to get the exact amount of salt, using the large and small spoons as shown in Figure 3.9).

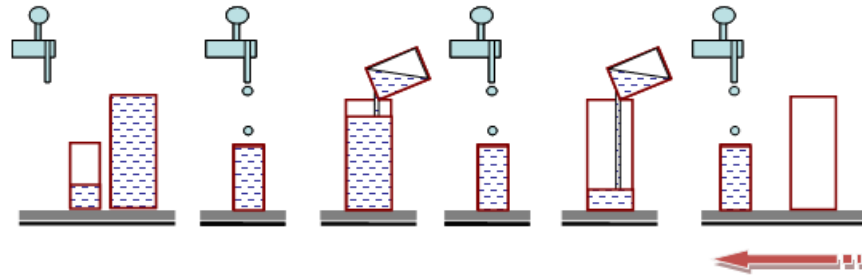

Figure 3.9: Procedure single measure refilling method.

Analysis of the Salt Problem

A problem space analysis was undertaken of the water jug problem pictorially depicted in the three levels of similarity in the source to solve the salt target problem. Newell and Simon (1972) analyzed problems in terms of space, which consists of an initial state, several intermediate steps, and a goal state.

The objectives of the problem space theory are:

- To determine the boundaries in terms of the initial and the goal state of the problem.
- To define all the steps involved in solving the problems including short cuts.
- To help identify the obstacles or constraints that participants face in the various steps while solving the problem. This is where the participants usually tend to indulge in looping (repeat the same steps without being able to proceed).

The principle model of the source problem gives a general idea about the super ordinate concept of measuring substances like liquids or flour. However, there is no concrete information is given in this model as shown in Figure 3.10.

Resources: One large jug filled with water, and one small empty container.

Constraints: Lack of complete information, or adequate tools.

Solution: Fill the empty container with water from the large jug.

Outcome: The remaining water in large jug is the amount of water required.

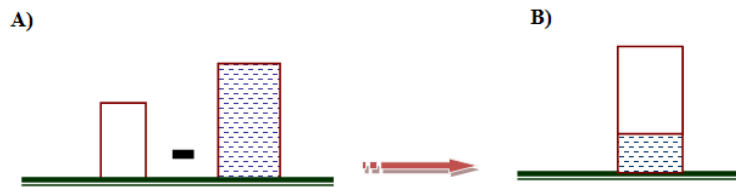

Figure 3.10: A) The initial state of the principle level. B) The goal state of the principle level: measuring out the amount of water required.

- Strategy Level: The Similar Strategy model is depicted as conveying an idea, but not the procedural process, that could be used for measuring substances with containers of different sizes (Figure 3.11).
- Resources: One large jug empty, and three glasses filled with water.
- Constraints: No exact measures for knowing the volume of water. No measuring marks on the jug or glasses.

Solution:

- Empty the first glass filled with water in the large jug.
- Empty the second glass filled with water in the large jug.
- Empty the third glass filled with water until the large jug is full, the remaining water in this glass is the amount required.

Outcome:

The remaining water in the last glass is the amount of water required.



Figure 3.11: A) The initial state of the Strategy level. B) The goal state: required amount of water remaining in a glass.

- Procedural Level: The similar procedure model shows the step-by-step process involved in solving problems of measuring substances when only two measuring containers, a large and a small container are available (Figure 3.12).
- Resources: One large empty jug, one glass filled with water.
- The initial state: Filling a glass with tap water, and an empty large jug.
- The goal state: Measuring out the required amount of water.
- Constraints: Non-availability of exact measures to determine the volume of water. No measuring marks on the jug or glasses.

Solution:

- Fill the glass with water.
- Empty it into the large jug.
- Refill the glass.
- Empty it again into the large jug.
- Repeat this operation for the third time.
- After filling the jug with the third glass of water, the remaining water in the glass is the amount required.

Outcome:

The remaining water in the glass is the amount of water required after the large jug is full.

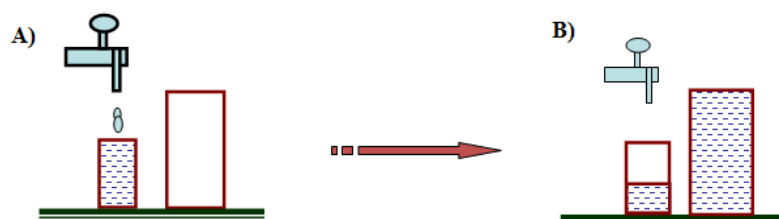

Figure 3.12: The initial and goal state of the procedural level. A) The initial state Source of water, the required amount of water. B) goal state: measuring out the (tap) One large jug (empty), One glass.

Figure 3.13 shows the problem space analysis of the salt problem from two different perspectives. On the right side of the Figure is a graphic representation of how the problem could be solved involving nine precise steps. On the left is another way (longer) the problem could be solved using an extraordinary number of steps. It was observed that although both the ways can lead to a successful solution, the latter method may result sometimes in failure. The procedural level of similarity tends to elicit the shorter precise method of the solution while the strategy level tends to elicit the long method.

The Validity of the Levels of Similarity

In order to ensure that the pictures adequately depict the different levels of similarity or abstraction in the source problems for the target Salt problem, two judges from the Department of Psychology were given the definition of the three levels of abstraction. They were also given the Elephant problem (the source and the target) to compare the information of each level according to the definition of the levels, and suggest any modifications for the problems.

Summary

In this chapter, the researcher attempted to describe the most crucial aspect of the study: the selection of problem tasks and their properties. The preliminary experiments A and B guided the researcher in building tasks that took into consideration the mental set (R to L direction) of the Arab participants and their understanding of analogical problem-solving. As the empirical validity of the study largely depended on the representation of the problem tasks, both the target and the source problems were systematically analyzed to determine the precise effects of self-support methods on transfer performance. The subsequent Chapter 4 reports the first experiment of the study using the SE as SSM.



Figure 3.13: The space theory of the solved problem

CHAPTER 4: THE EFFECT OF SELF-EXPLANATION ON PROCEDURAL LEVEL OF SIMILARITY

Introduction

The most important goal for education is to support students' deep, robust knowledge and understanding, so they can benefit from learning, and apply their knowledge in solving different kinds of problems. Although a significant difference was found at the procedural level of similarity in the condition of R to L direction in the preliminary experiment (B), the overall performance of all the groups in the three levels of similarity (principle strategy and procedure) was low. The responses revealed that poor transfer occurred mostly because either the participants failed to notice that the two problems were analogous, or they were not able to adapt a procedure from the source to the target problem. This phenomenon was also noticed by Chen (2002) who observed that although procedural similarity influenced the degree of analogical transfer, the basic patterns of problem-solving performance remained the same even when clear hints regarding analogous relations were given. He attributed this to failure in the execution process, which resulted from a difficulty in adapting the source model solution and not in accessing it or mapping the key components to the target problem. Thus, based on the findings of the preliminary experiments, it was considered imperative to examine and analyze the process of problem solving, through think-aloud protocols, to identify and assess the cognitive processes that facilitate and strengthen transfer, as well as the obstacles that impede the execution of a solution process in procedural similarity in analogical problem-solving. At the same time, it was considered equally important to investigate the

effect of self-explanation (SE) as an internal self-support method on transfer performance.

The Think-Aloud Protocol

Think-aloud means that participants verbalize their thought processes as strategies they are using to tackle a specific problem situation. Verbal protocols are used to derive coding categories. It is a technique widely used in studying mental processes to understand what types of information subjects report when instructed to verbalize their thoughts spontaneously (Ericsson & Crutcher, 1991).

Ericsson and Simon (1984) consider think-aloud reports to be part of the normal sequential thought processes of performing a task as opposed to introspective reports which are meant to affect the performance. Short et al. (1991) investigated this assumption and found that thinking aloud leaves task performance unchanged and proposed that verbal protocols obtained while thinking aloud during task performance can help in understanding the internal problem-solving processes and strategies employed by the learner. Chen (2002) used verbal reports in the field of analogical problem-solving to examine how participants used the source analogue models in solving the target problem. The verbal protocols helped identify the obstacles that prevented a subject from successfully executing a procedure learned from the source to the target analogue.

As a thorough review of literature of the think-aloud method was undertaken in chapter 2, this chapter discusses only some important studies that provide evidence to support the claim that SE could also enhance problem-solving by analogy.

The think-aloud method of SE has been widely used to assess its impact on performance. VanLehn and Jones (1993) proposed that SE helps participants

generate three types of explanation; Explanation to detect and fill the gaps in their knowledge, Explanation to help in schema formation, and Explanation to help in analogical enhancement.

Aleven and Koedinger (2002) used this method to explore how students explain their own solutions while they solve problems from geometry, while Renkl (1997) used SE to investigate individual differences in learning from worked-out examples by examining the quality of explanations produced. Renkl et al. (1998) provided experimental evidence about the effect of SE on transfer. In their experiment, half of the participants received SE training with information about its importance before the presentation of the instructional example, while the other half was assigned to the VB group, which was not given any prior training. The results showed that the performance of the SE group was significantly higher in both near and far transfer.

Other researchers sought to determine the reasons behind the improved problem-solving performance of participants who used SE. Chi et al. (1989) found through SE reports that successful learners frequently elaborated on the processes related to the conditions of applications and goals of the problem. They also found that SE increased anticipative reasoning by more frequently relating the steps of the solution to the domain principles. Chi et al. (2001) further used SE to support the hypothesis that good students learn with understanding because they generate many explanations which refine and expand the conditions for action and facilitate problem-solving.

Besides studying the SE effect on performance in a wide variety of domains, ranging from physics problem-solving to geometry and programming, the impact of the type of representations of problems on SE was also

investigated. Researchers have either presented material as text (Chi et al., 1994) or in text and diagrams (Ainsworth & Loizou, 2003; Aleven & Koedinger, 2002; Chi et al., 1989).

Ainsworth and Loizou (2003) explored the effect of the material (text or diagrams) on the SE. They found that students who were given diagrams performed significantly better on post-tests and generated significantly more explanations than students given text only. They also found that diagrams not only generated more explanations but also were more effective in learning because they reduced memory load.

SE has also often been used as a meta-cognitive method to enhance learning in domain-specific areas, such as science and mathematics. According to Chi et al., (1989) SE facilitated complete understanding of the domain theory in order to construct explanations. They gave subjects worked-out examples containing text and diagrams in physics. Renkl (1997) used the domain of probability calculation, whereas Ainsworth and Loizou (2003) gave their students a topic from biology about the human circulatory system.

This brief review, of the think aloud methods, provided a good deal of evidence of its beneficial effects on learning in general and determining the cognitive processes that underlie problem solving in particular. Although, the importance of self-explanation is evident from a wide range of studies that tackled this issue, nevertheless, its direct effect on analogical problem-solving has not been fully explored.

In Experiment 1, non-domain specific everyday problems were used which did not require any prior knowledge, but some insight. Although, mathematical in nature, they are considered general-domain problems because

they include simple operations like weighing objects and measuring out substances that require some insight for understanding a solution process depicted pictorially.

Experiment 1

The think aloud protocols are considered more useful in generating a description of the reasoning steps and to identify the cognitive processes that aid or impede transfer performance. Additionally, as successful transfer in analogical problem-solving depends on the extent to which the problem solver utilizes the various cognitive skills, Experiment 1 discusses the effect of think aloud methods (SE or VB) in processing and applying information from a source problem which is pictorially represented to an analogous verbal target. At the same time, think aloud protocols were used to reveal how an individual perceives or interprets pictorial information.

Self-explanation (SE) is a think aloud method that generally supports the construction of ideas and actions while engaging in problem solving. The first reason for using SE in this experiment is to investigate the relation between SE, analogical problem solving, type of representation (pictorial and verbal) and levels of similarity (principle, strategy and procedural). Second, pictorial formats are becoming popular because they make complex principles appear simple and interesting to deal with. In analogical problem solving pictorial type of representation has been rarely used perhaps because of difficulties associated with its construction and/or interpretation. Third, problems involving understanding a principle underlying a process, for transfer, are greatly determined by the level of similarity used in the analogous source and target problems. Therefore, it is assumed that SE as a self-support method will facilitate

the transfer process as well as reveal the cognitive strategies in interpreting problems pictorially represented in the source.

Experiment 1 investigates how pictorial source models in different levels of similarity are explained and the information applied in solving a verbal target problem. Precisely, it elaborates on the role of SE as an alternative to using hints, schema induction, and multiple representations in increasing learning and transfer performance.

Two think-aloud methods, VB (control), and SE (experimental), were used to: (a) determine the cognitive processes underlying problems involving a procedure, (b) to assess the effects of SE on problem-solving performance, and (c) the effect of procedural level of similarity on transfer performance.

Hypotheses

The hypotheses of Experiment 1 were as follows:

- SE is predicted to have a significant positive effect on strength of transfer performance.
- Procedural similarity is predicted to have a significant positive effect on the participant's strength of transfer performance.

In addition, this study explored some issues related to the role of SE in eliciting the cognitive processes considered crucial when solving problems represented pictorially and differing in the type of source (levels of similarity) information/knowledge provided. Some questions that Experiment 1 attempted to answer were:

- What is the difference between the number of solvers and non-solvers in each level of similarity?

- Is there a difference between solvers and non-solvers in the time spent and lines generated according to levels of similarity and think aloud conditions of VB or SE?
- What cognitive processes are elicited in the different levels of similarity and think aloud conditions?
- What is the relationship between the cognitive processes revealed and strength of transfer?
- What are the differences between solvers and non-solvers in the cognitive processes used?

Methodology

Participants

The participants were all female because this experiment was conducted in the female campus of King Abdul-Aziz University. All universities in Saudi Arabia have separate campuses for male and female students. Forty-eight (48) Saudi female undergraduates with ages ranging from 18 to 26 participated in this experiment for course credit. They were randomly assigned to two think aloud conditions; SE as experimental and VB as control group consisting of 24 participants each. The 24 participants in each condition were then randomly assigned to three levels of similarity; principle, strategy and procedural with 8 participants in each level. They were tested individually without any interference from the researcher.

Procedure

As the findings of the preliminary experiments (A & B) established that the R to L direction positively influenced transfer performance, all the experiments in this study adhered to this direction. Colleagues in the Department of Psychology were requested to send volunteers from among their students for this study. The students were given course credit for their participation. The

participants were given appointments to undertake the experiment according to the time suitable to them.

In this experiment each participant was given a demonstration of the think-aloud protocol which was either VB or SE followed by a practice session to ensure they understood how to go about it. A multiplication problems, such as (46×23) and matrix problems from Raven's Progressive Matrices test were used for demonstration because they represented a problem in pictorial form. This was to familiarize the participants with how to perform a task and verbalize while solving the problem. Both the introductory sessions and experiments were held in the meeting room of the social services department. In the introductory session after greeting the participant, the researcher gave a brief explanation of the purpose of the experiment. The participant was told that she is being given a problem-solving task through which the researcher would assess her performance. To relax the participant, she was assured that it was not a test of her intelligence or problem-solving abilities. When the participant was ready, a demonstration was given according to the think aloud condition assigned. The difference between the VB and SE is in the orientation training where arithmetic word problems were used. The demonstration for the control group VB condition was conducted in the following way:

Often we tend to think aloud when confronted with a problem. In this experiment it is very important that you think aloud while performing the task. A demonstration of how to go about solving a problem and at the same time saying aloud what is being done is presented. Here is an example of how to solve the math problem 46×23 aloud and at the same time on paper.

- Place 46 then 23 directly below,
- Multiply 3×6 this is equal to 18,
- put 8 down and keep 1 in mind.
- After that multiply 3×4 which is equal to 12
- add the 1 where $12 + 1 = 13$.
- put the number 13 before the number 8 it becomes 138.

- Next take number 2 and multiply it by 6,
- $2 \times 6 = 12$, put number 2 directly below number 3
- and keep 1 in mind.
- Then multiply $2 \times 4 = 8$
- add the 1 which is equal to 9.
- Now put 9 before the 2
- and then add the two lines.
- The result is equal to 1058.

The demonstration for the SE condition was also conducted in the same place. The participants were specifically instructed to give details and explain every action taken while solving the problem. The same example as in the VB condition was used for demonstration.

In order to solve 46×23 , here every step taken was explained as follows:

- Write 46 in the first line
- Directly below put number 2 below number 4,
- and number 3 below number 6.
- Draw a horizontal line.
- Start multiplying 3 by 6 which are in the units position
- and put 8 down in the units position
- Carry 1 and replace it on the top of number 4.
- Multiply 3 by 4
- The result here is equal to 12.
- Add the 1 on the 4 to the 12,
- it makes it 13.
- Write the 3 before number 8 in the tens position
- and write the 1 on the hundreds position thus making it 138 in the upper result line.
- Next multiply the 2 which is in the tens position and multiply it by 6
- The result is equal to 12
- Put the 2 under the tens position in the second line of the result
- and carry 1 up on the number 4.
- Now multiply 2 by 4
- and add the 1 on the top of the 4 to the result,
- which gives $8 + 1 = 9$.
- Write 9 under the hundreds position before the number 2.
- It becomes 92,
- add the two results line to get 1058.

The demonstration in each condition was followed up by a practice session in order to make sure that the participant understood the VB or SE procedure. The researcher was present in the room to observe the participant unobtrusively without interference, except to prompt gently if talking stopped for more than 30 seconds.

Instructions

The instructions given to the participants during the actual experiment were similar to that used by many researchers who asked participants to talk aloud and verbalize anything that comes to mind (Ericsson and Simon, 1993; Renkl, 2002). Ainsworth and Loizou (2003) asked students to generate explanations for themselves as they are learning. They limited their prompts to only asking learners to self-explain if they became silent, or asked for further clarification if what they stated was vague.

In Experiment 1, instructions for the control group VB condition of the source problems were given as follows:

Please look carefully at the pictures on the first page of the booklet. Talk *aloud for audio recording while you are figuring out the problem. By 'talk aloud'* I mean that you should verbalize anything that comes to your mind as you think of it.

Instructions for the experimental group SE condition of the source problems were given as follows:

Explain the pictures keeping in mind that you have to express in detail and loudly, for recording every step that you are taking to solve the problem. This should be done as if you are explaining it to someone else or yourself-while you are solving the problem.

Materials

A problem-solving booklet containing the source pictorial schematic model followed by its target problem was constructed in the Arabic language for the two problems: the Elephant (Chen 2002) and the Salt (Sternberg, 1986) (see Appendix A).

The source problem was represented in three levels of similarity in pictorial form that depicted using smaller objects to find the weight of a larger

object. In the target problem, the participants were asked to generate possible solutions for obtaining the weight of an elephant. The critical item was a boat, along with other relevant items, such as a small scale, rocks, and various other small objects that were introduced naturally in the story for generating the solution. Sketches of these objects, along with some other items (e.g., table, containers, and boxes), were provided in the problem-solving booklet.

The second target was the Salt problem, which was isomorphic to the water jugs problem (Luchins, 1942). The source problem was represented in terms of three levels of similarity in pictorial form with no numerical information, such as adding and subtracting to obtain a required amount of salt. The target problem required the participant to measure out a specific amount of substance without an exact measuring spoon. The critical items were the 11g spoon and the 4g spoon along with the salt container. Sketches of these objects, along with some other items (e.g., containers, and boxes), were provided in the problem-solving booklet. Irrelevant items were added to differentiate between the participants who choose the relevant key elements from those who do not. Refer to chapter 3 of this thesis for more detailed descriptions of the target and source problems.

Scoring

The scoring scheme is in two parts for the two problems: source and target problems.

Source Problem: The scoring scheme evaluated participants' interpretations and their general understanding of the source models. A correct and complete answer for the interpretation of the source model was assigned a score of 1, while an incorrect or incomplete answer received a score of 0. An

appropriate and complete solution is one which includes the idea that smaller objects can equal the weight of a larger item for the Elephant problem, or to measure out a specific quantity of water by using different jugs or containers in the jug problem.

Target Problem: Two measures concerning participants' problem-solving performance for the target problem were applied: a measure of the complete solution and a measure of strength of transfer. Chen (2002) estimated the percentage of participants successfully solving the target problem. If the answer was correct and complete, a score of 1 was given. If the answer was incorrect or incomplete, a score of 0 was given. In the present Experiment 1, the same criteria for assessing the percentage of solvers and non-solvers in the target problem were applied to compare with Chen's findings. Therefore, in terms of the complete solution, the participant was assigned a score of 1 if the answer was correct and complete, and a score of 0 was assigned if the answer was incorrect or incomplete.

The complete solution for the Elephant problem is to put the elephant on the boat and mark the water level on the boat, then replace the elephant with rocks or other smaller items, such as containers or boxes until the water surface reached the mark, and last weigh the smaller items separately with the small scale. The sum of these objects is the total weight of the elephant.

The complete solution for solving the Salt problem is to fill the 4g spoon and empty it into the 11g spoon, and repeat this process twice so the 11g spoon is full and 1g of salt remains in the 4g spoon.

Strength of Transfer, the second performance indicator, was measured on a four-point effectiveness scale (0-3). The performance was assessed in terms of

the degree to which the participants generated the correct solution thereby indicating the strength of transfer from the source model to target. This concept is introduced in the study based on the patterns of transfer performance revealed in the preliminary experiments A and B. It was observed that the range of performance could be divided into four categories: Complete successful transfer, High partial transfer, Low partial transfer, and Wrong or no transfer. These categories more or less coincided with the three levels of similarity procedural, strategy and principle respectively.

Complete successful transfer (score = 3): A participant scored three points if the answer was complete and successful in solving the target problem. The complete solution for the Elephant problem is: putting the elephant on the boat and marking the water level on the boat, replacing the elephant with rocks or other smaller items such as containers or boxes until the water surface reached the mark, and weighing the smaller items separately with the small scale and adding them together (Chen, 2002). The steps for a complete solution of the Salt problem are: fill the 4g spoon and empty it into the 11g spoon. Repeat this process twice so the 11g spoon is full and 1g of salt remains in the 4g spoon.

High partial transfer (score = 2): A score of two points is given if the participant gave a strategy plan for solving the target problem but did not achieve a final solution for solving the target problem. In the Salt problem, an example of a strategy plan is: fill the 11g spoon and empty it into the 4g spoon, repeat this process twice so the 11g spoon is empty and 3g of salt in the 4g spoon. This solution gives a strategy but not a complete procedure.

Low partial transfer (score = 1): An answer was assigned a score of 1 if it contained only the idea of estimating salt or the elephant's weight without an

explanation of how to implement this principle. An example of such a general solution for the Elephant problem is: we can compare the elephant to the small animals, by weighing the animals separately using the scale and then adding up their weights. In the Salt problem, an example of a principle only solution is: considering $\frac{1}{4}$ of the 4g spoon as equal to 1g (this solution gives only a general idea with no strategy plan and neither a complete solution).

Wrong or no Transfer (score =0): If the answer was incorrect or the participant did not provide a solution the score is 0. An example of a wrong solution for the Elephant problem is "cut the elephant in several pieces and weigh them" and for the Salt problem" we can guess 1g of salt by seeing it."

A correlation was computed between the scores achieved on the Salt and the Elephant problems. A significant positive correlation ($r=.212$ $p< .01$) was found between the performance of both the problems. This allowed the researcher to analyze each problem separately as well as derive a combined score. In the combined scores on the two source problems (for Elephant and Salt), ranges from a maximum of 2 (one on each problem if correct) to a minimum of 0. On the other hand, in the target problems the participant can score a maximum of 6 (three on each problem) on the two problems or minimum of 0.

Statistical Analysis

The study was intended to investigate the effectiveness of procedural similarity and the SE method in transfer performance. The scoring of the verbal protocols yielded both quantitative and qualitative data. In order to examine the hypothesis a 3×2 between-subjects, ANOVA was conducted for each independent variable (two conditions and three levels of similarity) and their interaction effects. To answer the questions stated earlier in this chapter, the

researcher first, compared the number of solvers and non-solvers in each level of similarity and protocol condition, second, compared the percentage of solvers and non-solvers in the source model, third compared the percentage of solvers and non-solvers in the source model who came up with a complete and successful solution for the target problem, and finally, compared the percentage of solvers, based on strength of transfer scale (ST), according to conditions and levels of similarity. Chi square tests were used to assess the significance of difference, whenever appropriate. Comparing the Mean performance (based on ST) in each level and condition, was also undertaken whenever appropriate also.

In addition, qualitative analysis is used to compare solvers and non-solvers in terms of time spent and lines generated according to levels and conditions. Finally, correlations were computed between the cognitive processes and strength of transfer to determine their relative effect on transfer performance.

Results

The present study used two methods of think-aloud (VB & SE) and three levels of similarity to assess their effects on problem-solving performance. It was predicted that procedural similarity would significantly influence the strength of transfer performance compared to other levels of similarity. It was also predicted that the SE method would have a significant effect than VB on the strength of transfer performance in all the three levels of similarity. In addition, this study was planned to explore a number of related issues about the role of SE, when solving problems represented pictorially and differing in the type of source information/knowledge provided. It also aimed to identify the cognitive processes that facilitate the problem-solving performance, and the difficulties or constraints a participant experiences while solving analogical problems.

Quantitative Analysis

The number of participants with correct solutions for the source problems of the Salt and Elephant, were 44 (91.7%) and 42 (87.5%) respectively. In order to determine whether there was a significant difference in the number of participants who solved the Elephant and Salt problems correctly, McNemar's test was conducted to determine whether the row and column marginal frequencies were equal to one another. There was no significant difference between the two problems, McNemar $\chi^2(1, N = 48) = .430, p = .727$.

Table 4.1 shows the number of participants with a complete solution for the target problems of the Elephant and Salt, 9 (18.8%) and 10 (20.8%) respectively, indicating no significant differences between the two problems. McNemar's test was conducted to determine whether there was a significant difference in the proportion of participants who solved the target Elephant and Salt problems correctly. No significant difference McNemar $\chi^2, (1, N = 48) = 0.004, p = .999$ was found between the two problems.

To determine whether the difference in the number of solvers and non-solvers in the source problem who came up with a complete and successful solution for the target problem was significant, a chi-square test was applied; no significant difference was observed in the Elephant problem $\chi^2(1, N = 48) = 1.58, p = 0.208$ or in the Salt problem $\chi^2(1, N = 48) = 1.14, p = 0.284$.

Table 4.1

Number of Solvers in each Target Problem according to Performance on the Source Problem

Source problem	Target problem			
	Elephant (n = 48)		Salt (n = 48)	
	Correct	Incorrect	correct	in correct
Correct	9	33	10	34
Incorrect	0	6	0	4
Total	9	39	10	38

Results of the Source Problems

Chi-square test was used to assess the difference between the numbers of participants who solved both Elephant and Salt source problems in the three levels of similarities irrespective of conditions. For the source problems, if a participant got both the Elephant and Salt problems correct, they were assigned to a “correct” group. If a participant did not have correct responses for both the Elephant and Salt problems, she was assigned to an “incorrect” group. No significant difference was found $\chi^2 (2, N = 48) = 5.74, p = .057$ in the procedural, strategy, and principle levels, where the solvers were (16) 100%, (12) 75%, and (11) 69%, respectively. In the think-aloud conditions of SE and VB, regardless of levels of similarity, the solvers were (21) 88% and (18)75% respectively which was also found no significant $\chi^2 (1, N = 48) = .123, p = .267$. The high percentage of solvers (Table 4.2) in all levels of similarity and conditions indicates that the source problem was understood by most of the participants.

Table 4 2

Number of Participants who Solved both Source Problems according to Levels and Conditions

	Think-aloud conditions	
	VB	SE
Levels of similarity		
Principle	6(75%)	5(62%)
Strategy	4(50%)	8 (100%)
Procedure	8(100%)	8 (100%)

Results of the Target Problems

Analysis was undertaken here in terms of solvers who came up with a complete and successful solution according to Measure 1 mentioned in the scoring scheme (a correct and complete solution scored 1 and incorrect or incomplete scored 0). These were solvers who solved the source problem correctly as well. A significant difference $\chi^2 (1, N = 32) = 6.79, p = 0.009$ was found between solvers who were 18.2%, and 81.8 % in strategy and procedural levels respectively (Table 4.3). Table 4.4 shows the solvers who generated a successful complete solution for the target problems, according to both the levels and conditions where 25% of the complete solvers are in the SE condition of the strategy level, while 62.5% are in the procedural level of the same condition. On the other hand, in the VB condition, there are 50% in the procedural level and none in the strategy level.

A second measure of performance on the target problem was on the basis of the Strength of Transfer (ST) where a complete and correct answer (score = 3), high partial solution (score = 2), low partial solutions (score = 1), and a wrong or no solution (score = 0). Percentages of participants who solved the source problem successfully and scored 2 & 3 on ST are shown in Table 4.4 according to the levels and conditions. It can be seen that, generally, there are more solvers

in all three levels of the SE condition compared to the VB. However, both conditions showed an equal effect in the procedural level, which generated 87% solvers (Table 4.5).

Table 4.3

Solvers of both the Source and Target Problems according to Levels of Similarity.

	non solvers	Solvers	
Levels of similarity	n = 16	n =16	Chi square
Strategy	14 (67%)	2 (18%)	
Procedure	7(33%)	9(82%)	$\chi^2 (1, N = 32) = 6.79, p = 0.009$

Note: There were no complete solution solvers in the principle level

Table 4.4

Number of Solvers in the Target Problem according to Levels and Conditions

Levels of similarity	The Conditions				N
	VB (n = 24)		SE (n = 24)		
	score 0	score 1	score 0	score 1	
Principle	8 (100%)	0 (0%)	8 (100%)	0 (0%)	16
Strategy	8 (100%)	0 (0%)	6 (75%)	2 (25%)	16
Procedure	4 (50%)	4 (50%)	3 (37.5%)	5 (62.5%)	16

Table 4.5

Number of Participants who solved both the Target Problems according to Levels and Conditions

Levels of similarity	Conditions	
	VB	SE
	Solvers	Solvers
Principle	2 (25%)	1 (12.5%)
Strategy	2 (25%)	4 (50%)
Procedure	7 (87%)	7 (87%)

Solvers: score 2&3

Comparing Mean performance:

The Mean performance on the target problem (based on the ST effectiveness scale of 0 to 3) in the condition of SE was found to be higher than VB $M = 3.38$, $SD = 1.66$ & $M = 2.54$, $SD = 1.77$ respectively. With regard to the levels of similarity, the Mean performance score for the target problem was found to be higher in the procedural level ($M = 4.44$, $SD = 1.37$) as compared to the strategy and principle (Table 4.6).

Table 4.6

Descriptive Statistics of Performance on Target Problem according to Protocol Conditions and Levels of Similarity

The level of similarity	Think aloud Conditions	Mean	SD	N
Principle	VB	1.5	1.414	8
	SE	2.13	0.835	8
	Total	1.81	1.167	16
Strategy	VB	1.88	1.246	8
	SE	3.38	1.598	8
	Total	2.63	1.586	16
Procedure	VB	4.25	1.282	8
	SE	4.63	1.506	8
	Total	4.44	1.365	16
Total	VB	2.54	1.769	24
	SE	3.38	1.663	24
	Total	2.96	1.75	48

Experiment 1 hypothesized that the procedural level of similarity and the condition of SE would have a significant effect on transfer performance. A 2 (Verbal protocol) x 3 (levels of similarity) ANOVA was conducted on the total performance in the two target problems. Significant main effects were found for levels of similarity $F(2, 42) = 16.182$, $p < .001$, $MSE = .334$ and for the protocol conditions where $F(1, 42) = 4.667$, $p = 0.037$, $MSE = 0.273$, thereby confirming both the hypotheses stated for this experiment. However, no interaction effects of

condition and levels was found, $F(2, 42) = .782$ $p = .464$, $MSE = .472$. Follow up comparisons, using the Dennett's significant difference test, showed that participants in the procedural level ($M = 4.44$, $SD = 1.37$) scored significantly higher than in other levels of similarity. In the SE conditions (Table 4.6) the Mean performance ($M = 3.38$, $SD = 1.66$) was higher than VB condition ($M = 2.54$, $SD = 1.77$). This phenomenon is also illustrated in Figure 4.1.

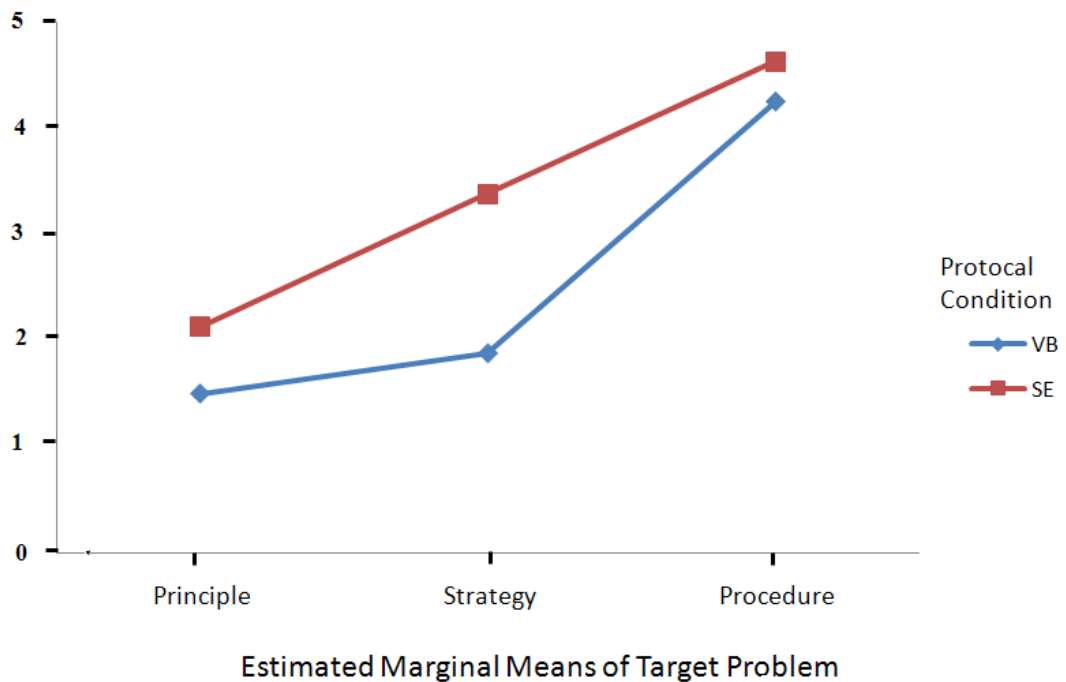

Figure 4.1: Estimated marginal means of both target problems according to levels and conditions. This figure shows the effect of procedural level of similarity in both VB and SE conditions. There is also a strong effect of SE on the strategy level of similarity.

The Coding of Verbal Protocols

The methodology of constructing the coding scheme is more of a challenging task in the pictorial representation (PR) compared to the verbal representation (VR). This is mainly due to the fact that in the VR there is a great deal of consistency in understanding the problems among the participants whereas in the PR, each person tends to have his/her own interpretation of the

problem. This is perhaps why many reliable coding schemes have been developed and used in VR over the last two decades (e.g. Chi et al. (1989); Renkl (1997); Ainsworth and Loizou (2003)). One of the main aims of Experiment 1 was to develop a systematic coding methodology for PR.

Six (6) participants were piloted with the objective of gathering information about the type of protocols generated during analogical problem-solving. The participants were randomly assigned to the think aloud conditions of SE or VB and to strategy or procedural levels of similarity. Each participant solved two analogous problems Elephant and Salt. A graduate student transcribed the protocols from the audio tapes literally without any restructuring or interpretation.

The coding process involved two stages: segmentation and categorization. Segmentation is dividing the verbal protocols into units each consisting of a single idea (e.g. This is a glass, and this is a large container, this is a tap of water, dripping water) while categorization is the process of determining the type of cognitive processes or sub-process generated (e.g. Explanation, Inference). This two-stage approach is described below.

Segmentation

Two coders, Assistant Professors from the Department of Psychology at King Abdul Aziz University, and the researcher segmented the verbal protocols in order to build a coding scheme and also to assess the reliability of segmentation. The process of segmentation was introduced with an example from Chi et al., (1989) to orient the coders about the method of segmentation. Then the coders were provided with the transcribed raw protocols of the 6 participants as well as their audio tapes. Each coder independently segmented the protocols

and was blind to participant information to reduce bias. To illustrate the procedure of segmentation and its reliability, an example of a participant's protocols, from the source problem of The Salt Target Problem, is given below.

Segmentation by Coder A

This blue thing/ is a tap of water /O.K / Ah / This is an empty glass/ Ah / and then/ This is a small cup of water / and then / We pour water / from the tap /into the small glass/. Then / I should take this / the small glass / of water /empty it /in to the large glass/ It contains a quarter / Because this glass/ is small / and that glass is big / it takes less space/ O.K / then/ We should repeat it / by filling the small glass of water / and emptying it/ in to large glass / It took more space / despite the fact that / the second glass /is not as full / as the one /in the first picture/ O.K / so let us see the next one/ No water has fallen on the ground / In the first example / it took less space / despite the fact that / water is being more/ In the second example / despite the fact that / there being less water /which took more space/ Hmm/ there is a relationship / O.K / In the last picture / we fill the large glass / and there remains little water / in the small glass.

(Total segments = 52).

Segmentation by Coder B

This blue thing/ is a tap/ of water /O.K / Ah / This is an empty glass/ Ah / and / then/ This is a small cup/ of water / and / then / We pour water / from the tap /In to the small glass/ Then / I should take this / the small glass / of water /empty it /in to the large glass/ It contains a quarter / Because this glass is small / and that glass is big / it takes less space/ O.K / then/ We should repeat it / by filling the small glass/ of water / and emptying it/ into large glass / It took more space / despite the fact that / the second glass /is not as full / as the one /in the first picture/ O.K / so let us see the next one/ No water has fallen/ on the ground / In the first example / it took less space / despite the fact that / water is being more/ In the second example / despite the fact that / there being less water /which took more space/ Hmm/ there is a relationship / O.K / In the last picture / we fill the large glass / and there remains little water / in the small glass.

(Total segments = 57).

Segmentation by the researcher

This blue thing/ is a tap of water /O.K / Ah / This is an empty glass/ Ah / and / then/ This is a small cup/ of water / and / then / We pour water / from the tap /In to the small glass/. Then / I should take this / the small glass of water /empty it /into the large glass/ It contains a quarter / Because this glass is small / and that glass is big / it takes less space/ O.K / then/ We should repeat it / by filling the small glass/ of water / and emptying it/ in to large glass / It took more space / despite the fact that / the second glass /is not as full / as the one in the first picture/ O.K / so let us see the next one/ No water has fallen/ on the ground / In the first example / it took less space / despite the fact that / water is being

more/ In the second example / despite the fact that / there being less water /which took more space/ Hmm/ there is a relationship / O.K / In the last picture / we fill the large glass / and there remains little water / in the small glass.

(Total segments = 54).

The agreement between coders, inter-coder reliability, should be at least 85% to be considered valid. The inter-coder reliability is the percentage of the total number of segment indicators on which two coders agreed, divided by the total number of segment indicators (Green & Gilhooly, 1996). For example, comparing Coders A and B in the segmentation below where the red slash indicates the difference in segmentation between the coders:

Differences in Segmentations of Coder A & B

This blue thing/ is a tap / of water /O.K / Ah / This is an empty glass/ Ah / and / then/ this is a small cup / of water / and / then / We pour water / from the tap /in to the small glass. Then / I should take this / the small glass / of water /empty it /into the large glass/ It contains a quarter / Because this glass / is small / and that glass is big / it takes less space/ O.K / then/ We should repeat it / by filling the small glass / of water / and emptying it/ in to large glass / It took more space / despite the fact that / the second glass /is not as full / as the one /in the first picture/ O.K / so let us see the next one/ No water has fallen / on the ground / In the first example / it took less space / despite the fact that / water is being more/ In the second example / despite the fact that / there being less water /which took more space/ Hmm/ there is a relationship / O.K / In the last picture / we fill the large glass / and there remains little water / in the small glass.

% agreement = (Total #of segment indicators agreeing/Total # segment indicators) x 100

Total segments = 52 (coder A) + 57 (coder B) = 109

- Total difference in segmentation (red slashes) = 109 – 7 = 102
- % agreement = (102/109) X 100 = 94%.

Thus, the 94% agreement between the two coders and at least 92% between each coder and the researcher indicates a high degree of inter-coder agreement. In addition, the inter-coder agreement on the segmentation for the

other five verbal protocols was also fairly high (more than 90%) between any two coders.

Categorization of the Protocols

The categorization process was developed based on the task analysis and analogical problem solving theories such as: Componential Sub-theory (Sternberg, 1987, 2000), Structure-Mapping theory (Gentner, 1983), Pragmatic and Multi-constraint theories (Gick & Holyoak, 1980, 1983), and the models of Chi et al. (1989) and Renkl (1997). The objective was to determine the type of cognitive processes and sub-processes involved in analogical problem-solving. The researcher analyzed the protocols, and initially Model 1 (Appendix B, Figure B.1) was constructed to depict the categories of cognitive processes, which may be classified as follows: Selectivity, Inference, Mapping, Goal Directness, Mathematical Strategy, Justification, Meta-strategy, Monitoring, Paraphrases, Obstacles and other expressions. Model 1 was evaluated by the two independent coders and modified accordingly. Meetings and discussions took place several times resulting in a final version of The Cognitive Processes Model (CPM). The details regarding the development stages of the model are described in Appendix B.

The CPM (Figure 4.2) consists of three top-level content categories: Explanation, Inference, and Analogizing. While the solution of the source problems only required the cognitive processes of Explanation and Inference, the target problem involved all the three content categories. Broadly, Explanation and Inference are regarded as the main processes involved in understanding the problem. Analogizing is the important process of deriving the analogy between the source and target problems (transfer) for achieving the right solution. Other

processes, such as Monitoring and Obstacles, involved in both the source and target problems are also included.

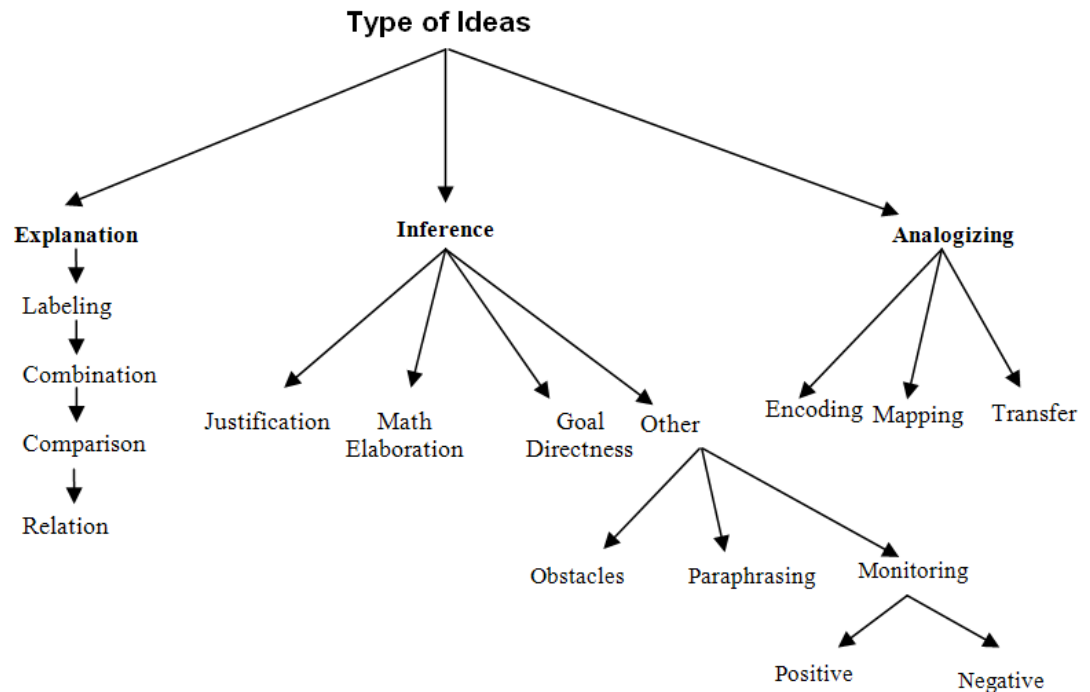

Figure 4.2: The Cognitive Processes Model (CPM).

Some examples of identifying the three content categories considered to be involved in problem solving by analogical reasoning are described below:

Explanation is the initial process involved in understanding the problem. In a pictorial representation, the process of explanation plays an important role in gathering superficial information about the attributes of the various objects depicted. According to Chi et al. (1989) and Neuman & Schwarz (1998) any self-explanatory act that may support the solution of the problem, specifically by constructing new knowledge. In the problems used in this study, the process of explanation involves understanding each element and its role for deriving a coherent meaning of the sequence of pictures, which to a great extent determines the effectiveness of problem solving.

The process of explanation involves four sub-processes: Labeling, Combining, Comparing, and Relation. The number of responses in the form of any of these sub-processes indicates the degree to which a participant has engaged in the process of explanation. These sub-processes share a hierarchical relationship where the sub-process of relations is the highest and labeling is the lowest. For example, if a participant indicates the use of comparing, then it is assumed that the lower two (combination and labeling) have been already taken place, perhaps internally. For example, if the participant said that this object is larger than these two small ones, this means that three sub-processes were accomplished; labeling each object, combining the two small ones, and comparing them with the large object.

Labeling describes the act of defining the elements and objects in each picture. The participant names the objects and understands the words as well as the symbols in the problem. They interpret correctly the objects in the source or target problem. This is similar to the categorical explanation described by Neuman & Schwarz (1998) as the act of labeling. It may be mentioned here that a participant may give all or some of the responses. A response that is qualitatively different from another is counted. For example a participant, while interpreting the source jug problem (Figure 4.3), may say it is a rectangle or a metal box and then settle down to saying that it is a jug. Here the response will be counted as 3 ideas in the sub-process of labeling. As there is no fixed maximum score to indicate a quantitative difference in responses (indicating a sub- process) among participants, only frequencies accrued in each content category were computed. This strategy was applied to all categories of cognitive processes discussed in this section. The type and number of correct responses identified in the sub-process of

labeling for the source of the Salt problem in the strategy and procedural level of similarity are given as examples in Figures 4.3 & 4.4.

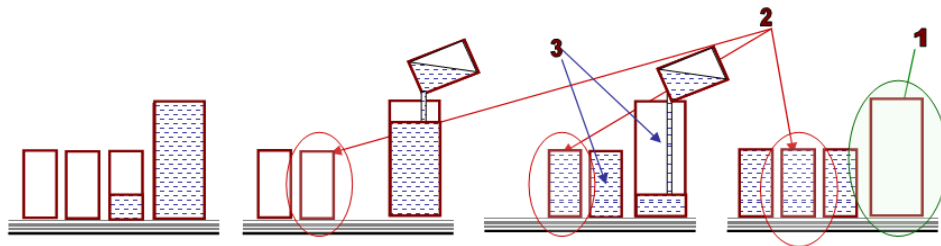

Figure 4.3: Sub-process of Labeling in the Strategy level

1. The large objects are identified as a jug, a large cup, a glass, a metal box, a container, a measurement, a bottle, a rectangle, a box of oil or anything that indicates capacity.
2. The small objects are identified as a jug, a small cup, a glass, a metal box, a container, a measurement, a bottle, a small rectangle or anything that indicates capacity.
3. Water, oil, liquid

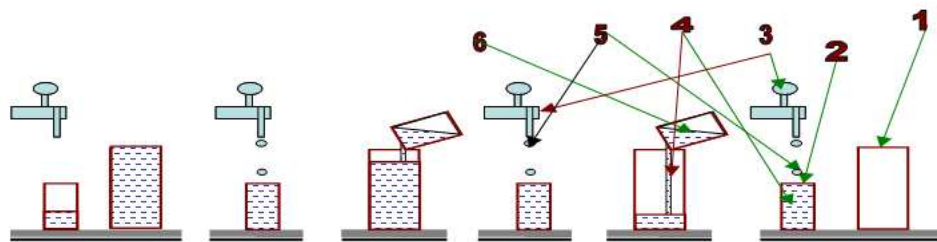

Figure 4.4: Sub-process of Labeling in the procedural level

1. The large object is identified as a Jug, Large cup, Glass, metal box, container, measurement, bottle, rectangle, box of oil, or anything that indicates capacity.
2. The small object is identified as a Jug, small cup, Glass, metal box, container, measurement, bottle, small rectangle, or anything that indicates capacity.
3. Source of water/liquid, tap.
4. Water, liquid, sand or flour
5. Dripping water, oil, or liquid

Combination is close to what has been termed as deductive explanations by (Neuman & Schwarz, 1998), which involves the understanding of new propositions out of existing ones by combining two or more objects. The participant combines the objects within each picture to achieve an integrative

solution. The type and number of correct responses in the source of the Salt problem at the strategy and procedural levels are shown in Figures 4.5 & 4.6.

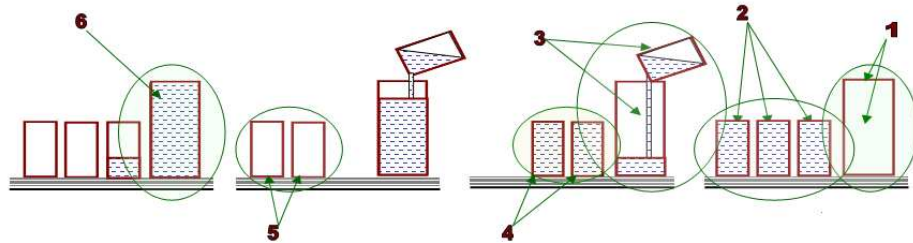

Figure 4.5: Sub-process of Combination in the strategy level.

1. An empty jug
2. Three glasses are full of water.
3. Glass of water is being emptied in the jug.
4. Two small glasses full of water.
5. Two small glasses are empty.
6. Large jug is full of water.

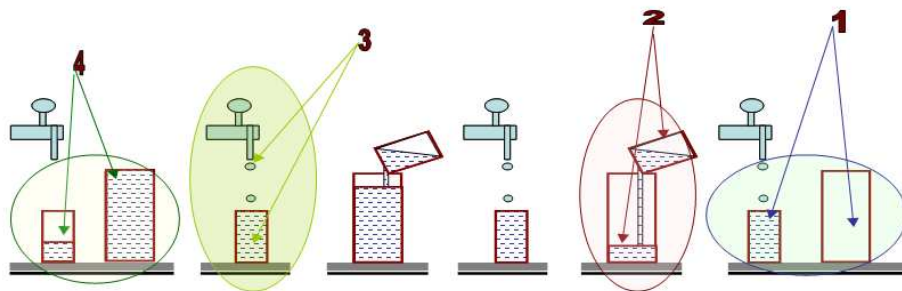

Figure 4.6: Sub-process of Combination in the procedural level.

1. Empty jug and full glasses of water.
2. A full glass of water is being emptied into the large jug.
3. Glass of water is being filled from the tap.
4. Large jug full of water and one third of water is remaining in the glass

Comparison is when two or more objects in different pictures are compared. This sub-process involves comparing the movement or the placement of the objects in two or more pictures. An example of comparison, in the source problem of the Elephant at the procedural level of similarity, is shown in the movement of the object from picture A to D in Figure 4.7 while Figure 4.8 is an example of the source for the salt problem in the strategy level.

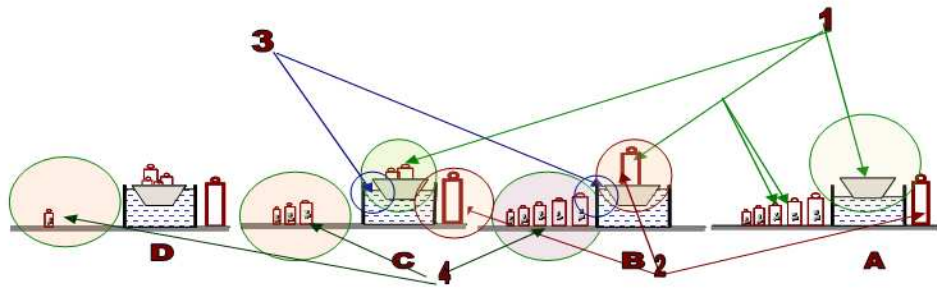

Figure 4.7: Sub-process of Comparison in procedural level of similarity.

1. The tray is empty (picture A), the large object is placed on the tray (picture B) and two small objects are placed in the tray (picture C).
2. The large object is transferred from the floor (picture A) to tray in (picture B) and finally back to the floor (picture C).
3. The water level is up (picture B). The water level is down (picture C).
4. Five small objects in (Pictures A and B) and three in (picture C) as well as one in (picture D), are on the floor.

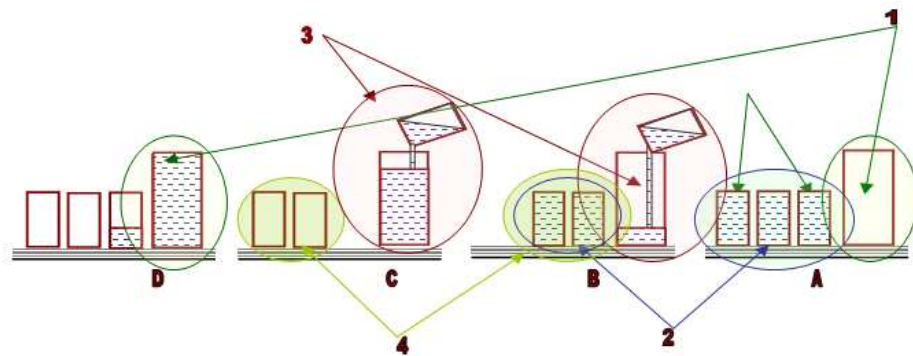

Figure 4.8: Sub-process of Comparison in strategy level of similarity.

1. The large jug is empty (picture A), the large jug is full (picture D).
2. There are three glasses full of water in picture A and two glasses full (picture B).
3. The large container is one fourth full (picture B). The large container is three fourths full (picture C).
4. There are two full glasses (picture B) and there are two empty glasses in (picture C).

It was observed from the protocols that the sub-process of comparing is invariably included labeling and combining activities. This is because the participant qualitatively goes a step further by also interpreting the superficial relation between objects after merely naming them based on their superficial features. Thus, a participant may exhibit only the sub-process of comparing,

thereby also indicating the presence of the labeling and combination processes.

To illustrate this, an example is given below.

- This is one cup (labeling)
- Full of water (combination)
- Another cup is empty (comparison)

Relation is a process of explaining that involves discovering the basic principle underlying the sequence of processes depicted in the pictures. This process is similar to Neuman and Schwarz's (1998) definition of explanation as an activity of discovering new variables. Here, the responses of the participants show a deeper analysis of the objects as well as discovering the process or strategy related with them, such as measuring out a specific amount of water. In exhibiting the sub-process of relation, a participant gives a right and complete interpretation of all the pictures. As this is a higher order process of explanation, as compared to labeling, combining, and comparing, thus when a participant exhibits this sub-process, the other sub-processes are assumed to be inherent. Responses that indicate the full understanding of the entire process in the source Elephant problem at the procedural level are depicted in the pictures from A to D (Figure 4.9).

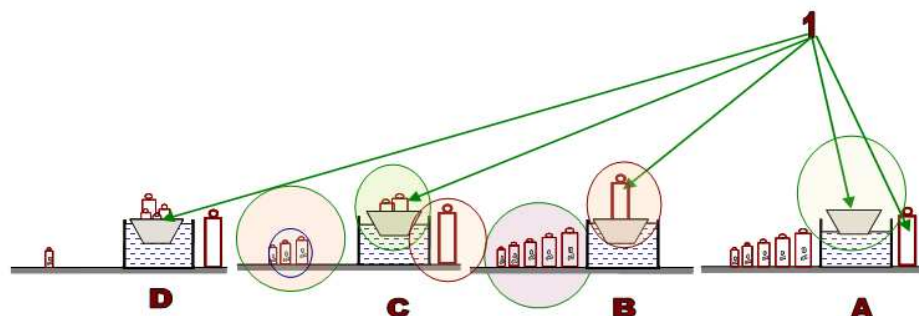

Figure 4.9: Sub-process of Relation in the procedural level.

1. When the large object is placed in the vessel, the level of water goes up (picture B).
2. Placing two small objects does not get the level of water to the same point as of the big object (picture C).
3. Placing four small objects brings the water level to the same point as of the big object (picture D).

The response of a full understanding of the entire process, for the source problem of the Salt problem at the strategy level of representation, is depicted in the pictures from A to D shown in Figure 4.10.

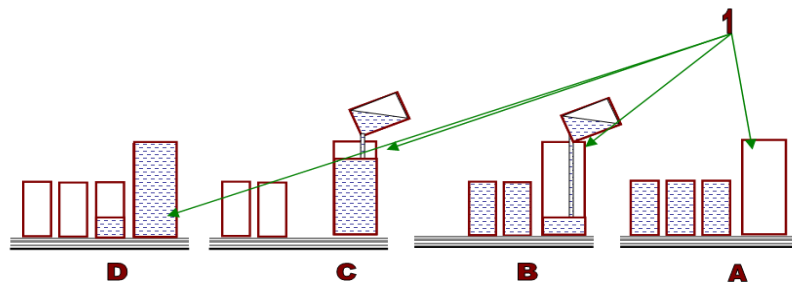

Figure 4.10: Sub-process of Relation in the strategy level.

The pictures above show how to use the small and the large containers to measure out a required amount of water/liquid, by emptying the small containers of water to fill the large container. Some water (the required amount) remains in the small container when the large one is full.

Inference is a relatively deeper analysis of the problem compared to explanation. It involves the sub-processes of mathematical elaboration, justification, and goal directness. These sub-processes, which may take place in any order, are evidence of the quality of inference drawn from the elements represented in the source and target problems. While interpreting a problem, a participant may apply the cognitive process of explanation and its sub-processes with or without a deeper understanding or inference. It also indicates why a participant is doing what he/she is doing. These sub-processes have been referred to by Chi, et al. (1989) as monitoring statements and as 'others' in kinds of ideas generated.

Mathematical Elaboration in this study is similar to mathematical elaboration in (Chi, et al., 1989; Renkl, 1997). This process indicates whether the participant is able to use and compare mathematical relationships or notice underlying principles when he/she uses or understands relations between quantity of substances and sizes of objects. The participant shows understanding of some basic mathematical knowledge. For example, in the Salt problem, a mathematical principle is considered to be correctly applied when a participant states that three times a 4g spoon equals 12, and or the large container is empty so it will take more than one glass. Here the responses of the participant show understanding of some basic mathematical knowledge in two ways as exemplified below:

1. The elephant is equal to the total weight of small objects, such as stones or animals.
2. The sum of the weight of the stones gives the same water level as that of the elephant.

Goal Directness is similar to some extent to impose a goal from the model of Chi et al. (1989). The participant is considered to have imposed a goal or purpose for an action if he/she indicates a clear goal in the source or the target problems, which affects the gathering of information.

Examples:

1. I have to get 1g of salt without guessing.
2. I have to get the weight of the elephant.

Justification is the stage, where the participant provides reasons for choosing from various options that help solve the problem. Justification occurs when the participant gives the right reason for an action taken as in Figure 4.9.

Examples:

1. The level of water is high because the tray is empty. (Figure 4.9 a)
2. The water level goes up when the large object is placed in the vessel. (Figure 4.9 b)

Analogizing is a term introduced by the researcher to describe the process that takes place when a participant sees and derives the analogy between the source and target problems in all experiments of this study. This process, which is involved only in the target problem, consists of three essential processes: Selective Encoding, Mapping, and Transfer.

Selective Encoding: In analogical problem solving, selective encoding is a mechanism that determines the information selected for retrieval. This selection of the information relates to the superficial attributes of objects. An example of selective encoding in the Elephant problem, is when a participant chooses the object attribute in terms of size from the source, then relates it to the size of the elephant in the target problem (that is, the big object and the small objects in the source with the elephant and rocks or small animals in the target), and/or when a participant associates the vessel with the boat (the vessel holds large objects as does the boat in the source).

In the Salt problem, examples of selective encoding are when a participant selects and retrieves the attribute of capacity, depicted in the source by the large jug and small glasses, and compares them to the two spoons (large and small) in the target problem, and/or when the water tap is compared to the salt dispenser as a source of salt.

Mapping is a process that usually either immediately follows or accompanies selective encoding. A participant identifies the corresponding components in the source and target problems (selective encoding) and carries them over to the conceptual structure of the target problem. In the process of

mapping, the encoded information and the superficial similarity of objects in both source and target problems are integrated with the process that is depicted and associated with them. This identifies the structural or higher-order relations, where the objects chosen take the form of key tools or connections that are required for applying the procedure. Thus, the mapping process is a process of integrating the information of object attributes, according to the function they serve while simultaneously being aware of the limitations or the obstacles in making certain choices.

Transfer is the process in which the participant applies what he/she has learned from the source to the target problem to get a correct or partially correct solution. The strength of transfer depends upon the type of solution the participants generate. Four types of transfers have been identified and are categorized as follows: Complete successful transfer, High partial transfer, Low partial transfer, Wrong or no transfer as it was discussed earlier.

Other processes is a category applied to both source and target problems. This category consists of monitoring statements, paraphrasing or other processes that may contribute to the qualitative analysis of the protocols.

Monitoring is based on Renkl's model (1997) where monitoring statements are considered either positive or negative, reflecting the participant's perception of his/her ability to solve the problem. Positive monitoring is a positive perception, such as "Oh, it is very simple." Negative monitoring is negative perception, such as when a participant says, "I don't know what I should do here."

Paraphrasing is based on the model of Chi et al. (1989), in which a participant either restates what has been said or verbalizes what is shown

pictorially. Verbal paraphrasing is when the participant says or writes words after seeing or reading the material while pictorial paraphrasing occurs when participants use lines or arrows while verbalizing.

Obstacles relate to perceived constraints in problem solving. For example, if the participant says that he/she does not have the resources to solve the problem or fails to understand any aspect of the problem.

All the processes and their sub-processes mentioned above apply to the analysis of protocols generated for both the source and target problems, except the processes of analogizing which is applied only to target problems.

Inter coder reliability for Categorization

After segmentation of the verbal protocols for the Elephant and Salt problems solved by six participants the process of assigning cognitive categories to each segment was undertaken by two coders and the researcher in the following way; First, the coders were provided with the protocols that they segmented earlier, the code definitions of the CPM and a coding sheet (Table 4.7). Second, coding was blind to condition and participant information. Each coder used coding sheets and independently coded the segmented protocols of all the six participants according to the provided coding scheme. Third, the researcher assigned numbers to each cognitive sub-process in order to determine similarities and differences in assigning coding categories. Finally, a table was built that depicted the degree of correspondence, in the coding of the researcher and any one of the two coders, on the segments of one problem.

Cohen's Kappa method was applied to compute the degree of agreement between a coder and the researcher. Table 4.8 shows that the maximum Kappa inter-coder reliability between coder A and the researcher was 0.892 (number of

segments = 49 for the source and target salt in the procedural level of similarity), p value > 0.0001 for participant # 6. The least inter coder reliability was 0.717 (number of segments = 102 for the strategy level of similarity in the source and target Salt problem), p value > 0.0001 for participant # 2. On the other hand, for the Elephant problem Kappa's inter-coder reliability between coder B and the researcher was 0.868 (number of segments = 77 for the source and target in the procedural level of similarity), p value > 0.0001 for participant 1. The least inter coder reliability was 0.734 (number of segments = 114 for the strategy level of similarity in the source and target Elephant problem), p value > 0.0001 for participant 3. In general, Kappa according to Van Someren, Barnard & Sandberg (1994) must be above 0.70 in order to have acceptable inter-coder reliability, while Coolican (2004) considered a value of Kappa > 0.6 as satisfactory. Therefore, these results indicate a good agreement between two coders. However, there was some disagreement between the coders and the researcher in coding of protocols which was successful resolved through discussions. For example, there were some protocols where the coders disagreed in categorizing between combination and comparison or between comparing and mathematical elaboration. One coder considered combination and comparison to be essentially the same. However, all coders agreed upon combination referring to combining objects within the same frame while comparison referred to objects in different pictures even if they were the same objects. Kappa's correlation, between coder A and the researcher, on the cognitive process of Explanation was found to be 0.89 and more than 0.85 on the rest of the categories. This indicates high inter-coder reliability on the coding scheme.

Reliability of Coding in the main experiment

For the main experiment, the researcher and one of the coders coded the verbal protocols. The researcher coded the entire data set (48) out of which 12 were randomly assigned (25%) to a coder for reliability. On the 10/12 individuals who were independently coded, Kappa's correlation was at least 0.8 for each individual, p value < 0.0001 , indicating strong agreement between the coders.

Table 4.7

Kappa Inter-Coder reliability for all Participants between coder A and the researcher on the salt problem

p #	Level of similarity	Coder & Researcher	No. of Segmentation.	P Value	% agreements
1	Strategy	0.753	55	> 0.0001	0.80
2	Strategy	0.717	102	> 0.0001	0.75
3	Strategy	0.883	62	> 0.0001	0.90
4	procedure	0.779	57	> 0.0001	0.81
5	procedure	0.781	39	> 0.0001	0.82
6	procedure	0.892	49	> 0.0001	0.92

Table 4.8

The coding sheet

level of similarity			The coding Sheet			protocol#		
Principle	Strategy	Procedure				Verb	self	
score b1	score b2	score b				score t1	score t2	score t
			participant age					
			Time:					
<i>Elephant</i>	<i>Salt</i>					<i>Elephant</i>	<i>salt</i>	
source1	source2	Total	Total score			targt1	target2	total
			num of line					
			num of words					
			1 lab	1 labeling				
			2 cb-ob	2 combine two objects or more in one pic.				
			3 cb-pic	3 compare two pictures				
			4 m	4 Relation				
			5 jus	5.. Justification:				
			6. math	6. Mathematical elaboration				
			7 gl	7. Goal directness				
			8. enc	8. Encoding				
			9. mp	9. Mapping				
			10 tr	10. Transfer				
			11 obst..	11. Obstacles/constraints				
			others					

Verbal protocols Analysis

In the analysis of the verbal protocols the principle level of similarity was not included because the information provided in this level only conveyed an idea or principle in a single picture frame, whereas a series of pictures depicted a process in the strategy and procedural levels, giving more information that could be verbalized. Thus, as the principle level generated very little protocol which was not comparable with the other two levels it was excluded

As mentioned in the results section, protocols of both the Elephant and Salt problems have been combined for assessing the cognitive processes revealed.

Results of Time and Amount of Protocol Generated

The analysis undertaken here relates to the question of whether there is a difference in time spent and protocols generated according to levels of similarity and protocol conditions. The audio recording of each participant also indicated the time she took for each problem. An overall average of 720 seconds (SD = 124) was taken by participants to solve the two problems Elephant and Salt where the average time was 215 and 470 seconds for the source and target problems respectively.

With regard to time and lines vs. levels and conditions in the Source and Target problem, the source problem participants spent an average of 165s and 265s (SD= 52 and SD = 69) in the strategy and procedure levels respectively. It was found that significantly more time was spent in the procedural than strategy levels of similarity $F(1, 30) = 21.51, p < 0.001$. In the conditions of VB and SE where the Mean time taken was 201 sec. SD = 66 and 229 SD = 90 respectively, the difference was found not significant $F(1, 30) = .97, p = .33$.

In the target problem, participants spent an average of 429 sec. SD = 136 and 512 sec. SD = 126 in the strategy and procedure levels respectively where the difference again was found not significant $F(1, 30) = 1.36, p = .25$). In the conditions of SE and VB the Mean time taken was 442 sec. SD = 108 and 498 sec. SD = 157 respectively. These differences in time between conditions were also not significant $F(1, 30) = 3.23, p = 0.08$). Significant differences were found in the time spent by the solvers in the procedural level of similarity $F(1, 9) = 9.51, p = .014$ and $F(1, 9) = 6.83, p = .028$ in the source and target problems respectively. On the other hand, no significant differences between the conditions were found in time spent.

Comparing the solvers and non-solvers in terms of Mean time spent and number of lines generated (Table 4.9), a significant difference was found where the time spent in the source problem by solvers was more ($M = 255, SD=86$) than non-solvers ($M = 194, SD = 68$) with $F(1, 30) = 4.79, p = 0.04$). The solvers and non-solvers also differed significantly in the number of lines generated in the target problem where the solvers generated more lines ($M = 90, SD = 33$) than non-solvers ($M = 62, SD = 30$) with $F(1, 30) = 6.38, p = 0.02$).

Table 4.9

The Mean and SD of the Time Spent and Number of Lines Generated by Solvers and Non-solvers in both Source and Target Problems

The levels of similarity	Time in seconds				Num of line			
	Source		Target		Source		Target	
	Mean	SD	Mean	SD	Mean	SD	Mean	SD
Non-solvers	194.19	68.44	460.14	139.43	55.95	21.53	61.52	29.53
Solvers	255	85.65	489.45	132.82	50.91	24.48	90.27	32.56

Analysis of the Cognitive Processes

This section relates to the question of what cognitive processes are elicited in different levels of similarity and protocol conditions.

Cognitive processes that were found crucial for transfer are illustrated in Model CPM (Figure 4.2). These cognitive processes were assessed in terms of the number of times they occurred (frequencies) during the problem-solving processes. Repetitive sentences indicating the same process were not included. Data for all the cognitive and their sub-processes were tested for homogeneity, using the Levine's test. All the cognitive processes and sub-processes were found homogeneous, except the sub - processes of relations and justification for the source problem and the sub-processes of combination for the target problem.

The average number of frequencies revealed in the source problems, Elephant and Salt problems, is reported here. The main processes involved in the source problem are explanation and inference. In the process of explanation, the number of participants who indicated this cognitive activity were 17 and 15, and in the process of inference 4 and 3 in the strategy and procedure levels respectively (Table 4.10). These differences were found not significant $F(1, 30) = 1.28, p = 0.267$, and $F(1, 30) = 1.05, p = .313$ for explanation and inference respectively. However, a significant difference was found between the levels of similarity in the source problem in the sub-process of labeling (category of Explanation). Participants produced more labeling in the strategy level than in the procedure level $F(1, 30) = 6.4, p = 0.017$.

No significant differences were found between the two conditions of VB and SE in the number of explanations and Inference generated in the source problems.

Table 4.10

The Mean and SD of the Frequencies of Explanation and Inference Processes in both Source Problems

The levels of similarity	frequency of Explanation				frequency of inference			
	VB		SE		VB		SE	
	Mean	SD	Mean	SD	Mean	SD	Mean	SD
Strategy	16.6	6.78	17.13	4.36	3.5	2.2	2.25	3.15
Procedure	15	3.7	14.88	4.67	3.88	1.7	3.62	2.5

The target problem involved the cognitive process of analogizing in addition to explanation and inference. The average number of explanation, inference, and analogizing generated in the strategy and procedural levels according to conditions is shown in Table 4.11. A significant difference was found in the cognitive process of inference $F(1, 30) = 9.9, p = 0.004$, and analogizing $F(1, 30) = 14.42, p = 0.001$. Within the process of inference, a significant difference was found in its sub processes of justification $F(1, 30) = 4.5, p = 0.04$, and mathematical elaboration $F(1, 30) = 10.9, p < 0.0001$. Here, it was seen that these sub-processes in the target problem showed more effect in the procedural level of similarity, compared to those in the strategy level of similarity. A significant difference was also found in the analogizing sub processes of mapping $F(1, 30) = 13.36, p < 0.0001$. Table 4.12 shows the descriptive statistics of these sub processes.

Table 4.11

The Mean and SD of the Frequencies in the Main Processes of Explanation, Inferences, and Analogizing in the Target Problem

Cognitive Processes			The levels of similarity	
			Strategy	Procedure
Explanation	Verb	Mean	12.13	13.13
		SD	8.6	5.87
	SE	Mean	14.25	14.63
		SD	7.05	4.53
Inference	Verb	Mean	5.13	11
		SD	3.48	3.55
	SE	Mean	8.13	10.88
		SD	4.45	3.83
Analogizing	Verb	Mean	2	4.62
		SD	1.2	1.92
	SE	Mean	3.5	5.88
		SD	1.6	2.23

Table 4.12

The Mean and SD of the Frequencies in the Sub-processes of Inferences, and Analogizing in the Target Problem

The levels of similarity	Inference				Analogizing					
	Justification		Math elab.		Goal		Encoding		Mapping	
	Mean	SD	Mean	SD	Mean	SD	Mean	SD	Mean	SD
Strategy	1.94	1.29	2.13	2.13	2.56	1.6	1.56	0.63	1.44	1.03
Procedure	3.19	1.97	4.38	1.71	3.38	1.2	1.94	0.93	2.75	1.00

Factors Affecting Strength of Transfer

In the following section, the analysis of data was undertaken with the objective of understanding first, the association between the various cognitive processes and the strength of transfer; second, the extent to which the cognitive processes mentioned above account for the difference between solvers and non-solvers; and third, the effect of levels of similarity and the two protocol conditions on the cognitive processes generated.

Relationship between the Cognitive Processes and Strength of Transfer

This analysis related to the relationship between the cognitive processes and strength of transfer. In the target problem, the main cognitive sub-processes that showed a significant relationship with strength of transfer, was inference $\rho = 0.415$ and analogizing $\rho = 0.501$ (Table 4.13). With respect to the sub-processes of inference and analogizing the only sub-processes that showed a significant relationship were mathematical elaboration $\rho = 0.477$, and mapping from the process of analogizing $\rho = 0.493$ respectively (Tables 4.14 & 4.15).

Table 4.13

Correlations between the Main Cognitive Processes and the Strength of Transfer

	1	2	3	4
Strength of transfer	1.000			
Explanation	0.321	1.000		
Inference	0.415**	0.174	1.000	
Analogizing	0.501**	0.345*	0.724**	1.000

* correlation is significant at the 0.05 level

** correlation is significant at the 0.01 level

Table 4.14

Correlation between the Sub-processes of Inference and the Strength of Transfer

	1	2	3	4
Strength of transfer	1.000			
Justification	0.305	1.000		
Math	0.477**	0.517**	1.000	
Goal	0.171	0.327	.498**	1.000

* correlation is significant at the 0.05 level

** correlation is significant at the 0.01 level

Table 4.15

Correlation between the Sub-processes of Analogizing & Strength of Transfer

ST & Analogizing	1	2	3
Strength of transfer	1.000		
selective encoding	0.202	1.000	
Mapping	0.493**	0.438*	1.000

* correlation is significant at the 0.05 level

** correlation is significant at the 0.01 level

In order to answer the question regarding the differences in the cognitive processes between solvers and non-solvers, Mann-Whitney test was used. This is because the data of the cognitive processes, which indicate the number of times a sub-process has been applied, is nominal (frequencies) and the independent variables (levels and conditions) are dichotomous.

Examining solvers and non-solvers in the cognitive process of explanation revealed that, in the target problem, solvers differed significantly (Mdn = 22) from the non-solvers (Mdn = 14) in the sub-process of combination ($U = 55.5$, sig., $z = -2.1$) and relation, (Mdn = 26) and (Mdn = 13) with a $U = 16$, sig., $z = -4.3$, respectively.

In the category of Inference in the target problem, the solvers differed significantly (Mdn = 23) from the non-solvers (Mdn = 13) in the sub-process of justification ($U = 40.5$, sig., $z = -3.15$) and mathematical elaboration (solvers Mdn = 22) (non-solvers Mdn = 13) with a $U = 50.5$, sig., $z = -2.7$). The solvers also differed (Mdn = 21) from the non-solvers (Mdn = 14) in the sub-process of goal directness $U = 67.0$, sig., $z = -2.1$.

With regard to the cognitive process of analogizing in the target problem, it was found that the solvers differed (Mdn = 22) from non-solvers (Mdn = 14) in the sub-process of mapping only $U = 55$, sig., $z = -2.49$.

The data was also analyzed to assess the effect of strategy and procedural levels of similarity, on the cognitive sub-processes revealed, during the solution of the source and target problems. In the source problem, no significant difference was found in the degree of the sub-processes of explanation (labeling, combination, comparison and relations) revealed in the strategy and procedural levels.

In the target problem, all the sub-processes of explanation did not vary significantly as a result of the levels of similarity. With regard to the role of cognitive processes of Inference and analogizing according to strategy and procedural levels of similarity in the target problems, a significant difference was found between the levels in the sub-processes revealed. The procedural level (Mdn = 20) differed significantly from strategy level (Mdn = 13) in the sub-process of justification ($U = 68$, sig., $z = -2$) and mathematical elaboration (Mdn = 22 & 11 respectively) with $U = 47$, sig., $z = -3.1$. These results indicate that only the sub-processes of justification and mathematical elaboration from the category of Inference were influenced by the level of similarity shared between the source and target problems. The procedural level (Mdn = 22) also differed significantly from strategy (Mdn = 11) in the sub-process of mapping $U = 45$, sig., $z = -3.25$.

Lastly, data was also analyzed to assess the effect of think-aloud protocols, VB and SE, on the cognitive sub-processes where no significant differences were found in the sub-processes of explanation, Inference, and analogizing according to protocol conditions.

Types of Ideas Generated

The types of ideas generated were classified as explanation, inferences, and others. Explanation refers only to those ideas that say something about

labeling, combining, comparing, or relations. Inferences are ideas that indicate justification, mathematical elaboration, and goal directness. The following are some examples of the ideas generated by a participant, which are considered as explanations:

We will try to solve the problem with these things, glass jar without specific measure, maybe the salt container, but we don't know the quantity it possibly contains., the chef , and the piece of steak , a collection of ordinary containers , whose capacity we don't know, two spoons, the 11g spoon, and the 4g spoon

An idea is considered to be an inference statement if it refers to justification, mathematical elaboration, and/ or goal directness. For example, ideas generated by two participants considered as inference, are given below:

- -If we took the 11g and
- Fill it up with salt
- Then we have 11g of salt on side
- then we can take the 4g spoon.
- fill it up from the 11g.
- the remaining amount is 7.
- we fill for the second time.
- the 4g spoon
- the remaining amount is 3.
- How can we solve this problem?
- He needs 1g of salt.
- how can we solve it
- 1g of salt.
- it is still a problem.
- how we can get only 1g.
- let me go back to the first problem (source).
- he fills the small glass and empty it in the large.
- Fill the 4g spoon.
- Empty it in the 11g spoon.
- Refill it again.
- Now we have 8g in the 11g spoon.
- Fill it for the third time.
- In this step when we empty the 4g spoon.
- there is some remaining in the 4g spoon .
- The remaining is 1g.
- And this what we need.

The category of 'others' includes ideas that relate to paraphrasing, monitoring or eliminating the irrelevant objects. Example ideas, taken from different participants, that indicate monitoring in the source problem:

- *I'm going to look at the diagram.*
- *I'm going to reread the problem.*
- This is something to remember.
- I can benefit from this.
- I can think of another solution.

Here is an example of an idea that indicates the process of elimination in the target problem: "We cannot use apples or boxes to weigh the elephant."

In the analysis of protocols in the 'other' category, it was found that the solvers (56%) tended to indulge more in the process of eliminating irrelevant information in comparison to non-solvers (17%). Among the solvers, 22% repeated the ideas in comparison to 44% of the non-solvers. Positive monitoring was used more by the solvers (78%) than non-solvers (48%). They did not differ much on paraphrasing, for which solvers was 78% and non-solvers was 61%.

Discussion

Conceptual Analysis of Prediction

This research, which takes Chen's (2002) study on procedural similarity a step further, examined the effect of different levels of abstraction (Principle, Strategy, and Procedural similarity) shared between the source and target on the cognitive processes produced, which in turn affect strength of analogical transfer. Experiment 1 also investigated the effects of two verbal protocol conditions (SE and VB), on transfer performance. In addition, the verbal protocols helped understand the cognitive processes, underlying analogical problem solving (Chi et al. 1989; Renkl, 1997).

Analogical problem solving involves understanding the relationship between two situations, and mapping the corresponding key elements of the source and target problem (Gentner, 1989). Several studies have elaborated on the issue of analogical transfer, and studied experimentally how individuals represent problems, draw analogies, and apply source solutions (Chen, 2002; Gentner, 1989; Holyoak & Thagard, 1989a). Although these studies have identified several factors that affect transfer, the knowledge of the relationship between the various types of similarity and cognitive processes involved in transfer remains limited, especially when using pictorial types of representation. As observed by Markman & Gentner (2000), both the material and the quality of the representation influence the effectiveness of analogical mapping and transfer.

Many researchers have also found that when the source and target problems share a high level of similarity, participants would find it easier to implement an analogy (Chen, 2002; Chen & Siegler, 2000 ; Markman & Gentner, 2000). According to Catrambone, (2002), surface and lower order structural features equally affect access only if higher order relations are shared. This phenomenon was found to be very true in this study, where the degree of higher order relations (process) shared between the source and target problems were manipulated. In the procedural level of similarity, where the higher order relations shared were maximum, the superficial features when not mapped correctly, affected the transfer process. For example, for the target Salt problem, the source problem at procedural level of similarity showed pictorially a method, to measure out a substance without adequate measuring tools. Measuring out 1g of salt requires the method of filling the small object (4g spoon), and emptying it into the larger one (11g spoon). The superficial and structural features in the

procedural level (small and large containers in the source problem) needed to be mapped correctly to the target problem, in order to successfully transfer the higher order process of measuring.

The Role of the Representation

In this study, it was assumed that the level of source problem representation would affect the strength of transfer while solving the target problem. The source problems were pictorially represented in a hierarchical order of similarity to the target problem (principle, strategy, and procedure), to examine and assess the degree or strength of transfer in the procedural level of similarity, as compared to the other levels. This assumption which was investigated by Chen (2002) and reexamined in a different cultural context in the preliminary studies remained an integral part of the main study.

To successfully solve the source problem, it was assumed that participants would use the cognitive processes of explanation (involving labeling, combination, comparison, and relations) and inference (involving justification, mathematical elaboration and goal directness). However, the manifestation of these processes is greatly determined by the level of representation. For example, in the source of the principle level of representation for the Elephant problem, an idea of a large object being equal to many small objects was given only in one picture frame. It was expected that in the principle level of similarity, the principle would be described with very little explanation and Inference. In contrast, in the strategy and procedure levels of similarity (of the source), a series of pictures depict a process. The stimulus is both rich and varied in terms of information, which readily elicits the cognitive processes of explanation and inference. Therefore, the quantity and quality of the cognitive processes are not

only expected to be more in the strategy and procedural levels, but also expected to influence the solution of the source problem.

With regard to the effect of the three levels of similarity on the cognitive processes, while solving the target problem and during the process of transfer, it is essential that all the three main processes (explanation, inference, and analogizing) described in the model and their sub-processes, be applied or revealed. Therefore, the type of representation (principle, strategy, or procedural similarity) between the source and target problem would influence the cognitive processes applied or revealed differently. Although all the cognitive processes play an important role in the solution of the target problem, it was expected that the impact of level representation would have more effect on the processes of selective encoding, mapping and transfer, which are the sub-processes of Analogizing.

Selective encoding is a process by which a participant integrates the superficial object attributes in the source and target problems. Researchers have postulated that effective transfer is influenced by the process of encoding materials or objects and other characteristics of the representation. In the principle level of representation, a participant has very little information from the source problem to depend on while solving the target. Therefore, it is assumed that a participant will indulge in selective encoding only by integrating the superficial object attributes, for example in the Elephant problem where the large object : small object : the elephant: small rocks. In the principle level, it is also assumed that the participants would only map the superficial features from the source to the target. This is obviously due to the absence of any concrete procedure, which is important when constructing a schema, which subsequently

influences the mapping process. As a result, it is expected that the type of transfer that a participant would come up with in the principle level of similarity, would be low partial transfer.

On the other hand, the participants at the strategy level of similarity have a sequence of pictures of different objects, depicting a process that elicits the process of selective encoding. This level is higher than the principle level, because it not only shares some of the superficial attributes with the target problem, but also describes a functional or operational relation among the elements, to depict a process. This added feature of the strategy level provides a basis for understanding a structural or higher order relation between the source and target, which helps provide a schema or an effective strategy but not the exact procedure to solve the target problem. Therefore, this level helps a participant select and encode (selective encoding) some of the object attributes in the source not merely for their superficial similarity with the target, but also for the structural relationship among them. For example, in the pictorial representation of strategy level for the Salt problem, the objects are depicted to show a process of how to measure a required amount of substance, using a multi-measure non-refilling method. A participant will indicate the process of selective encoding, by selecting and matching some superficial object attributes shared by the source and target like for example; The small container : the large container : the 4g spoon : the 11g spoon. However, this superficial matching becomes meaningful only, when the process that they depict, is also encoded.

Markman & Gentner (2000) found that higher order relations among objects are very important in structural mapping, they encode important relations, such as causal and implication relationships. After the relevant information of the

source problem is retrieved and encoded, the common structural relations among the elements serves as a guide for matching them. Thus, in the strategy level a participant may form a schema required, but may not be able to map it correctly to the target, because of failure to integrate a process from the source with objects in the target, which are different from that in the source. As observed by Chen & Mo (2004), the mapping between elements of the problem becomes less effective, when corresponding objects share only functional relations and differ in object attributes. Consequently, it is predicted that the strategy level of similarity between the source and target would result in high partial transfer where a participant may give only a strategy for solving the problem, without a step-by-step process.

The third level of similarity is the procedural level, where the source and target problem shared the highest level of similarity, both at the superficial (object attributes) and structural levels (similar process). Thus, it was expected that it would be relatively easier for participants to encode both the object attributes and the process; for example, the pictorial representation at the procedural level in the source of Salt problem, the objects show a process of how to measure a required amount of substance using a single measure refilling method. Both the source and the target share features which can be understood as an analogy (water tap: small container: large container: salt dispenser: 4g spoon: 11g spoon). A participant may be able to readily apply the mapping process by aligning the superficial and structural relations between the objects in the source and target. Thus, it was expected that at this level the participants would come up with the optimal solution (full transfer) to the target problem. It may be mentioned here that in these types of problems, which depict a process or

procedure, it is not sufficient to perceive the higher order relations, as observed by Gentner (1989), without taking into account the object or superficial attributes, because they are an important part of the procedure. It is quite obvious that the difficulty faced in the process of mapping in the strategy level is due to the object attributes that depict the process in the source being different to those available in the target, while in the procedural level of similarity, both the objects and the processes could be easily integrated into the target, because of high level of similarity.

The Role of the Think-Aloud Protocols

The other issue addressed in this experiment, was the role of think-aloud protocols in the strength of transfer in analogical problem solving. Two methods of think-aloud protocols were used in this experiment: VB and SE. The difference between the two conditions is in the instructions and practice sessions given to the participants. In the VB, the participants were asked only to verbally report, for recording how they were going about solving the problem. In the SE condition, the participants were instructed to explain to themselves or as if to somebody else how they are solving the problem.

An interaction between the level and condition of protocols was inevitable. For example, in the principle level, the conditions of VB and SE would be less effective, as compared to strategy and procedural levels, because the information provided in the source of this level, is limited only to a general idea. With respect to the effect of the protocol conditions on the cognitive processes, it was expected that SE would help generate qualitatively more processes. For example, participants may give more detailed explanations or justification for their choices while solving the source or target problems.

It was also predicted that the SE condition of the think-aloud protocol would aid performance more. There are several reasons for assuming this. First, the participants in the SE group tend to indulge in meta-cognition more where he/she frequently monitors the thought processes, in terms of progress towards a clear goal or give justification for choosing various options. Second, the participant tends to adopt two roles; one role as instructor to explain and give information (ask question and try to answer it) and the other role as a learner who wants to understand the problem. Third, SE affects the internal representation of the problem, where the participant tends to go back and forth by referring to the source problem and trying to see the connection between both situations. Fourth, the pictorial type of representation is helpful in eliciting more SE, which in turn influences performance. The imposition of SE thus tends to affect the generating of inferences and reconstructing the learner's own mental model. Moreover, SE also helps understand the role of the various cognitive sub-processes and the sources of errors in solving problems by analogy.

The Strength of Transfer

The concept of the strength of transfer was introduced in this study, on the basis of the assumption that the verbal protocols and levels of similarity would generate varied degrees of performance. The degree of performance could be conveniently divided into four categories namely: Complete and correct transfer, High partial transfer, Low partial transfer, and Wrong or no transfer that coincide with the three levels of similarity procedural, strategy and principle respectively.

The strength of transfer is the main dependent measure, which is measured in terms of overall performance on the target problem, in all the three levels of similarity and the two conditions. It was hypothesized that different

levels of similarity would affect the strength of transfer outcome. Since the source problem is represented in pictorial form, the initial step in this type of analogy is to encode it. If the participants encode the object attributes and map the structural relations to solve the target problem by giving the correct process then a successful transfer would be the outcome. The type of transfer, therefore, depends mainly on the effectiveness of selective encoding and mapping while solving the target problem.

In this experiment, it was predicted that procedural level of similarity would have a significant effect on transfer, due to its influence on selective encoding and mapping. The main reason for this prediction is that the source and target problems being isomorphic it is easier to find the corresponding elements while solving the problem.

Critical analysis of the findings

The primary aim of this study was to determine the effect of SE, as a self-support method, and procedural similarity in increasing transfer performance. The results of the study identified the cognitive processes that contributed to effective transfer in analogical problem solving. The study explored the nature of verbal protocols produced, to build a coding scheme emphasizing the cognitive processes and sub-processes involved in problem solving by analogy using a pictorial type of representation. Additionally, the results also provided insights into some distinguishing characteristics of solvers and non-solvers in general.

How does the SE affect transfer?

There has been evidence from previous research that SE in other study domains influences learning and problem solving (Ainsworth & Loizou 2003;

Chi et al., 1989, 1994; Neuman & Schwerz, 1998; Renkl, 1997). As such, the initial prediction of Experiment 1 was that the SE condition would positively influence performance transfer over the VB. The results from Experiment 1 confirmed both previous research and the initial prediction that SE influences performance. Improvement from SE is more likely because it initially induces some conscious effort (cognitive load) to gain a better understanding of the source problem. Ainsworth and Loizou (2003) explained that diagrams decrease memory load and cognitive effort by computational offloading letting the learners engage in meaning-making activities. This experiment provides further support for this observation that diagrammatic representations strongly influence the emergence of causal explanations. An example of a participant's protocol, where more justification and causal relations is revealed while solving the salt target is given below

"Fill the 4g spoon, (because in the previous picture the small glass was emptied in the large jug) and Empty it in the 1g spoon, Refill it again, (the same procedure of refilling the glass from the tap), Now we have 8g in the 11g spoon, $4 + 4 = 8$, Fill it for the third time, In this step when we empty the 4g spoon only 3g will fill the 11g spoon, there is 1g, this is the 1g remaining what we need."

Moreover, presenting the source problem as a series of interrelated images encouraged participants to generate explanations for the differences between successive images. Furthermore, in this study it was noticed that participants in the SE condition took more responsibility to understand the material thoroughly and in a more coherent manner than those in the verbal condition. This is because participants in the SE condition simultaneously performed two roles: first as a learner trying to understand the problem and second as an instructor explaining the problem

The verbal protocols revealed that most participants initially found it difficult to integrate information and derive meaning from the source problem. However, in the SE condition the participants were able to gather related information and integrate the visual knowledge logically to understand the principle underlying the problem with relative ease. Participants in the SE condition gave more evidence of trying various methods to understand and analyze the pictorial information in more detail. They created mental images of the objects in the diagram which later aided in the process of alignment of the objects in the target problem. For example, in the Elephant problem the image of the large object is aligned with the elephant. They also provided more justifications in comparing the sequences of pictures, filling the gaps, and using different approaches to discover the underlying principles. This was demonstrated in the Salt problem where participants in the procedural level of similarity were able to fill in gaps by determining a glass was filled or emptied even though those actions were not shown. Further, the experiment revealed that participants in the SE condition raised questions as they explored the material and tried to answer them through their explanation. Through this action, more information was generated through reasoning and elaboration around the difficult concept or idea

In the VB condition participants focused only on the superficial similarity between source and target problems and repeated the same ideas over and over. Although participants in the VB condition made observations about the problem and correctly interpreted the source problem, their verbal protocols reflected random thinking and lack of causal information. Thus, they did not tend to focus

on obtaining the principle or the meaning behind the diagrammatic representation.

How does the Procedural Similarity affect transfer?

Analogical problem solving involves knowledge transfer from one situation to another. The effect of procedural level of similarity observed in earlier studies (Chen 2002, 1996; Gick & Holyoak, 1980, 1983) was also apparent in this experiment as the performance in this level was higher and more effective than other levels of similarity.

The results from Experiment 1 showed that in the principle level of similarity, benefits were limited despite SE. This is because at this level of similarity a participant needs to transform an abstract idea into a concrete procedural operation. Most participants provided only general ideas for the problem solution because the principle level of similarity only shared a common solution principle with the target rendering it difficult to transfer the abstraction from the source to the target problem.

In the strategy level of similarity, the dissimilar procedure between the source and target problems created some difficulties in applying the source solutions. However, the probability of successfully solving the problem was relatively higher than the principle level.

In contrast, the procedural level of similarity shared the characteristics of both the object and process between the source and target problems. Indeed, there was a statistically significant difference between the likelihood of solving the target problem in the strategy level of similarity and the procedural level of similarity. In the procedural level of similarity, the likelihood of transfer was highest because the surface features and structural relations integrate to facilitate

the process of drawing an analogy. As mentioned above, these findings were consistent with Chen (1996, 2002) who observed that the level of similarity between the source and the target largely determines the degree of transfer and performance. Thus, the probability of arriving at a complete solution is highest when transfer was guided by procedural details.

What is the impact of the levels of similarity on the protocols?

It is important to highlight the impact of the three levels of similarities on verbal protocols generated. In the principle level of similarity (Figure 3.3) the model was simple as such the verbal protocols in both SE and VB conditions were very limited (6-7 lines) due to which comparisons with other levels were not assessed. In contrast, in the strategy (Figure 3.4) and procedural (Figure 3.5) levels of similarity participants generated a fair amount of verbal protocols in both conditions. The increase in verbal protocols is due to the fact that each model consists of at least four pictures, each consisting of several objects. As expected, the participants were able to encode the objects in each picture, and consider the inter-relation between the objects within the pictures by observing their movements and/or change of locations throughout the pictures. There was no significant difference between the strategy and procedural level of similarity in number of lines produced although the procedurally similar information tended to positively affect problem solving performance.

Does the amount of information affect the problem solving?

The sudden-solution feature characteristic of insight problems generally is known to affect the amount of information and the resulting verbal protocols generated by the participants. It was observed that insight problems tend to

generate three type of protocols depending on the amount of information. The first category consisted of short, relevant and insightful protocols. Here the key elements are discovered, the relationship among the problem objects within the source problem and the concept behind it is understood and connected with the target problem to derive an appropriate solution procedure. Thus, although these protocols are considered short, the information produced was highly effective. These participants understood the problem fully and the procedural knowledge was later correctly mapped from the source to the target.

The second category consisted of long, meaningful and elaborate protocols. Here, the participants encoded the key elements, described the superficial features (large, small), connected the relationship within the different pictures (up, down), elaborated on the causes, discovered the concept of the problem, and the methodology of using the rules. Although, less concise than the first category, these protocols were also highly informative that helped understand the problem thoroughly leading to establishing connections between the source and target problems.

The third category consisted of long, repetitive and disconnected protocols. Participants in this category tended towards; incorrectly encoding key elements, were uncertain about the relationship among the problem objects, did not discover the concept, and provided redundant and shallow explanations. Further, participants in this category often provided unexpected explanations for the processes such as “this is a family trip to the Red Sea” in describing the source diagram in the Elephant problem. These participants were unable to understand the pictorial information in the appropriate way and thus could not transfer the information to the target problem.

Chi et al. (1989) observed that the more the information produced and repetition the better chances of reaching the correct solution in analogical problem solving. The second category of protocols described above corresponds with this view. Although, Experiment 1 also found that when analyzing the target problem, solvers produced significantly more lines of protocol than non-solvers however reaching the correct solution (as the protocols of the first category) depended largely on the quality of information produced. If the protocols helped in making the right connection between source and target problems, then a participant's chances of reaching the sudden correct solution is increased even if longer time was taken. Thus, if the information generated in the protocols contained superficial and redundant information, lacking the necessary connections between objects, then the participant would not be likely to reach a correct solution.

Previous studies (Chi et al. 1989; Chi, 1994; Ainsworth & Loizou, 2003), found that SE generally allows the participants to produce lots of information leading to better understanding by integrating the new information with their prior knowledge. The use of a pictorial format in the source problem provided a way for participants to manage the information load created by the SE process.

Does the amount of time spent affect the problem solving?

The amount of time spent analyzing the source problem was significantly higher for solvers than non-solvers. Interestingly, there was no difference between solvers and non-solvers in the time spent on the target problem. The time solvers spent in solving both target problems, ranged from 250 seconds to 700 seconds. This wide range of time can be attributed to an important feature of

problems of insight, where one may take less time because of suddenly moving from a state of not knowing to that of knowing how to solve the problem. This feature also affects the amount of explanation that is produced because soon after insight, participants tend to quickly select tools and, at the same time, deal with constraints associated with the various options. On the other hand, one who spends more time in solving the target problem tends to produce a lot of information while trying to solve the problem, until an insight into the solution of the problem occurs. Therefore, the point of time at which insight occurs would affect both the time taken and the amount of verbal protocol generated. The faster the insight occurs the less time spent and the explanation produced. This is to say that performance in insight problem solving is not necessarily affected by the amount of data participants produce, but rather by the ideas or quality of sub-processes generated that help in solving the problem. Renkl et al. (1998) also found that time on task was not related to performance. They explained this lack of time effects as a positive indication of the effect of quality learning processes on learning outcomes.

What is the difference between the solvers & non-solvers?

The primary distinction between solvers and non-solvers was in their ability to attain an in-depth understanding of the source problem and apply it to the target. The solvers tended to deeply analyze the relationship between the pictures, representing the source problem, while interpreting it. This understanding enabled them to discover the principles and concepts beyond the problem and to determine the relations among different objects to reach a coherent and comprehensive understanding for solving the target problem. An

example of the solution for the Elephant problem is given below to illustrate a solver's understanding of the sinking principle the source problem:

“The tray is empty because the other objects on the floor, the large object is placed on the tray, I think something is happening here, Oh, the water level is different between the two pictures, O.K now, two small objects are placed in the tray...also the water level is still the same as the first picture. OK we can add two more objects to see...aha now the water level is the same as in the second picture. Then those four equal the large object.”

In contrast non-solvers, may have succeeded in understanding the source problem, but failed in implementing. The failure may be attributed to their shallow perception of relations among objects, leading to their inability to apply the same concept or idea to other situations. This is consistent with Chi et al. (1989), who reported that poor students produce little explanation, if any, and that their explanations do not connect with their understanding of the principles and concepts.

With regard to the difference between solvers and non-solvers of the target problem, although, there was no significant difference in the time spent they differed greatly in the method of analyzing the problem. Most solvers started with a quick reading to get an overall idea or understanding of the problem, went back for systematic review (reading each statement carefully, explaining each statement to themselves, connecting the acquired information to the pre and post statements), gave some justifications, looked for more details, connected the relations between the sentences, and then re-read the statement again looking for key elements that may help to solve the problem. It is believed that this approach improved the participants' performance and ability to reach the correct solution. These observations are parallel with findings from Chi et al.

(1989). They observed that, in general, good students explain and provide justifications for each action, which positively affects their understanding.

In contrast, most non-solvers read the target problem in a superficial manner that negatively affected their performance. For example, in the Elephant problem, one of the participant's solutions for the target problem was "let the wise man use another test to measure the young man's intelligence" while another participant said "he can cut the elephant into small pieces to be weighed."

What types of cognitive processes affect solvers and non-solvers?

The results of Experiment 1 identified four statistically significant sub-processes differentiating solvers and non-solvers: justification, mathematical elaboration, goal directness and mapping. The solvers generated more justification, which prompted them to give reasons for their actions. It served the important function of keeping participants focused on choosing correct options, while at the same time being aware of constraints and difficulties they were facing.

The solvers also understood and compared the mathematical relationships between objects and the underlying principle. They inferred rules from the source problem that improved their chances of successful transfer mainly because these rules are important not only to comprehend the target problem but also to form the sub rules that affect the degree of the strength of transfer. An explanation based only on principles is beneficial but not enough for full successful transfer. An effective problem solving procedure requires the explanations of both the principles and the inference of rules of the problem. On the other hand, the lack of understanding of such relations hinders the non-solvers from conducting successful transfer. Support of this result comes from the work of Larkin and

Simon (1987) Chi et al. (1989) who highlighted the importance of translating the principles and definitions into specific inference rules. SE simplifies this inference of rule construction. This is also in line with who proved that inference rules construction serves some additional purposes. Chi et al. (1989) observed that when subcomponents of rules were not encoded, because the students may not have realized how important they were, it affected their understanding.

In addition, goal directness of solvers caused them to set sub-goals in order to help them in achieving full successful transfer. Renkl (1997) distinguished between two types of successful learners: principle-based explainers, whose explanation focused on principles and goals, and anticipative reasoners, whose explanation anticipated steps in the solution of problems. Ainsworth and Loizou (2003) found that explanations associated with successful problem-solving strategies, are either goal or principle oriented. This same distinction emerged in the present experiment. Solvers who applied the process of goal directness tended to direct their solution according to the goal and sub-goals they monitored at every step. The principle-based solvers, on the other hand, relied on the principle and mathematical elaboration.

The mapping process is considered the most essential for transfer because it integrates objects attributes between the source and target problems. Solvers identified the key objects and mapped the structural relations between the source and target problems. They conducted a comprehensive mapping process that involved simultaneous object and procedural comparisons between the source and target. Their mapping process included alignment of several attributes, such as: object attributes (big, small or light and heavy), object movement (the change in the object positions, for example what was on the floor is on the scale in the

next frame), change in object situation (what was full is empty in the next frame), and logical order of the process. The solvers succeeded in finding the common relational structure and matching the fundamental objects and attributes. They also understood all characteristics in a logical order of the process and applied it to solve the target problem.

In contrast, non-solvers mainly produced two types of mapping: Superficial mapping, where only object attributes are noticed and mapped, and Structural mapping, where along with superficial attributes, the movement and change in object situation may be noticed and mapped. However, a successful and complete transfer between source and target problems, depicting a step-by-step process, also requires an understanding of the process in the source, and mapping and adapting it to the target problem. These findings are consistent with the results of Novick and Holyoak (1991) that mapping is a crucial process but not sufficient. They argued that even with successful mapping a lack of adapting the source solution procedure to work for the target problem could affect transfer. The findings of this experiment were also in line with Chen (2002), who observed that although a complete solution for the target problem was determined by procedural similarity, the failure in transfer was mainly due to the difficulty in executing the procedure depicted in the source problem, and not in accessing the models or in mapping the key components between the model and the target problem. For example, the following protocol illustrates the sub-processes of justification, mathematical elaboration, goal directness and mapping the correct key elements in the salt target problem:

I have to get 1g of salt, without guessing, I have two measuring spoons, one is a 4g spoon, the other is 11g spoon, filling 4g spoon , three times gives, 12 g, I can subtract, by using the 11g spoon, to get the 1g, therefore, I will fill the 4g spoon, and empty it in the 11g one time,

refill the 4g spoon , and empty it in the 11g , a second time, refill the 4g spoon, and empty it in the 11g, a third time, the 11g spoon is full, there is 1g, left in the 4g spoon.

Therefore, most of the failure in problem solving could be attributed to the inability to successfully apply or adapt the solution acquired in the source, to the target problem and/or failure to access the source problem. Verbal protocols revealed that only 45% of participants accessed the source models and benefited from them in solving the target problems.

Although the sub-processes of comparison and encoding did not show a statistically significant relationship with transfer they are important to success. The sub-process of comparison includes labeling and combining activities. This is because the participant qualitatively goes a step further by interpreting the superficial relation between objects after naming them based on their superficial features. Thus, a participant may exhibit only the sub-process of comparing, thereby also indicating the presence of the labeling and combination processes. We illustrate this with an example of a verbal protocol:

- This is one cup (labeling)
- Full of water (combination)
- Another cup is empty (comparison).

Although the results showed no difference between solvers and non-solvers in the encoding process, transfer was often negatively affected by selecting the wrong objects to be mapped. This is because the sub-process of encoding is an important mechanism to determine the information to be retrieved and mapped. An example from a protocol is given below of selecting “the large spoon instead of the small spoon” as the object to be filled in the Salt problem which is wrong encoding that affects transfer.

If we select the 11g spoon and fill it up with salt then empty it into the 4g the remaining is 7g. Fill the 4g once again the remaining is 3g.

Contributions

The main contribution of this experiment was constructing an empirical coding scheme which to the best of the researcher's knowledge is the first for pictorial representation in a non-domain specific area. Most studies focused mainly on analyzing the verbal protocols in verbal representations and/or domain-specific diagrams. For example, Ainsworth and Loizou (2003) gave information about the human circulatory system in diagrams and verbal format. Chi et al. (1989) gave their students diagrams for the problems involving Newton's laws of motion. Renkl (2002 & 2005) used worked-out examples. The coding scheme proposed in this experiment provides a firm methodological ground for developing coding schemes for other representations in general and pictorial representation in particular. It also describes how an individual uses the various cognitive processes to derive meaning from diagrams that initially appear to be ambiguous..

Analogical reasoning is an important cognitive tool for enhancing learning. This experiment is considered unique because it provided evidence for SE as a self-support method (instead of hints and other external support methods) in learning by analogical problem solving using two different representations; pictorial source and verbal target.

Limitations

Although the results of the Experiment are broadly applicable to most learning situations, they are subject to limitations resulting from its design and/or execution.

The design of this experiment compared two think aloud conditions (SE & VB) and three levels of similarity. The results were clearly in favor of SE and

procedural level of similarity as predicted. One limitation of this experiment was using two think aloud conditions (SE and VB) which were difficult to control. This is because sometimes a person instructed to verbalize only tended to self explain or vice versa which could have an effect on performance. Ericsson & Simon (1993) predicted that verbalization should not affect the sequence of problem solving while some others held that VB has a direct impact on problem solving performance. However, as this experiment did not include a No think aloud group to compare with VB this issue could not be investigated. This limitation was overcome to some extent by comparing the performance of solvers and non-solvers regardless of condition.

The second limitation of the experiment is related to levels of similarity. The principle level of representation is indispensable in domains that do not lend themselves easily to the strategy and procedural level of representation. However, it was observed in this experiment that the pictorial representation of the source in the principle level did not generate enough protocols (in both SE & VB) to determine the cognitive processes it elicits and thus was excluded from protocol analysis. Perhaps, if this level was also represented in a sequence of related pictures (instead of one picture showing the general principle) depicting the general principle, of weighing large objects or measuring out an amount of substance, it would generate sufficient protocols for comparison with the other two levels of similarity.

The third limitation of the study is related to the pictorial representation of the source problem in the three levels of similarity. As observed by Ericsson & Simon (1984) concurrent verbal protocols for visual data tend to increase the cognitive load which could affect both the protocols and the performance.

Moreover, the current experiment did not take into account the fact that people differed in their verbalization and self-explanation skills. This, it was observed, was perhaps the reason why some participants solved the problem without completely explaining or verbalizing how they went about it which could have affected the think aloud protocols generated. Furthermore, as one of the purposes of this experiment was to elicit verbal protocols it was imperative for the researcher to frequently remind some participants to keep talking. The effect of this interference while problem solving is not known.

The coding scheme consisted of all reasoning steps that could be expected based on task analysis, theories of cognitive processes in problem solving, and protocols of piloted participants. Nevertheless, it may not adequately represent all the protocols generated as it is considered relatively new in explaining pictorial type of information. Therefore, some segments could not be coded due to lack of corresponding cognitive process or sub-process and so had to assigned to the 'others' category. An example of this is illustrated below.

This is a water tap (combination), dripping water (combination), and filling the glass (combination), the first picture like (other), the glass is filling (comparison), in the second one (other), two glasses (combination)

Experiment 1 used only pictorial representations in the source problem for a verbal target. An issue that arises here is whether transfer performance would be affected if the source and target were in the verbal format. This issue is addressed in the next Experiment 2.

Conclusion

A significant difference was found between the number of complete and successful solvers in the procedural levels of similarity, as compared to the strategy level. The Mean strength of transfer (ST) performance on the target

problem in the procedural level was also significantly higher, compared to the strategy and principle levels of similarity. The Mean ST performance in the SE was found to be higher than VB condition. These findings clearly showed that despite a high level of similarity (procedural), between the source and the target problems the self-support methods of SE helps elicit or optimize cognitive processes crucial for effective learning and transfer. Although, SE initially puts a cognitive load on the problem solver to explain, it often results in a better understanding of the problem, which in turn serves as a means of cognitive offloading. Moreover, it increased meta-cognitive activities that induce a participant to indulge more in noticing and linking key ideas in analogical situations.

Three main cognitive processes of explanation, inference, and analogizing, and their sub-processes, were identified as being involved in analogically solving domain free everyday problems. A significant relationship was found between inference and analogizing processes and strength of transfer. The procedural level of similarity generated significantly more processes of justification, mathematical elaboration (in the category of inference) and mapping (in the category of analogizing) in the target problem, compared to the strategy level.

Although, the results in this study reinforced the view that SE was a simple but powerful method for acquiring knowledge during problem solving, it was also observed that when transfer required adaptation of a complex multi-step procedure, participants may be able to encode and map the common features of elements in the source and target, and yet be unable to derive the analogous solution. This may be because the method of SE induces some stress to

understand the problem, but does not ease the working memory that has to hold and deal with the multi-components of information. Thus, lack of accessing of the source problem and/or the failure to map a procedure to solve the target problem, remained as issues.

CHAPTER 5: MODALITY OF REPRESENTATION AND ITS EFFECT ON TRANSFER IN PROBLEM SOLVING BY ANALOGY

Introduction

Experiment 1 investigated the effect of self-explanation and procedural similarity using pictorial representations on analogical problem solving. Since the target problem was represented verbally, it was speculated that there may be some individual differences in dealing with pictorial formats and/or problems in adapting or mapping pictorial information from a source to a verbal target. Therefore, the next study was aimed at comparing effects of verbal and pictorial representations on transfer.

External Representation

Research on problem solving by analogy has established that the level of abstraction of the source information is an important factor that affects analogical transfer. There is sufficient evidence that when only an abstract idea is given in the source problem (example, principle level) there is often failure in transfer (Catrembone, 1994; Chen, 2002, Chen & Siegler 2000; Novick & Holyoak, 1991). Moreover, results of Experiment 1 in this thesis have also established that the ease, with which a source solution is implemented, is largely determined by the procedural similarity shared by a source analogue and target problem.

Modality (e.g., verbal or pictorial) is another important aspect of representation that affects both the level of similarity and/or the transfer process. Researchers have often used either or both pictorial or verbal representations as cognitive tools to enhance memory and thinking, to highlight their advantages in different contexts. For example, Larkin and Simon (1987) emphasized the

cognitive properties of external representation while describing the possible advantages of diagrams over text. They concluded that visual patterns are better representations not merely because they contain more information, but because they also support more efficient computations. On the other hand, texts, according to them, required the construction of mental models that simulate physical objects, persons, and events described, leading to inferences based on these simulations. Zhang (1997, 2001) considered external representations as intrinsic to a task in that they guide constraint and determine the pattern of cognitive behavior. His concept of representational effect seems similar to Larkin and Simon's theory of informationally equivalent representations, leading to computational differences in behaviors. Zhang refers to representational effect as when different representations of a common abstract structure generate different representational efficiencies. He considers it a useful tool to formulate isomorphic problems of common abstract structure with different representations, help identify factors that affect the processing behavior in cognitive tasks, and at the same time also help compare the representational efficiencies in these isomorphic representations. Furthermore, Zhang observed that comparison of relative efficiencies and behaviors can be made in learned tasks, such as addition and multiplication, where the format of representation determined what information is perceived or what processes are activated and what structures will be discovered from the specific representation. This he refers to as "representational determinism" (Zhang 1997).

Ainsworth and Peevers (2003) reported an experiment that explored whether the informational and computational properties of external representations interact to influence problem solving and learning. The problem

task required operating a complex device for deriving an optimal solution process, the instructions for which were given in diagrammatic, tabular, or textual form. They found that performance was better when the instructions were in a single representation of textual form, as compared to diagrams and multiple external representations (MER) in which information is distributed over a number of separate representations. This they attributed to the increased costs of working, in terms of difficulty, that these forms demanded.

Ainsworth and Loizou (2003) compared learning with text or diagrams. They observed that, although post-test knowledge inference questions in textual format could have been of advantage to the text students, the diagram students performed better. They attributed this to the cognitive, semantic, and affective factors underlying the differences between text and diagrams. The study provided evidence that diagrams facilitate computational offloading, encourage causal explanations, and elicit more interest.

How visual representation of information influences learning and whether changes in comprehension processes are due to the impact of diagrams were questions investigated by Butcher (2006). Using text only, text with simplified diagrams, and text with detailed diagrams, the Butcher study assessed the potential effects of different representations on students' learning outcomes and comprehension processes. His study found a learning advantage when diagrams were carefully designed to highlight the representation of critical relationships of the domain information. It also found that simplified diagrams generated more integrated inferences indicating deeper comprehension. Participants who used diagrams also demonstrated greater learning even though they did not spend significantly more time than the text-only condition.

Thus, the advantages of both diagrammatic and textual forms have been established in different domains of learning. However, in analogical problem solving, the effectiveness of a representation is determined by its potential to increase the cognitive activities of search, recognition, and inference. In Experiment 1 one aspect of representation; that is, the degree of similarity shared between the source and target problem on transfer performance, was manipulated, but the form of representation was consistent; that is, pictorial source and verbal target. This experiment found the method of SE combined with procedural level of similarity to be effective in transfer performance. Nevertheless, the protocols revealed a pattern of discrepancy in target performance, which led to the speculation that there could be differential effects of the pictorial source on transfer performance in general, and on solving a verbal target in particular. Therefore, it was considered important to address the effect of modality of representations and their influence on transfer.

Experiment 2

Experiment 2 was planned to address three issues that specifically relate to assessing the effect of type of representation (verbal and pictorial) in the source problem on transfer performance. The first is whether a verbal source problem, when paired with a verbal target, helps transfer performance more by reducing the problem of adapting the solution from a pictorial source to verbal target. The second is whether informationally and computationally equivalent verbal and pictorial type of representations in the source problem would still differ in their influence on transfer performance. The third is to assess the effect of individual differences in working with the verbal and pictorial formats of

domain-free problems requiring a step-by-step process solution to be learned and executed in the target.

Hypotheses

1. It is predicted that there would be a within-subjects significant difference in transfer performance on the pictorial and verbal format of the problem.
2. It is predicted that transfer performance in the pictorial type of representation would be significantly better than the verbal type in the procedural level of similarity.

External representations greatly determine both learning and problem-solving behaviors. Researchers have extensively highlighted the advantages of pictorial and verbal representations in different contexts. For example, Larkin and Simon (1987) in diagrammatic reasoning, Zhang (1997, 1998) in external representation, Tversky (1999) in diagrams and thinking, Chen (2002) in procedural similarity, Chen and Mo (2004) schema induction in problem-solving, Davis and Goel (2001) in visual analogical problem solving, and Novick and Holyoak (1991) in mathematical problem solving. However, relatively few studies have compared the effect of pictorial and verbal versions of representation in the source model on transfer in analogical problem solving. According to Zhang (1997), representations are intrinsic to many cognitive tasks and do not merely impose and stimulate the internal mind, rather, they help guide, constrain, and direct the problem-solving behavior.

Some major reasons underlying the first assumption of this study are : First, effective transfer performance is dependent on understanding a concrete process in the source problem. In order to understand this process, a person needs to manipulate the objects involved. It is assumed that verbal descriptions

of objects showing a process (such as the jug problem in the source), fall short in conveying the movement of the objects in terms of initial to goal state, in addition to increasing “cognitive load” by trying to hold all the information in the working memory. Larkin and Simon (1987), in their studies of diagrammatic problem solving, have also concluded that diagrammatic representations support operators that can recognize features easily and make inferences directly. They explicitly state that, when problems are informationally equivalent, their representations will lead to different computational demands, which may account for behavioral differences. Besides, Reisberg (1987) is of the opinion that pictures can give people access to knowledge and skills that are unavailable from internal representations. In this experiment, for example, the word “scale” may evoke different interpretations. In contrast, when a scale is depicted pictorially, it not only bears resemblance to what it represents, but also ensures that everyone gets the same meaning of what type it is and how it works. Thus, problems that involve item-specific processes are better represented through diagrams like, for example, assembling pieces of furniture.

Second, the theme of the source and target problems is weight equivalence, which is not domain-specific, although it involves some general mathematical reasoning. These problems are based on the type of problems used by Chen (2002), who described them as neither well-defined nor ill-defined, but those that require both a concrete procedure and some insight to solve. A verbal representation, it is assumed, may restrict the interpretation of the problem to the syntactic meaning of the words, whereas a diagrammatic representation allows for more flexibility, in terms of thinking and interpretation that may lead to insight (Chen, 2002). Moreover, a verbal description of the problem gives

information, both relevant and irrelevant, that requires continuous sifting and integration for effective internal representation whereas, in a diagrammatic representation, a person indulges more in search activities that are directed towards figuring out what the pictures are conveying. This could affect the process of accessing and mapping, which are important features of analogical problem solving.

The second assumption is based on the findings of the previous experiments of this study, where it was found that, when a concrete step-by-step process is to be described that involves the manipulation of objects or devices, the procedural level of similarity in the source model, compared to the principle and strategy levels, would facilitate transfer in analogical problem solving. This is because a pictorial representation facilitates the mental simulation of a process that involves manipulation of objects (Tversky, 1999), thereby enhancing learning and increasing the chances of successful transfer. Moreover, as there is an element of insight required in solving these novel problems (no previous learning required), it is expected that dynamic pictures would better activate the cognitive process of inference, which is considered crucial for effective transfer. In addition, regarding differentiating between learned tasks and novel or discovery tasks, Zhang and Norman (1994) are also of the view that the format of representation in the latter will determine what information is perceived and what processes are activated (representational determinism). Three isomorphic representations (lines, color, and numerals) of their Tic-Tac-Toe study showed that different representations of a common underlying structure can lead to the discovery of different properties of the underlying structure in terms of different forms of strategies that not only determine problem difficulties but also affect the

pattern of knowledge transfer. Thus, this study established that representations not only determine learning but also the acquisition of more general forms of strategy.

Methodology

Participants

Eighty-four (84) female undergraduates between the ages of 18 to 27 ($M = 21.33$, $SD = 1.74$) enrolled in the psychology course at King Abdul Aziz University participated for course credit. They were randomly assigned to two levels of similarity; strategy, or procedure, where each participant took two types of representation: pictorial and verbal. They were tested within small groups and none of them had participated in the prior experiments.

Design and Materials

The hypothesis was tested using a mixed experimental design that consisted of two independent variables; two types of representation (verbal and pictorial) as the within-subject factor and two levels of similarity (strategy and procedural) as the between-subjects factor.

New problems were designed to represent two levels of similarity (strategy and procedure) in two types of representation (verbal and pictorial). Moreover, each problem was depicted in two versions, pictorial and verbal, in the source. This was to assess the effects of the pictorial and verbal versions of representations in the source problems on transfer performance. Thus, each level of similarity also consisted of two groups, according to the versions of the source problem.

Two target problems, namely the Lab Problem and the Almond Problem, together with their source analogies, were constructed by the researcher. The

source problems were pictorially or verbally represented, at either strategy or procedural levels of similarity. The information represented in the source models is a process that involves operations of numerals and objects depicting changes from an initial state to a goal or desired state. Thus, it is considered a dynamic representation but different from animation in that the information is persistent.

Analogous problems, namely Bar 1 and Bar 2, were pictorially represented, while Ball 1 and Ball 2 were verbally represented in the strategy and procedural levels of similarity, respectively, in the source for the Lab Problem. Similarly, another set, namely Jug 1 and Jug 2 in the pictorial and Art 1 and Art 2 in the verbal format in the two levels of similarity strategy and procedural respectively, were constructed as source analogues for the Almond problem (Appendix C).

There is sufficient evidence that when only an abstract idea is given in the source problem (for example, the principle level) there is often failure in transfer (Chen, 2000, 2002; Novick & Holyoak, 1991). In Experiment 2, the principle level of similarity was not used because the focus was on identifying those factors that help in optimizing cognitive processes, such as noticing, retrieving, and mapping, considered crucial for effective transfer. Moreover, the principle level of similarity was omitted also because the results of previous experiment in this study clearly indicated that this level of similarity often resulted in failure of complete transfer. This is obviously because a general idea only in the principle level of similarity did not depict a step-by-step process to be understood in the source and implemented in the target problem.

In the strategy level, Group 1 took the pictorial version of the Jug 1 problem, and Group 2 took the verbal version of the same problem, called Art 1.

At the same level, the Ball 1 verbal problem corresponds to the Bar 1 pictorial problem. Thus, the design consisted of two groups in each level of similarity (Figure 5.1). Each group, which consisted of 21 participants, was given two isomorphic problems at the strategy or the procedural level.

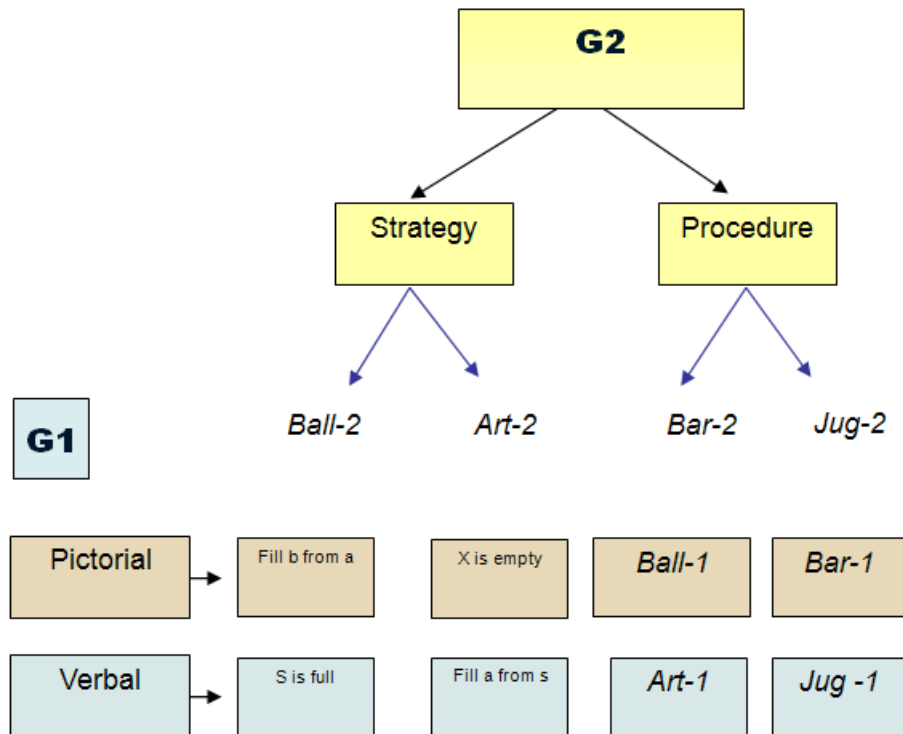

Figure 5.1: The various problems used according to levels of similarity and type of representation

Construction of Problem Tasks

In analogical problem solving, it is assumed that experience gained from a general solution principle or rule in one instance (source) helps solve a target problem that differs in superficial features but has a similar goal structure or solution.

This experiment aimed to assess the effects of two representations (pictorial and verbal) of the source problem on transfer performance. According to Larkin and Simon (1987), sentential and diagrammatic representations both

use a set of symbolic expressions to define the problem. In sentential representations, the expression is translated into simple formal language while, in diagrammatic representations, each expression or element contains information that is stored in a location in the diagram.

The following steps were involved in building the tasks for this experiment. First, a target problem was constructed in verbal form. Second, it was translated into a sequence of formal sentences that were, in turn, translated into a diagram. The data structure in verbal representations consisted of several statements that described objects and their functional relations in the Arabic language. On the other hand, for the pictorial form, the same information is depicted in terms of state, location, and movement of each element or object.

The basic problem task for the target problem (Almond) was derived from Luchins' (1942) classic water jug problems. The second target problem (Lab) is derived from the odd-one-out problem, in which the goal is to determine which item, from among other similar items, is different (Appendix C).

The source problems have been manipulated to depict either a strategy or procedural similarity with the target problem. In these two levels the solution process depicts different item-specific operations for solving problems involving different quantity types. Thus, while in the procedural similarity the operation (process) required is the same as the target, in the strategy level both the item-specific operations and quantity types differ from those required by the target problem. For example, estimating volume rather than weight has been used in the source problems at the strategy level because of the need to depict the same principle of estimating a certain amount of liquid by adding or subtracting from the available measures. Chen and Mo (2004) also used different quantity types,

such as length, area, volume, and weight, which involve physical item-specific manipulations for solving the problems. The transfer of a solution from one type of quantity (e.g., volume problem) to another (e.g., weight problem) also requires the transformation of the specific strategy or procedural operations.

Moreover, the theme of the problems has been maintained in all the experiments conducted so far. That is, all the problems revolve around estimating quantities without adequate measures by using a simple mathematical operation of addition or subtraction. For example, the Salt problem in Experiment 1 has been replaced by the Almond problem in this experiment. Estimating weights without any mathematical operation, such as in the Elephant problem used in Experiment 1, has been replaced by the Lab problem in this experiment.

Levels of Abstraction

Experiment 2 also aimed to study the interaction effects of modality or type of representation and levels of similarity. It had been established by Chen (2002) and Experiment 1 that the level of abstraction or similarity between the source and target problems influences the effectiveness of transfer in analogical problem solving. The source problems share either a strategy or a procedure with the target problem. Procedural is differentiated from strategy level of similarity, in the extent to which the solution illustrated in a source analogue, is similar to that required by the target solution.

The Strategy Level: Here the source analogue and target problem share a general principle along with a concrete strategy to implement it. However, they still differ in the concrete operational details required to solve the target as no procedure is given that could be applied directly to solve the target problem. An

example of the source model at the strategy level for the Almond target is the Art 1 problem in verbal and the Jug 1 problem in pictorial format.

The Procedural Level: Procedure is defined as the transformation of a general solution principle or idea into concrete operations (a sequence of actions) relevant to attain a goal. The source and target share a similar solution not only at the more general levels, but also at the most specific level in their concrete procedural details. The similar procedure models, therefore, describe the exact method that can be directly applied to solve the target problem. Examples are the Art 2 source problem for the Almond problem in the verbal form and the Jug 2 problem in the pictorial form. The source problems for the Lab problem are the Ball 2 and the Bar 2 problems. Thus, the two sets of source problems depicted a solution process that was represented at the strategy and procedural levels of similarity in two modalities: pictorial and verbal. Task analysis for all the problems chosen for this experiment were undertaken to ensure their informational and computational equivalence (Appendix D).

Results

The dependant variable (transfer) was quantitatively analyzed in two ways: first, in terms of mean transfer performance, strength of transfer (ST), on the target problem; second, in terms of number of solvers/non-solvers. Mixed ANOVA with repeated measures was used to assess mean transfer performance according to type of representation (verbal and pictorial) as a within-subjects' factor, levels of similarity (strategy and procedure) as the between-subjects' factor and the interaction effects of these two factors. Percentages were used to compare the number of solvers and non-solvers according to type of representation and levels of similarity in the source and target problems. Chi-

square tests were used to compare the number of solvers according to type of problem (sources 1 & 2 and their target problems), types of representation (pictorial and verbal), and levels of similarity (strategy and procedural).

ANOVA Results

The mean transfer performance was measured on a four-point effectiveness (ST) scale of 0 to 3. In this experiment, the degree to which the participants generated the correct solution performance indicated the strength of transfer from the source model to the target problem. Mixed ANOVA was used to verify the hypotheses of the study. The model was mixed in terms of types of representation and levels of similarity. ANOVA results revealed a within-subjects' main effect for type of representation $F(1, 82) = 6.995$, $MSe = 4.339$, $p < .01$ and a between-subjects' main effect of level of similarity on target problem performance, $F(1, 82) = 8.895$, $MSe = 15.482$, $p = .004$, thereby supporting the predictions of this experiment. However, no interaction effect was found between the two independent factors type of representations and levels of similarity $F(1, 82) = .47$, $MSe = .292$, $p = .495$.

Analysis of the combined source and target scores was also undertaken to assess the effect of the two types of representation and levels of similarity on performance as a whole. A participant's score on the source problem ranged between 0 to 2 and the target performance was rated on a scale of 0 to 3. Scores on these two problems were added to yield a combined score for each (source + target) problem. The mean performance on pictorial was higher ($M=2.96$, $SD = 1.56$) than verbal ($M = 2.29$ with $SD = 1.64$). A main effect for type of

representation was found on the combined source and target problem performance $F(1, 82) = 15.373$, $MSe = 1$, $p < 0.0001$.

A main effect of the levels of similarity on the combined source and target performance was also found $F(1, 82) = 6.06$, $MS2 = 22.149$, $p = .016$. It was observed that the mean performance on the pictorial type ($M = .691$ $SD = .781$) in the strategy level was similar to the verbal type ($M = .714$ $SD = .742$) in the procedural level. Again, no interaction effects were found between these two factors $F(1, 82) = .8$, $MSe = 1.006$, $p = .374$.

Solvers and Non-Solvers

This section deals with analysis that was undertaken to assess the performance pattern of each group. Problems were designed to represent two levels of similarity (strategy and procedure) in two types of representation (verbal and pictorial). Each problem was also depicted in two versions, pictorial and verbal, in the source to assess the effects of representation of the source problems on transfer performance. Thus, each level of similarity consisted of two groups according to the versions of the source problem (Figure 5.1). In the strategy level, Group 1 took the pictorial version of the Jug 1 problem and Group 2 took the verbal version of the same, called Art 1. On the same level, the Ball 1 verbal problem corresponds with the Bar 1 pictorial. Thus, the design consisted of two groups in each level of similarity. Each group consisted of 21 participants. Each participant was given two problems (PS + VS and their targets) at the strategy or the procedural level.

Participants' performance on the source and target problems is described below. The scores for the source problem ranged from 0 to 2, where a score of 0 indicates a non-solver and scores of 1 and 2 are regarded as solvers for giving

either a general understanding of the source or a complete and accurate understanding, respectively. The performance on the target problem was rated on ST scale of 4 ranging from 0 to 3. A participant receiving a score of 2 and 3 was regarded as a solver of the target problem while those receiving scores of 0 and 1 were non-solvers.

Table 5.1 shows the percentage of solvers according to type of representation (verbal & pictorial) in each level of similarity (strategy & procedural) for source 1 (pictorial source PS and its target the Almond problem) and source 2 (verbal source VS target, the Lab problem). The percentage of participants who solved Source 1 correctly at the strategy level were 81% and 62% in the pictorial and verbal forms, respectively, and at the procedural level 91% and 81% in the pictorial and verbal forms, respectively. The analogue target (Almond problem) for Source 1 was solved by 33% and 38% of participants in the pictorial and verbal forms, respectively, of those who took the source at the strategy level and 57% and 52% in the pictorial and verbal forms, respectively, in the procedural level.

Table 5.1

Solvers according to Level of Similarity and Type of Representation

Problem	Level of Similarity			
	Strategy		Procedure	
	Pic.	Ver.	Pic.	Ver.
	n = 21	n = 21	n = 21	n = 21
Source 1	17 (81%)	13 (62%)	19 (91%)	17 (81%)
Source 2	19 (91%)	13 (62%)	17 (81%)	13 (62%)
Target 1 (Almond)	7 (33%)	8 (38%)	12 (57%)	11 (52%)
Target 2 (Lab)	7 (33%)	5 (24%)	16 (76%)	10 (48%)

Table 5.2 shows the crosstabs of the four groups in terms of the number of participants who solved each source problem, according to type of representation and levels of similarity. First, those who correctly solved both Source 1 and its Almond target problem were 24% and 38%, in PS and VS respectively, at the strategy level and 57% and 48% in the procedural level. It also shows the results of Source 2 and its target, the Lab problem.

Table 5.2

Solvers of both the Source and its Target Problems

Level of Similarity		Target (PS)		Target (VS)	
		Solver		Solver	
		n= 21		n= 21	
Strategy	Source 1	Solver	5 (24%)	8 (38%)	
	Source 2	Solver	7 (33%)	5 (24%)	
Procedure	Source 1	Solver	12 (57%)	10 (48%)	
	Source 2	Solver	16 (76%)	8 (38%)	

In order to assess if there is any significant difference according to type of representation, the solvers of source problems 1 and 2 of Almond and Lab target problems respectively (Table 5.3) in the PS and VS were compared irrespective of levels of similarity. Each participant took two source problems, one in pictorial format (N = 84) and one in verbal format (N = 84). This being a repeated measure, a non-parametric test of Wilcoxon signed rank test was applied. There was a significant difference between the representation ($z = -2.69$, $N\text{-ties} = 57$, $p = .007$, two-tailed).

On the other hand, a comparison of transfer performance on the target problem according to type of representation, that is verbal and pictorial source, a significant difference was found between the representations ($z = -2.67$, $N\text{-ties} = 67$, $p < .01$, two-tailed).

Table 5.3

Solvers for Source Pictorial and Source Verbal Scores

		Source verbal score	
		Not Correct	Correct
Source pictorial score	Not Correct	44	6
	Correct	21	13

To compare the solvers of the target Almond (source 1) and Lab (source 2) analogues in the PS and VS, simple chi-square tests were used. The correct and complete solutions were 18 and 16 for the Almond and Lab problems, respectively, in the pictorial source, and 9 and 10 for the Almond and Lab problems in the verbal source. No reliable differences were found between the target analogues in source 1 and 2 of the pictorial representation $\chi^2(1, N=84) = .198, p = .657$. Likewise, in the verbal form, no reliable differences were found between the target analogues $\chi^2(1, N=84) = .064, p = .794$.

As no difference was found in the performance of the target analogues for Almond and Lab, the data was combined to get a single composite score in order to compare the overall performance of the groups according to representation, such as Almond + Lab scores of PS or Almond + Lab scores of VS.

Solvers of the source problem

Solvers were compared according to type of representation and levels of similarity in the source problem. The Wilcoxon signed rank test found a significant difference between the solvers of pictorial and verbal source representations ($z = -2.69, N\text{-ties} = 57, p = .007, \text{two-tailed}$).

Solvers of the source problems in the strategy level were 13 and 10 in the pictorial and verbal forms, respectively. This difference was found not significant $\chi^2(1, N=42) = .504, p = .478$. On the procedural level, the number of

solvers were 21 and 9 in the pictorial and verbal forms, respectively with $\chi^2(1, N = 42) = 11.45, p = .001$, indicating a significant difference.

Paired t-test was used to assess problem-solving performance in terms of mean performance on the source problems. Performance on pictorial representation was significantly higher than the verbal with $t(83) = 4.085, p < 0.001$.

Solvers of the Target Problem

In the target problem the range of scores is 0 to 3, where scores of 2 and 3 are considered as solvers for coming up with at least a high partial or a complete solution, respectively. The number of solvers in the pictorial and verbal representations of the strategy level were 16 and 12, respectively. At the procedural level, the solvers were 28 and 21 in the pictorial and verbal forms, respectively with a chi-square of $\chi^2(1, N = 42) = 15.463, p < .001$, indicating a significant difference.

The target problem solvers of pictorial representations according to the two levels; strategy and procedural, were 16 and 28, respectively $\chi^2(1, N = 84) = 6.87, p = .009$ which was found to be significant. The results of the verbal target problem-solving showed 12 and 21 solvers in the strategy and procedural levels of similarity, respectively, with a significant difference $\chi^2(1, N = 84) = 4.04, p = .044$.

The mean performance on the pictorial target problem of the pictorial form was found to be higher ($M = 1.7$ and $SD = 1.07$) than the verbal form ($M = 1.38$ and $SD = 1.17$). Results of paired t-test showed this difference as significant $t(83) = 2.65, p = 0.01$ as shown in Table 5.4.

Table 5.4

Mean and SD According to Levels and Conditions

	Strategy		Procedure	
	n = 42		n = 42	
	Mean	SD	Mean	SD
PS	1.17	0.66	1.36	0.73
VS	0.88	0.77	0.93	0.71
Total (n = 84)	1.26	0.70	0.90	0.74
Target (PS)	1.36	0.98	2.05	1.06
Target (VS)	1.12	1.11	1.64	1.19
Total (n = 84)	1.38	1.17	1.70	1.07

Other Important Findings

In Experiment 2, time was recorded for all the four groups. The average time spent was 277 sec. and 186 sec. in the source problem of the pictorial and verbal type of representations respectively which was found significant in the paired t test $t = (25) 10.46, p < 0.0001$. In the target problem, however, no significant differences was found in the average time participants spent of 400 sec. and 460 sec. in the strategy and procedure levels, respectively.

All participants were required to answer some questions in written form. Theses retrospective report undertaken to know which type of representation (verbal or pictorial) they preferred (in the source problem) and found more helpful in solving the target problem. The percentage of participants who reported that they benefited from the pictorial type of representation was 64% and those who said they benefited from the verbal type of representation was 45%. On the other hand, solvers (83%) said that they benefited from the pictorial form, as compared to 62% who reported they benefited from the verbal form. This difference was found not significant.

About 50% reported that they did not see a connection between the source and the target problems, irrespective of type of representation. Among the non-solvers of the source problem, 14% misinterpreted it in the pictorial type, while 28% either misinterpreted it or did not attempt to solve it in the verbal type.

Discussion

Experiment 2 examined and compared both the pictorial and the verbal forms of representation at two levels of abstraction: strategy and procedure. The results revealed that, in problems involving a multi-step process (procedure) to be learned and applied through analogical reasoning, procedural level of similarity combined with pictorial representation is more effective than verbal representation in enhancing transfer performance. The results also showed a higher mean performance in the pictorial source problems as compared to verbal. Interestingly, it was also observed that the combined source and target performance scores in the pictorial type of the strategy level of similarity were almost equivalent to the verbal type in the procedural level of similarity.

Critical analysis of the findings

How does the level of similarity affect transfer?

The results of Experiment 2, with respect to levels of similarity, are largely consistent with Experiment 1. What differentiates the procedural level from the strategy level of similarity is that the former demonstrates procedural operations along with the physical object manipulations necessary for solving the problem. In Experiment 2, the type of quantity used is weight equivalence, where a goal weight is achieved by adding to and/or subtracting from the available weights or measures. For example, a general principle could be $A - (B$

+ C + D) where A is the total quantity and B, C, and D are weights of containers of different sizes. Although the general principle of the solution, adding or subtracting, is the same for all problems, the procedural operations involved in the manipulation of quantities for the principle level differ compared to the strategy level.

This experiment demonstrated that when participants experience a problem that could be solved with similar operations, performance is usually better in the procedural level of similarity. These findings are consistent with Novick & Holyoak (1991), Chen (2002), and Chen and Mo (2004).

It was also confirmed, as predicted, that when a pictorially represented source problem shares a procedural level of similarity with the target problem participants' performance is better than in verbal representation. These findings are in agreement with Zhang and Norman (1994), who observed that different representations for isomorphic problems have different efficiencies; that is, even with concrete operations and procedural levels of similarity, there are still differences in problem-solving behavior. In addition to the positive and significant influence of procedural similarity, pictorial representation was also shown to be more effective than verbal representation at the strategy level.

How does modality of representation affect transfer?

In general, it is difficult to determine which representation (verbal or pictorial) is more advantageous for a certain task, using both types of representations verbal and pictorial. Experiment 2 helped determine the preferred representation for procedural problems. The findings clearly demonstrated that pictorial representations made it easier for participants to transfer knowledge to the target problem because they constructed a mental model by perceiving the

problem as a series of images that were processed by noticing the relations, superficial features, and the movement of objects between successive images. Analysis of responses also revealed that, in the pictorial representation, participants perceived both the object and the associated properties depicted (such as small, large, etc.), and therefore tended to develop a corresponding internal representation that may help in solving the target problem. This is consistent with the observations of Gilmore and Green (1984) that, as mental models gained by pictorial representations depend upon reenacting simulations, they make behavior available for application in a new situation.

In contrast, to the pictorial representations, verbal representations generated more variability in comprehension. For example, participants in the source verbal problem (Art 1 Problem and Art 2 Problem) were often found to manipulate the three measures (the key tools needed for the operating process to reach a goal) in different ways that were often contradictory to that explicitly stated in the problem. Some examples of the responses in the verbal form are as follows:

- The easiest way is to fill the 5-cup container three times, because it is closest to the required 16 cups. (Art 1 problem)
- We can weigh each ball against the other to find the odd ball (Ball 1 problem).

This observation confirmed the findings of Reed (1999) who described the cognitive operations involved in solving word problems. He is of the view that a person must use linguistic knowledge to translate the givens and goals of the problem followed by the integration stage, which involves the identification of implicit relations and constraints. Lastly, the problem solver must organize this information into mental schemas or situation models, which are stored in memory as strategic knowledge that perhaps results in “cognitive overloading.”

The findings of Experiment 2 showed that participants in the pictorial representation indexed information by location which affected the process of noticing relations among the objects. On the other hand, in the verbal representation, each sentence is translated into formal language and then examined for meaning and relations between the words and other sentences which perhaps imposed an additional burden of understanding the text. These findings are also in line with Larkin and Simon (1987), who emphasized that the difference between pictorial and verbal representations is that the former explicitly preserves the information and shows the topological and geometric relations of the objects, while the latter maintains other kinds of relations, such as logical or hierarchical. They suggested that diagrams are considered to be perceptual chunks that represent related information at adjacent locations, thereby making inferences of relevant information easier. The richness of imagery or mental animation allows for the discovery of new relations that are not immediately apparent in the verbal statement of the problem.

The process of analogizing depends upon three main cognitive processes: selective encoding, mapping, and transfer. The cognitive process of selective encoding involves identifying the relevant information in the source and mapping it to the target. In Experiment 2, this activity was found to vary as a result of the type of representation. For example, a participant in the pictorial representation at the procedural level (Lab target problem) used a self-diagram to explain the solution steps. Another from the same group indicated the application of selective encoding by grouping the jars in the target just as given in the source problem. On the other hand, there were recurring errors in selective encoding when the source problem was verbal. Although some successfully solved the

verbal source problem, the information retrieved to solve the target problem was often found less adequate, resulting in an incorrect solution.

In the example given below (source strategy, pictorial form, Bar 1 problem). it can be seen that the participant understood the pictorial representation of the source problem by showing a successful adaptation of both the process and the objects in the source problem to the target problem.

Participant 1 (source strategy, pictorial form, Bar 1 problem).

- In the first frame, the picture shows an empty tray on a scale, with four bars on the right and four bars on the left side.
- In the second frame, the tray has four bars taken from the right side, which weigh 8kg.
- In the next frame, the two bars taken from the left side are 5 kg, and thus not equal.
- In the last frame, one bar, weighs 3kg which is the odd one.
- Participant 1 (solutions for the Lab Target problem and full successful transfer):
- Put four jars on each side of the balance.
- If they are equal we take the next four.
- Otherwise we take the heavier group.
- We then split them into two groups of two jars.
- Determine which of the two is heavier.
- Then weigh the two on the heavier side against each other.

An illustration below of the verbal representation of the source at the strategy level shows that the problem solver tended to re-represent the information given in the problem in detail, perhaps to develop a clear mental picture. Nevertheless, the participant failed in adapting the process aspect of the solution to solve the target problem. This could probably be attributed to the lack of ease in retrieving information from verbal stimuli. According to Zhang (2001), external representations are not simply inputs and stimuli to the internal mind. They are more than memory aids, because they constrain and determine the pattern of cognitive behavior and the way the mind functions.

Participant 2 (source strategy, verbal form, Ball 1 problem):

- Sondus divided the balls into three groups.
- Each group consists of four balls.
- She put in the tray the first group and noted the weight.
- She then put the next group of four and noted the weight.
- If the two groups weighed the same, it meant that the odd one is in the third group.
- Otherwise, the lighter ball is in the group that weighs least.
- After determining the group that contains the lighter ball,
- She divided the four groups into two groups, and compared the weights.
- The group of two that is lesser in weight is identified,
- And the two balls are then weighed separately to determine the lighter one.

Participant 2 (solutions for the Lab Target problem Low Partial transfer):

- Divide the jars into four groups of three each.
- She weighed each group against the other.
- The heavier group of three can be weighed by hand two at a time.

Comparing the responses of participant 1 and participant 2 on the two forms of representation at the strategy level, it was observed that, when a connection between the source and target is noticed and the verbal and pictorial problems are informationally equivalent at the source level, the efficiency in solving the target problem is influenced more by the pictorial type of representation.

Similar findings were also reported by Cox (1997), who observed that diagrams, graphs, and pictures, which are forms of external representations, are more beneficial than verbal representation. These results are further supported by Butcher (2006), Ainsworth and Loizou (2003), and Zhang (2001), who reported that diagrams are more effective than sentential representation. Therefore, the assumption that a pictorial type of representation influences performance more in problem solving through analogical reasoning, was confirmed. The findings of this experiment also provide further support to the observation that problems

requiring a step-by-step procedure to solve lend themselves easily to the pictorial type of representation.

Analysis of retrospective reports of participants indicated that a majority of them (83%) preferred pictorial representation. Comparing the sources of misinterpretation in the two forms of representation, 14% of the non-solvers of the source problem, misinterpreted it in the pictorial type, while 28% either misinterpreted it or did not attempt to solve it in the verbal type. A common source of misinterpretation in the pictorial form was that it tends to elicit projective responses. For example, a participant who viewed the pictorial representation of the Bar problem described each colored bar as a situation in life, thereby projecting her own meaning into the picture. Another source of error in pictorial representation was seeing each frame in itself. This failure to see the relationship among the pictures was, perhaps, because the participant failed to notice the arrows.

On the other hand, in the verbal form there is a tendency towards erroneous internal representation of the external information, or the inability to understand the logical relationships among the statements of information, or failure to notice the goal or the failure to derive an equation that is described explicitly in words. For example, in the Lab problem, to get the 15 cups required, a participant gave an equation of $(24 - 15 = 7)$, and then multiplied it by 2, which was again divided by 3. The required equation was merely to add the three measures $(2 + 7 + 6 = 15)$. An example from the Art problem, is when a participant used the tools to mix the paint but not to measure it, showing a wrong understanding of the goal.

How is time spent on problem solving related to levels of similarity and type of representation?

Experiment 2 also revealed that participants in a pictorial representation for the source problem spent significantly more time processing the source problem than those given the verbal form. However, no significant difference was found between the average time participants spent in the strategy level and procedural levels in the target problem. The additional time spent by participants on the source problem with the pictorial representation can be explained by the extra time needed to correctly interpret the images. Pictures tend to appear mysterious or ambiguous until a person becomes actively involved in encoding the objects in the different pictures and deriving coherent relations between them. This operational cost of spending more time to comprehend the images seems to help in developing a deeper or better understanding of the problem that helps increase the effectiveness of transfer.

What differentiates solvers from non-solvers?

It is also important to assess the transfer performance in terms of solvers (who score 2 or 3) and non-solvers (who score 0 or 1) in the target problem. In the pictorial representation, solvers gave a holistic description of the problem by analyzing each frame in terms of the process it depicted and figuring out what each meant in reaching a logical conclusion. In contrast, non-solvers tended to only superficially analyze the diagram and, as such, often misinterpreted the intended meaning of the relations between objects in the pictures. This often resulted in participants learning only part of the meaning, which in turn greatly affected understanding of the problem and ability to transfer knowledge to the target problem.

On the other hand, in the verbal representation, solvers tended to focus on both the process and the characters/objects described, while non-solvers focused on either the process or the context (object), were more dependent on the semantic meaning of the words, and tended to read the problems faster.

Contributions and Limitations of Experiment 2

Experiment 2 was successful in investigating and comparing the difference between pictorial and verbal representations in analogical problem solving. Specifically, the within subjects' design of the experiment contributed towards understanding the effect of verbally and pictorially represented (informationally equivalent) source problems in procedural level of similarity on strength of transfer performance.

This experiment also contributes to the methodology of constructing isomorphic problems in two different formats while taking into account the computational and informational equivalence. The construction, of both representations (verbal and pictorial) is well described to guide other researchers.

A major limitation of this experiment is that it did not use think aloud protocols to compare the cognitive processes revealed in the pictorial and verbal forms of representation. Moreover, the experiment did not use a self-support method, self explanation or any other, in the verbal and pictorial representations to compare its effects on transfer. As such, it was observed that half of the participants reported that they failed to notice a connection between the source and target. It was also observed that while a participant in the pictorial format supported herself by representing diagrammatically the source problem while solving its target, in the verbal format one participant also resorted to diagrams to understand the verbal problem.

Thus, having addressed the issue of using different or same formats of representation in this experiment it was considered useful to use both these formats (Pictorial and verbal source) again to assess the effectiveness of SCD, as a self-support method, on transfer performance in the next Experiment 3.

Conclusion

This study was primarily undertaken to complete the understanding of other factors, besides levels of similarity, that influence transfer performance in analogical problem solving. Experiment 1 investigated the effect of think-aloud protocols of self-explanation on transfer which also helped determine the cognitive processes and sub-processes that influenced analogical problem solving. Although, self-explanation and procedural similarity showed a profound effect on transfer performance, it was considered essential to address some issues related to the comparative effects of the two types of representations, verbal and pictorial, and their interaction with the strategy and procedural levels of similarity on the problem-solving performance by analogical reasoning.

The results of Experiment 2 revealed, as predicted, a main effect of type of representation and level of similarity on the target problem performance, supporting the prediction that pictorial representation and procedural similarity enhance transfer performance. A within-subjects main effect of type of representation revealed that pictorial representation was more effective than verbal in transfer performance. However, no significant interaction effects were found between the two independent factors: type of representation and levels of similarity. Analysis of the combined source and target scores found that performance on the pictorial type in the strategy level was similar to the verbal type in the procedural level. Therefore, the assumption that a pictorial type of

representation influences performance more in problem solving through analogical reasoning was confirmed.

In Experiment 1 it was observed that none of the participants attempted to use diagrams in conjunction with SE while solving the problems or retrieving information. In Experiment 2 although the absence of a self-support method resulted in half of the sample reporting that they did not see a connection between the source and the target problems, two participants resorted to self-diagrams to gain a better understanding. These observations formed the basis for investigating another self-support method, self-constructed diagrams, as a tool in optimizing the crucial cognitive processes in analogical problem solving in Experiment 3.

CHAPTER 6: THE ROLE OF SELF-CONSTRUCTED DIAGRAMS IN ANALOGICAL PROBLEM SOLVING

Introduction

Experiment 1 found that problem-solving performance is significantly enhanced when combined with the self-explanation method and procedural similarity. However, the protocols revealed that despite self-explanations, failures or errors in performance persisted due to lack of some cognitive processes considered crucial. Thus, although self-explanation helped gain better understanding by increasing meta-cognitive activities, such as monitoring progress towards the goal and justification of actions, it perhaps failed to reduce the working memory load, which affected the retrieval and mapping processes. This was also attributed to the different forms of representations used in the source (pictorial) and target (verbal) problems. Therefore, this issue of dissimilar source and target formats of representation was investigated in the second experiment, where direct comparisons were undertaken between the two types of representation (verbal and pictorial) in a within-subjects experimental design. The findings of Experiment 2 showed that the strength of transfer was significantly higher in the pictorial source /verbal target than in the verbal source /verbal target condition of representation. Nevertheless, in the same experiment, as no self support method was used, it was also found that about 50% of the participants reported that they did not see a connection between the source and the target problems irrespective of type of representation.

Thus, having ensured that the type of problem representation used in the previous experiments, is not the main cause underlying failure to adapt a solution

process, the researcher returned to the basic issue of the study, which was to find an effective self-support method that could replace external support (such as hints, schema induction, MMR etc.) in enhancing transfer performance.

Ainsworth and Iacovides (2005), Van Meter (2001), and Van Meter et al. (2006) are among the recent researchers focusing on factors that enhance learning. They used and found that self-constructed diagrams increased learning performance by activating crucial cognitive processes and simultaneously reducing cognitive load. Thus, in this experiment, it was proposed that using self-constructed diagrams (SCD) as a means of self-support may help reduce the number of non-solvers and enhance transfer performance, by increasing the probability of eliciting the crucial cognitive processes that facilitate noticing of commonalities and differences in the source and target problems. Two main issues were addressed:

1. Does using self-constructed diagrams (SCD) overcome the problem of noticing and retrieval and enhance performance?
2. Do self-constructed diagrams reduce the differing effects of the type of representation (verbal and pictorial) on performance?

The Importance of Externalizing Representation

In the last two decades, multi-media learning environments have widened to include combinations of representations, such as diagrams, equations, tables, text, graphs, animations, sound, video, and dynamic simulations. These multiple external representational (MER) systems have been found to be effective in enhancing learning; they allow flexibility by distributing information in a way that simplifies each representation. However, they also have the disadvantage of adding to the cognitive load of the learner due to switching among

representations and integrating additional and/or redundant information. As observed by Ainsworth (2006), there is a tendency of learners to treat representations in isolation that, along with facing difficulties in integrating information from more than one source, has produced mixed results in MER research.

Researchers (Ainsworth & Van Labeke 2002, Ainsworth & Burcham 2007; Chi et al 1989; Chi et al. 1994) tested the notion of externalizing representation (ER) by drawing a diagram to help interpret the initial internal representation into an external stimulus, which upon re-processing, helps in finding a solution. They found that high explainers generated more diagrams while self-explaining, thereby concluding that drawing diagrams is an alternative constructive activity for enhancing learning. Anderson and Helstrup (1993) used the term perceptual assistance to describe the facilitating effect of externalization (drawing) upon the synthesis of novel patterns from simple shapes.

Cox and Brna (1995) and Cox (1997) referred to work scratchings (self-constructed diagrams) as external representations, and observed that even when some learners drew incorrect representations, they nevertheless came up with correct inferences. This perhaps implies that while drawings may not be perfect re-representations, they still serve as tools that stimulate and support the problem-solving process. Tversky (1999, 2002 & 2005), who carried out exhaustive research in the nature and usefulness of graphics in understanding the pragmatics of linguistic and pictorial communication, described drawing elements as a dialogue that problem solvers conduct with themselves that reveals their underlying mental organization or conceptual structure.

Van Meter (2001) studied the benefit of student-generated drawings as a learning strategy in fifth and sixth-grade. Drawing methods involved providing participants with blank paper and a pencil and instructing participants to make a picture to show the important ideas in text. Three experimental drawing conditions and a reading control tested the hypothesis that drawing is effective only when students are supported during the construction process. The drawing participants group constructed drawings only, whereas illustration comparison participants compared drawings with a provided illustration. Prompted illustration comparison (PIC) participants answered prompting questions to guide this comparison process. Van Meter found that (PIC) participants constructed the most accurate drawings and scored significantly higher on the free-recall posttest.

The above review shows methodological variations in self constructed diagrams research specifically, in using drawing methods, in the types of participants (ranging from first grade to college students), in the problem content including science topics (Van Meter, 2001), and math word problems and social studies (Heiser & Tversky, 2002). Outcome assessments have also varied across studies with free recall, comprehension, and recognition to posttests. Despite these methodological variations, there is abundant evidence that self-constructed drawings enhance meaningful learning through hands-on activity. Experiment 3 is designed to test the effect of self-constructed diagram in both verbal and pictorial representations.

Some cognitive theories that lend support to the effectiveness of self-constructed diagrams in learning in general are briefly discussed here. Mayer's (2001) theory of multimedia learning is based on the human information processing system, which consists of dual channels for (visual/pictorial and

verbal) processing both of which have a limited capacity for processing. Active learning, according to this theory, entails coordinating cognitive processes in the two channels, by selecting relevant words or information from the textual and pictorial formats, organizing and integrating them with prior knowledge and generating a coherent verbal and visual representation. That MER enhances performance based on the notion that two representations are better than one, is also endorsed by (Ainsworth, 2006).

In the context of effectiveness of representations, the Cognitive Load Theory (CLT) provides guidelines for presenting information (verbally or pictorially) in a manner that stimulates learner activities to optimize intellectual performance and develop competencies, thus enabling learners to recognize and define new problems as well as solve them effectively (Kirschner, 2002). The CLT also proposes that working memory, which is used to organize, contrast, compare, or work on information, is limited because it can process only two or three items of information simultaneously, as opposed to holding information. As a result, there is a need to determine which methods of learning and problem solving assure that the limits of the learner's working memory load are not exceeded when processing information, but at the same time maintain an optimal load for the information to be transferred as a learning experience to the LTM.

Van Meter et al. (2006) proposed a processing model of drawing construction that is an extension of Mayer's Generative Theory of Textbook Design. Though, They found the model consistent with Mayer's in the processes of selection, organization, and integration, they also found some important differences related to the construction of the nonverbal representation (drawings), and the integration of the verbal and nonverbal representations. Van Meter et al.

(2006) observed that, as the verbal representation serves as the foundation for the construction of the nonverbal representation, the selection and organization of verbal elements are crucial processes in the drawing strategy. The nonverbal representation thus, serves as the internal image the learner depicts in a drawing. This entire process is interpreted as being recursive (Van Meter et al., 2006). To summarize, the Generative Theory of Drawing Construction emphasizes the process of integration, as an additional benefit of Self Constructed Diagrams.

Thus, there is ample theoretical and empirical evidence that self-constructed diagrams (SCD) are effective personal interactive ERs, facilitating better understanding when learners construct a coherent mental representation from the presented material. They are also considered a more practical and easier alternative to think-aloud (self-explanation), hints, MERs, and MMRs for enhancing problem-solving performance.

Experiment 3

This experiment was conducted to compare the effect of SCD on transfer performance in problem solving by analogical reasoning. The source problems were represented in pictorial and verbal representations at two levels of similarity, while the target problems were represented verbally.

Hypotheses

It was hypothesized that:

1. The condition of self-constructed diagrams (SCD) will have a positive influence on performance (strength of transfer) more than the condition of ND.

2. Participants in the procedural level of similarity will perform better than the participants in the strategy level of similarity in the self-diagram condition.
3. There will be no within-subjects significant difference between the performance in the two types of representations, pictorial and verbal, in the SCD condition.

It was predicted that constructing self-diagrams would have a positive effect on transfer for two reasons. First, in problem tasks, requiring some insight and concrete procedure the method of SCD, will help a person simulate the step by step process in the source problem, resulting in learning a solution process that increases the probability of retrieving and mapping activities. Second, the self-drawing activity not only helps generate more self-explanations, but is also an effective means of reducing working memory load (Ainsworth & Iacovides, 2005; Van Meter et al. , 2006). As stated by Cox (1999), the usefulness of external representation depends upon three-way interaction: (a) the semantic and cognitive properties of representation, (b) the task demands, and (c) the effects of within-subjects' factors, such as prior knowledge and cognitive style.

Moreover, as also viewed by Davies et al. (2003), two situations that may appear dissimilar non-visually may appear similar when re-represented visually, thereby helping develop some notion of similarity and reducing alignment problems that hinder analogical problem solving. For example, in this study the source problem depicts a method for weighing heavy objects. This information may or may not be recalled while solving the target problem that involves different elements, but requires the same method. However, when a person re-represents the situation in drawings, there is a tendency to see similarities or differences more readily in the two problems

Self diagrams, therefore, helps a person construct additional external representations that will guide or monitor his understanding of the problem and its solution. Re-representing the problem helps strengthen the logical understanding of the key elements and their functions. This is because in problem solving, constructing one's own representations tends to involve a person actively with the problem that, besides increasing the probability of noticing similarities and differences, helps the learner discover the crucial step (insight) that underlies the solution process. For example, a person may have solved the source problem correctly, yet is not able to see the connection with the target problem. However, while self-drawing, there is a probability that he will notice having done something similar, which helps in discovering the crucial step needed to solve the target problem. Moreover, just as the self-explanation method in Experiment 1 helped organize and integrate information, while mentally simulating a process, it was also expected that SCD would provide a stronger scaffold, by inducing an element of experiencing the solution process.

Methodology

Participants

One hundred and sixty female undergraduate students in the age range of 19 to 26 ($M = 21.19$, $SD = 1.31$) enrolled in Psychology courses at King Abdul-Aziz University, participated in this experiment for course credit.

Materials

Two target problems, and their source problems that were developed by the researcher in Experiment 2, were used here. The source problems (for target Almond and Lab problems) were depicted pictorially or described verbally, in the strategy and procedural levels of similarity.

A pilot study was conducted to determine the extent to which the problems are suitable for constructing diagrams. Eight participants were given two problems, one in the verbal, and the other in the pictorial representation with instructions to re-represent the problems diagrammatically. All the participants were given a brief demonstration of how to self-explain by sketching. The results of the pilot study indicated that the participants constructed diagrams for all the problems with ease, which indicated the suitability of the problems for this experiment. Figures 6.3 and 6.4 show some of those diagrams reproduced here.

Design

Figure 6.1 illustrates the design of the experiment according to the levels of similarity and drawing conditions. Each participant solved four problems: the Almond problem, the Lab problem (targets), and their source problems (according to the levels of similarity and drawing conditions assigned).

A three-factor mixed design was used. The first factor was the two levels of similarity (strategy and procedure). The second factor was the two drawing conditions (SCD and ND), and the third factor was a within groups measure of type of representation verbal and pictorial. The main dependant measure was the transfer performance score on the target problem (strength of transfer).

Thus, the design consisted of four groups; two experimental (SCD) and two control groups (ND). Group 1 was given two isomorphic problems at the strategy level, with the condition of instruction to construct self-diagrams. Group 2 was given two problems at the procedural level, with the condition of instruction to construct self-diagrams. Groups 3 and 4 (ND groups) were given the same two problems in the strategy and procedural levels, with no instruction to draw. This design helped assess the main effects of the level of similarity,

drawing condition, and type of representation on performance, along with their interaction effects (Figure 6.1).

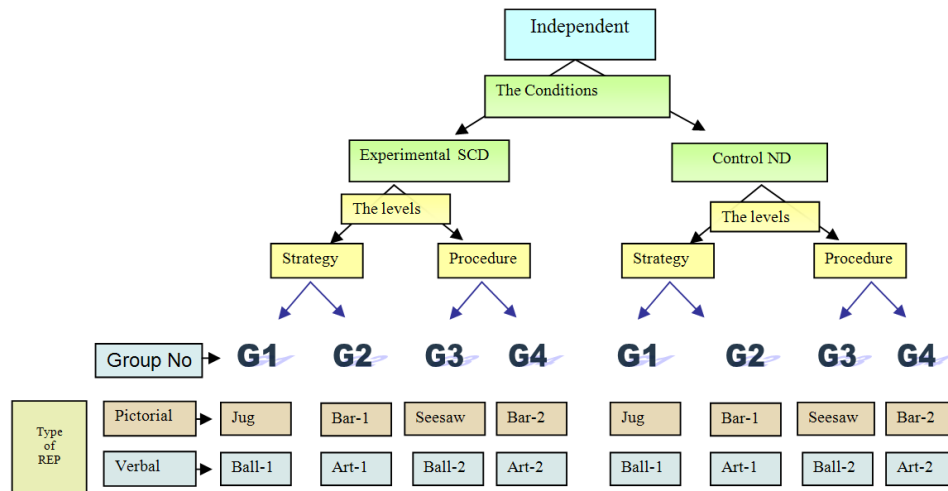

Figure 6.1: The design of the experiment: four main groups in each condition. Note. 'G': is group number.

Procedure:

Participants were randomly assigned to two main groups: experimental (SCD) condition and ND control groups. Each condition had two levels of similarity, either procedure or strategy. All groups took two types of representation: verbal and pictorial. Counter balance of order of representation (verbal and pictorial) of the source for the target problems (Almond and Lab) were also taken into account.

- The experiment was held in the meeting room of the social services department.
- Participants were assigned either to the SCD or ND conditions. The participants in the two conditions were tested in separate groups; so as to avoid the possibility of their influencing each other.

- Participants were tested in groups of 4 to 6, randomly assigned either to strategy or procedural level of similarity, after assigning to SCD or ND conditions.
- Each participant took two isomorphic problems (source problems and its target), one source in the verbal format and the other source in the pictorial representation, and their analogous target problems represented in verbal representation. No time limit was given in this experiment to ensure stress free performance. However, to compare how much time was spent in each type of representation, each participant was given a stopwatch to record the time of starting and ending each problem.
- A brief introduction, explaining the purpose of the experiment, was given.
- Each experimental group was given a demonstration of how to self-construct a diagram.
- The participants were first assured that it is not a test of their intelligence or abilities. They were informed that it is a problem-solving task, through which the researcher wants to understand how one goes about solving problems.
- The participants were specifically instructed to give details and explain by self-drawing every action taken, while solving the problem
- A practice session was given to make sure that all the participants understood the procedure of self-explaining diagrammatically, in both the verbal and pictorial representations.

The instructions for SCD and ND conditions for verbal and pictorial representations were given, instruction 1 and 2 for SCD conditions while instructions 3 and 4 for the ND conditions, both orally and in written form as follows:

Instruction 1 for the pictorial format:

Please look carefully at the sequence of pictures, and write the meaning or what they convey or your understanding of the problem. Then, self-explain the problem diagrammatically using any shapes, arrows, and elements as well as words or phrases to clarify your drawing. And finally, solve the problem by writing all the steps that are needed for solving the problem.

Instruction 2 for the verbal format:

Please read the problem carefully, and write the meaning or what they convey or your understanding of the problem. Then, self-explain the problem diagrammatically using any shapes, arrows, and elements as well as words or phrases to clarify your drawing. And finally, solve the problem by writing all the steps that are needed for solving the problem.

Instruction 3 and 4 for the ND condition:

Please look carefully at the sequence of pictures and write the meaning or what they convey and your understanding of the problem. And solve the problem, by writing all the steps that are needed for solving the problem.

Please read the problem carefully and write the meaning or what they convey and your understanding of the problem. And solve the problem, by writing all the steps that are needed for solving the problem.

Scoring

Quantitative Scoring

The framework of scoring is similar to the one used in Experiments 1 and 2.

Source problem scoring: Participants' comprehension of the source models was assessed by evaluating their interpretations of the meaning and solution of the problems, which was either written, sketched or both. The answer was rated on a three-point scale. Whenever a problem was misinterpreted, a score of zero was given, when correctly interpreted by giving a general idea, a score of one was given, and if it was interpreted as showing a complete process, a score of two was given.

Target problem scoring: Two measures concerning participants' problem-solving performance for the target problem were applied.

- Participants successfully solving the target problem: If the answer was a correct and complete a score of 1 was given and a score of zero if it was incorrect.
- The concept of Strength of Transfer was used here as in the previous experiments, for assessing the transfer of performance. This was measured on a four-point effectiveness scale (0-3) where the performance is assessed in terms of the degree to which the participants generated the correct solution, thereby indicating the strength of transfer from the source model to target. As in the previous experiments, the degree of performance is divided into four categories: complete and correct transfer, high partial transfer, low partial transfer, and wrong or no solution.
 - Complete and correct (score = 3): A participant scored three points if the answer was complete and successful in solving the target problem.
 - High partial solutions (score = 2): A score of two points was given if the participant gave a strategy for solving the target problem but did not achieve a final solution for solving the target problem.
 - Low partial solutions (score = 1): An answer was assigned a score of 1 if the provided solution contained only the idea of estimating the weight without an explanation of how to implement this principle.
 - Wrong or no solution (score = 0): If the answer was incorrect or the participant did not provide any solution a score of zero was given.

Development of the Drawing Protocol Analysis

This study was conducted with the objective of finding an effective alternative to external support methods such as hints, multiple external representation, multimedia representation, etc. to enhance transfer performance in solving analogical problems. It was assumed that SCD would be more effective

than self-explanation at facilitating the cognitive processes involved in analogical problem solving and improve the likelihood of successful transfer. Analyzing the drawing protocols generated was considered quite challenging because the researcher had to develop a specific methodology for identifying these cognitive processes in the protocols. Thus, an entirely different approach was adopted for coding and interpreting the drawing protocols.

As mentioned earlier in this Chapter, very few researches have used this method of externalizing representation by self-constructed diagrams. Among them, the most noteworthy are Cox and Brna (1995) who used it in problems such as Syllogisms, Euler circles and Arrangement problems.

Cox (1995) instructed participants to build their own diagrams while solving the problems and analyzed the type of diagrams generated. However, he did not analyze what information precisely affected the problem-solving performance. They categorized the diagrams according to the following characteristics: Plan, Minimal plan, Directed graph, Logic, Set diagram, Tabular representation, and Letters and lines. Examples of these are reproduced below in Figures 6.2a to 6.2f.

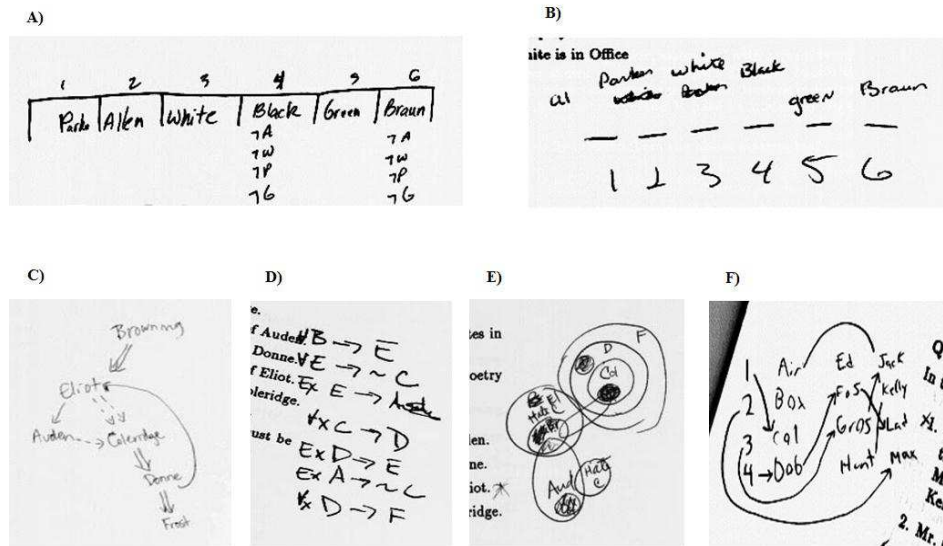

Figure 6.2: categorization of drawing protocols by (Cox & Brna, 1995). A) Plan, B) Minimal plan, C) Directed graph, D) Logic, E) Set diagram and F) Letters and lines.

Ainsworth & Iacovides (2005) and Van Meter et al. (2006) studied the effect of SCD on performance in learning contexts. However, they also neither analyzed the information generated in the diagrams nor the relative contribution of each aspect of the diagram in understanding or solving a problem.

In this study, the researcher developed a coding scheme to analyze all the information revealed in the drawing protocols, identify the various cognitive processes that were used to solve the problem, and determine their effect on transfer performance. The following procedure was adopted to develop the coding scheme:

The first step was to choose two judges to interpret verbally the diagrams generated by the participants. These judges were two colleagues who previously assisted the researcher in building the coding scheme for verbal protocols in Experiment 1. After briefly acquainting them with the aim of this study, they were given the drawing protocols of 8 participants.

The judges were provided with Form A to interpret the drawing protocols of each participant. Tables 6.1 to 6.4 are examples of the English translation of the judges' responses recorded in Arabic in Form A.

Next, the verbal translations of the diagrams generated by the judges were organized and analyzed by the researcher to identify the kind of cognitive processes and their sub-processes revealed in the SCD while solving the analogical problems. Table 6.5 shows how the researcher analyzed the diagrams and what aspects of the diagram were identified and interpreted verbally by the judges as indicating the thinking processes or steps taken by a participant in problem solving. Here, the researcher found that the drawing protocols revealed the same cognitive processes, as generated in the self-explanation verbal protocols of Experiment 1 (Figure 4.4).

The researcher then developed a scoring sheet (Appendix E) to interpret and score the drawing protocols of these 8 participants. This was then further interpreted and scored, according to the thinking processes revealed in the drawing protocols.

In addition, Table 6.5 also shows how the researcher identified the cognitive processes and their sub-processes (as frequencies) from the judges' verbal interpretations described in the previous tables. This Table relates to 4 participants (p) in the strategy level. For example, in the Art source problem, p1 generated 3 units of drawings, depicted the activity of relation (which includes labeling, combining and comparing) and 2 activities indicating mathematical operations. It may be mentioned here that the cognitive process of analogizing relates only to the target problem. The frequencies of the processes revealed in the target problem identified for the same participant were comparing and

relations (in the category of Explanation), Mathematical elaboration and goal (in the category of Inference), and the sub-processes of encoding and mapping (in Analogizing). This participant, who also highlighted the constraint element in the problem, was able to achieve only partial transfer.

The judges were oriented with the terms used in the scoring sheet and were also given some guidelines, in question form, to use while analyzing and evaluating the drawing protocols. These questions are listed below:

- How many drawings were generated for each problem?
- How many ideas are shown through the diagrams?
- How does the diagram show a separate idea?
- What cognitive activity did the participant reveal in the ideas? (For example naming the objects, combining information, comparing etc.)
- Does the diagram indicate any mathematical operations?
- Is there any indication of a goal for solving the problem?
- Does the participant show the presence of obstacles or constraints in solving the problem?
- In your opinion, is the number of drawings generated by a participant sufficient?
- Did the participant use arrows, circles or lines to enhance an idea?
- Evaluate the diagrams generated for a problem by the participant on the following :
 - Number of drawings.
 - Clarity of the diagrams (easily conveys an idea).
- In your opinion, are the diagrams generated by a participant strong, moderate or weak in terms of understanding the problem?

The analysis and scoring of the drawing protocols of both the judges and the researcher were compared for reliability. Differences in opinion were resolved by discussion. For example, one judge (1) considered the number of

units generated by participant (A) to be five, whereas the researcher and judge (2) considered them to be four. A meeting was held between the researcher and the judges to discuss this issue, and they agreed upon four units because each unit represented a single idea or mental process. In case of disagreement regarding the number of processes, the researcher discussed the controversial issues with the judges until a unanimous agreement was reached. The correlation coefficient between both judges' scores and between the researcher and each judge were all found to be above 0.95.

Table 6.1

Form A, Judges' Analysis of the drawing protocols of participant 1

Name		Group procedural rep.		Verbal Source problem	
Age	19	Experiment Number	5		
Total Time	83 minutes	Start time	11:40	End Time	1:03
Problem Name	Problem Type	Score	Analysis	Comments	
Gallery	Verbal		The participant identified objects by labeling them in her drawings. She differentiated among the weights. She depicted the goal and labeled it. She compared the weight of the big bottle with the small ones. She also assessed the total weight of the three small ones to determine the remaining weight, which was the solution. She successfully depicted the solution by stating the remaining weight.		
Almond	Verbal		She depicted the weights; 12, 9, 5. She identified the almond box of 39 kg. , and divided it into 3 parts; each one weighing 13 kg. She showed the process solution by weighing 5 then 5Kg. Then, she weighed 10 against 10. She then compared 12 kg against 9 and 3, and depicted the right solution.		

Table 6.2

Form A, Judges' Analysis of the drawing protocols of participant 2.

Name		Group	3-1		
Age	19	Experiment Number	5		
Total Time	83 minutes	Start time	11:40	End Time	1:03
Problem Name	Problem Type	Score	Analysis	Comments	
Ball1	Pictorial		She identified the goal. She divided 3 parts of balls, each 4 balls in a group. She compared 4 against 4. She used arrows to identify the next operation. She compared 2 against 2, then 1 against 1. And that's how she identified the heavy bottle.		
Lab	Verbal		She used the same steps by using drawings. She identified 11 balls. She grouped them into 3 groups. She compared 4 against 4, then 2 against 2, then 1 against 1. She concluded the result by identifying the heavy bottle. She used a lot of arrows, and also circles to highlight the words that she might benefit from.		

Table 6.3

Form A, Judges' Analysis of the drawing protocols of participant 3.

Name	Azza	Group	3-1		
Age	21	Experiment Number	5		
Total Time	1 hour and 09 minutes	Start time	11:07	End Time	12:16
Problem Name	Problem Type	Score	Analysis	Comments	
Balls	Pictorial		She numbered the drawings. She drew 3 drawings. In the first one, she compared 4 balls against 4 balls. In the second one, she compared 2 balls against 2 balls, and identified the heavier one by arrows. In the third drawing, she compared one ball against another one, and identified the heavier one by an arrow.		
Lab	Verbal		The participant drew 6 drawing. The first one, she drew the box of sodium chloride. The second one, she drew a table which had 12 bottles. In the third one, she drew a scale of two trays, with 4 bottles in each. In the fourth drawing, she compared 4 bottles against 4. In the fifth drawing, also she compared 4 against 4. In the final drawing, she also compared 4 bottles against another 4. She used arrows to indicate which group of 4 bottles, had the heavier one.		

Table 6.4

Form A, Judges 'Analysis of the drawing protocols of participant 3.

Name	Azza	Group	3-1		
Age	21	Experiment Number	5		
Total Time	1 hour and 09 minutes	Start time	11:07	End Time	12:16
Problem Name	Problem Type	Score	Analysis	Comments	
Gallyry	Verbal		The participant drew 4 drawings. The first one drew a gallon with 42 green cups. The second one she drew a painting. The third one she drew cups of different weights; 12, 5, 9. She added two mathematical operations besides each drawing.		
Almond	Pictorial		The participant drew 4 drawings. The first one she drew 39 kg of almond box. The second one, she drew three different weights of 12, 9, and 5. The third one she put the wanted weight in a rectangle, 13 kg. the fourth one she drew 12 against 5 and 5 against 9 and 9 against 12. She also, conducted two mathematical operations and used arrows for showing less or more than signs to compare it to the wanted result.		

Table 6.5

The cognitive processes derived from the judges' verbal interpretations described in the previous Tables.

Name: P1, P2, P3, P4				Group	Exp no	3									level of similarity			
				Analysis of the judejes responcees for four participants who took the strategy level of similarity											Strategy	Procedure		
problem name	problem type	participants	Unit no	explanation				inference				Analogizing			Others			
				labelling	combining	comparing	Relations	Justification	Math elab.	Goal	constrain	Encoding	Mapping	transfer	Arnows	lines	others	
Art source	p	p1-str	3				/		//									
	p	p2	4	/	/	//	/								////			
	v	p3	4	/			/		/	/					////			
	v	p4	6		/	//	/		/	/								
Almond Target	Verbal	p1	7			/	/		/	/	/	//	/					
		p2	3	/	//						/	/			/			
		p3	3	/					////			/	/			//		
		p4	4		/				/	/	/	/	/	/				
Balls-P	v	p1	5	/	/		/		//						/			
	v	p2	6		/	///	/		/						//			
	p	p3	7	////			/		/						///			
	p	p4	4		/	/	/		/						///	///	////	
Lab Target	Verbal	p1	3		/		/			/	/				/			
		p2	8	/	/	///	/	/	/	/	/	//	//	/	///			
		p3	3			/	/					/	/	/				
		p4	6		/	/	/			/	/	/	/	/	///	///	///	
notes																		

Analysis of the Self-Drawings

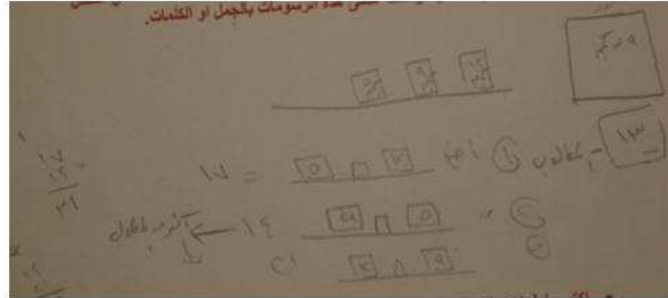
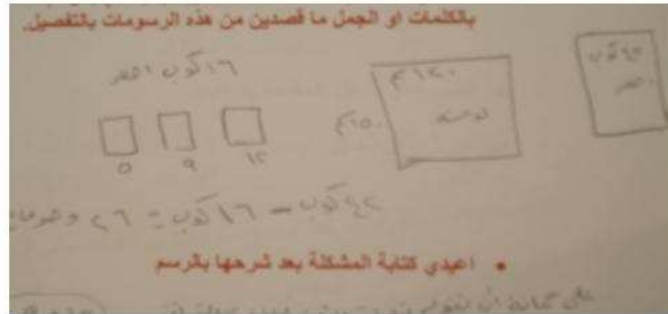
A self-constructed diagram is a process of understanding the problem, by drawing sketches to interpret and externalize the understanding of the problem. Solving a problem by drawing diagrams often helps gathering superficial and structural information about the attributes of the various objects and the process they depict. For each problem, a person may generate one or more sketches which were segmented into units. Each unit, separated by space, arrows or lines, consists of one or more schematic elements that are used by a person to depict an idea or interpretation of the objects or description of a process given in the problem. Geometric figures, such as lines, arrows, blocks/squares, mathematical symbols etc. have similar abstract meanings in mathematical word problems, and at the same time are context dependent. That is their meaning depends on the objects or process that is being described. For example, arrows may be used to show increase or decrease in the amount of substance and a plus or equal ($+/=$), may be used to combine two units to understand relations among objects or processes. The Figures 6.3 to 6.7 shows different separation of units.

As SCD are known to help express the understanding of a problem, the question of interest here is to know how much information is contained in each unit or diagram, and how this information affects the process of transfer in analogical reasoning.

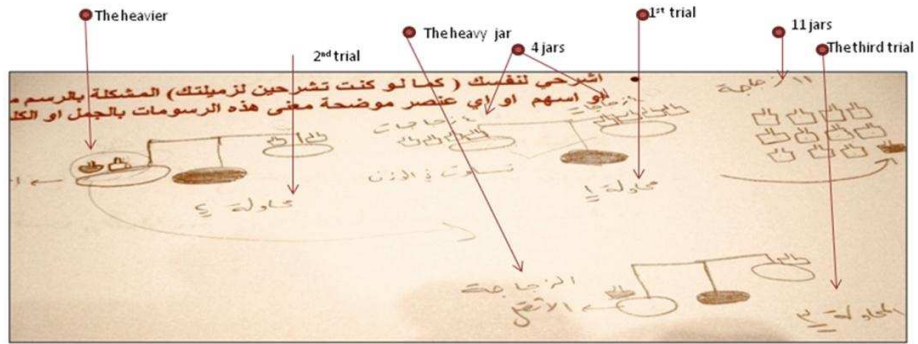

Figure 6.3: This self-constructed diagram shows 4 units separated by space. Note: (A part of the sketch is encircled by the researcher to highlight a particular feature.)

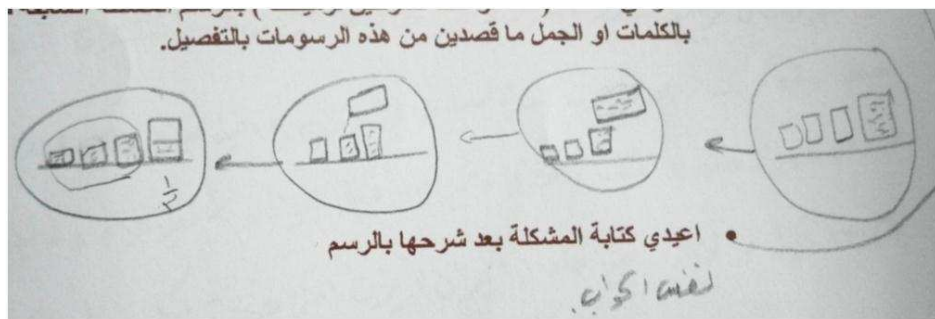

Figure 6.4: This diagram consists of 5 units separated by space, circles, and arrows.

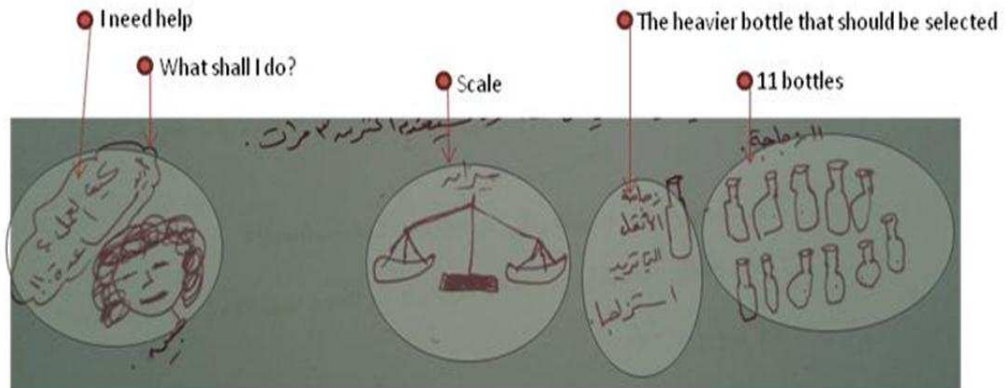

Figure 6.5: This participant drew 4 units separated them by space; the circles show these units.

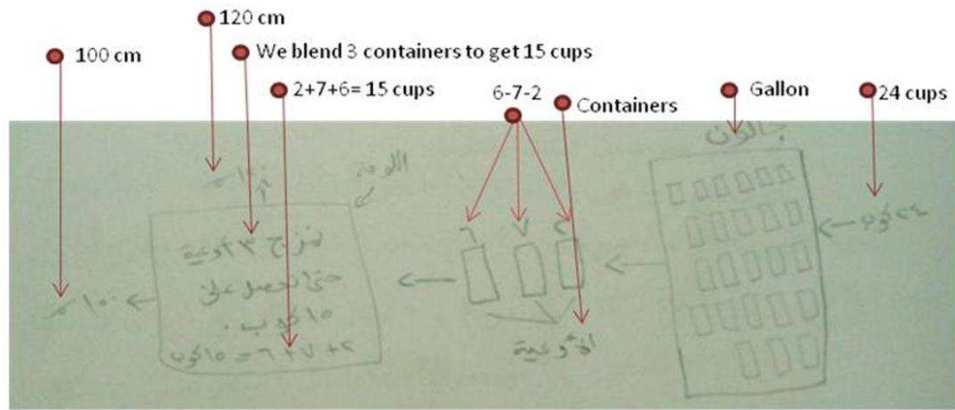

Figure 6.6: This participant drew 3 units separated by arrows and rectangles.



Figure 6.7: This participant produced 8 units separated by lines.

1. Container is full of water, filling the small containers.
2. Second picture: some water is filling the second container.
3. Third picture: the second container is filled, and now some water is filling the third container.
4. Forth picture: three containers have been filled with water, however, the water's color in the second container is black, so it has been returned to the first container, and been replaced with colorless water.
5. Big container filled with water. Requirement is to fill these three containers with water.
6. Water is filling the second container.
7. Now water is filling the third container.
8. The amount of water available in the first and second container is equal in.

Thus, the focus of the analysis was on how effectively the method of SCD helped elicit the three core content categories, which had been studied in the Experiment 1 in the SE condition: Explaining, Inference, and Analogizing and their related sub-processes involved in analogical reasoning. While the solution of the source problem only required the cognitive processes of Explaining and Inference, the target problem involved all the three content categories. Broadly, the process of Explaining and Inference are regarded as understanding the

problem from all aspects, while analogizing is the important process of noticing and deriving the link (analogy), between the source and target problems for achieving the right solution. The manifestation of each cognitive process or sub-process is scored along with its frequency of occurrence.

Coding Scheme for the Diagram

The cognitive processes revealed in the self-constructed diagrams are described below:

Explanation is the process of understanding the superficial and structural information in the problem. It consists for sub-processes (Labelling, Combination, Comparison And Relation).

Labeling is interpreting the elements or objects in the problem through sketches or labeling the sketches. Each correct interpretation of the objects in the source or target problem was counted as one idea. This is similar to the categorical explanation, described by (Neuman & Schwarz, 1998) as the act of labeling. It may be mentioned here that a person may draw more than one diagram to indicate, for example, a person. Here, each response that is qualitatively different from another was counted. For example, a person may draw the mother and the aunts. Here the response will be counted as 2 ideas in the sub-process of labeling. However, there is no limit on the number of ideas a person comes up with that indicates a cognitive process or sub-process. Therefore, quantitative differences among participants based on their responses that reveal the cognitive processes (for example labeling or combination as the sub-process of Explanation) are not taken into account. This strategy was applied to all categories of cognitive processes discussed in this section. Figure 6.8

shows the different sketches generated for the source problems, which indicate labeling.

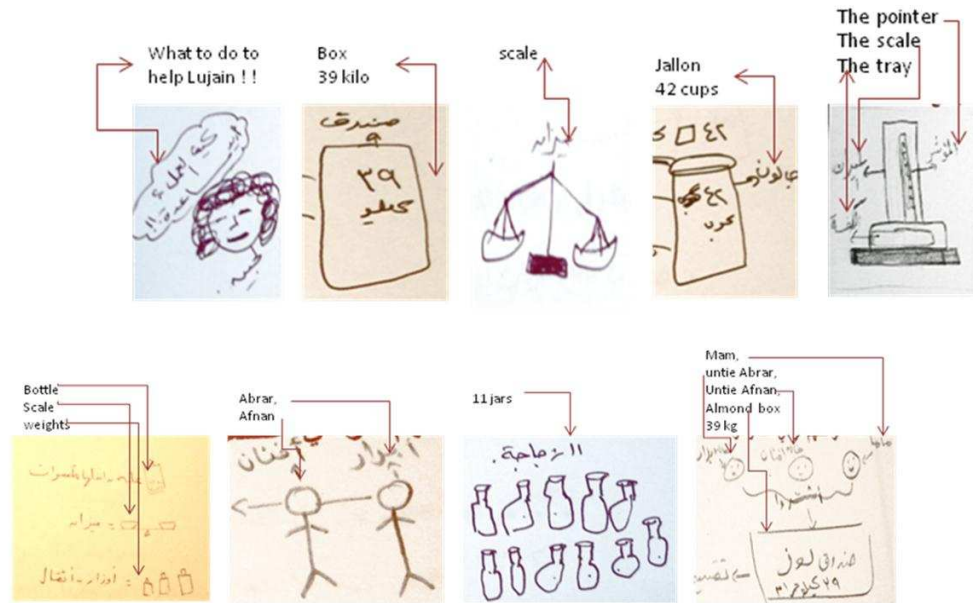

Figure 6.8: Labeling taken from several participants in The Almond target problem and Ball 1 source problem.

Note: All drawings that are reproduced in this study are to be seen from right to left direction.

Combination involves the creation of new propositions out of existing ones, by combining two or more objects within the diagram to achieve an integrative solution (Figures 6.9).

Comparison is the process when objects are highlighted for indicating size, weights, or processes as illustrated below in Figures 6.10, 6.11& 6.12.

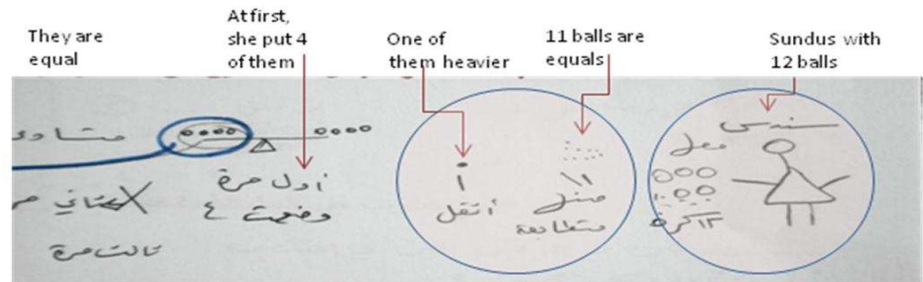

Figure 6.9: The sub-process of combination.

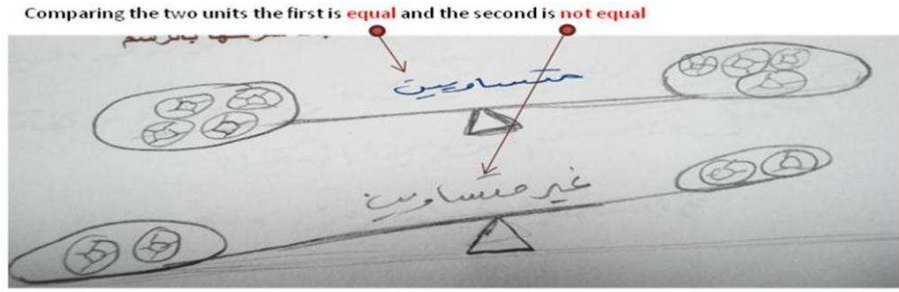

Figure 6.10: Comparing the two units the first is equal and the second is not equal.

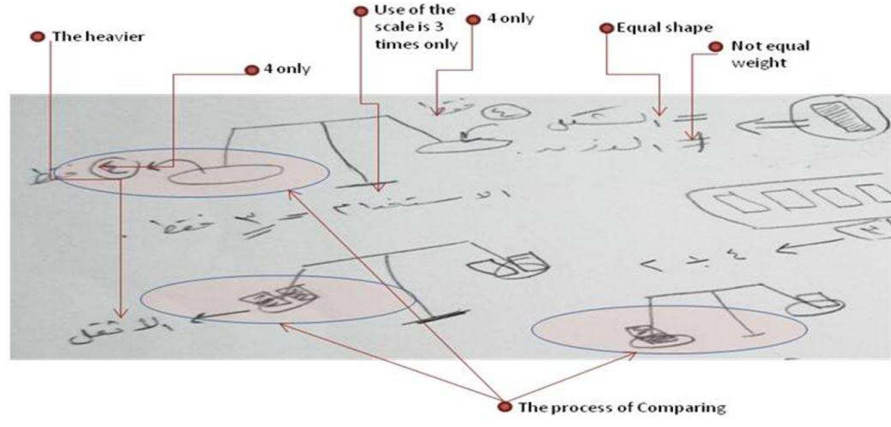

Figure 6.11: The sub-process of comparing.

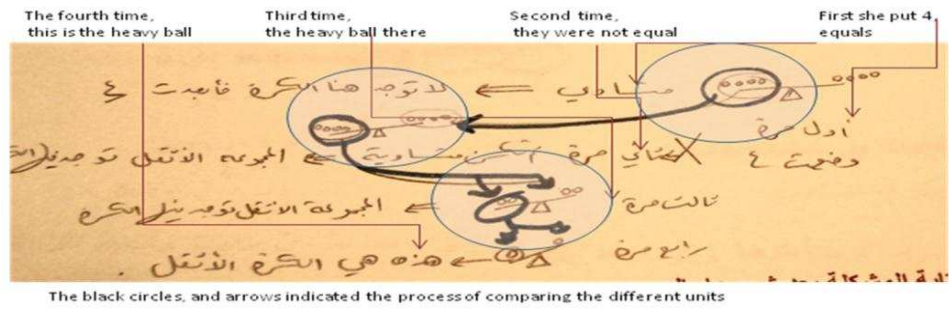

Figure 6.12: The sub-process of comparing. The circles and arrows indicate the process of comparing the different units drawn by the participants.

Relation occurs when several units of diagram indicate the full understanding of the entire process in the source or target problem. It involves the process of discovering the basic principle underlying the sequence of process depicted in the problem. Figures 6.13, 6.14, 6.15 and 6.16 are an example of how a participant used sketches and sentences to explain the process of relation in the Jug and Bar problems.

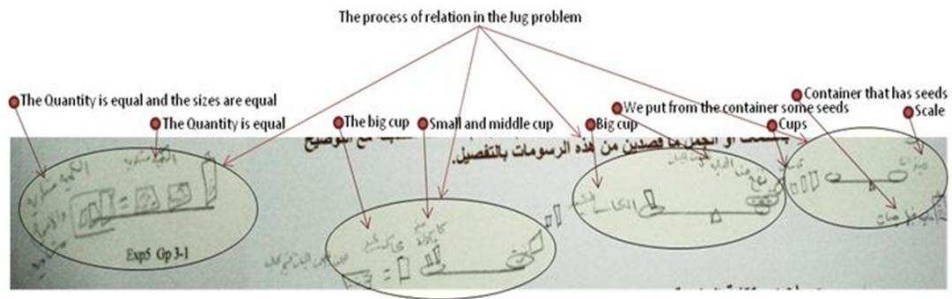

Figure 6.13: The process of relation.

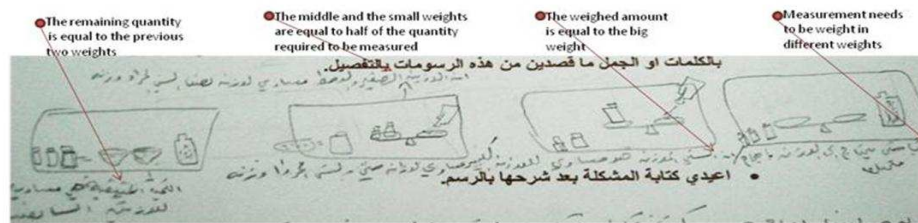

Figure 6.14: The process of relation.

Note: This is an example of how a participant used sketches and sentences to explain the process of relation in the Jug problem.

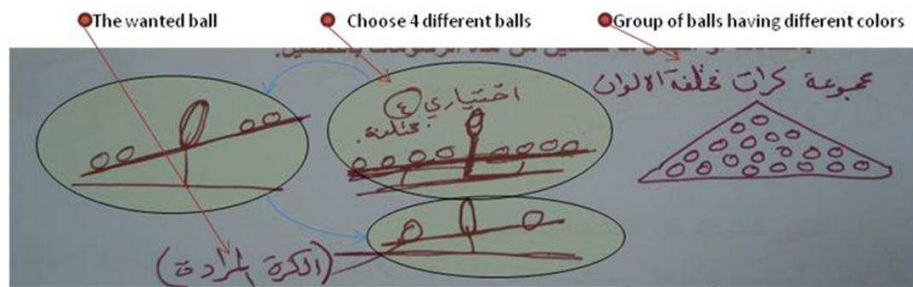

Figure 6.15: The process of relation in the Bar2 problem.

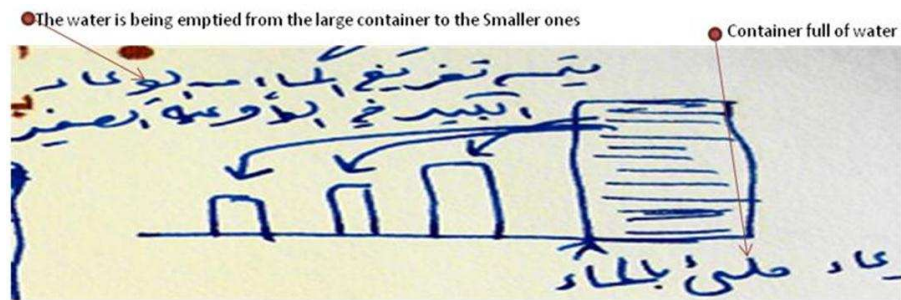

Figure 6.16: The process of relation in the Jug problem.

Note: The water is being emptied from the large container to the smaller ones, the process of relation may contain one frame or one unit implying a process.

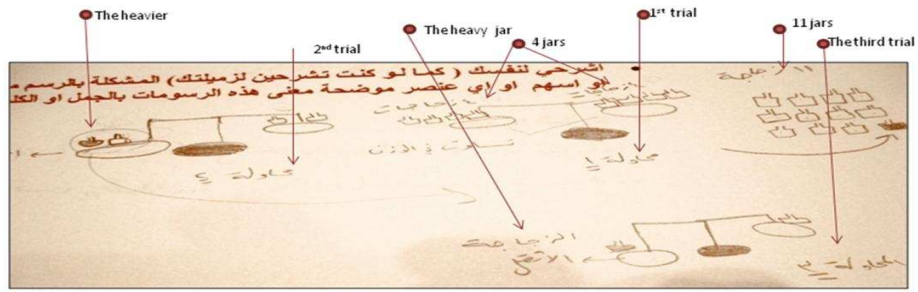

Figure 6.17: The process of relation in the Jug problem.

Inference is a relatively deeper analysis of the problem compared to explanation. It involves the sub-processes of mathematical elaboration, justification, and goal directness.

Mathematical elaboration is a process that indicates whether the participant is able to use and compare mathematical relationships or notice underlying principles while trying to understand relations between the quantity of substances and the sizes of objects (Figures 6.17 & 6.18).

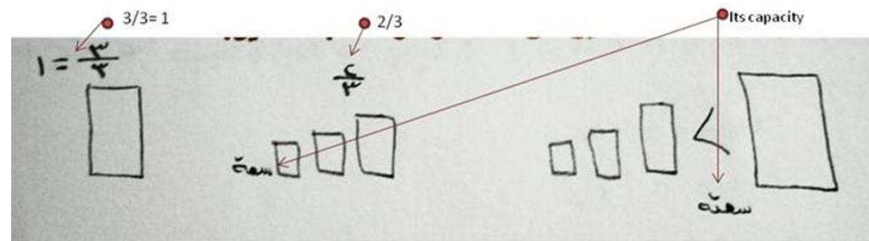

Figure 6.18: The sub-process of mathematical elaboration.

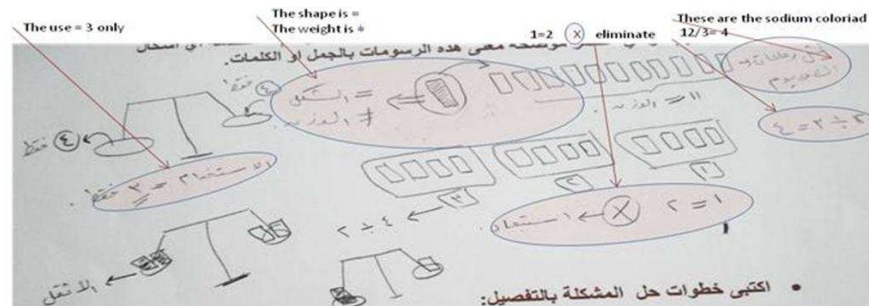

Figure 6.19: The sub-process of mathematical elaboration.

Goal Directness is when the participant is considered to have imposed a goal or purpose for an action if she indicates a clear goal in the sketch (Figures 6.20 & 6.21).

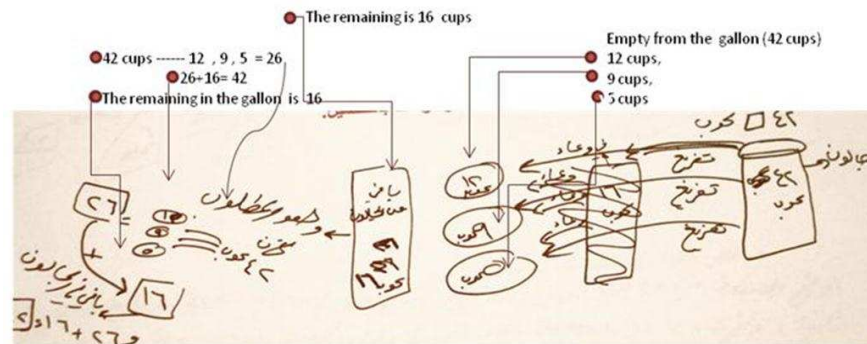

Figure 6.20: The sub process of mathematical elaboration.

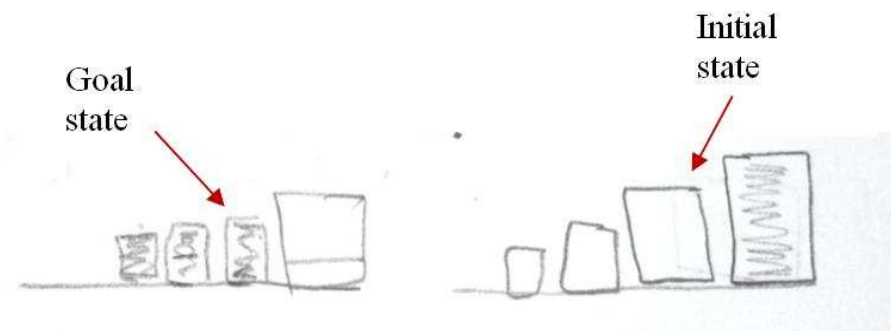

Figure 6.21: Initial state and goal state in the Jug problem.

Justification is the process where the participant clearly gives reasons for choosing from various options that help solve the problem. When used, it was found that this process was expressed in words and not in sketches.

Obstacles relate to perceived constraints in problem-solving. Figures 6.22 show how obstacles were depicted.

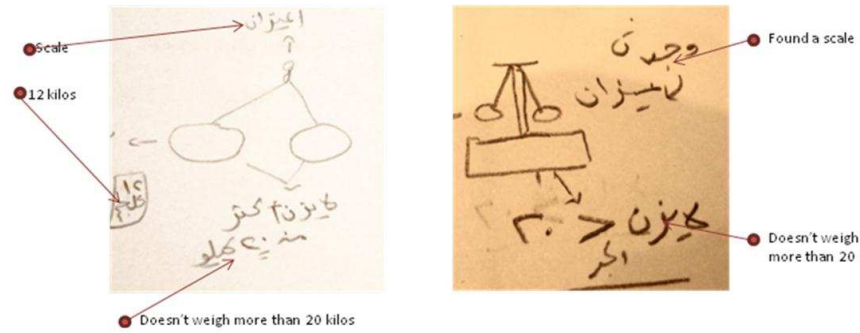

Figure 6.22: Depiction of obstacles in the self-constructed diagrams.

Analogizing: This process relates to the solution of the target problem only and consists of three essential processes: Selective Encoding, Mapping and Transfer. In this experiment the participant may use either words or sketches or both to solve the target problem. What is important in terms of studying the effect of self-drawing is to note the following:

- The extent to which self-drawing in the source problem helps solve the target problem.
- The number of units generated in the source problem,
- The similarity of the sketches in the source and the target and to what extent a participant has used drawings in the target problem that helped in better transfer performance.

Selective encoding is a mechanism that determines the information that will be selected for retrieval in analogical problem-solving. This selection of the information relates to the superficial attributes of objects. The process of selective encoding usually precedes and directly influences both the extent of mapping and/or the strength of transfer.

Mapping is a process of integrating the information of object attributes according to the function they serve and at the same time being aware of the limitations or the obstacles in making certain choices. The mapping process

includes three different types of mapping: procedural mapping, high partial mapping and low partial mapping.

Transfer is the process in which a participant applies what he/she has learned from the source to the target problem to get a correct or partially correct solution. The strength of transfer depends upon the type of solution the participants generate. Four types of transfers have been identified: Successful transfer, High partial transfer, Low partial transfer and Wrong transfer/No transfer. (For more information, please refer to Experiment 1).

Qualitative analysis of Diagrams

A scoring sheet was developed to systematically record the responses of each participant in each problem for the SCD condition (Appendix E). The diagram was analyzed as follows:

- The quality of drawings generated was evaluated according to the clarity and number of cognitive processes revealed. They were classified as follows: Strong receiving a score of 5 to 7 if the drawings generated revealed at least 5 of the 7 sub-cognitive processes (4 sub-processes of Explanation + 3 sub-processes of inference) in the source problem; Moderate receiving a score of 3 to 4 if the diagrams showed at least three sub-cognitive processes and Poor receiving a score of 1 to 2 if the diagrams showed two or less sub-processes. For example in Figure 6. 21 the participant showed the process of labeling and goal through two units only, thereby getting a score of 2 which is considered a poor diagram. Figure 6.19 illustrates a strong solution where the participant received a score of 7 out of 7 (strong) on the number of cognitive processes revealed.

- The number of cognitive sub-processes that a participant generated was counted for each source and target problem in the categories of explanation, inference and analogizing.
- Analysis of how arrows, circles, and lines have been used to highlight the important ideas or information was also noted.

Statistical Analysis

Data was analyzed first to examine the effects of the type of representation (verbal and pictorial) on the numbers of solvers and non-solvers both in the source and target problems. Percentages, along with Chi square tests where applicable, were used to answer the following questions:

- How many participants solved the pictorial source problem correctly in each condition, SCD and ND?
- How many participants solved the target of the pictorial source problem correctly in each condition?
- Of those who solved the pictorial source problem correctly, how many of them solved its target problem?
- How many participants solved the verbal source problem correctly in each condition?
- How many participants solved the target of the verbal source problem correctly in each condition?
- Of those who solved the verbal source problem correctly, how many of them solved its target problem correctly?

Second, the hypotheses were tested using the 2 x 2 x 2 mixed ANOVA consisting of three independent variables; levels of similarity (strategy and procedure); instruction conditions (SCD and ND) and type of representation (verbal and pictorial). The first two factors are between groups and the third is a within group repeated measure. Last, a qualitative analysis was undertaken of the SCD to assess their specific contribution to transfer performance.

Results

Experiment 3 was a 2x2x2 mixed design experiment consisting of three independent variables with Levels of Similarity (strategy SL and procedural PL) and Condition of Drawing (SCD and ND) as between-subjects factors and Type of Representation (verbal source VS and pictorial source PS) as the within-subjects factor.

Each participant (N = 160) took two source problems; pictorial and verbal (PS and VS) and their target analogues, which was represented in the verbal format only to help compare performance across levels and conditions.

Two main dependent measures were the number of solvers (percentages) according to the type of representation in the source and target problem, and the strength of transfer (Mean performance) in the target problem. In addition, the type of diagrams produced in terms of the cognitive processes revealed both in the source and the target problems were analyzed qualitatively as dependent measures.

The results are reported here in three sections: In Section 1 analysis of solvers and non-solvers was undertaken. Section 2 shows the results of 2x2x2 mixed ANOVA and Section 3 deals with the qualitative analysis of diagrams.

Descriptive Analysis

Section 1: The description of the first dependent measure in terms of solvers and non-solvers both in the source and target problems are reported along with Chi square tests (where needed) here. To ensure the reliability of the scoring scheme mentioned above, two colleagues from the department of psychology independently scored the performance of 30 participants randomly

selected. Pearson's correlation indicated a high inter-scorer reliability shown in Table 6.6.

Table 6.6

Correlations Inter-scorer Reliability

	N	Pearson Correlation
Pictorial source score	30	.841**
Verbal source score	30	.745**
Target PS score	30	.841**
Target VS score	30	.973**

** Correlation is significant at the 0.01 level (2-tailed).

In this experiment, each participant analyzed two problems, one in a pictorial and the other in a verbal representation, which was counterbalanced by ensuring that half the sample took the verbal format first followed by the pictorial and the other half took pictorial first in each condition and level of similarity. After ensuring the equality of variance ($F = 2.57$, $p = 0.11$), the t test showed no difference in the Mean performance of those who took the pictorial problem first ($M = 6.56$, $SD = 2.44$) and those who took the verbal problem first ($M = 6.48$, $SD = 2.09$) $t(158) = 0.24$, $p = 0.11$, thereby indicating no effect of order of representation on performance.

The analysis of time spent in solving the source and target problems in the verbal and pictorial representations showed that the participants spent an average of 11 minutes on each problem (source and target) in each representation (Table 6.7). The Mean time for the verbal source problem is $M = 10.94$, $SD = 5$ was the same as the Mean time for the pictorial source problem is $M = 10.69$, $SD = 5.04$). On the target VS ($M = 11.57$, $SD = 5.19$) and PS ($M = 11.06$, $SD = 5.5$) also the participants took nearly the same time.

Table 6.7

Descriptive of Time Spent on Source and Target Problems

Time	N	Mean	SD
Time for Pictorial Source Problem.	160	10.69	5.04
Time for Verbal Source Problem.	160	10.94	5.00
Time for Target PS Problem.	160	11.06	5.50
Time for Target VS Problem.	160	11.57	5.19

Descriptive analysis related to type of solvers according to type of representation, condition of drawing, and levels of similarity are shown in Tables 6.8 to 6.11.

Table 6.8 shows that in the pictorial type of representation the percentage of participants in SCD who got both the source and target correct is 71% and 52.5% in the ND. On the other hand, in the verbal representation 79% of participants in the SCD condition solved both source and target compared to only 36% in the ND condition (Table 6.9). These results clearly indicate that SCD facilitated the process of transfer.

For the pictorial representation, in the procedural level of similarity 70% of participants solved both the source and target problem compared to only 54% in the strategy level of similarity (Table 6.10). The same was true for the verbal representation with 63% of solvers achieving full transfer in the procedural level compared to 53% in the strategy level (Table 6.11).

Table 6.8

Pictorial Representation

	Experimental (SCD)		Control (ND)	
	Target correct	Target incorrect	Target correct	Target incorrect
Source Correct	57 (71.35%)	20 (25%)	42 (52.5%)	33 (41.3%)
Source incorrect	2 (2.5 %)	1 (1.3%)	1 (1.3%)	4 (5%)

Table 6.9

Verbal Representation

	Experimental (SCD)		Control (ND)	
	target correct	target incorrect	target correct	target incorrect
Source Correct	63 (79%)	17 (21%)	29 (36%)	32 (40%)
Source incorrect	0	0	6 (8%)	13 (16%)

Table 6.10

Pictorial Representation

	Strategy		Procedure	
	Target correct	Target incorrect	Target correct	Target incorrect
Source Correct	43 (54%)	31 (39%)	56 (70%)	22 (28%)
Source incorrect	2 (2.5%)	4 (5%)	1 (1.3%)	1 (1.3%)

Table 6.11

Verbal Representation

	Strategy		Procedure	
	Target correct	Target incorrect	Target correct	Target incorrect
Source Correct	42 (53%)	25 (31%)	50 (63%)	24 (30%)
Source incorrect	4 (5%)	9 (11%)	2 (3%)	4 (5%)

Each participant analyzed two source problems, one in each format, pictorial ($N = 160$) and verbal ($N = 160$). This being a repeated measure, a non parametric Wilcoxon signed-rank test was applied. There was no significant difference between the representation ($z = 0.719$, $N\text{-ties} = 73$, $p = 0.472$, two-tailed).

The same statistical test was applied to target problems to assess the effect of pictorial and verbal representation in the source problem on transfer performance. Again no significant difference was found between the representations ($z = 0.075$, $N\text{-ties} = 89$, $p = 0.940$, two-tailed).

To assess the effect of conditions, (irrespective of levels of similarity) Chi Square tests were applied. No significant difference was revealed in the number of participants who solved the PS, 77 (96%) and 75 (94 %) in the experimental (SCD) and control (ND) conditions respectively $\chi^2 (1, N = 160) = .53, p = .468$. However, a significant difference was revealed between those who solved the VS in the SCD condition 80 (100%) and ND 61 (76%) conditions $\chi^2 (1, N = 160) = 21.56, p < .001$. On the other hand, the target problem for the PS was solved by 59 (74%) and 43 (54%) in the SCD and ND condition respectively, indicating significant differences between the two conditions $\chi^2 (1, N = 160) = 6.92, p = 0.009$. Finally, a significant difference was found in the analogue target for the VS where the solvers were 63 (79%) and 35 (44 %) in the SCD and ND condition respectively, $\chi^2 (1, N = 160) = 20.65, p < .001$ (Table 6.12). Interestingly, these findings demonstrate that participants benefitted even from a verbal representation in the SCD condition.

Regarding the two levels of similarity, it was found that the number of solvers in PS were 74 (93%), 78 (98%), and in the VS they were 67 (84%), 74 (93%) in the strategy and procedural level of similarity respectively. No significant difference was found between solvers in the strategy and procedural level of similarity in PS $\chi^2 (1, N = 160) = 2.10, p = .147$ and the VS $\chi^2 (1, N = 160) = 2.92, p = .087$.

Table 6.12

The number of Solvers for the Pictorial and Verbal source and Target Problems in Drawing Conditions

Type of Rep.	The Conditions				Chi square
	Experimental (SCD)		Control (ND)		
	Solvers	%	Solv s	%	
	n = 80		n = 80		
Solvers PS	77	96	75	94	$\chi^2 (1, N = 160) = .53, p = 0.468$
Solvers VS	80	100	61	76	$\chi^2 (1, N = 160) = 21.56, p < 0.001^{**}$
Solvers Target PS	59	74	43	54	$\chi^2 (1, N = 160) = 6.92, p = 0.009^{**}$
Solvers Target VS	63	78	35	44	$\chi^2 (1, N = 160) = 20.65, p < .001^{**}$

**0.01 level of significance

On the other hand, the number of participants who solved the target for PS were 45 (56%) and 57 (71%) in the strategy and procedural levels respectively, indicating a significant difference $\chi^2 (1, N = 160) = 3.89, p = .048$ between the two levels of similarity in the PS target. No significant difference was found between those who solved the target of VS in the strategy 46 (58%) and procedural 52 (65%) levels of similarity, $\chi^2 (1, N = 160) = .948, p = .330$ (Table 6.13).

Table 6.13

Number of Solvers in both Source and Target Problem in each Level of Similarity

Type of problem	The level of similarity				Chi square between level (row)
	Strategy		Procedure		
	Count	%	Count	%	
	n = 80		n = 80		
Solvers PS	74	93	78	98	$\chi^2 (1, N = 160) = 2.10, p = .147$
Solvers VS	67	84	74	93	$\chi^2 (1, N = 160) = 2.92, p = .087$
Solvers Target PS	45	56	57	71	$\chi^2 (1, N = 160) = 3.89, p = 0.048^{*}$
Solvers Target VS Prob.	46	58	52	65	$\chi^2 (1, N = 160) = .948, p = .330$

*0.05 level of significance

The number of participants who solved both the target analogue and its source problem in the pictorial format represented at the strategy level of

similarity were 28 (70%), and 17 (43%) in the SCD and ND conditions respectively. In the procedural level of similarity these solvers were 31 (78%) in the SCD and 26 (65%) in the ND conditions. Chi square tests conducted for both levels of similarity and drawing conditions indicated that there was a significant difference for the strategy level $\chi^2(1, N = 80) = 6.14, p = 0.013$ but there was no significant difference in the procedural level $\chi^2(1, N = 80) = 1.52, p = 0.217$ (Table 6.14).

Similarly, significant differences were found between the number of participants who solved both the target analogue and its source problem in the verbal format at the strategy level. These were 30 (75%) and 16 (40%) in the SCD and ND conditions respectively with $\chi^2(1, N = 80) = 10.03, p = 0.002$. Also, a significant difference was found in the procedural level, $\chi^2(1, N = 80) = 10.77, p = 0.001$, where the number solvers were 33(83%) and 19(48%) in the SCD and ND conditions respectively (Table 6.15).

These findings not only confirmed the prediction related to the positive effects of the SCD on procedural similarity but also discovered that self-drawing even helped participants perform well in the strategy level of similarity and verbal form of representation.

Table 6.14

Pictorial Source and Target solvers in the Conditions of Drawing and Levels of Similarity

Level of Similarity	Conditions (N = 40)	Solvers Target PS		Chi square between conditions
		Count	%	
Strategy N = 80	Experimental(SCD)	28	70	$\chi^2(1, N = 80) = 6.14, p = 0.013^*$
	Control(ND)	17	43	
Procedure N = 80	Experimental(SCD)	31	78	$\chi^2(1, N = 80) = 1.52, p = .217$
	Control(ND)	26	65	

*0.05 level of significance

Table 6.15

Verbal Source and Target solvers in the Conditions of Drawing and the Level of Similarity

Level of Similarity	Conditions (N = 40)	Solvers Target VS		Chi square between conditions
		Count	%	
Strategy N = 80	Experimental(SCD)	30	75	$X^2(1, N = 80) = 10.03, p = 0.005^{**}$
	Control(ND)	16	40	
Procedure N = 80	Experimental(SCD)	33	83	$X^2(1, N = 80) = 10.77, p = 0.001^{**}$
	Control(ND)	19	48	

**0.01 level of significance

Complete solvers are those who scored 2 on the source and a score of 3 on the target. Table 6.16 shows that 85% of the participants came up with a full successful solution for both source and target problems in the pictorial representation of the source problem. In comparison, 51% showed a complete understanding for the source problem but gave only some probable solution (also referred to as a general solution strategy) for the target problem. In Table 6.17 it can be seen that 79% came up with a complete and successful solution for both the source and its target analogue and 62% gave only a general solution. These findings emphasize the importance of understanding, as accurately as possible, the source problem for the solution of the target problem.

Table 6.16

Source and Target solvers in the Pictorial Representation

Score for PS	Score for Target PS Problem							
	0		1		2		3	
	Count	%	Count	%	Count	%	Count	%
0	3	19	2	5	3	5	0	0
1	8	50	31	72	24	44	7	15
2	5	31	10	23	28	51	39	85

Table 6.17

Source and Target solvers in the Verbal Representation

Score for VS	Score for Target VS Problem							
	0		1		2		3	
	Count	%	Count	%	Count	%	Count	%
0	5	26	8	42	4	21	2	21
1	5	45	25	49	16	30	9	20
2	1	9	18	35	33	62	34	79

ANOVA Results

The analysis of results related to the second dependent measure, which is directly related to the hypotheses, is undertaken here. It was hypothesized that the condition of SCD will have a positive influence on transfer performance (strength of transfer ST) in both representations (verbal and pictorial) and levels of similarity (strategy and procedural).

Table 6.18 shows the Mean performance for all three independent variables. A 2 conditions (SCD and ND) \times 2 (strategy and procedural levels) \times 2 type of representation (Pictorial and Verbal) as a within-subjects factor ANOVAs revealed no significant main effects for type of representation, $F(1, 156) = 0.005$, $MS_e = 0.003$, $p = .943$, Wilks $\Lambda = 1$, $F(1, 156) = 0.005$, $p = .943$.

Target performance was higher in the SCD condition than the ND condition with Mean values of 2.07 and 1.58, respectively, indicating a significant main effect of conditions in the predicted direction, $F(1, 156) = 18.867$, $MS_e = 19.503$, $p < 0.001$.

With respect to the levels of similarity it was found, as predicted, that the participants in the procedural level of similarity performed better ($M = 1.98$) than those in the strategy level ($M = 1.67$), $F(1, 156) = 7.258$, $MS_e = 7.503$, $p =$

0.008, thereby indicating evidence of significant main effects of levels (Table 6.18). These findings are consistent with the previous experiments 1 and 2.

With regard to interaction effects, no overall interaction was revealed among all the independent variables $F(1, 156) = 0.005$, $MS_e = 0.003$, $p = .943$. In addition, no interaction effects were found between representation and conditions although there is some indication of its presence $F(1, 156) = 1.507$, $MS_e = .903$, $p = 0.222$ and $F(1, 156) = 0.130$, $MS_e = 0.078$, $p = .719$ respectively (Figure 6.23).

Levine's test for homogeneity of variance was found not significant only for the target analogue of the pictorial source but significant for the scores of the target analogue of the verbal source $F(3) = 3.84$, $p = 0.011$. As such, the Mann Whitney test was applied to analyze the difference in verbal and pictorial target performances. That is, the performance on the target analogue of a verbal source TVS and a pictorial source TPS, according to the two drawing conditions and levels of similarity. The results show that in the target performance of pictorial source (TPS) there is a significant difference in the Mean ranks of the SCD (89.09) and ND (71.91) conditions where $U = 2512.5$, $Z = -2.45$, $p = .014$. On the other hand, a significant difference was also found in the target performance of verbal source (TVS) with the Mean ranks of 94.71 and 66.29 in the SCD and ND respectively $U = 2263$, $Z = -4.07$, $p < .001$. These findings confirm the prediction of the positive effects of SCD on transfer performance.

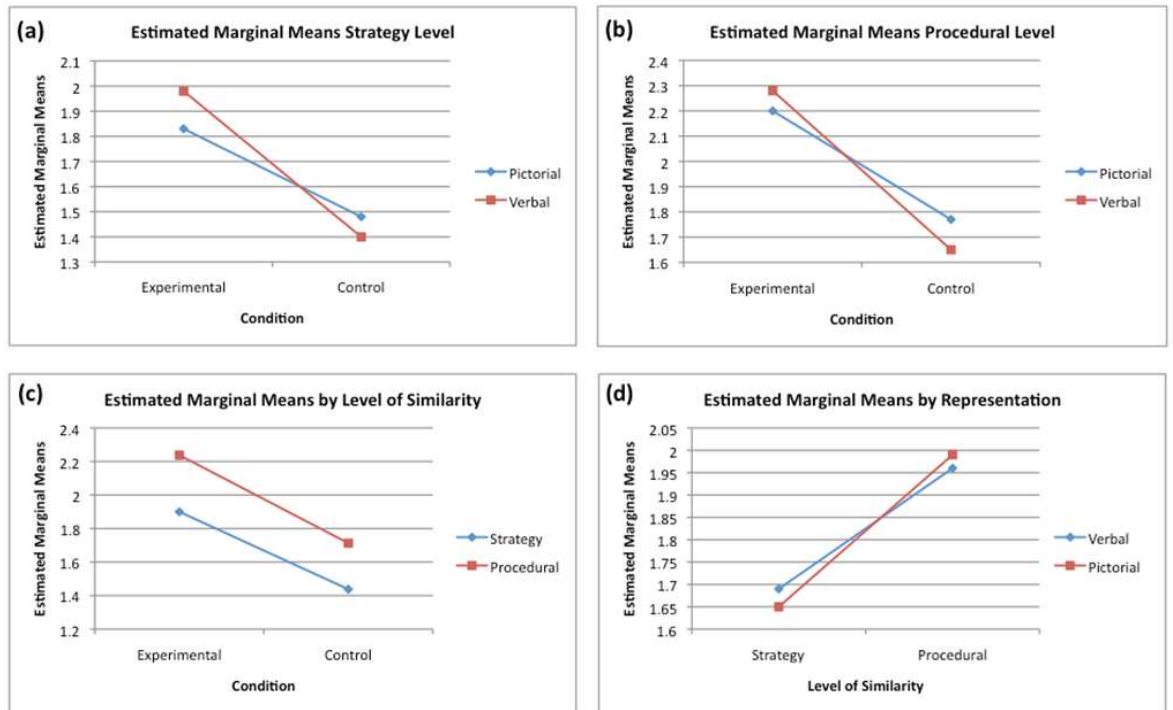

Figure 6.23: Profile Plots: The Conditions * Representation * the Level of Similarity.) The estimated marginal means of the condition * representation in Figure (a) The strategy level. (b) The procedural level. There is no significant interaction in (a) and (b). There is no interaction effect between the condition and levels of similarity (c) and between the levels and the representation (d).

Table 6.18

Mean Performance according to Levels of Similarity, Conditions of Drawing, and Type of Representation

	The condition	The level	Mean	SD	N
Pictorial target Score	Experimental	Strategy	1.83	0.931	40
		Procedure	2.2	0.791	40
		Total	2.01	0.879	80
	Control	Strategy	1.48	1.086	40
		Procedure	1.77	0.92	40
		Total	1.63	1.011	80
Verbal target score	Experimental	Strategy	1.98	0.768	40
		Procedure	2.28	0.751	40
		Total	2.13	0.769	80
	Control	Strategy	1.4	0.982	40
		Procedure	1.65	0.949	40
		Total	1.53	0.968	80

Qualitative Analysis of Drawing Protocols

This section reports and discusses the effect of the different cognitive processes on the strength of transfer in each type of representation and level of similarity. This discussion relates only to the performance of the experimental group (SCD).

The participants ($N = 80$) spent an average time of 13 minutes to solve each problem source and target ($M = 12.98$, $SD = 4.85$) and ($M = 13.63$, $SD = 4.24$) in the self-constructed diagram condition. The time spent on the target problem of the verbal source ($M = 13.09$, $SD = 4.99$) and of pictorial source ($M = 12.75$, $SD = 5.295$) was almost equal (Table 6.19).

Table 6.19

Descriptives of Time Spent on Source and Target according to Type of Representation in SCD Condition

Time in each problem	N	Mean	SD	Min	Max
Time for Source Pictorial Problem.	80	12.98	4.85	6	25
Time for Target PS Problem.	80	12.75	5.30	2	26
Time for Source Verbal Problem.	80	13.63	4.24	6	23
Time for Target VS Problem.	80	13.09	4.99	4	30

Inter-Coder Reliability for Diagrams

The protocols for the self-constructed diagram were independently coded by two judges. Each of the two judges transcribed and divided the protocols into units depicting the cognitive processes of Explanation (labeling, combination, comparison, and relations); or Inference (mathematical elaboration, and goal directness, and obstacles); and or Analogizing (selective encoding, mapping and transfer). Kappa's inter-coder reliability yielded > 0.75 agreement for the coding categories. This value for Kappa indicates good agreement between the two judges, as given by "benchmarks" (Van Someren et al. 1994). Examples of some

common sources of discrepancies between the judges that affected the reliability score are described below.

There was some disagreement in the number of elements in the labeling sub-process where one judge indicated a single labeling event for several items while another judge counted each item labeled as a separate event. In another case there was disagreement in counting the number of units and/or the number of drawing elements such as arrows. Lastly, sometimes the disagreement was in assigning coding categories to the protocols. For example, when a participant indicates a scale can weigh “at most 20 kilos” one judge regarded the diagram of the scale alone as labeling while the other considered both the “at most 20 kilos” statement with the picture as a constraint.

Analysis of the drawing units generated

Participants generated diagrams for each problem, which were coded according to the main cognitive processes and sub processes that they revealed. The protocols were first broken down into units where credit was given if a constructed diagram represented the corresponding element in the problem. The protocols that conveyed the same meaning or contained the same key words were considered as one idea or unit of the problem. A unit could be either one element or a group of elements showing sub-processes. For example, labeling or combining two elements or comparing is considered as the sub-processes of the cognitive process of Explanation. Thus, the total number of sub-processes that could be generated or depicted in self-drawings for the source problem is as follows:

1. Labeling 2. Combining 3. Comparing 4. Relations (under the main cognitive activity of Explanation) 5. Goal 6. Mathematical elaboration 7. Justifications/Obstacles (under Inferencing).

The target problem also includes all the seven sub-processes mentioned above, as they are basically required to understand any problem effectively. In addition, the target problem consists of the cognitive process of analogizing that includes the sub-processes of selective encoding, mapping and transfer. These are inferred from the type of solution that a person generates.

The number of units generated for each source and its target problem were counted and analyzed. As mentioned above, a drawing is considered a unit if it reveals a cognitive activity. For example, if an element in the problem (ball) is depicted in the diagram, it is considered as a unit showing the cognitive activity of labeling. The following analysis was undertaken to assess the number of cognitive activities (units) revealed in the drawings.

The Mean and SD were calculated as shown in Table 6.20 to allow for comparisons between the verbal and pictorial representations. The number of units generated in the verbal source ($M = 5.60$) is relatively higher than the pictorial source ($M = 3.95$) where the t-test found this difference significant ($t(79) = -5.644$ $p < .001$). This significance can be explained by the fact that in the pictorial representations some participants tended to highlight the key elements in the picture itself. On the other hand, the verbal representation of the source demanded a schematic translation of the key elements and the process described textually. The target problems were represented in verbal format for both the verbal and pictorial source to enable comparisons across levels, conditions and representations. Therefore, the Mean number of units generated in the targets of

the verbal and pictorial source problems did not show any variation. It was also observed that the verbal source generated more arrows ($M = 8.74$) than the pictorial source ($M = 7.71$).

Table 6.20

Descriptives of Number of Drawing Units and Arrows Generated

	N	Mean	SD
Total No. of units in Pictorial Source Prob.	80	3.95	1.87
Total No. of units in Target PS Prob.	80	4.98	2.34
Total No. of units in Verbal Source Prob.	80	5.60	2.39
Total No. of units in Target VS Prob.	80	4.89	2.19
Total No. of Arrows in Pictorial Source Prob.	80	7.71	4.99
Total No. of Arrows in Target PS Prob.	80	7.78	4.64
Total No. of Arrows in Verbal Source Prob..	80	8.74	5.11
Total No. of Arrows in Target VS Prob.	80	8.79	5.07

Besides assessing the occurrence of the crucial cognitive sub-processes, analysis was also undertaken to assess the relative strength of the main cognitive processes of Explanation and Inference. For example, if a person's drawings revealed all the 4 sub-processes of Explanation then she achieves a score of 4 on the cognitive process of Explanation and a score of 3 if all the sub-processes of Inference are depicted. Table 6.21 shows that participants in the verbal source revealed significantly more the cognitive processes of Explanation than in the pictorial source $t(79) = 3.71$ $p < .001$ and inference $t(79) = 3.82$ $p < .001$. Table 6.22 shows the results of the cognitive sub-processes analyzed in the target problem. The target problem involved an additional cognitive activity of analogizing that consisted of three sub-processes: selective encoding, mapping and transfer. Mapping is considered to be the most crucial activity hence it has been assessed in terms of Mean frequency. It is seen from Table 6.22 that the type of source representation (Mean PS = 2.18, and Mean VS = 2.16) did not

affect the activity of the mapping process. However, the activity of Explanation is relatively higher and nearly the same in the targets of both the VS and PS. This is perhaps, the effect of SCD on verbally represented target problems.

The cognitive sub-processes of Explanation and Inference need to be revealed through drawings to indicate how clearly a person understood the source problem. This analysis of diagrams was undertaken to understand their impact on the process of analogizing in the target problem or transfer performance. On a scale of 1 to 7, the diagrams were classified as strong if a person revealed 5 to 7 sub-processes in his drawings, moderate if it was 4 or 5, and weak if 2 or less.

Analysis of the quality of diagrams generated is shown in Table 6.21. Diagrams generated in the VS differed significantly from those of PS ($M = 4.2$, $SD = 1.36$ and $M = 3.69$, $SD = 1.57$) respectively with a $t(79) = 2.698$ $p = .009$). However, the target problems in the SCD indicated no reliable differences between the two representations (verbal and pictorial) on any of the above. The above findings clearly convey that because the verbal format required the problem to be re-represented pictorially it demanded a more systematic application of the cognitive processes to facilitate understanding and interpretation.

Lastly, assessing the degree of association between the various cognitive processes and the strength of transfer (ST), for the SCD condition ($N = 80$), revealed a significant correlation between ST of the Pictorial source (PS) problem and the processes of inference $r = 0.368$ and analogizing $r = 0.809$ (Table 6.23). The correlations were also significant between the ST of the verbal source problem and the processes of inference $r = 0.414$ and analogizing $r = 0.809$ (Table 6.24).

Table 6.21

Cognitive Processes revealed in the Source Problems

	Mean	SD	t-test
Explanation in Pictorial Source Prob.	2.89	1.48	
Explanation in Verbal Source Prob.	3.83	1.84	t(79) = 3.7, p<.001**
Inferences in Pictorial Source Prob.	1.06	1.27	
Inferences in Verbal Source Prob.	1.78	1.49	t(79) = 3.82, p<.001**
Diagram quality for Pictorial Source Prob.	3.69	1.57	
Diagram quality for Verbal Source Prob.	4.2	1.36	t(79) = 2.698 p = .009**

N = 80

Table 6.22

The Qualitative Analysis for Cognitive Processes in the Target Problems

	Mean	SD
Mapping of Target PS Prob.	2.18	0.82
Mapping of Target VS Prob.	2.16	0.80
Explanation in Target PS Prob.	3.35	1.83
Explanation in Target VS. Prob.	3.18	1.43
Inferences in Target PS Prob.	1.63	1.62
Diagram quality for Target PS Prob.	3.20	1.61
Diagram quality for target VS prob.	3.38	1.63

N = 40

Table 6.23

The Correlations between the Cognitive Processes and ST in the Target Problem of PS in the SCD

	1	2	3	4	5	6
1. Score for Target PS	1.000	-0.003	0.368**	0.809**	0.085	0.177
2. Explanation		1.000	-0.083	-0.004	0.523**	0.148
3. Inferences			1.000	0.477**	0.339**	0.214
4. Analogizing				1.000	0.252**	0.182
5. Total No. of units					1.000	0.115
6. Diagram quality						1.000

** Correlation is significant at the 0.01 level (2-

* Correlation is significant at the 0.05 level (2-tailed).

Table 6.24

The Correlations between the Cognitive Processes and ST in the Target VS Problem

Pearson Correlation						
	1	2	3	4	5	6
1. Score for Target VS	1	0.009	0.414**	0.834**	0.208	0.266**
2. Explanation		1	0.080	0.044	0.466**	0.178
3. Inferences			1	0.405**	0.568**	0.265**
4. Analogizing				1	0.168	0.222**
5. Total No. of units					1	0.127
6. Diagram quality						1

** Correlation is significant at the 0.01 level (2-tailed).

* Correlation is significant at the 0.05 level (2-tailed).

Discussion

Experiment 3 was conducted to study the role of SCD as a self-support method in increasing transfer performance while solving non-domain specific problems represented verbally and pictorially in the source at two levels of similarity: strategy and procedure. Each participant solved a verbal and a pictorial problem either in the strategy or procedural level of similarity of the SCD or ND conditions. The results of Experiment 3 showed that:

1. Participants in SCD condition scored significantly higher than in the ND condition for both target problems.
2. Participants' performances in the procedural level of similarity were significantly higher than those in the strategy level of similarity
3. There was no significant within-subjects difference in performance in the two types of representations, pictorial and verbal, in the SCD condition.

In addition to these main results, Experiment 3 highlighted several aspects related to the use of SCD in analogical problem solving.

How does the SCD affect transfer?

The results of this experiment confirmed the first hypothesis that the mean performance (strength of transfer ST) of the target problem in the SCD condition would be significantly higher than in the ND condition. SCD are likely to be a useful aid to analogical problem solving for several reasons.

First, SCD helped participants discover deeper structural relationships among the representations by going beyond surface similarities and differences thereby providing the participant with the opportunity to gather meaningful information and derive a more coherent understanding of the problem. This important characteristic of analogical reasoning was highlighted by Gentner's structural mapping theory (1980 & 1983) and Gentner and Markman (1997), and also supported by results from Van Meter et al. (2006) in studies with children.

Second, SCD help reduce the limitations of the working memory, which in turn positively affects the process of problem solving by representing and organizing information so that concepts can be frequently inspected and altered. This process externalizes information from the source problem leading to improved understanding of the principle and the procedural processes. In addition, when solving the target problem, externalization of information helps in identifying resemblance between both the source and target problem, which positively affects the transfer procedure. While Lewis (1989) referred to this phenomenon as facilitating learning by doing, Heiser and Tversky (2002) held that externalizing through depictions helps reduce the working memory load and increase the activity of self-monitoring or meta-cognition by frequently inspecting and altering the conceptualization of information. Kirschner (2002), in his cognitive load theory, emphasizes the importance of imposing and

maintaining the optimal intrinsic cognitive load in the working memory for the construction of adequate schemata of knowledge. The process of rerepresentation in SCD helps by offloading information gained from the source making it readily available for better integration of both the internal and the external representation. Zhang and Patel (2006) referred to this process as an integrated representational system in high-level cognitive phenomena. In general terms, Zhang and Patel (2006) described the components of a distributed cognitive system as internal and external representations. They wrote that “internal representations are the knowledge and structure in individuals’ minds; and external representations are the knowledge and structure in the external environment,” p. 334. Moreover, the findings of this study are also in accordance with the views of Ainsworth & Iacovides (2005) and Van Meter et al. (2006), that the process of externalizing enhances learning by reducing cognitive load, as well as with Mayer’s theory of Multimedia learning where he proposed that different formats of representation help people select and process information to construct a coherent mental representation.

Undoubtedly, the use of SCD in Experiment 3 created an ideal situation for offloading. This process was also present, to some extent, in the previous Experiment 1 where participants presented with a pictorial representation of the source problem had the opportunity to offload information by verbalizing it. However, SCD in Experiment 3 was more effective because it allowed greater offloading as compared to information verbalized based on a provided pictorial representation. Moreover, while verbalized information tends to be easily lost, if not remembered in entirety, SCD remains a concrete source of reference on the sketchpad. Thus, the results of both Experiment 1&3 confirmed that problem-

solving performance is significantly enhanced when combined with a self-support method.

Third, SCD demands active interactions between external representation and internal mental models. For example, Figure 6.24 illustrates a participant making connections between the fabricated representation and the constructed one. This finding is further supported by Cox and Brna (1995), who found that constructing diagrams or generating new representations besides interpreting the present one may have a positive effect on problem solving because this process demands active interactions between external and mental models. In addition, Cox (1999) emphasized that the process, of constructing and interpreting with external representations, is a crucial component of learning due to the dynamic interaction between external and internal models that takes place when subjects construct a personal version of the presented information.

Fourth, SCD plays the role of multiple external representations (MER). In SCD participants understand a fabricated representation by organizing the given information by location, according to their relations, and building an external representation consisting of propositions, properties of object (such as shape, size, location, or colour), relations between the objects (such as special relations), and the written symbols. This construction of a second external representation requires integration of the internal mental model and the fabricated representation, which facilitates constructing personal understanding of the problem's information and accordingly affects the transfer. Ainsworth and Van Labeke (2004) reported that providing learners with multiple representations produced mixed results. Experiment 3 clearly established that the benefits of multiple representations can be acquired by involving the learner in building

them. This external self representation not only reflects the understanding of the problem, but also helps focus on the most important information. Sometimes, an incorrect or incomplete rerepresentation, may still lead to a better understanding of the problem.

Fifth, SCD highlights the cognitive processes generated which facilitate the transfer process. Specifically, SCD helped improve performance and transfer by increasing the cognitive processes of encoding the key elements, mapping of corresponding elements, and understanding the relational structures between these elements. An example, of SCD in the source and its target analogue are shown in Figure 6.24 where the drawing depicts the process in the source problem correctly. The sketchpad, which was created on top of the given representation, shows a successful transfer achieved by a participant who took the pictorial source (Jug 2) and its Almond target problem at procedural level of similarity. It shows the sub-process of labeling (1), combination (2), comparison (3), relation (4), math elaboration (5), goal (6), and constraints (7). It was observed here that the participant did not re-represent in drawings but instead used the provided pictorial representation itself to highlight the main features and elaborate on them. Nonetheless, the target problem shows how she used selective encoding and mapped the system of relations between the two problems. The SCD in the target problem, for the same participant (Figure 6.24), shows how the information in the verbal format was translated into diagrams. Creating a nonverbal representation from a verbal one requires a person to select and integrate information that serves as an additional representation in a different modality.

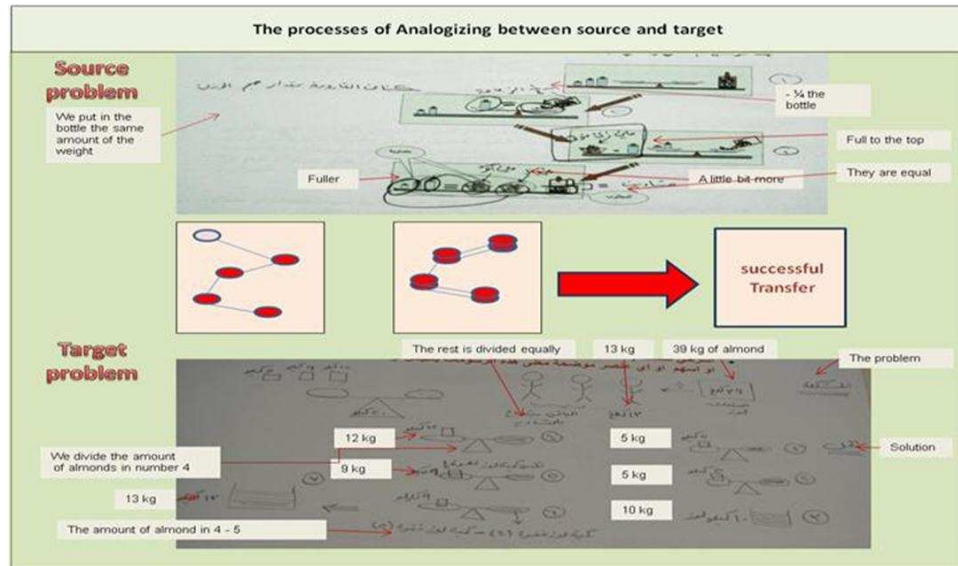

Figure 6.24: Comparison of the source and target generated diagrams in the Pictorial source representation.

Sixth, SCD illustrates the important role of common drawing elements, such as arrows, lines, circles and squares. They are used in SCD to perform many functions. For example, Figures 6.4 to 6.7 show the use of drawing elements to separate distinct ideas within their SCD. In Figures 6.4 and 6.6, circles to perform this function were used, while in Figure 6.7 lines were used. Drawing elements can also serve as indicators of the important words or objects in a problem representing the movement of an object such as up, down or next process, or goals and obstacles. The use of drawing elements are also reported in Tversky and Lee (1999) who discussed the importance of these elements and indicated that they may help in retrieving information from LTM.

How does the level of similarity affect transfer?

With respect to the levels of similarity it was found, as predicted, that participants in the procedural level of similarity performed better than those in the strategy level. These findings are also consistent with Experiments 1 and 2 of this study and as well as Chen's (2002, 1996) who predicted and found that the

procedural similarity between the source and target problem facilitates transfer significantly more than the strategy level in analogical problem solving.

Another important finding of this Experiment was that participants of SCD who analyzed the source problem (verbal or pictorial) in the strategy level of similarity showed effective transfer performance where the mean performance score was significantly higher in SCD. This finding clearly communicates that even when the source problem did not share any superficial or structural properties with the target problem, that is, no procedural details of the solution, externalization of representation (SCD) helps discover some commonalities. This has been referred to by Gentner (1989) as the alignable differences and similarities, which are relevant to the common causal or goal structure in the two problem situations, which facilitate transfer.

What is the effect of modality on transfer?

No significant main effects for the type of representation, regardless of levels of similarity and conditions of drawing, were found. Interestingly, this finding is contrary to results from Experiment 2 where a significant main effect of the type of representation on target performance was shown which confirmed the prediction that pictorial representation in the source facilitates better performance than verbal. The lack of a significant difference between verbal and pictorial representations can be attributed to the use of SCD. It is likely that the SCD helped raise the level of performance in the verbal form to nearly the same level as that of the pictorial representation. This conclusion is based on the fact that with SCD both the verbal source and target representations are externalized in diagrammatic form, thus providing two representations of the same problem. Indeed, in the target performance of the verbal source (TVS) a significant

difference was found in the SCD and ND conditions. This difference again can be attributed to the role of SCD which transforms a verbal representation into a pictorial one that serves as a second representation.

What is the difference between the solvers and non-solvers?

As indicated in the results of Experiments 1 and 2, the main distinction between solvers and non-solvers was how the source and target problems were understood. In Experiment 1, the lines of protocol produced, as well as the cognitive processes involved, quantified the level of detail reached by solvers. In Experiment 3, the diagrams of solvers showed objects organized in space according to their relations and/or according to the information that expresses the goal or obstacle. Accordingly, these participants determined the main objects, the goals and obstacles and obtained greater knowledge about the problem, all of which facilitated problem solving. As an example, the vivid and highly similar source (Figure 6.25) and target (Figure 6.26) diagrams produced, by a solver in the verbal source of procedural level of similarity, show how precisely the participant selected, labeled and organized information in a way that helped elicit the processes of inference and mapping required for implementing the solution process in the target problem effectively.

These findings provide additional support for the view that two representations are better than one (Ainsworth 2006). However, unlike MERs, a participant does not merely integrate information from various representations but actively selects, organizes and creates her own interpretation of the given problem, thus providing a deeper experience for the solver. Van Meter et al. (2006) explain the process of integration as intrinsic to SCD because constructing a drawing is building a nonverbal representation derived from the verbal, which

in itself demands integration. In contrast, non-solvers may either misinterpret information in the problem or introduce errors in representation at any stage of problem solving. Such misunderstandings will affect the cognitive processes and performance in the target problem.

In addition, solvers focus on both the goal as well as the constraints imposed by the problem. They depict this information pictorially in different ways, the correct interpretation highlights the analogy between the source and target problem and therefore externalization facilitates the transfer of the procedural processes from the source to the target. Figure 6.25 is an example of a solver's sketchpad of the source pictorial problem (Jug 2) in the procedural level of similarity. It shows all the sub-processes of explanation and inference that helped generate a comprehensive understanding of the problem and successful transfer. Another example of source (Figure 6.27) and target (Figure 6.28) problems are depicted for a solver with a verbal source problem and procedural level of similarity. The selective encoding and mapping is clear, the participant drew 12 balls in the source problem and 12 jars in the target problem which triggered the activity of noticing the connection between the two problems. In contrast, non-solvers may take into account only the goal, while having only limited representation of the obstacles. However, without proper interpretation of the constraints, knowing the goal alone is not always enough to lead to successful problem solving.

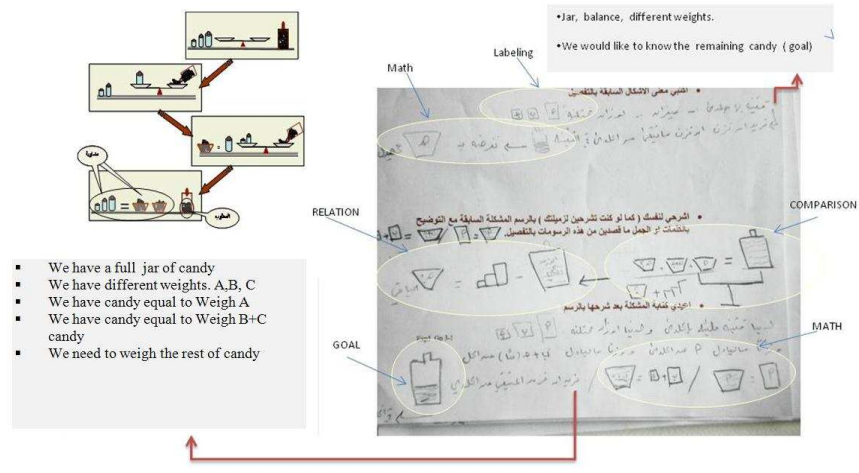

Figure 6.25: The sketchpad of the pictorial source (Jug 2 problem).

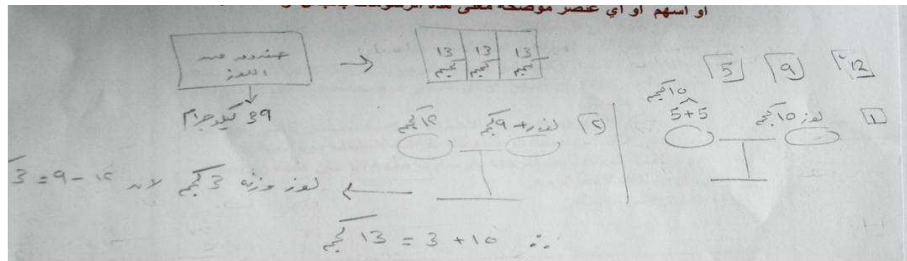

Figure 6.26: The sketchpad of the target problem for the pictorial source (Jug 2).

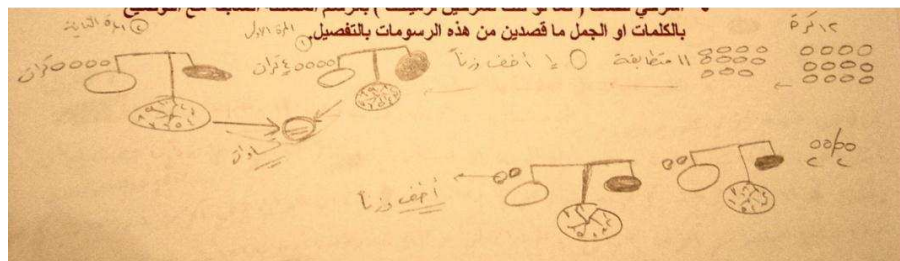

Figure 6.27: Sketchpad of source verbal problem.

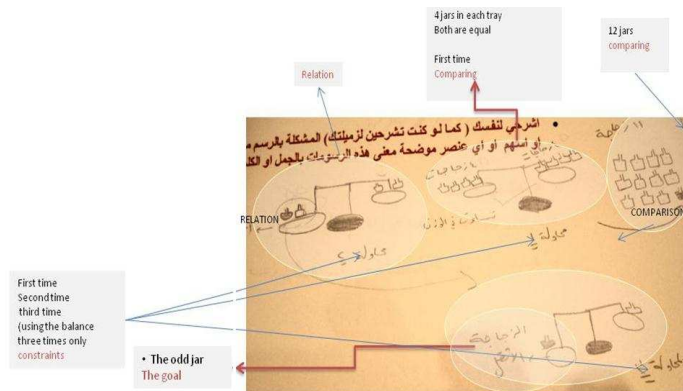

Figure 6.28: Sketchpad of the target Lab problem.

Contributions and limitations

Experiment 3 made some significant contributions to the field of analogical reasoning in general and the role of SCD in learning in particular. The methodology of this experiment is considered unique in that it compares two informationally and computationally equivalent modalities of representation (pictorial and verbal) of the source problem to investigate the effect of SCD on transfer performance in a within subjects design. Moreover, the drawing protocols revealed how the pictorial and the verbal representations influence the cognitive processes involved in solving problems of analogical reasoning. Specifically, these protocols helped gain some insight into how people form mental models of external stimuli that effects their learning outcomes.

Another major contribution of Experiment 3 was the development of a coding scheme for analyzing SCD protocols. Very few researchers have used this method of externalizing representation by self-constructed diagrams (e.g. Cox 1995; Ainsworth & Iacovides 2005; Van Meter et al. 2006). However, they neither analyzed the information generated in the diagrams nor the relative contribution of each aspect of the diagram in understanding or solving a problem. Thus, to the researcher's knowledge, this coding scheme is considered the first of its kind because it introduces a fairly robust method for identifying the cognitive processes from SCD that affect the process of problem solving.

Although, the results of Experiment 3 confirmed the hypotheses, it is important that these results be viewed within the limitations imposed by the study which besides providing a context for interpretation, would serve as motivation for future studies of SCD.

First, retrospective reports of participants indicated that training in SCD for a limited time of one hour was not sufficient. As the positive effects of SCD are likely to increase with experience it is expected that improvements in training will yield more robust results. Future studies could consider multiple levels of training for participants in order to determine the level of experience that maximizes problem-solving success.

Second, the analysis of SCD produced by participants focused only in identifying cognitive processes and sub-processes, but did not take into account the type of errors. While it seems that even a partially correct SCD could sometimes help with transfer, it is not clear how errors in this compound to impact the problem solving process. For example, a participant that initially drew an incorrect number of balls may carry that error throughout the SCD representation and thus may be unable to solve the problem. On the other hand, other types of errors may be less harmful. Therefore, categorizing errors and assessing their impact on transfer remains an open question for future analysis of the data.

As the purpose of this experiment was to elicit a sufficient amount of SCD protocols time was not imposed as a constraint. Imposing a time limit for solving the source and target problem would perhaps yield different SCD protocols and also provide a uniform condition for comparisons between the transfer performance of solvers and non-solvers.

Conclusions

This experiment investigated the role of the SCD and its effect on transfer performance in non-domain specific problems represented verbally and pictorially in the source at two levels of similarity, strategy and procedural. The

first and second hypothesis related to transfer performance according to drawing conditions and levels of similarity. The third prediction related to the within subjects difference in performance according to modality of representation.

The Mean performance (strength of transfer, ST) of the target problem in the SCD condition was found to be significantly higher than in the no-drawing (ND) condition confirming the hypothesis. With regard to levels of similarity, irrespective of modality of representation and conditions of drawing, performance in the procedural level of similarity was found significantly higher than in the strategy level. The hypothesis that there will be a no significant within-subjects difference between the verbal and pictorial representations in the SCD condition was accepted as no significant main effects for modality of representation were found, irrespective of levels of similarity.

Some findings that are considered interesting and important that widened the researcher's perspective about the role of the self support method of SCD are:

Contrary to previous experiments of this thesis, it was found that participants of SCD who took the source problem in the strategy level of similarity with the target problem also showed effective transfer performance.

No significant difference was found in the target performance of pictorial and verbal sources of representation. This was perhaps due to the positive effects of personally rerepresentating pictorially the verbal source (as opposed to fabricated pictorial representation) in the SCD condition.

In the target performance of verbal source (TVS) a significant difference was found between the SCD and ND conditions upholding the view that two representations are better than one. However, unlike MERs, a person does not merely integrate information from various representations but actively selects,

organizes and creates his own interpretation of the given problem that provides for a deeper experience.

Finally, Experiment 3 served as the basis for the development of the Generative Procedural Model of Analogical Problem solving presented in the next chapter.

CHAPTER 7: THE GENERATIVE PROCEDURAL MODEL FOR ANALOGICAL PROBLEM-SOLVING

The proposed Generative Procedural Model for Analogical Problem-Solving (GPM) is an attempt to demonstrate the effect of the self-support method (SCD) on procedural type of information depicted verbally or pictorially in analogical problem-solving. As discussed earlier, the levels of abstraction and the type of representation are important determinants of transfer performance; therefore the interaction of these with each of the self-support methods is conveyed through this working model. Examples of four participants have been reproduced as case studies to depict, through the model, the processes each went through when solving a source problem and its analogous target in two levels of similarity (procedural and strategy) and two modalities of representation (pictorial and verbal).

The Generative Procedural Model (GPM), which is largely an outcome of this study, also draws on some theories and models of problem solving which are: Cognitive Load Theory (CLT), Kirschner (2002); Model of Learning from Illustrated Text, Mayer and Sims (1994); The Multimedia Theory, Mayer (1999b & 2001); Generative Theory of Drawing construction, Van Meter et al. (2006); The Structure Mapping Theory, Gentner (1983); and The Multiconstraints Theory, Gick & Holyoak (1980, 1983). As these theories have been dealt with in detail in Chapter 2 a quick review highlighting those features that compare with the GPM will be mentioned here followed by an analysis of the case studies through the model.

Structural Mapping theory and the Multi Constraints theory

According to the Structural Mapping Theory (1983), analogy is a device for conveying that two situations share a relational structure despite arbitrary degrees of differences in the objects that make up the domain. Therefore, although analogical reasoning mainly involves the process of comparison, its essence lies in discovering interconnected systems of relations and their arguments. This, according to Gentner and Markman (1993), entails understanding the interaction between conceptual cognitive processes and representational schemes that permit structural alignment and mapping that are relevant to the common causal or goal structure between the two situations. Gentner and Markman (1997) also emphasized that systematic and coherent base information maximizes the amount of information that can be mapped. In their model of cognitive processing, (Figure 7.1), they highlight the alignment of similarities and differences take place internally by selecting those categories that match best (mapping) from memory or discovering new ones.

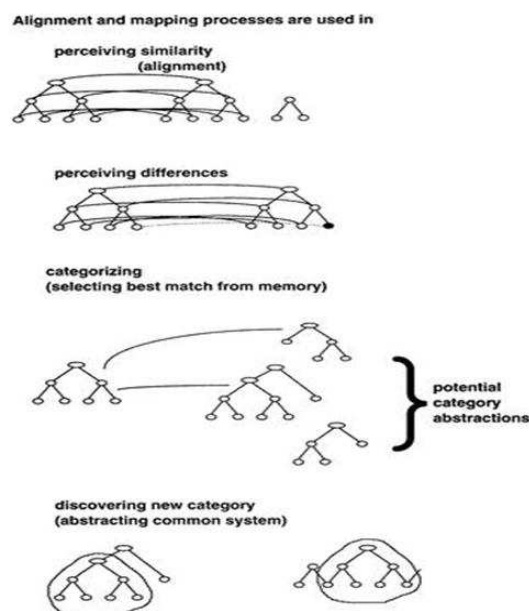

Figure 7.1: Gentner & Markman (1997) Model of Mapping cognitive processing

Holyoak & Thaggard (1989a) developed a Multiconstraints approach that was among the first, which recognized that problem-solving by analogy is governed by levels of similarity between the source problem and its target. Additionally, they delineated the importance of goals and constraints as pragmatic considerations that heavily influence the initial selection of information from the source and subsequent transfer process.

The GPM derived from this study illustrates dynamically how problems represented at the procedural level of similarity facilitate the process of superficial and structural alignment, as compared to the strategy level, as well as the role of pragmatic factors (goals and constraints) in guiding the mapping and transfer processes as revealed by the think-aloud and drawing protocols.

The Cognitive Load Theory

According to the Cognitive Load Theory (CLT), problem-solving often puts more cognitive load on working memory that has a limited capacity of processing two to three items of information at a time. Complex problems often require learners to engage in reasoning processes that involve comparing and contrasting information of familiar or unfamiliar elements simultaneously. Lack of understanding a problem, due to individual differences in working memory limitations, could result in noticing, accessing or mapping problems in analogical transfer performance. The CLT holds that as the limited working memory is connected to an unlimited long term memory, it is important that the representation of a problem does not exceed the limits of the working memory (intrinsic CL) and at the same time maintain an optimal level that helps construct and store schemas into long term memory (Kirschner, 2002).

The GPM also shows the effect of using self support methods of SE and SCD (as opposed to external aids such as hints and MERs) on reducing CL and acquiring adequate schemas in complex learning tasks that involve highly interconnected information related to a procedure.

Cognitive Theory of Multimedia Learning

The cognitive theory of Multimedia learning (Mayer, 1999b) which is based on Paivio's Theory (1986) holds that human information processing system consists of dual channels, visual/pictorial and verbal processing, and that each channel has a limited capacity for processing. The experiments, on which the theory was based, aimed at examining the effect of individual differences on learning from visual and verbal instruction based strictly on the idea that learners use more than one sense of modality (visual, auditory or both). Mayer defines multimedia learning environments as those in which instructional material (scientific or mathematical explanation) is presented in multiple forms of representation that includes visual (animation or illustration) and verbal (text). Constructivist learning, according to this theory, occurs when learners seek to make sense of the presented material. This entails coordinating cognitive processes in the two channels by selecting relevant words or information from the textual and pictorial formats, organizing and integrating them with prior knowledge, and generating a coherent verbal and visual representation that aids problem-solving transfer (Figure 7.2).

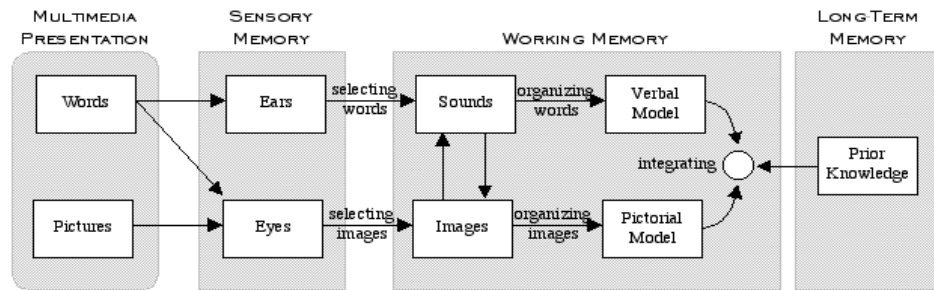

Figure 7.2: Mayer Model.

The GPM illustrates the role of the self-support methods, in developing constructivist learning, by facilitating a coherent integration of information, from presented material, rerepresentations (through SE or SCD) and internal resources (STM and LTM).

Learner-Generated Drawing Model

The Learner-generated drawing model of Van Meter et al. (2006) is an extension of the Generative Theory of Textbook Design (Mayer & Sims, 1994; Mayer et al. 1995) that aimed at explaining how learning from illustrated texts occurs. The model is based on the results of an experiment conducted on fourth and sixth grade learners to test the hypothesis that drawing results in the acquisition of a mental model. The supported drawing condition was compared to unsupported and non-drawing condition. It was found that self-drawing, both with and without support, enhanced performance by increasing the self-monitoring activity. Consistent with Mayer's model, Van Meter et al. (2006) found that readers performed three activities: selecting key elements from text and illustrations, organizing the selected elements to make coherent verbal and nonverbal representations, and integrating the representations to form a mental model that supports conceptual transfer. Van Meter's model differs from Mayer's in the differences that emerged as a result of drawing from a verbal text

and integrating the verbal and the nonverbal representations. Thus, Van Meter's model revealed the additional benefits of drawing manifested in the process of integration that takes place when learners construct drawings which induces engagement in nonverbal representational processes in a manner that necessarily leads to integration across verbal and nonverbal modalities. Learners can construct drawings only if they first derive a nonverbal representation from the verbal representation.

In the research carried out in this thesis there are cognitive processes involved in analogical problem solving that are in addition to those described by Mayer (1999b) and Van Meter et al. (2006). In the GPM, the process of integration in processing a verbal representation is consistent with Van Meter et al. (2006). The processes of organizing and selecting also correspond roughly to those proposed in the cognitive framework of this study.

Thus, the GPM integrates the points of view of various theories that are relevant to effective transfer performance while solving analogical problems that involve learning and implementing a procedure. It depicts how the self support methods (SSM) ensure active participation with the problem solving process that maintains the intrinsic CL. At the same time, SSM increase the probability of noticing structural correspondence of elements and their systematicity that may get stored in LTM as a schema of procedural information. Finally, it encompasses the advantages of multiple representations where a verbal representation is rerepresented into a pictorial version (dual modality) or the pictorial one is rerepresented in the same modality through SCD.

The GPM conveys the findings of the study that investigated how adults use analogy in acquiring knowledge. It examines the effects of levels of

similarity (strategy and procedural) and type of representation (verbal and pictorial) on the process of transfer where learning is expected to occur.

The Generative Procedural Model (GPM) for Analogical Problem-Solving

The model depicts how a representation is perceived and processed in the working memory when using a self-support method while solving a problem. Novel problems requiring insight that do not require any prior knowledge have been used in the study. The model is based on the framework of cognitive processes derived in Experiment 1 namely Explanation, Inference, and Analogizing. While the first two were found to be invariably involved in the solution of the source problem, the process of analogizing occurs while solving the target problem.

The GPM can be compared to the Multimedia learning model (Mayer, 1999b) and the Learner-generated drawing model of Van Meter et al. (2006) to highlight similarities and differences on three dimensions; Assumptions of the model, Cognitive processes, and Methodology.

Comparison of Models

The first assumption of GPM, though consistent with Mayer's dual channel processing, differs in that it uses only one representation, instead of two different modalities, which when combined with a self-support method (SE or SCD) generates two types of information (audio and visual) that are integrated. The concepts of selectivity and referential are similar in both models.

The second assumption of the model is based on Kirschner's (2002) view that the working memory cannot hold more than two to three chunks of information at one time. The self support methods SE and SCD tend to create

some cognitive load initially by inducing a person to explain what he perceives but at the same time it becomes a means of cognitive offloading.

The third assumption relates to the mapping process, which is the most fundamental and unique process in analogical reasoning. However, in problems that involve the acquisition of procedural knowledge, mapping is a crucial process but not sufficient for transfer. This is because the solution process from the source problem needs to be adapted (procedural mapping) to the target problem, which is contingent on the process of encoding the key elements and mapping both the superficial and structural relations between the source and the target problems. Therefore, it is assumed that SCD scaffolds the simulation of a procedure thereby facilitating procedural mapping.

Figures 7.3, 7.4, and 7.5 below show the important similarities and differences in assumptions, cognitive processes and methodology between the proposed model and that of Van Meter's and Mayer's approaches. All three models share the first two assumptions (Figure 7.3). In the third assumption the GPM differs from the other two models in that it is specifically based on problem-solving by analogical reasoning and not general learning contexts.

Figure 7.4 compares the cognitive processes identified and depicted in these models. The current model shows all the three crucial cognitive processes and their sub-processes. As both Van Meter et al. (2006) and Mayer (1999b) based their models on learning in general, they were restricted to the cognitive activities of selecting, organizing and integration essential for effective learning. However, the process of integration differs in these three models. Mayer refers to it as coordinating information from the Multimedia (textual and pictorial) formats for generating a coherent verbal and visual representation that aids

problem-solving, Van Meter et al. (2006) describe it as a necessary outcome of the drawing activity that induces integration across verbal and nonverbal modalities. That is, learners construct drawings only if they first derive a nonverbal representation from the verbal representation.

Assumptions		
Generative Procedural Model (GPM) (proposed model)	Learner Generated Drawings (Van Meter)	Multimedia Learning Model (Mayer)
1-Dual channels: for processing the information	Dual channels: for processing the information	Dual channels: for processing the information
2-Limited capacity of the working memory.	Limited capacity of the working memory	Limited capacity of working memory
3-Problem-solving by Analogical Reasoning.	Learning a topic from biology	Learning about a science topic-lightening

Figure 7.3: Comparing Assumptions

Cognitive processes		
Generative Procedural Model	Learner Generated Drawings	Multimedia Learning Model
It shows all the three cognitive processes and their sub-processes revealed during analogical problem-solving	Identified the processes of selecting, organizing (as Mayer's) and integration while learning	Cognitive processes of selecting, organizing and integration while dealing with information from multimedia sources
1. Explanation (labeling, combining, comparison, and relation)		
2. Inference (math elab., goal directness, and justification)		
3. Analogizing (encoding, mapping and transfer)		
4. The processes of selecting, organizing and integration		

Figure 7.4: Comparing Cognitive processes

Figure 7.5 compares the methodologies used in the studies to derive the model. It clearly shows that the current model is based on an entirely different,

and perhaps unique, methodology to investigate the precise effects of SCD and SE on analogical problem-solving.

Methodology		
Generative Procedural Model	Learner Generated Drawings	Multimedia Learning Model
Dynamic model draws upon Mayer (1999b), Kruschner (2002) and Van Meter et al. (2006) Based on experiments that investigated problem-solving by analogy in university students Everyday non-domain specific analogical problems involving a process to be learnt that does not require any specific knowledge	Conceptual Model based on Mayer (1994, 1999b) Based on experiment to investigate learning outcomes in 5th & 6th graders. Science topic from biology with no prior knowledge.	Dynamic based on Paivio (1986) & Baddeley (1996) Experiments used university students Science topic depicting a process with no prior knowledge.
Single representation either verbal or pictorial.	Text representation	Used multimedia pictorial and verbal representation of scientific information depicting a process
Analogical problem consisting of source and target	Learning from prescribed text	Learning a scientific process
Problems in the source represented at strategy and procedural levels of similarity with verbal target	Textual representation	Used multimedia pictorial and verbal representation of scientific information depicting a process
Instruction to draw while solving source and target problems	Instruction to draw	No diagrams
Drawing without support and no drawing conditions	Two conditions of drawing with and without support	No drawing
To assess transfer performance	To assess learning	To assess individual differences in processing visual and auditory information
Outcome assessed on a 4 point scale (strength of transfer)	Post assessments of learnt material	Outcome not specified
The model shows the effect of both SE and SCD and procedural similarity on transfer performance	The model shows the effect of SCD on learning	The model shows the effect of using dual channels audio and visual to process information from multimedia sources.

Figure 7.5: Comparing Methodology

Description of the GPM

The GPM is based on the idea that learners process information, represented verbally/text or pictorially, through the two sensory channels, audio/verbal and visual. During the process of learning, learners try to form mental representations of the visually or verbally/text presented materials. This information input is supported by visual (SCD) or auditory (SE). Analysis of SCD and SE protocols helped build the GPM that depicts the manifestation of the various cognitive processes while solving the source and target problems by analogical reasoning. The GPM describes separately how the source and the target problems are processed.

The source problem: Processing of pictorial information takes place when a person tries to figure out what the images convey. This initial and incomplete understanding of the pictures (internal model) is used to identify and select some key elements while figuring out the meaning and the purpose (what, why and how) of the pictures which may impose a cognitive load on the working memory. The condition of explaining to self, through explanation or drawings, helps organize the selected information and externalize it. Consistent with Mayer's and Van Meter's model, the participant starts with the first frame of a sequence of pictures from which an element or more is selected (selectivity) that enters the working memory through the visual channel. For example, a participant will apply the cognitive sub-process of labeling to the image of scale to build a corresponding pictorial mental model of the selected element. A referential activity takes place between the element externalized on to the sketch pad (icons/drawings or words) and the presented material to modify the internal mental model if needed. As each chunk of information is processed it is

externalized (offloading) through SCD. This activity is repeated every time an element/s is selected either from the same frame or a different one, by applying various cognitive processes to understand the problem such as labeling, relations, goal directness etc. This will either add to the previous understanding or modify it resulting in gaining a comprehensive understanding of all aspects of the problem and re-representing it adequately on the personal sketch pad. This constructivist learning generates both a mental model and its external representation that enhances the activities of evaluating and monitoring information resulting in a coherent learning experience. In contrast, multiple representations tend to increase cognitive load of the working memory, which may result in losing important information in constructing a mental model from various sources. Rerepresenting provides the same benefits without overload. Moreover, as the problem also involves understanding a procedure SCD also provides the opportunity to experience or simulate the implementation of the process. This process of simulation perhaps activates the LTM to store the learning as procedural information. Thus, a two way processing takes place where creating SCD activates the different cognitive processes to interpret the represented pictures, which in turn refine the rerepresentation of the problem in the same modality. Moreover, the referential process during SCD helps reduce the perceptual errors inherent in some pictorial representations. The result of this activity is an integration of a mental pictorial model and a rerepresentation of the same which perhaps provides for some experiential learning that is manifested in the solution outcome. Thus, the GPM depicts how learners build an external representation based on the extent to which they understand the source problem. Problem solvers focus on the goals of the problem and/or the obstacles that may

impede attaining a correct solution. They also tend to develop a deeper understanding of the problem for easy access while solving the target problem. We skip the verbal source problem as it follows the same procedure as the verbal target that is undertaken below.

The target problem: The target problem being in the verbal format takes the same processing path as the verbal source problem. The difference lies in the activity of integration that takes place during the cognitive activity of analogizing, which involves selective encoding, mapping and transfer. In processing the verbal target problem the written words enter through the visual channel creating a visual image as a base. This image may further create a word sound base corresponding to the visual image as described in Mayer's model (2001) for processing printed words. These activate the application of a cognitive activity which is translated into drawings on the sketchpad. Based on the fact that visual memory is more readily accessible than verbal, the sketchpad of the target problem is aided by the visual memory of the source sketchpad. This is evident when information is categorized and explained in more or less the same way as the source problem. For example, the same pattern of drawings in the source and target sketchpads of a participant in Figures 7.6 to 7.22 show the activity of selective encoding which triggered the activity of noticing the connection between the two problems which is considered very crucial in analogies. The icons on the sketchpad then reenter the working memory through the visual channel, which helps refine or update the understanding of the written words and generate a comprehensive pictorial model. Thus, the verbal representation serves as the internal mental model that is rerepresented diagrammatically. Van Meter et al. (2006) refer to this as a recursive process where a person inspects and

modifies information and detects comprehension errors. Additionally, the problem of executing the solution was found to be minimized perhaps due to experience gained in simulating a procedure diagrammatically in the source problem. The process of integration in the GPM takes place in two ways. The first is consistent with the observation of Van Meter et al. (2006) that the process of integration is inherent in the process of translating verbal information into pictorial. The second way integration takes place is when a person sees the structural relations between the two problems and integrates them to derive a solution or discovers the interconnected systems of relations and their arguments as described by Gentner (1983).

Therefore, the verbal representation differs from the pictorial one, described earlier, in that the person has developed a representation in a different modality (pictorial) corresponding to the represented text that serves the purpose of having more than one type of representation. Finally, a coherent understanding of the problem is derived when information from the two modalities, verbal and pictorial, is integrated with prior knowledge leading to an effective learning outcome.

The validity of the GPM can be demonstrated by illustrating different cases to show how information is processed according to levels of similarity and modality of representation. The model consists of four main parts; Type of representation given (words or pictures), the sensory memory (ears and eyes), the internal world (WM and LTM) and the external world (sketchpad). The working path is indicated by red and blue lines.

Case study 1 (Figures 7.6 to 7.22) illustrates an effective transfer performance in a pictorial source (Bar 2) and verbal target problem (Lab) at the

procedural level of similarity in the condition of SCD. Figure 7.6 shows the initial state in the model for element/s to be selected for processing the source problem in procedural level of similarity. Figure 7.7 shows that the participant has selected the second frame to begin processing the pictorial information. The red line indicates the working path where the selected elements enter the sensory memory through the visual channel (eyes) creating images in the working memory. Prior knowledge in the LTM (underlying all the cognitive processes) activates the cognitive sub-process of labeling forming a mental model (MM) of scale which is offloaded on to the sketchpad.

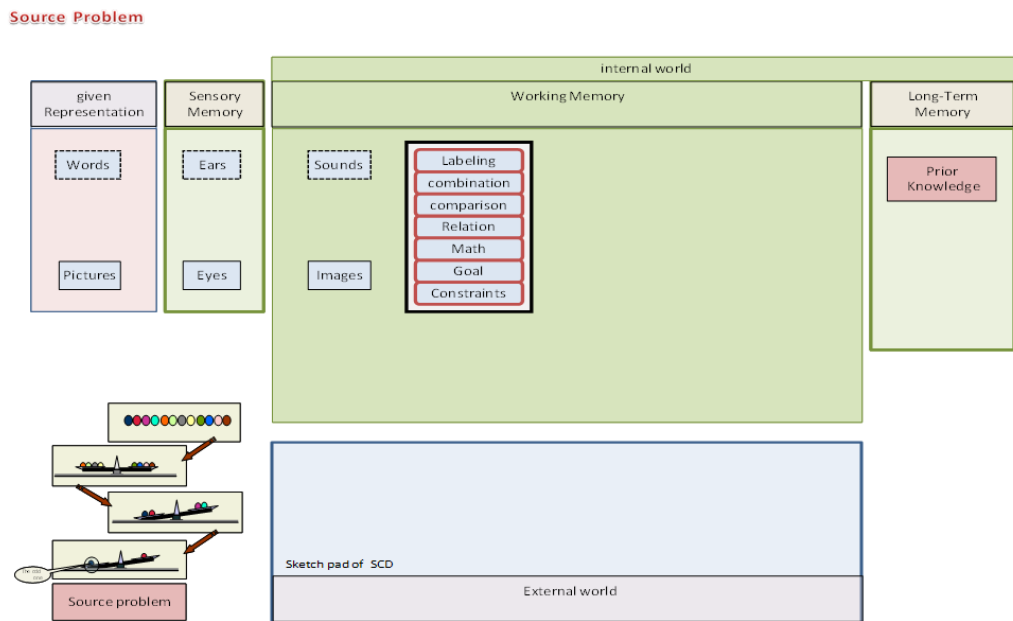

Figure 7.6: The initial state of the model.

Source Problem

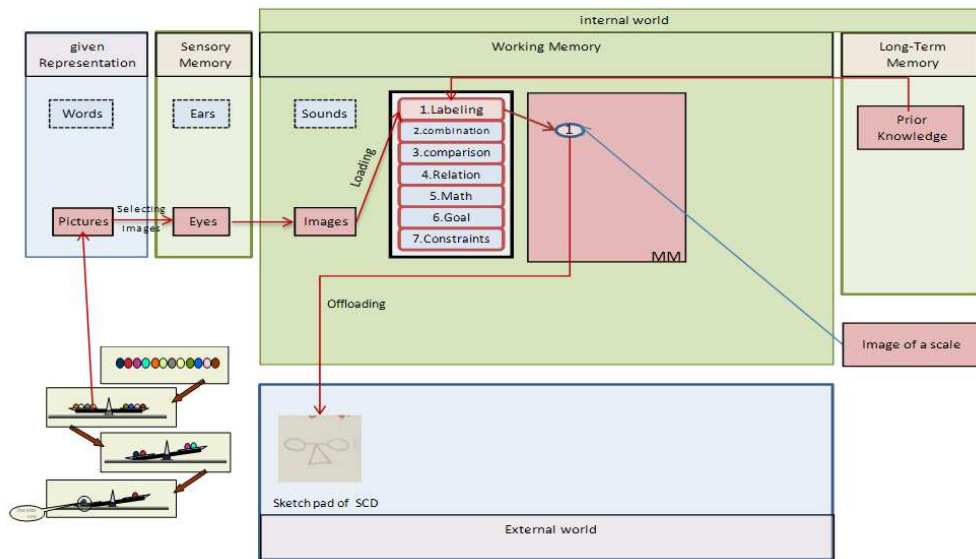

Figure 7.7: The Cognitive Process Of Labeling (1).

Figure 7.8 shows that other elements are selected indicating the sub-process of combination (developing MM of 12 balls). The participant rerepresents the information by grouping the balls equally in different colors. Now the sketchpad has two images, the scale and the 12 balls, which are not yet connected in the mental model. This drawing also serves as a referential activity for both ensuring the correctness of the first interpretation and helping understand further information given in the problem. Next, the sub-process of comparison (Figure 7.9) takes place when the participant compares two groups of balls, identifying them as equal in weight. The model illustrates that, through the process of comparison, the participant has connected the information scale and balls present in the mental model.

Source Problem

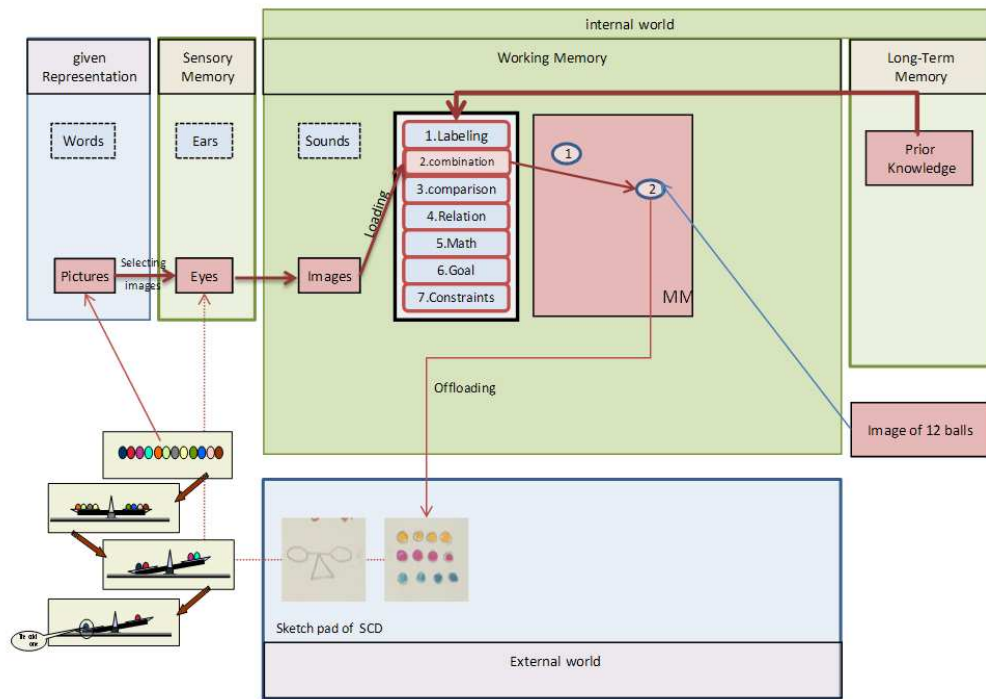

Figure 7.8: The sub-process of combination (2).

Source Problem

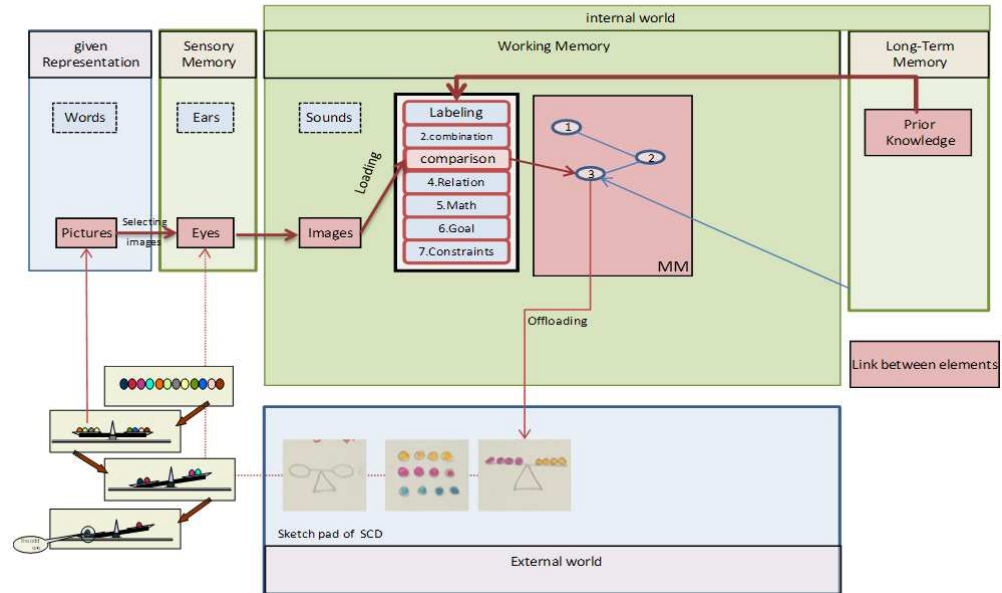

Figure 7.9: The sub-process of comparison (3).

In Figure 7.10 the sub-process of math elaboration takes place which the participant indicates by identify the heavier side in the scale. Here the participant shows an understanding of the problem by connecting all offloaded information.

In Figure 7.11, the participant returns to the source problem to select the fourth frame. The sub-process of relations is applied for understanding the association among the key elements in the problem. The fifth drawing on the sketchpad shows how the participant identified the odd ball that made one side of the scale heavier.

The cognitive sub-process of understanding the goal takes place in Figure 7.12. Here the participant derives a correct understanding of the process depicted in the final drawing by identifying the heavier odd ball.

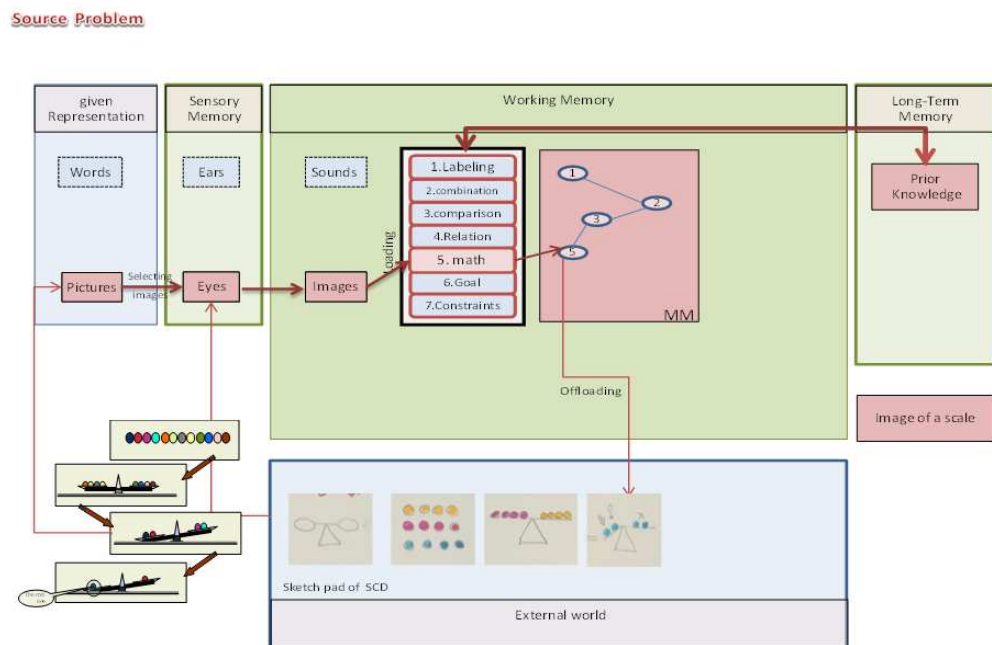

Figure 7.10: The sub-process of math elaboration (5).

Source Problem

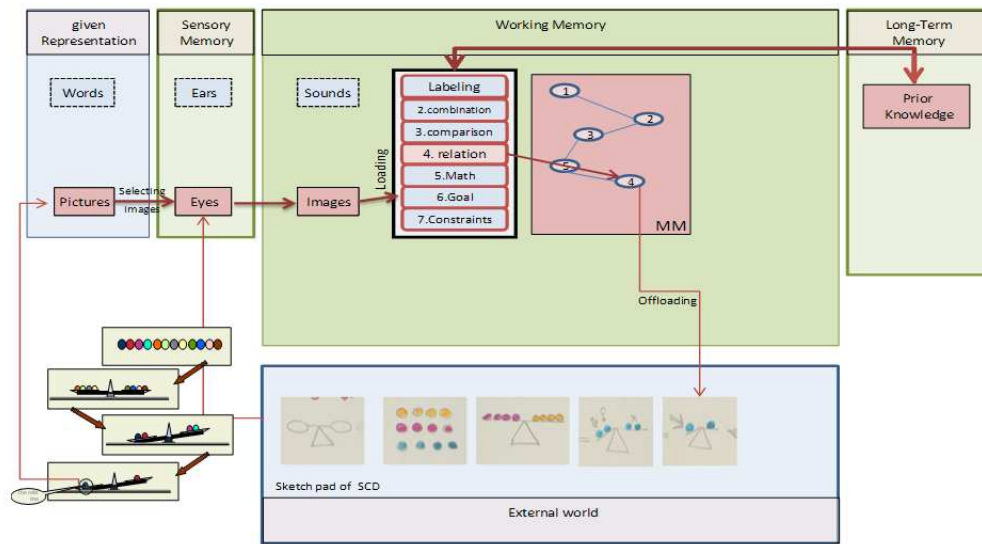

Figure 7.11: The cognitive sub-process of relations (4).

Source Problem

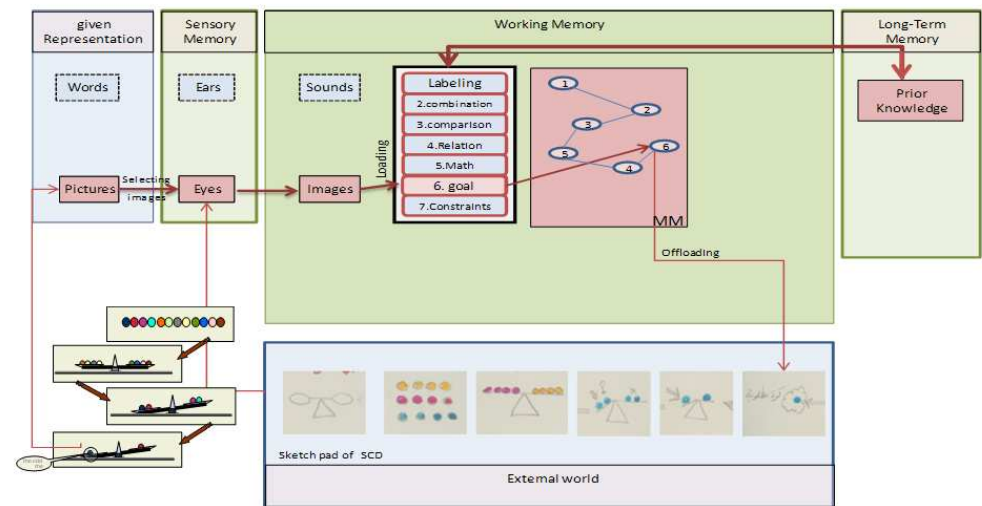

Figure 7.12: The cognitive sub-process of goal directness (6).

Figure 7.13 shows the process of integration that takes place in the working memory. The images in the mental model, the rerepresented knowledge on the sketchpad, and prior knowledge in LTM are integrated resulting in successful problem solving. It is assumed that the diagrams on the sketchpad of the source problem (Figure 7.14) are experiences that become part of procedural knowledge in the LTM.

The initial state of the verbal target problem (Lab) in Figure 7.15 shows that it involves the cognitive processes of Analogizing in addition to the seven cognitive sub-processes in the working memory. It also indicates the possibility of images from the source problem present in the LTM. The sensory memory is ready to select one or more verbal elements for processing.

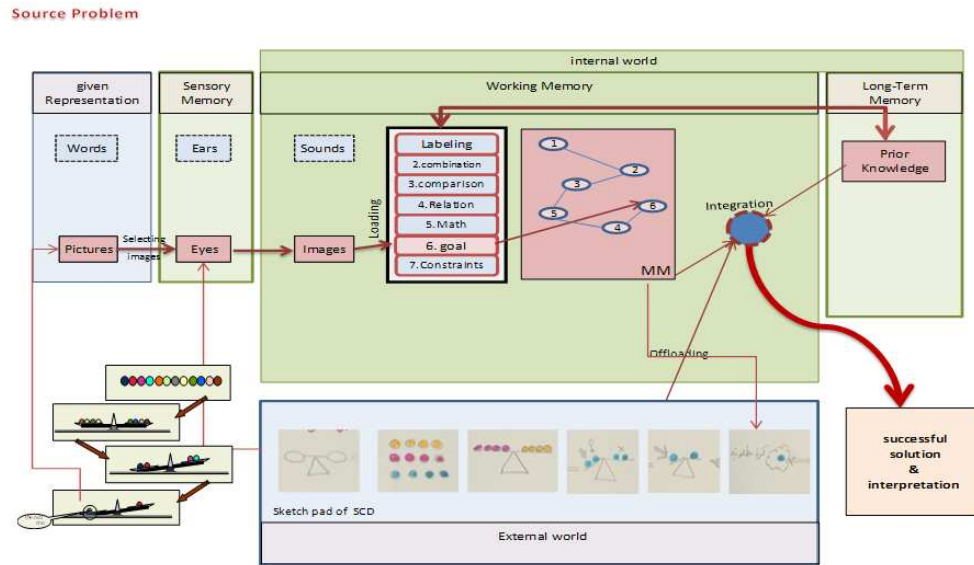

Figure 7.13: The process of integration.

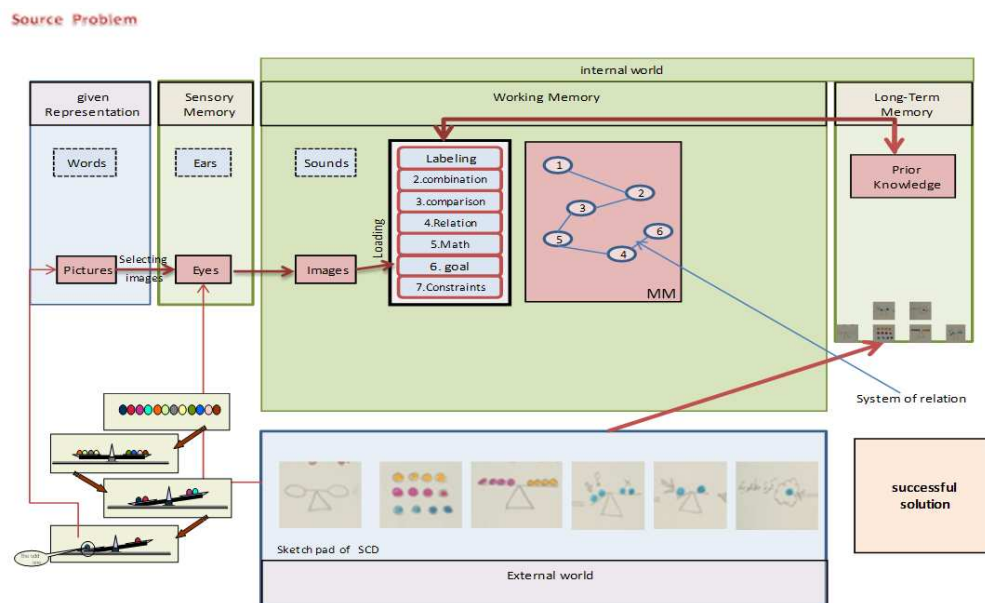

Figure 7.14: The final state of the source problem.

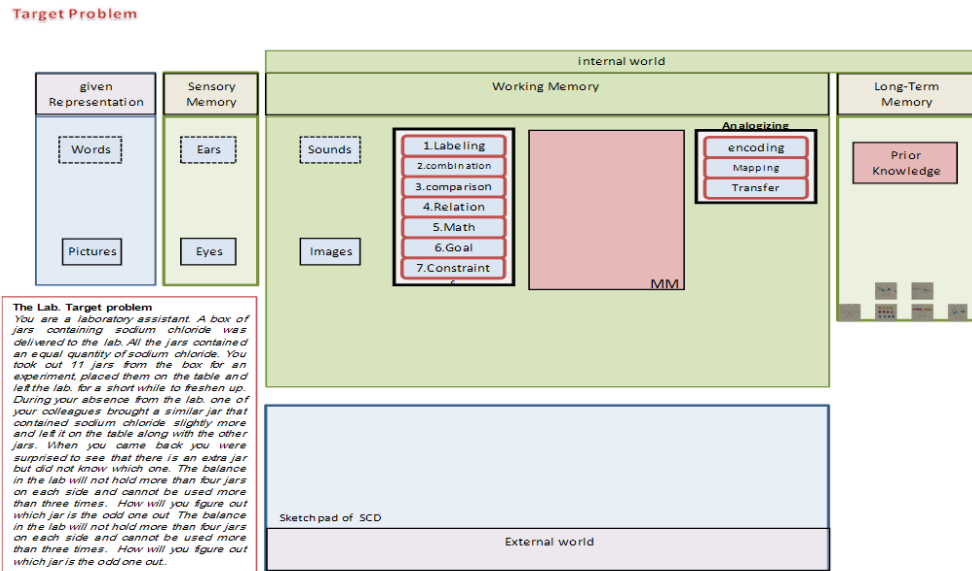

Figure 7.15: Initial state for the target problem.

The red line indicates the path of processing the information in the target problem that is similar to the source problem. In Figure 7.16 some key verbal elements are selected from the texts (highlighted in red) that enter the sensory memory through eyes for processing in the working memory. The cognitive process of combination has taken place where a mental model of the 11 jars and the odd one is formed and offloaded on to the sketchpad. We can infer from the diagrams that the sub-process of encoding is taking place at the same time because they strongly resemble the image of the source problem in the LTM indicated by the dark blue line.

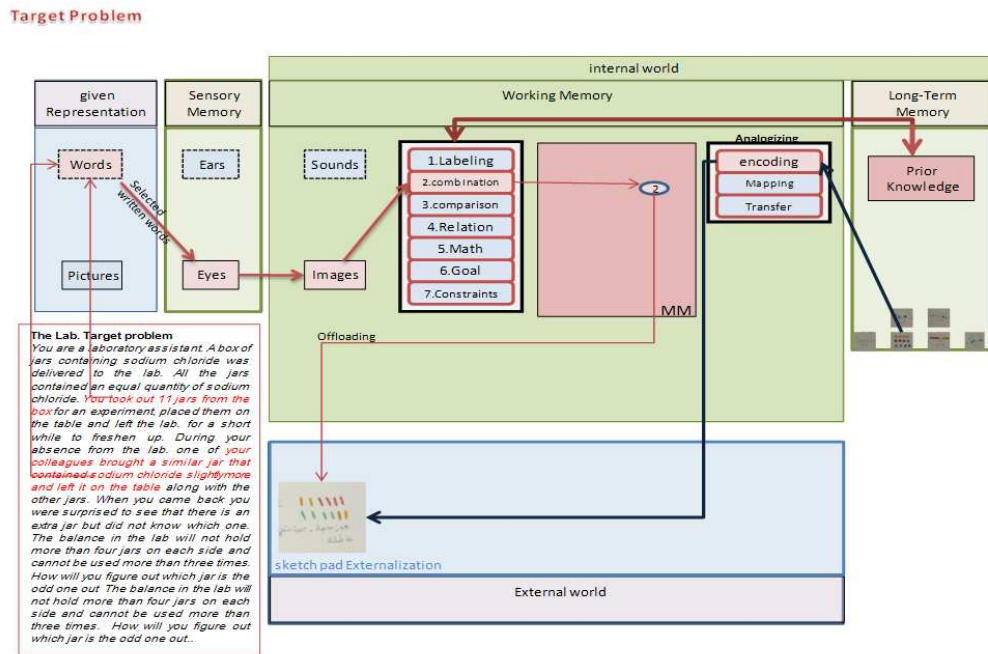

Figure 7.16: the cognitive sub-processes of combination (2) and encoding.

Figure 7.17 illustrates that the cognitive sub-process of identifying the constraints, present in the lab problem, has taken place and the resulting diagram is offloaded on to the sketchpad. In Figure 7.18 other verbal key elements are selected and processed using the sub-process of comparison (4 against 4 jars), that are also offloaded on to the sketchpad. The process of mapping has begun here.

Figure 7.19 shows application of the process of math elaboration. The offloaded drawing indicates that the participant is continuing the mapping process (dark blue line) by retrieving information from the stored images in LTM. This can be deduced because the drawing here is similar to the one in Figure 7.10 of the source problem.

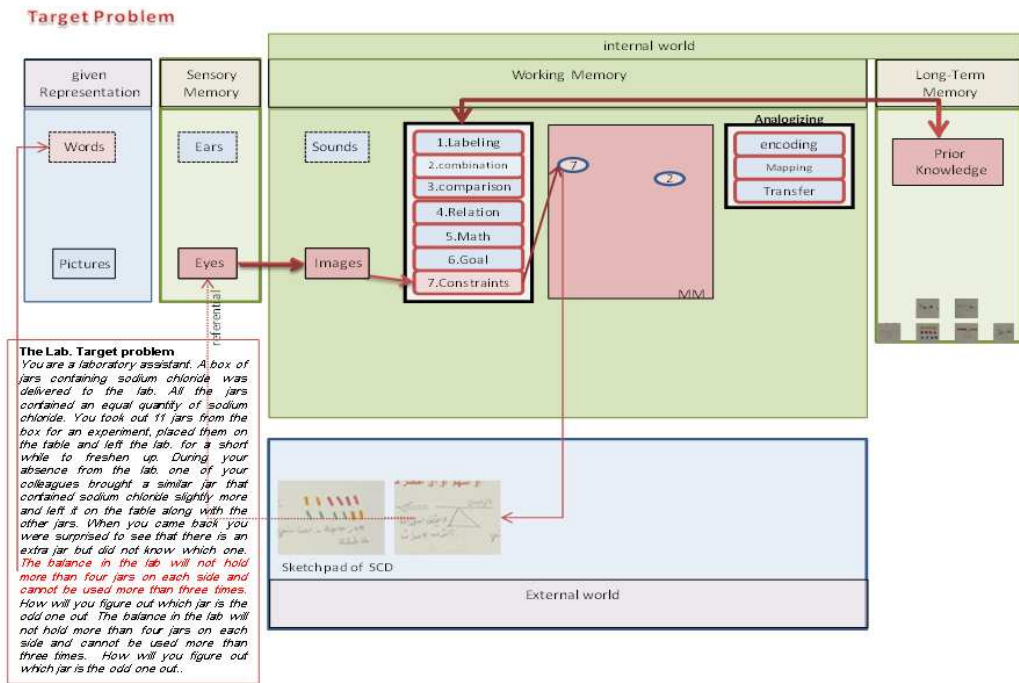

Figure 7.17: The process of constraining (7).

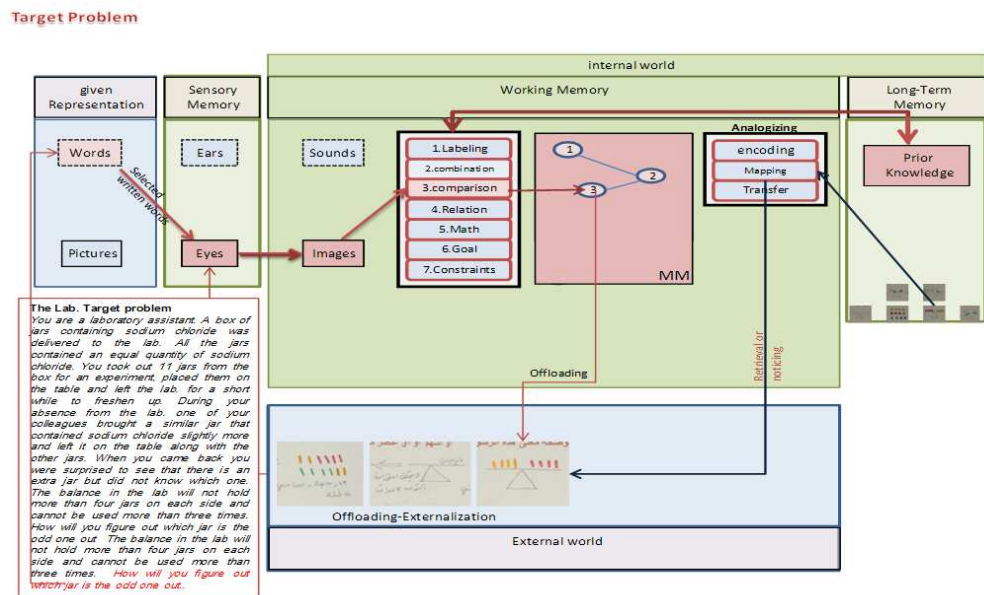

Figure 7.18: The sub-processes of comparison (3) and Mapping.

Target Problem

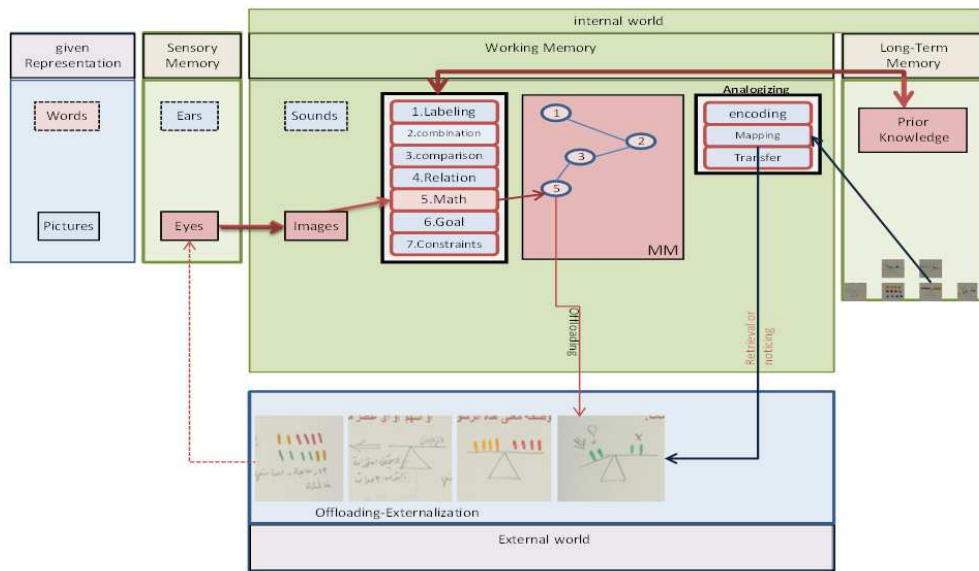

Figure 7.19: The sub-process of math elaboration (5) and Mapping.

Target Problem

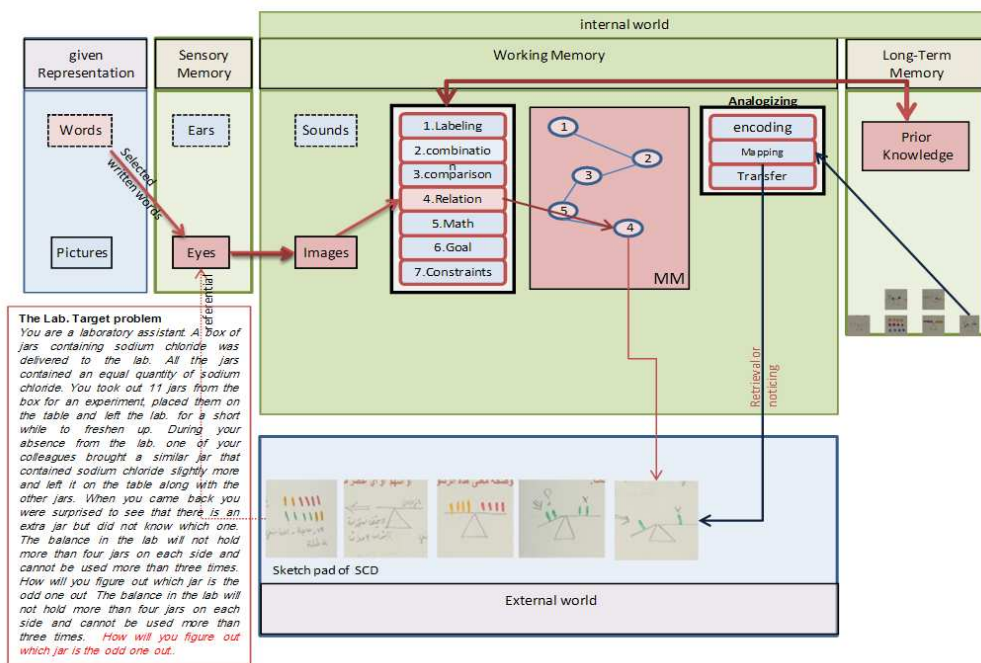

Figure 7.20: The sub-processes of relations (4) and mapping.

A system of relations has been developed in the MM which further facilitates the mapping process (Figure 7.20). The sub-process of goal directness in Figures 7.21 guides the participant to achieve correct and complete transfer. In Figure 7.22, the researcher infers that the successful transfer was an outcome of

integration between the mental model of the verbal and externalized pictorial rerepresentation on the sketchpad along with the prior knowledge in the LTM.

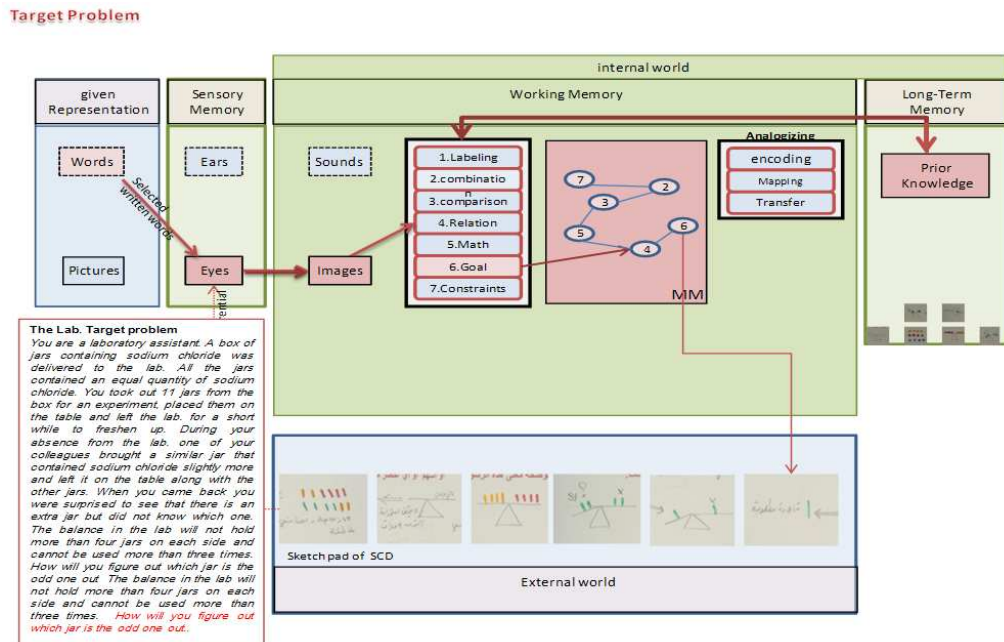

Figure 7.21: The sub-process of goal directness (6) and transfer.

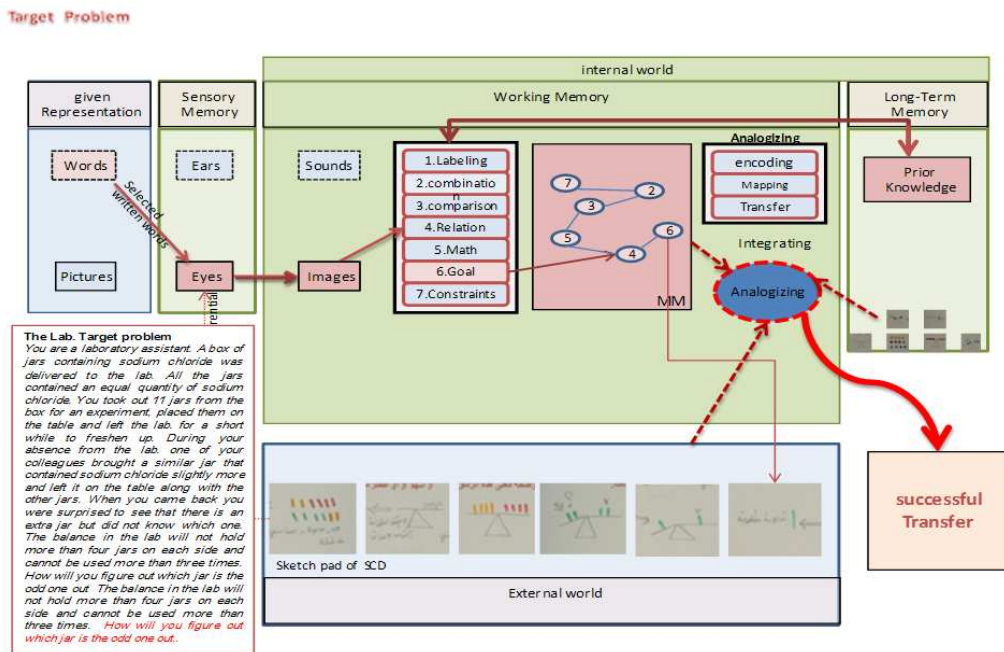

Figure 7.22: The process of integration.

Case study 2 is of a participant in the verbal representation of the source (Ball 1) problem at the strategy level of similarity to the target (Lab) problem

(Figure 7.23). Figure 7.24 shows the participant selected some sentences (highlighted in red) for processing, which is indicated by the drawing of a scale and group of 4 balls offloaded on the sketchpad. The cognitive sub-process of combination is inferred from these drawings. The next Figure 7.25 shows the process of math elaboration indicating an understanding that the two trays are equal. The diagrams in Figure 7.26 show that the last group of 4 balls is compared (2 against 2) to deduce that one tray is heavier than the other. This drawing experience is now stored as procedural information in LTM (Figure 7.27).

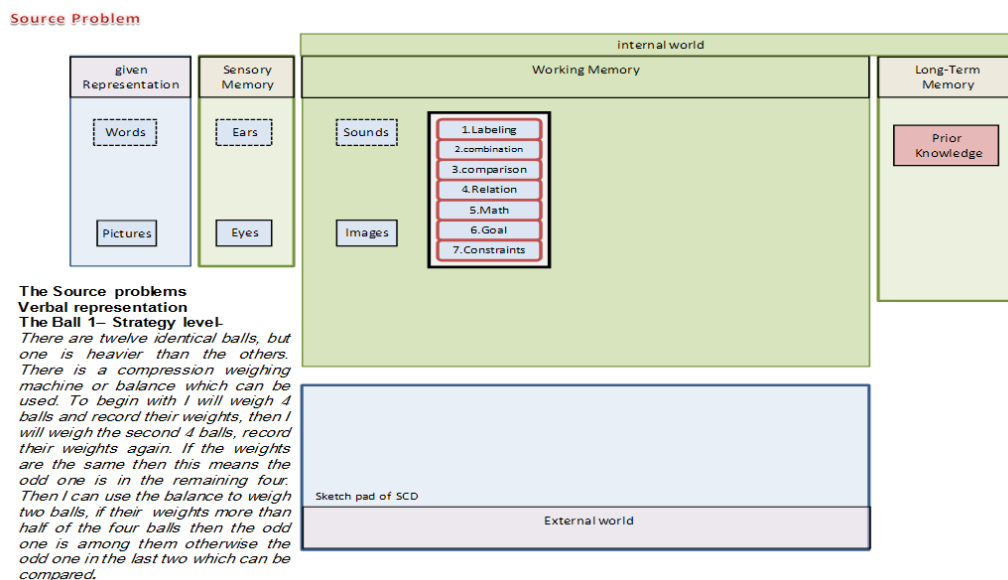

Figure 7.23: Initial state for the verbal source problem.

Source Problem

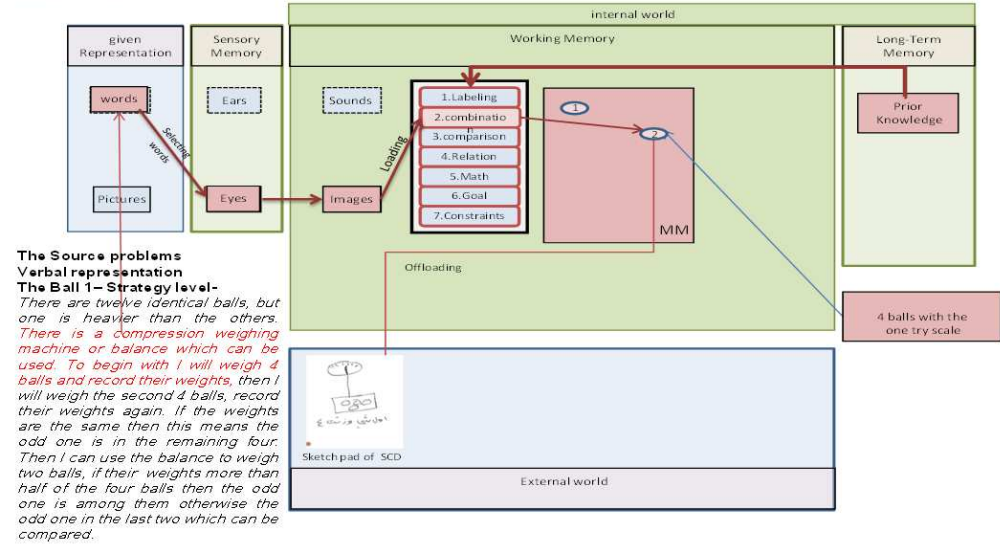

Figure 7.24: The cognitive process of combination (2).

Source Problem

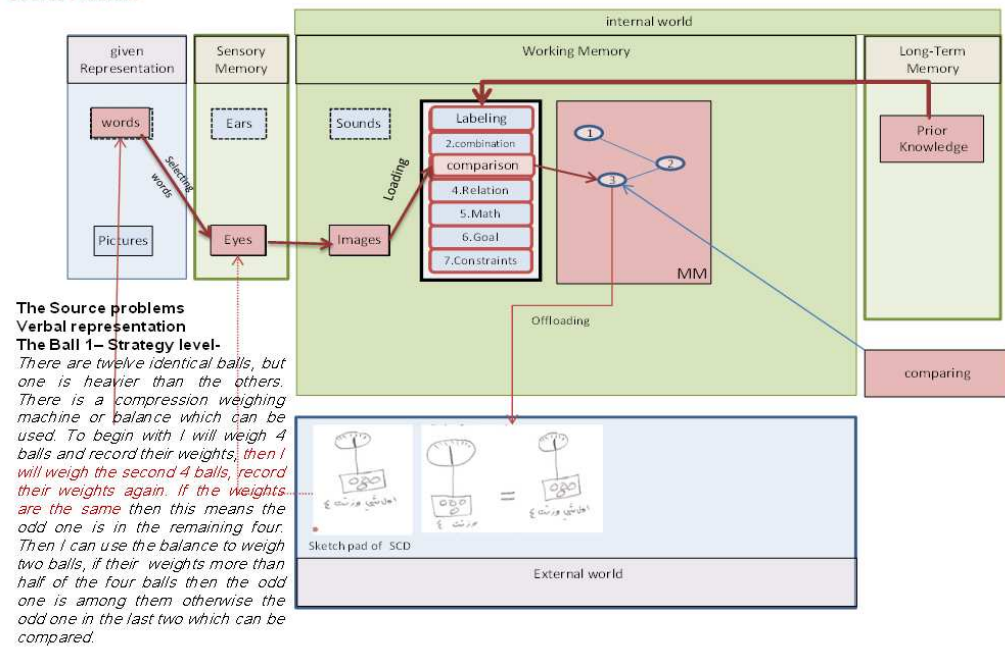

Figure 7.25: The sub-process of combination.

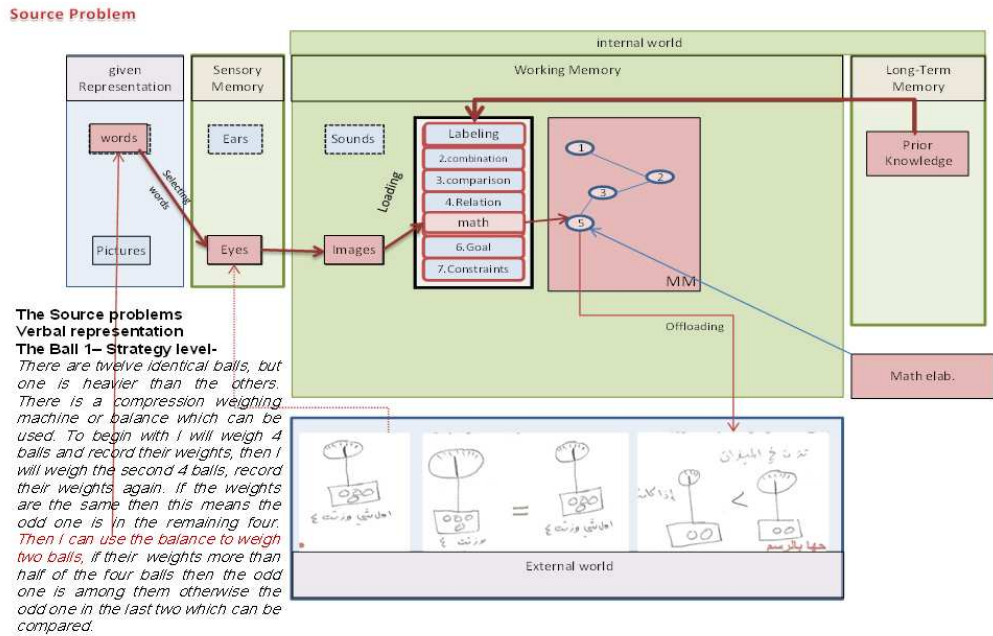

Figure 7.26: The sub-process of math elaboration.

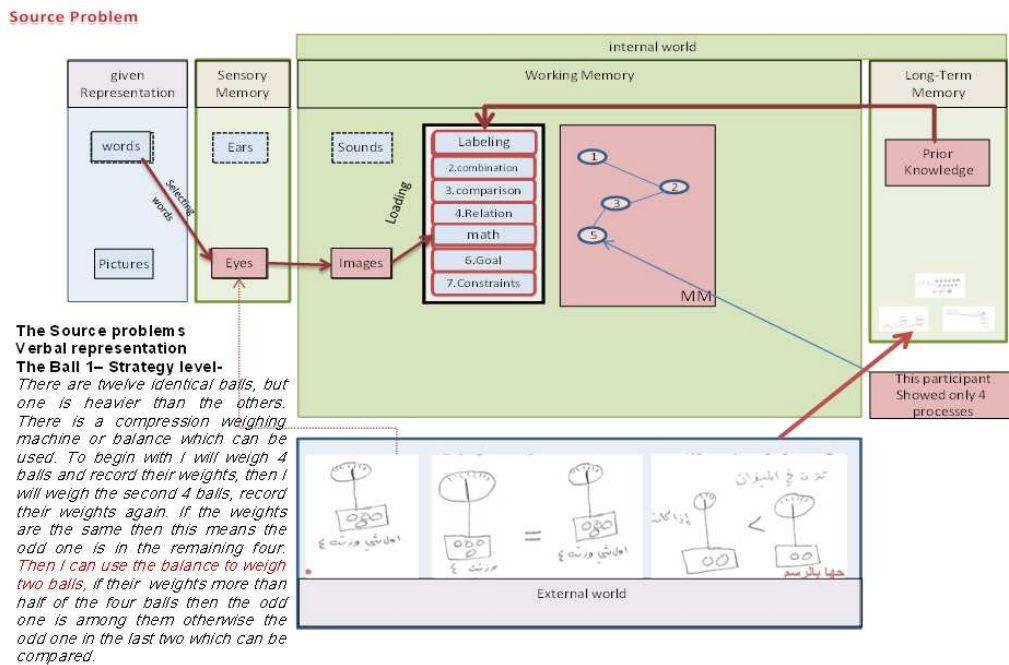

Figure 7.27: The final state of the source problem case 2

Figure 7.28 is the initial state of the verbal target Lab problem. In Figure 7.29 some key elements were selected (highlighted in red) which entered the sensory memory (through the eyes) for processing in the working memory. The sub-process of combination and comparison are applied and the resulting mental

model is offloaded by translating it into drawings on the sketchpad. At this stage, selective encoding (indicated by the dark blue line) between the source and target problem is also taking place.

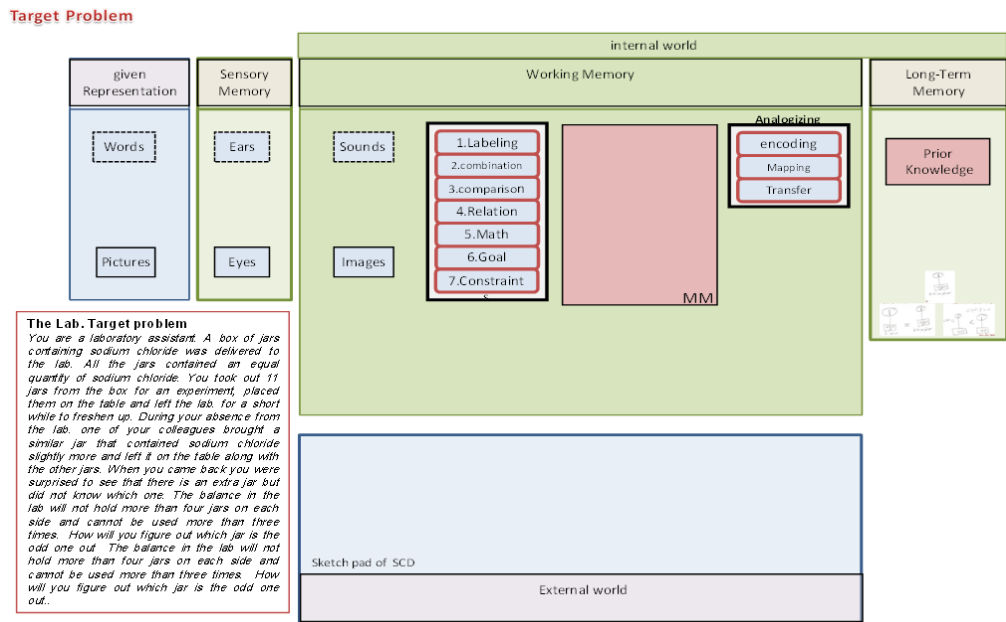

Figure 7.28: Initial state for the target problem. The sensory memory selected some verbal elements, one or more, to construct an internal metal model.

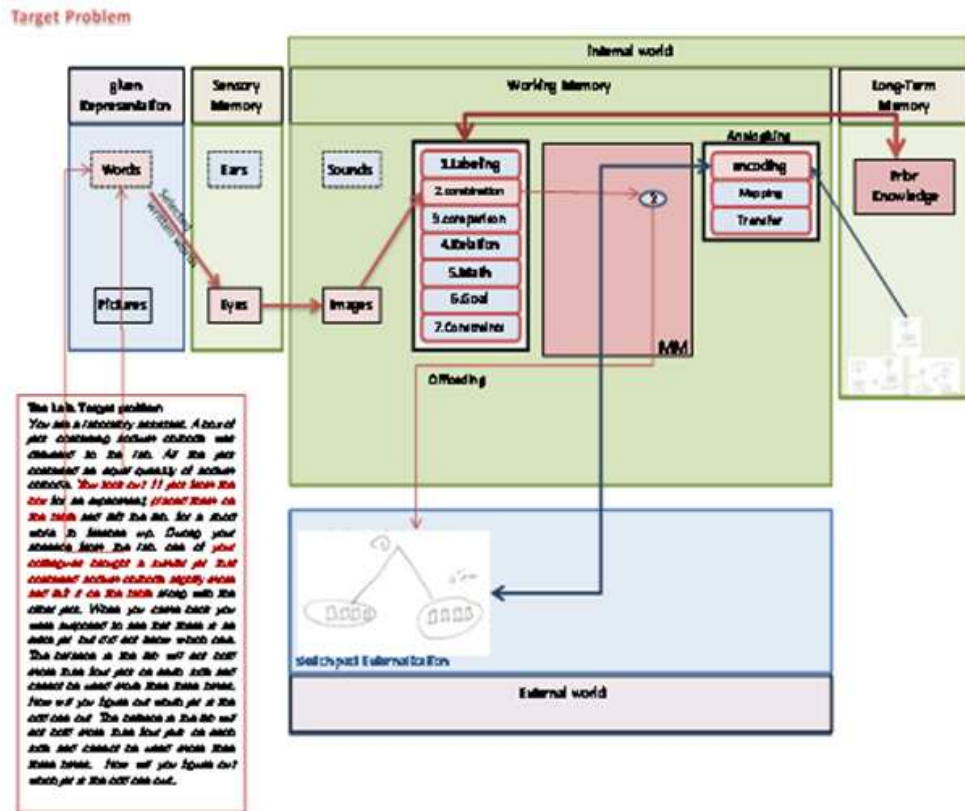

Figure 7.29: The cognitive sub-process of combination and comparison.

Other verbal key elements are selected and processed using the sub-process of math elaboration. The resulting external representation is offloaded on the sketchpad as shown in Figure 7.30 indicating that the process of mapping has begun. In Figure 7.31, the participant specifies the goal to achieve the solution and Figure 7.32 illustrates the final state of the target problem. Thus, the process of integration is taking place in the working memory where the mental model, the re-represented knowledge and prior knowledge in LTM result in the outcome of full successful transfer.

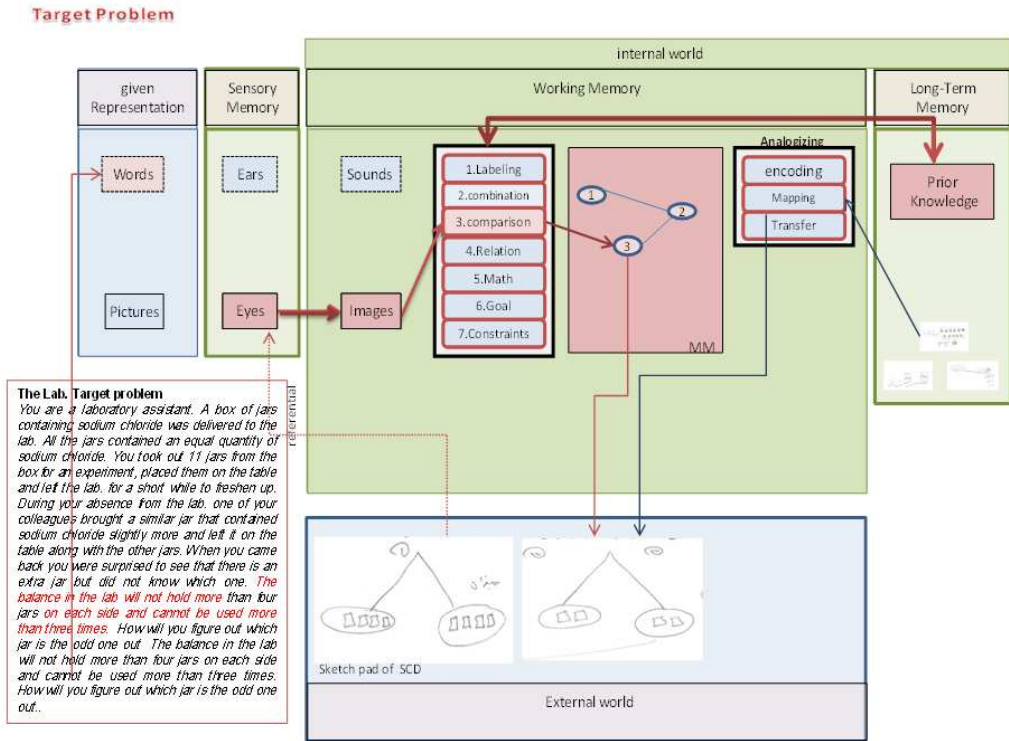

Figure 7.30: The cognitive sub-process of math elaboration and mapping.

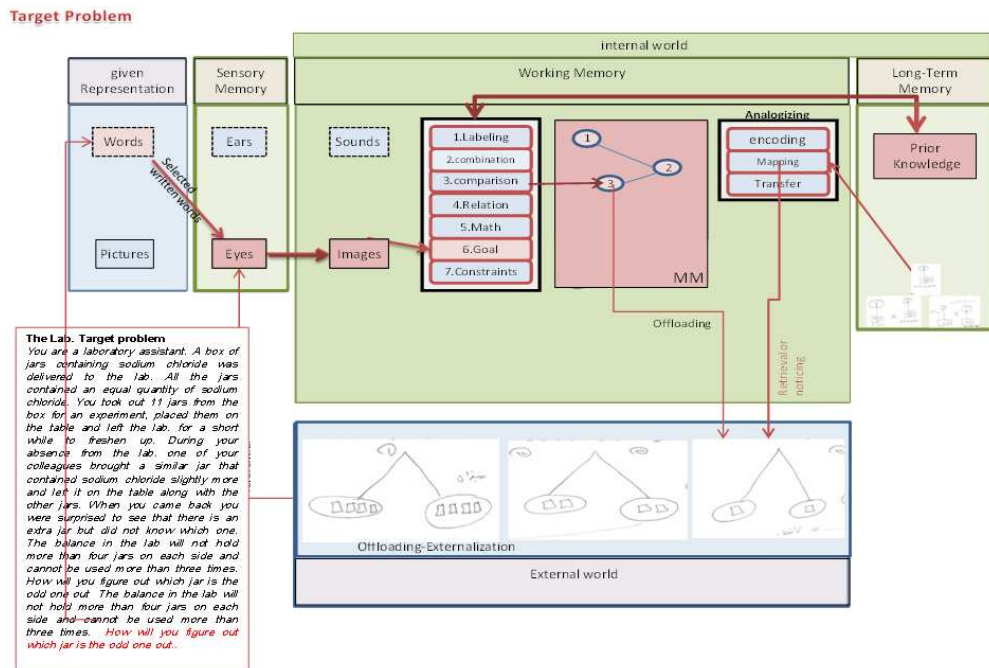

Figure 7.31: The cognitive sub-process of goal and mapping

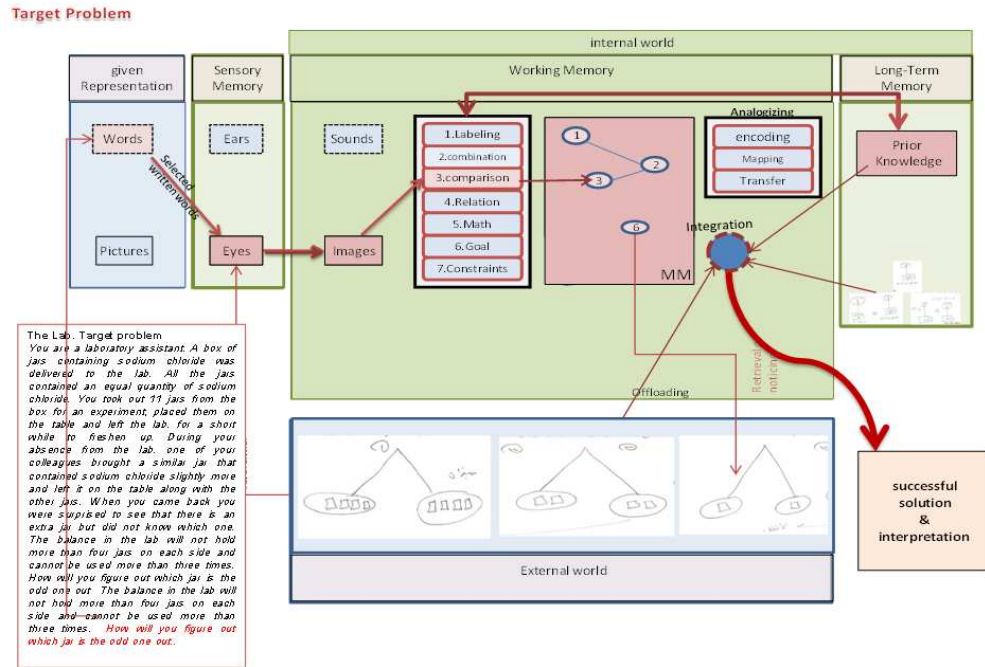

Figure 7.32: The final state of the target problem indicating integration (case 2)

Case study 3 depicts a participant analyzing the verbal source problem (Ball 2) represented at the procedural level of similarity with the target problem (Lab). Figure 7.33 illustrates the initial state for the verbal source (Ball 2) in Figure 7.34. The participant has selected some sentences from the verbal source problem (in red) that enter the sensory memory through eyes. The sub-process of combination was demonstrated to process the selected information forming a mental model of grouping 11 balls and isolating the odd one which is then offloaded on to the sketchpad.

Source Problem

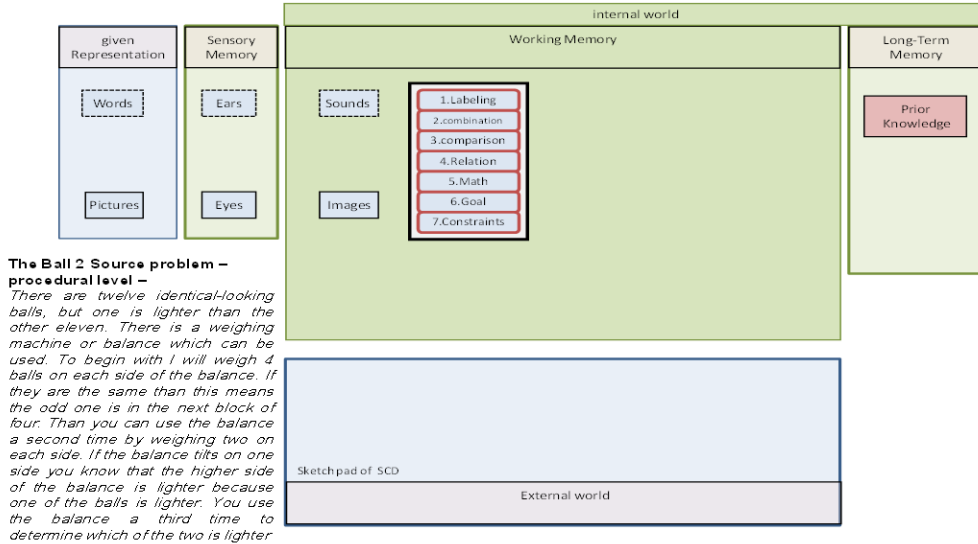

Figure 7.33: Initial state for Case 3

Source Problem

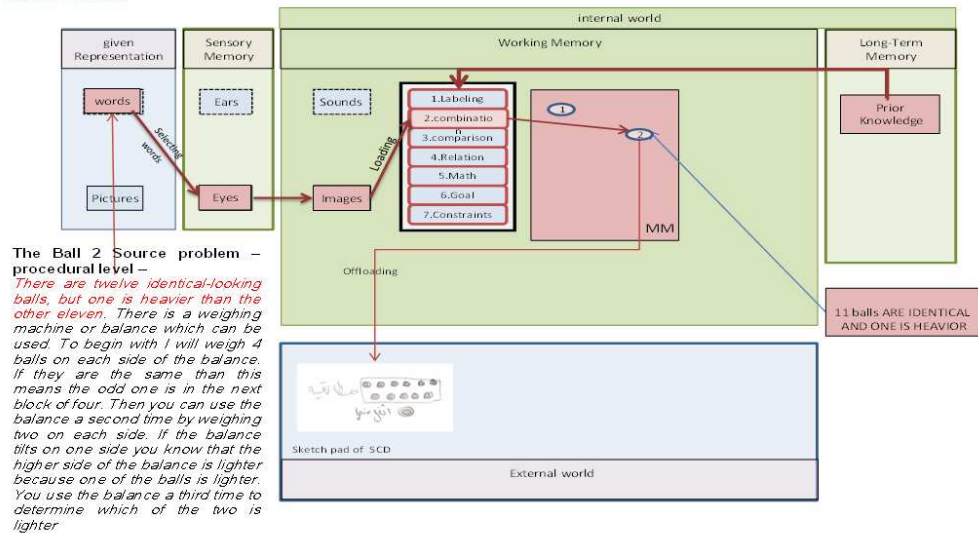

Figure 7.34: The cognitive sub-process of combination.

Figure 7.35 shows that the participant is processing more information by applying the process of comparison in building a mental model of a scale with two trays holding four balls each which is then offloaded to the sketchpad. The process of comparison continues in Figure 7.36 where some more sentences are selected and processed, indicating one side of the scale as heavier in the offloaded drawings. These drawings indicate an incomplete understanding of the source problem by not taking into consideration the information describing the last two

steps needed to identify the odd ball. Thus, this participant was restricted to only using the cognitive process of explaining, consisting of labeling, combining and comparing and not indulging in any Inferencing. This predicts a strong probability of failure to solve the target problem. Figure 7.37 shows the final state of the source problem, which is an incomplete understanding of the source problem and the probability of this drawing experience being stored as procedural information in the LTM.

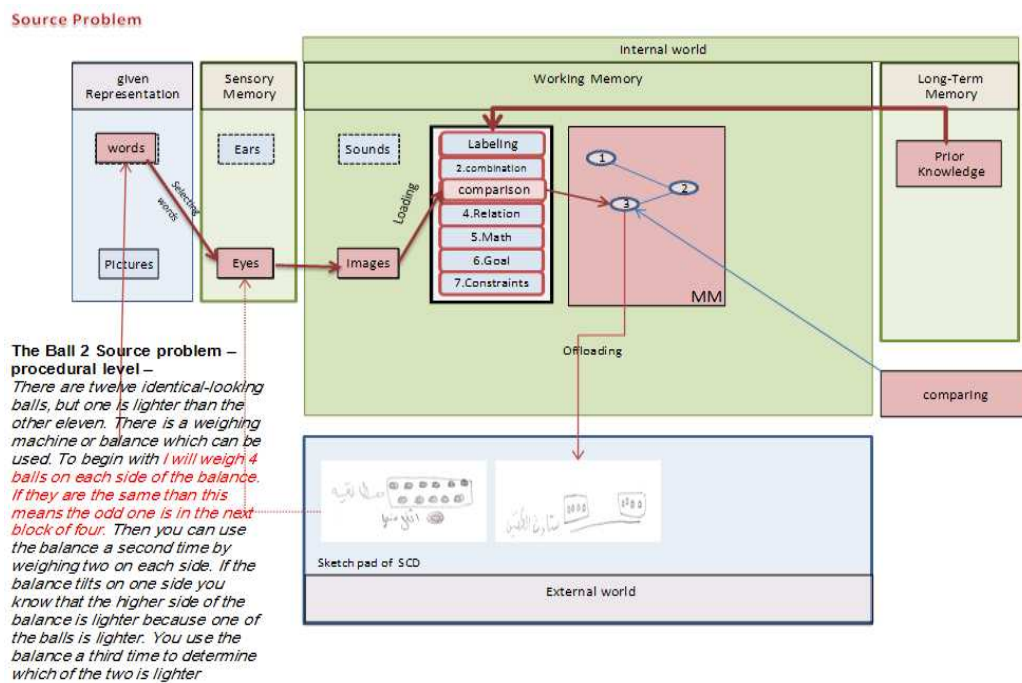

Figure 7.35: The cognitive sub-process of comparison.

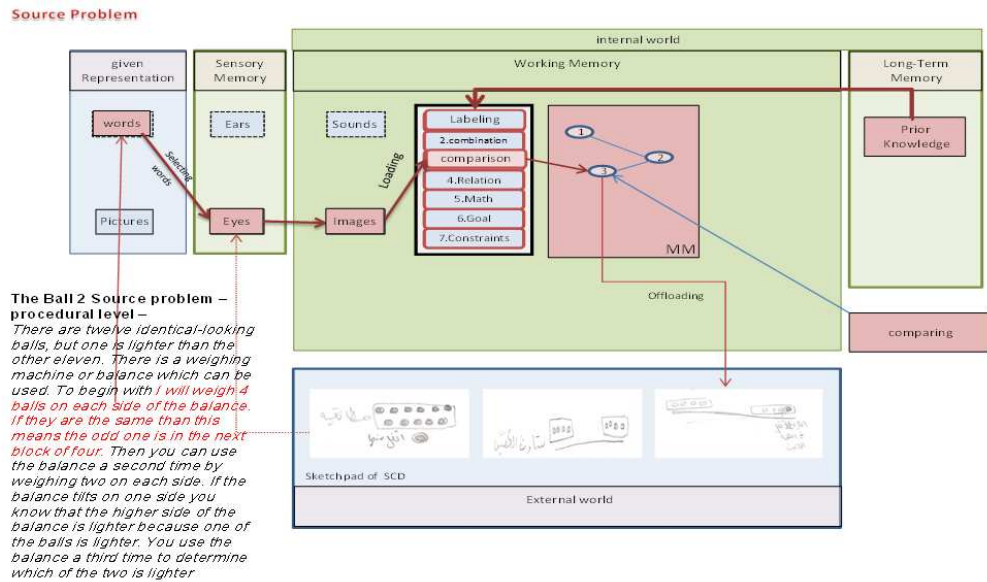

Figure 7.36: The cognitive sub-process of comparison continues

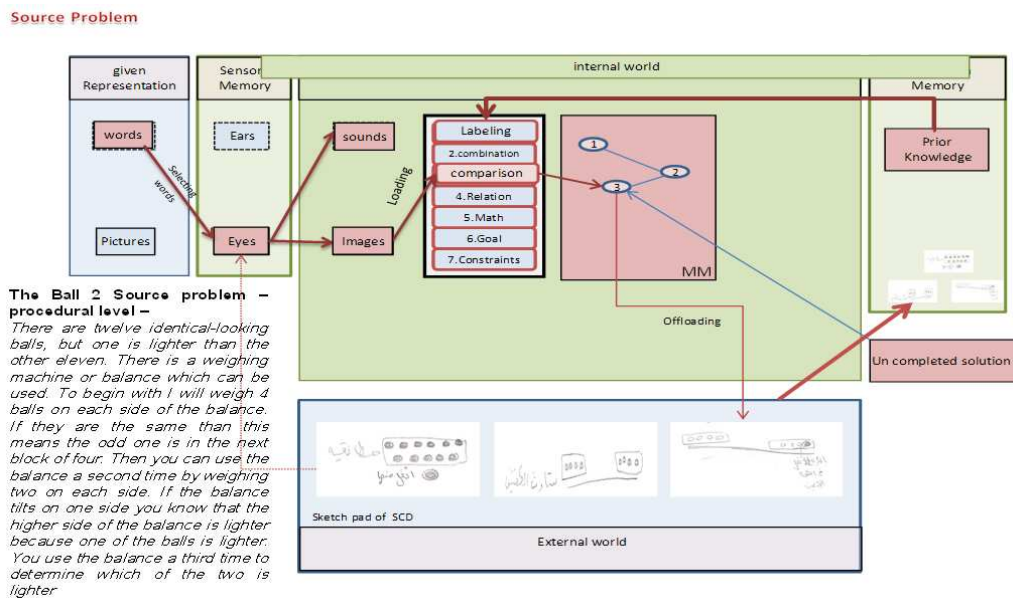

Figure 7.37: Final state of the source problem (Case 3)

Figure 7.38 is the initial state of the verbal target (Lab) problem. Some information is selected and processed using the sub-process of combination. The drawing indicates that the participant has also applied the selective encoding process by replacing the 11 jars (instead of 11 balls) and isolating the odd one. More information is selected (Figure 7.39) by comparing 3 against 3 jars and indicating clearly in written form that this process will be repeated thrice. The

drawings in Figure 7.40 indicate that the incorrect mapping process was due to the failure to apply the sub-processes of inferencing (goal, math elaboration and constraints). Here the participant derived an incorrect procedure of comparing 3 against 3 jars. The integration process inferred indicates a lack of integrated system of relations between the source and the target problem that resulted in unsuccessful transfer performance as predicted earlier (Figure 7.41).

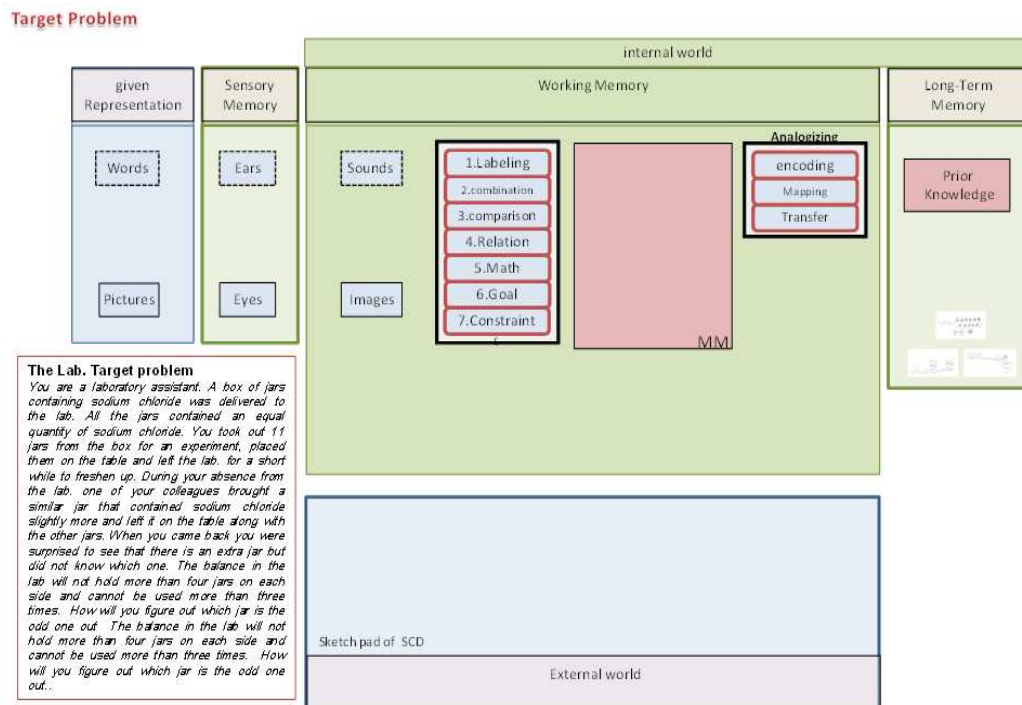

Figure 7.38: Initial state of the target problem (case 3)

Target Problem

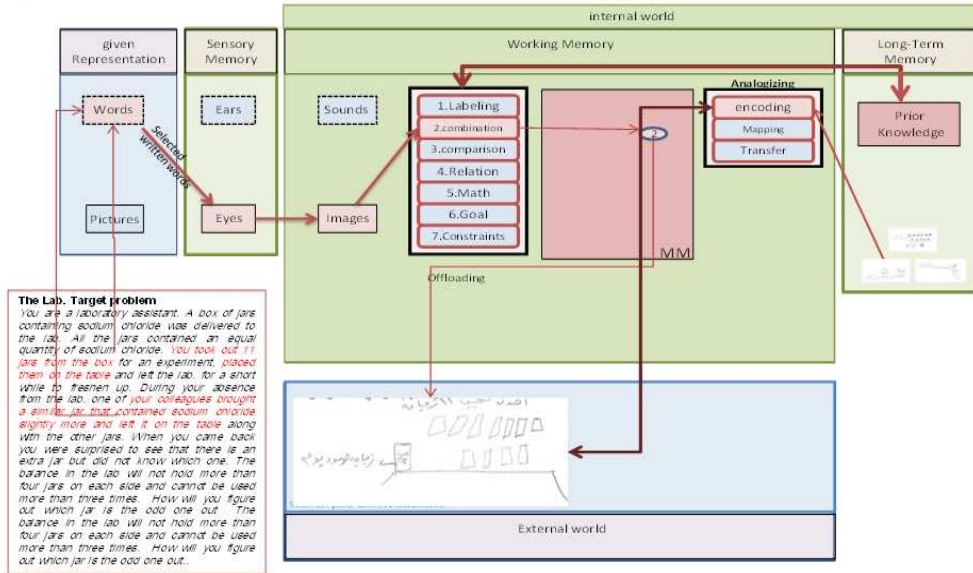

Figure 7.39: The cognitive process of comparing

Target Problem

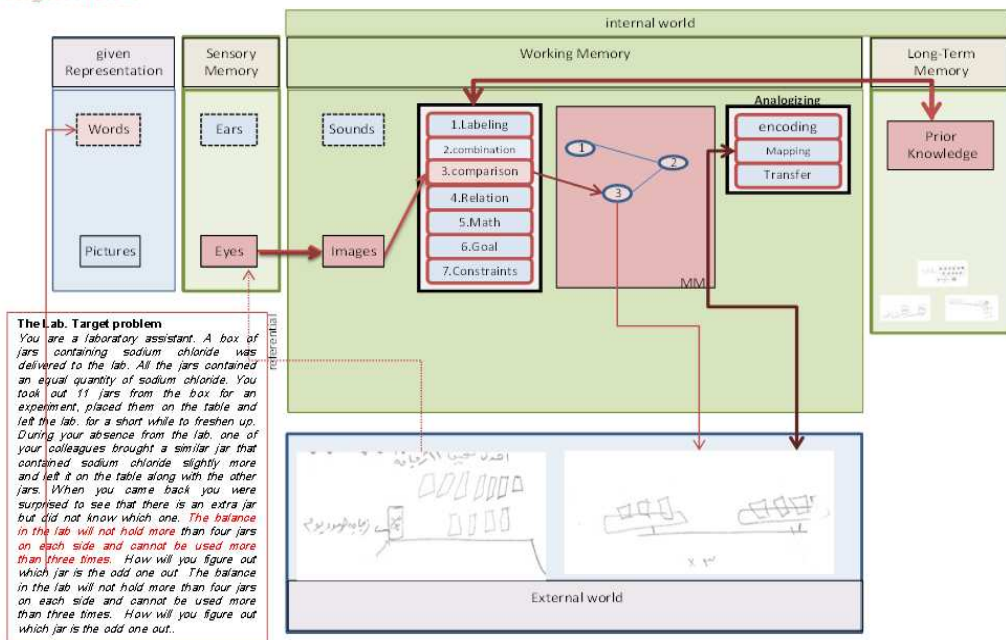

Figure 7.40: The cognitive process of mapping.

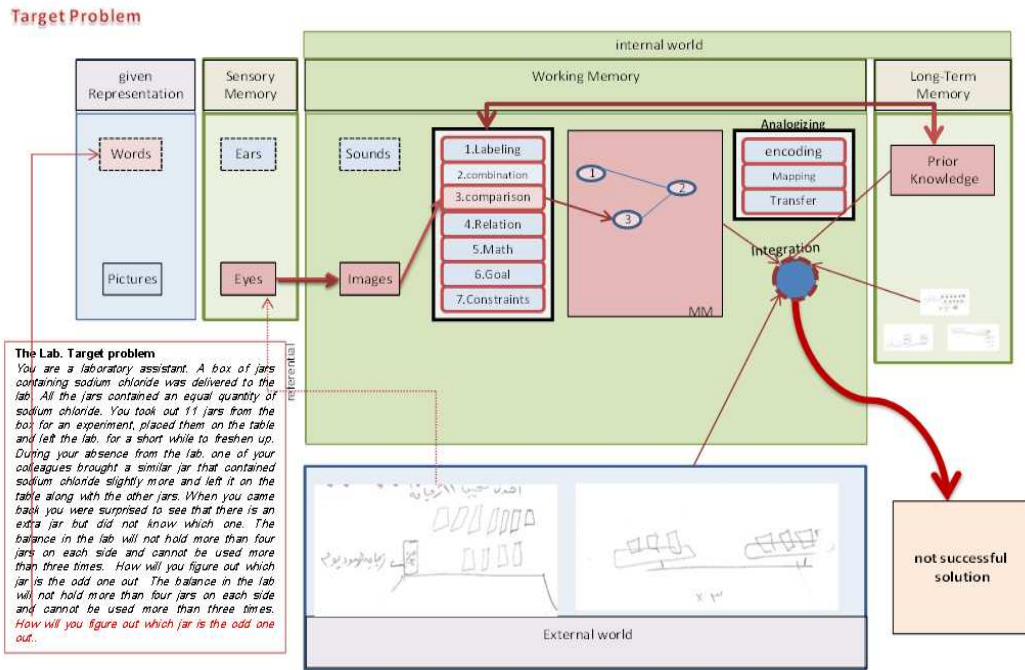

Figure 7.41: The final state of the target problem and the process of integration (case 3)

The SCD protocols of three case studies of problem solving described the GPM in both verbal and pictorial representations under the strategy and procedural levels of similarity. Additionally, Figure 7.42 has been illustrated to convey how the model helped the researcher deduce the positive effects of the self-support method of SCD in successful transfer in problem solving by analogical reasoning. It clearly shows that the diagrammatic rerepresentation of the source problem has influenced the understanding of the target problem as the sub processes of combination, comparison, relations, math elaboration, and goal directness have been depicted in the SCD in almost the same way indicating the alignment of similarities as mentioned by Gentner (1983, 1989). Figure 7.42 also explicitly shows how the cognitive processes generated through drawings while solving the source problem help form a strong interconnected system of relations in the mental model that influence the formation of the same while solving the

target problem, thereby resulting in procedural mapping and full successful transfer.

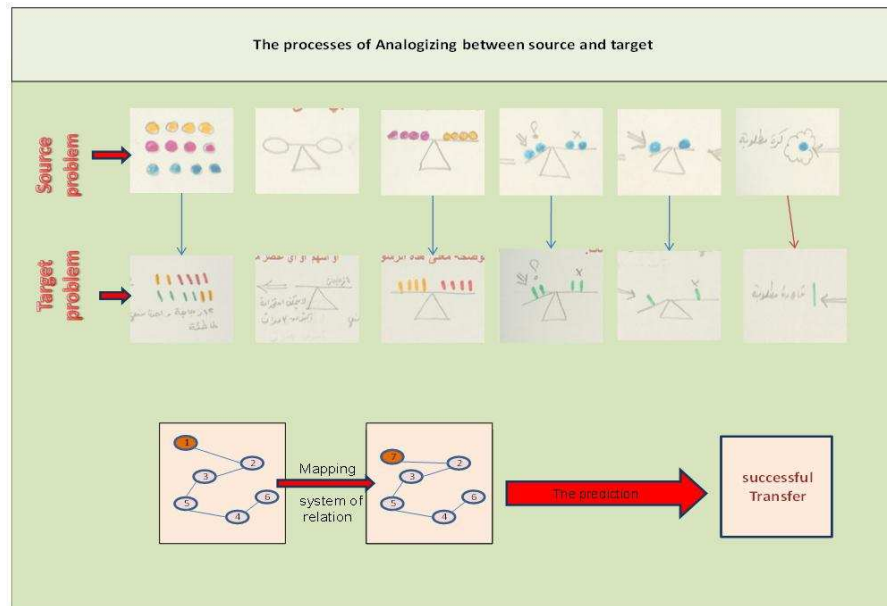

Figure 7.42: Integrated system of relations between the source and target problems.

The second case was that of a participant who took the verbally represented source problem in the strategy level and achieved a successful transfer despite generating very few drawings (three each in the source and target). The analysis of this case through the model shows that the core ideas were well grasped from the problem (evident in the drawings) by noticing the connection between the source and target by imposing the structure learned in the source, filling the gaps and effectively integrating information.

The third case was that of a participant who took a verbally represented problem in the procedural level of similarity. The model shows how this participant was unsuccessful in analogical transfer. The generated drawings in the source indicated that the problem was rerepresented very superficially using only the sub-processes of labeling and combining and missing the last steps of the

process described in the problem. This incomplete understanding is attributed to the lack of using other important cognitive sub-processes in analyzing the source problem, which also affected the understanding of the target problem.

The case studies analyzed above provide sufficient evidence of the working of the model. Analysis of the SCD through the model showed that they help in eliciting the crucial cognitive sub-processes required for identifying the various elements of the problem, connecting and integrating ideas that stimulate memory to recall what was drawn earlier. The model clearly depicts the importance of mental processes (explanation, inference and analogizing and their sub-processes) and how they take place while solving analogical problems. However, this does not necessarily mean that the participant would get the correct solution (case study 3) primarily because implementing a procedure demands selecting and encoding the key elements, aligning the similarities and differences in the source and target problems, mapping the system of relations, and applying the sequence of the process to solve the problem.

The proposed model contributes to our understanding of not only how information is processed from verbal and pictorial representations during problem-solving by analogy but also the potential of a self-method (SCD experiment 3) in optimizing the processes of noticing, retrieval and successful implementation of a learned solution process. However, it is also imperative to see how the findings of Experiment 1 relate to the think aloud methods of self explanation/verbalization and illustrated through the model.

Applying the GPM to Self explanation

A fourth case study from Experiment 1 is analyzed to highlight the process of transfer performance while using the think aloud method of SE or VB.

This participant solved the pictorial source problem for Salt target in the procedural level of similarity. The participant selected an object from the first frame through the visual channel and applied the cognitive sub-process of labeling (Figure 7.43). At the same time this information is offloaded (red line) from their mental model by self-explaining, “what I have is a water tap” that reenters as words through the auditory channel (blue line Figure 7.43). At this point, some of the verbal information may enter the LTM (blue dotted line).

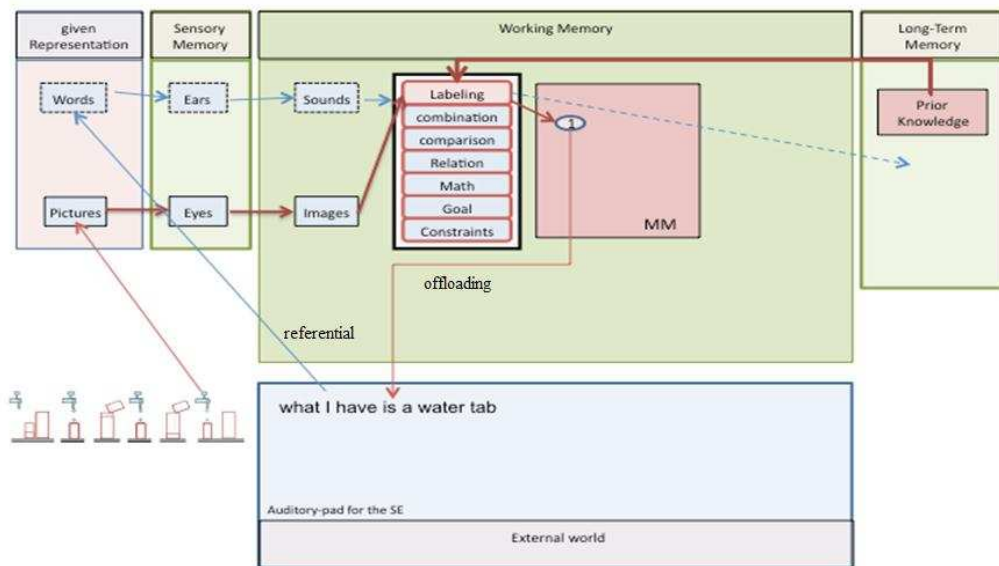

Figure 7.43: The cognitive sub-process of labeling

In Figure 7.44 & 7.45 the participant then selects two other objects from the same frame to combine and compare them as "here are two containers, one is big and one is small, the big one is empty, and the small one is completely full under the tap". This information received through the visual channel is added to the working memory. The verbal protocols re-enter through the auditory channel where they are processed and may enter LTM (blue dotted line).

The cognitive sub-processes of mathematical elaboration is shown in Figure 7.46 "we put the water in the big container, roughly, we filled one fourth

of it" while in Figures 7.47 & 7.48 the participant continues the process of comparing "In the other picture is the same small container, we emptied it". Goal directness is indicated Figures 7.49 and 7.50 "we need two and a half cups, to fill up the big container" & "There is some water remaining in the last cup", and the process of integration in Figure 7.51.

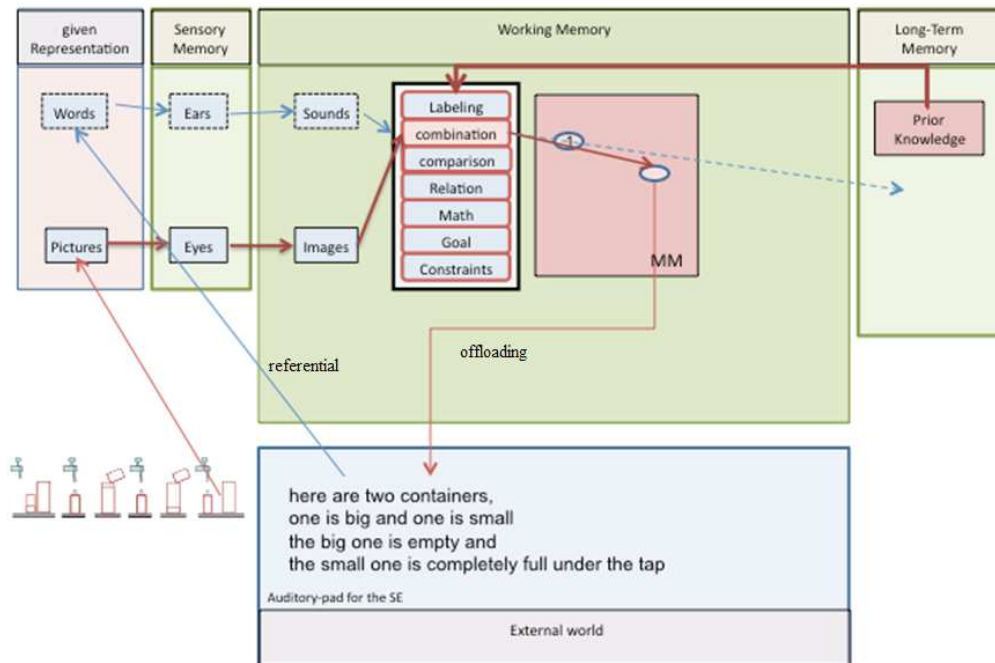

Figure 7.44: The cognitive sub-process of combination

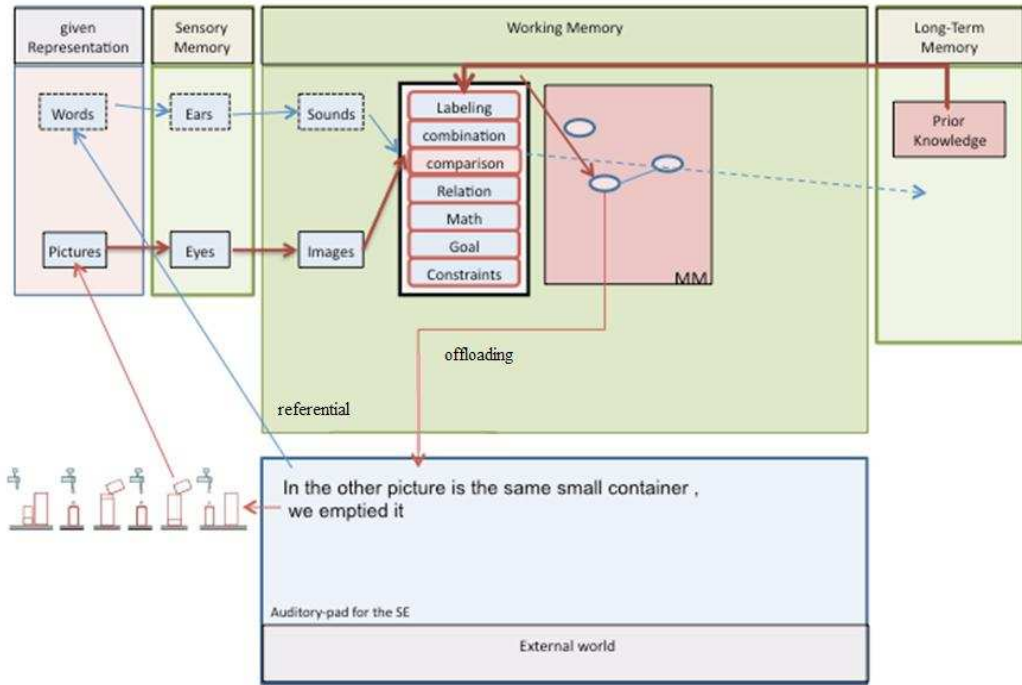

Figure 7.45: The cognitive sub-process of comparison

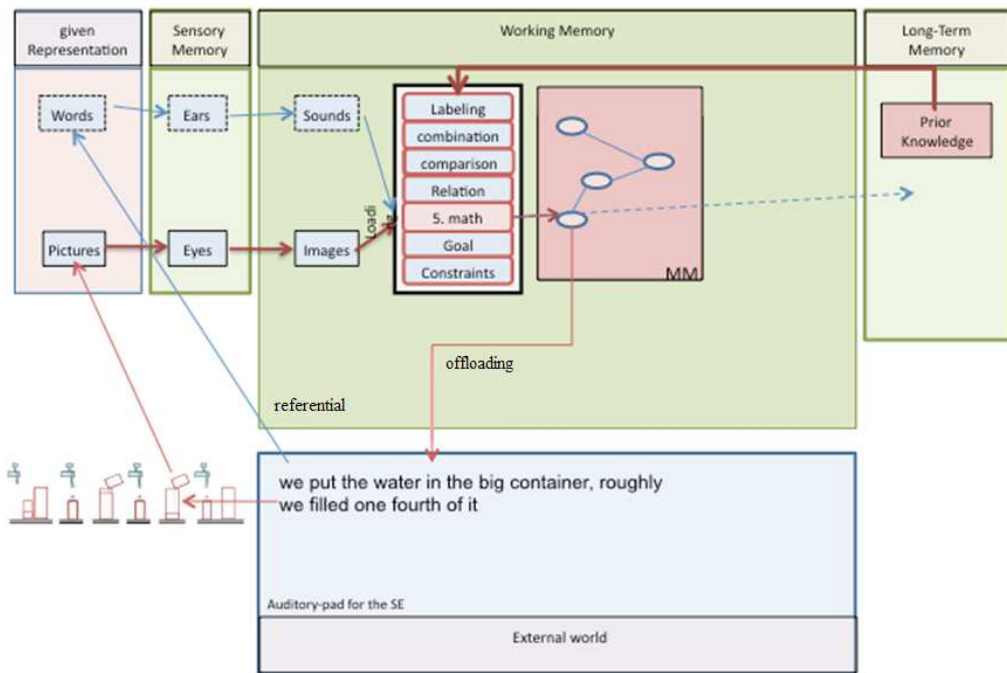

Figure 7.46: The cognitive sub-process of math elaboration

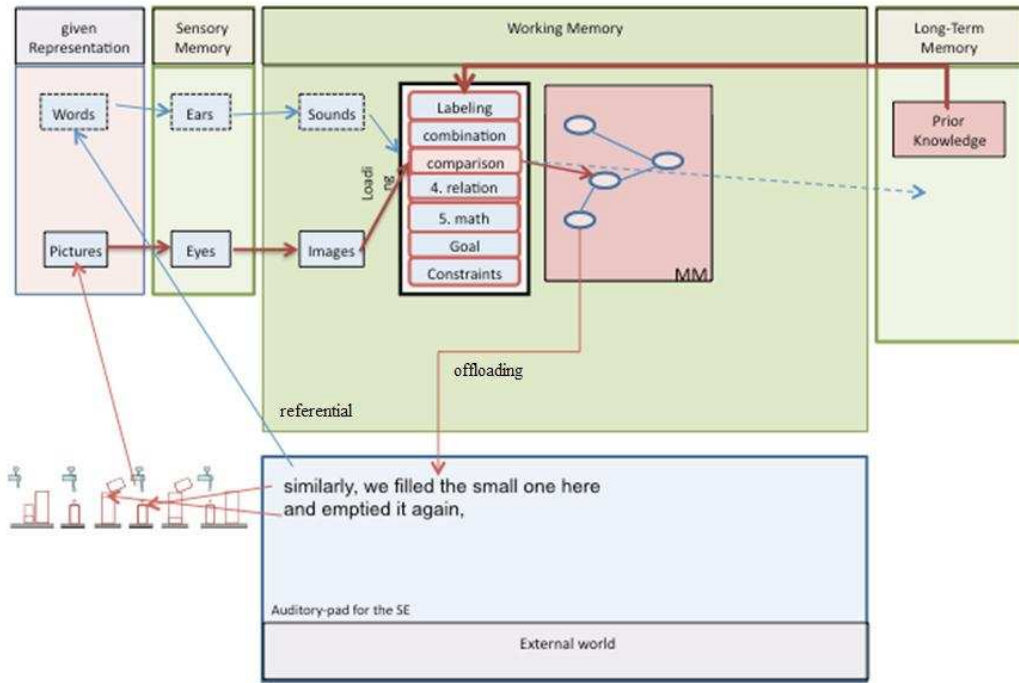

Figure 7.47: The cognitive sub-process of comparing

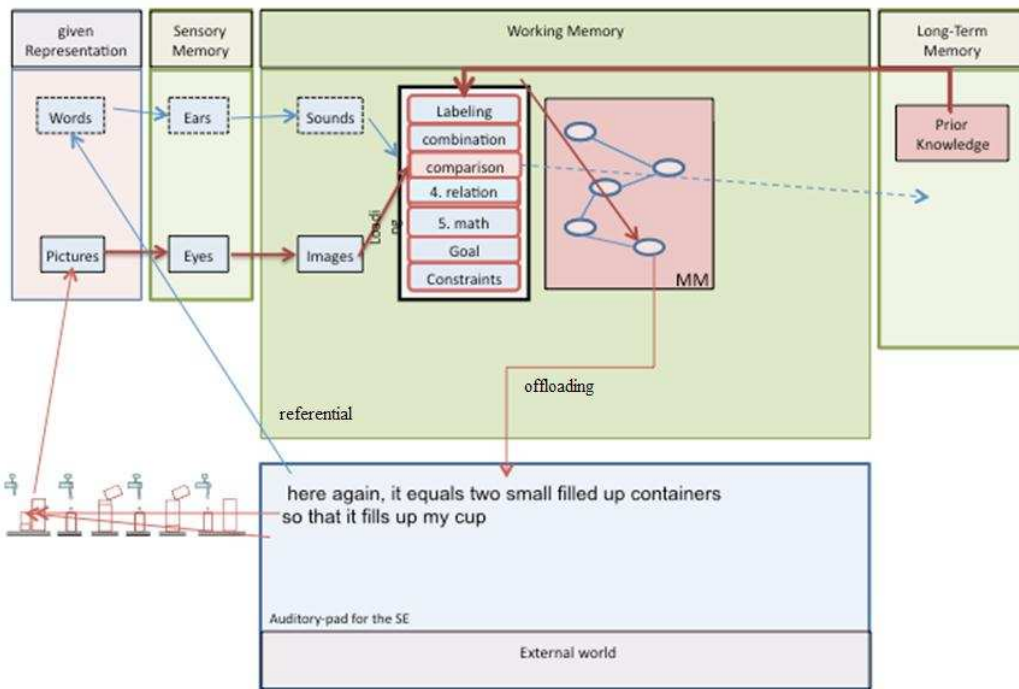

Figure 7.48: The cognitive sub-process of comparing

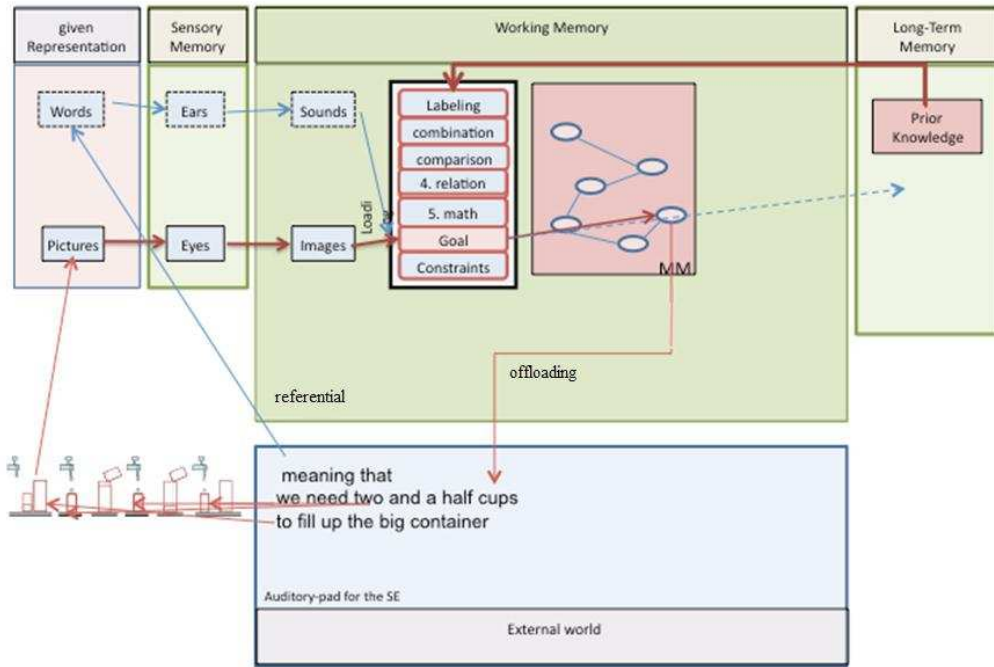

Figure 7.49: The sub-process of goal directness

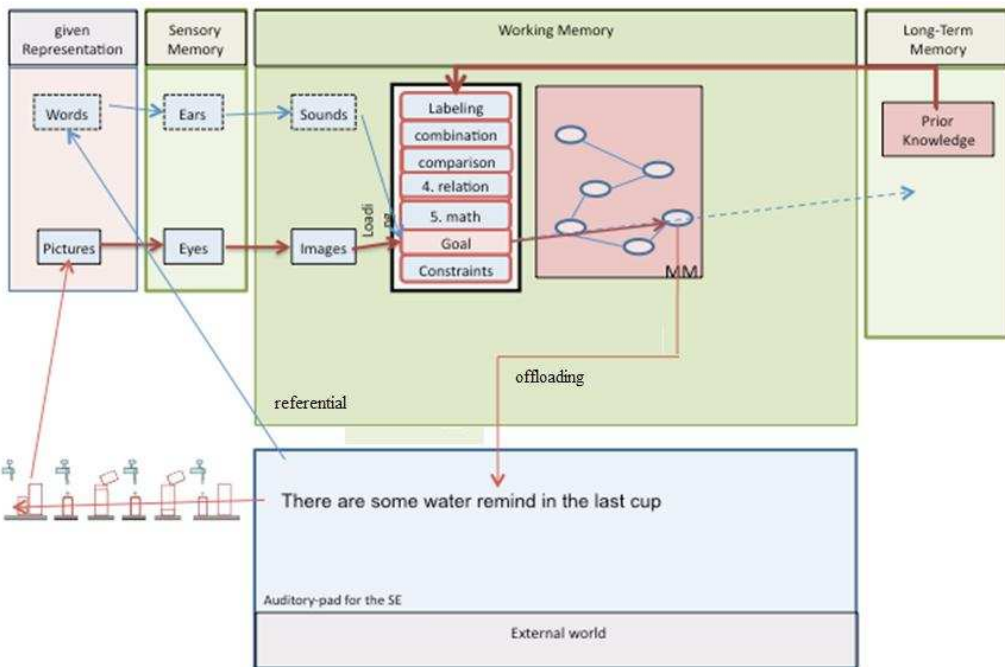

Figure 7.50: The sub-process of goal directness

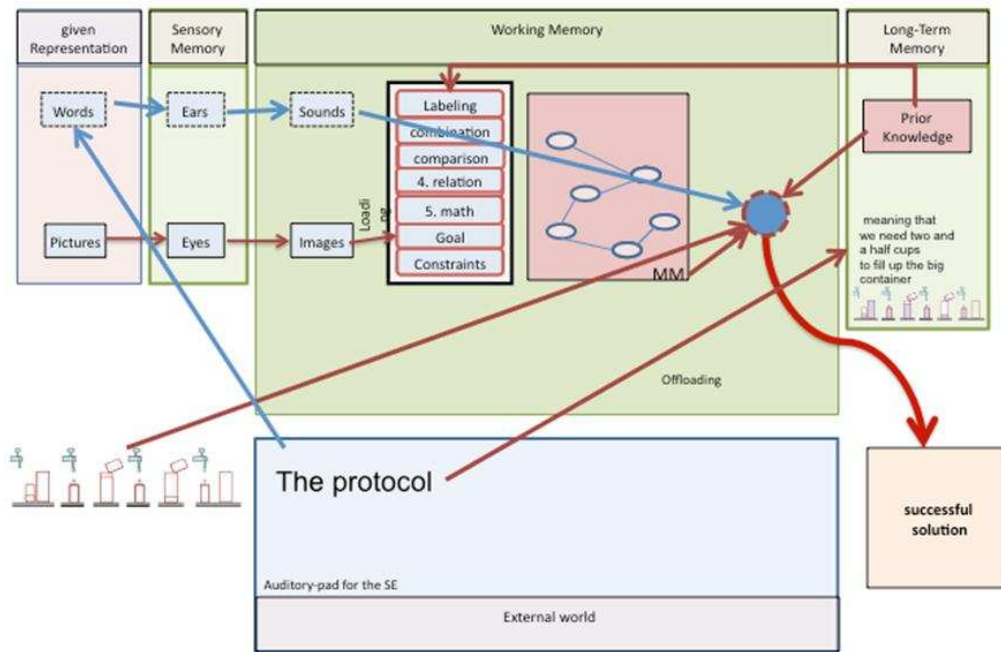

Figure 7.51: The process of integration.

Case study 4 demonstrated how GPM generalizes quite easily to the self-support method of SE where the information input is both visual (pictorial and verbal representation) and auditory (SE or VB). In the process of problem solving, participants form a mental model for the pictorial given representation, verbalize it or self-explain it aloud as illustrated in case 4. The auditory pad, which replaces the sketchpad in the SCD condition, holds the result of participants' problem analysis through the major cognitive processes and sub-processes. Although the same cognitive processes and sub-processes are involved in both SE and SCD, information is processed in the model differently which is briefly illustrated in the cognitive processes of offloading, referential and integration. As each chunk of information is processed it is externalized (offloading) through SE or VB. This activity is repeated (referential) by processing the VB or SE through the auditory channel. This second processing step may additionally affect the understanding leading to maintaining the information already externalized or to modify it further. Thus, a two way

processing takes place where the SE or VB activates the different cognitive processes to interpret the represented pictures that in turn refine the rerepresentation of the problem. The referential process during SE helps reduce the perceptual errors inherent in some pictorial representations. The evaluating and monitoring processes that tend to become pronounced due to SE results in the construction of a coherent learning experience optimizing the cognitive processes required for understanding a problem and offloading the working memory. For example, referential and offloading events occur in case study four in Figures 7.43 to 7.50. This process perhaps, helps in storing the learning process as procedural information in LTM.

The process of integration in SE and VB is also different from the SCD as it involves combining information from the given representation, the constructed mental model, prior knowledge in LTM along with what the participant remembers from the verbal protocol (auditory pad Figure 7.51). Unlike the sketchpad (Figure 7.22) the auditory pad is not permanently available and the information committed to the auditory pad may be forgotten. Because of the transient nature of the auditory pad, the mental model maybe revised or modified by the process of referential (SE) which may help or hinder modifying the problem solving process.

Thus, although the GPM was developed specifically to depict the processing of procedural problems using the self-support method of SCD, the format of the model can easily be generalized to other contexts or conditions such as SE or VB (Experiment 1) and written responses (Experiment 2). The fourth case study successfully demonstrated how the model can be applied to the self support method of SE and/or VB. The only structural distinction in the model

under the SE condition is that an auditory pad replaces the sketchpad and in Experiment 2 the text pad of written responses replaces the sketch or auditory pads.

Discussion

The focus of this thesis was to study the effect of the self-support methods of SE and SCD on eliciting the cognitive processes found to improve transfer performance, it was essential to develop a model that depicts the role and effects of these mental processes during the analogical problem solving process. The discussion of the GPM is undertaken firstly, to examine its validity in the light of the findings of the three experiments conducted for this thesis, secondly, to critically evaluate its distinctive characteristics, and finally, to consider some of its limitations.

The validity of the GPM can be established by reexamining the findings related to the major predictions of the study.

It was hypothesized in experiment 1 that SE would significantly improve transfer performance over the VB. This hypothesis which was found true can also be successfully depicted in the GPM by comparing the cognitive processes of referential, offloading and integration in the conditions of SE and VB. Although, information processing follows the same path in SE and VB the referential activity was found to be more pronounced in SE due to the pressure imposed to explain. This often resulted in the same information repeatedly entering through the auditory channel thereby, increasing the probability of observing connections between the source and the target problems. In contrast, in the VB condition participants were more likely to engage only in a superficial analysis of the problem. Thus, as information would enter the auditory channel,

perhaps only once, there is a low probability of it being corrected or modified. In addition, the increased referential activity, in SE compared to VB, tended to increase offloading of information on to the auditory pad. Consequently, the process of integration in SE is more effective and directly affects the performance.

In Experiment 2 it was predicted that transfer performance in the pictorial representation would be more effective than verbal representation in the procedural level of similarity. The GPM highlights the factors that contributed to the confirmation of this hypothesis. When processing pictorial information the mental image tends to be quite similar to the pictorial representation. As such connections between objects depicted are very likely to be preserved in the mental model which facilitates the retrieval process. In contrast, when a verbal representation is processed it needs to be transformed into a mental image which may or may not reflect the information provided. Here, slight variations in word choice and interpretation may lead to different mental images affecting the understanding of the problem. The SCD protocols in Figure 7.7 of the GPM show how a pictorial representation is more effective in successful problem solving when depicting a procedure to be learned and implemented.

It was predicted in Experiment 3 that the condition of SCD would have a positive influence on performance more than the ND condition. The GPM has been developed mainly on the basis of SCD protocols. It clearly depicts how the SCD serves as a permanent external representation constructed on the sketchpad leading to a deeper involvement with the problem solving process that helps establish connections between objects and reducing cognitive load in both the representations (verbal and pictorial) and levels of similarity (procedural and

strategy). The GPM depicts these phenomena in the analysis of the first three case studies presented earlier in this chapter.

Procedural level of similarity was an integral part of the study since it was intrinsically related to the tasks used. It was hypothesized that the Procedural level of similarity facilitates problem solving more than other levels of similarity. The GPM in Figure 7.42 demonstrates the process of alignment between source and target problems in the procedural level of similarity. The procedural details understood in the source problem tend to develop a mental image that scaffolds the transfer process. This is because the transfer distance (in terms of direct application to the target problem), between the source and target, is the least in the procedural level of similarity requiring adaptation of superficial features only. Whereas, in the strategy level of similarity, the source and the target share a concrete strategy for implementation, that differs in the procedural details, also requiring an adaptation of the structural features. It was found that despite solving the source problem, this lack of adaptation affected the transfer process in the strategy level. As such, provided that participants are able to successfully map objects and relations, the probability of successful problem solving will be high.

Distinctive characteristics of the GPM

The Generative procedural model was developed to describe and understand how different levels of similarity, modalities of representation and self-support methods (SSM) affect transfer performance in problem solving.



Figure 7.52: The GPM is applicable to multiple SSM, levels of similarity and representation.

The methods of SE and SCD used in experiment 1 & 3 served two major aims of this thesis. First, they provided evidence as effective self support methods and second they helped in accessing the mental processes underlying successful analogical problem solving illustrated in the GPM.

The term 'Generative' was used to convey the same meaning as Van Meter et al. (2006) and Mayer (1999b) in studies involving drawing inferences, from protocols, about the underlying cognitive structure in which knowledge is integrated from verbal or pictorial representations.

The GPM is considered 'Procedural' because it describes how procedural information in different representations is understood and implemented in solving problems by analogical reasoning.

The uniqueness of the model is that it is descriptive with a high potential to identify sources of processing errors and predicting the quality of transfer performance. As a descriptive model the case studies illustrated how problems varying in different levels of similarity, modality of representations, and self support conditions affect the strength of transfer. For example using case study 1 the model describes the problem solving process in the procedural level of similarity, pictorial representation, and SCD condition. Figures 7.6 to 7.14 relate to the source problem while 7.15 to 7.22 describe how the participant goes about

solving the target problem successfully. The predictive aspect of the GPM is clearly depicted in Figure 7.14 by examining the cognitive processes applied by the participant that confirmed the prediction of successful transfer performance in the target problem.

On the other hand, through case study 3 the GPM illustrates the problem solving process in procedural similarity, verbal representation and SCD condition. Figures 7.33 to 7.37 depict how the participant solved the source problem as an example of the descriptive aspect of the model. It can be seen that this participant used only three processes; labeling, combining and comparing which is considered insufficient or an indication of lack of complete understanding of the source problem. As such, it could be predicted from the model that this participant will tend to be either a partial solver or a non-solver of the target problem. GPM in Figure 7.38 shows the target performance of this participant which supports the prediction of being a non-solver.

Another important characteristic of GPM is that it is a comprehensive synthesis of different theories of learning; Kirschner's CLT theory (2002), The Multimedia Theory of Mayer (1999b & 2001), and The Generative Theory of Drawing construction Van Meter et al. (2006). This synthesis provided some more insight into how the mental processes can be elicited and strengthened to maintain an optimal cognitive load for successful problem solving. In accordance with Gentner's model (Figure 7.1), which depicts the mental model as a connection between nodes (sub-processes), the GPM shows specifically how cognitive processes construct nodes in the mental model and how these nodes are related to one another.

A major advantage of the GPM is that it can be easily adapted or generalized to problems specifically involving a procedural solution such as solving problems in mathematics/physics. This is because many problems in mathematics and physics use analogies involving procedural information for problem solving such as application of a formula to attain a solution. For example, in physics the standard equation relating the force 'F' on an object to the product of its mass 'm' and acceleration 'a'. $F = ma$. This formula is broadly applicable, but in each use students must successfully encode the quantities F, m and a, from the specifics of the problem. That is, quantities must be mapped to these variables from the particular context. In some contexts, two of the quantities will be given, say F and m, and the student will be required to infer 'a'. In other contexts, students will be required to make inferences about one variable changing with respect to another. In this case the constraints are determined by the algebraic equation. However, the student will maintain a model of the procedure for solving an equation for an unknown variable. In word problems, specific objects need to be mapped to these variables with the underlying procedure for solving the problem remaining the same. For example, a problem could be represented verbally: "An object weighing 42kg traveling at 52m/sec² hits a wall, what is the force of impact?" In this case the student needs to recognize that "kg" indicates a mass and map "42kg" to 'm'. Similarly, 52m/sec² will be recognized as units of acceleration and mapped to 'a'. Lastly, the two quantities are multiplied together to solve for 'F'. This problem illustrates the presence of constraints, (the algebraic expression $F = ma$) and the need to engage in mapping and transfer of knowledge from previous experience of solving algebraic equations for successful problem-solving.

The GPM provides a step-by step analysis of the individual cognitive processes used by problem solvers. This feature of the GPM makes it particularly helpful for teachers and others who are interested in improving problem-solving of learners. On one hand, the GPM can help teachers improve representations of problems by locating those features of representation that fail to elicit cognitive processes important for a complete understanding of the problem. For example, giving the underlying principle for weighing heavy objects (one large object is equal to several smaller ones) in this study predictably failed because the pictorial representation was not rich enough (lacked a process) to elicit the cognitive processes essential for understanding and applying it to another problem requiring the same principle. On the other hand, it can also help teachers identify difficulties or errors that occur during the problem solving process. These could either be again due to inadequate representation, as found when the strategy level of representation was used to represent a process of weighing heavy objects, or the failure to align differences and similarities despite an ideal representation in the procedural similarity. In the later case, the GPM can help locate those cognitive processes that need to be strengthened through practice or training.

Thus, the GPM serves as a rubric which can be adapted to problem solving situations for designing training programs or lessons that focus on developing cognitive skills according to the nature of the problem. For example, transferring information from graphs, showing the rate of increase in unemployment over the past years, to solving a problem of increasing crime rate requires cognitive skills that help derive a link between these two issues in terms of interrelated causes and effects. The model can be used to determine the best

representation, in terms of determining the cognitive skills required by such a problem. It may require stronger comparing or inferencing activity and less of labeling. Case studies 1 to 4 illustrated the use of GPM in analogical problem solving in two modalities (verbal and pictorial), and two levels of similarity (strategy and procedural) through SE and SCD protocols derived from various problems such as the Lab, the Almond and the Salt problems used in this thesis.

Ideally, the GPM should be adapted to domain-specific problems such as mathematics and physics to aid in application by educators. For example, specific versions of the GPM could be developed for solving word problems in algebra. Further research in problem-solving, specifically in domain-specific problems, should be undertaken to lead improvement in the GPM. On the other hand, the GPM cannot be generalized to tasks such as translating text from Arabic to English because they are rich in semantic meaning that renders assigning cognitive categories difficult if not impossible.

To sum, the GPM is considered as providing the rubrics for understanding how different factors in problem representation interact with the self support methods in determining the strength of transfer performance in analogical reasoning. Specifically, analysis of the diagram protocols (case studies 1 to 3) revealed that they help in eliciting the crucial cognitive sub-processes required for identifying the various elements of the problem, connecting and integrating ideas that stimulate the memory to recall the drawings of the source problem.

The study of workings of the mind is still in its infancy and this model is an attempt to deduce from the findings of this study how the process of analogical problem solving occurs. Although the model is not breaking ground it

certainly contributes to our knowledge of the analogical problem solving process using different modalities, levels of similarity and self support methods.

Limitation

While the GPM is a useful model for problem solving, there are several limitations. First, as the problem-solving procedure must be analyzed in detail, the GPM is difficult to use in analyzing a large number of individuals. Moreover, as the cognitive processes are depicted in detail (sub-processes as in cases 1 to 4), the model is lengthy and involved demanding some expertise. As such, educators and others using the model will need to be trained in the cognitive processes involved. A shorter and more comprehensive version of GPM is needed to make it less cumbersome and applicable to analyzing problem solving performance.

The model is based only on non-domain insight tasks involving analogical reasoning where strength of transfer is the outcome that depends on the process of integration. The process of integration first takes place in the source where it integrates the information from the dual channels (audio & visual), the fabricated and rerepresented information, the constructed mental model and the LTM. In the target problem this process includes the process of analogizing which directly affects the transfer performance. The model lacked focus on this important process as the study did not consider how each of these factors influence the integration process. Further studies need to focus on this process.

The GPM is neither complete nor totally inclusive as it lacks computer implementation that would assist in the analysis of individual learners.

Lastly, the study involved multiple factors; Modalities of representation, Levels of similarity, and Self-support methods that generated a lot of data both

quantitative and qualitative. This prevented the researcher from making deeper qualitative comparisons of problem solving behavior patterns.

Conclusions

The study of analogical problem solving is still in its infancy and this model is an attempt to deduce from the findings of this study how the process of analogical problem solving occurs. Although the model is not breaking ground it certainly contributes to our knowledge of the analogical problem solving process.

The GPM demonstrated its validity through four case studies. It highlighted the dynamics of analogical problem solving by illustrating how people deal with different modalities (verbal and pictorial), levels of similarity (strategy and procedural) and conditions (SCD, SE). It describes the process of problem solving that also includes the possibility of predicting strength of transfer performance. Specifically, analysis of the drawing protocols from the SCD condition (case studies 1 to 3), through the model, indicates how the problem is understood or interpreted, connecting and integrating ideas that stimulate the participant's memory and motivate them to recall their drawings as experiences, and identifying the reasons behind failure (case 3). In addition, the GPM can be easily generalized to problem analogies, arguments, story analogies, and formal analogies as well as mathematics and physics problems involving a procedure. As such, the GPM has a high potential for transformation into a computer program for cognitive tutoring. It can be refined, to make it more comprehensive and manageable, to become a useful tool for educators in determining the effectiveness of representations and planning problem solving training programs for enhancing learning outcomes.

CHAPTER 8: GENERAL DISCUSSION

This chapter summarizes the three experiments conducted in this study followed by an overall discussion of each independent variable. It also includes the contributions as well as limitations of the findings.

Summary of the Thesis

Thinking by analogy is trying to reason and learn about a new situation (the target analog) by relating it to a more familiar situation (the source analog) that can be viewed as structurally parallel (Holyoak & thagrad, 1997). Drawing analogies greatly depends on the direct similarity of the elements involved, in the source and target problems, and what according to the reasoner is the purpose of the analogy. At the same time, modality of representation also is known to directly influence the ease with which analogies are achieved or adapted. According to (Zhang, 1997; Zhang, 2001) external representation can reduce the difficulty of a task by supporting recognition based memory. However, the nature of tasks determines which mode of representation (pictorial or verbal) it easily lends itself to. In this study, non-domain specific everyday problems, not requiring any prior knowledge but some insight, were used. They involved a process to be understood in the source problem and applied in the solution of the target. The source problems pictorially depicted a process of weighing heavy objects without adequate tools at different levels of similarity (abstraction) with the target problem, which was only verbally (written) represented.

Some exploratory experiments conducted by the researcher in the field of analogical reasoning found that despite pictorial representation and procedural level of similarity the overall transfer performance was very low. This was

mainly attributed to the lack of noticing an analogous relationship between the source and target problems and/or failure to adapt a procedural solution to a new situation. This problem was overcome by most researchers (Holyoak and Thagard, 1997; Gick & Holyoak, 1980; Chen, 2002; Pedone et al, 2001) by using external support such as hints, schema induction, multiple representations and so forth.

The objective of this thesis was to determine the potential of self-support methods, like SE and self-constructed diagram, in eliciting mental processes that maximize spontaneous access and also aid the execution of the solution in solving problems depicting a procedure to be implemented. In analogical problem-solving the source and target problems are often considered as being multidimensional involving different types and levels of similarity. Therefore, they involve multi-componential cognitive activities that need to be understood by investigating not only how an analogy is drawn but also how an analogous solution is implemented. To achieve this purpose, three separate experiments were conducted. Each experiment focused on a particular set of issues related to the process of transfer in analogical problem-solving.

Experiment 1 (N=48), was planned to examine the precise effects of SE on transfer performance and also to help identify, through think aloud protocol analysis, the cognitive processes that facilitate transfer in analogical problem-solving. It consisted of three levels of similarity (principle, strategy and procedural) and two think aloud conditions (VB and SE) to investigate the effect of SE and procedural similarity on transfer performance. It also aimed to examine the cognitive factors associated with pictorial representation and different levels of similarity. A comprehensive coding scheme for analyzing the verbal protocols was developed by the researcher. On the basis of this protocol analysis, a

cognitive model was generated that illustrated the type and sequence of cognitive processes (and their sub-processes) crucial in processing information involving a multi-step process to be derived from the source problem and implemented in the target. This model was subsequently used in developing the overall model towards the end of the study.

Thus, this experiment focused on protocol analysis to understand how an analogy is drawn and implemented as well as the effect of procedural similarity and SE on transfer performance when the source model is pictorially represented at different levels of similarity. The findings that confirmed the importance of procedural similarity were in line with Chen's (2002) study. The experiment also revealed the effectiveness of procedural similarity when combined with SE in facilitating transfer problems requiring a process to be understood. The role of SE has been established as a meta-cognitive method to enhance learning mostly in domain specific areas to assess its impact on learning performance (Chi et al., 1989). In domain-free analogical problem-solving the verbal protocol analysis in this experiment revealed that SE motivated the problem solver to notice relations, identify constraints and monitor progress towards the goal. This study also found, as observed by Van Lehn and Jones (1993), that SE helped detect and fill the gaps in knowledge, develop a schema and enhance analogical reasoning.

Moreover, contrary to (Chi et al., 1989; Ainsworth & Loizou, 2003; Renkl, 1997) who found good students generate many explanations, in this study the amount of SE was determined by how quickly a person gained insight and solved the problem. Thus, the difference between solvers and non-solvers was not related to the amount of SE generated as shown in the following examples.

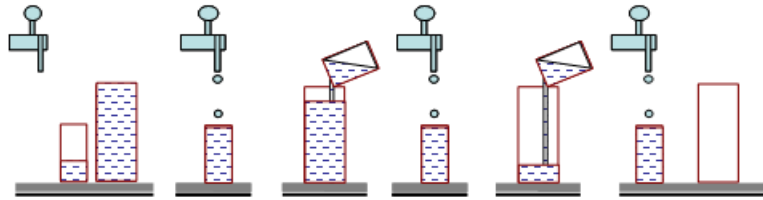

Figure 8.1: Procedural level of similarity: The refilling method

Participant 1. Translated generated protocol:

- Here is a full glass of water
- a water tap
- we empty the small glass
- into the large one
- then we fill the small glass again
- from the tap
- now .
- the large glass is full
- *this means....*
- that the large glass is equal to two and a half small glasses (Figure 8.1)

Participant 2. Translated generated protocol:

- This is a tap of water.
- water dripping into the glass.
- this glass is small
- this is an empty glass.
- now the glass is full
- the small glass of water
- has been emptied into the large glass or container.
- the container is almost one third full
- because the container is large
- and this glass is small.
- O.K then.
- We should repeat this process again.
- by filling the small glass of water
- and emptying it in to large container.
- now the large container is almost full.
- ok so the next step is
- we also fill the small glass
- and fill large container
- Hmm....
- there is a relationship
- (Silent)
- ok
- in the last picture we fill the large glass
- and there remains some water in the small glass.
- Oh!
- so large container contains holds less than three glasses of water (Figure 8.1)

The above examples show that the first participant skipped some steps and stopped explaining as soon as she understood the meaning and the process depicted while the second one generated relatively more detailed explanation to achieve an understanding of the problem. However, as also observed by Renkl (1997), the solvers in this study also showed a deeper understanding by tending towards goal directness and principle based reasoning while the non solvers were comparatively found to be superficial explainers.

In Experiment 1 the problems in the source were represented pictorially at different levels of similarity while the target for all levels was represented in verbal form to enable comparisons across levels and methods. However, Zhang (1998) is of the opinion that different representations of the same task structures could generate different types of behavioral outcomes referred to as representational efficiency. Although he manipulated different structures within the pictorial format (the Tic Tac Toe problem), it was considered useful to investigate this premise by using two different representations, verbal and pictorial, of a source problem. Moreover, it was also speculated that there could be some individual differences in interpreting or dealing with a pictorial representation in the source and/or adapting the knowledge to the verbal target. Therefore, it was considered imperative to resolve the issue of individual differences and also investigate whether informationally and computationally equivalent pictorial and verbal representations differ in their impact on transfer performance.

Experiment 2 was thus planned to assess the effects of two different representations, informationally equivalent (pictorial and verbal) in the source on target performance in a within subjects design consisting of 84 participants. The

participants were randomly assigned to two levels (strategy and procedural) of similarity where each participant took two problems: a) verbal source and its verbal target and b) pictorial source and its verbal target problems. A significant within subjects difference in representation was found as predicted where the performance in the pictorial source was more effective than the verbal source. This is primarily because for novel and discovery tasks depicting a process to be implemented, the format of representation determines the information perceived, the processes activated, and the attributes discovered from the specific representation (Zhang, 1997). While (Ainsworth & Loizou, 2003) observed that diagrams tend to reduce memory load and stimulate causal explanations, (Tversky, 2002) explained that elements that are arranged in space, in groups, orders, or distances can be iconically more meaningful in conveying ideas and facilitating more inference.

With regard to levels of similarity it was found that the participants in the procedural level of similarity performed significantly better than those in the strategy level. These are in line with both the previous findings of this study and Chen (2002). Analysis of retrospective reports related to the two forms of representation revealed that most participants found the pictorial form easier to map which supports the view of Larkin & Simon (1987) that diagrams represent chunks of relevant information which facilitate inference.

Experiment 3 was the last in the series of experiments conducted in this study related to the issue of increasing effective transfer performance in problem-solving by analogy. This experiment (N=160) consisted of two levels of similarity (strategy & procedural), two conditions of drawing (SCD & ND) as between subjects factors and two types of representations (verbal source &

pictorial source and their isomorphic verbal targets) as a within subjects factor. In this experiment (3) it was assumed that self-constructed drawings would serve a wider purpose by not only ensuring the optimal use of the mental processes but also a more cost-effective alternative, in terms of personal representation, to using two representations, verbal and pictorial. The results of this experiment extended the findings of the previous ones in an important way, by showing that constructing diagrams (SCD) helped in better performance and transfer by increasing the cognitive processes of encoding the key elements, mapping of corresponding elements, and understanding the relational structures between these elements. The findings confirmed the first hypothesis that the Mean performance (strength of transfer ST) of the target problem in the SCD condition would be significantly more than in the no drawing (ND) condition. In general, with respect to the levels of similarity, irrespective of type of representation and drawing conditions, it was found as predicted that the participants in the procedural level of similarity performed better than those in the strategy level. These findings were consistent with the previous Experiments 1 and 2.

The hypothesis that the SCD condition will have a positive influence on performance (strength of transfer) more than the condition of no-diagram (ND) was accepted. The second hypothesis that the participants in the procedural level of similarity will perform better than the participants in the strategy level of similarity in the self-diagram condition was also accepted. Finally, the last hypothesis that there would be no within-subjects significant difference between the performance in the two types of representations, pictorial and verbal in the self-constructed diagram condition was found true.

This experiment generated several important findings. First, there was no difference found in the target performance of pictorial and verbal source representation in the SCD condition. This was attributed to the positive effects of SCD on the verbal representation, where both (source and target) representations are externalized in a personal way that help in understanding and retrieving the relevant information which may facilitate transfer. Second, when SCD was found to be equally effective in increasing performance in the strategy level of similarity, with the target problem. Finally, a significant difference was found in the SCD and ND conditions in the target performance of verbal source. This was obviously because SCD helps build a personal version of the given problem in a different modality, wherein a verbal representation is reproduced nonverbally.

Overall Discussion

This study aimed to assess the effect of self-support methods such as SE and SCD to strengthen those mental processes that were found to be crucial for transfer in solving problems that involve a multistep process. To achieve this purpose the study used non-domain specific everyday problems depicting a process of weighing heavy objects or measuring out substances without adequate tools. These problems did not require any specific prior knowledge but some insight to discover the crucial steps required to solve the problem in the source and transfer the solution to the target problem. The problems were pictorially represented in the source while the target was in the verbal format to help make comparisons of transfer performance in various levels of similarities (abstraction) in all experiments: SE in Experiment 1, modality of representation in Experiment 2, and SCD in experiment 3. An overall discussion of each of these experimental manipulations in this study is briefly undertaken below, followed by some

specific contributions of the study along with its limitations to serve as motivation for further research.

Modality of Representation

The medium of representation (verbal or pictorial) is an important factor affecting the quality of transfer performance. However, the subject of the problem and its purpose often determine whether it lends itself easily to a particular mode. The problems here required understanding a process that involved working with objects differing in size and functional relations. Thus, the choice and design of the problem tasks was a crucial step in ensuring the empirical value of the study. Among some criteria laid down for selecting and developing the problem tasks was that the tasks should be two isomorphic non-domain specific tasks (source and target); should lend themselves easily to both pictorial and verbal representation, and should depict a step-by-step process or a procedure.

It was observed that there was a lack of systematic investigation regarding analogical reasoning with diagrams as compared to verbal. This was perhaps due to the difficulty of constructing diagrammatic source analogs in terms of time and efforts. In this study, the researcher made a pioneering effort to illustrate how to design systematically and informationally equivalent verbal and pictorial representations of non-domain specific problems in analogical reasoning.

In Experiment 1, only pictorial depiction of such a problem was used on the assumption that it will not only reduce the cognitive load of interpreting the meaning of these objects but would also prove more helpful in conveying the procedural details of how these objects can be operated or manipulated. Although the benefits of this representation were not questioned, before drawing conclusive

inferences regarding the effect of pictorial representation on transfer performance it important to examine the comparative effects of the pictorial and verbal representation of the problem in different levels of similarity in Experiment 2.

The verbal and pictorial versions of the problems involved ensuring their informational and computational equivalence. According to Larkin & Simon (1987) inference from a representation depends upon what operators are available for modifying and augmenting data structures. Comparing two representations, sentential and diagrams, depends on how these are organized into data structures and on the nature of the processes that operate upon them. A problem analysis, of the pictorial and verbal versions of the source (Art 1 problem) and their verbal target the Almond problem, was undertaken to indicate their data structures and the process solution. Figure 8.2 shows the verbal and pictorial source representations (versions) in procedural level of similarity. The initial states of the verbal and pictorial source and the target problems are given along with the required goal state, the inherent obstacles and the procedure to reach the goal solution. This analysis of the problem shows the extent to which the information data is congruent with the computational requirements of the solution in each modality. On the other hand, a comparison of the two representations (columns 1 and 2) helps understand the probability of equivalence in inferring information.

According to Stenning & Oberlander (1995) two strategies are used for enriching diagrams; create multiple diagrams and augment diagrams with new symbols. They refer to the limited abstraction representational system (LARS) as a type of complex diagram which abstracts over several models where each sub-diagram corresponds to one model depending on the precise interpretation. In this thesis the researcher used both strategies (in representing the source problem

pictorially) to convey the meaning of the objects that is dependent on the multistep process sequentially depicted in four pictures. At the same time each pictorial frame corresponds to the specificity of representation, which is characteristic of (MARS) or minimal abstraction representational system.

In Experiment 2, transfer performance in the pictorial representation in the source was found to be more effective than verbal in general and procedural similarity in particular. This is in line with the views of Zhang (1997) and Cheng (2002) where the former advocated that an appropriate representation should facilitate recognition based memory and Cheng argued that pictorial representation is often more beneficial than text.





Verbal Source Representation art gallery	Source pictorial representation	Target problem the almond problem
Initial state: • 42 g of paint • 3 measures 3,9,14 g	•Initial state 	Initial state: • box of 39 kg of almond •Mother and her 2 sisters, must had an equal amount •weighing instrument • three measure 12, 9, 5 kg
Goal state: get 16 g of paint	Goal state: 	Goal state: get 13 k of almond exactly
Obstacle: Only three weight available		Obstacle: the instrument will not hold more than 20 k at a time. To get the required amount instrument and the 3 weighs
Procedure: •weigh the paint against 14gms •Put it in one side •Then weigh the paint against both 9 & 3gms •The remaining is the required amount (In other words she had to subtract These 3 weights from the whole amount.)		Procedure: •weigh the Almond against 12 gms •Put it in one side •Then weigh the paint against both 9 & 5gms •The remaining is the required amount
The Goal : 16 gms of paint	The Goal : the rest amount in The jar 	The Goal : 13 kg of Almond

Figure 8.2: Problem analysis of the verbal and pictorial source problems and their verbal target.

Additionally, according to Larkin & Simon (1987) the advantages of diagrams are computational, that is, “*diagrams can be better representations not because they contain more information, but because the indexing of this*

information can support extremely useful and efficient computational processes. But this means that diagrams are useful only to those who know the appropriate computational processes for taking advantage of them. Furthermore, a problem solver often also needs the knowledge of how to construct a “good” diagram that lets him take advantage of the virtues we have discussed p. 67”

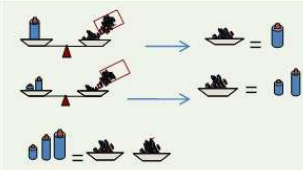
In the same way Zhang (2001) also observed that the type of representation determines what information is perceived or processed. For example, in a classical verbal representation the semantic meaning of the words will govern how relations are drawn while in a pictorial representation a person often perceives the intended meaning and either adds, deletes or transforms this information.

Another important determinant of transfer performance is the level of similarity or abstraction shared between the source and target problems. This is taken up below.

Levels of Abstraction

Analogical reasoning usually involves the process of identifying the underlying structured isomorphism in one (the source) and applying it to solve another problem (the target) that could be solved by using a similar but not identical strategy. As the analogical approach is considered multilevel in nature it thus depends on, and is guided by, the level of representation in the source problem. Understanding pictorial and verbal information processing at different levels of similarity was considered equally important in identifying the mechanisms that optimize analogical transfer. The probability of successfully solving a problem by analogy is greatly determined by the degree of diversity (or similarity) shared between the source and the target problems. Chen (1996,

2002) proposed three levels of similarity that reflect the relations between a source analogue and a target problem as follows: The first type is Superficial similarity, where the problems may be similar or different in their surface attributes, such as objects or characters in the source and target problems. The second type is Structural similarity, where the source and target may share some features, solution principle, or causal relations among the key components. And the third type is Procedural similarity between the source and target which is considered as an important factor for facilitating the transfer of the solution process. Thus, problems may share the same superficial attribute, structural features or procedural processes or they are different. The three experiments reported here investigated how people process information at different levels of similarity. In the first experiment, problem-solving at all three levels of similarity was undertaken, while the intermediate and higher levels (strategy and procedure) were applied in second and third experiment. A consistent assumption in all the experiments of this study was that the process of implementing a source solution (transfer performance) is influenced positively by the procedural level (similar procedural details) of relations shared between the source and target analogue. Consistent with previous findings concerning the effect of procedural similarity (e.g., Chen 2002; Gick & Holyoak 1980; Gentner & Markman, 1993) this study also provided evidence that the procedural level of similarity elicited more cognitive processes that directly influenced positive transfer performance. Solving problems by analogy begins with the mechanisms of noticing and mapping analogical relations between the source and target problems, which have been examined extensively in other studies (e.g., Gentner, 1989; Gentner & Markman, 1993; Ross, 1989). In problems depicting a process,

the superficial similarities were found to be as critical as the structural (the operational details) in the source problem for mapping and implementing it in the target problem to reach a goal. For example, in the Art Gallery problem (Figure 8.2) in the source for the Almond target problem, if a participant selects the small weights to map with the large ones in the target it would result in wrong mapping and implementation. According to Ross & Kilbane (1997) when the objects between the problems were identical, they were often assigned to the same variable roles. In problems that lack superficial similarity (example strategy level) there is a tendency to notice the correspondences, but the dissimilarity of the objects may make the correspondences less compelling to use. Thus, the effects of superficial similarity on mapping and implementing a process solution are somewhat contrary to Gentner's views. High superficial similarity of objects and their structural roles tend to facilitate better mapping. This feature associated with process based analogical solutions, therefore, may cause difficulty in applying a solution to another problem situation. The results of this study provided sufficient evidence that implementation of a learnt solution is associated with the effects of procedural similarity on transfer. That is, participants receiving source models similar in procedure to the target solution were better able to generate complete solutions than those who received source models with strategy level of similarity. Moreover, it was also found that the effect of procedural similarity became more profound when combined with self-support methods of SE (Experiment 1) and SCD (Experiment 3).

The Self-Support Methods (SE, SCD)

The major concern of this research was to explore the effects of SE and self-constructed diagram in problem-solving by analogy. Both self-support

methods were found to be effective in transfer performance. In Experiment 1, the think aloud protocols served a dual purpose of determining the nature of (type and sequence) cognitive processes involved in solving the problems used in this study and assessing the impact of SE on transfer performance. The cognitive framework derived helped understand precisely where and how the method of SE was instrumental in helping a person solve problems by analogy. Self-explaining aloud not only helps externalize the internal representation of the problem but also activates the audio sensory memory. Thus, when a person actively engages in a dialogue with himself to explain and analyze the information in the source problem it perhaps strengthens memory traces in the short-term memory or helps in cognitive offloading thereby increasing the probability of its retrieval and subsequent transfer. The protocols also revealed that SE method was particularly effective in promoting the cognitive sub-processes of inference considered crucial in the target problem such as goal directness, justification and mathematical elaboration by frequently indulging in the meta cognitive activity of monitoring progress, filling gaps and /or overcoming problem constraints.

Self-constructed diagrams are an extension of SE where a person self explains with diagrams. This method provides the benefit of both externalizing and re-representing information in a similar (pictorial and diagrammatic) or different format (verbal to diagrams). Generating personal sketches scaffolds information processing that helps simulate a procedure that may get stored in LTM, thereby increasing the probability of access and retrieval. Moreover, the SCD proved to be equally effective in the verbal representation and the strategy level of similarity. While the former was attributed to SCD providing a re-representation in a different format or more than one representation the latter was

because it also helped a person adapt and map dissimilarities between the source and target overcoming the difficulty observed by Ross & Kilbane (1997) that superficial dissimilarities make them less compelling to use. Analysis of the protocols of both SE and SCD revealed that participants who manifested the cognitive processes of Explanation (Labeling, Combination, Comparison, and relations) and Inference (goal directness, mathematical elaboration and justification) in solving the source problem were able to analogize (selective encoding, mapping and transfer) more efficiently. It was concluded that the condition of self-support methods, SE and SCD, tended to induce some cognitive stress for encoding information as thoroughly as possible and understand all aspects of the problem which made retrieval and the execution process more spontaneous while solving the target problem. The study provided sufficient evidence for SE and SCD as alternatives for external support methods such as giving hints or multiple representations (not always possible) while working with analogies.

A comparison of the methods of SE and SCD is shown in Figure 8.3. Both the methods reflect a person's depth of understanding. Some other characteristics shared by these methods include inducing the need (self directed) to explain, monitor and focus more on the problem. As mentioned earlier both methods initially create some stress to explain or draw but eventually they serve the purpose of cognitive offloading. The important differences in these two methods relate to points 6, 7 and 8 shown in Figure 8.3. While in SE the mental manipulation of information involves problems of forgetting vital information or failing to connect it, which may affect the cognitive process of noticing; in SCD there is less possibility of forgetting because of concrete simulation of the

problem that facilitates noticing. In point 7 there is a low possibility of integration of experience with the LTM in SE compared to its high possibility in SCD. Finally, retrieval in SE depends on verbal memory alone while in SCD it depends on both verbal and pictorial memory.

To conclude, it is an established fact that analogies are an effective cognitive tool for enhancing learning. However, people rarely tend to notice analogies spontaneously because they often find difficulty in deriving the essential information and adapting or applying it to a new situation. This compelled researchers to use different techniques of external support (such as hints, schema induction, multiple representation etc.) to induce analogical reasoning. The way in which these two self-support methods were used in this study has contributed to our understanding of how we can optimize the benefits of analogical reasoning in situations and environments that do not permit external support methods.

<u>SELF-EXPLANATIONS</u>	<u>SELF-CONSTRUCTED DRAWINGS</u>
<ol style="list-style-type: none"> 1. Information is presented in pictorial or verbal format 2. Process through the audio and visual sensory 3. Constructs a verbal mental model through VB 4. Cognitive load occurs because of the stress on the learner to understand and explain 5. Offloading occurs when the learner talks it out or explains it. 6. Mental manipulation of information involves problems of forgetting vital information or failing to connect it affects the cognitive process of noticing. 7. Low possibility of Integration of experience with the LTM 8. Retrieval depends on verbal memory. 9. Monitoring through referential activity to fill gaps and derive complete explanations 10. It reflects the depth of understanding 11. The need to explain makes a person focus on the problem 12. Learner tends to be self directed. 	<ol style="list-style-type: none"> 1. Information is presented in pictorial or verbal format 2. Process through the audio and visual sensory 3. Constructed a verbal & pictorial mental model through SCD 4. Cognitive load occurs to create a re-representation diagrammatically 5. Offloading occurs by drawing the internal representation 6. Less possibility of forgetting because of concrete simulation of the problem that facilitates noticing 7. High possibility of Integration of experience with the LTM 8. Retrieval depends both on verbal memory and pictorial memory. 9. Monitoring through Referential activity and frequent inspection of drawings helps complete the depiction in drawings 10. It reflects both depth and vividness of understanding 11. The need for deriving an explanation from drawings makes a person focus 12. Learner tends to be self directed.

Figure 8.3: Comparison of self-support methods SE and SCD

Contributions of the Study

Although the use of the methods of SE and SCD have been prevalent for enhancing learning performance, the uniqueness of this study lies in the methodology developed by the researcher to achieve its purpose which was to enhance transfer performance in problem-solving by analogy. The benefits of pictorial representation have been often underscored but they were rarely used in analogical problem-solving due to the difficulty of constructing a pair of isomorphic problems. Chen (2002) depicted an everyday problem through sketches in the source problem but did not describe systematically how such representations can be developed. In this study the researcher used a systematic method for constructing isomorphic problems both pictorially and verbally the details of which are given in Chapters 3 and Appendix D. Specifically, the researcher adapted several novel problems to depict their three levels of similarity in two modalities in the source problem.

The researcher also developed a unique method of analyzing verbal and drawing protocols that are of use to the field of analogical problem-solving. First, to analyze the think aloud protocols, the researcher introduced a coding scheme (Chapter 4). Second, the researcher developed the first known method for analyzing and coding drawing protocols (Chapter 6). Finally, the most significant contribution of this thesis was the development of “The Generative Procedural Model for Analogical Problem-solving”. The model depicts what cognitive processes take place in the working memory, and how the SCD diagrams helped integrate information between the source and target problems that influences the process of transfer.

Educational Implications

A major interest of the researcher has been to understand how self-support methods can be applied in educational settings. The experimental findings demonstrate that self-support methods (such as SE and SCD) have educational implications for enhancing learning and problem-solving skills. These self-support methods stimulate discovery learning by inducing active involvement and meta-cognitive activities that are essential for reducing passive learning or motivational problems in students. Early training in explaining and drawing help inculcate in children analytical and critical thinking skills and creativity. These methods can become an integral part of teaching methods particularly in complex tasks that need some scaffolding of information. Teachers can identify perceptual errors and problems of comprehension. Thus, the method of SCD is an effective self explaining method for enhancing learning that can be used by children and adults. Therefore, is a need to conduct studies focusing on developing SE and SCD skills in children. In a pilot investigation the researcher examined the effect of SE/SCD training. This investigation involved three children (grades 4 to 6). Each was asked to use SE /SCD to explain the passage of food through the digestive system. In another investigation seven children in the same age range solved problems from the Raven's progressive matrices using only SE. The children demonstrated success in using the acquired SE/SCD skills in understanding the subject of learning thereby indicating that training in such processes is beneficial.

Further studies, of analogical reasoning using self-support methods in math, statistics or other abstract scientific concepts, particularly among children are needed.

Limitations of the Study

Although, the study is considered unique in its methodology it has some inherent limitations related to the experimental design, the tasks chosen and the analysis of the results. These are undertaken below.

The aim of this thesis involved examining the effects of procedural similarity, type of representations, and the self support methods in overcoming difficulties of implementing a procedural solution in analogical problem solving. Therefore, the task had to be multipurpose; involve understanding and implementing a process, be represented in different levels of similarity where the procedural level could be distinguished from other levels, represented verbally/pictorially, and generate enough think aloud and drawing protocols to identify the cognitive processes that aid or impede transfer performance.

Researchers investigated analogical reasoning by classical analogy (Sternberg, Kaufman & Grigorenko 2008), or narrative analogy (Holyoak 1984, Pedone et al., 2001). Classical analogy could be used as verbal and figural, but it has only one relation such as A:B that could be figured and applied to C:D with no procedural information involved. Thus, it has a low probability of generating quality protocols to determine the underlying cognitive processes crucial in analogical problem solving. Therefore, they were not suitable for the aims of this study.

Domain free problem analogies are similar to math word problems but differ in that the structural relations is embedded in a narration that requires no prior knowledge and sometimes also includes an element of insight. The researcher used Chen's Elephant problem as it was an everyday problem that required no prior knowledge and built to examine precisely the effect of different

levels of similarity represented pictorially. The problem, with an element of insight, is considered neither ill defined nor a well defined problem. This feature of the problem made it potentially high for generating quality protocols and therefore, it formed the basis for all tasks used in this study.

Both the source and target problems required insight and a concrete procedure to solve it. Nevertheless, this inherent property of insight itself has a tendency to become an obstacle that affects the initial interpretation, particularly in pictorial representations, of the problem that is considered important. For example, some interpreted the pictorially represented source problem of the salt as doors and windows, which subsequently affected the transfer process. In verbal representations the lack of insight sometimes led to looping (repeating the same idea). Therefore, insight problems tend to be more vulnerable to individual differences that were not taken into account in this study. It is speculated that, although the insight problems served the purpose of the study by exposing the underlying cognitive strategies, a problem task not requiring insight may perhaps increase the effectiveness of the self support methods in strengthening the process of understanding and reasoning as well as helping overcome obstacles to problem solving.

Representation of the problems is another issue that could affect the results. In this study the pictorial representation of the tasks in the source problem consisted of a series of pictures depicting a process presented horizontally (experiment1) in four progressive frames. This created a tendency to perceive each frame in itself or failure to notice the connection between the pictures. Using a vertical presentation (experiments 2 & 3) along with arrows to show the connection between the frames did not make much difference in the performance.

However, using animated instead of static representation would have most probably improved transfer performance by reducing the mental manipulation of objects as found by Pedone et al. (2001) in the Dunker problem. Therefore, other methods of presenting pictorial representations will certainly contribute to our understanding of the role of presentation in analogical reasoning.

The study also had some methodological shortcomings. As the sample was restricted to female undergraduates it cannot be generalized, hence there is a need to investigate how the self support methods enhance learning outcomes in analogical reasoning in mixed groups of different ages.

A limitation of the study related to analysis of the data is that it did not deeply investigate the different reasons behind failure. Analyzing the type of errors that occurred while solving the analogous problems would provide more insight into the difficulties encountered in solving problems by analogy. Specifically, a comparison of the type of errors that occur due to pictorial and verbal representations and levels of similarity in SE and SCD conditions would have extended the scope of the study.

Another important issue is related to the scoring of the responses that affected the results. For example, the maximum score for the elephant source and target problem is 4 and the minimum is 0. This method tended to collapse variations in responses and classify them into broad categories. Assigning a score to each correct step would increase the range of scores and probably deepen the analysis, generate more variation in performance results, and at the same time reveal a more precise pattern of cognitive responses.

Ideally, time should be used as a constraint in all problem solving situations to compare performance or learning outcomes. In this study it was not

used purposefully in order to elicit maximum protocols. Perhaps, introducing a time constraint condition would help know the extent to which it influences the effectiveness of the self support methods of SE/SCD.

Finally, the study did not use video recordings that could provide additional information particularly in cases of failure. In addition, video recordings of SCD would reveal precisely how a person went about rerepresenting the problem which can help identify behavioural patterns of interpreting analogical information.

In view of the above contributions and limitations of the study this line of inquiry needs to be continued particularly involving the following issues.

As the study established to a great extent that SCD was effective even when the information shared between the source and target was low in similarity, it is suggested that studies be conducted focusing on using this self support method in problems of various domains that do not lend themselves easily to representations in higher levels of similarity.

The study also identified the effect of SCD on cognitive processes considered crucial for successful transfer. A deeper examination of the effect of SCD on each of the cognitive processes in isolation is needed. For example, how much of the activity of combining and comparing information will affect the other processes in general and transfer in particular?

Mapping is the most crucial process in an analogy that is contingent on the process of explanation and inference. It would be worthwhile to study the effects of training in developing cognitive skills in the major cognitive process of explanation that would enhance the ability to draw structural alignment of commonalities rather than only superficial features.

Lastly, the right to left direction of presenting pictures in the source problems had a significant impact on transfer performance for Arabic-speaking participants. Therefore, those producing diagrams while devising problems of analogy, such as, educators, textbook publishers, etc should take into account the cultural mental sets of the people for whom these problems are meant. For example, diagrams should be read in the same direction as the text would be read.

Overall Conclusion

Research in analogical problem-solving has often substantiated that analogies require supportive methods like hints, schema induction or multiple representations, to initiate or increase the mental processes that optimize spontaneous retrieval of the information from the source and mapping it to the target problem.

This study which furthers the work of Pedone et al. (2001) and Chen (2002) has made some significant contributions to the field of analogical problem-solving by adding to our understanding of how people externalize their reasoning. It introduced a methodology for constructing diagrammatic representations and analyzing drawing protocols, which focused on examining the mental processes that affect the interpretation of a problem in the source and implementation of the solution in the target problem. It has also highlighted the importance of self-support methods as opposed to external methods such as giving hints for noticing links (between source and target) or using multiple representations to help develop a schema and induce active participation. The outcome of the study was the proposed model “Generative Procedural Model of Analogical Problem-solving” to depict how analogies are processed and successfully implemented (transfer) by using the self-support methods.

To summarize, the study highlighted that procedural level of similarity positively influences transfer performance. Pictorial is preferable to verbal type of representation in the source when the problem involves depicting a multi-step process requiring manipulation of objects. The SE method positively influences transfer performance by inducing active participation and meta-cognitive activities. The limitation of this method was difficulties in holding and manipulating multi-componential information in the working memory. The condition of SCD was found to be an effective scaffold for problem-solving. Its benefits were seen across types and levels of representation. That is, besides being effective in pictorial representation and procedural similarity it also proved to be effective in verbal representation and strategy level of similarity. The SCD had a direct impact on eliciting and optimizing the cognitive processes of retrieving and noticing similarities and differences in the source and target problems, drawing important inferences while keeping the constraints in view, simulating a process in a concrete way and gaining procedural knowledge in the LTM for future access. The study provided new insights into the nature of analogical reasoning by contributing to our understanding of how people perceive process and implement knowledge gained from pictorial type of information. The factors that influence the transfer of learning in general.

REFERENCES

- Ainsworth, S. (2006). DeFT: A conceptual framework for considering learning with multiple representations. *Learning and Instruction*, 16(3), 183-198.
- Ainsworth, S. & Burcham, S. (2007). The impact of text coherence on learning by self-explanation. *Learning and Instruction*, 17(3), 286-303.
- Ainsworth, S., & Iacovides, I. (2005). Learning by constructing self-explanation diagrams. Paper presented at the 11th Biennial Conference of European Association for Research on Learning and Instruction, Nicosia, Cypress.
- Ainsworth, S., & Loizou, A. T. (2003). The effects of self-explaining when learning with text or diagrams. *Cognitive Science*, 27(4), 669-681.
- Ainsworth, S. E., & Peevers, G. J. (2003). The Interaction between informational and computational properties of external representations on problem-solving and learning. In R. Altmann & D. Kirsch (Eds.), *Proceedings of 25th Annual Conference of the Cognitive Science Society*.
- Ainsworth, S.E & Van Labeke, N (2002). Using a multi-representational design framework to develop and evaluate a dynamic simulation environment. Paper presented at Dynamic Information and Visualisation Workshop, Tuebingen, Germany.
- Ainsworth, S. & VanLabeke, N. (2004). Multiple forms of dynamic representation. *Learning and Instruction*, 14(3), 241-255.
- Aleven, V. & Koedinger, K. (2002). An effective metacognitive strategy: Learning by doing and explaining with a computer-based cognitive tutor. *Cognitive Science*, 26, 147-179.
- Anderson, R. E. & Helstrup, T. (1993). Multiple perspectives on discovery and creativity in mind and on paper. *Advances in psychology*, 98, 223-253.
- Bassok, M. & Holyoak, K.J. (1989). Interdomain transfer between Isomorphic topics in Algebra and Physics. *Journal of Experimental Psychology: Learning, Memory, and Cognition*, 15(1), 166.
- Butcher, K.R. (2006). Learning from text with diagrams: Promoting mental model development and inference generation. *Journal of Educational Psychology*, 98(1), 182-197.
- Catrambone, R. (1994). Improving examples to improve transfer to novel problems. *Memory & Cognition*, 22(5), 606-615.

- Catrambone, R. (2002). The effects of surface and structural feature matches on the access of story analogs. *Journal of Experimental Psychology: Learning, Memory, and Cognition*, 28(2), 334.
- Catrambone, R., & Holyoak, K.J. (1989). Overcoming contextual limitations on problem-solving transfer. *Journal of Experimental Psychology: Learning, Memory, and Cognition*, 15(6), 1147-1156.
- Chen, Z. (1996). Children's analogical problem-solving: The effects of superficial, structural, and procedural similarity. *Journal of Experimental Child Psychology*, 62(3), 410-431.
- Chen, Z. (2002). Analogical problem-solving: A hierarchical analysis of procedural similarity. *Journal of Experimental Psychology: Learning, Memory, and Cognition*, 28(1), 81-98.
- Chen, Z. (2007). Learning to map: Strategy discovery and strategy change in young children. *Developmental Psychology*, 43(2), 386-40318.
- Chen, Z., & Mo, L. (2004). Schema induction in problem-solving: A multidimensional analysis. *Journal of Experimental Psychology: Learning, Memory, and Cognition*, 30(3), 583-600.
- Chen, Z., Mo, L., & Honomichl, R. (2004). Having the memory of an elephant: Long-term retrieval and the use of analogues in problem-solving. *Journal of Experimental Psychology: General*, 133(3), 415-433.
- Chen, Z. & Siegler, R.S. (2000). Intellectual Development in Childhood. In R.J. Sternberg (Ed.), *Handbook of Intelligence* (pp. 92-116). New York, Cambridge University Press.
- Cheng, P.C.H. (2002). Electrifying diagrams for learning: principles for complex representational systems. *Cognitive Science*, 26(6), 685-736.
- Cheng, P. C. H. (2004). Why diagrams are (sometimes) six times easier than words: Benefits beyond locational indexing. *Lecture Notes in Computer Science*, 242-254.
- Cheng, P.W. & Holyoak, K.J. (1985). Pragmatic reasoning schemas. *Cognitive Psychology*, 17(4), 391-416.
- Cheng, P. H. C., Lowe, R. K., & Scaife, M. (2001). Cognitive science approaches to understanding diagrammatic representations. *Artificial Intelligence Review*, 15(1), 79-94.
- Cheng, P. C.-H., & Shipstone, D. M. (2003). Supporting learning and promoting conceptual change with box and AVOW diagrams. Part 2: Their impact on student learning at A-level. *International Journal of Science Education*, 25(3), 291-305.

- Chi, M. T. H., Bassok, M., Lewis, M.W., Reimann, P., & Glaser, R. (1989). Self-explanations: How students study and use examples in learning to solve problems. *Cognitive Science*, 13(2), 145-182.
- Chi, M. T. H., De Leeuw, N., Chiu, M.H., & Lavancher, C. (1994). Eliciting self-explanations improves understanding. *Cognitive Science*, 18(3), 439-477.
- Chi, M., Siler, S., Jeong, H., Yamauchi, T., & Hausmann, R. (2001). Learning from human tutoring. *Cognitive Science*, 25(4), 471–533.
- Coolican, H. (2004). *Research Methods and Statistics in Psychology* (4th ed.). London: Hodder & Stoughton
- Cox, R. (1997). Representation interpretation versus representation construction: a controlled study using switch ERII. In B.du Boulay and R.Mizoguchi (Eds.), *Artificial intelligence in education: Knowledge and media in learning systems. Proceedings of the 8th World Conference of the Artificial Intelligence in Education Society* (pp. 434–444). Amsterdam: IOS.
- Cox, R. (1999). Representation construction, externalized cognition and individual differences. *Learning and Instruction*, 9, 343–363.
- Cox, R. & Brna, P. (1995). Supporting the use of external Representations in Problem-solving: the Need for Flexible Learning Environments. *Journal of Artificial Intelligence in Education*, 6, 239-302.
- Davies, J. & Goel, A.K. (2001). Visual analogy in problem-solving. *Proc.IJCAI*, 1, 377-382.
- Daives, J., A.K. & Goel, et al. (2003). Visual rerepresentation in creative analogies. *International Joint Conference on Artificial Intelligence*. Acapulco, Mexico.
- Ericsson, K. A., & Crutcher, R. J. (1991). Introspection and verbal reports on cognitive processes--Two approaches to the study of thinking: A response to Howe* 1. *New Ideas in Psychology*, 9(1), 57-71
- Ericsson, K.A., & Simon, H.A. (1980). Verbal reports as data. *Psychological Review* 87(3), 215-251.
- Ericsson, K.A. & Simon, H.A. (1984). *Protocol analysis: Verbal reports as data*. Cambridge, MA: MIT Press.
- Ericsson, K.A. & Simon, H.A. (1993). *Protocol analysis: MIT Press Cambridge, Mass.*
- Eysenck, H.J. (1998). *Intelligence: A new look*. Transaction Pub.

- Ferguson, E.L. & Hegarty, M. (1995). Learning with real machines or diagrams: Application of knowledge to real-world problems. *Cognition and Instruction*, 13(1), 129-160.
- Funke, J. (1991). Solving complex problems: Exploration and control of complex systems. *Complex problem-solving: Principles and mechanisms*, 185-222.
- Gentner, D. (1983). Structure-mapping: A theoretical framework for analogy. *Cognitive Science*, 7(2), 155-170.
- Gentner, D. (1989). The mechanisms of analogical learning. In S. Vosniadou and A. Ortony (Eds.), *Similarity and analogical reasoning* (pp. 199—241). New York: Cambridge University Press.
- Gentner, D. & Markman, A. (1993). Structure alignment during similarity comparison. *Cognitive Psychology*, 25, 431-467.
- Gentner, D., & Markman, A.B. (1997). Structure mapping in analogy and similarity. *American Psychologist*, 52(1), 45-56.
- Gentner, D., Rattermann, M.J., & Forbus, K.D. (1993). The roles of similarity in transfer: Separating retrievability from inferential soundness. *Cognitive Psychology*, 25(4), 524-575.
- Gentner, D. & Toupin, C. (1986). Systematicity and surface similarity in the development of analogy. *Cognitive Science*, 10(3), 277-300.
- Gick, M.L., & Holyoak, K.J. (1980). Analogical problem-solving. *Cognitive Psychology*, 12(3), 306-355.
- Gick, M.L., & Holyoak, K.J. (1983). Schema induction and analogical transfer. *Cognitive Psychology*, 15(1), 1-38.
- Gick, M.L., & Lockhart, R. S (1995). Cognitive and affective components of insight. *The nature of insight*, 197-228.
- Gick, M.L., & Paradigm, A. P. S. (1989). 12 two functions of diagrams in problem-solving by analogy. *Knowledge Acquisition from Text and Pictures*, 215.
- Gilmore, D. J. & Green, T. R. G. (1984). Comprehension and recall of miniature programs. *International Journal of Man-Machine Studies*, 21, 31-48.
- Green, C., & Gilhooly, K. (1996). Protocol analysis: Practical implementation. In J. Richardson (Ed) *BPS Handbook of qualitative research methods for psychology and the social sciences* (pp. 55–74).
- Grossen, B., & Carnine, D. (1990). Diagramming a logic strategy: Effects on difficult problem types and transfer. *Learning Disability Quarterly*, 13(3), 168-182.

- Hegarty, M. (2004). Diagrams in the mind and in the world: Relations between internal and external visualizations. *Lecture Notes in Computer Science*, 1-13.
- Hegarty, M., Mayer, R.E., & Monk, C.A. (1995). Comprehension of arithmetic word problems: A comparison of successful and unsuccessful problem solvers. *Journal of Educational Psychology*, 87(1), 18-32.
- Heiser, J. & Tversky, B. (2002). Diagrams and descriptions in acquiring complex systems. *Proceedings of the 24th Annual Conference of the Cognitive Science Society*, 447-452.
- Heiser, J., Tversky, B., & Silverman, M. (2004). Sketches for and from collaboration. *Visual and spatial reasoning in design III*, 69-78.
- Holyoak, K.J. (1984). Analogical thinking and human intelligence. R. J. Sternberg (Ed.), *Advances in the psychology of human intelligence*, 2, 199-230.
- Holyoak, K.J. (1985). The pragmatics of analogical transfer. In G. H. Bower (Ed.), *The psychology of learning and motivation*. San Diego: Academic Press.
- Holyoak, K.J. & Thagard, P. (1989a). Analogical mapping by constraint satisfaction. *Cognitive Science*, 13(3), 295-355.
- Holyoak, K.J., & Thagard, P. (1989b). A computational model of analogical problem-solving. In S. Vosniadou and A. Ortony (Eds.), *Similarity and analogical reasoning* (pp. 242-266). New York: Cambridge University Press.
- Holyoak, K.J. & Thagard, P. (1995). *Mental leaps: Analogy in creative thought*. MIT Press.
- Holyoak, K.J. & Thagard, P. (1997). The analogical mind. *American Psychologist*, 52: 35-44.
- Hummel, J.E. & Holyoak, K.J. (1997). Distributed representations of structure: A theory of analogical access and mapping. *Psychological Review*, 104(3), 466.
- Jonassen, D. H. (1997). Instructional design models for well-structured and ill-structured problem-solving learning outcomes. *Educational Technology Research and Development*, 45(1), 65-94.
- Jonassen, D. H. (2000). Toward a design theory of problem-solving. *Educational Technology Research and Development*, 48(4), 63-85.
- Jonassen, D. H., & Kwon, H. (2001). Communication patterns in computer mediated versus face-to-face group problem-solving. *Educational Technology Research and Development*, 49(1), 35-51.

- Kaplan, C.A., & Simon, H.A. (1990). In search of insight. *Cognitive Psychology*, 22(3), 374-419.
- Keane, M. (1988). *Analogical problem-solving*. Chichester, England: Ellis Horwood.
- Kershaw, T.C., & Ohlsson, S. (2001). Training for insight: The case of the nine-dot problem. In J.D. Moore and K. Stebbing (Eds.), *Proceedings of the Twenty-third Annual Conference of the Cognitive Science Society* (pp. 489-493). Mahwah, NJ: Lawrence Erlbaum Associates.
- Kershaw, T.C., & Ohlsson, S. (2004). Multiple causes of difficulty in insight: The case of the nine-dot problem. *Journal of Experimental Psychology: Learning, Memory, and Cognition*, 30(1), 3-13.
- Kershaw, T.C., Ohlsson, S., & Coyne, C. (2003). The fallacy of single-source explanations: The multiple difficulties of the nine-dot problem. In R. Alterman and D. Kirsh (Eds.), *Proceedings of the Twenty-Fifth Annual Conference of the Cognitive Science Society [CD-ROM]*. Cognitive Science Society.
- Kirschner, P.A. (2002). Cognitive load theory: Implications of cognitive load theory on the design of learning. *Learning and Instruction*, 12(1), 1-10.
- Kotovsky, K., Hayes, J.R., & Simon, H.A. (1985). Why are some problems hard? Evidence from tower of Hanoi. *Cognitive psychology*, 17(2), 248-294.
- Kroger, J.K., Holyoak, K.J., & Hummel, J.E. (2004). Varieties of sameness: the impact of relational complexity on perceptual comparisons. *Cognitive Science*, 28(3), 335-358.
- Larkin, J.H., & Simon, H.A. (1987). Why a Diagram is worth ten thousand words. *Cognitive Science*, 11(1), 65-100.
- Lewis, A.B. (1989). Training students to represent arithmetic word problems. *Journal of Educational Psychology*, 81(4), 521-531.
- Luchins, A.S. (1942). Mechanisms in problem-solving. *Psychological Monographs*, 45(248).
- MacGregor, J.N., Ormerod, T.C., & Chronicle, E.P. (2001). Information-processing and insight: A process model of performance on the nine-dot and related problems. *Journal of Experimental Psychology: Learning, Memory, and Cognition*, 27(1), 176-201.
- Maier, N. R. F. (1930). Reasoning in humans: I. On direction. *Journal of Comparative Psychology*, 10, 115-143.
- Markman, A.B. & D. Gentner (2000). Structure mapping in the comparison process. *American Journal of Psychology*, 113, 501-538.

- Mayer, R.E. (1993). Comprehension of graphics in texts: An overview. *Learning and Instruction*, 3(3), 239-245.
- Mayer, R.E. (1996). Learning strategies for making sense out of expository text: The SOI model for guiding three cognitive processes in knowledge construction. *Educational Psychology Review*, 8, 357-371.
- Mayer. (1997). Multimedia Learning: Are We Asking the Right Questions? *Educational Psychologist*, 32(1), 1-19.
- Mayer, R.E. (1999a). Problem-solving. *Encyclopedia of Creativity*. San Diego: Academic Press.
- Mayer, R.E. (1999b). Multimedia aids to problem-solving transfer. *International Journal of Educational Research*, 611-623.
- Mayer, R.E. (2001). *Multimedia learning*. Cambridge: Cambridge University Press.
- Mayer, R.E., Dow, & Mayer. (2003). Multimedia Learning in an Interactive Self-Explaining Environment: What Works in the Design of Agent-Based Microworlds? *Journal of Educational Psychology*, 95(4), 806-812.
- Mayer, R.E. & Sims, V.K. (1994). For whom is a picture worth a thousand words? Extensions of a dual-coding theory of multimedia learning. *Journal of Educational Psychology*, 86(3), 389-401.
- Mayer, Steinhoff, Bower, & Mars. (1995). A generative theory of textbook design: Using annotated illustrations to foster meaningful learning of science text. *Educational Technology Research and Development*, 43(1), 31-41.
- Nenman, Y., & Schwarz, B. (1998). Is self-explanation while solving problems helpful? The case of analogical problem-solving. *British Journal of Educational Psychology*, 68(1), 15-24.
- Newell, A. & Simon, H.A. (1972). *Human problem-solving*. Englewood Cliffs: NJ Prentice-Hall.
- Novick, L.R. (1992). The role of expertise in solving arithmetic and algebra word problems by analogy. *Advances in psychology*, 91, 155-188.
- Novick, L. R., & Bassok, M. (2005). Problem solving. In K. J. Holyoak & R. G. Morrison (Eds.), *Cambridge handbook of thinking and reasoning* (pp. 321-349). New York: Cambridge University Press.
- Novick, L.R., & Holyoak, K.J. (1991). Mathematical Problem-solving by Analogy. *Journal of Experimental Psychology: Learning, Memory, and Cognition*, 17(3): 398-415.

- Paivio, A. (1986). *Mental representation: A dual-coding approach*. Oxford, England: Oxford University Press.
- Paivio, A. & Clark, J.M. (1991). Dual coding theory and education. *Educational Psychology Review*, 3(3), 149-170.
- Pedone, R., Hummel, J.E., & Holyoak, K.J. (2001). The use of diagrams in analogical problem-solving. *Memory & Cognition*, 29(2), 214-221.
- Reed, S.K. (1987). A structure-mapping model for word problems. *Journal of Experimental Psychology: Learning, Memory, and Cognition*, 13, 124-139.
- Reed, S.K. (1999). *Word problems: Research and curriculum reform*. Mahwah, Lawrence: Erlbaum Associates.
- Reed, S.K., Ernst, G.W., & Banerji, R. (1974). The role of analogy in transfer between similar problem states. *Cognitive Psychology*, 6, 436-450.
- Reisberg, D. (1987). External Representation and the advantages of externalizing one's thoughts. *Proceedings of the Eighth Annual Conference of the Cognitive science society*. Hillside, NJ: Erlbaum.
- Renkl, A. (1997). Learning from worked-out examples: A study on individual differences. *Cognitive Science*, 21(1), 29.
- Renkl, A. (2002). Worked-out examples: Instructional explanations support learning by self-explanations. *Learning and Instruction*, 12(5), 529-556.
- Renkl, A. (2005). The worked-out examples principle in multimedia learning. In R. E. Mayer (Ed.), *The Cambridge handbook of multimedia learning* (pp. 229-246). New York: Cambridge University Press.
- Renkl, A., Stark, R., Gruber, H., & Mandl, H. (1998). Learning from worked-out examples: The effects of example variability and elicited self-explanations. *Contemporary Educational Psychology*, 23(1), 108.
- Robertson, S.I. (2001). *Problem-solving*: Psychology Press Ltd, Hove, East Sussex
- Ross, B.H. (1989). Distinguishing types of superficial similarities: Different effects on the access and use of earlier problems. *Journal of Experimental Psychology: Learning, Memory, and Cognition*, 15, 456-468.
- Ross, B.H., & Kilbane, M.C. (1997). Effects of principle explanation and superficial similarity on analogical mapping in problem-solving. *Journal of Experimental Psychology: Learning, Memory, and Cognition*, 23, 427-440.

- Roy, M., & Chi, M. T. H. (2005). The self-explanation principle in multimedia learning. In R. E. Mayer (Ed.), *Cambridge handbook of multimedia learning* (pp. 271–286). New York: Cambridge University Press.
- Sadoski, M., & Paivio, A. (2004). A dual coding theoretical model of reading. *Theoretical Models and Processes of Reading*, 5, 1329-1362.
- Short, E.J., Evans, S.W., Friebert, S.E., & Schatschneider, C.W. (1991). Thinking aloud during problem-solving: Facilitation effects. *Learning and Individual Differences*, 3(2), 109-122.
- Simon, H.A. & Hayes, J.R. (1976). The understanding process: Problem isomorphs. *Cognitive Psychology*, 8(2), 165-190.
- Spellman, B.A., & Holyoak, K.J. (1996). Pragmatics in analogical mapping. *Cognitive Psychology*, 31(3), 307-346.
- Stenning, K. & Oberlander, J. (1995). A cognitive theory of graphical and linguistic reasoning: logic and implementation. *Cognitive Science*, 19, 97–140.
- Sternberg, R.J. (1986). *Intelligence applied*. Orlando: Harcourt Brace Jovanovich Publishers.
- Sternberg, R.J. (1987). *Beyond IQ: A triarchic theory of human intelligence*. New York: Cambridge University Press.
- Sternberg, R.J. (1996). *Cognitive Psychology*. Fort Worth: Harcourt Brace College Publishers.
- Sternberg, R.J. (1997). *Successful intelligence*. New York: Plume.
- Sternberg, R.J. (2000). *Handbook of intelligence*. Cambridge University Press.
- Sternberg, R.J. (2003). *Cognitive Psychology* (3rd ed). Wadsworth: VickiKnight.
- Sternberg, R.J. & Davidson, J.E. (1999). Insight. In M. A. Runco and S.R. Pritzker (Eds.), *Encyclopedia of Creativity* (Vol. 2, 57- 69). San Deigo, Academic Press.
- Sternberg, R.J., Forsythe, G.B., Hedlund, J., Horvath, J., Snook, S., Williams, W. M., Wagner, R.K., & Grigorenko, E.L. (2000). In M.W. Eysenck (Ed.), *Practical Intelligence in Everyday Life*. New York: Addison Wesley Longman Inc.
- Sternberg, R.J. & Grigorenko, E.L. (2002). *Intelligence applied* (2nd ed). New York: Oxford University Press.
- Sternberg, R. J., Kaufman, J. C., & Grigorenko, E. L. (2008). *Applied intelligence: Cambridge University Press*.

- Sternberg, R.J. & Ketron, J.L. (1982). Selection and implementation of strategies in reasoning by analogy. *Journal of Educational Psychology*, 74(3), 399-413.
- Thagard, P., Holyoak, K.J., Nelson, G., & Gochfeld, D. (1990). Analog retrieval by constraint satisfaction. *Artificial Intelligence*, 46(3), 259-310.
- Tversky, B. (1999). What does drawing reveal about thinking. *Visual and Spatial Reasoning in Design*, 93-101.
- Tversky, B. (2002). What do sketches say about thinking? In T. Stahovic, J. Landay, and R. Davis (Eds.), *Proceedings of AAAI spring symposium on sketch understanding*. Menlo Park, CA: AAAI Press.
- Tversky, B. (2005). Functional significance of visuospatial representations. In P. Shah and A. Miyake (Eds.), *Handbook of Higher-level Visuospatial thinking* (Pp. 1-34). Cambridge: Cambridge University Press.
- Tversky, B., & Lee, P. U. (1999). Pictorial and verbal tools for conveying routes. *Spatial information theory: cognitive and computational foundations of geographic information science*, 51-64.
- VanLehn, K., & Jones, R. M. (1993). What mediates the self-explanation effect? Knowledge gaps, schemas or analogies? In M. Polson (Ed.), *Proceedings of the Fifteenth Annual Conference of the Cognitive Science Society*. Hillsdale, NJ: Lawrence Erlbaum Associates.
- Van Meter, P. (2001). Drawing construction as a strategy for learning from text. *Journal of Educational Psychology*, 93(1), 129-140.
- Van Meter, P., Aleksic, M., Schwartz, A., & Garner, J. (2006). Learner-generated drawing as a strategy for learning from content area text. *Contemporary Educational Psychology*, 31(2), 142-166.
- Van Someren, M. W., Barnard, Y. F., & Sandberg, J. A. C. (1994). *The think aloud method: A practical guide to modelling cognitive processes*: Citeseer.
- Vosniadou, S. & Ortony, A. (1989). *Similarity and analogical reasoning*. Cambridge University Press.
- Zhang, J. (1997). The nature of external representations in problem-solving. *Cognitive Science*, 21(2), 179-217.
- Zhang, J. (1998). A distributed representation approach to group problem-solving. *Journal of the American Society for Information Science*, 49(9), 801-809.
- Zhang, J. (2001). External representations in complex information processing tasks. *Encyclopedia of Library and Information Science*, 68(31), 164-180.

- Zhang, J., Johnson, T.R., & Wang, H. (1998). Isomorphic representations lead to the discovery of different forms of a common strategy with different degrees of generality. Paper presented at the Proceedings of the 20th Annual Conference of the Cognitive Science Society. Hillsdale
- Zhang, J., & Norman, D. A. (1994). Representations in distributed cognitive tasks. *Cognitive Science*, 18(1), 87-122.
- Zhang, J. & Patel, V.L. (2006). Distributed cognition, representation, and affordance. *Pragmatics & Cognition*, 14(2), 333-341.

APPENDIX

A. MATERIAL USED IN EXPERIMENTS 1

A.1 The “Elephant” Target Problem

Many years ago there lived in China a young man. Wishing to further his education, he went to a wise man in a remote land.

“Master,” he said, “if you will allow me to study with you for one year, I will give you, in payment, this elephant.” And he displayed to the wise man an elephant, strong and beautiful.

“How much does the elephant weigh, my son?” asked the wise man.

“I do not know, Master” the boy replied.

“Weigh the elephant. Come back tomorrow and we will begin to learn from each other.”

“So the boy left, running through the town, looking for a scale to weigh the elephant. The largest scale he could find, however, was only scaled to 200 pounds. The next morning the boy sat, despondent, under a big tree, on a rocky river bank. As he watched, a boat came into view; the old man was rowing toward him. The old man got out of the boat, went to the boy and sat down

“How much does your elephant weigh?”

“I cannot find a large scale, master.”

“It is not the elephant I am measuring, my son. It is the student's thinking. You have everything you need to weigh the elephant. When you have done so, you may join me.” And the old man stood up and moved up the path to his school, leaving the boy with the problem (Chen, 2002).

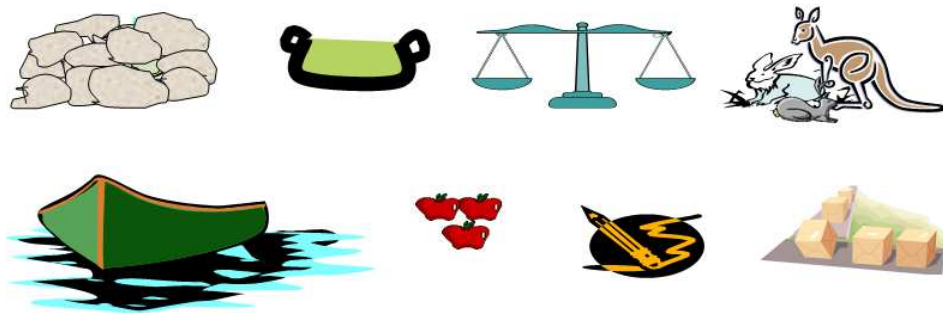

Figure A.1: Tools for the target elephant problem

The source problems for *The “Elephant”*

The source problem for “Weigh the Elephant” was presented in the pictorial schematic models for each of the three levels of similarity: principle, strategy, and procedure.

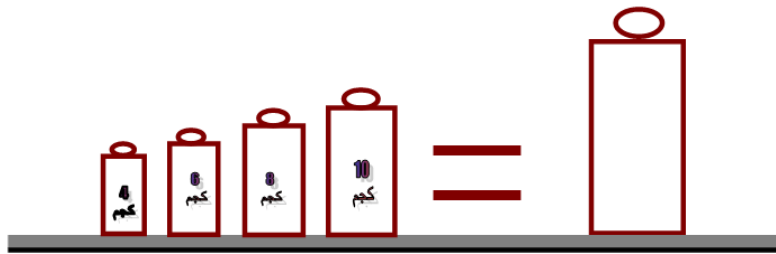

Figure A.2: Principle level of similarity

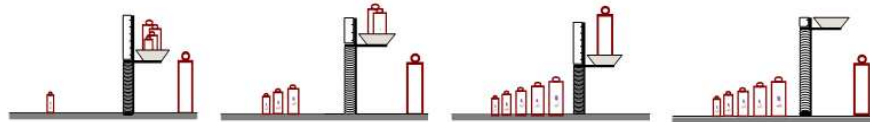

Figure A.3: Strategy level of similarity



Figure A.4: Procedural level of similarity

A.2 The “Salt” Target Problem

A cook needs 1 gram of salt to season a special meat he is cooking. When he opens the drawer to get a measuring spoon, he finds out that he has only an 11 gram measuring spoon and a 4-gram measuring spoon. How can the cook measure out exactly 1 gram of salt?

The source problems for the "weighing the elephant" was presented in the pictorial schematic models for each of the three levels of similarity Principle, Strategy, and Procedure.



Figure A.5: Tools for the target salt problem

The source problems for The “Salt”

The source problems for the Salt were presented in the pictorial schematic models for each of the three levels of similarity: Principle only, Strategy, and Procedure.

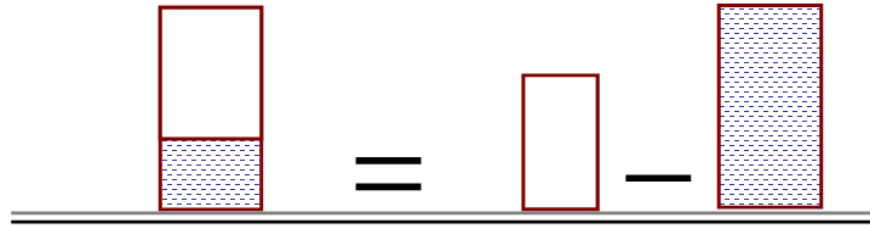

Figure A.6: Principle level of similarity

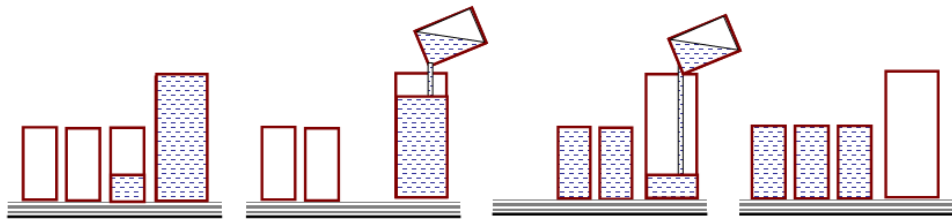

Figure A.7: Strategy level of similarity

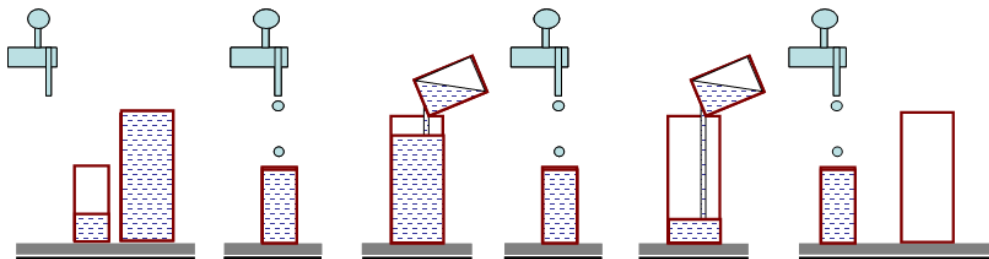

Figure A.8: Procedure level of similarity

B. THE CODING OF VERBAL PROTOCOL FOR PICTORIAL REPRESENTATION

The methodology of constructing the coding scheme is more of a challenging task in the pictorial representation (PR) compared to the verbal representation (VR). This is mainly due to the fact that in the VR there is a great deal of consistency in understanding the problems among the participants whereas in the PR, each participant may have his/her own interpretation of the problem(s). This is perhaps why many reliable coding schemes have been developed and used in VR over the last two decades (e.g. Chi, Bassok et al. (1989); Renkl (1997); Ainsworth and Loizou (2003)). One of the main aims of Experiment 1 is to develop a systematic coding methodology for PR. A pilot study of six (6) participants was conducted with the objective of gathering information about the type of PR protocols generated during analogical problem-solving. The coding process involves two main stages: categorization and segmentation. Determining the type of cognitive processes generated (eg. Explanation, Inference) while solving the problem is referred to as categorization while the process of segmentation involves dividing these protocols into measurable units (eg. This is a glass, and this is a large container, this is a tap of water, dripping water). This two-stage approach is described below.

Categorization of the Protocols

The categorization process was developed based on analogical problem solving theories such as: Componential Sub-theory (Sternberg, 1987, 2000), Structure-Mapping theory (Gentner, 1983), Pragmatic and Multi-constraint theories (Gick & Holyoak, 1980, 1983), and the models of Chi et al. (1989) and

Renkl (1997). The objective was to determine the type of cognitive processes and sub-processes involved in analogical problem-solving. The researcher analyzed the protocols, and initially Model 1 (Figure B.1) was constructed to depict the categories of cognitive processes, which may be classified as follows:

Selectivity: This processes helps distinguish between effective sub-processes that lead to correct solutions and ineffective sub-processes that lead to wrong solutions. In the case of the Elephant problem, the participant must encode or identify the defining attributes of each term in the analogy just as A: B:: C: D (or, large container: small container:: elephant: stone).

Inference: This category has been used in order to distinguish the solvers (who infer the steps for problem-solving) from non-solvers who did not notice the structural similarity between the two situations. Inferring correctly means seeing the relationship between the first and the second terms in the analogy (A: B) or between the objects (large container: small containers) in the source of the Elephant problem used in this study.

Mapping: Mapping refers to identifying the corresponding elements between the source and target problems and applying the structural concept from the source to the target. In this experiment, the relationship between the source (large container) and the target (elephant) must be mapped in the elephant problem.

Transfer: This process involves applying the relationship observed between A: B (large container: small container) to C: D (Elephant: stone).

Goal Directness: When participants see or discover the goal in the source or the target problems, this affects information gathering to reach an effective solution of the problem.

Mathematical Strategy: This process indicates whether the participant is able to use and understand mathematical relationships between sizes of objects and quantity of substances.

Justification: In this process, participants provide reasons for choosing from various options, elements, or processes that help solve the problem.

Meta-strategy: A reference is made to a plan or strategy for solving the problem.

Monitoring: Monitoring expressions are of two types (positive or negative) and emerge from a participant's perception of his/her ability to solve the problem.

Paraphrases: These are comments that either re-state what is said in the text, or verbalize what is shown pictorially.

Obstacles: These are comments that relate to perceived constraints in problem-solving.

Other expressions: refers to responses that do not fit into the coding scheme.

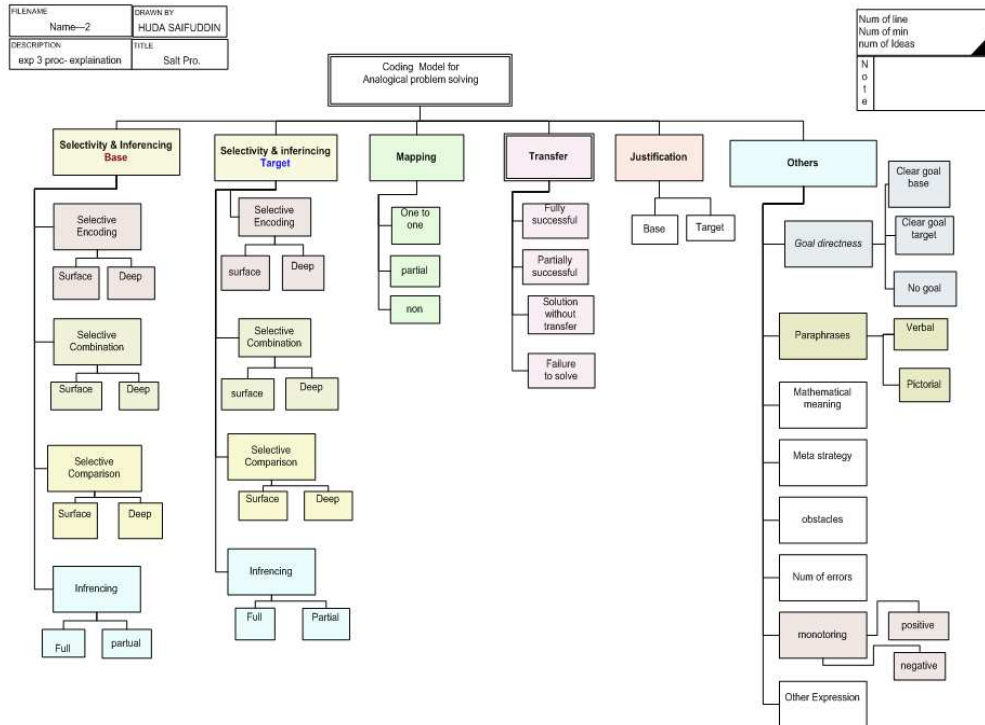

Figure B.1 Model 1: The initial Categorization model for analyzing the verbal protocols

The initial categorization model (Figure B.1) was evaluated by two independent coders. They received model B1, the cognitive processes categories proposed by researcher, and a copy of the six-participant booklet. The coders made the following suggestions:

- Redundant and un-necessary processes should be eliminated, by combining the processes of selectivity and inference for both source and target problems in one main process called explanation (encoding, combination/comparison, relations and noticing coherence).
- The processes of goal directness and monitoring should be considered as main processes.
- The sub-processes of mapping, transfer, and justification may main processes.

According to these suggestions, model B-2 was constructed and presented to the coders for further suggestions.

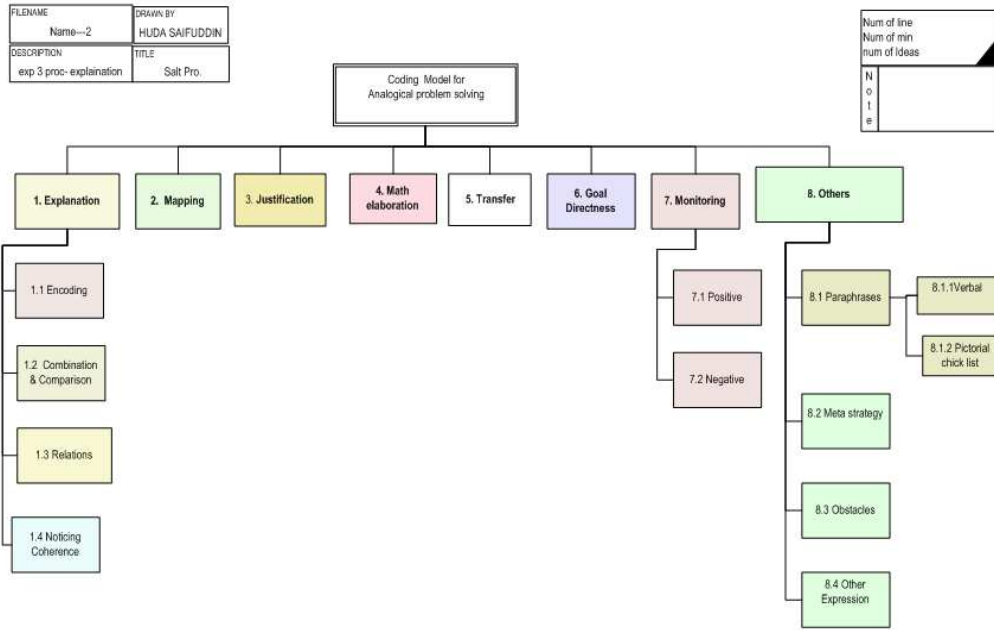

Figure B.2 Model 2: The first stage of modification for the Categorization model

Per the coders suggestions, a second main modification was presented by combining the processes of mapping, justification, math elaboration, and transfer to be sub-processes of the “processes during problem solving”, resulting in model (Figure B.3). The model was further modified, for the third time, by the coders, requesting more elaboration on the sub-processes. These modifications were implemented in model 4, shown in Figure B.4. At this stage, the coders applied the coding scheme on the participants’ transcripts, resulting in more modification for the fourth time.

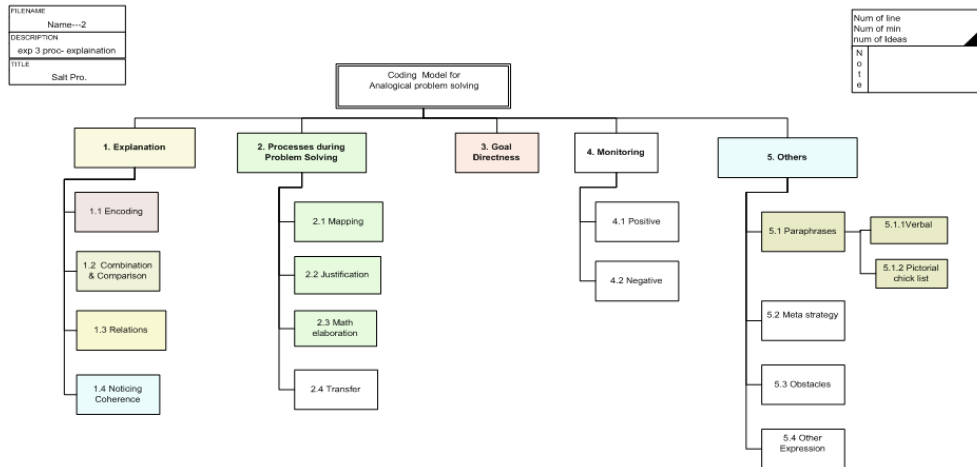

Figure B.3 Model 3: The second stage of modification for the Categorization model

After continued discussions with coders, the researcher finalized the categorization of explanation, inference, and analogizing; where the former two processes applied for source and target problems while the later process applied for the target problem only. When constructing the scoring sheet (Table B.2) according to The Cognitive Process Model (CPM) (Figure B.5), differences between correct and incorrect actions were taken into account, e.g. correct encoding and wrong encoding also.

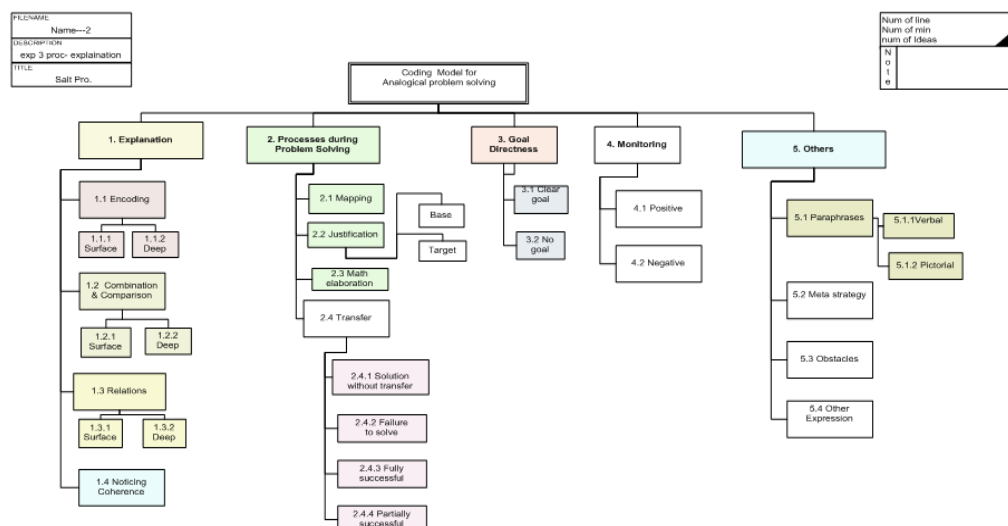

Figure B.4 Model 4: The third stage of modification for the Categorization model

The Cognitive Processes Model (CPM)

Three top-level content categories were identified: Explanation, Inference, and Analogizing. While the solution of the source problems only required the cognitive processes of Explanation and Inference, the target problem involved all the three content categories. Broadly, Explanation and Inference are regarded as the processes of understanding the problem from different aspects. Analogizing is the important process of deriving the analogy between the source and target problems for achieving the right solution. Other processes, such as Monitoring and Paraphrasing, involved in both the source and target problems are also included.

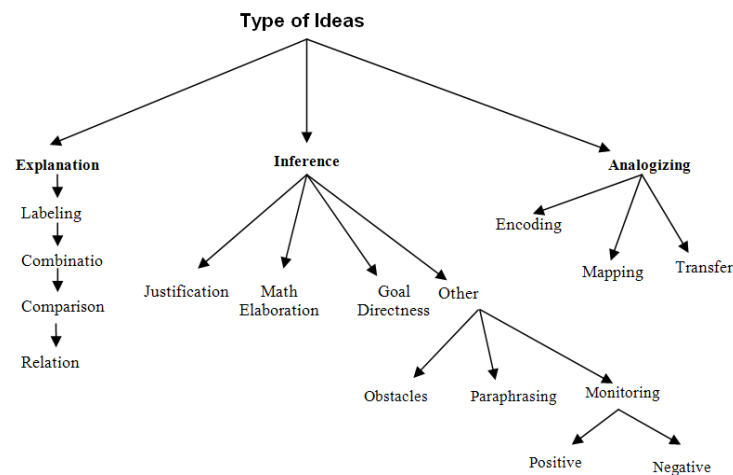

Figure B.5: The Cognitive Processes Model (CPM).

Note: the categorization and its reliability was discussed in Chapter 4.

An example of the coding:

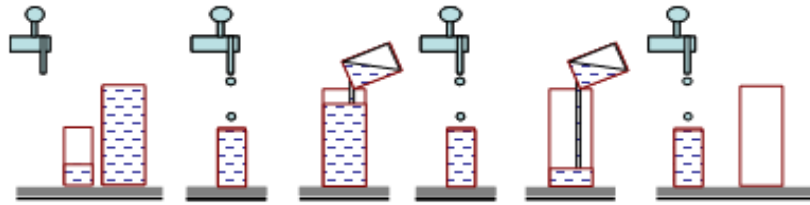

Figure B.6: Procedural level of similarity

The protocol:

1. This is a water tap (combination)
2. dripping water (combination)
3. and filling the glass (combination)
4. the first picture like (other)
5. the glass is filling (comparison)
- 6 in the second one (other)
7. two glasses (combination)
8. the third one (other)
9. is almost the same as the first picture (comparison)
10. the water is dripping to fill the glass (combination)
11. In the fourth picture (other)
12. The glass is filled more (comparison)
13. now
14. the container is full (comparison)
15. and the glass is half full (Relation)

Target Problem (Salt problem);

The Protocol:

1. We have several things here (labeling)
2. container or jar (labeling)
3. the salt container (labeling)
4. but we don't know the quantity that possibly contains (constrain)
5. the chef (labeling)
6. the piece of steak (labeling)
7. A collection of containers (combination)
8. whose capacity we don't know (constrain)
9. two spoons (combination)
10. without any guessing (constrain)
11. the first 11 gram spoon (labeling)
12. and the second 4 gram spoon (comparison)
13. we can possibly use the 4 gram spoon (mapping)
14. but, here there is a big part of guessing (mapping)
15. how are we going to solve this problem (constrain)
16. It might be the chef (error/ constrain)
17. I think the chef (error/ wrong mapping)
18. He is like the wise man who has the experience (wrong encoding)
19. we will choose the chef (wrong encoding)
20. Maybe
21. the chef will be able to solve this problem (wrong encoding)
22. the chef obviously
23. has all the tools (wrong encoding)

24. the chef will solve the problem (no transfer)

Table B.1:

The Code Definitions

1. Labeling	Names the objects and understands the symbols in the problem	The large object is identified as a container, a measurement, a bottle or a jar
2. Combination	Combines and compares the encoded information in the picture.	The large object is bigger than any two small objects.
3. Comparison	Combines and compares the encoded information in the picture.	The large object is bigger than any two small objects.
4. Relations	Understanding the meaning of the process depicted in the picture.	The large container equals the four small ones / the two sides are equal.
5. Mathematical Elaboration	Uses or understands relations between quantity of substances and sizes of objects.	$10 + 8 + 6 + 4 = 28$ $20 + 8 = 28$ Or the large one equals 4 small ones.
6. Justification	Clearly gives reasons for choosing from various options that which help solve the problem.	<i>"The marker is high because the tray is empty".</i>
7. Goal Directedness	States that the goal of the problem.	is to find out the weight of the large object.
8. Encoding	Names the objects and understands the symbols in the problem and retrieve the similar information	The elephant is the same as the big object
9. Mapping	Identifies the corresponding components in the source and target problems.	The large object = the elephant. The tray = the boat the small items = the rocks
10. Transfer	Applies what he/she has learnt, from the source to the target problem, to get a correct or partially correct solution.	The elephant is equal to a sum of small objects.
11. Others	Obstacles sentences	

Note: The code categories are: Labeling, Combination, Comparison, Relations, Justification, Mathematical elaboration, Goal Directedness, Encoding, Mapping, Transfer Others (Obstacles, Monitoring, Paraphrasing,).

C. MATERIALS USED IN EXPERIMENT 2& 3

1. Almond Problem (Target)

During the holy month of Ramadan the rate of dry fruits like dates, almonds, pistachios and raisins goes up sharply. Therefore a few families get together and buy a box at the whole sale rate rather than buy a kilo or two individually which costs them more. Suppose your mother along with your two aunts decided to buy a box of almonds weighing 39 kilograms, which is to be equally divided among the three. You were asked to weigh out 13 kg of Almonds for each of them. However, when you went into the kitchen you found that there are only three weights 12 kg., 9 kg., and 5 kg. How will you weigh 13 kg of almonds exactly without guessing and using only these three weights keeping in mind that the balance (weighing instrument) will not hold more than 20 kg. at one time.

Source Problems (Verbal Representation):

(a) Art 1 Problem – Strategy level-

For the art gallery, Jumana was asked to make a large poster 120cm x150 cm. She was given a gallon of 24 cups of paint. She needed to mix 15 cups of green paint for this poster but she did not have the exact measure. However, she had three containers that will hold 2, 7 and 6 cups, respectively. After some thought she decided to use the containers available. She filled the three containers with the paint from the gallon and got the amount required.

(b) Art 2 Problem - Procedural level -

For the art gallery, Jumana was asked to make a poster. She was given a 42 gram of paint. She needed to mix 16 grams of green paint for this poster but she did not have the exact measure. However, she had three different measures that will hold 3, 9 and 14grams, respectively. After some thought she decided to use the measures available. She weighed out 3, 9 and 14 grams from the paint given to her. The remaining was the amount required.

Source Problems (Pictorial Representation):

(c) Jug 1 Problem: Strategy level
Procedural level

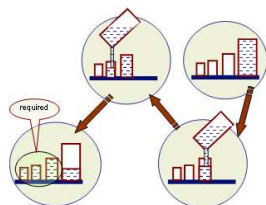

(d) Jug2 Problem:

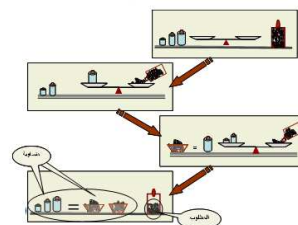

2. Lab Problem (Target)

Lujain is a laboratory assistant. A box of jars containing sodium chloride was delivered to the lab. All the jars contained an equal quantity of sodium chloride. She took out 11 jars from the box for an experiment, placed them on the table and left the lab. For a short while, to freshen up. During her absence from the lab, Jana one of her colleagues brought a similar jar that contained slightly more quantity of sodium chloride, and left it on the table along with the other jars. When Lujain came back, she was surprised to see that there is an extra jar but did not know which one. The balance in the lab will not hold more than four jars on each side, and cannot be used more than three times. How will she figure out which jar is the odd one out.

Source Problems (Verbal Representation):

(a) Ball 1 Problem – Strategy level-

There are twelve identical balls, but one is lighter than the others. There is a compression weighing machine or balance, which can be used. To begin with, I will weigh 4 balls and record their weights, then I will weigh the second 4 balls, record their weights again. If the weights are the same, then this means the odd one is in the remaining four. Then I can use the balance to weigh two balls, if their weight is more than half of the four balls, then the odd one is among them, otherwise the odd one in the last two, which can be compared.

(a) Ball 2 Problem – Procedural level-

There are twelve identical balls, but one is heavier than the other eleven. There is a weighing machine or balance which can be used. To begin with, I will weigh 4 balls on each side of the balance. If they are the same, then this means the odd one is in the next block of four. Then you can use the balance a second time by weighing two on each side. If the balance tilts on one side you know that the higher side of the balance is lighter; because one of the balls is lighter. You use the balance a third time; to determine which of the two is heavier.

Source Problems (Pictorial Representation):

(c) Bar 1 – Strategy level

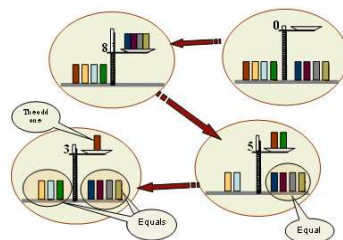

(d) Bar 2 - Procedural level

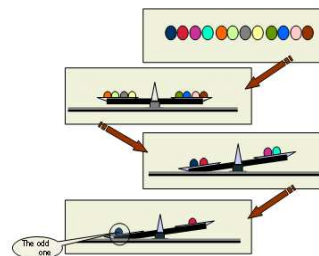

D. TASK ANALYSIS FOR EXPERIMENTS 2 & 3

Appendix D presents the task analysis for the source and target problems presented in Appendix C that were applied in Experiments 2 and 3.

Task Analysis for the Almond Problem (Target)

During the holy month of Ramadan, the rate of dry fruits like dates, almonds, pistachios and raisins goes up sharply. Therefore a few families get together and buy a box at the whole sale rate, rather than buy a kilo or two individually, which costs them more. Suppose your mother along with your two aunts decided to buy a box of almonds weighing 39 kilograms, which is to be equally divided among the three. You were asked to weigh out 13 kg of Almonds for each of them. However, when you went into the kitchen, you found that there are only three weights 12 kg., 9 kg., and 5 kg. How will you weigh 13 kg of almonds exactly, without guessing and using only these three weights, keeping in mind that the balance (weighing instrument) will not hold more than 20 kg. at one time.

- Initial State: A box of almonds weighing 39 kg
- Goal State: Required amount 13 kg of almonds.
- Resources: 2, 9 and 5 kg weights and a balance scale.
- Constraints: No guessing, the balance will hold only 20kg at a time.
- Solution steps:
 - Firstly weigh out 9+5 kg of the almonds from 39 kg
 - Then weigh out 12kg
- Outcome: The amount remaining is 13 kg.

Source problem: Art 1 problem, Strategy level, Text format for Target Almond problem. The Art gallery problem gives a strategy only, and not the exact procedure to solve the target problem of weighing out a specific amount of almonds. The strategy, illustrated below, describes how to fill the different containers and add them up to get the required amount. The problem for the art gallery is stated below:

Jumana was asked to make a large poster 120cm x150 cm. She was given a gallon of 24 cups of paint. She needed to mix 15 cups of green paint for this poster, but she did not have the exact measure. However, she had three containers that will hold 2, 7 and 6 cups, respectively. After some thought, she decided to use the containers available. She filled the three containers with the paint from the gallon and got the amount required.

Task Analysis:

- Initial state: 24 cups of paint (A).
- Goal State: 15 cups of paint.
- Resources: Three measures of different sizes 2, 7, and 6 cups (B, C, D).
- Constraints: No exact measure of 15 cups.
- Solution steps: $B+C+D$.
- Outcome: 15 the required amount.

Source problem: Jug 1 problem, Strategy level, Pictorial format for Target Almond problem

Task analysis:

- Initial state: A large jug full of water and three empty glasses.
- Goal State: The water in the three small glasses is the amount required.
- Resources: Four jugs of different sizes and water.
- Constraints: No exact measure for knowing the volume of water needed, and also there are no measuring marks on any of the containers.
- Solution Steps: Empty the water from the large jug into the three small glasses.
- Outcome: is the total amount of the water in the three glasses. Figures (D.1 & D.2).

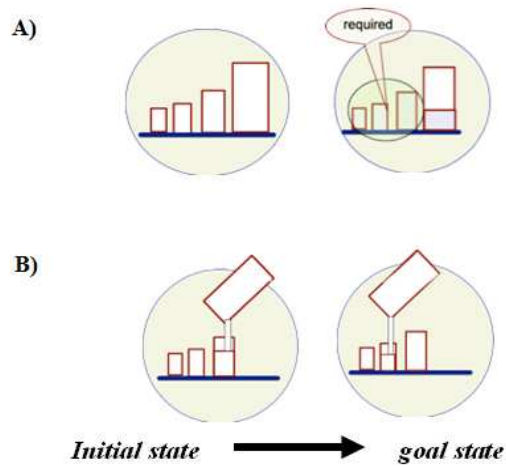

FIGURE D.1: A) Jug 1 Problem. B) Solution steps.

Source problem: Art 2 problem, Procedural level, Verbal form for Target Almond problem

This problem, at the procedural level of similarity, describes not only a strategy, but also shares complete procedural details with the target problem. The problem for the art gallery is stated below:

Jumana was asked to make a poster. She was given a 42 gram of paint. She needed to mix 16 grams of green paint for this poster, but she did not have the exact measure. However, she had three different measures that will hold 3, 9 and 14grams, respectively. After some thought, she decided to use the measures available, she weighed out 3, 9 and 14 grams from the paint given to her. The remaining was the amount required.

Task Analysis:

- Initial state: 42 grams of paint (A).
- Goal State: 16 cups of paint.
- Resources: Three measures of different sizes 3, 9 and 14 grams (B, C, D).
- Constraints: No exact measure of 16 grams.
- Solution steps: $A - (B + C + D)$.
- Outcome: 16 grams is the required amount.

Source problem: Jug 2 problem, Procedural level, Pictorial form for Target Almond problem (Figure D.3).

Task Analysis:

- Initial State: A seesaw balance with three weights of different sizes and a jar of seeds.
- Goal State: A required amount.
- Resources: Three weights of different sizes.
- Constraints: No exact measure and also the balance will not hold all the weights at one time.

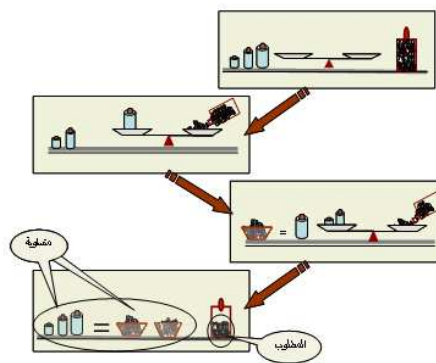

Figure D.3: The pictorial source problem in the procedural level of similarity

Solution Steps:

- First, put the large weight on one tray of the balance, and on the other, put the seeds equal to the weight.
- Remove the weight and the seeds, and then put it aside.
- Then, put the two smaller weights on the balance, and measure out seeds once again.

Outcome: the required amount is the seeds remaining in the jar (Figure D.4)

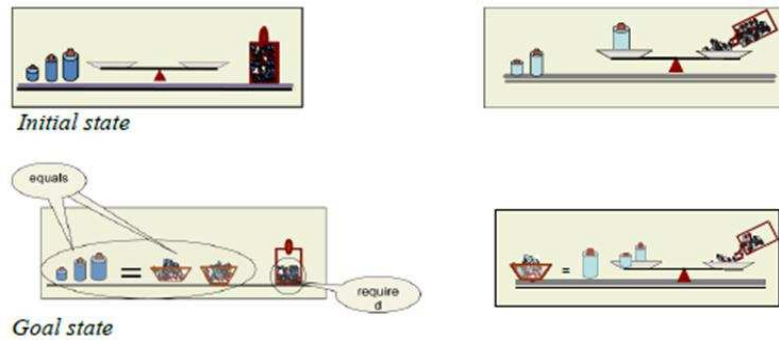

Figure D.4: Solution steps.

Task Analysis for The Lab Problem (Target)

Lujain is a laboratory assistant. A box of jars containing sodium chloride was delivered to the lab. All the jars contained an equal quantity of sodium chloride. She took out 11 jars from the box for an experiment, placed them on the table and left the lab. For a short while, to freshen up. During her absence from the lab, Jana one of her colleagues brought a similar jar that contained slightly more quantity of sodium chloride, and left it on the table along with the other jars. When Lujain came back, she was surprised to see that there is an extra jar but did not know which one. The balance in the lab will not hold more than four jars on each side, and cannot be used more than three times. How will she figure out which jar is the odd one out.

Task Analysis:

- Initial State: Eleven similar looking jars of sodium chloride of equal quantity.
- Goal State: Identify the odd jar weighing more than the rest.
- Resources: A balance.
- Constraints: the balance will not hold more than 4 jars on each side and also cannot be used more than three times.
- Solution Steps:
 - First, put four jars on each side of the balance if they are equal, then the odd one is in the third group of four, or if one side of the balance tilts to the lower side, then the odd jar is in that group.
 - Second, from the heavy group of four, put two on each side and determine which side of the balance goes down.

- Lastly, take the two that are on the heavy side, and put them on each side of the balance
- Outcome: the side of the balance that goes down has the odd jar

Source problem: Ball 1 problem, Strategy level, Verbal format for Target

Lab problem

There are twelve identical balls, but one is lighter than the others. There is a compression weighing machine or balance, which can be used. To begin with, I will weigh 4 balls and record their weights, then I will weigh the second 4 balls, record their weights again. If the weights are the same, then this means the odd one is in the remaining four. Then I can use the balance to weigh two balls, if their weight is more than half of the four balls, then the odd one is among them, otherwise the odd one in the last two which can be compared.

Task Analysis:

- Initial State: Twelve identical balls.
- Goal State: Identify the odd ball weighing lighter than the rest.
- Resources: A balance.
- Constraints: No weights are available and no guessing.
- Solution Steps:
 - First, put four balls on each side of the balance if they are equal, then the odd one is in the third group of four or if one side of the balance tilts to the higher side, then the odd jar is in that group.
 - Second, from the lighter group of four put two on each side, and see which side of the balance goes up
 - Lastly, take the two that are on the upper side of the balance, and put them on each side of the balance
- Outcome: the side of the balance that goes up, has the odd ball.

Source problem: Bar 1 problem, Strategy level, and Pictorial format for

Target Lab problem.

Task Analysis:

- Initial State: Eight identical bars.
- Goal State: Identify the odd bar.
- Resources: A balance.
- Constraints: No weights are available and no guessing.
- Solution Steps:
 - First, put four bars on the balance and note their weight.
 - Then, put the next four bars.
 - Choose two bars from the heavier four bars.
 - If their weight is equal to the half of the weight of the first group, then weigh one bar from the other two bars individually.
 - Select the odd bar.

Outcome: When a set of two bars is not equal to other set of two bars, then one of the two is the odd one (Figure D.5)

Source problem: Bar 1 problem, Strategy level, and Pictorial format for Target Lab problem.

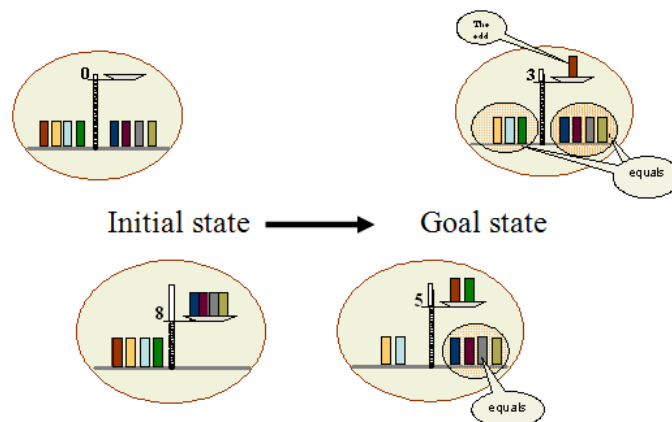

Figure D.5: Solution steps.

Source Ball 2 problem - procedural level - verbal form for Target Lab problem

There are twelve identical balls, but one is heavier than the other eleven. There is a weighing machine or balance which can be used. To begin with, I will weigh 4 balls on each side of the balance. If they are the same, then this means the odd one is in the next block of four. Then you can use the balance a second time by weighing two on each side. If the balance tilts on one side you know that the higher side of the balance is lighter; because one of the balls is lighter. You use the balance a third time; to determine which of the two is heavier.

Task Analysis:

- Initial State: Twelve identical balls.
- Goal State: Identify the heavier odd ball.
- Resources: A balance.
- Constraints: No weights are available and no guessing.
- Solution Steps:
 - First, put four balls on each side of the balance if they are equal, then the odd one is in the other group of four or if one side of the balance tilts to the lower side, then the odd ball is in that group.
 - Second, from the heavier group of four put two on each side, and see which side of the balance goes up.
 - Lastly, take the two that are on the lower side of the balance, and put them on each side of the balance.
- Outcome: the side of the balance that goes down has the odd ball.

Source problem: Bar 2 problem, Procedural level, Pictorial form for Target Lab problem

Task Analysis:

- Initial State: Twelve identical bars
- Goal State: Identify the odd bar weighing more than the rest.
- Resources: A balance.

- Constraints: No weights are available and no guessing.

Solution Steps:

- First, put four bars on each side of the balance if they are equal, then the odd one is in the other group of four or if one side of the balance tilts to the lower side, then the odd bar is in that group.
- Second, from the heavier group of four put two on each side and see which side of the balance goes up
- Lastly, take the two that are on the lower side of the balance and put them on each side of the balance
- Outcome: the side of the balance that goes down has the odd bar (Figure D.6).

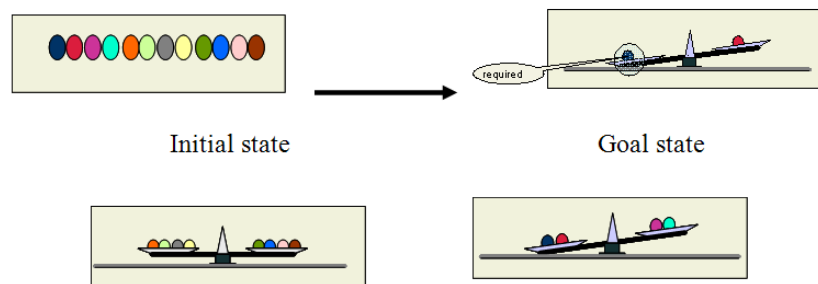

Figure D.6: Solution steps

The researcher determined the reliability and validity of the materials, by finding the extent to which the problems chosen, were suitable in terms of difficulty, information, meaning, and clarity, as well as whether they depict the level of similarity (strategy and procedure) that they are meant to. Two judges were chosen from the Department of Psychology and the Faculty of Science. Each judge was given two versions (verbal and pictorial) of a problem, along with its target problem in both the strategy and the procedural levels of similarity. The judges evaluated the suitability of each problem, in terms of level of similarity, after solving them.

To assess the informational/computational equivalence and the degree of agreement on the verbal and pictorial formats of the problems, the same judges were required to list the information given, and describe the process depicted in both the verbal and pictorial versions of the source problem. This was achieved by asking these judges to first analyze the source problem along with its target, and second to compare the information given through the verbal and pictorial versions of a source problem in the same level of similarity. The judges were given the following instructions both verbally and in writing format:

In this booklet, there are three problems. Each problem is represented in two ways, pictorial and verbal. First, please list out the information that each problem gives, along with the steps needed to solve the target problem. Second, please answer the questions related to the problems.

In order to evaluate the suitability of the problems, the judges were required to answer and discuss some questions with the experimenter after solving the problems. The following questions are an example:

- Are the Art 1 and Jug 1 problems structurally the same?
- Did they help solve the Almond problem?
- How suitable to participants is the level of difficulty of the Almond problem on a scale of 1 to 10?
- What changes do you recommend in each problem with regard to the following?
 - Clarity of pictures.
 - The level of similarity depicted.
 - Meaning of words.
 - Need for more information.

Evaluation of the suitability of the problems

The judges evaluated the problems at the strategy and procedural levels, in both verbal and pictorial formats, in two phases. In the first phase, they rated

the problems in terms of their suitability for undergraduates (level of difficulty) as well as whether the source problem adequately conveyed the level of similarity (strategy or procedure), that it was meant to reveal. The judges accepted the two targets, the Lab and the Almond problems, with their corresponding source problems. These chosen source problems were modified, according to the recommendations of the judges. For example, in the pictorial representation, the problem illustrated below in Figure D.7, was designed to depict a strategy level of similarity with its target Lab problem. The judges pointed out that it was conveying more a procedure for the target problem of the Lab, rather than only giving a strategy of how to solve it. This was modified as shown in Figure D.8. The important change in the second illustration Figure D.8, was using a different method as well as objects (bars) for weighing, thus giving only a strategy for solving the Lab target problem.

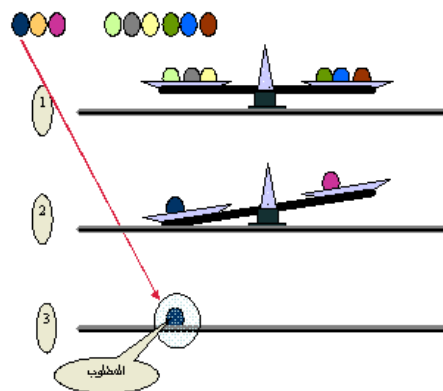

Figure D.7: The initial version strategy pictorial form.

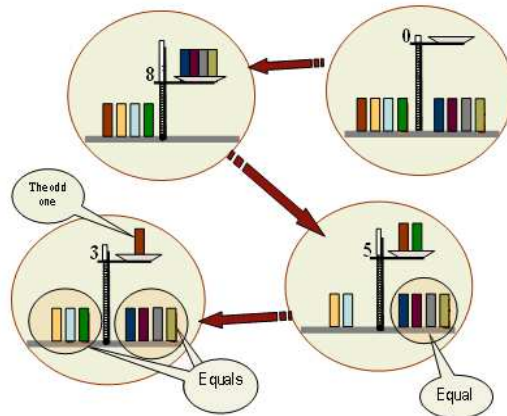

Figure D.8: The modified version strategy pictorial form.

Relevant changes were also made in the verbal format of the problem. Second, the source problem of the Jug (Figure D.9) was presented as conveying a procedure for the Almond problem. One of the judges observed that in order to convey a procedure, the picture in the source model, should show the use of a balance for weighing objects, rather than containers for measuring substances. Thus, the problem was modified to give the exact procedure as shown in Figure D.10; to solve the Almond problem. The details of evaluation after modifications are given in Table D.1.

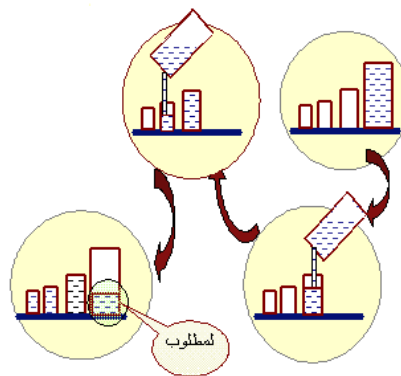

Figure D.9: Procedure pictorial form.

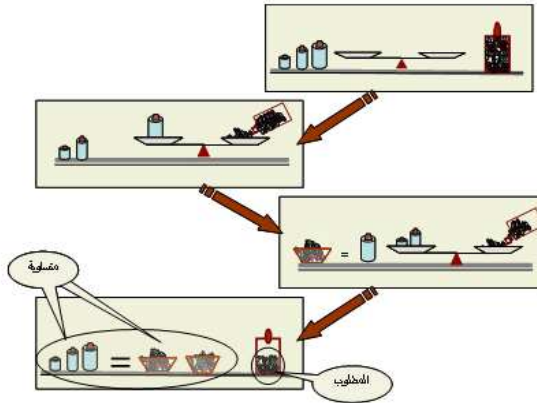

Figure D.10: The modified version Procedure pictorial.

Table D.1

Problem Evaluation according to Judges after Modification of the Source and Target Problems

Target Problem	Verbal Source	Pictorial source	Level of similarity was given	clarity of Pictures		Structural level of similarity Depicted		Informational Equivalent		level of difficulty for the target	
				J1	J2	J1	J2	J1	J2	J1	J2
Almond	Art-1	Jug 1	Strategy	Clear	o.k.	Strategy	Strategy	The same	The same	4	5
Almond	Art-2	Jug 2	Procedure	Clear	Clear	Procedure	Procedure	The same	The same	5	4
Lab	Ball-1	Bar-1	Strategy	o.k.	o.k.	Strategy	Strategy	The same	The same	4	4
Lab	Ball-2	Bar-2	Procedure	Clear	Clear	Procedure	Procedure	The same	The same	4	3

In the second step, the modified versions of the problems in the verbal and pictorial format were given to the same judges to evaluate the effectiveness of the problems after the changes, and to compare them for informational and computational equivalence. The results in Table D.2 show the degree of agreement between judges on the problems according to form of representation. All the verbatim responses of the judges are produced here (in Appendix D).

Table D.2

Judges' Agreement on Evaluation of the Source and their Target Problems

				Agreement %		Agreement %	Agreement %
Source problems	Type	level	Kind	Between coders		Between researcher and coder1	Between researcher and coder1
Jug (1) -	source 1	strategy	PS* Pictorial	8/8	100.00	8/10	80.00
Art gallery 1	Source 1	strategy	VS** Verbal	7/8	87.50	7/8	87.50
Jug (2)	source 1	Procedure	Pictorial	9/10	90.00	9/9	100.00
Art gallery 2	source 1	Procedure	Verbal	9/10	90.00	9/10	90.00
Target Almond problem				100			
Source problems	Type	level	Kind	Agreement %			
Bar problem 1	source 2	strategy	Pictorial	8/10	80.00	9/10	90
Ball problem 1	source 2	strategy	Verbal	11/14	78.57	11/13	85.00
Bar problem 2	source 2	Procedure	Pictorial	14/16	87.5	14/15	93.00
Ball problem 2	source 2	Procedure	Verbal	11/13	84.62	11/11	100
Target Lab problem				100			

*PS pictorial source **VS verbal source

An example of the information that judges extracted from the Jug source problem (Strategy level & Pictorial source PS):

Judge 1:

- The first picture: a container full of water or liquid.
- There are also 3 different size containers.
- In the second picture: We fill one of the three containers.
- And we fill the second and third containers in the last picture.
- The last picture shows that the three small containers are filled.
- And there is some amount remaining.
- The amount required is in the three containers.

Judge 2:

- There are 4 containers of different sizes.
- The largest one is full with liquid.
- The next picture shows that one of small containers is being filled from the large one.
- And the third picture shows that the container is full.
- And the second one is almost full as well.
- And the last picture it shows that the 3 small containers are full.
- And there is some remaining in the large container.
- The required amount is the sum of the 3 containers.

Agreement between the two judges' ideas was 100%.

Art 1 problem (Strategy level & Verbal source VS)

Jumana was asked to make a large poster 120cm x150 cm. She was given a gallon of 24 cups of paint. She needed to mix 15 cups of green paint for this poster, but she did not have the exact measure. However, she had three containers that will hold 2, 7, and 6 cups, respectively. After some thought, she decided to use the containers available. She filled the three containers with paint from the gallon, and got the amount required.

Please list all the information from this problem:

Judge 1:

Some paint is required to do a poster 120cm x 150cm for the art gallery.

- Jumana had a gallon ,which has 24 cups of paint.
- And she needed 15 cups.
- *She didn't have the exact measure.*
- She had 3 containers 2, 7 & 6 cups.
- She thought that she can use the 3 containers.
- Where the sum of them is equal to 15.
- And get the required amount.

Judge 2:

Jumana had to make a large poster for the art gallery.

- Jumana needed 15 cups of green paint.
- She had 24 cups of paint.
- She had 3 measuring cups 2, 6 & 7.
- She filled the 3 containers.
- That equals to 15 cups.
- And she got the required amount, which is 15 cups.

Agreement between the two judges' ideas was 87.5%.

The Almonds Problem Target problem:-

The Art 2 source problem – procedural level – verbal representation
Please list all the information in this story:

Judge 1

- Jumana has 42 cups of paint
- She needs 16 cups of the paint
- to make a large poster for the art gallery 120cm x 150cm

- she did not have the exact measure
- there are 3 different containers 14, 9 & 3 cups
- She can get the 16 cups by filling the 3 containers which equals to 26 cups
- And the remaining is the required amount
- Which is 16 cups

Judge 2:

- Jumana wanted to do a large poster to the art gallery
- The size of the poster 120x150 cm
- She needs 16 cups of the green color
- There isn't a measuring cup for 16
- She found different measure 14, 9 and 3
- Jumana had 42 gallon of the green color.
- She used the 3 containers
- To find 16 cups of the green color she filled up the 14 measuring cup
- And also filled the 9 and the 3
- And the remaining is the 16 cups is the required amount.

Agreement = $9/10 \times 100 = 90\%$

The Jug2 (Seesaw) Source problem – Procedural level – pictorial representation.
Please list all the information from these pictures

Judge 1

- There are 3 different weights and a balance of 2 trays
- There is a jar filled with something
- We put the large weight in one tray
- And we put some of the things in the other tray, until they are balanced
- We remove the large scale and empty the tray in a bowl
- These amount equal to the large weight
- Then we put the 2 small weights
- and empty some of the things from the jar until they are balanced
- And empty the tray in another bowl
- The last pictures shows that the 3 weights equal to the amount in the two bowls
- And the remaining in the jar is the required amount.

Judge 2:

- This is a balance
- with three different Weights
- We need to measure candy
- from the large jar
- We put the large Weight and get the exact measure for that
- Then remove this amount of candy in a large bowl
- We put the two remaining weights
- and measure some more from the jar
- O.K the remaining amount is the required amount

Agreement = $9/10 \times 100 = 90\%$

The Lab Problem: The Bar1 source problem—strategy level – pictorial representation

Please list all the information from these pictures

Judge 1

- In the first picture the scale is on zero
- And the second picture 4 rectangular are equal to 8
- And the third picture 2 rectangular from the other side equals 5
- And also the 4 rectangular which is equals to 8 are equals
- Each one is equal to 2
- And the last picture the red one is equal to 3
- And the other 7 are equal
- Each rectangular equal to 2.

Judge 2:

- These is a rectangular shape, like cylinders with different color
- And there is compression balance, it is on the zero
- In the second picture: four cylinders on the tray
- their weight is equal to 8
- The other 4 on the floor
- The next picture the previous four cylinder are equal
- That means each cylinder equal to 2
- There are 2 other cylinders on the tray
- Their weigh is equal to 5
- The red cylinder is equal to 3 and it is the different one
- And the 7 other cylinder are equal
- The red cylinder is the required one.

$$\text{Agreement} = 8/10 \times 100 = 80 \%$$

The Ball source problem – strategy level – verbal representation

Please list all the information from this story.

Judge 1

- There are 12 identical balls
- There is one lighter than the other
- I have to find the odd one
- I have a compression type of scale
- This type has a vertical rod
- And the tray on the top of that
- This is description for the weighing instruments
- For solving the problem
- I place the first 4 on the tray and remove it
- And then weigh the next 4
- If they are same as the first one
- We'll take the last 4 and weigh
- 2 balls against the other 2

- and then we can determine which ball is the lighter.

Judge 2

- There are 11 balls
- One ball is lighter than the others
- I have to figure out which one is the lighter
- I have a scale with one tray
- It is a compression type of a scale
- There is a description for the scale
- I place 4 balls on the tray and measure them.
- Then I weigh the next 4
- If they are the same as the first four then I will take the remaining balls
- The four balls will be compared
- 2 balls against the other 2
- I can determine on which side is the lighter ball.

$$\text{Agreement} = 11/14 \times 100 = 79 \%$$

The Bar 2 source problem – procedural level – pictorial representation
Please list all the information from these pictures

Judge 1

- there are 12 balls in the first picture
- They are similar sizes
- and different colors
- In the second picture there is a weighing balance with 2 trays
- We divide the balls to 3 groups
- The first 4 on one tray
- And the second 4 on the other tray
- The balls were equal
- And the next picture we took the last 4
- And we put 2 balls against the other two
- The tray which has red and blue balls is down
- It is heavier than the other one
- we compare the red and the blue balls
- And the required ball is the blue one
- I think because it's heavier.

Judge 2

- We have 12 balls
- It is different colors
- We have a balance with 2 trays
- The first tray it has 4 balls
- And the other tray it has 4 balls also
- Both trays are equal
- Which means the ball is on this side
- Is equal to the 4 balls on the other side

- We took the last 4 balls
- We put 2 in front of the other 2
- The left tray was down
- Which means the red and blue
- Is heavier than the pinkish and green
- In the last step
- We measure the red with the blue ball
- The blue was the required ball.

Agreement = $14/16 \times 100 = 87.5\%$

The Ball 2 source problem – procedural level – verbal representation

Please list all the information from this story:

Judge 1

- There is 12 balls
- 11 is equal
- 1 is different
- We have to figure out
- Which is the heavier ball
- First of all, we differentiate between balls
- And then we use the balance of 2 trays
- We put 4 against 4
- And they are equal
- The heavier ball is in the last 4 balls
- We specify the group that has the heavier ball
- Then we weigh 2 balls against each other
- Then we weigh each one with the other
- And the heavier ball will be found.

Judge 2

- One ball among the twelve identical balls is different
- Which one is the heavy ball
- which is the different one
- weigh 4 with the other 4
- If they are equal then the heavy one in the last 4
- We have to divide this group of 4
- We can weigh 2 with the other 2
- The heavy one will be on the lower tray
- Then we can weigh 1 with the other 1
- To differentiate which is the heavy ball.

Agreement = $11/13 \times 100 = 85\%$

The Almonds problem (Target):

During the holy month of Ramadan, the rate of dry fruits like dates, almonds, pistachios and raisins goes up sharply. Therefore, a few families get together and buy a box at the whole sale rate, rather than buy a kilo or two individually which costs them more. Suppose your mother along with your two

aunts decided to buy a box of almonds weighing 39 kilograms, which is to be equally divided among the three. You were asked to weigh out 13 kg of Almonds for each of them. However, when you went into the kitchen, you found that there are only three weights 12 kg., 9 kg., and 5 kg. How will you weigh 13 kg of almonds exactly, without guessing and using only these three weights, keeping in mind that the balance (weighing instrument) will not hold more than 20 kg. at one time.

The Judges were asked to solve the target problem. Both the judges in the strategy level solved the target problem but in different ways. The different solutions were presumably correct; because the source model was at the strategy level, where no specific procedure is given to solve the target problem. The first judge solved the problem by:

- We can use the 9 kg.
- Weight first and weighing out 9 kg. of almonds.
- She used the same weight once again to weigh out another 9 kg.
- That gave her a total of 18 kg.
- Then she used the 5 kg weight to weigh out 5 kg from the 18 kg.
- The remaining is the required amount of 13 kg.
- The second judge solved the problem by weighing out 12, 9, and 5 kg. of almonds from the total amount of 39 kg.
- The remaining is the 13 kg required.

The judges also evaluated the informational and computational equivalence between the verbal and pictorial versions of each problem, at the strategy and procedural levels of similarity. The within-judges comparison for both the versions of the source problems was found to be fairly high in similar information. Table D.3 is an example of the responses of Judge 1 on the Jug and Art gallery problems, where the same color is used to indicate the similar information in both formats, pictorial and verbal. For example, the color yellow is used to show a similar idea regarding the container of paint in the two verbal and pictorial versions of the problems. The color green shows how the judge recognized different sizes of cups, the orange shows how the judge understood the process to solve the problem and the blue color represents the problem being

solved. The white color indicates no similarity of these ideas in the two versions. Thus, the Figure explicitly shows that almost all the relevant and important information was elicited from the two versions by this judge.

Table D.3

The Informational Equivalence of the two versions according to Judge 1

Pictorial Version (A)	Verbal Version (B)
The first picture: a container is full of water or liquid.	Some paint is required to do a poster 120cm x 150cm.
There are also 3 different size containers.	Jumana had a gallon which has 24 cups of paint.
In the second picture: We fill one of the three containers.	And she needed 15 cups.
And we fill the second and third containers in the last picture.	She didn't have the exact measure.
The last picture shows that the three small containers are filled.	She had 3 containers 2, 7 & 6 cups.
And there is some amount remaining.	She thought that she can use the 3 containers.
The amount required is in the three containers.	Where the sum of them is equal to 15 And get the required amount.

Pilot Study:

A pilot study was conducted to establish the reliability and validity of the new problems devised. All the problems concern weighing, measuring and estimating things, without adequate tools of measurement. The objectives of the pilot study were:

- To determine the extent to which the new problems devised for this study, are suitable and clearly conveyed the information of the problem.
- To ensure the informational and computational equivalence of the pictorial and verbal formats of the source problems.

The results of the modified versions of the problems were verified by administering them to a sample of undergraduates. Sixteen participants were

randomly assigned to four groups, with 4 in each, who solved two source problems one in each modality (verbal and pictorial) either at the strategy or procedure levels, along with their target problems, which were in verbal format only. For example, Figure 5.1 shows that G1 took the Jug 1 (target Almond) and Ball 1 (target Lab.) problems in the pictorial and verbal formats respectively, at the strategy level, while G4 took the Bar 2 (target Lab) and Art 2 (target Almond) problems in the pictorial and verbal formats, at the procedural level. Participants were given 10 minutes to solve each source and its target problem, after which they were asked to answer some questions related to the level of difficulty, clarity and whether the source model helped them in solving the target problem.

Table D.4

Results of pilot study for the source and target problems:

The Name of the problem n=16	Type	level	Format	Number of participants solved the source	num of participants solved the target
Jug 1 (Group 1) n=4	source 1	Strategy	Pictorial	2/4	1/4
Art 1 (Group 2) n=4	source 1	Strategy	Verbal	2/4	1/4
Jug 2 (Group 3) n=4	source 1	Procedure	Pictorial	3/4	2/4
Art 2 (Group 4) n=4	source 1	Procedure	Verbal	3/4	1/4
Bar 1 (Group 1)	source 2	Strategy	Pictorial	3/4	1/4
Ball 1 (Group 2)	source 2	Strategy	Verbal	2/4	1/4
Bar 2 (Group 3)	source 2	Procedure	Pictorial	4/4	3/4
Ball 2 (Group 4)	source 2	Procedure	Verbal	3/4	2/4

The results in Table D.4 clearly indicate that the source problems were solved at least by 50% of the participants, thereby indicating that the problems were clear in depiction and understandable in meaning. The time limit of ten minutes was also sufficient. As the nature and range of the solutions was similar to Experiment 1, the same scoring procedure in terms of solvers/non-solvers and

strength of transfer applied. Table D.4 indicated the number of participants who solved each source and each target problem.

Procedure

Each participant received a booklet, consisting of one of the four conditions, designed to ensure counterbalancing of the problems, according to type of representation. For example, the booklet for condition 1 consists of strategy level, with pictorial source (PS) problem and its verbal target, followed by the verbal source (VS) problem and its target. The booklet for condition 2, had the strategy level with the VS and its verbal target, followed by the PS and its verbal target problem. The same procedure was applied to the other two conditions in the procedural level of similarity. Counter-balancing of the order was also applied to the two isomorphic targets problems (Almond and Lab). The participants were given 10 minutes to solve each source and its target problem. The general instructions given to all participants verbally were:

The booklet consists of two parts. In each part, you have two problems to solve. Read the instructions carefully given before each problem carefully, and please ask if you have any questions. You have 10 minutes to solve the two problems in each part.

In order to obtain some information on the impact of the two forms of representations (verbal and pictorial), retrospective reports were gathered from participants. Each participant was requested to answer the following questions after they completed the test:

- What is the range of difficulty for the Almond problem on a scale from 1-10, where 1 is very easy and 10 are very difficult?

- What is the range of difficulty for the Lab problem on a scale from 1-10, where 1 is very easy and 10 are very difficult?
- Did you benefit from the previous Almond problem (pictorial or verbal)?
- Did you benefit from the previous Lab problem (pictorial or verbal)?
- Which representation did you benefit from more: a) the verbal, b) the pictorial?
- Which representation did you prefer: the pictorial or verbal in these types of problems?

Scoring

Comprehension of the source models was assessed by evaluating participants' interpretations of the meaning of the models. The answer was rated on a 3-point scale of 0 to 2. A wrong solution was given a zero (e.g., in the Jug 2 pictorial problem, the balance was interpreted as judgment in life and in the art gallery problem as a non-logical solution was given, such as, "buy another measure for 16 gram"). Whenever a model was correctly interpreted by giving a general idea, a score of 1 was given. For example, in the Jug 1 problem, the response of, "to figure out the amount of water," or, for the Art gallery problem the response of, "she can use the three containers to figure out the 15 cups of paint."

Whenever a model was interpreted by showing a complete process, a score of 2 was given (e.g., in the ball problem it was said, "This group of pictures is comparing the 12 balls, we start comparing 4 against 4, and if it's equal, we can compare the last group 2 against 2 to figure out which is the odd ball, in this case, the heavier ball.")

Two measures concerning participants' problem-solving performance for the target problem were applied. First, participants, successfully solving the target problem, where the answer was correct and complete, received a score of 3. If the answer was correct, but incomplete, a score of 2 was given. If the answer conveyed only a relevant idea, a score of 1 was given, while a score of 0 was assigned if the answer was incorrect or only a very general idea not specific to the problem was given. Participants with scores of 2 and 3 were considered a solver, and 0 and 1 were considered as a non-solver.

Second, the concept of Strength of Transfer was used, as in the previous experiment, for assessing the effectiveness of transfer of performance. This was measured on a four-point effectiveness scale (0-3), where the performance was assessed, in terms of the degree to which the participants generated the correct solution, thereby indicating the strength of transfer from the source model to the target. The concept of the strength of transfer used in this experiment was based on the assumption that the verbal and pictorial type of representation and levels of similarity would generate varied degrees of performance. The previous experiment, as well as the pilot study conducted for this experiment, showed that the degree of performance could be conveniently divided into four categories, namely: complete and correct transfer, high partial transfer, low partial transfer and no/ wrong solution coinciding with two levels of similarity procedural, and strategy respectively. A complete and correct transfer yielded a score of 3. A person scored three points if the answer was complete and correct in solving the target problem.

The complete solution for the Almond problem is:

- Putting the 12 kg weight in the balance scale on one side.
- And on the other side the amount of almond equal to weight.
- Take this Weight out and also empty the almonds in a separate tray or container.
- Put the other two weights (9&5) on one side.
- And put another amount of almonds from the main container on the other side of the balance till both sides are equal.
- The amount remaining in the main container is the required amount which is 13 kg.

The complete solution for solving the Lab problem is:

- In the weighing balance with 2 trays,
- We then put 4 containers on one tray and the other 4 against them on the other tray,
- If the containers were equal, then we will take the last group of four.
- After we decide on which group of four containers had the heavy one.
- We put 2 containers against the other two.
- The tray which has the heavy container, will weigh down.
- We compare the two containers against each other.
- And find the container that is heavier.

A high partial transfer yielded a score of 2, which was given if the participant gave a relevant plan, for solving the target problem, but did not achieve a final solution for solving the target problem. Considering the Lab problem as an example of a strategy plan is, "Put five containers against the other five, and if it is equal then compare the other two." This answer has a strategy, but did not take the constraint into account.

A low partial transfer yielded a score of 1, which was given if the participant's solution contained only the idea of estimating the weight without an explanation of how to implement this principle. An example of such a general solution for the Almond problem is, "We can give 12 kg to each one and divide the last three kilo equally." An example of the Lab problem principle only solution is, "We can compare the containers to find the odd one." This answer is only a general idea that has no concrete plan. A wrong solution or no solution yielded a score of zero (0). If the answer was incorrect or the participant did not provide any solution the score was zero. An example of the wrong solution for the Almond problem is, "We can go to the supermarket and weigh it over there" and for the Lab problem, "We can guess the heavy one by weighing with our hands."

E. THE SCORING SHEET FOR SCD

Table e1

Scoring Sheet for SCD

Name		Age		Group	Exp no	ID num.		level of similarity									
problem name	problem type	Time	Score	Unit no	Analysis								Strategy	Procedure			
					<i>explanation</i>				<i>inference</i>				<i>Analogizing</i>		<i>Others</i>		
					labelling	combining	comparing	Relations	Justification	Math elab.	Goal	constrain	Encoding	Mapping	transfer	Arrows	others
Art source	verbal pictorial																
Almond Target	Verbal																
Balls-P	verbal pictorial																
Lab Target	Verbal																
notes																	