

## Forehead reflectance photoplethysmography to monitor heart rate: preliminary results from neonatal patients

This content has been downloaded from IOPscience. Please scroll down to see the full text.

2014 Physiol. Meas. 35 881

(<http://iopscience.iop.org/0967-3334/35/5/881>)

View [the table of contents for this issue](#), or go to the [journal homepage](#) for more

Download details:

IP Address: 128.243.253.108

This content was downloaded on 28/04/2014 at 09:34

Please note that [terms and conditions apply](#).

# Forehead reflectance photoplethysmography to monitor heart rate: preliminary results from neonatal patients

M R Grubb<sup>1</sup>, J Carpenter<sup>1</sup>, J A Crowe<sup>1</sup>, J Teoh<sup>1</sup>, N Marlow<sup>2</sup>, C Ward<sup>3</sup>, C Mann<sup>3</sup>, D Sharkey<sup>3</sup> and B R Hayes-Gill<sup>1</sup>

<sup>1</sup> Electrical Systems and Optics Research Division, Faculty of Engineering, University of Nottingham, Nottingham NG7 2RD, UK

<sup>2</sup> UCL Institute for Women's Health, University College London, London WC1E 6HX, UK

<sup>3</sup> Division of Child Health, Obstetrics and Gynaecology, School of Medicine, University of Nottingham, Nottingham NG7 2UH, UK

E-mail: [James.Carpenter@nottingham.ac.uk](mailto:James.Carpenter@nottingham.ac.uk)

Received 28 October 2013, revised 10 March 2014

Accepted for publication 26 March 2014

Published 17 April 2014

## Abstract

Around 5%–10% of newborn babies require some form of resuscitation at birth and heart rate (HR) is the best guide of efficacy. We report the development and first trial of a device that continuously monitors neonatal HR, with a view to deployment in the delivery room to guide newborn resuscitation. The device uses forehead reflectance photoplethysmography (PPG) with modulated light and lock-in detection. Forehead fixation has numerous advantages including ease of sensor placement, whilst perfusion at the forehead is better maintained in comparison to the extremities. Green light (525 nm) was used, in preference to the more usual red or infrared wavelengths, to optimize the amplitude of the pulsatile signal. Experimental results are presented showing simultaneous PPG and electrocardiogram (ECG) HRs from babies ( $n = 77$ ), gestational age 26–42 weeks, on a neonatal intensive care unit. In babies  $\geq 32$  weeks gestation, the median reliability was 97.7% at  $\pm 10$  bpm and the limits of agreement (LOA) between PPG and ECG were +8.39 bpm and  $-8.39$  bpm. In babies  $< 32$  weeks gestation, the median reliability was 94.8% at  $\pm 10$  bpm and the LOA were



Content from this work may be used under the terms of the [Creative Commons Attribution 3.0 licence](https://creativecommons.org/licenses/by/3.0/). Any further distribution of this work must maintain attribution to the author(s) and the title of the work, journal citation and DOI.

+11.53 bpm and –12.01 bpm. Clinical evaluation during newborn deliveries is now underway.

Keywords: photoplethysmography, neonatal, resuscitation, heart rate, delivery room

(Some figures may appear in colour only in the online journal)

## 1. Introduction

It is estimated that 6.5–9 million newborns worldwide require resuscitation at birth each year (Saugstad *et al* 2005), which approximates to around 5%–10% of newborns in the UK (Robertson 2005). A newborn's heart rate (HR) is the best indicator of effective resuscitation and guidelines recommend that it is assessed at 30 s intervals (Perlman *et al* 2010). Currently, the established method of achieving this within the delivery room is to use a stethoscope, but estimating HR in this way has been demonstrated to be subject to human error (Voogdt *et al* 2010, Theophilopoulos and Burchfield 1997). Furthermore, the use of a stethoscope requires a lone resuscitator to pause resuscitative efforts for a short period of time to perform auscultation, so interrupting the flow of resuscitation and potentially prolonging stabilization of the newborn. International guidelines (Perlman *et al* 2010) recommend that when the newborn HR is less than 100 bpm then the resuscitation protocol should be commenced.

With little advance in newborn resuscitation technology in recent years it is unclear if more effective resuscitation could reduce morbidity and mortality in those at greatest risk. However, where attempts have been made to improve resuscitation practice through structured training programs, there have been significant improvements in the outcomes of high risk births (Patel *et al* 2001). It is likely that better monitoring during newborn resuscitation could also improve the process and hence the outcome of babies born in poor condition. The new ILCOR 2010 guidelines (Perlman *et al* 2010) recommend using pulse oximeters (POs), where available, to monitor oxygen saturations and HR. However, these can take 1–2 min to establish a reliable HR at birth (Kamlin *et al* 2006, Leone *et al* 2006), and particularly can be unreliable in babies with poor peripheral perfusion (Kamlin *et al* 2008). Furthermore, POs are not available in every delivery room with recent UK data suggesting <20% of neonatal units use them to assess HR and all use a stethoscope as a first line (Mann *et al* 2012). Another solution, namely electrocardiogram (ECG) monitoring, is problematic in the delivery room because of difficulties attaching electrodes to the newborn's wet skin and the possibility of skin stripping in premature infants. However, Katheria *et al* (2012) have recently demonstrated that these problems can be overcome. Additionally, the delivery of at-risk babies into a polythene bag to prevent hypothermia (Leone *et al* 2006) restricts access to limbs and chest for PO probes and ECG electrodes respectively.

Photoplethysmography (PPG) is a well-established method for both obtaining information about blood volume changes and monitoring HR (Allen 2007, Nitzan *et al* 1998), where in the latter application the cardiac synchronous component of the PPG signal is isolated and processed. Most devices used in adult clinics use transmission mode PPG, in the form of POs, but there is also a precedent in its use in reflection mode, from a site on the left thigh, to monitor the HR and breathing rate in newborn babies for up to 8 h (Johansson *et al* 1999).

We have identified that during resuscitation the forehead is a suitable site for the measurement of a newborn's HR using a PPG device. This paper presents the first published

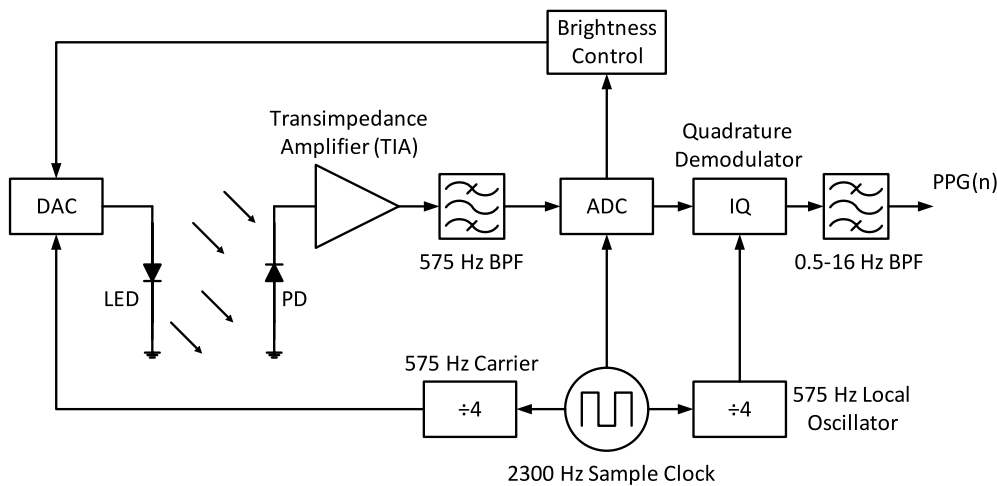

**Figure 1.** Block diagram of PPG device.

results, to the authors' knowledge, on the deployment of a head mounted PPG device operating in reflection mode for newborns in the neonatal intensive care unit (NICU). We plan future work to include analysis of HR accuracy during resuscitation.

## 2. Methods

### 2.1. Measurement site

The most suitable measurement site should not interfere with any of the care or resuscitation procedures. Given that many preterm infants are placed into a polythene bag, the most accessible part of the baby is the head. As both the choice of a suitable site, and appropriate sensor design to provide a stable skin/sensor interface, can help minimize movement artifacts it was considered that the forehead represented the option that should be explored first. This choice is compatible with current care pathways and the deployment of a reflectance mode sensor means it can either be incorporated in, or held in place, by the newborn's hat while the trunk and limbs are wrapped in an insulating bag.

Physiologically, the forehead represents a suitable site because its perfusion is maintained longer in preference to perfusion in the extremities (Fernandez *et al* 2007). Branson and Mannheimer (2004) observed that tissue immediately above the eyebrow is supplied by the supraorbital artery, branching from the internal carotid artery, and so lacks the vasoconstrictor response present in peripheral regions. Furthermore, Tur *et al* (1983) investigated regional skin perfusion at 52 different anatomic positions, between the toe and forehead, using reflectance PPG with an infrared light emitting diode (LED). Their results demonstrated that the hands and face, including the forehead, had the highest cutaneous perfusion when compared to other sites on the body.

### 2.2. Newborn forehead reflectance PPG device

**2.2.1. Overview.** Figure 1 shows a block diagram of the PPG device ('HeartLight'). A light source (LED) is square wave modulated at 575 Hz to enable suppression of interference from

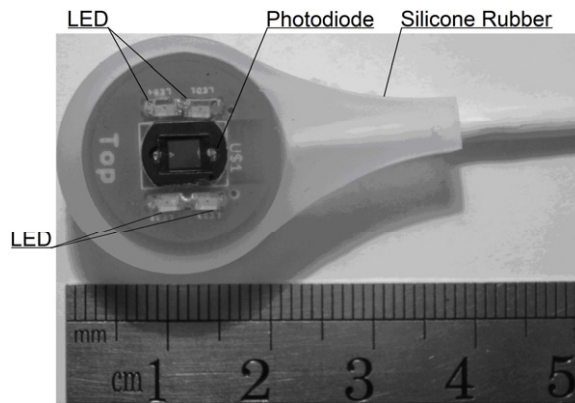

**Figure 2.** A photograph of the PPG forehead reflectance sensor.

ambient light. The intensity of the source is controlled via a digital-to-analogue converter used to optimize the detected signal level for varying values of light attenuation by the illuminated tissue. After interaction with tissue, a component of which will be a cardiac synchronous variation in blood volume, the diffusely reflected light is detected by the photodiode (PD), from here it is amplified, filtered, and then sampled by an analogue-to-digital converter (ADC) at 2300 Hz and subsequently demodulated using a quadrature demodulator to recover the PPG signal (Grubb *et al* 2009, Crowe *et al* 2007).

**2.2.2. Forehead reflectance sensor.** A photograph of the reflectance sensor is shown in figure 2 and consists of the LED light source and PD. The light source consisted of four 525 nm LEDs (Marl, E1S02-3G0A7-02) arranged in pairs either side of a PD (Vartec, VTB8440B) to provide even illumination of the tissue beneath the sensor. This wavelength was used as it has been shown that pulsatile blood produces the greatest depth of modulation in wavelengths between 500 and 600 nm (Crowe and Damianou 1992, Cui *et al* 1990).

The sensor, including the LEDs, was encapsulated in medical silicone rubber (Bluestar Silicones, Silbione 4420) using a custom made stainless steel mould. The PD surface was covered with a thin transparent film (Smith and Nephew, Opsite Flexifix). This was because the rubber thickness was difficult to control, and a thick layer over the PD may have coupled light to it directly from the LEDs (light shunting). This arrangement provided a small sensor for forehead fixation with a disposable cover and a rubber moulding that could be wiped clean with alcohol. These materials were selected for their biocompatibility as standardized by ISO 10993.

**2.2.3. Low noise PPG processing electronics.** The processing electronics consists of three functional blocks. Firstly, the analogue front end, which used a transimpedance amplifier (TIA) to amplify and convert the photocurrent to a voltage. This signal is a 575 Hz carrier, a frequency unlikely to be present within the operating environment and above the  $1/f$  noise-corner frequency of the TIA, amplitude modulated by the PPG. This signal was band-pass filtered at 575 Hz, by a 68 Hz filter bandwidth, to isolate the carrier, provide anti-alias filtering, and attenuate interfering constant and low frequency light sources at the PD.

Secondly, the ADC and data-logging was provided by a modified electrophysiological recorder (Monica Healthcare Ltd, AN24). This device quadrature-sampled the carrier (i.e.

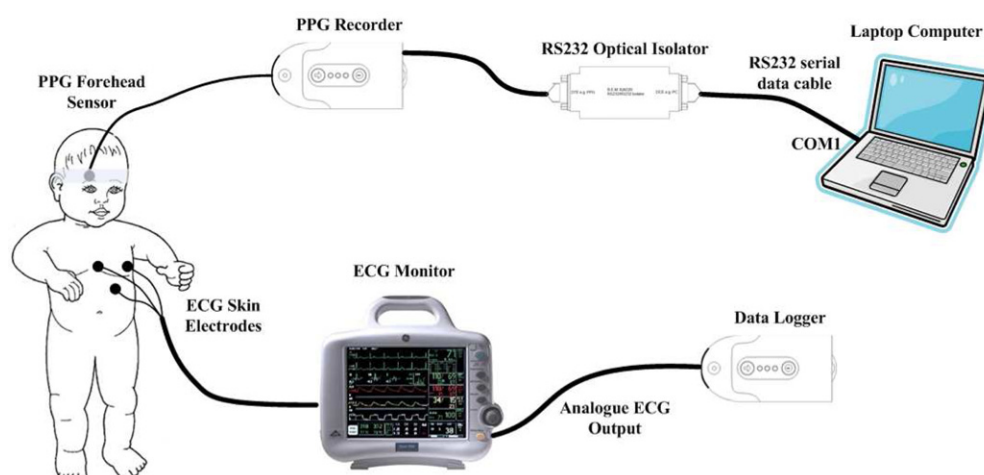

**Figure 3.** Experimental equipment for simultaneous PPG and ECG recording.

at 2300 Hz) and recorded the data to an SD card. This data was downloaded after each recording via a USB interface. An existing medical device was used because compliance with the medical device directive (93/42 and its 2007 amendment) and associated standards (e.g. BS EN 60601-1 and 60601-2) was already demonstrated. This was an important criterion for the hospital risk assessment and indemnity process.

Thirdly, the digital signal processing comprising the lock-in detection utilizing a simple quadrature demodulator algorithm, followed by a 0.5–16 Hz band-pass filter, was implemented in MATLAB (version 7.12, MathWorks).

### 2.3. Clinical evaluation

**2.3.1. Patient recordings.** The HeartLight study (UKCRN Study ID 5844) was designed to evaluate this technology in a stepwise approach. The first phase involved device development and assessment prior to actual delivery room resuscitation studies. This involved simultaneous recording of the PPG from the reflectance sensor and the ECG using commercial units (GE Healthcare, Dash3000). Recordings of 20 min duration were made from stable newborns that had been admitted to the NICU, Nottingham University Hospitals NHS Trust, Nottingham, and were undergoing routine ECG monitoring so providing the comparator. Exclusion criteria were: newborns receiving phototherapy, those with extensive skin disease, receiving palliative care, where there were language or social barriers to obtaining consent, or patients that the attending physicians felt were too clinically unstable.

The study received approval from the UK NHS Research Ethics Service (NHS REC reference 07/H1208/66) and Nottingham University Hospitals department for research and development. Parents provided written informed consent for their baby to participate in the study.

The experimental equipment used is shown in figure 3. Each participant had their ECG leads transferred from their NICU monitor to the study monitor display for the duration of the recording. The reflectance sensor was sited on the forehead above the left or right eyebrow and held in place by a headband/hat. The PPG signal was displayed in real time on a computer via an RS232 serial connection and medical optical isolator (Brutech, BEM-ISAD20). The

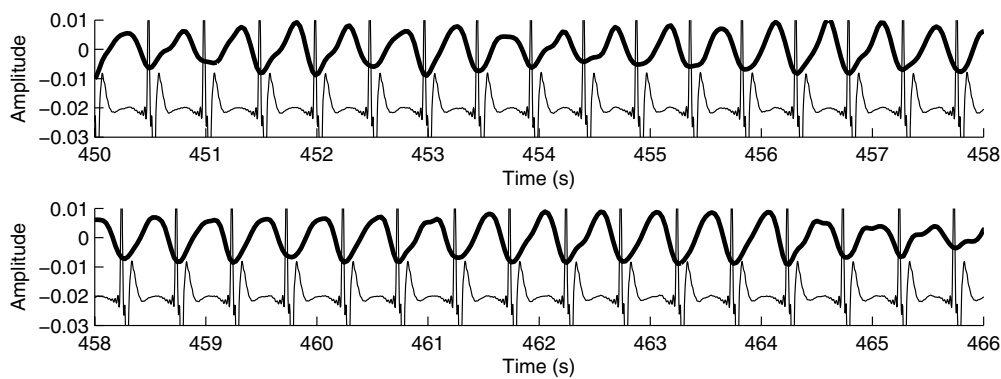

**Figure 4.** PPG (bold line) and ECG from an infant 33+2 weeks+days gestation, aged 2 days, weight 2.10 kg. Ethnic origin: white.

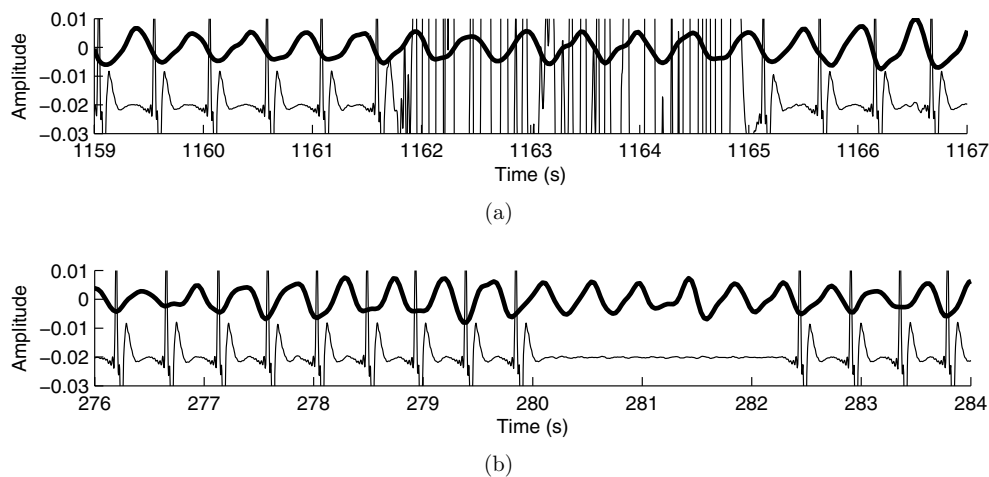

**Figure 5.** Examples of noisy ECG (a) and dropped ECG beats (b) plotted with PPG (bold line). Moments where the quality of the ECG prevented derivation of an accurate HR comparator were excluded, despite the PPG signal sometimes remaining reliable.

sensor was repositioned at the start of the recording if either the researcher could not see a pulsatile signal, or they judged that the signal quality was low and hence could be improved by relocating the sensor. Figure 4 shows a typical simultaneous PPG (bold line) and ECG plot.

**2.3.2. Heart rate extraction, reliability and accuracy.** For each recording, the PPG and ECG data were aligned using event markers and inspected to ensure that the beats were paired for the duration of the recording. To ensure fair comparison of paired HRs, all the data sets were truncated to 20 min. Data was excluded where the researchers physically adjusted either the PPG sensor or ECG electrodes. Additionally, moments where the ECG was of too poor quality to calculate a HR were excluded (figure 5).

HR extraction used a 2 s wide window, centered at 1 s increments, giving a 1 s refresh rate. The PPG HR ( $HR_{PPG}$ ) in each window was estimated using a discrete Fourier transform

**Table 1.** Summary statistics for group 1 (gestation  $\geq 32$  weeks) and group 2 (gestation  $< 32$  weeks) neonatal participants. Data are medians and range (minimum–maximum).

	Group 1 ( $n = 53$ )	Group 2 ( $n = 24$ )
Gestation (weeks+days)	33+2 (32+0 – 42+0)	31+1 (26+6 – 31+5)
Age (days)	6 (0 – 69)	12 (2 – 58)
Birth weight (Kg)	1.66 (1.22 – 4.9)	1.26 (0.75 – 1.82)
HR <sub>ECG</sub> (bpm)	141 (70 – 212)	161 (71 – 213)

(DFT) technique (Rusch *et al* 1996). HR<sub>PPG</sub> was selected as the spectral line with the largest amplitude within the range 0.5–4 Hz, corresponding to 30–240 bpm. A value for HR<sub>PPG</sub> was marked as unreliable if the largest amplitude fell outside this frequency range, or if a single HR<sub>PPG</sub> spectral line deviated significantly from the median of the preceding 10 windows. ECG HR (HR<sub>ECG</sub>) was determined by searching for the waveform peaks corresponding to the QRS segment of the ECG and then computing the average R–R interval within each 2 s window.

Positive percent agreement (PPA) was used to quantify *reliability* of the PPG data (FDA 2007) on the set of windows where HR<sub>ECG</sub> could be determined ( $a$  windows).  $b$  is a subset of  $a$  and represents the total number of windows that HR<sub>PPG</sub> could be reliably extracted. Further,  $c$  is a subset of  $b$  and represents windows where there was agreement between HR<sub>PPG</sub> and HR<sub>ECG</sub> at three agreement levels (AL):  $\pm 3$  bpm,  $\pm 5$  bpm, and  $\pm 10$  bpm. The PPA *reliability* is  $100 \times \frac{c}{a}$ . Consequently the PPA is the percentage of time the calculated HR<sub>PPG</sub> was within the AL.

The measure of PPA *reliability* on each subject was therefore based on how successfully the optical sensor detected the PPG and how successfully the DFT technique estimated the HR<sub>PPG</sub> of each window. It represents the amount of data that was not disrupted by poor signal quality.

A Bland–Altman plot and resulting limits of agreement (LOA) were used to quantify overall *accuracy* between HR<sub>PPG</sub> and HR<sub>ECG</sub> (Bland and Altman 1986) on windows where HR<sub>PPG</sub> could be determined. The difference between the paired HRs (HR<sub>ECG</sub> – HR<sub>PPG</sub>) was plotted against their average ( $(\text{HR}_{\text{ECG}} + \text{HR}_{\text{PPG}})/2$ ). The mean and standard deviation of the difference between the HRs were calculated for each recording. The interval two standard deviations either side of the mean difference represented the LOA. With the bias removed (by subtracting the mean from the positive LOA), each recording produced one LOA value.

### 3. Results

In total 99 participants were recruited from the NICU. Technical problems resulted in no ECG data being logged in 22 of these recordings, although usable PPG data was present in 14 of these. In the other eight PPG recordings, four suffered from poor signal quality because continued manipulation of the ECG electrodes to try and gain a good ECG signal caused excessive motion in the PPG sensor. A further two were excluded because of internal electronic connection problems and two could not be aligned according to the protocol and were excluded but in fact still contained good quality signals. Hence data from 77 participants were analyzed. The participants were separated into two gestational groups, the first group ('group 1') having a gestation  $\geq 32$  weeks ( $n = 53$ ), and the second group ('group 2') having a gestation  $< 32$  weeks ( $n = 24$ ). The summary statistics for these participants are presented in table 1.

The PPG pulsatile signal was observed in all of the 77 NICU recordings included in the analysis. Figure 6 shows the median, interquartile range and range, with outliers, of the PPA



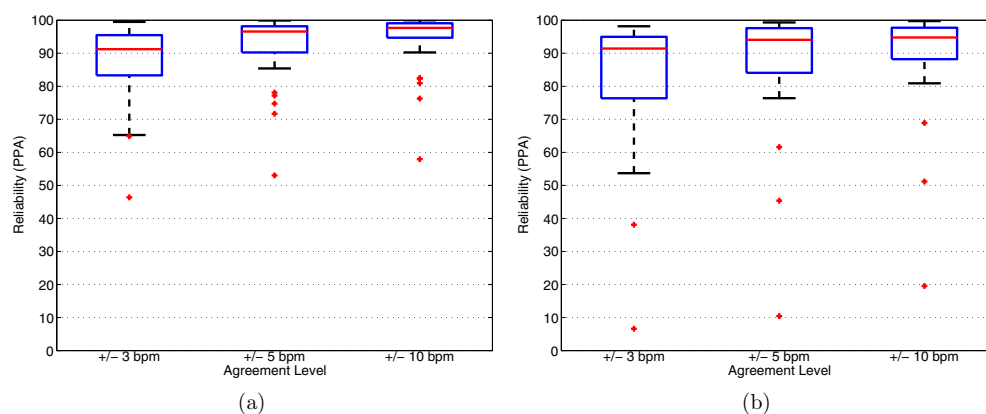

**Figure 6.** (a) PPA reliability of NICU recordings from the 53 group 1 infants. Each agreement level box plot is comprised of 53 PPA points. The median value is the central line in each box, with the edges of the box indicating the interquartile range. Whiskers are plotted to the maximum or minimum values that are not considered outliers. Outliers are defined as greater or less than 1.5 times the interquartile range and are plotted individually. Median values are 91.2%, 96.6% and 97.7% for the  $\pm 3$ , 5 and 10 bpm plots respectively. (b) PPA reliability of NICU recordings from the 24 group 2 infants. Each agreement level box plot is comprised of 24 PPA points. Median values are 91.4%, 94.0% and 94.8% for the  $\pm 3$ , 5 and 10 bpm plots respectively.

reliability versus AL. For group 1, the median PPG reliability at  $\pm 3$  bpm was 91.2%, and for group 2 91.4%. At an AL of  $\pm 10$  bpm this rose to 97.7% (group 1) and 94.8% (group 2). An agreement of  $\pm 10$  bpm was considered the level of clinical acceptability, as errors less than this would be unlikely to cause an incorrect assessment of the newborn.

The LOA (with bias removed) was calculated for each individual recording and the descriptive statistics for the set of LOAs are median [interquartile range] (range) for group 1, 3.77 [2.52 7.11] (1.74 46.17) bpm and, for group 2, 4.34 [2.37 9.21] (1.91 49.13) bpm.

The HR pairs from all recordings were aggregated into two sets (one for each group). Figure 7 illustrates the accuracy using Bland–Altman plots and the LOA from these aggregated HR pairs in the group 1 and group 2 recordings. The accuracy of the aggregated pairs in terms of bias adjusted LOA are, for group 1,  $\pm 8.39$  bpm and, for group 2,  $\pm 11.77$  bpm.

In one recording in gestational group 2, no reliable PPG signal was consistently evident despite repeated adjustment of the sensor head and this produced a PPA reliability of 6.6% ( $\pm 3$  bpm), 10.44% ( $\pm 5$  bpm) and 19.55% ( $\pm 10$  bpm), and a bias adjusted LOA, quantifying accuracy, of  $\pm 40.07$  bpm. This single recording accounts for the diagonal set of points from 140 to 200 bpm (average) in figure 7(b). Removing this outlier sets the aggregated group 2 bias adjusted LOA to  $\pm 8.91$  bpm.

The HR pairs from the two groups were aggregated and a scatterplot of  $HR_{PPG}$  against  $HR_{ECG}$  (figure 8) illustrates the sensitivity (89.9%) and specificity (99.8%) of the device and HR extraction technique at a threshold of 100 bpm.

#### 4. Discussion

This preliminary NICU study demonstrates that it is possible to continuously record the PPG pulsatile signal, using a green light reflectance mode sensor, from the forehead of infants

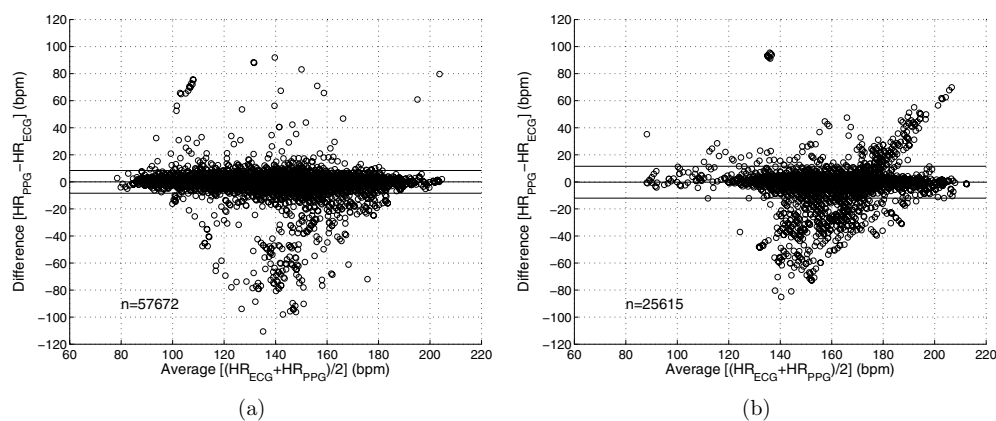

**Figure 7.** Accuracy analysis: (a) Bland–Altman plot and LOA of paired HR<sub>PPG</sub> and HR<sub>ECG</sub> for all group 1 infants. The number of paired HRs is 57 672. LOA of +8.39 bpm and –8.39 bpm, with a bias of 0.00 bpm. The percentage of points not within the LOA was 1.39%. (b) Bland–Altman plot and LOA of paired HR<sub>PPG</sub> and HR<sub>ECG</sub> for all group 2 infants. The number of paired HRs is 25,615. LOA of +11.53 bpm and –12.01 bpm, with a bias of –0.24 bpm. The percentage of points not within the LOA was 2.85%.

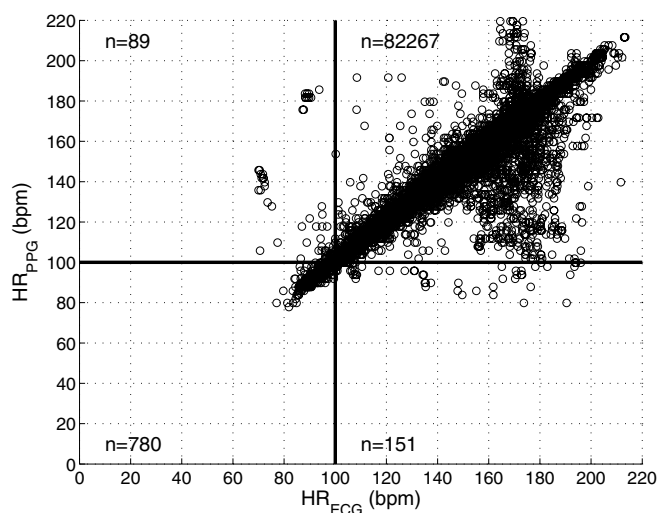

**Figure 8.** Paired HR<sub>PPG</sub> and HR<sub>ECG</sub> of the figure 7 data from both gestational groups. The total number of paired HRs is 83 287. The figure divides into four quadrants, revealing the sensitivity and specificity of detection at <100 bpm, where the lower left quadrant is the true positive (TP = 780) condition, upper left quadrant is false negative (FN = 89), upper right quadrant is true negative (TN = 82 267) and lower right quadrant is false positive (FP = 151). The sensitivity is  $100 \frac{TP}{TP+FN} = 89.8\%$  and the specificity is  $100 \frac{TN}{TN+FP} = 99.8\%$  at this HR threshold. A linear regression analysis resulted in  $r^2 = 0.94$  with  $p$ -value < 0.01.

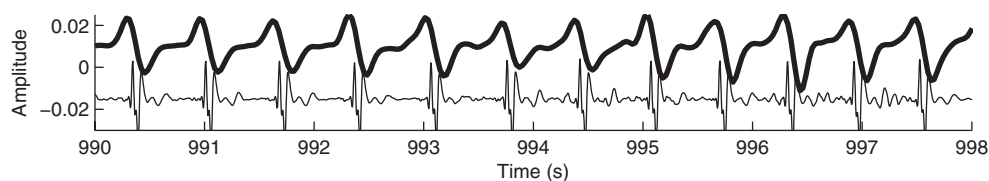

**Figure 9.** An example of a bradycardia in a group 2 infant ( $HR_{ECG} = 89$  bpm). Although the PPG signal (bold line) is of good quality, the HR extraction algorithm detected the first harmonic, whose presence is a result of the dichroic notch.  $HR_{PPG}$  was thus approximately twice  $HR_{ECG}$ .

across a range of gestations and weights. The range of HRs (ECG) observed during all the recordings was 70–213 bpm, and the group 2 infants had a median  $HR_{ECG}$  20 bpm higher than group 1, as would be expected from the more preterm babies.

The PPA *reliability* results were encouraging, indicating that the target of  $\pm 10$  bpm agreement was achieved for a median of 98% of the recording length in group 1 and 95% in group 2. Additionally, these figures are derived from data which has excluded moments where the ECG was noisy but the PPG remained visible. Therefore the reliability of the PPG device compared to the true HR may be higher.

The Bland–Altman analysis of *accuracy* showed that the DFT technique could extract the HR with a LOA within  $\pm 10$  bpm in infants older than 32 weeks and  $\pm 12$  bpm in infants younger than 32 weeks. However, a single recording in the second gestational group with poor signal quality, which resulted in low PPA *reliability*, caused the increase to above  $\pm 10$  bpm in this group. Excluding this outlier confirmed that the device was accurate to within acceptable clinical standards.

Singh *et al* (2008) studied 30 stable NICU babies, with a mean gestation of 29 (SD 4) weeks, comparing a Masimo PO on the hand to an ECG, with a view to the use of PO in the delivery room for monitoring HR. They reported a LOA of  $\pm 12$  bpm, rising to  $\pm 28.4$  bpm in the lowest quality recordings. These results are comparable with this study, but our PPG device has the advantage of operating in reflectance mode where it can be placed on the forehead making it more suitable for the delivery room for reasons discussed earlier. Furthermore, Singh's study used 2 s average HR values, rather than each second as this PPG device produces, potentially smoothing any transient differences between measurement techniques.

The two groups of false negatives in figure 8 can be explained through incorrect detection of bradycardia. Figure 9 demonstrates that the PPG device has acquired a high quality signal during one bradycardia episode. However, in this case the HR extraction algorithm calculated  $HR_{PPG}$  at twice  $HR_{ECG}$  due to the presence of the dichroic notch which manifests as a harmonic of the HR frequency. This harmonic is not as heavily filtered at lower HRs as at higher HRs. The number of false negative errors is not therefore a result of poor signal acquisition by the device and so could be reduced through digital filtering and HR extraction techniques which suppress the influence of this harmonic. Additionally, the episodes of bradycardia observed in this study illustrated that lower frequency respiratory variations, which also modulate the PPG signal, did not affect the HR extraction in these cases. Normal infant spontaneous respiratory rates are around 40–60 bpm, but during active resuscitation a respiratory rate of 30–40 bpm is recommended (Whyte *et al* 1999). Despite these rates being faster than for adults, the cardiac synchronous PPG signal remains reliable and HR extraction is still feasible.

As is the case with all physiological measurement devices, motion artifact had the greatest effect on reliability, and a previous study using a PO also noted that HR was inaccurate in vigorous infants (Kamlin *et al* 2008). Approximately 10% of the data points in figure 6 are

represented as outliers. This is partly because the majority of results cluster around the median value, which reduces the interquartile range. The outlying PPA values were mostly recordings where there was slippage of the sensor (e.g. the fixing hat was too large for babies with small head diameter) or where the baby kept knocking the sensor out of position. During resuscitation, however, motion artifact is most likely to arise from the clinician handling the baby, for example during attempts to place an endo-tracheal tube, though this has not yet been quantified. It is planned to investigate how motion artifact can be reduced by improving sensor fixation on the forehead. A suitable technique should provide rapid and secure fixation of the sensor but without using adhesives. Further improvements are likely to come from HR extraction that is rugged and resistant to motion artifact (Maeda *et al* 2011). The *reliability* measure will be used to quantify improvements in the method for sensor fixation and HR extraction.

A transition from manual HR assessment at 30 s intervals, to continuous assessment raises further questions concerning the reporting of HR to the clinician, particularly the refresh rate and the application of averaging. Currently, the HR trend, albeit at a low sample rate, is used to evaluate an infant's response to resuscitation, and comments from clinicians indicated that the 1 s refresh rate and 2 s window provided a trend with too much short term variability, responding to events such as fleeting bradycardia (pathological drop in HR), that may lead to an incorrect assessment and distract the clinician. A suitable low pass filter could be applied to the HR data to overcome this problem. Commercial POs, for example, provide a HR averaging window that is adjustable between 2 and 16 s, and there have been studies to evaluate its effect in the clinic (Ahmed *et al* 2010). Further work is planned to assess user needs for the optimum range of values for these parameters.

## 5. Conclusion

International guidelines recommend the use of HR to guide newborn resuscitation. Continuous HR monitoring has the potential to enhance delivery room management and stabilization of the newborn, and reflectance PPG has the potential to provide a non-invasive method of measuring HR. The high sensitivity and specificity of the device in this study, at detecting a HR < 100 bpm when resuscitation needs to be instigated, warrants further clinical evaluation.

The proposed forehead site necessitates a reflectance mode sensor and we suggest that green light (wavelengths between 500 and 600 nm) should be used in preference to red or infrared wavelengths, due to the increased depth of modulation (Crowe and Damianou 1992, Cui *et al* 1990).

Initial observations of PPG data recorded during this study, of the reflectance sensor in babies in the NICU, demonstrated that the pulsatile signal can be detected on the forehead of neonates for a range of gestations and weights. The first phase of this study has also demonstrated the value of a continuous display of the PPG signal from the device that enabled the sensor to be repositioned when the signal was poor. We are currently recruiting preterm infants in the delivery room to evaluate the technique during actual newborn resuscitation.

This is a new instrument that could significantly change how heart rate is assessed in the delivery room. A cheap and cleanable PPG device could offer advantages over current methods, such as a stethoscope or PO, especially in the situations where oxygen is not available (e.g. home births or developing countries) thereby improving accuracy of HR assessment and subsequent management. Future work will apply usability design processes (BS 62366) and participatory design methods to develop prototype operator–equipment interfaces for the new monitor, and evaluate them during simulated resuscitation.

## Acknowledgments

This work was funded through a MRC Portfolio award and by Action Medical Research (grant number SP4183). The authors are grateful for the support of the University of Nottingham, the Nottingham University Hospitals Trust, and the Medicines for Children Research Network. NM receives a proportion of funding from the Department of Health's NIHR Biomedical Research Centres funding scheme at UCLH/UCL.

## References

- Ahmed S J M, Rich W and Finer N N 2010 The effect of averaging time on oximetry values in the premature infant *Pediatrics* **125** E115–21
- Allen J 2007 Photoplethysmography and its application in clinical physiological measurement *Physiol. Meas.* **28** R1–R39
- Bland J M and Altman D G 1986 Statistical methods for assessing agreement between two methods of clinical measurement *Lancet* **1** 307–10
- Branson R D and Mannheimer P D 2004 Forehead oximetry in critically ill patients: the case for a new monitoring site *Respir. Care Clin. North Am.* **10** 359–67
- Crowe J and Damianou D 1992 The wavelength dependence of the photoplethysmogram and its implication to pulse oximetry *Proc. 14th Annu. Int. Conf. IEEE Engineering in Medicine and Biology Society* (New York: IEEE) vol 6 pp 2423–4
- Crowe J, Grubb M, Hayes-Gill B and Miles N 2007 Photoplethysmography *WO Patent* 2007122375
- Cui W, Ostrander L E and Lee B Y 1990 *In vivo* reflectance of blood and tissue as a function of light wavelength *IEEE Trans. Biomed. Eng.* **37** 632–9
- FDA 2007 Guidance for industry and FDA staff: statistical guidance on reporting results from studies evaluating diagnostic tests *Technical Report* 1620 ([www.fda.gov/downloads/MedicalDevices/DeviceRegulationandGuidance/GuidanceDocuments/ucm071287.pdf](http://www.fda.gov/downloads/MedicalDevices/DeviceRegulationandGuidance/GuidanceDocuments/ucm071287.pdf))
- Fernandez M, Burns K, Calhoun B, George S, Martin B and Weaver C 2007 Evaluation of a new pulse oximeter sensor *Am. J. Crit. Care* **16** 146–52
- Grubb M R, Hayes-Gill B R, Crowe J A, Sharkey D, Marlow N and Miles N J 2009 Towards forehead reflectance photoplethysmography to aid delivery room resuscitation in newborns *4th European Conf. Int. Federation for Medical and Biological Engineering* vol 22 pp 1053–6
- Johansson A, Oberg P A and Sedin G 1999 Monitoring of heart and respiratory rates in newborn infants using a new photoplethysmographic technique *J. Clin. Monit. Comput.* **15** 461–7
- Kamlin C O F, Dawson J A, O'Donnell C P F, Morley C J, Donath S M, Sekhon J and Davis P G 2008 Accuracy of pulse oximetry measurement of heart rate of newborn infants in the delivery room *J. Pediatr.* **152** 756–60
- Kamlin C O F, O'Donnell C P F, Davis P G and Morley C J 2006 Oxygen saturation in healthy infants immediately after birth *J. Pediatr.* **148** 585–9
- Katheria A, Rich W and Finer N 2012 Electrocardiogram provides a continuous heart rate faster than oximetry during neonatal resuscitation *Pediatrics* **130** E1177–81
- Leone T A, Rich W and Finer N N 2006 A survey of delivery room resuscitation practices in the United States *Pediatrics* **117** E164–75
- Maeda Y, Sekine M and Tamura T 2011 Relationship between measurement site and motion artifacts in wearable reflected photoplethysmography *J. Med. Syst.* **35** 969–76
- Mann C, Ward C, Grubb M, Hayes-Gill B, Crowe J, Marlow N and Sharkey D 2012 Marked variation in newborn resuscitation practice: a national survey in the UK *Resuscitation* **83** 607–11
- Nitzan M, Babchenko A, Khanokh B and Landau D 1998 The variability of the photoplethysmographic signal—a potential method for the evaluation of the autonomic nervous system *Physiol. Meas.* **19** 93
- Patel D, Piotrowski Z H, Nelson M R and Sabich R 2001 Effect of a statewide neonatal resuscitation training program on apgar scores among high-risk neonates in Illinois *Pediatrics* **107** 648–55
- Perlman JM *et al* 2010 Special report-neonatal resuscitation: 2010 international consensus on cardiopulmonary resuscitation and emergency cardiovascular care science with treatment recommendations *Pediatrics* **126** E1319–44
- Robertson N J 2005 Air or 100 decide *Crit. Care* **9** 128–30

- Rusch T L, Sankar R and Scharf J E 1996 Signal processing methods for pulse oximetry *Comput. Biol. Med.* **26** 143–59
- Saugstad O D, Ramji S, Rootwelt T and Vento M 2005 Response to resuscitation of the newborn: early prognostic variables *Acta Paediatr.* **94** 890–5
- Singh J K S B, Kamlin C O F, Morley C J, O'Donnell C P F, Donath S M and Davis P G 2008 Accuracy of pulse oximetry in assessing heart rate of infants in the neonatal intensive care unit *J. Paediatr. Child Health* **44** 273–5
- Theophilopoulos D T and Burchfield D J 1997 Accuracy of different methods for heart rate determination during simulated neonatal resuscitations *J. Perinatol.* **18** 65–7
- Tur E, Tur M, Maibach H I and Guy R H 1983 Basal perfusion of the cutaneous microcirculation: measurements as a function of anatomic position *J. Invest. Dermatol.* **81** 442–6
- Voogdt K G, Morrison A C, Wood F E, van Elburg R M and Wyllie J P 2010 A randomised, simulated study assessing auscultation of heart rate at birth *Resuscitation* **81** 1000–3
- Whyte S D, Sinha A K and Wyllie J P 1999 Neonatal resuscitation—a practical assessment *Resuscitation* **40** 21–25