

PHYSIOLOGIC AND PHARMACOLOGIC PROPERTIES  
OF NORMAL AND DYSTROPHIC MUSCLE IN THE  
DOMESTIC FOWL (GALLUS DOMESTICUS)

CENTRE FOR NEWFOUNDLAND STUDIES

TOTAL OF 10 PAGES ONLY  
MAY BE XEROXED

(Without Author's Permission)

SUSAN ELLEN HOWLETT



007290





PHYSIOLOGIC AND PHARMACOLOGIC  
PROPERTIES OF NORMAL AND DYSTROPHIC MUSCLE  
IN THE DOMESTIC FOWL (GALLUS DOMESTICUS)

BY

Susan E. Howlett, B.Sc.(Hons.), M.Sc. ©

A thesis submitted to the School of Graduate  
Studies in partial fulfillment of the  
requirements for the degree of  
Doctor of Philosophy

Faculty of Medicine  
Memorial University of Newfoundland

February, 1985

St. John's, Newfoundland

Canada

ABSTRACT

fi

This study examined some physiologic and pharmacologic properties of normal and dystrophic chicken muscle. The pathogenesis of muscular dystrophy is unknown, and several competing hypotheses have been proposed. As recent evidence suggests that it may be linked to a muscle membrane defect, these studies are of interest in assessing the functional state of dystrophic muscle membranes.

The contractile responses to intra-arterial injections of acetylcholine, carbachol, potassium chloride, caffeine and neostigmine were examined in innervated and denervated in vivo extensor digitorum communis (EDC) muscle preparations from normal and dystrophic chickens. In addition, the electrophysiologic properties of this preparation were characterized in normal and dystrophic muscles. The pharmacologic responses to serotonin and noradrenalin were assessed in in vitro ischiatic artery preparations of the chicken.

Sensitivity to acetylcholine was reduced in dystrophic muscle, although this appears to be associated with enhanced hydrolysis of acetylcholine in dystrophic muscle. The development of extrajunctional acetylcholine sensitivity in denervated dystrophic muscle was also reduced when compared to normal muscle. Denervated dystrophic muscle did not exhibit denervation atrophy. In the disease

group, the duration of the intracellular action potential was increased. The results also suggested that the dystrophic ischiatic artery was less sensitive to serotonin than was normal muscle.

This study supports the hypothesis that the functional state of the dystrophic muscle membrane is altered in the muscular dystrophies. The defect may also be present in the vascular smooth muscle of dystrophic chickens.

Keywords: chicken, muscular dystrophy, smooth muscle, electrophysiology, denervation, pharmacology, contractile physiology.

DEDICATION

This thesis is dedicated to the memory of

Anne-Marie Howlett

December 20, 1962 - October 19, 1982



## ACKNOWLEDGEMENTS

To my supervisor, Dr. Ted Hoekman, for his congenial help and encouragement throughout my graduate training, I express my sincere thanks. The members of my supervisory committee, Dr. Detlef Bieger and Dr. Sue White, have also been invaluable. They always had time to discuss my research, offering valuable comments and new insights.

I would like to express special thanks to Dr. Chris Trigg. He has been ever willing to provide advice on a wide range of topics. In addition, I would like to thank Dr. Dave Bryant for his patient help with the statistical analysis of these data.

To Mrs. Sheila Stuart, who keeps track of the graduate students, my sincere thanks.

I am indebted to Jim Ross and the animal care staff for the time and effort they devoted to the maintenance of our breeding flocks. The staff in Medical Audio-Visual Services were also extremely helpful.

This research would not have been possible without funding. The Muscular Dystrophy Association of Canada, Memorial University of Newfoundland and the Faculty of Medicine generously provided financial support.

Finally, I would like to express my heartfelt thanks to my husband, Ken, for his support and good humor during

the production of this thesis and also for his help reading  
earlier drafts of this manuscript.

Portions of this thesis have been previously published:

HOEKMAN, T.B., V.J. UMANEE, S.E. HOWLETT, AND P.A. REDFERN. 1980. A comparison of contractures of a fast twitch muscle in normal and dystrophic chickens following close intra-arterial injection of depolarizing drugs. The Pharmacologist 22: 180.

HOWLETT, S.E., AND T.B. HOEKMAN. 1981. An in vivo electrophysiologic study of the indirectly-elicited action potential in dantrolene sodium-attenuated extensor digitorum communis muscles of normal and dystrophic chickens. The Pharmacologist 23: 143.

HOWLETT, S.E., AND T.B. HOEKMAN. 1983a. Neural regulation of dystrophic avian muscle. The 12th Annual Meeting of the Society for Neuroscience. Abstract #273.7.

HOWLETT, S.E., AND T.B. HOEKMAN. 1983b. Sex differences in the phenotypic expression of avian dystrophy. Exp. Neurol. 81: 50-63.

HOWLETT, S.E., P.A. REDFERN, V.J. UMANEE, AND T.B. HOEKMAN. 1980. A new nerve-muscle preparation for the study of pharmacologic responses in dystrophic chickens. The Pharmacologist 22: 180.

## TABLE OF CONTENTS

	Page
ABSTRACT.....	ii
DEDICATION.....	iv
ACKNOWLEDGEMENTS.....	v
TABLE OF CONTENTS.....	viii
LIST OF ILLUSTRATIONS.....	xii
LIST OF TABLES.....	xv
LIST OF ABBREVIATIONS.....	xvi
 I INTRODUCTION	
1.1 Background.....	1
1.1.1 The human muscular dystrophies.....	1
1.1.2 Murine dystrophy.....	5
1.1.3 Avian dystrophy.....	6
1.1.4 Hamster dystrophy.....	7
1.2 Contemporary Hypotheses.....	8
1.2.1 Myogenic vs. neurogenic.....	8
1.2.2 The vascular hypothesis.....	14
1.2.3 The membrane defect theory.....	17
1.2.4 A maturational defect.....	29
1.3 The Rationale for the Present Studies.....	35
 II MATERIALS AND METHODS	
2.1 General Methods.....	39
2.1.1 Chickens.....	39

2.1.2	Clinical assessment.....	39
2.2	The EDC <u>In Vivo</u> Preparation.....	40
2.2.1	General surgery.....	40
2.2.2	Arterial cannulation.....	43
2.2.3	Immobilization of the preparation.....	49
2.2.4	Mechanical and electrical circuits.....	52
2.2.5	Experimental protocol.....	55
2.2.6	Intra-arterial cannulation technique.....	56
2.2.7	Measurements.....	57
2.2.8	Statistics.....	61
2.3	Denervation Experiments.....	62
2.3.1	Denervation.....	62
2.3.2	General surgery and experimental protocol.....	63
2.4	Electrophysiology.....	64
2.4.1	General surgery.....	64
2.4.2	Electrophysiologic recording.....	64
2.4.3	Experimental protocol.....	65
2.4.4	Measurements.....	66
2.4.5	Statistics.....	69
2.5	Smooth Muscle <u>In Vitro</u> Experiments.....	70
2.5.1	General preparation.....	70
2.5.2	Experimental protocol.....	70
2.5.3	Measurements and statistics.....	76
2.6	Drugs and Reagents.....	77

III RESULTS

3.1 Muscle Pharmacology..... 79

3.1.1 Physical Data..... 79

3.1.2 Control Experiments..... 82

3.1.3 Acetylcholine responses..... 85

3.1.4 Carbachol responses..... 104

3.1.5 Potassium chloride responses..... 106

3.1.6 Caffeine responses..... 107

3.1.7 Neostigmine responses..... 108

3.2 Denervated Muscle..... 108

3.2.1 Physical Data..... 108

3.2.2 Control Experiments..... 114

3.2.3 Acetylcholine responses..... 114

3.2.4 Potassium chloride responses..... 138

3.2.5 Caffeine responses..... 140

3.3 Electrophysiology..... 141

3.3.1 Physical Data..... 141

3.3.2 Dantrolene sodium..... 141

3.3.3 Action potential characteristics..... 145

3.4 Smooth Muscle..... 158

3.4.1 Physical Data..... 158

3.4.2 Control experiments..... 158

3.4.3 Pharmacologic responses..... 159

## IV DISCUSSION

4.1	Muscle Pharmacology.....	171
4.1.1	Physical characteristics.....	171
4.1.2	Acetylcholine and carbachol responses.....	175
4.1.3	Potassium sensitivity.....	180
4.1.4	Caffeine sensitivity.....	182
4.1.5	Dantrolene sodium sensitivity.....	185
4.2	Denervation Studies:.....	186
4.2.1	The effects of denervation.....	186
4.2.2	Physical characteristics.....	188
4.2.3	Acetylcholine sensitivity.....	190
4.2.4	Caffeine sensitivity.....	191
4.2.5	Potassium sensitivity.....	192
4.4	Electrophysiology.....	193
4.4.1	Physical characteristics.....	193
4.4.2	Action potential characteristics.....	193
4.5	Smooth Muscle.....	198
4.5	General Discussion.....	202
4.6	Summary.....	205
4.7	Future Experiments.....	206
	REFERENCES.....	208

## LIST OF FIGURES

Figure		Page
1.1	Duchenne's original case of / pseudohypertrophic muscular dystrophy.....	3
2.1	Dorsal aspect of the wing of the fowl.....	42
2.2	The cannula used for intra-arterial injection.....	46
2.3	Ventral aspect of the wing illustrating the procedure for cannulation of the ulnar artery.....	48
2.4	Experimental apparatus for the <u>in vivo</u> extensor digitorum communis muscle preparation.....	51
2.5	Position of the wing in the experimental apparatus.....	54
2.6	Pharmacologic responses of the <u>in vivo</u> extensor digitorum communis muscle preparation.....	60
2.7	Action potential data record and analysis.....	68
2.8	Experimental apparatus for the isolated vascular smooth muscle experiments.....	72
2.9	Cumulative concentration-response curves for chicken ischiatic artery.....	74
3.1	The effects of intra-arterial and intra- venous injections of drugs on blood pressure and muscle contraction.....	84
3.2	The dose-response curves for the twitch ratio vs. the dose of acetylcholine.....	87
3.3	The dose-response curves for the twitch ratio vs. an extended dose range of: acetylcholine.....	89
3.4	The dose-response curves for the contracture amplitude vs. the dose of acetylcholine.....	91



3.5	The dose-response curves for the twitch ratio vs. the dose of carbachol.....	93
3.6	The dose-response curves for the contracture amplitude vs. the dose of carbachol.....	95
3.7	The dose-response curves for the twitch ratio vs. the dose of potassium chloride.....	97
3.8	The dose-response curves for the contracture amplitude vs. the dose of potassium chloride.....	99
3.9	The dose-response curves for the twitch ratio vs. the dose of caffeine.....	101
3.10	The dose-response curves for the contracture amplitude vs. the dose of caffeine.....	103
3.11	Innervated vs. denervated muscle for the female group only. The dose-response curves for the twitch ratio vs. the dose of acetylcholine.....	117
3.12	Innervated vs. denervated muscle for the male group only. The dose-response curves for the twitch ratio vs. the dose of acetylcholine.....	119
3.13	Innervated vs. denervated muscle for the female group only. The dose-response curves for the contracture amplitude vs. the dose of acetylcholine.....	121
3.14	Innervated vs. denervated muscle for the male group only. The dose-response curves for the contracture amplitude vs. the dose of acetylcholine.....	123
3.15	Innervated vs. denervated muscle for the female group only. The dose-response curves for the twitch ratio vs. the dose of potassium chloride.....	125
3.16	Innervated vs. denervated muscle for the male group only. The dose-response curves for the twitch ratio vs. the dose of potassium chloride.....	127

- 3.17 Innervated vs. denervated muscle for both male and female groups. The dose-response curves for contracture amplitude vs. the dose of potassium chloride..... 129
- 3.18 Innervated vs. denervated muscle for the female group only. The dose-response curves for the twitch ratio vs. the dose of caffeine..... 131
- 3.19 Innervated vs. denervated muscle for the male group only. The dose-response curves for the twitch ratio vs. the dose of caffeine..... 133
- 3.20 Innervated vs. denervated muscle for both male and female groups. The dose-response curves for contracture amplitude vs. the dose of caffeine..... 135
- 3.21 Dantrolene sodium dose-response curve..... 144
- 3.22 Representative action potentials recorded from normal and dystrophic muscle cells..... 147
- 3.23 Frequency distribution of resting membrane potentials recorded from normal and dystrophic muscle fibres..... 149
- 3.24 Frequency distribution of the action potential rate of rise recorded from normal and dystrophic muscle fibres..... 151
- 3.25 Frequency distribution of the action potential amplitude recorded from normal and dystrophic muscle fibres..... 153
- 3.26 Frequency distribution of the action potential duration at half the maximum amplitude recorded from normal and dystrophic muscle fibres..... 155
- 3.27 The concentration-response curve for the percent maximum response vs. the dose of serotonin in the ischiatic artery..... 163
- 3.28 The concentration-response curve for the percent maximum response vs. the dose of noradrenalin in the ischiatic artery..... 165

## LIST OF TABLES

Table	Page
I. Physical Characteristics of Normal and Dystrophic Chickens: The Effects of Sex and Disease.....	80
II. ED <sub>50</sub> AND ID <sub>50</sub> Values of Normal and Dystrophic Muscle.....	105
III. Physical Characteristics of Normal and Dystrophic Chickens: Denervation Effects on the Female Group.....	109
IV. Physical Characteristics of Normal and Dystrophic Chickens: Denervation Effects on the Male Group.....	110
V. ED <sub>50</sub> Values of Normal and Dystrophic Muscle: Innervated vs. Denervated Muscle.....	137
VI. Physical Characteristics of Normal and Dystrophic Chickens: Electrophysiology Group.....	142
VII. Estimates for the Action Potential Characteristics.....	157
VIII. Physical Characteristics of Normal and Dystrophic Chicken Ischiatic Artery.....	160
IX. 5-HT vs. Ketanserin - EC <sub>50</sub> Values and Dose Ratios.....	166
X. NA vs. Prazosin - EC <sub>50</sub> Values and Dose Ratios.....	168
XI. Ketanserin and Prazosin - pA <sub>2</sub> Values.....	169

## LIST OF ABBREVIATIONS

ACh	:	acetylcholine
AChE	:	acetylcholinesterase
ALD	:	anterior latissimus dorsi muscle
CAF	:	caffeine
CARB	:	carbachol
DF	:	dystrophic female chicken
DM	:	dystrophic male chicken
EC <sub>50</sub>	:	concentration of drug producing 50% of the maximum response
EC <sub>100</sub>	:	concentration of drug producing 100% response
ED <sub>50</sub>	:	dose of drug producing 50% of the maximum response
EDC	:	extensor digitorum communis muscle
EMG	:	electromyogram
5-HT	:	serotonin
ID <sub>50</sub>	:	dose of drug producing 50% of the maximum inhibitory response.
KCl	:	potassium chloride
l <sub>0</sub>	:	resting length of the muscle
NA	:	noradrenalin
NEO	:	neostigmine
NF	:	normal female chicken
NM	:	normal male chicken
P	:	maximum twitch tension
P <sub>0</sub>	:	maximum tetanic tension
PLD	:	posterior latissimus dorsi muscle

SR : sarcoplasmic reticulum  
U<sub>1</sub> : neuronal uptake  
U<sub>2</sub> : extraneuronal uptake

## CHAPTER I

### INTRODUCTION

#### 1.1 Background

1.1.1 The human muscular dystrophies. The muscular dystrophies are a group of genetic diseases of unknown pathogenesis which are characterized by progressive muscle cell degeneration and muscle weakness. The first brief clinical description of muscular dystrophy in man was published by Bell in 1830 (Ogg, 1971). Meryon (1852) detailed several cases, in one kinship, of a hereditary muscle disease restricted to males, a disorder now called Duchenne muscular dystrophy. He commented that the lack of either central or peripheral nervous system involvement suggested the disease was a primary myopathy and not secondary to an underlying neuropathy. Duchenne (1868) provided the classic description of pseudohypertrophic muscular paralysis, emphasizing the enlarged muscles (see Figure 1), particularly those of the calf, and presence of mental retardation in his affected patient. Around the turn of the century a number of reports were published describing various muscular dystrophies, limb-girdle

Figure 1.1 Duchenne's original case of pseudohypertrophic muscular dystrophy. Note the pelvic lordosis and enlarged calf muscles (figure reprinted from Tyler, K.L. and McHenry, L.C.: Pseudohypertrophic muscular dystrophy and Gower's sign. Neurology, 33: 88-89, 1983)

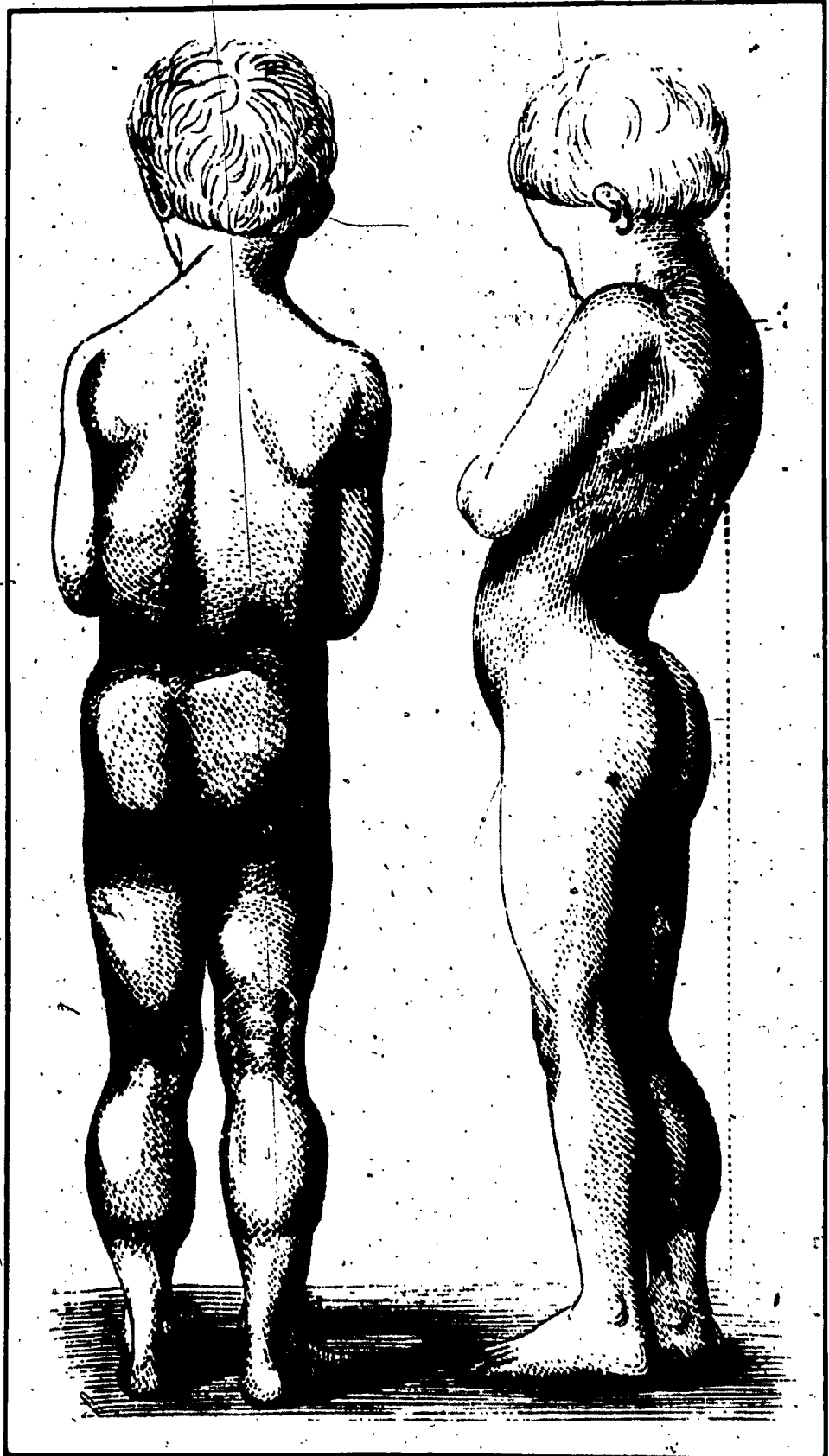



(Leyden, 1876), scapulohumeral (Erb, 1884), ocular (Hutchinson, 1879) distal (Gowers, 1902) and myotonic (Steinert, 1909), each with a characteristic pattern of inheritance, age of onset, rate of progression and distribution of affected muscles.

Further advances in the study of muscular dystrophy resulted from the development and refinement of such diagnostic tests as the measurement of creatine kinase levels in the serum (Ebashi, Toykura, Momoi & Sugita, 1959), sensitive EMG recordings (Adrian & Bronk, 1929) and muscle histochemistry which, according to Dubowitz, "...has probably contributed more to our understanding of neuromuscular disorders in the past 10 years than conventional histology in the previous hundred..."

(Dubowitz, 1974). Furthermore, the recognition of several animal models of dystrophy greatly facilitated research efforts. Although muscular dystrophy has been described in the chicken, mouse, hamster, sheep, dog, turkey, duck, mink and cow (Harris & Slater, 1980); only the mouse, chicken and hamster models have been extensively examined.

This review is not intended as an exhaustive survey of the extensive body of literature in the area of muscular dystrophy research. Major theories, advanced over the past twenty-five years to explain the etiology of the muscular dystrophies, will be considered. Emphasis will be placed on studies with animal models, in particular, the

dystrophic chicken model, as the review is designed to introduce the reader to studies which are relevant to the work reported here.

1.1.2 Murine dystrophy. The dystrophic mouse (dy), described by Michelson, Russell and Harman (1955) was the first animal model of muscular dystrophy. The mutant was expressed in an inbred strain of Bar Harbour mice (strain 129/RE). Paralysis and ataxia, particularly of the hindlimbs, are the most conspicuous clinical signs of the disease (Michelson et al., 1955). Other characteristics of the disorder include autosomal recessive inheritance (Michelson et al., 1955), myotonia (Silverman & Atwood, 1980a), preferential involvement of the fast twitch fibres (Butler & Cosmos, 1977) and early death. In addition, amyelination of the peripheral nerves occurs in murine dystrophy (Bradley & Jenkinson, 1973) although the degree to which this contributes to the pathogenesis of the disease is still unclear (Parry & Desypris, 1983). A second mouse mutant (dy<sup>2j</sup>) was described by Meier and Southard (1970). This appears to be a variant of the original mutant (dy) with a milder course and with preferential involvement of the slow twitch fibres (Butler & Cosmos, 1977). The dy<sup>2j</sup> model is now widely used as these mice are capable of spontaneous breeding, obviating the need for ovary transplants which were required to

reproduce the old dy mutant. Heterozygous and homozygous littermates are used as controls.

1.1.3 Avian dystrophy. Muscular dystrophy of the domestic fowl was first described by Asmundson and Julian (1956). The disease occurred as a spontaneous mutation in an inbred line of meat-producing New Hampshire chickens which were selected for heavy pectoral muscles. The earliest symptom of avian dystrophy is the progressive inability of affected chickens to right themselves when placed in the supine position (Entrikin, Patterson, Weidoff & Wilson, 1978). The disease is characterized by progressive muscle necrosis and fat replacement (Julian & Asmundson, 1963), preferential involvement of twitch fibres and sparing of slow tonic fibres (Cosmos, 1966; Cosmos & Butler, 1967), autosomal recessive inheritance (Asmundson & Julian, 1956), myotonia (Holliday, Van Meter, Julian & Asmundson, 1965) and a relatively normal lifespan (Wilson, Randall, Patterson & Entrikin, 1979). A second major line of dystrophic chickens was produced when members of the original mutation were crossed with white leghorn chickens to produce the Storr's line (Cosmos, Butler, Mazlish & Allard, 1980). Genetically unrelated white leghorn chickens are commonly used as the control for this model. This represents a limitation of the Storr's model of avian dystrophy, particularly with respect to biochemical

7

studies, as Rushbrook, Yuan & Stracher (1982) have shown that differences in myosin isoenzymes between normal and dystrophic chicken muscles are actually strain differences. The use of genetically-matched lines of normal and dystrophic New Hampshire chickens, however, minimizes this problem.

1.1.4 Hamster dystrophy. The dystrophic hamster model was first described in an inbred colony of Syrian hamsters by Homburger, Baker, Nixon & Whitney (1962). The authors remarked upon the polymyopathic nature of the disease, with both cardiac and skeletal muscle showing severe necrotic changes. Since this original report, the dystrophic hamster has been used to study the mechanisms of myopathy in both cardiac and skeletal muscle (Homburger, 1979). Early clinical diagnosis of the disease is made by measurement of plasma creatine kinase levels, biopsy, early fatigue (Homburger, Nixon, Eppenburger & Baker, 1966) or the presence of focal areas of myolysis on the lower surface of the tongue (Handler, Russfield & Homburger, 1975). Hamster dystrophy is characterized by autosomal recessive inheritance, progressive necrosis of cardiac and skeletal muscle fibres and premature death (Homburger, 1979). Several lines of dystrophic hamsters are maintained and genetically related controls are available.

## 1.2 Contemporary Hypotheses

1.2.1 Myogenic vs. neurogenic. Early clinicians described muscular dystrophy as a primary myopathy, recognizing that although the clinical presentation of disease resembled spinal motor atrophy, there was no evidence to suggest an underlying neuropathy. This idea prevailed for approximately 70 years despite reports of a high incidence of mental retardation in patients with both myotonic and Duchenne muscular dystrophies (Walton & Gardner-Medwin, 1974). Dubowitz (1969) commented on this finding and, coupled with his observations that dystrophic muscle fibres degenerate in groups, suggested that dystrophy developed as a result of a primary neuropathy. At an early stage the controversy was cast, perhaps unfortunately, in "myogenic" versus "neurogenic" terms.

Despite the application of new techniques to test this hypothesis, the issue remains unresolved. In 1970, McComas, Sica & Currie introduced incremental stimulation of the nerve, a technique for estimating the number of motor units in a muscle. These were reduced in patients with all types of muscular dystrophy. The absence of pathologic change in the motor neurons suggested that in dystrophy they were "sick" rather than dead (McComas, Sica & Campbell, 1971). This hypothesis, known as the "sick" motor neuron hypothesis, sparked a lively debate about the

nature of the primary defect in muscular dystrophy. The incremental stimulation technique has been harshly criticised (Feasby & Brown, 1974; Parry, Mainwood & Chan, 1977) and is not now commonly used. Parry and his colleagues, however, using both horseradish peroxidase labelling and ventral root splitting, demonstrated a reduction in the number of motor units in dystrophic mice (Parry, McHanwell & Haas, 1982; Bateson & Parry, 1983).

Tissue transplant studies have been frequently used to support both myogenic and neurogenic theories of muscular dystrophy. Using the minced muscle technique, Salafsky (1971) and Hironaka & Miyata (1975) transplanted normal mouse muscle mince into dystrophic hosts and dystrophic muscle mince into normal hosts. Each transplant developed the characteristics of the host, suggesting that a neurogenic or at least a non-muscle factor influenced the development of dystrophy.

Cosmos (1973), however, employed similar techniques with dystrophic chickens and showed that the donor muscle retained its characteristics. Normal regenerates in dystrophic chickens did incorporate abnormal cells with time but, following the myogenic hypothesis, this was attributed to the failing environment of the dystrophic host. Moreover, normal muscle grafted into young dystrophic mice improved the structure and function of the dystrophic muscle (Laird & Timmer, 1965; Law & Yap, 1979).

Recently, however, Hironaka, Ikari, Miyata, Morimoto & Tsunoo (1984a), noted that whole muscle transplants of neonatal chicken muscle assumed the phenotypic characteristics of the host. These findings, complimentary to the neurogenic hypothesis, were in accordance with earlier embryo studies suggesting that dystrophic neural tubes transplanted into normal chick embryos induced dystrophic changes in the normal muscles (Rathbone, Stewart & Vetrano, 1975). Yet it is also known that limb-bud transplants between normal and dystrophic chick embryos, however, develop the phenotype of the donors supporting the idea that the defect is myogenic in origin (Linkhart, Yee & Wilson, 1975; Linkhart, Yee, Nieberg & Wilson, 1976).

One problem inherent in the transplant studies is that muscle introduced into a dystrophic host encounters an environment where synergist and antagonist muscles are degenerating. This may result in improper muscle stretch and consequent growth abnormalities. To circumvent this difficulty, parabiotic pairs of mice, in which the normal and dystrophic muscles are cross-reinnervated, have been studied. These studies have failed to support the neurogenic hypothesis; the phenotype of the muscle is not altered by the innervation (Douglas, 1975; Law, Cosmos, Butler & McComas, 1976; Law, 1977).

One elegant approach, which overcomes the problems of the transplant studies, examines mouse chimeras derived from the aggregation of normal and dystrophic embryos.

These chimeras have genetic characteristics of both normal and dystrophic mice. Using an isoenzyme marker to tag genetically normal and dystrophic cells, Peterson (1974) has demonstrated the absence of disease in genetically dystrophic muscle and its presence in genetically normal muscle. One explanation for the absence of disease in genetically dystrophic muscle is found in the work of Law (1982). He has shown that normal limb-bud mesenchyme transplanted into dystrophic muscle successfully competes with the host tissue and dramatically improves muscle structure and function. Possibly, normal mesenchyme in the mouse chimera survives in preference to the dystrophic tissue but it is important to note that this does not explain the presence of dystrophic features in genetically normal muscle.

Tissue culture techniques have been used to assess the involvement of nerve and muscle in the pathogenesis of dystrophy. The results of these studies support the myogenic hypothesis. Data from these experiments show that cultured dystrophic muscle fails to respond to the trophic influence of either normal sciatic nerve extract (Johnson, Bailey & Wenger, 1981) or extract prepared from normal sympathetic ganglia (Kobayashi, Tsukagoshi & Shimizu, 1982).

Others have studied the rate of axonal transport in normal and dystrophic peripheral nerves to elucidate the nature of the primary defect in muscular dystrophy. Here



too the results have been equivocal. Although some studies report altered anterograde axonal transport in the dystrophic mouse (Bradley & Jaros, 1973; Komiya & Austin, 1974; Brimijoin & Schreiber, 1982), anterograde and retrograde axoplasmic transport are not abnormal in the nerves of either the dystrophic chicken (DeSantis, Hoekman & Limwongse, 1977; DiGiamberardino, Couraud & Barnard, 1979; Stromska, Ochs & Muller, 1981) or the dystrophic hamster (Boegman & Wood, 1981). Recently, however, Behrens, Torrealba, Court, Soza & Ramirez (1983) reported reduced axonal transport in one patient with myotonic dystrophy.

The foregoing discussion considered the involvement of the peripheral nervous system in dystrophy. Researchers have also examined the central nervous system of normal and dystrophic chickens. Using recording techniques, Stokes (1977) found that the activity pattern in the brachial spinal cord of dystrophic chick embryos was reduced when compared to the pattern recorded in the normal spinal cord. The number of neurons in the brachial spinal cord of both dystrophic chickens (Susheela, Seraydarian & Abbott, 1980) and chick embryos (Murphy, 1982) is increased when compared to normal chickens. These findings are evidently still in dispute as another study reports no difference in motor neuron survival between normal and dystrophic chickens (Oppenheim, Rose & Stokes, 1982).

Although the neurogenic hypothesis arose from very

early studies reporting a high incidence of mental retardation in dystrophy patients, few studies have examined the brains of dystrophic animals. Frostholm, Baudry & Bennett (1981) reported increased calcium accumulation by brain mitochondria from dystrophic mice. The numbers of both beta-adrenergic binding sites (Wilkinson & Khan, 1982) and alpha<sub>2</sub>-adrenergic binding sites (Wilkinson & Manchester, 1983) are reduced in brain homogenates from mice with muscular dystrophy, although the authors suggest that these differences may be attributed to differences in general health and body weight rather than disease. These studies considered whole brain homogenates; future experiments pinpointing changes to specific brain regions and nuclei should serve to clarify these findings. This approach has recently been employed by Wilkinson (1984) who reported altered gonadotropin release from the pituitaries of both dystrophic hamsters and dystrophic mice. Abnormalities of the reproductive system are commonly associated with human myotonic dystrophy (Harper, 1979).

The role of the nervous system in the pathogenesis of muscular dystrophy remains unclear. Evidence supporting the neurogenic hypothesis of muscular dystrophy has not been discredited and recent studies continue to support this idea. By contrast, other reports, equally credible, indicate that the defect is myogenic. A defect common to

both nerve and muscle therefore seems reasonable. As knowledge about the nature of the intimate relationship between muscle and nerve is expanded, the reasons for the controversy should become apparent.

1.2.2 The vascular hypothesis. Desmos (1961) first proposed that the primary defect in muscular dystrophy originated in the vascular system. Based upon his observations that the tongue-to-arm circulation times were slowed in both Duchenne patients and carriers, he proposed that chronic anoxia triggered muscle necrosis. Hathaway, Engel and Zellweger (1970) expanded this idea proposing that the characteristic foci of degenerating fibres in Duchenne dystrophy resembled a muscle infarct. They demonstrated that muscle lesions similar to those seen in Duchenne muscular dystrophy are produced in normal rabbit muscle by injecting Sephadex beads into the artery supplying the muscle (Hathaway *et al.*, 1970).

Similar observations have followed. Arterial ligation coupled with injections of vasoconstrictors, either serotonin (5-HT), or noradrenalin (NA), produces lesions similar to those seen in dystrophy (Engel & Derreg, 1975). Parker and Mendell (1974) showed that imipramine, a 5-HT uptake inhibitor, also produced muscle damage. Furthermore, functional alterations of vascular adrenergic receptors in the blood vessels supplying skeletal muscle

are present in dystrophy patients (Mechler, Mastaglia, Haggith & Gardner-Medwin, 1980; Mechler & Mastaglia, 1981).

Support for this hypothesis is also found in animal studies. In the dystrophic chicken, chronic 5-HT injections exacerbate the onset of clinical signs of dystrophy and 5-HT antagonists significantly delay the onset of the disease (Hudecki, Pollina, Bhargava & Hudecki, 1980). Moreover, Hunter and Elbrink (1983) showed increased contractility in response to a variety of agonists in isolated strips of aorta from dystrophic hamsters.

Studies supporting the vascular hypothesis, however, have been criticised. Munsat, Hudgson and Johnson (1977) questioned the degree to which ischemic muscle lesions resemble those in muscular dystrophy. In addition, compromised blood flow to the skeletal muscles of patients with muscular dystrophy has not been demonstrated (Bradley, O'Brien, Walder, Murchison, Johnson & Newell, 1975; Leinonen, Juntunen, Somer & Rapola, 1979). Furthermore, there is no evidence for increased serum levels of biogenic amines in dystrophy patients (Mendell, Murphy & Engel, 1972).

Morphologic investigations of the blood vessels in dystrophic muscle have not been supportive of the vascular hypothesis. Although abnormal capillary structure is present in muscle from patients with Duchenne dystrophy,

similar abnormalities have been reported for a wide range of disease states (Leinonen et al., 1979; Fidzianska, Goebel, Kosswig & Burch, 1984). Moreover, the number of capillaries per muscle fibre is actually increased in dystrophic mouse muscle (Burch, Prewitt & Law, 1981; Atherton, Cabric & James, 1982).

There is still controversy regarding the role of purported vascular abnormalities in the pathogenesis of muscular dystrophy. It is clear that vascular lesions are capable of producing muscle fibre necrosis, however, muscles respond to a host of challenges with necrosis. For example, alcoholism (Martin, Slavin & Levi, 1982), malnutrition (Dastur, Manghani, Osuntokun, Sourander & Kondo, 1982), excessive strength training exercise (Salminen & Vihko, 1983), pharmacologic substances such as corticosteroids (Braunstein & DeGirolami, 1981) and denervation (Stracher, McGowan, Hedrych & Shafiq, 1979) all produce muscle fibre necrosis.

Furthermore, many reports suggest that muscular dystrophy may involve not only skeletal and cardiac muscle but smooth muscle (Nowak, Ionasescu & Anura, 1982; Nowak, Anuras, Brown, Ionasescu & Green, 1984; Bodensteiner & Grunow, 1984) and perhaps non-muscle tissues as well (see section 1.2.5). Based on current knowledge it would not be unreasonable to expect the primary muscle defect to be expressed in vascular smooth muscle. The presence of

abnormalities in vascular smooth muscle from either dystrophic patients or dystrophic animals does not necessarily support the vascular theory of muscular dystrophy.

1.2.3 The membrane defect theory. The membrane defect theory evolved rather slowly. Originally, the evidence linking muscular dystrophy to altered membrane function was not compelling. Observations that elevated levels of enzymes characteristically found in muscle were present in the serum of dystrophy patients suggested that the muscle membrane might be abnormally permeable.

The first study linking abnormal membrane function to Duchenne dystrophy was reported by Sibley and Lehninger (1949). They showed that serum aldolase levels from patients with Duchenne dystrophy were substantially elevated when compared to normal. The significance of these findings was, however, first recognized by Schapira, Dreyfus and Schapira (1953) who reported elevated serum aldolase levels in all the Duchenne dystrophy patients they examined.

These studies were the impetus for many subsequent reports of elevated "muscle" enzyme levels in the serum of dystrophy patients. The levels of lactate dehydrogenase (Wieme & Herpol, 1962); creatine kinase (Ebashi *et al.*, 1959) and other enzymes (Munsat, Baloh, Pearson & Fowler,

197) are increased in the serum of patients with muscular dystrophy. Increased serum enzymes are also present in the dystrophic chicken (Farrell, Eyerman & Tureen, 1966; Barnard & Barnard, 1979; Liu, Barnard & Barnard, 1980), the dystrophic mouse (Stamp & Lesker, 1967) and the dystrophic hamster (Homburger et al., 1966; Barnard & Barnard, 1979; Liu et al., 1980).

These results suggested to proponents of the membrane defect theory that the inherited defect might involve an abnormally "leaky" sarcolemma. The evidence for the membrane defect theory in the human dystrophies has been reviewed (Rowland, 1980; Lucy, 1980; Jones & Witkowski, 1983) hence only recent studies on humans and animals will be emphasized here.

The data in support of the membrane defect theory suggest that the sarcolemma is either physically disrupted or abnormally permeable (Rowland, 1980). The concept of physical disruption of the sarcolemma is supported by the presence of "delta" lesions (plasma membrane disruption) in the sarcolemma of the non-necrotic muscle fibres of patients with Duchenne dystrophy (Mokri & Engel, 1975; Wakayama, Bonilla & Schotland, 1983). In the mouse model, however, delta lesions were present only in dying muscle cells (Shivers & Atkinson, 1984).

Other structural changes are present in the plasma membranes of patients with muscular dystrophy. Using

freeze-fracture techniques, the number of intra-membrane particles (integral membrane proteins) has been shown to be altered in both the protoplasmic (P) and external (E) faces of dystrophic muscle membranes (Shotton, 1982). This decrease in the number of integral membrane proteins may be an early sign of a membrane abnormality which precedes the formation of focal membrane lesions. Furthermore, the number of caveolae, which may be associated with the t-tubule network, are increased in dystrophic human muscle (Bonilla, Fischbeck & Schotland, 1981). Capaldi, Dunn, Sewry & Dubowitz (1984) have shown that lectin binding to dystrophic plasma membranes is reduced and suggest that a structural abnormality may account for this difference.

Large molecules which do not penetrate normal muscle are readily incorporated into dystrophic muscles, supporting the notion of a membrane defect in muscular dystrophy. Molecules such as horseradish peroxidase (Morki & Engel, 1975) and procion yellow (Bradley & Fulthorpe, 1978) are readily incorporated into the muscle fibres of DMD patients. Horseradish peroxidase is also incorporated into the muscle fibres of dystrophic chickens (Libelius, Jirmanova, Lundquist, Thesleff & Barnard, 1979) and dystrophic mice (Libelius, Jirmanova, Lundquist & Thesleff, 1978). These changes are consistent with either physical disruption or abnormal permeability of the membrane.

Several studies, however, have demonstrated that



dystrophic muscle shows some selectivity with respect to both the incorporation and the escape of molecules. The failure of dystrophic chicken muscles to take up manganese (Pettegrew, Minshew & Feit, 1984) and the absence of some small cytoplasmic muscle enzymes in the serum of Duchenne dystrophy patients (Rowland, Layzer & Kagen, 1968) suggests that dystrophic muscle is abnormally permeable.

The observation that the ionic content of dystrophic muscles is altered supports the hypothesis that a membrane defect exists in the muscular dystrophies. The intracellular concentrations of both sodium and chloride are increased in dystrophic chicken muscle (Misra, Smith, Chang, Sparks, Cameron, Beall, Harrist, Nichols, Fanguy & Hazelwood, 1980). Intracellular sodium levels are also increased in dystrophic mouse muscle (Atwood & Kwan, 1978; Ward & Wareham, 1984). Charlton, Sliverman and Atwood (1981) and Ward and Wareham (1984) have shown reduced intracellular potassium levels in dystrophic mouse muscle. These reports are consistent with altered membrane conductance in dystrophic muscle.

Given that an electrolyte imbalance exists across dystrophic muscle membranes, abnormalities in the electrical properties of dystrophic muscle membranes would not be unexpected. Indeed, this appears to be the case. The passive and active membrane characteristics are altered in in vitro nerve-muscle preparations of dystrophic chicken

muscle (Warnick, Lebeda & Albuquerque, 1979) and dystrophic mouse muscle (Kerr & Sperelakis, 1983). Differences in the electrical properties of cultured dystrophic muscle membranes have been reported (Merickel, Gray, Chauvin & Appel, 1981) although these results have not been reproduced using different techniques (Rothman & Bischoff, 1983; Tahmouh, Askansas, Nelson & Engel, 1983).

The reported presence of a membrane defect in the sarcolemma led some investigators to examine other muscle membranes such as the t-tubule system and the sarcoplasmic reticulum (SR). T-tubule vacuolization and proliferation is present in dystrophic chicken muscle (Malouf & Sommer, 1976; Nonaka & Sugita, 1981; Kidd & Yasumura, 1982) but not in dystrophic mouse muscle (Silverman & Atwood, 1980b). Phospholipid levels are altered in the sarcolemma and the t-tubules of dystrophic avian muscle (Sumnicht & Sabbadini, 1982) and in whole muscle from both dystrophic mice (Pearce & Kakulas, 1980) and patients with Duchenne dystrophy (Pearce, Johnsen, Wysocki & Kakulas, 1981). Cholesterol levels are increased in the SR of dystrophic chicken muscle (Hsu & Kaldor, 1971; Kawamoto & Baskin, 1983) and in sarcolemma of patients with DMD (Fischbeck, Bonilla & Schotland, 1983). Unique lipids, present in the muscle membranes of dystrophic chickens, have been reported by Kundu *et al.* (1982) and by Kester and Privitera (1984). These alterations may be linked to membrane dysfunction in

dystrophy as phospholipid-to-cholesterol ratios are important in regulating membrane fluidity (Oldfield & Chapman, 1972; Madden, Chapman & Quinn, 1979).

As calcium is critical in regulating muscle contraction, the membranes of the SR from dystrophic muscle have been examined. Altered SR function, however, has not been universally reported for dystrophic muscle. The transport of calcium by the calcium-ATPase in SR vesicles is increased in the dystrophic chick embryo (Ettienne & Singer, 1978) and decreased in the adult (Ettienne & Singer, 1978; Scales & Sabbadini, 1979; Hanna, Kawamoto, McNamee & Baskin, 1981; Kosk-Kosicka, Scales, Kurzmack & Inesi, 1982; Kawamoto & Baskin, 1983) although the developmental studies of Kosk-Kosicka et al. (1982) suggest that muscle abnormalities precede the SR defects. The amount of calcium ATPase, however, is similar in normal and dystrophic SR from chicken, mouse and human muscles (Dux & Martonosi, 1983) and calcium-dependent ATPase activity is normal in mice with muscular dystrophy (Mrak & Fleischer, 1982; Volpe, Mrak, Costello & Fleischer, 1984). These discrepancies between laboratories may be related to the difficulty in obtaining uncontaminated SR fractions (Rowland, 1980).

Much of our knowledge about the function of normal membranes has come from the study of erythrocytes. Given that erythrocytes have been well characterized and are

readily accessible, researchers investigating the membrane defect theory have extensively examined these cells. Roses and Appel (1973) first observed defects in the erythrocyte protein kinase of patients with myotonic dystrophy and suggested that the primary lesion in muscular dystrophy was a generalized membrane defect. Other studies investigating the red blood cell support this view. The ion permeability of the erythrocyte membrane is altered both in chickens with muscular dystrophy (Watanabe & Yamashita, 1981) and in patients with Duchenne dystrophy (Sha'afi, Rodan, Hintz, Fernandez & Rodan, 1975). Concanavalin A binding sites (which may be involved in the modulation of membrane fluidity) are decreased on the erythrocytes of both dystrophic chickens (Beppu, Nakajima, Nishiyama, Uono & Hirano, 1983) and dystrophy patients (Uono, Beppu, Nakajima, Nishiyama & Hirano, 1981). Other studies of red cell fluidity in dystrophic chickens have shown that the microviscosity of erythrocyte membranes is increased in chickens with muscular dystrophy (Sha'afi et al., 1975). This may be due to the elevated cholesterol content of these tissues (Stewart, Werstiuk, Vickers & Rathbone, 1977). The studies of Sha'afi et al. (1975) and Stewart et al. (1977), however, have been criticised by workers who failed to replicate their results in a line of dystrophic chickens with genetically-matched controls (Eckstein, Randall & McNamee, 1979; Kuhn & Logan, 1983).

Functional abnormalities of the erythrocytes from both animals and patients with muscular dystrophy have also been reported. Membrane protein phosphorylation is abnormal in the erythrocytes of the dystrophic hamster (Johnson, 1984) and in patients with dystrophy (Mabry & Roses, 1981). Basal enzyme activities in the erythrocyte membranes of dystrophic chickens are reduced (Rodan, Hintz, Sha'afi & Rodan, 1974). Although defects in the red blood cells of both patients and animals with dystrophy have been well characterized, these abnormalities have not been linked to a functional deficit in dystrophy. Neither anemia nor decreased red cell survival times have been reported to be associated with dystrophy.

Researchers investigating the membrane defect theory have examined the membranes of various formed elements in blood, particularly with regard to the human dystrophies. Yarom, Meyer, More, Liebergall and Eldor (1983) reported platelet abnormalities in the human muscular dystrophies although other studies suggest platelet function is normal (Bolhuis, Goldhoorn & DeGroot, 1982; Nicholson, McLeod & Sugars, 1984). As platelets have an appreciable ability to contract, further studies would seem warranted.

The number of recent studies of membranes in muscular dystrophy are a tribute to the excitement generated by the membrane defect theory. Although some of the supportive data have been questioned, it is clear that a membrane

defect is present in the muscle and erythrocytes of both patients and animals with dystrophy. What is less apparent, however, is whether these abnormalities are closely linked to the gene for muscular dystrophy. Tissue culture work, developmental studies and the investigation of young animals should help resolve this question.

The presence of a membrane defect in the sarcolemma and possibly in other membranes of dystrophic muscle does not, in itself, explain muscle cell necrosis in the muscular dystrophies. One explanation of how the membrane defect might be fatal for cells arises from the work of several laboratories investigating the role of calcium in muscular dystrophy. The suggestion that elevated intracellular calcium levels were involved in the pathogenesis of muscular dystrophy was first made by Morki and Engel (1975). This idea was developed by Wrogemann and Pena (1976) who proposed a general calcium overload hypothesis to account for muscle cell necrosis in a variety of muscle disorders. In its original form, the calcium overload hypothesis held that the genetic abnormalities present in a variety of muscular dystrophies lead to a sarcolemmal defect which permits the influx of calcium. This excess calcium would be taken up by the mitochondria and, eventually, damage them thus leading to an overall decrease in the amount of energy available to the cell. This decrease in energy is followed by inadequate calcium

extrusion, increased intracellular calcium, hypercontraction of affected regions of the muscle fibres and ultimately, muscle cell necrosis (Wrogemann & Pena, 1976). This hypothesis is attractive because it proposes a general mechanism of cell necrosis which not only explains how several distinctly different genetic defects produce similar symptoms (ie: the muscular dystrophies of man and animal), but how other stimuli produce cell necrosis (ie: overuse, vitamin E deficiency, ischemia). The original theory has recently been modified to include not only calcium-mediated hypercontraction but calcium-activated proteases and phospholipases as links between elevated calcium levels and muscle cell necrosis (Nylen & Wrogemann, 1983).

There is a considerable body of evidence from both human and animal studies to support this view. Intracellular calcium levels are elevated in Duchenne dystrophy patients and in other conditions characterized by muscle cell necrosis (Bodensteiner & Engel, 1978; Emery & Burt, 1980; Bertorini, Bhattacharya, Palmieri, Chesney, Pifer & Baker, 1982). Recently, Bertorini, Cornelio, Bhattacharya, Dones, Dworzak and Brambati (1984) demonstrated an increase in the intracellular calcium concentration in fetuses at risk for Duchenne muscular dystrophy, suggesting that the excessive calcium accumulation preceded muscle cell necrosis.

Alterations in the mitochondria of dystrophic muscle

have been reported. These data support the calcium overload hypothesis. The fragility of muscle mitochondria is increased in Duchenne dystrophy patients (Scholte & Busch, 1980). Defective oxidative phosphorylation resulting from increased mitochondrial calcium is present in both the cardiac and skeletal muscles of the dystrophic hamster (Wrogemann, Jacobson & Blanchaer, 1973; Proschek & Jasmin, 1982) and the dystrophic mouse (Nylen & Wrogemann, 1983).

The calcium antagonist, verapamil, prevents cardiomyopathy in the hamster model of dystrophy (Slack, Boegman, Downie & Jasmin, 1980). Diltiazem decreases the elevated intracellular calcium levels in both skeletal and cardiac dystrophic hamster muscle (Bhattacharya, Palmieri, Bertorini & Nutting, 1982). Hudecki, Pollina and Heffner (1984) have shown improved functional ability in dystrophic chickens treated with calcium antagonists.

Local regions of hypercontraction are a consistent finding in the muscles of both patients with dystrophy (Cullen & Fulthorpe, 1975) and dystrophic mice (Law, Saito & Fleischer, 1983). Feit, Stauver, Domke and Shay (1982) have shown that fragmentation of normal muscle produces a mass of myofilaments while homogenization of dystrophic muscle yields rows of intact sarcomeres, possibly due to defective relaxation. These findings have been linked to excess calcium in dystrophic tissues.

Increased lysosomal activity is present in dystrophic



mouse muscle (Law et al., 1983) and in dystrophic chicken muscle (Baxter & Suelter, 1983) and acid phosphatase levels are elevated in dystrophic avian muscle (Baxter & Suelter, 1984). Calcium-activated neutral protease activity is increased in human dystrophic muscles (Kar & Pearson, 1977) and in dystrophic hamster and mouse muscle (Neerunjun & Dubowitz, 1979).

Experiments in which muscle calcium concentrations have been manipulated also support the calcium overload hypothesis. The delta lesions characteristic of pre-necrotic muscle fibres from patients with Duchenne dystrophy may be reproduced in animals by treatment with membrane-active agents, notably the calcium ionophore A23187 (Pestronk, Parhad, Drachman & Price, 1982).

Finally, Leonard and Salpeter (1982) showed that prolonged agonist activation of the neuromuscular junction induces extensive damage in dystrophic mouse muscle unless the muscle is "protected" by removing calcium from the bathing medium.

Although many studies support the membrane defect theory, conflicting results, particularly in studies which examine extramuscular tissues, lead some researchers to suggest that the observed membrane defects are secondary changes and not the direct result of the defective gene for muscular dystrophy (Lucy, 1980; Rothman & Bischoff, 1983; Nicholson et al., 1984; Pettegrew et al., 1984).

Developmental studies on animal models and the investigation of minimally affected muscle fibres and extramuscular tissues from both young animals and humans should help to resolve this controversy.

1.2.4 A maturational defect. The suggestion that muscular dystrophy is a failure of muscle maturation has been advanced by several prominent research groups. Cosmos and her co-workers have proposed that the differentiation of embryonic muscle fibres into adult twitch fibres is impaired in avian dystrophy, dystrophic muscle retaining fetal muscle characteristics. Embryonic avian muscle has high levels of oxidative enzymes, low levels of glycolytic enzymes and slow myosin ATP-ase; all these properties are characteristic of both dystrophic avian twitch muscles and normal avian embryonic muscles (Cosmos, 1966; Cosmos & Butler, 1967). With the onset of activity, embryonic twitch muscle fibres differentiate into the characteristic adult isoenzyme pattern, acquiring fast myosin ATP-ase and glycolytic enzymes (Cosmos, 1966; Cosmos & Butler, 1967). Proponents of this view suggest that dystrophic twitch muscle fibres cannot respond to the neural signal to switch from fetal muscle characteristics to an adult profile. Dystrophic tonic fibres are spared the disease because they are never required to make this transition.

In the dystrophic chicken, cross-reinnervation of a

fast twitch muscle, the posterior latissimus dorsi (PLD), with the nerve of a tonic muscle, the anterior latissimus dorsi (ALD), shows that a majority of the fibres in the cross-reinnervated PLD adopt the characteristics of a tonic muscle and fail to express the disease (Cosmos, Butler, Allard & Mazliah, 1979). These data support the hypothesis of a maturational defect.

Recent data suggest that the hypothesis proposed by Cosmos and her colleagues needs to be expanded. The results of Barnard, Lyles and Pizzey (1982) suggest that the various avian fibre types are differentially affected by dystrophy, however, some twitch fibres may not show signs of the disease. Furthermore, tonic muscle fibres may be affected by dystrophy. Several reports suggest that, in older chickens, the ALD shows signs of the disease (Barnard & Barnard, 1979; Kundu et al., 1982). It is possible, however, that the altered properties of the ALD resulted from, at least in part, the degenerating synergist and antagonist muscles.

Recently, Vrbova has viewed Duchenne muscular dystrophy as a disturbance of nerve-muscle interaction, leading to a failure of muscle maturation and, ultimately, to muscle degeneration (Vrbova, 1983). She argues that during normal muscle development the neuronal pattern of activity changes in the neonate so that the low frequency continual activity present in the immature organism is

replaced, in mature twitch fibres, by high frequency transient activity. This increased activity is thought to be responsible for development of the SR and for the increased speeds of contraction and relaxation observed in mature twitch fibres.

Several lines of evidence support this notion. Denervation of neonatal muscle followed by reinnervation causes selective degeneration of the fast twitch fibres (Luthert, Vrbova & Ward, 1980); perhaps this is due to the inability of the immature muscle to respond to the activity pattern of an older animal (Vrbova, 1983). The presence of embryonic characteristics in adult dystrophic muscle, the decreased contraction and relaxation times and the reduced calcium uptake by the SR suggest that dystrophic muscle fails to mature. In addition, low frequency stimulation of neonatal dystrophic mouse muscle reduces muscle necrosis (Luthert et al., 1980).

Based on these observations, Vrbova proposes that muscle wasting in muscular dystrophy is caused by the slower rate of maturation of dystrophic muscle. This leads to inappropriate matching between muscle and nerve and subsequent abnormalities in the development of the SR, increased intracellular calcium and, ultimately, cell death (Vrbova, 1983). This hypothesis is compatible with the findings of Cosmos and her co-workers.

Other data supporting Vrbova's work come from

Karpati's group. They have shown that denervation or cordotomy of young dystrophic hamster muscles prevent muscle necrosis (Karpati, Carpenter & Prescott, 1982). Chronic denervation attenuates, but does not prevent, muscle cell necrosis in dystrophic chicken muscle (Ashmore, Lee, Summers & Hitchcock, 1984). In a follow-up study Karpati and his colleagues demonstrated that continual denervation prevented muscle necrosis while subsequent reinnervation permitted the development of necrotic muscle fibres in the dystrophic hamster (Karpati, Armani, Carpenter & Prescott, 1983a). Lee, Ashmore & Hitchcock (1984) have reported similar results in dystrophic chicken muscle.

Denervation both removes the trophic influence of the nerve and renders the muscle inactive. Immobilization of a limb reduces the muscle activity but leaves the trophic influence intact. A recent study suggests that it is activity and not this trophic influence which is responsible for the necrosis in dystrophy. Wirtz and Loermans (1983) have shown that limb immobilization prevented the development of necrotic lesions in dystrophic mouse muscle. Future experiments using this technique should yield important information about the role of muscle activity in dystrophic cell necrosis.

Karpati and his colleagues proposed that chronic growth hormone deficiency would retain dystrophic muscle in an

immature state. They showed that a deficiency in growth hormone both retarded growth and reduced muscle necrosis in dystrophic hamsters (Karpati, Jacob, Carpenter & Prescott, 1983b). Notably, Zatz, Betti & Levy (1981) reported a benign course of Duchenne dystrophy in a patient with both Duchenne dystrophy and congenital growth hormone deficiency, although chronic treatment with a growth hormone inhibitor failed to have a beneficial effect on patients with Duchenne dystrophy (Collipp, Kelemen, Chen, Castro-Magana, Angula & Derenoncourt, 1984).

Karpati and his co-workers conclude from their findings that denervated or growth hormone-deficient dystrophic muscles exist in an immature state, a state which negates the effect of the gene alteration leading to necrosis (Karpati et al., 1983a; Karpati et al., 1983b). These data may also be interpreted to support the hypothesis advanced by Vrbova. Perhaps both denervation and immobilization prevent or attenuate the development of dystrophy by eliminating the inappropriate muscle activation. The role of growth hormone in the causation of necrosis, however, remains unclear.

Dystrophic muscle shares many of the biochemical properties of neonatal muscle. Some metabolic enzymes which normally undergo fetal-to-adult isozyme transformation are present in their fetal or neonatal forms in human dystrophic muscle (Fitzsimmons & Hoh, 1981; Takagi,

Ishiura, Nonaka & Sugita, 1982; Romero-Hurrera & Lieska, 1982). High levels of specific embryonic acetylcholinesterase (AChE) isozymes characteristic of normal embryonic twitch muscle are present in the mature twitch fibres of dystrophic chickens (Wilson, Linkhart, Walker & Nieberg, 1973; Patterson & Wilson, 1976). The presence of neonatal myosins has also been reported in dystrophic avian twitch muscle (Bandman, 1984).

The extent to which adult dystrophic muscle resembles immature normal muscle, however, has recently been questioned (Reichman & Pette, 1984). Using new histochemical techniques Miike (1983) concluded that the immature fibres in dystrophic muscle were actually regenerating fibres not developmentally arrested, immature fibres. The continued presence of fetal and neonatal characteristics in dystrophic muscle may be due either to the massive regeneration occurring in dystrophic muscle or to inhibition of the transition to the adult state in diseased muscle (Fitzsimmons & Hoh, 1981; Bandman, 1984). Despite these criticisms a great deal of evidence supports Vrbova's work. Further experiments concerning muscle development and the formation of nerve-muscle contacts in dystrophy should critically test this hypothesis.

### 1.3 The Rationale for the Present Studies

A growing body of evidence supports the view that membrane defects, especially in the muscle cell membranes, are present in the muscular dystrophies. Whether these defects are expressed as maturational defects in the SR, as Vrbova (1983) believes, or whether they are present in the mature sarcolemma, as Wrogemann and Pena (1976) believe, is however, controversial. The presence of lesions in the neural and vascular tissues of dystrophic animals need not implicate these tissues as the primary locus of the disease as changes in many systems may be occurring concurrently as the disease progresses. This is readily apparent in human myotonic muscular dystrophy where patients show a variety of systemic effects such as cataracts, frontal baldness, intellectual impairment and testicular atrophy (Harper, 1979) which may be expressed to varying degrees (Pryse-Phillips, Johnsen & Larsen, 1982). It is apparent, however, that in avian dystrophy, as in Duchenne dystrophy, muscle is the primary target of the disease process.

Although the pharmacologic properties of dystrophic muscle membranes would be of interest in assessing the membrane defect theory, most pharmacologic studies of both patients and animals with muscular dystrophy have examined the effectiveness of various forms of chronic drug therapy.



Very few studies have examined the pharmacologic properties of normal and dystrophic muscle, either in vivo or in vitro. Information about the physiologic and pharmacologic characteristics of normal and dystrophic muscle from young chickens should yield important information about the functional state of muscle membranes in avian muscular dystrophy. The use of young chickens in the study of avian dystrophy is preferable as incipient abnormalities are more likely to be associated with the primary defect in muscular dystrophy than are delayed ones. Changes in older animals may be secondary to the effects of long-term chronic muscle disease. The in vivo extensor digitorum communis (EDC) nerve-muscle preparation has been developed in this laboratory (Howlett, Redfern, Umanee & Hoekman, 1980; Howlett & Hoekman, 1983a). The preparation is suitable for the physiologic measurement of drug responses to close intra-arterial injections of agents acting at the neuromuscular junction (Hoekman, Umanee, Howlett & Redfern, 1980) and lends itself to electrophysiologic studies (Howlett & Hoekman, 1981). Furthermore, the easy accessibility of the radial nerve facilitates denervation experiments (Howlett & Hoekman, 1983b).

The EDC preparation has been used in the present work to examine the acute mechanical responses of normal and dystrophic muscle to injected pharmacologic agents. By using suitable pharmacologic probes, functional differences

in the membranes of the sarcolemma, the sarcoplasmic reticulum and the neuromuscular junction may be revealed.

Changes in the electrophysiologic properties of dystrophic muscle might indicate a functional abnormality in the sarcolemma. These studies would provide direct information regarding the integrity of neuromuscular transmission and indirect information about the conductance properties of the membrane. Electrophysiologic measurements of muscle action potentials and resting membrane potentials in normal and dystrophic muscle have been conducted in this study.

The ability of dystrophic muscle to develop the characteristic changes associated with denervation might be altered if a membrane defect were present. Therefore, some physiologic and pharmacologic properties of denervated normal and dystrophic EDC muscle have been examined to determine the response of these muscles to the removal of the trophic influence of the nerve.

Functional differences between vascular smooth muscle from normal and dystrophic chickens might implicate another muscle membrane system in avian dystrophy. Furthermore, this study would be informative as vascular smooth muscle has been implicated in the pathogenesis of muscular dystrophy. To investigate the involvement of vascular smooth muscle in avian dystrophy, the pharmacologic responses of normal and dystrophic ischiatic arteries have

been compared.

The research, therefore, was conducted as follows. (1) In vivo intra-arterial injection techniques were developed for the EDC muscle preparation. (2) The contractile responses to injected drugs were characterized for normal and dystrophic muscle. (3) These responses were also compared in denervated and sham-operated muscles from both normal and dystrophic chickens. (4) The resting membrane potentials and the action potentials were recorded from normal and dystrophic EDC muscle cells in vivo. (5) The pharmacologic responses of isolated vascular smooth muscle from normal and dystrophic chickens were compared. (6) All these results were compared between chickens which were closely matched for age and sex.

## Chapter II

## MATERIALS AND METHODS

## 2.1. General Methods

2.1.1 Chickens. Dystrophic New Hampshire chickens (Line 413) and their genetically matched controls (Line 412) from lines developed by the Department of Avian Sciences, University of California at Davis, were reared locally at the Memorial University Vivarium. Breeding flocks of both normal and dystrophic chickens were found to produce fertile eggs; the fertility rate was slightly lower for the dystrophic flock. The chickens were housed "on the floor" in large enclosed pens. Food (Masterfeeds Chick Starter #16533) and water were provided ad libitum.

2.1.2 Clinical assessment. Chickens were transported from the animal care facility to the laboratory where they were weighed and their sex determined. If the sex was not readily apparent, verification was made by autopsy at the end of the experiment. The chickens were screened for dystrophy using the exhaustion score test (Entrikin et al., 1978); the chicken was placed on its back

by the experimenter, released and allowed to right itself as many times as possible in succession. The number of successful "flips" was recorded as the exhaustion score.

## 2.2 The EDC Muscle-Radial Nerve In Vivo Preparation

2.2.1 General surgery. Normal and dystrophic chickens, aged 55-60 days were anaesthetized by intravenous (IV) injection of either urethane (1.2 g/kg) or, in a limited number of experiments, chloralose (80 mg/kg). A tracheostomy was performed and the jugular vein was cannulated with PE-50 tubing (I.D. 0.58 mm, O.D. 0.965 mm; Intramedic Polyethylene Tubing, Becton Dickinson & Co.) to establish a route for infusion of fluids, drugs and anesthetic supplements. The neck skin was then sutured. In some experiments blood pressure was recorded through an arterial cannula (PE-50 tubing) in the ischiatic artery; the cannula was attached to a pressure transducer (Gould Statham P23 Physiological Pressure Transducer).

The extensor digitorum communis muscle preparation was isolated according to the techniques of Howlett and Hoekman (1983a). The feathers were removed from the dorsal aspect of one wing and an incision was made in the skin overlying the EDC muscle (see Figure 2.1). The distal tendon was

Figure 2.1 Dorsal aspect of the wing of the fowl, Gallus domesticus, indicating the position of the extensor digitorum communis muscle (figure reprinted with permission of Commonwealth Scientific and Industrial Research Organization from Sullivan, G.E.: Anatomy and embryology of the wing musculature of the fowl (Gallus). Australian Journal of Zoology, 10: 459-518, 1962).

Calibration bar is 5 cm.

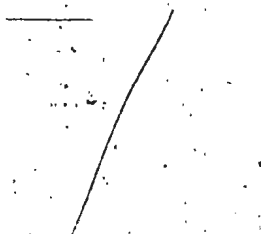

Extensor Digitorum Communis Muscle

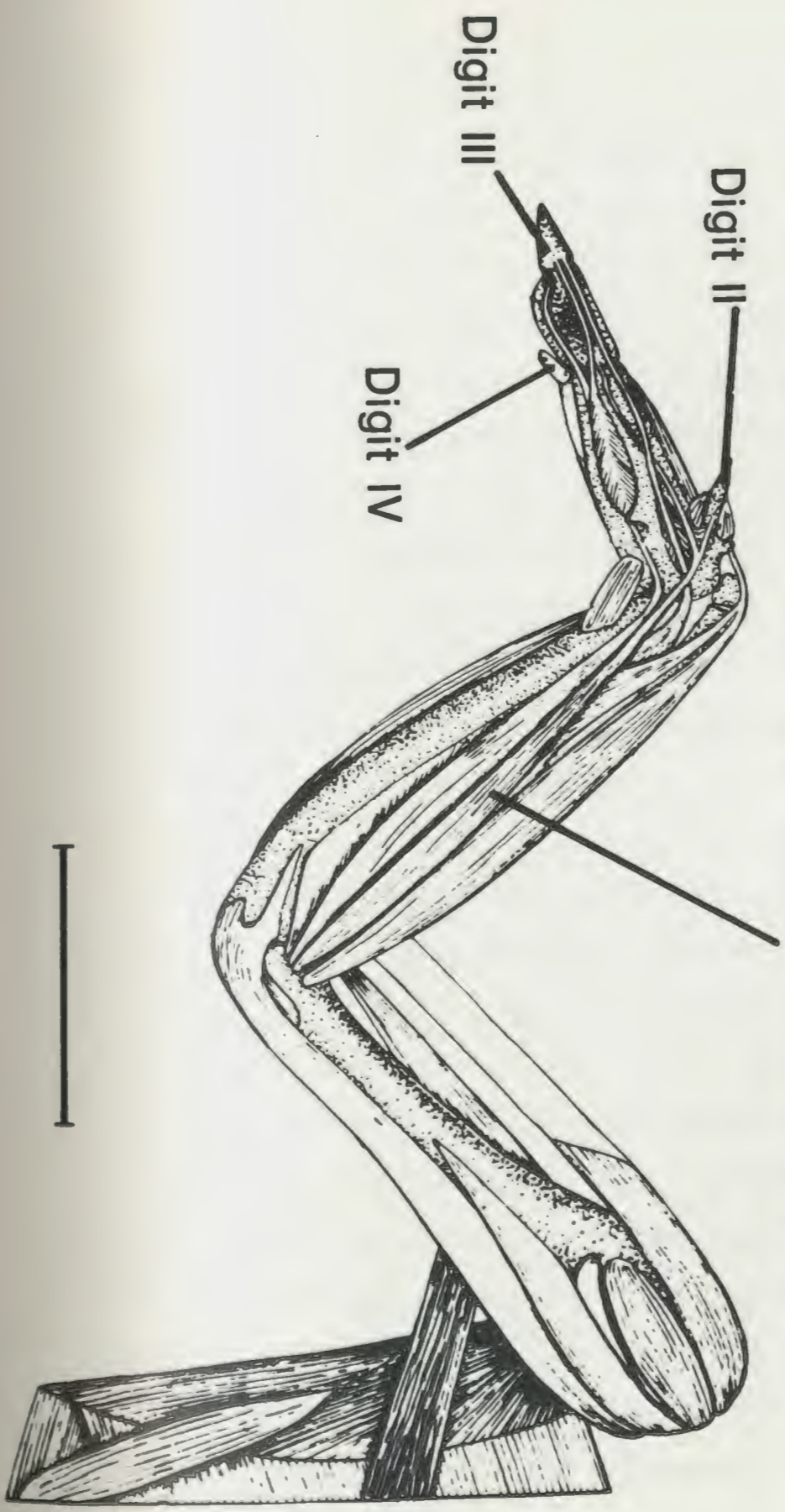

exposed and the resting length of the muscle ( $l_0$ ) was measured with the wing in the flexed position. The tendon was then severed from its insertion on the middle (III) digit (see Figure 2.1). The muscle was fixed to the transducer hook with a square knot; the free end of the tendon was used to form half the knot with a length of 2-0 silk serving as the other half. Steel pins were driven through the elbow and wrist joints to secure the wing in the muscle bath. The portion of the radial nerve overlying the humerus was exposed and snared with a loose ligature taking care not to injure the associated blood vessels. A 10-gauge biopsy needle was inserted into the abdominal air sacs to provide unidirectional ventilation with humidified air (Burger and Lorenz, 1960).

2.2.2 Arterial cannulation. A cannula was fashioned from a 23-gauge Butterfly Infusion Set (Venisystems, Abbott Ireland Ltd.), a 27-gauge needle (0.5 inch Yale Hypodermic Needle, Becton, Dickinson & Co.), PE-10 tubing (I.D. 0.28 mm, O.D. 0.61 mm; Intramedic Polyethylene Tubing, Becton, Dickinson & Co.) and PE-20 tubing (I.D. 0.38mm, O.D. 1.09 mm). The tubing on the infusion set was peeled off and cut to a length of 2.5 cm. The ends of a 1 cm length of PE-20 tubing were flared with a match and one end was slipped onto the exposed butterfly needle; the original tubing, now 2.5 cm in length, was slipped back



over the PE-20 tubing to secure the needle in position. With small forceps and pliers the 27-gauge needle was carefully removed from the plastic hub, inserted into the barrel of the 23-gauge butterfly needle and glued in position with 5-minute epoxy. The assembly of this cannula is illustrated in Figure 2.2A. The end of a length of PE-10 tubing (approximately 20 cm) was flared with a match and slipped over the end of the cannula, now 27-gauge (see Figure 2.2B). A 50 microlitre Hamilton microsyringe (Microliter #705, Hamilton Co.), filled with physiological saline was inserted into the hub of the cannula and 20 microlitres were injected into the cannula (see Figure 2.2B). The PE-10 tubing was cut at the meniscus to produce a cannula with a calibrated 20 microlitre dead space. The cannula was then filled with heparinized saline (2,000 units of heparin per litre of physiological saline) and ready for use.

The ventral aspect of the wing was denuded of feathers and a 4-5 cm skin incision was made following the course of the ulnar artery (see Figure 2.3) which was clearly visible through the skin. The brachial artery and its bifurcation into the ulnar and radial arteries were exposed by separating the biceps muscle and the triceps muscle. The connective tissue was removed from the ulnar artery in the region of the bifurcation and the vessel was snared with a loose ligature of 5-0 silk. Similarly, the artery was

Figure 2.2. The cannula used for intra-arterial injection of drugs into the extensor digitorum communis muscle.

(A) Parts required to assemble the cannula: a 21-gauge needle (1); a 23-gauge Butterfly infusion set (2); PE-20 tubing (3); remainder of the 23-gauge Butterfly infusion set (4). The calibration bar is 1 cm.

(B) Photograph of the assembled cannula and a 50 microlitre Hamilton microsyringe. Calibration bar is 1 cm.

A

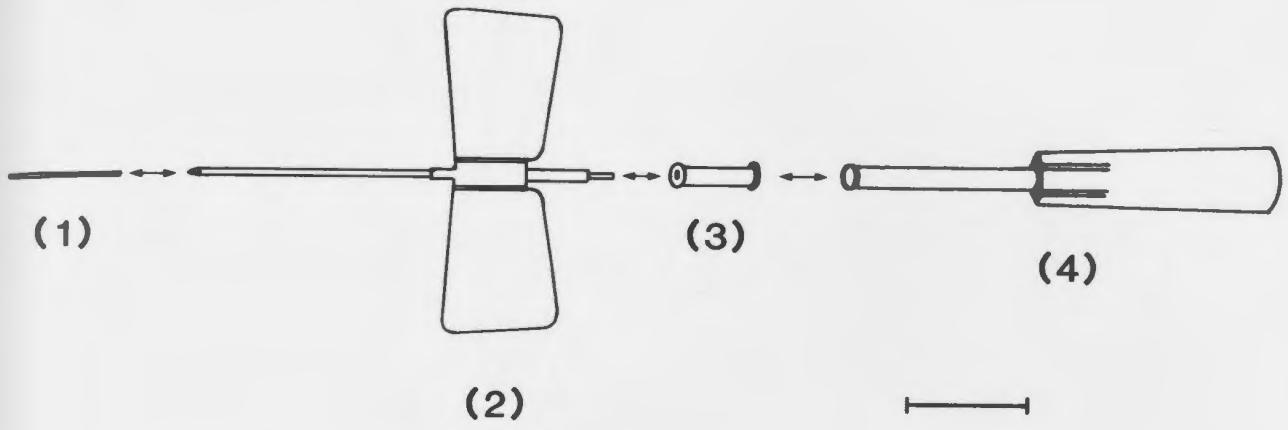

B

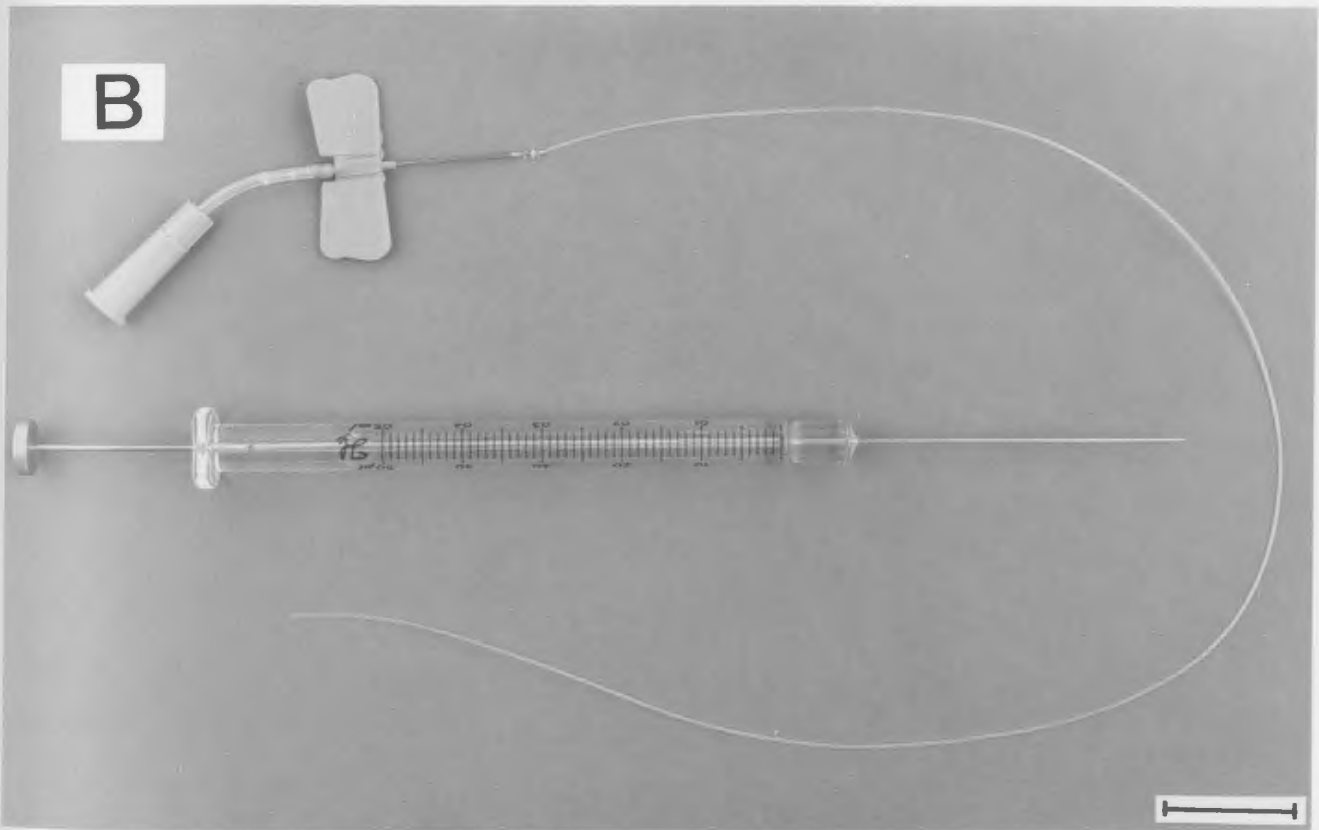
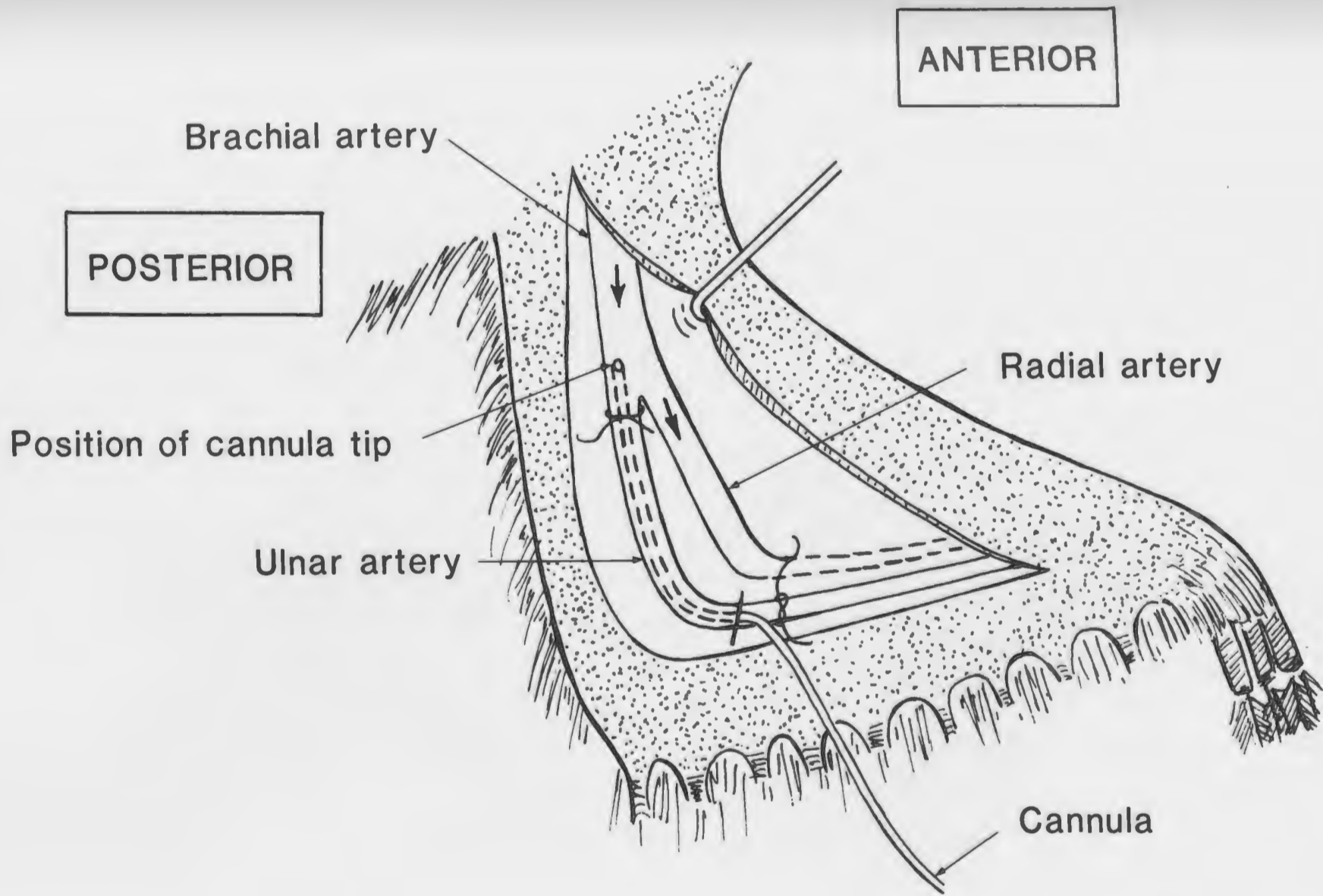

Figure 2.3. Ventral aspect of the wing illustrating the procedure for cannulation of the ulnar artery. The cannula (PE-10 tubing) is gently advanced through a small incision in the ulnar artery to the point where the brachial artery bifurcates into the ulnar and radial branches. It is then secured in this position with a length of 5-0 silk.



snared by a pair of ligatures at a point approximately 3 cm from the bifurcation and the distal end of the artery was tied with a square knot. A small incision was made in the vessel and the cannula was advanced through the incision so that the tip came to rest within 1 mm of the bifurcation point (see Figure 2.3, page 48). The remaining two ligatures were tied to secure the cannula; the cannula tubing was tied in a loop to prevent inadvertent dislocation of the cannula. Finally, the skin incision was sutured with 5-0 silk.

2.2.3 Immobilization of the preparation in an electrically shielded cage. The equipment used in this study is illustrated in Figure 2.4. The feathers were removed from the region overlying the thoracic vertebrae and two incisions, just long enough to accommodate a vertebral clamp, were made on either side of the vertebral crests. The chicken was suspended by this clamp in a modified stereotaxic apparatus. The wing was immobilized by hooking the curved ends of two "horseshoe-shaped" brackets over the ends of the steel pins protruding from the wrist and elbow joints and clamping these brackets to the proximal and distal ends of the plexiglass muscle bath. To insure immobility tension was exerted on the forearm by tightening an externally mounted wing nut on the threaded rod which also served to attach the wing in the bath.

Figure 2.4 Experimental apparatus.

- (A) Faraday cage.
- (B) Modified stereotaxic apparatus with vertebral clamp to suspend chicken.
- (C) Plexiglass muscle chamber.
- (D) Isometric force transducer
- (E) Bipolar stimulating electrode.
- (F) Stimulus isolation unit.
- (G) Thermoregulated lamp (g) thermosensitive probe.
- (H) Large scale mechanical micromanipulator for gross adjustments of the microelectrode position.
- (I) Probe for the microelectrode pre-amplifier.
- (J) Hydraulic micromanipulator for fine adjustments of the microelectrode position.

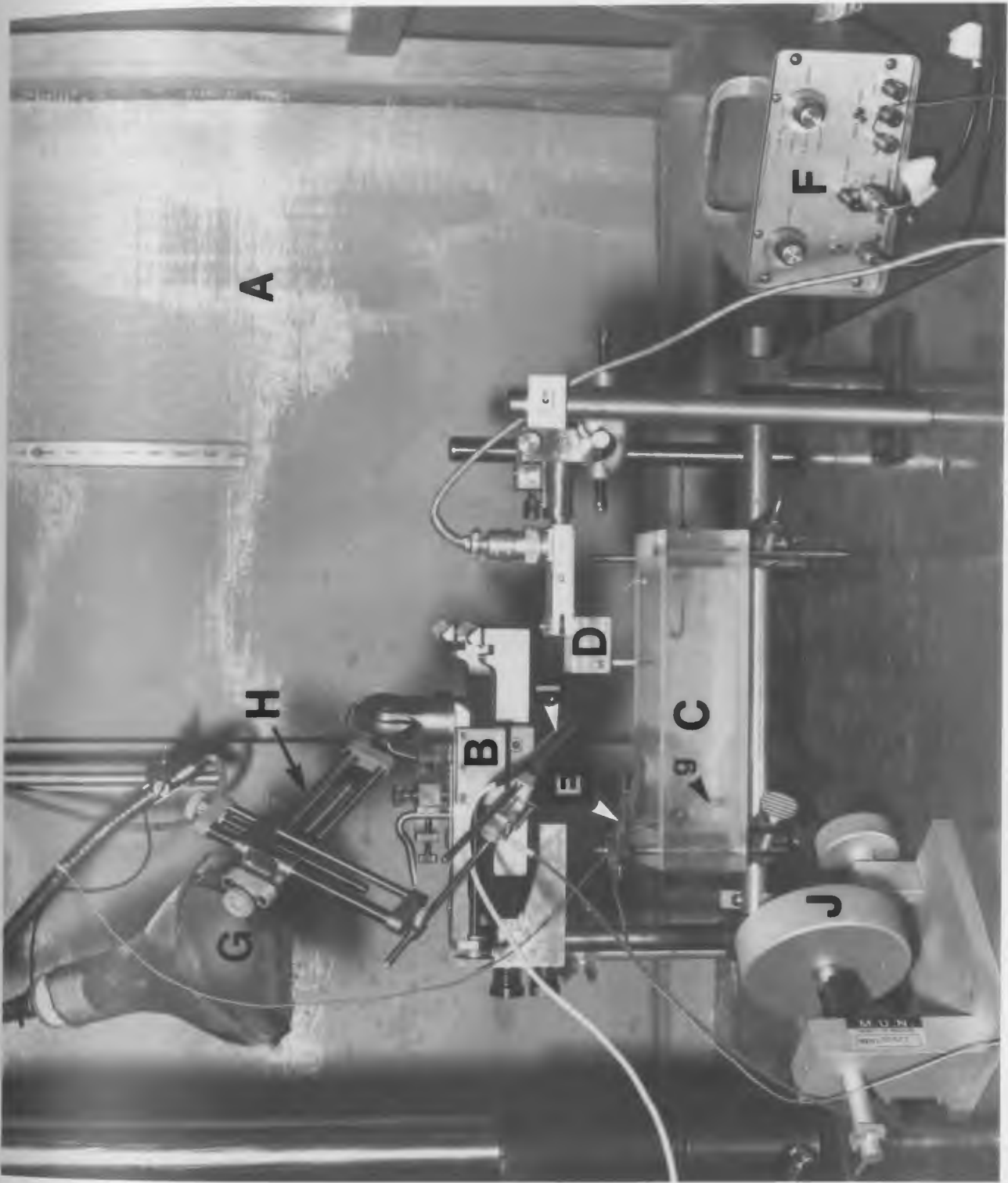



Bipolar platinum iridium stimulating electrodes were positioned beneath the radial nerve and were shielded from the underlying tissues by a thin strip of parafilm. In some experiments a bipolar platinum electrode (NE-200 X 100 mm, Rhodes Medical Instruments Inc.) was placed in contact with the muscle to record the surface electromyogram (EMG). The vertebral clamp served as a reference electrode for the electrical responses. The immobilized preparation is illustrated in Figure 2.5.

The nerve was covered with gauze soaked in mineral oil and the entire wing was immersed in mineral oil warmed to 34 °C with a thermoregulated heat lamp; this temperature corresponded to the recorded temperature of subcutaneous muscles in the contralateral wing. The chicken was warmed with a heat lamp and covered with a "space blanket" to reduce heat loss; core temperature was monitored with an oral temperature probe. In many experiments the blood pressure was monitored to assess any drug-related changes in this parameter. At the conclusion of the experiment, the EDC muscle was removed from the chicken and weighed to yield muscle wet weight. The muscles were allowed to dry at room temperature for 3 weeks and weighed again to measure muscle dry weight.

2.2.4 Mechanical and electrical circuits. The isometric contractile responses of the EDC were recorded

Figure 2.5 Position of the wing in the experimental

apparatus (reprinted with permission of Academic Press  
from Howlett, S.E. and Hoekman, T.B.: Sex differences  
in the phenotypic expression of avian dystrophy.

Experimental Neurology, 81: 50-63, 1983).

- (A) Plexiglass muscle chamber.
- (B) Vertebral clamp.
- (C) Isometric force transducer.
- (D) Radial nerve with bipolar stimulating electrode.
- (E) Extensor digitorum communis muscle.
- (F) "Horseshoe-shaped" brackets used to immobilize  
the wing.

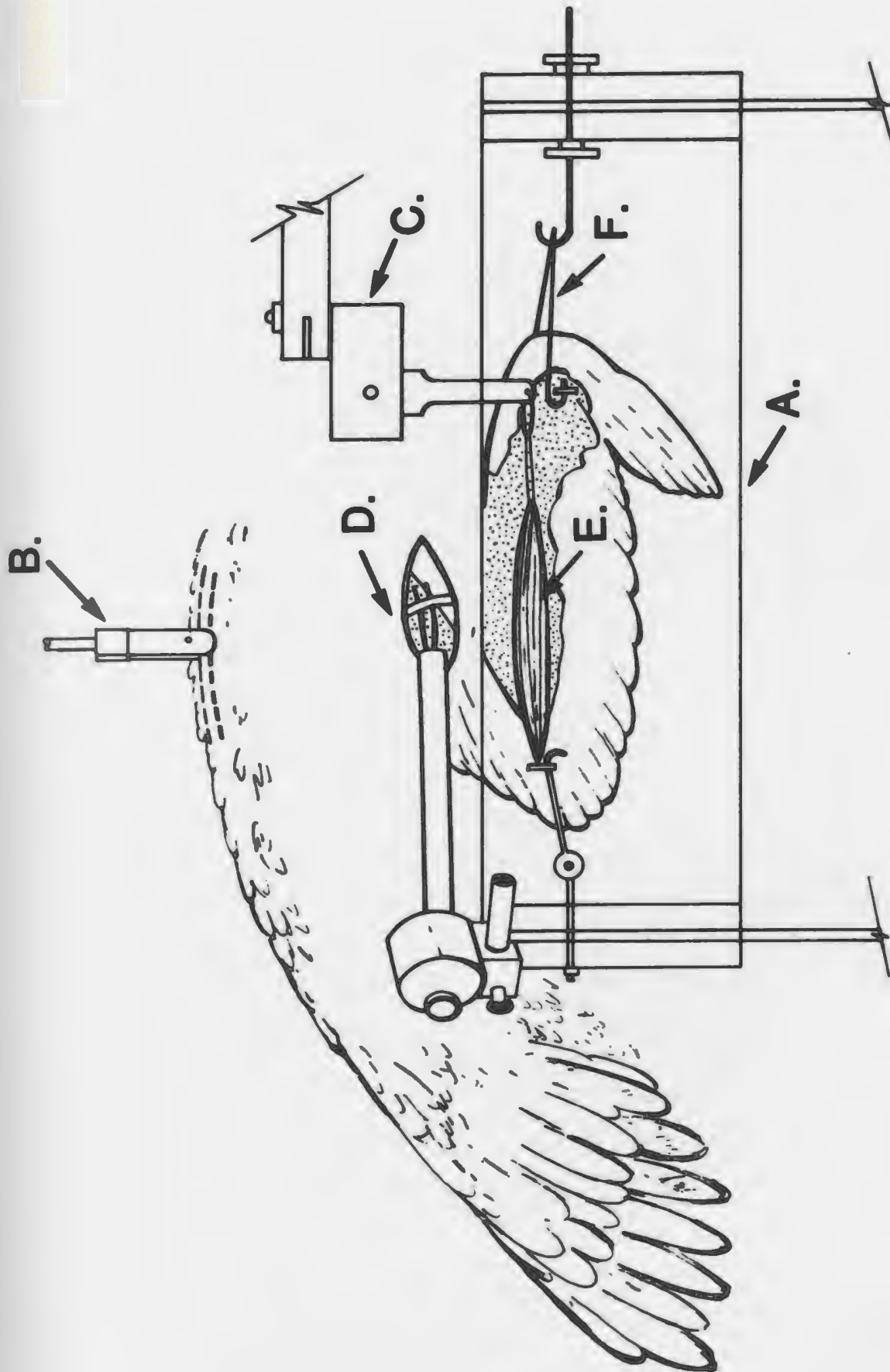

using a force-displacement transducer (Grass model FT03C) modified with a right angle attachment lever to accommodate the hook on the EDC tendon (see Figure 2.5, page ). The output of the transducer was amplified by a DC preamplifier with an integral transducer bridge input circuit (gain = 1-10K) and displayed simultaneously on a chart recorder (Gould Brush 220) and on a storage oscilloscope (Tektronix 5111). The EMG was recorded differentially between the surface electrode in contact with the muscle and ground (at the vertebral clamp); this signal was directed through an AC coupled preamplifier (gain = 1-10 K) and monitored on the oscilloscope. The mechanical and electrical responses of the muscle were recorded intermittently on magnetic tape for later analyses (3 3/4 inches per second) using a four channel FM tape recorder (Hewlett-Packard Model 3964-A).

The radial nerve was stimulated by the output of two pulse generators (Tektronix PG-505) controlled by a custom made digital pulse counter. The pulse counter enabled the delivery of a designated number of stimuli at two independent rates; automatically alternating between the two pulse generators. The output of both pulse generators was coupled to the muscle through a stimulus isolation unit (W-P Instruments NP-1).

2.2.5 Experimental protocol. At the start of the experiment the muscle length was adjusted with a rack-and-

pinion drive mounted to the force-transducer to determine the length required to generate peak twitch tension,  $l_0$ , in the intact chicken. Several experiments were conducted in which the length-tension relationship was determined for normal and dystrophic muscles to assess any disease-related changes in this parameter. The optimal conditions for stimulation, the preferred polarity for the stimulus pulse and the voltage which was 25% supramaximal for the twitch response, were also determined. Finally, the baseline resting tension was set to zero using the balance bridge and a 200 Hz, 50 pulse tetanus was delivered to take the "slack" out of the mechanical connections. If any deviation in the baseline was observed after the tetanus the baseline was reset to zero and the procedure repeated until no further shifts were evident. Throughout the experiment the muscle was stimulated by one pulse generator at a frequency of 0.2 Hz with a pulse duration of 0.2 msec.

2.2.6 Intra-arterial injection technique. The preparation was stimulated for approximately one hour to allow the establishment of a stable baseline twitch response. Drugs were drawn up in a 50 microlitre Hamilton syringe. The syringe was inserted into the hub of the cannula and, immediately following a twitch response, 50 microlitres of drug were injected resulting in an injected bolus of 30

microlitres. The 20 microlitres of drug remaining in the cannula dead space were drawn back up in the syringe and discarded. The cannula was then flushed with a small amount of heparinized saline. When the baseline response was re-established for at least five minutes, the next dose was administered. Dose-response curves were constructed for acetylcholine (ACh), potassium chloride (KCl), caffeine (CAF) and carbachol (CARB). Drug concentrations were administered in random order. If two drugs were administered to one chicken, an interval of at least one hour was allowed to elapse after recovery from the last injection before the first administration of another drug. In the experiments with neostigmine (NEO), a bolus of drug (12 micrograms/30 microlitre bolus) was injected immediately preceding a 200 Hz tetanus; the results were compared to a control 200 Hz tetanus from the same chicken.

Drug dilutions were made fresh daily (ACh and CARB) or weekly (KCl, CAF NEO) from frozen stock solutions. All drugs were made up in physiological saline and were kept on ice during the experiment. Control injections of cold heparinized saline, physiological saline, 1M sodium chloride and 1M mannitol were given prior to the experimental injection series. The effects of all agents on arterial blood pressure were noted.

#### 2.2.7 Measurements. The physical characteristics

of the chickens used in these experiments were noted. The exhaustion score, age (days), chicken body weight (kg), muscle wet weight (g) and muscle dry weight (g) were recorded for each chicken used in this study. In addition, the ratio of wet weight to dry weight, the ratio of the chicken body weight to muscle wet weight (kg/g), the maximum muscle twitch (P) (Newtons/g muscle wet weight) and maximum muscle tetanus ( $P_0$ ) (Newtons/g muscle wet weight) were computed for each subject.

The following parameters were measured to construct dose-response curves to ACh, KCl, CAF and CARB. The amplitude of the muscle contracture response was measured (see Figure 2.6a). The muscle contracture was defined as the drug-induced increase in baseline tension occurring in the absence of nerve stimulation. These data were expressed as muscle contracture force (Newtons) exerted per gram of muscle wet weight. The degree to which an injected drug potentiated (Figure 2.6b) or depressed (Figure 2.6c) the muscle twitch was also measured. These results were expressed as ratios of the post-injection twitch amplitude over the pre-injection twitch amplitude. Finally, the effects of NEO on a 200 Hz tetanus were measured. The degree of post-tetanic potentiation, expressed as post-tetanic twitch amplitude over pre-tetanic twitch amplitude, was recorded.

Figure 2.6 Pharmacologic responses of the in vivo extensor digitorum communis muscle preparation. The data presented were recorded from normal, indirectly stimulated muscle.

- (A) Muscle contracture response.
- (B) Twitch potentiation.
- (C) Twitch depression (note that a muscle contracture response is also illustrated in this data record).

The vertical and horizontal calibration bars are 0.98 Newtons and 24 seconds, respectively.



### A. Muscle Contracture

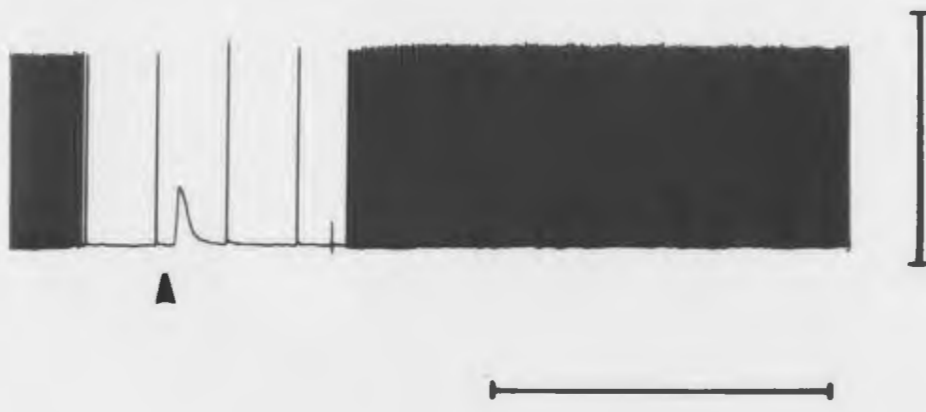

### B. Twitch Potentiation

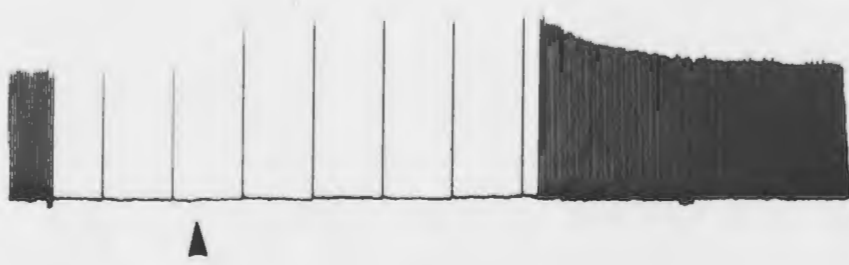

### C. Twitch Depression

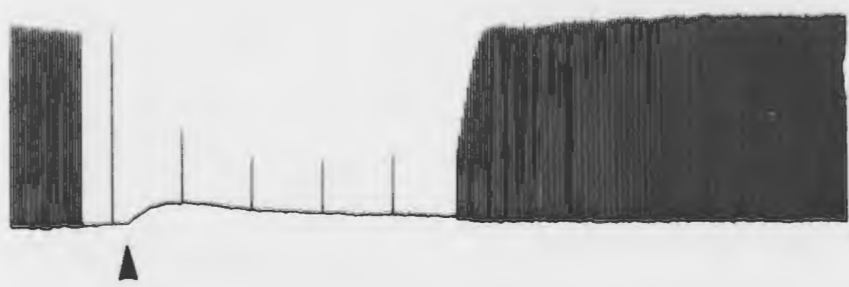

2.2.8 Statistics. As the effects of avian muscular dystrophy on the contractile characteristics of muscle have been shown to vary between sexes (Howlett and Hoekman, 1983), the sex of the chickens was considered in the data analysis. Accordingly, the chickens were divided into four groups: normal female chickens (NF), dystrophic female chickens (DF), normal male chickens (NM) and dystrophic male chickens (DM). Two-way analysis of variance between the four groups, with sex and disease as the two main factors, was conducted on all measures recorded in the present study. The results were expressed as the mean plus or minus the standard error of the mean. In this fashion, the significance of differences in the physical characteristics between the four treatment groups was determined. All dose-response curves for which the maximum response could be readily determined (ACh contractures, CARB contractures and CARB twitch depression) were normalized as the percentage of the maximum response. The  $ED_{50}$  value (the dose producing 50% of the maximum response) was calculated for the contracture data and the  $ID_{50}$  value (the dose producing 50% of the maximum response inhibition) was calculated for the twitch depression data. Differences between groups were assessed using analysis of variance. Regression analysis was performed on the linear portion (20% to 80%) of the normalized dose-response curve for each experiment and differences in the slopes between

groups were determined using analysis of variance. For those curves for which the  $ED_{50}$  response could not be measured, the y-intercepts of the regression lines were compared between groups. The significance of differences between groups for the other dose-response curves was assessed using linear regression; analysis of variance was conducted on the slopes and the y-intercepts of these lines. The dose-response curves for the CAF and KCl contractures were subjected to linear transformation using the square root transform method of Winer (1971); regression analysis and analysis of variance was conducted on the transformed data. The data obtained for the post-tetanic potentiation recorded in response to injected neostigmine were pooled (male and female) and the normal and dystrophic groups were compared using a t-test. All analyses were performed using standard microprocessor program packages. The level of significance selected for the study was  $p < 0.05$ .

### 2.3 Denervation Experiments

2.3.1. Denervation. Three days prior to experimentation the chickens were transported to the laboratory and anesthetized with halothane (3% in 95%  $O_2$ /5%  $CO_2$  for

induction and 1% in 95% O<sub>2</sub>/5% CO<sub>2</sub> for maintenance). After removing the feathers and cleansing the field, a small skin incision was made just beside the radial nerve where it crossed the humerus using aseptic technique. The nerve was carefully dissected away from the associated blood vessel and a 3 mm segment of nerve was removed. The skin was then sutured and the wound was treated with topical antibiotics (neomycin, bacitracin and polymyxin B) and lidocaine. Control chickens were treated in exactly the same manner except that the nerve was not severed. The chickens were then allowed to recover from either the denervation or the sham operation for three days. In all cases the success of the denervation was evidenced by the drop of the pinion feathers ipsilateral to the denervated side.

#### 2.3.2 General surgery and experimental protocol:

The general surgery was performed three days after either denervation or a control operation in the same manner as described in section 2.2.1 with the following exceptions. For direct stimulation, the fascia covering the muscles was slit at two points and a pair of platinum plate electrodes were slipped inside the fascia to contact the length of the muscle, one electrode on each side of the muscle.

The arterial cannulation was performed as described in section 2.2.2 and the preparation immobilized (section 2.2.3). The recording circuits, the stimulating circuits

and the experimental protocol were outlined in sections 2.2.4 and 2.2.5. The intra-arterial injection technique outlined in section 2.2.6 was used in these studies. The responses to ACh, KCl and CAF in addition to the physical characteristics of the chickens were examined and these were measured as described (section 2.2.7). The statistical approach has also been outlined (section 2.2.8). Two-way analysis of variance was conducted on these data, however, the main factors in this analysis were disease and denervation. The chickens were separated into two groups, a male group and a female group, and analysis was performed on these groups individually.

## 2.4 Electrophysiology

2.4.1 General surgery. The general surgical procedures for the electrophysiology experiments resemble those described in section 2.2.1 except that the thick fascia covering the EDC muscle was cut to expose the muscle surface and facilitate recording. The preparation was immobilized as described in section 2.2.3.

2.4.2 Electrophysiologic recording. Micropipettes were fabricated from capillary tubes (W-P Instruments Inc.,

# 1B100F-4), pulled to a vertical pipette pull 700-G) and filled with mounted in an electrode microelectrode pre-amplifier M-707). The indifferent bird at the vertebral cl through a pre-amplifier simultaneously on the os. The responses were also inches per second) for 1 derivative of the action custom-made differentiating stimulating circuits were section 2.2.4.

2.4.3 Experiment recording, the muscle twitch muscle relaxant dantrolene sodium was from Pharmaceuticals. Twenty in the following solution ml of H<sub>2</sub>O. A blocking d through the IV jugular c Instruments Model 355) a. Using a hydraulic p

50-12-1) the electrode tip was placed in contact with the surface of the muscle (equipment is illustrated in Figure 2.4, page 51). The DC offset potential was adjusted and the capacitance compensated on the preamplifier. The electrode was tested; only electrodes with tip resistances of 5-15 megohms were used in this study. The electrode was then advanced through the first 2-3 cells to avoid any potentially damaged cells. Only clean penetrations were included in this study; a clean penetration was one in which there was an abrupt drop in resting membrane potential as the electrode entered the cell and the recorded resting membrane potential was stable. In this manner, a total of 30-40 cells were sampled per chicken.

2.4.4 Measurements. The exhaustion scores and the chicken body weights were recorded for the chickens used in this portion of the study. Although accurate figures were unavailable, the age range of the subjects was from 6-8 weeks. Dose-response curves were constructed for dantrolene sodium concentration (mg/kg) versus the percent twitch blockade. The following measurements were made from the oscilloscope trace of the action potentials recorded in this study: the resting membrane potential (mV), the action potential amplitude (mV), the overshoot (mV) and the action potential duration at half the maximal amplitude (ms) (see Figure 2.7). The first derivative or rate of rise of the

Figure 2.7 Action potential record (A) and the data analysis procedure (B). The data presented were recorded with an intracellular electrode in a normal EDC muscle.

(A) Photograph of a representative action potential: action potential (i); rate of rise (first derivative) of the action potential (ii).

(B) Parameters of the action potential measured in the present experiment: action potential (i); action potential rate of rise (ii).



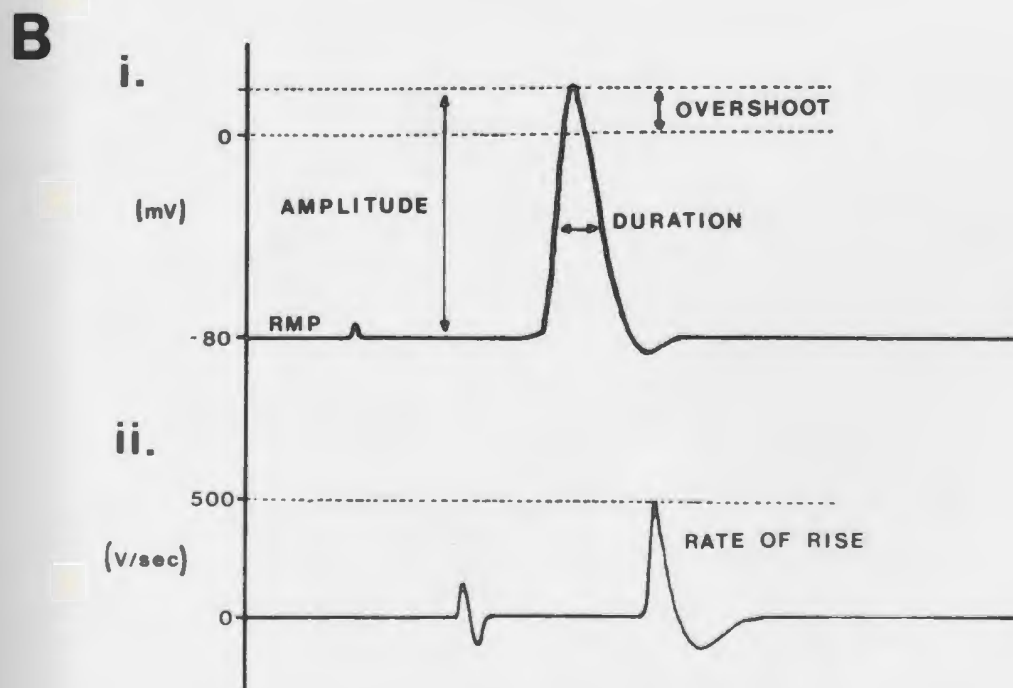
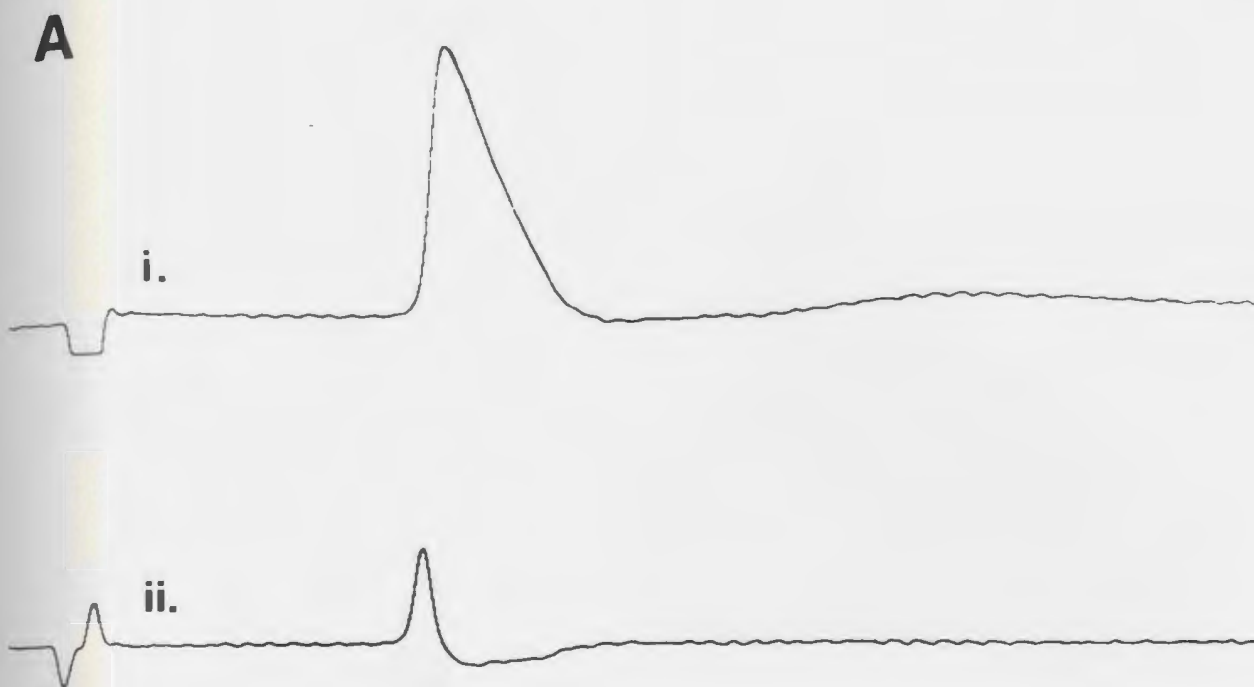

action potential (volts/s) was also measured (see Figure 2.7) using a differentiator ( $C = 0.0005$  F,  $R = 100$  K).

2.4.5 Statistics. The chickens were separated into four groups, normal female chickens, dystrophic female chickens, normal male chickens and dystrophic male chickens. All values were expressed as the mean plus or minus the standard error of the mean. The physical characteristics of the chickens were analyzed using two-way analysis of variance, with sex and disease as main factors. Regression analysis was performed on the linear portion of the dantrolene sodium dose-response curves for each chicken and the differences in the slopes between the four treatment groups were assessed using analysis of variance. The  $ID_{50}$  values were calculated for these curves. For illustrative purposes, the action potential characteristics were expressed as frequency distributions. Next, an estimate of each action potential characteristic was obtained by pooling the data for each experiment and arriving at one estimate of each parameter for each chicken. These data were divided into four groups (NF, DF, NM, DM) and differences between groups were examined using two-way analysis of variance with sex and disease as main factors. All tests were performed using standard computer programs. The significance level for the present experiment was  $p < 0.05$ .

## 2.5 Smooth Muscle In Vitro Experiments

2.5.1 General preparation. Normal and dystrophic male chickens served as subjects in the present study. Following cervical dislocation, the ischiatic artery was removed and dissected free of overlying connective tissues. Using techniques described by Hooker, Calkins and Fleisch (1977), the arteries were cut into 2.5 mm rings and mounted in an isolated tissue bath for isometric recording at a pre-load tension of 2 grams (see Figure 2.8). In several experiments the pre-load tension was varied between 0.5 and 4.0 grams to determine the optimal pre-load value of 2 grams. The tissues were equilibrated for a minimum of 1.5 hours at 40°C in a gassed (95% O<sub>2</sub>, 5% CO<sub>2</sub>) bathing medium of the following composition (mM): NaCl 118; KCl 4.6; CaCl<sub>2</sub> 2.7; MgCl<sub>2</sub> 1.2; KH<sub>2</sub>PO<sub>4</sub> 1.2; NaHCO<sub>3</sub> 25; glucose 11 (Knight and McGregor, 1974).

2.5.2 Experimental protocol. Two responses to an EC<sub>100</sub> concentration of either 5-HT 10<sup>-5</sup> M or NA 10<sup>-4</sup> M were obtained and then two cumulative concentration-response curves were constructed by step-wise addition of the agonist, either 5-HT or NA, after each response had plateaued (see Figure 2.9). The concentration-response curve to 5-HT was repeated after a 30 minute pre-exposure

Figure 2.8 Experimental apparatus for the isolated  
vascular smooth muscle experiments.

- (A) Isotonic transducer.
- (B) Metal rod used to suspend tissues.
- (C) Support clamp for metal rod.
- (D) Aeration, 5% CO<sub>2</sub>, 95% O<sub>2</sub>.
- (E) Glass muscle chamber surrounded by a jacket filled with warm (41°C) water.
- (F) Bath drainage outlet.

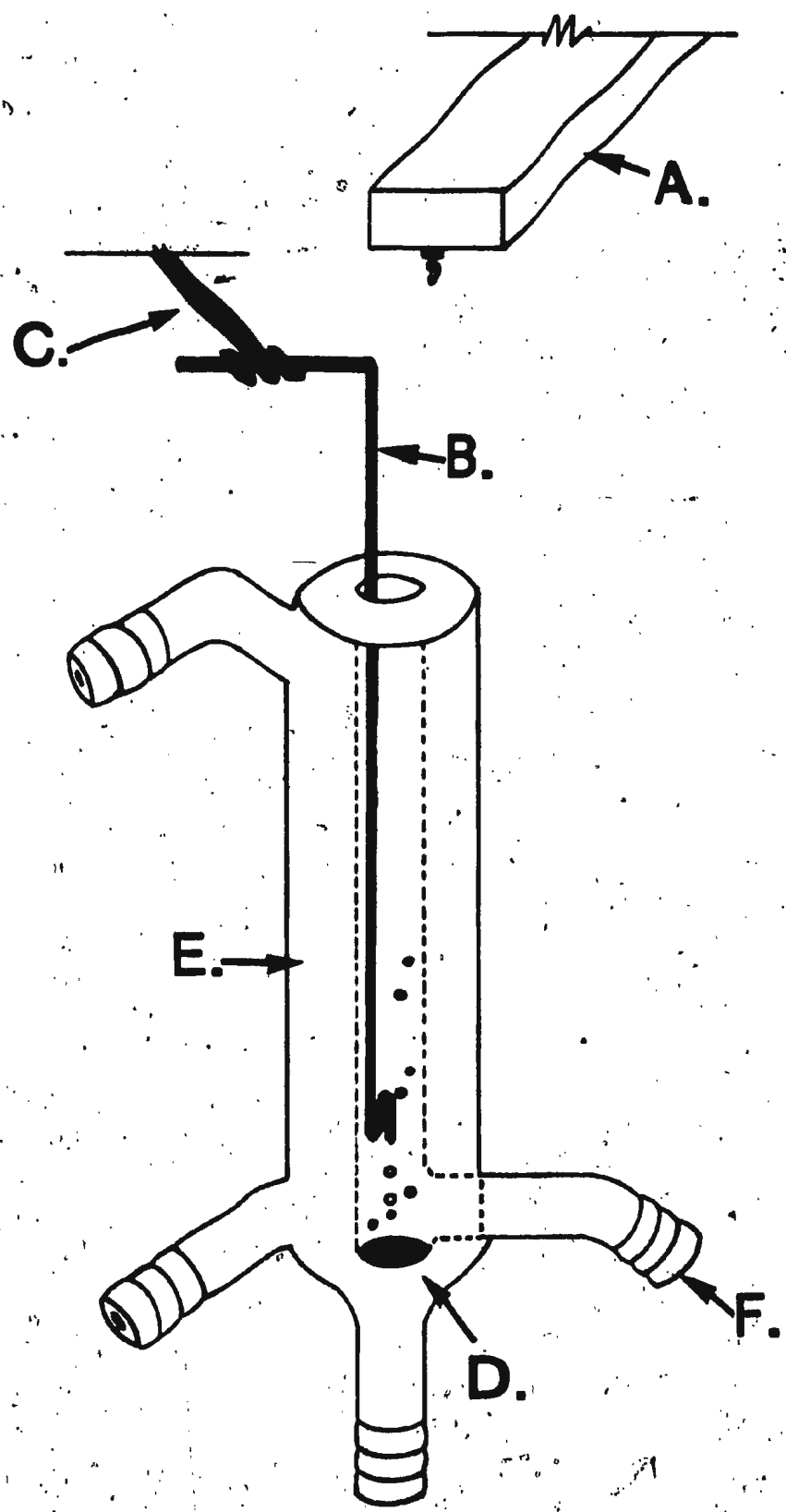

Figure 2.9 Cumulative concentration-response curves  
obtained for the ischiatic artery of a normal chicken.

(A) Concentration-response curve for 5-HT.

(B) Concentration-response curve for NA.

The vertical and horizontal calibration bars are 4.0  
grams and 3.0 minutes, respectively.

**A. NORADRENALINE**



**B. SEROTONIN**

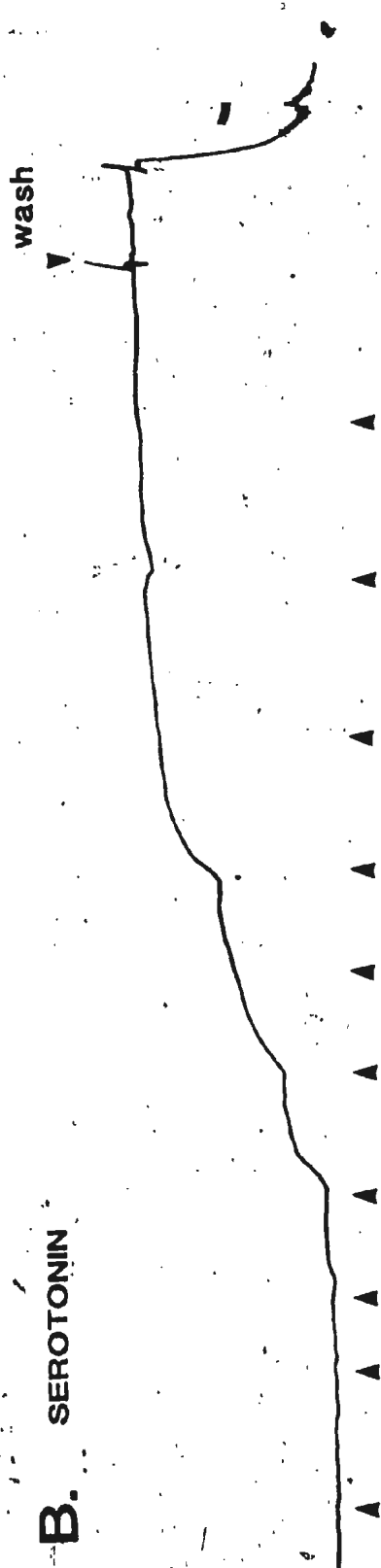

to either cocaine ( $10^{-5}$  M) or, in a limited number of experiments, to fluoxetine ( $10^{-6}$  M) to block neuronal uptake ( $U_1$ ) of 5-HT. In the case of NA, concentration-response curves were collected after a 30 minute pre-exposure to propranolol ( $10^{-7}$  M), to block beta-adrenoceptor-mediated effects, cocaine, to block  $U_1$  and beta-estradiol ( $10^{-5}$  M), to block extraneuronal uptake ( $U_2$ ). Then each concentration-response curve was repeated in the presence of either fluoxetine or cocaine after a 30 minute pre-exposure to a range of concentrations of either ketanserin, to block the action of 5-HT at 5-HT<sub>2</sub>-receptors or prazosin, to block the action of NA at alpha<sub>1</sub>-adrenoceptors. It had previously been demonstrated that the concentrations of  $U_1$ ,  $U_2$  and beta-adrenoceptor antagonists used produced optimal inhibition of the appropriate system.

The tissues were washed several times over a 30-40 minute recovery period before obtaining further concentration-response curves. In most experiments, concentration-response curves to the agonist alone were collected for one normal and one dystrophic tissue to assess any time-dependent changes in vascular reactivity. To test the possibility that the responses to 5-HT were indirectly mediated via a synapse, concentration-response curves to 5-HT were obtained in the presence of tetrodotoxin ( $10^{-7}$  to  $10^{-5}$  M). To determine the specificity of the response, a concentration-response curve



for 5-HT was constructed in the presence of prazosin ( $10^{-7}$  to  $10^{-6}$  M) and a concentration-response curve for NA was conducted in the presence of ketanserin ( $10^{-7}$  M). At the conclusion of the experiment the tissues were allowed to dry and the dry weight was measured on an electrobalance. In a limited number of experiments the wet weights of large segments of arteries from the contralateral leg were recorded; these vessels were dried and re-weighed to yield wet/dry ratios.

2.5.3 Measurements and statistics. Data from the concentration-response curves were expressed as percentages of the maximum response either in the presence of cocaine (for the 5-HT data) or in the presence of both cocaine and propranolol (for the NA data). These data were pooled across chickens and the mean and standard error of the mean were calculated for the range of concentrations tested. Since ketanserin and prazosin are competitive antagonists, the  $EC_{50}$  ratios were computed (ie. the ratios of the  $EC_{50}$  value in the presence of the antagonist plus cocaine divided by the  $EC_{50}$  value in the presence of cocaine alone). Following the methods of Tallarida and Jacob (1979), Schild plots were constructed for these data and the  $pA_2$  values for both ketanserin and prazosin were calculated.

The grams-tension per mg dry weight was calculated for

the maximum response to both 5-HT and to NA. In a limited number of experiments, ratios of wet weight over dry weight were calculated to test for differences between tissues from normal and dystrophic chickens. These data were expressed as the mean plus or minus the standard error of the mean and differences were assessed using a t-test. The data analysis in the present experiments was performed either with a pharmacologic computer package designed by Tallarida and Murray (1981) or with standard analysis of variance programs. The significance level accepted in the present experiment was  $p < 0.05$ .

## 2.6 Drugs and Reagents

The manufacturers and specifications of all drugs and chemical reagents used in the present study are summarized below. The anesthetics employed were urethane (ethyl carbamate, Sigma Chemical Co.), alpha-chloralose (Sigma) and halothane (somnothane, Canadian Hoechst Ltd.).

The drugs used in this study were acetylcholine chloride (Sigma), carbachol (carbamylcholine, BDH), potassium chloride (Fischer Scientific Co.), caffeine sodium benzoate (Sigma), neostigmine bromide (Sigma), dantrolene sodium (a gift of Norwich Pharmaceuticals),

fluoxetine (a gift of Eli Lilly Co.); ketanserin tartate (a gift of Janssen Pharmaceuticals), propranolol hydrochloride (Sigma), cocaine hydrochloride (BDH), serotonin oxalate (Sigma), noradrenalin hydrochloride (Sigma), prazosin hydrochloride (a gift of Pfizer Canada), beta-estradiol (Sigma), tetrodotoxin (citrate-free, Calbiochem) and heparin (heparin sodium injection, 1,000 USP units/ml, Organon Canada Ltd.).

The chemical reagents used in the present study were sodium chloride (BDH, AnalaR grade), potassium chloride (Baker Chemical Co., Baker Analyzed Grade), sodium bicarbonate (Baker, Baker Analyzed Grade), magnesium chloride ( $MgCl_2 \cdot 6 H_2O$ , Baker, Baker Analyzed Grade), glucose (BDH, AnalaR grade), calcium chloride (dihydrate, Baker, Baker Analyzed Grade), potassium phosphate dibasic (Fisher), sodium hydroxide (Sigma) and mannitol (Fisher).

## Chapter III

## RESULTS

## 3.1 Muscle Pharmacology

3.1.1 Physical data. The physical parameters measured in this study, expressed as the mean plus or minus the standard error of the mean, are summarized in Table I. Results indicated that the ability to rise from the supine position was significantly reduced in dystrophic chickens ( $0.1 \pm 0.1$  for female chickens and  $0.2 \pm 0.2$  for male chickens) when compared to normal chickens ( $16.5 \pm 1.0$  for female chickens and  $13.9 \pm 0.6$  for male chickens). No significant effect of sex was noted.

Although the age of the chickens did not differ between study groups, the male chickens were significantly heavier than the female chickens ( $1.022 \pm 0.028$  kg for normal male chickens and  $0.967$  for dystrophic male chickens vs.  $0.717 \pm 0.032$  kg for normal female chickens and  $0.761 \pm 0.032$  kg for dystrophic female chickens). This was true of both diseased and control groups.

The muscle wet weights were significantly increased in the dystrophic group ( $0.219 \pm 0.010$  g for female chickens

TABLE I  
Physical Characteristics of Normal and Dystrophic Chickens:  
The Effects of Sex and Disease

Parameter <sup>a</sup>	NF	DF	NM	DM
flip score <sup>c</sup>	16.5 $\pm$ 1.0	0.1 $\pm$ 0.1	13.9 $\pm$ 0.6	0.2 $\pm$ 0.1
age (days)	59.5 $\pm$ 0.9	59.8 $\pm$ 1.2	60.7 $\pm$ 0.8	60.5 $\pm$ 1.2
chicken wt. <sup>b</sup> (kg)	0.717 $\pm$ 0.032	0.761 $\pm$ 0.032	1.022 $\pm$ 0.028	0.967 $\pm$ 0.028
muscle wet wt. <sup>b,c</sup> (g)	0.190 $\pm$ 0.010	0.219 $\pm$ 0.010	0.273 $\pm$ 0.010	0.320 $\pm$ 0.020
muscle dry wt. <sup>b,c</sup> (g)	0.051 $\pm$ 0.003	0.062 $\pm$ 0.004	0.072 $\pm$ 0.003	0.076 $\pm$ 0.004
wet/dry ratio	3.79 $\pm$ 0.07	3.60 $\pm$ 0.10	3.79 $\pm$ 0.15	3.82 $\pm$ 0.08
muscle wet wt.(g) <sup>c</sup> /chk. wt.(kg)	0.263 $\pm$ 0.007	0.296 $\pm$ 0.010	0.263 $\pm$ 0.007	0.326 $\pm$ 0.015
twitch tension <sup>c</sup> (N/g)	2.46 $\pm$ 0.16	2.99 $\pm$ 0.18	2.47 $\pm$ 0.17	3.12 $\pm$ 0.30
tetanic tension <sup>c</sup> (N/g)	15.63 $\pm$ 1.73	19.11 $\pm$ 1.90	15.66 $\pm$ 0.67	19.67 $\pm$ 2.27
number of chickens	13	13	13	13

a all results are expressed as X  $\pm$  SEM.

b the effect of factor 1 (sex) is significant

c the effect of factor 2 (disease) is significant

and  $0.320 \pm 0.020$  g for male chickens) when compared to the control group ( $0.190 \pm 0.010$  g for female chickens and  $0.237 \pm 0.010$  g for male chickens). The effect of sex was also significant on this measure indicating that the muscle wet weight in female chickens was less than that in the male chickens. These significant differences were preserved in the dry weight measurements; dystrophic muscles were heavier than normal muscles and those from male chickens were heavier than those from female chickens ( $0.051 \pm 0.003$  g for muscles from normal female chickens,  $0.062 \pm 0.004$  g for muscles from dystrophic female chickens,  $0.072 \pm 0.003$  g for muscles from normal male chickens and  $0.076 \pm 0.004$  for those from dystrophic male chickens). The wet:dry ratios, however, did not differ significantly between groups.

The ratio of muscle wet weight (g) to chicken body weight (kg) was increased in the dystrophic group when compared to the normal group ( $0.263 \pm 0.007$  g/kg for normal female chickens,  $0.296 \pm 0.010$  g/kg for the dystrophic female chickens,  $0.263 \pm 0.007$  g/kg for the normal male chickens and  $0.323 \pm 0.015$  g/kg for dystrophic male chickens). The effect of sex was not significant on this measure.

The maximum twitch tension (Newtons) per gram of muscle (wet weight) was significantly increased in both dystrophic groups ( $2.99 \pm 0.18$  N/g for dystrophic female

chickens and  $3.12 \pm 0.30$  N/g for dystrophic male chickens) when compared to the normal groups ( $2.46 \pm 0.16$  N/g for normal female chickens and  $2.47 \pm 0.17$  N/g for normal male chickens). A parallel increase in the tetanic tension (N) per gram of muscle (wet weight) was noted in the dystrophic group ( $19.11 \pm 1.90$  N/g for dystrophic female chickens and  $19.67 \pm 2.37$  N/g for dystrophic male chickens) when compared to the control group ( $15.63 \pm 1.73$  N/g for the normal female chickens and  $15.66 \pm 0.67$  N/g for the normal male chickens). The effect of sex on the ability of muscle to develop tension, however, was not significant.

3.1.2 Control experiments. The results of several control experiments are reported here. There were no apparent differences between normal and dystrophic groups in either  $l_0$  or the length-tension curves measured for this muscle. Injections of cold saline, heparinized saline, 1 M sodium chloride and 1 M mannitol had no notable effect on the muscle contractile response. Repeated dose-response curves within a subject were not quantitatively different. Intra-arterial injections of ACh and CARB produced a substantial drop in blood pressure in addition to their effects on muscle. Intra-venous injections of these agents which produced large decreases in blood pressure, however, failed to affect muscle contractile responses (see Figure 3:1). Both intra-venous and intra-

Figure 3.1 The effects of intra-arterial and intra-venous injections of drugs on blood pressure and muscle contraction in a normal chicken.

- (A) The effect of ACh on blood pressure (upper trace) and on muscle contraction (lower trace).
- (B) The effect of KCl on blood pressure (upper trace) and on muscle contraction (lower trace).
- (C) The effect of CARB on blood pressure (upper trace) and on muscle contraction (lower trace).
- (D) The effect of CAF on blood pressure (upper trace) and on muscle contraction (lower trace).

The horizontal calibration bar is 24 seconds.



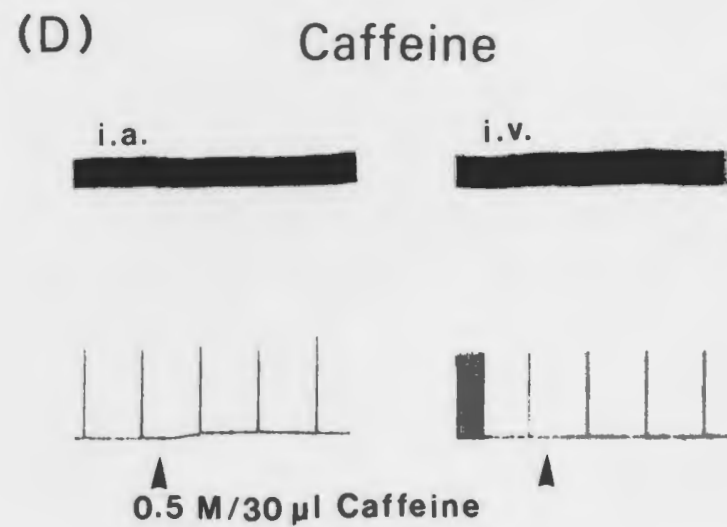
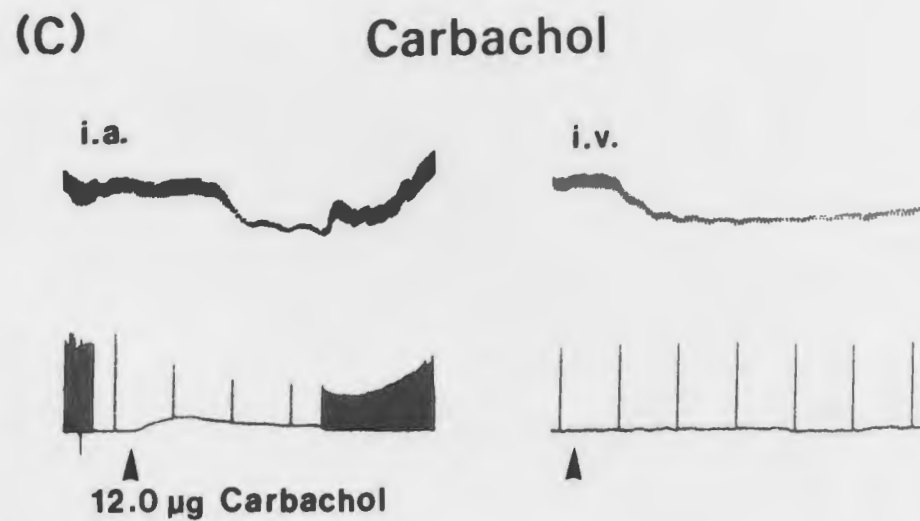
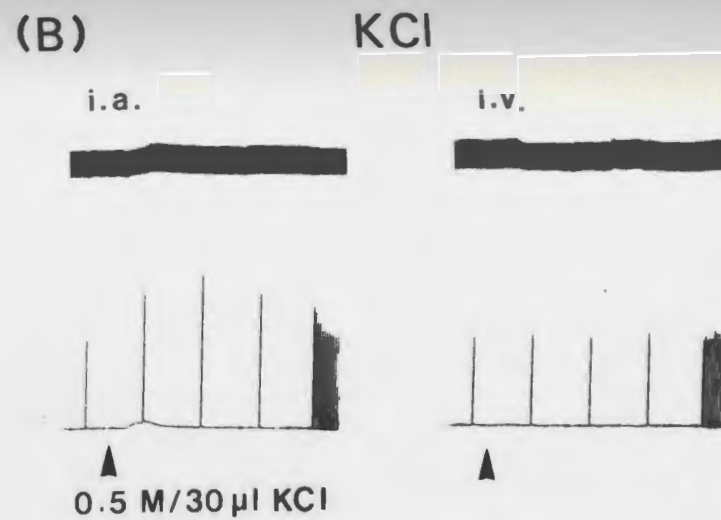
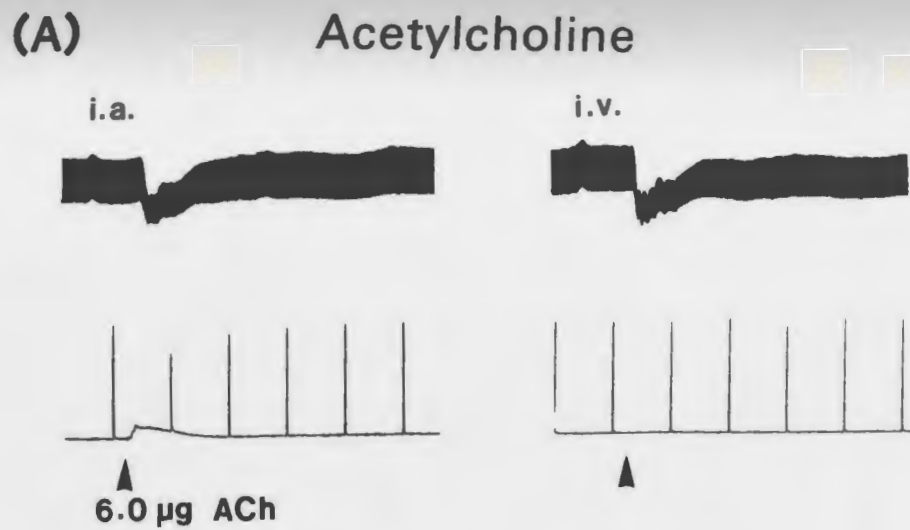

arterial injections of CAF and KCl had insignificant effects on blood pressure (see Figure 3.1).

3.1.3 Acetylcholine responses. The results of the intra-arterial injection studies for innervated muscle are illustrated graphically as dose-response curves (see Figures 3.2 to 3.10). As shown in Figure 3.2, twitch depression in response to ACh was markedly reduced in dystrophic muscle. This difference was present in dystrophic muscle from both female (Figure 3.2A) and male (Figure 3.2B) chickens. The results of analysis of variance on the slopes of these lines showed that there were no significant differences between groups. Analysis of variance on the y-intercepts of these lines, however, demonstrated that the effect of disease was significant on this measure ( $0.790 \pm 0.073$  for the normal female chickens vs.  $1.160 \pm 0.004$  for the dystrophic female chickens and  $0.879 \pm 0.051$  for the normal male chickens vs.  $1.060 \pm 0.033$  for the dystrophic male chickens). These data demonstrate that the y-intercept of the regression line is increased in dose-response curves from both dystrophic groups. In other words, the dose-response curves for dystrophic muscle were shifted to the right. No significant effect of sex was noted. In a few experiments, an extended dose range was administered to dystrophic muscle. These data are presented in Figure 3.3 and

Figure 3.2 The dose-response curves for the twitch ratio  
(post-twitch/pre-twitch) vs. the dose of acetyl-  
choline. N = 7 chickens per group.

- (A) Female group. The effect of disease on the y-intercept of these lines is significant.
- (B) Male group. The effect of disease on the y-intercept of these lines is significant.

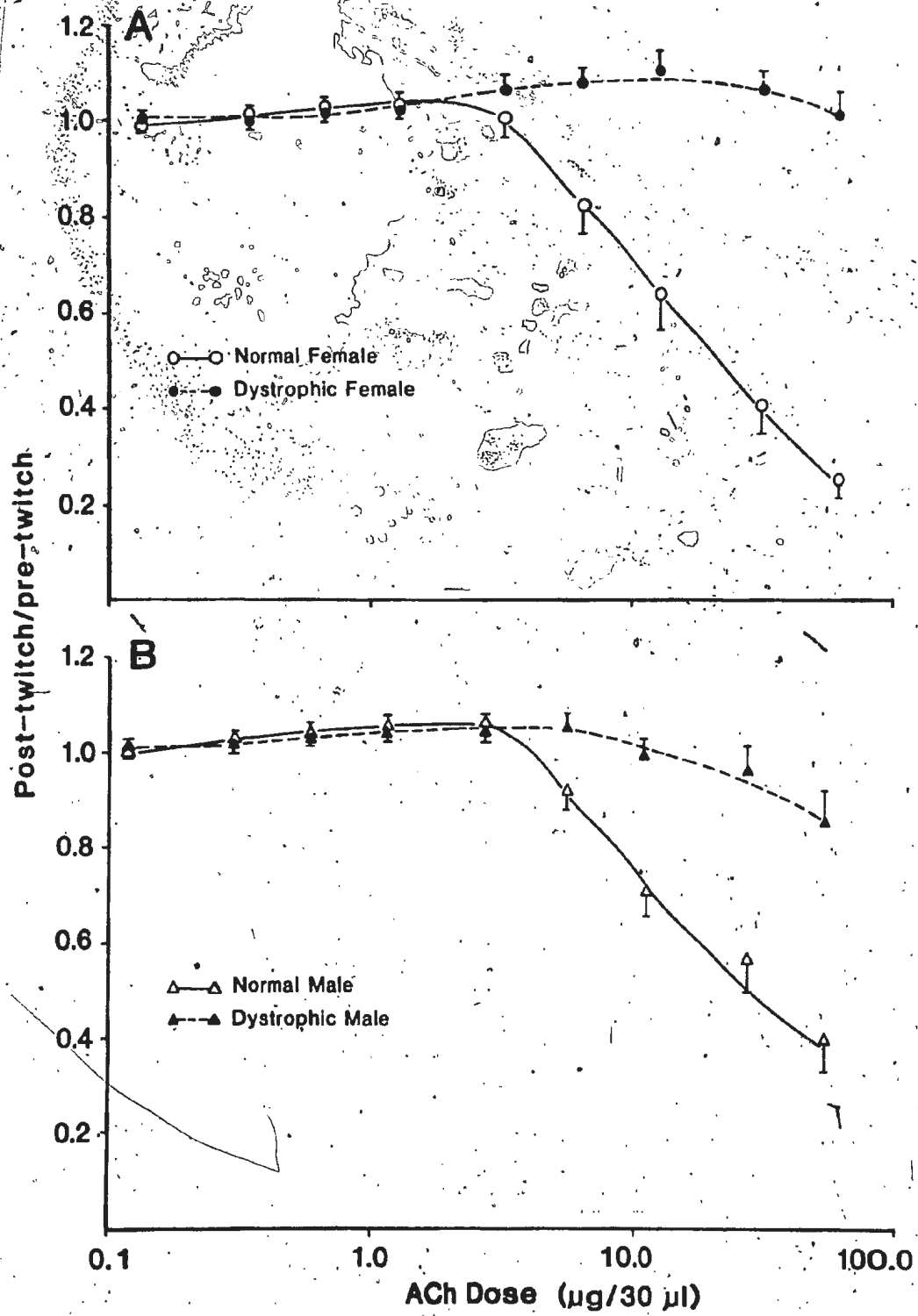

Figure 3.3 The dose-response curves for the twitch ratio (post-twitch/pre-twitch) vs. the dose of acetylcholine. The data from male and female chickens have been pooled and the concentration range has been extended for the dystrophic group. N = 14 for the normal group and N = 6 for the dystrophic group.

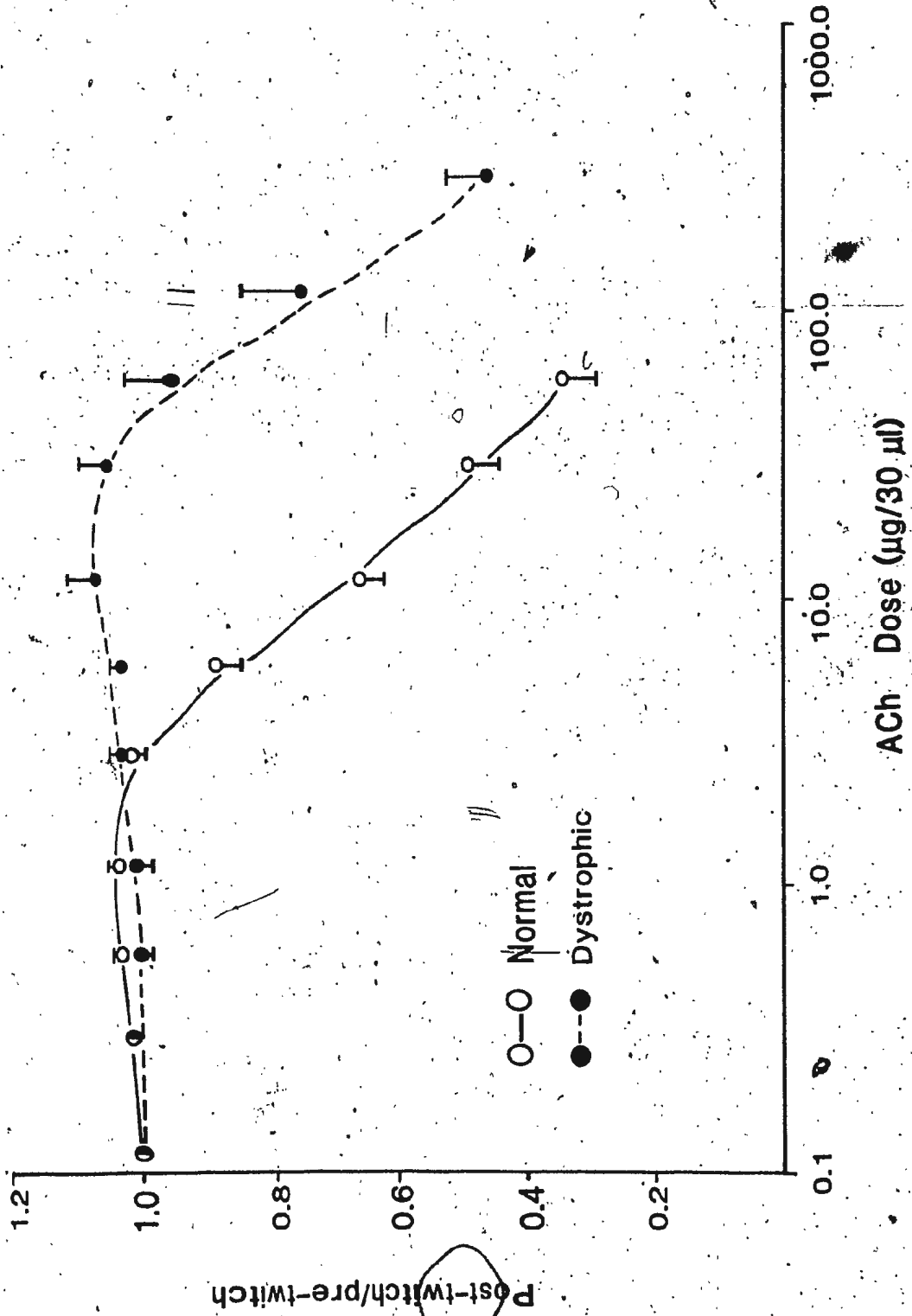

Figure 3.4. The dose-response curves for the contracture amplitude (Newtons/gram muscle wet weight) vs. the dose of acetylcholine. N = 7 chickens per group.

- (A) Female group. No significant differences between groups.
- (B) Male group. No significant differences between groups.

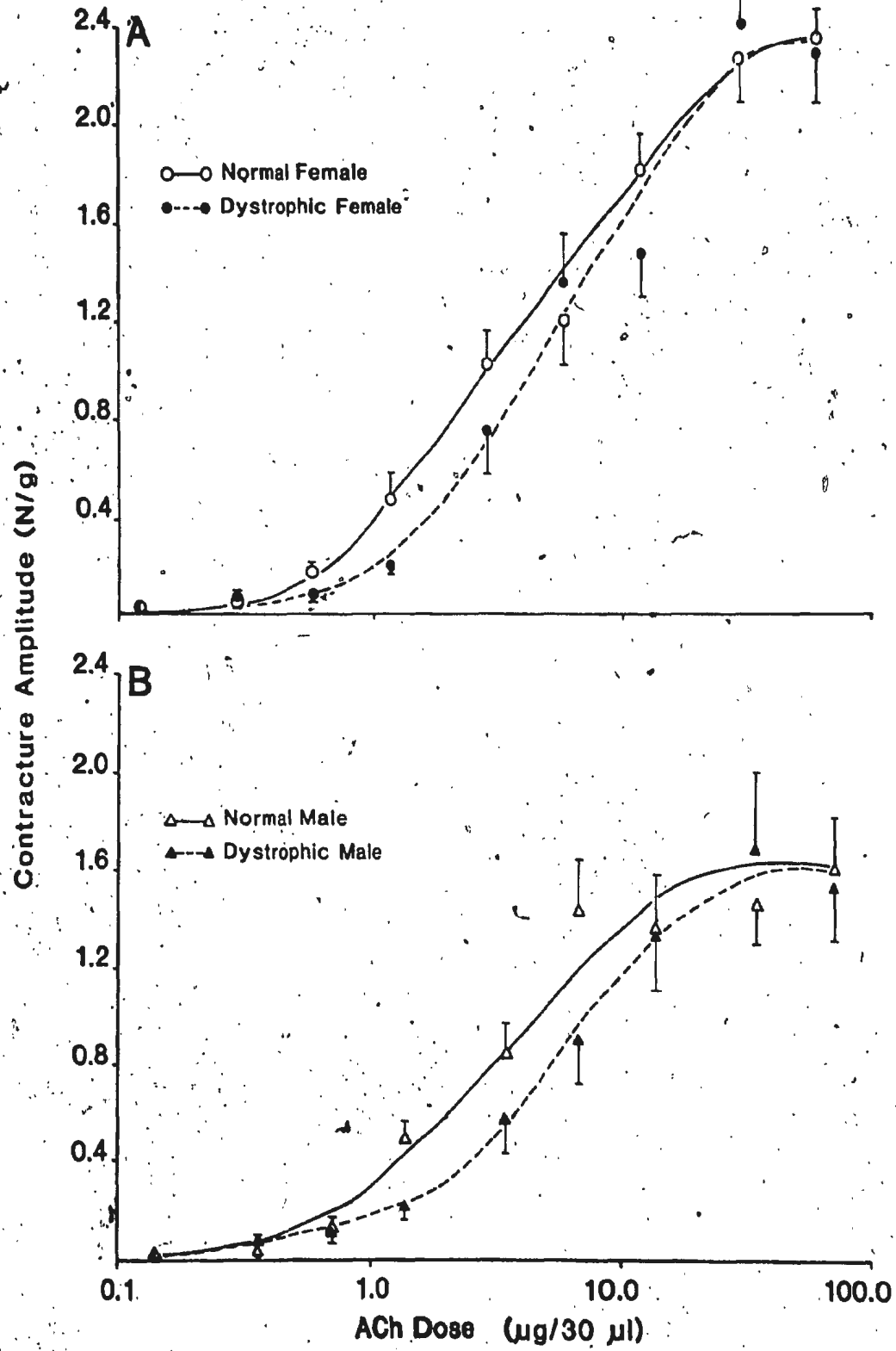



Figure 3.5 The dose-response curves for the twitch ratio  
(post-twitch/pre-twitch) vs. the dose of carbachol. N  
= 6 chickens per group.

(A) Female group. No significant differences between  
groups.

(B) Male group. No significant differences between  
groups.

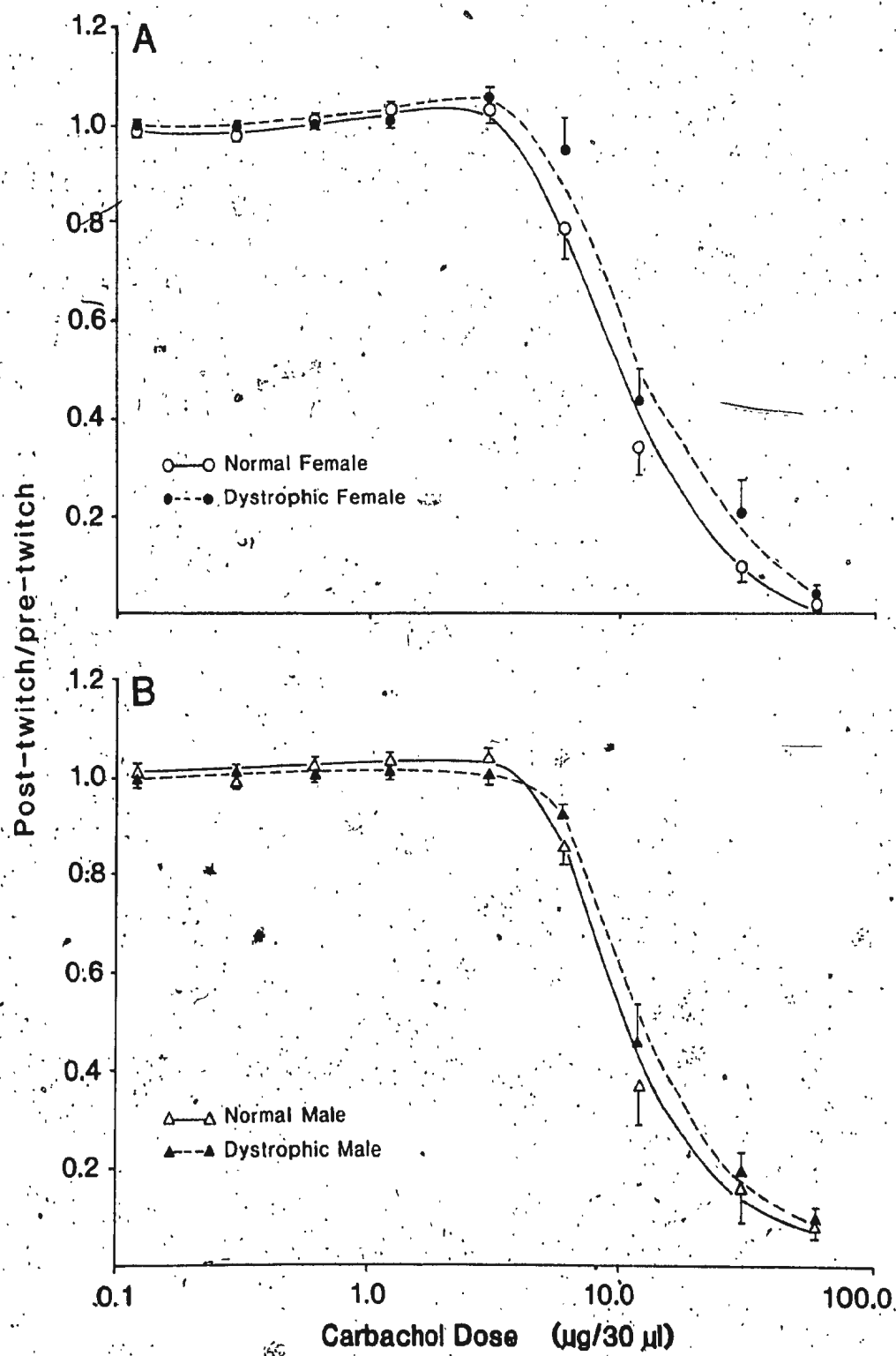

Figure 3.6 The dose-response curves for the contracture amplitude (Newtons/gram muscle wet weight) vs. the dose of carbachol. N = 6 chickens per group.

(A) Female group. No significant differences between groups.

(B) Male group. No significant differences between groups.

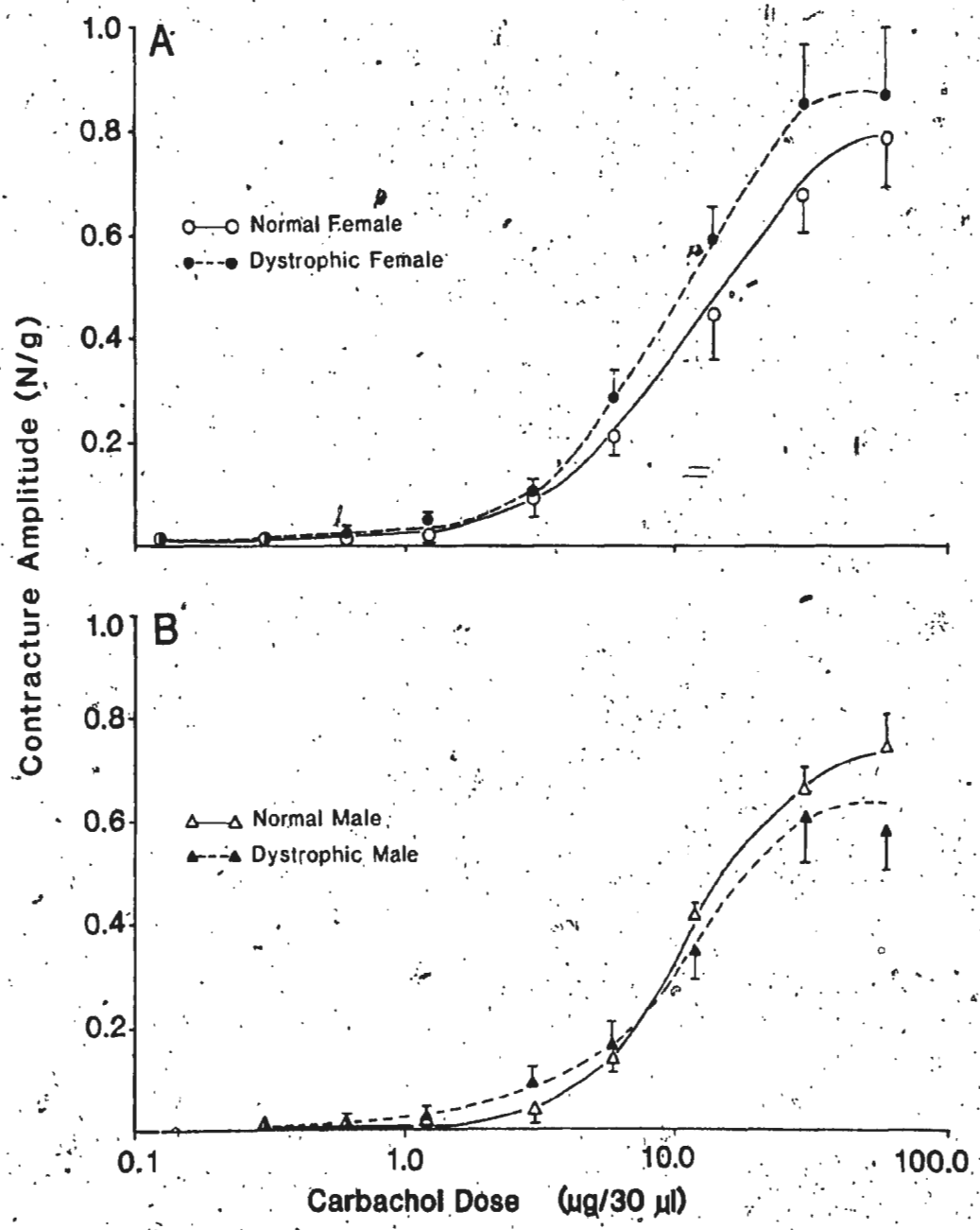

Figure 3.7. The dose-response curves for the twitch ratio (post-twitch/pre-twitch) vs. the dose of potassium chloride. N = 6 chickens per group.

- (A) Female group. The effect of disease is significant on the slope.
- (B) Male group. The effect of disease is significant on the slope.

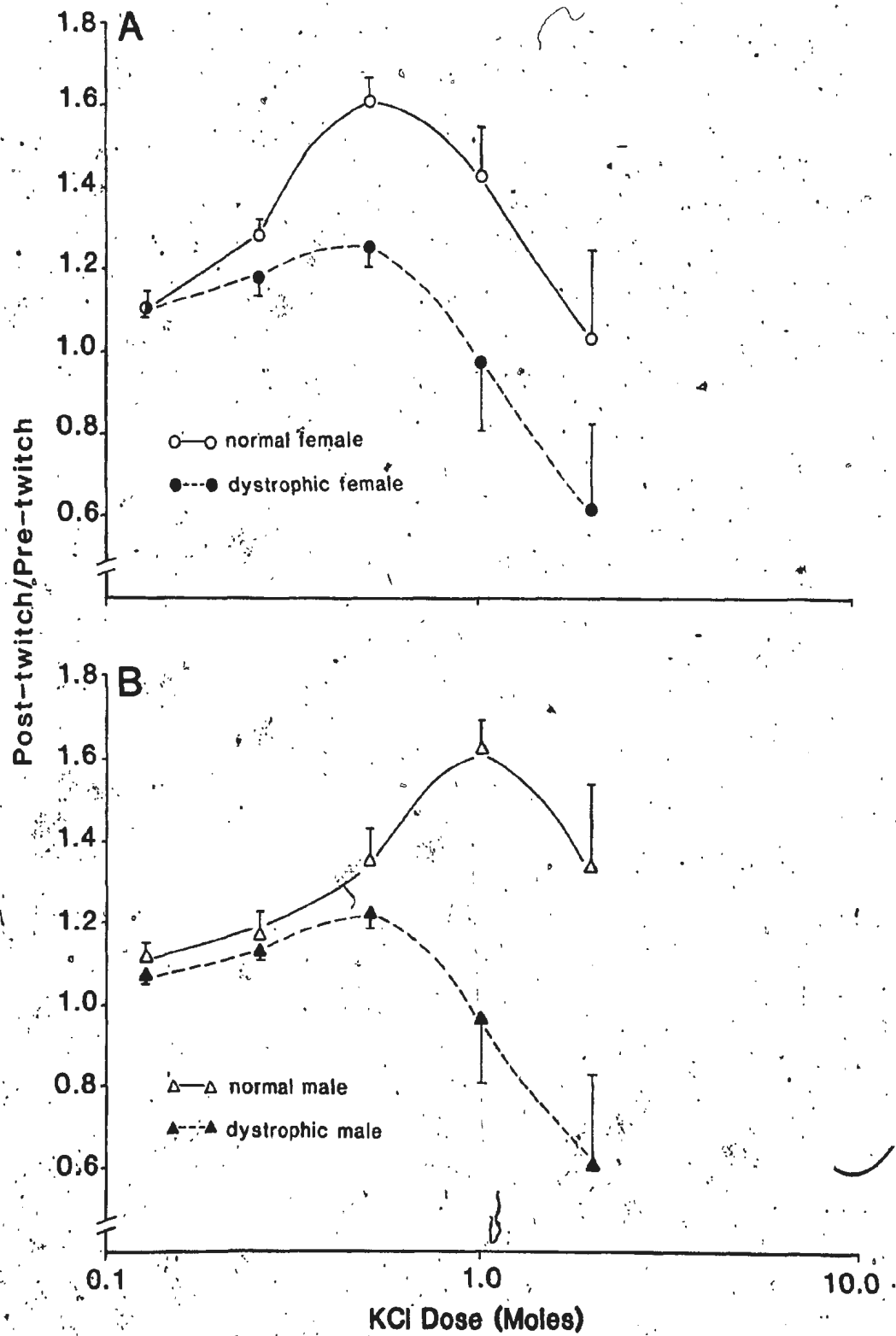

Figure 3.8 The dose-response curves for the contracture amplitude (Newtons/gram muscle wet weight) vs. the dose of potassium chloride. N = 6 chickens per group.

- (A) Female group. No significant differences between groups.
- (B) Male group. No significant differences between groups.

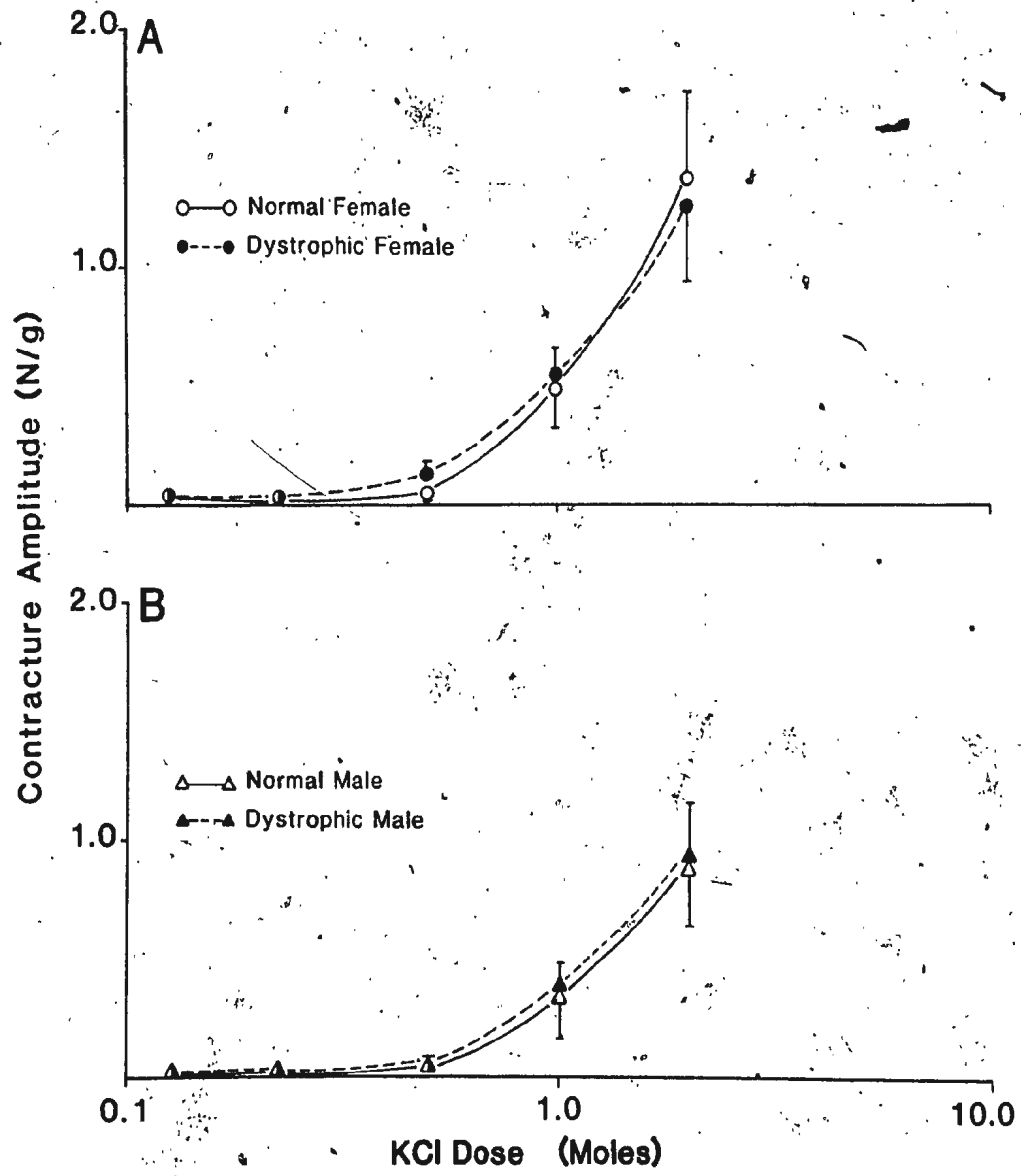
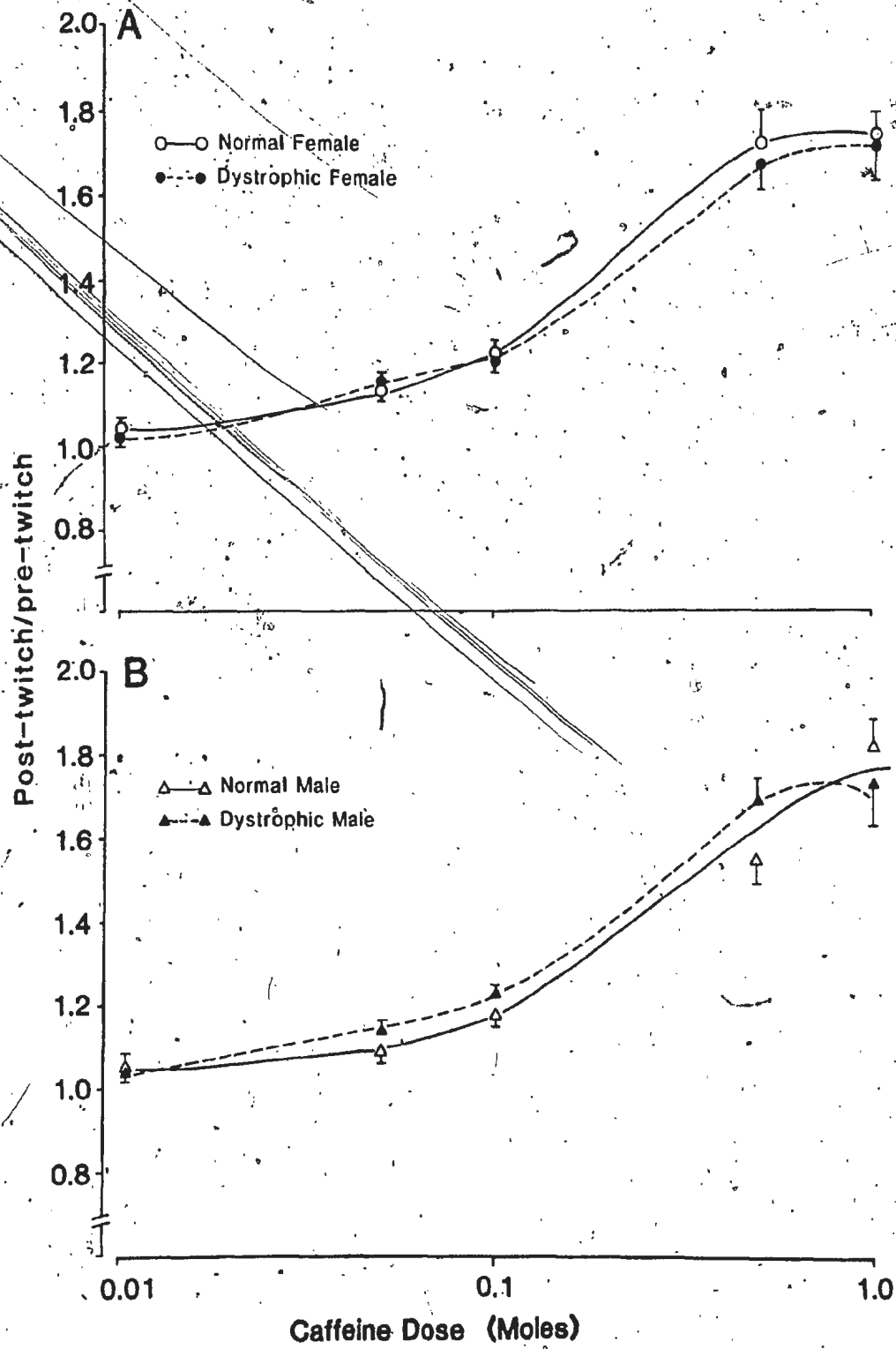



Figure 3.9 The dose-response curves for the twitch ratio  
(post-twitch/pre-twitch) vs. the dose of caffeine. N  
= 6 chickens per group.

(A) Female group. No significant differences between  
groups.

(B) Male group. No significant differences between  
groups.



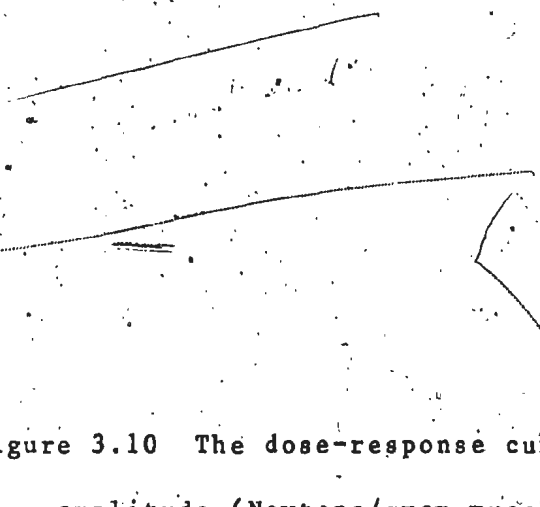
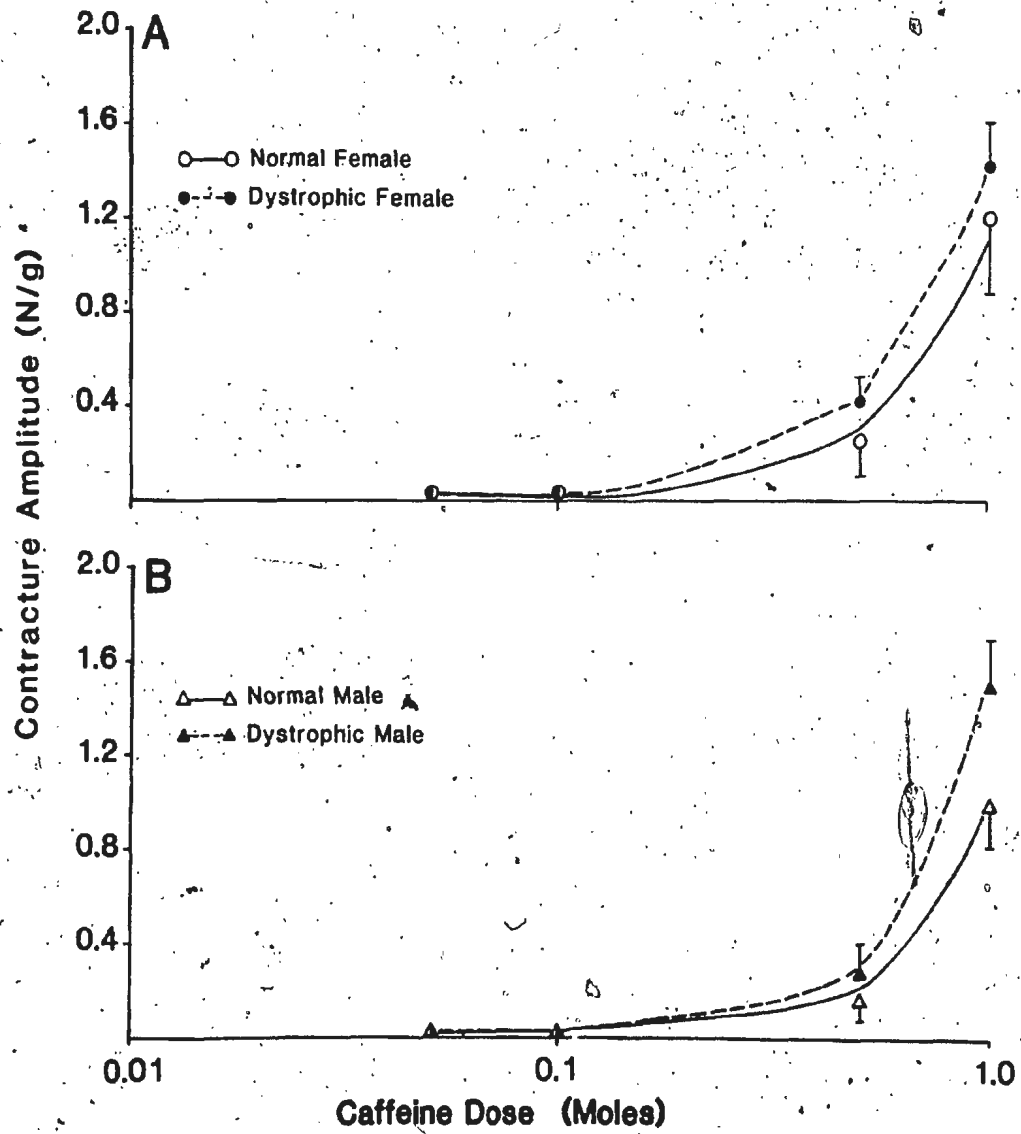

Figure 3.10 The dose-response curves for the contracture  
amplitude, (Newtons/gram muscle wet weight) vs. the  
dose of caffeine. N = 6 chickens per group.

(A) Female group. No significant differences between  
groups.

(B) Male group. No significant differences between  
groups.



illustrate that substantial twitch depression occurred in dystrophic muscle at high concentrations of ACh. The  $ID_{50}$  values for these curves were estimated to be  $21.7 \pm 3.5$  for the normal group and  $185.2 \pm 36.0$  for the dystrophic group. These data also suggest that the dose-response curves obtained for dystrophic muscle were shifted to the right.

Analysis of the ACh contracture responses in normal and dystrophic muscles (Figure 3.4A & B page 91) suggested that the normal muscle appeared slightly more sensitive to ACh than the dystrophic muscle. There were no significant differences between groups, however, for the slopes of the regression lines of these curves. Neither the effect of sex nor the effect of disease were significant on these measures.

The effects of sex and disease on the  $ED_{50}$  values, however, were significant (see Table II). These results suggested that normal muscles were more sensitive to ACh than dystrophic muscles and that the male chickens were slightly more sensitive to the drug than the female chickens ( $5.78 \pm 0.52 \mu\text{g}/30 \mu\text{l}$  for the normal female chickens vs.  $7.96 \pm 0.34 \mu\text{g}/30 \mu\text{l}$  for the dystrophic female chickens and  $3.51 \pm 0.65 \mu\text{g}/30 \mu\text{l}$  for the normal male chickens vs.  $6.71 \pm 0.61 \mu\text{g}/30 \mu\text{l}$  for the dystrophic male chickens).

#### 3.1.4 Carbachol responses. The twitch depression

TABLE II  
ED<sub>50</sub> AND ID<sub>50</sub> Values of Normal and Dystrophic Muscle

Parameter <sup>a</sup>	ED <sub>50</sub> Values		ED <sub>50</sub> Values	
	NF	DF	NM	DM
ACh contracture <sup>b,c</sup> ( $\mu\text{g}/30 \mu\text{l}$ )	5.78 $\pm$ 0.52	7.96 $\pm$ 0.34	3.51 $\pm$ 0.65	6.71 $\pm$ 0.61
CARB contracture ( $\mu\text{g}/30 \mu\text{l}$ )	14.9 $\pm$ 3.4	9.6 $\pm$ 1.2	11.3 $\pm$ 1.4	11.0 $\pm$ 1.0
	ID <sub>50</sub> Values		ID <sub>50</sub> Values	
ACh twitch depres- <sup>d</sup> sion ( $\mu\text{g}/30 \mu\text{l}$ )	21.7 $\pm$ 3.5	185.2 $\pm$ 36.0		
CARB twitch depres- sion ( $\mu\text{g}/30 \mu\text{l}$ )	10.7 $\pm$ 1.6	12.0 $\pm$ 1.7	12.0 $\pm$ 2.7	12.4 $\pm$ 1.9
number of chickens	7	7	7	7

a all results are expressed as X  $\pm$  SEM.

b the effect of factor 1 (sex) is significant

c the effect of factor 2 (disease) is significant

d this value was estimated from the results of several experiments in which the dose range for ACh was extended to estimate the complete curve. Data from male and female chickens have been pooled; t-test showed that effect of disease was significant.

produced in response to CARB (Figure 3.5, page 93 ) was of similar magnitude in both normal and dystrophic muscle. This was true of muscles from female (Figure 3.5A) and male (Figure 3.5B) chickens. No significant effects of either sex or disease were evident on the slopes of the regression lines. Similarly, the  $ID_{50}$  values for the twitch response were not significantly different between groups (Table II, page 105).

The muscle contractures produced in response to injected CARB were similar in normal and dystrophic chickens (Figure 3.6, page 95); this was true of muscle contracture responses from both female (Figure 3.6A) and male (Figure 3.6B) chickens. Analysis of variance on the slopes and the  $ED_{50}$  values (see Table II, page 105) of these lines showed that no significant effects of either sex or disease were observed on these parameters.

3.1.5 Potassium chloride responses. The data illustrating the twitch depression produced in response to intra-arterial injections of KCl has been presented in Figure 3.7 (page 97). Slight twitch potentiation at low doses followed by twitch depression at higher doses was observed for both the female (Figure 3.7A) and the male (Figure 3.7B) dystrophic groups. On the other hand, twitch potentiation was observed at all doses in the normal group (see Figure 3.7A for data from female chickens and Figure

3.7B for data from male chickens). Analysis of variance showed that the slope of the regression line was altered in the dystrophic group when compared to the normal group. The values were  $0.037 \pm 0.12$  for the normal male chickens vs.  $-0.435 \pm 0.09$  for the dystrophic male chickens and  $0.039 \pm 0.11$  for the normal female chickens vs.  $-0.435 \pm 0.15$  for the dystrophic female chickens. The y-intercept did not differ significantly between groups. The effect of sex was not significant on this parameter.

There were no significant effects of disease on either the slopes or the y-intercepts of the regression lines for the KCl contracture response (Figure 3.8, page 99). The effect of sex on this parameter was not significant (see Figure 3.8A for data from female chickens and Figure 3.8B for data from male chickens).

3.1.6 Caffeine responses. Analysis of the twitch potentiation produced by CAF demonstrated no significant differences between normal and dystrophic muscles (Figure 3.9, page 101). Similarly, there were no significant differences in the responses of female chickens (Figure 3.9A) when compared to those of male chickens (Figure 3.9B).

Although the caffeine contracture responses appeared to be slightly enhanced in the dystrophic group (see Figure 3.10, page 103), this trend was not statistically



significant. Analysis of variance on the slopes and the y-intercepts of the regression lines showed no significant effects of either disease or sex (see Figure 3.10A for data from female chickens and 3.10B for data from male chickens).

3.1.7 Neostigmine responses. A limited amount of data was obtained for the response of normal and dystrophic chicken muscle to injected neostigmine. Following a tetanus, post-tetanic twitch depression was observed for the normal group; the post-twitch/pre-twitch ratio was  $0.622 \pm 0.063$ . By contrast, a slight post-tetanic twitch potentiation was observed for the dystrophic group; the post-twitch/pre-twitch ratio was  $1.008 \pm 0.063$ . This difference was significant in the present study.

### 3.2 Denervated Muscle

3.2.1 Physical data. The physical characteristics of the female chickens in both innervated and denervated groups are summarized in Table III. Similar results for the male chickens are tabulated in Table IV. Results indicate that, for all groups, the exhaustion scores were significantly reduced for the dystrophic chickens. The

TABLE III

Physical Characteristics of Normal and Dystrophic Chickens:  
Denervation Effects on the Female Group

Parameter <sup>a</sup>	Innervated		Denervated	
	NF	DF	NF	DF
flip score <sup>c</sup>	20.1 $\pm$ 2.2	0.5 $\pm$ 0.3	16.4 $\pm$ 1.6	0.7 $\pm$ 0.5
age (days)	56.0 $\pm$ 0.6	57.0 $\pm$ 1.7	56.9 $\pm$ 0.6	57.4 $\pm$ 0.6
chicken wt. <sup>c</sup> (kg)	0.626 $\pm$ 0.053	0.669 $\pm$ 0.072	0.656 $\pm$ 0.045	0.682 $\pm$ 0.059
muscle wet wt. <sup>c</sup> (g)	0.171 $\pm$ 0.013	0.215 $\pm$ 0.024	0.151 $\pm$ 0.009	0.212 $\pm$ 0.021
muscle dry wt. <sup>c</sup> (g)	0.049 $\pm$ 0.004	0.059 $\pm$ 0.005	0.040 $\pm$ 0.009	0.064 $\pm$ 0.008
wet/dry ratio	3.65 $\pm$ 0.10	3.80 $\pm$ 0.10	3.85 $\pm$ 0.14	3.54 $\pm$ 0.10
muscle wet wt.(g) <sup>c</sup> /chk. wt.(kg)	0.275 $\pm$ 0.012	0.325 $\pm$ 0.023	0.232 $\pm$ 0.019	0.313 $\pm$ 0.060
twitch tension <sup>b</sup> (N/g)	4.24 $\pm$ 0.88	4.92 $\pm$ 0.53	1.71 $\pm$ 0.42	2.64 $\pm$ 0.25
tetanic tension <sup>b</sup> (N/g)	16.28 $\pm$ 2.81	15.19 $\pm$ 3.24	4.88 $\pm$ 0.86	7.67 $\pm$ 0.97
number of chickens	6	6	6	6

a all results are expressed as X  $\pm$  SEM.

b the effect of factor 1 (denervation) is significant

c the effect of factor 2 (disease) is significant

TABLE IV

Physical Characteristics of Normal and Dystrophic Chickens:  
Denervation Effects on the Male Group

Parameter <sup>a</sup>	Innervated		Denervated	
	NM	DM	NM	DM
flip score <sup>c</sup>	17.0 $\pm$ 1.7	0.3 $\pm$ 0.3	17.4 $\pm$ 2.1	0.1 $\pm$ 0.1
age (days)	56.8 $\pm$ 1.6	58.3 $\pm$ 1.7	56.9 $\pm$ 2.3	58.7 $\pm$ 3.0
chicken wt. <sup>c</sup> (kg)	0.676 $\pm$ 0.018	0.723 $\pm$ 0.058	0.703 $\pm$ 0.031	0.882 $\pm$ 0.046
muscle wet wt. <sup>c</sup> (g)	0.221 $\pm$ 0.029	0.248 $\pm$ 0.023	0.157 $\pm$ 0.011	0.257 $\pm$ 0.019
muscle dry wt. <sup>c</sup> (g)	0.064 $\pm$ 0.005	0.072 $\pm$ 0.004	0.046 $\pm$ 0.008	0.067 $\pm$ 0.015
wet/dry ratio <sup>b</sup>	3.83 $\pm$ 0.09	3.76 $\pm$ 0.08	3.56 $\pm$ 0.08	3.67 $\pm$ 0.06
muscle wet wt.(g) <sup>b</sup> /chk. wt.(kg)	0.325 $\pm$ 0.039	0.342 $\pm$ 0.016	0.221 $\pm$ 0.007	0.298 $\pm$ 0.013
twitch tension <sup>b</sup> (N/g)	3.36 $\pm$ 0.38	3.17 $\pm$ 0.36	2.20 $\pm$ 0.25	1.77 $\pm$ 0.28
tetanic tension <sup>b</sup> (N/g)	12.74 $\pm$ 1.23	11.14 $\pm$ 2.98	4.86 $\pm$ 0.48	6.09 $\pm$ 1.52
number of chickens	6	6	6	6

a all results are expressed as X  $\pm$  SEM.

b the effect of factor 1 (denervation) is significant

c the effect of factor 2 (disease) is significant

exhaustion scores for the normal female chickens were  $20.1 \pm 2.2$  for the innervated group and  $16.4 \pm 1.6$  for the denervated group and the values for the dystrophic female chickens were  $0.5 \pm 0.3$  for the innervated group and  $0.7 \pm 0.5$  for the denervated group. Comparable results were obtained for the male group. The effect of sex was not significant on this measure for any group examined.

No significant differences in the chicken ages were apparent between groups, however, the dystrophic male chickens were significantly heavier than the normal male chickens. The body weights for the normal male chickens were  $0.676 \pm 0.018$  kg for the innervated group and  $0.703 \pm 0.031$  kg for the denervated group; the body weights for the dystrophic male chickens were  $0.723 \pm 0.058$  kg for the innervated group and  $0.882 \pm 0.046$  for the denervated group. No significant differences on this measure were detected for the female group.

The wet weights of muscles from dystrophic chickens were significantly greater than those from normal chickens. The wet weights for the normal female group were  $0.171 \pm 0.013$  g for innervated muscle and  $0.151 \pm 0.009$  g for denervated muscle; the values for the dystrophic female group were  $0.215 \pm 0.024$  g for innervated muscle and  $0.212 \pm 0.021$  g for denervated muscle. Similar results were obtained for the dystrophic male chickens. An increase in muscle dry weight, which corresponded to the increase in

muscle wet weight, was evident for the dystrophic muscles. These data suggest that significant denervation atrophy does not occur in dystrophic muscle. When the denervated muscle weights were expressed as a percent of the control muscle weight, atrophy of the normal muscle was evident however, no significant atrophy occurred in the dystrophic muscle. The values were  $0.88 \pm 0.06$  for the normal female chickens vs.  $0.99 \pm 0.09$  for the dystrophic female chickens and  $0.71 \pm 0.05$  for the normal male chickens vs.  $1.07 \pm 0.08$  for the dystrophic male chickens.

The dry weights of muscle from the normal female group were  $0.049 \pm 0.004$  g for innervated muscle and  $0.040 \pm 0.009$  g for denervated muscle and the dry weights for the dystrophic group were  $0.059 \pm 0.005$  g for innervated muscle and  $0.064 \pm 0.008$  g for denervated muscle. As noted for the muscle wet weights, comparable results on this measure were obtained for the male chickens. It should be noted, however, that no significant differences between groups were noted for the muscle wet:dry ratios (see Table III, page 109, for female chicken data and Table IV, page 110, for male chicken data).

When the values obtained for the wet weight of denervated muscle were expressed as percent of the control muscle weight, it was apparent that although a decrease was observed for the denervated normal group, no decrease in muscle wet weight was observed for the denervated

dystrophic group. This failure to atrophy in response to denervation was observed in dystrophic muscles from both the female (Table III, page 109) and male (Table IV, p. 110) groups.

As indicated in Table III (page 109), the muscle wet weight (g) per chicken body weight (kg) was significantly increased in dystrophic female chickens from both study groups. The values for normal chickens were  $0.275 \pm 0.012$  g/kg for the innervated group and  $0.232 \pm 0.019$  g/kg for the denervated group and the values for the dystrophic chickens were  $0.325 \pm 0.023$  g/kg for the innervated group and  $0.313 \pm 0.060$  g/kg for the denervated group. By contrast, Table IV (page 110) illustrates that the muscle wet weight (g) per chicken body weight (kg) was significantly decreased in the male denervated group when compared to the control group. The muscle wet weight per chicken body weight ratio for the normal male group was  $0.325 \pm 0.039$  g/kg for innervated muscle and  $0.221 \pm 0.007$  g/kg for denervated muscle; the values for the dystrophic male group were  $0.342 \pm 0.016$  g/kg for innervated muscle and  $0.298 \pm 0.013$  g/kg for denervated muscle.

The amount of twitch tension generated per gram of muscle wet weight (N/g) was markedly decreased in the denervated muscle when compared to innervated muscle. The values for the twitch tension per gram of muscle for the normal female group were  $4.24 \pm 0.88$  N/g for innervated

muscle and  $1.71 \pm 0.42$  N/g for denervated muscle; similar values for the dystrophic female group were  $4.92 \pm 0.36$  N/g for innervated muscle and  $2.64 \pm 0.25$  N/g for denervated muscle (see Table III, page 109). Significant decreases in the tension generating capacity of muscle from the denervated male group were recorded (Table IV, page 110). These differences were independent of disease.

In a similar manner, the tetanic tension per gram of muscle wet weight (N/g) was markedly decreased in denervated muscle. The values for the normal female group were  $16.28 \pm 2.81$  N/g for innervated muscle and  $4.88 \pm 0.86$  N/g for denervated muscle and values for the dystrophic female group were  $15.19 \pm 3.24$  N/g for innervated muscle and  $7.67 \pm 0.97$  N/g for denervated muscle (see Table III, page 109). Comparable decreases were observed in the denervated male group (Table IV, page 110). No significant effects of disease were noted.

3.2.2 Control experiments. The control experiments performed in this section were the same as those conducted in section 3.1.2, except that the  $l_0$  measurements and the length-tension curves were not examined in these muscles. Results of these control experiments were similar to those obtained for indirectly-stimulated muscle.

3.2.3 Acetylcholine responses. The results of the

intra-arterial injection studies for both innervated (sham operated) and denervated muscle have been divided into two groups, a male group and a female group, and analyzed separately. The results are illustrated graphically as dose-response curves (see Figures 3.11 to 3.20).

Figure 3.11 illustrates the twitch depression recorded in response to intra-arterial ACh injection in innervated and denervated, normal and dystrophic muscle from female chickens. Similar results for the male chickens are summarized in Figure 3.12. Results indicate that, as shown previously, the magnitude of twitch depression in innervated muscle was greater in normal muscle than in dystrophic muscle. Following denervation the dose-response curves were shifted to the left (Figure 3.11). Analysis of variance performed on the regression lines indicates that denervation had a significant effect on both the slope and the y-intercept. The y-intercept was increased in dose-response curves from denervated muscle. The mean values of the y-intercepts for the normal female group were  $0.862 \pm 0.091$  for innervated muscle and  $1.023 \pm 0.219$  for denervated muscle, and the values for the dystrophic female group were  $0.979 \pm 0.089$  for innervated muscle and  $1.039 \pm 0.025$  for denervated muscle. Similar results were obtained for the male group. The magnitude of the slope of the regression line was also increased as a consequence of denervation. The values for the slope obtained for the



Figure 3.11 Denervated muscle vs. innervated muscle for the female group only. The dose-response curves for the twitch ratio (post-twitch/pre-twitch) vs. the dose of acetylcholine. N = 7 chickens per group.

The effect of denervation on both the slope and the y-intercept is significant.

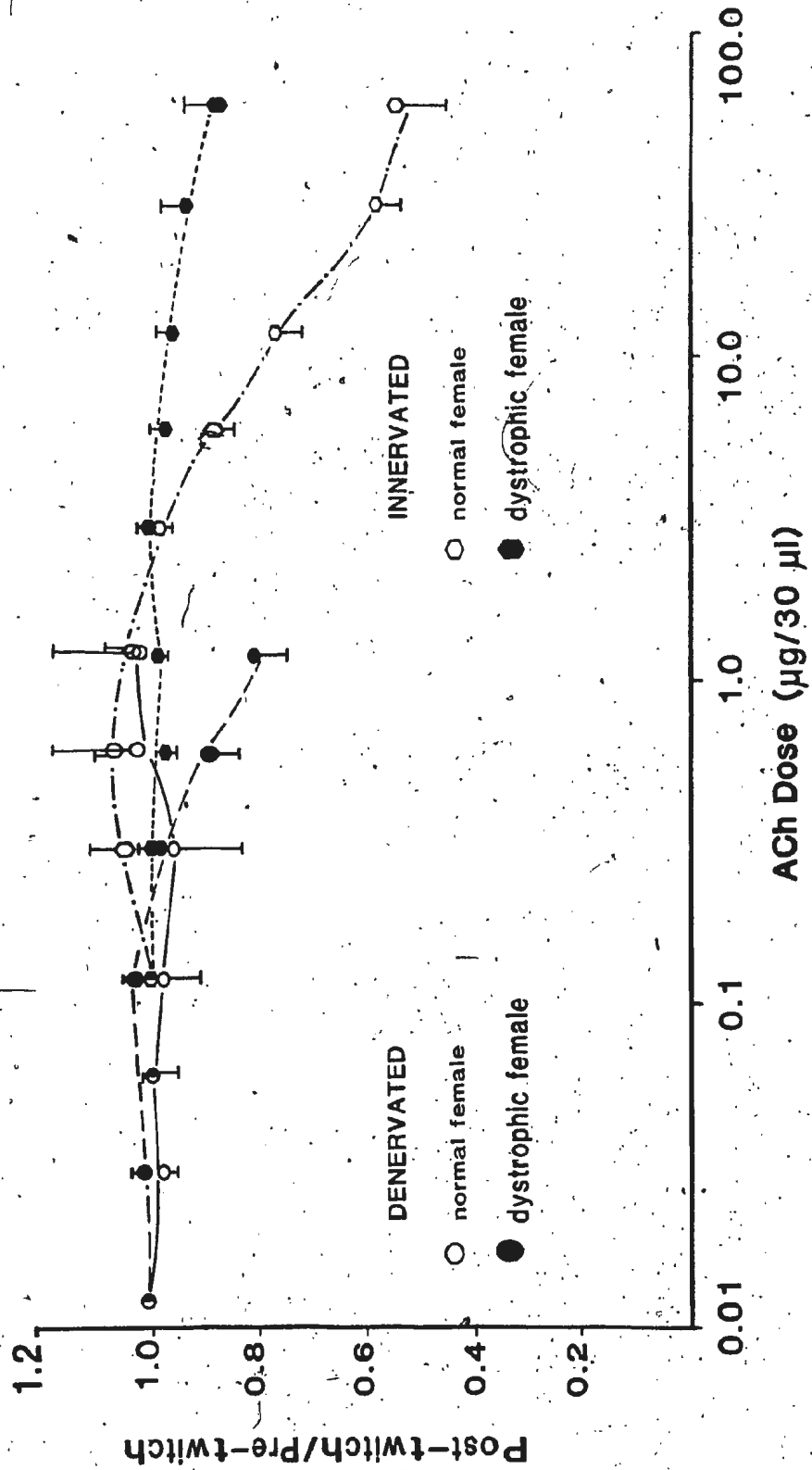
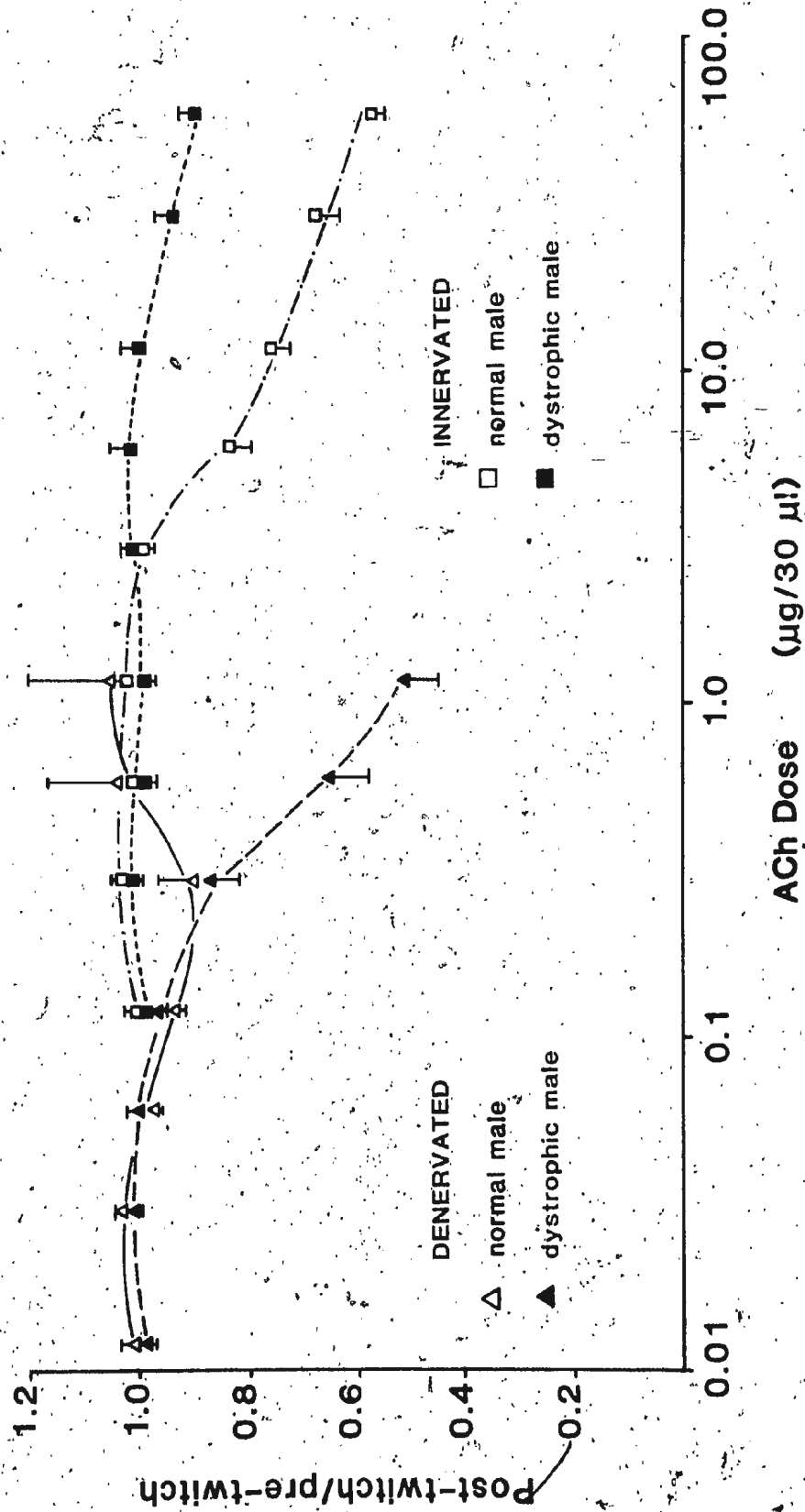

Figure 3.12 Denervated muscle vs. innervated muscle for the male group only. The dose-response curves for the twitch ratio (post-twitch/pre-twitch) vs. the dose of acetylcholine.  $N = 7$  chickens per group.

The effect of denervation on both the slope and the y-intercept is significant. The effect of disease on the y-intercept is also significant.





Figure 3.13 Denervated muscle vs. innervated muscle for the female group only. The dose-response curves for the contracture amplitude (Newtons/gram muscle wet weight) vs. the dose of acetylcholine. N = 7 chickens per group.

The effect of denervation on both the slope and the y-intercept is significant.

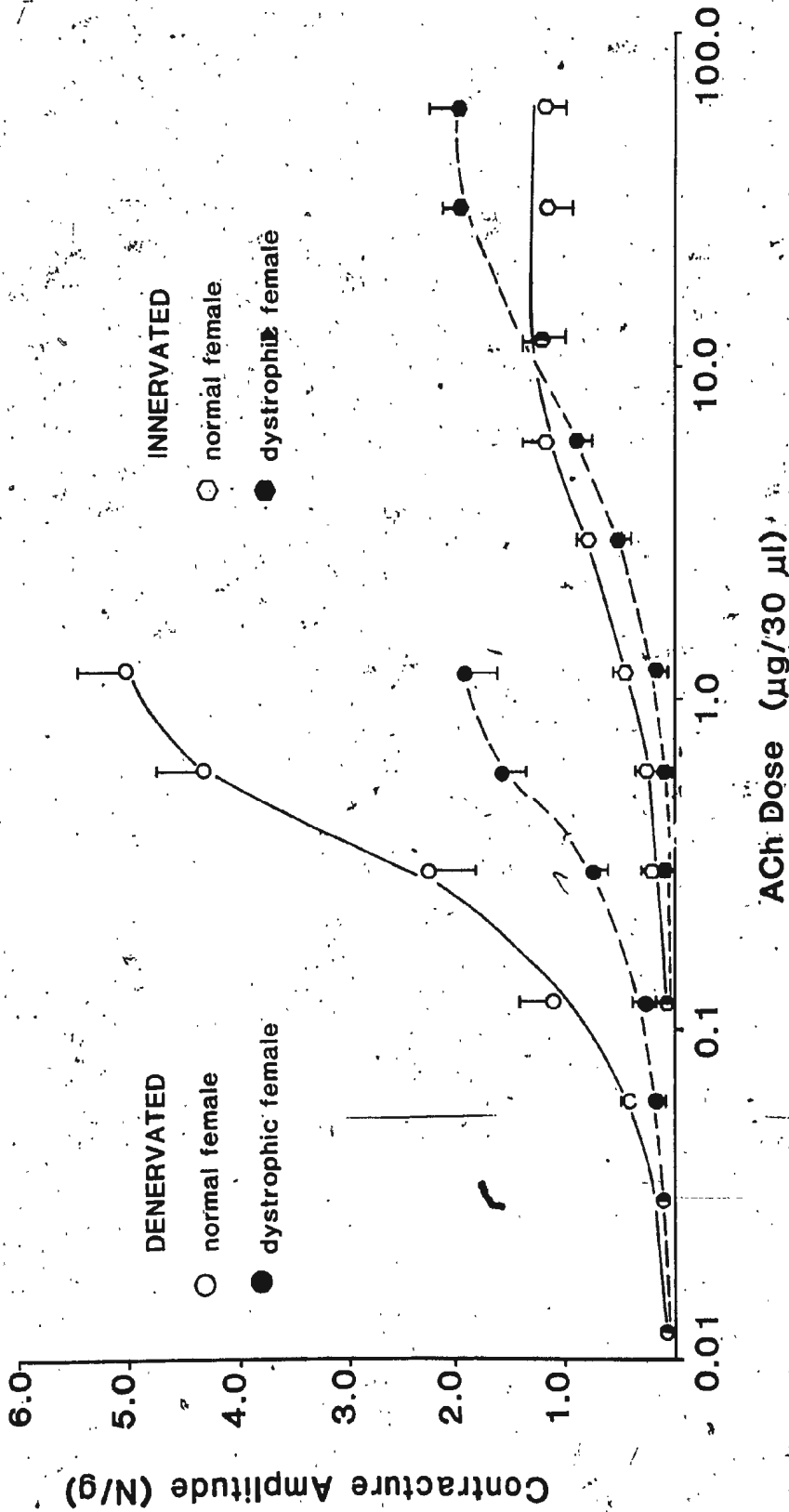

Figure 3.14 Denervated muscle vs. innervated muscle for the male group only. The dose-response curves for the contracture amplitude (Newtons/gram muscle wet weight) vs. the dose of acetylcholine.  $N = 7$  chickens per group.

The effect of denervation on both the slope and the y-intercept is significant. The effect of disease on the slope is also significant.

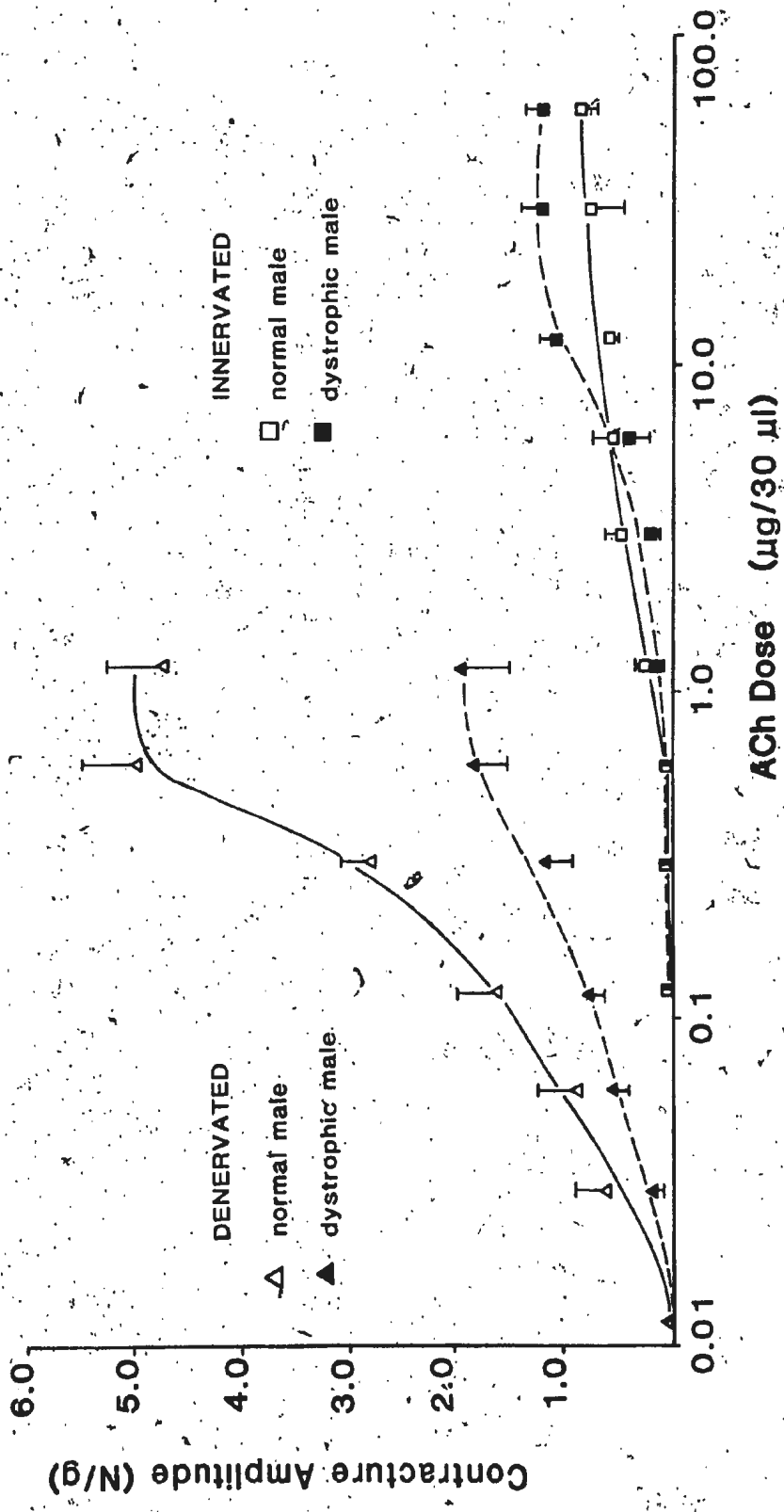



Figure 3.15 Denervated muscle vs. innervated muscle for the female group only. The dose-response curves for the twitch ratio (post-twitch/pre-twitch) vs. the dose of potassium chloride. N = 5 chickens per group.

(A) Innervated muscle.

(B) Denervated muscle.

The effect of denervation is significant on the y-intercept.

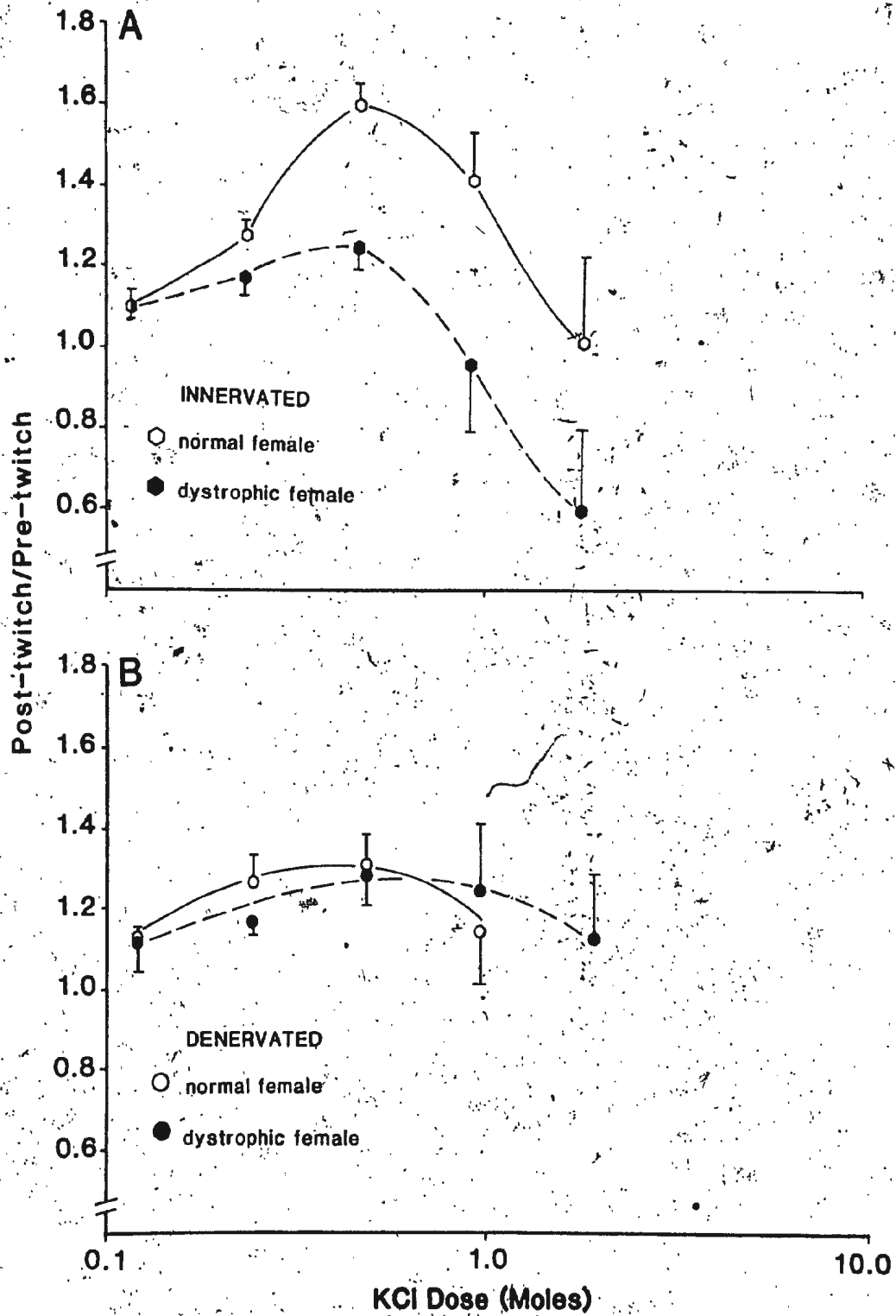

Figure 3.16 Denervated muscle vs. innervated muscle for the male group only. The dose-response curves for the twitch ratio (post-twitch/pre-twitch) vs. the dose of potassium chloride.  $N = 5$  chickens per group.

(A) Innervated muscle.

(B) Denervated muscle.

The effect of denervation is significant on the y-intercept.

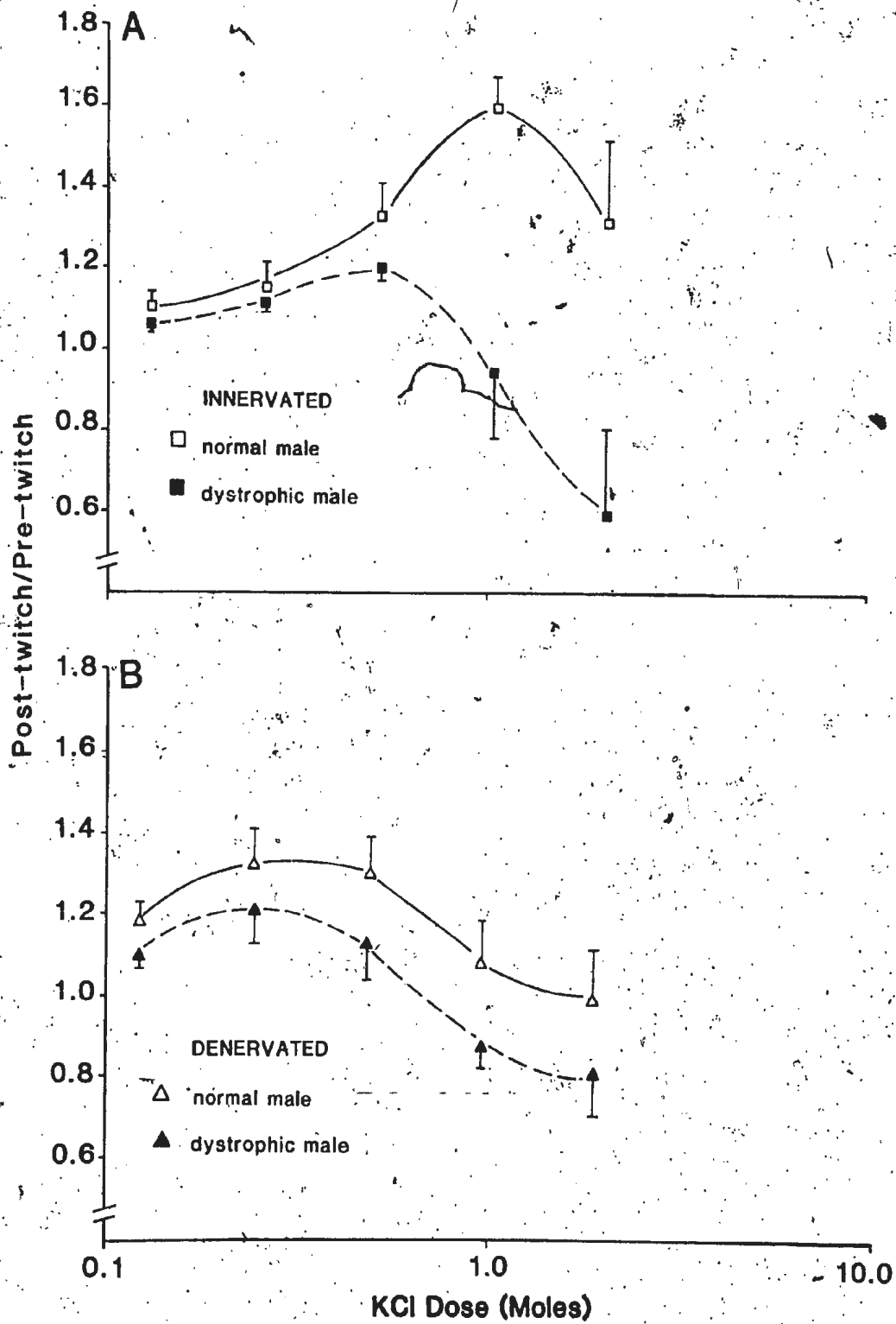

Figure 3.17 Denervated muscle vs. innervated muscle for both male and female groups. The dose-response curves for the contracture amplitude (Newtons/gram muscle wet weight) vs. the dose of potassium chloride. N = 5 chickens per group.

- (A) Innervated muscle, female group.
- (B) Denervated muscle, female group.
- (C) Innervated muscle, male group.
- (D) Denervated muscle, male group.

No significant differences between groups.

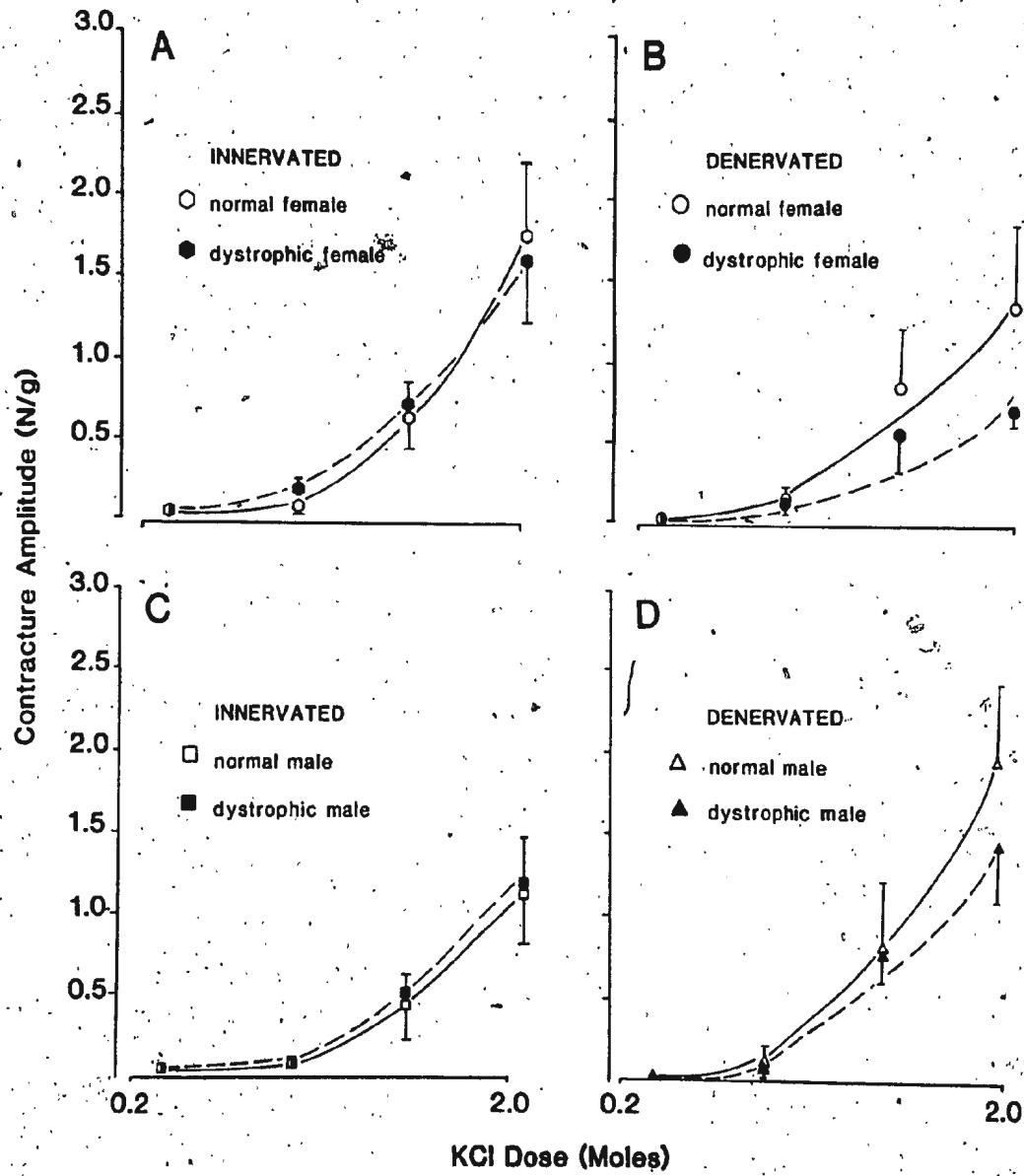

Figure 3.18 Denervated muscle vs. innervated muscle for the female group only. The dose-response curves for the twitch ratio (post-twitch/pre-twitch) vs. the dose of caffeine. N = 5 chickens per group.

(A) Innervated muscle.

(B) Denervated muscle.

No significant differences between groups.

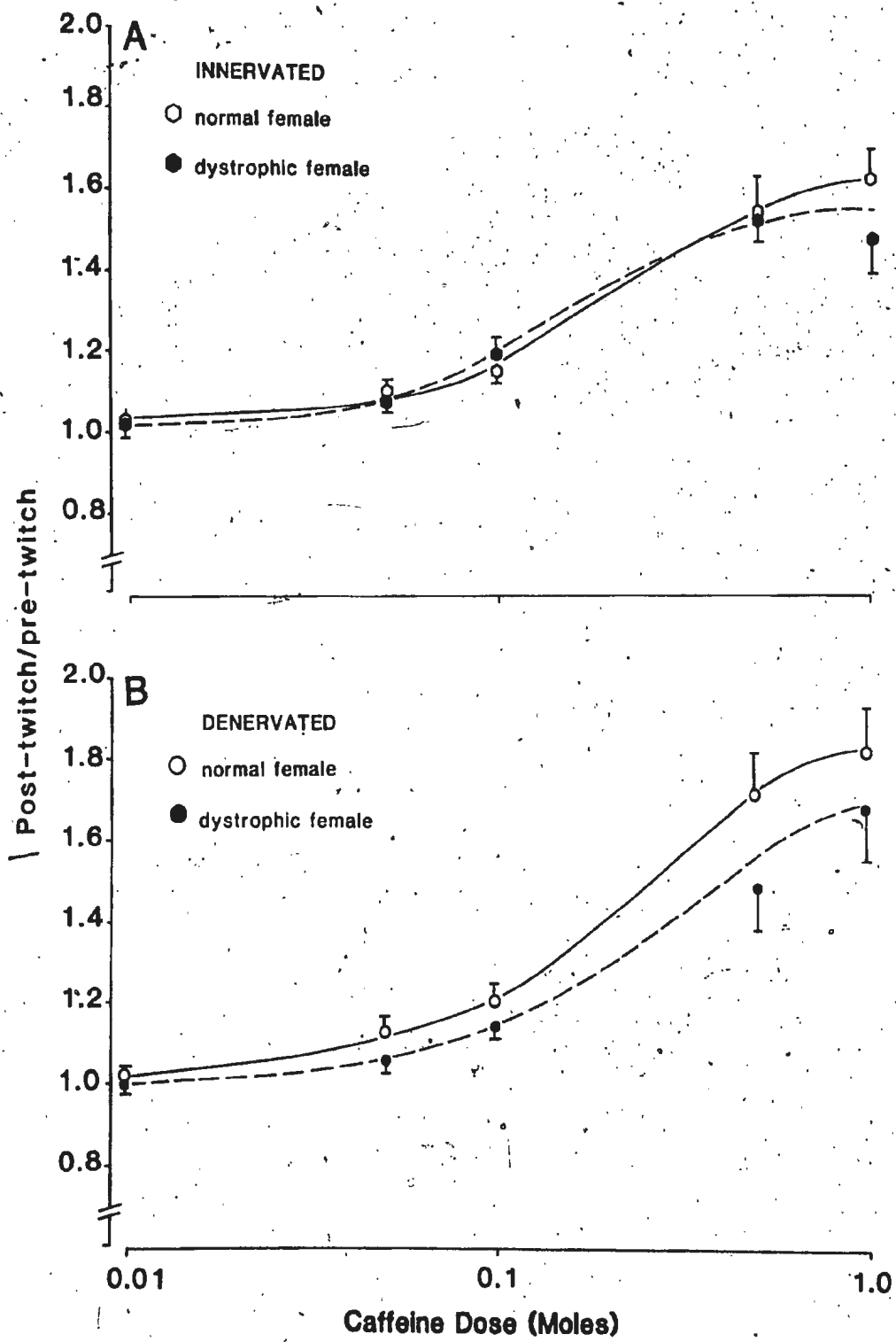



Figure 3.19 Denervated muscle vs. innervated muscle for the male group only. The dose-response curves for the twitch ratio (post-twitch/pre-twitch) vs. the dose of caffeine. N = 5 chickens per group.

(A) Innervated muscle.

(B) Denervated muscle.

No significant differences between groups.

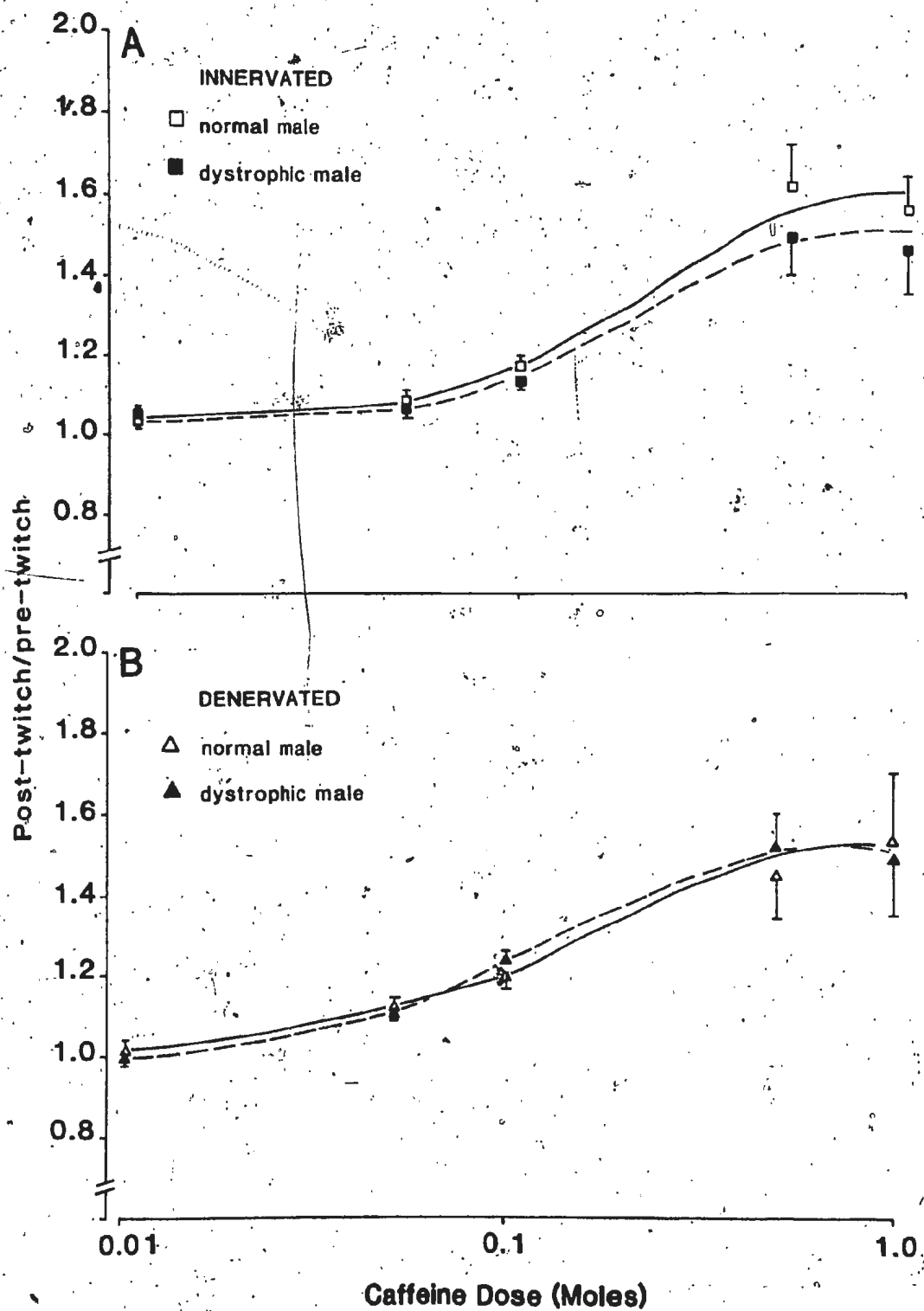
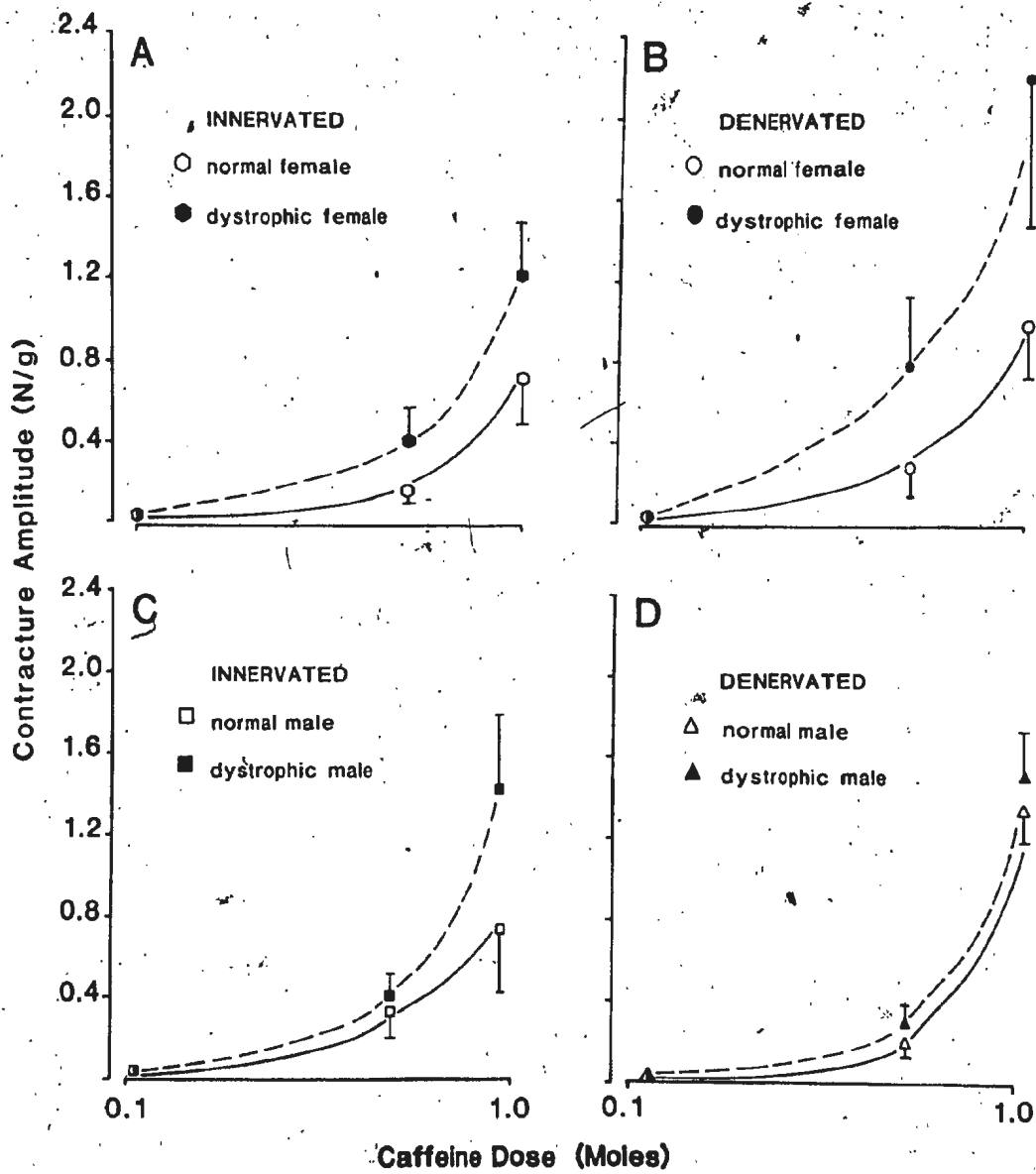

Figure 3.20 Denervated muscle vs. innervated muscle for both male and female groups. The dose-response curves for the contracture amplitude (Newtons/gram muscle wet weight) vs. the dose of caffeine. N = 5 chickens per group.

- (A) Innervated muscle, female group.
- (B) Denervated muscle, female group.
- (C) Innervated muscle, male group.
- (D) Denervated muscle, male group.

No significant differences between groups.



normal female chickens were  $-0.0058 \pm 0.0013$  for the innervated group and  $-0.681 \pm 0.067$  for the denervated group; values of the slope for the dystrophic female groups were  $-0.0017 \pm 0.0002$  for the innervated group and  $-0.239 \pm 0.080$  for the denervated group. Similar results were obtained for the male group (Figure 3.11, page 117).

Analysis of the ACh contracture responses obtained for innervated and denervated muscle from normal and dystrophic female chickens showed that the dose-response curves were shifted to the left in both normal and dystrophic denervated muscles when compared to control muscles (see Figure 3.13, page 121). Analysis of variance on the slope of the regression lines indicates a significant effect of denervation on both normal and dystrophic responses; the slope was increased for the denervated group. The values for the slope of the regression line for the female group were  $9.38 \pm 3.5$  for the normal innervated muscle vs.  $188.7 \pm 35.7$  for the normal denervated muscle and  $3.4 \pm 0.5$  for the dystrophic innervated muscle vs.  $127.7 \pm 9.3$  for the dystrophic denervated muscle.

The effect of denervation on the  $ED_{50}$  values obtained for the female group was significant (see Table V), suggesting that the dose-response curves obtained in denervated muscle were shifted to the left. The  $ED_{50}$  values for ACh in normal muscles from female chickens were

TABLE V

ED<sub>50</sub> Values of Normal and Dystrophic Muscle:  
Innervated vs. Denervated Muscle

Parameter <sup>a</sup>	Innervated		Denervated	
	NF	DF	NF	DF
ACh contracture <sup>b,c</sup> ( $\mu\text{g}/30 \mu\text{l}$ )	2.83 $\pm$ 0.69	8.22 $\pm$ 1.66	0.28 $\pm$ 0.06	0.36 $\pm$ 0.01
number of chickens	6	6	6	6
	NM	DM	NM	DM
ACh contracture <sup>b</sup> ( $\mu\text{g}/30 \mu\text{l}$ )	3.14 $\pm$ 0.78	4.65 $\pm$ 0.92	0.19 $\pm$ 0.05	0.37 $\pm$ 0.09
number of chickens	6	6	6	6

a all results are expressed as X  $\pm$  SEM.

b the effect of factor 1 (denervation) is significant

c the effect of factor 2 (disease) is significant

2.82  $\pm$  0.69  $\mu\text{g}/30 \mu\text{l}$  for the innervated group and 0.284  $\pm$  0.058  $\mu\text{g}/30 \mu\text{l}$  for the denervated group; values for dystrophic muscles from female chickens were 8.22  $\pm$  1.66  $\mu\text{g}/30 \mu\text{l}$  for the innervated group and 0.364  $\pm$  0.012  $\mu\text{g}/30 \mu\text{l}$  for the denervated group. The effect of disease on the  $\text{ED}_{50}$  values was significant for the female group suggesting that the dystrophic muscles were less sensitive to ACh than the normal muscles. A similar shift in the sensitivity of denervated muscle to ACh, as measured by the  $\text{ED}_{50}$  ratio, was observed in the male group (see Table V). One difference between the male and female chickens on this measure was that the effect of disease was statistically significant for the female group but not for the male group. There was, however, a tendency for the dystrophic muscles of the male group to be less sensitive to ACh.

3.2.4 Potassium chloride responses. The results presented for the innervated group are the results obtained using indirect stimulation (see section 3.1.5) as incomplete dose-response curves were obtained for directly stimulated muscle.

The muscle twitch responses to injected KCl are illustrated in Figure 3.15, page 125, for the female group and in Figure 3.16, page 127, for the male group. The results for the innervated group have been previously discussed (section 3.1.5). In brief, these results showed

that, for both male and female groups, the normal muscle twitch was significantly potentiated at doses which depressed the dystrophic muscle twitch. The results for the denervated group, however, suggest that the marked twitch potentiation in response to KCl that was apparent in innervated normal muscle was absent in denervated normal muscle. By contrast, denervation had no significant effect on the KCl-induced twitch depression seen in the innervated dystrophic muscle. The results of analysis of variance on the regression lines showed that although the slopes were unchanged by denervation, the y-intercepts were significantly reduced for all denervated groups. The values of y-intercept obtained for the female group were  $1.85 \pm 0.04$  for the innervated normal muscles vs  $1.39 \pm 0.06$  for the denervated normal muscles and  $1.54 \pm 0.04$  for the innervated dystrophic muscles and  $1.42 \pm 0.05$  for the denervated dystrophic muscles. Similar results were obtained for the male group. No significant effects of disease were recorded on these measures.

The results for the muscle contracture, in response to injected KCl, are illustrated in Figure 3.17, page 129. The data for the innervated group were previously discussed (see section 3.1.5). As noted in section 3.1.5, there were no significant differences between the normal and dystrophic contracture responses (see Figures 3.17 a & c). Moreover, analysis of variance on the data for the



denervated group showed that there were no significant differences between groups on this measure (see Figure 3.17 b & d). Results for the male and female chickens were similar.

3.2.5. Caffeine responses. The twitch potentiation in response to injected caffeine for innervated and denervated muscle from normal and dystrophic female chickens is illustrated in Figure 3.18, page 131. No significant differences between groups were shown for either the slopes or the y-intercepts of the regression lines. The results of analysis of variance on these data for the male group (see Figure 3.19, page 133) show that no significant effects of either disease or denervation are apparent on the measures of slope and y-intercept.

The contracture responses in the presence of caffeine, for all groups, are illustrated in Figure 3.20, page 135. Results of regression analysis and subsequent analysis of variance indicate that there were no significant differences between groups on these measures, despite a trend towards increased caffeine contractures in all dystrophic muscles.

### 3.3 Electrophysiology

3.3.1 Physical Data. The dystrophic chickens used in this study exhibited the characteristic inability to rise from the supine position (see Table VI). The exhaustion score in the dystrophic group ( $1.0 \pm 0.8$  for dystrophic female chickens and  $0.7 \pm 0.6$  for dystrophic male chickens) was significantly reduced when compared to that obtained in the normal group ( $17.9 \pm 1.2$  for normal female chickens and  $18.6 \pm 0.7$  for normal male chickens). Detailed age data were not collected for the chickens used in this portion of the study, all the birds being within the 6-8 week age range. No significant differences in chicken weight were observed in this group.

3.3.2 Dantrolene sodium. Complete muscle twitch blockade by dantrolene sodium was not achieved in this study, however, dantrolene blocked about 80 percent of the muscle twitch for both normal and dystrophic muscles. The percentage of muscle twitch blockade produced versus the dose of dantrolene sodium is illustrated in Figure 3.21. As indicated in the legend, the  $ED_{50}$  values did not differ significantly between groups suggesting that the sensitivity of normal and dystrophic muscle to this compound was similar. This observation was true for

TABLE VI

Physical Characteristics of Normal and Dystrophic Chickens:

Electrophysiology Group

Parameter <sup>a</sup>	NF	DF	NM	DM
flip score <sup>b</sup>	17.9 $\pm$ 1.2	1.0 $\pm$ 0.8	18.6 $\pm$ 0.7	0.7 $\pm$ 0.6
chicken wt. (kg)	0.611 $\pm$ 0.144	0.554 $\pm$ 0.045	0.675 $\pm$ 0.096	0.611 $\pm$ 0.054
number of chickens	7	7	7	7

a all results are expressed as X + SEM.

b the effect of factor 2 (disease) is significant

Figure 3.21 Dantrolene sodium dose-response curve

expressed as dose of dantrolene sodium (mg/kg) vs. percent twitch blockade for normal (solid line, closed symbols) and dystrophic (dotted line, open symbols) muscles. N = 5 chickens per group.

- (A) Dose-response curve for the female group. The mean ID<sub>50</sub> value for the normal female chickens is  $1.49 \pm 0.45$  mg/kg and the mean for the dystrophic female chickens is  $1.09 \pm 0.22$  mg/kg.
- (B) Dose-response curve for the male group. The mean ID<sub>50</sub> value for the normal male chickens is  $1.26 \pm 0.08$  and the mean for the dystrophic male chickens is  $1.25 \pm 0.25$  mg/kg.

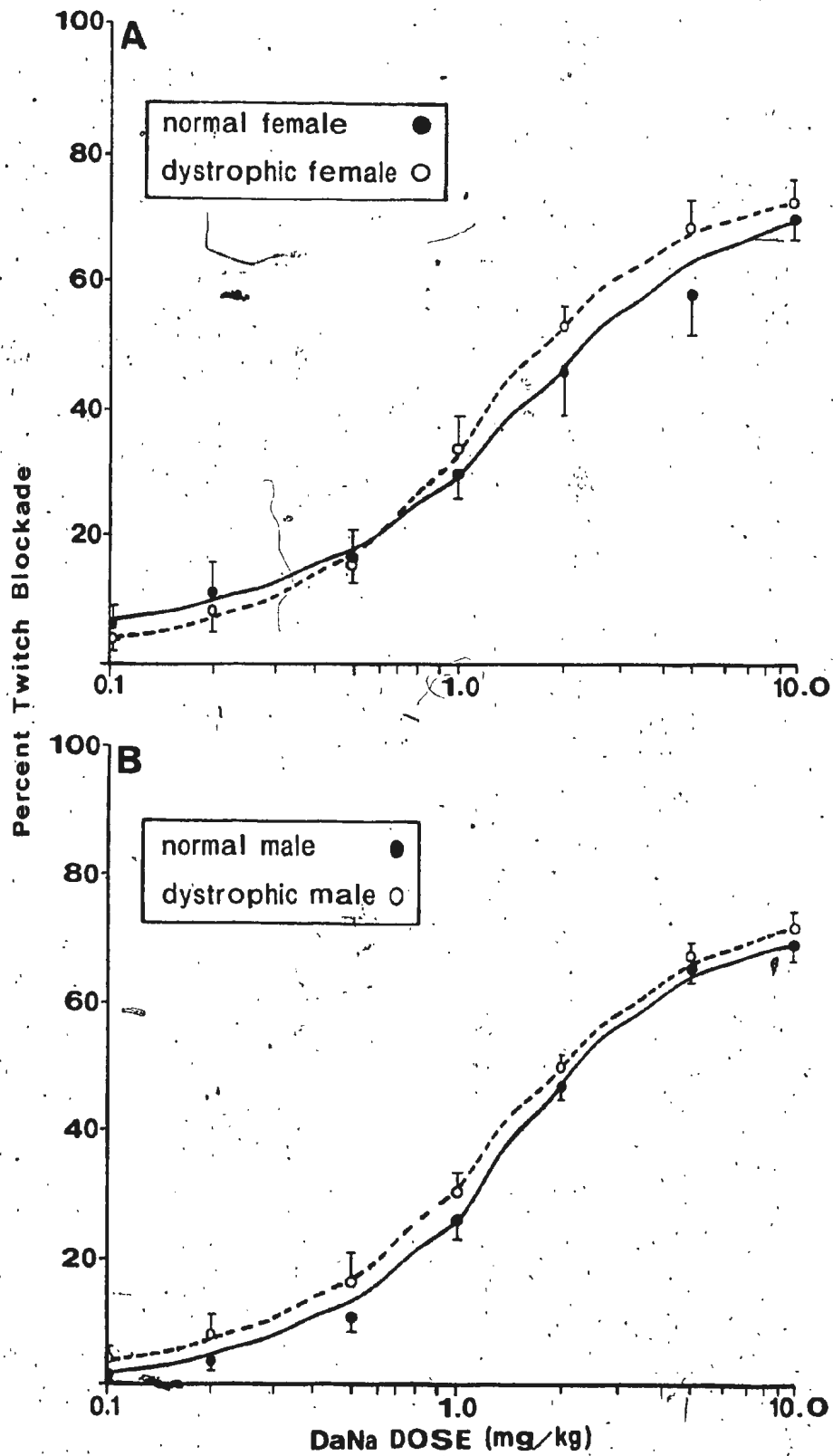

muscles from both female (Figure 3.21A) and male (Figure 3.21B) chickens.

Despite this apparently similar sensitivity to dantrolene, the number of times a supra-maximal nerve stimulus failed to generate an action potential was greater in dystrophic muscle than in normal muscle. Moreover, these "failures" occurred in fibres that were classified as "clean" electrode penetrations with resting membrane potentials within the normal range. A profound increase in the number of failures has been demonstrated in older dystrophic chickens (Hoekman, personal communication).

3.3.3 Action potential characteristics. Figure 3.22 illustrates representative intracellular action potentials from both normal muscle (Figure 3.22Ai) and dystrophic muscle (Figure 3.22Bi). The rates of rise of these action potentials are also presented in this photograph (Figure 3.22Aii and Bii).

For illustrative purposes, frequency distributions have been constructed for selected action potential characteristics measured in this study. These data are presented in Figures 3.23 to 3.26. No differences between the resting membrane potentials recorded from normal and dystrophic muscle fibres were apparent (see Figure 3.23A, page 149 for data from female chickens and Figure 3.23B, page 149 for data from male chickens). Similarly, sig-

Figure 3,22 Representative action potentials recorded from normal and dystrophic muscle cells.

(A) Normal muscle action potential (i); normal muscle rate of rise (ii).

(B) Dystrophic muscle action potential (i); dystrophic muscle rate of rise (ii).

The vertical and horizontal calibration bars are 60 mV and 1.0 ms, respectively.

**A**

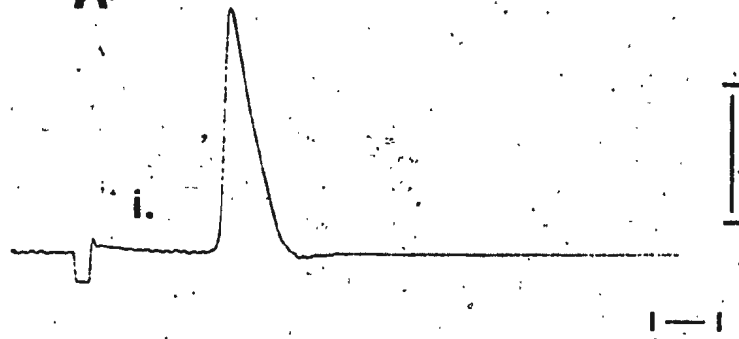

**ii.**

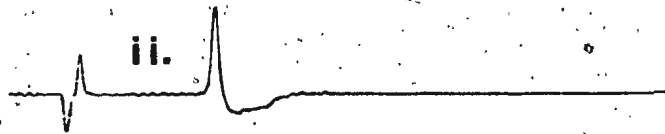

**B**

**i.**

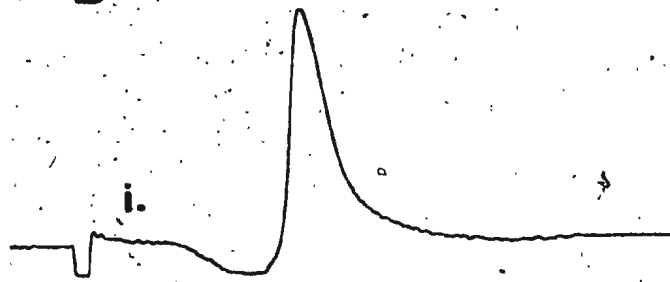

**ii.**

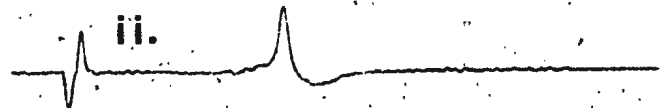



Figure 3.23 Frequency distribution of resting membrane potentials (mV) recorded from normal and dystrophic muscle fibres. Note that 30-40 muscle fibres were sampled from each of 7 chickens.

(A) Female group.

(B) Male group.

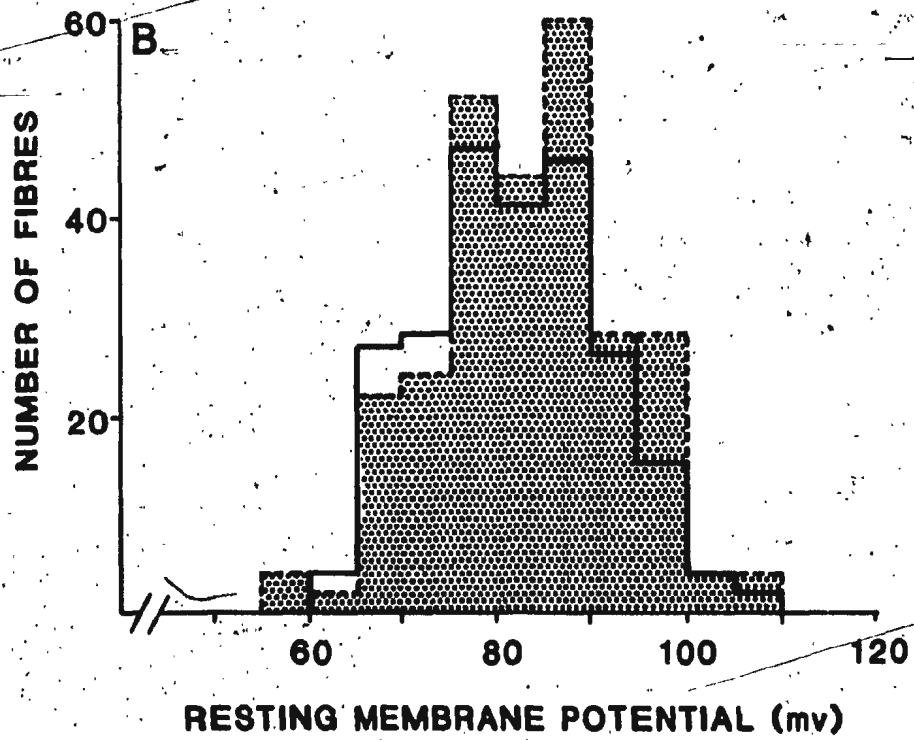
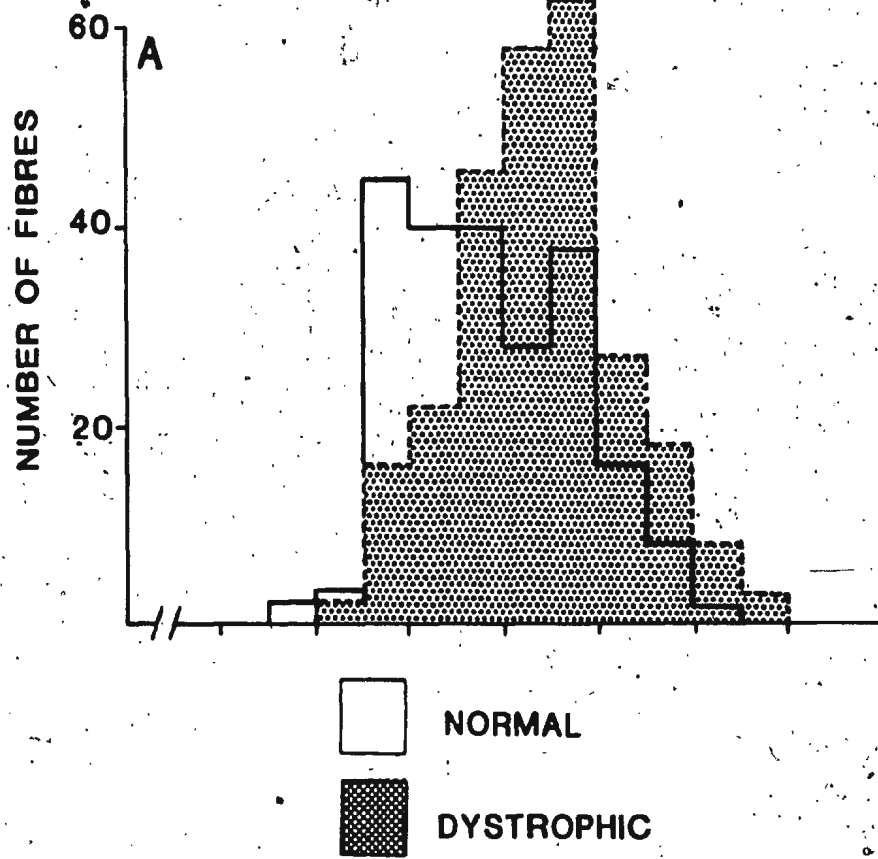

Figure 3.24 Frequency distribution of the action potential rate of rise (V/s) recorded from normal and dystrophic muscle fibres. Note that 30-40 muscle fibres were sampled from each of 7 chickens.

(A) Female group.

(B) Male group.

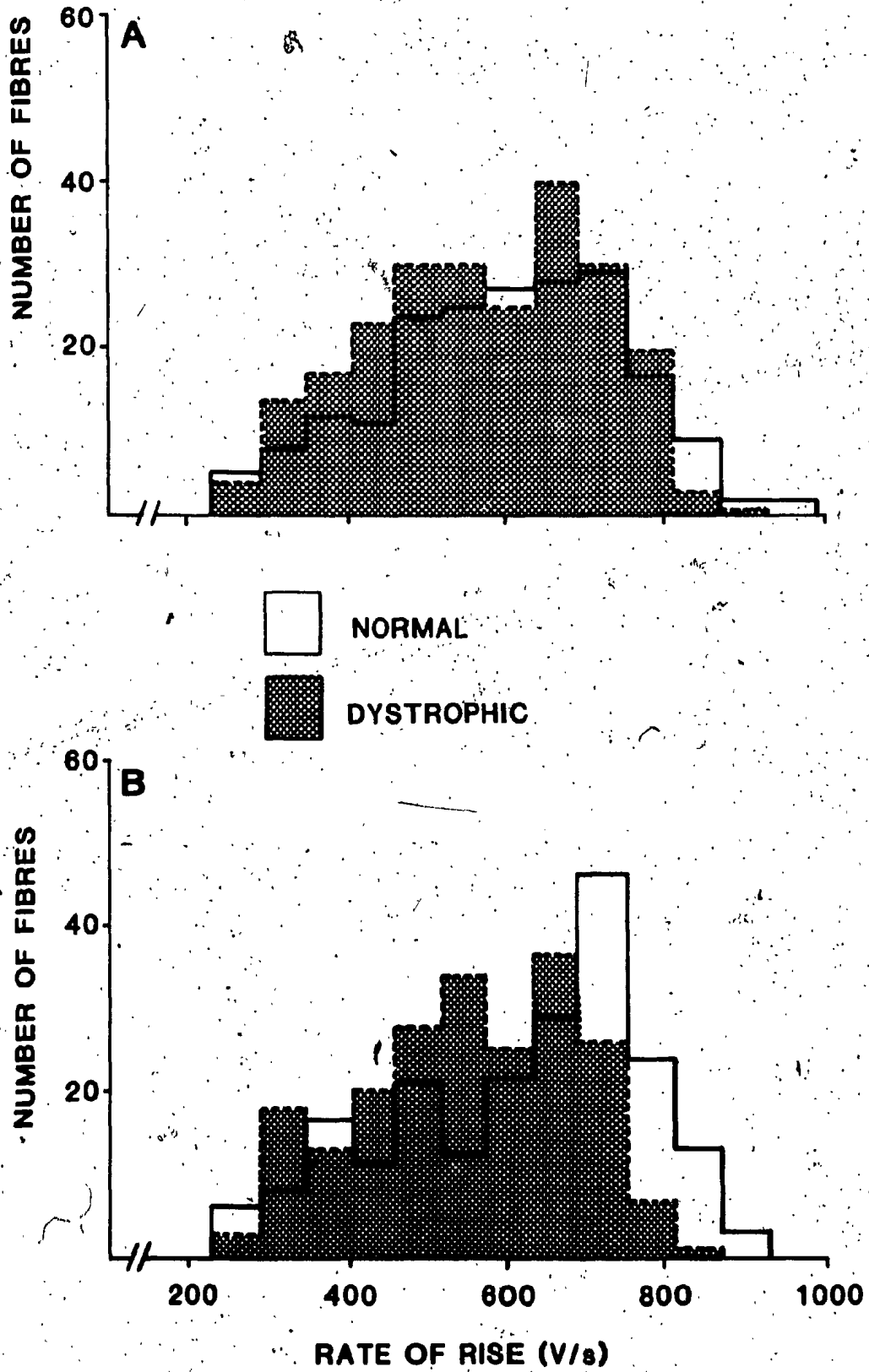
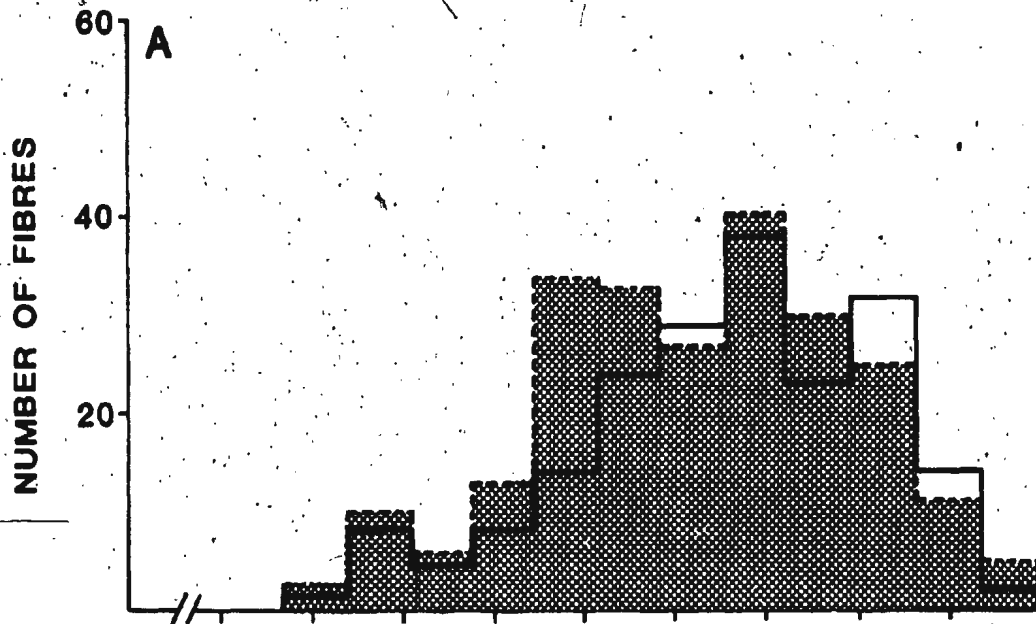

Figure 3.25. Frequency distribution of the action potential amplitude (mV) recorded from normal and dystrophic muscle fibres. Note that 30-40 muscle fibres were sampled from each of 7 chickens.

(A) Female group.

(B) Male group.



□ NORMAL  
▨ DYSTROPHIC

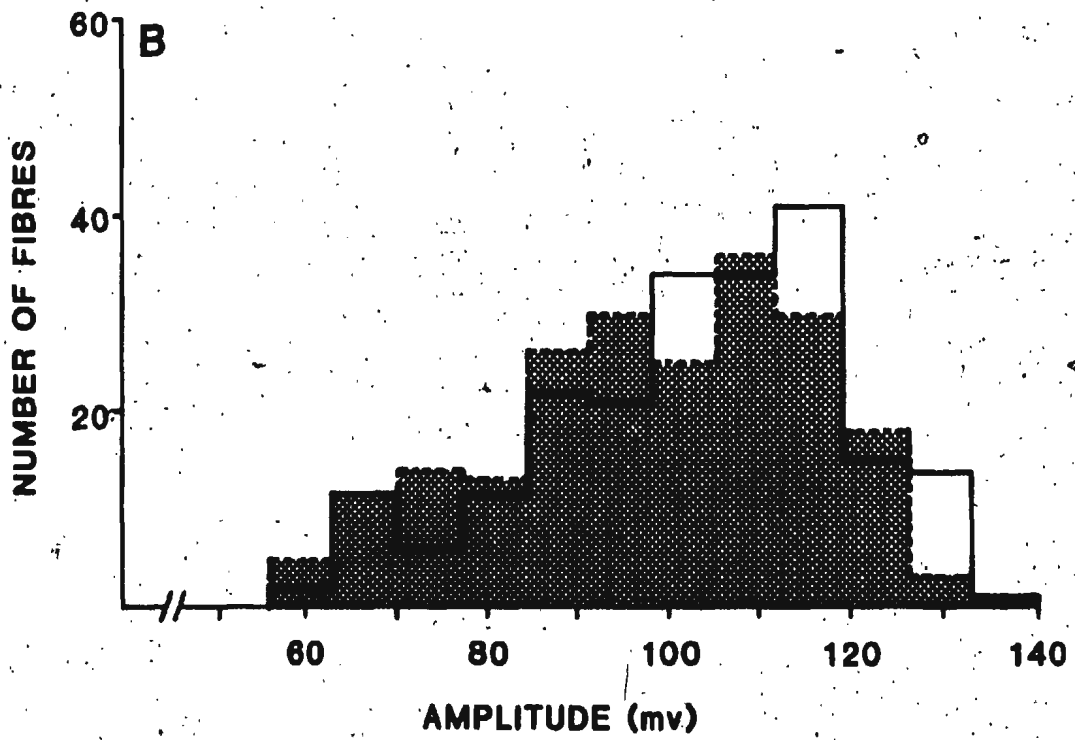
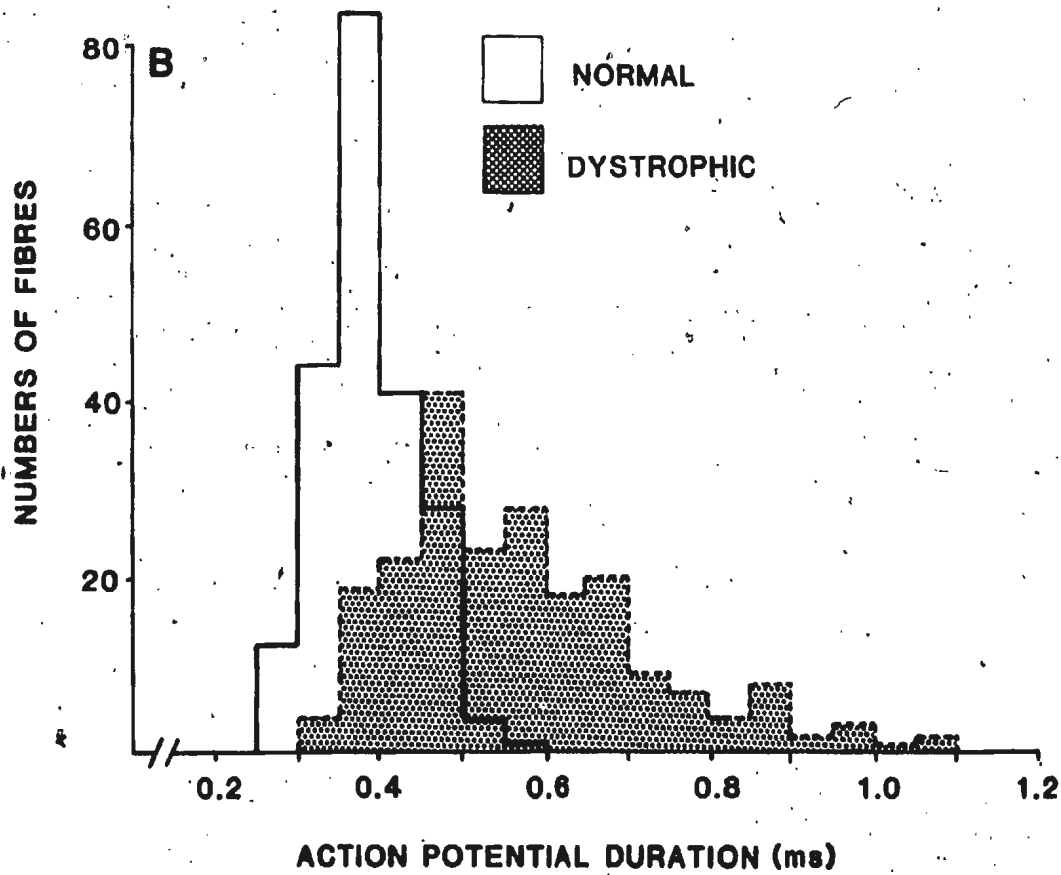
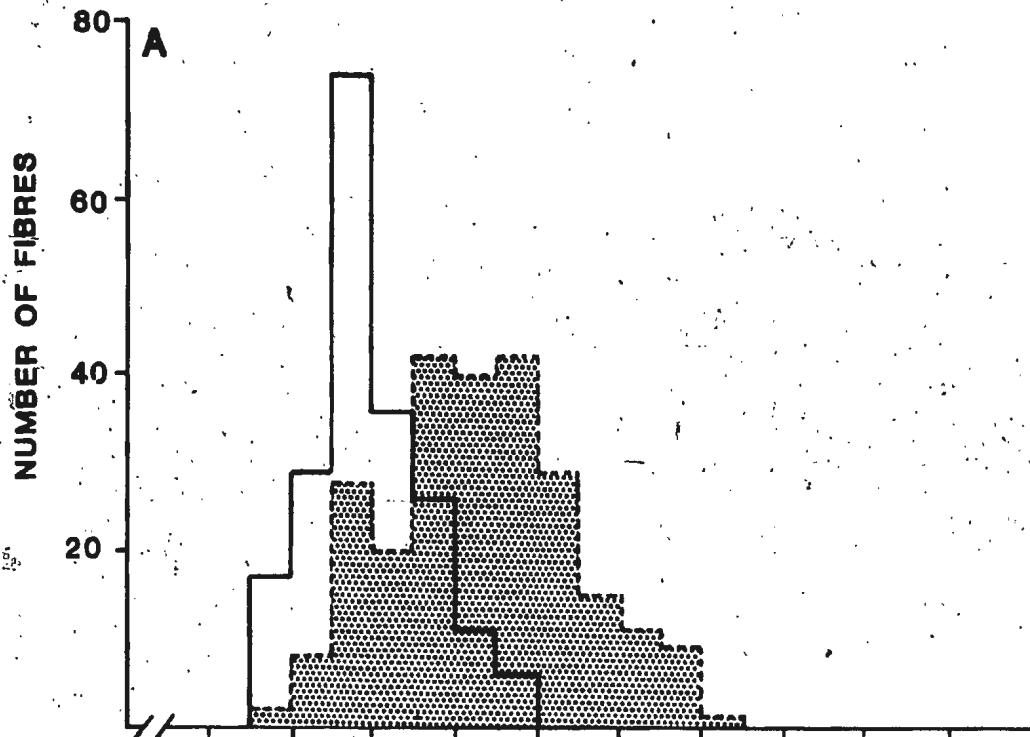

Figure 3.26 Frequency distribution of the action potential duration (ms) at half the maximum amplitude recorded from normal and dystrophic muscle fibres. Note that 30-40 muscle fibres were sampled from each of 7 chickens.

(A) Female group.

(B) Male group.





nificant differences between groups were not evident for either the action potential rate of rise (see Figure 3.24A, page 151 for data from female chickens and Figure 3.24B, page 151 for data from male chickens) or the action potential amplitude (see Figure 3.25A, page 153 for data from female chickens and Figure 3.25B, page 153 for data from male chickens). By contrast, the action potential duration at half the maximum amplitude (see Figure 3.26, page 155) appeared to be increased in dystrophic muscle when compared to normal muscle; this was true of muscles from both female and male chickens (see Figure 3.26A for data from female chickens and Figure 3.26B for data from male chickens).

These data have been quantified and the means plus or minus the standard error of the mean, in addition to the results of the analysis of variance, are summarized in Table VII. The duration of the action potential at half the maximum amplitude was significantly increased in muscle from both dystrophic female chickens ( $0.54 \pm 0.01$  ms) and dystrophic male chickens ( $0.57 \pm 0.04$  ms) when compared to muscles from their normal counterparts ( $0.40 \pm 0.02$  ms for the normal female chickens and  $0.39 \pm 0.01$  ms for the normal male chickens). Significant differences between groups were not observed for the other parameters measured in this study (see Table VII).

TABLE VII

## Estimates for the Action Potential Characteristics

Parameter <sup>a</sup>	Female Chickens		Male Chickens	
	Normal	Dystrophic	Normal	Dystrophic
resting membrane potential (mV)	79.3 ± 2.3	84.8 ± 1.7	83.8 ± 1.7	84.6 ± 1.5
action potential <sup>b</sup> duration (ms)	0.40 ± 0.02	0.54 ± 0.01	0.39 ± 0.01	0.57 ± 0.04
rate of rise (V/sec)	580.8 ± 42.3	551.9 ± 30.8	583.7 ± 59.6	542.3 ± 19.2
action potential amplitude (mV)	105.5 ± 2.6	103.3 ± 2.5	100.7 ± 5.5	97.9 ± 3.5
action potential overshoot (mV)	25.6 ± 2.3	16.6 ± 3.7	18.4 ± 3.7	12.9 ± 3.2
number of chickens	7	7	7	7

a all results are expressed as X ± SEM.

b the effect of factor 2 (disease) is significant

### 3.4 Smooth Muscle

3.4.1 Physical data. Male chickens, between 6-8 weeks of age, were used in the present study. The dystrophic chickens demonstrated the characteristic inability to rise from the supine position.

3.4.2 Control Experiments. The results from a number of control experiments are reported in this section. Repeated concentration-response curves to the agonist alone (either 5-HT or NA) showed no time-dependent changes in either contractility or sensitivity. The agonist effects were selective; prazosin did not block the response to 5-HT and ketanserin did not block the response to NA. Tetrodotoxin blocked neither the response to NA nor the response to 5-HT, suggesting that these responses were not mediated by nerve fibres depending on fast sodium channels. The addition of fluoxetine did not affect the response to 5-HT, however, this response was potentiated by cocaine. Consequently, cocaine was used to block reuptake ( $U_1$ ) for both the NA and the 5-HT experiments. The addition of beta-estradiol to block extraneuronal uptake ( $U_2$ ) had no apparent effect on the concentration-response curves constructed for either 5-HT or NA; beta-estradiol was not

routinely used in these studies. Cocaine and propranolol (to block beta-receptor stimulation) were used for the concentration-response curves obtained with NA and cocaine alone was used to construct the the 5-HT concentration-response curves.

The wet:dry ratios of ischiatic artery segments did not differ between normal and dystrophic chickens. The mean ratio for normal tissues was  $3.40 \pm 0.14$  and for dystrophic tissues was  $3.34 \pm 0.30$ .

3.4.3 Pharmacologic responses. The muscle dry weights (mg), tension generated in response to an  $EC_{100}$  concentration of agonist (g) and the ratio of these measures (g tension generated per mg tissue dry weight) for both agonists are presented in Table VIII. In all cases the dystrophic arteries were significantly heavier than the normal arteries ( $0.62 \pm 0.02$  mg and  $0.69 \pm 0.02$  mg for normal tissues vs.  $0.74 \pm 0.03$  mg and  $0.82 \pm 0.02$  mg for dystrophic tissues). The dystrophic arteries generated significantly less tension in response to 5-HT than did the normal tissues ( $3.13 \pm 0.12$  g for the normal tissues vs.  $2.80 \pm 0.10$  g for the dystrophic tissues). This difference was not significant for the experiments where NA was the agonist ( $2.90 \pm 0.18$  g for the normal tissues vs.  $3.09 \pm 0.17$  g for the dystrophic tissues). When tension development was normalized for the muscle weight, the

TABLE VIII  
Physical Characteristics of Normal and Dystrophic  
Chicken Ischiatic Artery

Parameter <sup>a</sup>	5-HT Group		NA Group	
	Normal	Dystrophic	Normal	Dystrophic
muscle dry wt. <sup>c</sup> (mg)	0.62 ± 0.02	0.74 ± 0.03 <sup>b</sup>	0.69 ± 0.02	0.82 ± 0.02 <sup>b</sup>
tension (g)/agonist dose, EC <sub>100</sub>	3.13 ± 0.12	2.80 ± 0.10 <sup>b</sup>	2.90 ± 0.18	3.09 ± 0.17
tension/muscle wt. (g/mg)	5.28 ± 0.27	3.96 ± 0.19 <sup>b</sup>	4.41 ± 0.35	3.86 ± 0.25
N	39	39	23	21

a all results are expressed as X ± SEM.

b significantly different from normal, p < 0.05.

c the mean of the muscle dry weights for individual ring preparation.

dystrophic tissue generated significantly less tension in response to 5-HT than did the normal tissue ( $5.28 \pm 0.27$  g/mg for the normal tissues vs.  $3.96 \pm 0.19$  g/mg for the dystrophic tissues). A reduction in the tension-generating capacity of dystrophic arteries was not observed in response to NA. To summarize, the dystrophic ischiatic artery weighed more than the normal vessel and, in the case of 5-HT, the vessel generated less tension.

The results of the present study demonstrated that, in the chicken ischiatic artery preparation, ketanserin acted as a competitive antagonist for 5-HT and prazosin behaved as a competitive antagonist for NA. This was true of both normal and dystrophic tissues. These data are illustrated in Figure 3.27 (for the responses to 5-HT) and Figure 3.28 (for the responses to NA). Figure 3.27 shows that the concentration-response curve for 5-HT obtained from the dystrophic ischiatic artery was shifted to the right when compared with the control curve; this parallel shift appeared to be preserved in tissues treated with ketanserin. By contrast, Figure 3.28 suggests that there was no difference in the sensitivity of normal and dystrophic muscle to NA.

These data are further supported by the analysis of  $EC_{50}$  values calculated from the dose-response curves of normal and dystrophic tissues. The responses to 5-HT are presented in Table IX. The mean  $EC_{50}$  value for the control

Figure 3.27 The concentration-response curves for the percent maximum response (normalized response) vs. the concentration of serotonin illustrating the competitive antagonism of ketanserin. The responses obtained in the presence of ketanserin were calculated relative to the control maximum response. Note that not all the concentrations of ketanserin used have been illustrated.

upper graph - normal tissue

lower graph - dystrophic tissue

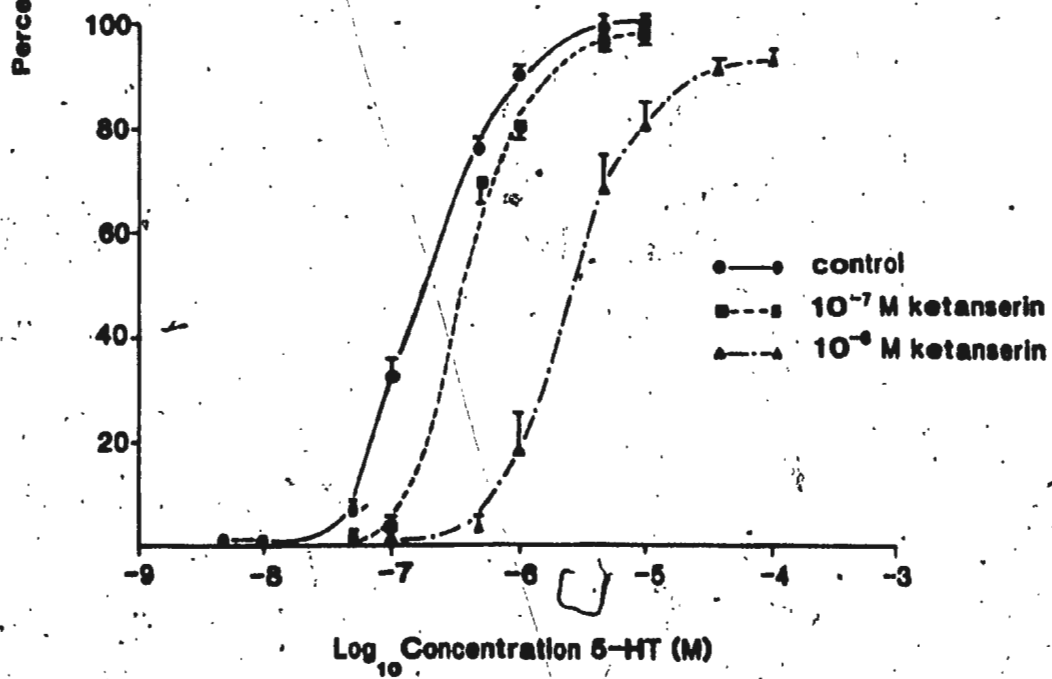
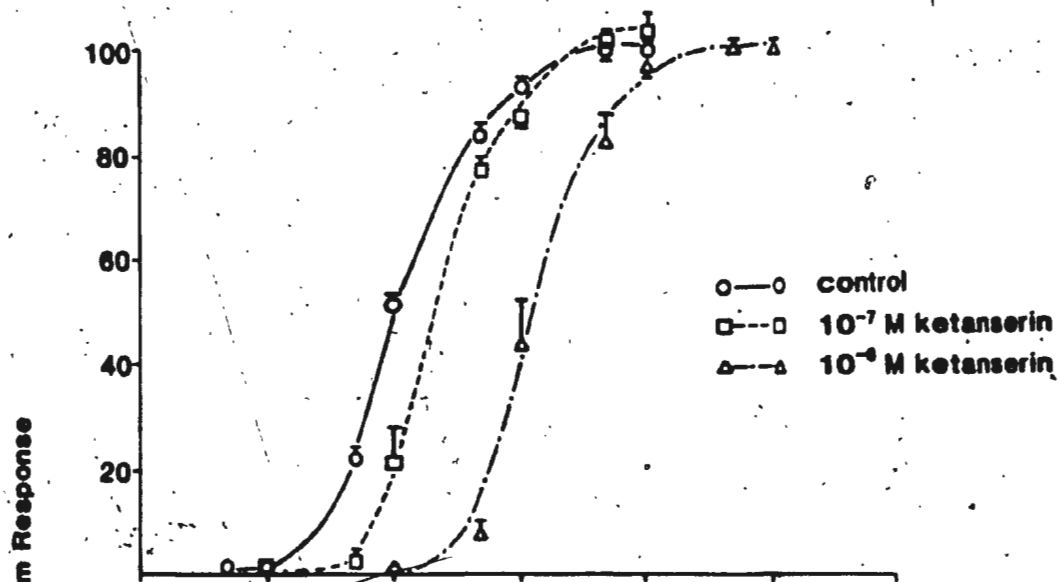



Figure 3.28 The concentration-response curves for the percent maximum response (normalized response) vs. the concentration of noradrenalin illustrating the competitive antagonism of prazosin. The responses obtained in the presence of prazosin were calculated relative to the control maximum response. Note that not all the concentrations of prazosin used have been illustrated.

upper graph - normal tissue

lower graph - dystrophic tissue

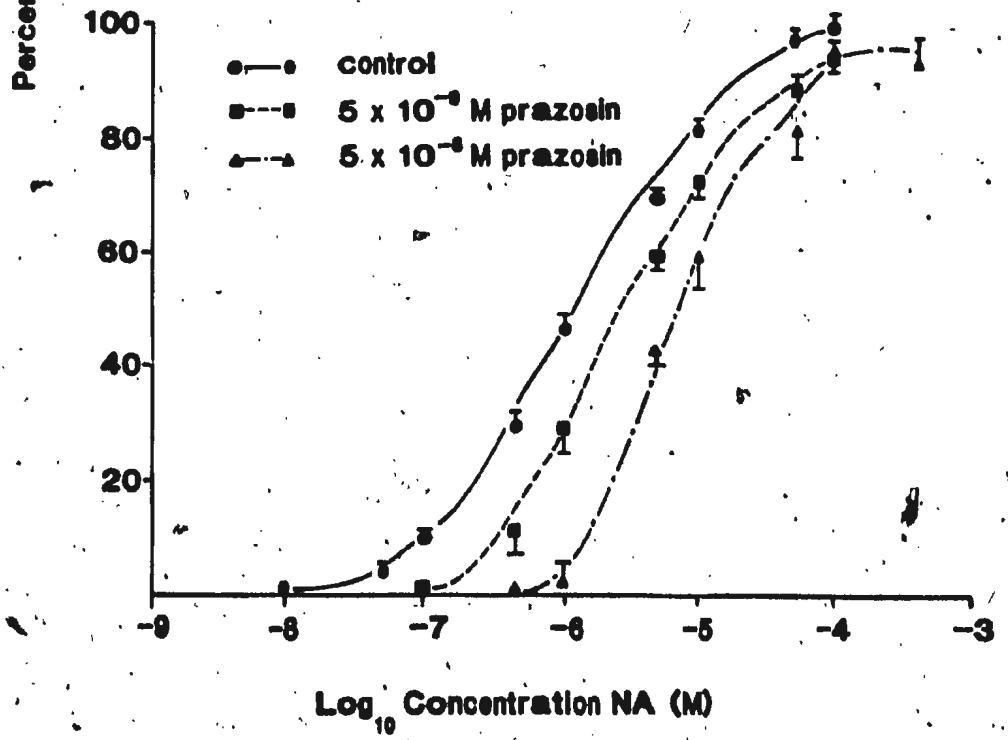
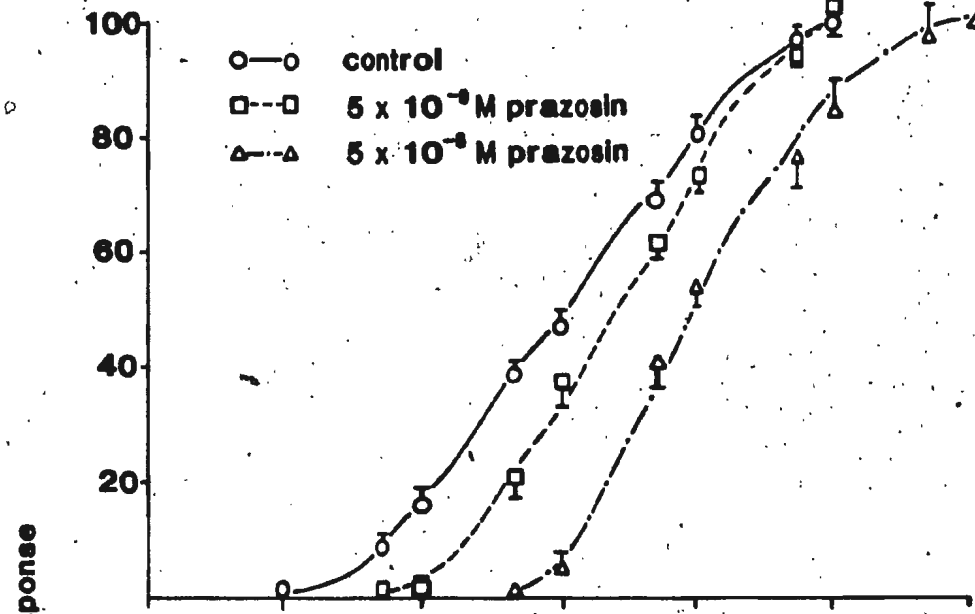

TABLE IX

5-HT vs. Ketanserin - EC<sub>50</sub> Values and Dose Ratios

Condition <sup>a</sup>	Normal		
control	$0.98 \times 10^{-7}$	$+ 0.04 \times 10^{-7}$ (16)	Dose Ratio
$5 \times 10^{-8}$ M ketanserin	$2.32 \times 10^{-7}$	$+ 0.56 \times 10^{-7}$ (4)	2.06
$1 \times 10^{-7}$ M ketanserin	$2.21 \times 10^{-7}$	$+ 0.20 \times 10^{-7}$ (4)	2.47
$5 \times 10^{-7}$ M ketanserin	$6.52 \times 10^{-7}$	$+ 1.43 \times 10^{-7}$ (4)	6.67
$1 \times 10^{-6}$ M ketanserin	$7.37 \times 10^{-6}$	$+ 0.37 \times 10^{-6}$ (4)	14.45
Condition <sup>a</sup>	Dystrophic		
control <sup>b</sup>	$1.87 \times 10^{-7}$	$+ 0.15 \times 10^{-7}$ (16)	Dose Ratio
$5 \times 10^{-8}$ M ketanserin	$3.00 \times 10^{-7}$	$+ 0.23 \times 10^{-7}$ (4)	1.80
$1 \times 10^{-7}$ M <sup>b</sup> ketanserin	$8.02 \times 10^{-7}$	$+ 0.21 \times 10^{-7}$ (4)	3.88
$5 \times 10^{-7}$ M ketanserin	$7.88 \times 10^{-7}$	$+ 0.89 \times 10^{-7}$ (4)	5.04
$1 \times 10^{-6}$ M ketanserin	$2.81 \times 10^{-6}$	$+ 0.60 \times 10^{-6}$ (4)	15.44

a all values are expressed as  $X \pm \text{SEM}$ , the number of chickens per group is shown in parentheses below each result.

b significantly different from normal,  $p < 0.05$ .

curve obtained in response to 5-HT was  $0.98 \times 10^{-7} \pm 0.04 \times 10^{-7}$  M for the normal tissue and the mean for the dystrophic tissue was  $1.87 \times 10^{-7} \pm 0.15 \times 10^{-7}$  M. This difference was statistically significant (see Table IX, page 166). These results suggested that the dystrophic tissue was less sensitive than the normal tissue to 5-HT. This shift in sensitivity was apparently preserved in the ketanserin-blocked tissues (see Table IX, page 166), although the difference was statistically significant only at  $1 \times 10^{-7}$  M ketanserin.

The  $EC_{50}$  values for NA are summarized in Table X. As illustrated in this table, there was no significant difference in the sensitivity of normal and dystrophic tissues to NA. The mean  $EC_{50}$  value for normal tissue was  $1.56 \times 10^{-6} \pm 0.17 \times 10^{-6}$  M and the mean for dystrophic tissue was  $1.56 \times 10^{-6} \pm 0.27 \times 10^{-6}$  M. In addition, no significant differences between the  $EC_{50}$  values of normal and dystrophic tissues were apparent for the prazosin-blocked preparations (see Table X).

From these data the  $EC_{50}$  ratios were computed and Schild plots were constructed for ketanserin vs. 5-HT and for prazosin vs. NA using four concentrations of the appropriate antagonist (see Tables IX and X). Linear regression analysis was performed on these data and the  $PA_2$  values obtained from the x-intercept of these lines. The results of this analysis are tabulated in Table XI.

TABLE X

NA vs. Prazosin - EC<sub>50</sub> Values and Dose Ratios

Condition <sup>a</sup>	Normal		
control	$1.56 \times 10^{-6} + 0.17 \times 10^{-6}$ (25)		Dose Ratio
$5 \times 10^{-9}$ M prazosin	$2.84 \times 10^{-6} + 0.37 \times 10^{-6}$ (8)		2.28
$1 \times 10^{-8}$ M prazosin	$3.78 \times 10^{-6} + 0.96 \times 10^{-6}$ (8)		3.03
$5 \times 10^{-8}$ M prazosin	$5.79 \times 10^{-6} + 0.69 \times 10^{-6}$ (7)		6.37
$1 \times 10^{-7}$ M prazosin	$6.15 \times 10^{-6} + 2.25 \times 10^{-6}$ (2)		10.10
Condition <sup>a</sup>	Dystrophic		
control	$1.56 \times 10^{-6} + 0.27 \times 10^{-6}$ (25)		Dose Ratio
$5 \times 10^{-9}$ M prazosin	$2.86 \times 10^{-6} + 0.51 \times 10^{-6}$ (8)		1.73
$1 \times 10^{-8}$ M prazosin	$2.87 \times 10^{-6} + 0.55 \times 10^{-6}$ (8)		2.79
$5 \times 10^{-8}$ M prazosin	$8.80 \times 10^{-6} + 2.51 \times 10^{-6}$ (7)		5.82
$1 \times 10^{-7}$ M prazosin	$9.50 \times 10^{-6} + 4.00 \times 10^{-6}$ (2)		8.47

<sup>a</sup> all values are expressed as X + SEM, the number of chickens per group is shown in parentheses below each result.

TABLE XI.  
Ketanserin and Prazosin - pA<sub>2</sub> Values

PRAZOSIN		
Parameter <sup>a</sup>	Normal	Dystrophic
equation	$y = -0.644 x + 5.45$	$y = -0.743 x + 6.11$
correlation coefficient	$r = -0.999$	$r = -0.988$
pA <sub>2</sub>	8.47	8.22

KETANSERIN		
Parameter <sup>a</sup>	Normal	Dystrophic
equation	$y = -0.842 x + 6.12$	$y = -0.800 x + 5.85$
correlation coefficient	$r = -0.991$	$r = -0.930$
pA <sub>2</sub>	7.27	7.32

<sup>a</sup> all values are expressed as  $\bar{X} \pm \text{SEM}$ .

Results showed that there were no differences in the calculated  $pA_2$  for normal and dystrophic tissues; this was true of both antagonists. The  $pA_2$  values were 7.27 for ketanserin in normal tissues, 7.32 for ketanserin in dystrophic tissues, 8.47 for prazosin in normal tissues and 8.22 for prazosin in dystrophic tissues. The regression coefficients indicated that the data points were a good fit to a straight line. The slopes of both lines, however, were less than unity suggesting that the antagonism in this preparation may be complex.

## Chapter IV

## DISCUSSION

The results of the present study are consistent with the hypothesis that functional alterations of muscle membranes are present in dystrophic avian muscle. The results further suggest that membrane alterations might be present in the smooth muscle as well as the skeletal muscle of dystrophic chickens.

Although the finding that ACh sensitivity is reduced in dystrophic muscle does not support a particular theory of muscular dystrophy, these data suggest that some previously reported abnormalities of dystrophic muscle may be a consequence of enhanced ACh hydrolysis at the dystrophic neuromuscular junction.

#### 4.1 Muscle Pharmacology

4.1.1 Physical characteristics. The dystrophic chickens used in the present study were unable to rise from the supine position, a classic sign of avian dystrophy (Entrikin et al., 1978). All the chickens were within the



same age range. Age was an important consideration in this study as muscular dystrophy is a progressive disease. Dystrophy-related changes in the muscles of adult dystrophic chickens may not be apparent in younger chickens.

The female chickens were smaller in stature than the male chickens and their muscles were smaller than those of male chickens. This was true of both normal and dystrophic groups. As muscle size and body size (ie. growth and muscle stretch) may affect the expression of avian dystrophy (Karpati et al., 1983b; Frankeny, Holly & Ashmore, 1983), and, as the expression of avian dystrophy differs in male and female chickens (Wilson et al., 1979; Howlett & Hoekman, 1983a), sex was considered in the assessment of the responses to intra-arterial injection.

The wet and dry weights of the dystrophic EDC muscles were increased when compared to normal muscles, a finding consistent with hypertrophy. The wet:dry ratios were similar for normal and dystrophic muscle, suggesting the difference in weights was not due to water accumulation. This is an important consideration as water accumulation has been described in the muscles of older dystrophic chickens (Chang, Misra, Beall, Fanguy and Hazelwood, 1981) and water deprivation retards the progression of avian dystrophy (Entrikin, Patterson, Mouritsen & Wilson, 1983).

The ratio of the muscle weight to chicken body weight

was increased in both dystrophic groups. This data concurs with the results of Pizzey and Barnard (1983a) who reported an increase in the muscle weight to body weight ratio for the dystrophic pectoralis muscle. This measure, however, is decreased in the fast twitch muscles of older dystrophic chickens (Hoekman, 1976; Pizzey & Barnard, 1983a). The histologic studies of Pizzey and Barnard (1983b) have shown initial hypertrophy of the affected muscle fibres of dystrophic chickens. Eventually, regeneration can no longer keep pace with the cell death and muscle fibre necrosis and atrophy proceed rapidly after day 60 ex ovo (Pizzey & Barnard, 1983b). Muscle fibre hypertrophy is prominent in dystrophic EDC muscles from young chickens and probably accounts for the increased weight of dystrophic EDC muscles (Howlett 1982).

The stimuli responsible for hypertrophy of dystrophic muscle fibres are unknown. Hironaka, Ikari and Miyata (1984b) observed a reduction in the number of dystrophic avian muscle fibres although individual muscle fibres were hypertrophied. They suggest that muscle fibre hypertrophy in dystrophy is a compensatory response to an initial loss of muscle fibres during development. It is also possible that the myotonia, characteristic of this model of dystrophy, (Holliday, et al., 1965) produces an initial exercise-induced muscle fibre hypertrophy (Howlett & Hoekman, 1983a). Alternately, passive muscle stretch is

also known to be a powerful stimulus for muscle fibre hypertrophy (Gutmann, Schiaffino & Hanzlikova, 1971); unequal degeneration of synergist and antagonist muscles may induce compensatory hypertrophy in the remaining fibres. The effect of passive stretch on the pathogenesis of avian dystrophy is currently being investigated (Lee et al., 1984) and, coupled with examination of the effect of chronic stimulation, should expand our knowledge of the nature of hypertrophy in the muscular dystrophies.

The maximum twitch and tetanic tensions generated per gram of dystrophic EDC muscle were increased when compared to those generated by normal muscle. These data support the notion that functional muscle hypertrophy occurs in young (56-63 days) dystrophic chickens.

By contrast, Hironaka et al. (1984b) studied chickens of a similar age (60-65 days) and showed that twitch and tetanic tension development was decreased in dystrophic extensor carpi radialis muscles although the tetanic tension development was increased for single dystrophic muscle fibres. This discrepancy may reflect a difference in the elastic elements of the two muscles. Alternately, the dystrophic process may proceed more rapidly in the extensor carpi radialis muscle than in the EDC muscle and only hypertrophied muscle fibres were selected for individual fibre tension measurement.

The contractile characteristics of the EDC muscles of

older (six months) chickens differ significantly from those of younger chickens. Dystrophic EDC muscles from older chickens exhibit substantially reduced twitch and tetanic tensions per. gram of muscle (Howlett & Hoekman, 1983a).

It is known that the physiologic output of a dystrophic muscle depends upon a number of factors. The progressive nature of the disease dictates that comparisons be made between normal and dystrophic chickens of comparable age. At the age examined in the present study (56 - 63 days), hypertrophy of dystrophic muscle fibres results in an increased tension output. This is probably an early, transient change as the eventual result of avian dystrophy is to greatly reduce muscle tension output.

4.1.2 Acetylcholine and carbachol responses. The data obtained in the present study suggest that the sensitivity to injected ACh was reduced in dystrophic muscle, a finding of some interest. Twitch depression (depolarizing blockade) in response to injected ACh was minimal in dystrophic chickens at doses which produced substantial twitch depression in normal muscles. By contrast, twitch depression in response to carbachol, an ACh receptor agonist which is not readily hydrolyzed by acetylcholinesterase (AChE), was similar in normal and dystrophic muscle. The threshold for twitch depression in response to both ACh and to carbachol was 3 - 6  $\mu$ g/30  $\mu$ l

for normal muscle. The threshold for twitch depression in dystrophic muscle was 3 - 6  $\mu\text{g}/30 \mu\text{l}$  for carbachol and 30 - 60  $\mu\text{g}/30 \mu\text{l}$  for ACh.

One interpretation of these results is that AChE and pseudocholinesterase, known to be present in unusually large quantities in the region of the motor end plates of dystrophic chicken muscles (Wilson, Kaplan, Merhoff & Mori, 1970; Wilson, Linkhart & Nieberg, 1973), inactivated ACh and reduced its action at the neuromuscular junction.

This suggestion is supported by both the ACh and the carbachol contracture data. The  $\text{ED}_{50}$  values for the ACh contracture responses suggest that normal muscles were more sensitive than dystrophic muscles to injected ACh. The  $\text{ED}_{50}$  values for the carbachol contracture responses, however, show that normal and dystrophic muscles were equally sensitive to carbachol. Moreover, ACh sensitivity in dystrophic muscle was reduced at low doses but achieved the same maximum response. These observations support the notion that ACh was hydrolyzed by AChE to a greater extent in dystrophic muscle than in normal muscle, reducing its interaction with ACh receptors at the neuromuscular junction.

There are several possible problems with this interpretation. Jedrzejczyk, Wieckowski, Rymaszewska and Barnard (1973) have demonstrated that the amount of AChE is reduced while the amount of pseudocholinesterase is

increased in the synaptic cleft of the neuromuscular junction of dystrophic chickens. This study, however, used both the Storr's and the New Hampshire (Line 304) dystrophic chickens; no genetically-matched control chickens are available for these lines of dystrophic chickens and this complicates the assessment of "differences" between normal and dystrophic chickens (Rushbrook et al., 1982).

Another objection might be that elevated levels of plasma AChE are present in the dystrophic chicken (Lyles, Barnard & Silman, 1980). Hence, ACh could be hydrolyzed prior to its arrival at the neuromuscular junction. The muscle response time to injected drugs, however, is virtually instantaneous minimizing AChE-drug interaction effects. Moreover, increased plasma AChE would be expected to affect the duration, not the onset, of the response. Furthermore, AChE represents only 5% of the total chicken plasma cholinesterase (Lyles et al., 1980).

Data from this laboratory nonetheless suggest that ACh is more rapidly hydrolysed at the dystrophic neuromuscular junction than at the normal neuromuscular junction. Hoekman has shown that the indirectly-elicited dystrophic muscle twitch is blocked by curare at lower doses than the normal muscle twitch (Hoekman, manuscript in preparation). Although the difference in curare sensitivity in normal and dystrophic muscle suggests a reduction in the number of ACh

receptors, the number of ACh receptors is similar in normal and dystrophic avian muscle (Porter & Barnard, 1976). Moreover, the present study has shown that the sensitivity to carbachol was similar in normal and dystrophic muscles. In addition, preliminary results reported in this study suggest that the sensitivity to neostigmine is reduced in the dystrophic chicken muscles. Taken together, these observations suggest that elevated AChE is present in the region of the neuromuscular junction. Although the results of the present study do not rule out altered receptor binding characteristics in dystrophic muscle, it appears likely that enhanced hydrolysis of released ACh by junctional AChE was responsible for the difference in curare sensitivity of normal and dystrophic muscle.

It is difficult to assess how this proposed increase in ACh hydrolysis contributes to the pathogenesis of avian dystrophy. Such changes as enhanced ACh sensitivity (Hoekman et al., 1980) that might be attributed to the primary defect in avian dystrophy may, in fact, be secondary to the altered AChE. Abnormal AChE may create a population of "functionally" denervated fibres in dystrophic muscles by reducing the margin of safety for neuromuscular transmission.

Some evidence for this hypothesis exists. The amplitude and duration of ACh contractures is increased in older dystrophic chickens of both the Storrs and the New.

Hampshire lines (Hoekman et al., 1980). Furthermore, extrajunctional ACh sensitivity has been reported in the twitch fibres of older dystrophic chickens (Warnick et al., 1979). As denervation causes normal muscle to develop extrajunctional ACh sensitivity and to respond to injected ACh with a sustained muscle contracture (Vrbova, Gordon and Jones, 1978), the increase in ACh sensitivity in older dystrophic chickens may to some extent, reflect denervation supersensitivity. In addition, ACh hydrolysis in vivo may contribute to the neuromuscular failure which has been reported for the dystrophic chicken (Albuquerque & Warnick, 1971; Warnick et al., 1979; Howlett, present study). It is also conceivable, however, that the tonic (multiply innervated) fibre population, which is increased by about 10% in dystrophic avian fast twitch muscles (Barnard et al., 1982) is at least partially responsible for the increased ACh sensitivity in older dystrophic muscles.

Interestingly, similar alterations in ACh sensitivity have been reported for dystrophic mouse muscle. Muscles from older dystrophic mice are more sensitive to neostigmine and less sensitive to curare than normal mouse muscle, although the sensitivity to these agents is similar in younger mice (Baker, Wilson, Oldendorf & Bland, 1960). This suggests that older dystrophic mouse muscle is supersensitive to acetylcholine.

Just as the muscles of young chickens are less



sensitive to ACh than normal muscle, Harris and Ribchester (1979) have shown similar ACh sensitivity in young normal and dystrophic mice. Tissue culture studies on developing mice myotubes and satellite cells show that  $^{125}\text{I}$ -alpha bungarotoxin binding is reduced in dystrophic myotubes (Cossu, Eusebi & Molinaro, 1984) and that dystrophic mouse satellite cells are unresponsive to ACh (Eusebi & Molinaro, 1984). These data indicate that ACh sensitivity in young dystrophic mouse muscle is either similar to normal or reduced.

From the available literature however, it is difficult, using the mouse model, to link this altered ACh sensitivity to abnormal AChE levels. Recent studies have shown that the molecular forms of AChE are altered, moreover, the amount of AChE is probably reduced in young dystrophic mouse muscles (Skau & Brimijoin, 1981; Lindenbaum & Livett, 1983). More studies must be conducted to determine the nature of the altered ACh sensitivity in dystrophic mouse muscle.

4.1.3 Potassium sensitivity. The intra-arterial injection of potassium ions into skeletal muscle is known to potentiate the muscle twitch response by increasing the duration of the active state plateau (Goffart & Ritchie, 1952). At higher concentrations injected potassium will depolarize the muscle membrane, producing twitch depression

and muscle contracture (Hodgkin & Horowicz, 1960; Lorkovic, 1983). The results of the present study suggest that although the contracture responses are of similar magnitude in normal and dystrophic muscle, twitch depression occurs in dystrophic muscle at potassium concentrations which produce twitch potentiation in normal muscle.

The twitch data are somewhat difficult to interpret. If simple mechanical failure of the dystrophic muscle was occurring, resulting in an inability to prolong the plateau of active state, this difference should also have been apparent in the caffeine twitch data for the dystrophic group. Alternately, if the failure were "electrical", depolarization of the muscle membrane would account for the the lower threshold for twitch depression in dystrophic muscle. Electrophysiologic evidence reported herein, however, suggests that there is a slight tendency for the dystrophic muscle membrane to be hyperpolarized.

The mechanism of potassium twitch potentiation might be as follows: at low potassium doses, increased extracellular potassium might be expected to stimulate the  $\text{Na}^+ - \text{K}^+$  pump producing hyperpolarization. It is known that post-activity hyperpolarization of non-myelinated mammalian nerve fibres is responsible for the production of action potentials with prolonged duration (Ritchie & Straub, 1957). A similar effect in muscle would thereby prolong the duration of the muscle action potential, increasing the

duration of the active state plateau and ultimately producing twitch potentiation (Sandow, Taylor & Preiser, 1965).

It is hypothesized that the increased intracellular sodium present in dystrophic avian muscle (Misra *et al.*, 1980) might stimulate the  $\text{Na}^+ - \text{K}^+$  pump, perhaps maximally. If this situation obtains, only the depolarizing effect of potassium would be possible; thus twitch depression would be recorded. Although one might normally expect the effect of elevated extracellular potassium on excitable membranes to be depolarization; it has been demonstrated that low doses of potassium produce relaxation of vascular smooth muscle accompanied by membrane hyperpolarization (reviewed by Haddy, 1983). These responses are ouabain-sensitive and are thought to be the result of potassium stimulation of the electrogenic  $\text{Na}^+ - \text{K}^+$  pump (Haddy, 1983).

Hence, the failure of low doses of potassium to potentiate the dystrophic muscle twitch may be related to the stimulation of the  $\text{Na}^+ - \text{K}^+$  pump by high levels of intracellular sodium. In dystrophic muscle, the effect of low doses of potassium would be to depolarize the muscle membrane.

4.1.4 Caffeine sensitivity. Early reports showed that the effect of caffeine on skeletal muscle was to activate the contractile apparatus without appreciably

altering the time course of the action potential (Sandow, Taylor, Isaacson & Seguin, 1964). Specifically, caffeine was shown to increase the active state plateau duration and potentiate the muscle twitch (Sandow et al., 1965). In high concentrations caffeine produces a transient baseline contracture (Sandow, 1965). The proposed site or sites of action of caffeine were the t-tubules and the SR (Sandow, 1965; Luttgau & Oetliker, 1968).

It has been thought for many years that caffeine induces calcium release from the SR by a mechanism which is surface membrane potential independent (Endo, 1977), although some recent studies question this interpretation. Based on their studies with muscle birefringence patterns, Poledna and Morad (1983) suggested that caffeine suppressed calcium reuptake by the SR, increasing sarcoplasmic calcium. Anwyl, Bruton and McLoughlin (1984) showed that low levels of potassium depolarization augmented caffeine contractures whereas high levels depressed caffeine contractures and proposed that caffeine acted on the sarcolemma to modify the muscle activation and inactivation. Despite this controversy, evidence supporting the notion that caffeine acts on the SR to cause calcium release is still compelling. Su and Hasselbach (1984) showed that caffeine produced transient, dose-dependent calcium release from isolated SR vesicles and suggested that the membrane response resulted from the

activation of a caffeine-sensitive calcium gate on the SR . Kinetic analysis of its action suggests that caffeine increases the affinity of calcium for binding sites on the SR (Yamamoto & Kasai, 1982); these sites may be the so-called "trigger" calcium sites (Frank, 1980) producing calcium-activated calcium release from the SR. Yoshioka and Somlyo (1984) suggested that caffeine increases the passive permeability of the sarcoplasmic reticulum to calcium.

At present, the mechanism of action of caffeine is not clearly defined but its effects on skeletal muscle may involve actions at more than one site. Regardless of the precise mechanism of action, caffeine increases the sarcoplasmic calcium concentration.

The results of the present study suggest there are no significant differences in the sensitivity of normal and dystrophic muscle to intra-arterial injections of caffeine. Twitch potentiation in response to caffeine injection was equal in normal and dystrophic muscle. Similarly, caffeine contractures were not different in normal and dystrophic muscle.

These results do not appear to support the calcium overload hypothesis. This hypothesis predicts that dystrophic muscle would be more sensitive to caffeine than normal muscle. It is likely that the site or sites of caffeine-induced calcium release are functional in normal

and dystrophic avian muscle.

4.1.5 Dantrolene sodium sensitivity. Dantrolene sodium is a novel skeletal muscle relaxant which depresses muscle contraction without interfering with either neuromuscular transmission or muscle resting and action potentials (reviewed by Britt, 1984). The primary site of action of dantrolene sodium is at the SR, where the drug is thought to inhibit calcium release (Morgan & Bryant, 1977; Desmedt & Hainaut, 1978). A secondary action of dantrolene sodium, blockade of the "trigger" calcium, has been proposed by Morgan and Bryant (1977). As complete blockade of the muscle twitch is not achieved with dantrolene sodium, some workers have proposed that muscle mitochondria may supply some of the calcium required for muscle contraction (Bowman, Houston, Khan & Rodger, 1979).

The data obtained in the present study demonstrate that no appreciable difference in sensitivity to dantrolene sodium exists between normal and dystrophic muscle. Blockade of about 80 % of the muscle twitch recorded from both normal and dystrophic muscle was noted in the present study. If dystrophic chicken muscle indeed contains elevated levels of intracellular calcium, one might have expected to observe either reduced sensitivity to dantrolene sodium or a reduction in the ability of this compound to block the muscle twitch. These results fail to

support the calcium overload hypothesis of muscular dystrophy.

If the calcium overload hypothesis were tenable, dantrolene sodium would seem to have been an excellent therapeutic choice for the treatment of muscular dystrophy. It is noteworthy that chronic administration of dantrolene sodium to dystrophic chickens produced some decrease in muscle fibre necrosis but no improvement in the righting ability of affected chickens (Cosmos & Butler, 1980).

#### 4.2 Denervation Studies

4.2.1 The effects of denervation. The effects of chronic denervation on the physiologic, pharmacologic and morphologic properties of skeletal muscle twitch fibres have been well characterized (reviewed by Vrbova, Gordon & Jones, 1978 and McArdle, 1983). The most obvious structural change in the short term is muscle fibre atrophy. This is followed, in the long term, by abnormalities of cell organelles, muscle cell degeneration and fibrosis (Vrbova et al., 1978).

The electrophysiologic properties of the muscle membranes are also altered by denervation. Depolarization of the muscle membrane is an early consequence of denervation (Albuquerque & McIsaac, 1970) and may result

from either increased  $\text{Na}^+$  permeability, inhibition of the  $\text{Na}^+-\text{K}^+$  pump, or both (McArdle, 1983). This change is responsible for muscle fibrillation (Denny-Brown & Pennybacher, 1938), resulting from spontaneous fluctuations in the membrane potential. Eventually, miniature end-plate potentials cease (Birks, Katz & Miledi, 1960). The rate of rise of the denervated muscle action potential is decreased (Redfern & Thesleff, 1971) and the passive electric properties of the resting cell membrane are altered (Albuquerque, Warnick & Sansone, 1971).

One of the most notable membrane changes which occurs in response to denervation is an increased sensitivity to ACh. Brown (1937) showed that injected ACh produced a contracture in chronically-denervated muscle at concentrations 1000 times more dilute than those required to produce a response in normal muscle. Iontophoresis (Axelsson & Thesleff, 1959) and binding studies (Frambrough, 1970) have demonstrated the presence of a large number of extrajunctional ACh receptors on denervated muscle membranes. The appearance of these receptors has been correlated with the increased sensitivity of the muscle to injected ACh.

The similarity between denervated and dystrophic muscles has led to speculation about the role of the nerve in the pathogenesis of muscular dystrophy. Indeed, the proponents of the neurogenic hypothesis of muscular



Dystrophy support the notion that muscle cell necrosis is secondary to a lesion in the nervous system. The validation of this hypothesis is complicated by the fact that the precise events responsible for particular denervation-associated changes are still in question. Some changes are apparently a result of disuse and may be mimicked by muscle immobilization; other changes may result from the removal of a trophic substance released by the nerve.

The present findings suggest that dystrophic muscle responds to the removal of both activity and "trophic" factors in a novel manner. The development of extrajunctional ACh sensitivity in denervated dystrophic muscle is altered and dystrophic muscle failed to exhibit significant denervation atrophy. Further examination of the stimuli responsible for the atypical denervation response in dystrophic muscle may yield important clues regarding the roles of activity and trophic regulation in normal muscle.

4.2.2 Physical characteristics. The wet and dry weights of the dystrophic muscles were significantly greater than normal although the wet:dry ratios were similar for normal and dystrophic muscles. As noted in section 4.1.1, it was felt that the increased weight reported for the dystrophic control group was a consequence

of muscle fibre hypertrophy rather than increased tissue water.

Notably, although denervation atrophy occurred in normal muscle, no muscle atrophy was apparent in dystrophic muscle. This virtual absence of denervation atrophy in dystrophic chicken muscle has not been previously reported for the dystrophic chicken. In fact, Lee et al. (1984) reported that normal patagialis muscles did not atrophy in response to denervation whereas dystrophic patagialis muscles did.

The reasons for this discrepancy are unclear. One might speculate that the dystrophic EDC muscle was stretched as a consequence of denervation while the normal EDC was not; stretch is thought to be responsible for the lack of atrophy of the denervated chick anterior latissimus dorsi muscle (Feng, Yang & Wu, 1962). It is difficult, however, to interpret the lack of denervation atrophy reported by Lee et al. (1984) in the normal patagialis muscle.

Not unexpectedly, the muscle twitch and tetanic tensions per gram of muscle were greatly reduced in the denervated muscles of both normal and dystrophic chickens. A reduction in the tension-generating capacity of denervated muscle has been reported (Lewis, 1972). The reduced tension generating capacity is related to the loss of contractile protein in these muscles.

4.2.3. Acetylcholine sensitivity. As previously described, the ACh sensitivity of denervated muscles is known to be substantially increased. The muscle contracture data and the ED<sub>50</sub> results presented in this study suggest that increased ACh sensitivity was present in both the normal and dystrophic EDC muscles three days after denervation. Furthermore, these data suggest that the denervated dystrophic muscles are slightly less sensitive to ACh than normal denervated muscles. The maximum contracture response, normalized for the weight of the muscle, was much larger in the normal denervated group than in the dystrophic denervated group. This was true of both male and female groups.

It is possible that denervated dystrophic muscle is simply incapable of generating large amounts of tension yet the ability of denervated dystrophic muscle to develop both twitch and tetanic tension appears equal to that of denervated normal muscle. These data may indicate that the coupling of ACh receptors to the contractile apparatus is altered in dystrophic denervated muscle.

The results for the twitch ratios in innervated muscle concur with those reported in section 4.1.2. The results for the normal muscle are not surprising. One would not expect to record ACh-induced twitch depression from directly-stimulated muscle. The intense, direct current

required to directly stimulate the EDC should overcome any focal depolarization blockade. Moreover, the contracture response data suggest that depolarization blockade should be greater in the normal group than in the dystrophic group. Viewed in this light, the twitch data for the denervated dystrophic muscle are difficult to interpret. These data clearly show twitch depression of directly stimulated dystrophic muscle. Although no simple explanation for these data can be offered at this time, altered coupling of the ACh receptors to the contractile apparatus is consistent with this result. Intracellular recording of the response to ACh would be helpful in assessing this hypothesis.

4.2.4. Caffeine sensitivity. Denervation did not effect the ability of injected caffeine to potentiate the muscle twitch response. This was true of normal and dystrophic denervated muscles, from both male and female groups. Similarly, the caffeine contracture responses of both normal and dystrophic denervated muscle did not differ appreciably from those recorded in innervated muscle. These results are of interest as they suggest calcium release is similar in the denervated muscles of normal and dystrophic chickens. Consequently, differences between normal and dystrophic denervated muscle are unlikely to involve the muscle contractile machinery.

Changes in the responsiveness of denervated muscle to caffeine have been reported. Long-term (several weeks) denervation studies have shown that caffeine sensitivity increases in denervated normal muscle (Gutmann & Sandow, 1965). This change is probably related to the fact that the volume of SR is increased in denervated muscles (Pellagrino & Franzini, 1963). It would be of interest to assess the caffeine sensitivity of normal and dystrophic muscle in a long-term denervation study.

4.2.5 Potassium sensitivity. The effect of increased external potassium on the twitch ratio was to increase twitch depression, an effect that differed very little between control and denervated dystrophic muscle. The results for normal muscle, by contrast, indicate that the pronounced twitch potentiation observed for the control group was virtually absent in the denervated group.

These data are of particular interest as the proposed mechanism for twitch potentiation in response to injected KCl is the stimulation of the  $\text{Na}^+ - \text{K}^+$  pump. As inhibition of the  $\text{Na}^+ - \text{K}^+$  pump has been reported for denervated muscle (the evidence for this has been reviewed by McArdle, 1983), pump stimulation is unlikely to occur in these muscles. This would account for the absence of twitch potentiation in normal denervated muscle.

Denervation also reduces the resting membrane

potential, reducing the threshold for twitch depression. The membrane depolarization at this stage is generally not great (Deshpande, Warnick, Guth & Albuquerque, 1980), which probably accounts for the absence of any quantitative change in muscle sensitivity to potassium as assessed by the contracture response.

#### 4.3 Electrophysiology.

4.3.1 Physical characteristics. The chickens used in this section of the study showed typical signs of avian dystrophy, including a decreased ability to rise from the supine position.

4.3.2 Action potential characteristics. Differences between normal and dystrophic chickens were present for selected characteristics of the action potentials recorded from the EDC muscle. There was a tendency towards hyperpolarization of the resting membrane potential in the dystrophic group, however, this was not significant at the level chosen for the present study. Hyperpolarization of the dystrophic avian muscle membrane has been reported for dystrophic (Line 413) avian muscle in vitro for chickens aged 4 - 40 weeks (Warnick, et al., 1979) and for chickens

aged 6 weeks (Korenaga, 1980). For another line of dystrophic chickens (Line 455) Gunther and Letinsky (1982) reported a slight depolarization of the dystrophic avian muscle membrane in chickens aged 5 - 15 weeks. It is difficult, however, to assess the significance of pooled data for such wide age ranges due to the progressive nature of the disease. Hyperpolarization of dystrophic muscle membranes is perhaps not unexpected as elevated intracellular sodium concentrations have been demonstrated in dystrophic avian muscle (Misra et al., 1980); increased intracellular sodium would stimulate the electrogenic  $\text{Na}^+$ - $\text{K}^+$  pump causing a slight membrane hyperpolarization at rest (Ritchie & Straub, 1957).

In the present study, the rate of rise and amplitude of the action potentials recorded from dystrophic muscle fibres were similar to those recorded from normal muscle. There was a tendency towards a reduced overshoot in the dystrophic fibres. These findings concur with the data of Warnick et al. (1979) on an in vitro preparation of the posterior latissimus dorsi muscle.

The only alteration in the action potentials recorded from dystrophic muscle in this study was a detectable increase in the action potential duration at half the maximum amplitude. This observation has not been made previously for dystrophic avian muscle. One might have predicted a reduction in the duration of action potentials

recorded from the large diameter dystrophic muscle fibres; hypertrophied muscle fibres were probably sampled more readily than the small population of atrophic and split fibres.

An increase in the duration of the muscle action potential has been reported for the dystrophic mouse, however. Kerr and Sperelakis (1983) have described increased action potential duration in dystrophic mouse muscle and Saito, Ohkura, Kashima, Katayama and Tanaka (1982) demonstrated increased duration of the cardiac action potential in the heart of the dystrophic mouse.

The increased action potential duration might be related to a number of factors. The possible basis for the increased action potential duration in dystrophic fibres is a prolongation of sodium channel opening. This appears unlikely since prolonged sodium channel opening would also be expected to increase the amplitude of the action potential; the present study found no evidence for increased action potential amplitude. Alternatively, the increased action potential duration may be due to increased membrane capacitance; this has been reported for dystrophic chicken muscle (Lebeda & Albuquerque, 1975; Korenaga, 1980).

Proliferation of the t-tubule network in dystrophic chicken muscle probably accounts for the increased membrane capacitance (Crowe & Baskin, 1978). Increased membrane



capacitance should attenuate both the rising and falling phases of the action potential, yet the rate of rise is not appreciably decreased in dystrophic EDC muscle fibres. The increased fibre diameter and the increased membrane capacitance likely act in opposite directions. This results in a net increase in the action potential duration.

For mouse muscle however, the action potential duration is increased in dystrophy (Kerr & Sperelakis, 1983) and membrane capacitance is decreased (Dangain & Vrbova, 1983). The action potential duration is increased in mammalian slow twitch fibres when compared to fast twitch fibres (Florendo, Reger & Law, 1983); possibly the presence of slow twitch, immature or regenerating fibres in dystrophic muscle (Cosmos, 1966; Cosmos & Butler, 1967) is sufficient to account for the increased action potential duration. Yet this is unlikely as most dystrophic fibres sampled in the present study had long duration action potentials; slow twitch, immature and regenerating fibres comprise a small proportion of the total number of muscle fibres in dystrophic chickens of this age (Pizzey & Barnard, 1983b).

Perhaps the most plausible explanation for the increased action potential duration in dystrophic muscle fibres is that the potassium channels are altered in some way in dystrophic avian muscle fibres. There is some support for this notion as reduced potassium conductance

has been reported in dystrophic mouse fibres (Sellin & Sperelakis, 1978) although Lebeda and Albuquerque (1975) reported normal potassium conductance in dystrophic chicken muscle. Lebeda and Albuquerque (1975), however, examined the old Line 304 dystrophic chickens. The electrophysiologic properties of the newer Line 413 dystrophic chickens are, however, appreciably different (Warnick et al., 1979).

The increased duration of the dystrophic muscle action potential should increase the duration of the active state plateau and, ultimately, the duration of the muscle twitch (Sandow et al., 1965). It is interesting that neither the time course of the muscle twitch nor the duration of the active state plateau are altered in avian dystrophy (Hoekman, 1976; Howlett & Hoekman, 1983a). One explanation for this apparent paradox is to posit altered excitation-contraction coupling in dystrophic muscle. Reported membrane abnormalities of both the t-tubules (Sumnicht & Sabbadini, 1982) and the sarcoplasmic reticulum (Hsu & Kaldor, 1971; Kawamoto & Baskin, 1983) are consistent with abnormal excitation-contraction coupling. The failure of these long-duration action potentials to produce an attenuated muscle twitch suggests that alterations in the electrophysiologic properties of the surface membrane of the dystrophic avian muscle fibre are not consistent with the contractile response.

The increased duration of the dystrophic muscle action potential and its failure to prolong the indirectly-elicited muscle twitch support the hypothesis that a membrane defect is present in the sarcolemma of dystrophic avian muscle fibres.

#### 4.4 Smooth muscle

The present study compares some physiologic and pharmacologic properties of vascular smooth muscle from normal and dystrophic chickens.

The dry weights of ischiatic artery segments from dystrophic chickens were greater than those from normal chickens, but the wet:dry ratios were similar in both groups. Increased connective tissue, fat infiltration and significant populations of both atrophic and hypertrophic fibres, however, are present in the smooth muscle of the gut of patients with muscular dystrophy (Pruzanski & Ruvos, 1967; Nowak et al., 1982). Although it is possible that the increased tissue weight is due to increased muscle protein, the absence of increased muscle contractility suggests that non-contractile protein and fat account for the increased tissue weight.

The results of this study showed that the response of

dystrophic tissues to an  $EC_{100}$  concentration of 5-HT was less than that of normal tissues. The responses of normal and dystrophic tissue to an  $EC_{100}$  concentration of NA, however, were similar. Although these differences might reflect an abnormality of the 5-HT receptor, this is not the only interpretation possible. As the maximum tension generated by normal muscle in response to NA is less than that produced in response to 5-HT, perhaps dystrophic tissues are simply incapable of generating high levels of tension. This may account for the diminished gastrointestinal motility which has been reported in the smooth muscle of patients with a variety of muscular dystrophies (Nowak *et al.*, 1982; Nowak *et al.*, 1984; Bodensteiner & Grunow, 1984).

The concentration-response curves for 5-HT were shifted to the right in the dystrophic group when compared to the normal group. Moreover, the  $EC_{50}$  values obtained for dystrophic tissues were significantly greater than those obtained for normal tissues. This suggests that dystrophic vessels were less sensitive to 5-HT than were normal vessels. The apparent  $PA_2$  values for ketanserin were similar in normal and dystrophic tissues, indicating decrease in agonist affinity was not accompanied by a change in antagonist binding in dystrophic preparations.

By contrast, the sensitivity to NA was similar in normal and dystrophic vessels. The reduced sensitivity in

response to 5-HT could be a consequence of either a reduction in the number of 5-HT receptors or a defect in the coupling of these receptors to the contractile apparatus.

It is not surprising to find alterations in the number or the function of receptors in dystrophic tissue.

Abnormal receptor populations have been described in both animal and human muscular dystrophy. Patients with myotonic dystrophy have a relative insulin insensitivity (Moxley, Griggs & Goldblatt, 1980). A decreased number of insulin binding sites has been reported in the muscles of patients with Duchenne muscular dystrophy (DePierro, Lauro, Testa, Ferretti, DeMartinis & Deilatonio, 1982). Furthermore, an increased number of glucocorticoid binding sites are present in the cytosol of both dystrophic mouse muscle (Dubois & Almon, 1984) and dystrophic chicken muscle (Dubois & Almon, 1982) when compared with normals. Functional alterations in the vascular adrenergic receptors of myotonic dystrophy patients have also been reported (Mechler & Mastaglia, 1981).

Hunter and Elbrink (1983) reported no change in the sensitivity of the dystrophic hamster aorta to a variety of agonists (including 5-HT) when compared to the aorta of normal hamsters. They also reported that the tension generated per gram of muscle was increased in dystrophic tissues in response to all agonists; the wet weights of the

strips of dystrophic hamster aorta were substantially decreased when compared to normal.

The discrepancies between the results of the present study and those of Hunter and Elbrink (1983) may simply reflect differences between the hamster and the chicken models of dystrophy. It is also possible however, that the increased contractility and decreased weight of the dystrophic hamster aorta are secondary changes in response to the cardiomyopathy which is a prominent feature of hamster dystrophy (Homburger, 1979). Jasmin and Proschek (1982) have shown cardiomyopathy in the heart of dystrophic hamsters at the age used by Hunter and Elbrink (1983).

A vascular theory of muscular dystrophy predicts increased sensitivity to both catecholamines and indolamines in dystrophic tissues, the results of the present study fail to confirm this hypothesis. The dystrophic ischiatic artery is less sensitive to 5-HT than the normal vessel and both normal and dystrophic vessels are equally sensitive to NA. Other studies have also failed to confirm a vascular pathogenesis of muscular dystrophy. Burch et al. (1981) and Atherton et al. (1982) used morphometric techniques to demonstrate blood vessel proliferation in the necrotic muscles of dystrophic mice. These findings suggest that blood flow to dystrophic muscles may, in fact, be increased instead of decreased.

These findings show that the changes in vascular

smooth muscle which exist in avian dystrophy are not consistent with the hypothesis that muscle fibre necrosis in muscular dystrophy is secondary to muscle ischemia. The results do suggest that smooth muscle abnormalities are present in the avian model of muscular dystrophy. These abnormalities of smooth muscle function are consistent with the notion that a membrane defect is present in the muscular dystrophies.

#### 4.5 General Discussion

The data presented in this thesis suggest that a number of differences exist between normal and dystrophic avian muscle. Although they do not unequivocally support one theory of muscular dystrophy, they do suggest that a defect of the sarcolemma is present in muscle from young dystrophic chickens.

Support for the membrane defect theory was demonstrated using several different approaches. In particular, the altered duration of the action potential suggests that the dystrophic muscle membrane is functionally impaired. This impairment may be linked to altered membrane conductance. Furthermore, the response of dystrophic muscle to denervation differs from the response

of normal muscle. The development of extrajunctional ACh sensitivity is apparently diminished in dystrophic muscle when compared to normal muscle. Moreover, dystrophic muscle fails, in the short-term, to exhibit denervation atrophy.

The results of the present study further suggest that the membrane defect is not necessarily restricted to skeletal muscle. Functional abnormalities in the vascular smooth muscle of dystrophic chickens were demonstrated in the present study. Abnormalities of tissues other than skeletal muscle suggest to some investigators that the primary genetic defect in muscular dystrophy resides in some tissue other than skeletal muscle. The neurogenic and vascular theories of muscular dystrophy lend credence to this view. The results of the present study, however, suggest that muscular dystrophy is expressed both in skeletal muscle and in vascular smooth muscle. The data are not consistent with the hypothesis that muscular dystrophy is secondary to a primary lesion in the vascular system. Perhaps other reported abnormalities of the vascular system result, not from a primary vascular lesion, but rather are a direct manifestation of the disease in vascular smooth muscle.

Not all the data reported in this thesis are supportive of a particular theory of muscular dystrophy. Many reported "differences" between normal and dystrophic chickens may be secondary to another abnormality. The



results of the ACh and carbachol studies caution against interpreting denervation-like changes in dystrophic muscle as evidence for a neurogenic cause of muscular dystrophy. Several of the reported changes may also be explained on the basis of enhanced ACh hydrolysis in vivo at the neuromuscular junction. Moreover, the twitch blockade of dystrophic muscle produced by KCl may be related to the pump stimulation produced by elevated intracellular sodium levels. The latter suggestion could be tested by considering the effect of ouabain on the muscle membranes of the dystrophic chicken.

Several of the investigations conducted in this study were designed assess the role of calcium in the disease. While results of these studies failed to support the calcium overload hypothesis they do not disprove it. The chief objection is that the techniques employed here may not have been sensitive enough to detect early changes in calcium handling. This limitation arises from the in vivo injection technique. While the ability of the investigator to manipulate the environment surrounding the muscle is limited in this preparation, the in vivo injection technique does permit analysis of whole muscle function in an innervated, well-perfused preparation. The examination of small muscle fibre bundles in vitro would complement the results of the present study. Marking these fibres for histologic analysis would permit correlation of abnormal

physiologic and pharmacologic properties with muscle fibre morphology.

Although the abnormalities reported in the present investigation are present in young chickens, developmental studies on neonatal chicks and chick embryos would be informative. These studies would help to assess whether the changes are closely linked to the dystrophic gene or are secondary to some other underlying defect.

#### 4.6 Summary

From the data obtained in the present study several points should be emphasized:

- 1) The in vivo EDC preparation is well-suited to assess the responses of normal and dystrophic muscle to intra-arterial injections of pharmacologic agents.
- 2) Changes in ACh sensitivity which may previously have been attributed to denervation in dystrophic muscle are perhaps a consequence of enhanced AChE activity.
- 3) Dystrophic avian muscle responds normally to acute injections of compounds which alter calcium handling in

skeletal muscle. Further investigations are required to assess the involvement of calcium in the pathogenesis of avian dystrophy.

4) The results presented here support the hypothesis that a membrane defect is present in dystrophic avian muscle membranes.

4) The data further suggest that muscular dystrophy is expressed in the vascular smooth muscle of the dystrophic chicken.

#### 4.7 Future Experiments

The results raise several issues for future consideration. The abnormal response of dystrophic muscle to denervation cannot be readily explained. To this end, it would be of interest to record the membrane depolarization produced in response to iontophoretically applied ACh in denervated normal and dystrophic muscle.

The similarity of the responses of normal and dystrophic muscle to both caffeine and dantrolene suggests that gross changes in calcium handling are not an early feature of chicken dystrophy. Studies of calcium handling

in isolated fibre bundles from the muscles of young and old dystrophic chickens would be helpful in this regard.

The presence of abnormalities in the vascular smooth muscle of the dystrophic chicken is consistent with the notion that smooth muscle is affected by avian dystrophy. The extent to which smooth muscle abnormalities are present in avian dystrophy should be assessed in other smooth muscle preparations. Examination of the cardiac muscle of diseased chickens would also be helpful in assessing the spectrum of muscle involvement in avian dystrophy.

## REFERENCES

ADRIAN, E., AND D. BRONK. 1929. The discharge of impulses in motor nerve fibres: Part II. J. Physiol. 67: 119.

ALBUQUERQUE, E.X. AND R.J. McISAAC. 1970. Fast and slow muscles after denervation: Exp. Neurol. 26: 183-202.

ALBUQUERQUE, E.X., AND J.E. WARNICK. 1971. Electrophysiological observations in normal and dystrophic chicken muscles. Science 172: 1260-1263.

ALBUQUERQUE, E.X., J. WARNICK AND P.M. SANSONE. 1971. The pharmacology of batrachotoxin II. Effect on electrical properties of the mammalian nerve and skeletal muscle membrane. JPET. 176: 511-528.

ANWYL, R., J.D. BRUTON, AND J.V. MCLOUGHLIN. 1984. The effect of external potassium, multivalent cations and temperature on caffeine contractures in rat skeletal muscle. Brit. J. Pharmacol. 82: 609-614.

ASHMORE, C.R., Y.B. LEE, P. SUMMERS, AND L. HITCHCOCK. 1984. Stretch-induced growth in chicken wing muscles: Nerve-muscle interaction. Am. J. Physiol. 246: C378-C385.

ASMUNDSON, V.S., AND L.M. JULIAN. 1956. Inherited muscle abnormality in the domestic fowl. J. Heredit. 47: 248-252.

ATHERTON, G.W., M. CABRIC, AND N.T. JAMES. 1982. Stereological analyses of capillaries in muscles of dystrophic mice. Virchows Arch. 397: 347-354.

ATWOOD, H., AND I. KWAN. 1978. Dystrophic and normal mice show age dependent divergence of muscle sodium concentrations. Exper. Neurol. 60: 386-392.

AXELSON, J., AND S. THESLEFF. A study of supersensitivity in denervated mammalian muscle. J. Physiol. 147: 178-193.

BAKER, N., L. WILSON, W. OLDENDORF, AND W.H. BLAHD. 1960. Supersensitivity to neostigmine and resistance to d-tubocurarine in mice with hereditary myopathy. Am. J. Physiol. 198: 926-930.

BANDMAN, E. 1984. Myosin components of the latissimus dorsi and pectoralis major muscles of the dystrophic chicken. Muscle & Nerve 7: 312-326.

BARNARD, E.A., AND P.G. BARNARD. 1979. Use of genetically dystrophic animals in chemotherapy trials and application of serotonin antagonists as antidystrophic drugs. Ann. N.Y. Acad. Sci. 317: 374-399.

BARNARD, E.A., J.M. LYLES, AND J.A. PIZZEY. 1982. Fibre types in chicken skeletal muscle and their changes in muscular dystrophy. J. Physiol. 331: 333-354.

BATESON, D.S., AND D.J. PARRY. 1983. Motor units in a fast twitch muscle of normal and dystrophic mice. J. Physiol. 345: 515-525.

BAXTER, J.H., AND C.H. SUELTER. 1983. Skeletal muscle lysosomes: comparison of lysosomes from normal and dystrophic avian pectoral muscles as a function of age. Muscle & Nerve 6: 187-194.

BAXTER, J.H., AND C.H. SUELTER. 1984. Multiple acid phosphatase in avian pectoral muscle - the postmicrosomal supernatant acid phosphatase is elevated in avian dystrophic muscle. Arch. Biochem. Biophys. 228: 397-406.

BEHRENS, M.I., G. TORREALBA, J. COURT, M.A. SOZA, AND B. RAMIREZ. 1983. Axonal transport dysfunction in dystrophia myotonica. Acta Neuropathol. 62: 157-158.

BEPPU, H., M. NAKAJIMA, F. NISHIYAMA, M. UONO, AND H. HIRANO. 1983. Concanavalin A binding sites on erythrocytes of normal and genetically dystrophic chickens. J. Neurol. Sci. 59: 401-414.

BERTORINI, T.E., S.K. BHATTACHARYA, G.A. PALMIERI, C.M. CHESNEY, D. PIFER, AND B. BAKER. 1982. Muscle calcium and magnesium content in Duchenne muscular dystrophy. Neurol. 32: 1088-1092.

BERTORINI, T.E., F. CORNELIO, S.K. BHATTACHARYA, F. PALMIERI, I. DONES, F. DWORZAK, AND B. BRAMBATI. 1984. Calcium and magnesium content in fetuses at risk and pre-necrotic muscular dystrophy. Neurol. 34: 1436-1441.

BHATTACHARYA, S.K., G.M. PALMIERI, T.E. BERTORINI, AND D.F. NUTTING. 1982. The effect of diltiazem on dystrophic hamsters. Muscle & Nerve 5: 73-78.

BIRKS, R., B. KATZ, AND MILEDI, R. 1960. Physiological and structural changes at the amphibian myoneural junction in the course of nerve degeneration. J. Physiol. 150: 145-168.

- BODENSTEINER, J.B., AND A.G. ENGEL. 1978. Intracellular calcium accumulation in Duchenne dystrophy and other myopathies: a study of 567,000 muscle fibres in 114 biopsies. Neurol. 28: 439-446.
- BODENSTEINER, J.B., AND J.E. GRUNOW. 1984. Gastroparesis in neonatal myotonic dystrophy. Muscle & Nerve 7: 486-488.
- BOEGMAN, R.J., AND P.L. WOOD. 1981. Axonal transport in dystrophic hamsters. Can. J. Physiol. Pharmacol. 59: 202-204.
- BOLHUIS, P.A., B.G. GOLDHOORN, AND J.G. DEGROOT. 1982. Normal platelet aggregation in myotonic dystrophy. J. Neurol. Sci. 56: 337-342.
- BONILLA, E., K. FISCHBECK, AND D.L. SCHOTLAND. 1981. Freeze fracture studies of muscle caveolae in human muscular dystrophy. Am. J. Pathol. 104: 167-173.
- BOWMAN, W.C., J. HOUSTON, H. KHAN, AND W. RODGER. 1979. Effects of dantrolene sodium on respiratory and other muscles, and on respiratory parameters in the anesthetized rat. European J. Pharmacol. 55: 293-303.
- BRADLEY, W.G., AND J.J. FULTHORPE. 1978. Studies of sarcolemmal integrity in myopathic muscle. Neurol. 28: 670-677.
- BRADLEY, W.G., AND E. JAROS. 1973. Axoplasmic flow in axonal neuropathies. II. Axoplasmic flow in mice with motor neuron disease and muscular dystrophy. Brain 96: 247-258.
- BRADLEY, W., AND M. JENKISON. 1973. Abnormalities of peripheral nerves in murine muscular dystrophy. J. Neurol. Sci. 18: 227-247.
- BRADLEY, W.G., M.D. O'BRIEN, D.W. WALDER, D. MURCHISON, M. JOHNSON, AND D.J. NEWELL. 1975. Failure to confirm a vascular cause of muscular dystrophy. Arch. Neurol. 32: 466-473.
- BRAUNSTEIN, P.W., AND V. DEGIROLAMI. 1981. Experimental corticosteroid myopathy. Acta Neuropathol. 55: 167-172.
- BRIMIJOIN, S., AND P.A. SCHREIBER. 1982. Reduced axonal transport of 10S acetylcholinesterase in dystrophic mice. Muscle & Nerve 5: 405-410.
- BRITT, B.A. 1984. Dantrolene. Can. Anesth. Soc. 31: 61-75.

BROWN, G.L. 1937. The actions of acetylcholine on denervated mammalian and frog muscles. J. Physiol. 89: 438-461.

BURCH, T.G., R.L. PREWITT, AND P.K. LAW. 1981. In vivo morphometric analysis of muscle microcirculation in dystrophic mice. Muscle & Nerve 4: 420-424.

BURGER, R.E., AND F.W. LORENZ. 1960. Artificial respiration in birds by unidirectional air flow. Poultry Sci. 39: 236-237.

BUTLER, J., AND E. COSMOS. 1977. Histological and structural analyses of the phenotypic expression of the dy gene in 129/ReJ dy/dy and C57BL/6J dy2j/dy2j mice: Exp. Neurol. 57: 666-681.

CAPALDI, M., M.J. DUNN, C.A. SEWRY, AND V. DUBOWITZ. 1984. Altered binding of Ricinus-communis I lectin by muscle membranes in Duchenne muscular dystrophy. J. Neurol. Sci. 63: 127-142.

CHANG, D.C., L.R. MISRA, P. BEALL, R.C. FANGUY, AND C.F. HAZELWOOD. 1981. NMR study of muscle water protons in muscular dystrophy of chickens. J. Cell Physiol. 107: 139-145.

CHARLTON, M.P., H. SILVERMAN, AND H.L. ATWOOD. 1981. Intracellular potassium activity in muscles of normal and dystrophic mice. Exp. Neurol. 71: 203-219.

COLLIPP, P., J. KELEMEN, S.Y. CHEN, M. CASTRO-MORGANA, M. ANGULA, AND A. DERENCOURT. 1984. Growth hormone inhibition causes increased selenium levels in Duchenne muscular dystrophy: A possible new approach to therapy. J. of Med. Gen. 21: 254-257.

COSMOS, E. 1966. Enzymatic activity of differentiating muscle fibres. Dev. Biol. 13: 163-181.

COSMOS, E. 1973. Muscle-nerve transplants: experimental models to study influence on differentiation. Physiologist 16: 167-177.

COSMOS, E., AND J. BUTLER. 1967. Differentiation of fibre types of muscle from normal and dystrophic chickens. A quantitative and histochemical study of the ontogeny of muscle enzymes. Pages 197-204 in A.T. Milhorat, Ed., Exploratory Concepts in Muscular Dystrophy and Related Disorders, Excerpta Medica, Amsterdam.



COSMOS, E., AND J. BUTLER. 1980. Animal models of muscle disease, Part III: Compilation of therapeutic trials for hereditary muscular dystrophy. Muscle Nerve 3: 427-435.

COSMOS, E., J. BUTLER, E.P. ALLARD, AND J. MAZLIAH. 1979. Factors that influence the phenotypic expression of genetically normal and dystrophic muscles. Ann. N. Y. Acad. Sci. 317: 571-592.

COSMOS, E., J. BUTLER, J. MAZLIAH, AND E.P. ALLARD. 1980. Animal models of muscle diseases I: avian dystrophy. Muscle & Nerve 3: 252-262.

COSSU, G., F. EUSEBI, AND M. MOLINARO. 1984. Reduced acetylcholine sensitivity in dystrophic mouse myotubes in vitro. Muscle & Nerve 7: 73-76.

CROWE, L.M., AND R.J. BASKIN. 1978. Freeze fracture of intact sarcotubular membranes. J. Ultrastru. Res. 62: 147-154.

CULLEN, M.J., AND J.J. FULTHORPE. 1975. Stages in fibre breakdown in Duchenne muscular dystrophy. J. Neurol. Sci. 24: 179-200.

DANGAIN, J., AND G. VRBOVA. 1983. Elimination of polyneuronal innervation in a fast muscle of normal and dystrophic mice. J. Physiol. 342: 267-275.

DASTUR, D.K., D.K. MANGHANI, B. OSUNTOKUN, P. SOURANDOR, AND K. KONDO. 1982. Neuromuscular and related changes in malnutrition. J. Neurol. Sci. 55: 207-230.

DENNY-BROWN, D., AND J. PENNYBACHER. 1938. Fibrillation and fasciculation in voluntary muscle. Brain 61: 311-334.

DEPIRRO, R., R. LAURO, G. FERRETTI, C. DEMARTINIS, AND R. DELLANTONIO. 1982. Decreased insulin receptors but normal glucose metabolism in Duchenne muscular dystrophy. Science 216: 311-313.

DESANTIS, M., T. HOEKMAN, AND V. LIMWONGSE. 1977. Retrograde transport of peroxidase in motor neurons innervating slow and fast muscles: absence of a difference between normal and dystrophic chickens. Brain Res. 119: 454-458.

DESHPANDE, S., J. WARNICK, L. GUTH, E.X. ALBUQUERQUE. 1980. Quantal release of acetylcholine does not regulate the resting membrane potential of mammalian skeletal muscle. Evidence from in vivo experiments. Exp. Neurol. 70: 122-137.

DESMEDT, J.E., AND K. HAINAUT. 1978. Excitation-contraction coupling in single muscle fibres and the calcium channel in sarcoplasmic reticulum. Ann. N.Y. Acad. Sci. 307: 433-435.

DESMOS, J. 1961. Mesure des temps de circulation chez 79 myopathes. Rev. Fr. Etud. Clin. Biol. 6: 876-887.

DIGIAMBERARDINO, L., J.Y. COURAUD, AND E.A. BARNARD. 1979. Normal axonal transport of acetylcholinesterase forms in peripheral nerves of dystrophic chickens. Brain Res. 160: 196-202.

DOUGLAS, W.B. 1975. Sciatic cross-reinnervation of normal and dystrophic muscle in parabiotic mice. Isometric contractile properties of reinnervated tibialis anticus and triceps surae. Exp. Neurol. 48: 647-663.

DUBOIS, D. AND R. ALMON. 1982. The chicken dystrophic model. Does hypersensitivity to glucocorticoids cause atrophy? Exp. Neurol. 75: 555-565.

DUBOIS, D. AND R. ALMON. 1984. Increased content of glucocorticoid receptors in mouse muscular dystrophy. Endocrine Res. Comm. 10: 3-10.

DUBOWITZ, V. 1969. Chemical and structural changes in muscle. In D.J. Allen & D.N. Raine, Ed., Some Inherited Disorders of Brain and Muscle, Livingstone, Edinburgh.

DUBOWITZ, V. 1974. Histochemical aspects of muscle disease. Page 310 in J.N. Walton, Ed., Disorders of Voluntary Muscle, Churchill Livingstone, Edinburgh.

DUCHENNE, G.B. 1868. Recherches sur la paralysie musculaire pseudohypertrophique ou paralysie myosclerotique. Arch. Gen. Med. 11: 5-25.

DUX, L., AND A. MARTONOSI. 1983. Membrane crystals of calcium-ATPase in sarcoplasmic reticulum of normal and dystrophic muscle. Muscle & Nerve 6: 568-573.

EBASHI, S., Y. TOYOKURA, H. MOMOI, AND H. SUGITA. 1959. High creatine phosphokinase activity of sera of progressive muscular dystrophy patients. J. Biochem. 46: 103.

ECKSTEIN, T.B., W.R. RANDALL, AND M.G. MCNAMEE. 1979. Erythrocyte plasma membrane fluidity in avian muscular dystrophy. Exp. Neurol. 64: 315-326.

EMERY, A.F.H., AND D. BURT. 1980. Intracellular calcium and pathogenesis and antenatal diagnosis of Duchenne muscular dystrophy. Brit. Med. J. 280: 355-356.

ENDO, M. 1977. Calcium release from the sarcoplasmic reticulum. Physiol. Rev. 57: 71-108.

ENGEL, W.K., AND E.C. DERRER. 1975. Drugs blocking the muscle damaging effects of 5-HT and noradrenaline in aorta-ligatured rats. Nature 254: 151-152.

ENTRIKIN, R.K., G.T. PATTERSON, J.A. MOURITSON, AND B.W. WILSON. 1983. Water deprivation: beneficial effect on muscular dystrophy in chickens. Exp. Neurol. 79: 746-752.

ENTRIKIN, R.K., G.T. PATTERSON, P.M. WEIDOFF, AND B.W. WILSON. 1978. Righting ability and skeletal muscle properties of phenytoin treated dystrophic chickens. Exp. Neurol. 61: 650-663.

ENTRIKIN, R.K., G.T. PATTERSON, AND B.W. WILSON. 1981. Baclofen, procainamide, verapamil and phenylamine in hereditary muscular dystrophy of the chicken. Exp. Neurol. 72: 82-90.

ERB, W.H. 1884. "Über die "juvenile Form" der progressiven Muskelatrophie Ihre beziehungen" zur sogenannten Pseudohypertrophie der Muskeln. Deutsche's Archiv für Klinische Medicin 34: 466-519.

ETIENNE, E.M., AND R.H. SINGER. 1978. Calcium binding, ATP-dependent calcium transport and total tissue calcium in embryonic and adult avian dystrophic pectoralis. J. Memb. Biol. 44: 195-210.

EUSEBI, F. AND M. MOLINARO. 1984. Acetylcholine sensitivity in replicating satellite cells. Muscle & Nerve 7: 488-492.

FARRELL, P.M., E.L. EYERMAN, AND L.L. TUREN. 1966. Comparison of plasma creatine phosphokinase changes in nutritional and genetic muscular dystrophy in the chicken. Ann. N.Y. Acad. Sci. 138: 102-111.

FEASBY, T.E., AND W.F. BROWN. 1974. Variation of motor unit size in the human extensor digitorum brevis and thenar muscles. J. Neurol. Neurosurg. Psychiat. 37: 916-926.

FELT, H., M. STAUFER, R. DOMKE, AND J.W. SHAY. 1982. Fragmentation analysis of normal and dystrophic avian muscle. Muscle & Nerve 5: 373-381.

FENG, T.P., H.W. YANG, AND W.Y. WU. 1963. The contractile trophic changes of the anterior and posterior latissimus dorsi of the chick following denervation. In E. Gutmann and P. Hnik, Eds., Effects of Use and Disuse on Neuromuscular Functions, Chech. Acad. Sci. Pub. House, Prague.

FIDZIANSKA, A., H.H. GOBEL, R. KOSSWIG, AND U. BURCK. 1984. Killer cells in Duchenne disease - ultrastructural study. Neurol. 34: 295-303.

FISCHBECK, K.H., E. BONILLA, AND D.L. SCHOTLAND. 1983. Freeze fracture analysis of plasma membrane cholesterol in Duchenne muscular dystrophy muscle. Ann. Neurol. 13: 532-535.

FITZSIMONS, R.B., AND J.F.Y. HOH. 1981. Embryonic and foetal myosins in human skeletal muscle. The presence of foetal myosins in Duchenne muscular dystrophy and infantile spinal atrophy. J. Neurol. Sci. 52: 367-384.

FLORENDO, J.A., J.R. REGER, AND P.K. LAW. 1983. Electrophysiologic differences between mouse EDL and soleus. Exp. Neurol. 82: 404-412.

FRAMBROUGH, D.M. 1970. Acetylcholine sensitivity of muscle fibre membranes: mechanism of regulation by motoneurons. Science 168: 372-373.

FRANK, G.B. 1980. The current view of the source of trigger calcium in excitation-contraction coupling in vertebrate skeletal muscle. Biochem. Pharmacol. 29: 2399-2406.

FRANKENY, M.A., R.G. HOLLY, AND C.R. ASHMORE. 1983. Effect of graded duration stretch on normal and dystrophic skeletal muscle. Muscle & Nerve 6: 269-277.

FROSTHOLM, A., M. BAUDRY, AND W.F. BENNETT. 1981. Increased calcium accumulation by brain mitochondria in dystrophic mice. Brain Res. 210: 437-441.

GOFFART, M. AND J. RITCHIE. 1952. The effect of adrenalin on the contraction of mammalian skeletal muscle. J. Physiol. 116: 357-371.

GOWERS, W.R. 1902. On myopathy and a distal form. Brit. Med. J. ii: 89-92.

GUNTHER, J.S., AND M.S. LETINSKY. 1982. A preparation for studying dystrophic avian muscle and neuromuscular junctions. Muscle Nerve 5: 7-13.

GUTMANN, E. AND A. SANDOW. 1965. Caffeine-induced contracture and potentiation of contraction in normal and denervated muscle. Life Sci. 4: 1149-1156.

GUTMANN, E., S. SCHIAFFINO, AND V. HANZLIKOVA. 1971. Mechanism of compensatory hypertrophy in skeletal muscle of the rat. Exp. Neurol. 31: 451-464.

HADDY, F.J. 1983. Potassium effect on contraction in arterial smooth muscle mediated by  $\text{Na}^+\text{-K}^+$  ATPase. Fed. Proc. 42: 239-245.

HANDLER, A.H., A.B. RUSSFIELD, AND F. HOMBURGER. 1975. Tongue lesion specificity for diagnosis of myopathy in inbred Syrian hamsters. Proc. Soc. Exp. Biol. Med. 148: 573-577.

HANNA, S., R. KAWAMOTO, M. MCNAMEE, AND R.J. BASKIN. 1981. Enzymatic activity of dystrophic chicken sarcoplasmic reticulum. Biochem. Biophys. Acta. 643: 41-54.

HARPER, P.S. 1979. Pages 139-149 in Myotonic Dystrophy, Saunders, London..

HARRIS, J.B. AND R. RIBCHESTER. 1979. The relationship between end plate size and transmitter release in normal and dystrophic muscles of the mouse. J. Physiol. 297: 245-265.

HARRIS, J.B., AND C.R. SLATER. 1980. Animal models: what is their relevance to the pathogenesis of human muscular dystrophy. Brit. Med. Bull. 36: 193-197.

HATHAWAY, P.W., W.K. ENGEL, AND H. ZELLWEGER. 1970. Experimental myopathy after microarterial embolization. Arch. Neurol. 22: 365-377.

HIRONAKA, T., AND Y. MIYATA. 1975. Transplantation of skeletal muscle in normal and dystrophic mice. Exp. Neurol. 47: 1-15.

HIRONAKA, T., Y. IKARI, Y. MIYATA, S. MORIMOTO, AND A. TSUNOO. 1984a. Transplantation of the extensor carpi radialis longus muscle in normal and dystrophic chickens. Exp. Neurol. 83: 392-402.

HIRONAKA, T., Y. IKARI, AND Y. MIYATA. 1984b. Development and growth of ECRL muscles in normal and dystrophic chickens. Exp. Neurol. 83: 378-391.

HODGKIN, A.L. AND P. HOROWICZ. 1960. Potassium contractures in single muscle fibers. J. Physiol. 153: 386-403.

HOEKMAN, T.B. 1976. Isometric contractile properties of the posterior latissimus dorsi muscle in normal and genetically dystrophic chickens. Exp. Neurol. 53: 729-743.

HOEKMAN, T.B., V.J. UMANEE, S.E. HOWLETT, AND P.A. REDFERN. 1980. A comparison of contractures of a fast twitch muscle in normal and dystrophic chickens following close intra-arterial injection of depolarizing drugs. The Pharmacologist 22: 180.

HOFMANN, W.W. 1980. Mechanisms of muscle hypertrophy. J. Neurol. Sci. 45: 206-216.

HOLLIDAY, T.A., J.R. VAN METER, L.M. JULIAN, AND V.S. ASMUNDSON. 1965. Electromyography of chickens with inherited muscular dystrophy. Am. J. Physiol. 209: 871-876.

HOMBURGER, F. 1979. Myopathy of hamster dystrophy: history and morphological aspects. Ann. N.Y. Acad. Sci. 317: 2-17.

HOMBURGER, F., J.R. BAKER, C.W. NIXON, AND R. WHITNEY. 1962. Primary generalized polymyopathy and cardiac necrosis in an inbred line of Syrian hamsters. Med. Exp. 6: 339-345.

HOMBURGER, F., C.W. NIXON, M. EPPENBURGER, AND J.R. BAKER. 1966. Hereditary cardiomyopathy in the Syrian hamster: studies on pathogenesis. Ann. N.Y. Acad. Sci. 138: 14-27.

HOOKER, C.S., P.J. CALKINS, AND J.H. FLEISCH. 1977. On the measurement of vascular and respiratory smooth muscle responses in vitro. Blood Vessels 14: 1-12.

HOWLETT, S.E. 1982. The Mechanical and Histochemical Characteristics of an In Vivo Nerve-Muscle Preparation of Normal and Dystrophic Avian Muscle: Effects of Sex, Disease and Age, M.Sc. dissertation, Memorial University of Newfoundland, St. John's, Nfld.

HOWLETT, S.E., AND T.B. HOEKMAN. 1981. An in vivo electrophysiologic study of the indirectly-elicited action potential in dantrolene sodium-attenuated extensor digitorum communis muscles of normal and dystrophic chickens. The Pharmacologist 23: 143.

HOWLETT, S.E., AND T.B. HOEKMAN. 1983a. Sex differences in the phenotypic expression of avian dystrophy. Exp. Neurol. 81: 50-63.

HOWLETT, S.E., AND T.B. HOEKMAN. 1983b. Neural regulation of dystrophic avian muscle. The 12th Annual Meeting of the Society for Neuroscience. Abstract #273.7.

HOWLETT, S.E., P.A. REDFERN, V.J. UMANEE, AND T.B. HOEKMAN. 1980. A new nerve-muscle preparation for the study of pharmacologic responses in dystrophic chickens. The Pharmacologist 22: 180.

HSU, Q., AND G. KALDOR. 1971. Studies on the lipid composition of the fragmented sarcoplasmic reticulum of normal and dystrophic chickens. Prog. Soc. Biol. Med. 138: 733-737.

HUDECKI, M.S., C.M. POLLINA, A.K. BHARGAVA, AND R.S. HUDECKI. 1980. Screening of antiserotonergic drugs with genetically dystrophic chickens. Arch. Neurol. 37: 545-550.

HUDECKI, M.S., C.M. POLLINA, AND R.R. HEFFNER. 1984. In vivo effect of three calcium blockers in chickens with inherited muscular dystrophy. Exp. Neurol. 84: 512-523.

HUNTER, E.G., AND J. ELBRINK. 1983. Increased contractility in vascular smooth muscle of dystrophic hamsters. Can. J. Physiol. Pharmacol. 61: 182-185.

HUTCHINSON, J. 1879. On ophthalmoplegia externa, or symmetrical paralysis of the ocular muscles. Lancet i: 229.

JASMIN, G., AND L. PROSCHEK. 1982. Hereditary cardiomyopathy in the Syrian hamster I. Progression of heart and skeletal muscle lesions in the UM-X7.1 line. Muscle Nerve 5: 20-25.

JEDRZEJCZYK, J., J. WIECKOWSKI, T. RYMASZEWSKA, AND E.A. BARNARD. 1973. Dystrophic chicken muscle: altered synaptic acetylcholinesterase. Science 180: 406-408.

JOHNSON, D.D., S. BAILEY, AND B.S. WENGER. 1981. Trophic action of sheep sciatic nerve extracts on skeletal muscle cultures from normal and dystrophic chick embryos: failure of dystrophic muscle to respond. Exp. Neurol. 73: 421-429.

JOHNSON, R.M. 1984. Membrane protein phosphorylation in the intact erythrocytes of genetically dystrophic hamsters. Muscle & Nerve 7: 369-373.

JONES, G., AND J. WITKOWSKI. 1983. Membrane abnormalities in Duchenne muscular dystrophy. J. Neurol. Sci. 58: 159-174.

JULIAN, L.M., AND V.S. ASMUNDSON. 1963. Muscular Dystrophy of the Chicken. Pages 458-497 in G.H. Bourne & N.S. Golarz, Eds., Muscular Dystrophy in Man and Animals, Karger, N.Y.

KAR, N.C., AND C.M. PEARSON. 1978. Muscular dystrophy and activity of proteinases. Muscle Nerve 1: 308-313.

KARPATI, G., M. ARMANI, S. CARPENTER, AND S. PRESCOTT. 1983a. Reinnervation is followed by necrosis in previously denervated skeletal muscles of dystrophic hamsters. Exp. Neurol. 82: 404-412.

KARPATI, G., S. CARPENTER, AND S. PRESCOTT. 1982. Prevention of skeletal muscle necrosis in hamster dystrophy. Muscle & Nerve 5: 369-372.

KARPATI, G., P. JACOB, S. CARPENTER, AND S. PRESCOTT. 1983b. Hypophysectomy-induced growth retardation mitigates the prevalence of skeletal muscle fibre necrosis in genetically dystrophic hamsters. Soc. for Neurosci. Annual Meeting, Nov. 1983. Abstract # 172.10.

KAWAMOTO, R.M., AND R.J. BASKIN. 1983. Calcium transport, ATPase activity and lipid composition in sarcoplasmic reticulum isolated from isogenic lines of normal and dystrophic chickens. Biochem. Biophys. Acta 732: 620-626.

KERR, L.M., AND N. SPERELAKIS. 1983. Calcium-dependent slow action potentials in normal and dystrophic mouse skeletal muscle. Am. J. Physiol. 245: C415-422.

KESTER, M., AND C.A. PRIVITERA. 1984. An elevated content of a unique lipid in dystrophic chicken myoblast membranes. J. Exp. Zool. 230: 159-164.

KIDD, P.M., AND T. YASUMURA. 1982. T-system abnormalities in differentiating skeletal muscle fibres of dystrophic chicken. Muscle & Nerve 5: 471-478.

KNIGHT, A., AND D.D. MCGREGOR. 1974. Development of vascular smooth muscle reactivity in chickens: response of mesenteric and hind-limb blood vessels to noradrenalin and acetylcholine. Blood Vessels 11: 212-228.

KOBAYASHI, T., H. TSUKAGOSHI, AND Y. SHIMIZU. 1982. Trophic effects of sympathetic ganglia on normal and dystrophic skeletal muscles in tissue culture. Exp. Neurol. 77: 241-253.



KOMIYA, Y., AND L. AUSTIN. 1974. Axoplasmic flow of protein in the sciatic nerve of normal and dystrophic mice. Exp. Neurol. 43: 1-12.

KORENAGA, S. 1980. Electrical properties of muscle membranes and of neuromuscular junction in normal and dystrophic chickens. Jpn. J. Physiol. 30: 313-331.

KOSK-KOSICKA, D., D. SCALES, M. KURZMACK, AND G. INESI. 1982. A serial study of muscle microsomes during the early growth of genetically dystrophic chickens. Biochem. Biophys. Acta 691: 193-200.

KUHN, D.E., AND D.M. LOGAN. 1983. Aspects of hepatic cholesterol metabolism in normal and dystrophic chicken embryos. Can. J. Biochem. Cell Biol. 61: 378-386.

KUNDU, S.K., L.K. MISRA, AND M.G. LUTHRA. 1982. Muscle glycolipids in inherited muscular dystrophy of chickens. FEBS Letters 150: 359-364.

LAIRD, J.L., AND R.F. TIMMER. 1965. Homotransplantation of dystrophic and normal muscle. Arch. Pathol. 80: 442-446.

LAW, P.K. 1977. Myotrophic influence on motoneurons of normal and dystrophic mice in parabiosis. Exp. Neurol. 54: 444-452.

LAW, P.K. 1982. Beneficial effects of transplanting normal limb bud mesenchyme into dystrophic mouse muscles. Muscle & Nerve 5: 619-627.

LAW, P.K., E. COSMOS, J. BUTLER, AND A.J. MCCOMAS. 1976. The absence of dystrophic characteristics in normal muscles successfully cross-reinnervated by nerves of dystrophic genotype: physiological and cytochemical study of crossed solei of normal and dystrophic parabiotic mice. Exp. Neurol. 51: 1-21.

LAW, P., A. SAITO, AND S. FLEISCHER. 1983. Ultrastructural changes in muscle and motor end plate of the dystrophic mouse. Exp. Neurol. 80: 361-382.

LAW, P.K., AND J.L. YAP. 1979. New muscle transplant method produces normal tension in dystrophic muscle. Muscle & Nerve 2: 356-363.

LEBEDA, F.J., AND E.X. ALBUQUERQUE. 1975. Membrane cable properties of normal and dystrophic chicken muscle fibres. Exp. Neurol. 47: 544-557.

LEE, Y.B., C.R. ASHMORE, AND L. HITCHCOCK. 1984. Effect of stretch and denervation on protease activity of normal and dystrophic chicken muscle. Exp. Neurol. 84: 420-427.

LEINONEN, H., J. JUNTUNEN, H. SOMER, AND J. RAPOLA. 1979. Capillary circulation and morphology in Duchenne muscular dystrophy. Eur. Neurol. 18: 249-255.

LEONARD, J.P., AND M.M. SALPETER. 1982. Calcium mediated myopathy at the neuromuscular junction of normal and dystrophic muscle. Exp. Neurol. 76: 121-138.

LEWIS, D.M. 1972. The effect of denervation on the mechanical and electrical responses of fast and slow mammalian twitch muscle. J. Physiol. 222: 51-75.

LEYDEN, E. 1876. Page 531 in Klinik der Rückenmarks-Krankheiten, Vol. 2, Hirschwald, Berlin.

LIBELIUS, R., I. JIRMANOVA, I. LUNDQUIST, AND S. THESLEFF. 1978. Increased endocytosis with lysosomal activity in skeletal muscle of dystrophic mouse. Exp. Neurol. 37: 387-400.

LIBELIUS, R., I. JIRMANOVA, I. LUNDQUIST, S. THESLEFF, AND E. BARNARD. 1979. T-tubule endocytosis in dystrophic chicken muscle and its relation to muscle fibre degeneration. Acta Neuropath. 48: 31-38.

LINDENBAUM, M.H. AND B.G. LIVETT. 1983. Acetylcholinesterase molecular forms in C57BL/6J dystrophic mice. Muscle Nerve 6: 638-645.

LINKHART, T.A., G.W. YEE, P.S. NIEBERG, AND B.W. WILSON. 1976. Myogenic defect in muscular dystrophy of the chicken. Develop. Biol. 48: 447-457.

LINKHART, T.A., G.W. YEE, AND B.W. WILSON. 1975. Myogenic defect in acetylcholinesterase regulation in muscular dystrophy of the chicken. Science 187: 549-557.

LIU, P.K.S., E.A. BARNARD, AND P.J. BARNARD. 1980. Blood plasma pyruvate kinase as a marker of muscular dystrophy. Exp. Neurol. 67: 581-600.

LORKOVIC, H. 1983. Postassium contractures in mouse limb muscles. J. Physiol. 343: 569-576.

LUCY, J.A. 1980. Is there a membrane defect in muscle and other cells? Brit. Med. Bull. 36: 187-192.

LUTHERT, P., G. VRBOVA, AND K.M. WARD. 1980. Effect of slow frequency electrical stimulation on muscles of dystrophic mice. J. Neurol. Neurosurg. Psychiat. 43: 803-809.

LUTTGAU, H.C., AND H. OETLIKER. 1968. The action of caffeine on the activation of the contractile mechanism in striated muscle. J. Physiol. 194: 57-74.

LYLES, J.M., E.A. BARNARD, AND I. SILMAN. 1980. Changes in the levels and forms of cholinesterases in the blood plasma of normal and dystrophic chickens. J. Neurochem. 34: 978-987.

MABRY, M.E., AND A.D. ROSES. 1981. Increased [32P]-phosphorylation of tryptic peptides of erythrocyte spectrin in Duchenne muscular dystrophy. Muscle & Nerve 4: 489-493.

MADDEN, T.D., D. CHAPMAN, AND P.J. QUINN. 1979. Cholesterol modulates activity of calcium-dependent ATPase of the sarcoplasmic reticulum. Nature 279: 538-541.

MALOUF, N.N., AND J.R. SOMMER. 1976. Chicken dystrophy - the geometry of the t-tubules. Am. J. Pathol. 84: 299-318.

MARTIN, F.C., G. SLAVIN, AND A.J. LEVI. 1982. Alcoholic muscle disease. Brit. Med. Bull. 38: 53-56.

MCARDLE, J.J. 1983. Molecular aspects of the trophic influence of the nerve on muscle. Prog. Neurobiol. 21: 135-198.

MCCOMAS, A.J., R.E.P. SICA, AND M.J. CAMPBELL. 1971. 'Sick' motoneurons: a unifying concept of muscle disease. Lancet i: 321-325.

MCCOMAS, A.J., R.E.P. SICA, AND S. CURRIE. 1970. Muscular dystrophy: evidence for a neural factor. Nature 226: 1263.

MECHLER, F., AND F.L. MASTAGLIA. 1981. Vascular adrenergic receptor response in skeletal muscle in myotonic dystrophy. Ann. Neurol. 9: 157-163.

MECHLER, F., F.L. MASTAGLIA, J. HAGGITH, AND D. GARDNER-MEDWIN. 1980. Adrenergic receptor response of vascular smooth muscle in Becker dystrophy. J. Neurol. Sci. 46: 291-302.

MEIER, H., AND J.L. SOUTHARD. 1970. Muscular dystrophy in the mouse caused by an allele at the dy locus. Life Sci. 9: 137.

MENDELL, J.R., D.L. MURPHY, AND W.K. ENGEL. 1972. Catecholamines and indolamines in patients with Duchenne muscular dystrophy. Arch. Neurol. 27: 518-520.

MERICKEL, M., R. GRAY, P. CHAUVIN, AND S. APPEL. 1981. Cultured muscle from myotonic muscular dystrophy patients: altered membrane electrical properties. Proc. Nat. Acad. Sci. Biol. Sci. 78: 648-653.

MERYON, E. 1852. On granular and fatty degeneration of the voluntary muscles. Medico-chirurgical trans. 35: 73-84.

MICHELSON, A.M., E.S. RUSSELL, AND P.J. HARMAN. 1955. Dystrophia muscularis: a hereditary primary myopathy in the mouse. Proc. Nat. Acad. Sci. 41: 1079-1084.

MIKE, T. 1983. Maturational defect of regenerating muscle fibres in cases with Duchenne and congenital muscular dystrophies. Muscle & Nerve 6: 545-552.

MISRA, L.K., N.K.R. SMITH, D.C. CHANG, R.L. SPARKS, L.L. CAMERON, P.T. BEALL, R. HARRIST, B.L. NICHOLS, R.C. FANGUY, AND C.F. HAZLEWOOD. 1980. Intracellular concentration of elements in normal and dystrophic skeletal muscles of the chicken. J. Cell. Physiol. 103: 193-200.

MOKRI, B., AND A.G. ENGEL. 1975. Duchenne dystrophy: EM findings pointing to a basic defect or early abnormality in the plasma membrane of the muscle fibre. Neurol. 25: 1111-1120.

MORGAN, K.B., AND S.H. BRYANT. 1977. The mechanism of action of dantrolene sodium. JPET 201: 138-147.

MOXLEY, R., R. GRIGGS, AND D. GOLDBLATT. 1980. Muscle insulin resistance in myotonic dystrophy-effect of supraphysiologic insulinization. Neurol. 30: 1077-1083.

MRAK, R.E., AND S. FLEISCHER. 1982. Normal function in SR from mice with muscular dystrophy. Muscle & Nerve 5: 143-151.

MUNSAT, T.L., R. BALOH, C.M. PEARSON, AND W. FOWLER. 1973. Serum enzyme alterations in neuromuscular disorders. JAMA 226: 1536-1543.

MUNSAT, T.L., P. HUDGSON, AND M. JOHNSON. 1977. Experimental serotonin myopathy. Neurol. 27: 772-782.

MURPHY, B.J. 1982. Motorneuron formation in the brachial spinal cord of the dystrophic chick embryo. Exp. Cell Biol. 50: 181-186.

NEERUNJUN, J.S., AND V. DUBOWITZ. 1979. Increased calcium-activated neutral protease activity in muscles of dystrophic hamsters and mice. J. Neurol. Sci. 40: 105-111.

NICHOLSON, G.A., J.G. MCLEOD, AND J.W. SUGARS. 1984. A study of platelet protein phosphorylation in Duchenne muscular dystrophy-further evidence against the membrane defect theory. J. Neurol. Sci. 64: 21-32.

NONAKA, I., AND H. SUGITA. 1981. Intracytoplasmic vacuoles in alpha white fibres of dystrophic chicken muscle - probable early event initiates massive fibre necrosis. Acta Neuropathol. 55: 173-181.

NOWAK, T.V., S. ANURAS, B.P. BROWN, V. IONASESCU, AND J.B. GREEN. 1984. Small intestinal motility in myotonic dystrophy patients. Gastroenterology 86: 808-813.

NOWAK, T.V., V. IONASESCU, AND S. ANURAS. 1982. Gastrointestinal manifestations of the muscular dystrophies. Gastroenterology 82: 800-810.

NYELEN, E.G., AND K. WROGEMANN. 1983. Mitochondrial calcium content and oxidative phosphorylation in heart and skeletal muscle of dystrophic mice. Exp. Neurol. 80: 69-80.

OGG, E. 1971. Milestones in Muscle Research, Muscular Dystrophy Association of America Inc., N.Y.

OLDFIELD, E., AND D. CHAPMAN. 1972. Dynamics of lipids in membranes: heterogeneity and the role of cholesterol. FEBS Lett. 23: 285-297.

OPPENHEIM, R.W., L.L. ROSE, AND B.T. STOKES. 1982. Cell death of motoneuron in chick embryo spinal cord VII: the survival of brachial motoneurons in dystrophic chickens. Exp. Neurol. 78: 112-120.

PARKER, J.M., AND J.R. MENDELL. 1974. Proximal myopathy induced by serotonin-imipramine stimulates Duchenne dystrophy. Nature 247: 103-104.

PARRY, D.J., AND G. DESYPRIS. 1983. Slowing of the twitch of dystrophic mouse muscle is partially due to altered activity pattern. Muscle Nerve 6: 397-407.

PARRY, D.J., G.W. MAINWOOD, AND T. CHAN. 1977. The relationship between surface potentials and the number of active motor units. J. Neurol. Sci. 33: 283-296.

PARRY, D.J., S. MCHANWELL, AND N. HAAS. 1982. The number and size of motoneurons in the soleus motor nucleus of the normal and dystrophic (C57 BL/6J dy2j/dy2j) mouse. Exp. Neurol. 75: 743-754.

PATTERSON, G.T., AND B.W. WILSON. 1976. Distribution of extrajunctional acetylcholinesterase in muscle from normal and dystrophic chickens. Exp. Neurol. 50: 214-225.

PEARCE, P.H., R.D. JOHNSEN, S.J. WYSOCKI, AND B.A. KAKULAS. 1981. Muscle lipids in Duchenne muscular dystrophy. Aust. J. Exp. Biol. Med. Sci. 59: 77-91.

PEARCE, P.H., AND B.A. KAKULAS. 1980. Skeletal muscle lipids in normal and dystrophic mice. Aust. J. Exp. Biol. Med. Sci. 58: 397-408.

PELLAGRINO, C., AND C. FRANZINI. 1963. An electron microscopic study of denervation atrophy in red and white skeletal muscle fibres. J. Cell Biol. 17: 327-349.

PESTRONK, A., I.M. PARHAD, D.B. DRACHMAN, AND D.L. PRICE. 1982. Membrane myopathy: Morphological similarity to Duchenne muscular dystrophy. Muscle Nerve 5: 209-214.

PETERSON, A.C. 1974. Chimaera mouse study shows absence of disease in genetically dystrophic muscle. Nature 248: 561-564.

PETTEGREW, J., AND N.F.H. MINSHEW. 1984. <sup>31</sup>P-NMR studies of normal and dystrophic chicken muscle. Muscle Nerve 7: 442-446.

PIZZEY, J.A., AND E.A. BARNARD. 1983a. Structural change in muscles of the dystrophic chicken. I. Quantitative indices. Neuropathol. Appl. Neurobiol. 9: 21-38.

PIZZEY, J.A., AND E.A. BARNARD. 1983b. Structural change in muscles of the dystrophic chicken II. Progression of the histopathology in the pectoralis muscle. Neuropath. Appl. Neurobiol. 9: 149-164.

POLEDNA, J., AND M. MORAD. 1983. Effect of caffeine on the birefringence signal in single skeletal muscle fibres and mammalian heart. Possible mechanism of action. Pflugers Arch. 397: 184-189.

PORTER, C.W., AND E.A. BARNARD. 1976. Ultrastructural studies on the acetylcholine receptor at motor endplates of normal and pathologic muscles. Ann. N.Y. Acad. Sci. 274: 85-107.

PROSCHEK, L., AND G. JASMIN. 1982. Hereditary polyomyopathy and cardiomyopathy in the Syrian hamster II. Development of heart necrotic changes in relation to defective mitochondrial function. Muscle Nerve 5: 26-32.

PRUZANSKI, W., AND A.G. HUVOS. 1967. Smooth muscle involvement in primary muscle lesions. I. Myotonic dystrophy. Arch. Pathol. 83: 229-233.

PRYSE-PHILLIPS, W., G.J. JOHNSON, AND B. LARSEN. 1982. Incomplete manifestation of myotonic dystrophy in a large kinship in Labrador. Ann. Neurol. 11: 582-591.

RATHBONE, M.P., P.A. STEWART, AND F. VETRANO. 1975. Dystrophic spinal cord transplants induce abnormal thymidine kinase activity in normal muscles. Science 189: 1106-1107.

REDFERN, P. AND S. THESLEFF. 1971. Action potential generation in denervated rat skeletal muscle I. Quantitative aspects. Acta Physiol. Scand. 81: 557-564.

REICHMANN, H., AND D. PETTE. 1984. Enzyme activity and activity profiles in muscle fibres of dystrophic, immature normal and adult normal BL6 mice. Muscle Nerve 7: 121-126.

RITCHIE, J.M. AND R.W. STRAUB. 1957. The hyperpolarization which follows activity in mammalian non-medullated fibres. J. Physiol. 136: 80-97.

RODAN, S.B., R.L. HINTZ, R.I. SHA'AFI, AND G.A. RODAN. 1974. The activity of membrane bound enzymes in muscular dystrophic chickens. Nature 252: 589-591.

ROMERO-HERRERA, A.E., AND N.G. LIESKA. 1982. Tropomyosin and troponin C from human fetal, adult and dystrophic skeletal muscle. Muscle Nerve 5: 707-712.

ROSES, A.D., AND S.H. APPEL. 1973. Protein kinase activity in erythrocyte ghosts of patients with myotonic muscular dystrophy. Proc. Nat. Acad. Sci. 70: 1855-1859.

ROTHMAN, S.M., AND R. BISCHOFF. 1983. Electrophysiology of Duchenne dystrophy myotubes in tissue culture. Ann. Neurol. 13: 176-179.

RÓWLAND, L.P. 1980. Biochemistry of muscle membranes in Duchenne muscular dystrophy. Muscle & Nerve 3: 3-20.

ROWLAND, L.P., R.B. LAYZER, AND L.J. KAGEN. 1968. Lack of some muscle proteins in serum of patients with Duchenne dystrophy. Arch. Neurol. 18: 273-276.

RUSHBROOK, J., A.I. YUAN, AND A. STRATCHER. 1982. Two major allelic forms of myosin light chain-1 in strains of normal and dystrophic chickens. Muscle Nerve 5: 505-574.

SAITO, K., H. OHKURA, T. KASHIMA, H. KATANASAKO, AND H. TANAKA. 1982. An electrophysiologic study on the myocardium of dystrophic mice. Experientia 38: 359-360.

SALAFSKY, B. 1971. Functional studies of regenerated muscles from normal and dystrophic mice. Nature 229: 270-272.

SALMINEN, A., AND V. VIHKO. 1983. Susceptibility of mouse skeletal muscles to exercise injuries. Muscle & Nerve 6: 596-601.

SANDOW, A. 1965. Excitation-contraction coupling in skeletal muscle. Pharmacol. Rev. 17: 625.

SANDOW, A., S.R. TAYLOR, K. ISAACSON, AND J.J. SEGUIN. 1964. Electromechanical coupling in potentiation of muscle contraction. Science 143: 577-579.

SANDOW, A., S.R. TAYLOR, AND H. PREISER. 1965. Role of the action potential in excitation-contraction coupling. Fed. Proc. 24: 1116-1123.

SCALES, D.J., AND R.A. SABBADINI. 1979. Microsomal t-system: A stereological analysis of purified microsomes derived from normal and dystrophic skeletal muscle. Cell Biol. 83: 33-46.

SCHAPIRA, G., J.C. DREYFRUS, AND F. SHAPIRA. 1953. L'elevation du taux de l'aldolase serique: test biochemique de myopathies. Sem. Hosp. Paris 29: 1917-1921.

SCHOLTE, H.R., AND H.F.M. BUSCH. 1980. Early changes of muscle mitochondria in Duchenne muscular dystrophy. Partition and activity of mitochondrial enzymes in fractionated muscles of unaffected boys and adults and patients. J. Neurol. Sci. 45: 217-234.

SELLIN, L.C., AND N. SPERELAKIS. 1978. Decreased potassium permeability in dystrophic mouse skeletal muscle. Exp. Neurol. 62: 605-617.



SHA'AFI, R.I., S.B. RODAN, R.L. HINTZ, S.M. FERNANDEZ, AND G.A. RODAN. 1975. Abnormalities in membrane microviscosity and ion transport in genetic muscular dystrophy. Nature 254: 525-526.

SHIVERS, R.R., AND B.G. ATKINSON. 1984. The dystrophic murine skeletal muscle cell plasma membrane is structurally intact but "leaky" to creatine phosphokinase: A freeze fracture analysis. Am. J. Pathol. 116: 482-497.

SHOTTON, D.M. 1982. Quantitative freeze-fracture electron microscopy of dystrophic muscle membranes. J. Neurol. Sci. 57: 161-190.

SIBLEY, J.A., AND A.L. LEHNINGER. 1949. Aldolase in the serum and tissues of tumor-bearing animals. J. Nat. Cancer Instit. 9: 303-309.

SILVERMAN, H., AND H.L. ATWOOD. 1980a. Increase in oxidative capacity of muscle fibres in dystrophic mice and correlation with overactivity in these fibres. Exp. Neurol. 68: 97-113.

SILVERMAN, H., AND H.L. ATWOOD. 1980b. Surface density of t-tubules in normal and dystrophic mouse muscles. Exp. Neurol. 70: 40-46.

SKAU, K.A. AND S. BRIMIJOIN. 1981. Abnormal distribution of skeletal muscle acetylcholinesterase molecular forms in dystrophic mice. Exp. Neurol. 74: 111-121.

SLACK, B.E., R.J. BOEGMAN, J.W. DOWNIE, AND G. JASMIN. 1980. Cardiac membrane cholesterol in dystrophic and verapamil-treated hamsters. J. Mol. Cell Card. 12: 179-185.

STAMP, W.G., AND P.A. LESKER. 1967. Enzyme studies related to sex differences in mice with hereditary muscular dystrophy. Am. J. Physiol. 213: 587-591.

STEINERT, H. 1909. Myopathologische Beiträge: I. Über das klinische und anatomische Bild des Muskelschwunds der Myotoniker. Deutsche Zeitschrift für Nervenheilkunde 37: 38-104.

STEWART, P.A., E.S. WERSTIUK, J.D. VICKERS, AND M.P. RATHBONE. 1977. Elevated cholesterol in tissues of chicken embryos with hereditary myotonic muscular dystrophy. Exp. Neurol. 57: 475-485.

STOKES, B.T. 1977. Multiunit activity pattern in the brachial spinal cord of dystrophic chick embryos. Exp. Neurol. 56: 179-188.

STRATCHER, A., E.B. MCGOWAN, A. HEDRYCH, AND S.A. SHAFIQ. 1979. In vivo effect of protease inhibitor in denervation atrophy. Exp. Neurol. 66: 611-618.

STROMSKA, D., S. OCHS, AND J. MULLER. 1981. Rate of axoplasmic transport in the dystrophic chicken. Exp. Neurol. 74: 530-547.

SU, J.Y., AND W. HASSELBACH. 1984. Caffeine-induced calcium release from isolated sarcoplasmic reticulum of rabbit skeletal muscle. Pflugers Arch. 400: 14-21.

SULLIVAN, G.E. 1962. Anatomy and embryology of the wing musculature of the domestic fowl (Gallus). Aust. J. Zool. 10: 458-518.

SUMNICHT, G.E., AND P.A. SABBADINI. 1982. Lipid composition of transverse tubule membrane from skeletal muscle. Arch. Biochem. Biophys. 215: 628-637.

SUSHEELA, A.K., M. SERAYDARIAN, AND B.C. ABBOTT. 1980. Increased alpha-motor neurons in chicks afflicted with muscular dystrophy. Exp. Neurol. 67: 453-458.

TAHMOUSH, A.J., V. ASKANSAS, P.G. NELSON, AND W.K. ENGEL. 1983. Electrophysiologic properties of a neurally cultured muscle from patients with myotonic muscle atrophy. Neurol. 33: 311-316.

TAKAGI, A., S. ISHIURA, I. NONAKA, AND H. SUGITA. 1982. Myosin light chain components in single muscle fibres of Duchenne muscular dystrophy. Muscle Nerve 5: 399-404.

TALLARIDA, R.J., AND L.S. JACOB. 1979. The Dose-Response Relation in Pharmacology, Springer-Verlag, N.Y.

TALLARIDA, R.J., AND R.B. MURRAY. 1981. Manual of Pharmacologic Calculations with Computer Programs, Springer-Verlag, N.Y.

TYLER, K.L., AND L.C. MCHENRY. 1983. Pseudohypertrophic muscular dystrophy and Gower's sign. Neurol. 33: 88-89.

UONO, M., M. BEPPU, F. NAKAJMA, AND F.H.H. NISHIYAMA. 1980. Concanavalin A binding on erythrocytes in Duchenne muscular dystrophy. Pages 72-73 in K. Miyoshi, Ed., Current Research in Muscular Dystrophy, Proceedings of the Annual Meeting of the Muscular Dystrophy Research Group, Tokyo.

VOLPE, P., R.E. MRAK, B. COSTELLO, AND S. FLEISCHER. 1984. Calcium release from SR of normal and dystrophic mice. Biochem. Biophys. Acta 769: 67-78.

VRBOVA, G. 1983. Hypothesis: Duchenne muscular dystrophy viewed as a disturbance of nerve-muscle interaction. Muscle & Nerve 6: 671-675.

VRBOVA, G., T. GORDON, AND R. JONES. 1978. Nerve-Muscle Interactions. Chapman & Hall, Ltd. London.

WAKAYAMA, Y., E. BONILLA, AND D.J. SCHOTLAND. 1983. Muscle plasma membrane abnormalities in infants with Duchenne muscular dystrophy. Neurol. 33: 1368-1379.

WALTON, J.N., AND D. GARDNER-MEDWIN. 1974. Progressive muscular dystrophy and the myotonic disorders. Pages 561-613 in J.N. Walton, Ed., Disorders of Voluntary Muscle, Churchill Livingstone, Edinburgh.

WARD, K., AND A.C. WAREHAM. 1984. Intracellular activity of sodium in normal and dystrophic skeletal muscle from C57BL/6J mice. Exp. Neurol. 83: 629-633.

WARNICK, J.E., F.J. LEBEDA, AND E.X. ALBUQUERQUE. 1979. Junctional and extrajunctional aspects of inherited muscular dystrophy in chickens: development and pharmacology. Ann. N.Y. Acad. Sci. 317: 263-282.

WATANABE, K., AND T. YAMASHITA. 1981. Ion permeability in the erythrocyte membrane of the dystrophic chicken measured by a fluorometric method. Jpn. J. Physiol. 31: 963-968.

WEIME, R.J., AND J.E. HERPOL. 1962. Origin of the LDH isoenzyme pattern found in the serum of patients having primary muscular dystrophy. Nature 194: 287-288.

WILKINSON, M. 1984. Abnormal gonadotrophin release from pituitaries of muscular dystrophic mice and hamsters. J. Reproduc. Fertil. 71: 463-466.

WILKINSON, M., AND I. KHAN. 1982. Beta-adrenergic but not benzodiazepine binding sites are reduced in dystrophic mouse brain. Brain Res. Bull. 8: 547-549.

WILKINSON, M., AND E. MANCHESTER. 1983. Strain differences between alpha-2 and beta adrenergic receptor binding in dystrophic mice. Brain Res. Bull. 11: 743-746.

WILSON, B.W., W.C. KAPLAN, W.C. MERHOFF, AND S.S. MORI. 1970. Innervation and the regulation of acetylcholinesterase activity during the development of normal and dystrophic chicken muscle. J. Exp. Zool. 174: 39-54.

WILSON, B.W., S.G. LINKHART, AND P.A. NIEBERG. 1973. Acetylcholinesterase in singly and multiply innervated muscles of normal and dystrophic chickens. J. Exp. Zool. 186: 187-192.

WILSON, B.W., T.A. LINKHART, C.R. WALKER, AND P.S. NIEBERG. 1973. Tissue acetylcholinesterase in plasma of chick embryos and dystrophic chickens. J. Neurol. Sci. 18: 333-350.

WILSON, B.W., W.R. RANDALL, G.T. PATTERSON, AND R.K. ENTRIKIN. 1979. Major physiologic and histochemical characteristics of inherited dystrophy of the chicken. Ann. N. Y. Acad. Sci. 317: 224-246.

WINER, B.J. 1971. Statistical Principles in Experimental Design, p. 339, 2nd ed., McGraw-Hill, N.Y.

WIRTZ, P., AND H. LOERMANS. 1983. Immobilization of dystrophic mouse muscle prevents necrosis of muscle fibres. Muscle Nerve 6: 234-235.

WROGEMANN, K., B.E. JACOBSON, AND M.C. BLANCHAER. 1973. On the mechanism of a calcium-associated defect of oxidative phosphorylation in progressive muscular dystrophy. Arch. Biochem. 159: 267-278.

WROGEMANN, K., AND S. PENA. 1976. Mitochondrial calcium overload: a general mechanism for cell necrosis in muscle diseases. Lancet i: 672-673.

YAMAMOTO, N., AND M. KASAI. 1982. Kinetics of the activity of caffeine and procaine on the calcium-gated cation channel in SR vesicles. J. Biochem. (Tokyo) 92: 477-484.

YAROM, R., S. MEYER, R. MORE, M. LIEBERGALL, AND A. ELDOR. 1983. Platelet abnormalities in muscular dystrophy. Thromb. Haemost. 49: 168-172.

YOSHIOKA, T., AND A.P. SOMLYO. 1984. Calcium and magnesium content and volume of the terminal cisternae in caffeine-treated skeletal muscle. J. Cell Biol. 99: 558-565.

ZATZ, M., R.T.B. BETTI, AND J.A. LEVY. 1981. Benign Duchenne muscular dystrophy in a patient with growth hormone deficiency. Am. J. Med. Genet. 10: 301-304.

# Neurology

Official Journal of the American Academy of Neurology

7500 OLD OAK BOULEVARD, MIDDLEBURG HEIGHTS, OHIO 44130 (216)243-8100

December 11, 1984

Susan Howlett  
Memorial University of Newfoundland  
The Health Sciences Centre  
St. John's  
Newfoundland, Canada A1B 3V6

Dear Ms. Howlett:

The permission you requested in your letter of November 30 is not required. The diagram to which you refer was first published in a book by Duchenne in 1861 -- De L'Electrisation localisée et de son application à la pathologie et à la thérapeutique.

Sincerely,

*Peter G. Studer*  
Peter G. Studer  
Editor

PGS:1b

I, WE, CSIRO, being the

copyright holder of the material described below:

Figure 1 (page 466) of the article entitled " Anatomy and  
embryology of the wing musculature of the domestic fowl (Gallus) "

Australian Journal of Zoology, Volume 10, 1962

do hereby permit the inclusion of the described material in  
the thesis/report entitled:

" Physiologic and Pharmacologic Properties of Normal and Dystrophic  
Avian Muscle "

written by Susan E. Howlett and submitted in  
partial fulfillment of the requirements for the degree of  
Doctor of Philosophy at Memorial University  
of Newfoundland.

I further permit the National Library of Canada to  
microfilm this thesis, including the material to which I retain  
copyright, and to lend or sell copies of the film.

Full acknowledgment to the source is required.

DATE:

10 January 85

SIGNATURE:

B. J. Falby

Editor-in-Chief

**CSIRO Editorial and Publications Service**

1. T.B. Hoekman, being a co-author of the material described below:

Figure 1 (page 53) of the article entitled "Sex  
differences in the phenotypic expression of avian  
dystrophy "  
Experimental Neurology, Volume 81, 1983

do hereby permit the inclusion of the described material in the thesis entitled:

" Physiologic and Pharmacologic Properties of Normal  
and Dystrophic Avian Muscle "

written by Susan E. Howlett and submitted in partial fulfillment of the requirements for the degree of Doctor of Philosophy at Memorial University of Newfoundland.

I further permit the national library of Canada to microfilm this thesis and to lend or sell copies of the film.

DATE: December 3, 1984

SIGNATURE: Theodore B. Hoekman





DEC 17 1984

MEMORIAL UNIVERSITY OF NEWFOUNDLAND

St. John's, Newfoundland, Canada A1B 3V6

Faculty of Medicine  
The Health Sciences Centre

Telex: 016-4101-  
Tel.: (709) 737-6300

Please pardon the informality  
but to speed our reply we have  
answered on your own letter.

November 30, 1984

Academic Press, Inc.  
111 5th Ave.,  
New York, N.Y.  
10003 U.S.A.

To whom it my concern,

I am writing to request permission to use a diagram, for which you hold the copyright, in the methods section of my PhD thesis. The diagram in question appeared on page 53 in Volume 81 (1983) of the journal Experimental Neurology, in a paper entitled "Sex differences in the phenotypic expression of avian dystrophy" by S.E. Howlett and T.B. Hoekman. If you are willing to grant permission please sign the enclosed form and return it to me at your earliest possible convenience.

Thank you for your attention.

Sincerely,

*Susan Howlett*  
Susan Howlett



PERMISSION GRANTED  
provided that:

you obtain the permission of the author(s);  
the material to be used has appeared in our  
publication without credit or  
acknowledgement to another source; proper  
credit is given to our publication(s) \*\*

Date 12-21-84 By Martha Strassberger

Martha Strassberger  
Rights and Permissions  
ACADEMIC PRESS

Orlando, Florida 32887

\*\*should commercial publication result, please  
contact Academic Press again.





