

AGE VALIDATION AND COMPARISON OF GROWTH RATES  
IN BEHAVIOURALLY AND GEOGRAPHICALLY DISTINCT  
POPULATIONS OF CUNNER, TAUTOGOLABRUS ADSPERSUS

CENTRE FOR NEWFOUNDLAND STUDIES

**TOTAL OF 10 PAGES ONLY  
MAY BE XEROXED**

(Without Author's Permission)

WAYNE B. CHIASSON







National Library  
of Canada

Acquisitions and  
Bibliographic Services Branch

395 Wellington Street  
Ottawa, Ontario  
K1A 0N4

Bibliothèque nationale  
du Canada

Direction des acquisitions et  
des services bibliographiques

395, rue Wellington  
Ottawa (Ontario)  
K1A 0N4

Your file    *Votre référence*

Our file    *Notre référence*

## NOTICE

The quality of this microform is heavily dependent upon the quality of the original thesis submitted for microfilming. Every effort has been made to ensure the highest quality of reproduction possible.

If pages are missing, contact the university which granted the degree.

Some pages may have indistinct print especially if the original pages were typed with a poor typewriter ribbon or if the university sent us an inferior photocopy.

Reproduction in full or in part of this microform is governed by the Canadian Copyright Act, R.S.C. 1970, c. C-30, and subsequent amendments.

## AVIS

La qualité de cette microforme dépend grandement de la qualité de la thèse soumise au microfilmage. Nous avons tout fait pour assurer une qualité supérieure de reproduction.

S'il manque des pages, veuillez communiquer avec l'université qui a conféré le grade.

La qualité d'impression de certaines pages peut laisser à désirer, surtout si les pages originales ont été dactylographiées à l'aide d'un ruban usé ou si l'université nous a fait parvenir une photocopie de qualité inférieure.

La reproduction, même partielle, de cette microforme est soumise à la Loi canadienne sur le droit d'auteur, SRC 1970, c. C-30, et ses amendements subséquents.

Age Validation and Comparison of Growth Rates in  
Behaviourally and Geographically Distinct Populations  
of Cunner, *Tautoglabrus adspersus*

by

Wayne B. Chiasson

A thesis submitted to the  
School of Graduate Studies  
in partial fulfilment of the  
requirements for the degree of  
Master of Science

Department of Biology  
Memorial University of Newfoundland

June 1995

St. John's

Newfoundland



National Library  
of Canada

Acquisitions and  
Bibliographic Services Branch

395 Wellington Street  
Ottawa, Ontario  
K1A 0N4

Bibliothèque nationale  
du Canada

Direction des acquisitions et  
des services bibliographiques

395, rue Wellington  
Ottawa (Ontario)  
K1A 0N4

*Your file* *Votre référence*

*Our file* *Notre référence*

THE AUTHOR HAS GRANTED AN  
IRREVOCABLE NON-EXCLUSIVE  
LICENCE ALLOWING THE NATIONAL  
LIBRARY OF CANADA TO  
REPRODUCE, LOAN, DISTRIBUTE OR  
SELL COPIES OF HIS/HER THESIS BY  
ANY MEANS AND IN ANY FORM OR  
FORMAT, MAKING THIS THESIS  
AVAILABLE TO INTERESTED  
PERSONS.

L'AUTEUR A ACCORDE UNE LICENCE  
IRREVOCABLE ET NON EXCLUSIVE  
PERMETTANT A LA BIBLIOTHEQUE  
NATIONALE DU CANADA DE  
REPRODUIRE, PRETER, DISTRIBUER  
OU VENDRE DES COPIES DE SA  
THESE DE QUELQUE MANIERE ET  
SOUS QUELQUE FORME QUE CE SOIT  
POUR METTRE DES EXEMPLAIRES DE  
CETTE THESE A LA DISPOSITION DES  
PERSONNE INTERESSEES.

THE AUTHOR RETAINS OWNERSHIP  
OF THE COPYRIGHT IN HIS/HER  
THESIS. NEITHER THE THESIS NOR  
SUBSTANTIAL EXTRACTS FROM IT  
MAY BE PRINTED OR OTHERWISE  
REPRODUCED WITHOUT HIS/HER  
PERMISSION.

L'AUTEUR CONSERVE LA PROPRIETE  
DU DROIT D'AUTEUR QUI PROTEGE  
SA THESE. NI LA THESE NI DES  
EXTRAITS SUBSTANTIELS DE CELLE-  
CI NE DOIVENT ETRE IMPRIMES OU  
AUTREMENT REPRODUITS SANS SON  
AUTORISATION.

ISBN 0-612-06111-6

Canada



# Memorial

University of Newfoundland

This is to authorize the Dean of Graduate Studies to deposit two copies of my thesis/report entitled

Age Validation and Comparison of Growth Rates in  
Behaviourally and Geographically Distinct Populations  
of Cunner, *Tautoglabrus adspersus*

in the University Library, on the following conditions. I understand that I may choose only ONE of the Options here listed, and may not afterwards apply for any additional restriction. I further understand that the University will not grant any restriction on the publication of thesis/report abstracts.

*(After reading the explanatory notes at the foot of this form, delete TWO of (a), (b) and (c), whichever are inapplicable.)*

The conditions of deposit are:

(a) that two copies are to be made available to users at the discretion of their custodians,

OR

(b) that access to, and quotation from, this thesis/report is to be granted only with my written permission for a period of one year from the date on which the thesis/report, after the approval of the award of a degree, is entrusted to the care of the University, namely, \_\_\_\_\_ 19 \_\_\_\_, after which time the two copies are to be made available to users at the discretion of their custodians,

OR

(c) that access to, and quotation from, this thesis/report is to be granted only with my written permission for a period of \_\_\_\_\_ years from the date on which the thesis/report, after approval for the award of a degree, is entrusted to the care of the University; namely, \_\_\_\_\_, 19 \_\_\_\_, after which time two copies are to be made available to users at the discretion of their custodians.

Date Jan 27/99  
[Signature]  
Dean of Graduate Studies

Signed Wayne B. Chipson  
Witnessed by Margaret L. Vis-Comiso

### NOTES

- Restriction (b) will be granted on application, without reason given.  
*However, applications for restriction (c) must be accompanied with a detailed explanation, indicating why the restriction is thought to be necessary and justifying the length of time requested. Restrictions required on the grounds that the thesis is being prepared for publication, or that patents are awaited, will not be permitted to exceed three years.  
Restriction (c) can be permitted only by a Committee entrusted by the university with the task of examining such applications, and will be granted only in exceptional circumstances.*
- Thesis writers are reminded that, if they have been engaged in contractual research, they may have already agreed to restrict access to their thesis until the terms of the contract have been fulfilled.

## Abstract

The occurrence of annuli on sagittal otoliths of the cunner, *Tautoglabrus adspersus*, were validated by injection with oxytetracycline hydrochloride in a field study. Otoliths were then used to compare growth rates of behaviourally and geographically distinct populations. Territorial males exhibited significantly slower growth than non-territorial males from the same pair spawning population. Although group spawning males had similar rates of growth as did males from the pair spawning population, they did exhibit a negative correlation between length at age and gonadosomatic index (GSI), suggesting a tradeoff between gonadal investment and somatic growth. No such relationship existed for males from the pair spawning population. Females from the two populations grew at similar rates and their growth was not correlated with GSI. Newfoundland cunner appear to grow as fast as cunner from farther south where they have a longer growing season and higher temperatures. This suggests that some form of growth compensation occurs in Newfoundland cunner.

### **Acknowledgments**

I would like to thank Dr. J. M. Green for his guidance, patience and continued support throughout this research. Valuable reviews of this manuscript by Dr. D. Larson and Dr. G. Cowan are much appreciated. I would like to give special thanks to Bob Hooper for use of the Bonne Bay research station, the loan of equipment and his help on numerous dives. I would like to acknowledge the other divers who participated in the study: Duane Barker, Kirsten Deichmann and Phil Levin. Help in the laboratory was provided by Lori Mitchell, Natalie Miller and Beverly Ledrew. Dr. A. Whittick and Dr. R. Sheath generously loaned laboratory equipment. Assistance in manuscript preparation from Roy Ficken is gratefully acknowledged. Financial support from an NSERC operating grant to J.M. Green and from the School of Graduate Studies and Department of Biology, Memorial University, is greatly appreciated.



## TABLE OF CONTENTS

	Page
Abstract.....	ii
Acknowledgments.....	iii
Table of Contents.....	iv
List of Tables.....	vi
List of Figures .....	x
1.0 Introduction.....	1
2.0 Materials and Methods.....	9
2.1 Study Sites.....	9
2.2 Oxytetracycline Hydrochloride Experiment.....	15
2.3 Fish Collections for Growth Study.....	16
2.4 Processing of Fish.....	18
2.5 Otolith Removal and Preparation.....	18
2.6 Age and Growth.....	20
2.7 Gonadosomatic Index.....	24
2.8 Von Bertalanffy Growth Function.....	24
3.0 Results.....	26
3.1 Cunner Density.....	26
3.2 Observations of OTC-Injected Fish.....	26
3.3 Validation of Annuli.....	29
3.4 Growth.....	33

3.5 Gonadosomatic Index.....	72
3.6 Von Bertalanffy Growth.....	72
4.0 Discussion.....	83
4.1 Validation of Annular Checks.....	83
4.2 Cunner Growth.....	84
4.3 Comparison with other Growth Studies.....	92
4.4 Foraging and Predation.....	97
4.5 Sex Ratio.....	98
4.6 Von Bertalanffy Growth.....	99
4.7 Future Research.....	100
5.0 Conclusions.....	102
Literature Cited.....	104

LIST OF TABLES

	Page
Table 2-1: Collections made of cunner, <i>T. adspersus</i> , for age and growth analysis in Newfoundland and Maine.....	17
Table 3-1: Tagged and injected cunner, <i>T. adspersus</i> , recaptured from the fish processed in Broad Cove (212) and Gadd's Harbour (250). The O represents opaque bone while the H represents hyaline bone.....	30
Table 3-2: Back calculated lengths for male and female cunner, <i>T. adspersus</i> , from Gadd's Harbour, Newfoundland. Numbers in parentheses indicate the number of fish used to calculate mean length at age and mean growth increment.....	38
Table 3-3 Back calculated lengths for male and female cunner, <i>T. adspersus</i> , from Norris Point, Newfoundland. Numbers in parentheses indicate the number of fish used to calculate mean length at age and mean growth increment.....	39

Table 3-4:	Back calculated lengths (BC) for non-territorial (NT) male, territorial (T) male, and female cunner, <i>T. adspersus</i> , from Broad Cove, Newfoundland. Numbers in parentheses indicate the number of fish used to calculate mean length at age and mean incremental growth.....	40
Table 3-5:	Back calculated lengths for male and female cunner, <i>T. adspersus</i> , from Appledore Island, Maine. Numbers in parentheses indicate the number of fish used to calculate mean length at age and mean growth increment.....	41
Table 3-6:	Analysis of covariance examining length at age of male cunner, <i>T. adspersus</i> , collected in Bonne Bay (Norris Point and Gadd's Harbour). *, **, *** indicates significance at the $P < 0.05$ , 0.01, and 0.001 levels, respectively.....	57
Table 3-7:	Analysis of covariance examining length at age for female cunner, <i>T. adspersus</i> , collected at Bonne Bay (Norris Point and Gadd's Harbour). *, **, *** indicates significance at the $P < 0.05$ , 0.01, and 0.001 levels, respectively.....	58

Table 3-8:	Analysis of covariance examining length at age for female cunner, <i>T. adspersus</i> , collected in Norris Point and Broad Cove. *, **, *** indicates significance at the P< 0.05, 0.01, and 0.001 levels, respectively.....	66
Table 3-9:	Analysis of covariance examining length at age of non-territorial male and territorial male cunner from Broad Cove and male cunner, <i>T. adspersus</i> , from Norris Point. *, **, *** indicates significance at the P< 0.05, 0.01, and 0.001 levels, respectively.....	67
Table 3-10:	Chi-square test for sex ratio difference among populations of cunner, <i>T. adspersus</i> . Expected counts are in parentheses below observed counts. $\chi^2 = 1.899$ , $df = 3$ , $p\text{-value} = 0.594$ .....	70
Table 3-11:	Analysis of covariance examining the length/weight relationship of cunner, <i>T. adspersus</i> , between sexes and among locations. *, **, *** indicates significance at the P< 0.05, 0.01, and 0.001 levels, respectively.....	71

Table 3-12: Estimated von Bertalanffy growth parameters for territorial male (TM), non-territorial male (NTM), group spawning male (GM) and female (F) cunner, *T. adspersus*, collected in Bonne Bay and Broad Cove, Newfoundland, and Appledore Island, Maine.....

81



## List of Figures

	Page
Figure 2-1: Locations from which cunner were sampled in Newfoundland [Gadd's Harbour (GH), Norris Point (NP) and Broad Cove (BC)] and Maine [Appledore Island (AI)]. Inset shows the two Newfoundland sites located in Bonne Bay.....	11
Figure 2-2: Habitat type in areas of cunner observations. Transects were performed randomly at a depth of 4-10 m.....	14
Figure 2-3 Ground otolith from a 200 mm female cunner, <i>T. adspersus</i> . RAD indicates where otolith radius was measured.....	23
Figure 3-1: The mean density of cunner, <i>T. adspersus</i> , per 15 X 1 m transect based on ten replicates. Broad Cove and Gadd's Harbour transects were made in September of 1993. NF is the mean density cunner of 12 Newfoundland sites which include Norris Point and Broad Cove (Levin, unpublished data). ME is the mean density of cunner at eight Gulf of Maine sites including Appledore Island (Levin, unpublished data) Bars indicate one standard error of the mean.....	28

Figure 3-2: Ground otolith from a 14-year-old cunner, *T. adspersus*, collected in Gadd's Harbour one year after injection with OTC. The arrow indicates the position of the OTC ring..... 32

Figure 3-3: Ground otoliths from a 5-year-old and a 8-year-old cunner, *T. adspersus*, recaptured one year following injection with oxytetracycline. (A) Otolith viewed under transmitted light in combination with ultraviolet light. The arrow indicates the position of the OTC ring. Bar = 30  $\mu$ m. (B) Otolith viewed under transmitted light. The arrow indicates the position of the OTC ring which has been determined from photos using ultraviolet light only. Bar = 20  $\mu$ m..... 35

Figure 3-4: Schematic diagram of cunner otoliths. (A) A cunner injected with OTC during June and recaptured in November. (B) A cunner injected with OTC in June and recaptured the following June. (C) A cunner injected with OTC in September and recaptured in June..... 37

- Figure 3-5: Comparison of mean back calculated and mean terminal length at age for cunner, *T. adspersus* collected in Gadd's Harbour, Newfoundland. The bars represent the standard deviation of the mean. Data for this plot combine the male and female back calculated lengths at age shown in table 3-2..... 43
- Figure 3-6: Comparison of mean back calculated and mean terminal length at age for cunner, *T. adspersus* collected in Norris Point, Newfoundland. The bars represent the standard deviation of the mean. Data for this plot combine the male and female back calculated lengths at age shown in table 3-3..... 45
- Figure 3-7: Comparison of mean back calculated and mean terminal length at age for cunner, *T. adspersus* collected in Broad Cove, Newfoundland. The bars represent the standard deviation of the mean. Data for this plot combine the male and female back calculated lengths at age shown in table 3-4..... 47

Figure 3-8: Comparison of mean back calculated and mean terminal length at age for cunner, <i>T. adspersus</i> collected at Appledore Island, Maine. The bars represent the standard deviation of the mean. Data for this plot combine the male and female back calculated lengths at age shown in table 3-5 in addition to fish of undetermined sex.....	49
Figure 3-9: Growth curves using back calculated mean length at age data of male and female cunner, <i>T. adspersus</i> , collected at the Bonne Bay sites (Norris Point and Gadd's Harbour).....	52
Figure 3-10: Growth curves using back calculated mean length at age data of territorial male, non-territorial male, and female cunner, <i>T. adspersus</i> , collected in Broad Cove, Newfoundland.....	54
Figure 3-11: Growth curve using back calculated mean length at age data for cunner, <i>T. adspersus</i> , collected in Appledore Island, Maine. Sexes were combined.....	56
Figure 3-12: Length frequency distribution of cunner, <i>T. adspersus</i> , collected during 1992 and 1993.....	60

Figure 3-13: Age frequency distribution of cunner, <i>T. adspersus</i> , collected during 1992 and 1993.....	62
Figure 3-14: Growth curves using back calculated mean length at age data of male and female cunner, <i>T. adspersus</i> , collected from Norris Point and Broad Cove, Newfoundland.....	64
Figure 3-15: Growth curves using back calculated mean length at age data of cunner (sexes combined) from Appledore Island, ME, Broad Cove, NF, Norris Point, NF, and Gadd's Harbour, NF.....	69
Figure 3-16: Gonadosomatic indexes for male cunner, <i>T. adspersus</i> , from Broad Cove, Norris Point, and Gadd's Harbour, Newfoundland. Collections from Broad Cove consist of non-territorial males.....	74
Figure 3-17: Gonadosomatic indexes for male cunner, <i>T. adspersus</i> , from Broad Cove, Norris Point, and Gadd's Harbour, Newfoundland, using back calculated lengths at age 5. Collections from Broad Cove consist of non-territorial males.....	76
Figure 3-18: Gonadosomatic indexes for female cunner, <i>T. adspersus</i> , from Broad Cove, Norris Point, and Gadd's Harbour, Newfoundland.	78

Figure 3-19: Gonadosomatic indexes for female cunner, *T. adspersus*, from Broad Cove, Norris Point, and Gadd's Harbour, Newfoundland, using back calculated lengths at age 5.. 80

Figure 4-1: Growth curves of cunner, *T. adspersus*, from present and past studies. (A) Aging of *T. adspersus* from Newfoundland [Naidu (1966)], Connecticut [Serchuk and Cole (1974)] and [Dew (1976) males; Dew (1976) females] using scale samples. (B) Aging of *T. adspersus* from Gadd's Harbour, Norris Point, and Broad Cove, Newfoundland and Appledore Island, Maine. CG=C. Gravel (1987); WC=W. Chiasson (present study)..... 94



## Introduction

The family Labridae consists of 500+ species, many of which are abundant on tropical reefs (Moyle and Cech, 1988). The cunner, *Tautoglabrus adspersus*, is a common inshore labrid distributed along the coast of the western North Atlantic from Chesapeake Bay to northern Newfoundland (Scott and Scott, 1988) and the only labrid found in Newfoundland waters. Cunner are usually associated with shallow inshore reefs, sheltered rock substrates, wrecks and wharves (Pottle and Green, 1979a; Whoriskey, 1983) but may be found in depths greater than 90 m (Bigelow and Schroeder, 1953). These fish maintain a small home range (Green, 1975; Olla et al., 1975) of less than 3000 m<sup>2</sup>, with most of the activity of female cunner limited to core areas, areas of intensive use, averaging less than 100 m<sup>2</sup> (Bradbury, 1993). When water temperature falls below 5-6°C, cunner in Newfoundland enter a state of torpor, characterized by a slowing of metabolic processes and inactivity that can last for 5-6 months (Green and Farwell, 1971).

Discrepancies exist in the literature regarding the lengths at age and life span of the cunner. Naidu (1966) reported that fish from Conception Bay, Newfoundland, obtain a maximum age of 10, years while Gravel (1987) described fish from the same area as being as old as 24 years. The former study used fish scales while the latter employed otoliths for

aging specimens. Research conducted further south in Wareham, Massachusetts, estimated that cunner were no older than 6 years (Serchuk and Cole, 1974). Dew (1976), also using scales for age analysis, regarded 5 years as the maximum readable age for male and female cunner collected at Fishers Island Sound, off the coast of Connecticut. In these studies, even though the age structures of the populations studied were different, the size ranges were similar.

These studies indicate that the aging of cunner poses some problems. Since the cunner has a high proportion of regenerated scales (Naidu, 1966; Serchuk and Cole, 1974; Gravel, 1987) extra care is needed to choose a suitable scale. More importantly the use of scales may underestimate the age of older fish as has been noted with other species (e.g. Beamish and McFarlane, 1983; Nedreaas, 1990). In Gravel's study (1987), the sagittal otoliths were used as an alternative to scales, but the method was not validated.

Lack of validation has been a common problem in fish aging. For example, Beamish and McFarlane (1983) found 35% of 500 studies surveyed did not consider the validation of ages. They suggested that all age classes should be validated by tag-recapture or use of known age fish. Weber and Ridgway (1962) were the first to discuss the possibility of marking fish bones using tetracycline and the potential use of such drugs in age validation studies. Antibiotics of the tetracycline series localize in new bone (Weber and

Ridgway, 1967) and fluoresce when subjected to ultraviolet illumination (Weber and Ridgway, 1962). Subsequent to these findings, antibiotics have been employed in numerous fish growth studies for validation purposes (e.g. Weber and Ridgway, 1967; Odense and Logan 1974; Fargo and Chilton, 1987; Bumguardner, 1991; Murphy and Taylor, 1991). The administration of such a drug can be done by incorporating it into the feed (Pedersen and Carlsen, 1991), by injection (Dekker, 1986; Fargo and Chilton, 1987), or by immersion (Secor et al., 1991a). The injection method has the advantage of allowing fish to be released immediately after processing, whereas the other methods require holding facilities.

The immersion technique for fluorescent tagging with tetracycline has been applied to juvenile cunner. Gleason and Recksiek (1990) immersed small cunner (15-40 mm standard length) in a tetracycline hydrochloride solution to evaluate the daily ring formation on otoliths. They confirmed that tetracycline compounds bind with the calcium of the cunner otoliths and fluoresce when observed with ultraviolet microscopy. This fact, along with the small home ranges that cunners are known to occupy, make a tag-recapture experiment in the field feasible for this species.

Otoliths are composed of calcium carbonate crystals embedded in an organic matrix. Layers of growth are added on in the form of a shell. When viewed under transmitted light,

summer growth is usually an opaque calcium rich (dark) zone whereas winter growth is a translucent (white or clear) zone. A completed annual ring or check is often defined as the interface between an inner translucent winter zone and the outer opaque summer zone (Cailliet et al., 1986). The validation of annuli determines if in fact the periods of fast growth and slow growth occur on an annual basis. An annulus should consist of an opaque zone (fast growth) and a translucent zone (slow growth) laid down on an annular basis. The oxytetracycline hydrochloride-induced mark permits the reader to evaluate growth zones and banding patterns during the period after injection up until the time of recapture. An injected cunner recaptured prior to the period of torpor should not have an annular check laid down outside of the oxytetracycline hydrochloride induced fluorescent band. On the other hand, a fish caught 12 months after injection should have one annular check laid down outside of the oxytetracycline hydrochloride induced fluorescent ring.

The first objective of the present study, given the uncertainty of aging cunner, was to validate the occurrence of annuli on the sagittal otoliths by using oxytetracycline hydrochloride in a field experiment. It was hypothesized that cunner recaptured 12 months after being injected with oxytetracycline hydrochloride would have one annular check laid down outside of the fluorescent ring.

Once the aging technique is validated, it is possible to use data from otoliths to examine several questions about the growth of cunner in relation to known variation in life history parameters and environmental conditions.

The cunner is one of many species of labrids that exhibit dualistic reproductive behavior. Both group spawning and pair spawning have been described in this species (Pottle et al., 1981). In Broad Cove, Newfoundland, spawning occurs mainly between territorial males and females while non-territorial males are excluded from territories and only spawn on occasion by sneaking (Pottle and Green, 1979b). Sneaking (interference spawning) by cunner is described by Martel and Green (1987). Pottle et al. (1981) observed group spawning in Bonne Bay, Newfoundland, that included more than 30 fish. Group spawning has not been observed in Broad Cove during the more than 20 years in which studies have been conducted there (Green, J.M., Memorial University of Newfoundland, pers. comm.).

In Newfoundland, spawning begins in mid to late July and lasts approximately three to four weeks (Pottle and Green, 1979a). In its southern range, Fishers Island Sound, Connecticut, Dew (1976) reported spawning during June, at which time, both male and female cunner were reported to be mature and spawn at lengths as small as 95 mm. For cunner in Newfoundland, gonads are easily distinguished from cunner as small as 100 mm in length.

Other labrid species, such as the slippery dick, *Halichoeres bivittatus*, (Warner and Robertson, 1978) and the bluehead wrasse, *Thalassoma bifasciatum*, (Warner and Hoffman, 1980), have similar spawning behaviour. Warner and Hoffman showed that the mating success of territorial bluehead wrasse varied inversely with overall population density and more specifically with non-territorial male numbers. Pottle et al. (1981) has suggested that a lower cunner density in Broad Cove as compared with Bonne Bay may account for males being able to establish territories in shallow water.

Gravel (1987) used terminal length at age data to investigate tradeoffs associated with both reproductive tactics of Newfoundland male cunners. She assumed that the reproduction costs of female cunner in pair spawning and group spawning populations were the same. Therefore, if there was no difference in the growth of females in pair and group spawning populations, differences in the growth of males could be attributed to their alternative reproductive tactics (Gravel, 1987). Although this study provided evidence that group spawning males invested more heavily in sex products than did pair spawning males, there was no indication of a tradeoff between sperm production and somatic growth rate.

In using terminal length data, it is not possible to gain information on the growth of an individual fish throughout its life. However, back calculation of growth



from a validated aging structure can provide such data for fish whose social status has been identified.

An interesting question relating to the occurrence of alternative reproductive tactics is whether the growth rates of young fish affect their social position or status at a later time. Using the same reasoning as Gravel (1987), I assumed that if the growth rates of female cunner are the same in Bonne Bay and Broad Cove, sites where male cunner have different reproductive tactics, then differences in growth rates among the males may be attributed to their different behaviour (i.e. group spawning vs. pair spawning). Therefore, I used back calculated growth from otoliths to evaluate the early growth of cunner from sites with different reproductive behaviour. I compared growth rates of territorial male cunner in Broad Cove with sympatric non-territorial male cunner and both of these with group spawning male cunner in Bonne Bay.

Dew (1976) described the period of torpor for cunner from Fishers Island Sound, Connecticut, to be approximately three to four months. In contrast, the period of inactivity can be five to six months for cunners in Newfoundland (Green and Farwell, 1971). Given that cunner from more northern latitudes may have a shorter growing season and are subjected to lower water temperatures, a third objective of this study was to compare the growth of cunner in populations from sites in Newfoundland with those from a more southern location,

Appledore, Maine. Latitudinal differences in growth rates were reported by Naidu (1966) for his collections throughout Newfoundland. His lengths at age were similar to those reported in Massachusetts (Serchuk and Cole, 1974). However, he used scales to age cunner, a method questioned by Gravel (1987).

The purposes of this study, therefore, were to first validate the use of otoliths as an aging technique for cunner and then study the growth rates of cunner from different geographical locations and with different reproductive strategies.

## Materials and Methods

### 2.1 Study Sites

Fish were examined from Bonne Bay (Norris Point and Gadd's Harbour, latitude 49°15' N longitude 59°30' W), and Conception Bay, (Broad Cove, latitude 47°35' N longitude 52°53' W), in Newfoundland, Canada, and Appledore Island (latitude 42°59' N longitude 70°37' W), Maine, USA (Fig. 2-1). The sites in Newfoundland were chosen because cunner from these sites exhibit the two types of spawning strategies found in this species. Gadd's Harbour in Bonne Bay was chosen as the specific site for the validation portion of the study because cunner tagged with colored Floy tags were readily caught in the local sport fishery whereas Gadd's Harbour had little or no recreational fishing pressure.

Habitat data for the study sites were determined by recording the macrophyte type at 50 cm intervals along 15 m transects. At points where macrophyte growth was absent, substrate types were recorded. Benthic algae were classified as kelps (e.g. *Laminaria* spp. and *Agarum* spp.), foliose algae (e.g. *Ulva lactuca*), branched algae (e.g. *Desmarestia* spp.) and crustose algae, while substrate types were categorized as rock, cobble, or sand. Random transects were surveyed in replicates of ten at each Newfoundland site along a 100-200 m stretch of shore line.

Figure 2-1: Locations from which cunner were sampled in Newfoundland [Gadd's Harbour (GH), Norris Point (NP) and Broad Cove (BC)] and Maine [Appledore Island (AI)]. Inset shows the two Newfoundland sites located in Bonne Bay.

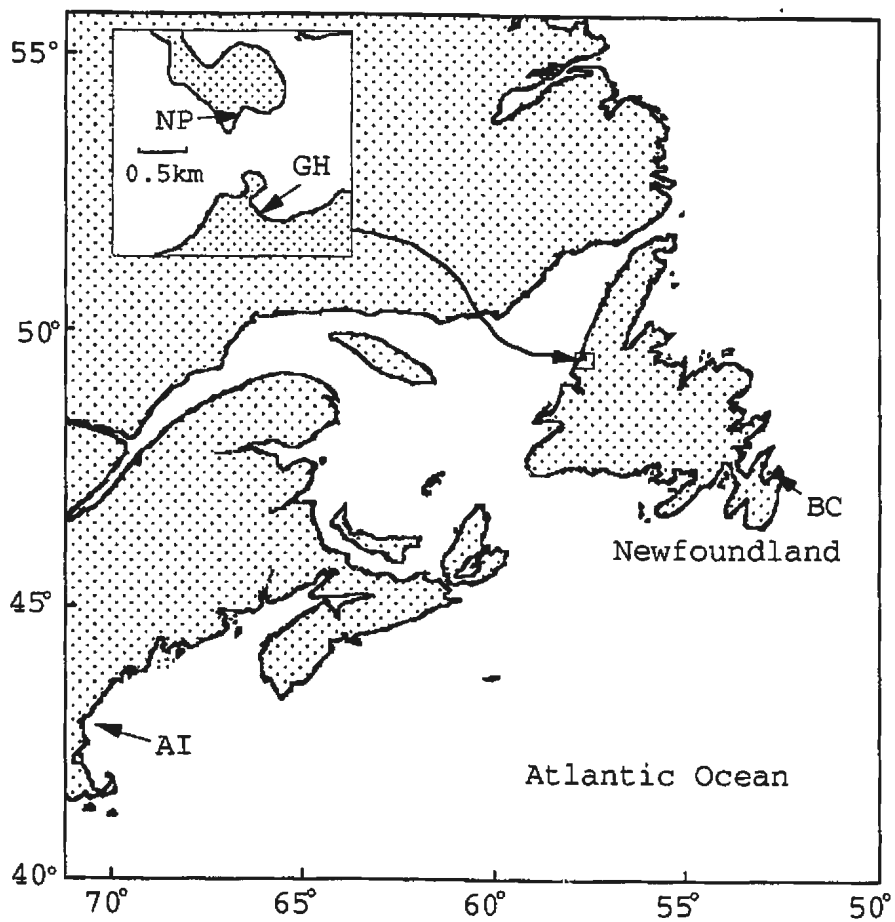

Research conducted in Gadd's Harbour, Bonne Bay, was at a depth of 2 to 10 m. Gadd's Harbour has a steeper slope than do the sites at Norris Point and Broad Cove and has a variety of macrophyte and substrate types (Fig. 2-2).

Fish were collected at Norris Point, Bonne Bay, from an area with sand and cobble as the dominant substrate. Macrophytes were present only on the underwater portion of the wharf (Fig. 2-2).

The research conducted in Broad Cove, Conception Bay, was at a depth of 2 to 10 m. This site is characterized by shallow sloping bedrock with sparse outcrops and boulders that provide cover for cunner during quiescent periods. The Broad Cove site is dominated by crustose algae and bare rock (Fig. 2-2).

The samples collected at Appledore Island, situated ten km off the coast of Maine, were from a depth of 2-8 m. This site is comprised of a rock ledge with 50% cover of *Laminaria* spp. as well as a dense understory of *Codium fragile* and *Chondrus crispus* (Levin, 1993).

Cunner density was determined for Gadd's Harbour and Broad Cove by enumerating fish along at least 10 randomly-placed 15 x 1 m transects. A SCUBA diver extended a transect line while a second diver followed 3-5 minutes later, enumerating fish at a rate of 8 to 10 m min<sup>-1</sup>. A T-bar was used to gauge the one meter width (Levin, 1991). This data set was collected with the same technique used by Levin

Figure 2-2: Habitat type in areas of cunner observations.  
Transects were performed randomly at a depth of  
4-10 m.

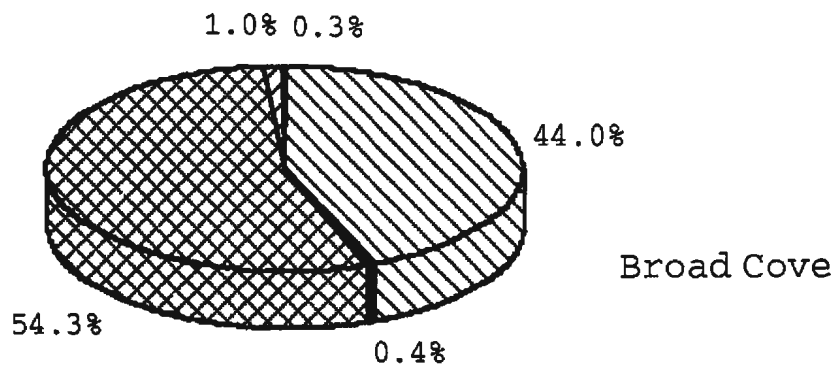
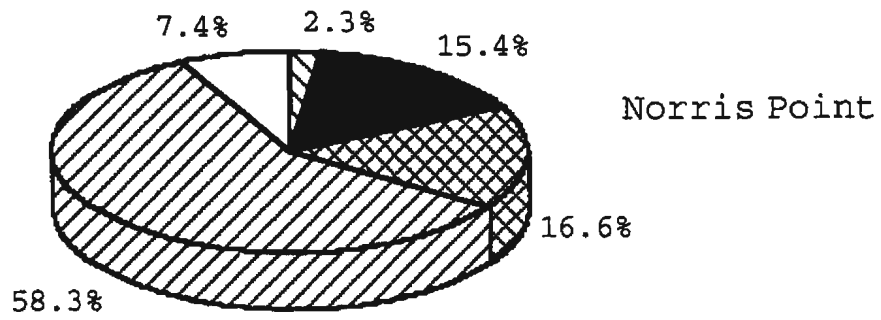
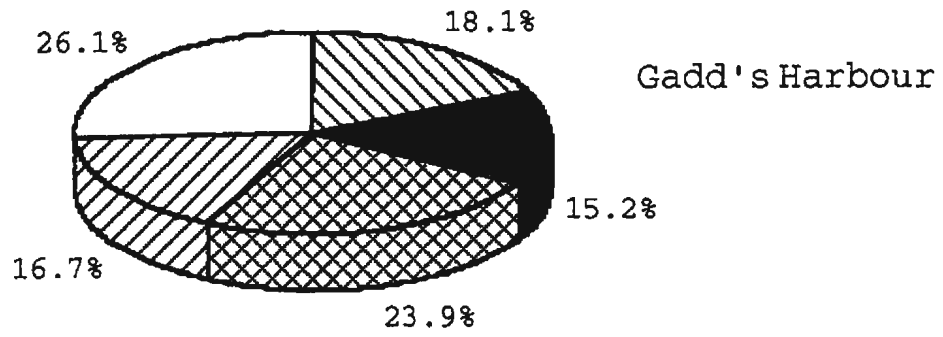
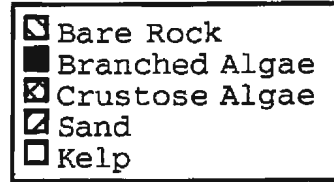



(1991) in which cunner density was estimated for Norris Point and Broad Cove.

## **2.2 Oxytetracycline Hydrochloride Experiment**

To validate annuli on cunner otoliths, 462 cunner (250 in Gadd's Harbour and 212 in Broad Cove) were injected with oxytetracycline hydrochloride (OTC) during the 1992 field season (Table 3-1). At Broad Cove, a hoop net baited with crushed sea urchins (*Strongylocentrotus drobachiensis*) was used to collect specimens for injection. The baited hoop net was positioned on the sea floor at a depth of 5-7 meters for approximately 10 minutes. When 10 to 20 cunner had aggregated above the net, it was hauled up into the boat. Fish were held in a 180 liter container filled with sea water and processed in the boat. Cunnners were anaesthetized using MS-222 at a concentration of 1:10,000. A syringe with a 21-gauge needle was used to inject the OTC solution intraperitoneally at a concentration of 75 mg·kg<sup>-1</sup> fish (Weber and Ridgway, 1967; McFarlane and Beamish, 1987). OTC injection dosage was determined by fish length based on a predetermined length-weight relationship (Gravel, 1987). To enable recapture of the OTC treated fish, cunnners were externally marked using Floy T-bar anchor tags (model # FD-68B) or with Carlin tags. Once fish recovered from the anaesthetics, they were released at the water surface by a

snorkeler who observed them during their initial descent in the water column.

In Bonne Bay, fish were captured using a modified shrimp trap baited with squid. This trap was left on the substrate for at least one hour before being retrieved. Captured fish were taken to the Department of Biology laboratory located at Norris Point, approximately 1.5 km away (a 5 minute boat ride). Fish were processed in a similar manner to those at Broad Cove. However, the dose was based directly on the weight of the fish. Fish were held in a flow-through seawater tank for 12 to 24 hours before release at the same general area where they were captured.

SCUBA was used to spear tagged and OTC-injected fish during the same season of injection as well as the following field season. Ground sagittal otoliths from OTC-injected fish were viewed with a Zeiss fluorescent microscope to determine the location of the OTC-induced fluorescent ring (Weber and Ridgway, 1962).

### **2.3 Fish Collections for Growth Study**

A total of 410 cunner was collected during 1992 and 1993 for growth analysis. An additional 227 Broad Cove cunner collected during previous studies were also examined (Table 2-1). Most of these fish were caught with a hoop net in the

Table 2-1: Collections made of cunner, *T. adspersus*, for age and growth analysis in Newfoundland and Maine.

Location	Collection Date	Number of fish	Sex Ratio (M:F)
Gadd's Harbour, NF	Nov. 15, 1992	23	1.0:1.1
Gadd's Harbour, NF	Jun. 26, 1993	81	1.0:2.7
Norris Point, NF	Jul. 7, 1993	70	1.0:1.6
Norris Point, NF	Nov. 16, 1993	23	1.0:5.7
Broad Cove, NF	1983-85	150	N/A
Broad Cove, NF	Jul. 28, 1992	53	1.0:2.1
Appledore, ME	Oct. 21, 1992	28	1.0:2.2
Appledore, ME	1992	80	N/A

manner previously described in section 2.2, but the 58 territorial males were speared by SCUBA divers.

The 28 fish collected from Appledore Island, Maine, were captured with baited eel and minnow traps. Otolith and length data on 80 cunner were also obtained from Appledore, Maine (Phil Levin, Texas A&M, unpublished data).

#### **2.4 Processing of Fish**

Total length (TL) was measured to the nearest millimeter on a measuring board and weight (WT) to the nearest 0.1 grams on a Saritorius Universal electronic balance. Gonads were excised and weighed to the nearest 0.01 gram (GWT). Somatic weight (SWT) was calculated by subtracting the gonad weight (GWT) from the total weight (WT). Gonadosomatic Index (GSI) was calculated using the following equation:

$$\text{GSI} = (\text{GWT}/\text{WT}) \times 100$$

Sex determination was based on macroscopic examination of the gonads.

#### **2.5 Otolith Removal and Preparation**

Otoliths were excised using a Bausch and Lomb Stereoscope (0.7-3.0X). For fish larger than 180 mm, the

stereoscope was unnecessary since otoliths could be removed with relative ease without magnification. The head of the fish was cut open using a scalpel or a small pair of scissors. A cut was made just above the eyes in a longitudinal direction to lift off the top of the skull and expose the brain (Cailliet et al., 1986). The brain was removed, revealing the otoliths enclosed in the canal system of the inner ear. This membranous canal system was removed from the fish and placed in a watch glass containing ethanol. The sagittal otoliths were teased away from the canal system, air dried and stored in labeled coin envelopes until mounting.

Otoliths were mounted on glass slides using thermoplastic glue (Crystal Bond) in the following manner. Glass slides were heated to 85-95°C (Secor et al. 1991b), a block of the glue was touched to the center of the slide, and an otolith was placed in the thermoplastic glue with its distal side down. Using a fine grade sandpaper attached to a board, the otoliths were slowly ground down in the sagittal plane (Secor et al., 1991b). An otolith was usually flipped over at least once to obtain a thin section which contained a plane through the nucleus. Brasso was also used in combination with the sandpaper for a better polished otolith. Some otoliths could not be used for back calculating growth since the grinding plane was not suitable. Problems arise when the grinding plane does not pass through the nucleus as

this may lead to the miscalculation of distances (Panfili and Ximenes, 1992).

## **2.6 Age and Growth**

Sagittal otoliths were examined under transmitted light to reveal the alternating opaque and translucent zones representing periods of fast and slow growth, respectively. Assuming that the validation of annuli is confirmed, an annulus is composed of the opaque and translucent zones while an annular check is counted at the transition of a translucent and an opaque zone. In most samples, it was difficult to see the outer opaque zone corresponding to the present years growth. Therefore, no ages were identified with a "+" indicating growth in the year of capture.

In older fish with thicker otoliths, grinding improved the detection of annuli. At least three blind readings were taken for each ground otolith by the author. A consensus was reached when two of three readings were identical (Cailliet et al., 1990).

Some problems were encountered in the manipulation or processing of the cunner otoliths. The otoliths were brittle and susceptible to breakage. During the grinding process, some otoliths were ground too far, thus making age or back calculations impossible to evaluate. Also, viterite otoliths were found in approximately 3% of the processed cunner.

These otoliths have a crystalline appearance which has been noted in other species, such as the widow rockfish, *Sebastes entomelas*, (Pearson et al., 1993). The viterite otoliths could not be used for age analysis or back calculations.

A Southern Micro Instruments Microcomp image analysis system consisting of a Goldstar 386 computer, an Olympus BHT microscope, Microcomp digitizing tablet, Panasonic WV-F300 color video camera, and a Sony Trinitron high resolution color video monitor was used to make measurements needed for the back calculations. Measurements were made from the nucleus to the edge of the otolith along the dorsal side (Fig. 2-3). Measurements were also made along this line from the nucleus to each annulus. Back calculated lengths at age were generated using DISBCAL (Frie, 1982). Analysis of covariance using Minitab was employed to compare lengths-at-age among locations (Anonymous, 1993). A Tukey's multiple comparison test was performed to examine the differences between all possible pairs of groups (Zar, 1974).

Length frequency distributions were compared using a Kolmogorov-Smirnov Two-Sample Test (Sokal and Rohlf, 1981; Sadovy et al., 1992; Perryman and Lynn, 1994) with Statview Statistical Package (Anonymous, 1987). Sex ratios were compared among locations with a Chi-square test from Minitab (Anonymous, 1993). Analysis of covariance (ANCOVA) with the General Linear Model was employed to compare length/weight

Figure 2-3: Ground otolith from a 200 mm female cunner, *T. adspersus*. RAD indicates where otolith radius was measured.



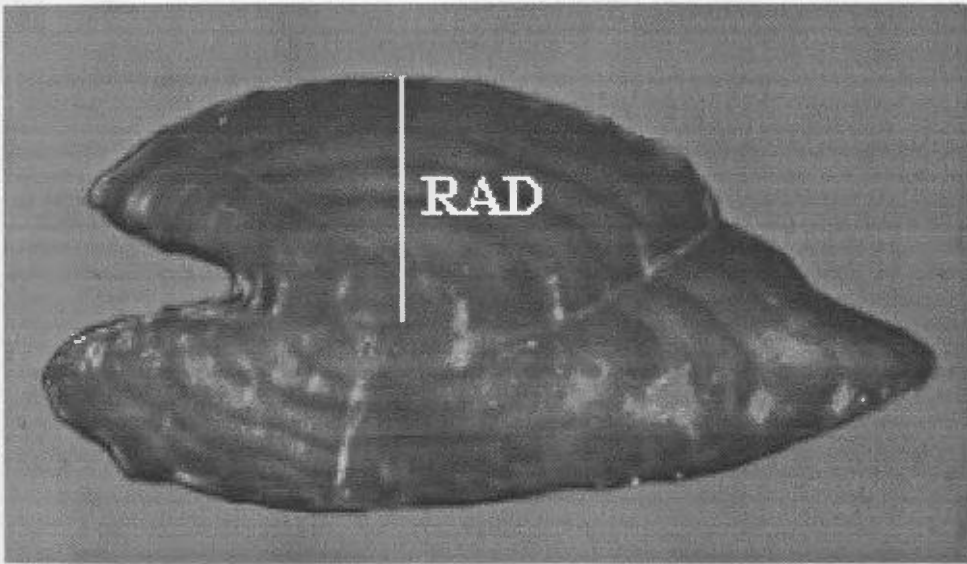

relationships between sexes and among sites according to the Minitab statistical package (Anonymous, 1993).

## **2.7 Gonadosomatic Index**

Gonadosomatic index (GSI) was plotted against length to investigate the relationships for sexes and sites. The correlation coefficient for GSI and length was calculated using the Minitab Statistical Package.

Back calculated lengths at age 5 were plotted against GSI to determine the relationship between gonad size and fish length. Age five was used since the fish at this age have been sexually mature for several years (Dew, 1976). I assumed that the GSI just prior to the commencement of spawning in a year was similar throughout the life span of an individual (i.e. a fish with a high GSI one year would have had a high GSI for previous years). The coefficient for GSI and length at age 5 were calculated with the level of significance determined by a randomization test (data were randomized 1000 times).

## **2.8 Von Bertalanffy Growth Function**

Many different types of models have been used to describe the growth of fishes. The von Bertalanffy model has been used in many studies including that by Serchuk and Cole

(1974) on cunner. In this study, the von Bertalanffy growth parameters were generated by the statistical package FISHPARM (Prager et al., 1987) using mean back calculated length at age data. The model is as follows:

$$L_t = L_{inf} \{1 - e^{-K(T-T_0)}\}$$

where  $L_t$  = length at age  $t$

$L_{inf}$  = asymptotic length at age for the sample

$K$  = Brody growth coefficient

$T$  = age of the fish

$T_0$  = the theoretical origin of growth

## **Results**

### **3.1 Cunner Density**

Cunner density was higher at the Gadd's Harbour site than at the Broad Cove site (Fig. 3-1): mean density of 25.4 adult cunner per transect ( $\pm 7.32$  SE) versus 7.0 ( $\pm 1.11$  SE) fish per transect, respectively. Other cunner density data were obtained from Levin (unpublished data) in which surveys were conducted in Newfoundland (mean density 4.2,  $\pm 0.56$  SE) and the Gulf of Maine (mean density 1.32  $\pm 0.42$  SE). These sites included Norris Point, Newfoundland (cunner density approximately 25), and Appledore Island, Maine (cunner density approximately 3).

### **3.2 Observations of OTC-Injected Fish**

At Broad Cove, frequent observations using snorkel and SCUBA were made of injected and uninjected fish. The behaviour of injected and uninjected fish was indistinguishable. At least two of the injected fish established territories the season following injection (a floy-tagged cunner was observed to have a territory 12 months after injection while a Carlin tagged fish was observed to have a territory 7 months after injection). In addition, one

Figure 3-1: The mean density of cunner, *T. adspersus*, per 15 X 1 m transect based on ten replicates. Broad Cove and Gadd's Harbour transects were made in September of 1993. NF is the mean density of cunner at 12 Newfoundland sites, which include Norris Point and Broad Cove (Levin, unpublished data). ME is the mean density of cunner at eight Gulf of Maine sites including Appledore Island (Levin, unpublished data) Bars indicate one standard error of the mean.

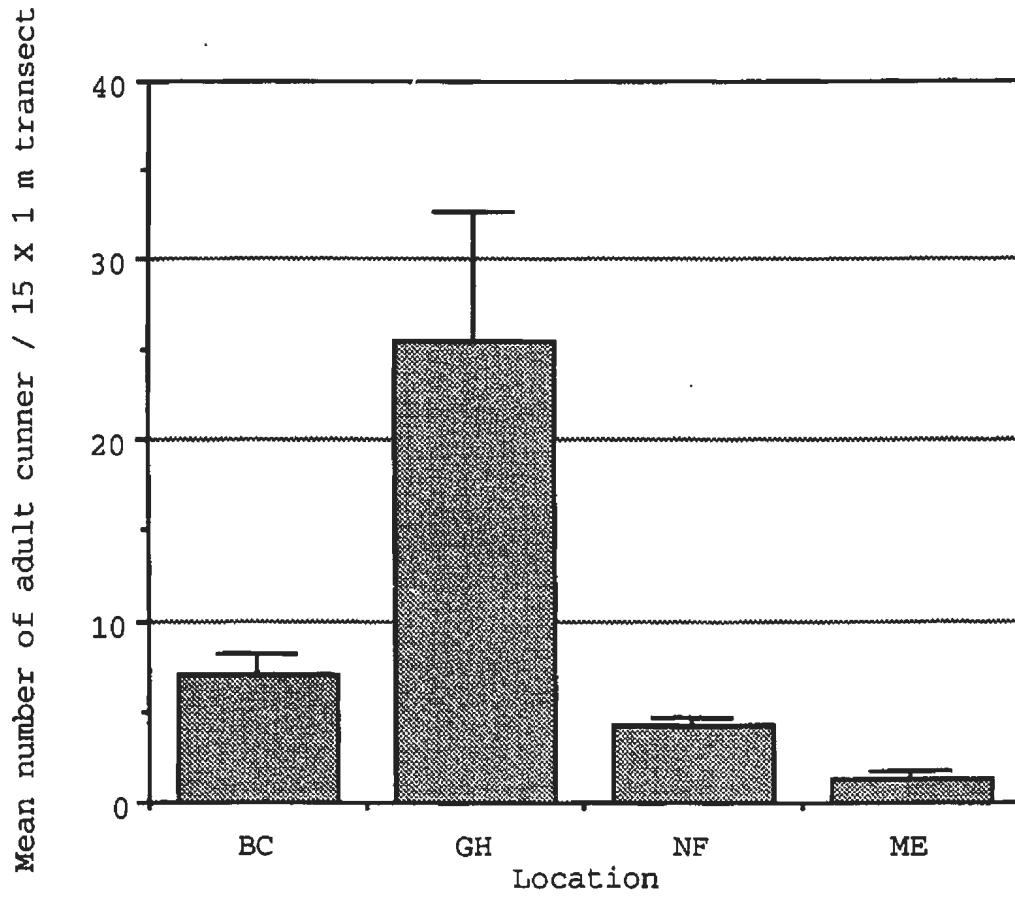

of these males was observed during its courting and spawning behaviour.

### 3.3 Validation of Annuli

Eight OTC-injected fish were recaptured, one from Gadd's Harbour and seven from Broad Cove (Table 3-1). Recaptured fish from both areas showed a fluorescent band comparable to that described by Weber and Ridgway (1962). Although some otoliths from uninjected fish showed autofluorescence, there was a distinct difference in fluorescence between injected and non-injected fish. The OTC-induced band was a distinct yellow ring whereas autofluorescence was blue, less distinct, and associated with an area instead of the ring formed by the OTC. The otolith of the injected Gadd's Harbour fish (Fig. 3-2) showed a fluorescent ring inside the edge of the otolith. Outside of this OTC ring was an opaque band associated with the summer growth and then a translucent band associated with the winter period. From the seven recaptured cunner at Broad Cove, four were recaptured at least one year following injection. The shortest period to recapture was four months while the longest period was 15 months. Fish recaptured during the same season as injection did not have an annular growth check formed on the otolith outside of the OTC induced ring while fish recaptured from both sites in 1993, the season following injection, did have an annular

Table 3-1: Tagged and injected cunner, *T. adspersus*, recaptured from the fish processed in Broad Cove (212) and Gadd's Harbour (250). The O represents opaque bone while the H represents hyaline bone.

Location	Tagging Date	Recapture Date	Otolith Growth Outside OTC Band	Terminal Age
Bonne Bay	16/06/92	26/06/93	O	14
Broad Cove	09/06/92	14/07/93	O-H	15
Broad Cove	09/06/92	18/06/93	O-H	8
Broad Cove	22/06/92	15/10/93	O-H-O	25
Broad Cove	22/06/92	30/10/92	O	15
Broad Cove	22/06/92	17/06/93	O-H	5
Broad Cove	26/06/92	18/06/93	O-H	25
Broad Cove	25/09/92	22/09/93	O-H-O	8



Figure 3-2: Ground otolith from a 14-year-old cunner, *T. adspersus*, collected in Gadd's Harbour one year after injection with OTC. The arrow indicates the position of the OTC ring.

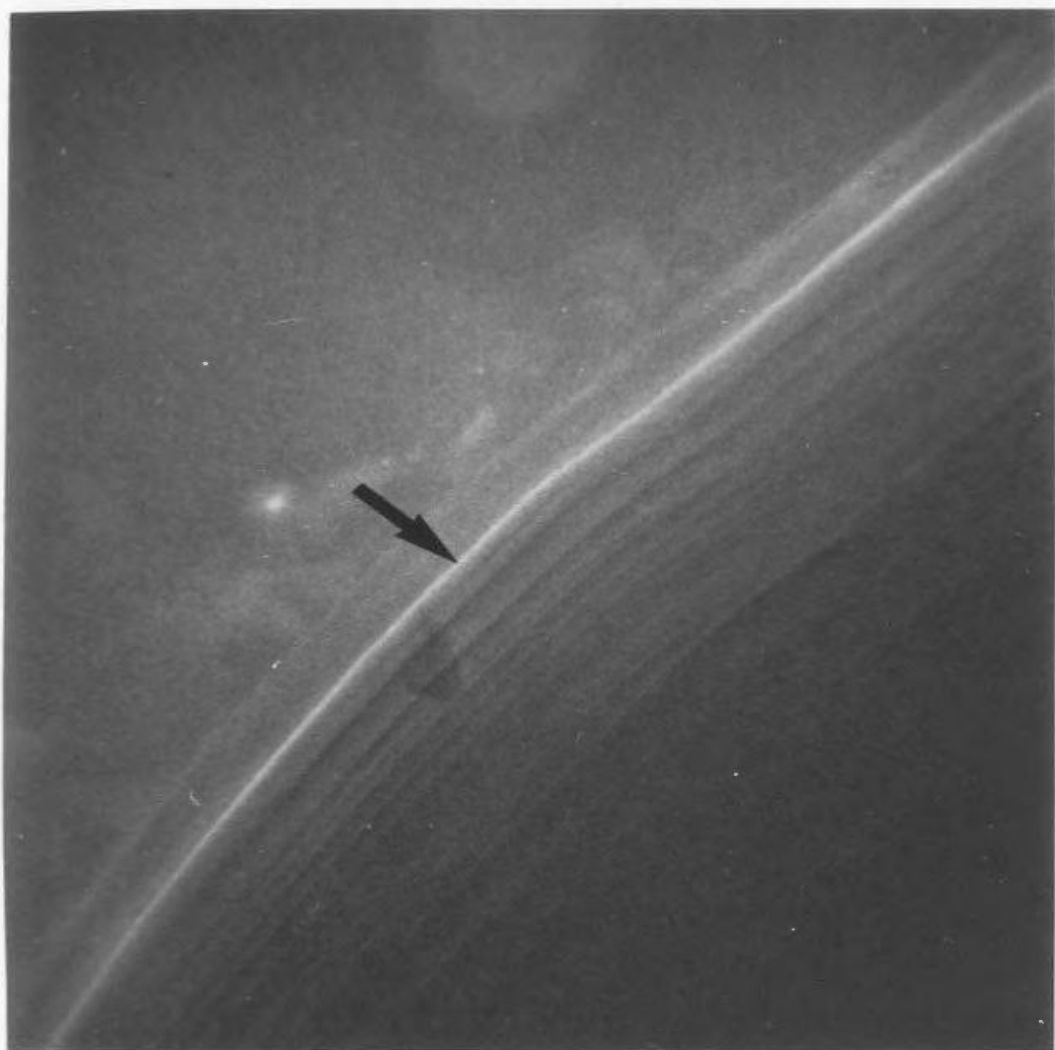

check formed outside of the OTC ring (Fig.3-3). Schematic diagrams of cunner otoliths indicate the position of the OTC band relative to the growth checks according to time of injection and time of capture (Fig. 3-4). For fish injected in June, soon after emerging from torpor, the OTC ring was very close to the previous winter band. When injected in September, the OTC ring was within the faster growth period.

### 3.4 Growth

Otolith radius (OR) and total fish length (TL) were correlated ( $r=0.75$ ;  $p<0.001$ ). Since there was no significant difference between the y-intercept and the origin, the zero value was used in the back calculation equation. Mean back calculated length at age data were estimated for both male and female fish from each location (Table 3-2 to 3-5). Approximately 91% of the mounted otoliths were used for back calculations while 87% of fish collected had their otoliths mounted. In general, annuli were easy to distinguish for the first 5 years. For many of the ground otoliths, annuli were difficult to read after a certain age which varied among individual cunner. In these cases, back calculations were made up until the last readable annulus.

Back calculated lengths at age were similar to the terminal lengths at age (Fig.3-5 to 3-8). The mean terminal length at age for the Appledore Island fish (Fig. 3-8) had a

Figure 3-3: Ground otoliths from a 5-year-old and a 8-year-old cunner, *T. adspersus*, recaptured one year following injection with oxytetracycline. (A) Otolith viewed under transmitted light in combination with ultraviolet light. The arrow indicates the position of the OTC ring. Bar = 30  $\mu\text{m}$ . (B) Otolith viewed under transmitted light. The arrow indicates the position of the OTC ring which has been determined from photos using ultraviolet light only. Bar = 20  $\mu\text{m}$ .

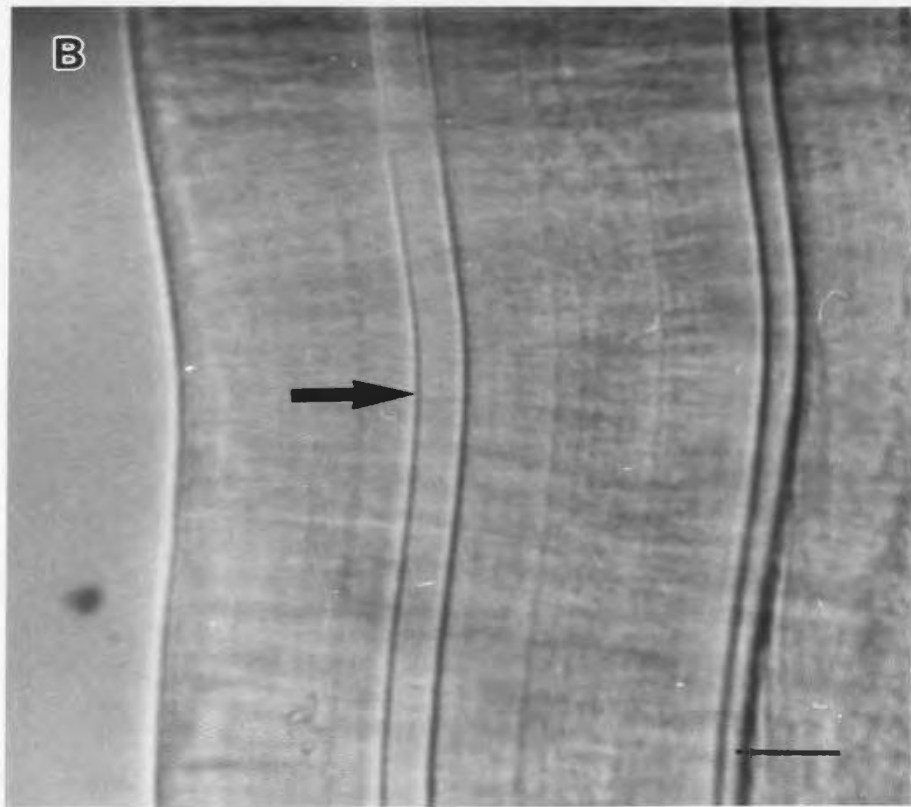
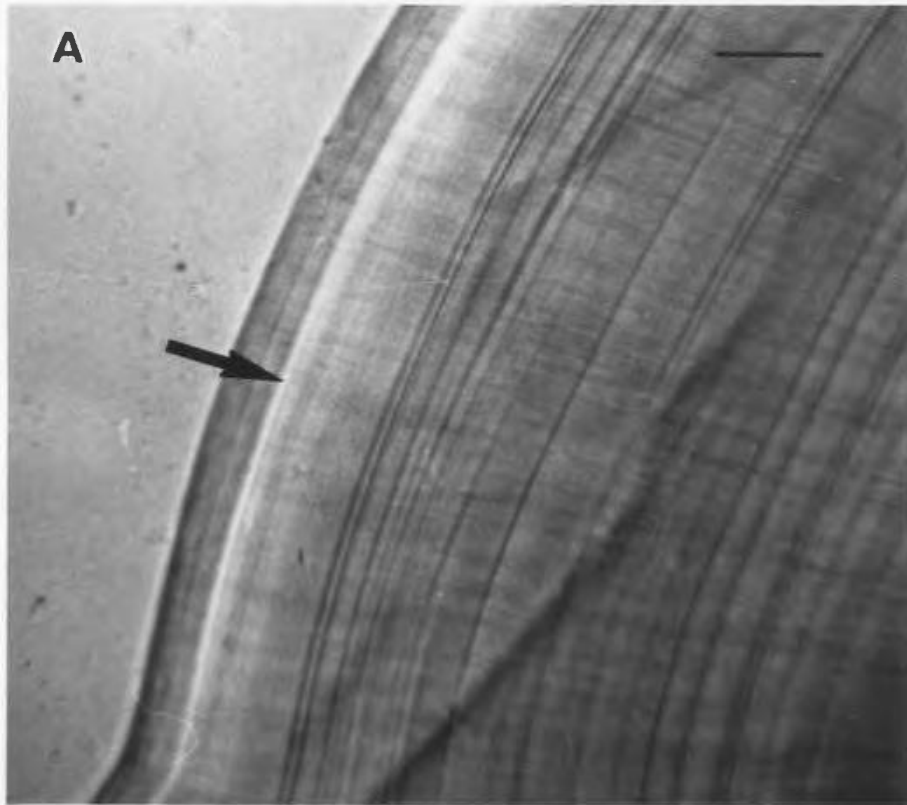

Figure 3-4: Schematic diagram of cunner otoliths. (A) A cunner injected with OTC during June and recaptured in November. (B) A cunner injected with OTC in June and recaptured the following June. (C) A cunner injected with OTC in September and recaptured in June.

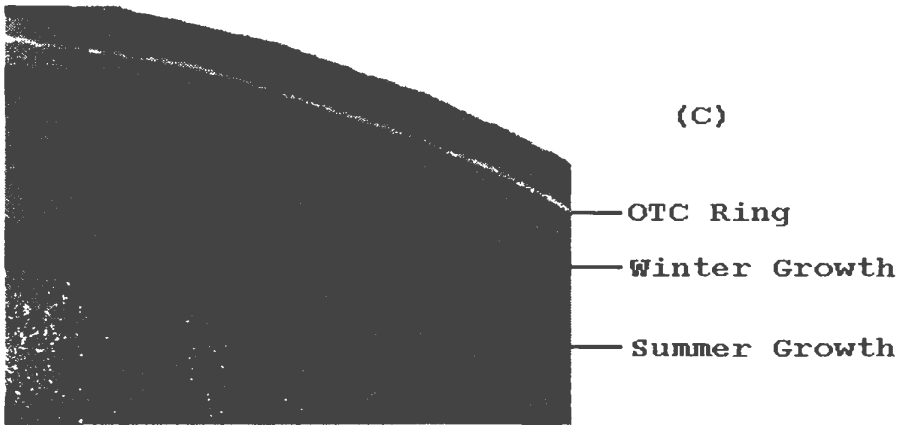
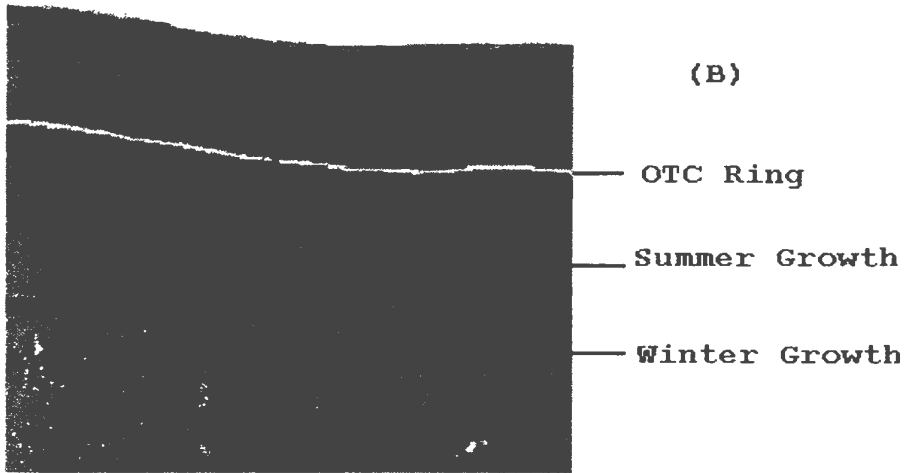
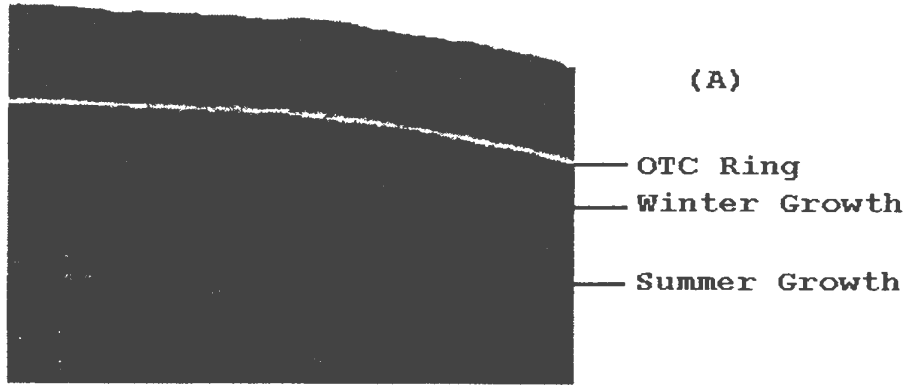

Table 3-2: Back calculated lengths for male and female cunner, *T. adspersus*, from Gadd's Harbour, Newfoundland. Numbers in parentheses indicate the number of fish used to calculate mean length at age and mean growth increment.

Age	Male		Female	
	Back Calculated Length (mm)	Growth Increment (mm)	Back Calculated Length (mm)	Growth Increment (mm)
1	52.0 (26)	52.0	44.9 (63)	44.9
2	82.2 (26)	30.2	72.7 (63)	27.8
3	99.8 (25)	17.6	88.7 (57)	16.0
4	111.2 (21)	11.4	101.0 (52)	12.3
5	118.4 (18)	7.2	109.0 (41)	8.0
6	124.9 (10)	6.5	115.6 (26)	6.6
7	129.7 (5)	4.8	119.3 (17)	3.7
8	122.4 (4)	-7.3	127.9 (12)	8.6
9	129.6 (1)	7.2	127.6 (8)	-0.3
10	134.7 (1)	5.0	128.6 (4)	1.0



Table 3-3: Back calculated lengths for male and female cunner, *T. adspersus*, from Norris Point, Newfoundland. Numbers in parentheses indicate the number of fish used to calculate mean length at age and mean growth increment.

Age	Male		Female	
	Back Calculated Length (mm)	Growth Increment (mm)	Back Calculated Length (mm)	Growth Increment (mm)
1	62.3 (22)	62.3	49.9 (39)	49.9
2	100.7 (22)	38.4	82.4 (38)	32.5
3	122.4 (20)	21.7	102.6 (37)	20.2
4	139.7 (20)	17.3	117.1 (36)	14.5
5	154.4 (18)	14.7	128.3 (32)	11.2
6	168.4 (13)	14.0	145.1 (14)	16.8
7	176.8 (9)	8.4	170.3 (6)	25.3
8	184.2 (6)	7.4	160.8 (4)	-9.5

Table 3-4: Back calculated lengths (BC) for non-territorial (NT) male, territorial (T) male, and female cunner, *T. adspersus*, from Broad Cove, Newfoundland. Numbers in parentheses indicate the number of fish used to calculate mean length at age and mean incremental growth.

Age	NT-Male		T-Male		Female	
	BC Length (mm)	Growth Incr. (mm)	BC Length (mm)	Growth Incr. (mm)	BC Length (mm)	Growth Incr. (mm)
1	56.5 (70)	56.5	59.9 (32)	59.9	50.3 (65)	50.3
2	91.1 (69)	34.6	93.3 (32)	33.4	80.4 (64)	30.1
3	113.5 (67)	22.4	113.5 (28)	20.2	101.7 (63)	21.3
4	131.3 (56)	17.8	131.1 (25)	17.6	119.3 (58)	17.6
5	143.9 (47)	12.6	146.6 (21)	15.5	133.6 (49)	14.3
6	153.2 (36)	9.3	154.9 (16)	8.3	143.5 (43)	9.9
7	163.8 (25)	10.6	162.9 (10)	8.3	153.3 (29)	9.8
8	175.5 (14)	11.7	163.9 (7)	1.0	154.9 (12)	1.6
9	186.6 (6)	11.1	164.8 (6)	0.9	158.4 (4)	5.1
10	204.5 (3)	17.9	167.9 (3)	3.0	166.2 (2)	7.8

Table 3-5: Back calculated lengths for male and female cunner, *T. adspersus*, from Appledore Island, Maine. Numbers in parentheses indicate the number of fish used to calculate mean length at age and mean growth increment.

Age	Male		Female	
	Back Calculated length (mm)	Growth Increment (mm)	Back Calculated Length (mm)	Growth Increment (mm)
1	80.2 (2)	80.2	47.6 (7)	47.6
2	110.2 (2)	30.0	77.0 (7)	29.4
3	127.9 (1)	17.7	99.0 (6)	22.0
4	141.6 (1)	13.7	99.5 (3)	0.5
5	156.0 (1)	14.4	99.0 (1)	-0.5

Figure 3-5: Comparison of mean back calculated and mean terminal length at age for cunner, *T. adspersus* collected in Gadd's Harbour, Newfoundland. The bars represent the standard deviation of the mean. Data for this plot combine the male and female back calculated lengths at age shown in table 3-2.

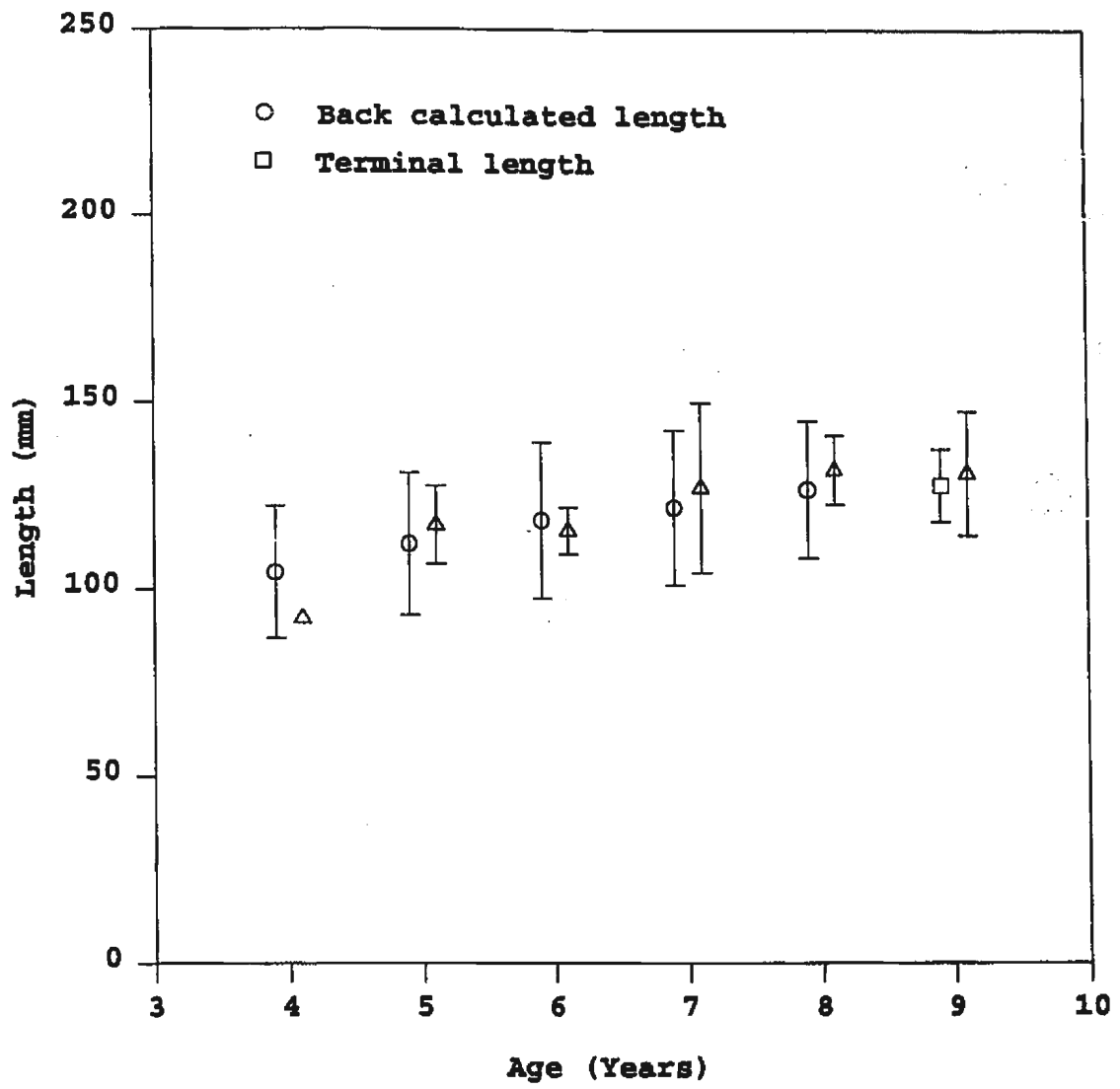

Figure 3-6: Comparison of mean back calculated and mean terminal length at age for cunner, *T. adspersus* collected in Norris Point, Newfoundland. The bars represent the standard deviation of the mean. Data for this plot combine the male and female back calculated lengths at age shown in table 3-3.

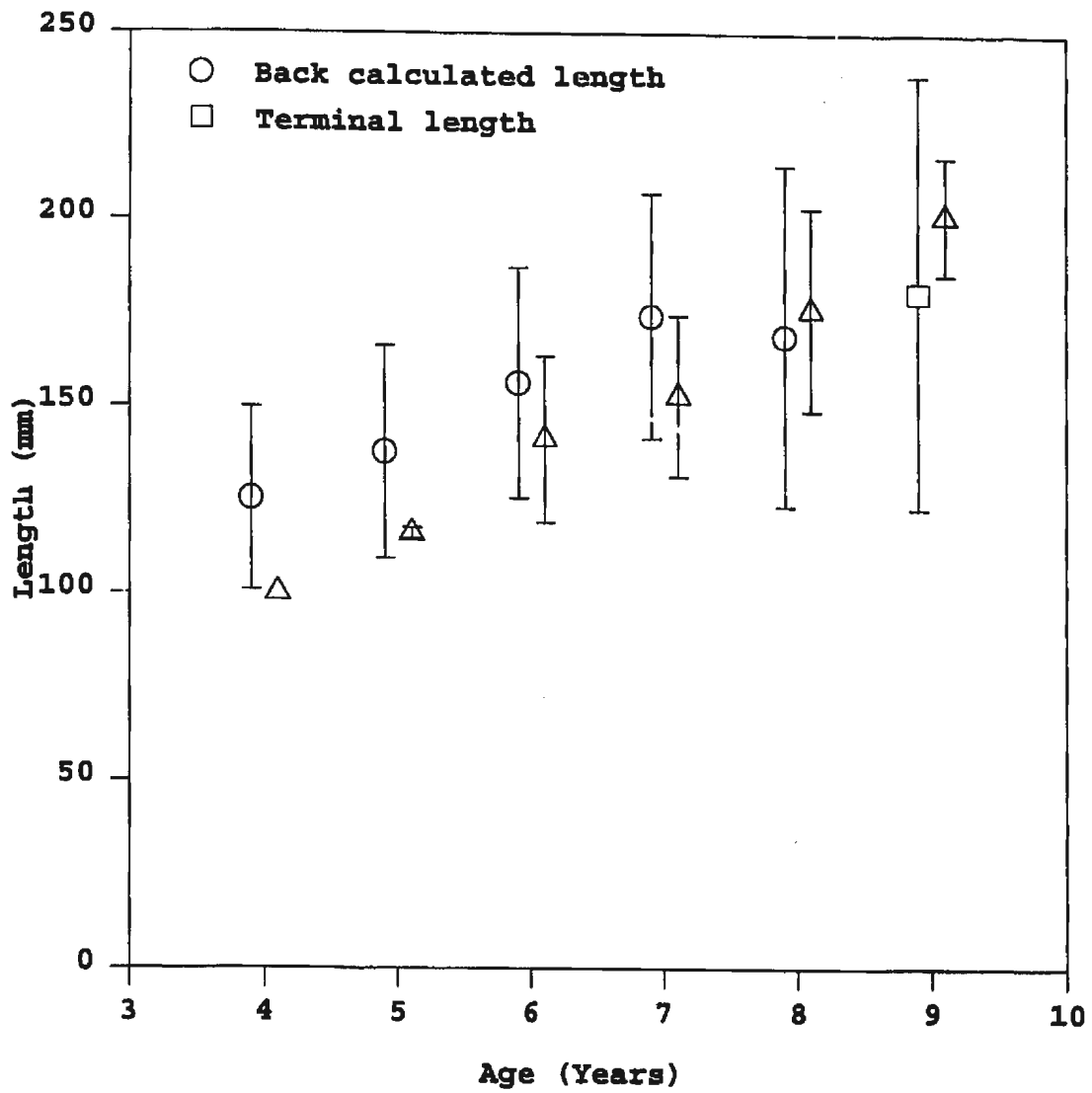

Figure 3-7: Comparison of mean back calculated and mean terminal length at age for cunner, *T. adspersus* collected in Broad Cove, Newfoundland. The bars represent the standard deviation of the mean. Data for this plot combine the male and female back calculated lengths at age shown in table 3-4.



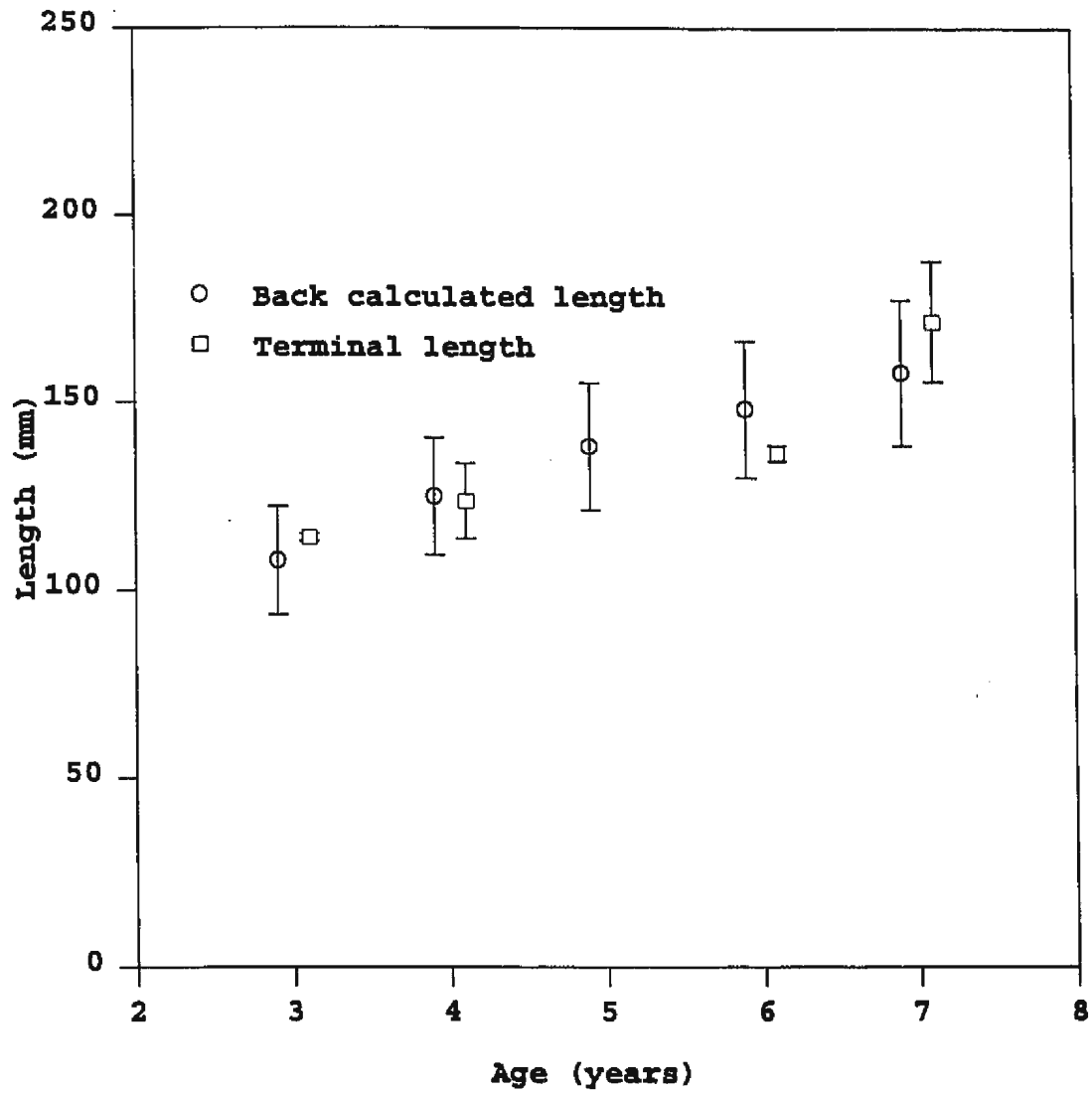
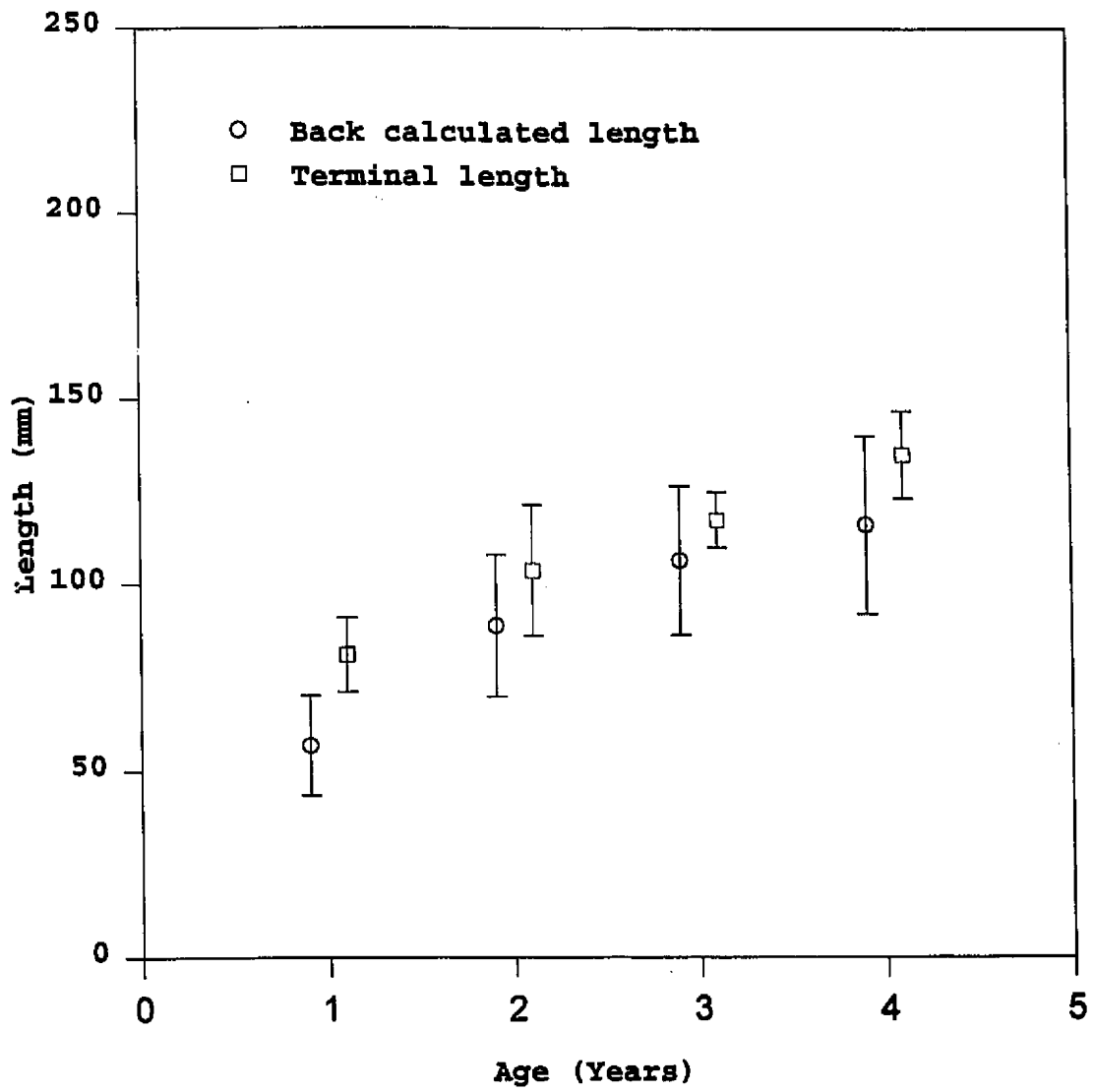

Figure 3-8: Comparison of mean back calculated and mean terminal length at age for cunner, *T. adspersus* collected at Appledore Island, Maine. The bars represent the standard deviation of the mean. Data for this plot combine the male and female back calculated lengths at age shown in table 3-5 in addition to fish of undetermined sex.



higher value compared to the mean back calculated lengths at age. However, this difference could not be statistically tested since the majority of fish from the Maine site were of undetermined sex.

The mean back calculated lengths at age were used to construct growth curves of male and female cunner from Gadd's Harbour and Norris Point sites, both in Bonne Bay, Newfoundland (Fig. 3-9) and Broad Cove located in Conception Bay, Newfoundland (Fig 3-10). The cunner from Appledore Island, Maine, were collected in October. Their gonads were small and difficult to identify thus making subsequent identification of sex impossible in many cases. As a consequence, the mean back calculated lengths at age of pooled sexes were used (Fig. 3-11). In all locations, there was a trend for male cunner to have a longer age-specific length than did female cunner.

The growth rates, for male and female cunner from Norris Point and Gadd's Harbour in Bonne Bay, were significantly different (Tables 3-6 and 3-7). There was a significant difference between locations in length frequencies ( $D=2.74$   $p<0.05$ ) (Fig.3-12). However, the age frequency in these populations (terminal age) did not differ significantly ( $D=0.88$ ,  $p=0.38$ ) (Fig.3-13).

The growth curves for cunner from the east coast (Broad Cove) and west coast (Norris Point) of Newfoundland are shown in Fig. 3-14. The growth rates of females from Broad Cove

Figure 3-9: Growth curves using back calculated mean length at age data of male and female cunner, *T. adspersus*, collected at the Bonne Bay sites (Norris Point and Gadd's Harbour).

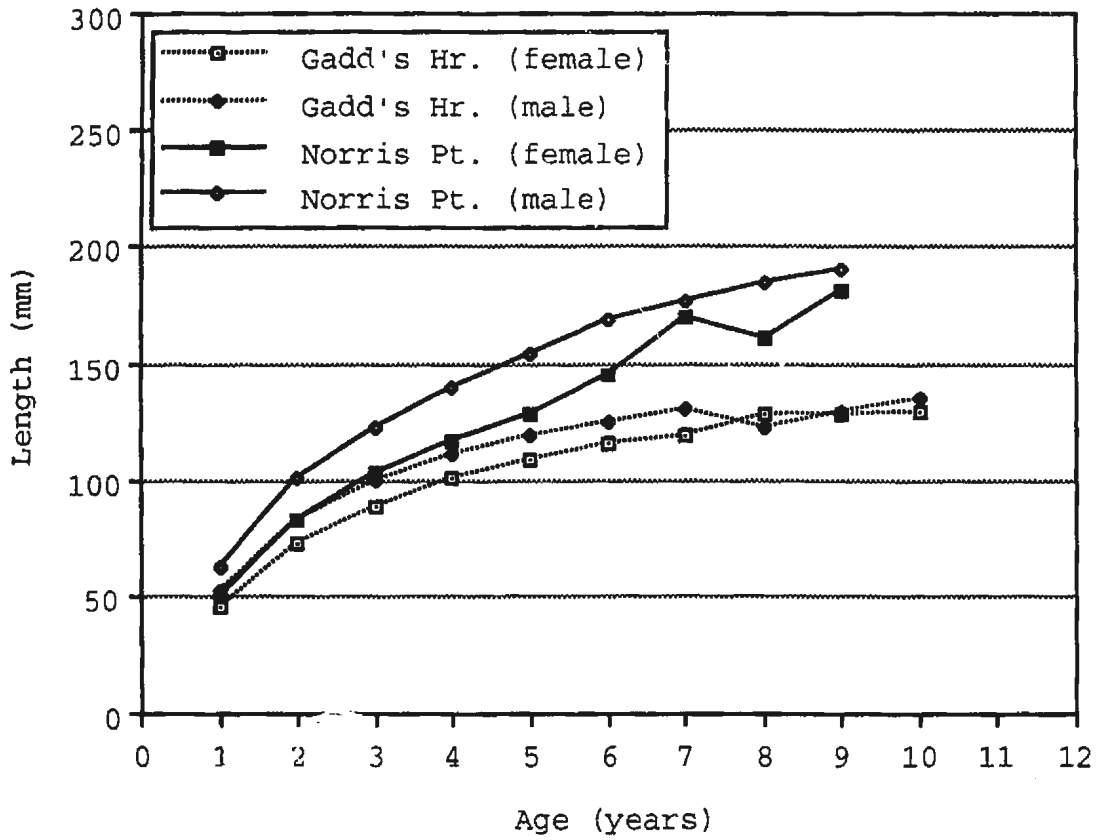

Figure 3-10: Growth curves using back calculated mean length at age data of territorial male, non-territorial male, and female cunner, *T. adspersus*, collected in Broad Cove, Newfoundland.

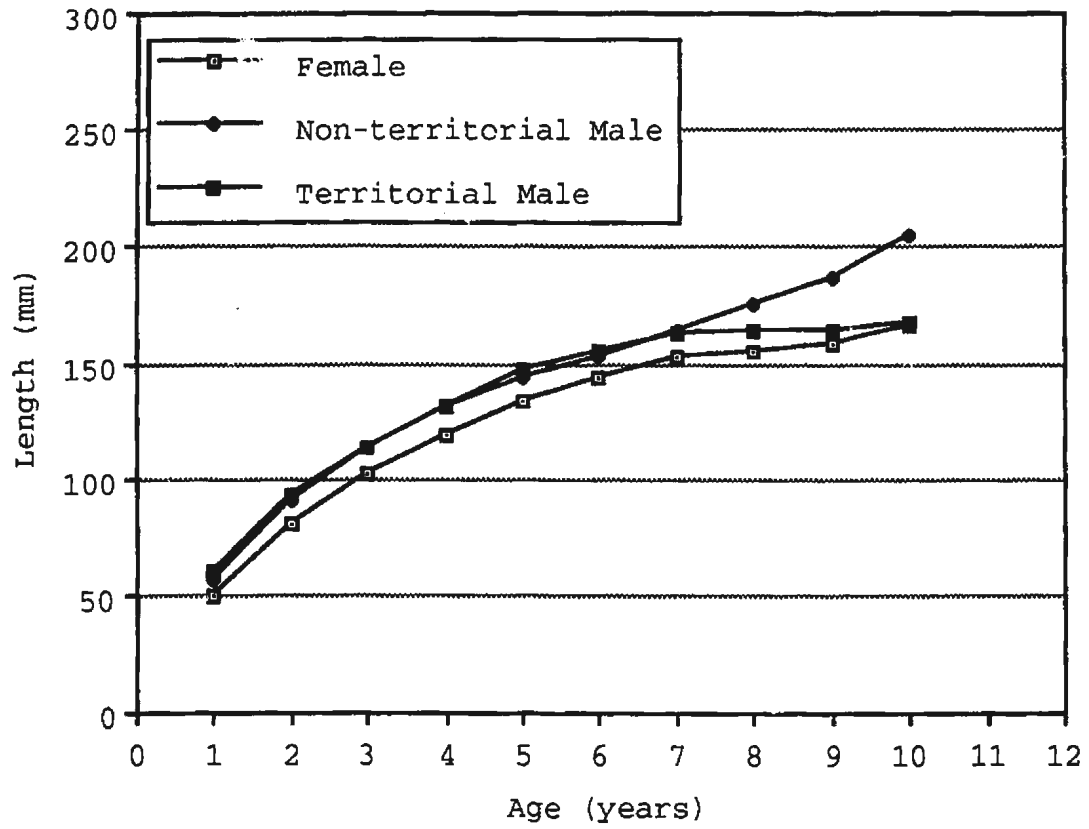



Figure 3-11: Growth curve using back calculated mean length at age data for cunner, *T. adspersus*, collected in Appledore Island, Maine. Sexes were combined.

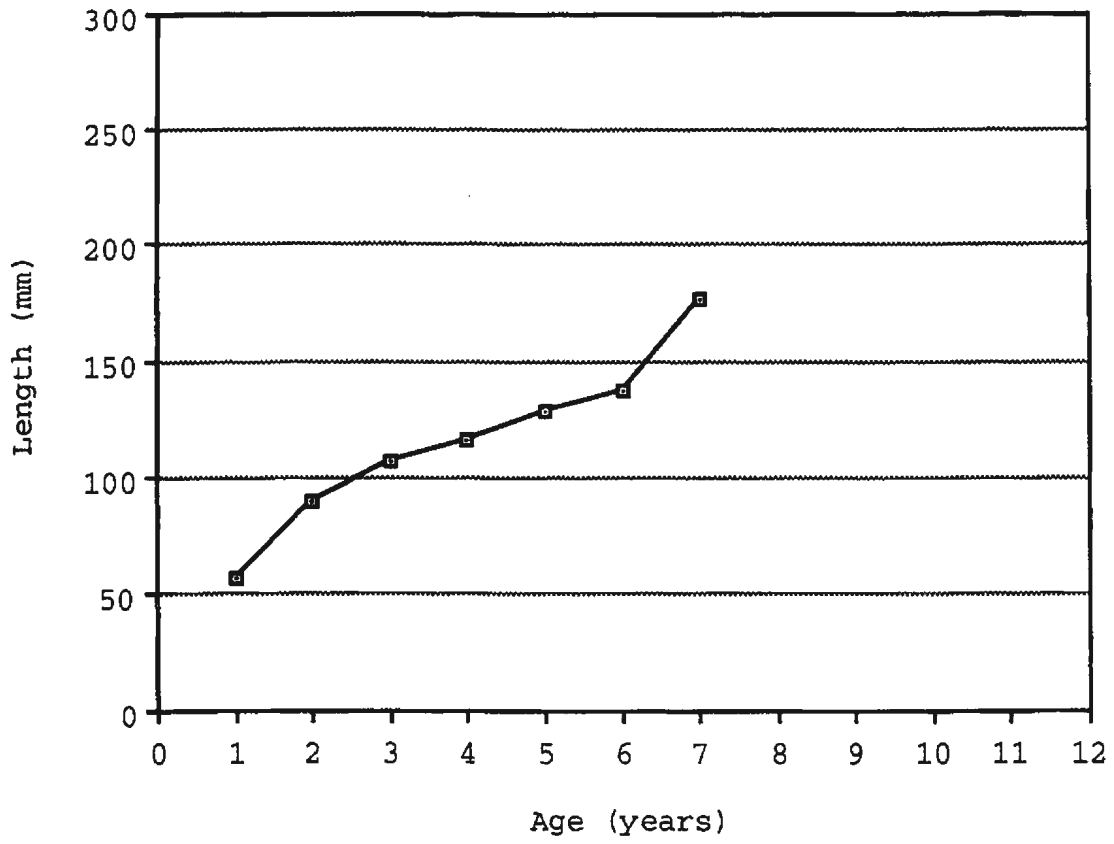

Table 3-6: Analysis of covariance examining length at age of male cunner, *T. adspersus*, collected in Bonne Bay (Norris Point and Gadd's Harbour). \*, \*\*, \*\*\* indicates significance at the  $P < 0.05$ ,  $0.01$ , and  $0.001$  levels, respectively.

Source	DF	SS	MS	F	
Age	1	5.2881	5.2881	1039.96	***
Site	1	0.0798	0.0798	15.68	***
Age X Site	1	0.0245	0.0245	4.81	*
Error	267	1.3577	0.0051		

Table 3-7: Analysis of covariance examining length at age for female cunner, *T. adspersus*, collected at Bonne Bay (Norris Point and Gadd's Harbour). \*, \*\*, \*\*\* indicates significance at the  $P < 0.05$ , 0.01, and 0.001 levels, respectively.

Source	DF	SS	MS	F
Age	1	11.9252	11.9252	1917.81 ***
Site	1	0.0318	0.0318	5.65 **
Age X Site	1	0.0518	0.0518	8.33 **
Error	549	3.4138	0.0062	

Figure 3-12: Length frequency distribution of cunner, *T. adspersus*, collected during 1992 and 1993.

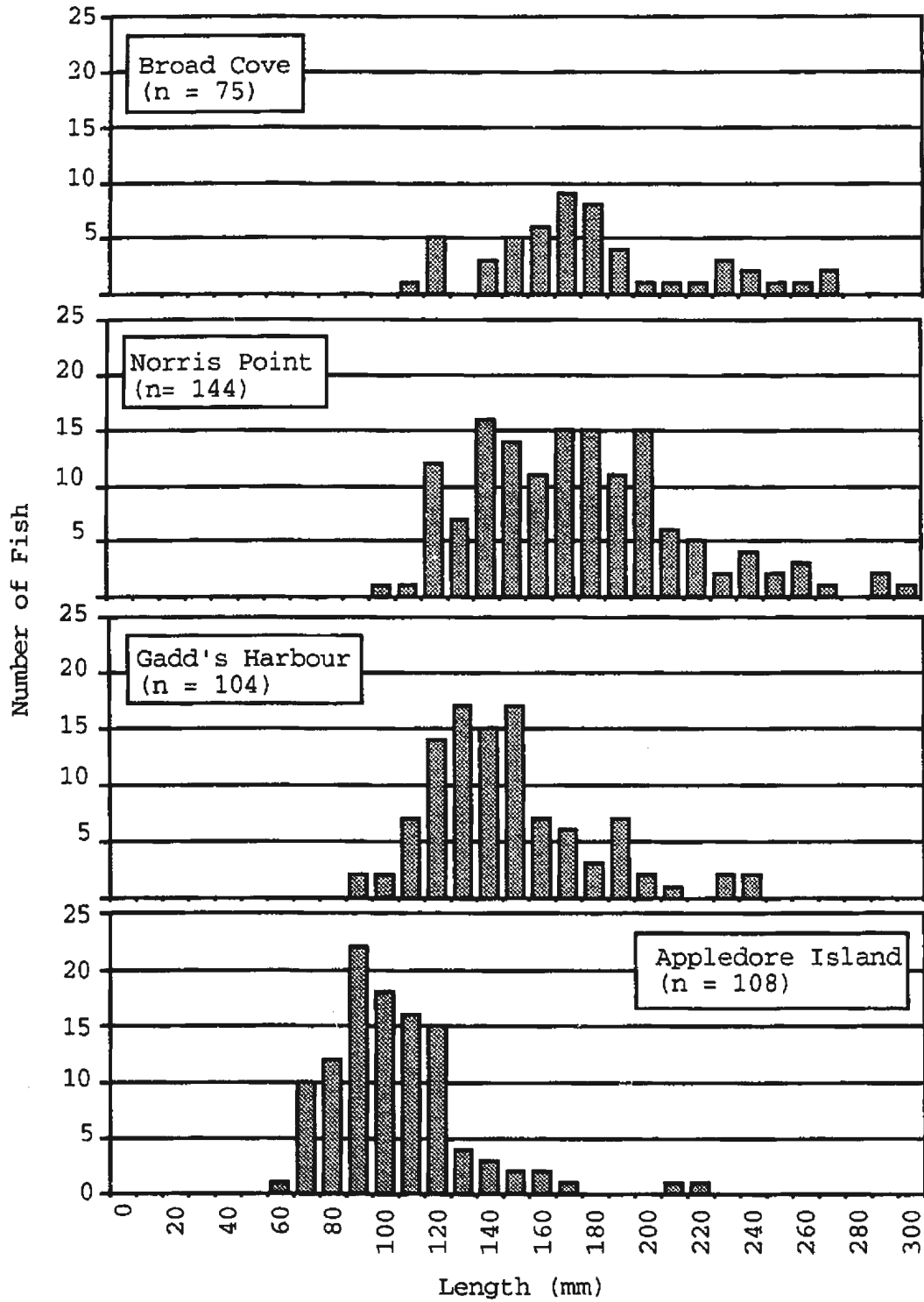

Figure 3-13: Age frequency distribution of cunner, *T. adspersus*, collected during 1992 and 1993.

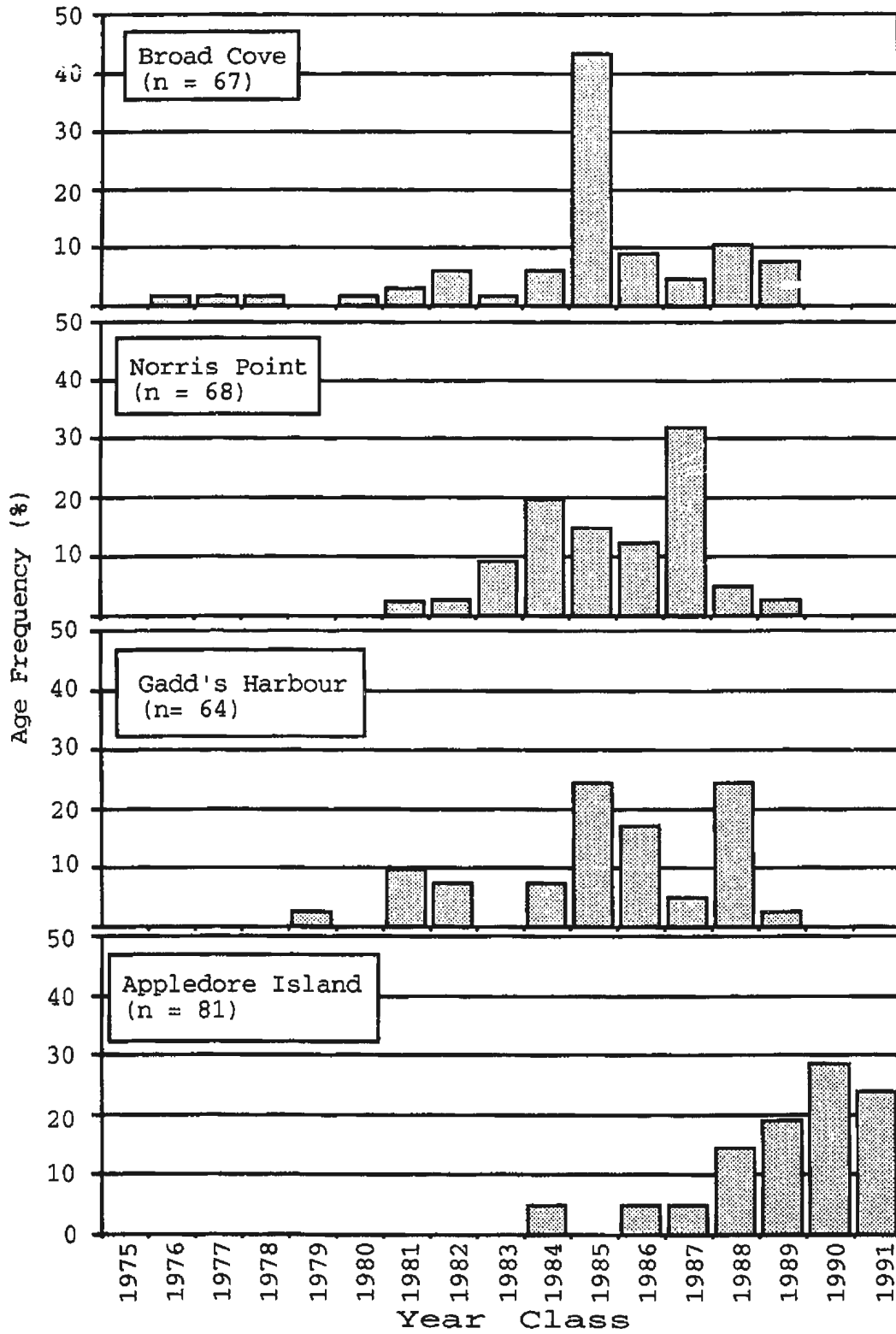
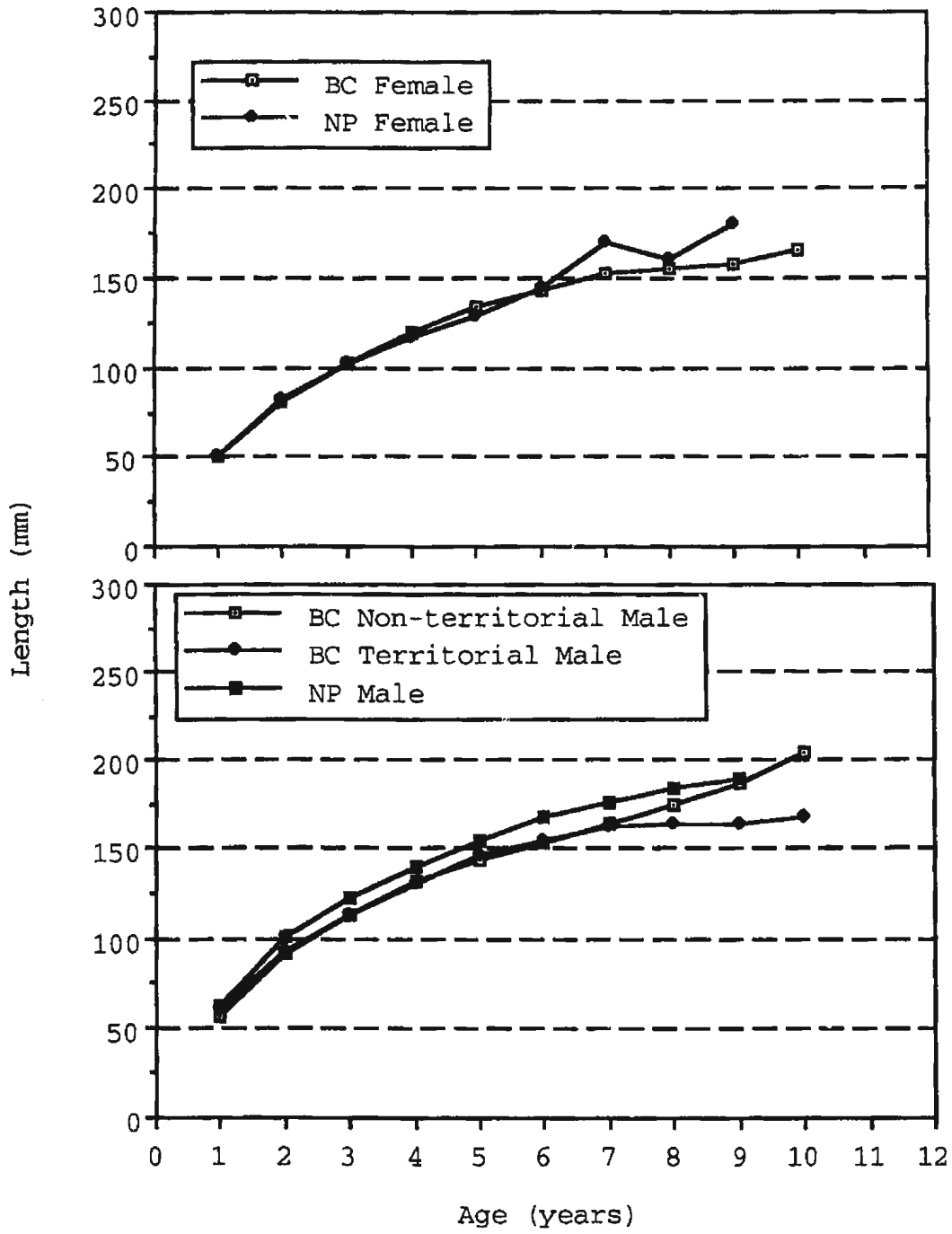



Figure 3-14: Growth curves using back calculated mean length at age data of male and female cunner, *T. adspersus*, collected from Norris Point and Broad Cove, Newfoundland.



and Norris Point were not significantly different (Table 3-8). However, there was a significant difference in growth rate among the territorial male, non-territorial male and group spawning male cunner (Table 3-9). Further analysis showed no significant difference between the non-territorial males from Broad Cove and group spawning males from Norris Point ( $p < 0.05$ ). Similarly, there was no difference between the non-territorial males from Broad Cove and the group spawning males from Norris Point ( $p < 0.05$ ). A significant difference did exist between the non-territorial male and territorial male cunner from Broad Cove ( $p > 0.05$ ). There was no significant difference between the Broad Cove and Norris Point populations in age frequencies (Fig.3-12;  $D=1.37$ ,  $p=0.17$ ) or length frequency (Fig.3-13;  $D=0.69$ ,  $p=0.49$ ). Growth curves for cunner from the four sites using mean back-calculated lengths at age are plotted in Figure 3-15.

Sex ratios were not statistically different among locations ( $\chi^2=1.899$ ;  $df\ 3$ ;  $p=0.594$ ) (Table 3-10). The length (TL)-to-somatic weight (SWT) relationship also did not differ significantly between sexes or among location (Table 3-11). In addition, the histogram of residuals was normal and the residuals were not associated with the model.

Table 3-8: Analysis of covariance examining length at age for female cunner, *T. adspersus*, collected in Norris Point and Broad Cove. \*, \*\*, \*\*\* indicates significance at the  $P < 0.05$ , 0.01, and 0.001 levels, respectively.

Source	DF	SS	MS	F
Age	1	13.8202	13.8202	2689.36 ***
Site	1	0.0014	0.0014	0.28 N.S.
Age X Site	1	0.0003	0.0003	0.06 N.S.
Error	595	3.0576	0.0051	

Table 3-9: Analysis of covariance examining length at age of non-territorial male and territorial male cunner from Broad Cove and male cunner, *T. adspersus*, from Norris Point. \*, \*\*, \*\*\* indicates significance at the  $P < 0.05$ , 0.01, and 0.001 levels, respectively.

Source	DF	SS	MS	F
Age	1	13.7939	13.7939	3173.38 ***
Status	2	0.0679	0.0339	7.81 ***
Age X Status	2	0.0311	0.0156	3.58 *
Error	710	3.0862	0.0043	

Figure 3-15: Growth curves using back calculated mean length at age data of cunner (sexes combined) from Appledore Island, ME, Broad Cove, NF, Norris Point, NF, and Gadd's Harbour, NF.

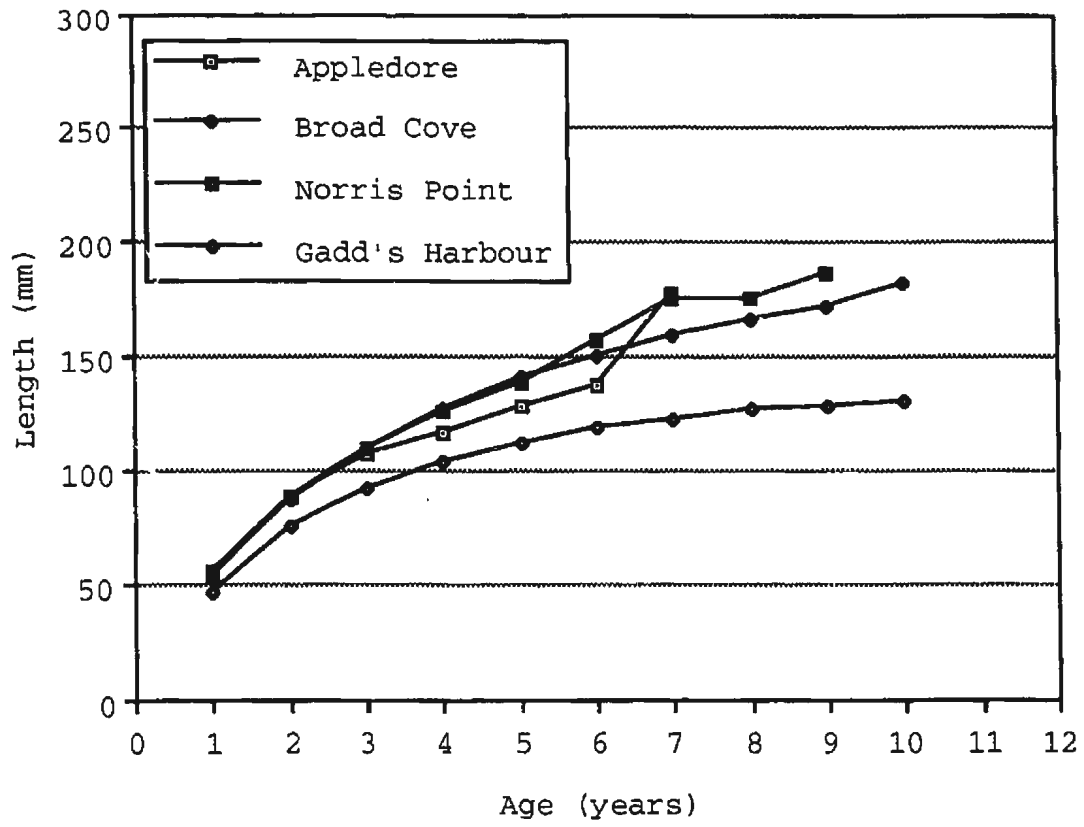

Table 3-10: Chi-square test for sex ratio difference among populations of cunner, *T. adspersus*. Expected counts are in parenthesis below observed counts.  $\chi^2 = 1.899$ ,  $df = 3$ ,  $p\text{-value} = 0.594$ .

	Male cunner	Female cunner	Total
Broad Cove	31 (26.77)	44 (48.23)	75
New Hampshire	5 (5.71)	11 (10.29)	16
Gadd's Harbour	33 (37.12)	71 (66.88)	104
Norris Point	52 (51.40)	92 (92.6)	144
Total	121	218	339



Table 3-11: Analysis of covariance examining the length/weight relationship of cunner, *T. adspersus*, between sexes and among locations. \*, \*\*, \*\*\* indicates significance at the  $P < 0.05$ , 0.01, and 0.001 levels, respectively.

	DF	SS	MS	F	
Log(TL)	1	16.3091	16.3091	1.1E+04	***
Location	2	0.0078	0.0039	2.64	N.S.
Sex	1	0.0009	0.0009	0.62	N.S.
Location X log(TL)	2	0.0081	0.0041	2.77	N.S.
Sex X log(TL)	1	0.0009	0.0009	0.65	N.S.
Location X sex	2	0.0035	0.0018	1.19	N.S.
Location X sex X log(TL)	2	0.0032	0.0016	1.08	N.S.
Error	243	0.3572	0.0015		

### 3.5 Gonadosomatic Index

Gonadosomatic index and terminal length were negatively correlated for male cunner from both Bonne Bay sites, namely Norris Point and Gadd's Harbour, while no significant relationship existed between gonadosomatic index and length for non-territorial male fish collected in Broad Cove (Fig. 3-16). The length at age 5 for male fish from Bonne Bay was also negatively correlated with gonadosomatic index (Fig. 3-17; Gadd's Harbour,  $r=-0.72$ ,  $p<0.001$ ; Norris Point,  $r=-0.64$ ,  $p<0.01$ ) while no significant relationship existed for non-territorial males from Broad Cove ( $r=0.03$ ,  $p>0.05$ ).

There was no significant correlation between gonadosomatic index and length for females from Broad Cove, Norris Point or Gadd's Harbour (Fig. 3-18). Likewise, no correlation existed between female cunner at age 5 and gonadosomatic index (Fig. 3-19).

### 3.6 Von Bertalanffy Growth

The von Bertalanffy growth parameters (Table 3-12) varied greatly among and within locations. The L-infinity was smallest in the slower growing Gadd's Harbour location with estimated values of 132.3 mm and 133.4 mm for male and female cunners respectively. The highest L-infinity value

Figure 3-16: Gonadosomatic indexes for male cunner, *T. adspersus*, from Broad Cove, Norris Point, and Gadd's Harbour, Newfoundland. Collections from Broad Cove consist of non-territorial males.

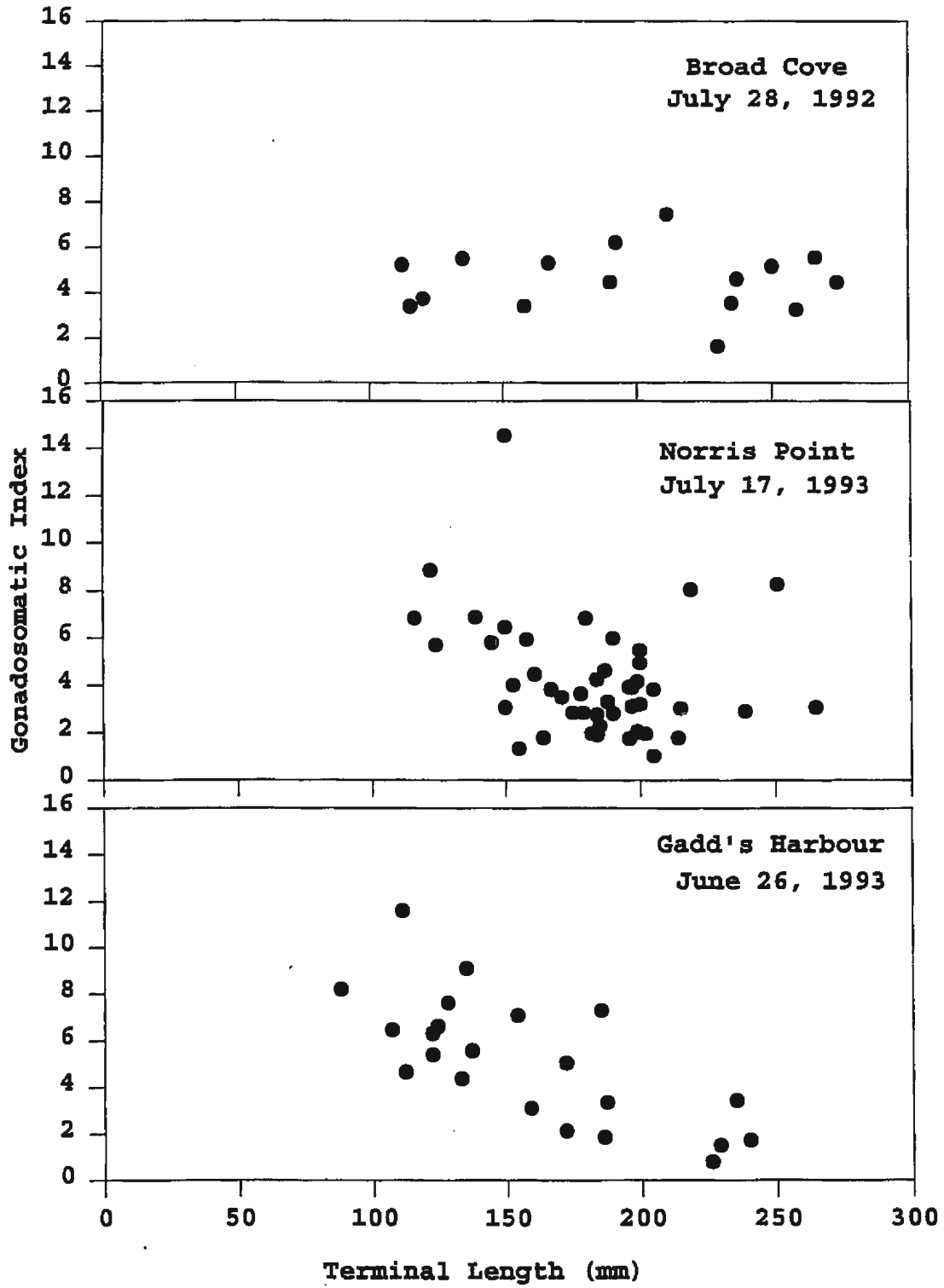

Figure 3-17: Gonadosomatic indexes for male cunner, *T. adspersus*, from Broad Cove, Norris Point, and Gadd's Harbour, Newfoundland, using back calculated lengths at age 5. Collections from Broad Cove consist of non-territorial males.

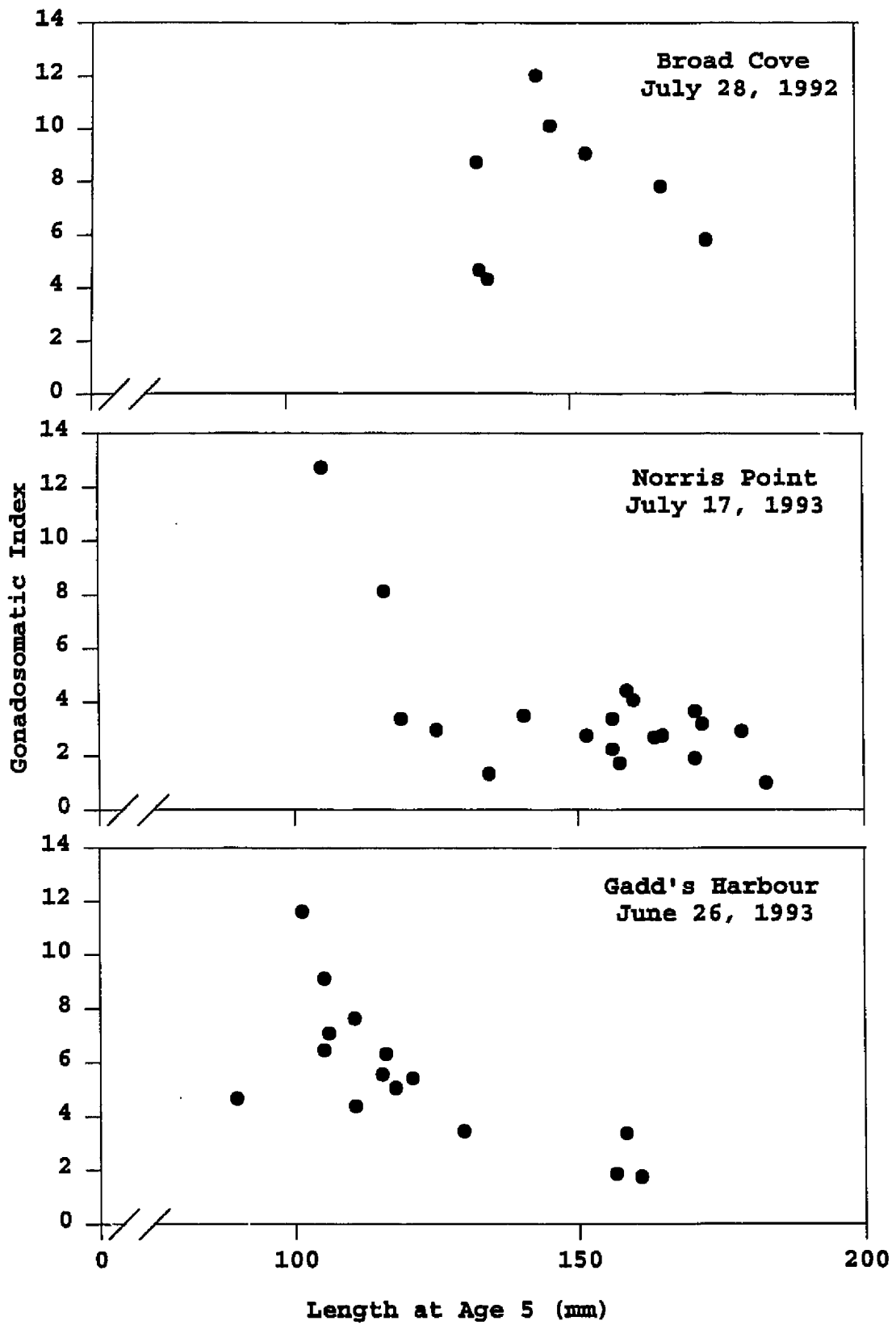

Figure 3-18: Gonadosomatic indexes for female cunner, *T. adspersus*, from Broad Cove, Norris Point, and Gadd's Harbour, Newfoundland.

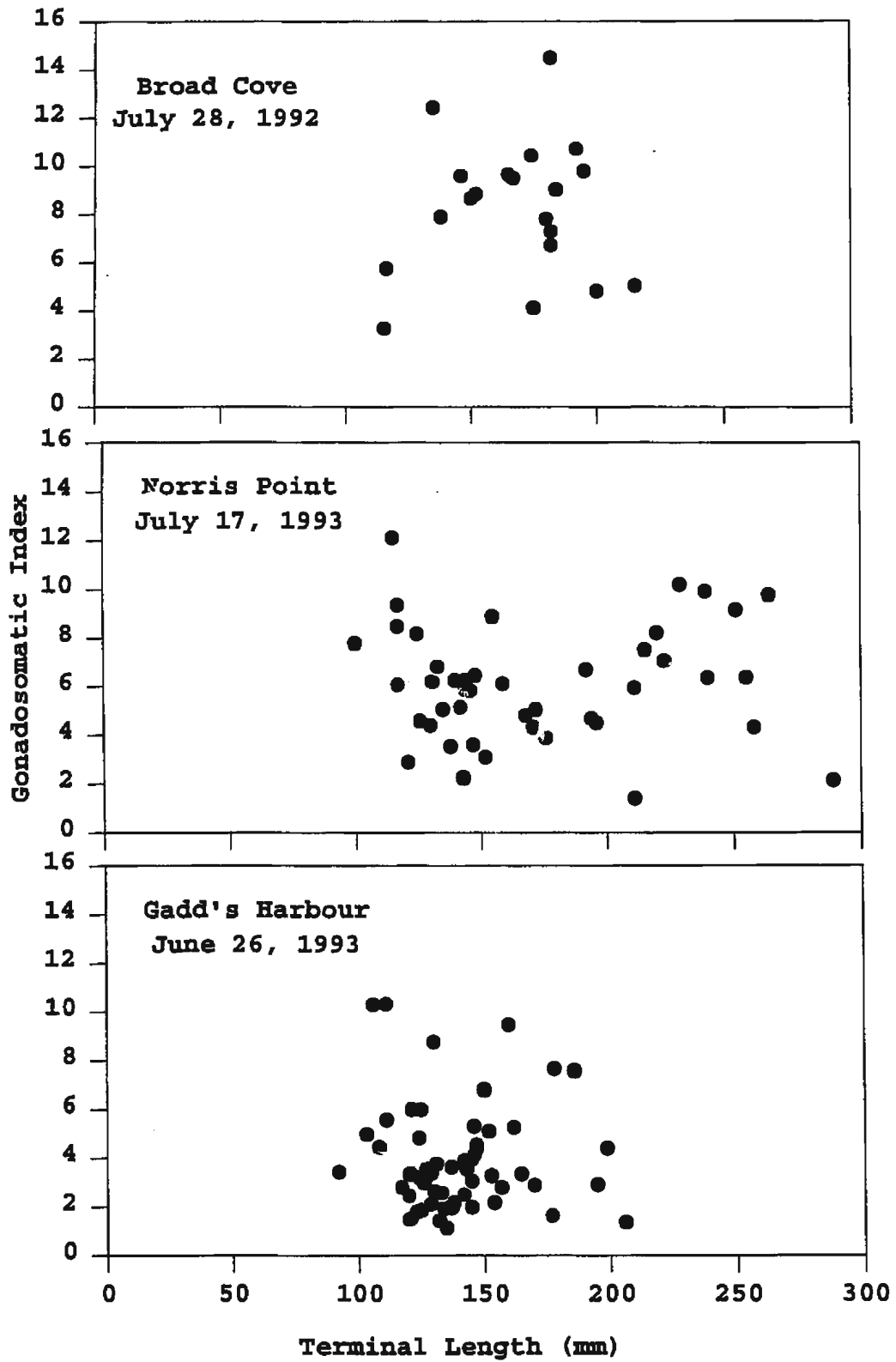



Figure 3-19: Gonadosomatic indexes for female cunner, *T. adspersus*, from Broad Cove, Norris Point, and Gadd's Harbour, Newfoundland, using back calculated lengths at age 5.

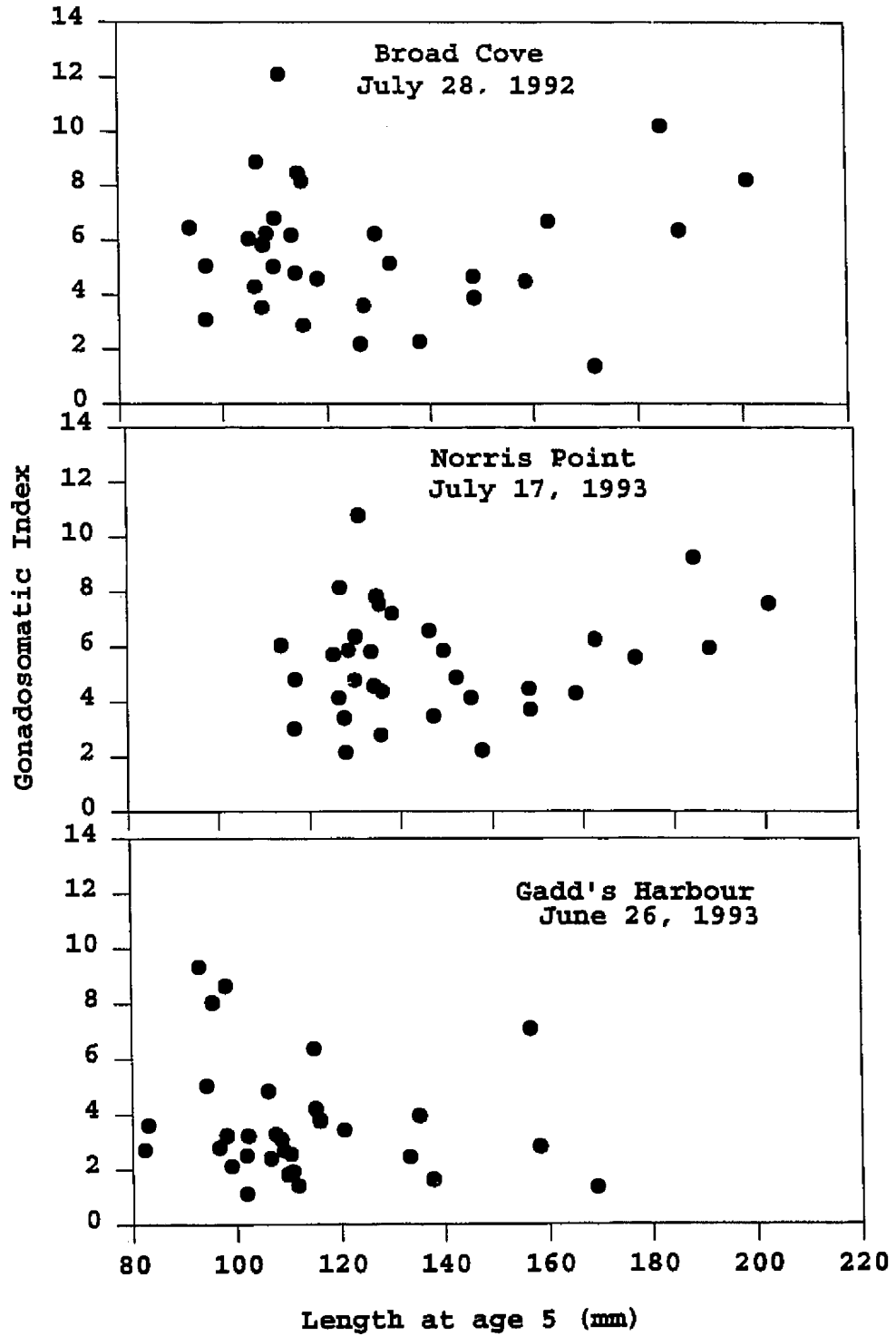

Table 3-12: Estimated von Bertalanffy growth parameters for territorial male (TM), non-territorial male (NTM), group spawning male (GM) and female (F) cunner, *T. adspersus*, collected in Bonne Bay and Broad Cove, Newfoundland, and Appledore Island, Maine.

Location	Sex	Linf.	K	To
Broad Cove	NTM	244.3	0.15	-0.98
Broad Cove	TM	174.6	0.34	-0.23
Broad Cove	F	175.2	0.27	-0.24
Gadd's Harbour	GM	132.3	0.45	-0.12
Gadd's Harbour	F	133.4	0.33	-0.28
Norris Point	GM	208.0	0.26	-0.45
Norris Point	F	211.6	0.18	-0.56
Appledore Island	GM and F	153.3	0.33	-0.54

recorded among the Newfoundland locations was 244.3 mm for Broad Cove non-territorial males.

## Discussion

### 4.1 Validation of Annular Checks

Opaque zones on the sagittal otoliths, when viewed with transmitted light, were validated as annular increments of fast growth by injecting fish with oxytetracycline hydrochloride (OTC). Otoliths from recaptured fish had a fluorescent ring indicating the time of injection. Therefore, the banding pattern outside of the fluorescent ring represented the growth patterns post-injection prior to recapture.

While OTC was effective in producing a fluorescent ring, the intensity of fluorescence varied among the otoliths examined. This variation may have been due to the injection dosages that were chosen based on data from other species such as sablefish, *Anoplopoma fimbria* (McFarlane and Beamish, 1987), brook trout, *Salvelinus fontinalis* (Hall, 1991), and American eel, *Anguilla anguilla* (Dekker, 1986, 1989). Despite some variation in intensity, all otoliths from injected and recaptured cunner had a distinct fluorescent band. Therefore, the concentration of 75 mg·kg<sup>-1</sup> fish can be considered an appropriate dosage for cunner and is recommended in future studies.

A factor that can affect the intensity of fluorescence is the tendency of OTC marks to degrade when exposed to light

(Hall, 1991). To avoid this possible confounding factor, otoliths were stored in the dark. Therefore, this should not have been a factor in the present study.

In addition to validating the occurrence of annuli, OTC injection provided information on the timing of the formation of annuli. As previously stated, the annular checks are the interface between the slow and fast growing bands. For fish injected in June, the OTC ring was located outside of an annular check and a small opaque band was observed between the annular check and fluorescent ring. This pattern indicates growth for the season began prior to injection. Therefore, the annulus was not associated with reproduction but with the slow growth during winter torpor. If the deposition of annuli is similar in other hard structures, such as scales, then Serchuk and Cole (1974), working with scales, may have misinterpreted the timing of the formation of annular checks in the cunner they examined since they suggested that annulus formation coincided with the beginning of spawning.

#### **4.2 Cunner Growth**

Since the otolith aging technique was shown to be valid, it was used to compare the growth of cunner from several geographical sites and behavioural and sexual groups. Back calculated and terminal length data for individual sites were

similar for the Newfoundland populations. The mean terminal length for cunner from Appledore, Maine, however, was greater at age than the mean back calculated length. Since these fish were collected in October and the back calculated lengths did not take into account the last or terminal year's growth, this result is not surprising. Terminal length would be expected to be greater than back calculated lengths and, for individual fish. The additional length should be relatively close to the mean annual increment of an additional years growth as was the case.

It was hypothesized that, due to similar environmental factors, populations from sites in close proximity would exhibit similar growth rates for individual fish. The Bonne Bay sites, Gadd's Harbour and Norris Point, are approximately 1.5 km apart. It is known that for cunner, fertilization of the planktonic eggs is external, and that settlement of the planktonic larvae occurs 3-4 weeks after hatching (J.M. Green, Memorial University of Newfoundland, pers. obs.). Populations in Bonne Bay are therefore likely to be part of a single genetic pool. Since cunner activity is cued by water temperature, the period of torpor and of growth is also similar for these two populations. Surprisingly, the growth rates of the populations at these Bonne Bay sites were significantly different, with the Gadd's Harbour fish exhibiting slower growth than Norris Point fish. From the age and length frequencies, it was apparent that length

frequency differences between fish at the two sites were not due to a difference in age structure. Rather, fish were significantly smaller at age in Gadd's Harbour than at Norris Point ( $p < 0.05$ ). Therefore, differences in growth rates among Newfoundland populations of cunner are not necessarily related to differences in water temperature. Even though the mean density of cunner was similar in Gadd's Harbour and Norris Point, there may be a greater concentration of cunner at the Gadd's Harbour site (R. Hooper, Memorial University of Newfoundland, pers. obs.) Whether a combination of cunner density and food availability, or food availability alone, produced the differences in growth rates in Gadd's Harbour and Norris Point is not clear. Further study is needed to answer this question.

The Norris Point and Broad Cove sites were chosen for growth comparison based on differences in the spawning behaviour of the cunner (i.e. group spawning in Bonne Bay vs pair spawning in Broad Cove). Gravel (1987) compared terminal lengths at age of cunners at these sites and found that Norris Point female cunner were smaller than those from Broad Cove. In the present study, the growth rates of females from Broad Cove and Norris Point were not significantly different based on back calculated growth ( $p < 0.05$ ). The differences in growth that were found for male cunner were not between the pair spawning and group spawning populations as was hypothesized, but instead, between the two



types of males (territorial and non-territorial) at Broad Cove. The growth rate of Norris Point males was not significantly different from either the growth of territorial or non-territorial males from Broad Cove. Rather, growth rates were intermediate between the other two locations.

In Broad Cove, even though the growth rate of non-territorial males is greater than that of territorial males, based on the first ten years of growth, the territorial males were larger at age for the first two years. However, this difference was not statistically significant. The acquisition of a territory is presumably difficult for any individual male. There are limited numbers of territories and many, if not most, surviving territorial cunner re-occupy the same territory year after year (Pottle, 1979). Consequently, it would be adaptive for non-territorial male cunner to increase in size as rapidly as possible, since a larger size would most likely increase the chances of acquiring an available territory. However, size alone is clearly not sufficient to insure acquisition of a territory. Some territorial males are smaller than the largest non-territorial males (Gravel, 1987; J.M. Green, Memorial University of Newfoundland, pers. comm.). Also, it has been shown that territorial males, removed from their territory for several days, are able to displace larger males when returned to their territory (J. Green, unpublished data).

The number of years a territory can be maintained by the same individual is not known, but cunner are long lived and if a territory is held by an individual for a number of years, this should have a negative effect on its growth relative to non-territorial males. That this is true is indicated by the fact that the mean annual increment for territorial male cunner is greatly reduced after age seven compared with the non-territorial males.

There was no correlation between gonadosomatic index and length for the Broad Cove non-territorial male cunner but there was a significant negative correlation for both Norris Point and Gadd's Harbour males. Jennings and Philipp (1992) reported that greater reproductive investment can contribute to reduced somatic growth in the longear sunfish, *Lepomis megalotis*. The negative relationship between gonadosomatic index and length for male cunner from both Bonne Bay sites is an indication of a tradeoff between somatic and gonadal growth. That this is not the case for the male cunner from Broad Cove is not surprising since no group spawning has ever been observed at that location. Since the non-territorial males rarely participate in spawning, it would be non-adaptive for these fish to make a large investment in gonads at the expense of somatic growth when the latter might be the determining factor in acquiring a territory.

The gonadosomatic index values for the present study had a mean value below that reported by Gravel (1987) and that

measured by Green (unpublished data). These differences in the gonadosomatic index values are likely due to time of sampling. The gonadosomatic index will be highest just prior to spawning. Pottle et al. (1981) observed 26 distinct spawning acts in 2h 10min on July 11, 1980 indicating that spawning can be intensive. If the sampling for the present study occurred after spawning had commenced, gonadosomatic index values would be lower than if spawning had occurred just prior to spawning. In addition, Gravel (1987) used eviscerated weights to calculate gonadosomatic indices which, due to technique alone, produces higher values compared to the present study.

Unlike male cunner from Bonne Bay, whose growth was inversely correlated with gonadal investment, no such trend existed for female cunner from any site. Previous studies have shown that female growth may not follow the same trend as growth in male fish. Jennings (1991) noted, for example, that female longear sunfish did not invest energy into gonads at the cost of somatic growth even though this tradeoff was evident in males. Likewise, Schultz and Warner (1991) observed that in female bluehead wrasse, *Thalassoma bifasciatum*, all significant correlations of fecundity and growth rate were positive, contradicting the predicted tradeoff. An advantage of greater size for female fish is an increase in fecundity. However, this increased fecundity may not be as important in a long-lived species such as the

cunner. This may be particularly true for populations with episodic recruitment as appears to be the case for Newfoundland cunner (P.S. Levin, Texas A&M, unpublished data).

Gravel (1987) found evidence to suggest the presence of two reproductive/growth tactics for male cunner from Bonne Bay. In this study, the negative relationship between gonadosomatic index and growth indicates a tradeoff is present in these populations. Group spawning populations, such as those at Norris Point and Gadd's Harbour, may be comprised of both fast and slow growing males. Faster growing, larger males may play a role in initiating spawning runs and these would be the males likely to acquire a territory if conditions were suitable. The slower growing, higher GSI males may join in spawning runs initiated by the larger males, with the result that they have equal fertilization success as the larger males.

Pottle et al. (1981) described territorial cunner from South Gull Rock, approximately 5 km from Norris Point. This raises the possibility that the faster growing, lower GSI, male cunner from Norris Point move into deeper waters or along the coast into areas favorable for establishing territories. However, it remains an unresolved question as to whether some presumptive males move away from Norris Point.

Population density in labrids has been shown to have an important effect on social interactions among individuals of a population. Several labrids, such as *Coris julis* (Lejeune, 1987), the California sheephead, *Semicossyphus pulcher*, (Cowen, 1990), and the bluehead wrasse (Warner and Swearer, 1991) are protogynous hermaphrodites. Populations of bluehead wrasse consist of females, small gonochoristic males referred to as initial phase males and large, terminal phase males. Some of the terminal phase males are a result of sex change by the largest females. In low density populations, terminal phase territorial males defend spawning sites and exclude non-territorial initial phase males from the mating process. Only pair spawning is observed under these conditions. In contrast, at high population densities, the proportion of initial phase males is thus higher enabling these males to take over the mating sites. Under these conditions, initial phase males and females perform group spawns (Warner and Swearer, 1991). In a Mediterranean labrid, *Thalassoma pavo*, a population density increase changed the mating system from only pair spawning to both pair and group spawning (Wernerus and Tessari, 1991).

In this study, the density of adult cunner was highest in the Bonne Bay sites where only group spawning was observed. Levin (unpublished data) found a similar cunner density as the present study at both Broad Cove and Bonne Bay. He also observed that the adult density was higher in

Newfoundland than in the Gulf of Maine. This would suggest that pair spawning should be the reproductive strategy of cunners at the Maine site. However, only group spawning has been reported there (Levin, pers. comm.). If the cunner density estimates are accurate, then other factors must influence which behavioural mating pattern is used.

I observed that adult cunner in Maine were more closely associated with the substrate than were the cunner at the Newfoundland sites. For this reason, it is possible that the adult cunner density at the Maine sites was underestimated. This point can only be resolved with further studies to evaluate the techniques for measuring cunner density.

#### **4.3 Comparison with other Growth Studies**

A comparison was made with past studies using length at age data from Naidu (1966), Serchuk and Cole (1974), Dew (1976), and Gravel (1987) (Fig. 4-1). Naidu (1966) used scales to age fish from many Newfoundland locations, one of which was Broad Cove. His length at age data showed a much faster growth rate than what was observed in this study. Gravel (1987), using otoliths, found growth rates to be much slower than those noted by Naidu (1966), and comparable to those measured in the present study. This indicates that otoliths are a more reliable structure than scales for aging cunner from Newfoundland.

Figure 4-1: Growth curves of cunner, *T. adspersus*, from present and past studies. (A) Aging of *T. adspersus* from Newfoundland [Naidu (1966)], Connecticut [Serchuk and Cole (1974)] and [Dew (1976) males; Dew (1976) females] using scale samples. (B) Aging of *T. adspersus* from Gadd's Harbour, Norris Point, and Broad Cove, Newfoundland and Appledore Island, Maine. CG=C. Gravel (1987); WC=W. Chiasson (present study).

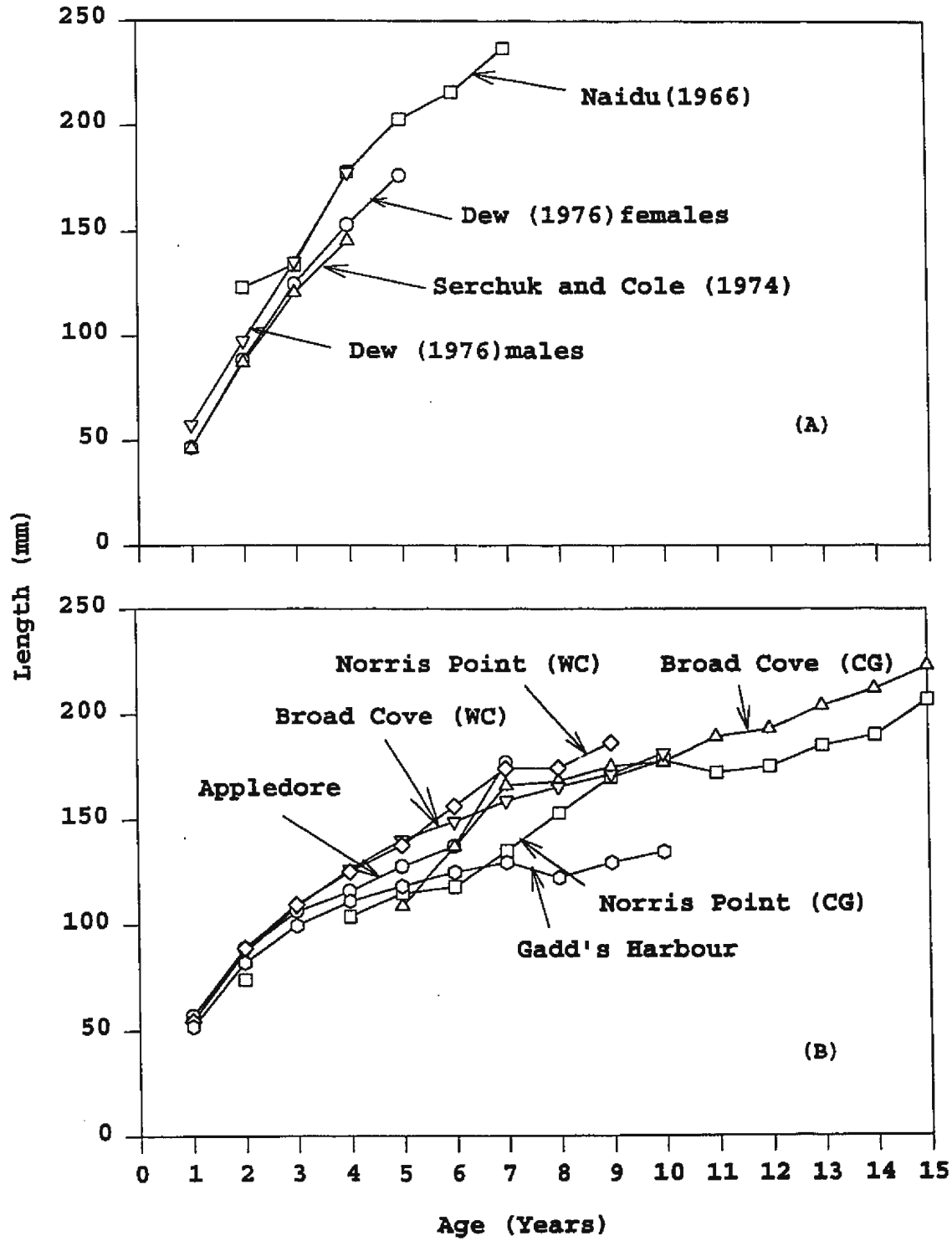



Dew (1976) used scales to back calculate ages for cunner from Fishers Island Sound, Connecticut. The growth of cunner from Connecticut was most similar to that of cunner from Weweantic River estuary (Serchuk and Cole 1974), also based on scales to back calculate lengths at age. The cunner from the Appledore Island, Maine, site were slower growing than either the cunner population studied by Dew (1976) or that studied by Serchuk and Cole (1974). Unfortunately, it is not possible to determine from these data sets whether the use of scales is valid for populations south of Newfoundland. The first few years of back calculated growth are comparable to cunner examined during the present study. In examining length at age data using both scales and otoliths, growth curves seem to be affected more by the aging structure than location (Fig. 4-1).

Interestingly, studies using otoliths to age cunner obtained a slower growth rate than those that used scales. This may be because it is more difficult to distinguish the scale annuli of older fish due to the crowding of circuli. This was the problem identified by Beamish and McFarlane (1983) for white suckers, *Catostomus commersoni*, in which ages were underestimated by half using scales as opposed to fin-rays. This may have also been a problem with the cunner scales aged by Dew (1976) and Serchuk and Cole (1974). Dew (1976) stated that the maximum age for his specimens may have been underestimated due to the difficulty in reading scales

of older fish. Serchuk and Cole (1974) also stated that annular marks were difficult to discern in older fish. It remains an open question whether or not ages determined from scales are valid for cunner from different areas.

It does appear that cunner exhibit some type of growth compensation and or enzymatic adaptation which enable northern populations in lower temperatures to grow as fast as more southern populations. Growth compensation, or the ability of an animal to achieve a normal body weight after a period of restricted diet, has been demonstrated in salmonids and cyprinids (Russell and Wootton, 1992). Another adaptation is shown in the green sunfish, *Lepomis cyanellus*, which has increased activities of some enzymes at different temperatures (Jobling, 1994). The overwintering period of torpor can be up to three months longer in the Newfoundland sites (Green and Farwell, 1971) as compared to cunner from Connecticut (Dew, 1976) and Massachusetts (B. Kelly and R. Lawton, Division of Marine Fisheries, Commonwealth of Massachusetts, pers. comm.). Cunnners become inactive in Newfoundland at 5-6°C (Green and Farwell, 1971). In contrast, the cunner in Connecticut go into torpor at 7-8°C. Despite the difference in length of torpor and environmental temperatures, Newfoundland cunner appear to grow as fast as those further south.

#### 4.4 Foraging and Predation

Foraging habit in response to predation may also affect the growth rate of cunner from different areas. For example, at the Broad Cove site, 10 or more fish may be attracted to a feeding station (consisting of crushed sea urchins or blue mussels), whereas at the Maine location (Appledore Island), fish fed individually at a similar feeding station rather than as members of an aggregation. When not feeding the former fish were usually out in the open while members of the latter type were under shelter. The difference in behaviour may be due to a difference in the risk of predation. Whoriskey (1983) studied the feeding behaviour of cunners at Scituate, Massachusetts and suggested that individual feeding, as I observed in Maine, may be an adaptation to predation. Individuals conducted rhythmic feeding forays over the surrounding area from points of shelter. Olla et al. (1975) observed that cunner in New York aggregated to feeding stations of crushed *Mytilus edulis* in a similar way as did cunner in Newfoundland. However, the cunner they observed restricted their daily movements to within a few meters of their nighttime shelter. Fish often searched the water column while remaining in close proximity to shelter. From the brief description of movements by Olla et al. (1975), and based on the ultrasonic tracking of female cunner in Broad Cove, Newfoundland (Bradbury, 1993), daily

movements of Newfoundland cunner, which experience little predation pressure, appear to be greater than those of populations from New York and Maine where predation risks may be higher. The effect that such a difference in foraging behaviour might have on growth rate in the cunner remains speculative.

#### 4.5 Sex Ratio

There was no significant difference between sex ratios among the different locations; the combined sex ratio was 1M:1.8F. Gravel (1987) also found the sex ratio for cunner collected in Norris Point and Broad Cove to be skewed towards females; 1M:19.1F and 1M:4F, respectively. The high percentage of female cunner collected in Norris Point by Gravel (1987) may have been affected by times of collection which were done throughout the day. To reduce the chances of obtaining biased samples, Warner (1975) collected bluehead wrasse in the morning since spawning, like in the cunner, occurs during the afternoon.

Two other studies of cunner show sex ratios with females outnumbering males: Pottle et al. (1981), 1M:3F, at Norris Point; Pottle and Green (1979a), 1M:1F, at Broad Cove. However, some studies showed the opposite to be true. Dew (1976) noted a sex ratio of 2.2M:1F at Fishers Island Sound, Connecticut, and Naidu (1966) recorded a sex ratio of 2.8M:1F

at Broad Cove, Newfoundland. Some of the discrepancies between sites and studies may have resulted from sex ratios being based on the use of external features and coloration. Determining the sex of cunner from Appledore Island, Maine, was difficult for fish collected in October. This was not the case for fish collected at the same time of year in Newfoundland, which had gonads which were easily identified.

One criteria for hermaphroditism in fishes is a skewed sex ratio (Sadovy and Shapiro, 1987). The sex ratio for protogynous hermaphrodites usually has a larger number of females, such as in the ballan wrasse, *Labrus bergylta*, where the male:female ratio was 0.08:1 (Dipper et al., 1977). One of the strongest indicators of hermaphroditism is the identification of transitional individuals (Sadovy and Shapiro, 1987). To date, no evidence has been provided to suggest that cunners are hermaphroditic despite the sex ratio which favors females. There is an energetic cost for sex reversal (Hoffman et al., 1985) and this may be one of the factors which prevents the cunner from being hermaphroditic.

#### **4.6 Von Bertalanffy Growth**

Using mean length at age data from Serchuk and Cole (1974), the computer program FISHPARM, gave identical values for the three von Bertalanffy constants (i.e. L-infinity, K and  $T_0$ ). Using mean lengths at age from the present study,

similar to what was used by Serchuk and Cole (1974), this computer package should have been appropriate for estimating the von Bertalanffy constants. However, the L-infinity, K and  $T_0$  values were highly variable among the sites. Other growth curves were tested such as the Logistic Growth function and the Gompertz Growth function. In all cases, the constants were quite variable among the different populations. Since the cunner is a slow growing fish, asymptotic levels may have been underestimated. In all locations, L-infinity values have been less than the maximum length of individuals at these sites.

#### **4.7 Future Research**

OTC is a good marker on the otoliths of cunner. A long term study using tetracycline with these long-lived fish could provide greater information on the growth of individual fish, especially if young age groups are selected. Further work using scales in combination with OTC could resolve problems involved with using scales for such a slow growing species.

The differences in growth patterns for cunner in Bonne Bay should be further examined. A more detailed study on food availability and diet should provide some insight onto the growth of cunner from Norris Point and Gadd's Harbour.

Latitudinal growth differences could be further explored by obtaining cunner from a greater number of sites. Also, the collection of specimens just prior to spawning could provide information on gonadal investment for other group spawning populations.

The estimation of cunner density poses a problem due to the differences in behaviour as observed during this study.

### **Conclusions**

- Injection of oxytetracycline hydrochloride demonstrated that an annulus on the sagittal otoliths of cunner consists of one opaque and one hyaline zone.
- There is a general trend in cunner for males to be longer at age than females.
- There can be a large difference in growth patterns in adjacent populations. The reason for this is not known but it does seem not to be due to environmental temperature alone.
- In group spawning cunner populations, males show a negative correlation between gonadosomatic index and somatic growth whereas pair spawning populations do not exhibit this relationship.
- In pair spawning populations, territorial males showed a marked decrease in growth after the age of seven which may correspond to the age at which the acquisition and maintenance of a territory commences.



- There does not appear to be a latitudinal difference in growth rates. This is surprising considering the temperature differences involved and may point to a growth compensation mechanism in cunner.

### Literature Cited

- Anonymous. 1993. Minitab Reference Manual. Sowers Printing Company, Lebanon, PA.
- Anonymous. 1987. Abacus Concepts, StatView II. Abacus Concepts, Inc., Berkeley, CA. 234pp.
- Beamish, R.J. and G.A. McFarlane. 1983. The forgotten requirement for age validation in fisheries biology. Transactions of the American Fisheries Society **112**: 735-743.
- Bigelow, H.B., and S.C. Schroeder. 1953. Fishes of the Gulf of Maine. Fishery Bulletin of the Fish and Wildlife Service. Vol. 53. U.S. Government Printing Office, Washington. 577 pp.
- Bradbury, C. 1993. Ultrasonic tracking of activity and movement patterns of female cunner, *Tautogolabrus adspersus*, in Broad Cove, Conception Bay, Newfoundland. M.Sc. Thesis. Memorial University of Newfoundland, St. John's, Newfoundland.
- Bumguardner, B.W. 1991. Marking subadult red drums with oxytetracycline. Transactions of the American Fisheries Society **120**: 537-540.
- Cailliet, G.M., M.S. Love and A.W. Ebeling. 1986. Fishes: a field and laboratory manual on their structure, identification, and natural history. Wadsworth, Inc. USA. 194 pp.
- Cailliet, G.M., K.G. Yudin, S. Tanaka, and T. Taniuchi. 1990. Growth characteristics of two populations of *Mustelus manazo* from Japan based upon cross-readings of vertebral bands. NOAA Technical Report NMFS **90**: 167-176.
- Cowen, R.K. 1990. Sex change and life history patterns of the labrid, *Semicossphus pulcher*, across an environmental gradient. Copeia **1990(3)**: 787-795.
- Dekker, W. 1986. Age reading of eels using tetracycline labeled otoliths. International Council for the Exploration of the Sea C.M. 1986/M:16. (mimeo.)
- Dekker, W. 1989. Death rate, recapture frequency and changes in size of tagged eels. Journal of Fish Biology **34**: 769-777.

- Dew, C.B. 1976. A contribution to the life history of the cunner, *Tautogolabrus adspersus*, in Fishers Island Sound, Connecticut. Chesapeake Science 17: 101-113.
- Dipper, F.A., C.R. Bridges, and A. Menz. 1977. Age, growth and feeding in the ballan wrasse *Labrus bergylta* Ascanius 1767. Journal of Fish Biology 11: 105-120.
- Fargo, J. and D.E. Chilton. 1987. Age validation for rock sole in Hecate Strait, British Columbia. Transactions of the American Fisheries Society 116: 776-778.
- Frie, R.V. 1982. Measurement of fish scales and back-calculation of body lengths using a digitizing pad and microcomputer. Fisheries 7(6): 5-8.
- Gleason, T.R. and C. Recksiek. 1990. Preliminary field verification of daily growth increments in the lapillar otoliths of juvenile cunners. American Fisheries Society Symposium 7: 562-565.
- Gravel, C.M. 1987. Alternative reproductive tactics and growth of male cunners, *Tautogolabrus adspersus* (Walbaum), in Newfoundland. M.Sc. Thesis. Memorial University of Newfoundland, St. John's, Newfoundland. 85 pp.
- Green, J.M. 1975. Restricted movements and homing of the cunner, *Tautogolabrus adspersus* (Walbaum) (Pisces: Labridae). Canadian Journal of Zoology 53: 1427-1431.
- Green, J.M. and M. Farwell. 1971. Winter habits of habits of the cunner *Tautogolabrus adspersus* (Walbaum, 1792), in Newfoundland. Canadian Journal of Zoology 49: 1497-1499.
- Hall, D.L. 1991. Age Validation and aging methods for stunted brook trout. Transactions of the American Fisheries Society 120: 644-649.
- Hoffman, S.G., M.P. Schildhauer and R.R. Warner. 1985. The costs of changing sex and the ontogeny of males under contest competition for mates. Evolution 39: 915-927.
- Jennings, M.J. 1991. Sexual selection, reproductive strategies, and genetic variation in the longear sunfish (*Lepomis megalotis*). Ph.D. Dissertation. University of Illinois at Urbana-Champaign. Urbana, Illinois. 169 pp.

- Jennings, M.J. and D.P. Philipp. 1992. Reproductive investment and somatic growth rates in longear sunfish. *Environmental Biology of Fishes* **35**: 257-271.
- Jobling, M. 1994. Fish bioenergetics. Chapman and Hall, Inc., New York. 309 pp.
- Lejeune, P. 1987. The effect of local stock density on social behavior and sex change in the Mediterranean labrid *Coris julis*. *Environmental Biology of Fishes*. **18**: 135-141.
- Levin, P.S. 1991. Effects of microhabitat on recruitment variation in a Gulf of Maine reef fish. *Marine Ecology Progress Series* **75**: 183-189.
- Levin, P.S. 1993. Habitat structure, conspecific presence and spatial variation in the recruitment of a temperate reef fish. *Oecologia* **94**: 176-185.
- Martel, G. and J.M. Green. 1987. Differential spawning success among territorial male cunners, *Tautogolabrus adspersus* (Labridae). *Copeia* **1987**: 643-648.
- McFarlane, G.A. and R.J. Beamish. 1987. Selection of dosages of oxytetracycline for age validation studies. *Canadian Journal of Fisheries and Aquatic Sciences* **44**: 905-909.
- Moyle, P.B. and J.J. Cech, Jr. 1988. *Fishes: an introduction to ichthyology*, 2<sup>nd</sup> edition. Prentice Hall, Inc., New Jersey. 559 pp.
- Murphy, M.D. and R.G. Taylor. 1991. Direct validation of ages determined for adult red drums from otolith sections. *Transactions of the American Fisheries Society* **120**: 267-269.
- Naidu, K.S. 1966. The age, growth, distribution and development of the commercially unexploited cunner, *Tautogolabrus adspersus* (Walbaum), in Newfoundland coastal waters. B.Sc. Thesis (honours), Memorial University of Newfoundland, St. John's, Newfoundland. 151 pp.
- Nedreaas, K. 1990. Age determination of Northeast Atlantic *Sebastes* species. *Journal du Conseil International pour l'Exploration de la Mer* **47**: 208-230.

- Odense, P.H. and V.H. Logan. 1974. Marking Atlantic salmon (*Salmo salar*) with oxytetracycline. Journal Fisheries Research Board of Canada **31**: 348-350.
- Olla, B.L., A.J. Bejda, and A.D. Martin. 1975. Activity, movements, and feeding behavior of the cunner, *Tautogolabrus adspersus*, and comparison of food habits with young tautog, *Tautoga onitis*, off Long Island, New York. Fishery Bulletin **73**: 895-900.
- Panfili, J. and M.-C. Ximenes. 1992. Measurements on ground or sectioned otoliths: possibilities of bias. Journal of Fish Biology **41**: 201-207.
- Pearson, D.E., D.A. Douglas, and B. Barss. 1993. Biological observations from the Cobb Seamount rockfish fishery. Fishery Bulletin **91**: 573-576.
- Pedersen, T. and B. Carlsen. 1991. Marking cod (*Gadus morhua* L.) juveniles with oxytetracycline incorporated into the feed. Fisheries Research **12**: 57-64.
- Perryman, W.L. and M.S. Lynn. 1994. Examination of stock and school structure of striped dolphin (*Stenella coeruleoalba*) in the eastern pacific from aerial photogrammetry. Fishery Bulletin **92**: 122-131.
- Pottle, R.A. 1979. A field study of territorial and reproductive behaviour of the cunner, *Tautogolabrus adspersus*, in Conception Bay, Newfoundland. M.Sc. Thesis. Memorial University of Newfoundland, St. John's, Newfoundland. 104 pp.
- Pottle, R.A. and J.M. Green. 1979a. Field observations on the reproductive behaviour of the cunner, *Tautogolabrus adspersus* (Walbaum), in Newfoundland. Canadian Journal of Zoology **57**: 247-256.
- Pottle, R.A. and J.M. Green. 1979b. Territorial behaviour of the north temperate labrid, *Tautogolabrus adspersus*. Canadian Journal of Zoology **57**: 2337-2347.
- Pottle, R.A., J.M. Green and G. Martel. 1981. Dualistic spawning behaviour of the cunner, *Tautogolabrus adspersus* (Pisces: Labridae), in Bonne Bay, Newfoundland. Canadian Journal of Zoology **59**: 1582-1585.
- Prager, M.H., S.B. Saila and C.W. Recksiek. 1987. FISHPARM: a microcomputer program for parameter estimation of nonlinear models in fishery science. Old Dominion University Oceanography Technical Report **87-10**: 18 pp.

- Russell, N.R., and R.J. Wootton. 1992. Appetite and growth compensation in the European minnow, *Phoxinus phoxinus* (Cyprinidae), following short periods of food restriction. *Environmental Biology of Fishes* **34**: 277-285.
- Sadovy, Y., M. Figuerola and A. Roman. 1992. Age and growth of red hind *Epinephelus guttatus* in Puerto Rico and St. Thomas. *Fishery Bulletin U.S.* **90**: 516-528.
- Sadovy, Y. and D.Y. Shapiro. 1987. Criteria for the diagnosis of hermaphroditism in fishes. *Copeia* **1987**: 136-156.
- Schultz, E.T. and R.R. Warner. 1991. Phenotypic plasticity in life-history traits of female *Thalassoma bifasciatum* (Pisces: Labridae): 2. Correlation of fecundity and growth rate in comparative studies. *Environmental Biology of Fishes* **30**: 333-344.
- Scott, W.B. and M.G. Scott. 1988. Atlantic Fishes of Canada. *Canadian Bulletin of Fisheries and Aquatic Sciences* **219**: 731 p.
- Secor, D.H., M.G. White and J.M. Dean. 1991a. Immersion marking of larval and juvenile hatchery-produced striped bass with oxytetracycline. *Transactions of the American Fisheries Society* **120**: 261-266.
- Secor, D.H., J.M. Dean, and E.H. Laban. 1991b. Manual for otolith removal and preparation for microstructural examination. Electric Power Research Institute and Belle W. Baruch Institute for Marine Biology and Coastal Research. University of South Carolina, Columbia, South Carolina. 85 pp.
- Serchuk, F.M. and C.F. Cole, 1974. Age and Growth of the cunner, *Tautoglabrus adspersus* (Walbaum) (Pisces: Labridae) in the Weweantic River estuary, Massachusetts. *Chesapeake Science* **15**: 205-213.
- Sokal, R.R. and F.J. Rohlf. 1981. *Biometry*, 2<sup>nd</sup> edition. W.H. Freeman and Company, New York. 859 pp.
- Warner, R.R. 1975. The adaptive significance of sequential hermaphroditism in animals. *American Naturalist* **109**: 61-82.

- Warner, R.R., and D.R. Robertson. 1978. Sexual patterns in the labroid fishes of the western Caribbean, I: The wrasses (Labridae). *Smithsonian Contrib. Zool.* **254**: 1-27.
- Warner, R.R., and S.G. Hoffman. 1980. Population density and the economics of territorial defense in a coral reef fish. *Ecology* **61**: 772-780.
- Warner, R.R., and S.E., Swearer. 1991. Social control of sex change in the bluehead wrasse, *Thalassoma bifasciatum* (Pisces: Labridae). *Biological Bulletin* **181**: 199-204.
- Weber, D.D., and G.J. Ridgway. 1962. The deposition of tetracycline drugs in bones and scales of fish and its possible use for marking. *The Progressive Fish-Culturalist* **24(4)**: 150-155.
- Weber, D., and G.J. Ridgway. 1967. Marking Pacific salmon with tetracycline antibiotics. *Journal Fisheries Research Board of Canada* **24**: 849-865.
- Wernerus, F.M. and V. Tessari. 1991. The influence of population density on the mating system of *Thalassoma pavo*, a protogynous Mediterranean labrid fish. *Marine Ecology* **12**: 361-368.
- Whoriskey, Jr., F.G. 1983. Intertidal feeding and refuging by cunners, *Tautogolabrus adspersus* (Labridae). *Fishery Bulletin* **81**: 426-428.
- Zar, J.H. 1974. *Biostatistical analysis*. Prentice-Hall Englewood Cliffs, New Jersey. 620 pp.





