

12-2007

THE MOLECULAR CHARACTERIZATION OF THE VIRUS AND VIRUS-LIKE AGENTS PRESENT IN TA TAO 5 GERMPLASM OF *PRUNUS PERSICA*

Diana Marini

Clemson University, dmarini@clemson.edu

Follow this and additional works at: https://tigerprints.clemson.edu/all_dissertations

 Part of the [Agronomy and Crop Sciences Commons](#)

Recommended Citation

Marini, Diana, "THE MOLECULAR CHARACTERIZATION OF THE VIRUS AND VIRUS-LIKE AGENTS PRESENT IN TA TAO 5 GERMPLASM OF *PRUNUS PERSICA* " (2007). *All Dissertations*. 143.

https://tigerprints.clemson.edu/all_dissertations/143

This Dissertation is brought to you for free and open access by the Dissertations at TigerPrints. It has been accepted for inclusion in All Dissertations by an authorized administrator of TigerPrints. For more information, please contact kokeefe@clemson.edu.

THE MOLECULAR CHARACTERIZATION OF THE VIRUS AND VIRUS-LIKE
AGENTS PRESENT IN TA TAO 5 GERMPLASM OF *PRUNUS PERSICA*

A Dissertation
Presented to
the Graduate School of
Clemson University

In Partial Fulfillment
of the Requirements for the Degree
Doctor of Philosophy
Plant and Environmental Sciences

by
Diana Beatriz Marini
December 2007

Accepted by:
Dr. Simon W. Scott, Committee Chair
Dr. N. Dwight Camper
Dr. Steven N. Jeffers
Dr. Gregory L. Reighard

ABSTRACT

Peach production in the southeastern United States is limited by late spring freezes. Ta Tao 5 germplasm, used either as an interstem or by chip bud inoculation, has been shown to delay bloom and avoid the effects of these late freezes. The growth modification is graft transmissible and the germplasm has been found to be infected with ACLSV, APruV-3, and PLMVd. Using a combination of PCR, cloning, and sequencing techniques, a molecular characterization of the three graft-transmissible agents present in Ta Tao 5 has been completed.

The complete nucleotide sequence of the genome of the isolate of ACLSV (ACLSV-Ta Tao 5) was determined. The genomic organization was typical of other isolates of ACLSV, but the sequence showed only 73% nucleotide identity to the Batalon1 isolate of ACLSV. This distant relationship with characterized isolates of ACLSV explains why primers recommended for PCR reactions used to identify the virus failed to detect the isolate from Ta Tao 5 reliably. This is the first complete genomic sequence of an isolate of ACLSV from peach.

The 3' terminal third of the complete sequence of APruV-3 isolated from Ta Tao 5 was obtained. Four ORFs and one long 819 nt NCR region were identified. The ORFs encoded for the TGB proteins and the CP, respectively. The aa sequence of the CP showed 94% identity with the corresponding published sequence of APruV- 3.

The genome of the isolate of PLMVd present in Ta Tao 5 was 337 nt in length and showed no obvious insertions or variations. The sequence showed more than 96% sequence identity with PLMVd isolates found in other parts of the world.

Reliable and sensitive techniques for the detection of the agents infecting Ta Tao 5 are described in this study. One-Step PCR was used to detect all three agents, and PLMVd also was detected readily by dot blot hybridization. The further studies necessary to determine the relationship between these three agents found in Ta Tao 5 and the bloom delay phenomenon now can be completed.

DEDICATION

This dissertation is dedicated to my husband, Antonio, who always encourages me to be a better person; to my children, Luz, Joaquin, and Nicolas, who are inexhaustible sources of happiness and help me forget any frustration; to my parents, Anita and Juan, who taught me the value of the simple things of life; to my mother-in-law, Pirucha, for her friendship and for helping with the children while I was studying; and to my sisters, Silvia and Ana, for their love and support.

ACKNOWLEDGEMENTS

I wish to especially thank to my advisor, Dr. Simon Scott, who with a lot of patience, encouraged, supported and guided me throughout these years and who is not only an excellent virologist but also a great person. I also thank the other members of my advisory committee for helpful advice and suggestions: Dr. Dwight Camper, Dr. Steven Jeffers, and Dr. Greg Reighard.

A special thanks to Dr. Phil Gibson, not only for his great help with many laboratory and field activities, but also for his friendship and camaraderie. I also would like to thank M. Tracy Zimmerman, who, with a lot of patience, taught and assisted me with molecular techniques and procedures. The technical assistance of Jane Lawrence, Kathy Brock, and Dave Ouellette are gratefully acknowledged.

I wish to thank the Instituto Nacional de Tecnologia Agropecuaria (INTA) from Argentina, for sending me and partially financing my stay in US.

Finally, I would like to thank for their help and friendship the many professors, students, and staff in the Department of Entomology, Soils, and Plant Sciences at Clemson University.

TABLE OF CONTENTS

	Page
TITLE PAGE	i
ABSTRACT	ii
DEDICATION	iv
ACKNOWLEDGEMENTS	v
LIST OF TABLES	viii
LIST OF FIGURES	x
CHAPTERS	
I. INTRODUCTION	1
II. LITERATURE REVIEW	4
Stone Fruit Characteristics and Economic Importance	5
The Peach	6
Peach Production in the Southeastern United States	8
Use of Peach Interstems to Alter Peach Phenology	10
Graft-Transmissible Agents in Ta Tao Germplasm and Bloom Delay	12
Filamentous Viruses that Infect Stone Fruits	18
Viroids that Infect Stone Fruits	29
Virus and Viroid Detection Methods	38
III. MOLECULAR CHARACTERIZATION OF THE ISOLATE OF APPLE CHLOROTIC LEAF SPOT VIRUS (ACLSV) PRESENT IN TA TAO 5 GERMPLASM OF <i>PRUNUS PERSICA</i>	62
Introduction	62
Materials and Methods	63
Results	69
Discussion	74

Table of Contents (Continued)

	Page
IV. MOLECULAR CHARACTERIZATION OF THE ASIAN PRUNUS VIRUS (APruV) ISOLATE PRESENT IN TA TAO 5	94
Introduction	94
Materials and Methods.....	97
Results.....	100
Discussion	102
V. MOLECULAR CHARACTERIZATION OF THE PEACH LATENT MOSAIC VIROID (PLMVd) ISOLATE PRESENT IN TA TAO 5	119
Introduction	119
Materials and Methods.....	122
Results.....	124
Discussion	125
VI. CONCLUSIONS	135
APPENDICES.....	139
REFERENCES	163

LIST OF TABLES

Table		Page
2.1	Ta Tao genotypes of peach (<i>Prunus persica</i>) imported into the US through the USDA Plant Introduction Station, Chico, California in 1933	59
2.2	Cultivars of <i>Prunus</i> spp. from which the six original isolates of virus that cross-reacted with antibodies to plum pox virus originated.....	60
2.3	Genera and viruses included within the family <i>Flexiviridae</i>	61
3.1	Viral sequences used for comparison in this study	78
3.2	Sequences of the primers used to detect and clone the isolate of apple chlorotic leaf spot virus (ACLSV) from Ta Tao 5 peach (<i>Prunus persica</i>) germplasm	79
3.3	A comparison of the percentage identity of the putative amino acid (aa) sequences of the RNA dependent RNA polymerase (RdRp), movement protein (MP) and coat protein (CP) of ACLSV from Ta Tao 5 isolate compared with other isolates of ACLSV and other <i>Trichovirus</i>	80
3.4	Multiple alignments of the nucleotide sequences that correspond to the target region for the Kummert primers (4F and 4R) in the seven published complete genomic sequences of ACLSV and the isolate from Ta Tao 5	81
3.5	Multiple alignments of the nucleotide sequences that correspond to the target regions for the Menzel primers (CLS6860 and CLS7536) in the seven published complete genomic sequences of ACLSV and the isolate from Ta Tao 5.....	82
3.6	Multiple alignments of the nucleotide sequences that correspond to the target region for the Candresse primers (A53 and A52) in the seven published complete genomic sequences of ACLSV and the isolate from Ta Tao 5.....	83

List of Tables (Continued)

Table	Page
4.1 Sequences of the primers used to detect and clone the isolate of Asian prunus virus (APruV) from Ta Tao 5 peach (<i>Prunus persica</i>) germplasm.....	106
4.2 Viral sequences used for comparison in this study	107
4.3 Percentage identity of the deduced amino acid (aa) sequences of the putative Triple Gene Block proteins 1 (TGB 1), TGB 2, TGB 3 and coat protein (CP) of the ApruV isolate from Ta Tao 5 compared with viruses belonging to genus <i>Foveavirus</i> and unassigned members of the family <i>Flexiviridae</i>	108

LIST OF FIGURES

Figure		Page
3.1	Schematic representation of the clones used to obtain the complete sequence of the isolate of ACLSV from Ta Tao 5	84
3.2	One-Step PCR amplification of the 390 bp band obtained with the primers 4F and 4 R (Kummert primers) and the isolate of ACLSV from Ta Tao 5 and the control isolate of ACLSV (P863)	85
3.3	Complete nucleotide sequence of the isolate of ACLSV from Ta Tao 5	86
3.4	A multiple alignment for the amino acid sequence of the CP of the isolate of ACLSV from Ta Tao 5 (TT5) and the seven completely sequenced isolates of ACLSV	90
3.5	Phylogenetic relationships among the isolate of ACLSV from Ta Tao 5 and members of the genus <i>Trichovirus</i> based on the amino acid sequence of the polymerase protein	91
3.6	Phylogenetic relationships among the isolate of ACLSV from Ta Tao 5 and members of the genus <i>Trichovirus</i> based on the amino acid sequence of the movement protein	92
3.7	Phylogenetic relationships among the isolate of ACLSV from Ta Tao 5 and members of the genus <i>Trichovirus</i> based on the amino acid sequence of the coat protein	93
4.1	Symptoms observed on <i>Nicotiana occidentalis</i> after sap inoculation with leaf tissue from Nemaguard seedlings chip-budded inoculated with Ta Tao 5	109
4.2	Arrangement of the clones produced using PCR reactions and different pairs of primers during the process of obtaining the partial sequence of the ApruV-3 isolate in Ta Tao 5	110

List of Figures (Continued)

Figure	Page
4.3 A 1% agarose gel buffered with 1x TBE and stained with ethidium bromide of the products of a One-Step PCR reaction using primers 678, 677 and CP-PLV1, CP-PLV2	111
4.4 Partial nucleotide sequence of the APruV-3 isolate from Ta Tao 5	112
4.5 Organization of the genome of apple stem pitting virus (ASPV) the type species of the genus <i>Foveavirus</i>	114
4.6 Phylogenetic relationships of the APruV-3 isolate from Ta Tao 5 and members of genus <i>Foveavirus</i> based on the aa sequence of the TGB 1 gene.....	115
4.7 Phylogenetic relationships of the APruV-3 isolate from Ta Tao 5 and members of genus <i>Foveavirus</i> based on the aa sequence of the TGB 2 gene.....	116
4.8 Phylogenetic relationships of the APruV-3 isolate from Ta Tao 5 and members of genus <i>Foveavirus</i> based on the aa sequence of the TGB 3 gene.....	117
4.9 Phylogenetic relationships of the APruV-3 isolate from Ta Tao 5 and members of genus <i>Foveavirus</i> based on the aa sequence of the CP gene	118
5.1 A multiple alignment of the complete sequences of the eight clones of PLMVd Ta Tao 5 and NC_003636	129
5.2 One-Step PCR amplification of RNA of PLMVd from plant total RNA isolated from young shoots of Ta Tao 5 trees	131
5.3 Dot-blot membrane probed using a DIG-labeled cRNA probe directed against PLMVd	132

List of Figures (Continued)

Figure	Page
5.4 Complete nucleotide sequences of the four clones (C1-C4) of PLMVd from <i>Prunus persica</i> cv. Ta Tao 5 prepared at Clemson University.....	133
5.5 Complete nucleotide sequences of the four clones (FL2, FL3, FL7 and, FL8) of PLMVd from <i>Prunus persica</i> cv. Ta Tao 5 prepared by Dr. Flores in Spain.....	134

CHAPTER I

INTRODUCTION

Peaches and nectarines are the most extensively cultivated stone fruits worldwide. Peaches account for more than 70% of the stone fruit produced in the United States. South Carolina (70,000 metric tons - mt) and Georgia (52,500 mt) are the second and third largest producers, respectively, after California (949,000 mt) (Agricultural Statistics, 2005). The largest part of California's production is for processing, whereas almost the entire crop in South Carolina and Georgia is sold as fresh fruit.

The profitability of peach orchards in the southeastern US has been quite low for some time. These lower economic returns are primarily due to the high cost of inputs and the low efficiency of production resulting from poor peach tree survival and yield. Peach tree short life (PTSL) Syndrome was a major problem for many years but some control of this has been achieved using Guardian[®] Brand BY520-9 rootstock. Currently, Armillaria root rot (also known as oak root rot) is the major cause of premature tree death in southeastern stone fruit orchards. Although some control of this may be possible with a newly developed rootstock Sharpe. In addition to the effects of pests and diseases, the industry in the southeastern US is subjected to extremely variable weather in the early part of the year and freezing injury to peach flowers in the spring is the major limitation to consistent peach production in the southeastern US (Reighard, 1995;

Reighard, 1998). The peach crop is affected by late frosts in 1 out of every 3 years. Damage may produce some thinning of the crop or, if severe, may eliminate the crop entirely. Heat sources, wind machines, and sprinkler irrigation are some of the techniques that have been used to minimize damage from spring frosts. Any condition/treatment that delays bloom until the risk of spring frosts is less works to the benefit of the producers. One of the most effective methods to produce bloom delay is the use of plant hormones. However these compounds are either not labeled for peach or perform inconsistently (Reighard, Ouelette & Brock, 2001). Interstems are used in other fruit crops to modify the growth of trees and attempts have been made to delay bloom in peach by using interstems of germplasm with high chilling hour requirements. Although a significant and practically useful delay in bloom was achieved, it became apparent that the delay was due to graft-transmissible agents present in the germplasm used for the interstem and not to modifications in the physiology of the tree. Tests detected the presence of three graft-transmissible agents (a viroid and two viruses) in the germplasm [*Prunus persica* (L) Batsch] cv Ta Tao 5.

The objectives of this dissertation are: 1) to complete a molecular characterization of each of these three graft-transmissible agents so that sensitive, rapid, and reliable molecular tests can be used to detect these agents in material being grown in the field to evaluate their respective roles in the observed bloom delay, and 2) to determine the phylogenetic relationships

between these agents and related entities that have been characterized previously.

CHAPTER II

LITERATURE REVIEW

Damage to peach flowers resulting from spring freezes is the most important limitation to consistent peach production in the southeastern United States. Heat sources, wind machines, and sprinkler irrigation are some of the techniques that have been used to minimize damage from spring frosts. One of the most effective methods to produce bloom delay is the use of plant hormones. However, these compounds are either not labeled for peach or perform inconsistently (Reighard, Ouellette & Brock, 2001). Ta Tao 5 peach [*Prunus persica* (L.) Batsch] has been used as an interstem to delay bloom and reduce scion vigor in other peach cultivars. Cultivars without the interstem but grafted with Ta Tao 5 chip buds also exhibited the same observed effects of bloom delay and reduced growth, suggesting that these effects are from graft-transmissible agents rather than from the effects of an interstem. The Ta Tao series of germplasm has been reported to be infected with peach latent mosaic viroid (PLMVd), apple chlorotic leaf spot virus (ACLSV), and asian prunus virus (APruV) (Gibson et al., 2001; Gibson, 2000). A PCR (Polymerase chain reaction) fragment amplified from Ta Tao 23 using PDO (Polyvalent degenerate oligonucleotides) grouped consistently with members of the genus *Trichovirus* (Foissac et al., 2001) of which ACLSV is the type species. Budding Redglobe peach with Ta Tao 5 delayed the time of full bloom for 5 to 6 days and fruit

maturity for 3.5 to 9 days, compared with non-treated trees (Reighard et al., 2001). Coronet peach trees inoculated with Ta Tao 5 bud chips showed significant differences in the time of full bloom, leaf defoliation, vegetative vigor, and fruit ripening as compared to non-inoculated trees. Tests detected PLMVd in all inoculated trees, but ACLSV was detected only in some. All observed effects could be related to the presence of PLMVd but not ACLSV (Gibson et al., 2001; Gibson, 2000). The involvement of APruV in the delay was not examined at that time as the virus was unknown. As part of an effort to determine the role of these three agents in the bloom delay induced by Ta Tao 5, we have completed a molecular characterization of the three agents allowing us to develop reliable and sensitive techniques for their detection.

Stone Fruit Characteristics and Economic Importance

Stone fruits are produced on species of tree crops that belong to the family *Rosaceae* and the genus *Prunus*. They include apricots (*Prunus armeniaca* L.), peaches [*P. persica* (L.) Batsch], nectarines [*P. persica* (L.) Batsch *nucipersica* (Suchow) C. K. Schneidi], plums (*Prunus salicina* L.), prunes (*Prunus domestica* L.), almonds (*Prunus dulcis*, Mill.), sweet cherries (*Prunus avium* L.), and sour cherries (*Prunus cerasus* L.). The fruit is a drupe with a hard stone that encloses the seed, and a fleshy, sweet pulp that surrounds the stone (Ogawa et al., 1995). Stone fruits are temperate trees and have a broader geographic origin than do pome fruits, with many species extending from eastern

Europe to China (Ogawa & English, 1991). As a group, stone fruits bloom earlier than do pome fruits and are, therefore, more prone to damage from freezing weather in early spring. Full production by stone fruit trees usually begins between the third or fourth year after planting and continues on a commercial basis for about 15 to 25 years. Usually, a stone fruit tree is composed of two parts: an above ground part, the scion cultivar that bears the fruit and an underground part, the rootstock that produces the root system (Lockwood & Coston, 2005). Most stone fruit trees are propagated by asexual methods such as grafting or budding on rootstocks, root cuttings, and tissue culture (Hartman et al., 1997), all of which have contributed to the spread of many viral diseases, both nationally and internationally.

Stone fruits are very important in the agricultural economy of many countries. In 2006, world stone fruit production was around 44 million metric tons (mt). The major world producers were: China (10 million mt), Italy (7 million mt) and United States (3 million mt) (FAO, 2007).

The Peach

Peaches and nectarines are the most extensively cultivated stone fruits. In 2006, production worldwide was approximately 17.2 million mt, with China accounting for about 44%, Italy for 10% and the United States for 5.4% of the total production (FAO, 2007).

Peaches originated in China where, according to ancient literature, the culture of the peach dates back at least 3,000 years. The ancestry of many of the most successful cultivars grown in the United States today originates from the “southern group” of Chinese peaches. These peaches are adapted to warm and moist climates and are less winter-hardy than the “northern group” of Chinese peaches (Li, 1984).

The peach flower buds develop in leaf axils on the current season’s growth. These buds will bear the following season’s fruits. Flower buds on peach are “simple” or “pure” because they contain only flower tissue, which contrasts with apple buds from which both flower and leaf tissues arise. Peach flowering is an extended process that is divided into three periods: initiation, differentiation, and anthesis and is under the control of plant hormones. Initiation occurs when the meristematic regions stop producing vegetative tissue and shift to production of reproductive tissue. In the southeastern United States, peach flower bud initiation usually occurs in late June or July. Differentiation occurs from bud initiation until the flower opens in the following March. During this time the various floral structures develop. Anthesis, the final stage in flowering, occurs as the flower opens (Lockwood & Coston, 2005).

In late summer buds enter dormancy, a state that needs to be broken by exposure to cool temperatures over winter. The chilling requirement of a peach cultivar is the number of hours below 7.2°C necessary to break bud dormancy. Different temperatures vary in their effectiveness to satisfy the chilling

requirement with temperatures between 4.4°C and 10°C being the most effective. Little chilling occurs below -1.1°C and chilling hours can be partially subtracted from the accumulated total by temperatures above 15.5°C. Most peach cultivars require between 600 and 1,000 h of chilling (Lockwood & Coston, 2005). Individuals in the Ta Tao series of germplasm typically require in excess of 1,000 h (Okie, 1990).

Peach Production in the Southeastern United States

Peaches account for more than 70% of the stone fruit produced in the United States. About 1.3 million mt of peaches and nectarines were produced in 2005. California is the major peach producer (949,000 mt), followed by South Carolina (70,000 mt) and Georgia (52,500 mt) (Agricultural Statistics, 2005). Approximately half of California's production is for processing, whereas almost the entire crop in South Carolina and Georgia is sold as fresh fruit.

Profitability of peach orchards in the southeastern US has been low for some time. These lower economic returns primarily are due to the high cost of inputs and the low efficiency of production resulting from poor peach tree survival and yield. Inefficient production and diminishing tree life-span and orchard longevity result from fruit growing problems such as the peach tree short life syndrome (PTSL). In the middle Georgia area, average tree longevity has declined from 20 years to about 8 years during the past few decades (Yadav, 1998). PTSL results from an interaction of weather, infestation by the

ring nematode [*Criconemoides xenoplax* Raski (= *Mesocriconema xenoplax* (Raski) Loof & de Grisse)], and cultural practices, such as previous crop, rootstock, and pruning date. Scion death is apparently caused by damage to the trunk from either cold injury or bacterial canker (*Pseudomonas syringae* pv. *syringae*) (Sharpe et al., 1989). The regionally developed rootstock Guardian[®] Brand BY520-9 is more tolerant to PTSL than any other rootstock grown in the southern US and has contributed to a decrease in the incidence of PTSL during the last few years (Okie et al., 1994; Nyczepir, Beckman & Reighard, 2006). Currently, *Armillaria* root rot (also known as oak root rot) is the major cause of premature tree death in southeastern stone fruit orchards. This disease is produced by two species of the fungi in the genus *Armillaria*: *A. tabescens* (Scop. [Dennis et al.]) and *A. mellea* (Vahl. Fr. [P. Kumm.]) (Cox, Scherm & Beckman, 2005).

Freezing injury to peach flowers in the spring is the major limitation to consistent peach production in the southeastern United States (Reighard, 1995; Reighard, 1998). The peach crop is affected by late frosts in 1 out of every 3 years. Damage may produce some thinning of the crop or, if severe, may eliminate the crop entirely. Over the years, many of the commercially popular cultivars have been selected to produce large numbers of buds so that freezing injury reduces the numbers to a load that the tree can sustain.

Research suggests that temperatures of -9°C are needed to kill 90% of peach flowers at flower first pink stage, whereas -4°C can kill 90% of blossoms at

full bloom (Ballard, Proebsting & Tukey, 1984). These temperatures occur commonly in the southeastern US during the spring. One strategy to avoid yield loss from spring frosts is to grow cultivars with high chilling hour requirements. However, in many areas of the southeastern US, such cultivars suffer from inadequate chilling in years when winters are mild, resulting in erratic bloom and poor fruit set (Okie et al., 1998). Late frosts, mild winters, and diseases also significantly affect peach yields in the southeastern US each year.

Use of Peach Interstems to Alter Peach Phenology

Interstems have been used on a limited basis in pome fruit production, particularly in controlling tree growth in apple (*Malus x domestica* Borkh.) and pear (*Pyrus communis* L.). The apple rootstock M.9, when used as an interstem on either M.M.106 or M.M.111 rootstocks, reduces tree size and is still very popular with the apple industry (Reighard, 1995). In the late 1960s, researchers started working to remove many of the viruses naturally present in the apple rootstocks to reduce incompatibility problems caused by the viruses. While the viruses have been removed, some of the size control provided by the rootstock has been lost. Therefore, the old “dirty” M.9 will produce a smaller tree than the “clean” M.9 EMLA rootstock. Currently in the industry nearly all apple rootstocks are virus-free (Crassweller & Schupp, 2006).

Interstems have not been used widely in stone fruit production in North America as it is generally believed that they have little effect on stone fruit scions,

cost more, and may develop weak graft unions (Reighard, 1995). In addition, little is known concerning the effect of interstems from genotypes with high chilling hour requirements on peach tree phenology (Anderson & Seeley, 1993).

The genotypes in the Ta Tao series of germplasm have high chilling hour requirements (> 1,000 h), are late blooming (around April 1 in SC), and produce white fleshed, clingstone peaches. This germplasm originated from trees collected by Peter Liu in 1933 from several villages near Feicheng, Shantung (now Shandong), China (36°N, 118°E). The series was originally imported into the US through the USDA Plant Introduction Station, Chico, California and was subsequently distributed to germplasm collections in North America. Currently, the USDA Southeastern Fruit and Tree Nut Research Laboratory in Byron, Georgia maintains some of these introductions. Ta Tao genotypes (Table 2.1) usually have low yields due to poor fruit set (Ackerman, 1957). These peaches were named “Ta Tao” or Fei peaches from the Feichengtao cultivar, a cultivar used as a tribute to emperors 400 years ago due to its large fruit size (Okie, 1990).

Ta Tao germplasm has been used to produce bloom delay in commercial peach cultivars. The bloom of Sunprince was delayed for several days using Ta Tao 24 as the rootstock (Okie, 1990). The flower phenology and fruit maturity of 10 peach cultivars were delayed 4 to 12 and 1 to 8 days, by using Ta Tao 5 and Ta Tao 24 respectively, as interstems (Reighard, 1995). Interstems of Ta Tao 5, Ta Tao 24 and an unknown peach with a high chilling requirement

(acronym PK1) significantly affected bloom date, tree size, fruit yield and maturity date. The Ta Tao interstems delayed full bloom of cultivars 1 to 13 days whereas the delay associated with PK1 interstems was about half that (Reighard, 1998).

Cultivars without the interstem, but grafted with Ta Tao chip buds, exhibited the same observed effects of bloom delay and reduced growth, suggesting that these effects are from graft-transmissible agents. Bloom delay resulting from the inoculation of graft-transmissible agents from Ta Tao 5 could be a potential benefit to southeastern US peach production. Late spring frosts could be avoided by a delay in bloom of a few days, and a delay in fruit ripening could extend the harvest period (Gibson et al., 2001). Chip bud inoculation of existing young orchards would result in substantial savings compared to the production of new trees using interstems and also make this technology immediately available.

Graft-Transmissible Agents in Ta Tao Germplasm and Bloom Delay

In the early spring of 1992, a plum pox-like virus (PPLV) was detected by enzyme linked immunosorbent assay (ELISA), immunosorbent electron microscopy (ISEM) and Western blot analysis in some *Prunus* species (James et al., 1994) (Table 2.2). However, important differences between plum pox virus (PPV) and PPLV were found. Of five different antisera against PPV, only the antiserum against strain Y consistently reacted with PPLV in double-antibody

sandwich (DAS) ELISA assays of woody hosts. In Western blot analyses, bands associated with the coat protein subunits of the PPLV found in Ta Tao germplasm were 52 kDa in size while those of the coat protein subunits of known PPV isolates are 32-37 kDa in size. Also, the symptoms produced in woody and herbaceous indicators by PPLV were different from symptoms known to be produced by infection with PPV (James & Godkin, 1996).

Reverse transcription-polymerase chain reactions (RT-PCR) with oligonucleotide primers designed to amplify the 3' non-coding region (NCR) of PPV could accurately differentiate between PPV and PPLV (Hadidi & Levy, 1994). The nucleotide sequence of PPV contains a unique 220 nucleotide (nt) sequence at the 3' NCR adjacent to the coat protein gene that is conserved among all PPV isolates sequenced (Lain, Reichmann & Garcia, 1989; Maiss et al., 1989; Teycheney et al., 1989; Wetzel et al., 1991; Cervera et al., 1993). PPLV did not yield any bands in RT-PCR using the PPV 3' NCR primers; however, it yielded a product with PPV coat-protein primers in RT-PCR. PPLV also reacted with a PPV cDNA probe containing the coat protein gene in molecular hybridization assays. Thus, the Asian germplasm did not appear to be infected with PPV but rather by another previously undescribed virus, possibly a potyvirus. Hadidi and Levy (1994) named it Asian prunus latent virus (APLV) because it did not cause visible symptoms on infected leaves of asian peach germplasm or *Prunus mume* Siebold & Zucc., grown under greenhouse conditions. The PPV-cross reacting agent has been diversely named as "plum

pox-like virus” (James, Thompson & Godkin, 1994), “Asian prunus latent virus/potyvirus”, “prunus latent virus” (Hadidi & Levy, 1994, Hari, et al., 1995), or Asian prunus virus (Marais et al., 2006).

Electron microscopy and immunogold electron microscopy of thin sections of APLV infected tissue cells did not detect the presence of cylindrical inclusion bodies (CI), characteristic of potyvirus infections. However, preparations of APLV contained a 68 kDa protein that reacted with antisera to the CI protein of tobacco etch virus (TEV) and maize dwarf mosaic virus (MDMV) in Western blot analysis (Hari et al., 1995). In further research, electron microscopy of thin sections of Ta Tao 25 (Q-375-02) showed flexuous rods distributed throughout the plant. No evidence of CI or viral aggregates was detected. *Aphis spiraecola* (Patch) and *Myzus persicae* (Suzler), efficient vectors of most PPV isolates, were unable to transmit APLV. APLV could also be distinguished from PPV by double-stranded (ds) RNA profiles. APLV has three to five bands of dsRNA, compared to the two bands typically associated with infections of PPV. Cross-reactions with a polyclonal antiserum against apple stem pitting virus (ASPV) were observed. This same antiserum also cross-reacts with PPV isolates (James & Godkin, 1996). All these findings indicated that the agent named PPLV or APLV is not a potyvirus.

A polyvalent nested RT-PCR test using degenerate primers containing inosine (polyvalent degenerate oligonucleotide [PDO]) was developed for filamentous viruses of fruit trees (Foissac et al., 2001). This nested-PCR assay

targets conserved regions of the viral RNA polymerase. The six original sources of *Prunus* germplasm that cross-reacted with PPV antisera (Table 2.2) were analyzed. Only four of the six amplified the expected 362-bp product. Ting Ting and Ku Chu'a Hung (KCH) failed to give a positive amplification. The products from three of these sources were cloned and sequenced and at least three different agents were found. The sequence of the entity found in Ta Tao 23 was closely related to isolates of ACLSV, the sequence from Agua was closely related to peach mosaic virus (PcMV), and the sequence from Bungo resembled species in the genus *Foveavirus* (Foissac et al., 2005). Further research, using a combination of PCR-based techniques on total RNAs or on purified dsRNAs, reported a continuous 4.1 kb sequence from the 3' region of the entity found in Bungo (Bungo-1) (Marais et al., 2006). Efforts to identify this agent or similar agents in the other PPV cross-reacting sources of *Prunus* (Table 2.2), a bonsai plant of *P. mume* from Japan, and Ta Tao 24 (provided by Simon Scott, Clemson, USA) provided evidence for the existence of at least two more distantly related viruses with a similar genomic organization in Bungo and KCH. BLAST analyses of the proteins encoded by these three amplicons showed weak but significant alignment with ASPV, the type member of the genus *Foveavirus*. These three new agents showed a long 3' NCR of around 820 nt, a feature unique among species within the genus *Foveavirus*. Moreover, this region is remarkably longer than the corresponding sequences for any member of the family *Flexiviridae*, which usually possess a 3'NCR of 100-200 nt. With overall

nucleotide and amino acid sequence identity levels in the sequenced regions of the coat protein (CP) gene of 74-76% and 60.8-67.5% respectively, these three new agents were proposed as new viruses belonging to the genus *Foveavirus* and named as Asian prunus virus 1, 2, and 3 (APruV-1, APruV-2, and APruV-3) (Marais et al., 2006). The agent found in Ta Tao 24 should probably be considered as a divergent isolate of APruV-1 rather than yet another APruV-related virus (Marais et al., 2006).

The potential involvement of the newly characterized APruV in the cross reactions with PPV specific reagents is uncertain. Only some of the eight accessions tested were positive for the new viruses, and PPV antiserum did not immunoprecipitate the in vitro synthesized coat protein of these new viruses (Marais et al., 2004 and 2006).

The complete genome of peach chlorotic mottle virus (PCMV), originally designated as *Prunus persica* cv Agua virus (4N6), was sequenced and analyzed (James, Varga & Croft, 2007). The PCMV genome has 9005 nt, excluding a poly A tail at the 3' end of the genome. This virus has a similar genome organization to ASPV, with 58% nt identity. Lower levels of nt identity (51-52%) were observed with the genome of rupestris stem pitting-associated virus (RSPaV), another *Foveavirus*, and with some members of the genus *Carlavirus* (48-52%). Five open reading frames (ORFs) were discovered with four untranslated regions (UTR) including a 5', a 3', and two intergenic UTRs. ORF 1 encodes the replicase complex, ORF2 to ORF 4 the triple gene block (TGB) and ORF 5

encodes the CP (James et al., 2007). There was no evidence of a nucleic acid binding protein ORF, suggesting a closer relationship to the members of the genus *Foveavirus* than to the genus *Carlavirus*. The expressed CP cross reacted with a polyclonal antiserum against ASPV and with PPV.

A virus isolated from Ta Tao 5 buds by sap inoculation to *Nicotiana occidentalis* 37B was partially purified and clones to the viral RNA were produced using oligo dt to prime cDNA synthesis. The sequence was closely related, although not identical (exceeds 85%), to the published sequence of ACLSV (GenBank accession number: M58152) (Gibson et al., 2001). ACLSV had been previously detected in Ta Tao 5, but these results are unpublished (James, D., Centre for Plant Health, Agriculture and Agri-Food Canada, Sidney, B. C., Canada, pers. comm.).

PLMVd has been associated with bloom delay and reduced vegetative shoot vigor in peaches and nectarines (Nemeth, 1986; Desvignes, 1986; Della Strada et al., 2005). The viroid was detected in field and greenhouse-grown peach and nectarine cultivars from all states in the U.S. (Skrzeczowski, Howell & Mink, 1996). In one study done at Clemson University, PLMVd was detected by dot-blot hybridization with a [³²P]-labeled cRNA probe in 115 of the 117 Coronet peach trees chip bud inoculated with Ta Tao 5. The control, non-inoculated trees, did not react with the PLMVd cRNA probe (Gibson, 2000). Coronet peach trees inoculated with Ta Tao 5 bud chips containing PLMVd and ACLSV exhibited significant differences in vegetative vigor, time of bloom, leaf

defoliation, and fruit ripening. Trees in which PLMVd was detected, but ACLSV was not, did not perform differently from trees in which both PLMVd and ACLSV were present. All observed effects could be related to the presence of PLMVd but not ACLSV (Gibson et. al., 2001).

To be able to characterize the graft-transmissible agents present in Ta Tao 5, it is important to have knowledge of the filamentous viruses and viroids that have been described as affecting stone fruits, including their symptomatology, taxonomy, host range, and detection techniques.

Filamentous Viruses that Infect Stone Fruits

Viruses are submicroscopic infectious particles (virions) composed of a protein coat and a nucleic acid core. They are classified based on the nature of their genome [double-stranded (ds) DNA, single-stranded (ss) DNA, dsRNA, ssRNA]. Within each group a combination of characters, such as particle morphology, genomic organization, and biological and serological properties, are used to classify viruses into families, genera, and species. Among the viruses, the particle morphologies most frequently observed are isometric, rod-shaped, geminate, bacilliform, and filamentous. The filamentous viruses are usually about 12 nm in diameter, are more flexuous than the rod-shaped particles, and can reach up to 2200 nm in length (Adams & Antoniw, 2004a).

Filamentous viruses have been associated with some of the most important diseases of stone fruits. The symptomatology produced by these

viruses is diverse and may affect yield, fruit quality, tree vigor, viability, and scion-rootstock compatibility (James, 1997). The flexuous viruses that are currently known to affect stone fruits belong to three families: *Flexiviridae*, *Closteroviridae*, and *Potyviridae*.

Family *Flexiviridae*

This is a recently described plant virus family, so-named because its members have flexuous virions. This family is justified from phylogenetic analysis of the virus polymerase and CP sequences. As a general rule distinct species have less than 72% identical nucleotide (nt) or 80% identical amino acid (aa) sequences between their entire CP or replication protein genes (Adams et al., 2004). This family has virions of 12-15 nm in diameter and up to 1000 nm in length. Members of this family possess monopartite, positive sense, ssRNA genomes containing up to six open reading frames (ORFs), and translation of at least some ORFs from subgenomic mRNAs (Table 2.3). The ssRNA has a 3' poly A tail of uncertain length. The ORFs code for a replication protein (150-250 kDa), one or more movement proteins (MP), and a single coat protein (22-44 kDa). In some viruses an ORF that codes for a protein that is thought to have nucleotide-binding properties and which may partially overlap the 3' end of the CP gene occurs. Some viruses in the family have a single MP and others encode a TGB (Table 2.3). The genera *Foveavirus*, *Trichovirus*, *Capillovirus*, and *Carlavirus* have virus species that affect stone fruits. In addition, there are

some unassigned species in the family: cherry green ring mottle virus and cherry necrotic rusty mottle virus both of which affect cherries (Table 2.3). Generally, the viruses of this family have mild effects on their hosts. All species can be transmitted by mechanical inoculation, many of them have no known vector and usually the virus particles accumulate in the cytoplasm (Adams et al., 2004).

The genus *Foveavirus* is novel with flexuous filamentous virions of 800 to over 1000 nm in length and 12-15 nm in diameter. Virions have helical symmetry and a surface pattern with cross-banding and longitudinal lines. The genome is a positive sense ssRNA 8.7-9.3 kb in size and has five ORFs encoding the replication-related proteins (ORF1), the MPs (ORF2 to 4, constituting the TGB), and the CP (ORF5). CP subunits are 28-44 kDa in size. The structure and organization of the viral genome resembles that of the other genera in the family, but ORF1 and the CP gene are significantly larger (Table 2.3) (Martelli & Jelkmann, 1998). The natural host range of individual species is restricted to either a single or very few hosts. No vector is known, virus transmission is by grafting and dispersal is through infected propagating material. The species in the genus are ASPV, apricot latent virus (ApLV), peach chlorotic mottle virus (PCMV) and RSPaV (Adams et al., 2004; James et al., 2007). ASPV is widespread in commercial apple cultivars, is quite a stable virus and is unevenly distributed in infected trees. Infection is usually latent in many commercial apples cultivars. It causes pitting of the woody cylinder of *Malus pumila* Virginia Crab and epinasty and decline of Spy 227. The virus has also been identified as

the casual agent of the disease pear vein yellows (PVY) (Schwarz & Jelkman, 1998; Jelkman, 1997; Jelkman et al., 1992). Leaf and fruit disorders of quince have also been related to ASPV (Jelkman, 1997; Nemeth, 1986). ASPV causes significant losses in yield quality and quantity, often in complex with other latent viruses, such as ACLSV and apple stem grooving virus (ASGV). Natural spread of ASPV seems to be through root grafts (Yanase, 1974; Yanase, Koganezawa & Fridlund, 1989; Koganezawa & Yanase, 1990).

Apricot latent virus (ApLV) is a recent addition to the genus *Foveavirus* (Nemchinov et al., 2000). The virus was first detected in Moldova in latently infected apricots (Zemtchik & Verdereveskaya, 1993). ApLV causes yellow spots in leaves of graft-inoculated peach seedlings. The viral agents of two diseases described in peaches, "peach asteroid spot disease" and "peach sooty ring spot", are most likely caused by variants of ApLV (Gentit et al., 2001). The vector of this virus is not known.

PCMV was isolated from one of the six original PPV cross-reacting germplasms, *Prunus persica* cv. Agua (Table 2.2) and the complete sequence of this genome has recently been published (James et al., 2007). Rigorous phylogenetic analysis indicates that PCMV is a new member of the genus *Foveavirus*. In bioassays, using the woody indicator *Prunus persica* GF 305, it produced chlorotic mottling and ring pattern symptoms. It was the only PPV-cross-reacting virus isolate that produce symptoms on GF 305 (reliable indicator for PPV) (James et al., 2007).

Some new but incomplete virus sequences with a high percentage of similarity to the genus *Foveavirus* were reported in *Prunus* accessions of Asian origin (Hadidi & Levy, 1994; James & Godkin, 1996; Marais et al., 2004; Foissac et al., 2005; Marais et al., 2006). These are referred to as APruV-1, APruV-2 and APruV-3, respectively.

The genus *Trichovirus* comprises four species: the type member ACLSV, cherry mottle leaf virus (CMLV), PcMV, and grapevine berry inner necrosis virus (GINV). These viruses have flexuous virions, 640-760 nm in length and 10-12 nm in diameter, that may show cross banding and criss-cross or rope-like features depending on the negative stain used. Their genome consists of a monopartite positive sense ssRNA 7.5-8 kb long containing three slightly overlapping ORFs that encode the replication-related protein, the MP of the '30k' superfamily type, and the CP. An additional ORF of unknown function is present at the 3' end of CMLV and PcMV. CP subunits are 21-27 kDa in size (Table 2.3) (Adams et al., 2004). Some of the species in the genus are transmitted by eriophyid mites (James & Mukerji, 1993; James & Howell, 1998). The host range of individual species is narrow or restricted to a single host (Adams et al., 2004).

ACLSV, the type member of the genus *Trichovirus*, has a worldwide distribution in a wide range of rosaceous hosts, including stone and pome fruits, as well as ornamental plants (Martelli, Candresse & Namba 1994; Spiegel et al., 2005).

CMLV and PcMV are other trichoviruses that affect *Prunus* spp. They are graft-transmissible pathogens and both are transmitted by two closely related species [*Eriophyses insidiosus* (Keifer & Wilson) and *E. inaequalis* (Wilson & Oldfield)] of eriophyid mites (Gispert, Perring & Creamer, 1998). These two viruses are very similar and are serologically related (Creamer, Gispert & Oldfield, 1994). They differ in host range and symptomatology and cause distinct diseases, but they share some common hosts (James, Jelkman & Upton, 1999).

CMLV occurs naturally in sweet cherry, ornamental flowering cherry (*Prunus serrulata* Lindl.), peach, and apricot. CMLV was first discovered in Oregon in the 1920s and has since been found in other parts of North America, Europe, and South Africa (Nemeth, 1986). A mottle-leaf pattern is the principal symptom. Mottling is irregular and chlorotic, causing leaf distortion early in the season; leaves pucker increasingly as the season advances. Leaves are smaller and may develop shot holes, but do not fall. When symptoms are severe, as in the case of Bing cherry, fruits are abnormally small, lack flavor, and ripen later than normal. Tree growth is retarded, and shoots develop a rosette appearance. Less susceptible cultivars display the same general, but less severe, symptoms (James & Mukerji, 1993).

PcMV naturally infects peach, almond, apricot, plum and wild *Prunus* spp (Cochran & Rue, 1944). Peach mosaic disease was first reported in 1932 in Texas and has been found in the southwestern US and Mexico. Symptoms of peach mosaic include mosaic on leaves in the spring and early summer, vein

clearing, color break and deformation of petals, stunted leaves, fruit deformity, and dwarfing of the twigs (Stout, 1939).

Prunus virus S, a Carlavirus, and cherry virus A, a Capillovirus, are the other two viruses in the family *Flexiviridae* that can affect stone fruits (Adams et al., 2004). However, little is known about these viruses.

Cherry green ring mottle virus (CGRMV) (Zhang et al., 1998) and cherry necrotic rusty mottle virus (CNRMV) (Rott & Jelkman, 2001) are two closely related viruses that affect cherry trees. These viruses produce a serious disease in sweet cherry characterized by necrotic spots, chlorotic areas, shot hole of leaves, and canker of the bark (Rott & Jelkman, 2001). CGRMV and CNRMV were previously classified as members of the genus *Foveavirus*, but after further phylogenetic analysis were placed as unassigned members of the family *Flexiviridae* (Table 2.3) (Adams et al., 2004).

Family *Potyviridae*

This family is characterized by its filamentous non-enveloped particles up to 900 nm in length and by the presence of characteristic inclusion bodies in the infected cells. The genome is single-stranded positive sense RNA 8.5 to 12 kb in length. The 3' terminus has a poly (A) tract and the 5' terminus generally has a genome-linked protein (VPg). The genome is translated into a single polyprotein, which is subsequently processed by virus-encoded proteases into functional products (Adams & Antoniw, 2004b). This family is a very large and

economically important group of viruses (Matthews & Hull, 2002). The genus *Potyvirus* has particles that are 700 nm or more in length, a monopartite genome, and is transmitted by insects (Adams & Antoniw, 2004b).

Plum pox virus (PPV) is the only recognized potyvirus that affects *Prunus* (Levy et al., 2000.). The Sharka disease, produced by PPV, is the most devastating viral disease worldwide affecting stone fruits. First described on plums in Bulgaria in 1915, it has spread throughout Europe, to parts of the Middle East (Egypt and Syria), India, Chile, the United States, Canada, Argentina, and China (Navratil & Safarova, 2005). There are more than 100 million infected stone fruit trees in Europe and yield losses in susceptible cultivars can be as high as 100% (Kegler & Hartman, 1998). Symptoms appear on leaves, fruits, flowers, and seeds. Leaves and fruits can show chlorotic and necrotic ring patterns and chlorotic bands or blotches. The fruits of apricots and plums can be deformed and rings may be present on their stones. Some peach cultivars can show color breaking of the flower petals and sensitive plum varieties can exhibit premature fruit drop and bark splitting (Nemeth, 1986). Some sweet cherry fruits develop chlorotic and necrotic rings, deformed fruits, and premature fruit drop (Nemchinov et al., 1998).

Man is responsible for long distance spread of PPV through contaminated propagative materials; the secondary spread results from aphid transmission and can be very rapid (Levy et al., 2000). PPV is aphid-transmitted in a non-persistent stylet-borne manner. Aphids can acquire the virus in probes as short

as 30 seconds and can transmit for up to 2 hours (Labonne et al., 1995). At least 20 aphid species can transmit PPV, and aphids can acquire the virus from feeding on infected fruits as well as from feeding on infected leaves (Gildow et al., 2004). To date, six strains have been characterized: M, D, EA, C, Rec and W (Kerlan & Dunez, 1979; Wetzel et al., 1991; Kalashyan et al., 1994; Crescenzi et al., 1994; Glasa et al., 2004; James & Vargas, 2004). All of these strains can infect most stone fruits, but only PPV-C can infect cherries (Gildow, 2001). PPV-M has been reported to be seed-transmitted in some cultivars in eastern and central Europe (Nemeth & Kolber, 1983).

PPV can be detected by several methods: biological tests, serological tests, molecular hybridization, and polymerase chain reaction based assays (Candresse et al., 1997). Methods for control and prevention of PPV include field surveys, use of certified nursery materials, use of resistant cultivars (if available), control of the vector (not so effective because of the non-persistent mode of transmission), and elimination of infected trees in nurseries and orchards (Ogawa et al., 1995).

Family *Closteroviridae*

This family comprises more than 30 plant viruses with filamentous, non-enveloped virions up to 2,200 nm in length and includes members with mono or bipartite, positive sense, ssRNA genomes (Karasev, 2000, Agranovsky & Lesseman, 2001). The closteroviridae possess the most flexible particles among

the elongated RNA viruses and their genome size ranges from 15.5 kb to 19.3 kb, values that are comparable to those of some animal viruses, which are the largest genomes among positive-stranded RNA viruses (Agranovsky, 1996, Agranovsky & Lesseman, 2001). Common symptoms induced by closteroviruses in woody species are seedling yellows, stem pitting, and limb die-back. Virus infections are phloem-limited, often giving rise to phloem necrosis and forming specific inclusions in phloem cells. Generally, closteroviruses are not easily sap-transmissible to herbaceous hosts, are not seed borne, are transmitted by aphids, whiteflies, or mealybugs, and exhibit high vector specificity (Candresse, 1995). The virus genes are expressed by sub-genomic mRNAs, proteolytic processing and ribosomal frameshift (+1) (Agranovsky, 1996).

To date, three closteroviruses have been reported in *Prunus* species, and all were recovered from little cherry diseased trees from Germany (Jelkman, Fechter & Agranovsky, 1997; Rott & Jelkman, 2002). They were called little cherry virus 1 (LChV-1), little cherry virus 2 (LChV-2), and little cherry virus 3 (LChV-3) (formerly little cherry virus-LC5, the Canadian isolate) (Theilmann, Orban & Rochon, 2004). Little cherry disease (LCD) was first reported in British Columbia, Canada in 1933 (Foster & Lott, 1947). LCD was distributed worldwide in Japanese flowering cherry trees (*P. serrulata*), which is a symptomless host. However, in susceptible cultivars such as Bing cherry, LCD induces small, deformed, and poorly ripening fruits, reducing yield by up to 90%. Some cultivars of sweet cherry also develop leaf symptoms such as leaf upward curling or

reddening. Cultivars with leaf symptoms also exhibit reduction in growth and vigor. This disease also affects sour cherries, producing smaller and paler colored fruits (Eastwell, 1997). The apple mealybug (*Phenacoccus aceris* Signoret) has been identified as the vector of LCD (Raine, McMullen & Forbes, 1986). However, only LChV-2 and LChV-3 seem to be mealybug-transmitted. Phylogenetic analyses indicate that LChV-1 is a remote member of the whitefly lineage of the genus *Closterovirus* (Jelkman, 1997). Transmission of LCD can also occur by grafting or budding (Raine et al., 1986). Control of LCD consists of controlling the vector, use of certified material, and removal of infected trees (Eastwell, 1997).

A closterovirus associated with plum bark necrosis stem pitting disease was found affecting plum cultivars in California (Marini et al., 2002) and other stone fruits species in the world (Bouani et al., 2004; Amenduni et al., 2004; Sanchez-Navarro et al., 2004; Usta et al., 2007).

Although the filamentous viruses that affect stone fruits are morphologically similar, the genetic, physical, and biochemical properties, as well as the symptomatology, vectors, and host range differ for each group. Most of the filamentous viruses have been little studied in the past for several reasons: they have a large genome, some of them are not mechanically transmissible, and they are unevenly distributed in the plants. Actually, with the development of molecular technologies, the situation is changing. In the last few years, a number of new filamentous viruses have been identified and phylogenetic trees

showing the relationships between the viruses have been developed. The taxonomy of flexuous viruses is currently in transition.

Viroids that Infect Stone Fruits

Viroids are single-stranded but covalently closed, circular, naked RNA molecules, which range from 246 to 401 nt in length, depending on species. Their circular structure and high degree of self-complementarity promote compact folding (Flores et al., 2005). Viroids do not encode any pathogen-specific peptide or protein, but replicate autonomously and spread in the plant by recruiting host proteins via a functional motif encoded in their genomes. It is not only the circular RNA structure that is exceptional, but also the absence of any encapsidation or other form of a protective coat (Tabler & Tsagris, 2004). The thermodynamically stable structure of most viroids consists of series of short helices and small loops (Steger & Riesner, 2003).

Viroids replicate by means of a rolling circle mechanism, using either an asymmetric or symmetric pathway (Flores et al., 2005). Replication includes a processing step of oligomeric replication intermediates to molecules of unit length. This step is catalyzed by an internal viroid ribozyme or by host RNase(s). Viroids are classified into two families, the *Pospoviridae* and the *Avsunviridae*, which are subdivided into several genera (Steger & Riesner, 2003). Members of the *Pospoviridae* replicate in the nucleus by a host-dependent RNA polymerase II in an asymmetric replication cycle. This family has a thermodynamically stable

rod-like secondary structure with five structural domains, C (central), P (pathogenic), V (variable), and TL and TR (terminal left and right, respectively). The 'central conserved region' (CCR) within the 'C' domain is formed by two conserved nucleotide stretches, in which those of the upper strand are flanked by an inverted repeat.

Members of the *Avsunviroidae* do not possess a CCR domain and self-cleave via a hammerhead ribozyme. They replicate in the chloroplast by the nucleus-encoded RNA polymerase in a symmetric replication cycle that includes a circular RNA of negative polarity (Tabler & Tsagris, 2004).

Most of the nearly 30 viroid species known belong to the family *Pospoviroidae* and are subdivided into five genera. The other four species, avocado sunblotch viroid (ASBVd), peach latent mosaic viroid (PLMVd), chrysanthemum chlorotic mottle viroid (CChMVd), and eggplant latent viroid (ELVd) form two genera within the second family, *Avsunviroidae* (Flores et al., 2005). The criteria for viroid species demarcation within each genus are an arbitrary level of below 90% of sequence similarity and distinct biological properties. Viroids differ greatly in their host ranges; generally, viroids in the family *Avsunviroidae* have narrower host ranges than most members of the family *Pospoviroidae* (Singh & Ready, 2003).

Some viroids produce very severe symptoms. Coconut cadang-cadang viroid (CCCVd) has killed millions of coconut palms in the Philippines, whereas

other viroids have less conspicuous effects, including delays in foliation, flowering, and ripening (Flores et al., 2003).

Generally, viroids in woody plants experience a latent period between infection and symptom expression. Symptoms may not appear unless the plant is producing fruits (Singh, Ready & Nie, 2003). The nature and severity of symptoms in a viroid-infected plant is the result of the presence or predominance of particular sequence variants within the viroid population (Singh et al., 2003).

Symptom expression is generally favored by high light intensity and high temperature, with the result that viroid diseases are probably more prevalent in warmer climates (Flores et al., 2005). Ultrastructural studies of leaves infected with peach latent mosaic viroid (PLMVd) have revealed structural alterations in the chloroplasts of latent strains, even though macroscopic symptoms are not visible in the infected leaves. Similar, although more frequent and severe, alterations are produced by a mosaic-inducing variant (calico) and in completely chlorotic (“bleached”) leaves some chloroplasts looked similar to proplastids (Flores et al., 2005; Rodio et al., 2006).

The most efficient viroid transmission mechanism is vegetative propagation of infected material. Mechanical transmission, by contaminated tools and machinery, has been reported for most viroids in both families. Some viroids are transmitted through seed or pollen and some are aphid-transmissible (Flores et al., 2005). Disinfection of knives and other tools with household bleach (1-3%) is an effective method for eliminating viroid transmission through crude

sap. However, the main method for preventing viroid contamination is the use of viroid-free propagation materials (Singh et al., 2003).

Although unique at the molecular level, viroids follow the classical scheme of infection, initial replication, spread, and replication in young tissue, causing a pathogenic effect, which is always the result of interference with host factors and their normal function (Tabler & Tsagris, 2004). Within the initially infected cells, viroids must move to their replication organelle, either the nucleus or the chloroplast, to generate the progeny for release to the cytoplasm and to invade neighboring cells via plasmodesmata. Systemic spread of viroids occurs through the phloem and follows the flow of photoassimilates from the photosynthetic source to sink tissues/organs of the plant (Flores et al., 2005).

The key to the biological activity of viroids is the self-complementary circular RNA and its resulting secondary structure, which could be functional or provide several binding signals to host factors (proteins or nucleic acids) that could help in the life cycle of the infectious agent (Tabler & Tsagris, 2004). This primary interaction triggers a cascade of events, still not well understood, that eventually lead to macroscopic symptoms (Flores et al., 2005). In potato spindle tuber viroid (PSTVd) mutations of 3-4 nucleotides have been reported to have marked effects on symptoms (Schnolzer et al., 1985). A correlation between the virulence of PSTVd strains and the activation of some protein kinases has also been reported (Diener, 2001). It is also possible that differential interactions with host proteins involved in viroid replication, movement, or accumulation could be

the starting point in viroid pathogenesis (Flores et al., 2005). Instead of proteins as the primary host target, base-pair interactions between viroids and host RNAs, resulting in interference with rRNA maturation, mRNA splicing, or 7S RNA assembly, have been proposed as possible molecular events initiating pathogenesis (Diener, 2001).

Although it is generally accepted that viroid diseases are induced by specific interference with the regulation of host gene expression, it is possible that viroids may influence host gene expression at both post-transcriptional and transcriptional levels. This is supported by the identification of viroid-specific small interfering (si) RNAs in plants infected by members of both the *Pospoviridae* (Markarian et al., 2004) and *Avsunviroidae* (Martinez, Flores & Hernandez, 2002; Markarian et al., 2004) families; together with the previous discovery that replicating PSTVd induced the methylation of PSTVd sequences transgenically inserted in the plant genome (Wassenegger, 1994). Some viroid-specific siRNAs might direct host DNA methylation or act like endogenous micro (mi) RNAs targeting host mRNAs for degradation (Markarian et al., 2004). As plant viruses have evolved proteins that can suppress plant RNA silencing, how viroids cope with plant RNA silencing mechanisms remains a mystery. Protection could be afforded by their compact conformation (Wang et al., 2004), by compartmentation in organelle, or by association with proteins (Flores et al., 2005).

PLMVd and hop stunt viroid (HSVd) are the only viroids known to naturally infect stone fruit trees. Peach latent mosaic (PLM) disease was first reported in France after graft indexing on peach GF305 indicator of peach germplasm imported from the US and Japan (Desvignes, 1976). PLM is induced by PLMVd and is economically important in peaches and nectarines, because it affects fruit quality, reduces lifespan of trees, and increases peach tree susceptibility to other biotic and abiotic stresses. Under field conditions, the first symptoms become visible two years after planting infected material. They may include delays in foliation, flowering, and ripening, deformation of fruits, usually discolored with cracked sutures and flattened stones, bud necrosis, open habit, and rapid aging of the trees. Symptoms on leaves are rare. Occasionally mosaic, blotch, vein banding, or calico symptoms appear on infected leaves. Sporadically, pink streaks on flowers and wood grooving are observed (Flores et al., 2003). PLMVd has been detected in naturally infected sweet cherries, plums, apricots, Japanese apricots (*Prunus mume*) (Hadidi et al., 1997; Faggioli, Loreti & Barba, 1997; Giunchedi et al., 1998; Osaki et al., 1999), and wild and cultivated pears (Kyriakopoulou, Gunchedi & Hadidi, 2001). PLMVd is associated with a fruit disease of 'Angeleno' plum named plum spotted fruit observed in orchards in Italy. The symptoms on plum fruits consist of numerous small areas of the epidermis with a lighter color than that of the surrounding skin. Discolored areas tend to be masked as the fruit matures (Giunchedi et al., 1998). PLMVd is latent in infected sweet cherry, apricot, Japanese plum and Japanese apricot (Hadidi et

al., 2003). Mixed infection of PLMVd with other viroids, such as apple scar skin viroid (ASSVd) and pear blister canker viroid (PBCVd), in wild or cultivated pears produces brown rusty circular patches on the fruit skin that cover the whole fruit (Kyriakopoulou et al., 2001).

In greenhouse testing, the natural PLMVd isolates have been divided into severe or latent strains depending on whether or not they induce symptoms on seedlings of the GF305 indicator. When preinoculated, the latent strains produce a cross-protection effect against the severe strains (Desvignes, 1976).

PLMVd is easily transmitted by grafting and budding, but is not transmitted by seeds or root contact (Flores et al., 2003). PLMVd has also been experimentally transmitted, although at a low rate, by aphids (Flores et al., 1992). PLMVd was mechanically transmitted with blades, which were either contaminated with purified PLMVd preparations (Flores et al., 1990a) or by slashing infected plants (Hadidi et al., 1997). Thus, contaminated pruning tools may play a role in viroid spread in commercial orchards. In addition, experimental trials have shown that pollen is a vehicle for infection with PLMVd in open fields (Flores et al., 2003).

HSVd is the other viroid that affects stone fruits and belongs to the family *Pospoviroidae*. Although it was described for the first time in the 1970s as the causal agent of a severe stunting on commercial Japanese hop (*Humulus lupulus*) (Sasaki & Shikata, 1997), it was later reported to infect a wide range of hosts including cucumber, grapevine, citrus, plum, peach, pear, apricot, almond,

and pomegranate (Shikata, 1990, Flores et al., 1990b; Astruc et al., 1996; Kofalvi et al., 1997; Canizales, Marcos & Pallas, 1999). The viroid was identified initially in Japan on the Japanese plum cv. 'Taiyo' (Sano et al., 1986). Furthermore, a similar fruit disorder was recognized on the peach cv. Asama-Hakutou (Y. Terai, pers. comm.). The disease was called dapple fruit disease. The symptoms are restricted to the fruit and vary according to the species (plum or peach) and cultivars. On plum the symptoms are irregular reddish blotches on the fruit, which result in the dapple fruit symptom. In some cultivars, the fruit surface becomes irregular. The maturation of infected fruits is retarded by one week or so. The infected fruit flesh becomes harder, which results in improved storage quality. On the plum cultivar Soldam, the pericarp looks polished due to a poor formation of the wax layer on the fruit surface and the flesh turns to yellowish red (Soldam yellow fruit disease).

The symptoms on peach fruits are characterized by chlorotic blotches on the pericarp of mature fruits or by crinkling on the fruit surface. HSVd was detected by reverse transcription-polymerase chain reaction (RT-PCR) in the J. H. Hale peach variety, grown in South Carolina, U.S. (Hadidi et al., 1991). There are no visible symptoms on the foliage or tree structure of affected plum and peach trees (Sano, 2003). The infection seems to be latent in apricot. Recent studies revealed 81% infection of the apricot trees tested in southeastern Spain (Canizales et al., 1998, 2001), 10.4% in Cyprus, 10.3% in Morocco, 5% in Greece, and 2% in Turkey (Amari et al., 2001). In 2004, HSVd was detected in

4.5% of apricot samples tested from the Canadian Clonal Genebank. It was the first report of HSVd in Canada (Michelutti et al., 2004). Although HSVd is latent in apricot, this host could be an important natural reservoir from which the viroid can be transmitted to other hosts. Even though HSVd has been isolated in almond, there are no significant data to determine the real incidence of HSVd in this crop (Pallas et al., 2003).

The viroid is mainly transmitted in nature by grafting (Terai, 1985; Terai, Sano & Shikata, 1990). However, mechanical transmission through contaminated tools cannot be excluded (Terai et al., 1990).

The HSVd isolates from plum and peach consist of 297 nucleotides with a few minor sequence variations. They were considered to be a type mainly infecting stone fruits, because other identical or very similar isolates were found to infect apricot and almond in Europe (Astruc et al., 1996; Kofalvi et al., 1997).

HSVd can be detected by biological and molecular methods. One of the most sensitive techniques to detect the plum and peach isolates of HSVd is the 'cucumber assay', which is also used to diagnose hop stunt disease. HSVd inoculated cucumber plants show symptoms of leaf curling, vein clearing and stunting 3-4 weeks after inoculation. However, this method is no longer in general use, as it requires high temperature greenhouse space. Dot-blot hybridization and RT-PCR are two highly reliable techniques for HSVd detection currently in use (Sano, 2003).

Mixed infections of HSVd and PLMVd have been detected in stunted peach trees cv. Redhaven growing in Sicily and exhibiting delayed budbreak (Tessitori, Reina & La Rosa, 2002). Several apparently symptomless peach trees from the experimental orchard of the Czech University of Agriculture in Prague were also reported to be infected with both HSVd and PLMVd (Hassan, Rysanek & Di Serio, 2004).

Virus and Viroid Detection Methods

To be able to control virus and virus-like infections and correlate them with a phenological effect, unambiguous identification of the agent is required. When a plant disease is caused by a virus, individual particles cannot be seen under the light microscope, but examination of cell sections or crude sap under the electron microscope may reveal virus particles. However, particles of many viruses are not always easy to find and even when such particles are revealed, proof that the particles are from the virus that causes the particular disease requires much additional work and time (Agrios, 2005). Many symptoms caused by viruses or virus-like agents resemble those caused by mutations, nutrient imbalance, insect or mite feeding damage, pesticide injury, or other pathogens. Only on rare occasions are the symptoms uniquely diagnostic. The determination that certain plant symptoms are caused by a virus or virus-like organism requires the elimination of every other possible cause of the disease and the transmission of the virus or virus-like agent from a diseased to a healthy

plant in a way that would exclude transmission by any other causal agent (Agrios, 2005).

If there is some clue of the agent involved, a single test may confirm the virus or virus-like agent's presence. But, more typically, a battery of tests is required and the choice of which ones to use and in what order to use them is often very difficult, especially when the disease in question is new or little is known about it (Dodds, 1993). In addition, the possibility that the disease could be caused by more than one virus or virus-like agent must be examined, particularly in long-lived perennial species which are exposed to different viruses on a yearly basis and can accumulate infections by more than one agent or species of agent (Chia, Chan & Chua, 1995).

Methods Involving Biological Activities of the Virus or Viroid:

a- Disease Symptoms and Host Range Studies

The host range of a virus or virus-like organism is the range of plant species known to serve as hosts for a given organism (Nemeth, 1983). There are several ways in which host plants can help in identification of a virus or viroid: (1) showing specific disease symptoms; (2) species of plants that can or cannot be infected by the agent, may be more or less characteristic for a particular virus or viroid; (3) the phenomenon of cross-protection has been used as an aid in diagnosis; and (4) the back-inoculation with the purified organism to the original

host species to determine if the agent found was the one causing the disease (Matthews, 1993).

Host range studies for diagnostic purposes are most useful for a virus with a narrow host range (Matthews, 1993). Disease symptoms, the natural and experimental hosts, and the host range, can give clues as to which virus or virus-like organism might be involved in a particular disease. However, for a more precise diagnosis, selections of other methods which depend on the properties of the agent particle itself are required (Matthews, 1993).

b- Biological Assays

The inoculation of plant viruses or viroids to different indicator plants, determination whether infection occurs and whether it becomes systemic or not, and careful observation of symptom development, remains a simple and most useful tool in plant virology and is usually essential when studying new virus/viroid species or strains (Matthews, 1993). Biological indexing or bioassay was the earliest method of identifying diseases caused by viruses or viroids and still represents a very important step in the detection and identification of these agents (Hodgson, Wall & Randles, 1998). It has the advantage of providing a visual assay of biological activity (symptom expression, potential for transmission, replication, etc.), but it is not always practical or possible (Singh & Ready, 2003).

Two different groups of indicator plants are used for stone fruit virus identification: herbaceous and woody indicators. The herbaceous plants are maintained in the greenhouse and used in assays for sap-transmitted viruses. The assay may be completed in a few weeks. The woody indicators require a lengthier incubation period, sometimes as many as 2 or 3 years and the plants are graft-inoculated by chip-budding or T-budding (Rowhani et al., 2005). Members of the genera *Nepovirus*, *Ilarvirus*, and *Trichovirus* that infect *Prunus* species are readily sap-transmissible to herbaceous indicators such as *Chenopodium quinoa*, *N. occidentalis*, *N. benthamiana*, and *Cucumis sativa*. Several *Prunus* species and varieties are used as woody indicators for detection of graft-transmissible diseases. Worldwide, the most extensively used woody indicators are *P. armeniaca* cv. Tilton apricot, *P. avium* cvs. Bing, Sam, and Canindex 1 cherries; *P. salicina* hybrid Shiro plum; *P. serrulata* cvs. Kwanzan and Shirofugen flowering cherries; *P. tomentosa* Nanking cherry; and *P. persica* cv. Elberta and GF305 (Rowhani et al., 2005). These form a group that will detect many of the viruses that infect stone fruits and may be supplemented either by local cultivars that show distinctive symptoms or by other cultivars that are developed as our knowledge of the viruses that infect fruit trees expands.

Several factors must be considered in the use of biological indexing, such as reliability of symptom recognition, time required for symptom development, variation in symptom severity, sensitivity, environmental effects, effect of multiple pathogens, and the scale and expense of testing (Singh & Ready, 2003).

Although biological assays are much more expensive, laborious, and time consuming than many other available methods, they are sensitive, remain widely used, and are an essential and integral part of virus identification (Matthews & Hull, 2002).

Biological tests for viroid detection have been important where suitable diagnostic plants have been identified. However, in some cases, some mild isolates of viroids may produce barely detectable symptoms on indicators or environmental conditions may affect the symptoms on the indicator. For these reasons, molecular methods are sometimes preferred instead of bioassays (Huttinga, 1996).

Methods Involving Physical Properties of Virus or Virus-Like Particles:

a- Inclusion Bodies

Virus-induced inclusions have long been used in diagnosing animal virus infections with light microscopy. Most plant virus infections can be diagnosed at the genus level, and some at the species level, by cytological studies. Virus-induced inclusions may consist of aggregated virus particles or coat protein shells, aggregated non-capsid proteins, altered cell constituents, or combinations of some of the mentioned types. Certain inclusions occur only in the cytoplasm (such as potyvirus cylindrical inclusions), others only in nuclei (such as of those of geminiviruses), while some occur in both cytoplasm and nuclei, and others in vacuoles and cytoplasm (Matthews, 1993). Potyviruses induce unique

cytoplasmic cylindrical inclusions (pinwheels). These inclusions are recognized as a characteristic of the genus and are diagnostic for infections by potyviruses (Matthews, 1993). Although many virus infections can be diagnosed at the genus level using the information of inclusion bodies obtained by light microscopy, some can only be diagnosed via electron microscopy (Matthews, 1993).

b- Electron Microscopy

For many viruses examination of thin sections in the electron microscope is a valuable procedure for detecting virions within cells and tissues. The long flexuous viruses, the plant reoviruses, and the rod-shaped viruses can be easily distinguished because their appearance generally differs from any other plant structure. However, they have to be present in sufficient concentration to be seen. Although in electron microscopy a positive identification is usually readily accepted, the absence of particles or inclusion bodies cannot be accepted as evidence that the particular agent is not present. Insufficient samples may have been examined, the preparation method may not have been appropriate, the concentration of the agent is not sufficient to be detected, or the agent may be restricted in distribution to specific tissues within the plant other than those examined. Most of the isometric viruses have staining properties and apparent diameters that make it very difficult to distinguish them from cytoplasmic ribosomes (Matthews & Hull, 2002).

Electron microscopy can be used to prove circularity and estimate the size of purified viroid molecules when spread under denaturing conditions. It cannot be used for diagnostic purposes on tissues or crude extracts, since the small viroid rods or circles cannot be identified in the mixture with plant components (Hanold, 1993).

A combination of electron microscopy and serology was first used by Larson in 1950 (Larson, Matthews & Walker, 1950). The support film on an electron microscope grid is first coated with specific antibody for the virus being studied. Grids are then floated on appropriate dilutions of the virus solution and then examined under the electron microscope. Thus, this method offers a diagnostic procedure based on two virus properties: serological reactivity and particle morphology. Various terms have been used to name this technique: serologically specific electron microscopy (SSEM), immunosorbent electron microscopy (ISEM), solid-phase immune electron microscopy and electron serology (Matthews & Hull, 2002).

In 1977 a modification to the ISEM general procedure was introduced. This consists of coating the virus particles with virus-specific antibody after they are adsorbed onto the EM grid. This process, called 'decoration', produces a halo of IgG molecules around the virus particles that can be readily observed in negatively stained preparations (Milne & Luisoni, 1977).

ISEM is unpractical when large numbers of samples have to be tested. Its main use is to confirm the identity of an unknown virus, in situations where only a

few diagnostic tests are needed; for example, confirmation of the results of ELISA assays or identification of a virus in a small number of samples displaying characteristics and potentially diagnostic symptoms (Matthews & Hull, 2002).

Even with the limitations outlined above, electron microscopy constitutes an indispensable tool in virus diagnosis, but it is usually used as a complement to other diagnostic methods (Nemeth, 1983).

Methods Depending on Viral Protein Properties:

a- Serological Assays

Serology was the first method widely adopted in the evolution of rapid plant pathogen detection and identification. Serology is based on the recognition of antigens by specific antibodies (Rowhani et al., 2005). This method depends on the surface properties of viral proteins, which for most plant viruses means the protein or proteins that make up the viral coat (Matthews & Hull, 2002). Because viroids lack a protein coat, the serological tests used to detect many plant viruses are not applicable (Podleckis & Hadidi, 1995).

The specificity of the antigen-antibody reaction permits viruses to be detected in the presence of host material and other impurities. Results are obtained in a few hours or overnight compared with days or even years for infectivity assays. In addition, the antiserum can be stored and comparable tests made over periods of years and in different laboratories (Matthews, 1991). However, one disadvantage of serology is that only 2-5% of the genetic

information of the viral genome occurs as antigenic determinants on the surface of the virus coat protein (Hull, 1986).

Viruses that are readily transmitted to herbaceous hosts (nepoviruses, ilarviruses, trichoviruses, and vitiviruses) usually can be purified in microgram amounts of high purity and can be injected into animals for the recovery of a serum that reacts to multiple epitopes of an individual viral protein. For non sap-transmissible viruses infecting *Prunus* species, purified virion antigens are more difficult to obtain, are obtained in nanograms quantities, and have greater problems with contamination – tannins and polysaccharides (Rowhani et al., 2005).

Monoclonal antibodies can be obtained by the fusion of B-lymphocytes from an immunized mouse with a mouse myeloma cell line *in vitro*. Selection of appropriate fused cells give ‘hybridomas’ which produce an antibody that reacts to only a single epitope of an individual viral protein (Matthews & Hull, 2002).

A wide variety of methods have been developed using the specificity of the reaction between antibodies and antigens: direct observation of specific precipitates of virus and antibody, either in liquid or in agar gels, ISEM, ELISA, and ‘dot blots’ using either polyclonal or monoclonal antibodies (Matthews, 1991). ELISA is a solid-phase assay in which each successive reactant is immobilized on a plastic surface and the reaction is detected by means of enzyme-labeled antibodies. Because of its great sensitivity (1-10 ng of virus/ml of sap) and economic use of reagents, ELISA is the most popular serological test

used in plant virology. The method can be adapted to quantitative measurement; it can be applied to viruses of various morphological types, and it is particularly convenient when large numbers of tests are needed (Matthews, 1993).

ELISA methods can be divided into direct and indirect procedures. Direct methods, such as double antibody sandwich (DAS)-ELISA, involve enzyme attachment to the antibody. In the indirect method (DASI)-ELISA, the antibody probe remains unlabeled, instead the enzyme is attached to the second antibody or to Protein A that reacts specifically to the probe antibody. DASI-ELISA is favored over DAS-ELISA for its greater sensitivity, broader reactivity, and because only a single enzyme conjugate, usually available commercially, is needed to assay for different viruses (Rowhani et al., 2005).

Although serological assays have been proved to be very important diagnostic tools, their use is limited by the availability and specificity of the antisera (Christie et al., 1995). Serological tests detect and measure the virus protein antigen, not the amount of infective virus (Matthews, 1991).

Methods Involving Properties of the Viral or Viroid Nucleic Acids:

a- Double-Stranded RNA (dsRNA)

Isolation and analysis of ds-RNA is a non-specific test that can be used in the early stages of diagnosis in addition to more specific tests, especially when the problems are new or unfamiliar (Dodds, 1993). ds-RNAs are associated with plant RNA viruses in two ways: as the genomic RNA of plant reoviruses and

cryptoviruses, and as the replicative form of ssRNA viruses. In tissue infected with ssRNA viruses a dsRNA form, twice the molecular weight of the genomic RNA, accumulates (Matthews & Hull, 2002). After extracting total nucleic acids from an infected plant, the method most commonly used for purification of dsRNA involves chromatographic adsorption and release from cellulose powder. The isolated dsRNAs are analyzed by gel electrophoresis, using either agarose or polyacrylamide gels. Each RNA virus should give a distinctive banding pattern of dsRNA. For viruses with monopartite genomes a single band of dsRNA is usually seen. Viruses with multi-partite genomes produce a corresponding number of bands of dsRNA (Valverde et al., 1986). However, dsRNA molecules smaller than the full-length dsRNA are almost always present. They may result from subgenomic ssRNAs that are expressed by the virus or in some hosts are endogenous for as yet unknown reasons. The presence, number, size, and abundance of major and minor dsRNAs for a specific virus can be used as a diagnostic tool to identify the virus at the genus level and, sometimes, strains of the same virus (Dodds, 1993).

b- Polyacrylamide Gel Electrophoresis (PAGE)

PAGE is a powerful and very flexible method in viroid diagnosis. It is based on the distinct mobility of small circular viroid RNAs. Due to their compact secondary structure, viroids migrate in most gel systems with a mobility which is less than expected for a molecule of their molecular weight. So, the

interpretation of gel patterns is often very difficult. If linear viroid forms are present, their size could be estimated in denaturing gels by comparison to linear RNA markers. Because only a very small part of the total RNA extracted from viroid-infected plants corresponds to the viroid RNA, partially purified viroid preparations are required for analysis by gel electrophoresis (Hanold, 1993).

Protocols in which electrophoresis under non-denaturing conditions is followed by electrophoresis under denaturing conditions (Returned gel electrophoresis) are very useful for viroid diagnosis (Rivera-Bustamante, Gin & Semancik, 1986). However, gel electrophoresis is not suitable when large numbers of samples are involved. The extraordinary progress made in nucleic acid research during the past 15 years has permitted the use of diagnostic methods based on the nucleotide sequence of the genome of the viruses or viroids: molecular hybridization and polymerase chain reaction (PCR) techniques (Pallas et al., 1998). Although molecular hybridization and PCR techniques have replaced PAGE for routine viroid diagnosis, electrophoresis remains an essential tool for the detection of unknown viroids (Hanold, Semancik & Owens, 2003).

c- Molecular Hybridization Techniques

Molecular hybridization as a diagnostic tool in plant virology was first used to detect viroids (Owens & Diener, 1981) and then applied to viruses (Maule, Hull & Donson, 1983). The Watson and Crick model for the structure of dsDNA showed that the two strands are bound together by hydrogen bonds between

complementary purine and pyrimidine bases. Molecular hybridization, based on the specific interaction between the bases, results in a stable hybrid formed by part (or the totality) of the nucleic acid of the pathogen to be detected and a labeled complementary sequence (probe). The dot-blot hybridization technique is the most common method for molecular hybridization, consisting of the direct application of a nucleic acid solution to a solid support, such as nitrocellulose or nylon membranes, and subsequent detection with specific probes (Pallas et al., 1998). In early studies, radioisotopes were used for labeling probes and results were visualized by autoradiography (Owens & Diener, 1981). Now, the availability of non-radioactive precursors to label nucleic acids has made molecular hybridization more accessible. Among the non-radioactive precursors, the ones derived from biotin and digoxigenin (DIG) molecules are the most widely used. Biotin (vitamin H) binds very tightly to avidin (a glycoprotein isolated from egg whites) and its microbial analogue, streptavidin (isolated from *Streptomyces avidinii*). Each avidin molecule has four biotin-specific binding sites. Using avidin molecules coupled to an enzyme (usually alkaline phosphatase or horseradish peroxidase), it is possible to detect biotin labeled probes by measuring enzymatic activity with chromogenic, fluorogenic, or chemiluminogenic substrates (Nikolaeva, 1995). The main disadvantages of this system are that the endogenous biotin of the plant sap extract may cause false positives or the presence of glycoproteins that bind avidin can produce problems regarding specificity and background (Pallas et al., 1998).

The other non-radioactive system is based on the specific interaction between the cardenolide-steroid digoxigenin (DIG) from digitalis plants and a high-affinity DIG-specific antibody coupled with a reporter group. DIG is bound via a spacer arm (eleven carbon residues) to uridine-nucleotides and incorporated enzymatically into nucleic acids by standard methods. As the cardenolide DIG is found exclusively in digitalis plants, this system does not have the problems of nonspecific reactions associated with the use of biotin (Nikolaeva, 1995).

Viroids and most plant viruses, including all of the viruses thus far reported to affect stone fruits, have RNA genomes. Because RNA-RNA hybrids are more stable than DNA-RNA hybrids, using RNA probes for virus or viroid detection offers the possibility of working under more stringent conditions, which will help to increase specificity and reduce background problems (Muhlbach et al., 2003).

The sample processing conditions for nonradioactive molecular hybridization analysis will depend on the virus or viroid being detected, the host, the type of probe and the method used for detecting the virus/viroid-probe hybrid. For routine analysis, sample manipulation can be reduced to a minimum by using the tissue-printing technique. It avoids sample extraction and only requires the direct transfer of the plant material by pressing the cut part of the plant onto the membrane. This technique can be used not only for diagnostic purposes, with the obvious advantage of reducing the test times, but also to study viroid distribution within the infected plant (Muhlbach et al., 2003). The sample (nucleic

acids) must be fixed onto a membrane by baking (for nitrocellulose membranes) or by ultraviolet cross-linking (for nylon membranes). Nonspecific binding sites on the membrane are blocked by incubation in a prehybridization solution (Pallas et al., 1998). Hybridization may detect picogram quantities (10^{-12}) of virus or viroid RNAs. Thus it is more sensitive than ELISA, which detects in the nanogram (10^{-9}) range (Chia et al., 1995).

d- Polymerase Chain Reaction (PCR)

PCR was developed in the mid-1980s (Mullis et al., 1986) and was rapidly adopted in plant pathology for detection and diagnosis of viroids, viruses, bacteria, phytoplasma, fungi, and nematodes as nucleic acid sequence for individual species, genera or viral families became available. It is a versatile, specific and sensitive method, which utilizes an exponential enzymatic amplification of specific DNA sequences. This process is achieved through multiple cycles of reactions performed at different temperatures: reaction 1- denature the DNA at temperatures $> 90^{\circ}\text{C}$; reaction 2-anneal two oligonucleotide primers to each strand of the denatured DNA at $50\text{-}75^{\circ}\text{C}$; and reaction 3-primer extension ($72\text{-}78^{\circ}\text{C}$) by a thermostable DNA polymerase, from the 3' hydroxyl end toward the 5' end of the molecule, to copy the target sequence whose ends are defined by the primers. In some systems reactions 2 and 3 may be combined. In the case of pathogens with RNA genetic materials (viroids and all stone fruit viruses) a previous reverse transcription step (RT) must be included to

copy the target RNA into cDNA. The presence of amplified DNAs can be visualized by gel electrophoresis analysis (Pallas et al., 1998).

The significance of PCR lies in its ability to amplify *in vitro* a specific DNA or cDNA sequence, of 50 bp to over 40,000 bp in length, from trace amounts to more than a million fold in a few hours (10^6 to 10^9 fold amplifications in 3 or 4 hours). In theory, PCR is highly specific and sensitive allowing the amplification of a single nucleic acid molecule from a complex mixture (Pallas et al., 1998). Furthermore, the selection of appropriate primers may permit the discrimination of sequences that differ by as little as a single nucleotide (Hadidi & Candresse, 2003).

Oligonucleotide primers must be 18-25 nucleotide residues in length, with 50% G+C content, no secondary structures, and high G+C content at the 3' ends. Primers can be targeted either to conserved regions or to variable regions of the pathogens. In primers designed for viroid detection, longer oligonucleotides with higher annealing temperatures are recommended to overcome the problem of intra-molecular base pairing of viroid molecules (Pallas et al., 1998).

The primer annealing temperature, incubation times for the different steps, and concentrations of primers, salts, and enzymes; may affect the specificity of the PCR reaction (Pallas et al., 1998). Preparation of plant extracts is another critical aspect of PCR. Most of woody plant tissues contain high levels of polysaccharides and phenolic compounds that affect the activities of PCR

enzymes. Different approaches have been proposed to avoid the effect of those components, including the addition of inhibitors, use of special columns that differentially bind viral RNAs, dilution of the extract and immuno-capture (IC) RT-PCR (Candresse, Hammond & Hadidi, 1998; Rowhani et al., 2000). It consists of binding virion-specific antibodies in wells of microtiter plates or tubes and incubating the sap extract to allow attachment of virions to the antibodies. Subsequent washing steps remove contaminants from the extract before RT-PCR is performed in the coated wells or tubes (Nemechinov et al., 1995). A limitation is the lack of availability of antibodies for some viruses.

Several variations of RT-PCR have been developed: nested, one-step, multiplex, and Real-time PCRs. Nested-PCR is designed for high specificity detection of templates present in very low amounts. An external primer pair is used for an initial amplification. Then, a second primer pair, which hybridizes within the initial amplified fragment, is used to prime a second amplification to further amplify the target segment (Foissac et al., 2001; Dovas & Katis, 2003a). In one-step PCR, all reagents required for reverse transcription and amplification are combined in a single PCR tube and the thermocycler program accomplishes first reverse transcription and then PCR (Rowhani et al., 2000). Multiplex-PCR has the advantage that it allows the concurrent identification of viruses in plant mixed infections in a single PCR experiment. It requires the use of multiple pairs of primers (one for each target template) and the product of each template is distinguished either by its size or fluorescent label (Dovas & Katis, 2003b). As

the number of primer pairs used in a reaction to detect virus increases, interference may occur. However, Sanchez Navarro et al. (2004) have demonstrated the ability to detect eight viruses simultaneously in samples from stone fruits.

The possibility that the detection of the amplicon could be visualized as the amplification progressed is the basis of the Real-time PCR. In Real-time PCR, a pair of oligonucleotide primers and a fluorescent-labeled oligonucleotide probe, designed to hybridize to a site between the two-primer binding sites, are usually used. There are different methods for Real-time PCR detection, which can be classified as amplicon sequence specific or non-specific methods (Mackay, Arden & Nitsche, 2002). The basis of the sequence non-specific detection methods is the use of DNA-binding fluorogenic molecules, such as SYBR® green 1, YO-PRO-1 or ethidium bromide. They bind to dsDNA and fluoresce when is exposed to light of a suitable wavelength. SYBR green is a fluorogenic minor groove binding dye that exhibits little fluorescence when in solution, but emits a strong fluorescent signal upon binding to double-stranded DNA (Morrison, Weiss & Wittwer, 1998).

The sequence specific methods are based upon the hybridization of fluorescently labeled oligonucleotide probe sequences to a specific region within the target amplicon that is amplified using traditional forward and reverse PCR primers. In the TaqMan system, an oligonucleotide probe sequence approximately 25–30 nt in length is labeled at the 5' end with a fluorochrome and

a quencher molecule at the 3' end. When the probe hybridizes to the target DNA, the proximity between the fluorochrome and the quencher prohibits fluorescence. After the TaqMan probe is degraded by the 5–3' exonuclease activity of the *Taq* polymerase as it extends the primer during each PCR amplification cycle, the chromophore is released and starts to fluoresce. The amount of fluorescence is monitored during each amplification cycle and is proportional to the amount of PCR product generated (Mackay et al., 2002).

Molecular beacons are other kinds of probes, designed to include a stem-loop formed by the annealing of the complementary arm sequences that are added on both sides of the probe sequences. When the stem structure is formed, the fluorophore transfers energy to the quencher and no fluorescence is emitted. When the probe hybridizes to the target amplicon during PCR amplification, the fluorophore and quencher move apart from each other and fluorescence can be detected (Cockerill & Smith, 2002). Another method uses two adjacent fluorogenic probes, now known as 'HybProbes', where the upstream oligoprobe is labeled with a 3' donor fluorophore and the downstream probe is labeled with a fluorophore acceptor at the 5' end. When the two probes are hybridized, the two fluorophores are located near each other and fluorescence is emitted (Mackay et al., 2002). All these methods eliminate the need for product detection by gel electrophoresis, are quantitative, and are highly sensitive (Rowhani et al., 2005).

Diagnostic methods for plant virus and virus-like organisms are being continuously improved. Although molecular hybridization and PCR have gained a higher level of sensitivity compared with other methods, a compromise between simplicity of automation and sensitivity must be chosen (Pallas et al., 1998).

Although a single method may be used to confirm the presence of an agent in situations such as screening material for infection by a single virus, reliance on a single test in situations where the identification of an agent is critical – screening budwood prior to propagation – is not optimal. Critical screening requires either repeated testing or a combination of different testing methods. For example, ELISA detects the presence of viral coat protein. Polyclonal antibodies may not detect all serotypes. Conversely, monoclonal antibodies detect only a single epitope and this may have been modified in specific isolates or may not be exposed by the method used to prepare samples. Bioassays detect infectious viruses. Nucleic acid detection methods detect the presence of the molecules associated with infection but offer no support as to whether those molecules are indeed infectious.

Within the filamentous group of viruses and viroids affecting stone fruits, some, like PPV, are devastating, while others are not necessarily pathogenic, for example, the possible role of some flexuous viruses and viroids in delaying bloom to minimize the risk from late spring freezes. However, before using a

virus as a tool in orchard management, it is important to have a good understanding of its characteristics.

Table 2.1

Ta Tao genotypes of peach (*Prunus persica*) imported into the US through the USDA Plant Introduction Station, Chico, California in 1933.

Ta Tao Genotypes	US accession numbers	Canadian virus-tested scheme numbers	Average date of full bloom in Chico, CA
Ta Tao 1	PI101663		March 27
Ta Tao 2	PI101664		March 28
Ta Tao 3	PI101665		March 28
Ta Tao 5	PI101667		March 28
Ta Tao 6	PI101668		March 27
Ta Tao 7	PI101669		March 29
Ta Tao 15	PI101677		March 30
Ta Tao 16	PI101678		March 28
Ta Tao 18	PI101680		March 29
Ta Tao 19	PI101681		March 30
Ta Tao 20	PI101682		March 31
Ta Tao 22	PI101684		March 30
Ta Tao 23	PI101685	Q375-23	March 29
Ta Tao 24	PI101686		March 28
Ta Tao 25	PI101687	Q375-02	March 30
Ta Tao 26	PI101688		March 26
Ta Tao 27	PI101689		March 27

Table 2.2

Cultivars of *Prunus* spp. from which the six original isolates of virus that cross-reacted with antibodies to plum pox virus originated (From: James et al., 1994).

Genus and species	Cultivars	Canadian virus-tested scheme numbers	Obtained from:
<i>Prunus mume</i>	Bungo	Q1256-01	Imported from Japan in 1985
	Ting Ting	Q1256-03	
<i>Prunus persica</i>	Ta Tao 23	Q375-23	USDA Plant Int. Station, Chico, CA (US) (came to the USA from China in 1933)
	Ta Tao 25	Q375-02	
	Ku Chu'a Hung	Q375-18	
	Agua	4-N-6	It was brought to Ontario (CA) from South Carolina USA (it is believed to have originally come from Mexico).

Table 2.3

Genera and viruses included within the family *Flexiviridae* (From: Adams et al., 2004 and Martelli et al., 2007). The length of the virus particles, the number of open reading frames (ORF), the type of movement proteins, and the molecular mass of the coat protein (CP) are indicated. Movement proteins are either of the 30K superfamily type or a triple gene block (TGB) proteins.

Genus	Virion length (nm)	ORF	Movement protein (s)	CP (KDa)
<i>Potexvirus</i>	470-580	5	TGB	22-27
<i>Mandarivirus</i>	650	6	TGB	34
<i>Allexivirus</i>	~800	6	TGB	26-29
<i>Carlavirus</i>	610-700	6	TGB	31-40
<i>Foveavirus</i>	723-800+	5	TGB	28-44
<i>Capillovirus</i>	640-700	2 or 3	30K	25-27
<i>Vitivirus</i>	725-785	5	30K	18-23
<i>Trichovirus</i>	640-760	3 or 4	30K	21-27
Viruses not assigned to a genus				
Banana mild mosaic virus (BanMMV)	580	5	TGB	27
Cherry green ring mottle virus (CGRMV)	1000+	5	TGB	30
Cherry necrotic rusty mottle virus (CNRMV)	1000+	5	TGB	30
Citrus leaf blotch virus (CLBV)	960	5	30K	41
Potato virus T (PVT)	640	5	30K	24
Sugarcane striate mosaic-associated virus (SCSMaV)	950	5	TGB	23

CHAPTER III

MOLECULAR CHARACTERIZATION OF THE ISOLATE OF APPLE CHLOROTIC LEAF SPOT VIRUS (ACLSV) PRESENT IN TA TAO 5 GERMPLASM OF *PRUNUS PERSICA*

Introduction

ACLSV possesses flexuous particles of 720 x 12 nm (length x diameter) and is the type member of the genus *Trichovirus*, a member of the family *Flexiviridae*. The virus has a worldwide distribution and induces a large variety of symptoms in fruit trees. ACLSV was first reported in *Malus* spp. but it also affects almonds, apricots, cherries, peaches, pears, plums, and some ornamental plant species (Nemeth, 1986; Desvignes & Boye, 1989). The severity of symptoms expressed depends largely on the plant species infected and the virus strains present (Nemeth, 1986). It is responsible for many serious diseases in stone fruits, including false plum pox or plum pseudo pox (Jelkman & Kunze, 1995), plum bark split (Dunez et al., 1972), cherry fruit necrosis (Desvignes & Boye, 1989), and 'viruela' and 'butteratura' diseases in apricot (Ragozzino & Pugliano, 1974). ACLSV is a serious problem in nurseries due to its worldwide distribution together with its capacity to induce severe graft incompatibilities in some prunus combinations (Desvignes & Boye, 1989). The virus is transmitted by mechanical inoculation, is not transmitted by seeds, and has no known vector (Buchen-Osmond, 2002).

Complete nucleotide sequences of the genome of ACLSV have been reported for isolates P863 (associated with plum bark split disease), P205 (apple top working disease), PMB1 (false plum pox), and Balaton1 (cherry necrosis) (German et al., 1990; German-Retana et al., 1997; Jelkman, 1996; Sato et al., 1993). Recently the genomic sequences of three other isolates from apple (MO-5, B6, and A4) that are not associated with specific diseases have been reported (Yaegashi et al., 2007b) (Table 3.1). The genome consists of a single positive sense ssRNA of about 7,545 to 7,555 nt in length, excluding the poly A tail. It has three open reading frames (ORF) encoding for a 216.5 kDa RNA replicase (ORF1), a 50.4 kDa movement protein (ORF2), and a 21.4 kDa coat protein (CP) (ORF3), respectively (Al Rwahnih et al., 2004).

The majorities of studies of ACLSV have examined the CP and have shown a high degree of variability among different isolates. This variability is higher in the region coding for the N-terminal part of the CP than in the region coding for the C-terminal part of the CP. However, a few isolates have shown high variability throughout the whole CP gene (Pasquini et al., 1998; Candresse et al., 1998; Krizbai et al., 2001; Al Rwahnih et al., 2004).

A trichovirus closely related to ACLSV was detected in symptomatic apricot and Japanese plum from Italy. As the nucleotide sequence of this virus shares only 65-67% nt identity to ACLSV, for the regions coding for the RdRp gene and the CP gene, and exhibits differences in serology and host range, it

was proposed that it be considered a different virus. This new agent was named Apricot pseudo-chlorotic leaf spot virus (APCLSV) (Liberti et al., 2005).

Many difficulties have been found in detecting ACLSV due to the high variability among different isolates, low particle stability, and low concentrations of the virus in the host. The concentration of ACLSV in apple trees in the northern hemisphere increases in March and reaches its maximum titer by May and June (Fuchs, 1980, 1982). There are considerable differences in the virus concentration among tissues of different organs in peach plants. Some researchers recommend testing flower petals by ELISA (Fuchs, 1980, 1982), while others suggest testing fruit tissue (Llacer et al., 1985). The virus has an erratic distribution in peach leaves, with the highest virus concentration being found at the base of the branches (Barba & Clark, 1986).

The techniques currently used to detect ACLSV in peaches include biological indexing in GF 305 peach seedlings, immunoelectron microscopy, serological indexing by ELISA using polyclonal and monoclonal antibodies, and PCR. ELISA assays for ACLSV become unreliable for indexing most host plants during the summer period. This effect is probably due to a reduction of virus titer during this period caused by elevated summer temperatures (Candresse et al., 1995).

PCR techniques have been used for the detection of ACLSV in recent years, and the test has the potential to become a reliable detection tool. However, it still has to be proven on a broad spectrum of virus isolates (Spiegel

et al., 2006). PCR detection of ACLSV has been mainly based on products amplified from the region of the viral genome that codes for the CP of the virus (Candresse et al., 1995; Kinard, 1995; Kinard, Scott & Barnett, 1996; Menzel, Jelkman & Maiss, 2002). However, some primers have been developed to amplify the RdRp regions of the replicase ORF because this region appears conserved among the different isolates of ACLSV and several other related viruses (Kummert et al., 2000; Foissac et al., 2005). In one study, in which 14 different isolates of ACLSV were analyzed, primers CLS6860 and CLS7536 (Menzel et al., 2002), which amplify a 676 bp fragment in the CP region, were the most reliable, detecting all isolates in all hosts. Primers 4 F/ 4 R (Kummert et al., 2000), amplifying a 390 bp fragment from the replicase region, detected most of the isolates but generated some false positives. Primers A53 and A52, one of the primer pairs originally used in the detection of ACLSV by PCR (Candresse et al., 1995), only detected half of the isolates (Spiegel et al., 2006).

Ta Tao 5, one member of a series of germplasm imported from China in the 1930s, is being used to delay bloom in peaches (Reighard, 1998). The germplasm was found to be infected with a virus by mechanical inoculation to *Nicotiana occidentalis* 37B. Initial identifications showed this virus to be ACLSV (Gibson, 2000; Gibson et al., 2001). However, detection of the virus in peach trees by PCR using primers A52 and A53 was often erratic. Experiments designed to assess the role of ACLSV in this bloom delay require reliable

detection of virus in order to confirm that experimental treatments involving inoculation with the virus have been established.

In this study the sequence of the complete genome of ACLSV isolated from Ta Tao 5 is described. Phylogenetic comparisons of this isolate with the seven other isolates of ACLSV for which complete genomic sequences are available clearly show that the isolate detected in Ta Tao 5 is atypical. Examination of the sequence also offers explanation as to why some of the primer pairs used for routine detection of ACLSV by PCR do not work.

Materials and Methods

Virus Sources and Maintenance

The viral sources used in this study came from Ta Tao 5 infected mother trees (PI101667) located at Musser Farm Research Center near Clemson, South Carolina. Ta Tao 5 vegetative buds were T-budded onto Nemaguard peach seedlings grown from seed that originated from virus-tested mother trees and maintained under controlled greenhouse conditions at Clemson University, SC. The plants were placed in a walk-in cooler for two months at 4°C to break dormancy and then they were moved back into the greenhouse to force them into growth. Plant material from Coronet peach inoculated with Ta Tao 5 budwood was used as well. Non-inoculated trees of Springprince peach and Ta Tao 5 plants that had been heat treated were used as negative control plants. The

Plum P863 isolate of ACLSV, provided by T. A. Candresse (Station de Pathologie Vegetale, Bordeaux, France), was utilized as the positive control.

Nucleic Acid Extraction

Total RNA was extracted from newly emerged shoots of peach germplasm using a modified procedure of Hughes and Galau (1988) (Appendix A). Total RNA was store at -80°C. Extractions were completed as necessary to provide material for PCR reactions.

Amplifications

The sequences of the primers used for PCR amplifications are presented in Table 3.2. The positions of the primers used to obtain the full length sequence of the isolate of ACLSV present in Ta Tao 5 are shown in Figure 3.1

One-Step PCR

One-Step PCR reactions were completed using plant total RNAs (Appendix D). Primers A52 and A53 (Candresse et al., 1995), CLS6860 and CLS7536 (Menzel et al., 2002), and 4 F/ 4 R (Kummert et al., 2000) were utilized to perform the PCR reactions. When Menzel primers were used, the annealing temperature was adjusted to 62°C and the cycle number was adjusted to 35.

RT-PCR

RT-PCR (Reverse Transcription-Polymerase Chain Reaction) to amplify longer fragments of the sequence of ACLSV was completed using cDNAs generated by Superscript III, Power Script™ Reverse Transcriptase or Im PROM II as detailed in Appendix C and the Advantage® 2 PCR Enzyme System. cDNA was synthesized using primers p938, p961, and p982. A PCR reaction was set up using p938 as downstream (ds) and p937 as upstream (us) primers, respectively; with cDNA from p938. A second reaction using cDNA synthesized with p982 and using primers 982 and p994 was also completed. A third reaction using cDNA synthesized with p961 and using p961 (ds) and the Consensus-Degenerate Hybrid Oligonucleotide Primer (CODEHOP) p960 (us) was completed. PCR products were separated by electrophoresis as described in Appendix E.

Cloning, Sequencing, and Sequence Analysis

PCR reactions that produced specific single bands were cloned directly, and reactions in which multiple bands occurred were cloned after the band of interest was excised from the gel. When faint DNA bands were obtained, MinElute gel Extraction was done as described in Appendix F. When bright bands were observed, the gel fragment was placed directly in a Nanosep MF 0.45 µm spin column (Pall Corporation, Ann Arbor, MI, USA) and centrifuged 5 m

at 18,000 g. The resulting DNA solution was used in cloning reactions, using either TOPO[®] or pGEM[®]-T Easy vectors. Plasmid purifications, sequencing, and sequence analyses were done as described in Appendix G. The viral sequences used for comparison are shown in Table 3.1.

Results

Molecular Detection of the ACLSV Isolate Present in Ta Tao 5

Amplification of ACLSV Product by One-Step PCR

Using total RNA from original Ta Tao 5 sources and One-Step PCR with primers 4 F/ 4 R, a strong band of the expected size (390 bp) was obtained in all the samples tested (Figure 3.2). A similar band was observed when using RNA from ACLSV P863 strain. No bands were present in PCR products amplified from non-inoculated peach trees or heat-treated Ta Tao 5 trees. The nucleotide sequence of the 390 bp band was closely related (82% similarity by BLAST search), but not identical to ACLSV sequences published in GenBank.

Erratic results were obtained when primers A53 and A52 were used in One-Step PCR with total RNA extracted from Ta Tao 5 sources. Either no amplification occurred or only faint bands were observed for Ta Tao 5 samples. A 358 bp product was amplified for ACLSV isolate P863 but no band was observed for non-inoculated and heat-treated Ta Tao 5 plants. The faint band obtained for some of the Ta Tao 5 sources and the single band for isolate P863

were cloned and sequenced and they corresponded to the sequences previously published for the CP region of ACLSV.

When primers CLS6860 and CLS7536 were used for One-Step PCR, no bands were observed for the Ta Tao 5 total RNA analyzed. A 676 bp band, corresponding to the CP coding region of ACLSV, was obtained with P863 ACLSV RNA. No bands were observed with non-inoculated trees and heat-treated Ta Tao 5 trees.

Sequencing of the Genome of the Associated ACLSV Isolate Present in the Ta Tao 5 Source

The 3' terminal region of the genome of the TaTao 5 ACLSV isolate (671 nt long, clone 6) was obtained from an oligo-dt clone generated by Gibson et al. (2000). A 390 nt clone, that corresponded to the replicase coding region of ACLSV, was amplified by One-Step PCR using Kummert 's primers 4 F/ 4 R [p868, 869, Figure 3.1]. To fill the gap between the two clones, gene specific primers 938 and 937 were designed from the sequence information of the 671 nt and 390 nt clones, respectively. A 1.5 kb clone was obtained by Advantage 2 PCR System, using these primers. This clone corresponded to the 5' end of the CP, the MP, and the 3' end of the RdRp of the ACLSV coding regions.

A degenerate primer (p960) designed using the CODEHOP program (Rose et al., 1998) and a multiple alignment of the four published complete sequences of ACLSV was used in conjunction with primer p960 to extend the

sequence toward the 5' terminus. A primer designed from the sequence within this fragment (p982) was used together with primer 994 (an area of sequence in the 5' NCR of ACLSV conserved in all four published complete sequences of ACLSV) to amplify a 4.7 kb fragment. Primer 1003, designed from a sequence adjacent to the 5' terminal region of this long fragment, was used with the SMART™ II oligo, UPM, and NUP to determine the 5' terminal of this sequence (Appendix D). The full length sequence of the isolate of ACLSV from Ta Tao 5 consisted of 7,474 nt plus a poly A tail of undetermined length (Figure 3.3).

Genomic Organization of the Associated ACLSV Ta Tao 5 Isolate

The genome organization of the isolate of ACLSV from Ta Tao 5 is similar to the genomic organization of the seven ACLSV complete sequences published to date. The complete nt sequence was closely related, but not identical (72.8, 70.3, 70.2, 70.1, 70, 70, and 69.5% nt identity by FASTA program), to the Balaton1 (cherry necrosis), P863, B6, PMB1, A4, MO-5 and, P205 ACLSV isolates, respectively.

Three putative complete ORFs (ORF1, ORF2, and ORF3) were identified coding for proteins from the complete sequence information obtained above. ORF1, ORF2, and ORF3 overlap each other and they extend from nucleotide 160 to 5,802, 5,714 to 7,054, and 6,750 to 7,331, respectively. Two non-coding regions (NCRs) of 159 and 143 nt were identified at the 5' and 3' end of the

genome, respectively. Downstream of the 3' NCR was a poly A tail of undetermined length.

The 1,880 aa residues (Mr 216 kDa) deduced from the nucleotide sequence obtained for ORF1 had a putative conserved domain corresponding to a viral RNA dependent RNA polymerase (RdRp). Approximately 75% identity was found between the polymerase domain of the Ta Tao 5 isolate and the other ACLSV isolates in paired comparisons using the FASTA program; the percentage identity dropped to 60% when comparisons were made with other members of the genus *Trichovirus* (Table 3.3).

ORF2 encodes for a putative protein of 446 aa residues (Mr 49.4 kDa). Database searches and computer-assisted alignment of this protein, identified it as a member of the 30 K superfamily type virus MP. BLAST search of the protein found 62% identity with the 51 kDa protein of APCLSV and 60% identity with the 50 kDa putative movement protein of ACLSV. The movement function of the 50 kDa ACLSV MP has been proved by Yoshikawa et al. (1999) using green fluorescent protein label. The aa sequence of MP of the isolate of ACLSV found in Ta Tao 5 shared approx 60% identity with the MP of the known ACLSV isolates (Table 3.3) but much less identity (47 and 34.5%, respectively) when compared to other viruses (CMLV and GINV) in the genus *Trichovirus* (Table 3.3).

ORF3 encodes for a putative protein of 193 aa residues (Mr 21.7 kDa). The aa sequence of CP from the isolate from Ta Tao 5 shared 75.6% to 72%,

identity with the CP sequences of ACLSV isolates but shared only 56%, 53.4% and 36.7% for other trichoviruses PcMV, CMLV and GINV, respectively (Table 3.3). A comparison of the CP sequence of the isolate from Ta Tao 5 with the sequences of the CP of other trichoviruses using the BLAST algorithm identified a conserved CP domain previously associated with trichoviruses. A multiple alignment of the aa sequences of the isolate from Ta Tao 5 and the CPs of the other completely sequenced ACLSV isolates is shown in Figure 3.4.

Phylogenetic Analysis

In analysis using amino acid sequences of the polymerase, CP, and MP, the isolate of ACLSV from Ta Tao 5 virus isolate grouped consistently into the genus *Trichovirus* with very high bootstrap values (Figure 3.5, 3.6, and 3.7). ApruV-1 (genus *Foveavirus*) and PVX (genus *Potexvirus*) were used as outgroups. The aa sequences of the polymerase, MP, and CP of the isolate of ACLSV from Ta Tao 5, were found to be more related to ACLSV or APCLSV than to other members of the genus *Trichovirus* (PcMV, CMLV or GINV-Figure 3.5, 3.6, and 3.7).

Primers Specificity

Multiple alignments for the sequences of the seven isolates of ACLSV published to date, and the sequence of the isolate from Ta Tao 5 that

corresponds to the target regions of the primer pairs of Kummert (replicase ORF); the coat protein and 3' UTR target regions of Menzel primers; and the coat protein target region of Candresse primers (A53-A52) are presented in Tables 3.4, 3.5, and 3.6, respectively. The Kummert primers, 4 F and 4 R, presented only three and two mismatches, respectively with the corresponding sequence from the Ta Tao 5 isolate (Table 3.4). The Menzel primers, CLS6860 and CLS7536, showed two and four mismatches with the corresponding sequence for the Ta Tao 5 isolate. The Candresse primers, A53 and A52, presented 12 and 12 mismatches, respectively (Tables 3.5, 3.6).

Discussion

Phylogenetic analysis, supported by high bootstrap values (100%) showed that the agent detected in Ta Tao 5 is a member of the family *Flexiviridae*, and belongs to the genus *Trichovirus*. The 7.47 kb length of the complete genome sequence of the agent is in concordance with the size proposed for viruses belonging to the genus *Trichovirus*, ~7.5 to 7.8 kb (Fauquet et al., 2005). In addition, the genome organization of the Ta Tao agent is identical to that of members of the genus *Trichovirus*, with three overlapping ORFs that encode for a polymerase, a MP belonging to the 30 K superfamily, and a CP (Adams et al., 2004; Fauquet et al., 2005). No evidence of an extra ORF, as found in some other members of the genus (PcMV and CMLV) was found in the Ta Tao 5 isolate.

The genome organization of the Ta Tao 5 agent is similar to that of the seven completely sequenced ACLSV isolates. The 216, 49.4 and 21.7 kDa proteins for the polymerase, MP, and CP, respectively, coded by the Ta Tao 5 agent are in complete agreement with the 216.5, 50.4 and 21.4 kDa cited as coded by most of the ACLSV isolates (Al Rwahnih, 2004). The length of the Ta Tao 5 agent amino acid CP is similar to the other completely sequenced ACLSV isolates, except for PMB1 and Batalon 1, which have a longer CP.

Examining the relationships among the species of trichovirus, the Ta Tao agent was more similar to the ACLSV isolates in the polymerase and CP protein regions than to APCLSV, but it grouped with APCLSV (ARPox1 and Sus2 isolates) with high bootstrap support in the MP tree. These data are not surprising because the MP is the least conserved of the three proteins encoded by ACLSV genome. Multiple ACLSV sequence alignments indicated that this high divergence is unevenly distributed along the 50 K MP of the ACLSV isolates (German et al., 1997). The relationships among the MPs may also reflect the host from which the virus was isolated. The MP interacts intimately with the plant host to facilitate movement, and it is therefore highly likely that the protein may vary according to the host to which the particular virus isolate is adapted. The polymerase and the CP function to replicate and protect the virus and as such may be less affected by the host from which the virus was isolated.

The percentage aa identities observed between the Ta Tao 5 agent and the other ACLSV isolates were below the value of 80% amino acids identity for

the complete polymerase and CP genes proposed as species demarcation criteria in the family *Flexiviridae* (Adams et al., 2004). Following only these criteria, we could argue that the agent found in Ta Tao 5 is a new species in the genus *Trichovirus*. However, previous reports have shown that the genome of ACLSV shows variation of 10 to 20% among different isolates (Candresse et al., 1995; Pasquini et al., 1998; Krizbai et al., 2001). Based on the identical genome organization found between the Ta Tao 5 agent and ACLSV, the high phylogenetic relationships, and the fact that the percentage identity for the aa sequences of the RdRp and CP genes were close to the limit for species demarcation (around 75%), the Ta Tao 5 agent described in this work should be considered an atypical ACLSV isolate rather than a new species in the genus *Trichovirus*. The sequence presented in this work is the first reported complete sequence of an ACLSV isolate detected in peach; therefore, closer relationships between the Ta Tao 5 ACLSV isolate and other isolates of ACLSV may be reported in the future. The variability found in the complete sequence of the Ta Tao 5 ACLSV isolate explained why the primers of Menzel and Candresse completely failed to amplify ACLSV in Ta Tao 5 sources by One-Step PCR. ACLSV-P863, used as positive control, presented few mismatches for the three pairs of primers; which explained the success of the amplification. As cited in previous work (Spiegel et al., 2006), it is prudent to consider a combination of diagnostic tools (bioassay, serology, and molecular based) for the most reliable detection of ACLSV in quarantine and certification programs.

There is only limited information on the molecular determinants of the pathogenicity of flexiviruses. Two examples include the 25 kDa protein encoded by ORF2 of PVX and the 10 kDa protein encoded by ORF5 of grapevine virus A (GVA), both of which are involved in symptom expression and RNA silencing suppression (Martelli et al., 2007). Recently, it was determined that the combination of two amino acids Ala⁴⁰ and Phe⁷⁵ or Ser⁴⁰ and Try⁷⁵ in the ACLSV CP sequence are required for infection of *C. quinoa* plants by mechanical inoculation (Yaegashi et al., 2007). The CP sequence of Ta Tao 5 ACLSV isolate contains both a Ser amino acid at position 40 and a Try amino acid at position 75. This gives some molecular evidence of the capacity for infectivity of the Ta Tao 5 ACLSV isolate. However, further studies will be necessary to determine the relationship between the ACLSV isolate found in Ta Tao 5 and bloom delay. The presence of an atypical ACLSV isolate in Ta Tao 5 germplasm has been determined by this study. Having the complete genome sequence of the Ta Tao 5 ACLSV isolate will permit the design of reliable tools to detect this virus in experimental trials to assess the role of it in bloom delay in peaches.

Table 3.1

Viral sequences used for comparison in this study: The geographic origin of the virus, the host from which it was isolated, and the accession number in GenBank are indicated.

Viral Isolate	Host	Origin	Accession n ^o
ACLSV-P863	Plum	France	M58152
ACLSV-P205	Apple	Japan	D14996
ACLSV-PMB1	Plum	Germany	AJ243438
ACLSV-Balaton1	Wild Cherry	Hungary	X99752
ACLSV-A4	Apple	Japan	AB326223
ACLSV-MO-5	Apple	Japan	AB326225
ACLSV-B6	Apple	Japan	AB326224
APCLSV-Sus2	Plum	Italy	AY713379
APCLSV-ARPOx1	Apricot	Italy	AY713380
CMLV	Cherry	Canada	AF170028
PcMV	Peach	USA	DQ117579
GINV	Grapevine	Japan	D88448
APruV-1	<i>Prunus mume</i> cv. Bungo	Japan	DQ205236
PVX	Potato	Russia	EU021215

Table 3.2

Sequences of the primers used to detect and clone the isolate of apple chlorotic leaf spot virus (ACLSV) from Ta Tao 5 peach (*Prunus persica*) germplasm. The melting temperature (T_m) of the primers and the size of the product amplified (bp) are indicated.

Primer name	Primer sequence	T _m °C	Product size (bp)
CLS6860 (F)	5' TTCATGGAAAGACAGGGGCAA 3'	62	676
CLS7536 (R)	5' AAGTCTACAGGCTATTTATTATAAGTCTAA 3'	62	
A53 (F)	5' GGCAACCCTGGAACAGA 3'	54	358
A52 (R)	5' CAGACCCTTATTGAAGTCGAA 3'	54	
4 F (F)	5' TTGCCATTATGAGGTTCACTGG 3'	54	390
4 R (R)	5' GATGTGAATAGAGCCTCTCACC 3'	54	
p937 (F)	5' GTGCGCTCTGAGGAACCTAAAAGAGACTGAGG 3'	68	1,500
p938 (R)	5' GATGTTCCCTTGAACCGCGATGTTTGCGAAGATGG 3'	68	
p960 (F)	5' CCTCACCTTCTACGCCGCNATHAARAA 3'	60	800
p961 (R)	5' CCATCAGGCACTCTGTATCTGC 3'	60	
p994 (F)	5' GACGTAACGCCTCAATCGTGG 3'	62	4,700
p982 (R)	5' CCTGCATGCATCAAGCAGTCG 3'	62	
P1003	5' TGTTCAAGAGCTCCTCCTGTGG 3'	62	196

Table 3.3

A comparison of the percentage identity of the putative amino acid (aa) sequences of the RNA dependent RNA polymerase (RdRp), movement protein (MP) and coat protein (CP) of the ACLSV isolate from Ta Tao 5 compared with other isolates of ACLSV and other *Trichovirus*.

TRICHOVIRUS	ACLSV TA TAO 5 ISOLATE		
	RdRp	MP	CP
ACLSV P863 Host: apple	74.7 %	60.2 %	75.6 %
ACLSV Batalon1 Host: cherry	74.3 %	60.0 %	75.1 %
ACLSV B 6 Host: apple	74.3 %	61.1 %	73.6 %
ACLSV PMB1 Host: plum	73.9 %	60.6 %	73.0 %
ACLSV A 4 Host: apple	75.1 %	60.2 %	73.1 %
ACLSV MO-5 Host: apple	74.2 %	59.1 %	74.1 %
ACLSV P205 Host: apple	74.6 %	60.6 %	72.0 %
PcMV Host: peach	61.8 %	50.0 %	56.0 %
CMLV Host: cherry	63.0 %	47.0 %	53.4 %
GINV Host grape	----	34.5 %	36.7 %

Table 3.4

Multiple alignments of the nucleotide sequences that correspond to the target region for the Kummert primers (4F and 4R) in the seven published complete genomic sequences of ACLSV and the isolate from Ta Tao 5. Mismatches among each sequence and the gene specific primer sequence are shown in bold.

Isolates	Sequences	Mismatches
	5' 3'	
P205	TTGCCATTATGAGGTTCACTGG	0
B6	TTGCCATTATGAG A TTCACTGG	1
P863	TTG C TATA A ATGAGGTTCACTGG	2
Balaton1	TTG C GATA A ATGAG A TTCACTGG	3
A4	TTG C TAT C ATGAG A TTCACTGG	3
Ta Tao 5 isolate	TTGCCATA A ATGAG A TTCAC G GG	3
PMB1	TTG C TAT C ATGAG A TTCAC A GG	4
MO-5	TTG C A ATA A ATGAG A TTCAC A GG ***** ** ***** ***** **	4
Kummert 4 F Primer (Forward)	TTGCCATTATGAGGTTCACTGG	
	5' 3'	
P205	GGTGAGAGGCTCTATTCACATC	0
B6	GGTGAGAGGCTCTATTCACATC	0
P863	GGTGAGAGGCTCTATTCACATC	0
MO-5	GGTGAGAGGCTCTATTCACATC	0
A4	GGTGAGAGGCTCTATTCACATC	0
Balaton1	GGTGAGAGGCTCT T TTTCACATC	1
PMB1	GGTGAGAGGCT T TATTCACATC	1
Ta Tao 5 isolate	GGTGAGAGGCT A TACTCACATC ***** * *****	2
Kummert 4 R Primer (Reverse)	GGTGAGAGGCTCTATTCACATC	

Table 3.5

Multiple alignments of the nucleotide sequences that correspond to the target regions for the Menzel primers (CLS6860 and CLS7536) in the seven published complete genomic sequences of ACLSV and the isolate from Ta Tao 5. Mismatches among each sequence and the gene specific primer sequence are shown in bold.

Isolates	Sequences	Mismatches
Balaton1	5' TTCATGGAAAGACAGGGGCAA 3'	0
P863	TTCATGGAAAGACAGGGGCAA	0
A4	TTCATGGAAAGACAGGGGCAA	0
P205	TTCATGGAAAGACAGGGGCAA	0
MO-5	TTCATGGAAAGACAGGGGCAA	0
B6	TTCATGGAAAGACAGGGGCAA	0
PMB1	TTCATGGAAAGACAGGGG T AA	1
Ta Tao 5 isolate	T GCATGGAAAGACAGGGG G AA * * * * * * * * * * * * * * * * * *	2
Menzel CLS6860 Primer (Forward)	TTCATGGAAAGACAGGGGCAA	
P863	5' TTAGACTTA-TAATAAATAGCCTGTAGACTT 3'	0
MO-5	TTAGACTTA-TAATAAATAGCCTGTAGACTT	0
Balaton1	TTAGACTTA-TAATAAATAGCCTGTAGACTT	0
A4	TTAGACTTA-TAATAAATAGCCTGTAGACTT	0
PMB1	TTAGACTTA-TAATAAATAGCCTGTAGACTT	0
B6	TTAGACTTA-TAATAAATAGCCTGTAGACTT	0
P205	TTAGACTTA-TAATAAATAGCCTGTAGACTT	0
Ta Tao 5 isolate	TTA A ACTT A AT T TAATAAGCCT A TAGACTT * * * * * * * * * * * * * * * * * *	4
Menzel CLS7536 Primer (Reverse)	TTAGACTTA-TAATAAATAGCCTGTAGACTT	

Table 3.6

Multiple alignments of the nucleotide sequences that correspond to the target region for the Candresse primers (A53 and A52) in the seven published complete genomic sequences of ACLSV and the isolate from Ta Tao 5. Mismatches among each sequence and the gene specific primer sequence are shown in bold.

Isolates	Sequences	Mismatches
	5' 3'	
P863	GGCAACCCTGGAACAGA	0
Balaton1	GGCAACCCTGGAACAGA	0
PMB1	GG T AATCCTGGAACAGA	2
A4	GGCAAT A CTGGAACAGA	2
B6	GGCAAT T TCTGGAACAGA	2
P205	GGCAAT T TCTGGAACAGA	2
MO-5	GGCAAT T TCTGGA A CTGA	3
Ta Tao 5 isolate	A TCAG- - - - G AGGG A AA * * *	12
Candresse A53 Primer (Forward)	GGCAACCCTGGAACAGA	
	5' 3'	
P863	TT T GATTT- - - -CAATAAGGGTCTG	2
PMB1	TT T GACTT- - - -CAATAAGGG C CTT	3
B6	TT T GATTT- - - -CAATAAGGGTCT T	3
A4	TTCGATTT- - - -CAATAA A GGGCTG	3
P205	TT T GACTT- - - -CAATAAGGG C CTA	3
MO-5	TTCGACTT- - - -CAACAA A GGT T TG	3
Balaton1	TT T GATTT- - - -CAACAA A GGGCT C	6
Ta Tao 5 isolate	TT A A A CT C AAG A CAAT T GGT G TT T T ** * * * * *	12
Candresse A52 Primer (Reverse)	TTCGACTT- - - -CAATAAGGGTCTG	

Figure 3.1
Schematic representation of the clones used to obtain the complete sequence of the isolate of ACLSV from Ta Tao5.

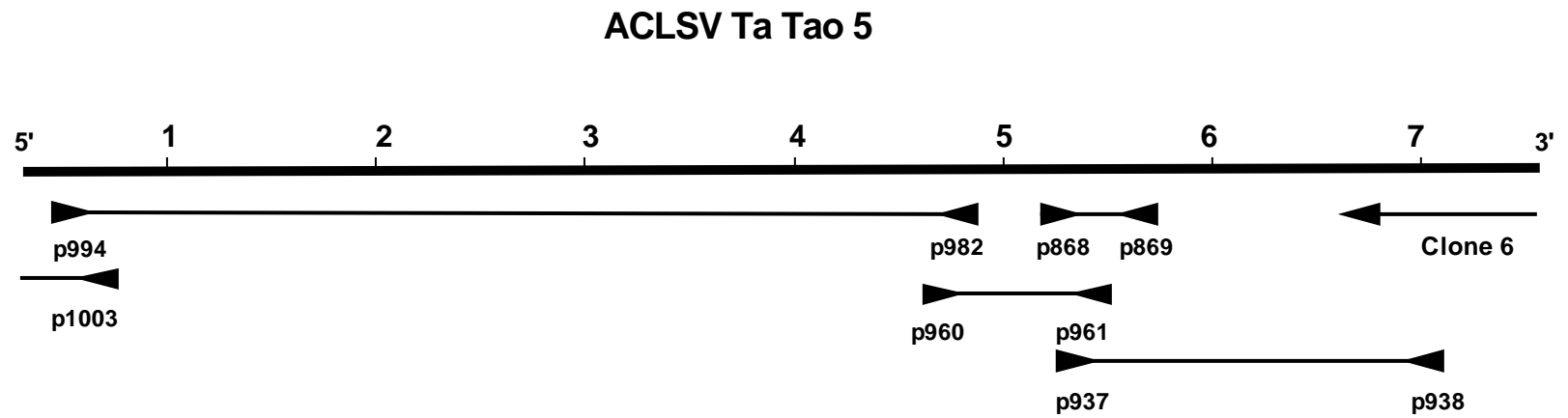

Figure 3.2

One-Step PCR amplification of the 390 bp band obtained with the primers 4 F and 4 R (Kummert primers) and the isolate of ACLSV from Ta Tao 5 and the control isolate of ACLSV (P863). Lanes 1 and 2 are for Ta Tao 5, lane 3 is the control (p863), lane 4 (M) is the molecular weight standard and lane 5 (H) is from non-infected material. The products were analyzed on a one percent agarose gel buffered with 1x TBE and stained with ethidium bromide.

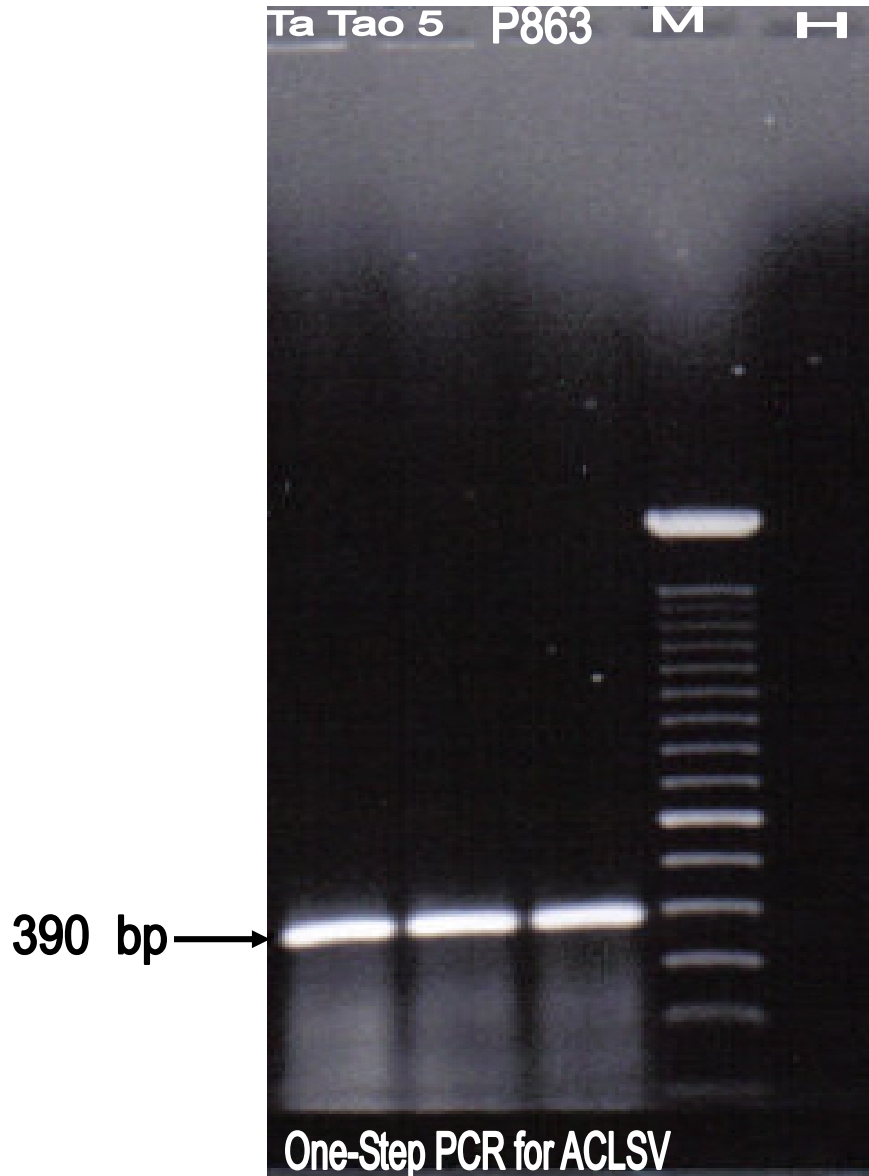

Figure 3.3

Complete nucleotide sequence of the isolate of ACLSV from Ta Tao 5.

```
ACGCGGGGAT ACTGAACAAG TATACACTCA AGACGTGAGT GAACAGATTG
ACGTAACGCC TCAATCGTGG TCAAGGATCT TCATCATTTG ATGAAATAAA
TTAAAGAAAA AAAAAAAAAA CAAGGAGAGT AAGGCAAGAA CTTCATTTGC
CTAGTGACTA TGGCTTTCTC ATACAGAACG CCACAGGAGG AGCTCTTGAA
CAGATTGCCC CAATCCCAAC AGGAGATACT GGGCAAATTC CAGTTTGAGA
GAATTGAAAA GGAGGAGGAA AAGAAGGTGG CCAACTTTTC CTACTTTTTG
CCAGAGAAAA CACGTGAATG GTTCACCAA TCTGGTGTGT ACCTTTCACC
TTTTGCCTAT GAGACTCATT CTCATCCAGG CTGCAAGACT CTGGAGAACC
ACCTTTTATT TAATGTAGTA GCTAGTTATA TTAGTAAATA TCCTTATGTA
GCATGTTTGA GCATCAAGTC CAACAAAATG AGCAAAAATGG AACGTCTTGG
TGCATCATCA GTTAAACCT ATGACATTCT GAATAGGTTA GTCACAGCTA
AGGACAAAGC CAGGTATGGT CCTCTTGTCT CAGAGGTTAG AGCACCTTGC
CCAAAAAAAA CAAATATCTT CATAATGAT GAGATTCATT ACTGGAGCAG
GAAGCAGTTG GAAAACCTCC TGATGATTAA TAAGCCAAAG AATCTCTGGG
CTACTCTGGT GTTTCCGCCC GAGATACTAG CAGGATATCG ATCCTCAGTG
TTGCCTTTCC TTTACCAATT TGAGATTTCA GGTAAAGATC TGATTTACAT
GCCTGATGGT GTTAGATCAG AAAGTTACAC CCAACCTCTA GAGAATGGGT
ATTTACTTTC TTCAAACAGC ATAATTATTT TTGATCACTG CAAAAAAAAA
GAGATCAGGT ACCAAATAAG TTTAATATAC TCATTAGGTT CACACCACCT
CTTCCACATT TTTCCGTGTC AAGATTTAAT GAAGGAGGAG GTTCGCCGGT
TTGGGCCTTA TGATTTGTTT GATGTTGGAT CTTTATTTGT GAGACCAGTT
AGAGTGCCCA TACAAGATTT TCCGCTTAGT GTGTTCAAGA AAATTTTCAT
TTACTTAAGC TCCCTTAAGA AACCAGATGA GCAATCAGCT GTGGCAAAAT
TGAGGCAACT CTCTGATGCG GATATCTCTA TCGAATCAGT GTTTCTAGTT
CAGGAATTCG CCAGTAGAAT AGAGAAGCAT GGCCTTGGTA ACTGGAGTTG
CTCTTTTTTG GATTGCATGA AAGATTGGTT TTTTGACAAA TTGCCATATA
ACCACGTTCT TGAGAAAATC GGACTGGCAG ATGATTTTAC TAGAAGACTC
ATGAAACTTA AACCTCTTTC ATTTGATATT CACACCTCTG ACCAGCCTCT
CACCGTCAGA ATGGTCATAG ATAGGATCTG GGGACCTGAT CAGATTGAAG
ATGACCCCTT GGTGGAATGC ATTTCAAAG ACAGAATCGG AGTTATCCAC
AACAAATTGA TCGTCAGAGG GATTCAGGGT GTCAAGACTA TTCTAAAATT
GGACAGTAGC AAGGTCCATG TCTACAATTA TGAAATCTAT TCAGATATTC
TTGCCACAAC TCCGTTGCGC AAATCTTATG ACGAGAATTT TGGATGCATC
AGAACAAGGA CTATGGTGAA ATTTCTCTCG AAGCACTCTT TGAGTGAAGC
TGCTGAGGTG AAAACCAATG CTAGATCGCT GGGTTGGTTG AATGGTAATG
AAACAATTAA CAAGACTGAT TTCCAGGTTA GCAAGGAGAT GGAAAGGAGA
AGGATTTCTC GGGAATGTAT GCAATACCAT TTCAAGAAAA CTGGAGCAAA
AGATCAGGAT GAGCTCATTT CCAAGCTCAT TATATTGGAA TCAACAAAGA
AGCAGATCAG AGGTGTCACA AAGGAGAAAG CCAAGAGAAG AAGGATGGTG
CCTGCTTACA TAGATGAAGT TAGGTGCCTG AAAACAGAAC AGGATAGTGC
TAACAATGGA TTGGACTCTA CATTTGTCAA ACAGGACCTT TCAATTAAAG
```

Figure 3.3 (Continued)

Complete nucleotide sequence of the isolate of ACLSV from Ta Tao 5.

```
GAAGAGAAGA AGAGAAGGAA AAATCAGAAG GTCCATGGTC TAACACTCAT
CAAGGAAAGG GCACCCCTGA CAAAGTAGAA GCCATCTTGA GTTGTCTCTCT
CAATTGCATT AAAATGTGTG AATCAGGTTT AATCAAAAGA GTAGGCGGCT
CCTTTGAGGC GCTTAAGAAC TACATTGGTG ACCTGCCCTT GGAACAGATC
AAAGGGAGAA GGGCTGCTTA TTTCTGTTTG GATTACCCAA TGATCTACTT
TCATGACAAG ATTTCCCTACA AGACTTTTGA AGCTACAGGT GAACTCAAAA
GGGTGATGAT CAAGGCAAGA TCCGACTGGG GAATTAACTT TAATTCAGCT
CTAGTTCAAA TTTATGAAGC CGGGACAAAA CTGCCCTCTCC ACAAGGATGA
CGAAGAGTGC TATGATGATG ATGGGGTCCT TACTATTAAT GTGGTGGGTG
AAGCTAGCTT TTCAACCACG TGTCATGACG AGATAACATT GCTTAAAGAG
GGGAATGAGT TACTCATGCC CTCTGGGTAC CAAAAGAAAT TCAGACATGC
TGTTAAGGTG CTTTCAGAAG GCGGTATCAG TGTGACTCTC AGGGTGCACA
AAAGAGATTT CAATTTTGAA TCAAAAGTGA AATTCATCAA AGGGAGGTAT
GATTGCCTTT TTGAATGCAT TGCTGAAATA ATCCACAAAA AACCAGAGGA
GGTTATGTCC CTTTTGCCTC ATGTGCTTGA CAGGTGTGTA AGTAACAAAG
GCTGCTCGAT AGATGATCTA AAGGCAATAT GTGACAAATA TGAGATTAAG
ATTGAATGTG AAGGGGACTG TGGGTTGGTC GAATGTGGGT CTCAAGGACT
CTCAATAGGT AGAATGAATC TCAGAGGCAA TCACTTCAGG GTTGCATCCA
TCAGAAGATC ATCAATTGTT TCTTTGGCCA ATTCAAAAAA AGAGATCAAG
TCAACAGGTT CTTTGGATCA TGTCATGATT AACTTCAAGA AGAGACTTCT
CCAAGTGGA ACCGACATCA CAAAGGCCAG CATCAAAGTT GATTTGATCA
GAGCTGGGAA ACTCCTCAA AGTCTAATGG ATGGCATGAC GGGAATTGTG
TCACATAACT CAACTCATGA GGGCTGGAGA ATAATCAATG GAATAAATAG
CACAGCTGAA ATGCGGGCTT TTATGAAAAT GATTAAGAAA GATGATGATA
AAGAAAGTAA TTTCTCTCA GACAGAGTTG GTGAACTTGA ATTTGAAAGG
AAAGAAATCA GTGGGATCTT TGGATTGCTT GGATCAGGTA AAAGTCATGC
TATCCAGAAT TTGATCTACA ATGAATTC AAAGGATCTCAA GGGATAATGG
TCATATGCC TAGAAGATTT CTTGCAAAG ACTGGTCTGA AAAGGGTGTG
GATGAGAAAG ATATCAAAC TTTGAGAGT GCATTGAAGT CAGACATTAA
AGGAAAGAGG CTCTTCATTT TAGATGAAGT GACCTTATTA CCCAGGGGTT
TTGTGGACCT ACTTTTGCTG AAAATGCACA TGGAAGGTGT CTTGAGAAAT
TCAACGGTTG TTTGTCTTGG AGATCCTTTG CAGGCTGGTT ACTTCAGTCA
GAGGGATGAT AGTTATTTGG CCAGGGACAA TGAAATCAA AGACTTTTTTC
CAAATGGTGT CAATTACAAA TGGTACAGCT ACAGAATAAA CAAATTCATT
GGAAAGAAGA TAAATGTCCC GAGCCTCAAT GAATTCATTG GCATTGATGA
GCAGAGTGCG ATATACAAGG ATATGCCCTC TGCATTTTCA TTTTGGACA
AAGGAGGAAA TCACCCTGAG GTTATACTTG TAGCAAGCAT GATAGAGAAG
GAACTTTACT CCAATTATGG CATGGTCATG ACTTTTGGGG AGTCTCAAGG
TCTCACTTTC GGGAATGGCA TCATCGTCCT ATCTGAAGAG GCAAACTTT
GCTCAGATGC TCACATAATG GTTGCAATCA CCAGGTTTCAG AAGAGGTTTT
```

Figure 3.3 (Continued)

Complete nucleotide sequence of the isolate of ACLSV from Ta Tao 5.

```
TGCTTCGCCC TTGGTAGTAA AGGTTTCGAAA GAGGACTACA TGAAATCAAT
GAAGAGTGGT CTTCTGCAGA GAATGTGCTC TGGATTGGGG GCTTCTCAAG
AATTTATCCT CAACACCTCA CCAGTCAAGC TTCATTTAAG CAAGAAGGCA
ATAGAATCTG GGGCGGGCAT TGACGAAATG GACAGGGAGG AGAGACTACA
GGGAGATGTG TGGCTCAAAA GTATGATATA CTTGGGGAAG AGATTTTCATC
TAGTTGAACC CTTTGGACAA GTAGTTTCTC TCGTTGACAG TGCCATTAATA
TGTCACATTC CCGTTTGTTT AGAGCAAACCT CTCCGGTCCGG AATTGGAAAA
GGTGTGGGCG AGGGAACACA GAGAATTCAG AGGAAAAAAT GGGTGGTTCGT
GTCAGTTCAG AGAAGAGGCT GGACCAAAGT GGATGGTTC ATATAAAATC
AATCAAGCCA TGAGTCATGA AGCCATTTAT CCAAGGCACA GAATGGATGA
TGATCTGACT TTCCTCGCTG CAATAAAGAA GAGGTTGAGA TTTGATAGTG
TGGCTAACAA CATGGCAAAG TTCAAAGCAG CAGAAAGTAG AGGTAAATAT
TTGGCAAAGA TCTTCTTGAA GCACGTGCCG ATCAAATCTG GACGAGATCA
ACGACTGCTT GATGCATGCA GGCAAGAATT TGAAGAGACA AAGTTATCGA
AGAGTGCTGC AACAATAGGA GCACATTCCTC AGAGATCAGA CACCGATTGG
CCGTTGGACA AAATTTTCTT ATTCATGAAA TCTCAGCTTT GCACCAAATT
TGAAAAGAGA TTCACGGAAG CTAAGGCTGG ACAAACTTTG GCCTGTTTTT
CCCACAGAAT CCTGGTTGAG TTTAGCCCTT GGTGTAGGTA CACAGAAAAA
ATTCTTTCTG CAAACTTGCC AGACAACCTT TACATTCATC AGAGAAAGAA
TTTCAGTGAG TTGGAGACCT TTGCGAAGAG ATACTCAAAC GGATCTGTTT
GTGTTGAATC GGACTIONACA GCTTTTGATG TTTCCAGGA TCACACAATA
CTTGCAATTC AGGTGCAACT GCTTAGGCAC TTTGGATGGG ATGAAAAAAT
TCTGCAGAGT TACATTAATA TGAAATGCAC ATTGGGGTGC AGGTTAGGTG
GCTTTGCCAT AATGAGATTC ACGGGCGAGT TCTCGACTTT CCTGTTCAAC
ACATTGGCCA ATATGGTATT CACCTTTTGC AGATACAGAG TGCCGTGATGG
CACCCCCATA TGTTTTGCTG GTGATGACAT GTGCGCTCTG AGGAACCTAA
AAGAGACTGA GGATCATGAA CTTATTCTAA ACAAATTGAG TCTCAAGGCA
AAAGTAAACA GGACCAAGGT TCCAATGTTT TGTGGGTGGA GACTGTGTTT
TGACGGTTTG ATCAAGGAAC CCTGTTTAAT ATATGAAAGG TTGCAAGTTG
CAATTGAGAA CAACAGACTC ATGGATGTCA TTGATTCCTA CTTCTTGAG
TTTTCATTTG CCTACAAGTT AGGTGAGAGG CTATACTCAC ATCTTGAAAT
TGAGCAGTTA AATTATCATC AAGTGCTGAC CAGATTTTTT GTCAAGAACA
AACATTTGCT TAGAGGTGAT TCAAGAAACA GTATTTCTGA ACTTGAGTGG
TTGTCCGACG AAGATGGCGA TGATGGTCAG GGGTCACAAA TCAAAGATCG
CAGAAGGGGA TATACCAATT GCTGGGGTGA GAAGCTCCAG AATTTATTCT
GATATCACAC CTTTCAAGAG AGCCTCCGAC CTAATGATTC ATTGGAATGA
ATTTGTTTTT AAGGTCATGC CTGAGGATAT AGTGGGCAA GGGTTCAGAT
TGGCATCGGT ACCTGTGGTG CCAATTTCTG AGATTCAATC TGTGCTGAGG
AAAAGGGAGG GAACGAACTA CGTGCATTGG GGTGCCCTGT CAATCTCAAT
TGATGCTCTG TTCAAGAAGA ATGCGGGGGT GACGGGTCAG TGTTATGTGT
```

Figure 3.3 (Continued)

Complete nucleotide sequence of the isolate of ACLSV from Ta Tao 5.

```
TTGACAAAAG GTGGACAACA TTTGATCAGG CCCTTTTGCA AAAATTTGAG
TTTAATCTGG ACAGAGGTTC CGCTACCCTG ATAACCTCAC CGAACTCCTC
TGTTTCACTT GATGATCCGG GTCTGATGGA CTCAATATGT GTGGCAGTAA
TGTTTGAGAA TTTAAATTTT AAATTGGAGA ATTACCCCAT AAGTGTGCGA
GTAGGCAACA TGTGTAGATT TTTCGACAGC TTTCTTAGTT CAGTTAGAAA
TAAAGATGAG TCAAATGCTC GGATCGAAGC TGCGAATGCT GAGCCACTTG
GCCTGGCTGA TTTTGGGTTT GAAGGTGGAG ACAGAATCAG TGAACTTTTT
GACTATGTTC AATCTGTTCC TGTCATGGCT GTTCAAACAA AAGAAATGGA
GATACCCAAG GGTCTCTTTG GTCTGATGGG CAAACGCACG GTCAAATCTT
TCGAATTCAC ATCCAAAGCG GGAATGCAA GAAGAAGAGA GTGGTCCAAG
CTTAAGATCT CAGGAGATGT CGCTGGGGTT AAGTTGCCAG CTTTTGGTGG
TGAATTTGAG AGATCTGACT CTATAGGAAG AAGGAAAAAG AAATTGGAGA
CGCCTGAAAA ACCTGGATCC ATTACTTCAG AGGGGTCATT GGTCAAGTAC
ATATCTGCAA GAGAATTTCA GTTTGCTAGA CAGGATCAGG AGGGAAAGAA
TGGCAGCCAC TTTGAACCTG CAGCTGAAGG TGGACAGGGA GTTGAGGGCT
TTCCTGGCGG AGGCCAATCG TCCCTTGCAT GGAAAGACAG GGGGAACAGT
GGAAGTATA CTGGAGTCCA TCTTCGCAA CATCGCAGTT CAAGGAACCT
CGGAGCAAAC GGAATTCCTC GACGTGGAAG TCGAGGTGAA GAAGAGTGGG
GATCCCACAG TGCTGCAGAA GTACAATCTG AGGACGGTCG TGGAGCTGAT
CAAGCTTTTT CGGACCACAT CTTCGGACAA AAACATCAAT ACCCTTACCT
TTAGGCAGAT ATGTGAAGCC TTCGCCCGG AAGCCAGGGA TGGGTTGGTT
AAACTCAAGA CAATTGGTGT TTTACCAAT CTGTATAAAA CAATGCCGGA
GGTGGGCAAT AAATATCCTG AGCTTATGTT TGATTTCAAC AAAGGGCTTA
ACCCGATGCT GATGAACAAG ACCCAGAGGG TGGTTGTCAC TAACCTTAAC
CGACGCCTTT TACAAACTGA ATTTGCTAAA AGTGAGAATG AGGCAAAGAT
TGCTTCGGTT TCTAACGATT TGTGCATTTA ACAGGTGGAG AAGATGTTGG
TTGAGGTTGA ATAAATAAAT GAACTCAAGA ACCCGTGAAT GAGTATAAAG
AGTCACGGTA TTTGAATTGG AGTGTTTAAA CTTAATATTA AATAGCCTAT
AGACTTTTAA ATATTTTACT ATAT
```

Figure 3.4

A multiple alignment for the amino acid sequence of the CP of the isolate of ACLSV from Ta Tao 5 (TT5) and the seven completely sequenced isolates of ACLSV. The positions of Ser⁴⁰ (S) and Try⁷⁵ (Y) amino acids in the Ta Tao 5 sequence are indicated by squares.

```

PMB1  MIKMNKAYQLTVILKIFSKGR TKVKLGP NPLLQRGHPLTTYLQESFSLLDKIRRRRMAA
B6     -----MAA
P205  -----MAA
A4     -----MAA
MO-5  -----MAA
P863  -----MAA
Bat    -MRLNIKGYSLTRILRNSSKAEGEEGLDRDQSRQRVHLSITSLLENFSLLEKIRRRRMAA
TT5    -----MAA
                                           ***

PMB1  VLNLQLKVDADLKAFLGAEGRPLHGKTGVILEQILESIFANIAIQGTSEQTEFLGLTVEV
B6     VLNLQLKVDADLKAFLAAEGRPLHGKTGAILEQILESIFANIAIQGTSEQTEFLDLMVEV
P205  VLNLQLKVDADLKAFLAAEGRPLHGKTGAILEQTLEAIFANIAIQGTSEQTEFLDVLVEV
A4     VLNLQLKVDADLKAFLAAEGRPLHGKTGAILEQTLEAIFANIAIQGTSEQTEFLDVMVEV
MO-5  VLNLQLKVDADLKVFLAAEGRPLHGKTGAILELTLESIFANIAIQGTSEQTEFLDLVVEV
P863  VLNLQLKVDASLKAFLGAENRPLHGKTGATLEQILESIFANIAIQGTSEQTEFLDLVVEV
Bat    VLNLQLKVDADLKAFLAKENRPLHGKTGATLEQILESIFANIAVQGTSEHTEFLDLTVEV
TT5    TLNLQLKVDRELRAFLAEANRPLHGKTGGTVELILESIFANIAVQGTSEQTDFLDVEVEV
      .***** .*:.*. .***** :* **:*****:*****:***: ***

PMB1  KSMEDQKVI GSYNLREVVNLIKAFKITSSDQININMTFRQVCEAFAPPEARNGLVKLYKYG
B6     KSMEDQKVI GSYNLKEVVNMIKAFKTTSSDPNISNMTFRQVCEAFAPPEARNGLVKLYKYG
P205  KSMEDQKV VGSFNLKEVVGLIKIFRTTSSDPNISSMTFRQVCEAFAPPEARNGLVKLYKYG
A4     KSMEDQKVI GSFNLKEVVSLIKIFKTTSSDPNINMTFRQVCEAFAPPEARNGLVKLYKYG
MO-5  KSMEDQKV VNSYNLKSVVDLIKIFKTTSSDPNINGMTFRQVCEAFAPPEARNGLVKLYKYG
P863  KSMEDQSV LGSYNLKEVVNLIKAFKTTSSDPNINKMTFRQVCEAFAPPEARNGLVKLYKYG
Bat    KSMEDQST LGSYNLREVVNLIKAFKTTSSDPNISGMTFRQVCEAFAPPEARNGLVKLYKYG
TT5    KKSGDPTV LQKYNLRTVVELIKLFRTTSSDKNINTLTFRQICEAFAPPEARNGLVKLTIG
      * . * ..: .:***: ** :** *: **** ** . :*****:*****:***** *

PMB1  VFTNLFTTMPEV GSKYPELMFDFNKGLNMFIMNKAQQKVITNMNRLLQTEFAKSENEAK
B6     VFTNLFTTMPEV GNKYPELMFDFNKGLNMFIMNKAQQKVITNMNRLLQTEFAKSENEAK
P205  VFTNLFSTTPEV GSKYPELMFDFNKGLNMFIMNKAQQKVITNMNRLLQTEFAKSENEAK
A4     VFTNLFSTMPEV GSKYPELMFDFNKGLNMFIMNKAQQKVITNMNRLLQTEFAKSENEAK
MO-5  VFTNLFTTMPEV GSKYPELMFDFNKGLNMFIMNKAQQKVITNMNRLLQTEFAKSENEAK
P863  VFTNLFTTMPEV GSKYPELMFDFNKGLNMFIMNKAQQKVITNMNRLLQTEFAKSENEAK
Bat    VFTNLFTTMPEV GSKYPELMFDFNKGLNMFIMNKAQQKVITNMNRLLQTEFAKSENEAK
TT5    VFTNLYKTTMPEV GNKYPELMFDFNKGLNPMLMNKTQRVVVTNLRLLQTEFAKSENEAK
      *****:.* *****.*****:*****:***:***:*** *****.*.***

PMB1  LSSVSTDLCI
B6     LSSVTTDLCI
P205  MSSVTTDLCV
A4     MSSVTTDLCI
MO-5  LSSVTTDLCI
P863  LSSVSTDLCI
Bat    ISSVSTDLCI
TT5    IASVSNDLCI
      :.***:***.

```

Figure 3.5
 Phylogenetic relationships among the isolate of ACLSV from Ta Tao 5 and members of the genus *Trichovirus* based on the amino acid sequence of the polymerase protein. Potato virus X (PVX) is used as an outgroup.

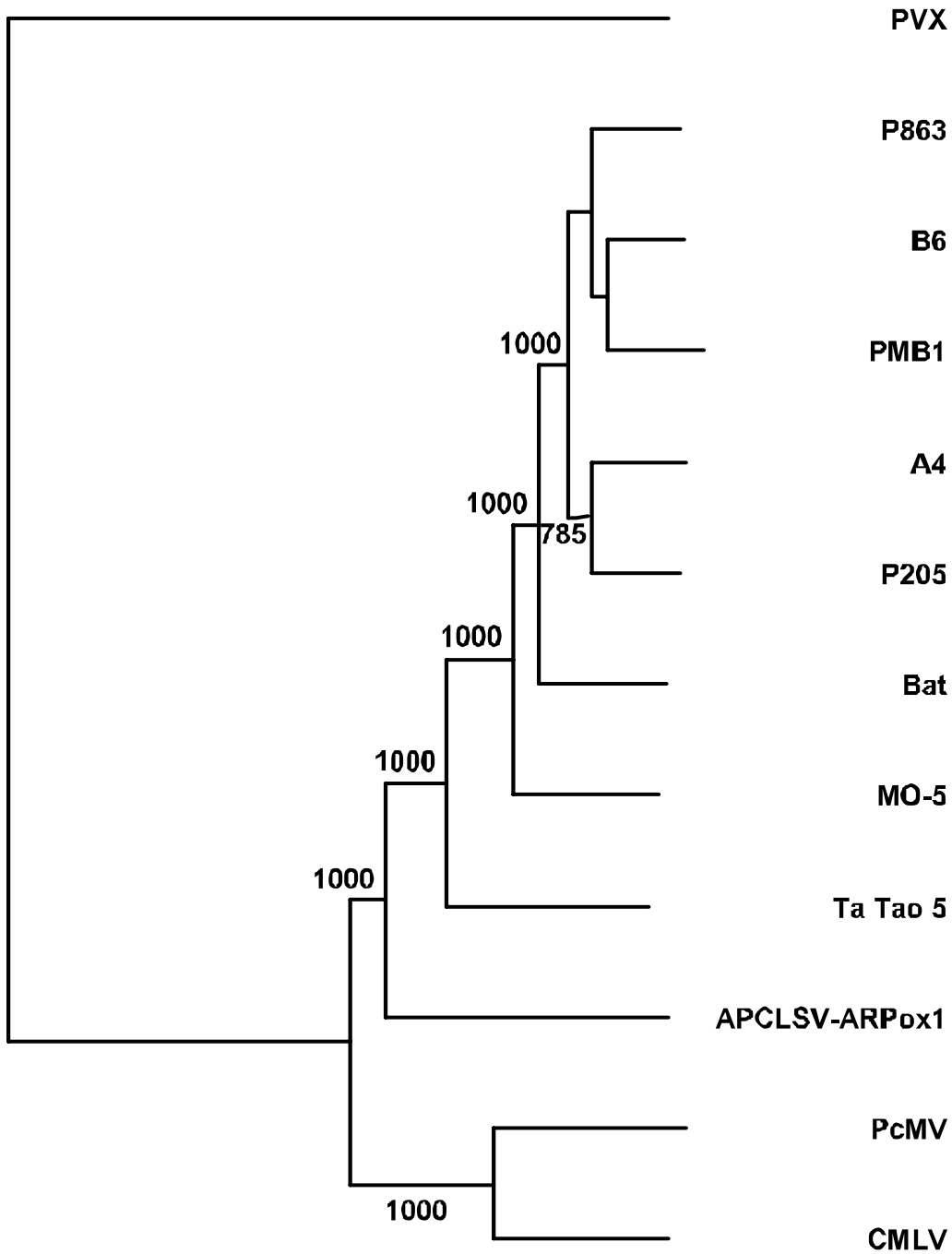

Figure 3.6

Phylogenetic relationships among the isolate of ACLSV from Ta Tao 5 and members of the genus *Trichovirus* based on the amino acid sequence of the movement protein. ARPox1 and Sus2 are isolates of APCLSV causing distinct diseases. Asian prunus virus 1 (APruV-1) and PVX are used as outgroups.

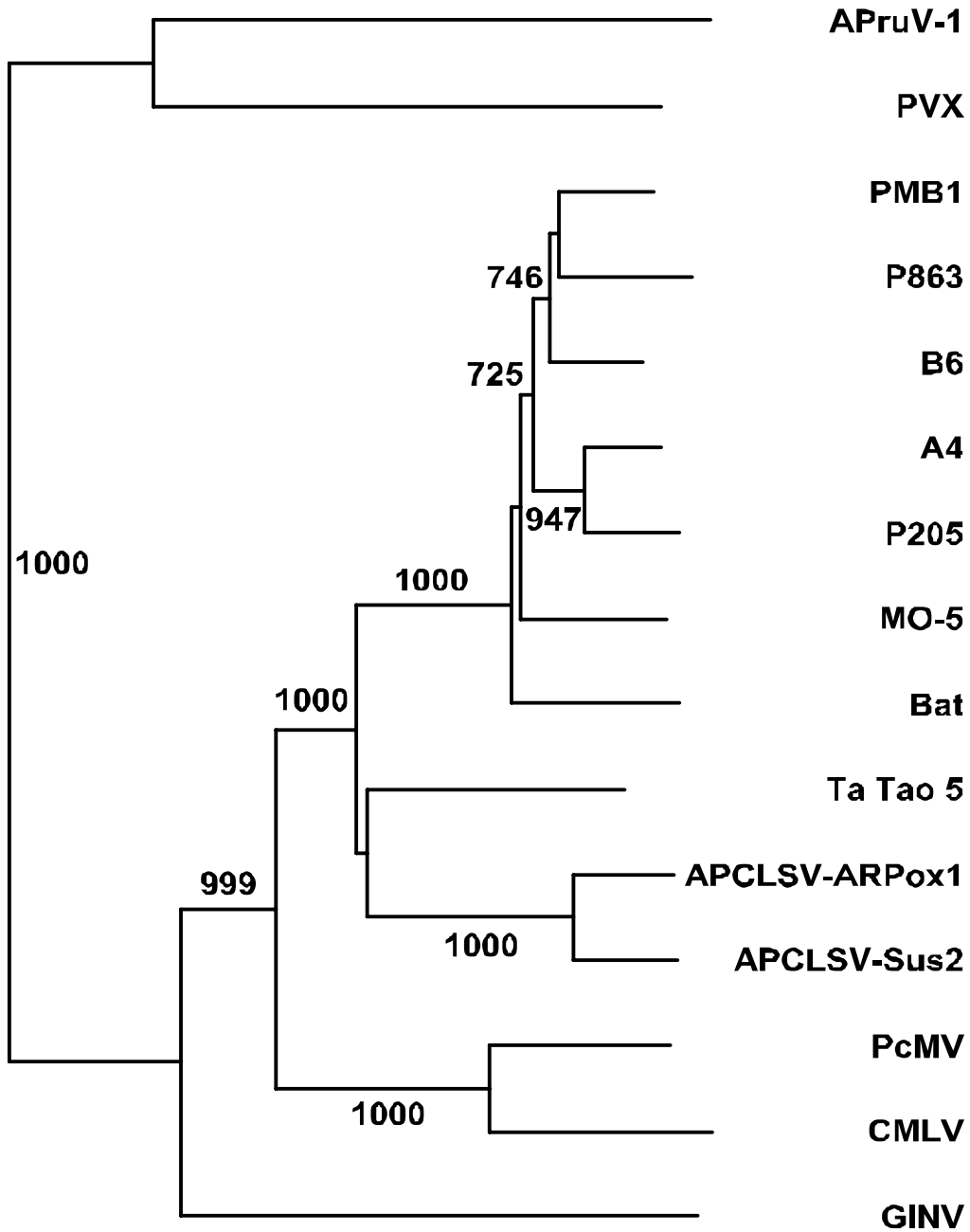
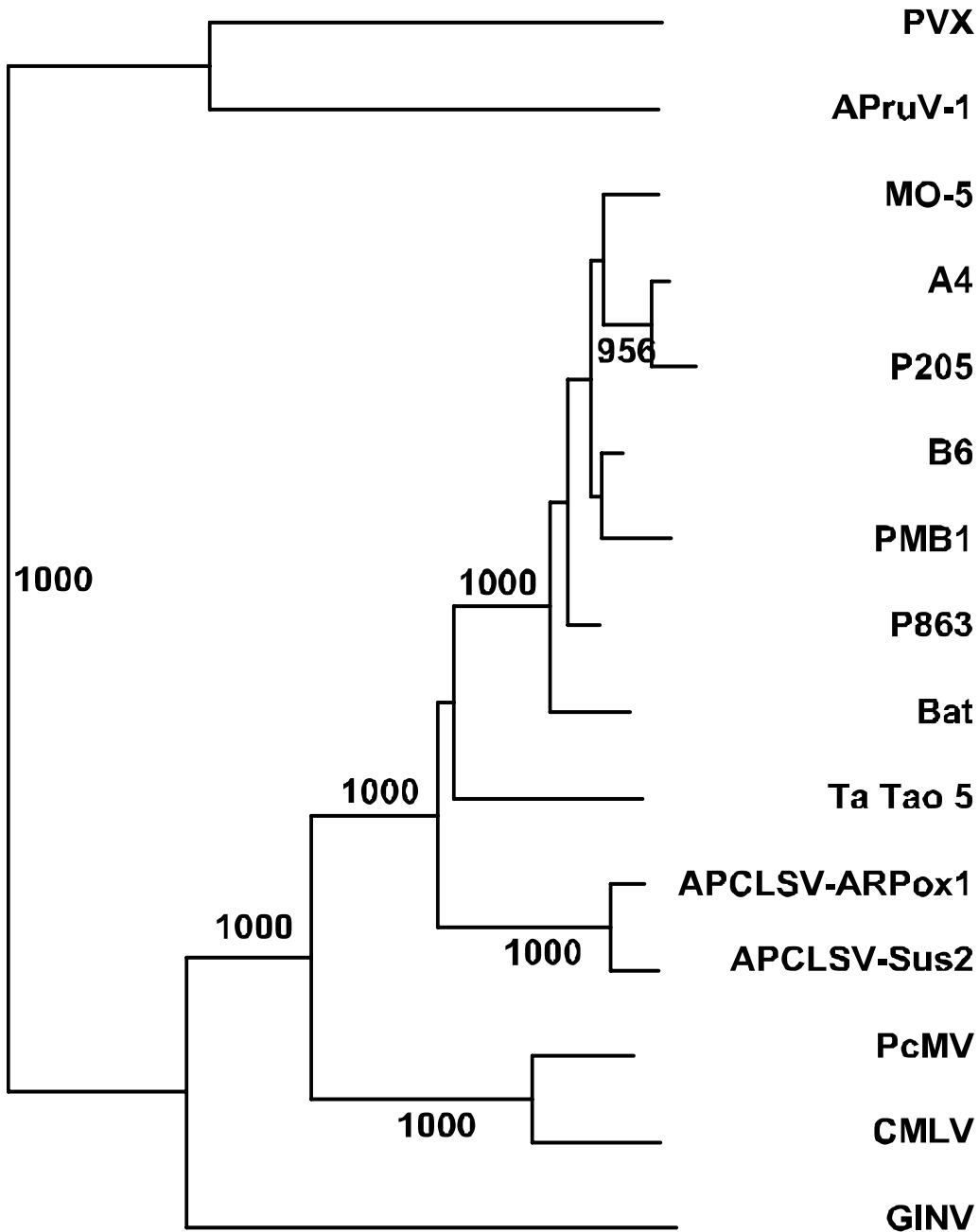

Figure 3.7

Phylogenetic relationships among the isolate of ACLSV from Ta Tao 5 and members of the genus *Trichovirus* based on the amino acid sequence of the coat protein. Asian prunus virus 1 (APruV-1) and PVX are used as outgroups.



CHAPTER IV

MOLECULAR CHARACTERIZATION OF THE ASIAN PRUNUS VIRUS (APruV) ISOLATE PRESENT IN TA TAO 5

Introduction

Few viruses with filamentous particles have been reported to infect peach trees. However, among these is plum pox virus (PPV), a virus which is associated with the disease “Sharka” and is considered to be a major problem to the stone fruit industry worldwide. Several studies have reported the cross-reaction of viral agents with filamentous particles present in *Prunus* spp. material, mostly of Asian origin (e.g. Ta Tao cultivars) with PPV antisera (Hadidi & Levy, 1994; James et al., 1994, James & Godkin, 1996), and these gave rise to concerns that PPV was present in a hitherto unsuspected source of germplasm. However, PPV could not be detected in this material by definitive serological, biological, or molecular techniques. The PPV-cross reacting agent has been diversely named since then as “plum pox-like virus” (James et al., 1994), “Asian prunus latent virus/potyvirus”, “prunus latent virus” (Hadidi & Levy, 1994, Hari, et al., 1995), or Asian prunus virus (Marais et al., 2006). There was evidence that the condition (cross-reaction with PPV antisera) could be graft-transmitted to other hosts. Three closely related agents were identified in two of the PPV-cross reacting sources (*Prunus mume* cv. Bungo and *P. persica* cv. KCH). These viruses, which were related to but distinct from existing members of the genus

Foveavirus, were named Asian prunus virus 1, 2 and 3 (APruV-1, APruV-2 and APruV-3) (Marais et al., 2006). However, it is still unclear whether ApruV is involved in the PPV cross-reactions. A bacterially expressed CP of APruV-3 obtained by in vitro experiments failed to react with the PPV antisera previously reported to show cross-reactions (Marais et al., 2004).

Recently, the complete sequence of a virus found in another of the PPV-cross reacting agents, *P. persica* cv. Agua, which originated from Mexico, was obtained and analyzed (James et al., 2007). It was named peach chlorotic mottle virus (PCMV). The bacterially expressed CP of this virus cross-reacted with a polyclonal antiserum against ASPV and with PPV. Although the identity between the aa sequence of the CPs of PCMV and ASPV was low (37%), they shared 11 peptides that may constitute linear epitopes responsible for the cross-reactions. No common linear epitopes were found in comparison between the aa sequences of the CP of PCMV and PPV. However, aa in the C-terminus region, common to PCMV and PPV, might contribute to the formation of conformational epitopes that could play a part in the cross reactions. Rigorous phylogenetic analysis indicates that PCMV is a new member of the genus *Foveavirus* (James et al., 2007).

The study of the viruses involved in the PPV cross-reactions has been complicated by the woody nature of the stone fruit host plants and by the fact that the *Prunus* material showing the cross-reactions is also infected with broadly

distributed viruses such as ACLSV and with the viroid PLMVd (Gibson et. al., 2001).

Little information is currently available on the symptoms that may be induced by the APruV agents on susceptible cultivars. In grafted GF305 peach trees, some symptoms are similar to those reported for the peach marbling disease, such as an enlargement and discoloration of the veins on old leaves (Desvignes et al., 1999), together with the chlorotic leaf-spotting reminiscent of the symptoms reported with other foveaviruses such as ApLV (Gentit et al., 2001). In addition, recent field indexing experiments showed fruit deformation, size reduction, and delayed maturation of fruits of the peach cultivar Springtime following graft-inoculation with the Bungo source [Table 2.2] (Marais et al., 2006). Late in the season, leaves may also show chlorotic symptoms together with premature reddening (Phil Gibson, pers. obs.).

Preliminary PCR tests using primers designed by Marais and Candresse (pers. comm.) to detect ApruV indicated the presence of one of these viruses in Ta Tao 5. Although the role of PLMVd and ACLSV present in Ta Tao 5 in bloom delay had been explored, the possibility that a third agent might be involved had not been investigated.

In this study, efforts were made to confirm the presence of APruV in Ta Tao 5, to complete a molecular characterization of the putative APruV isolate present in Ta Tao 5, and to establish phylogenetic relationships with other members of the genus *Foveavirus*.

Materials and Methods

Virus Sources and Maintenance

Ta Tao 5 trees (PI101667), and trees that had been propagated from heat-treated Ta Tao 5 germplasm were used as sources of virus. In addition, seedlings of Nemaguard peach T-budded with Ta Tao 5 were grown and maintained under controlled greenhouse conditions at Clemson University, SC and were used. Plants of Springprince peach located at Musser Farm Research Center that had not been inoculated with APruV were used as negative controls.

Virus Isolation and Partial Purification

Nemaguard peach seedlings grown in 1-gallon containers and which had been chip budded with heat treated Ta Tao 5 germplasm were placed in a cooler at 4C° for three months to break dormancy. The potted seedlings were returned to the greenhouse to initiate shoot growth. After the emergence of young leaves, they were used as a source of tissue to sap inoculate leaves of *Nicotiana occidentalis* 37 B (Appendix B). Systemically infected plants of *N. occidentalis* showing vein clearing and mosaic symptoms (Figure 4.1) were collected, and used to produce partially purified preparation of viruses (Appendix B).

Nucleic Acid Extraction

Total RNA was extracted from newly emerged peach shoots from all experimental field and greenhouse plants using a modified procedure of Hughes and Galau (1988) (Sara Spiegel, The Volcani Center, Israel, pers. comm.) (Appendix A). Total RNA was stored at -80°C. RNA was extracted from plants grown in the greenhouse at different times during the year after shoots were actively growing.

PCR Reactions for Detection and Cloning

The nt sequences of the various primers used in this study are presented in Table 4.1.

One-Step PCR

One-Step PCR tests to detect the presence of APruV in sources inoculated with Ta Tao 5 germplasm were completed using samples of plant total RNAs as detailed in Appendix D. Primers 678 and 677 (Candresse pers. comm.) amplified a fragment of the 3' UTR. Primers CP-PLV1 and CP-PLV2 (Marais et al., 2006) were designed from a consensus alignment of the CP gene of some ApruV isolates and amplified a 340 bp fragment.

Clones representing different parts of the viral genome were prepared using different PCR strategies and primers (Table 4.1 and Figure 4.2). The 3'

terminus of the virus was confirmed by using an anchored oligo DT primer, p929 (5' GACCACGCGTATCGATGTCGACTTTTTTTTTTTTTTTTTT 3') to synthesize cDNA and then completing PCR using primer p930 (5' GACCACGCGTATCGATGTCGAC 3') (Rott & Jelkman, 2001) as the downstream (ds) primer and p931 as the upstream (us) primer with an annealing temperature of 63°C. The 3' terminal region was extended to link to the fragment amplified from the CP (primers CP-PLV-1 and CP-PLV2) by using p904 (ds) and p905 (us) and Advantage® 2 polymerase mix (Appendix D). Sequence was extended from this fragment towards the 5' end by using p932 as the ds primer and p933 as the us primer and the Advantage® 2 polymerase mix. This yielded a fragment of 1,200 bp. Finally, cDNA was synthesized using primers p975 or p939 located in this 1,200 bp fragment and the SMART™ II Oligo (Appendix C). The resulting products were amplified by using UPM or NUP in a nested PCR reaction (Appendix D).

Cloning, Sequencing, and Sequence Analysis

PCR amplicons were purified from agarose gels using a MinElute gel Extraction kit, cloned into either TOPO® or pGEM®-T Easy Vectors, plasmids were purified and sequenced (Appendices F and G). The sequences of the PCR fragments were assembled into a contiguous sequence, analyzed, and placed into phylogenetic trees (Appendix G).

The published viral sequences used for comparison are shown in Table 4.2. The ACLSV isolate found in Ta Tao 5 (ACLSV-TT5) and potato virus S [(PVS), genus *Carlavirus*, family *Flexiviridae*] were used as outgroups in some of the phylogenetic trees.

Results

Molecular Detection of the Associated APruV in Ta Tao 5

All Ta Tao 5 sources analyzed (original, heat-treated, and Ta Tao 5 inoculated greenhouse plants) yielded bands of the expected size (409 bp and 340 bp with Candresse and Marais primers, respectively) by One-Step PCR. No bands were observed for non-inoculated healthy peach trees (Figure 4.3). The nucleotide sequence of the 409 bp fragment and the amino acid sequence of the 340 bp clone showed a high percentage of identity with the published sequences available for APruV (GenBank accessions DQ205236, DQ205237, and DQ205238). Extending these fragments and filling in gaps produced a contiguous sequence of 3,284 nt (Figure 4.4). BLAST search comparisons showed the nucleotide sequence was most closely related (91% identity) to the APruV- 3 isolate from KCH (GenBank accession DQ205238).

Four putative complete ORFs (ORF2 to ORF5) and one non-coding region (NCR) were identified from the partial sequence information obtained above. The ORFs overlap each other and they extend from nucleotide 17 to 736, 711 to

1,052, 985 to 1,182, and 1,239 to 2,645, respectively. A long NCR of 819 nt was identified at the 3' end of the genome, upstream of the poly (A) tail.

ORF2, 3 and 4 encode for putative proteins consisting of 239, 113, and 65 aa with M_r of 27, 12, and 7.1 kDa, respectively. BLAST search comparisons of the aa sequence of the proteins encoded by ORF2, 3 and 4 showed 79% identity to APruV-1 TGB protein 1, 91% identity to APruV-1 TGB protein 2, and 95% identity to APruV-3 TGB protein 3, respectively.

ORF 5 encodes for a putative protein of 408 aa with a molecular weight of 44 kDa, and the aa sequence showed 94% identity with the CP of APruV-3 coat protein. The genome organization of the partial sequence of the APruV isolate associated with Ta Tao 5 is similar to those of the members of the genus *Foveavirus* (Figure 4.5).

Table 4.3 shows the percentage identities (calculated using the FASTA program) of each of the proteins encoded by the Ta Tao 5 ApruV-3 virus isolate compared with viruses belonging to the genus *Foveavirus* and unassigned members of the family *Flexiviridae*. The highest identity levels were observed with ApruV protein sequences. Lower values for identity were found with other members of the genus *Foveavirus* (ASPV, ApLV, PSRV, PCMV and RSPaV) or with unassigned members of the family *Flexiviridae* (CNRMV, CGRMV).

Phylogenetic Analysis

The Ta Tao 5 isolate clustered consistently with the other published sequences for ApruV (with high bootstrap support) in the phylogenetic trees generated from the protein sequence alignments of TGB1, 2 and 3; and CP (Figure 4.6, 4.7, 4.8, and 4.9) respectively. The aa sequences for the TGB3 and CP of Ta Tao 5 virus isolate grouped with APruV-3 (100%) (Figure 4.8 and 4.9). No comparisons with the TGB1 and TGB2 proteins of APruV-3 protein were possible because other sequences for this region of the genome are not available in GenBank. For every phylogenetic tree generated, the APruV-3 isolate of Ta Tao 5 was more closely related to APruV and members of the genus *Foveavirus* (ASPV, ApLV, PSRV-Caserta 12 and RSPaV) than to unassigned members of the family *Flexiviridae* (CNRMV, CGRMV). The exception to this occurred with the TGB1 phylogenetic tree. The TGB1 of the APruV-3 isolate from Ta Tao 5 was more closely related to the TGB1 protein of CNRMV and CGRMV than to the TGB1 protein of RSPaV, a member of the genus *Foveavirus* (Figure 4.6).

Discussion

Phylogenetic relationships, supported by high bootstrap values, clearly indicate that the ApruV agent present in Ta Tao 5 is a member of the family *Flexiviridae* and has high affinity with members of the genus *Foveavirus* and with

the previously published sequences for APruV in particular. In comparison with the complete sequences of foveaviruses known today, the partial sequence presented in this work represents approximately the 3' terminal third of the complete genome sequence of the foveavirus found in Ta Tao 5.

In addition to the phylogenetic affinity, the genome organization of the 3' genome region of the Ta Tao 5 agent is very similar to that of members of the genus *Foveavirus*. Downstream of the replicase ORF, flexiviruses encode one or more proteins involved in cell-to-cell movement, which in the genus *Foveavirus* correspond to a set of three partially overlapping ORFs known as the triple gene block (TGB) proteins (Martelli et al., 2007; Fauquet et al., 2005). In concordance with that, one of the agents found in Ta Tao 5 encodes for three overlapping proteins, whose molecular weights and genome sequences are very similar to the corresponding proteins of other members of the Foveavirus genus, particularly to APruV. The TGB encoded proteins for APruV have calculated molecular weights of 27.2 (ORF2, TGB1), 12.1 (ORF3, TGB2), and 7.3 kDa (ORF4, TGB3) (Marais et al., 2006), which are very close to the 27, 12 and 7.1 kDa, found in Ta Tao 5 agent for TGB1, 2, and 3, respectively.

Some foveaviruses, such as ASPV, ApLV and APruV, are unique among members of the family *Flexiviridae* in having coat proteins with molecular weights > 40 kDa (Adams et al., 2004; Martelli et al., 2007). This feature is also observed in the Ta Tao isolate which encodes for a CP with an estimated molecular weight of 44 kDa.

Another interesting feature found in the Ta Tao 5 isolate is a very long 819 nt NCR identified at the 3' end of the genome, which resembles those of 882, 816, and 813 nt found in APruV-1, 2, and 3, respectively (Marais et al., 2006). This large 3' NCR (> 800 nt) appears to be a singular characteristic among the APruV and distinguishes them from other member of the genus *Foveavirus* with shorter 130 to 180 nt 3' NCR (Marais et al., 2006).

The species demarcation criteria in the Flexiviridae family is that distinct species have less than 72% identical nt or 80% identical aa sequences between their entire CP or replication protein genes (Adams et al., 2004). No replicase protein sequence is available from this study, but the complete CP sequence was determined and it showed 94.4% identity with APruV-3. Using the 80% identical aa criteria for species demarcation, the associated APruV present in Ta Tao 5 source should be considered as an isolate of APruV-3, rather than as distinct virus species in the genus.

The presence of APruV-3 in Ta Tao 5 was determined in this study, together with the fact that this virus could be transmitted readily to woody and herbaceous hosts by mechanical inoculation. No vector or seed transmission has been reported for APruV. Further research will be needed to establish the relationship between the APruV-3 isolate founded in Ta Tao 5 and bloom delay. However, the present work shows enough evidence to demonstrate that APruV-3 is one of the agents present in Ta Tao 5 together with ACLSV and PLMVd. Heat-treated Ta Tao 5 plants, which were found positive by One-Step PCR for APruV-3,

but negative for ACLSV and PLMVd (data no shown), could be used in future trials as APruV-3 sole source and give some clues of the role of this virus in bloom delay.

Table 4.1

Sequences of the primers used to detect and clone the isolate of Asian prunus virus (APruV) from Ta Tao 5 peach (*Prunus persica*) germplasm. The melting temperature (T_m) of the primers and the size of the product amplified (bp) are indicated.

Primer name	Primer sequence	T _m °C	Prod size (bp)
CP-PLV1 (F)	5' KCRGKATCAAAAAGCATAC 3'	48	340
CP-PLV2 (R)	5' AATCCATYTCCTTCCCCTCAA 3'	48	
p677 (F)	5' GTGTGTTAGTAAATATTAGTAGT 3'	55	409
P678 (R)	5' ACCCAGAACTACCGATCACT 3'	55	
p905 (F)	5' CTGGTGACGAATATTCCACCTTCTGGGTGG 3'	63	700
p904 (R)	5' CACTTTAGTCATGGCAGGTCGGAACCATGG 3'	63	
p929(R)	5' GACCACGCGTATCGATGTCGACTTTTTTTTTTTTTTV* 3'	63	600
p931 (F)	5' CGTAGATTTATGAGCTACGTCCTGTGG 3'	63	
p930 (R)	5' GACCACGCGTATCGATGTCGAC 3'	63	
p933 (F)	5' CTGCTGCACATGCTTAGCTCTGTTTCAGGATGG 3'	68	1200
p932 (R)	5' AGTAACCTCATGGGCCGTTGAAGCATTTTTGTCCTGG 3'	68	
939 (R)	5' CAACAGCCTCAACTGAGGTCGTCATGATGTCAGTTGTGG 3'	68	1200
UPM	5'CTAATACGACTCACTATAGGGCAAGCAGTGGTATCAACGCAGAGT3'	68	
975 (R)	5' ACACCTACAC TCAACCTAAC TAAAGTG 3'	60	1200
NUP	5'AAGCAGTGGTATCAACGCAGAGT 3'	60	
SMART Oligos	5' AAGCAGTGGTATCAACGCAGAGTACGCGGG 3'		

*V is C, G, or A.

Table 4.2

Viral sequences used for comparison in this study. The host from which the virus was isolated, the geographic origin, taxonomic classification, and the accession number in GenBank are indicated.

Viral Isolate	Host	Origin	Taxonomic Classification	Accession no
ApLV	Apricot	Italy	<i>Foveavirus</i> <i>Flexiviridae</i>	AF057035
PSRV-Caserta12*	Peach	Italy	<i>Foveavirus</i> <i>Flexiviridae</i>	AF318062
APruV-3	Peach Ku Chu'a Hung	China	<i>Foveavirus</i> <i>Flexiviridae</i>	DQ205238
APruV-2	<i>Prunus mume</i>	Japan	<i>Foveavirus</i> <i>Flexiviridae</i>	DQ205237
APruV-1	<i>Prunus mume</i>	Japan	<i>Foveavirus</i> <i>Flexiviridae</i>	DQ205236
PCMV	Peach Agua	Mexico	<i>Foveavirus</i> <i>Flexiviridae</i>	EF693898
ASPV	Apple	Germany	<i>Foveavirus</i> <i>Flexiviridae</i>	NC_003462
PVYV	Pear	Germany	<i>Foveavirus</i> <i>Flexiviridae</i>	BAA04852
RSPaV	Grapevine	Germany	<i>Foveavirus</i> <i>Flexiviridae</i>	NC_001948
CGRMV	Cherry	US	Unassigned <i>Flexiviridae</i>	AJ291761
CNRMV	Cherry	Germany	Unassigned <i>Flexiviridae</i>	NC_002468
PVS	Potato	Germany	<i>Carlavirus</i> <i>Flexiviridae</i>	CAI06119

* Peach sooty ringspot virus

Table 4.3

Percentage identity of the deduced amino acid (aa) sequences of the putative Triple Gene Block proteins 1 (TGB 1), TGB 2, TGB 3 and coat protein (CP) of the ApruV isolate from Ta Tao 5 compared with viruses belonging to genus *Foveavirus* and unassigned members of the family *Flexiviridae*(CNRMV and CGRMV).

VIRUSES	APruV TA TAO 5 ISOLATE			
	TGB 1	TGB 2	TGB 3	CP
APruV -3	---	---	95.8 %	94.4 %
APruV- 2	---	91.7 %	75.4 %	62.3 %
APruV -1	79.1 %	91.2 %	73.8 %	70.5 %
ASPV	38.8 %	60.7 %	46.3 %	29.4 %
PCMV	38.9 %	48.6 %	43.1 %	32.2 %
ApLV	---	---	---	29.0 %
PSRV-Caserta12	36.2 %	56.1 %	38.6 %	30.8 %
RSPaV	39.4 %	44.4 %	33.9 %	38.9 %
CNRMV	37.4 %	45.2 %	35.6 %	30.2 %
CGRMV	39.2 %	41.4 %	32.8 %	30.5 %

Figure 4.1

Symptoms observed on *Nicotiana occidentalis* (left) after sap inoculation with leaf tissue from Nemaguard seedlings chip-budded with Ta Tao 5. A leaf from a non-inoculated *N. occidentalis* plant is shown on the right.



Figure 4.2
 Arrangement of the clones produced using PCR reactions and different pairs of primers during the process of obtaining the partial sequence of the ApruV-3 isolate in Ta Tao 5.

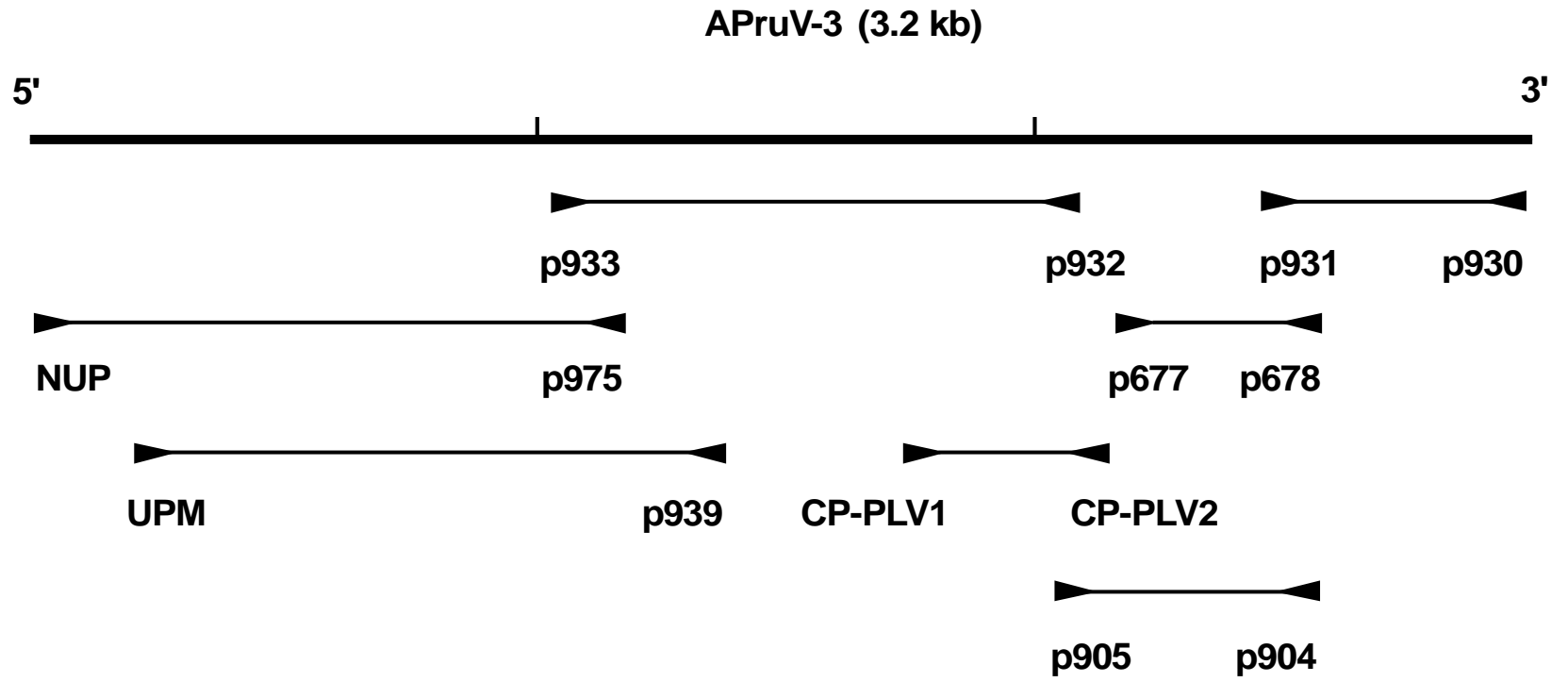

Figure 4.3

A 1% agarose gel buffered with 1x TBE and stained with ethidium bromide of the products from a One-Step PCR reaction using primers 678, 677 (Candresse) and CP-PLV1, CP-PLV2 (Marais) and the isolate of APruV from Ta Tao 5, yielding a 409 and 340 bp product, respectively. Lanes 1 and 2 are for Ta Tao 5, lane 3 (M) is the molecular weight standard and lane 4 (H) is from a non-infected material.

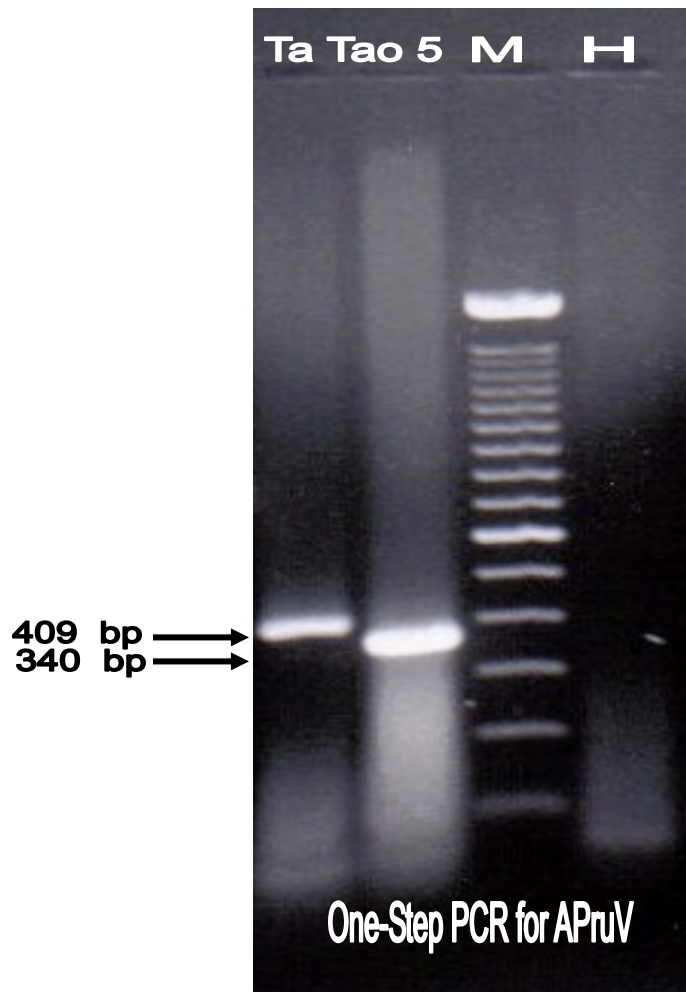

Figure 4.4

Partial nucleotide sequence of the ApruV-3 isolate from Ta Tao 5.

```
ACGCGGGGGA ATAAGTATGG ACTTTGTTTA CGATAAGTTA ATTGAGGCTG
GCTATATTAG AACTAGGTTG CCAATAAATT TTCCTATCAT AGTGCATTGC
ATTGCGGGGG CTGGGAAAAG CACTCTAATC AGAGAGATCA TAGAAGCCGA
CAATAGATTT GAGGCCTTCA CATAACGGTGT TCCTGATCCT GTTAACCTTT
CTGGAGTGAG GATCAAGAGT GCGGCTGATA TTGGTAGGGC GAGAGCGGAT
TCAATTAATA TAGTTGACGA ATACATTGGA CAAGCTTTGC CCGACGGCAC
TGCATTTTGC TTCGCTGACC CCAACCAATT TCCGTACACT TGTCTGACG
CACATTTTAC AAGTTATCAG ACCAAGCGTT TTGGGGACCA AACCTGCTCC
TTTCTCGGGA AATTAGACTG CGCTGCATCT TCATAAAGT CTGACCAATT
GATTTTTGAA AAGCTTTTTG AAGGTTCAAT TGAGGGCCAA ATTGTCTGTT
ACGAGAAGGA AATTTTTGAG CTGTTGGACA GGCACGGTGC CGATTACAAG
AAGGATTGTC AAATCAGAGG CTCCACTTTC GACATTGTGA CCTTCATCAC
ATCTTCTGAA TCCTTTGAGC CAGAAGATAG ATACAAAGTT TACCTGTGTT
TAACAAGGCA TCGTTCTGTT CTGCGTATTT TGAGTCCTGA GGGCATGTTT
TTAAGGGACA ATGCCAAGTT TGACGCCACC TCCTGATAAC ACAAGAGTCC
TCTTACCCAT CGCCGTTGGT TTGGGAGTTG GCATAGTCAT TTGGTGCTTA
ACAAGATCGA CCCTGCCTTC AGTTGGCGAC AACGTACACA GCCTCCCTCA
CGGGGGAAAT TATTTGGACG GCACAAAGAG GATCAGTTAT TGTGGGCCAA
GGGATAGCTT CCCAAGCAGC AATCTCTTTA AAGGAGGTAC TTTCTCGGCA
ATTTGCATTG TTGTGCTTTT AGTCTTCGCG ATTCATGTAT CAGAGTTATT
TAATAGGCCT AACCGTCGCA CTTGTGGTTG TGGGTCTGCT GCACATGCTT
AGCTCTGTTC AGGATGGTTG TCTAATAGTT GTTACTGGTG AGTCTGTATT
AGTTAAAAAT TGTGTGTATA CTAGTGAGTT CGTAGATTTG GTTAAGGGCC
TCAAACCTCA TAACCATTTG AAGTCACTTT AGTTAGGTTG AGTGTAGGTG
TATTGAAATA ACAAACGATT TGCTTTTGAG ATCTCAAAAT GACA ACTTCT
GTTTCGGCTG CCACA ACTGA CATCATGACG ACATCAGTTG AGGCTGTTGC
GGTCACAGCC TCAGCTAGTG AACCCGTTAT TCAACAGGAA ATCCTCCCAA
AGTCTACTGC TGTGGTCACT TCAACTGTGT CTGCTGCAAC TTCAGAAGCC
AAGAGGGTTG AAGACCCTTT TAGGACGAGA GCAAGCTTCT CACTATCGTC
ACTGACCAGC AGCTTGGGGG CCCTAAGTTC AACTGCAACA ACTGTTGCAT
CCTCAGCAAT CCCCAGGTC AAGTCTCAA CATTTGAAAA CTGGAGGGAG
AAACTAAAGA CCAAGGATGA CTTGAATTTT CCACGTGCTA CAGAAGTTGG
GAACTTAGGT TCATTTGAGG CAGGGGATGG GTCCCATGGG GGAAATAATG
GTCCTAAGGT TCATGGAGTT TCGCCCAGTA CAATGACGTA TGAACGGCAA
AATGAGGCTG GGGACTCGAG CGCCAAAACC ACTGTAGTCA GTTTGGGGTC
CCGACAAAGA ATGGTGTTTG AAGCTGCTAG AAAGAGGGCT CAGTTGAATA
TTGAGGCAGA TAGAGACAGC ATGGCTCCCC CTTTCGCCTC CGGCGACCTT
TTCTCTAGAC CCAAGGTTCA GGATGTTTCA CGGTTCTCGT ATGAGCCTAG
CTCACCAGAT GTGGCCACTG CAGAGAACAT AGAGTATATA CGAGCTGACC
TGGTGAGAGC TGGTGTTCCT ACAAAGGACC TAACCTTTGC TATGTGGGAT
ATCGCACGTT ACTGTGCCGA CGCTGGCTCG TCTGAGTCAA CAGAGTTTAT
```

Figure 4.4 (Continued)

Partial nucleotide sequence of the ApruV-3 isolate from Ta Tao 5.

```
TGGGACTAGC AGTTATGGGG GCAGAGTGAC TAGGATGGAA ATTGCTGCAA
TCATCAAAAA GCATACCACA CTCCGTAGGT TCTGTGGATT CTATGCTAAA
ATTGTGTGGA ACATTATGCT TGTTACCAAC ATACTACCAT CTGGGTGGAT
GAAGAGAGGT TATAAAGAAA ACACGAAGTT TGCAGCTTTT GACTTTTTTCG
TGCATGTATC CAACAATGCT GCCTTAGAGC CAGAGAACGG GCTCGTCAGG
AAACCATATC ATGAGGAGTT GGTGGCTGCG CAAGCTAACA AGGGTGTTAT
CCTGCACCGA ACCGAATCAG CCCAGGACAA AAATGCTTCA ACGGCCCATG
AGGTTACTGG TGGCAGAGCT GGGCCACGTT CAAGGTTGAC TTTGAAGGGA
AAGGAGATGG ACTGAGGACT TCAGTCAAGT GATGGTTTGG CCTAGAACCG
TGGAAAGGCC TAAAAGAGTC CACGTACCGT CTTAGGGAGA TAGTATGTGT
TTTAGTAAAT ATTAATAGTT TCCACTTCCT TAGGTTCCAG GTCTAGAACC
CAGGAGAGAC CAAAAGAGT CCTGGTGAGC GTTTAGCTAT GAGAACCCTCT
GCACTGCATA GGCCACACCA ACGCTAATCA TTGTGTGCCT TATGTGGGCA
AGTTAACCAG GTTGTGGCGG CAACCTGGAA TGTTAGATGC AAGCGTAGAT
TTATGAGCTA CGTCCTGTGG TTGGATTTCC ACCGTTATCT CGTCGTTAAG
AGAGTGACCC CTCTTTTCTC GCTTATGGGG GCATTGTTAG GCGGGCGTGT
GACCCATTGA AAGATGGGTT CCCTGCGTTA AGGGTAGTTG TGGTTTAGAA
TAAGCCTCCA TGGTTCCGAC CTGCCATGAT TAAAGTGATC GGTAGTTCTG
GGTAAGAAAT AACCTGTGC TTGGTGGCTA AGCATGACCA CTCAGTTTGA
CCGACTGGCC AGACAGGTCA CGTTTCCCAC TTCGATATCA AAAGTGGGCG
CATATCAAAG CGTTAAATTG TTCATCCGCA TATTTTGGAC TCCCAATTCT
TGGGGGTTTG AAATAGACTT TGGTCCTGGT TATCTGACCT TAAAAGAGCC
AAATAAACCG CATTTCAACG CGTTATAGTG TTCGCTGACA GACCGTACAA
ATAGTCTGTC TCACCGACCT AAGACCTAAA TAATTGAATA AGGGAAGGTG
ATTAAATAAA TTTGCTTTTT ATCGCTAATT TTGC
```

Figure 4.5
 Organization of the genome of apple stem pitting virus (ASPV) the type species of the genus *Foveavirus*. The location of the partial sequence of APruV-3 isolate from Ta Tao 5 is indicated by the black bar below. The ORFs in the sequence of ApruV-3 correspond to the ORFs shown for ASPV

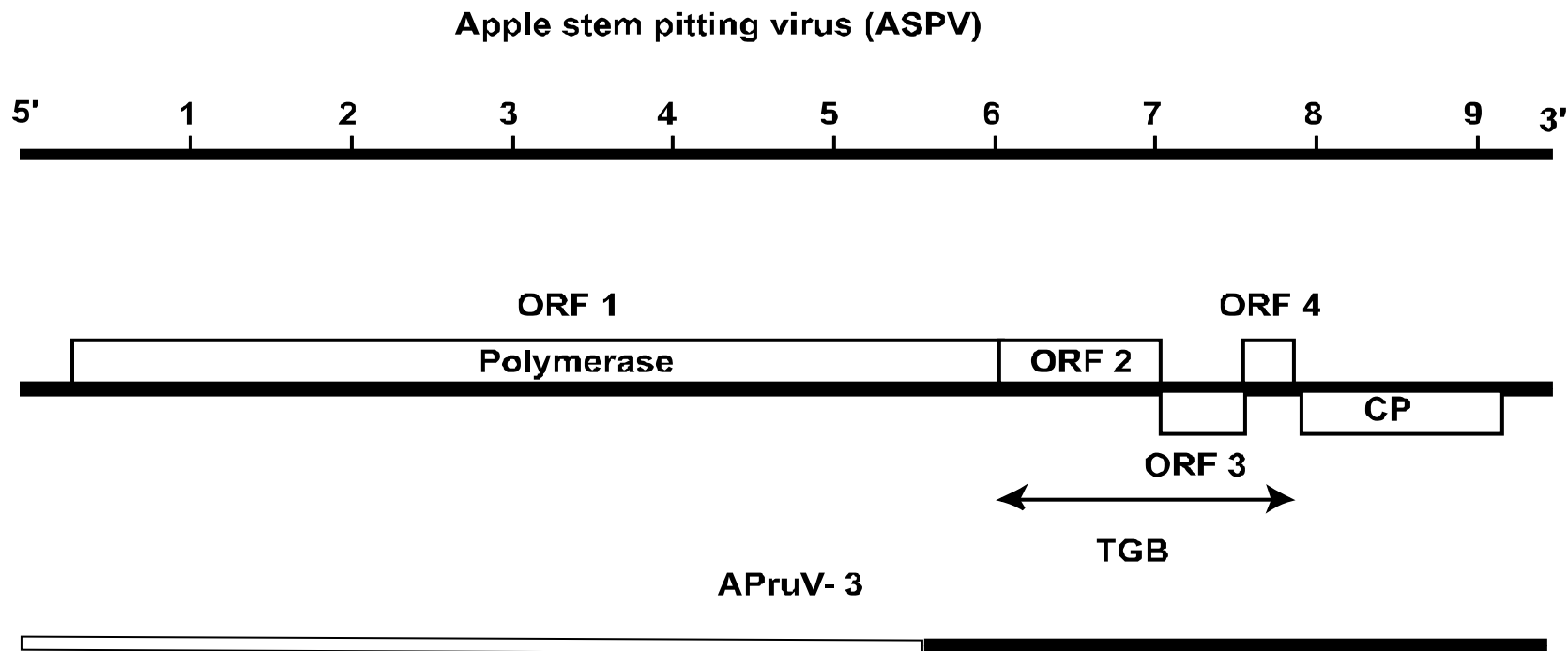

Figure 4.6

Phylogenetic relationships of the APruV-3 isolate from Ta Tao 5 and members of genus *Foveavirus* based on the aa sequence of the TGB 1 gene. CNRMV and CGRMV were originally considered to be members of the genus but are now regarded as member of the family *Flexiviridae* but have not been assigned to a particular genus. The isolate of ACLSV from Ta Tao 5 was used as an outgroup.

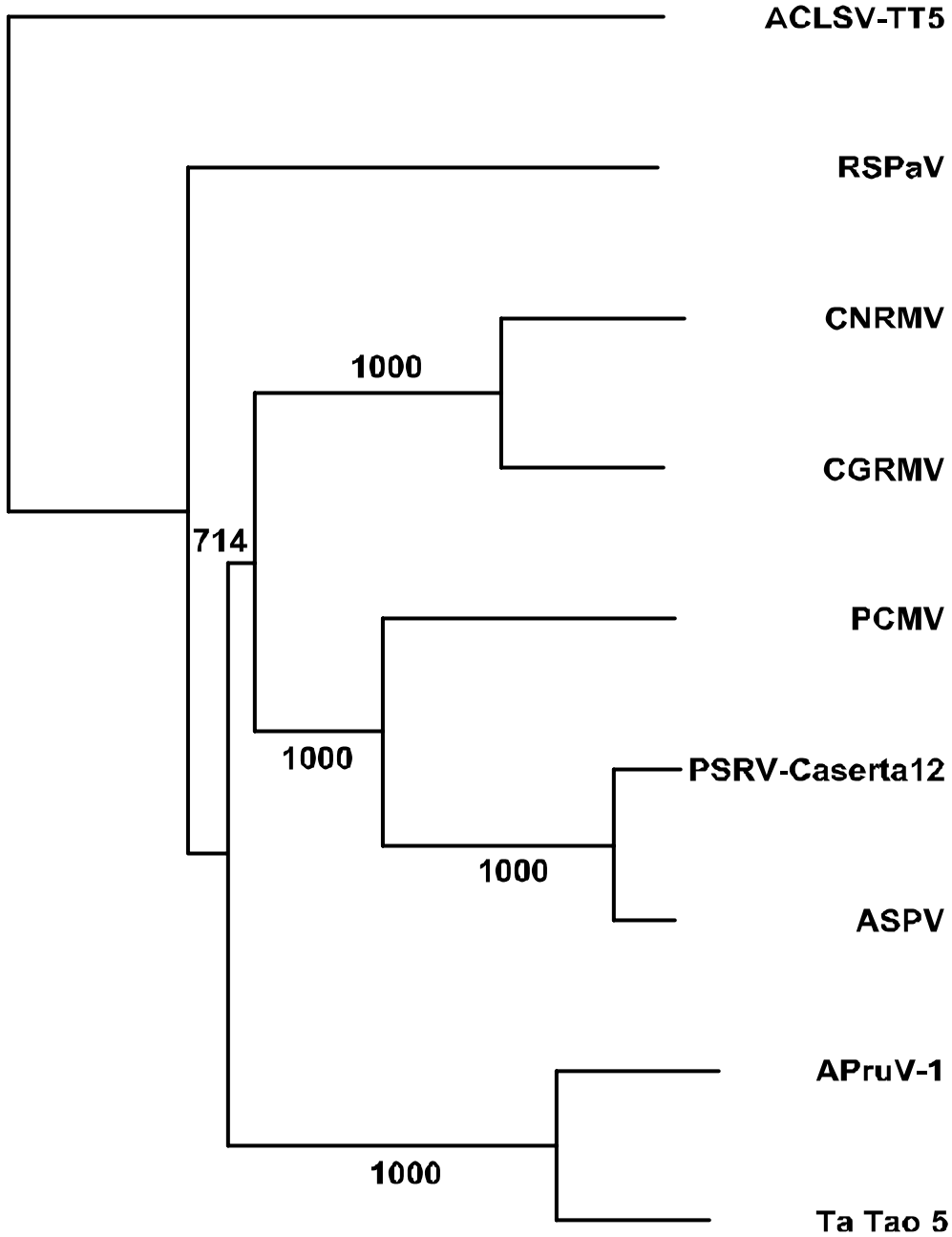

Figure 4.7

Phylogenetic relationships of the APruV-3 isolate from Ta Tao 5 and members of genus *Foveavirus* based on the aa sequence of the TGB 2 gene. CNRMV and CGRMV were originally considered to be members of the genus but are now regarded as member of the family *Flexiviridae* but have not been assigned to a particular genus. The isolate of ACLSV from Ta Tao 5 was used as an outgroup.

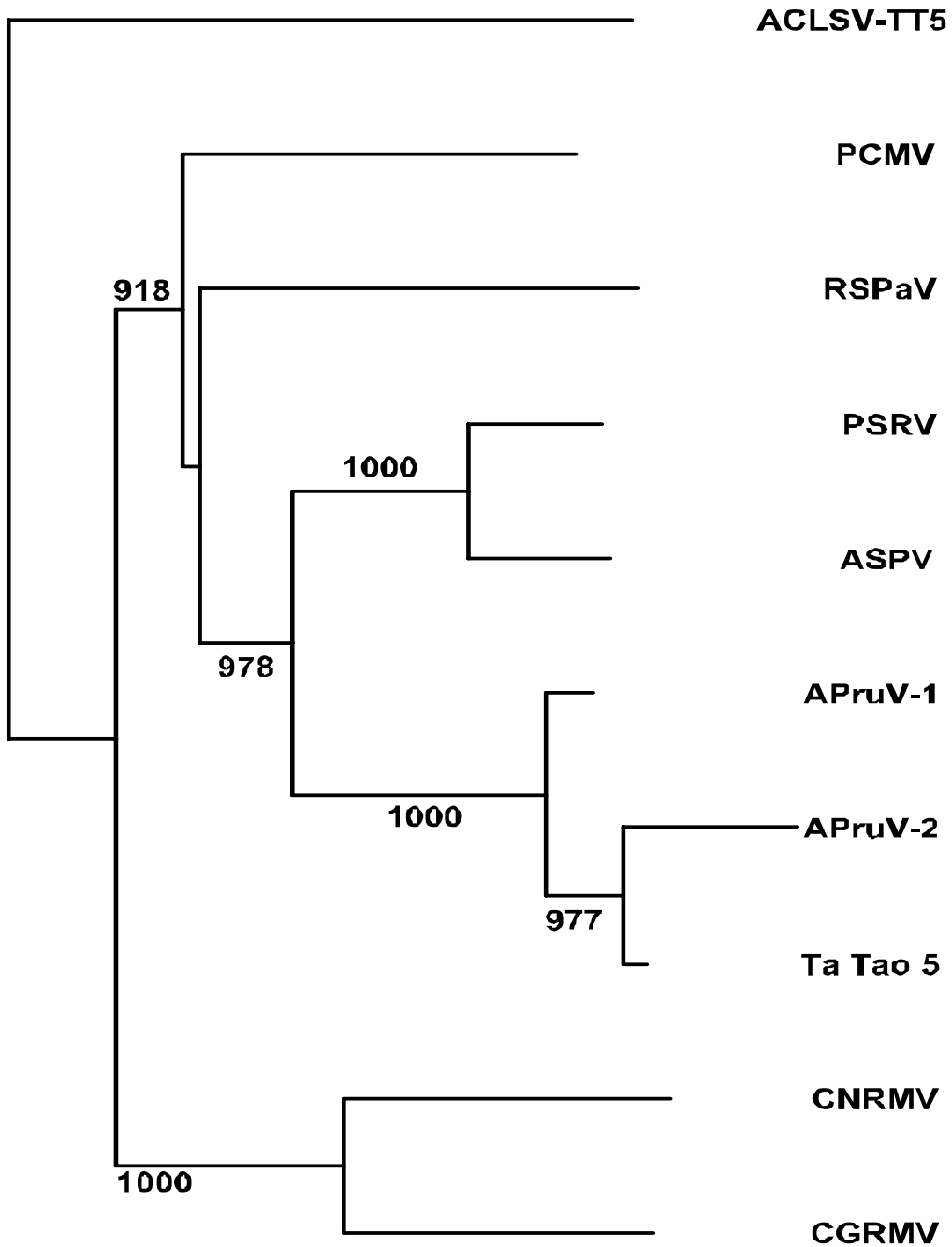

Figure 4.8

Phylogenetic relationships of the APruV-3 isolate from Ta Tao 5 and members of genus *Foveavirus* based on the aa sequence of the TGB 3 gene. CNRMV and CGRMV were originally considered to be members of the genus but are now regarded as member of the family *Flexiviridae* but have not been assigned to a particular genus. The isolate of ACLSV from Ta Tao 5 was used as an outgroup.

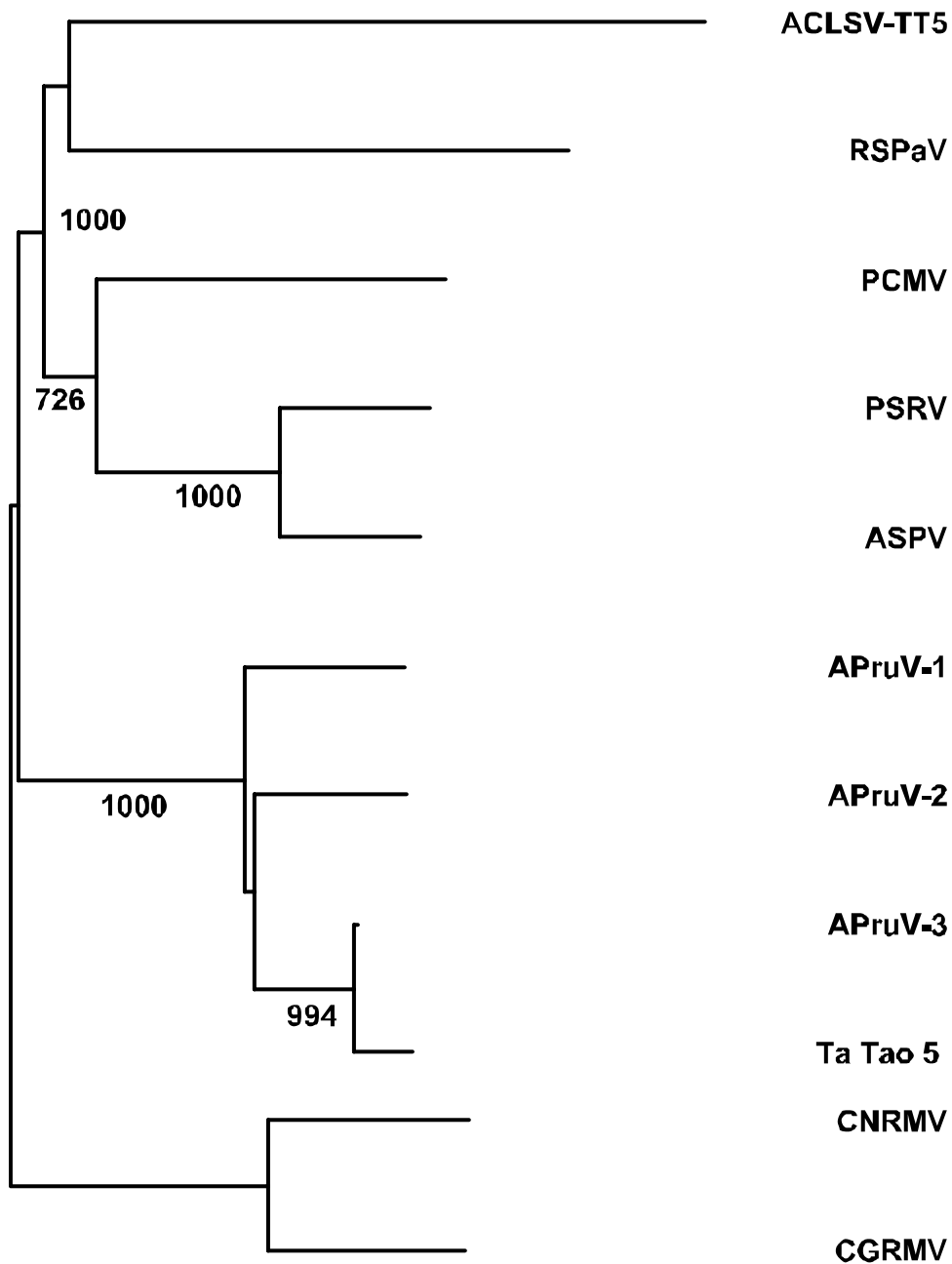
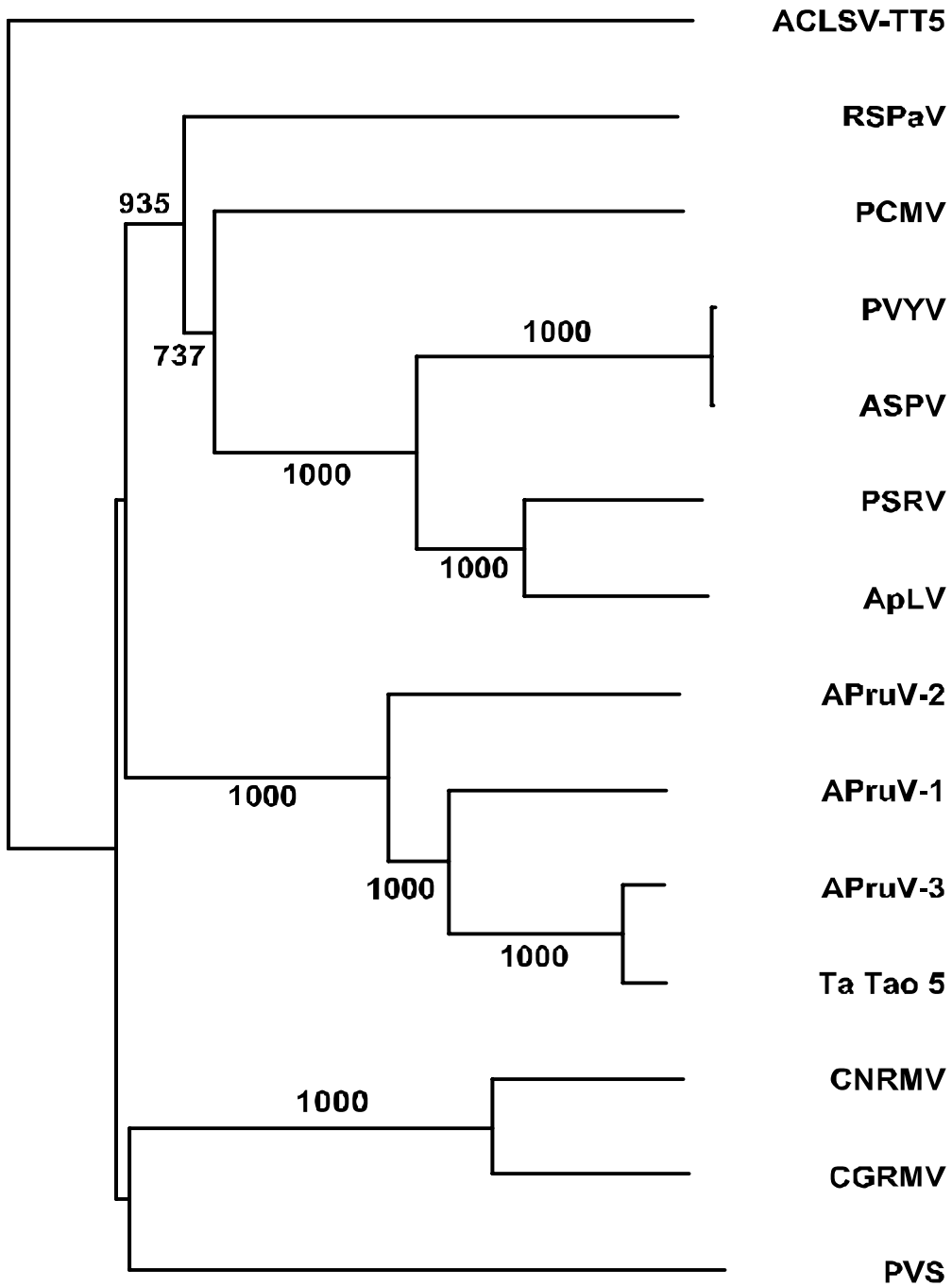

Figure 4.9

Phylogenetic relationships of the APruV-3 isolate from Ta Tao 5 and members of genus *Foveavirus* based on the aa sequence of the CP gene. CNRMV and CGRMV were originally considered to be members of the genus but are now regarded as member of the family *Flexiviridae* but have not been assigned to a particular genus. The isolate of ACLSV from Ta Tao 5 was used as an outgroup.



CHAPTER V

MOLECULAR CHARACTERIZATION OF THE PEACH LATENT MOSAIC VIROID (PLMVd) ISOLATE PRESENT IN TA TAO 5

Introduction

PLMVd has been found in North and South America, Asia (Japan and China), Europe (France, Spain, Italy, Austria, Greece, Romania, and Yugoslavia), Africa (Algeria and Morocco), and most recently, in Australia (Desvignes, 1986; Flores & Llacer, 1988; Flores et al., 1990b; Albanese et al., 1992; Flores et al., 1992; Shamloul et al., 1995; Di Serio & Ragozzino, 1995; Skrzeczkowski et al., 1996; Di Serio et al., 1999; Pelchat et al., 2000). The viroid was first detected in U S in 1995 (Skrzeczkowski et al., 1996).

Cloning and sequencing of isolates of PLMVd from peach has revealed a sequence of 335-342 nt in length with the presence of hammerhead structures in both polarity strands (Hernandez & Flores, 1992; Shamloul et al., 1995; Ambros et al., 1999; Pelchat et al., 2000). Analysis of the nucleotide sequences of isolates of PLMVd from sweet cherry indicated that the cherry isolate is 337 nt long. The cherry variant of PLMVd shares 91-92% identity with the French and Italian PLMVd peach isolates (Hadidi et al., 1997). The plum variant of PLMVd shares 92% identity with the French and Italian peach isolates (Giunchedi et al., 1998).

Molecular variants isolated from either European or North American sources showed high naturally occurring polymorphism (Pelchat et al., 2000; Malfitano et al., 2003; Fekih Hassen et al., 2007). After isolation of 34 PLMVd variants from nine different peach cultivars from North America, it was concluded that the North America isolates can not be differentiated from the European ones. Each PLMVd isolate is a complex mixture of RNAs and folds into a complex branched structure with the potential of including three new pseudoknots, resulting in a “globular-like” structure (Pelchat et al., 2000). Analysis of the progenies of single PLMVd clones has revealed the extremely heterogeneous character of this viroid (Ambros et al., 1999).

The molecular mechanisms by which viroids elicit symptoms remain largely unknown. It is generally accepted that they modify host-gene expression. Until recently, the mature viroid or some of its replicative intermediates have been considered as the primary pathogenic determinant, interacting with a host protein, or RNA (Diener, 2001). In recent years, it has been proposed that viroid symptoms could result from RNA silencing effects downregulating the expression of some host genes (Papaefthimiou et al., 2001).

In addition to the cascade of molecular events leading to symptom expression, a critical step toward understanding viroid pathogenicity is the molecular characterization of viroid genomes to identify regions responsible for their virulence (Rodio et al., 2006). A 12 to 13 nt insertion, always found in the U-rich loop capping the hammerhead arm, has been found in the Peach Calico

(PC) isolate (extreme chlorosis) in peach trees from Campania, Italy. Only those variants containing the 12 to 13 nt insertion were able to produce the PC symptomatology. This insertion is always found in the same position, has very limited sequence variability, and folds itself into a hairpin (Malfitano et al., 2003). Recent studies showed that this insertion confers to PLMVd the ability to block an early stage of chloroplast biogenesis by interfering with translation of plastid-encoded proteins (Rodio et al., 2006). A second population of PLMVd isolates, containing a 14 nt insertion also folding into a hairpin but capped by a GA-rich loop, was isolated recently. This variant does not elicit PC or other macroscopic leaf symptoms and the insertion might be acquired or lost in the course of infection as a consequence of recombination events (Rodio et al., 2006).

A field trial with Coronet peach trees that were chip-bud-inoculated with graft transmissible agents from Ta Tao 5 showed that there was an absolute correlation between bloom delay and the presence of PLMVd. Also, trees exhibited significant differences in vegetative vigor, leaf defoliation, and fruit ripening (Gibson, 2000; Gibson et al., 2001). No detrimental effects as frequently observed in Europe (Giunchedi et al., 1998, Flores et al., 2003), like peach calico symptoms or fruit deformation were observed on PLMVd infected trees growing in South Carolina; suggesting that this agent could be used in fruit tree crops as a tool of manipulating plant growth. However, field trials involving PLMVd at other locations in the US have not shown any bloom delays (J.K. Uyemoto & W. Howell, pers. comm.).

The objectives of this study were to find reliable detection methods for the PLMVd isolate present in Ta Tao 5, to perform a molecular characterization of the viroid isolate in Ta Tao 5 and to establish molecular relationships with known PLMVd sequences.

Materials and Methods

Virus Sources and Maintenance

Trees of Ta Tao 5 (PI101667) and seedlings of Nemaguard peach that had been chip-bud inoculated with Ta Tao 5 were used as sources of viroid. Trees of Springprince peach which had not been inoculated with PLMVd were used as negative control plants. All trees are located at the Musser Farm Research Center near Clemson, SC.

Nucleic Acid Extraction

In the springs of 2005, 2006, and 2007, total RNA was extracted from newly emerged peach shoots from the Ta Tao 5 trees. RNA was extracted using a modified procedure of Hughes and Galau (1988) (Sara Spiegel, The Volcani Center, Israel, pers. comm.) (Appendix A).

One-Step PCR

Samples of total plant RNA from Ta Tao 5 and healthy peach trees were used in One-Step PCR. PCR reactions were done as described in Appendix D, using primers p833 (5' TCTTGCCCCACCCTTCAACAAATG 3') and p834 (5' CAAACATGGCTTTTCACCTTCTGCA 3') as forward and reverse, respectively. Each reaction was subjected to 35 cycles of amplification. PCR products were electrophoresed as described in Appendix E.

cRNA Probe Synthesis and Dot Blot Hybridization

Digoxigenin (DIG)-labeled cRNA probes were synthesized as described in Appendix H from linearized plasmids containing a PLMVd clone supplied by Skrzeczkowski, IAREC, Prosser, WA. The probes were utilized to detect PLMVd in samples in three ways: 1) direct petiole blotting, 2) plant total RNA blotting, and 3) samples prepared using Ames buffer, by dot blot hybridization as detailed in Appendix H. Dot blot hybridizations were performed during the springs of 2005, 2006, and 2007.

Cloning, Sequencing, and Sequence Analysis

Products from One-Step PCR reactions analyzed on agarose gels were purified using a MinElute gel Extraction kit, cloned into *Escherichia coli* using

TOPO[®] Cloning Reaction and Transformation, and finally sequenced as detailed in Appendices F and G.

The sequence of PLMVd reference isolate (GenBank accession NC_003636), four clones sequenced in Spain by Dr. Flores (Ta Tao 5 FL 2, 3, 7, and 8), and the sequence of four clones prepared from Ta Tao 5 at Clemson University (Figure 5.1) were aligned using Clustal X.

Results

Molecular Detection of the PLMVd Isolate Present in Ta Tao 5

One-Step PCR and Dot Blot Hybridization

A band of the expected size, around 340 bp, was observed for all the Ta Tao 5 sources analyzed by one-step PCR. No bands were amplified when healthy peach total RNA was utilized (Figure 5.2). Positive reactions were observed by dot blot hybridization for all the Ta Tao 5 samples blotted on the membrane and for the positive controls (PLMVd plasmid and RNA). The non-inoculated Springprince; *i.e.*, healthy, did not react with the cRNA probe for PLMVd (Figure 5.3). Comparing the results of the three different ways of processing samples, plant total RNA blotting was the best, because it showed darker spots, corresponding to the reactions between the probe and the PLMVd RNA present in each sample (Figure 5.3).

Sequencing and Characterization of the PLMVd Isolate Present in Ta Tao 5

The sequences of the four clones produced at Clemson University (PLMVd DM-C1 to PLMVd DM-C4), are shown in Figure 5.4. The genome of the isolate of PLMVd present in Ta Tao 5 was 337 nt long. It showed more than 96% identity with other PLMVd sequences published in Gene Bank. The sequences of the four clones produced by Flores in Spain are shown in Figure 5.5.

A multiple alignment of the eight Ta Tao 5 clones (FL and DM clones) and NC_003636 (PLMVd reference isolate) is shown in Figure 5.1. The 11 nt insertion, characteristic of the peach calico strains, was not present in any of the Ta Tao 5 sequences compared (Figure 5.1). Some minor differences could be observed among the PLMVd reference sequence (NC_003636) and the eight Ta Tao 5 PLMVd isolates. However, they have not been associated with any detrimental symptom.

Discussion

As described in previous work (Gibson, 2000; Gibson et al., 2001), PLMVd was readily detected in every experimental tree exposed to Ta Tao 5 by dot blot hybridization in the present study. Dot blot nucleic acid detection systems are an easy and economical way to detect the presence of the viroid. DIG-labeled non-radioactive probes were used in the present work with the advantage of being safer and easier to use than the radioactive ones. Although using plant total

RNA to blotting the membrane instead of direct petiole blotting added one more step to the technique, it should be considered in cases where low viroid concentration is expected or the material is not succulent enough. One-step PCR was an alternative method to detect the viroid, although it was more time consuming and expensive than hybridization techniques.

Based on the criteria for demarcation of species in the family *Avsunviridae* [less than 90% of sequence similarity and distinct biological properties (Flores et al., 2005)], the viroid found in Ta Tao 5 is an isolate of PLMVd rather than a different species in the family, and it is practically identical to isolates found in other parts of the world. The work of Pelchat et al. (2000) showed little variation in the sequences of PLMVd isolated from nine North American peach cultivars.

Because viroids do not encode any pathogen-specific peptide or protein, their primary pathogenic effects must result from the direct interaction of the viroid genome or some viroid derived RNA with host factors (Rodio et al., 2006). PLMVd variants inducing PC have a size of 348-351 nt, slightly longer than the 336-338 nt genome of typical variants from non-symptomatic and mosaic inducing isolates (Rodio et al., 2006). Ta Tao 5 PLMVd isolate genome lacked the PC insertion, and this could be a reason for it not producing deleterious symptoms on peach growing in South Carolina.

Viroids, like viruses, exist in their hosts as populations of closely related sequence variants (quasi-species). The nature and severity of symptoms in a viroid-infected plant is the result of the presence or predominance of particular

sequence variants within the viroid population (Singh et al., 2003). Many studies have shown that the change of a few nucleotides or even one nucleotide in viroid genomes could change dramatically the symptom expression on the host (Dickson et al., 1979; Visvader & Symons, 1985; Hammond, 1992; Reanwarakorn & Semancik, 1998; Qi & Ding, 2003). Heat stress, for example, can significantly alter the structure of viroid quasi-species (Flores et al., 2005). However, the nt changes observed in our study could not be associated with any differential symptom.

PLMVd is consistently linked to the phenological effects associated with graft-transmissible agents from Ta Tao 5 in peach trees growing in South Carolina: reduced vegetative shoot vigor, delayed bloom, and fruit ripening (Gibson, 2000). These effects could be used as a tool to manage high-density peach orchards, avoid damage from late spring frosts, and extend the harvest period (Gibson, 2000). Although the use of Ta Tao 5 PLMVd isolate as a tool in peach orchard management could give excellent results for peach growers in South Carolina, attempts to emulate this practice in other locations may not be as successful. No deleterious symptoms associated with infection by PLMVd have been observed in the US. Indeed the viroid was endemic in the US for years before its presence was detected (Skrzeczowski et al., 1996). The French had blamed the US for exporting PLMVd to Europe in certified material. Tests showed that many of the certified sources of peach material in the US were indeed contaminated with PLMVd. On the contrary, PLMVd is associated with

deleterious effects on peaches in Europe (Giunchedi et al., 1998, Flores et al., 2003). As testing for the presence of viroids becomes more widespread and observations on the performance of peach cultivars at different locations throughout the world are made, the association between PLMVd and the presence of deleterious disease may be resolved.

Figure 5.1

A multiple alignment of the complete sequences of the eight clones of PLMVd Ta Tao 5 and NC_003636. The point of insertion for the sequence that is associated with calico symptoms is shown by an arrow (see page 131).

Primer 834

```
Ta Tao 5 FL2 CTGGATCACACCCCCCTCGGAACCAACCGCTTGGTTCCCGAAGGAAAAGT
Ta Tao 5 FL8 CTGGATCACACCCCCCTCGGAACCAACCGCTTGGTTCCCGAAGGAAAAGT
Ta Tao 5 FL7 CTGGATCACACCCCCCTCGGAACCAACCGCTTGGTTCCCGAAGGAAAAGT
Ta Tao 5 FL3 CTGGATCACACCCCCCTCGGAACCAACCGCTTGGTTCCAGAAGGAAAAGT
PLMVd DM C4 CTGGATCACACCCCCCTCGGAACCAACCGCTTGGTTCCCGAAGGAAAAGT
PLMVd DM C3 CTGGATCACACCCCCCTCGGAACCAACCGCTTGGTTCCCGAAGGAAAATT
PLMVd DM C1 CTGGATCACACCCCCCTCGGAACCAACCGCTTGGTTCCCTGAAGGAACAGT
PLMVd DM C2 CTGGATCACACCCCCCTCGGAACCAACCGCTTGGTTCCCGAAGGAAAAGT
PLMVd
NC_003636 CTGGATCACACCCCCCTCGGAACCAACCGCTTGGTTCCAGAAGGAAAAGT
***** *

Ta Tao 5 FL2 CCCACCTTACCTCATTGCGAGGTGCTTAGCCTTTCCATCGA-AGCTGCAG
Ta Tao 5 FL8 CCCACCTTACCTCATTGCGAGGTGCTTAGCCTTTCCATCGA-AGCTGCAG
Ta Tao 5 FL7 CCCACCTTACCTCATTGCGAGGTGCTTAGCCTTTCCATCGA-AGCTGCAG
Ta Tao 5 FL3 CCCACCTTACCTCATTGCGAGGTGCTTAGCCTTTCCATCGA-AGCTGCAG
PLMVd DM C4 CCCACCTTACCTCATTGCGAGGTGCTTAGCCTTTCCATCGA-AGCTGCAG
PLMVd DM C3 CCCACCTTACCTCATTGCGAGGTGCTTAGCCTTTCCATCGA-AGCTGCAG
PLMVd DM C1 CCCACCTTACCTCATTGCGAGGTGCTTAGCCTTTCCATCGA-AGCTGCAG
PLMVd DM C2 CCCACCTTACCTCATTGCGAGGTGCTTAGCCTTTCTATCGA-AGCTGCAG
PLMVd
NC_003636 CCCACCTTACCTCATTGCGAGGTGCTTAGCCTTTCTATCGGGAAGTGCAG
***** *

Ta Tao 5 FL2 TGCTC-GACTAGGGCACCCCAAGGTGGAGGGGCTGAGAGGTCATCACTCT
Ta Tao 5 FL8 TGCTC-GACTAGGGCACCCCAAGGTGGAGGGGCTGAGAGGTCATCACTCT
Ta Tao 5 FL7 TGCTC-GACTAGGGCACCCCAAGGTGGAGGGGCTGAGAGGTCATCACTCT
Ta Tao 5 FL3 TGCTC-GATTAGGGCACCCCAAGGTGGAGGGGCTGAGAGGTCATCACTCT
PLMVd DM C4 TGCTC-GACTAGGGCACCCCAAGGTGGAGGGGCTGAGAGGTCATCACTCT
PLMVd DM C3 TGCTC-GACTAGGGCACCCCAAGGTGGAGGGGCTGAGAGGTCATCACTCT
PLMVd DM C1 TGCTC-GACTAGGGCACCCCAAGGTGGAGGGGCTGAGAGGTCATCACTCT
PLMVd DM C2 TGCTC-GAATAGGGCACCCCAAGGTGGAGGGGCTGAGAGGTCATCACTCT
PLMVd
NC_003636 TGCTCCGAATAGGGCACCCCAAGGTGGAGGGGCTGAGAGGCTTTACTCT
***** **

Ta Tao 5 FL2 CTCATAAGTCTGGGCTAAGCCCCTGATGAGCCGTTGAGATACGGCGAAA
Ta Tao 5 FL8 CTCATAAGTCTGGGCTTAGCCCCTGATGAGCCGTTGAGATACGGCGAAA
Ta Tao 5 FL7 CTCATAAGTCTGGGCTAAGCCCCTGATGAGCCGTTGAGATACGGCGAAA
Ta Tao 5 FL3 CTCATAAGTCTGGGCTAAGCCCCTGATGAGCCGTTGAGATACGGCGAAA
PLMVd DM C4 CCCATAAGTCTGGGCTTAGCCCCTGATGAGCCGTTGAGATACGGCGAAA
PLMVd DM C3 CCCATAAGTCTGGGCTTAGCCCCTGATGAGCCGTTGAGATACGGCGAAA
PLMVd DM C1 CCCATAAGTCTGGGCTTAGCCCCTGATGAGCCGTTGAGATACGGCGAAA
PLMVd DM C2 CTCATAAGTCTGGGCTTAGCCCCTGATGAGCCGTTGAGATACGGCGAAA
PLMVd
NC_003636 CTCATAAGTCTGGGCTAAGCCCCTGATGAGTCGCTGAAATGCGACGAAA
* ***** ** * *****
```

Figure 5.1 (Continued)

A multiple alignment of the complete sequences of the eight clones of PLMVd Ta Tao 5 and NC_003636. The point of insertion for the sequence that is associated with calico symptoms is shown by an arrow.

```

                                GAACAAAAGCTC
                                ↓
Ta Tao 5 FL2      CTTATGGATGAGAAGAGTTTTCGTCTCATTTTCAGAGACTCGTCAGTGTGCT
Ta Tao 5 FL8      CTTATGGATGAGAAGAGTTTTCGTCTCATTTTCAGAGACTCGTCAGTGTGCT
Ta Tao 5 FL7      CTTATGGATGAGAAGAGTTTTCGTCTCATTTTCAGAGACTCATCAGTGTGCT
Ta Tao 5 FL3      CTTATAGATGAGAAGAGTTTTCGTCTCATTTTCAGAGACTCATCAGTGTGCT
PLMVd DM C4      CTTATGGATGAAAAGAGTTTTCGTCTCATTTTCAGAGACTCATCAGTGTGCT
PLMVd DM C3      CTTATGGATGAAAAGAGTTTTCGTCTCATTTTCAGAGACTCATCAGTGTGCT
PLMVd DM C1      CTTATGGATGAAAAGAGTTTTCGTCTCATTTTCAGAGACTCATCAGTGTGCT
PLMVd DM C2      CTTATGGATGAGAAGAGTTTTCGTCTCATTTTCAGAGACTCATCAGTGTGCT
PLMVd
NC_003636        CTTAT-GACAAGAAGAGTTTTCGTCTCATCTCAGAGACTCGTCAGTGTGCT
***** ** * *****

Ta Tao 5 FL2      TAGCACAGACTCTTCTTCCAGAATCACTTCTGGAGGGGACCGGGTTTGAA
Ta Tao 5 FL8      TAGCAC-GACTCTTCTTCCAGAATCACTTCTGGAGGGGACCGGGTTTGAA
Ta Tao 5 FL7      TAGCAC-GACTCTTCTTCCAGAATCACTTCTGGAGGGGACCGGGTTTGAA
Ta Tao 5 FL3      TAGCACAGACTCTTCCATCCAGAATCACTTCTGGAGGGGACCGGGTTTGAA
PLMVd DM C4      AAGCACAGACTCTTCTTCCAGAATCACTTCTGGAGGGGACCGGGTTTGAA
PLMVd DM C3      AAGCACAGACTCTTCTTCCAGAATCACTTCTGGAGGGGACCGGGTTTGAA
PLMVd DM C1      AAGCACAGACTCTTCTTCCAGAATCACTTCTGGAGGGGACCGGGTTTGAA
PLMVd DM C2      AAGCACAGACTCTTCTTCCAGAATCACTTCTGGAGGGGACCGGGTTTGAA
PLMVd
NC_003636        TAGCACAGACTCTTCCATCCAGAATCACTTCTGGAGGGGAC-GGGTTTGAA
***** *****

Ta Tao 5 FL2      TCCCGGGTAGACGTCGTAATCCAGTTTCTACGGCGGTAC
Ta Tao 5 FL8      TCCCGGGTAGACGTCGTAATCCAGTTTCTACGGCGGTAC
Ta Tao 5 FL7      TCCCGGGTAGACGTCGTAATCCAGTTTCTACGGCGGTAC
Ta Tao 5 FL3      TCCCGGGTAGACGTCGTAATCCAGTTTCTACGGCGGTAC
PLMVd DM C4      TCCCGGGTAGACGTCGTAATCCAGTTTCTACGGCGGTAC
PLMVd DM C3      TCCCGGGTAGACGTCGTAATCCAGTTTCTACGGCGGTAC
PLMVd DM C1      TCCCGGGTAGACGTCGTAATCCAGTTTCTACGGCGGTAC
PLMVd DM C2      TCCCGGGTAGACGTCGTAATCCAGTTTCTACGGCGGTAC

                                Primer 833

PLMVd
NC_003636        TCCCGGGTAGACGTCGTAATCCAGTTTCTACGGCGGTAC
*****

```

Figure 5.2

One-Step PCR amplification of RNA of PLMVd from plant total RNA isolated from young shoots of Ta Tao 5 trees (lane 3), using primers p833 and p834. Reading left to right, lane 3= Ta Tao 5, lane 4= 100 bp marker (M), lane 5= healthy peach (H). The product was subject to electrophoresis in a 1% of agarose gel buffered with 1x TBE and stained with ethidium bromide. Primer dimers were visible at the bottom of lane 3.

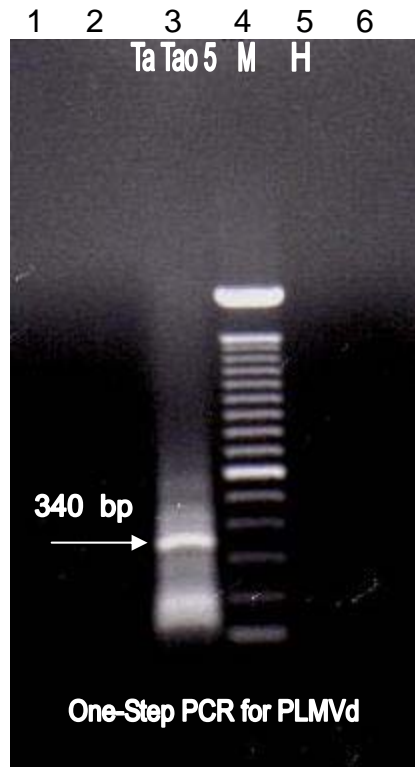

Figure 5.3

Dot-blot membrane probed using a DIG-labeled cRNA probe directed against PLMVd. Three different ways of samples processed are shown. Sample 1 to 48 correspond to Ta Tao 5-treated peaches, a plasmid containing a PLMVd insert (Plasmid), PLMVd RNA (Posit.), and RNA from healthy peach (Healthy), were blotted on the membrane.

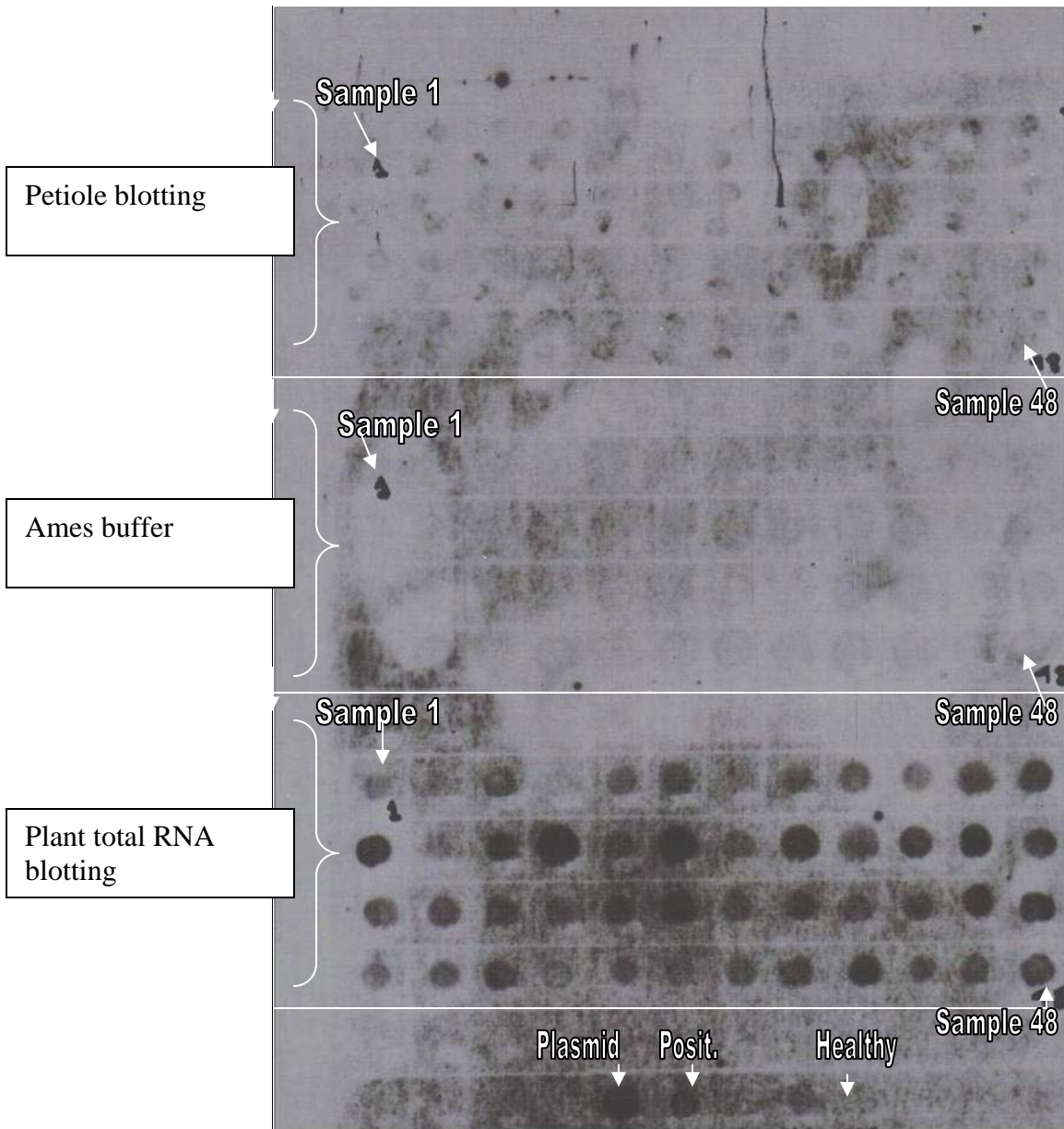

Figure 5.4

Complete nucleotide sequences of the four clones (C1-C4) of PLMVd from *Prunus persica* cv. Ta Tao 5 prepared at Clemson University.

PLMVd DM C1

CTGGATCACA CCCCCCTCGG AACCAACCGC TTGGTTCCTG AAGGAACAGT CCCACCTTAC
CTCATTGCGA GGTGCTTAGC CTTTCCATCG AAGCTGCAGT GCTCGACTAG GGCACCCCAA
GGTGGAGGGG CTGAGAGGTC ATCACTCTCC CATAAGTCTG GGCTTAGCCC ACTGATGAGC
CGTTGAGATA CGGCGAAACT TATGGATGAA AAGAGTTTCG TCTCATTTCA GAGACTCATC
AGTGTGCTAA GCACAGACTC TTCTTCCAGA ATCACTTCTG GAGGGGACCG GGTTTGAATC
CCGGGTAGAC GTCGTAATCC AGTTTCTACG GCGGTACCTG GATCACA

PLMVd DM C2

CTGGATCACA CCCCCCTCGG AACCAACCGC TTGGTTCCTG AAGGAAAAGT CCCACCTTAC
CTCATTGCGA GGTGCTTAGC CTTTCTATCG AAGCTGCAGT GCTCGAATAG GGCACCCCAA
GGTGGAGGGG CTGAGAGGTC ATCACTCTCT CATAAGTCTG GGCTTAGCCC ACTGATGAGC
CGTTGAGATA CGGCGAAACT TATGGATGAG AAGAGTTTCG TCTCATTTCA GAGACTCATC
AGTGTGCTAA GCACAGACTC TTCTTCCAGA ATCACTTCTG GAGGGGACCG GGTTTGAATC
CCGGGTAGAC GTCGTAATCC AGTTTCTACG GCGGTACCTG GATCACA

PLMVd DM C3

CTGGATCACA CCCCCCTCGG AACCAACCGC TTGGTTCCTG AAGGAAATTT CCCACCTTAC
CTCATTGCGA GGTGCTTAGC CTTTCCATCG AAGCTGCAGT GCTCGACTAG GGCACCCCAA
GGTGGAGGGG CTGAGAGGTC ATCACTCTCC CATAAGTCTG GGCTTAGCCC ACTGATGAGC
CGTTGAGATA CGGCGAAACT TATGGATGAA AAGAGTTTCG TCTCATTTCA GAGACTCATC
AGTGTGCTAA GCACAGACTC TTCTTCCAGA ATCACTTCTG GAGGGGACCG GGTTTGAATC
CCGGGTAGAC GTCGTAATCC AGTTTCTACG GCGGTACCTG GATCACA

PLMVd DM C4

CTGGATCACA CCCCCCTCGG AACCAACCGC TTGGTTCCTG AAGGAAAAGT CCCACCTTAC
CTCATTGCGA GGTGCTTAGC CTTTCCATCG AAGCTGCAGT GCTCGACTAG GGCACCCCAA
GGTGGAGGGG CTGAGAGGTC ATCACTCTCC CATAAGTCTG GGCTTAGCCC ACTGATGAGC
CGTTGAGATA CGGCGAAACT TATGGATGAA AAGAGTTTCG TCTCATTTCA GAGACTCATC
AGTGTGCTAA GCACAGACTC TTCTTCCAGA ATCACTTCTG GAGGGGACCG GGTTTGAATC
CCGGGTAGAC GTCGTAATCC AGTTTCTACG GCGGTACCTG GATCACA

Figure 5.5
 Complete nucleotide sequences of the four clones (FL2, FL3, FL7, and FL8) of PLMVd from *Prunus persica* cv. Ta Tao 5 prepared by Dr. Flores in Spain.

Ta Tao 5 FL2

```
CTGGATCACA CCCCCCTCGG AACCAACCGC TTGGTTCCCG AAGGAAAAGT CCCACCTTAC
CTCATTGCGA GGTGCTTAGC CTTTCCATCG AAGCTGCAGT GCTCGACTAG GGCACCCCAA
GGTGGAGGGG CTGAGAGGTC ATCACTCTCT CATAAGTCTG GGCTAAGCCC ACTGATGAGC
CGTTGAGATA CGGCGAAACT TATGGATGAG AAGAGTTTCG TCTCATTTCA GAGACTCGTC
AGTGTGCTTA GCACGACTC TTCTTCCAGA ATCACTTCTG GAGGGGACCG GGTTTGAATC
CCGGGTAGAC GTCGTAATCC AGTTTCTACG GCGGTAC
```

Ta Tao 5 FL3

```
CTGGATCACA CCCCCCTCGG AACCAACCGC TTGGTTCCAG AAGGAAAAGT CCCACCTTAC
CTCATTGCGA GGTGCTTAGC CTTTCCATCG AAGCTGCAGT GCTCGATTAG GGCACCCCAA
GGTGGAGGGG CTGAGAGGTC ATCACTCTCT CATAAGTCTG GGCTAAGCCC ACTGATGAGC
CGTTGAGATA CGGCGAAACT TATAGATGAG AAGAGTTTCG TCTCATTTCA GAGACTCATC
AGTGTGCTTA GCACGACTC TTCATCCAGA ATCACTTCTG GAGGGGACCG GGTTTGAATC
CCGGGTAGAC GTCGTAATCC AGTTTCTACG GCGGTAC
```

Ta Tao 5 FL7

```
CTGGATCACA CCCCCCTCGG AACCAACCGC TTGGTTCCCG AAGGAAAAGT CCCACCTTAC
CTCATTGCGA GGTGCTTAGC CTTTCCATCG AAGCTGCAGT GCTCGACTAG GGCACCCCAA
GGTGGAGGGG CTGAGAGGTC ATCACTCTCT CATAAGTCTG GGCTAAGCCC ACTGATGAGC
CGTTGAGATA CGGCGAAACT TATGGATGAG AAGAGTTTCG TCTCATTTCA GAGACTCATC
AGTGTGCTTA GCACGACTCT TCTTCCAGAA TCACTTCTGG AGGGGACCGG GTTTGAATCC
CCGGGTAGACG TCGTAATCCA GTTTCTACGG CGGTAC
```

Ta Tao 5 FL8

```
CTGGATCACA CCCCCCTCGG AACCAACCGC TTGGTTCCCG AAGGAAAAGT CCCACCTTAC
CTCATTGCGA GGTGCTTAGC CTTTCCATCG AAGCTGCAGT GCTCGACTAG GGCACCCCAA
GGTGGAGGGG CTGAGAGGTC ATCACTCTCT CATAAGTCTG GGCTTAGCCC ACTGATGAGC
CGTTGAGATA CGGCGAAACT TATGGATGAG AAGAGTTTCG TCTCATTTCA GAGACTCGTC
AGTGTGCTTA GCACGACTCT TCTTCCAGAA TCACTTCTGG AGGGGACCGG GTTTGAATCC
CCGGGTAGACG TCGTAATCCA GTTTCTACGG CGGTAC
```

CHAPTER VI

CONCLUSIONS

Ta Tao 5 germplasm is infected with ACLSV, APruV-3, and PLMVd. These agents are graft-transmissible and therefore can be readily transferred to other peach cultivars. The ease of movement of these agents and the potential to be involved with bloom delay makes them an attractive tool for the management of orchards so as to avoid late spring freezes. However, it is not yet clear if the bloom delay is the result of the presence of a single agent or an interaction between more than one of the three agents. Studies to define the relationship between bloom delay and the agents require sensitive molecular tests to identify each agent reliably and unambiguously. Prior to this work, Ta Tao 5 was known to be infected with PLMVd, but the presence of the viroid produced no adverse effects unlike reports on infection of peach with PLMVd from Europe. ACLSV had been detected in the germplasm, but could not be detected reliably using PCR and currently recommended primers. A foveavirus was also known to infect Ta Tao 5, but it was unidentified and uncharacterized. For the beneficial effects of the Ta Tao 5 germplasm to be used most effectively, an understanding of the roles of the three agents in the bloom delay is essential.

The complete nucleotide sequence of the genome of the isolate of ACLSV from Ta Tao 5 (ACLSV-Ta Tao 5) was determined (GenBank accession EU223295) The genome is 7,474 nt long, excluding the poly A tail and contains

three ORFs: encoding for a 216 kDa RNA replicase (ORF1), a 49.4 kDa MP (ORF2), and a 21.7 kDa CP (ORF3). This sequence is the first complete nucleotide sequence of the genome of an isolate of ACLSV from peach. Comparisons between the nucleotide sequence of ACLSV-Ta Tao 5 and the seven previously sequenced isolates of ACLSV showed that the sequence was most closely related (72.8%) to the Batalon1 ACLSV isolate, but was substantially different from other isolates of the virus. This variability in the nucleotide sequence explains why some of the primers used for PCR completely failed to detect ACLSV in Ta Tao 5. The aa sequences of the proteins coded by ORF1 and ORF3 of ACLSV-Ta Tao 5 showed only 73.9-75.1% and 72-75.6% identity with the corresponding proteins of other isolates of ACLSV, respectively, and confirm that the ACLSV isolate in Ta Tao 5 is atypical.

A contiguous sequence of 3,284 nt of the foveavirus isolate in Ta Tao 5 was produced. Based on comparisons with other foveaviruses it represents the 3' terminal third of the complete genomic sequence. Four putative ORFs and one long NCR region were identified. ORF2, 3, and 4 encode for proteins of 27.2, 12.1 and 7.3 kDa, respectively, and these correspond to the TGB1, 2 and 3 proteins identified in other foveaviruses. ORF4 encodes for a CP of 44 kDa. A very long 819 nt NCR was identified at the 3' end of the genome. The 3.2 kb nucleotide sequence showed 91% identity with the nucleotide sequence of the published sequence of the foveavirus APruV-3, and the aa sequence of the CP showed 94% identity with the corresponding published sequence of APruV-3.

These relationships identify the foveavirus present in Ta Tao 5 as APruV-3. The sequence extends the known nucleotide sequence for APruV-3 by 1 kilobase and demonstrates that APruV-3 is present in another member of the Ta Tao series of germplasm (Ta Tao 5) having previously been identified in Ta Tao 23, Ta Tao 25, and Ku Chu'a Hung (PI101676).

The genome of the isolate of PLMVd present in Ta Tao 5 was 337 nt long and showed more than 96% sequence identity with PLMVd isolates found in other parts of the world. The sequence did not contain any notable inserts or variations and, unlike other viroid isolates reported from Europe, did not appear to have deleterious effects on trees. There is no obvious explanation for the differences between the symptomatology seen in US and Europe. However, PLMVd has been endemic in the US for many years even though it was only detected here in 1995. Prior to this, the French had claimed that the US was a source of the viroid appearing in France.

The molecular characterizations reported here will make possible reliable and sensitive techniques for the detection of the three agents infecting Ta Tao 5. The isolate of ACLSV from Ta Tao 5 could be detected by One-Step PCR, using the primers designed by Kummert; although primers designed by Candresse and Menzel failed to amplify this virus. Having the complete sequence of the genome of the isolate of ACLSV found in Ta Tao 5 will permit the design of other molecular tools (e.g., RNA probes and highly specific primers) to detect this virus in a more economic, sensitive, and easier way. APruV-3 was easily detected by

One-Step PCR using either the Candresse or Marais primers. However, these primers also detect APruV-1 and 2. Knowing that Ta Tao 5 is infected with APruV-3 will also allow specific detection of this virus. PLMVd was readily detected in every experimental tree exposed to Ta Tao 5 by dot-blot hybridization, using non-radioactive probes and One-Step PCR. Plant total RNA blotting was the best way to process samples for the dot-blot hybridization technique and, although blotting RNA added one more step to the technique, it should be considered in cases where low viroid concentration is expected or succulent material is not available.

Although the use of Ta Tao 5 germplasm as a tool in orchard management may give excellent results for peach growers in South Carolina (and other parts of the Southeast) in their battle against late spring freezes, attempts to emulate this practice in other locations may not be as successful. PLMVd isolates detected in other parts of the world have been shown to have deleterious effects on tree growth and fruit yield. However, the molecular characterizations reported here will make possible further studies necessary to determine the relationship between these three agents found in Ta Tao 5 and bloom delay.

APPENDICES

Appendix Index

	Page
Appendix A	
Plant Total RNA Extraction	142
Appendix B	
Sap Inoculation	143
Virus Purification	143
Appendix C	
cDNA Synthesis	145
1- Superscript™ III	145
2- Power Script™	146
3- Im Prom-II™	146
Appendix D	
Polymerase Chain Reactions	148
1- One-Step RT-PCR	148
2- Reverse Transcription-PCR	149
3- 5' RACE PCR	150
Appendix E	
Gel Electrophoresis	152
Appendix F	
MinElute gel Extraction	153
Appendix G	
Cloning and Sequencing	154
1- TOPO®	154
2- pGEM®-T Easy Vector	155
Plasmid Purification	156

Appendix Index (Continued)

	Page
Sequencing and Sequence Analysis	156
Appendix H	
cRNA Probe Synthesis	159
Hybridization	160

Appendix A

Plant Total RNA Extraction: Sara Spiegel Method

Fresh tissues were homogenized at the ratio of 1:10 (w:v) of extraction buffer (200 mM Tris-HCl, pH 8.5, 1.5% sodium dodecyl sulfate (SDS), 300 mM lithium chloride, 10 mM Na₂EDTA, 1% Nonidet P-40, 1.5% Na Deoxycholate, and 0.5% 2-mercaptoethanol), in ELISA bags (Agdia, Elkhart, IN, ACC 00930). The extract was transferred to a sterile 1.5 ml microcentrifuge tube and centrifuged for 10 m at 12,000 **g** at 4°C. The supernatant was transferred to a sterile 1.5 ml microcentrifuge tube and an equal volume of 3 M potassium acetate, pH 6.5, was added. The mixture was kept on ice for 10 m and centrifuged for 15 m at 12,000 **g** at 4°C. The supernatant was recovered, mixed with an equal volume of isopropanol, and kept overnight at -20°C. The nucleic acid precipitate was collected by centrifuging for 15 m at 12,000 **g** at 4°C, washing with 200 µl of 70% ethanol, and was allowed to air dry at room temperature (RT). The pellet was resuspended in 30 µl of sterile distilled water and stored at -80°C.

The amount of RNA in each sample was determined by recording the absorbance at 260 nm using an UV/VIS spectrophotometer and calculating the concentration using an extinction coefficient of 25 (mg/ml)⁻¹cm⁻¹.

Appendix B

Sap Inoculation

Plants of *Nicotiana occidentalis* 37B were inoculated using newly expanded leaf tissue collected from seedlings of Nemaguard peach [*Prunus persica* (L.) Batsch] that had been chip-bud inoculated with Ta Tao 5 peach. The leaves were ground in a pestle and mortar using 0.05 M Tris HCl, pH 8.5, buffer containing 0.01 M MgSO₄, 0.02 M NaDIECA, 0.04M sodium thioglycollate, and 2% nicotine (1:5, w:v). The sap was applied to the leaves using a finger encased in a latex glove. The plants of *N. occidentalis* were shaded for 24 h prior to inoculation and for 24 h after inoculation. Prior to inoculation the leaves of the plants were dusted lightly with corundum. After the 24 h post inoculation period, plants received 16 h supplemental illumination (Grolites) daily. A systemic mottle developed approx 14–21 days after inoculation.

Virus Purification

Tissue of *N. occidentalis* 37B harvested 21–28 days after inoculation was used as source material for purification. Tissue was harvested, cooled to 4°C, and homogenized in a Waring blender using 0.05 M Tris HCl, pH 8.5 buffer containing 0.01 M MgSO₄, 0.02 M NaDIECA, 0.04M, and sodium thioglycollate (1:3, w:v). The sap extract was filtered through cheese cloth. Magnesium bentonite (prepared according to Dunn and Hitchborn, 1965) was resuspended to

form a slurry containing 40 mg/ml. The bentonite was added to the sap extract at the rate of 40 mg/100ml and stirred for 1 h at RT. The mixture was subject to centrifugation at 10,000 **g** for 15 m. The supernatant was retained and the addition of bentonite, stirring, and centrifugation was repeated several times until a pale straw-colored supernatant was obtained. The supernatant was centrifuged at 142,000 **g** for h. The subsequent supernatant was discarded and the pellets were resuspended over night in 0.05 M Tris HCl, pH 8.5 buffer. After centrifugation at 12,000 **g** for 15 m, aliquots of the supernatant were applied to a controlled-pore glass bead column prepared and operated as described by Barton (1977) but buffered using 0.05 M Tris HCl, pH 8.5 buffer. The elute from the column was analyzed by passage through a flow cell of 1 cm path length placed in an ISCO type 6 optical unit linked to an ISCO UA5 absorbance/fluorescence detector. Those fractions containing the virus were collected, pooled, and then centrifuged at 331,000 **g** for 1 h. Viral RNA was extracted from this pellet using an RNeasy Plant RNA Kit (QIAGEN Inc., Valencia, CA) according to the manufacturer's instructions.

Appendix C

cDNA Synthesis

cDNA was synthesized using different enzymes and procedures depending on the proposed use of the cDNA.

1) Superscript™ III Reverse transcriptase

One microgram of RNA was mixed with 2 pmol of downstream gene specific primer and sterile distilled water was added to a final volume of 12 µl. Samples were heated at 90°C for 2 m, placed on ice for 1 m, heated at 70°C for 10 m, and placed on ice for 1 m. Four microliters of 5x buffer (250 mM Tris-HCl, pH 8.3, 375 mM KCl, 15 mM MgCl₂), 2 µl of 1 mM dithiothreitol (DTT), and 1 µl of 10 mM deoxynucleotide triphosphates (dNTPs) were added to each sample. Samples were heated at 42°C for 2 m, 1 µl of Superscript III was added, and the mixture incubated at 42°C for 50 m, heated at 70°C for 15 m, and cooled at 4°C. One microliter of RNase H (20 U) was added, and the mixture was incubated at 37°C for 20 m and was stored at -20°C.

2) Power Script™ Reverse transcriptase

One microgram of RNA was mixed with 1 µl of 12 µM gene specific primer A and 1 µl of 12 µM SMART II™ A oligonucleotide. Sterile water was added to a final volume of 5 µl. Samples were incubated at 70°C for 2 m and cooled on ice for 2 m. Two microliters of 5x first strand buffer (250 mM Tris-HCl, pH 8.3, 375 mM KCl, 30 mM MgCl₂), 1 µl of 20 mM DTT, 1 µl of 10 mM dNTPs and 1 µl of Power Script RT (Clontech Laboratories, Inc. Mountain View, CA, USA) were added to each sample. The tubes were incubated at 42°C for 1.5 h and the reactions were diluted with 100 µl of Tricine-EDTA buffer (10mM Tricine, pH 8.5, 1 mM Na₂EDTA). Samples were incubated at 72°C for 7 m and stored at -20°C.

3) Im Prom-II™ Reverse Transcriptase

One microgram of RNA was mixed with 20 pmol of gene specific primer, 1 µl of 12 µM SMART II™ A primer and sterile distilled water to a final volume of 5 µl. The samples were heated at 70°C for 5 m, placed on ice for 5 m. Four microliters of Im-Prom-II™ 5x reaction buffer (Promega Corporation, Madison, WI, USA), 1 µl of 10 mM dNTPs, 1.5 to 8 mM MgCl₂, 0.5 µl of recombinant RNasin Ribonuclease Inhibitor (20 U), 1 µl of Im Prom-II™ RT and sterile distilled water to a final volume of 20 µl, were added to each sample. The tubes were incubated at 25°C for 5 m followed by an extension period 1 h at 42°C. The RT was inactivated by incubating the samples at 70°C for 15 m. One hundred

microliters of Tricine-EDTA buffer (10mM Tricine, pH 8.5, 1 mM Na₂EDTA) were added; the samples were heated at 72° C for 7 m and stored at -20°C.

Appendix D

Polymerase Chain Reactions (PCR)

Several variations of PCR were used depending on the aim of the reaction. One-step PCR was used primarily for detection of agents in total RNA. RT-PCR using Q-Taq (QIAGEN Inc., Valencia, CA) and the Advantage® 2 PCR Enzyme System (Clontech Laboratories, Inc. Mountain View, CA. US) was used to amplify fragments of the agents as the building of contiguous full length sequences was completed. The Advantage® 2 PCR Enzyme System was used to amplify long fragments >1 kb.

1) QIAGEN One-Step™ RT-PCR

QIAGEN OneStep™ RT-PCR kit (QIAGEN Inc., Valencia, CA) was used to perform detections of ACLSV, APruV, and PLMVd. Each reaction consisted of 5 µl of buffer (Tris-HCL, (NH₄)₂SO₄, 12.5 Mm MgCl₂, DTT, pH 8.7), 1 µl of 10 mM dNTP, 0.75 µl of upstream gene specific primer (20 pmol/µl), 0.75 µl of downstream gene specific primer (20 pmol/µl), 1 µl of enzyme mix (Omniscript™ reverse transcriptase, Sensiscript™ reverse transcriptase, and HotStarTaq™ DNA Polymerase), 1 µg of RNA, and sterile water to a final volume of 25 µl.

The thermocycler reaction conditions for ACLSV were 30 m at 37°C , 15 m at 95°C, followed by 40 cycles of 30 sec at 94°C, 30 sec at 54°C, and 2 m at 72°C, with a final extension of 10 m at 72°C. The reverse transcription

temperature was adjusted to 50°C for APruV and 42°C for PLMVd. The annealing temperature was adjusted to 55°C and 60°C for APruV and PLMVd, respectively. For APruV reactions the number of cycles of amplification was increased to 45.

2) Reverse Transcription (RT)-PCR

RT-PCR was performed on cDNAs synthesized using one of the three reverse transcriptases. Each reaction consisted of 5 µl of 10x buffer (Tris-HCl, KCl, (NH₄)₂SO₄, 15 mM MgCl₂, pH 8.7), 1 µl of 10 mM dNTP, 1 µl of downstream gene specific primer (20 pmol/µl), 1 µl of upstream gene specific primer (20 pmol/µl), 3 µl of cDNA, 0.3 µl of QIAGEN Taq (5 U/µl) (QIAGEN Inc., Valencia, CA), and sterile distilled water to a total volume of 50 µl. The thermocycler conditions were 1 cycle of 3 m at 94°C, 35 cycles of 30 sec at 94°C, 30 sec at 55°C, and 2 m at 72°C, with a final extension of 10 m at 72°C.

In a few cases the RT-PCR was performed using Consensus-Degenerate Hybrid Oligonucleotide (CODEHOP) Primers (Rose et al., 1998). These degenerate primers required the use of 4 µl of each primer and a corresponding adjustment in the volume of water added to the reaction.

PCR conditions when using CODEHOP primers were 1 cycle of 3 m at 94°C, 5 cycles of 30 sec at 94°C, 30 sec at 42°C, and 2 m at 72°C, followed by 30 cycles of 30 sec at 94°C, 30 sec at 60°C, and 2 m at 72°C, with a final extension of 10 m at 72°C.

Reaction conditions for performing RT-PCR using the Advantage[®] 2 PCR Enzyme system were as follows:

Two microliters of cDNA were mixed with 5 μ l of 10x Advantage[®] 2 PCR Buffer (400 mM Tricine-KOH, pH 8.7, 150 mM KOAc, 35 mM Mg(OAc)₂, 37.5 μ l/ml BSA, 0.05% Tween 20 and 0.05% Nonidet-P40), 1 μ l 10 mM dNTPs, 0.5 μ l (20 pmol/ μ l) of each, downstream and upstream gene specific primers, 1 μ l of 50x Advantage[®] 2 Polymerase Mix, and sterile water to complete a 50 μ l reaction.

The thermocycler reaction conditions were: 1 m at 95°C, followed by 35 cycles of 30 sec at 95°C and 3 m at 68°C, followed by an extension of 3 m at 68°C, and a further extension of 10 m extension 70°C.

3) 5' RACE PCR (Clontech Laboratories, Inc. Mountain View, CA. US)

The PCR reaction was made by mixing 2.5 μ l cDNA (made with SMART RACE cDNA Amplification kit), 5 μ l of 10x Advantage[®] 2 PCR Buffer, 1 μ l of 10 mM dNTP's, 5 μ l 10x Universal Primer A Mix (UPM; 0.4 μ M), 0.5 μ l gene specific primer (20 pmol/ μ l), 1 μ l 50x Advantage[®] 2 Polymerase Mix and sterile water to a final volume of 50 μ l.

The thermocycler program consisted of 5 cycles of 94°C for 30 sec, 72°C for 7 m, followed by 5 cycles of 94°C for 30 sec, 70°C for 30 sec and 72°C for 7 m, 20 cycles of 94°C for 30 sec, 68°C for 30 sec and 72°C for 7 m; with a final extension of 10 m at 70°C. For some reactions a second nested PCR was

needed. Five microliters of the 5' SMART RACE PCR product were diluted into 245 μ l Tricine-EDTA buffer. Five microliters of the diluted primary PCR product were mixed with 5 μ l of 10x Advantage® 2 PCR Buffer, 1 μ l of 10 mM dNTP's, 1 μ l Nested Universal Primer A Mix (NUP; 10 μ M), 0.5 μ l gene specific primer (20 pmol/ μ l), 1 μ l 50x Advantage® 2 Polymerase Mix and sterile water to a final volume of 50 μ l. PCR conditions were 25 cycles of 94°C for 30 sec, 68°C for 30 sec and 72°C for 7 m, with a final extension of 10 m at 72°C.

Appendix E

Gel Electrophoresis

An aliquot (8 μ l) of each PCR product was mixed with 2 μ l bromophenol blue dye dissolved in 15% Ficoll and analyzed by electrophoresis through a 1% TBE (89 mM Tris-borate, pH 8.3, and 2 mM Na₂EDTA) ultra pure™ agarose (Invitrogen, Carlsbad, CA) gel at 90 V for 1 hour. Each 20 ml gel contained 2 μ l ethidium bromide (0.1 mg/ml). A Ready Load™ 100 bp DNA ladder (Invitrogen, Carlsbad, CA) was used as a size standard.

Appendix F

MinElute gel Extraction Kit (QIAGEN Inc. Valencia, CA, USA)

Ethidium bromide-stained bands of DNA were excised from the agarose gel with a scalpel. Excess agarose was removed to minimize the size of the gel slice. The gel slice was weighed in a 1.5 ml microcentrifuge tube and three volumes of buffer QG (solubilization and binding buffer) were added to one volume of gel; e. g., 300 μ l of buffer were added to 100 mg of gel. The sample was incubated at 50°C for 10 m or until the gel slice was completely dissolved. One gel volume of isopropanol was added to the sample and mixed by inverting the tube several times. The sample was applied to a MinElute column (provided with the kit) and centrifuged for 1 m at 10,000 **g**. The flow-through was discarded, 500 μ l of QG buffer added and the column centrifuged for 1m at 10,000 **g**. The column was washed by adding, 750 μ l of buffer PE to the column, allowing it to incubate for 3 m and centrifuging for 1 m at 10,000 **g**. The flow-through was discarded and the column centrifuged for an additional 1 m at 13,000 **g**. To elute membrane bound DNA, the MinElute column was placed into a clean 1.5 ml microcentrifuge tube, 10 μ l of sterile distilled water were added to the center of the membrane, the column was allowed to stand for 1 m and then centrifuged for 1m at 10,000 **g**. The flow-through was stored at 4°C.

Appendix G

Cloning and Sequencing

1) TOPO[®]

For each reaction, 0.5 to 4 μ l of fresh PCR product or DNA purified from an agarose gel, 1 μ l of salt solution, and sterile water were mixed to a final volume of 5 μ l. One microliter of 10 ng/ μ l of pCR[®]II-TOPO[®] vector (Invitrogen, Carlsbad, CA) was added to the mixture, incubated for 5 m at room temperature, and placed on ice. The 6 μ l were gently added into a vial of thawed OneShot[®], chemically competent, *Escherichia coli* TOP10F cells and incubated for 30 m on ice. The cells were heat-shocked for 30 sec at 42°C, incubated for 2 m on ice, 250 μ l of room temperature S.O.C medium (2% tryptone, 0.5% yeast extract, 10 mM sodium chloride, 2.5 mM potassium chloride, 10 mM magnesium chloride, 10 mM magnesium sulfate, 20 mM glucose) were added, and the cells shaken for 1 h at 37°C. The transformation mix was spread onto 1.5% Difco Bacto agar plates amended with Luria Bertani (LB) medium (1% tryptone, 0.5% yeast extract, 1% NaCl, adjusted to pH 7.0) containing 20 mg/ml of X-gal [5-bromo-4-chloro-3-indoyl- β -D-galactopyranoside in dimethylformamide], 50 mg/ml ampicillin, and 20 mg/ml IPTG [isopropyl- β -D-thiogalactopyranoside]), and incubated for 16 h at 37°C to allow colonies to grow. After incubation, the plates

were placed in the refrigerator to allow blue white screening to become fully effective.

2) pGEM®-T Easy Vector

Ligation reactions were set up by mixing 1 to 3 µl of fresh PCR product or DNA purified from an agarose gel, 5 µl of 2x Rapid Ligation Buffer (60 mM Tris-HCl, pH 7.8, 20 mM MgCl₂, 20 mM DTT, 2 mM ATP, 10% polyethylene glycol), 1 µl pGEM®-T Easy Vector (50 ng), 1 µl of T4 DNA Ligase enzyme (3 Weiss units/ul) and deionized water to a final volume of 10 µl. The reactions were incubated overnight at 4°C to obtain the maximum number of transformants.

Two to ten microliters of ligation reactions were added into a vial containing 50 µl of thawed JM 109 High Efficiency Competent Cells and incubated for 20 m on ice. The cells were heat-shocked for 50 sec at 42°C, incubated for 2 m on ice, 400 µl of room temperature S.O.C medium added, and the cells were shaken for 1.5 h at 37°C. Aliquots (50 to 75 µl) of the transformed cells were plated onto LB/ampicillin/IPTG/X-Gal plates and incubated overnight at 37°C. After incubation, the plates were placed in the refrigerator to allow blue white screening to become fully effective.

Plasmid Purification

White colonies were selected from the transformants growing on the plates of LB agar. A single colony was placed in 5 ml of LB medium containing 10 µl of ampicillin (50 mg/ml) and grown for 16 h at 37°C while shaking at 220 rpm. The cultures were centrifuged at 18,000 **g** for 2 m to pellet the cells, the supernatant was discarded, and each pellet resuspended in 250 µl of chilled resuspension buffer. An equal volume of lysis buffer was added and the samples were incubated for 5 m at RT. Two hundred and fifty microliters of neutralization buffer were added, and the samples were processed through two columns, as indicated by the manufacturer's procedure (QIAGEN Inc., Valencia, CA). DNA was eluted from the second column using 100 µl of EB QIAprep elution buffer.

The presence of an insert was confirmed by comparing the samples with uncut plasmid, by electrophoresis in a 1% ultra pure™ agarose gel in 1x TBE buffer containing ethidium bromide (0.1 mg/ml) at 90 V.

Sequencing and Sequence Analysis

The samples were sequenced completely in both directions using M13 forward (5' GTAAAACGACGGCCAG 3') and M13 reverse (5' CAGGAAACAGCTATGAC 3') primers and the ABI Prism®BigDye™ Terminator V 3.1 Cycle Sequencing Ready Reaction kit (Applied Biosystems, Foster City, CA, US). Each sequencing reaction consisted of 8 µl ABI

Prism®BigDye™ mix, 1 µl of M13F or M13R primer (@3.2 pmol/µl), 2 µl purified plasmid, and water to a final volume of 20 µl. Sequencing conditions were 1 cycle of 96°C for 2 m followed by 25 cycles of 96°C for 10 sec, 50°C for 5 sec, and 60°C for 4 m. Two microliters of 2.2% SDS were added to each tube, followed by incubation at 98°C for 5 m, and 25°C for 10 m. The samples were purified using a Sephadex G-50 (Sigma, St. Louis, MO, USA) column. To prepare the column 50 mg of Sephadex were mixed with 800 µl of water, allowed to hydrate for at least 30 m, added to a spin column, drained, and the column centrifuged for 2 m at 1,300 **g**. The total sequencing reaction (22 µl) was placed in the center of the column, centrifuged for 2 m at 1,300 **g** and the elute was collected, freeze-dried, and analyzed in either an ABI 377 or an ABI 3130 sequencer (Applied Biosystems, Inc., Foster City, CA, USA). Sequence fragments were assembled using GenJockey II software (Biosoft, Ferguson, MO) and compared with existing sequences in GenBank using Blastx and Blastn algorithms (Altschul et al., 1997) through the National Center for Biotechnology Information (NCBI). Multiple sequence alignments were completed using the CLUSTAL X program (Thompson, Higgins & Gibson, 1997) with bootstrap values based on 1000 replications. Phylogenetic trees were constructed using the program NJPLOT (Perrière & Gouy, 1996). Pairwise comparisons were done using the FASTA sequence comparison program through the University of Virginia web page. Genome organization was assessed using Gene Mark Tool

(Besemer, Lomsadze & Borodovsky, 2001) developed at the Georgia Institute of Technology, Atlanta, Georgia, USA.

When sequencing long clones (> 1Kb), sequencing primers with a T_m of 62°C were designed from the previously obtained sequence and used in sequencing reactions at a concentration of 3.2 pmol/μl.

Appendix H

cRNA Probe Synthesis

Plasmids containing clones from PLMVd, ACLSV and APruV were linearized by digestion with restriction enzymes. Ten to fifteen microliters of plasmid were mixed with 3 μ l of restriction enzyme (*Eco RV*), 3 μ l of restriction enzyme buffer, and sterile water added to a total volume of 30 μ l. The mixture was incubated for 2 h at 37°C and 20 m at 65°C. Following incubation, the DNA was extracted with G-25 Sephadex columns (MicroSpin™ G-25 Columns, Amersham Pharmacia, Biotech Inc., Piscataway, NJ, USA). Complete linearization of the samples was confirmed by comparing the mobility of digested and nondigested plasmid when subjected to electrophoresis in a 1% agarose gel in 1x TBE buffer containing ethidium bromide (0.1 mg/ml) at 90 V.

cRNA probe was synthesized and labeled using a DIG RNA Labeling kit (SP6/T7) (Boehringer Mannheim Corp., West Germany). Thirteen microliters of linearized DNA, 2 μ l of dNTP (10 mM ATP, 10 mM CTP, 10 mM GTP, 6.5 mM UTP, 3.5 mM DIG-UTP, pH 7.5), 2 μ l of 10x transcription buffer, 1 μ l of RNase inhibitor, and 2 μ l of either SP6 or T7 RNA polymerase (20 U/ μ l) were mixed in a final volume of 20 μ l. The mixture was incubated for 2.5 h at 37°C, 2 μ l of DNase I (10 U/ μ l) added and the mixture heated to 37°C for 15 m. Two microliters of 0.2 M Na₂EDTA, pH 8 was added to stop the reaction. An aliquot (2 μ l) of each cRNA probe was mixed with 1 μ l of distilled water and 3 μ l of formamide and

analyzed by electrophoresis through a 2% TAE (0.04 M Tris-acetate buffer, 1 mM EDTA, pH 8) agarose gel at 90 V for 1 hour. *E. coli* ribosomal RNA (0.3 µl) mixed with 1.7 µl of distilled water and 2 µl of formamide was used as size standard. For band visualization, the gel was stained for 5 m with ethidium bromide (0.1 mg/ml).

The cRNA probe concentration was determined by taking the absorbance at 260 nm using an UV/VIS spectrophotometer and calculating the concentration using an extinction coefficient of $25 \text{ (mg/ml)}^{-1} \text{ cm}^{-1}$.

Hybridization

The cRNA probes were used to detect PLMVd and APruV bound to nylon membranes. Grids were printed on the membranes using a dot matrix printer and Microsoft Excel Software. Three different ways of processing samples were compared: 1) Two newly emerged leaves, one from each branch located 1.5 m above the ground, were collected. The petioles were sliced and blotted onto a nylon membrane (Nylon membrane positively charged, Boehringer Mannheim Corp., Mannheim, FRG) for 5 s and allowed to air-dry for 5 m; 2) Three microliters of each plant total RNA (Sara Spiegel, The Volcani Center, Israel, pers. comm.) were applied onto a nylon membrane and allowed to air-dry for 5 m; 3) Fresh tissue (100 mg) was homogenized in 150 µl of Ames buffer (1 M NaCl, 0.01 M MgCl₂, 0.3 M NaAc, 0.004 M Ethanol, 0.1 M SDS, pH 6) (Agdia®, Elkhart, Indiana, USA) with a mortar and pestle. The extract was transferred to a

1.5 ml centrifuge tube, incubated at 37°C for 15 m, and an equal volume of chloroform added to each tube. The tubes were centrifuged at 14,000 **g** for 5 m at 4°C and 3 µl of the upper layer of each tube spotted on a membrane and allowed to air-dry for 5 m.

Positive and negative RNA controls were also blotted onto each membrane. Positive controls were: 1:100 and 1:1000 dilutions of either PLMVd or APruV plasmids and concentrated RNA and 1:10 and 1:100 dilutions of a PLMVd or APruV positive sample for PLMVd and APruV detections, respectively. The negative control was a concentrated RNA from a healthy peach. The membrane was cross linked (Stratagene UV Stratalinker 1800, La Jolla, CA, US) using the auto setting (1200 microjoules x 100), immersed in prehybridization solution (Dig Easy Hyb. Roche, Nonnenwald 2, Penzberg, Germany), and incubated for 1 h at 68°C in a hybridization oven (Techne Hybridiser HB-1D, Techne Corp. Princeton, NJ, US). The prehybridization solution was discarded, the RNA probe, which had been diluted in prehybridization solution (100 ng probe/ml prehybridization solution), was added, and the membrane incubated overnight at 68°C.

The membrane was developed using the following washing scheme at room temperature unless otherwise noted. The membrane was washed twice for 5 m with 0.33 ml /membrane cm² of 2x wash solution (2x SSC containing 0.1% SDS) and twice for 15 m at 68°C with 0.5 ml/cm² of 0.2x wash solution (0.2x SSC containing 0.1% SDS). The membrane was washed sequentially as follows: 5 m

with washing buffer (100 mM maleic acid, pH 7.5, 0.3% [v/v] Tween 20 - 0.7 ml/cm²), 1 h with blocking solution (1 ml/cm²), 30 m with antibody solution (0.03 μl/cm² of anti-digoxigenin-AP [7,500 U/ml anti-digoxigenin Fab fragments conjugated to alkaline phosphatase] in blocking solution) (0.3 ml/cm²), twice for 15 m with washing buffer (1ml/cm²), once for 5 m with detection buffer (0.1 M Tris-HCl, 0.1 M NaCl, pH 9.5) (0.4 ml/cm²), and once for 5 m with CDP-StarTM (0.013 ml/cm²). The membrane was wrapped in plastic and exposed on Kodak Scientific Imaging Film (Ready Pack BIOMAX Light Film Chemiluminescence 13 x 18 cm, Eastman Kodak Co., Rochester, NY, USA) for 1 h, 3 h, and overnight.

REFERENCES

- Ackerman WL (1957) Evaluation of foreign fruits and nuts. Late blooming peach and nectarine varieties tested at Chico, California. USDA-ARS, Crops Res Div, U S Plant Int Garden, Series I, 8
- Adams M, Antoniw J (2004a) Description of plant viruses. Web site sponsored by the Association of Applied Biologists. Developed and maintained by scientists at Rothamsted Research, <<http://www.dpvweb.net/intro/index.php>>, accessed September 8, 2007
- Adams M, Antoniw J (2004b) Notes on Family *Potiviridae*. Web site sponsored by the Association of Applied Biologists. Developed and maintained by scientists at Rothamsted Research, <<http://www.dpvweb.net/notes/showfamily.php?family=Potyviridae>>, accessed September 8, 2007
- Adams M, Antoniw J, Bar-Joseph M, Brunt A, Candresse T, Foster G, Martelli G, Milne R, Frauquet M (2004) The new plant virus family *Flexiviridae* and assessment of molecular criteria for species demarcation. *Arch Virol* 149: 1045-1060
- Agricultural Statistics (2005) United States Department of Agriculture. National Agricultural Statistics Service. United States Government Printing Office Washington 2005. V1 to V37
- Agranovsky AA (1996) Principles of molecular organization, expression, and evolution of *closteroviruses*: over the barriers. *Adv Virus Res* 47: 119-218
- Agranovsky A, Lesseman D (2001) *Closteroviridae*. In: Tidona C, Darai G (eds) *The Springer index of viruses*. Springer, Berlin Heidelberg, New York, pp 1509-1511. CD-ROM
- Agrios GN (2005) *Plant Pathology*, 5th edn. Academic Press, Inc. San Diego, CA, US

- Albanese G, Giunchedi L, La Rosa R, Poggi-Pollini C (1992) Peach latent mosaic viroid in Italy. *Acta Hort* 309: 331-338
- Al Rwahnih M, Turturo C, Minafra A, Saldarelli P, Myrta A, Pallas V, Savino V (2004) Molecular variability of apple chlorotic leaf spot virus in different hosts and geographical regions. *J Plant Pathology* 86: 117-122
- Altschul SF, Madden TL, Schaffer AA, Zhang J, Zhang Z, Miller W, Lipman DJ (1997) Gapped BLAST and PSI-BLAST: A new generation of protein database search programs. *Nucleic Acids Res* 25: 3389-3402
- Amari K, Canizales MC, Myrta A, Sabanadzovic S, Srhiri M, Gavriel I, Caglayan K, Varveri C, Gatt M, Di Terlizzi B, Pallas V (2001) First report on *Hop stunt viroid* from some Mediterranean countries. *Phytopath Medit* 39: 271-276.
- Ambros S, Hernandez C, Flores R (1999) Rapid generation of genetic heterogeneity in progenies from individual cDNA clones of peach latent mosaic viroid in its natural host. *J Gen Virol* 80: 2239-2252
- Amenduni T, Hobeika C, Minafra A, Savino V (2004) Detection of plum bark necrosis stem pitting-associated virus (PBNSPaV) from different stone fruit species and optimization of diagnostic tools. *Acta Hort* 657: 93-97
- Anderson JL, Seeley SD (1993) Bloom delay in deciduous fruits. *Hort Reviews* 15: 97-144
- Astruc N, Marcos JF, Macquarie G, Candresse T, Pallas V (1996) Studies on the diagnosis of hop stunt viroid in fruit trees: Identification of new hosts and application of a nucleic acid extraction procedure based on non-organic solvents. *Eur J Plant Pathology* 102: 837-846
- Ballard JK, Proebsting EL, Tukey RB (1984) Critical temperatures for blossom buds-peaches. *Wash State Univ Ext Bull* pp 1-914

- Barba M, Clark MF (1986) Detection of strains of apple chlorotic leafspot virus by F(ab)₂-based indirect ELISA. *Acta Hort* 193: 297-304
- Barton RJ (1977) An examination of permeation chromatography on columns of controlled pore glass for routine purification of plant viruses. *J Gen Virol* 35: 77-87
- Besemer J, Lomsadze A, Borodovsky M (2001) GeneMarkS: a self-training method for prediction of gene starts in microbial genomes. Implications for finding sequence motifs in regulatory regions. *Nucleic Acids Res* 29: 2607-2618
- Bouani A, Minafra A, Alami I, Zemzami M, Myrta A (2004) First report of plum bark necrosis stem pitting-associated virus in Morocco. *J Plant Pathology* 86: 91 (Abstr.)
- Buchen-Osmond C (2002) Apple chlorotic leaf spot virus. The Universal Virus Database of the International Committee of Taxonomy on the viruses (ICTVdB). <<http://www.ncbi.nlm.nih.gov/ICTVdb/Ictv/index.htm>>, accessed August 10, 2007.
- Candresse T (1995) *Closterovirus*. In: Granoff A, Webster RG (eds) *Encyclopedia of Virology*. Academic Press, London, pp 1-8. CD-ROM
- Candresse T, Hammond RW, Hadidi A (1998) Detection and identification of plant viruses and viroids using polymerase chain reaction (PCR). In: Hadidi A, Khetarpal RK, Koganczawa H (eds) *Plant Virus Disease Control*. APS, St Paul, MN, US, pp, 399-416
- Candresse T, Cambra M, Dallot S, Lanneau M, Asensio M, Gorris MT, Revers F, Macquaire G, Olmos A, Boscia D, Quiot JB, Dunez J (1997) Comparison of monoclonal antibodies and polymerase chain reaction assays for the typing of isolates belonging to the D and M serotypes of plum pox potyvirus. *Phytopathology* 88: 198-204

- Candresse T, Lanneau M, Revers F, Macquaire G, German S, Grasseau N, Dunez J, Malinowski T (1995) An immunocapture PCR assay adapted to the detection and the analysis of the molecular variability of the Apple chlorotic leaf spot virus. *Acta Hort* 386: 136-147
- Canizales M, Marcos JF, Pallas V (1999) Molecular characterization of an almond isolate of hop stunt viroid (HSVd) and conditions for eliminating spurious hybridization in its diagnosis in almond samples. *Acta Hort* 105: 553-558
- Canizales M, Marcos JF, Pallas V (1998) Studies on the incidence of hop stunt viroid in apricot trees (*Prunus armeniaca*) by using an easy and short extraction method to analyze a large number of samples. *Acta Hort* 472: 581-585
- Canizales M, Aparicio F, Amari K, Pallas V (2001) Studies on the aetiology of Apricot 'Viruela' disease. *Acta Hort* 550: 249-258
- Cervera MT, Reichmann JL, Martin MT, Garcia JA (1993) 3' -terminal sequence of the plum pox virus P5 and V06 isolates: evidence for RNA recombination within the potyvirus group. *J Gen Virol* 74: 329-334
- Chia T, Chan Y, Chua N (1995) Tissue-print hybridization for the detection and localization of plant viruses. In: Singh R P, Singh U S (eds) *Molecular Methods in Plant Pathology*. CRC Press, Boca Raton, pp 145-149
- Christie R, Edwardson JR, Simone GW (1995) Diagnosis of plant virus diseases by light microscopy. In: Singh R P, Singh U S (eds) *Molecular Methods in Plant Pathology*. CRC Press, Boca Raton, pp 31-49
- Cochran LC, Rue JL (1944) Some host-tissue relationships of the peach mosaic virus. *Phytopathology* 34: 934 (Abstr.)
- Cockerill FR, Smith TF (2002) Rapid-cycle real-time PCR: a revolution for clinical microbiology. *Am Soc Microbiol News* 68: 77-83

- Cox KD, Scherm H, Beckman TG (2005) Armillaria root and crown rot. In: Horton D, Johnson D (eds) Southeastern Peach Growers Handbook, Cooperative Extension Service, University of Georgia. Athens, Georgia, US, pp 162–166
- Crasweller RM, Schupp JR (2006) Apple rootsoctcks. Part I: Cultural Information. Tree Fruit Production Guide. Colleague of Agricultural Sciences Pennsylvania State University.
< <http://tfpg.cas.psu.edu/138.htm>>, accessed September 24, 2007
- Creamer R, Gispert C, Oldfield GN (1994) Partial characterization of peach mosaic virus. In: Epstein A, Hill J (eds) Rose Rossette Symptoms, Iowa State University. Ames, Iowa, US, pp 21-23
- Crescenzi A, Nuzzaci M, Levy L, Piazzolla P, Hadidi A (1994) Infezioni di sharka su ciliegio dolce in Italia meridionale. Inf Agrario 34: 73-75
- Desvignes JC (1999) Virus diseases of fruit trees, Ctifl (ed), Paris, France
- Desvignes JC (1986) Peach latent mosaic and its relation to peach mosaic and peach yellow mosaic virus diseases. Acta Hort 193: 51-57
- Desvignes JC (1976) The virus diseases detected in greenhouse and in the field by the peach seedling of GF 305 indicator. Acta Hort 67: 315-323
- Desvignes JC, Boye R (1989) Different diseases caused by chlorotic leaf spot virus on the fruit trees. Acta Hort 235: 31-38
- Diener TO (2001) The viroid: biological oddity or evolutionary fossil? Adv Virus Res 57: 137-184
- Dickson E, Robertson HD, Niblett CL, Horst RK, Zaitlin M (1979) Minor differences between nucleotide sequences of mild and severe strains of potato spindle tuber viroid. Nature 277: 60-62

- Di Serio F, Ragozzino A (1995) Indagini sulla presenza del viroide del mosaico latente del pesco (PLMVd) in Campania. *Inf Fitopatol* 9: 57-61
- Di Serio F, Malfitano M, Flores R, Randles JW (1999) Detection of PLMVd in Australia. *Aust Plant Pathology* 28: 80-81
- Dodds J (1993) dsRNA in diagnosis. In: Matthews REF (ed) *Diagnosis of Plant Viruses*. CRC Press, Boca Raton, FL, pp 273-294
- Dovas CI, Katis NI (2003a) A spot-nested RT-PCR method for the simultaneous detection of members of the *Vitivirus* and *Foveavirus* genera in grapevine. *J Virol Methods* 170: 99–106
- Dovas CI, Katis NI (2003b) A spot multiplex nested RT-PCR for the simultaneous and generic detection of viruses involved in the aetiology of grapevine leafroll and rugosewood of grapevine. *J Virol Methods* 109: 217–26
- Dunez J, Marenaud C, Delbos RP, Lansac M (1972) Variability of symptoms induced by apple chlorotic leaf spot virus (ACLSV). A type of ACLSV probably responsible for bark split disease of prune trees. *Plant Dis* 56: 293-295
- Dunn DB, Hitchborn JH (1965) The use of bentonite in the purification of plant viruses. *Virology* 25: 171-192
- Eastwell K (1997) Little cherry disease in perspective. In: Monette P L (ed) *Filamentous Viruses of Woody Plants*. Research Signpost, Triandrum, India, pp 143-151
- Faggioli F, Loreti S, Barba M (1997) Occurrence of peach latent mosaic viroid (PLMVd) on plum in Italy. *Plant Dis* 81: 423 (Abstr.)
- Fauquet CM, Mayo MA, Maniloff J, Desselberger U, Ball L (2005) *Virus taxonomy*, VIIIth report of the ICTV. Elsevier, Academic Press, London.

- Fekih Hassen I, Massart S, Motard J, Roussel S, Parisi O, Kummert J, Fakhfakh H, Marrakchi M, Perreault JP, Jijakli MH (2007) Molecular features of new peach latent mosaic viroid variants suggest that recombination may have contributed to the evolution of this infectious RNA. *Virology* 360: 50-57
- Flores R, Llacer G (1988) Isolation of a viroid-like RNA associated with peach latent mosaic disease. *Acta Hort* 235: 325-332
- Flores R, Hernandez C, Desvignes JC, Llacer G (1990a) Some properties of the viroid inducing the peach latent mosaic disease. *Res Virol* 141: 109-118
- Flores R, Hernandez C, Garcia S, Llacer G (1990b) Is apricot 'viruela' (pseudopox) induced by a viroid? In: Proceedings of the 8th Congress of the Med Phytopathol Union, Agadir, Spain
- Flores R, Hernandez C, Martinez de Alba AE, Daros JA, Di Serio F (2005) Viroids and viroid-host interactions. *Ann Rev Phytopath* 43:117-139
- Flores R, Hernandez C, Llacer G, Shamloul AM, Giunchedi L, Hadidi A (2003) Stone fruit viroids. In: Hadidi A, Flores R, Randles J, Semancik J (eds) *Viroids*. Science Publishers, Inc & Csiro Publishing, pp 156-160
- Flores R, Hernandez C, Avinent L, Hermoso A, Llacer G, Juarez J, Arregui JM, Navarro L, Desvignes JC (1992) Studies on the detection, transmission and distribution of peach latent mosaic viroid in peach trees. *Acta Hort* 309: 325-330
- Foissac X, Svanella-Dumas L, Gentit P, Dulucq M, Marais A, Candresse T (2005) Polyvalent degenerate oligonucleotides reverse transcription-polymerase chain reaction: A polyvalent detection and characterization tool for *Trichovirus*, *Capillovirus*, and *Foveavirus*. *Phytopathology* 95: 617-625

- Foissac X, Svanella-Dumas L, Dulucq MJ, Candresse T, Gentit P (2001)
Polyvalent detection of fruit tree *tricho*, *capillo* and *foveaviruses* by nested RT-PCR using degenerated and inocine containing primers (PDO RT-PCR). Acta Hort 550: 37–44
- Food and Agriculture Organization of the United Nations, FAO Bulletin (2007)
<<http://www.fao.org>>, accessed 26 September, 2007
- Foster W, Lott T (1947) "Little cherry", a virus disease. Sci Agric 27: 1-6
- Fuchs E (1982) Studies of the development of concentration of apple chlorotic leaf spot virus (CLSV) and apple stem grooving virus (SGV) in apple trees. Acta Pkytopath Acad Sci Hung 17: 23-27
- Fuchs E (1980) Serological detection of apple chlorotic leaf spot virus (CLSV) and apple stem grooving virus (SGV) in apple trees. Acta Pkytopath Acad Sci Hung 15: 69-73
- Gentit P, Foissac X, Svanella-Dumas L, Peypelut M, Candresse T (2001)
Characterization of two different apricot latent virus variants associated with peach asteroid spot and peach sooty ringspot diseases. Arch Virol 146: 1453-1464
- German-Retana S, Bergey B, Belbos RP, Candresse T, Dunez J (1997)
Complete nucleotide sequence of the genome of a severe cherry isolate of apple chlorotic leaf spot trichovirus (ACLSV) Arch Virol 142: 833-841
- German S, Candresse T, Lanneau M, Huet JC, Pernollet JC, Dunez J (1990)
Nucleotide sequence and genomic organization of apple chlorotic leaf spot closterovirus. Virology 179:104-112
- Gibson P (2000) Graft-transmissible effects of 'TaTao 5' Peach. Ph.d. dissertation, Clemson University. Clemson, SC, US, pp 96

- Gibson P, Reighard G, Scott S, Zimmerman M (2001) Identification of graft-transmissible agents from Ta Tao 5 peach and their effects on Coronet peach. *Acta Hort* 500: 309-314
- Gildow F (2001) Plum pox virus educate to eradicate. A review and update. College of Agricultural Sciences Cooperative Extension at Pennsylvania State University.
<http://www.cas.psu.edu/issues/Sharka/review_update.htm>. accessed July 27, 2007
- Gildow F, Damsteegt V, Stone A, Schneider W, Luster D, Levy L (2004) Plum pox in North America: identification of aphid vectors and a potential role for fruit in virus spread. *Phytopathology* 94: 868-874
- Gispert C, Perring T, Creamer, R (1998) Purification and characterization of peach mosaic virus. *Plant Dis* 82: 905-908
- Giunchedi L, Gentit P, Nemchinov L, Poggi-Pollini C, Hadidi A (1998) Plum spotted fruit: a disease associated with peach latent mosaic viroid. *Acta Hort* 472: 571-579
- Glasa M, Palkovics L, Kominek P, Labonne G, Pittnerova S, Kudela O, Candresse T, Pubr Z (2004) Geographically and temporally distant natural recombinant isolates of plum pox virus are genetically very similar and form a unique PPV subgroup. *J Gen Virol* 85: 2671-2681
- Hadidi A, Candresse T (2003) Polymerase chain reaction. In: Hadidi A, Flores R, Randles J, Semancik J (eds) *Viroids*. Science Publishers, Inc & Csiro Publishing, pp 115-122
- Hadidi A, Levy L (1994) Accurate identification of plum pox potyvirus and its differentiation from asian prunus latent potyvirus in *Prunus* germplasm. *EPPO Bull* 24: 633-643

- Hadidi A, Giunchedi L, Shamloul AM, Poggi-Pollini C, Amer M (1997) Occurrence of peach latent mosaic viroid in stone fruits and its transmission with contaminated blades. *Plant Dis* 81:154-158
- Hadidi A, Terai Y, Powell A, Scott SW, Desvignes JC, Ibrahim LM, Levy L (1991) Enzymatic cDNA amplification of Hop Stunt Viroid variants from naturally infected fruit crops. *Acta Hort* 309: 339-344
- Hadidi A, Giunchedi L, Osaki H, Shamloul AM, Crescenzi A, Gentit P, Nemchinov L, Piazzolla P, Kyriakopoulou PE (2003) Peach latent mosaic viroid in temperature fruit hosts. In: Hadidi A, Flores R, Randles J, Semancik J (eds) *Viroids*. Science Publishers, Inc & Csiro Publishing, pp 161-164
- Hammond RW (1992) Analysis of the virulence modulating region of potato spindle tuber viroid (PSTVd) by site mutagenesis. *Virology* 187:654-662
- Hanold D (1993) Diagnostic methods applicable to viroids. In: Matthews R E F (ed) *Diagnosis of Plant Viruses*. CRC Press, Boca Raton, FL, pp 780
- Hanold D, Semancik JS, Owens RA (2003) Polyacrylamide gel electrophoresis. In: Hadidi A, Flores R, Randles J, Semancik J (eds) *Viroids*. Science Publishers, Inc & Csiro Publishing, pp 95-102
- Hari V, Abdel-Ghaffar MH, Levy L, Hadidi A (1995) Asian prunus latent virus: an usual potyvirus detected in germplasm from east Asia. *Acta Hort* 386: 78-83
- Hartman H, Kester D, Davies F, Geneve R (1997) *Plant Propagation: Principles and Practices*, 6th edn. Prentice Hall, Inc, New Jersey, US
- Hassan M, Rysanek P, Di Serio F (2004) Mixed infection of peach trees with peach latent mosaic viroid and hop stunt viroid in the Czech Republic. *Acta Hort* 657: 397-400

- Hernandez C, Flores R (1992) Plus and minus RNAs of peach latent mosaic viroid self cleave in vitro via hammerhead structures. In: Proceedings Natl Acad Sci US, 89: 3711-3715
- Hodgson RA, Wall GC, Randles JW (1998) Specific identification of coconut tinangaja viroid for differential diagnosis of viroids in coconut palm. *Phytopathology* 88: 774-781
- Hughes DW, Galau G (1988) Preparation of RNA from cotton leaves and pollen. *Plant Mol Biol Rep* 64: 253-257
- Hull R (1986) The potential for using dot-blot hybridization in the detection of plant viruses. In: Jones R A C, Torrance L (eds) *Developments and applications of virus testing*. Suffok, Lavenham, pp 3-12
- Huttinga H (1996) Sensitivity of indexing procedures for viruses and viroids. *Adv Bot Res* 23: 59-71
- James D (1997) Serological reactions of some filamentous viruses of temperature fruit trees. . In: Monette P L (ed) *Filamentous Viruses of Woody Plants*. Research Signpost, Triandrum, India, pp 159-170
- James D, Godkin S (1996) Identification and differentiation of *Prunus* virus isolates that cross-react with plum pox virus and apple stem pitting virus antisera. *Plant Dis* 80: 536-543
- James D, Howell WE (1998) Isolation and partial characterization of a filamentous virus associated with peach mosaic virus disease. *Plant Dis* 82: 909-913
- James D, Mukerji S (1993) Mechanical transmission, identification, and characterization of a virus associated with mottle leaf in cherry. *Plant Dis* 77: 271-275

- James D, Varga A (2004) Preliminary molecular characterization of plum pox potyvirus isolate W3174: evidence of a new strain. *Acta Hort* 657: 177-182
- James D, Jelkman W, Upton C (1999) Specific detection of cherry mottle leaf virus using digoxigenin-labeled cDNA probes and RT-PCR. *Plant Dis* 83: 235-239
- James D, Thompson DA, Godkin SE (1994) Cross reactions of an antiserum to plum pox potyvirus. *EPPO Bull* 24: 605-614
- James D, Varga A, Croft H (2007) Analysis of the complete genome of peach chlorotic mottle virus: identification of non-AUG start codons, *in vitro* coat protein expression, and elucidation of serological cross-reactions. *Arch Virol* 152, DOI 10.1007/s00705-007-1050-x
- Jelkman W (1997) Apple stem pitting virus. In: Monette PL (ed) *Filamentous Viruses of Woody Plants*. Research Signpost, Trivandrum. pp 133-142
- Jelkman W (1996) The nucleotide sequence of a strain of apple chlorotic leaf spot virus (ACLSV) responsible for plum pseudopox and its relation to an apple and plum bark split strain. *Phytopathology* 86: S101 (Abstr.)
- Jelkman W, Kunze L (1995) Plum pseudopox in German plum after infection with an isolate of apple chlorotic leaf spot virus causing plum line pattern. *Acta Hort* 386: 122-125
- Jelkman W, Fechtner B, Agranovsky A (1997) Complete genome structure and phylogenetic analysis of little cherry virus, a mealybug transmissible closterovirus. *J Gen Virol* 78: 2067-2071
- Jelkman W, Kunze L, Vetten H, Lesemann D (1992) cDNA cloning of dsRNA associated with apple stem pitting disease and evidence of the relationship of the virus-like agents associated with apple stem pitting and pear vein yellows. *Acta Hort* 309: 55-62

- Kalashyan YA, Bilkey ND, Verderevskaya TD, Rubina EV (1994) Plum pox potyvirus on sour cherry in Moldova. EPPO Bull 24: 645-649
- Karasev A (2000) Genetic diversity and evolution of *Closteroviruses*. Annu Rev Phytopathology 38: 293-324
- Kegler H, Hartman W (1998) Present status of controlling conventional strains of plum pox virus. In: Hadidi A, Khetarpal R, Koganezawa (eds) Plant Virus Disease Control. APS Press, St Paul, MN, US, pp 616-628
- Kerlan C, Dunez J (1979) Biological and serological differentiation of strains of sharka virus. Ann Phytopath 11: 241-250
- Kinard G (1995) Development and application of nucleic acid based detection systems for chlorotic leafspot and stem grooving viruses of apple. Ph.d. dissertation, Clemson University, Clemson, SC, US, pp 127
- Kinard GR, Scott SW, Barnett OW (1996) Detection of apple chlorotic leaf spot and apple stem grooving viruses using RT-PCR. Plant Dis 80: 616-621
- Kofalvi SA, Marcos JF, Canizales MP, Pallas V, Candresse T (1997) Hop stunt viroid (HSVd) sequence variants from *Prunus* species: evidence for recombination between HSVd isolates. J Gen Virol 78: 3177-3186
- Koganezawa H, Yanase H (1990) A new type of elongated virus isolated from apple trees containing the stem pitting agent. Plant Dis 74: 610-614
- Krizbai L, Ember I, Nemeth M, Kolber M, Pasquini G, Faggioli F (2001) Characterization of Hungarian isolates of apple chlorotic leaf spot virus. Acta Hort 472: 291-295
- Kummert J, Vendrame M, Steyer S, Lepoive P (2000) Development of routine RT-PCR tests for certification of fruit tree multiplication material EPPO Bull 30: 441-448

- Kyriakopoulou PE, Gunchedi L, Hadidi A (2001) Peach latent mosaic viroid and pome fruit viroids in naturally infected cultivated pear *Pyrus communis* and wild pear *P. amygdaliformis*: implications on possible origin of these viroids in the Mediterranean region. *J. Plant Pathology* 83: 51-62
- Labonne G, Yvon M, Quiot JB, Avinert L, Llacer G (1995) Aphids as potential vectors of plum pox virus: Comparison of methods of testing and epidemiological consequences. *Acta Hort* 386: 207-217
- Lain S, Reichmann JL, Garcia JA (1989) The complete nucleotide sequence of plum pox potyvirus RNA. *Virus Research* 13: 157-172
- Larson RH, Matthews RE, Walker JC (1950) Relationships between certain viruses affecting the genus *Brassica*. *Phytopathology* 40: 955-962
- Levy L, Damsteegt V, Scorza R, Kolber M (2000) Plum pox potyviruses disease of stone fruits. *APS Bulletin*.
<<http://www.apsnet.org/online/feature/PlumPox/Top.html>>, accessed June 27, 2007
- Li Z (1984) Peach germplasm and breeding in China. *HortSci* 19: 348-351
- Liberti D, Marais A, Svanella-Dumas L, Dulucq MJ, Alioto D, Ragozzino A, Rodoni B, Candresse T (2005) Characterization of apricot pseudo-chlorotic leaf spot virus, a novel *Trichovirus* isolated from stone fruit trees. *Phytopathology* 95: 420-426
- Llacer G, Cambra M, Lavina A, Aramburu J (1985) Suitable conditions for detection for apple chlorotic leaf spot virus in apricot trees by enzyme-linked immunosorbent assay (ELISA). *Agronomie* 5: 809-812
- Lockwood DW, Coston DC (2005) Peach tree physiology. In: Horton D, Johnson D (eds) *Southeastern Peach Growers Handbook*, Cooperative Extension Service, University of Georgia. Athens, Georgia, US, pp 5-7

- Mackay IM, Arden KE, Nitsche A (2002) Survey and summary of real-time PCR in virology. *Nucleic Acids Res* 30:1292–1305
- Maiss E, Timpe U, Briske A, Jelkmann W, Casper R, Himmler G, Mattanovich D, Katinger HWD (1989) The complete nucleotide sequence of plum pox virus RNA. *J Gen Virol* 70: 513-524
- Malfitano M, Di Serio F, Covelli L, Ragozzino A, Hernandez C, Flores R (2003) Peach latent mosaic viroid variants inducing peach calico (extreme chlorosis) contain a characteristic insertion that is responsible for this symptomatology. *Virology* 313: 492-501
- Marais A, Svanella-Dumas L, Foissac X, Gentit P, Candresse T (2006) Asian prunus viruses: new related members of the family *Flexiviridae* in *Prunus* germplasm of Asian origin. *Virus Res* 120: 176-183
- Marais A, Svanella-Dumas L, Foissac X, Candresse T (2004) Molecular characterization of a new *foveavirus* in *Prunus* accessions of Asian origin. *Acta Hort* 657: 87-92
- Marini DB, Zhang YP, Rowhani A, Uyemoto JK (2002) Etiology and host range of a closterovirus associated with plum bark necrosis-stem pitting disease. *Plant Dis* 86: 415-417
- Markarian N, Li HW, Ding SW, Semancik JS (2004) RNA silencing as related to viroid induced symptom expression. *Arch Virol* 149: 397-406
- Martelli G, Jelkmann W (1998) *Foveavirus*, a new plant virus genus. *Arch Virol* 143: 1245-1249
- Martelli GP, Candresse T, Namba S (1994) *Trichovirus*, a new genus of plant viruses. *Arch Virol* 134: 451-455
- Martelli GP, Adams MJ, Kreuze JF, Dolja VV (2007) Family *Flexiviridae*: a case study in virion and genome plasticity. *Ann Rev Phytopath* 45: 73-100

- Martinez de Alba AE, Flores R, Hernandez C (2002) Two chloroplastic viroids induce the accumulation of the small RNAs associated with post-transcriptional gene silencing. *J Virol* 76: 13094-13096.
- Matthews R (1993) Experimental transmission of viruses and diagnosis. In: Matthews R (ed) *Plant Virus Diseases*. CRC Press, Inc. Boca Raton, pp 49-72
- Matthews REF (1991) *Plant Virology*. 3rd edn. Academic Press, Inc. San Diego, CA, US
- Matthews R, Hull R (2002) *Plant Virology*. 4th edn. Academic Press, Inc. San Diego, CA, US
- Maule AJ, Hull R, Donson J (1983) The application of spot hybridization to the detection of DNA and RNA viruses in plant tissues. *J Virol Methods* 6: 215-224
- Menzel W, Jelkman W, Maiss E (2002) Detection of four apple viruses by multiplex RT-PCR assays with co-amplification of plant mRNA as internal control. *J Virol Methods* 99: 81-92
- Michelutti R, Al Rwahnin M, Torres H, Gomez G, Luffman M, Myrta A, Pallas V (2004) First record of hop stunt viroid in Canada. *Plant Dis* 88:1162 (Abstr.)
- Milne R, Luisoni E (1977) Rapid immune electron microscopy of virus preparations. *Methods Virol* 6: 265-281
- Morrison TM, Weiss JJ, Wittwer CT (1998) Quantification of low-copy transcripts by continuous SYBR green I monitoring during amplification. *Biotechniques* 24: 954–962

- Muhlbach HP, Weber U, Gomez G, Pallas V, Duran-Vila N, Hadidi A (2003) Molecular hybridization. In: Hadidi A, Flores R, Randles J, Semancik J (eds) Viroids. Science Publishers, Inc & Csiro Publishing, pp 103-114
- Mullis KF, Faloan F, Scharf S, Saiki R, Horn G (1986) Specific enzymatic amplification of DNA in vitro: the polymerase chain reaction. Cold Spring Harbor Symp. Quant Biol 51: 263-273
- Navratil M, Safarova D (2005) First Incidence of plum pox virus on apricot trees in China. Plant Dis 89: 338 (Abstr.)
- Nemchinov L, Shamloul A, Zemtchik E, Verderevskaya T, Hadidi A (2000) Apricot latent virus: a new species in the genus *Foveavirus*. Arch Virol 145: 1801-1813
- Nemchinov L, Crescenzi A, Hadidi A, Piazzolla P, Verderevskaya T (1998) Present status of the new cherry subgroup of plum pox virus (PPV-C). In: Hadidi, A, Khetarpal RK, Koganezawa H (eds.) Plant Virus Disease Control. APS Press, St. Paul, MN, US, pp 629-638
- Nemchinov L, Hadidi A, Candresse T, Foster JA, Verderevskaya TD (1995) Sensitive detection of apple chlorotic leafspot virus from infected apple or peach tissue using RT-PCR, IC-RT-PCR, or multiplex IC-RT-PCR. Acta Hort 386: 51-62
- Nemeth M (1986). Virus, mycoplasma, and rickettsia diseases of fruit trees. Akademiai Kiado, Budapest, Hungary
- Nemeth M, Kolber M (1983) Additional evidence on seed transmission of plum pox virus in apricot, peach, and plum, proved by ELISA. Acta Hort 130: 293-300
- Nikolaeva OV (1995) Nucleic acid hybridization methods in diagnosis of plant viruses and viroids. In: Singh R P, Singh U S (eds) Molecular Methods in Plant Pathology. CRC Press, Boca Raton, pp 133-144

Nyczepir AP, Beckman TG, Reighard GL (2006) Field evaluation of Guardian™ peach rootstock to different root-knot nematode species. *Acta Hort* 713: 303-310

Ogawa JM, English H (1991) Diseases of temperate zone tree fruit and nut crops. University of California. Division of Agriculture and Natural Resources. Oakland, CA, US. Publication 3345

Ogawa JM, Zehr E, Bird G, Richie D, Uriu K, Uyemoto J (1995) Compendium of stone fruit diseases. APS, St. Paul, MN, US

Okie WR (1990) Ta Tao, P.I. 101686, affects bloom date and tree size of Sunprince peach. *Fruit Var J* 44: 87-89

Okie WR, Reighard GL, Newall WC, Graham CJ, Werner DJ, Powell AA, Krewer G, Beckman TG (1998) Spring freeze damage to the 1996 peach and nectarine crop in the southeastern United States. *HortTech* 8: 381-386

Okie WR, Beckman TG, Nyczepir AP, Reighard GL, Newall WC, Zehr EI (1994) BY520-9, a peach rootstock for the Southeastern United States that increases scion longevity. *HortSci* 29: 705-706

Osaki H, Yamamuchi Y, Sato Y, Tomita Y, Kawai Y, Miyamoto Y, Ohtsu Y (1999) Peach latent mosaic viroid isolated from stone fruits in Japan. *Ann Phytopath Soc Japan* 65: 3-8

Owens RA, Diener TO (1981) Sensitive and rapid diagnosis of potato spindle tuber viroid disease by nucleic acid hybridization. *Science* 213: 670-672

Pallas V, Gomez G, Amari K, Canizales MC, Candresse T (2003). Hop stunt viroid in apricot and almond. In: Hadidi A, Flores R, Randles J, Semancik J (eds) *Viroids*. Science Publishers, Inc & Csiro Publishing, pp 168-170

- Pallás V, Sánchez-Navarro JA, Más P, Cañizares MC, Aparicio F, Marcos JF, (1998) Molecular diagnostic techniques and their potential role in stone fruit certification schemes. *Options Méditerr* 19: 191-208
- Papaefthimiou I, Hamilton AJ, Denti MA, Baulcombe DC, Tsagris M, Tabler M (2001) Replicating potato spindle tuber viroid RNA is accompanied by short RNA fragments that are characteristics of post-transcriptional gene silencing. *Nucleic Acid Res* 29: 2395-2400
- Pasquini G, Faggioli F, Pilotti M, Lumia V, Barba M (1998) Characterization of apple chlorotic leaf spot virus isolates from Italy. *Acta Hort* 472: 195-199
- Pelchat M, Levesque D, Ouellet J, Laurendeau S, Levesque S, Lehoux J, Thompson DA, Eastwell KC, Skereczkowski LJ, Perreault JP (2000) Sequencing of peach latent mosaic viroid variants from nine North American peach cultivars shows that this RNA folds into a complex secondary structure. *Virology* 271: 37-45
- Perrière G, Gouy M (1996) WWW-query: an on-line retrieval system for biological sequence banks. *Biochimie* 78: 364- 369
- Podleckis EV, Hadidi A (1995) New trends in detection of fruit tree viroids. *Acta Hort* 386: 606-610
- Qi Y, Ding B (2003) Inhibition of cell growth and shoot development by a specific nucleotide sequence in a noncoding viroid RNA. *Plant Cell* 15:1360-1374
- Raine J, McMullen R, Forbes A (1986) Transmission of the agent causing little cherry disease by the apple mealybug *Phenacoccus aceris* and the dodder *Cuscuta lupuliformis*. *Can J Plant Pathol* 8: 6-11
- Ragozzino A, Pugliano G (1974) La butteratura delle albicocche. Indagini preliminary sullu eziologia. *Riv Ortoflor Ital* 58: 136-145

- Reanwarakorn K, Semancik JS (1998) Regulation of pathogenicity in hop stunt viroid related-group II. *Gen Virol* 79: 3163-3171
- Reighard GL (1998) Manipulation of peach phenology, growth, and fruit maturity using interstems. *Acta Hort* 465: 567-572
- Reighard GL (1995) Use of peach interstems to delay peach. *Acta Hort* 395: 201-207
- Reighard GL, Ouelette DR, Brock KH (2001) Modifying phenotypic characters of peach with graft transmissible agents. *Acta Hort* 557: 163-168
- Rivera-Bustamante R, Gin R, Semancik JS (1986) Enhanced resolution of circular and linear molecular forms of viroid and viroid-like RNA by electrophoresis in a discontinuous-PH system. *Anal Biochem* 156: 991-995
- Rodio ME, Delgado S, Flores R, Di Serio, F (2006) Variants of peach latent mosaic viroid inducing peach calico: uneven distribution in infected plants and requirements of the insertion containing the pathogenicity determinant. *J Gen Virol* 87: 231–240
- Rott M, Jelkman W (2002) Little cherry closterovirus occurrence of LChV-1 and 2, complete genomic characterization of LCh V-2 and its relation to the proposed LChV-3, isolated from Canada. In: *Proceedings XII Int Congr Virol*, p 444
- Rott M, Jelkman W (2001) Complete nucleotide sequence of cherry necrotic rusty mottle virus. *Arch Virol* 146: 395-401
- Rowhani A, Uyemoto JU, Golino D, Martelli G (2005) Pathogen testing and certification of *Vitis* and *Prunus* species. *Annu Rev Phytopath* 43: 261-278

- Rowhani A, Biardi L, Johnson R, Saldarelli P, Zhang YP (2000) Simplified sample preparation method and one-tube RT-PCR for grapevine viruses. In: Proceedings of the 13th Int. Counc. Study Viruses Virus-Like Dis. Grapevine, Adelaide, Australia
- Sanchez-Navarro J, Aparicio F, Herranz M, Minafa A, Myrta A, Pallas V (2004) Simultaneous detection and identification of eight stone fruit viruses by one step RT-PCR. *Eur J Plant Pathology* 00: 1-9
- Sano T (2003) Hop stunt viroid in plum and peach. In: In: Hadidi A, Flores R, Randles J, Semancik J (eds) *Viroids*. Science Publishers, Inc & Csiro Publishing, pp 165-167
- Sano T, Hataya T, Terai Y, Shikata E (1989) Hop stunt viroid strains from dapple fruit disease of plum and peach in Japan. *J Gen Virol* 70: 1311-1319
- Sano T, Hataya T, Terai Y, Shikata E (1986) Detection of a viroid-like RNA from plum dapple disease occurring in Japan. In: *Proceedings of Japan Academy Series 62B*: 98-101
- Sasaki M, Shikata E (1977) On some properties of hop stunt disease agent, a viroid. In: *Proceedings of Japan Academy Series 53B*:109-112
- Sato K, Yoshikawa N, Takanashi T (1993) Complete nucleotide sequence of the genome of an apple isolate of apple chlorotic leaf spot virus. *J Gen Virol* 74:1927-1931
- Schnolzer M, Haas B, Ramm K, Hoffmann H, Sanger H (1985) Correlation between structure and pathogenicity of potato spindle tuber viroid (PSTV). *EPPO Bull* 4: 2181-2190
- Schwarz K, Jelkmann W (1998) Detection and characterization of European apple stem pitting virus sources from apple and pear by PCR and partial sequence analysis. *Acta Hort* 472: 75-86

- Shamloul AM, Minafra A, Hadidi A, Giunchedi L, Waterworth HE, Allam EK (1995) Peach latent mosaic viroid: nucleotide sequence of an Italian isolate, sensitive detection using RT-PCR and geographic distribution. *Acta Hort* 386: 522-530
- Sharpe RR, Reilly CC, Nyczepir AP, Okie WR (1989) Establishment of peach in a replant site as affected by soil fumigation, rootstock, and pruning date. *Plant Dis* 73: 412-415
- Shikata E (1990) New viroids from Japan. *Semin Virol* 1: 107-115
- Singh RP, Ready K (2003) Biological Indexing. In: Hadidi A, Flores R, Randles J, Semancik J (eds) *Viroids*. Science Publishers, Inc & Csiro Publishing, pp 89-94
- Singh RP, Ready K, Nie X (2003) Biology. In: Hadidi A, Flores R, Randles J, Semancik J (eds) *Viroids*. Science Publishers, Inc & Csiro Publishing, pp 30-48
- Skrzeckowski LJ, Howell WE, Mink GI (1996) Occurrence of peach latent mosaic viroid in commercial peach and nectarine cultivars in the U.S. *Plant Dis* 80: 823 (Abstr.)
- Spiegel S, Thompson D, Varga A, Rosner A, James D (2006) Evaluation of reverse transcription-polymerase chain reaction assays for detecting apple chlorotic leaf spot virus in certification and quarantine programs. *Can J Plant Pathol* 28: 280-288
- Spiegel S, Thompson D, Varga A, James D (2005) An apple chlorotic leaf spot virus isolate from ornamental dwarf flowering almond (*Prunus glandulosa* 'Sinensis'): detection and characterization. *HortSc* 40: 1401-1404
- Steger G, Riesner D (2003) Molecular Characteristics. In: Hadidi A, Flores R, Randles J, Semancik J (eds) *Viroids*. Science Publishers, Inc & Csiro Publishing, pp 15-29

- Stout GL (1939) Peach mosaic. Calif Dep Agric Bull 28:177-200
- Tabler M, Tsagris M (2004) Viroids: petite RNA pathogens with distinguished talents. Trends Plant Science 9: 339-348
- Terai Y (1985) Symptoms and graft-transmission of plum dapple fruit disease. Ann Phytopath Soc Japan 51: 363-364
- Terai Y, Sano T, Shikata E (1990) Back-inoculation of plum dapple fruit disease and graft-transmission of peach dapple fruit disease. Ann Phytopath Soc Japan 56:428 (Abstr.)
- Tessitori M, Reina A, La Rosa R (2002) First report of mixed infection of hop stunt viroid and peach latent mosaic viroid on peach. Plant Dis 86: 329 (Abstr.)
- Teycheney PY, Tavert G, Delbos RP, Ravelonandro M, Dunez J (1989) The complete nucleotide sequence of plum pox virus RNA (strain D). Nucleic Acids Res 17: 10115-10116
- Theilmann S, Orban S, Rochon D (2004) High sequence variability among little cherry virus isolates occurring in British Columbia. Plant Dis 88: 1092-1098
- Thompson JD, Gibson TJ, Plewniak F, Jeanmougin F, Higgins DG (1997) The ClustalX windows interface: flexible strategies for multiple sequence alignment aided by quality analysis tools. Nucleic Acids Res 24: 4876-4882
- Usta M, Sipahioglu HM, Ocak M, Myrta A (2007) Detection of apricot latent virus and plum bark necrosis stem pitting-associated virus by RT-PCR in Eastern Anatolia (Turkey). EPPO Bull 37: 181-185

- Valverde RA, Dodds JA, Heick JA (1986) Double-stranded ribonucleic acid from plants infected with viruses having elongated particles and undivided genomes. *Phytopathology* 76: 459-465
- Visvader JE, Symons RH (1985) Eleven new sequence variants of citrus exocortis viroid and the correlation of sequence with pathogenicity. *Nucleic Acids Res* 13: 2907-2920
- Wang MB, Bian XY, Wu LM, Smith NA (2004) On the role of RNA silencing and evolution of viroids and viral satellites. In: *Proceeding Natl Acad Sci US*, 101: 3275-3280
- Wassenegger M, Heimes S, Riedel L, Sanger H (1994) RNA-directed de novo methylation of genomic sequences in plants. *Cell* 76: 567-576
- Wetzel T, Candresse T, Ravelonandro M, Delbos RP, Mazyad H, Aboul-Ata AE, Dunez J (1991) Nucleotide sequence of the 3'-terminal region of the RNA of the El Amar strain of the plum pox potyvirus. *J Gen Virology* 72: 1741-1746
- Yadav AK (1998) Commodity Sheet FVSU-001, Peaches. Agricultural Research Station. Fort Valley State University. College of Agriculture, Home Economics and Allied Programs. University System of Georgia.
- Yaegashi H, Takahashi T, Isogai M, Kobori T, Ohki S, Yoshikawa N (2007a) Apple chlorotic leaf spot virus 50 kDa movement protein acts as a suppressor of systemic silencing without interfering with local silencing in *Nicotiana benthamiana*. *J Gen Virol* 88: 316-324
- Yaegashi H, Isogai M, Tajima H, Sano T, Yoshikawa N (2007b) The combinations of the two amino acids (Ala40 and Phe75 or Ser40 and Tyr75) in the coat protein of apple chlorotic leaf spot virus are crucial for infectivity. *J Gen Virol* 88: 2611-2618
- Yanase H (1974) Studies on apple latent viruses in Japan. *Bull Fruit Tree Res Stn Ser C* 1: 47-109

Yanase H, Koganezawa H, Fridlund PR (1989) Correlation of pear necrotic spot with pear vein yellow and apple stem pitting, and a flexuous filamentous virus associated with them. *Acta Hort* 235: 157 (Abstr.)

Yoshikawa N, Oogake S, Terada M, Miyabayashi S, Ikeda Y, Takahashi T, Ogawa T (1999) Apple chlorotic leaf spot virus 50 kDa protein is targeted to plasmodesmata and accumulates in sieve elements in transgenic plant leaves. *Arch Virol* 144: 2475-2483

Zemtchik Y, Verdereveskaya T (1993) Latent virus on apricot unknown from Moldova conditions. *Russian Agr Biology* 3: 130-133

Zhang Y-P, Kirkpatrick B, Smart C, Uyemoto J (1998) cDNA cloning and molecular characterization of cherry green ring mottle virus. *J Gen Virol* 79: 2275-2281