

We are IntechOpen, the world's leading publisher of Open Access books Built by scientists, for scientists

5,000

Open access books available

125,000

International authors and editors

140M

Downloads

Our authors are among the

154

Countries delivered to

TOP 1%

most cited scientists

12.2%

Contributors from top 500 universities



WEB OF SCIENCE™

Selection of our books indexed in the Book Citation Index
in Web of Science™ Core Collection (BKCI)

Interested in publishing with us?
Contact book.department@intechopen.com

Numbers displayed above are based on latest data collected.

For more information visit www.intechopen.com



Optimization Techniques of Islanded Hybrid Microgrid System

Sk. Shezan Arefin

Abstract

The utilization of energy is increasing day by day, it is an unavoidable truth. This large demand for energy cannot be satisfied by the conventional power sources alone. Sustainable power sources, for example, solar and wind turbine-based energy system are the most effective and both economically and environmentally feasible. The Hybrid renewable energy system (HRES) is a recent concept in the field of sustainable development which joins at least two renewable power sources like wind turbine, solar module and other inexhaustible sources such as ocean energy, fuel cell etc. This chapter starts with an audit by addressing the possible difficulties that can occur while a solar power plant and the wind farm will be integrated together to supply power to the main grid or in a islanded manner. This chapter gives an overview of the optimization techniques that can improve the integration of the hybrid systems to the grid as well as with the islanded load. This review also sheds significant light on the techniques to improve the equality of a grid integrated solar-wind hybrid energy system. It also includes the critical findings on the strategies that are necessary to build an efficient grid-connected and islanded solar-wind hybrid energy system.

Keywords: renewable energy, solar energy, wind energy, HRES, optimization, simulation

1. Introduction

Replace power is an essential factor for industrialization, urbanization and budgetary development of any nation. There are diverse sorts of conventional and non-conventional energy sources used to generate power. Solar and wind energy systems are a standout among the most prominent sources of energy [1]. The use of solar-based and wind energy system has turned out to be progressively well known because of particular and condition agreeable nature. The field of solar and the wind energy has experienced a pivotal advancement for late decades in this in all cases usage of independent to utility characteristic solar-wind frameworks. Sun-powered and wind vitality framework works much of the time in remain independent or network associated mode, yet the reasonability of these sources are less an immediate after-effect of the stochastic thought of sun-powered and wind assets [2]. The hybrid renewable power sources with framework coordination defeat this downside of being whimsical in nature. Half-breed sustainable power source framework (HRES) is a blend of unlimited and consistent vitality source, and it might besides consolidate no under two maintainable power sources that work in remain independent or

system-related mode. The HRES that joins sun-based arranged and wind vitality sources works in two modes: concurrent and consecutive [3]. In synchronous mode, the sun-controlled and wind vitality frameworks produce vitality at the same time, while in a successive mode, they create a control on the other hand. The essential credits of HRES are to consolidate under two maintainable power age advancements to make fitting utilization of their working qualities and to get efficiencies higher than that could be gotten from a solitary power source. This paper shows the viewpoint of solar-wind half and half practical power source framework covering issues of achievability such as illustrating, controlling, change method, unwavering quality and power nature of the framework [4, 5]. The worldwide infiltration of sustainable power source in control systems is expanding quickly particularly for sunlight-based photovoltaic (PV) and wind systems. The sustainable power source meant around 19% of the total energy utilization worldwide in 2012 and kept on ascending amid the year 2013, according to the 2014 inexhaustible worldwide status report [6, 7]. The report highlighted that interestingly the PV establishment limit on solar and wind control is actually irregular and can make specialized difficulties to the network control supply particularly when the amount of solar and wind power integration increases or the grid is not sufficient to deal with fast changes in generation levels. Furthermore, if sun or wind is utilized to supply energy to a stand-alone system, energy storage system ends up with a guaranteed supply of power [8, 9]. The extent of the energy storage relies upon the irregularity level of the solar or wind energy systems. This paper gives a survey of difficulties and opens doors for combined PV and wind energy system. The paper audits the fundamental research works to identify the ideal measuring configuration, control hardware topologies and control strategies for both solar and wind energy systems [7, 10, 11]. The use of vitality has transformed into a fundamental matter of stresses in the latest decades because of speedy addition in vitality request. Furthermore, natural issues of customary vitality sources, for instance, ecological changes and an Earth-wide temperature boost, are perpetually compelling us for elective utilization of vitality assets. As indicated by the reports released by World Health Organization (WHO), brisk and twisting impacts of characteristic change prompt the death of 160,000 individuals for reliably and the rate is assessed to be increased by 2020 [12]. Environmental change causes disastrous incidents, for example, surges, dry spells and astounding changes in climate temperature. Also, there are a couple of sicknesses predominantly malaria, malnutrition, diarrhea and so forth getting to be plainly pandemic among the communities. One of the disasters was reported in 2003 which assaulted European nations and caused demising of 20 thousand individuals while remained \$10 billion misfortunes in the plant part. Directly, conventional vitality sources constitute ideally around 80% of overall vitality usage [12]. Those fundamental compelling reason on substitute the energy sources might have been set off concurred for discovering nuclear noteworthiness in the mid-twentieth century, which might climb to ten on twenty times more than oil-based stock. In any case, there are a few confinements related to atomic energy generations. For instance, atomic fusion is the exposure of uranium and thorium minerals, which are viewed as petroleum derivatives also. Also, atomic plants are at present accessible just in vast scale power generations. Subsequently, for cooking, heating and other small-scale applications, sustainable power sources are the best solutions yet [13].

Reasonable power sources like daylight-based, wind, biomass, hydropower and tidal vitality are promising CO₂-free decisions. Despite the general recognition with central purposes of practical power source utilization, this wellspring of vitality contributed to just around 1.5% of world vitality as of 2006. The example is assessed to rise to 1.8% of each by 2030 [14, 15].

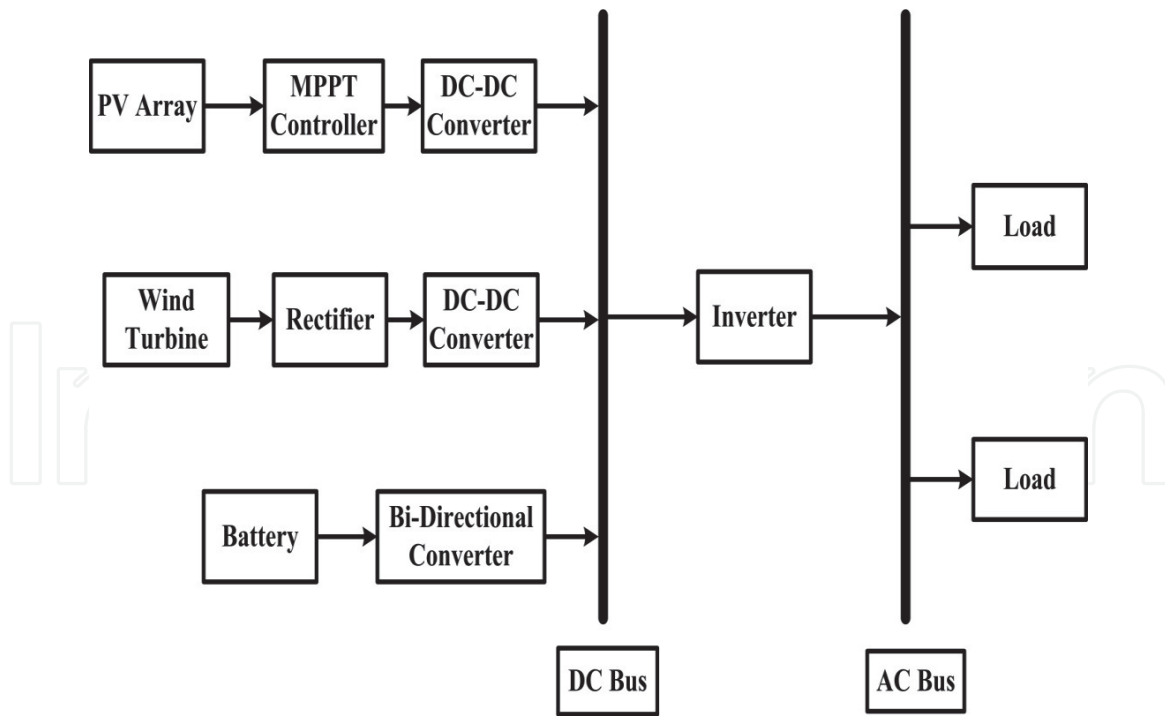

Figure 1.
A complete block diagram of a hybrid PV-wind renewable energy system [16, 17].

Figure 1 shows the complete block diagram of a hybrid PV-wind renewable energy system. The basic diagram gives the general idea of the architecture of an HRES.

2. Evolutionary of optimization methods used in HRES

The developmental calculation is one of the subclasses of counterfeit consciousness technique to decrease the streamlining trouble. The use of various algorithms and optimization methods are involved with the evolutionary technique in simulating the HRES.

2.1 Optimization with genetic algorithm

Genetic algorithm is an indiscriminate chase and enhancement framework guided by the profound quality of the common hereditary framework. Genetic algorithm is being widely used for optimization of various characterizations. Applications of renewable energy technologies with GA are gaining popularity day by day. Solar and wind energy, as well as the geothermal energy technology, is gaining more popularities in terms of simulation and optimization techniques. GA is a versatile heuristic hunt calculation in view of the transformative thoughts of normal choice and hereditary qualities. Liu et al. clarified an elitist methodology of ideal measuring of independent mixture of PV-wind control frameworks utilizing hereditary calculation with loss of energy supply likelihood as a limitation and limits the aggregate capital of the whole framework [18].

Zhao et al. used a hereditary calculation for PSO to see the most ideal capacity model of a daylight-based breeze blend with inexhaustible essentialness structure with quick overall combining [9]. Zhou et al. utilized GA with the plan to also supply fluctuating load that was spotted in the region from Xuzhou, China [19]. From the demonstration it can be said that the framework might convey vitality for a standalone establishment for a worthy cost. Fadale et al. Produced ideal measuring of mixture of PV-wind battery framework utilizing fuzzy logic with GA, which

chooses the ideal number about PV panels, WT and battery units, and further, GA is utilized to assume perfect control design from guaranteeing an off-network blend of inexhaustible essentialness system [20]. Turku et al. created true energy planning from claiming an off-grid HRES utilized to warming plus lighting previously, a prototype private house. In this chapter, double-coded GA may be utilized as opposed to arranged basic straight customizing on minimizing that operational unit cost of HRES [21].

2.2 Optimization with particle swarm optimization

Particle swarm optimization (PSO) is a populace built static streamlining act enthused toward social conduct for winged animal flocking or fish schooling, the place winged animal flocking or fish educating is the aggregate movement of a vast number for self-impelled substances. Zhao et al. offered enhancing the PSO algorithm for the ideal limit plan from claiming a free wind-PV mixture force supply framework. The technique of PSO completely depended on various types of data set based on the practically implemented parameters. Various researchers are using PSO as the perfect prediction tool for various purposes. An integration of the hybrid energy framework ability ideal configuration may be an ordinary non-linear incorporated basic streamlining issue. An algorithm is anticipated and also tried to look into the framework found in an island. The drawbacks and strength of the algorithm can talk about shortages gotten turns out its possibility and effectiveness [22]. Dehgan et al. created the majority positive position measuring of hydrogen built wind/PV plant permitting for dependability indices by applying a molecule swarm streamlining. Wang et al. altered the PSO calculation by creating a multicultural plan of the coordinated force area framework. Affectability contemplates may be likewise conveyed out to analyze those effects from claiming different framework parameters on the general configuration execution [23]. Measuring of solar-wind renewable vitality framework will be done by Sanchez et al. [24]. Also, an evolutionary calculation strategy known as PSO may be utilized with those expenses of framework as a goal capacity. PSO calculation is utilized by Ardakani et al. for ideal measuring of the system's part [25]. Thus as an eventual outcome, the perfect number of PV modules, wind turbine and battery close to the inverter capacity is obtained. Bansal et al. made streamlining of blend PV/wind/batteries imperative-ness structure using multi-target atom swarm streamlining (MOPSO) [26]. An objective work to cosset of the mixture framework may be framed that incorporates starting costs; yearly working costs furthermore support expenses. Because of that many-sided nature for mixture renewable vitality framework with nonlinear essential analytics planning, MOPSO is used to take care of the issue. Those enhanced PSO might stay away from that alternative of a neighborhood base trap. Keyrouz et al. formed a bound together MPPT to controlling a mixture of wind-solar and power module framework [27]. A following calculation method has been constructed Bayesian lion's share of the information joined with swarm quickness is used concerning delineation a streamlining, looking calculation by Amer et al. For limiting the hardship from guaranteeing imperativeness with a satisfactory choice of the era taking secured close by contemplating those incidents the center of planning additionally ask for sides to diminish the cost [28]. The conclusion reveals that PSO execution may be quicker, and it is also skilled at providing a streamlining design that recovers around 10% of the aggregate expense of the incorporated framework. Borhanazad et al. created streamlining for microgrid framework utilizing MOPSO and also discovered those are the best setup for the mixture framework utilizing energy oversight economy algorithm [29].

2.3 Optimization with fuzzy logic

Nema et al. have shown a perfect money-related operation from asserting sharp network by fluffy pushed quantum developmental technique. Adhikari et al. Elucidated examination, design moreover control of an independent composed non-regular essentialness change system for the perspective of those fluffy basis control strategy toward detecting those dc voltage besides current yield about sun situated and the revised yield voltage about enduring request short of breath quick present (PMBLDC) generator driven by a breeze turbine. Chakraborty et al. created insight activity speculation operation of a sharp matrix using soft moved quantum developmental framework [30].

2.4 Optimization with artificial neural network

Neural networking system will be an interconnectedness get together of re-enacted neurons that occupy a logical model or computational model for information changing in light of an association with approximate estimation. Fidalgo et al. connected an artificial neural networking (ANN)-based way to deal with applying preventive control techniques to an extensive hybrid energy system. ANNs are a fundamental piece, which is superior to standard measurable strategies in the progressive security design population and additionally evaluates that degree of security [31]. Martin et al. suggested a neural system control technique for multi-energy regular dc transport mixture energy supply eventually Tom's perusing examining that uniqueness for sun oriented energy, wind vitality. Levenberg-Marquardt algorithm that is interfaced with the neural system may be utilized and the energy component is acquainted in the preparation. During et al. created a mixture model to an hourly numeral for PV-wind renewable vitality framework that can also be utilized with the computational brain-power of PSO for registering distinctive definitions of the cost slip [32].

2.5 Optimization with game theory in HRES

For the 1838 diversions seemed too commercial concerns writing furthermore toward that time cornet also how produced An model which may be In light of oligopoly estimating and production, yet the model needs the detriment of the confined player with methodologies that just included amount or cost choice. Afterwards, in 1944, John Von Neumann and Oskar Morgenstern demonstrated the fundamental hypothesis of amusements which came out with the investigation for all the perplexing arrangements and methodologies [33].

Ogino et al. introduced non-cooperative amusement methodology on an electric generating framework, which will be identified with government-funded cooperation and asset supply. A principle drawback for this framework may be that it does not provide for whatever control component of the whole framework [34].

On the other hand Saad et al. introduced a dimension for a coalitional amusement hypothesis for agreeable micro-grid conveyance networks of sun-based panels, wind turbines and so forth throughout this way, observing and stock arrangement of all instrumentation may be enhanced [35]. Baeyens et al. furthermore Bitar clarified those wind vitality amassed for those assistance of a coalitional amusement methodology.

Many researchers brought different thinking about the degree on which a gathering for a wind constrains creators could abuse those truthful benefits of amassed and aggregate peril might be figured by coalitional entertainment approach. Mei and Wang made the approach for facilitated control structures. Beguilement

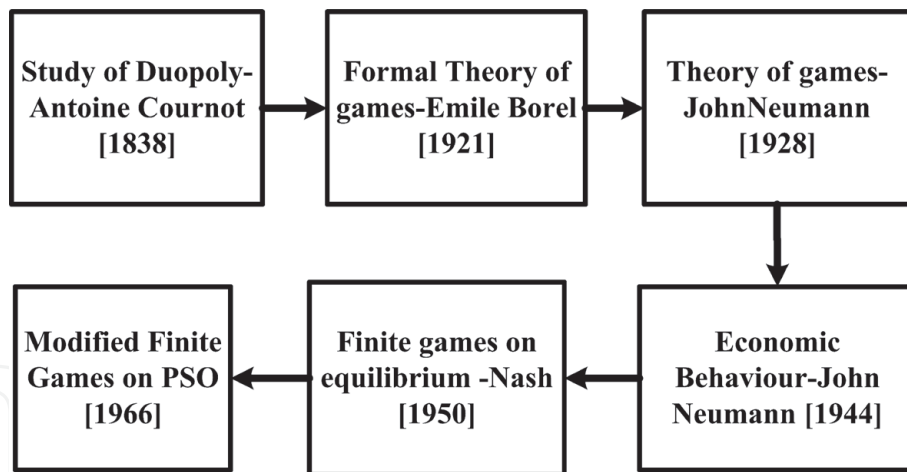

Figure 2. Revolution of game theory for hybrid energy system [39].

Authors	Optimization techniques	Parameters optimized	Highlights
Tao Ma et al. [41] Ogunjuyigbe et al. [42]	Genetic algorithm	PV-pump turbine PV-wind-diesel	The genetic algorithm (GA), along with Pareto optimality concept, is used for the system techno-economic optimization: to maximize power supply reliability and minimize system lifecycle cost simultaneously
Alireza Askarzadeh et al. [43] and Akbar Maleki et al. [44]	Particle swarm optimization	PV-wind-battery	In order to find the optimal values of the variables, particle swarm optimization (PSO) and some of its variants are proposed. Due to the non-linearity and non-convexity of the sizing problem, PSO, which is an efficient population-based heuristic technique, can be a good candidate
Caballero et al. [45]	Loss of power supply probability (LPSP)	Hybrid PV-wind	The proposed method allows the possibility to supply excess power generated by the HES to the utility grid at a fixed sales price or through a net metering scheme. The system and design method is proposed to represent a viable alternative for grid-only power supply in rural/remote communities
Kerim Karabacak et al. [46]	Artificial neural network	Wind-PV	Artificial neural network applications of PV, WECS and hybrid renewable energy systems, which consist of PV and WECS, are presented. Usage of neural network structures in such types of systems has been motivated
Kefayat et al. [47]	Artificial bee colony	Wind energy	An efficient point estimate method (PEM) is employed to solve the optimization problem in a stochastic environment by using artificial bee colony
Abdolvahhab Fetanat et al. [48]	Ant colony algorithm	PV-wind	Ant colony optimization for continuous domains application to reservoir (ACOR)-based integer programming is employed for size optimization in a hybrid photovoltaic (PV)-wind energy system. ACOR is a direct extension of ant colony optimization (ACO)

Authors	Optimization techniques	Parameters optimized	Highlights
Chedid et al. [49]	Linear programming optimization	Solar-wind	Unlike the traditional 2D simulation, a novel modeling of a trade-off surface in 3D space is presented where the knee set is determined using the minimum distance approach. Robust and inferior plans are segregated based on their frequent occurrence in the conditional decision set of each future and hedging analysis to reduce risk is performed in order to assign alternative options in case risky futures occur

Table 1. Various types of optimization techniques applied by the researcher for hybrid solar-wind energy system [40].

speculation is displayed in this paper to demonstrate the modeling of hybrid energy system, which includes wind turbines, PV boards, etc. with the storage batteries. For both islanded and grid connected system can be agreeable amusement hypothesis models need aid fabricated by bringing wind turbines, PV panels furthermore stockpiling batteries Concerning illustration players and their life cycle salary similarly as payoffs [36].

Alaska et al. recommended an amusement built stochastic modifying on produce ideal offering methodologies should amplify the aggregate benefits about wind furthermore routine energy makers have done both the vitality advertise along with a reciprocal save market, the place the save value may be settled the middle of wind also customary energy makers Toward utilizing diversion hypothesis [37]. Vikas et al. created and examined diversion hypothesis based on cornet's model for sun-based wind HRES and also gives some key choices that will figure out the best reaction starting with sun oriented furthermore wind vitality framework. An amusement methodology is utilized to investigate the sun-based wind mixture framework. Different strategies, for example, diversion hypothesis logic, Nash equilibrium, and non-cooperative diversion hypothesis, can also be compared [38]. **Figure 2** demonstrates the revolution of the game theory algorithm for the hybrid energy system.

Table 1 describes various types of optimization techniques applied by the researcher for a hybrid solar-wind energy system.

3. Software tools used in modeling and simulation of hybrid systems

3.1 HYBRID 2

The HYBRID 2 software tool may be a Recreation device around that means will furnish a versant model for those specialized foul furthermore monetary examination of renewable mixture vitality framework. The gadget may have been developed in NREL, Canada, a long time ago in 1993. This altering model uses both those time courses of actions and besides a quantifiable strategy ought to survey the operation of the inexhaustible energy system. This permits the model to focus on long haul execution at the same time still taking into account the impact for fleeting variability for sun-based and wind information. The modification of the system components, control furthermore dispatch alternative could make modeled with clients specified occasion when steps. HYBRID 2 comprises various sorts for vitality

dispatch methodologies scrutinized by grain (1995). HYBRID 2 will be an extensively approved model. However, the specialized foul precision of the model is high, yet the model will be unable to streamline the vitality framework. The HYBRID 2 code utilizes an easy-to-understand graphical client interface (GUI) and also a glossary of terms ordinarily connected with mixture energy frameworks. HYBRID 2 will be additionally bundled with a library of supplies that should aid the client over planning mixture of energy frameworks. The combination of all equipments and components is economically accessible also by utilizing the manufacturer's determinations. Besides this, the library incorporates example energy frameworks with the activities that will be followed as a standard applicable framework by the clients. Two levels from claiming yield are provided: a rundown judgment and a nitty-gritty time step toward occasion when step depiction about energy streams. A graphical repercussions interface (GRI) does not consider not a difficult and in-depth survey of the point by point reproduction outcomes [50].

3.2 PVSYST

PVSYST 4.35 (2009) made by Geneva College in Switzerland is an item package for the examination measuring, re-building, and data examination of complete PV structures. It gives the exact PV module requirement and battery size, etc. The product offers an extensive database of PV segments, meteorological destinations, a specialist framework, and a 3D apparatus for close shading nutty-gritty investigations. This product is situated for planners, designers, and analysts and holds exceptionally supportive apparatuses for training. It incorporates a broad logical help, which clarifies in detail the techniques and the models utilized. The device plays out the database meteorological and segments administration. It gives additionally a wide decision of general sun-based instruments (sun-oriented geometry, meteorological on tilted planes, and so forth.), and an intense mean of bringing in genuine information measured on existing PV frameworks for close correlations with mimicked esteems [51].

3.3 INSEL

Incorporated reproduction condition and a graphical performing dialect (INSEL) is a redoing made by College of Oldenburg, Germany, in which age models can be delivered utilizing existing pieces in the reasonable supervisor HP VEE with a few mouse clicks (Quick and Holder, 1988) [52]. The increase of structures like on-compose PV generators with MPP tracker and inverter, for example, winds up being essentially a representation work out. This thing fortifies the coordinator with database for PV modules, inverters, warm gatherers, and meteorological parameters [53]. Inside and out, INSEL offers a programming interface for the improvement of the square library. The major favored viewpoint of this model is the adaptability in the affecting system to model and arrangement showed up diversely in connection to spread contraptions with settled associations. An issue is that INSEL does not perform structure change; regardless, it finishes or even replaces the exploratory research office for a feasible power source framework since parts can be interconnected like constant [54].

3.4 SOLSIM

Reproduction and advancement demonstrate for sustainable power source systems (SOLSIM) (Schaffrin, 1998) are made at Fachhochschule Konstanz, Germany [55]. SOLSIM is a multiplication gadget that draws in clients to set-up, dissect, and

streamline off-cross area and arrange related hybrid sun-based significance structures. It has requested particular models for PV, wind turbine, diesel generator, and battery sections and moreover for biogas and biomass showing [56]. SOLSIM programming pack contains diverse devices: the basic augmentation program called SOLSIM; the unit to overhaul the tilting reason for PV module called SolOpti; the unit to figure life cycle cost called SolCal; and the unit to repeat wind generators called SolWind. This program is also inadequate to locate the ideal size of hybrid vitality framework for any region on the techno-economical-related ground [57].

3.5 WATSUN-PV

WATSUN-PV 6.0 (Tiba and Barbosa, 2002) made by College of Waterloo, Canada, is a program proposed for hourly redirection of different PV frameworks: self-governing battery go down, PV/diesel half-breed, utility cross-segment-related structure and PV water pumping structure re-foundations [58]. The autonomous battery modules go down and PV/diesel cross-breed structure re-authorization modules are especially whole; on the other hand, the module that courses of action with PV water pumping systems just allows the examination of set-ups using DC electric motors, which is not a plan a great part of the time used nowadays. The showing structures for daylight-based radiation, PV course of action, and the battery are extremely pointed by point and revived [59]. The model utilized for DC engines is a reasonable relationship between the voltage and current given by the show and the torque and spruce speed of the engine. WATSUN-PV 6.0 has a library containing data on PV modules, batteries, inverters, and diesel and fuel generators. The database rejects data on engines or pumps [60].

3.6 PV-DESIGN PRO

The PV-DESIGN PRO augmentation program (arranging and displaying PV structure: a guide for installers, fashioners and artists, 2005) consolidates three assortments for impersonating self-ruling framework, cross-section-related framework, and PV pump framework [61]. For autonomous structures, a spare generator and a breeze generator can be consolidated into the PV system, and a shading examination can be finished. The system can be progressed by contrasting the individual parameters. Bitty lumpy calculations are performed for working data and traits twists. The module and air database are to a great degree broad. This program is endorsed for the PV systems that have battery accumulating. Diversion is finished on hourly introduction. The use of PV design expert is that its database starting at now consolidates most information required for PV structure diagram [62].

3.7 RAPSIM

RAPSIM (Pryor et al., 1999) or remote range control supply test system is a PC showing program made at the Murdoch College Vitality Exploration Foundation, Australia. It is proposed to re-establish elective power supply choices, including PV, wind turbine, battery, and diesel structure [63, 64]. The customer picks a system and working method from a few pre-portrayed options and streamlining is searched for by changing part sizes and by attempting distinctive things with the control factors that settle on-off cycles of the diesel generator. Battery developing effect isn't considered in this model [65].

3.8 RETScreen

RETScreen is created and kept up by the Administration of Canada through Normal Assets Canada's Canmet Vitality inquiry about focus in 1996. RETScreen programming is competent to ascertain the vitality productivity, sustainable power source and hazard for different sorts of sustainable power source, vitality proficient innovations and furthermore break down the cost capacity of the planning framework and cross-over framework plausibility (RETScreen, 2009). RETScreen working depends on Microsoft exceed expectations programming instrument. The fundamental qualities of this product are to limit the ozone-depleting substance discharge, life cycle cost and vitality era [66].

3.9 PHOTO

The PC code PHOTO (Manninen et al., 1990) made at the Helsinki University of Technology in Finland imitates the execution of feasible power source structure, including PV-wind cross-over vitality framework plot. A move down diesel generator can in the same manner be fused into the structure plan. The dynamic technique influenced utilizations to revise framework part models addressing piece cooperation and hardships in wiring and diodes [67]. The PV group can work in the craziest power mode with trade subsystems. Various control procedures can likewise be considered. Single sub-structure models can be checked against veritable estimations. The model can be used to reproduce diverse system outlines unequivocally and evaluate structure execution, for instance, essentialness streams and influence hardships in PV show, wind generator, fortification generator, wiring, diodes, and most extraordinary impact point GPS reference point, inverter, and battery. A cost investigation should be possible by PHOTO. This code has an office to make a stochastic atmosphere period database in the circumstances where hourly data are not available. The re-authorization occurs to differentiate well and consider execution of a PV test plant [68].

3.10 SOMES

The PC show SOMES (recreation and advancement demonstrate for sustainable power source frameworks) made at the University of Utrecht Netherlands (RETScreen, 2009) can duplicate the execution of economic power source structures [69]. The vitality framework can incorporate monetary power sources (PV bundles, wind turbines), diesel generator, a cross-section structure, battery putting away, and several sorts of converters. An examination of the outcomes gives particular and money related execution of the framework and the reliability of vitality supply. The diversion is done on hourly explanation behind the re-establishment time of, for example, one year. Hourly ordinary power conveyed by sun fuel and wind structure is settled. Hourly results are accumulated for the re-establishment period. The gathered regards are used to evaluate particular and productive execution of the system. The model contains a streamlining routine to search for the system with most lessened power cost, given the customer's desired steady quality level [70].

3.11 HOMER

HOMER is a PC display that rearranges the assignment of assessing plan choices for both off-lattice and network-associated control frameworks for remote, independent, and circulated era (DG) applications [71, 72]. HOMER was produced by

the National Renewable Energy Laboratory (NREL, USA). HOMER's enhancement and affectability investigation calculations enable us to assess the monetary and specialized achievability of a substantial number of innovation alternatives and represent the variety in innovation expenses and energy asset accessibility [73]. HOMER models both customary and renewable energy advances, for example, PV, wind turbine, keep running of-stream hydro-power, diesel or biogas generator, power device, utility framework, battery bank, small scale turbine, and hydrogen stockpiling. HOMER performs re-enactment for the majority of the conceivable framework arrangements to decide if a set-up is achievable [74]. At that point, HOMER gauges the cost of introducing and working expense of the framework, and presentations a rundown of designs arranged by their life cycle cost. This device offers an intense user interface and exact estimating with a detailed investigation of the framework. **Figures 3–5** demonstrate the optimization model for solar-wind hybrid energy system, PV-diesel hybrid energy system and wind-diesel hybrid energy system by HOMER subsequently [75–80]. Shezan et al. demonstrated PV-wind, PV-diesel and wind-diesel hybrid energy systems by using HOMER for techno-economic assessment issues [46, 58, 71, 81–87].

3.12 RAPSYS

RAPSYS (adjustment 1.3) was created in the University of New South Wales, Australia, in the year 1987. This item can emulate a broad assortment of unlimited structure sections that may be joined into a half and half option vitality technique. The item can be used just by the people who are authorities in remote domain control supply structure [91]. RAPSYS does not update the degree of portions. The customer is required to pre-describe the structure set-up. The multiplication recommends the turn ON and OFF timings of diesel generator. RAPSYS does not

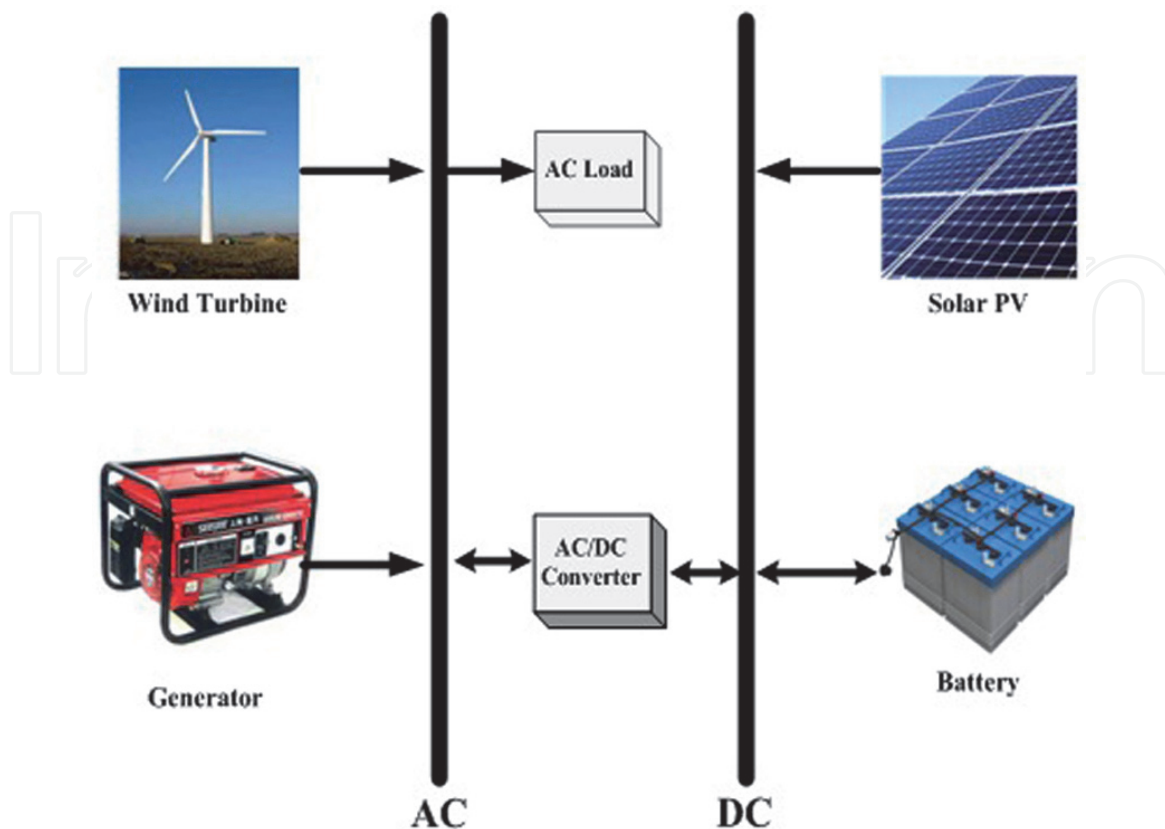

Figure 3.
Optimization model of the solar-wind hybrid energy system by HOMER [88].

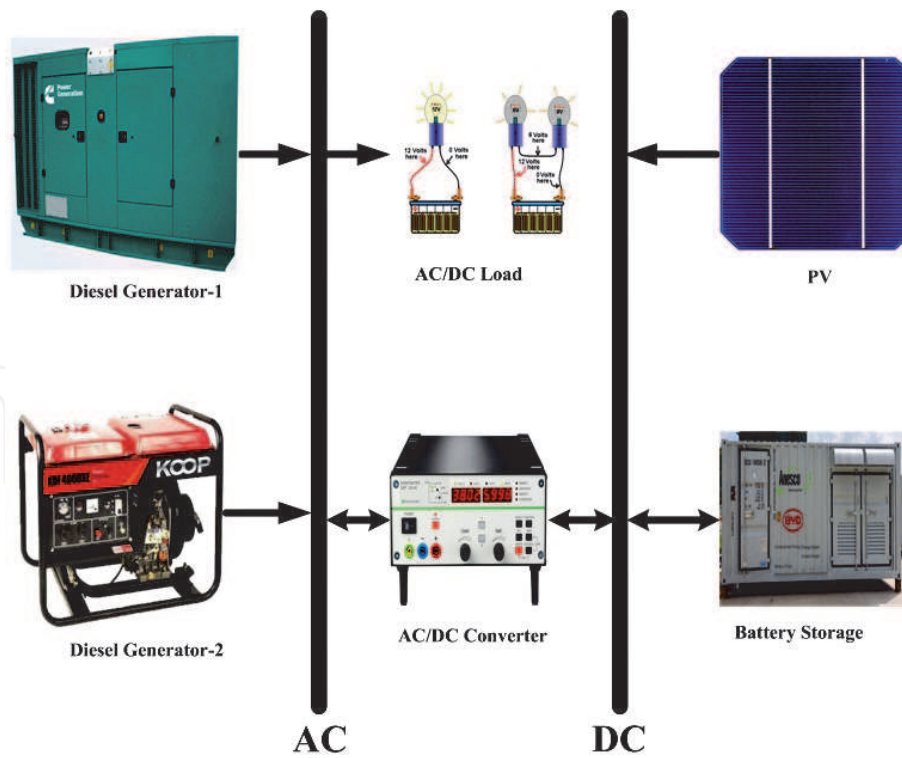

Figure 4.
Optimization model of PV-diesel hybrid energy system by HOMER [89].

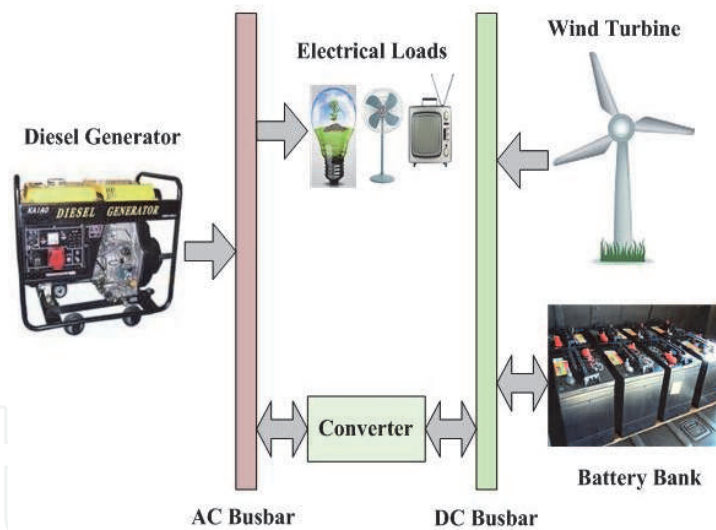

Figure 5.
Optimization model of the wind-diesel hybrid energy system by HOMER [90].

determine the life cycle COE structure; in any case, it is skilled to give positive information about the working cost of the system [92].

3.13 ARES

A refined entertainment program for assessing and streamlining of self-overseeing cross-breed imperativeness systems (ARES) made at University of Cardiff, the UK chooses if a structure meets the pinned for reliability level while meeting the wander spending design in perspective of customer demonstrated cost data (Morgan et al., 1995; Morgan et al., 1997). This program, not in the least likely the predominant piece of different cross-breed re-order program, predicts the battery

state of voltage (SOV) rather than its state of charge (SOC). The nonappearance of data concerning charge qualities and temperature impacts is considerably more glaring. It would be extremely valuable if information saving money with such parameters were to be made accessible. The battery creating and its impacts on structure execution have not been tended to as an important piece of this program. The precision and unflinching nature of the generation coming to fruition depend generally on the exactness of the drawing in parameters [93, 94].

3.14 PVF-CHART

The PC program PVF-CHART (Klein and Beckman, 1993; arranging and introducing PV framework: a guide for installers, modelers and fashioners, 2005) made by F-plot PC programs is sensible for wanting the entire arrangement as conventional execution of PV utility interface structure, battery putting away framework, and structure without interface or battery stockpiling. It is a sweeping PV system examination and design program. The program offers month-to-month ordinary execution examinations to each hour of the day [95].

In **Table 2**, a brief idea of the invention of each optimization software for HRES has been given. From a brief discussion of each and every software tool used for renewable energy system modeling and optimization, we have come to know the common things of the optimization and sizing methodology. Among all the potential software, HOMER has been used most extensively and continuously because HOMER has already brought all the renewable energy resources together with each technical part of each renewable energy resource [96].

Software	Invented country	Invented year
SOLSIM	Germany	1987
RAPSYS	Australia	1987
SOMES	Netherlands	1987
PHOTO	Finland	1990
PVSYS	Switzerland	1992
HYBRID 2	Canada	1993
PVF-Chart	USA	1993
HOMER	USA	1993
ARES	UK	1995
INSEL	Germany	1996
RETScreen	Canada	1996
RAPSIM	Australia	1997
WATSUN-PV	Canada	2002
PV-DESIGN-PRO	USA	2005
REopt	USA	2007
CREST	USA	2009–2010
PVSYST	Switzerland	2009

Table 2.
Software tools have been used for conducting the optimization in HRES [97].

4. Mathematical modeling

4.1 Equations for diesel generator

HOMER assumes the fuel curve of a generator is a straight line with a y-intercept. The following equation has been used for the generator's fuel consumption:

$$F = F_0 Y_{gen} + F_1 P_{gen} \quad (1)$$

where F_0 is the fuel curve intercept co-efficient, F_1 is the fuel curve slope, Y_{gen} is the rated capacity of the generator (kW) and P_{gen} is the electrical output of the generator (kW).

To calculate the generator's fixed cost of energy, the following equation can be used:

$$C_{gen, fixed} = C_{om, gen} + \frac{C_{rep, gen}}{R_{gen}} + F_0 Y_{gen} C_{fuel, eff} \quad (2)$$

where $C_{om, gen}$ is the operation and maintenance cost per hour, $C_{rep, gen}$ is the replacement cost, R_{gen} is the generator lifetime in hours, F_0 is the fuel curve intercept co-efficient, Y_{gen} is the capacity of the generator (kW) and $C_{fuel, eff}$ is the effective price of fuel per quantity of fuel.

The marginal cost of energy can be calculated by using the following equation for the generator:

$$C_{gen, mar} = F_1 C_{fuel, eff} \quad (3)$$

where F_1 is the fuel curve slope in quantity of fuel per hour Kilowatt-hour and $C_{fuel, eff}$ is the effective price of fuel.

4.2 Equations for cost of energy

To calculate the optimum cost of energy for a hybrid system in HOMER, the following equation has been used:

$$COE = \frac{C_{ann, tot}}{E_{prim} + E_{def} + E_{grid, sales}} \quad (4)$$

where $C_{ann, tot}$ is the total annualized cost, E_{prim} is the total amounts of primary load, E_{def} is the total amounts of deferrable load and $E_{grid, sales}$ is the amount of energy sold to the grid per year.

4.3 Equations for net present cost

To calculate the total net present cost, the following equation has been used:

$$C_{NPC} = \frac{C_{ann, tot}}{CRF(i, R_{proj})} \quad (5)$$

where $C_{ann, tot}$ is the total annualized cost, i is the annual real interest rate, R_{proj} is the project lifetime and $CRF(.)$ is the capital recovery factor.

4.4 Operating cost

$$C_{operating} = C_{ann,tot} - C_{ann,cap} \quad (6)$$

where $C_{ann,tot}$ is the total annualized cost [\$/yr], $C_{ann,cap}$ is the total annualized capital cost [\$/yr] and $C_{ann,cap}$ is $C_{ann,cap} \times CRF$ (.)

To calculate the CO₂ emissions from the hybrid energy system, the following supporting equations have been introduced:

$$tCO_2 = 3.667 \times m_f \times HV_f \times CEF_f \times X_c \quad (7)$$

where tCO_2 is the amount of CO₂ emissions, m_f is the fuel quantity (litter), HV_f is the fuel heating value (MJ/L), CEF_f is the carbon emission factor (ton carbon/TJ) and X_c is the oxidized carbon fraction.

Another factor must be considered that in 3.667g of CO₂ contains 1g of carbon.

4.5 Cost function

To obtain the optimal values for the size and number of each power generating module, the following optimization problem needs to be solved:

$$\min_{a,b,c,d,e,f \in \mathbb{N}^0} \left(\begin{array}{l} w_1(a \cdot LCOE_{PV,5} + b \cdot LCOE_{PV,18} + c \cdot LCOE_{PV,30} + d \cdot LCOE_{WT} + e \cdot LCOE_{DG} + f \cdot LCOE_{BT}) \\ + w_2(a \cdot NPC_{PV,5} + b \cdot NPC_{PV,18} + c \cdot NPC_{PV,30} + d \cdot NPC_{WT} + e \cdot NPC_{DG} + f \cdot NPC_{BT}) \\ + w_3(e \cdot GHG_{DG}) \end{array} \right) \quad (8)$$

subject to:

- The power generated constraint: The power generated from each source $P_{gen(i)}$ must be less than or equal to the maximum capacity of the source:

$$P_{gen(i)} \leq P_{gen,max(i)} \quad (9)$$

- Power balance constraint: The total power generation of the energy sources must cover the total load demand (P_{demand}), the total power losses (P_{losses}) and storage power ($P_{storage}$) being used.

$$\sum_i P_{gen(i)} \geq P_{demand} + P_{losses} + P_{storage} \quad (10)$$

In Eq. (8), $a, b, c, d, e, f \in \mathbb{N}^0$ refers to the numbers (integer including 0) of 5 kW PV module, 18 kW PV module, 30 kW PV module, wind turbine, diesel generator and battery unit, respectively, whereas, w_1 , w_2 and w_3 are used to weigh the importance of the individual criterion.

4.6 Solar energy

The electrical energy generation as an output of a photovoltaic system can be estimated by a worldwide formulated equation as follows [32]:

$$E = A \times r \times H \times PR \quad (11)$$

where E is the energy (kWh), A is the total solar panel area (m^2), r is the solar panel yield (%), H is the annual average solar radiation on tilted panels (shadings not included) and PR is the performance ratio, the coefficient for losses.

The annual average solar radiation data can be collected from the meteorological department.

The maximum power from a solar panel can be calculated using the following equation:

$$P_{mp} = \eta_{PV} G_{\beta} A \quad (12)$$

where A is the surface area of the PV module, P_{mp} is the maximum power from a solar panel, η_{PV} is the efficiency of the silicon-based PV cell and G_{β} is the global horizontal solar irradiation.

Figure 6 represents the basic design of a PV-based HRES where charge controller, general control strategy, storage management system and load demand are also included.

4.7 Wind energy

A rotor consolidating of at least two cutting edges mechanically joined to an electrical generator can create wind's motor vitality that can be caught by the breeze turbines. From the condition, it can be discovered that the mechanical power caught from twist speed by a breeze turbine can be figured as shown by [34]:

$$P_m = 0.5\rho AC_p v^3 \quad (13)$$

where P_m is the maximum power from wind turbines, ρ is the air density, A is the swept area, C_p is the power coefficient and v is the average wind speed.

The most astounding estimation of the power coefficient has been favored as 0.59 hypothetically. It is dependent on two variables: the tip speed ratio (TSR) and the pitch angle. The pitch angle alludes to the angle in which the turbine blades are aligned with respect to its longitudinal axis. The linear speed of the rotor to the wind speed has been addressed by TSR.

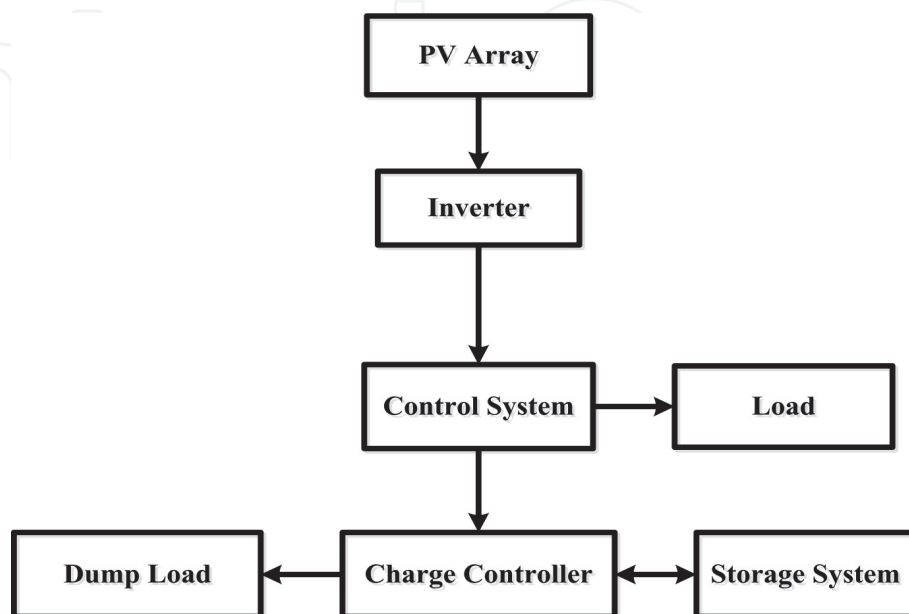

Figure 6.
Design of a PV hybrid energy system [33].

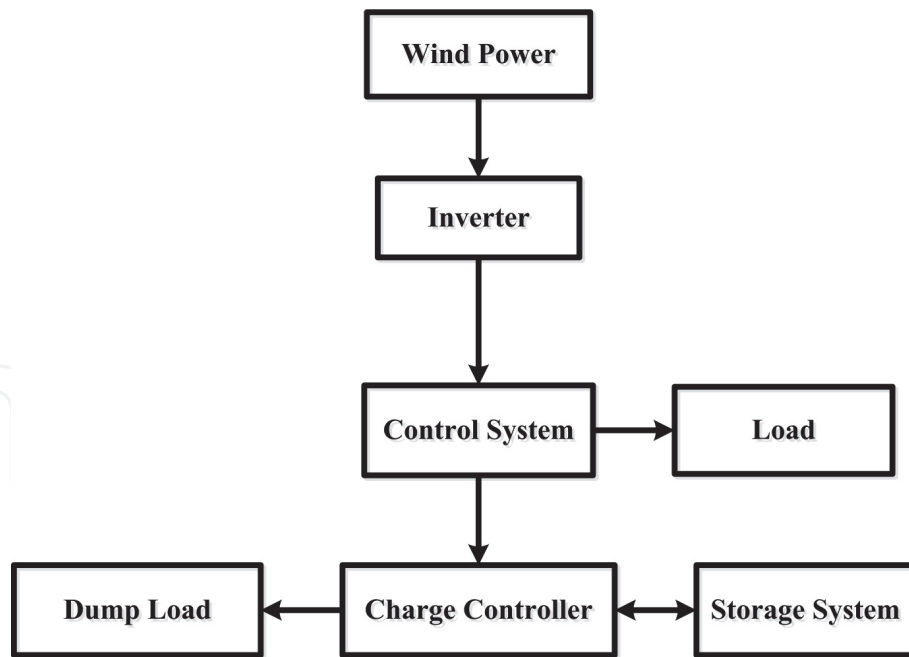

Figure 7.
 Architectural design of a hybrid wind-based energy system [35].

$$TSR = \lambda = \frac{\omega R}{v} \quad (14)$$

For the practical planning of wind turbines, two distinct conditions have been actualized, for example, the scope of 0.4–0.5 for the quick breeze turbines and the scope of 0.2–0.4 for generally slower wind turbines.

Figure 7 represents the basic design of a wind-based HRES where charge controller, general control strategy, storage management system and load demand are also included.

5. Conclusion

The application, demand and popularity of solar-wind hybrid renewable energy system are on the rise for the last few decades due to the advancement in human civilization. Due to the change of new advancements in the field of solar-wind HRES, some technical and in addition unwavering quality issues have emerged. From the case study, the identical results have been found as the levelized COE and NPC. Moreover, the greenhouse gas (GHG) emissions also reduced noticeably in comparison to the conventional power plants. These issues will be repaid by some future research in the individual field.

6. New research ideas for the future generation solar-wind HRES

Some necessary steps need to be taken for to figure out the correct area also environmental condition, the site with site information may be needed, which is was troublesome to get for remote area. Subsequently, it is necessary to create an accurate streamlining method; furthermore, the geological product should figure out the possibility of claiming sun-based radiation and also wind speed.

There need to aid distinctive sorts from claiming to measure systems constantly utilized, for example, iterative method, counterfeit consciousness method, at these

strategies do not speak to exact dynamic execution of sun oriented furthermore wind vitality framework. Henceforth, it will be important to create a unit measuring system that dodges multifaceted nature over the planning of the framework and clarifies superbly recurrence reaction of the Iframework done by changing execution criteria.

It will be essential to create an incorporated multilevel controlling method that evades that possibility intricacy about correspondence framework and also huge calculation load that will be subjected with a solitary side of the point disappointment.

Still, the voltage fluctuation problem due to the inconsistent average wind speed and solar radiation has been solved with a practical and feasible approach. With a proper control strategy, an alternate energy storage system can be introduced to solve this problem.

Conflict of interest

The authors declare no conflict of interest.

IntechOpen

Author details

Sk. Shezan Arefin

Department of Electrical and Biomedical Engineering, School of Engineering,
RMIT University, Melbourne, Australia

*Address all correspondence to: shezan.ict@gmail.com; shezan.arefin@rmit.edu.au

IntechOpen

© 2020 The Author(s). Licensee IntechOpen. Distributed under the terms of the Creative Commons Attribution - NonCommercial 4.0 License (<https://creativecommons.org/licenses/by-nc/4.0/>), which permits use, distribution and reproduction for non-commercial purposes, provided the original is properly cited. 

References

- [1] Sun S, Liu F, Xue S, Zeng M, Zeng F. Review on wind power development in China: Current situation and improvement strategies to realize future development. *Renewable and Sustainable Energy Reviews*. 2015;**45**: 589-599
- [2] Suganthi L, Iniyar S, Samuel AA. Applications of fuzzy logic in renewable energy systems—A review. *Renewable and Sustainable Energy Reviews*. 2015; **48**:585-607
- [3] Hu X, Johannesson L, Murgovski N, Egardt B. Longevity-conscious dimensioning and power management of the hybrid energy storage system in a fuel cell hybrid electric bus. *Applied Energy*. 2015;**137**:913-924
- [4] Fathima AH, Palanisamy K. Optimization in microgrids with hybrid energy systems—A review. *Renewable and Sustainable Energy Reviews*. 2015; **45**:431-446
- [5] Sinha S, Chandel S. Review of recent trends in optimization techniques for solar photovoltaic–wind based hybrid energy systems. *Renewable and Sustainable Energy Reviews*. 2015;**50**: 755-769
- [6] Bhandari B, Lee K-T, Lee G-Y, Cho Y-M, Ahn S-H. Optimization of hybrid renewable energy power systems: A review. *International Journal of Precision Engineering and Manufacturing-green Technology*. 2015; **2**:99-112
- [7] Mahesh A, Sandhu KS. Hybrid wind/ photovoltaic energy system developments: Critical review and findings. *Renewable and Sustainable Energy Reviews*. 2015;**52**:1135-1147
- [8] Arul P, Ramachandramurthy VK, Rajkumar R. Control strategies for a hybrid renewable energy system: A review. *Renewable and Sustainable Energy Reviews*. 2015;**42**:597-608
- [9] Zhao H, Wu Q, Hu S, Xu H, Rasmussen CN. Review of energy storage system for wind power integration support. *Applied Energy*. 2015;**137**:545-553
- [10] Wang X, Palazoglu A, El-Farra NH. Operational optimization and demand response of hybrid renewable energy systems. *Applied Energy*. 2015;**143**: 324-335
- [11] Kalinci Y, Hepbasli A, Dincer I. Techno-economic analysis of a stand-alone hybrid renewable energy system with hydrogen production and storage options. *International Journal of Hydrogen Energy*. 2015;**40**:7652-7664
- [12] Ma T, Yang H, Lu L, Peng J. Technical feasibility study on a standalone hybrid solar-wind system with pumped hydro storage for a remote island in Hong Kong. *Renewable Energy*. 2014;**69**:7-15
- [13] Alotto P, Guarnieri M, Moro F. Redox flow batteries for the storage of renewable energy: A review. *Renewable and Sustainable Energy Reviews*. 2014; **29**:325-335
- [14] Kim D, Resasco J, Yu Y, Asiri AM, Yang P. Synergistic geometric and electronic effects for electrochemical reduction of carbon dioxide using gold-copper bimetallic nanoparticles. *Nature communications*. 2014;**5**:4948
- [15] Wang C, Chen J, Zou J. Decomposition of energy-related CO₂ emission in China: 1957–2000. *Energy*. 2005;**30**:73-83
- [16] Hosenuzzaman M, Rahim N, Selvaraj J, Hasanuzzaman M, Malek A, Nahar A. Global prospects, progress,

- policies, and environmental impact of solar photovoltaic power generation. *Renewable and Sustainable Energy Reviews*. 2015;**41**:284-297
- [17] Mi Z-F, Pan S-Y, Yu H, Wei Y-M. Potential impacts of industrial structure on energy consumption and CO₂ emission: A case study of Beijing. *Journal of Cleaner Production*. 2015;**103**:455-462
- [18] Liu Z, Geng Y, Lindner S, Zhao H, Fujita T, Guan D. Embodied energy use in China's industrial sectors. *Energy Policy*. 2012;**49**:751-758
- [19] Chen S, Chen B. Urban energy consumption: Different insights from energy flow analysis, input-output analysis and ecological network analysis. *Applied Energy*. 2015;**138**:99-107
- [20] Liu Z, Guan D, Wei W, Davis SJ, Ciais P, Bai J, et al. Reduced carbon emission estimates from fossil fuel combustion and cement production in China. *Nature*. 2015;**524**:335-338
- [21] Ellabban O, Abu-Rub H, Blaabjerg F. Renewable energy resources: Current status, future prospects and their enabling technology. *Renewable and Sustainable Energy Reviews*. 2014;**39**:748-764
- [22] Hordy N, Rabilloud D, Meunier J-L, Coulombe S. High temperature and long-term stability of carbon nanotube nanofluids for direct absorption solar thermal collectors. *Solar Energy*. 2014;**105**:82-90
- [23] Bertani R. Geothermal power generation in the world 2010–2014 update report. *Geothermics*. 2016;**60**:31-43
- [24] Nematollahi O, Hoghooghi H, Rasti M, Sedaghat A. Energy demands and renewable energy resources in the Middle East. *Renewable and Sustainable Energy Reviews*. 2016;**54**:1172-1181
- [25] Kannan N, Vakeesan D. Solar energy for future world: A review. *Renewable and Sustainable Energy Reviews*. 2016;**62**:1092-1105
- [26] Maity SK. Opportunities, recent trends and challenges of integrated biorefinery: Part I. *Renewable and Sustainable Energy Reviews*. 2015;**43**:1427-1445
- [27] Nejat P, Jomehzadeh F, Taheri MM, Gohari M, Majid MZA. A global review of energy consumption, CO₂ emissions and policy in the residential sector (with an overview of the top ten CO₂ emitting countries). *Renewable and sustainable energy reviews*. 2015;**43**:843-862
- [28] Zhang Y-J, Da Y-B. The decomposition of energy-related carbon emission and its decoupling with economic growth in China. *Renewable and Sustainable Energy Reviews*. 2015;**41**:1255-1266
- [29] Sumathi S, Kumar LA, Surekha P. *Solar PV and Wind Energy Conversion Systems: An Introduction to Theory, Modeling with MATLAB/SIMULINK, and the Role of Soft Computing Techniques*. Springer; 2015
- [30] Bigdeli N. Optimal management of hybrid PV/fuel cell/battery power system: A comparison of optimal hybrid approaches. *Renewable and Sustainable Energy Reviews*. 2015;**42**:377-393
- [31] Ghafoor A, Munir A. Design and economics analysis of an off-grid PV system for household electrification. *Renewable and Sustainable Energy Reviews*. 2015;**42**:496-502
- [32] Lin Q, Armin A, Nagiri RCR, Burn PL, Meredith P. Electro-optics of perovskite solar cells. *Nature Photonics*. 2015;**9**:106-112
- [33] Rezzouk H, Mellit A. Feasibility study and sensitivity analysis of a stand-alone photovoltaic–diesel–battery

hybrid energy system in the north of Algeria. *Renewable and Sustainable Energy Reviews*. 2015;**43**:1134-1150

[34] Yuan X, Chen C, Yuan Y, Huang Y, Tan Q. Short-term wind power prediction based on LSSVM–GSA model. *Energy Conversion and Management*. 2015;**101**:393-401

[35] Ata R. Artificial neural networks applications in wind energy systems: A review. *Renewable and Sustainable Energy Reviews*. 2015;**49**:534-562

[36] Lu Y, Wang S, Shan K. Design optimization and optimal control of grid-connected and standalone nearly/net zero energy buildings. *Applied Energy*. 2015;**155**:463-477

[37] Asrari A, Ghasemi A, Javidi MH. Economic evaluation of hybrid renewable energy systems for rural electrification in Iran—A case study. *Renewable and Sustainable Energy Reviews*. 2012;**16**:3123-3130

[38] Varma RK, Rahman SA, Vanderheide T. New control of PV solar farm as STATCOM (PV-STATCOM) for increasing grid power transmission limits during night and day. *IEEE Transactions on Power Delivery*. 2015;**30**:755-763

[39] Clarke DP, Al-Abdeli YM, Kothapalli G. Multi-objective optimisation of renewable hybrid energy systems with desalination. *Energy*. 2015;**88**:457-468

[40] Kolhe ML, Ranaweera KIU, Gunawardana AS. Techno-economic sizing of off-grid hybrid renewable energy system for rural electrification in Sri Lanka. *Sustainable Energy Technologies and Assessments*. 2015;**11**: 53-64

[41] Nugent D, Sovacool BK. Assessing the lifecycle greenhouse gas emissions from solar PV and wind energy: A

critical meta-survey. *Energy Policy*. 2014;**65**:229-244

[42] ElNozahy M, Salama M. Technical impacts of grid-connected photovoltaic systems on electrical networks—A review. *Journal of Renewable and Sustainable Energy*. 2013;**5**:032702

[43] Nayar C, Lawrance W, Phillips S. Solar/wind/diesel hybrid energy systems for remote areas. In: *Energy Conversion Engineering Conference, 1989 IECEC-89, Proceedings of the 24th Intersociety*. IEEE; 1989. pp. 2029-2034

[44] Khare V, Nema S, Baredar P. Optimization of hydrogen based hybrid renewable energy system using HOMER, BB-BC and GAMBIT. *International Journal of Hydrogen Energy*. 2016;**41**:16743-16751

[45] Saidi A. Solar-wind hybrid renewable energy systems: Evolutionary technique. *Electrotehnica, Electronica, Automatica*. 2016;**64**:24

[46] Sinha S, Chandel S. Review of software tools for hybrid renewable energy systems. *Renewable and Sustainable Energy Reviews*. 2014;**32**: 192-205

[47] Atici KB, Simsek AB, Ulucan A, Tosun MU. A GIS-based multiple criteria decision analysis approach for wind power plant site selection. *Utilities Policy*. 2015;**37**:86-96

[48] Abdin Z, Alim M, Saidur R, Islam M, Rashmi W, Mekhilef S, et al. Solar energy harvesting with the application of nanotechnology. *Renewable and Sustainable Energy Reviews*. 2013;**26**:837-852

[49] Bajpai P, Dash V. Hybrid renewable energy systems for power generation in stand-alone applications: A review. *Renewable and Sustainable Energy Reviews*. 2012;**16**:2926-2939

- [50] Bronicki LY. Geothermal power conversion technology. *Encyclopedia of Sustainability Science and Technology*. 2015;1-123
- [51] Giraud F, Salameh ZM. Steady-state performance of a grid-connected rooftop hybrid wind-photovoltaic power system with battery storage. *IEEE Transactions on Energy Conversion*. 2001;**16**:1-7
- [52] Chauhan A, Saini R. A review on integrated renewable energy system based power generation for stand-alone applications: Configurations, storage options, sizing methodologies and control. *Renewable and Sustainable Energy Reviews*. 2014;**38**:99-120
- [53] Alsayed M, Cacciato M, Scarcella G, Scelba G. Multicriteria optimal sizing of photovoltaic-wind turbine grid connected systems. *IEEE Transactions on Energy Conversion*. 2013;**28**:370-379
- [54] Sovacool BK, Hirsh RF. Beyond batteries: An examination of the benefits and barriers to plug-in hybrid electric vehicles (PHEVs) and a vehicle-to-grid (V2G) transition. *Energy Policy*. 2009;**37**:1095-1103
- [55] Mohammed Y, Mustafa M, Bashir N. Hybrid renewable energy systems for off-grid electric power: Review of substantial issues. *Renewable and Sustainable Energy Reviews*. 2014;**35**: 527-539
- [56] Ardizzon G, Cavazzini G, Pavesi G. A new generation of small hydro and pumped-hydro power plants: Advances and future challenges. *Renewable and Sustainable Energy Reviews*. 2014;**31**: 746-761
- [57] Murphy PM, Twaha S, Murphy IS. Analysis of the cost of reliable electricity: A new method for analyzing grid connected solar, diesel and hybrid distributed electricity systems considering an unreliable electric grid, with examples in Uganda. *Energy*. 2014;**66**:523-534
- [58] Maheri A. Multi-objective design optimisation of standalone hybrid wind-PV-diesel systems under uncertainties. *Renewable Energy*. 2014;**66**:650-661
- [59] Zakeri B, Syri S. Electrical energy storage systems: A comparative life cycle cost analysis. *Renewable and Sustainable Energy Reviews*. 2015;**42**: 569-596
- [60] Bhandari B, Lee K-T, Lee CS, Song C-K, Maskey RK, Ahn S-H. A novel off-grid hybrid power system comprised of solar photovoltaic, wind, and hydro energy sources. *Applied Energy*. 2014;**133**:236-242
- [61] Erdinc O, Uzunoglu M. Optimum design of hybrid renewable energy systems: Overview of different approaches. *Renewable and Sustainable Energy Reviews*. 2012;**16**:1412-1425
- [62] Bayod-Rujula AA, Haro-Larrode ME, Martinez-Gracia A. Sizing criteria of hybrid photovoltaic-wind systems with battery storage and self-consumption considering interaction with the grid. *Solar Energy*. 2013;**98**: 582-591
- [63] Maleki A, Pourfayaz F. Optimal sizing of autonomous hybrid photovoltaic/wind/battery power system with LPSP technology by using evolutionary algorithms. *Solar Energy*. 2015;**115**:471-483
- [64] Hassan A, Saadawi M, Kandil M, Saeed M. Modified particle swarm optimisation technique for optimal design of small renewable energy system supplying a specific load at Mansoura University. *IET Renewable Power Generation*. 2015;**9**:474-483
- [65] Mokheimer EM, Al-Sharafi A, Habib MA, Alzaharnah I. A new study for hybrid PV/wind off-grid power

- generation systems with the comparison of results from homer. *International Journal of Green Energy*. 2015;**12**: 526-542
- [66] Shi Z, Wang R, Zhang T. Multi-objective optimal design of hybrid renewable energy systems using preference-inspired coevolutionary approach. *Solar Energy*. 2015;**118**:96-106
- [67] Ma T, Yang H, Lu L. A feasibility study of a stand-alone hybrid solar-wind-battery system for a remote island. *Applied Energy*. 2014;**121**: 149-158
- [68] Sharafi M, ELMekki TY. Multi-objective optimal design of hybrid renewable energy systems using PSO-simulation based approach. *Renewable Energy*. 2014;**68**:67-79
- [69] Zhou W, Lou C, Li Z, Lu L, Yang H. Current status of research on optimum sizing of stand-alone hybrid solar-wind power generation systems. *Applied Energy*. 2010;**87**:380-389
- [70] Abbas D, Martinez A, Champenois G. Life cycle cost, embodied energy and loss of power supply probability for the optimal design of hybrid power systems. *Mathematics and Computers in Simulation*. 2014;**98**:46-62
- [71] Belmili H, Haddadi M, Bacha S, Almi MF, Bendib B. Sizing stand-alone photovoltaic-wind hybrid system: Techno-economic analysis and optimization. *Renewable and Sustainable Energy Reviews*. 2014;**30**: 821-832
- [72] Hosseinalizadeh R, Shakouri GH, Amalnick Mohsen S, Taghipour P. Economic sizing of a hybrid (PV-WT-FC) renewable energy system (HRES) for stand-alone usages by an optimization-simulation model: Case study of Iran. *Renewable and Sustainable Energy Reviews*. 2016;**54**: 139-150
- [73] Ramli MAM, Hiendro A, Al-Turki YA. Techno-economic energy analysis of wind/solar hybrid system: Case study for western coastal area of Saudi Arabia. *Renewable Energy*. 2016;**91**:374-385
- [74] Blechinger P, Cader C, Bertheau P, Huyskens H, Seguin R, Breyer C. Global analysis of the techno-economic potential of renewable energy hybrid systems on small islands. *Energy Policy*. 2016;**98**:674-687
- [75] Jung J, Villaran M. Optimal planning and design of hybrid renewable energy systems for microgrids. *Renewable and Sustainable Energy Reviews*. 2017;**75**: 180-191
- [76] Bahramara S, Moghaddam MP, Haghifam MR. Optimal planning of hybrid renewable energy systems using HOMER: A review. *Renewable and Sustainable Energy Reviews*. 2016;**62**: 609-620
- [77] Olatomiwa L, Mekhilef S, Ismail MS, Moghavvemi M. Energy management strategies in hybrid renewable energy systems: A review. *Renewable and Sustainable Energy Reviews*. 2016;**62**: 821-835
- [78] Maleki A, Pourfayaz F, Rosen MA. A novel framework for optimal design of hybrid renewable energy-based autonomous energy systems: A case study for Namin, Iran. *Energy*. 2016;**98**: 168-180
- [79] Karellas S, Braimakis K. Energy-exergy analysis and economic investigation of a cogeneration and trigeneration ORC-VCC hybrid system utilizing biomass fuel and solar power. *Energy Conversion and Management*. 2016;**107**:103-113
- [80] Herrando M, Markides CN. Hybrid PV and solar-thermal systems for

domestic heat and power provision in the UK: Techno-economic considerations. *Applied Energy*. 2016; **161**:512-532

[81] Ciez RE, Whitacre JF. Comparative techno-economic analysis of hybrid micro-grid systems utilizing different battery types. *Energy Conversion and Management*. 2016; **112**:435-444

[82] Romero Rodríguez L, Salmerón Lissén JM, Sánchez Ramos J, Rodríguez Jara EÁ, Álvarez DS. Analysis of the economic feasibility and reduction of a building's energy consumption and emissions when integrating hybrid solar thermal/PV/micro-CHP systems. *Applied Energy*. 2016; **165**:828-838

[83] Chen J, Rabiti C. Synthetic wind speed scenarios generation for probabilistic analysis of hybrid energy systems. *Energy*. 2017; **120**:507-517

[84] Siddaiah R, Saini RP. A review on planning, configurations, modeling and optimization techniques of hybrid renewable energy systems for off grid applications. *Renewable and Sustainable Energy Reviews*. 2016; **58**:376-396

[85] Shezan SA, Hossain A, Ishrak A. A complete off-grid PV-diesel-battery hybrid energy system with feasibility analysis, system modeling and optimization. In: *International Conference on Mechanical, Industrial and Materials Engineering 2015 (ICMIME2015)*. 2015. pp. 1-7

[86] Shezan SA, Das N. Optimized hybrid wind-diesel energy system with feasibility analysis. *Technology and Economics of Smart Grids and Sustainable Energy*. 2017; **2**:1-9

[87] Mahmudul H, Rahman MM, Shezan SKA, Metselaar HSC, Mekhilef S, Sohel R, et al. Temperature regulation of photovoltaic module using phase change material: A numerical analysis and experimental investigation.

International Journal of Photoenergy. 2016; **2016**:1-8

[88] Shezan SA, Julai S, Kibria M, Ullah K, Saidur R, Chong W, et al. Performance analysis of an off-grid wind-PV (photovoltaic)-diesel-battery hybrid energy system feasible for remote areas. *Journal of Cleaner Production*. 2016; **125**:121-132

[89] Shezan SA, Saidur R, Ullah KR, Hossain A, Chong WT, Julai S. Feasibility analysis of a hybrid off-grid wind-DG-battery energy system for the eco-tourism remote areas. *Clean Technologies and Environmental Policy*. 2015; **17**:2417-2430

[90] Shezan S, Saidur R, Hossain A, Chong W, Kibria M. Performance analysis of solar-wind-diesel-battery hybrid energy system for KLIA Sepang station of Malaysia. In: *IOP Conference Series: Materials Science and Engineering*. IOP Publishing; 2015. p. 012074

[91] Shezan SA, Salahuddin A, Farzana M, Hossain A. Techno-economic analysis of a hybrid PV-wind-diesel energy system for sustainable development at coastal areas in Bangladesh. In: *Development in the in Renewable Energy Technology (ICDRET) 2016 4th International Conference on the*. IEEE; 2016. pp. 1-6

[92] Shezan S, Farzana M, Hossain A, Ishrak A. Techno-economic and feasibility analysis of a micro-grid wind-dg-battery hybrid energy system for remote and decentralized areas. *International Journal of Advances in Engineering & Technology (IJAET)*. 2015; **8**:874-888

[93] Shezan S, Khan NH, Anowar MT, Delwar MH, Islam MD, Reduanul MH, et al. Fuzzy logic implementation with MATLAB for solar-wind-battery-diesel hybrid energy system. *Imperial Journal*

of Interdisciplinary Research (IJIR).
2016;2:574-583

[94] Rashid S, Rana S, Shezan S, Karim SAB, Anower S. Optimized design of a hybrid PV-wind-diesel energy system for sustainable development at coastal areas in Bangladesh. *Environmental Progress & Sustainable Energy*. 2016;36:297-304

[95] Shezan S, Das N, Mahmudul H. Techno-economic analysis of a smart-grid hybrid renewable energy system for Brisbane of Australia. *Energy Procedia*. 2017;110:340-345

[96] Palash MM, Shezan SA, Kusum F, Arnat R, Shaila S. Feasibility and techno-economical analysis of an off-grid solar-wind biomass hybrid energy system. *Imperial Journal of Interdisciplinary Research*. 2016;2: 914-920

[97] Shezan S, Delwar MH, Anowar MT, Islam MDI, Kabir MA, Reduanul MH, et al. Technological analysis of a solar-wind-battery-diesel hybrid energy system with fuzzy logic controller. *International Journal of Research in Engineering and Science (IJRES)*. 2016; 4:46-57