

Performance Investigation of Grid Connected Photovoltaic System Modelling Based on MATLAB Simulation

Adnan Hussein Ali, Hassan Salman Hamad, Ali Abdulwahhab Abdulrazzaq

Technical Instructors Training Institute, Middle Technical University, Iraq

Article Info

Article history:

Received Feb 23, 2018

Revised Jul 23, 2018

Accepted Aug 12, 2018

Keyword:

Current-voltage curve

Module irradiance

Photovoltaic (PV)

Power-voltage curve

ABSTRACT

Photovoltaic (PV) systems are normally modeled by employing accurate equations dealing with a behavior the PV system. This model has Characteristic of PV array cells, which are influenced by both irradiation and temperature variations. Grid-connected PV system is considered as electricity generated solar cell system which is connected to the grid utilities. This paper characterizes an exhibiting and simulating of PV system that executed with MATLAB /Simulink. The impact of solar irradiances as well as ambient temperature performances of PV models is investigated and noted that a lower temperature provides maximum power higher so that the open circuit voltage is larger. Furthermore, if the temperature is low, then a considerably short circuit current is low too.

Copyright © 2018 Institute of Advanced Engineering and Science.
All rights reserved.

Corresponding Author:

Adnan Hussein Ali,
Technical Instructors Training Institute,
Middle Technical University,
Baghdad, Iraq.
Email: aaddnnaann63@gmail.com

1. INTRODUCTION

The vast improvement of the recent common economy is a crisis factor of energy as well as the environment, that needs to decrease the requirement on conventional energy besides level improvement of utilization and enlargement of the energy resources such as renewable gradually [1], [2]. By concentrating on renewable source types, solar photovoltaic (PV) can be considered as the main contributors in the world energy sources due to unlimited offer features of power generation in addition to its clean (i.e. no emitted pollution and considers 100% environment friendly), therefore it may be a completely renewable energy technology which has afforded an expansion potential in addition to their world's quickest developing industries [3], [4].

A photovoltaic (PV) system utilizes a solar cell for converting the solar energy to electricity with depends on the photoelectric effect. PV system basically is a cell which may be classified as mono-crystalline, poly-crystalline, organic cell, amorphous, and Nano-PV cells. Now the technology of PV can be used in various applications like plants of solar power, PV grid-connected, home-produced usage, power communication, satellites, and currently aircrafts as well as electric vehicle applications [5]-[7].

In applications of photovoltaic (PV) system, it's necessary to design a comprehensive system to activate the solar cells (SCs) with optimal conditions and maximum efficiencies. The Maximum power point (MPP) is changing greatly with depending on the sunlight angle on the panel surface in addition to cell temperature, therefore the MPP may not be considered as the load operating point of PV system. PV systems can be designed for comprising many required modules with the purpose of supplying reliable energy for the grid [8], [9].

The feeding of electricity by Grid-connected PV systems are directly active with electrical network and working in parallel with a conventional power source. These systems had been satisfying an exponential

evolution rate through the previous decade. An abrupt evolution is coming from a growing attention of climate modification, tax incentives, as well as lowering the cost of PV systems. The major disadvantages PV solar energy created electrical supply concerns by variable power generation during the day, in addition to it permanently changes by atmospheric environments [10].

The system of typical PV grid-connected comprises of an array of PV, the inverter and controller as shown in Figure 1. An inverter part designed for the residential purposing to produce clean electricity close the usage point [11], it can be considered as the essence of PV grid-connected system, it comprises the controllers of maximum power tracking and a synchronization waveform, it may be created from inverting the power into the sinusoidal current injection system. The controller is tracking the PV maximum power point (MPP) so as to control the waveforms of inverter's current grid-connected to the network for transmitting power plus PV array maximum power phase equilibrium [12].

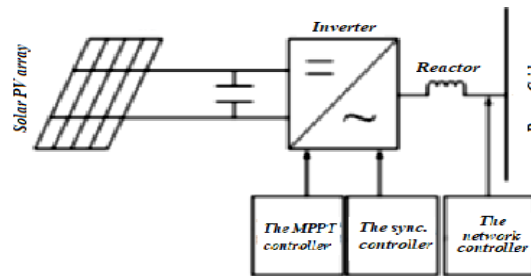

Figure 1. The PV structure system

In this paper, PV grid-connected which includes the inverter and the controller as a tracking the PV maximum power point is simulated to provide the desired DC voltage and current. The MATLAB simulation based on changing the solar irradiancies with constant temperature first and then varying temperature with constant irradiation to obtain the output voltage and current from PV array as well as the output power versus voltage and current. All the results obtained from simulation have been confirmed the validity of the models and efficiency of the suggested model parameters.

2. MATHEMATICAL DESCRIPTION OF PV CELLS MODELS

The basic principles for modeling a PV system represent a unit of converting the power of a PV generator system, they are also dealing with electrical characteristics, that's mean, the relationship of voltage-current of a PV cell with variable weather conditions [13]. The PV module output characteristics based on the solar insolation, the temperature of PV cell and then the PV module output voltage. The solar power radiations are frequently directly renewed to electricity with an impact of electrical phenomenon. An exposition to daylight creates photons that have energy more than the semiconductor gap energy and generates some pairs of electrons-hole that related to the incident irradiation.

The equivalent model circuit of a PV cell can be shown in Figure 2 (a) and (b), with a simplified PV equivalent model in (a) and single-diode model in (b). The production of electrical energy from the PV cell may be represented by current (I_{ph}) requested from a source of voltage-dependent current. The totals of generating energy (current and voltage) are related to solar radiation and the ambient temperature [14], [15].

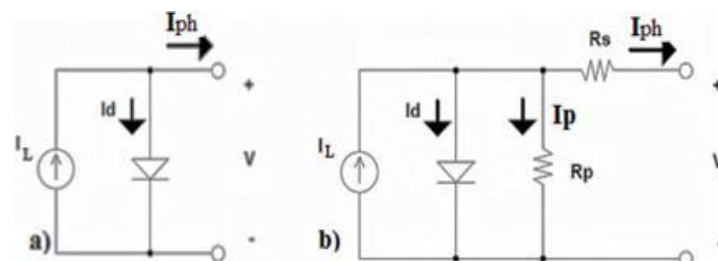

Figure 2. models of PV-cell equivalent-circuit: (a) Ideal or Simplified PV equivalent, (b) single diode model

The models of electrical performances that comprise cell temperature need parameters which describe the panel characteristics essentially. Some required parameters given by the specifications of manufacturer's module are included short-circuit current (I_{sc}) and open-circuit voltage temperature coefficients [16].

From Figure 2 with a solar cell equivalent circuit, since a representation of the semiconductor material of the solar cell represents a diode, the output voltage of the PV cell is expressed by V_{pv} or just V , the Serial resistance (R_s) and parallel (shunt) resistance (R_p). While I_{PH} is a generated photo current by a solar cell and I_d is the diode saturation current and I_p denotes the current of shunt resistance R_p . From the surveys, it is clear that the resistance R_p is large, so its effect usually may be neglected [17].

3. PRESENTATION OF PV MODULE

3.1. Ideal Single Diode Model

A diode is an anti-parallel connection with a PV unit that considers light generated current source, so output current I_{PH} is obtained by Kirchhoff law:

$$I_{PH} = I_L - I_d \quad (1)$$

I_L is the photocurrent and the diode current I_d that relates to the saturation current I_o and is expressed by:

$$I_d = I_o \left[\exp\left(\frac{V}{A \cdot N_s \cdot V_T}\right) - 1 \right] \quad (2)$$

With V be a voltage that imposed on the diode, and $V_T = k \cdot T_c/q$. I_o is the leakage or reverse saturation current of the diode (Amp), for silicon cell the $V_{Tc} = 26$ mV at 300 K, Boltzmann constant (k) = 1.38×10^{-23} J/K, and q is electron charge = 1.602×10^{-19} C, the thermal voltage V_T is important due to its high dependency of temperature. A is the ideality factor and depends on the technology PV cell.

For Figure 2(b) which contains, in addition to the current source (I_L), an anti-parallel diode with two resistors (R_s & R_p). With Shockley diode equation dependence, and applying the Kirchhoff's law, the identical mathematical model of current is given by:

$$I_{PH} = I_L - I_d - I_p \quad (3)$$

where I_p represents the current leak at shunt resistor, the module's output current comprising N_s cells connected in series be:

$$I = I_{ph} - I_o \left[\exp\left(\frac{V + I \cdot R_s}{a}\right) - 1 \right] - \frac{V + R_s \cdot I}{R_p} \quad (4)$$

It's clear that to determine the parameters is not easy of the above transcendent equation (4). On the other hand it proposes the best solution [18]. In all of PV products, the performances of PV cell specified in the module can be realized with standard test conditions (STC) which means the irradiance = 1000 W/m^2 , in addition to cell temperature of 25°C . The Temperature parameter has a considerable effect on the output power of the PV solar panel: with a temperature increased by one-degree ($^\circ\text{C}$) results in a decreasing of 0.4% in output power for Si solar panels [19].

3.2. Two Diode Model

A two diodes form can be considered modified arrangement of single diode circuit that takes in consideration the recombination effect by adding an additional parallel diode that shown in Figure 3.

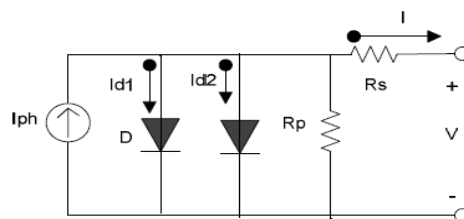

Figure 3. Two diode model

$$I = I_{ph} - I_{o1} \left(e^{\frac{V+IR_s}{n_{s1} v_T}} - 1 \right) - I_{o2} \left(e^{\frac{V+IR_s}{n_{s2} v_T}} - 1 \right) - \frac{V+IR_s}{R_p} \quad (5)$$

Nevertheless, two indefinite diode quality factors. Therefore, equations number and indefinite parameters are increasing, thereby creating calculations further complex little bit. Now, irradiance and temperatures are with low values, this model gives precise curve characteristics if it related to the first model. Hence, by taking all facets into attention, as concerns the mathematical computation in addition to the number of iterations is considered, the single diode model believes to be fast results because of less complexity equation with less computational errors not like a case model of two-diode. But two diode models offer more accurate and sharp characteristics with variable weather conditions at longer iterations and factor calculations.

In case of two diode model, both diodes have different diode quality factors (n_1 & n_2) hence, different reverse saturation currents as I_{o1} & I_{o2} . The fill factor FF can be defined as the maximum power that can be delivered to the load per the I_{sc} , V_{oc} production and It will be a real I-V characteristics measurement.

$$FF = \frac{P_{max}}{V_{oc} I_{sc}} = \frac{V_{mp} I_{mp}}{V_{oc} I_{sc}} \quad (6)$$

FF increases at reduction in temperature at a good cell that gives 0.7 or more values.

From I-V characteristics of PV cell, from equation (4), three topics at STC, the following equations at extreme point's changes to: At open circuit condition,

$$I = I_{ph} - I_o \left(e^{\frac{V+IR_s}{n_s v_T}} - 1 \right) - \frac{V_{oc}+IR_s}{R_p} \quad (7)$$

At short circuit condition,

$$I_{sc} = I_{ph} - I_o \left(e^{\frac{V_{sc}+IR_s}{n_s v_T}} - 1 \right) - \frac{V_{sc}+IR_s}{R_p} \quad (8)$$

At maximum power point condition,

$$I_{mp} = I_{ph} - I_o \left(e^{\frac{V_{mp}+I_{mp}R_s}{n_s v_T}} - 1 \right) - \frac{V_{mp}+I_{mp}R_s}{R_p} \quad (9)$$

3.3. Determination of the Parameters

3.3.1. Determination of I_{ph}

Based on Figure 2a and equation (2), the output current can be obtained at a condition of standard test conditions (STC) as:

$$I_{PH} = I_{L,ref} - I_{o,ref} \left[\exp\left(\frac{V}{A_{ref}}\right) - 1 \right] \quad (10)$$

Equation (10) permits computing $I_{L,ref}$ that can't be determined else. Applying STC which gives the PV cell is short-circuited:

$$I_{PH,sc} = I_{L,ref} - I_{o,ref} \left[\exp\left(\frac{0}{A_{ref}}\right) - 1 \right] = I_{L,ref} \quad (11)$$

The photocurrent depends on both irradiance and temperature:

$$I_L = \frac{G}{G_{ref}} (I_{L,ref} + \mu_{sc} \cdot \Delta T) \quad (12)$$

G: Irradiance (W/m^2), G_{ref} : Irradiance at STC= 1000 W/m^2 , $\Delta T = T_c - T_{c,ref}$ (Kelvin), $T_{c,ref}$: Cell temperature at STC = 25+ 273 =298 K, μ_{sc} : Coefficient temperature of short circuit current (A/K), provided by the manufacturer, $I_{ph,ref}$: Photocurrent (A) at STC.

3.3.2. Determination of I_o

The STC belongs to the IEC standards, the three most marked topics at STC are: short-circuit current I_{sc} ($V = 0, I = I_{sc,ref}$), open-circuit voltage V_{oc} ($I = 0, V = V_{oc,ref}$) and maximum-point power ($PMPP$) the current ($I_{mp,ref}$) and voltage ($V_{mp,ref}$). These topics are identified for all PV modules with $\pm 10\%$ tolerance and they realistically happening very rarely.

The shunt resistor R_p is normally considered high. By applying equation (5) at those three topics at STC, the following equations are achieved:

$$I_{sc,ref} = I_{PH,ref} - I_{o,ref} \left[\exp\left(\frac{I_{sc,ref} R_s}{A_{ref}}\right) - 1 \right] \tag{13-a}$$

$$0 = I_{PH,ref} - I_{o,ref} \left[\exp\left(\frac{V_{oc}}{A_{ref}}\right) - 1 \right] \tag{13-b}$$

$$I_{PM,ref} = I_{PH,ref} - I_{o,ref} \left[\exp\left(\frac{V_{PM,ref} + I_{PM,ref} R_s}{A_{ref}}\right) - 1 \right] \tag{13-c}$$

From above equations, the photocurrent can be written as:

$$I_{o,ref} = I_{sc,ref} \exp\left(\frac{-V_{oc,ref}}{A_{ref}}\right) \tag{14}$$

4. SIMULATION MODEL OF A PV ARRAY

The PV array comprises of PV cell arranged serially and in Parallel combination for providing the desired DC voltage and current. PV module utilized for simulation can be shown in Figure 4. The simulation of ($I-V$) and ($P-V$) curves for different values of irradiances and temperatures is obtained using MATLAB.

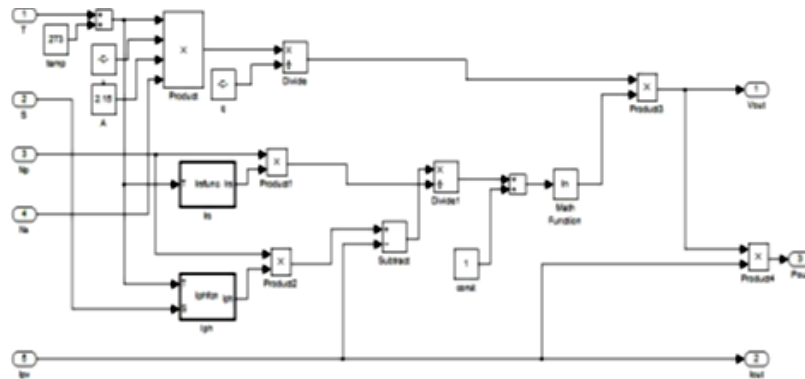

Figure 4. A PV array circuit diagram in MATLAB/Simulink

From Figure 4, PV module has been modelling and simulating with MATLAB/Simulink at a variable irradiance from (200 to 1000 W/m^2) and different temperatures from (25 to 60°C). This model included blocks which are established from equations (1 to 12).

4.1. Simulation Results

The obtaining waveforms from simulation by changing the solar insulations once and then temperatures that are supplied to the PV array model can be plotted separately each time as presented below.

- a) Figure 5 shows the irradiance is variable and ranged from 200 W/m^2 to 1000 W/m^2 while the temperature was maintained at 25 °C. It observes that with the solar radiation is increasing at constant temperature, the output voltage and current from PV array increases. Therefore, at higher insolation the required level voltage can be acquired.

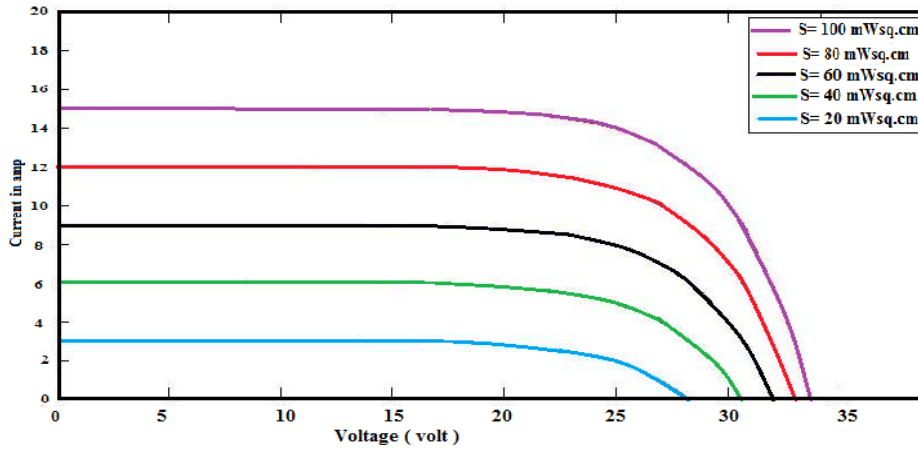

Figure 5. I-V curves for different irradiance levels at constant temperature 25°C

b) From Figure 6, any increasing of the solar insolation levels, then the power output obtained from PV array will be increased with respect to both voltage and current.

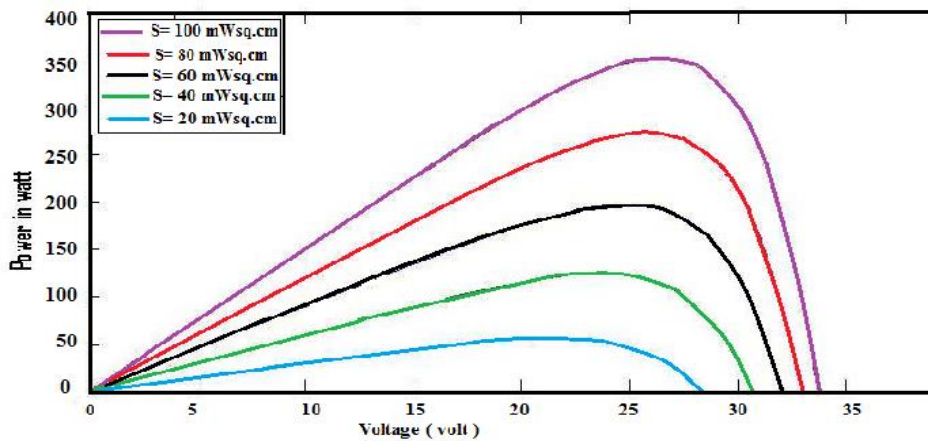

Figure 6. P-V curves for different irradiance levels at 25°C

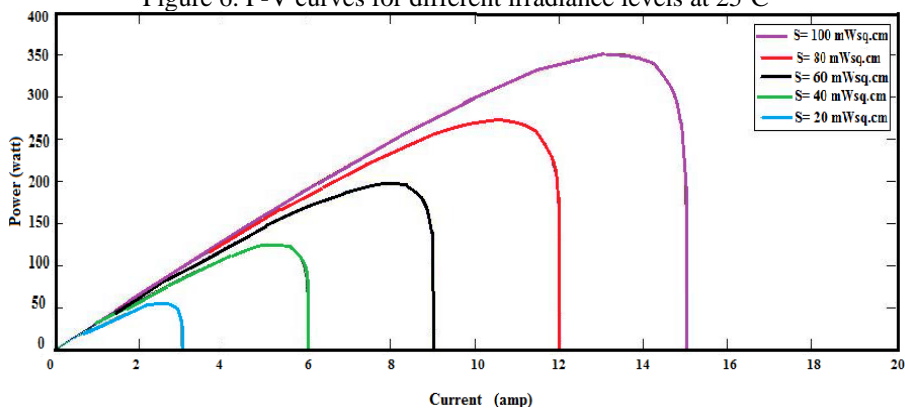

Figure 7. P-I curves for different irradiance levels at 25°C

c) The increasing of the temperature levels with a constant irradiance of 1000 W/m² gives decreasing in the voltage output from the PV array and at same conditions the current output increases a little compared with a voltage, consequently, a decreasing in the PV array's power output also. This can be shown in

Figure 8 for I(V) characteristics of variable temperature values, while Figure 9 and Figure 10 show the P(V) characteristics for voltage output, and for current output respectively.

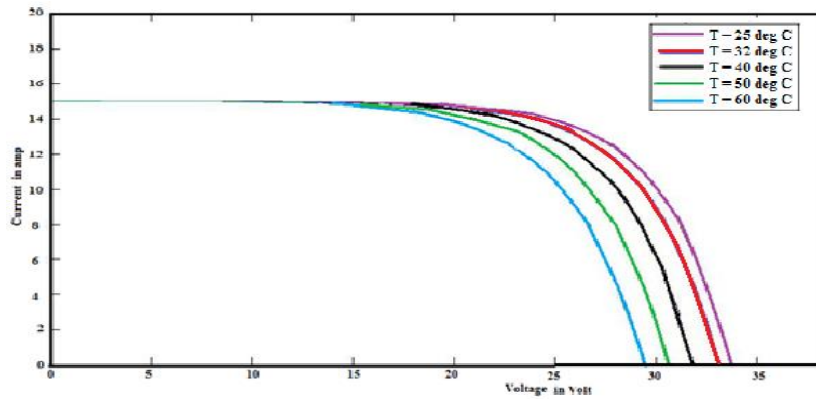

Figure 8. I-V curves for different temperatures at an irradiance of 1000 W/m².

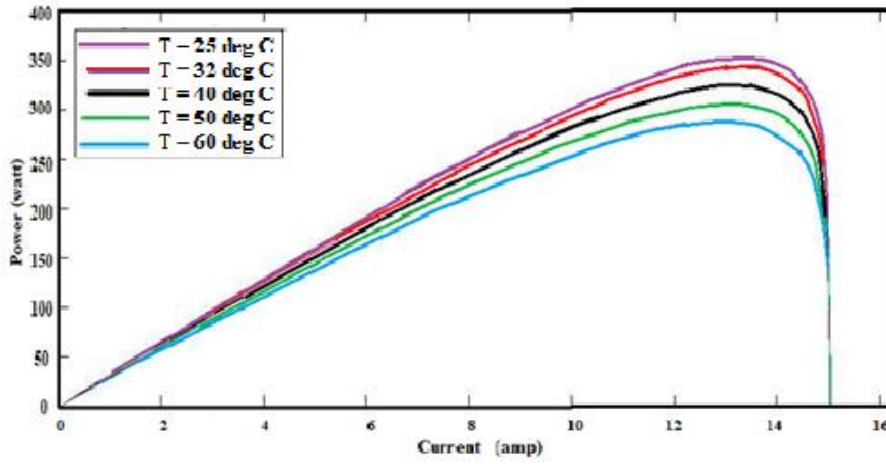

Figure 9. P-I curves (current) for various temperatures at an irradiance of 1000 W/m²

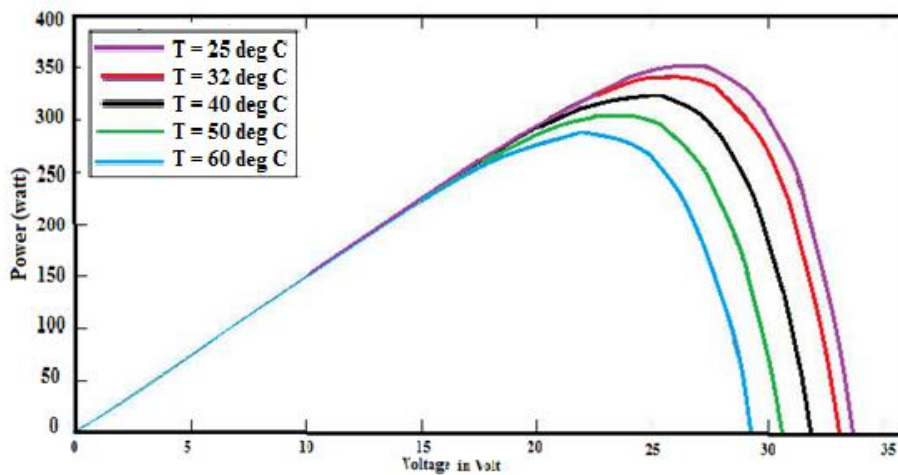

Figure 10. P-V curves (voltage) for various temperatures at irradiance of 1000 W/m²

The temperature variation from 25°C to 60°C in many steps with a fixed solar irradiance at 1 kW/m² have been simulated and a result for $I(V)$ and $P(V)$ demonstrate that if a solar radiation (G) remains constant, then the open circuit voltage decreases. These results produce a change of the maximum power point (MPP) operation which is compatible with equations (8) and (9). Alternatively, when the PV cell temperature (T_c) is specified with $T_c = 25^\circ\text{C}$ and the solar radiation is changed from 200W/m² to 1000W/m², the current output generated by the PV cell increases slightly as in Figures above.

5. CONCLUSION

PV solar system is quite utilized for grid connected power electricity for controlling the building illumination, housing appliances, and electrical instruments. In this Paper, for constructing a PV grid-connected system, a set of factors, desires to be taken into consideration in order to achieve most power generation. The parameters of solar irradiation and temperature dependence of PV cell performances are significantly associated. A mathematical model is derived of PV simulation in terms of solar irradiance and cell temperature and studied their behavior at different data of standard test conditions (STC). The open circuit (I-V), (P-V), and (P-I) curves are calculated from the PV array simulation designed in an environment of MATLAB and explaining in particularly their depending on irradiance levels and temperature parameters. The results agree with the recognized facts that a changed of about 0.4% of the normal PV module power if a reducing of cell temperature just one degree, also increasing the solar irradiance yields increasing the output power PV panel.

REFERENCES

- [1] I. de la Parraa, *et al.*, "PV performance modelling: A review in the light of quality assurance for large PV plants," *Renewable and Sustainable Energy Reviews*, vol. 78, pp. 780–797, 2017.
- [2] N. Onat, "Recent Developments in Maximum Power Point Tracking Technologies for Photovoltaic Systems," *International Journal of Photoenergy*, 2010.
- [3] R. Verma and K. Gupta, "Simulation of grid connected photovoltaic system using MATLAB/Simulink," *International Journal of Advanced Engineering, Management and Science (IJAEMS)*, vol/issue: 3(6), 2017.
- [4] R. Hernanz, *et al.*, "Modelling of photovoltaic module," *Renewable Energies and Power Quality, Granada, Spain*, 2010.
- [5] P. G. Nikhil and D. Subhakar, "An improved simulation model for photovoltaic cell," *Electrical and Control Engineering*, pp. 1978-1982, 2011.
- [6] M. Satyanarayana and P. S. Kumar, "Analysis and Design of Solar Photo Voltaic Grid Connected Inverter," *Indonesian Journal of Electrical Engineering and Informatics (IJEI)*, vol/issue: 3(4), pp. 199-208, 2015.
- [7] R. Ayaz, *et al.*, "An improved MATLAB-Simulink model of PV module considering ambient conditions," *Int. J. Photoenergy*, vol. 2014, pp. 1-6, 2014.
- [8] H. Sharma, *et al.*, "Modeling and Simulation of Off-Grid Power Generation System Using Photovoltaic," *TELKOMNIKA Indonesian Journal of Electrical Engineering*, vol/issue: 13(3), pp. 418-424, 2015.
- [9] Krismadinataa, *et al.*, "Photovoltaic module modeling using simulink/matlab," *The 3rd International Conference on Sustainable Future for Human Security, SUSTAIN*, 2012.
- [10] B. A. Allah and L. Djamel, "Control of Power and Voltage of Solar Grid Connected," *International Journal of Electrical and Computer Engineering (IJECE)*, vol/issue: 6(1), pp. 26-33, 2016.
- [11] H. Ibrahim and N. Anani, "Variations of PV module parameters with irradiance and temperature," *9th International Conference on Sustainability in Energy and Buildings, SEB-17, Chania, Crete, Greece*, 2017.
- [12] A. J. Abid, *et al.*, "Comprehensive Modeling of Photovoltaic Array based on Proteus Software," *International Journal of Applied Engineering Research (IJAER)*, vol/issue: 13(6), pp. 4440-4447, 2018.
- [13] O. M. Benaissa, *et al.*, "Modeling and Simulation of Grid Connected PV Generation System Using Matlab/Simulink," *International Journal of Power Electronics and Drive System (IJPEDS)*, vol/issue: 8(1), pp. 392-401, 2017.
- [14] K. S. Srikanth, *et al.*, "A Novel Grid-Connected PV-FC Hybrid System for Power-Management," *International Journal of Research in Advent Technology*, vol/issue: 2(4), 2014.
- [15] C. Qi and Z. Ming, "Photovoltaic Module Simulink Model for a Stand-alone PV System," *2012 International Conference on Applied Physics and Industrial Engineering, Physics Procedia*, vol. 24, pp. 94–100, 2012.
- [16] P. H. Zope, *et al.*, "Performance and Simulation Analysis of Single-Phase Grid Connected PV System Based on Z-Source Inverter," *International conference on Power Electronics, Drives and Energy System*, 2010.
- [17] R. Ayaz, *et al.*, "An improved MATLAB-Simulink model of PV module considering ambient conditions," *Int. Journal of Photoenergy*, vol. 2014, pp. 1-6, 2014.
- [18] Balasubramanian B., "Performance evaluation of solar photovoltaic (PV) array based on mathematical and simulation modelling: a review," *Aust J Basic Appl Sci*, pp. 469-77, 2014.
- [19] Ma T., *et al.*, "Solar photovoltaic system modelling and performance prediction," *Renew Sustain Energy Rev.*, pp. 304-15, 2014.