



**Manchester  
Metropolitan  
University**

---

Meng, Y and Naeem, MA and Sohail, M and Bashir, AK and Ali, R and Zikria, YB (2020) Elastic caching solutions for content dissemination services elastic caching solutions for content dissemination services of ip-based internet technologies prospective. Multimedia Tools and Applications. ISSN 1380-7501

---

**Downloaded from:** <http://e-space.mmu.ac.uk/626678/>

**Version:** Accepted Version

**Publisher:** Springer

**DOI:** <https://doi.org/10.1007/s11042-020-09626-7>

Please cite the published version

<https://e-space.mmu.ac.uk>

# Elastic Caching Solutions for Content Dissemination Services of IP-based Internet Technologies Prospective

Yahui Meng<sup>+</sup> · Muhammad Ali Naeem<sup>+</sup> · Muhammad Sohail · Ali  
Kashif Bashir · Rashid Ali\* · Yousaf Bin Zikria\*

Received: date / Accepted: date

**Abstract** The Information-Centric Networking (ICN) provides a new data dissemination Internet paradigm to support the communication services that will meet the end-users' modern requirements. ICN focuses on transmitting data rather than physical locations. It offers a cache-able environment to fulfill future requirements and delivers communication services with less congestion and bandwidth in a network. The current Internet needs to enhance its architectural design for information distribution by reducing the end-to-end communication practices. ICN-based architecture aims to fulfill the end-users' requirements and provide a better communication system compared to the current Internet

---

Y. Meng and M. A. Naeem  
School of Science, Guangdong University of Petrochemical  
Technology, Maoming 525000, China  
E-mail: mengyahui@gdpu.edu.cn (YM), mali-  
naeem7@gmail.com (MAN)

M. Sohail  
School of Computer Science and Communication Engineering,  
Jiangsu University, Zhenjiang 212013, Jiangsu, People's  
Republic of China  
E-mail: engrsohailaslam@gmail.com

A. K. Bashir  
Department of Computing and Mathematics, Manchester  
Metropolitan University, Manchester, United Kingdom  
E-mail: a.bashir@mmu.ac.uk

R. Ali  
School of Intelligent Mechatronics Engineering, Sejong  
University, Seoul 05006, Republic of Korea  
E-mail: rashidali@sejong.ac.kr

Y. B. Zikria  
Department of Information and Communication Engineering,  
Yeungnam University, Gyeongsan 38541, Republic of Korea  
E-mail: yousaf.bin.zikria@gmail.com

<sup>+</sup>First Authorship: Y. Meng, and M. A. Naeem .  
\*Correspondence: yousaf.bin.zikria@gmail.com (Y.B.Z)  
and rashidali@sejong.ac.kr (R.A)

system. ICN implements in-network caching (storage) to facilitate unicast and multicast mechanisms at the same time to deploy efficient and appropriate transmission of the desired information. In this situation, temporary storage is deployed all over the network to serve the requested objects (contents). In the last few years, ICN has shown up as engineering to replace the Internet design. In this paper, a comprehensive study about ICN-based caching mechanisms to enhance the IP-based Internet technologies is presented and analyzes the possible benefits using caching with the Internet of Things, Blockchain, Software Defined Network, 5G, genomic data sets, fog, and edge computing. In the end, the ICN-based caching strategies are mentioned that provide a diverse solution to deal with IP-based Internet technologies in an efficient way to deliver fast data dissemination.

**Keywords** Named Data Networking · Most Popular Cache · Video on Demand · IP-based networking · Multimedia applications

## 1 Introduction

Currently, the Internet has become a significant part of today's life. It was fabricated after a sequence of steps to present a better way of disseminating the information [1]. The advantages of the extract on the Internet have been raised to human social, personal, and academic benefits that cannot be detached from Internet usage. According to the recent forecast, the current Internet traffic has recorded rapid growth from the past several years. Usually, Internet traffic is concerned with data retrieval applications such as YouTube and Video on Demand (VoD). It is estimated that the video traffic alone will report 86% of total IP traffic at the end of

2020 [2]. On the other hand, the requirements are increasing for User-Generated Content (UGC) and high definition VoD traffic using the existing Internet. The content retrieval demand will continue up to a higher growth rate [3]. Although many attempts have been attempted to provide shared information, the Internet is still facing enormous challenges related to the data volume and network traffic due to the huge requirements of the end-users [4].

The existing Internet architectures have been designed using end-to-end (E2E) network model that establishes the host-centric communication, which depends on both sender and receiver. The sender is completely in charge of the communication in host-oriented architecture for data transmission across distant locations. The host-oriented architecture is complicated and exactly matches the new Internet paradigm [5]. It is essential to address the problems related to the management of network traffic that creates a big challenge for the design of IP-based architecture, for example, the IP traffic will produce deep blockages due to fewer resources. There is a need to modify the existing IP-based network to the flexible architecture that should handle contemporary IP-based architecture issues with efficient data dissemination services. In this situation, Information-Centric Network (ICN) provides a flexible solution to handle the issues related to the network traffic. ICN techniques provide the advantages of disseminating information [6]. Moreover, ICN offers a new model for communication that identifies what data need to transmit on the network rather than which components of the network are required to transmit the data [6].

It is expected that the existing IP-based Internet architecture will be insufficient to control the increasing issues related to the network traffic and the users as well as [7]. Several appearing issues such as bandwidth congestion, energy, and resource consumption still do not have satisfactory solutions for the existing Internet. These issues raise the demands for a new technological approach to have an efficient Internet architecture that can fulfill its actual requirements [8]. There is a research society that recognizes the limitations of the present Internet and deliberates the important needs of the future Internet and suggests new architectures and prototypes meet the Internet's future requirements. Besides, the tremendous progress of the Internet and the production of novel applications need to have a particular comprehensive Internet architecture. The existing Internet was not designed for the applications currently developed, such as voice over IP (VoIP), Network Address Translation (NAT), and many more. It is essential to have a change in Internet architecture [9] to solve these issues. For this purpose, the research communi-

ties have been proposing several architectures; however, the most dominant among them is ICN due to its versatility [10]. The Internet is progressively upgrading for information distribution. ICN functioning activities are based on the named information objectives. ICN is a receiver-driven networking approach, where end-users express their interest for specific content. The network is in-charge of routing the user names-based requests towards the appropriate content container. In ICN, the content itself is a major component rather than a host. ICN came up with several architectural approaches in which caching is the most elastic to enhance the data dissemination process [11][12].

Section 2 provides a comprehensive overview of the related surveys. In Section 3, the basic structure of ICN caching and its diverse categories are presented. Section 4 provides comprehensive knowledge about ICN caching contributions for IP-based Internet technologies. Section 5 presents the conclusion of the paper. In Section 6, the future research directions are described that explain how the ICN caching can be advantageous after using its various caching schemes for the other Internet technologies.

## 2 Related Work

Several survey papers have recently been published to provide the ICN-based caching functionalities and its approaches, such as cache deployment strategies and cache replacement policies. Besides, these surveys provide information about content caching and content eviction by explaining different content placement and replacement schemes. However, In this paper, a survey of state of the art caching techniques was presented, and the arising issues were addressed with a particular focus to reducing the redundancy. Moreover, this survey gives an idea to improve data availability through ICN-based caching techniques.

In Zhang *et. al.* [13], a limited number of cache management strategies were described such as Leave Copy Everywhere (LCE), Leave Copy Down (LCD), Move Copy Down (MCD), Random Cache, Probabilistic Caching, and some challenges such as cache transparency, cache coordination decision, and the data availability. However, it has limited information about the new caching techniques. In Md. Faizul Bari *et. al.* [14], the basic ICN-based architectures were presented, and ICN-based routing and naming techniques were described. Moreover, an analysis of routing and naming schemes using different aspects were presented. Besides, a comprehensive survey on the naming and routing environments was introduced. However, the ICN-based caching techniques were not defined. In [15], Alcardo Alex Barak-

**Table 1** Contributions and Limitations of existing surveys.

Reference	Contributions	Weaknesses
Zhang <i>et. al.</i> [13]	Provide knowledge about ICN-based communication architecture. Moreover, it explains some ICN architecture modules	It describes the ICN-based architectures and does not focus on the caching module. Small introduction for caching module
Md. Faizul Bari <i>et. al.</i> [14]	Explains ICN architectures and content naming and routing schemes of ICN	Limited to content naming and data routing schemes.
Alcardo Alex Barakabitze <i>et. al.</i> [15]	This paper explored the three ICN architecture design for the future Internet architecture, which are DONA, NetInf, PURSUIT.	Limited to three ICN-based architectures and data routing schemes.
Naeem <i>et. al.</i> [8]	Provide a comprehensive survey of probabilistic-based caching strategies	Limited to the probabilistic-based caching strategies.
Naeem <i>et. al.</i> [10]	Survey of diverse cache deployment strategies	Limited ICN-based caching strategies.
Safae Rahel <i>et. al.</i> [16]	It describes motivations, basics components, and the main features of NDN architecture.	Limited to the basic modules of NDN-based architecture.
Bernardini <i>et. al.</i> [17]	In this study, the performance of five CCN-based caching strategy is evaluated to check which one gives the best results in terms of the cache hit ratio, complexity, diversity, and stretch.	It is limited to caching the performance of five strategies that were published before 2015.
Amadeo <i>et. al.</i> [18]	It defines the functionalities of CCN architecture and its applicability to improve the wireless-based networks.	It has limited knowledge about the CCN modules.
Naeem <i>et. al.</i> [19]	It describes the functionalities of popularity-based caching strategies and provides a comparative analysis of these caching strategies.	It is limited to the popularity-based caching strategies and their performance.

abitze *et. al.* suggest for future Internet architectures such as Data-oriented Network Architecture (DONA), Content-Centric Networking (CCN), Named Data Networking (NDN), and Network of Information (NetInf) are presented. Moreover, ICN routing, Caching, and several significant properties were defined as well. A limited number of caching strategies, data routing techniques, and functionalities have also been described in this survey. In Naeem *et. al.* [8], the basic CCN architecture, and its caching-based features were introduced. Moreover, a survey and critical analysis of probabilistic-based caching strategies were presented in which the probabilistic-based caching strategies were divided into two categories, such as fixed-based probabilistic caching strategies and dynamic-based probabilistic caching strategies. Besides, a common simulation environment was established to analyze the caching strategy's better performance critically. However, the survey is limited to the probabilistic-based caching strategies. In [10], Naeem *et. al.* provides a brief description of the ICN-based Internet architecture and overviews the cache management strategies.

In [16], Safae Rahel *et. al.* presents the basic idea of ICN architecture with caching approaches, and its features that are used to minimize the energy consumption were described to enhance the data communication services. However, the caching strategies were presented concerning energy consumption and suggested some solutions using ICN-based caching strategies to enhance energy

efficiency. In [17], five CCN-based caching strategies such as Leave Copy Down (LCD), Cache Less for more, Max Gain Interwork Caching (MAGIC), Leave Copy Everywhere (LCE) and ProbCache were compared to evaluate the performance. The performance was estimated using the basic evaluation metrics such as cache hit, complexity, diversity, and stretch to find the best caching strategy. However, this survey is limited to the five CCN-based caching strategies that were published before 2015. In [18], the general functionalities of the Content-Centric Networking (CCN) (ICN-based architecture) are described. Moreover, in this study, the applicability of CCN within the wireless-based networks was determined to enhance the usage of resources, access control, and mobility of the network nodes. However, this survey provides limited information about CCN modules that helps to enhance the wireless-based networks.

In [19], authors provide knowledge about the popularity-based caching strategies, and it is comprehensively described the functionalities of popularity-based caching strategies. Moreover, in this survey, the popularity-based caching strategies were extensively studied in a simulation platform to evaluate the performance in terms of basic ICN-based metrics such as cache hit ratio, stretch ratio, diversity, and redundancy. However, this survey is limited to the NDN popularity-based caching strategies.

However, these surveys have provided restricted and

broad scope to describe caching. On the other hand, the present study provides a comprehensive survey to explain ICN caching and describes several solutions to meet up the future Internet and end-user requirements. Furthermore, several surveys such as [8, 13–16, 20–22] were published with limited scope to explain flexible caching approaches. However, this study provides a complete survey of emerging technologies such as IoT, fog computing, edge computing, SDN, 5G, and genome data set. This study also tells how ICN-caching is benefitted for content dissemination across the edges of the Internet to provide fast communication services. This survey focuses on the critical analysis of the IP-based Internet architectures and its emerging technologies. Table 1 illustrates the contributions and weaknesses of the earlier caching-based surveys.

### 3 Caching in Information-Centric Networking

An incredible expansion of today’s Internet traffic and frequent transmission of the same contents have been creating many troubles, such as bandwidth utilization, server load, response time, and usage of resources. These upward difficulties will be complicated to resolve in the future [1, 30]. Usage of the Internet is growing day by day, and the existing resources are limited to defeat the massive amount of raising needs [31]. For efficient data dissemination, the Internet requires to implement an optimal approach that can overcome these increasing problems [33]. Therefore, the current Internet will need to alter its architectural design according to the expected future requirements [32]. In this case, ICN offers a better solution to conquer these expected issues by deploying the cache-able routers throughout the network. The cache is temporary storage that is used to boost up the data dissemination process.

In Figure 1, the user sends a request for a specific piece of information, which can be downloaded from any router having the corresponding content in its cache [34]. On the other hand, in IP-based Internet, if a copy of requested data cannot reside near the user and the request needs to transmit to the server, which increases the usage of network resources and traffic [35]. However, Internet users are interested in downloading their desired content regardless of having information about the physical location. Thus, the Internet architecture design needs to change its architectural design to provide user-friendly data dissemination services.

In ICN caching, the subscribers send INTEREST messages to the network along with the content name to retrieve the desired content, the router having required content becomes provider and sends the requested data content to the appropriate user. In Figure 1, all the

user’s Interest messages are forwarded hop-by-hop. Each ICN router has to maintain three types of data structures, such as the Forwarding Information Base (FIB), the Pending Interest Table (PIT), and the Content Store (CS). The FIB keeps a record of the outgoing interfaces used to forward the INTEREST messages towards suitable data sources. The PIT provides statistics for those INTEREST messages that were not satisfied recently at a router but already arrived in the network, i.e., those INTEREST messages for which corresponding contents are predictable. At last, the CS serves the incoming Interests with locally cached contents. When an INTEREST arrives, each router extracts the content’s names and looks for the desired content in its CS, whose name matches. If the requested content is found, it is instantaneously sent back through the interface where the request was received and the INTEREST message discarded from CS. Otherwise, the router executes the longest prefix match on its FIB to make a decision towards which direction is suitable for received INTEREST to forward. If any entry is found in FIB, the router records incoming interface in PIT where the INTEREST was received and moves the INTEREST to the suitable source using FIB statistic. For example, a subscriber sends an INTEREST using the content name such as /aueb.gr/ai/new.htm. If the PIT previously has an entry for that content name, meaning that this exact content had already been requested, the incoming interface is added within the router’s PIT entry. The INTEREST is discarded. When content matches the INTEREST message at a publisher router, the INTEREST message is immediately discarded, and the requested content is sent to the requester. A copy of disseminated content is cached along the subscriber’s path in a hop by hop manner according to PIT records. Particularly, when a router receives a content, it first accumulates the corresponding router’s CS and then it executes a longest-prefix match in its PIT to trace the matching information content.

Content is duplicated through multiple interfaces using PIT records [36] to create multicast communication. Caching approaches are categorized into homogeneous, heterogeneous, cooperative, non-cooperative, off-path, and on-path. These approaches are different regarding their characteristics. However, ICN provides diverse caching categories to resolve the critical issues of IP-based Internet using an appropriate approach. The caching approaches are explained in the following sections.

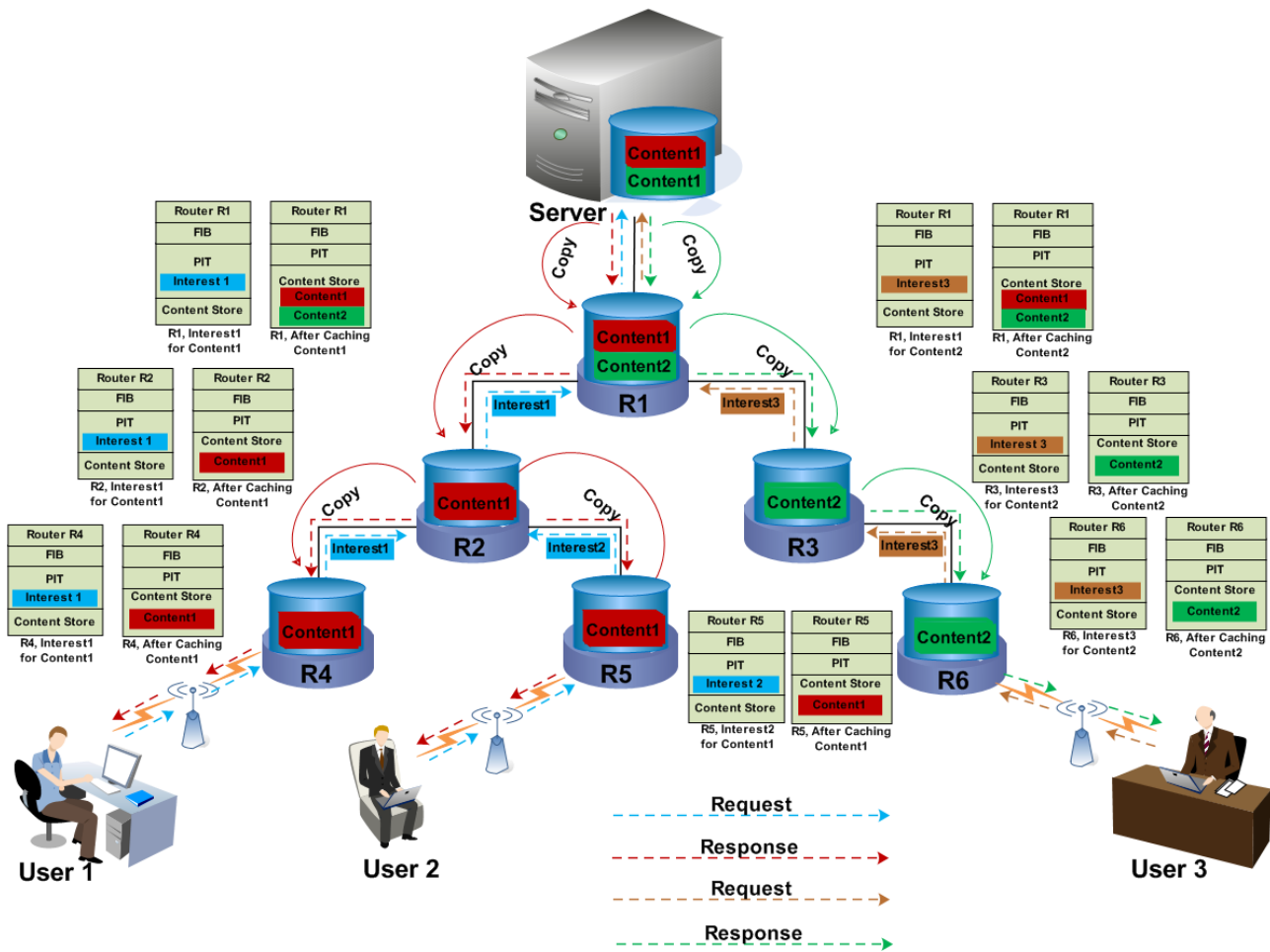

Fig. 1 ICN-based in-network caching

### 3.1 Homogeneous Caching

In homogeneous caching, equal cache capacity is allocated to the routers and same amount of data can be cached at these routers along the data routing path [32]. For example, in Figure 2 the routers R1, R2, and R3 have the same capacity of cache to store the same number of contents (e.g., these routers have the capacity to cache two contents). Therefore, Router R1, R2, and R3 are comparatively homogeneous.

### 3.2 Heterogeneous Caching

In heterogeneous caching, unequal cache capacity is distributed among routers along the data downloading path and each router will caches different amount of transmitted data content [37]. In Figure 2, router R2 and router R3 have relatively diverse cache capacities to store the transmitted contents. According to heterogeneous cache, router R2 has capacity to cache content

C2 and C5. On the other hand, the router R3 has capacity to cache only content C3.

### 3.3 Cooperative Caching

In cooperative caching, the routers share their information about the cached content to increase the distribution efficiency to make the fast data transmission for a subsequent request [38]. In the given Figure 2, when a user request is received for content C1 then Server1 responds to the request and a copy of C1 is cached along the data routing path at router R1 and R2 for the subsequent requests. Therefore, router R1 and R2 share their information because all the information about cached content at R1 and R2 is shared in routers (R1, R2) information table. According to this shared information, the cache of both routers R1 and R2 are cooperative.

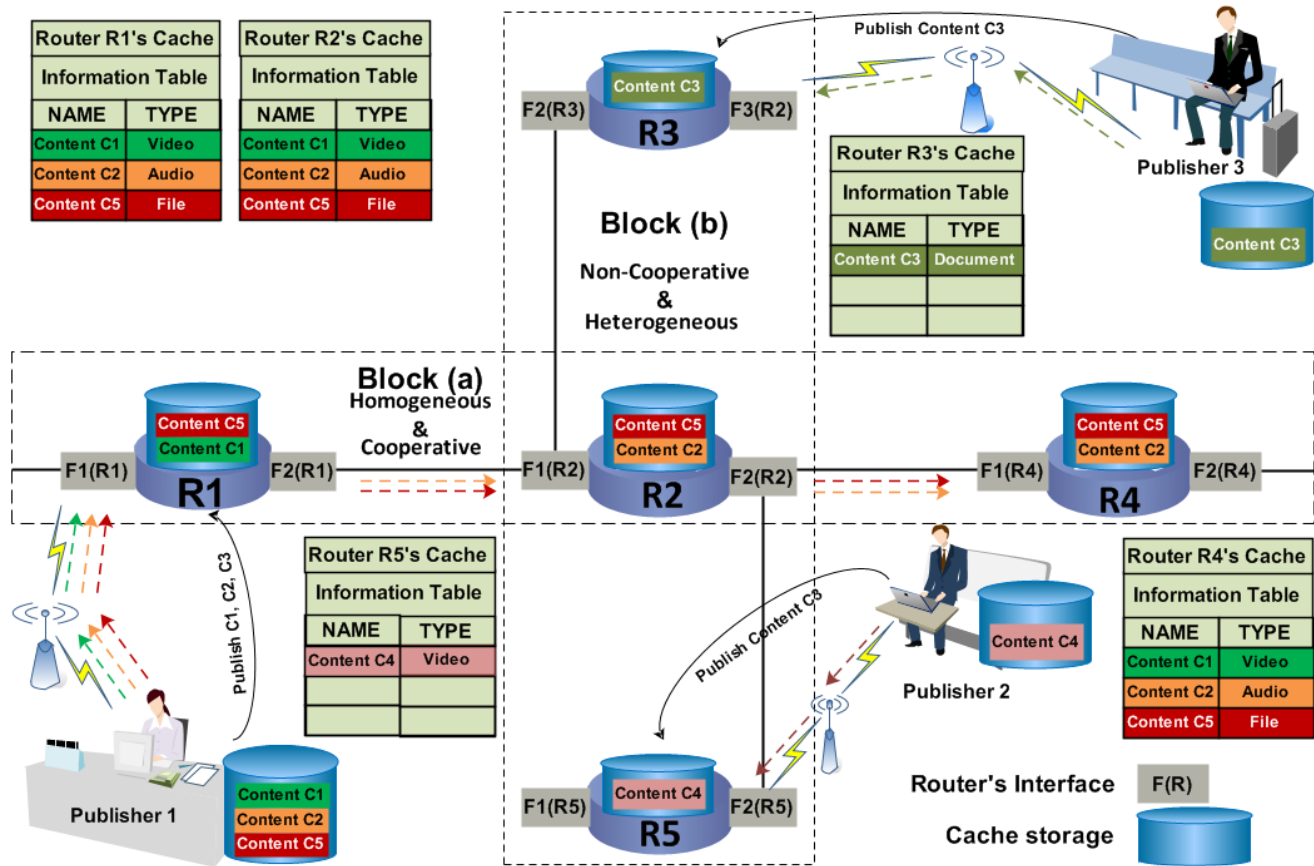

Fig. 2 Different caching categories

### 3.4 Non-Cooperative Caching

In non-Cooperative Caching, the caching routers do not share their content information with others. Each router individually makes the caching decision to caches a transmitted content alongside the data downloading path [38, 39]. No cooperation is done among the caching nodes (routers) during the transmission of contents. In Figure 2, the routers R2 and R3 have different information in their statistic tables because R2 and R3 do not share their information about the cached contents that both routers have different contents in their cache storage. Thus, according to different information, both router R2 and R3 are non-cooperative.

### 3.5 Off-Path Caching

Off-path caching is identical to the traditional proxy caching or CDN server. In off-path caching, the location of cached data is kept in the Name Resolution System (NRS) and the NRS will serve the incoming Interests by forwarding them towards the appropriate source routers. Therefore, the content retrieval in off-path caching requires redirection of requests. All the

contents are registered in NRS at the time of their creation and users can send their requests only for registered contents [40]. The basic problem in off-path caching is choosing a location for a content where to cache and how to reduce the overhead in order to inform the name resolution system when a new content is cached or old needs to discard. The exact information about the content depends on the NRS. However, the most necessary is to update NRS about the local information of contents. In off-path caching, user sends a request to the NRS and the NRS compares it with the available names of the contents stored in its record [34]. Afterward, the request is forwarded to the corresponding source (router, server) and the source sends the requested content to the user following the returning path, as shown in Figure 3. The block (a) illustrates the off-path caching mechanism, as the content is published in NRS and users send their requests to the NRS. NRS forward the users' requests to the appropriate publishers, then the requested content send to the requested users through NRS or it can be sent following the direct path to the users.





**Table 2** Caching mechanisms and advantages.

Caching Category	Caching Mechanism	Benefits
Homogeneous Caching [43]	In homogeneous caching, all network routers on the publisher-subscriber path cache the transmitted contents once they pass through them.	<ul style="list-style-type: none"> <li>– Simple caching structure</li> <li>– Low communication overhead</li> <li>– Fewer response time</li> <li>– Fast content dissemination</li> </ul>
Heterogeneous Caching [43]	In heterogeneous caching, all the network routers (nodes) available on the publisher-subscriber path do not allow to cache the similar contents.	<ul style="list-style-type: none"> <li>– Less Bandwidth requires for data transmission</li> <li>– Short publisher-subscriber path</li> <li>– Less redundant data transmissions</li> </ul>
Cooperative Caching [44]	In this mechanism, the network routers (nodes) share their information among one another about the content once they cache in the router's cache.	<ul style="list-style-type: none"> <li>– Less Bandwidth required for data dissemination</li> <li>– Short-stretch data delivery paths</li> <li>– Prevent redundant data dissemination</li> <li>– Fair allocation of capacity resources among the popular contents</li> </ul>
Non-Cooperative Caching [44]	In non-cooperative, the information about cached contents does not allow to share with the neighbor routers and therefore the caching decision is taken by each every network node individually	<ul style="list-style-type: none"> <li>– Required less usage of Bandwidth</li> <li>– Reduce response time for multiple deliveries of similar contents</li> <li>– Fast content dissemination</li> <li>– Reduces the publisher-subscriber path for data delivery</li> <li>– Fair allocation of capacity resources among the popular contents</li> </ul>
Off-Path Caching [45]	Off-path caching is somehow alike to content delivery network cache. In this content placement or conventional proxy caching is used to make caching decisions and the name resolution system (NRS) is required to inform upon the arrival of new contents	<ul style="list-style-type: none"> <li>– Deliver high data hit ratio</li> <li>– Low communication overhead</li> <li>– Less redundant data transmission</li> <li>– Required less Bandwidth for data transmissions</li> <li>– Reduces the delay in multiple downloading of similar contents</li> </ul>
On-Path Caching [46]	In on-path caching, when an interest packet (user request) arrives for some desired content, the network router answers with a copy of locally cached content without involvement of the NRS.	<ul style="list-style-type: none"> <li>– Required less cost for data dissemination</li> <li>– Fast data dissemination</li> <li>– Less usage of Bandwidth</li> <li>– Short-stretch in data discovery</li> <li>– Fair allocation of capacity resources among the contents</li> </ul>

proposes new Internet architecture in order to achieve efficient utilization of network resources in term to reduce bandwidth consumption and content retrieval time. In addition, it will improve data dissemination and reduce cost of resource utilization. Moreover, these caching mechanisms will contribute to the Internet, which will improve the content manageability through appropriate node selection in the network. In other words, if a content resides on the main server and it is most popular, for example, the server receives a lot of re-

quests for that content. Each time, whenever a request will receive, the server needs to send all the requests towards main server to download the content. On the other hand, In ICN caching, if the contents are cached along the path, then all the incoming requests will be satisfied by the locally cached contents and maximum bandwidth can be saved as well as content retrieval time will be minimized [42].

Table 2, illustrated some common advantage of ICN caching mechanisms over IP-Internet. ICN caching pro-

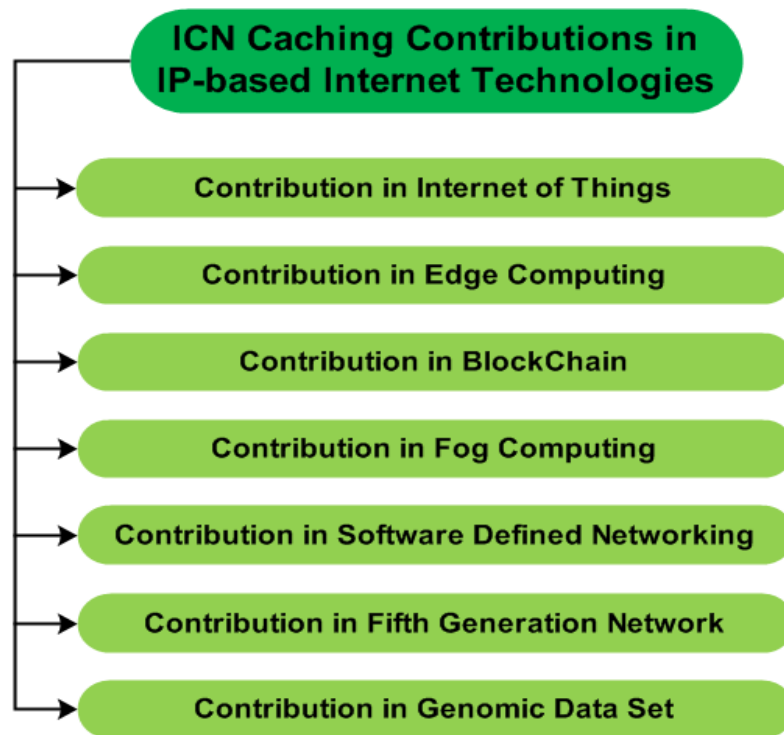

**Fig. 4** ICN-Based Caching contributions in IP-based Internet Technologies

vides several solutions for the diverse nature of Internet technologies such as IoT, genome data sets, blockchain, 5G, fog, and edge computing. These technologies are facing almost similar problems in which energy consumption, content retrieval latency, high congestion due to a large number of similar data dissemination, and resource consumption are most crucial. Therefore, ICN caching provides several types of structures (Cooperative and Non-Cooperative, Homogeneous and Heterogeneous, Off-Path and On-Path caching structures) to overcome the increasing issues of IP-based Internet technologies as shown in Figure 4. The following sections provide basic knowledge about the integration of ICN caching with diverse Internet technologies to enhance the structures for flexible data dissemination.

#### 4.1 ICN Caching contributions in Internet of Things

Internet of things (IoT) is a new emerging technology which is broadly acceptable to meet the future end-user requirements. Now, the usage of IoT infrastructure is increasing rapidly. The reason is that, the volume of diverse applications and transmitted contents is much higher as compared to the available IoT-based resources. Mostly the users are involved to download the User Generated Content (UGC) and they are strongly

interested in multimedia data that usually have high resolution and required high quality of services to disseminate. Basically, the current Internet architecture supports the location-based communications that extensively increases the data traffic because millions of redundant contents are transmitted over the Internet repeatedly due to end-to-end data broadcasting procedures. Consequently, several problems have been creating due to huge amount of redundant data traffic. In these problems the network congestion, bandwidth, energy, and resource consumption are significant. Therefore, the IoT-based modern technologies are facing same problems because of IP-based communication services. Thus, an efficient, reliable, and scalable Internet architecture is required to enhance the overall communication system [47, 48].

However, ICN is a new promising technology that can integrate with IoT-based environments to improve the data dissemination services. Besides, the IoT delivers several benefits to its environments such as tracking and identification technologies. Moreover, it distributes intelligence for smart devices and objects. The IoT can be emerged with several Internet-based technologies such as social science, telecommunication, electronic, and informatics [49]. Therefore, the IoT-based technologies can be enhanced by emerging its environments with ICN-based caching approaches. The cache-able environment is used to reduce the redundant data traffic

by caching the popular contents at the suitable intermediate location. Consequently, the cached content is used to fulfill the subsequent future requests and minimize the homogeneous data traffic. Moreover, caching popular content is the most flexible approach to reduce the overall network cost in terms of energy and power consumption. In addition, it decreases the content retrieval latency and increases the desired content availability for the diverse IoT users. Hence, the ICN-based caching architecture is the most significant to improve the overall performance of IoT-based network technologies. Figure 5 shows contributions of caching strategies for IoT systems.

#### 4.2 ICN Caching contributions in Edge Computing

ICN Caching with Edge Computing has demonstrated significant progress. The usage of Internet in our daily life is extensively increasing through the implementation of modern applications, such as software as a service, which includes Twitter, Google apps, Flickr, and the popular Facebook [50]. It has also changed the way of conducting business. Currently, content is being produced at an exponential rate and although processing occurs at the network edges, there is no guarantee that cloud computing can efficiently process these contents all the time [52]. As a result, the data traffic at the edges is much larger than the available capacity of the clouds, which require a large bandwidth to handle such huge amounts of network traffic. Consequently, a comprehensive construction is required that can provide the facility to process the data at edges in a more efficient and scalable manner [53, 54].

According to the latest forecast on data dissemination, around 180 PB of data will be produced per day at the end of 2020, if a city consists of a population of 1 million people [55, 56]. Therefore, it will be unfeasible for the present Internet to handle such large amounts of data transmission. Therefore, the usage of bandwidth, cost, energy, and resource consumption will be increased due to the exponential increase in Internet traffic generated by IoT devices at the edge. However, ICN caching provides the ability to process the contents efficiently at network edges because it leverages in-network cache that increases the resource availability to accommodate the popular contents without the involvement of primary clouds. It reduces the content retrieval time and network congestion. Moreover, it decreases the amount of redundant content at the cloud and can mitigate energy consumption. In addition, it delivers diverse contents to the consumers in less time and caches the desired contents near the consumers to fulfill their subsequent requirements. The edge computing can be merged

with ICN caching to provide a resourceful architecture that can fulfill the future requirements and handle a large amount of data traffic through caching of popular content near users [41]. Therefore, edge computing will process the contents at edge and ICN caching will deliver in-network cache to improve the communication process between the cloud and edge computing. Figure 6 shows contributions of caching strategies for Edge computing technology.

#### 4.3 ICN Caching contributions in Blockchain

Blockchain is a novel technology to provide distributed techniques. However, it has been facing challenges such as bottlenecks and data distribution restrictions because of IP-centric Internet paradigm. It usually delivers irregular connectivity due to inappropriate protocols. Consequently, the latency is maximized that caused inconsistency in blockchain [57]. In ICN caching, the content retrieval process is dependent upon globally unique name. Because, a similar type of information is enclosed in the content that associates with a specific global unique name and user can retrieve it easily from the network using its unique name. Basically, caching offers a location-independent architecture for the content distribution process, which enables the communication to be information-centric. It delivers a secured model for content dissemination in which the content is directly secured instead of securing the path between provider and user. The content is secured using three types of primitives such as data integrity, data authenticity, and access control. In on-path caching, contents are published in the network by authorized providers and these contents cannot be modified after its creation until it is detected.

Therefore, only particular users can access these published contents with appropriate authorization [58]. ICN caching achieves these goals by implementing the public key cryptography with each chunk of contents. All the contents are associated with a specific type of cryptographic signature and these signatures are assigned by their manufacturers at the time of creation. A public key is distributed by the manufacturer to his authorized users to verify the content integrity and authenticity [59]. A name-based access control (NAC) scheme is used in ICN to generate the appropriate data transmission by distributing the access keys to all authorized users. The NAC scheme requires validation using the public key that is authorized by the broadcaster. To produce authorized content, each content is associated with a particular trust model and the corresponding schema is used to provide the services to the users to

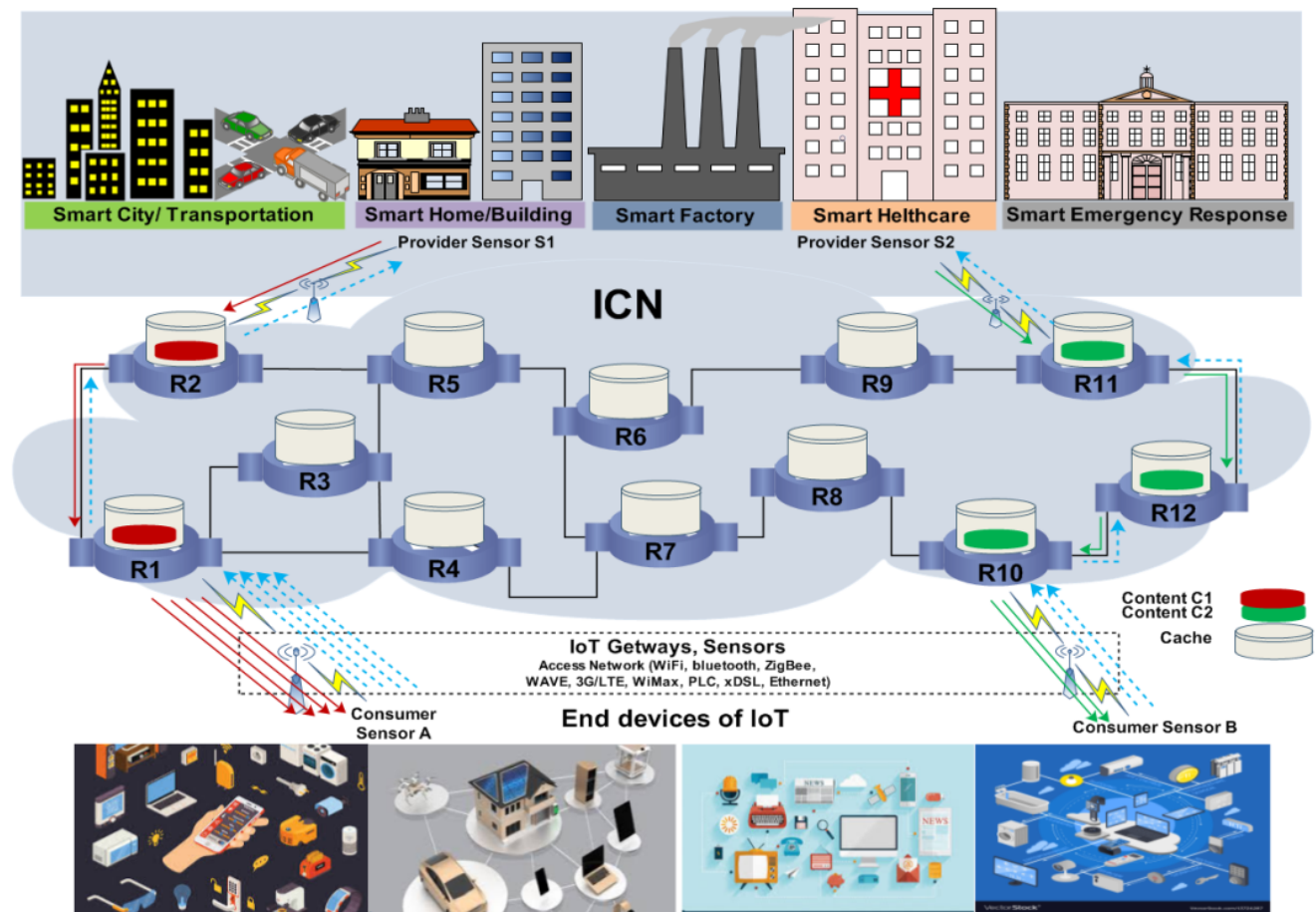

Fig. 5 ICN-Based Caching contributions for IoT systems.

investigate the following function: the security key locator field should be contained as expected in the schema, security key can be achieved by using the locator information and based on the public key signature should be matched with the names of retrieved content items [60]. Consequently, the verification process is repeated until it reaches the trusted broadcaster. The key of trusted broadcaster may be pre-configured, or it is distributed in a software package and it can be configured manually by the administrator. Therefore ICN caching provides lookup and validation services by using a public key management system to improve the blockchain architecture [61].

#### 4.4 ICN Caching contributions in Fog Computing

Fog computing enhances the concept of cloud computing in a distributed way. It attempts to utilize the network resources near the end network built by IoT devices, such as wireless sensor networks [62]. Fog computing works together with cloud computing to deliver high-quality services to the end-users with low latency.

It implements several capabilities of cloud computing, of which storage is the most important. The goal of fog computing is distributed storage which deploys to minimize the data retrieval latency through accommodating the popular data items near its users. However, it is difficult to make edge computing fully profitable. The reason is that, the amount of storage in edge computing is much smaller as compared to the transmitting data that disseminates through the network edges. Therefore, it needs to enhance the edge computing architecture using some flexible network approach that can minimize the expected issues [63,64]. Consequently, the ICN is a significant approach to emerge with fog computing to accomplish the efficient data dissemination targets. In fact, both ICN and fog computing are promising techniques that can broadly enhance the overall communication system. ICN have the ability to reduce the content dissemination delay. Basically, ICN have implemented a separate module known as caching. Caching module provides storage at underlying and global networks that improves the data transmission between the IoT-based heterogeneous devices and distributed fogs. A large number of cache management schemes have

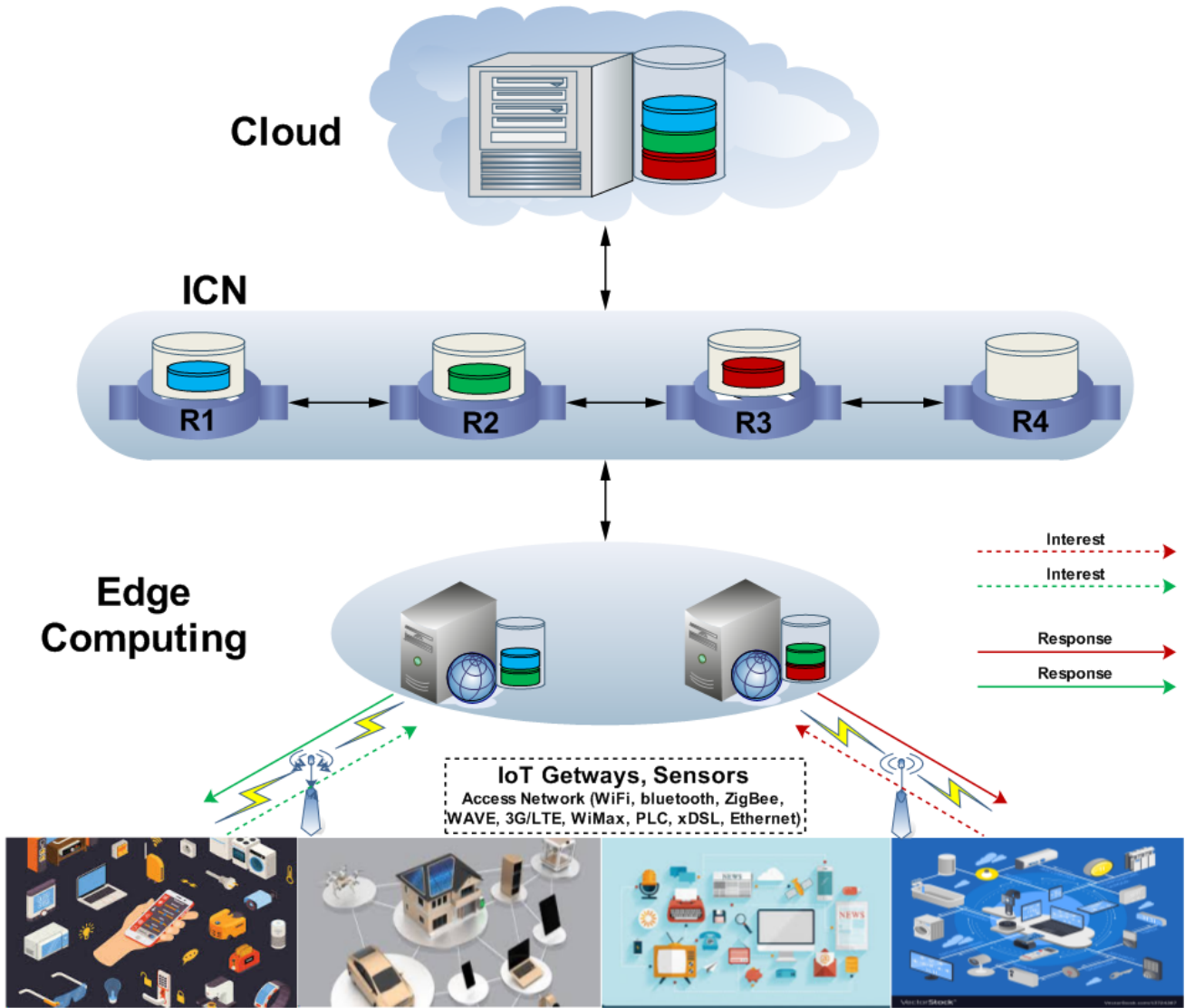

Fig. 6 ICN-Based Caching contributions for Edge Computing Technology.

been proposed that have the abilities to significantly enhance the overall network performance [65]. These cache management schemes are increases the availability of diversified data by caching it close to the end-users. Moreover, it delivers several benefits such as low congested in network links, less energy and power consumption, low communication overhead, and less cost [66]. To achieve the efficient performance of diversified network environments, ICN provides different kinds of caching strategies such as probabilistic-based caching strategies, centrality-based caching strategies and popularity-based caching strategies. Hence, we can use any of these kind of strategy according to the network requirements to enhance the overall network performance. Figure 7 shows contributions of caching strategies for Fog computing technology.

#### 4.5 ICN Caching contributions in Software-Defined Networking

There is difficult situation for the traditional Internet to meet up the increasing requirements of the modern environments in future. The reason is that, the current Internet supports the location-based architecture that delivers location-based communication services [71]. As a result, the available resources for data dissemination will be insufficient in future to minimize the network traffic related issues. Now, the network operators need high level strategies and configuration with distinct network device that increases the delay in dissemination and link congestion. Therefore, a new technology named as Software Defined Networking (SDN) was developed to enhance the Internet architecture. It is a flexible approach to reduce the current and expected

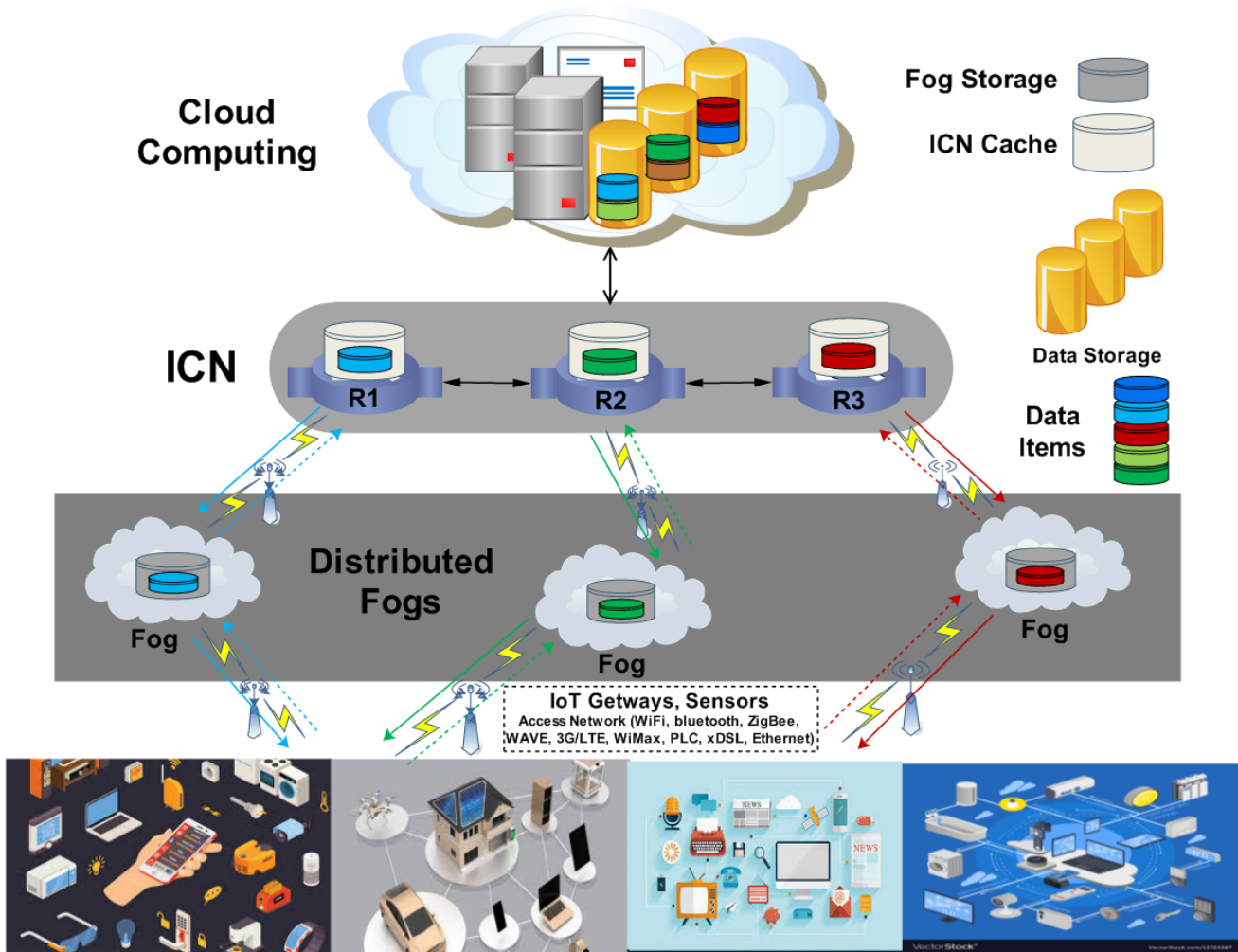

Fig. 7 ICN-Based Caching contributions for Fog Computing Technology.

issues of the Internet [67]. In SDN, the switches are deployed to lower down the data traffic flow level using controller in proactive and reactive manners. However, when a flow setup is created in forwarding state, the SDN cannot restart the setup for the subsequent users' requests. Consequently, the data retrieval latency is increased because the communication process remains inadequate to response all incoming requests within a particular time period. Moreover, if the controller is failed to perform its task the overall network flow will be stopped because the controller is a basic part of SDN to configure the operators, topology, and the validation of network resources. In addition, the SDN setup is risky in that network which is only associated to one controller [68]. The reason is that, if the controller breaks down, the flow will be stopped due to the unavailability of backup controller. Hence, the ICN-based caching is flexible approach in this situation to manage such type of critical issues to deliver the better network flow by providing the caching facilities to the transmitted con-

tents. The incoming requests will accomplish from the cached contents and the less number of requests will be sent to the distant servers. Thus, the overall SDN-based network performance will be improved [69,70]. Indeed, the integration of SDN and ICN-based caching will be more beneficial to enhance the communication services. The ICN caching will be handled by SDN controllers to perform efficient data dissemination. Consequently, the cached content will be managed through control plane and the network devices will be handled by data plane in SDN-based caching architecture [72]. Figure 8 shows contributions of caching strategies for Software-Defined Networking.

#### 4.6 ICN Caching contributions in Fifth Generation Networks

The 5G mobile network is not only the enhanced version of the 4G mobile network [73], it is a new technology



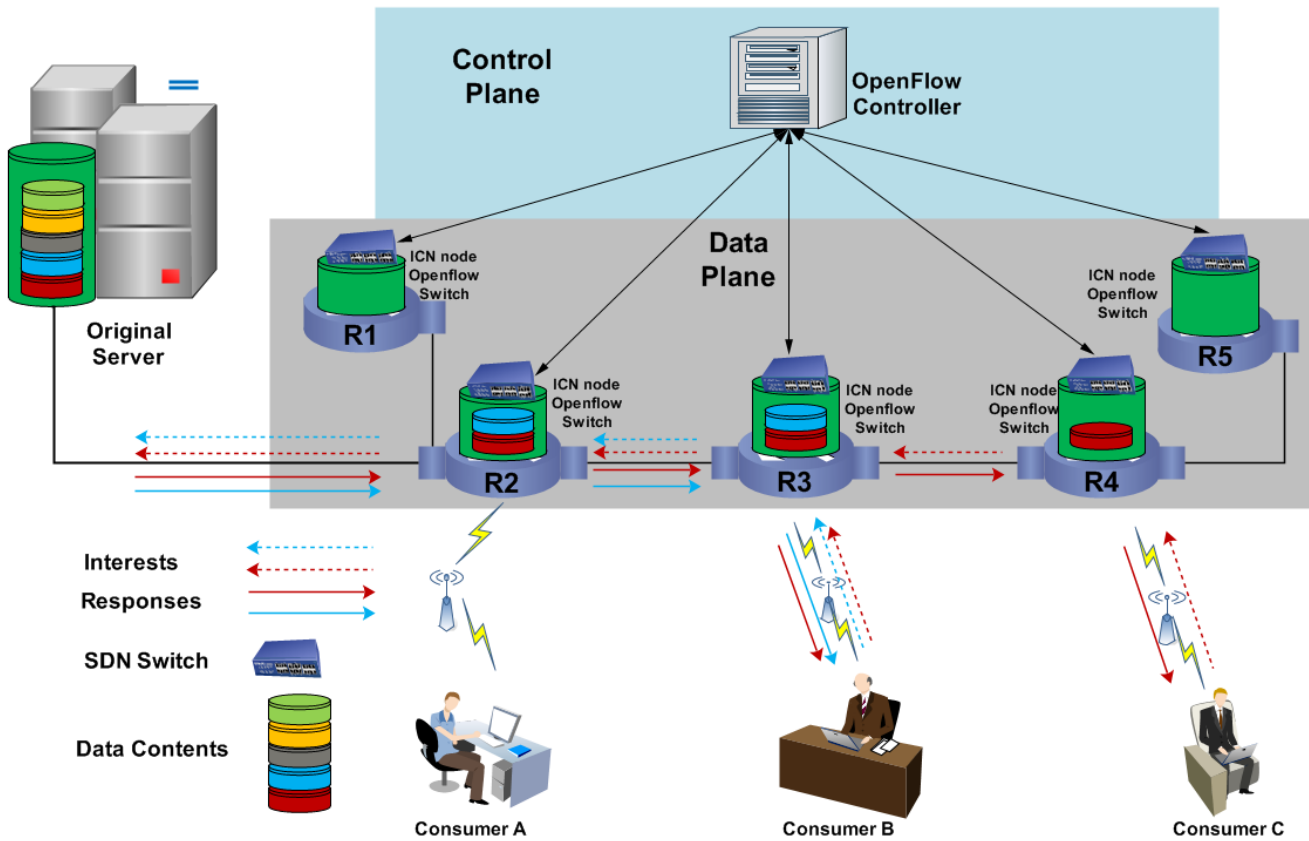

Fig. 8 ICN-Based Caching contributions for Software-Defined Networking.

for mobile-based communication that will deliver high-frequency content dissemination with a high bandwidth capacity. Moreover, it has capabilities to integrate with modern technologies such as conventional computing, IoT, and mobile devices [74]. The main objective of 5G technology is to connect everything located everywhere by using IoT technologies. Presently, the user demands for multimedia applications and ultra-high definition contents are significantly increasing day by day over the mobile Internet. However, the cellular-based networks are associated to the centralized architecture that delivers end-to-end data dissemination services. It is predicted that, the current mobile-based communication services will be insufficient to meet up the modern user requirements in future using presently working backhaul links and available bandwidth. The immense growth of mobile data traffic has been congesting the links of radio access networks. Therefore, a number of limitations have been carried out such as content retrieval delay, energy and power consumption [75,76]. However, a number of developments have been fabricated to expand the mobile-based network operators and equipment by enhancing the bandwidth of wireless-based network links and uses the modern technologies

to improve the access control layer. Moreover, the coordinated multi-point dissemination, physical layer, carrier aggregation, massive multi-input, and multi-output are the most important limitations while we are dealing with the long term evaluations of advance systems. In addition, multiple downloading of few popular contents which usually have large data size is another significant restriction which is increasing the multimedia traffic [77].

Therefore, the research community is keenly interested to find a flexible solution that has the ability to reduce the redundant data transmission. Therefore, ICN caching is the most appropriate approach to overcome the mentioned issues. In fact, it provides considerable caching facilities in the form of content placement strategies and content replacement policies to minimize the overall redundant data transmissions. Moreover, ICN-based caching can minimize the energy, resource consumption and has the ability to reduce the unnecessary data traffic by implementing the suitable content caching scheme [8].

Caching offers advantageous opportunities to the 5G networks, such as uniquely identifiable content naming, in-network caching per-chunk, name-based forwarding,

chunk-based data dissemination, and the receiver-driven content retrieval. Therefore, a user sends a request to any caching [78] node and the required content will be delivered to the user by any of the network node holding the corresponding content [42, 79]. Figure 9 shows contributions of caching strategies for 5G networks.

#### 4.7 ICN Caching for Genomic Data Sets

The usage of Internet is increasing and users are keenly interested in modern technologies such as software-defined networking (SDN) [81, 82], Internet of Things (IoT) [42], blockchain [80], edge cloud computing, and distributed fog computing [65]. Currently, the genomic data is massively created from the heterogeneous environments using smart devices. This data is the most significant for the medical fields. However, the genomic data science is suffering from the critical issues such as lack of documentation, distribution over several repositories, presence of comparable and diverse data formats. Moreover, the dissemination of redundant data sets in genomic science is a significant issue that needs a comprehensive solution to overcome the transmission related problems. The reason is that, genomic data sets are transmitted through IP-based Internet and usually store at remote databases that reinforce the data traffic. Indeed, similar type of data is transmitted over the same network several times that intensify the redundant data traffic. Therefore, a number of issues have been creating related to the genomic data transmission such as network congestion, high usage of resources, extra bandwidth, and energy consumption. In this situation, ICN-caching is a considerable approach to reduce such type of critical issues through implementing the cache-able network environment. It delivers a large number of caching schemes (content placement strategies and content replacement policies) to minimize the redundant transmission of genomic data sets. Moreover, caching has the ability to maximize the availability of popular data sets by caching these data sets near the desired user. Hence, the network congestion and energy consumption will be minimized and the bandwidth and resource will be used in efficient manner.

## 5 Conclusion and Future Directions

ICN caching is satisfactorily a leading development to meet the future requirements of the Internet. In this study, we are presenting a deep survey about the expected issues of the IP-based Internet and its solutions through caching of ICN. Initially, we presented the general idea about the existing problems of IP Internet and

then familiarized the representative approaches of ICN caching. Moreover, the ICN caching contributions in other communication technologies, such as IoT, cloud computing, fog computing, blockchain, SDN, 5G, and genomic data sat of in-network caching were discussed. Based on the caching-based integrated solution with other networking technologies, we concluded that the caching is more feasible for other networking fields and can deliver several benefits such as low response latency, low bandwidth, low congestion, and low power and resource consumption. In addition, caching provides a large number of caching schemes to deliver efficient communications services. This directed the research communities to a discussion of the research challenges and issues for ICN in-network caching which, though essential, have not expected much interest from the majority of research community.

#### 5.1 Future Directions for ICN as Internet Technologies

ICN caching provides fast data dissemination with less retrieval latency using caching module. Basically, caching is buildup using two types of approaches such as content placement strategies and replacement policies. The content placement strategies are responsible to cache a transmitted content at appropriate location where it has the high chance to download that will fulfill the subsequent end-user requirements. On the other hand, the content replacement policies are responsible to accommodate the highly requested content near the desired user by the eviction of less recently been downloaded data contents. Cache deployment deposits the user's desired content along the data routing path in provisional storage (cache) that is allocated within the network nodes. Caching plays an immense role in network performance by diminishing bandwidth consumption and reducing latency when accessing the required content over again. Caching also minimizes the server load while maximizing the availability of content. An essential operation of these caching strategies is forwarding the desired content to the interested users and caching a copy of the content near the interested users to minimize the average cost for subsequent Interests (requests). Recently, a number of content deployment strategies have been projected to deploy ICN in-network caching. These strategies boost up the information distribution and decrease reaction time [86, 87]. In addition, the caching strategies use fewer network resources and reduces the network traffic [88]. Therefore, ICN caching provides a large number of caching strategies to be deployed in diversified Internet environments to make efficient data communication services. It provides probabilistic-based caching strategies that are



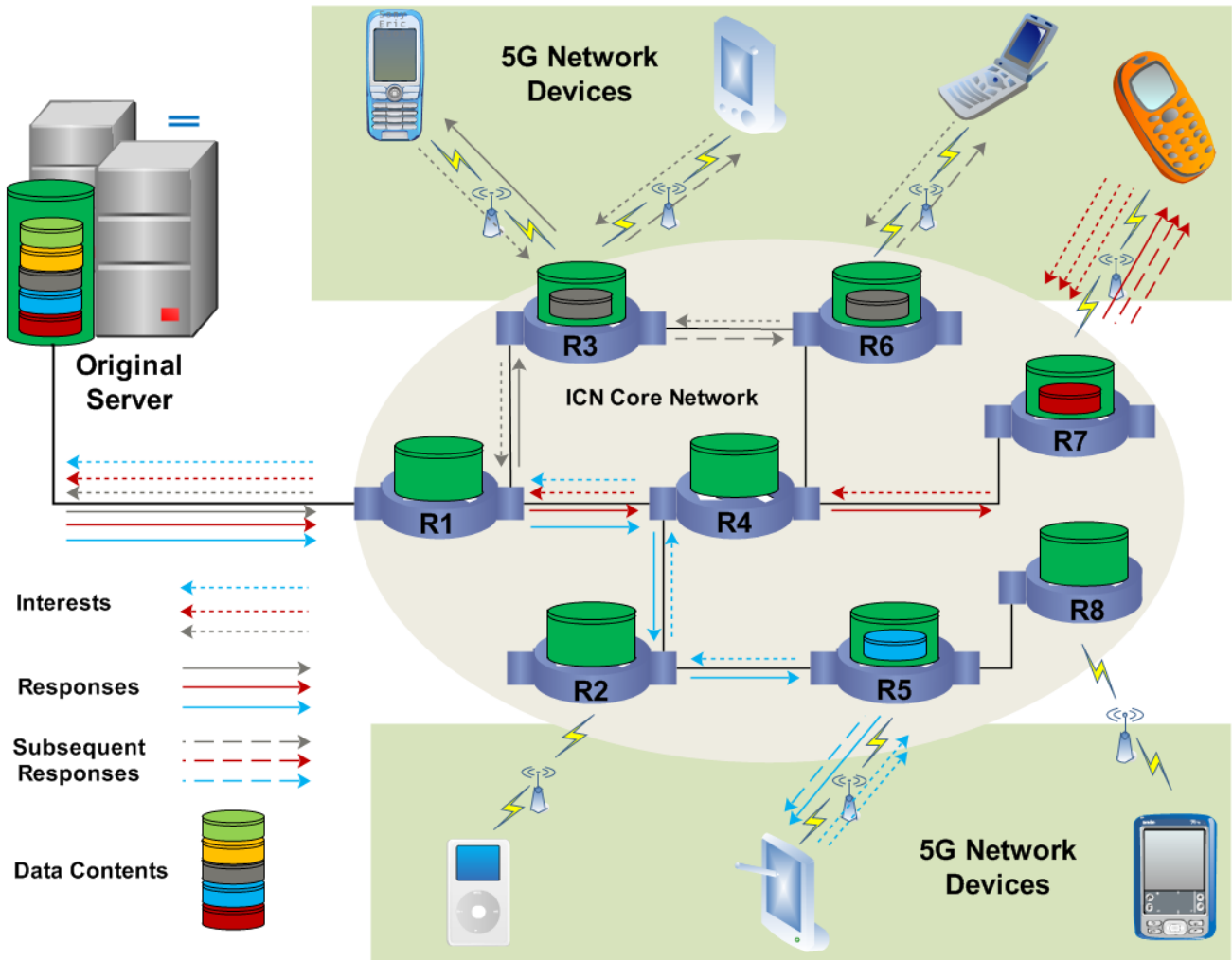

Fig. 9 ICN-Based Caching contributions for 5G networks.

separated into two sub-categories. The primary subcategory is Fixed Probabilistic Caching (FIX), and the secondary subcategory is dynamic probabilistic caching. In fixed-based caching strategies, Everywhere Probabilistic Caching (EPC), Priority-Based Probabilistic Caching (PBPC), Random-Based Probabilistic Caching (RPC) are included. However, in dynamic-based caching strategies, ProbCache, ProbCache+, Hop-based Probabilistic Caching (HPC) strategies are included. Moreover, it provides several other caching strategies, such as Leave Copy Down (LCD), Proxy-Based Caching Strategies, and Centrality-Based Caching Strategies. The most significant caching categories are content popularity-based caching strategies such as MAX-Gain In-network Caching (MAGIC) [89], WAVE Popularity-based and Collaborative Caching Strategy [90], Hop-based Probabilistic Caching (HPC) [91], LeafPopDown [92], Most Popular Cache (MPC) [93] strategy, Compound Popular Content Caching strategy, Efficient Hybrid Content Place-

ment (EHCP) Strategy, and Cache Capacity Aware Caching (CCAC) [94,95] strategy as shown in Figure 10. All these caching strategies are most significant to provide better communication services to the IP-based Internet technologies. Almost all types of strategies can be found with in ICN caching domain to use in diverse Internet technologies [96,97].

ICN is a promising future Internet architecture. Moreover, it has the potential to reduce the content retrieval latency and energy consumption. It is considered as the most emerging approach to integrate the other communication technologies such as IoT, fog, and edge computing. Thanks to the innovative caching module that has the ability to significantly minimize the overall data dissemination cost (usage of resources, energy, and power consumption) [98–103]. Thus, a large number of ICN-based caching schemes such as content placement strategies and content replacement policies have been developed that can be implemented in diverse communica-

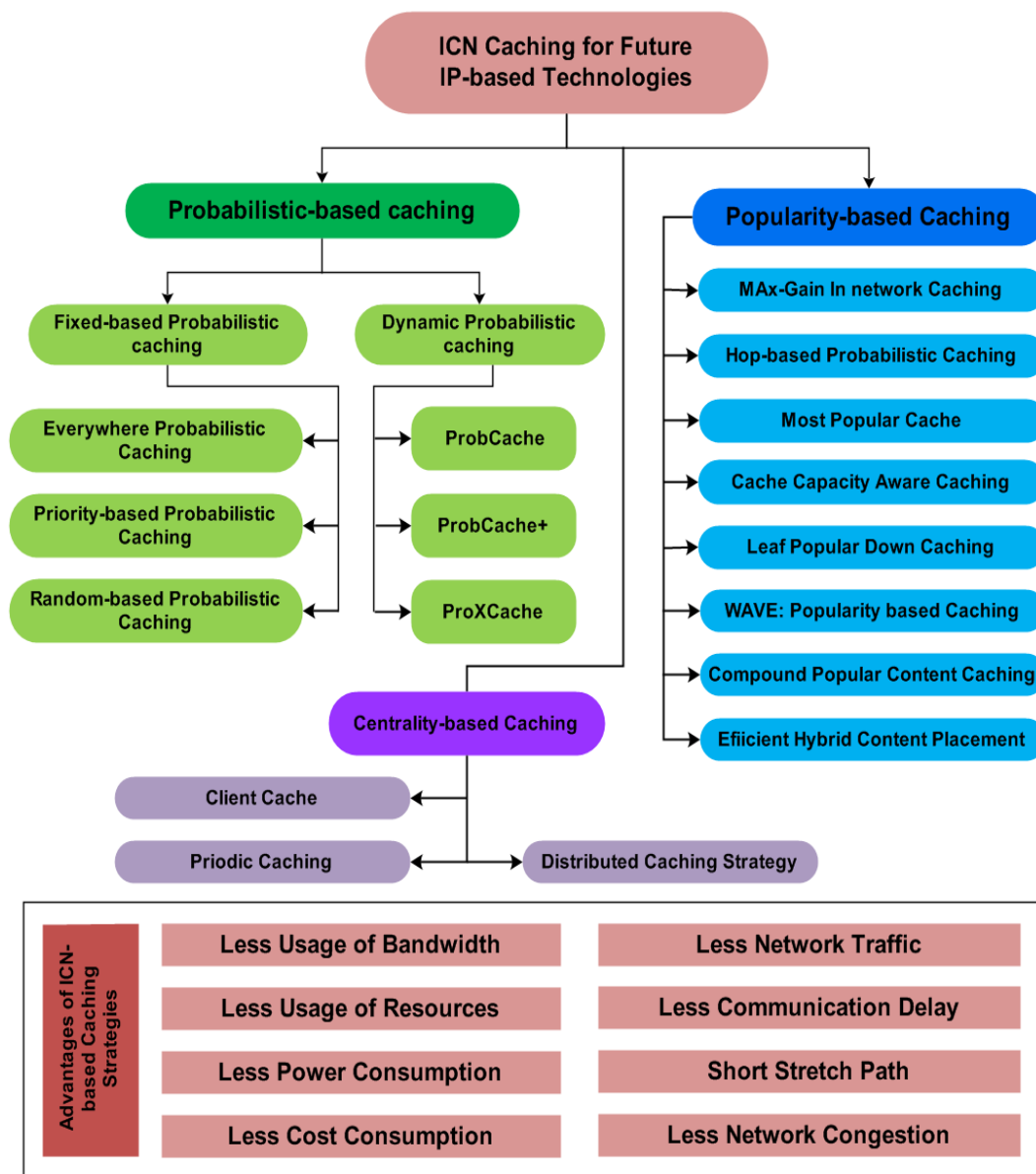

Fig. 10 ICN-Based Caching future directions for Internet Technologies

tion environments to enhance the overall performance of the heterogeneous Internet technologies [104–107].

## References

1. Naeem M.A., et al. (2019), Compound Popular Content Caching Strategy in Named Data Networking. *Electronics*, 8(7):771.
2. Juluri P, Tamarapalli V, and Medhi D (2016), Measurement of quality of experience of video-on-demand services: A survey. *IEEE Communications Surveys & Tutorials*, 18(1):401-418.
3. Zami T, Morea A, and Pesic J (2018), Benefit of progressive deployment of regenerators along with traffic growth in WDM elastic networks, in *Optical Fiber Communication Conference*, San Diego, California United States, 11–15 March. <https://doi.org/10.1364/OFC.2018.Tu2F.3>
4. Lee S, Preface: Smart Traffic Hubs, in *Digital Marketplaces Unleashed2018*, Springer. p. 407-416.
5. Ganesh K, Portea: Social Media Applications, in *Social Media Marketing2018*, Springer. p. 195-207.
6. Alubady R, et al. (2015), Review of Name Resolution and Data Routing for Information Centric Networking, in *The 4th International Conference on Internet Applications, Protocols and Services (NETAPPS2015)*. 2015.
7. Abdullah, W.D., A.M. MonzerHabbal, and M.B. Mahmuddin. Evaluation of user behavior and network performance in Malaysian Institution of Higher Education (MIHE) of wireless network. in *New Trends in Information & Communications Technology Applications (NTICT)*, 2017 Annual Conference on. 2017. IEEE.
8. Naeem, M.A., et al., Performances of Probabilistic Caching Strategies in Content Centric Networking. *IEEE*

**Table 3** List of abbreviations and acronyms used in this paper.

Acronyms	Full description
NDN	Named Data Networking
FIX	Fixed Probabilistic Caching
ICN	Information-Centric Networking
EPC	Everywhere Probabilistic Caching
SDN	software-defined networking
PBPC	Priority-based probabilistic caching
IoT	Internet of things
RPC	Random-based probabilistic caching
LCE	Leave Copy Everywhere
HPC	Hop-based Probabilistic Caching
LCD	Leave Copy Down
EHCP	Efficient Hybrid Content Placement
CCAC	Cache Capacity Aware Cache
NAC	Name-based Access Control
CS	Content Store
UGC	User Generated Content
PIT	Pending Interest Table
NRS	Name Resolution System
FIB	Forwarding Information Base
EU FP7	European Union Research and Innovation
NetInf	Network of Information
PSRIP	Publish Subscriber Internet Routing Paradigm
PURSUIT	Publish Subscriber Internet Technology
ICNRG	Information-Centric Network Research Group
VNI	Cisco Visual Network Index
CAGR	Compound Annual Growth Rate

Access, 2018.

9. Kobezak, P., et al. Host Inventory Controls and Systems Survey: Evaluating the CIS Critical Security Control One in Higher Education Networks. in Proceedings of the 51st Hawaii International Conference on System Sciences. 2018.
10. Naeem, M.A. and S.A. Nor. A survey of content placement strategies for content-centric networking. in AIP Conference Proceedings. 2016. AIP Publishing.
11. Meng Y, Naeem MA, R. Ali, Y. B. Zikria, and S. W. Kim, "DCS: Distributed caching strategy at the edge of vehicular sensor networks in information centric networking," *Sensors*, 19(20), 4407, Oct. 2019.
12. Xu, C., et al., Optimal Information Centric Caching in 5G Device-to-Device Communications. *IEEE Transactions on Mobile Computing*, 2018.
13. Zhang, G., Y. Li, and T. Lin, Caching in information centric networking: A survey. *Computer Networks*, 2013. 57(16): p. 3128-3141.
14. Bari, M.F., et al., A survey of naming and routing in information-centric networks. *IEEE Communications Magazine*, 2012. 50(12): p. 44-53.
15. Barakabitze, A.A., T. Xiaoheng, and G. Tan, A Survey on Naming, Name Resolution and Data Routing in Information Centric Networking (ICN). *Int. J. Adv. Res. Comput. Commun. Eng*, 2014. 3(10): p. 8322-8330.
16. Rahel, S., A. Jamali, and S. El Kafhali. Energy-efficient on caching in named data networking: A survey. in *Cloud Computing Technologies and Applications (CloudTech)*, 2017 3rd International Conference of. 2017. IEEE.
17. Bernardini, C., T. Silverston, et al. (2015). A comparison of caching strategies for content centric networking. *Global Communications Conference (GLOBECOM)*, 2015 IEEE, IEEE.
18. Amadeo M, Campolo C, Molinaro A, Ruggeri G. Content-centric wireless networking: A survey. *Computer Networks*. 2014 Oct 29;72:1-3.
19. Naeem, M. A., M. A. U. Rehman, et al. (2020). "A Comparative Performance Analysis of Popularity-Based Caching Strategies in Named Data Networking." *IEEE Access* 8: 50057-50077.
20. Zhang, L., et al., Named data networking. *ACM SIGCOMM Computer Communication Review*, 2014. 44(3): p. 66-73.
21. Zhang, M., H. Luo, and H. Zhang, A survey of caching mechanisms in information-centric networking. *IEEE Communications Surveys & Tutorials*, 2015. 17(3): p. 1473-1499.
22. Abdullahi, I., S. Arif, and S. Hassan, Survey on caching approaches in Information Centric Networking. *Journal of Network and Computer Applications*, 2015. 56: p. 48-59.
23. Bonomi, F., et al. Fog computing and its role in the internet of things. in Proceedings of the first edition of the MCC workshop on Mobile cloud computing. 2012. ACM.
24. Hua, Z.A. Study of ubiquitous learning environment based on Ubiquitous computing. in *Ubi-media Computing (U-Media)*, 2010 3rd IEEE International Conference on. 2010. IEEE.
25. Xylomenos, G., et al., A survey of information-centric networking research. *IEEE Communications Surveys & Tutorials*, 2014. 16(2): p. 1024-1049.
26. Veltri, L., et al. Supporting information-centric functionality in software defined networks. in *Communications (ICC)*, 2012 IEEE International Conference on. 2012. IEEE.
27. Dannewitz, C., et al., Network of Information (Net-Inf)—An information-centric networking architecture. *Computer Communications*, 2013. 36(7): p. 721-735.
28. Vasilakos, A.V., et al., Information centric network: Research challenges and opportunities. *Journal of Network and Computer Applications*, 2015. 52: p. 1-10.
29. Abdullahi, I., S. Arif, and S. Hassan, Cache-less redundancy using hypergraph in information-centric network. *Advanced Science Letters*, 2015. 21(11): p. 3546-3549.
30. Rayes, A. and S. Salam, Internet of Things (IoT) Overview, in *Internet of Things From Hype to Reality 2017*, Springer. p. 1-34.
31. Nikoleris, N., et al. CoolSim: Eliminating traditional cache warming with fast, virtualized profiling. in *Performance Analysis of Systems and Software (ISPASS)*, 2016 IEEE International Symposium on. 2016. IEEE.
32. Wang, Y., J. Bi, and K. Zhang, Design and implementation of a software-defined mobility architecture for IP networks. *Mobile Networks and Applications*, 2015. 20(1): p. 40-52.
33. Lee, M., et al., Content discovery for information-centric networking. *Computer Networks*, 2015. 83: p. 1-14.
34. Araldo, A., D. Rossi, and F. Martignon, Cost-aware caching: Caching more (costly items) for less (ISPs operational expenditures). *IEEE Transactions on Parallel and Distributed Systems*, 2016. 27(5): p. 1316-1330.
35. Xu, L., et al. An Autonomous System Based Security Mechanism for Network Coding Applications in Content-Centric Networking. in *International Conference on Mobile, Secure, and Programmable Networking*. 2017. Springer.
36. Tsudik, G., E. Uzun, and C.A. Wood. AC3N: Anonymous communication in Content-Centric Networking. in *Consumer Communications & Networking Conference (CCNC)*, 2016 13th IEEE Annual. 2016. IEEE.
37. Feng, B., et al., HetNet: A flexible architecture for heterogeneous satellite-terrestrial networks. *IEEE Network*, 2017.

38. Saha, S., A. Lukyanenko, and A. Ylä-Jääski. Cooperative caching through routing control in information-centric networks. in INFOCOM, 2013 Proceedings IEEE. 2013. IEEE.
39. Li, Z. and G. Simon, Cooperative caching in a content centric network for video stream delivery. *Journal of network and systems management*, 2015. 23(3): p. 445-473.
40. Ioannou, A. and S. Weber. Towards on-path caching alternatives in information-centric networks. in *Local Computer Networks (LCN)*, 2014 IEEE 39th Conference on. 2014. IEEE.
41. Ioannou, A. and S. Weber, A survey of caching policies and forwarding mechanisms in information-centric networking. *IEEE Communications Surveys & Tutorials*, 2016. 18(4): p. 2847-2886.
42. Naeem, M., et al., A Periodic Caching Strategy Solution for the Smart City in Information-Centric Internet of Things. *Sustainability*, 2018. 10(7): p. 2576.
43. Abani, N., T. Braun, and M. Gerla. Proactive caching with mobility prediction under uncertainty in information-centric networks. in *Proceedings of the 4th ACM Conference on Information-Centric Networking*. 2017. ACM.
44. Y. Meng, M. A. Naeem, R. Ali, and B. Kim, "EHCP: An Efficient Hybrid Content Placement Strategy in Named Data Networking Caching," *IEEE Access*.
45. Meddeb, M., et al. Cache coherence in machine-to-machine information centric networks. in *Local Computer Networks (LCN)*, 2015 IEEE 40th Conference on. 2015. IEEE.
46. Psaras, I., W.K. Chai, and G. Pavlou, In-network cache management and resource allocation for information-centric networks. *IEEE Transactions on Parallel and Distributed Systems*, 2014. 25(11): p. 2920-2931.
47. Li, S., et al. A comparative study of MobilityFirst and NDN based ICN-IoT architectures. in *10th International Conference on Heterogeneous Networking for Quality, Reliability, Security and Robustness*. 2014. IEEE.
48. Bai, X., et al. ICN: Interest-based clustering network. in *Proceedings. Fourth International Conference on Peer-to-Peer Computing*, 2004. Proceedings. 2004. IEEE.
49. Chen, J., et al., Exploiting ICN for realizing service-oriented communication in IoT. *IEEE Communications Magazine*, 2016. 54(12): p. 24-30.
50. Han, Q., S. Liang, and H. Zhang, Mobile cloud sensing, big data, and 5G networks make an intelligent and smart world. *IEEE Network*, 2015. 29(2): p. 40-45.
51. Duan, Q., Y. Yan, and A.V. Vasilakos, A survey on service-oriented network virtualization toward convergence of networking and cloud computing. *IEEE Transactions on Network and Service Management*, 2012. 9(4): p. 373-392.
52. Rost, P., et al., Cloud technologies for flexible 5G radio access networks. *IEEE Communications Magazine*, 2014. 52(5): p. 68-76.
53. Liang, B., et al., Mobile edge computing. *Key Technologies for 5G Wireless Systems*, 2017. 16(3): p. 1397-1411.
54. Xu, Y., et al. Distributed caching via rewarding: An incentive caching model for icn. in *GLOBECOM 2017-2017 IEEE Global Communications Conference*. 2017. IEEE.
55. Klinkowski, M.A. and K. Walkowiak, On the advantages of elastic optical networks for provisioning of cloud computing traffic. *IEEE Network*, 2013. 27(6): p. 44-51.
56. Index, C.V.N., Global Mobile Data Traffic Forecast Update, 2012-2017: [www.cisco.com/enUS/solutions/collateral/ns341/ns525/ns537/ns705/ns827/white\\_paper\\_c11-520862.html](http://www.cisco.com/enUS/solutions/collateral/ns341/ns525/ns537/ns705/ns827/white_paper_c11-520862.html), 2012.
57. Jin, T., et al. Blockndn: A bitcoin blockchain decentralized system over named data networking. in *Ubiquitous and Future Networks (ICUFN)*, 2017 Ninth International Conference on. 2017. IEEE.
58. Saucez, D., et al., *Information-Centric Networking (ICN) Research Challenges*. 2016.
59. Yang, K., J.J. Sunny, and L. Wang. Blockchain-based Decentralized Public Key Management for Named Data Networking. in *The International Conference on Computer Communications and Networks (ICCCN 2018)*. 2018.
60. Yu, Y., et al. Schematizing trust in named data networking. in *Proceedings of the 2nd ACM Conference on Information-Centric Networking*. 2015. ACM.
61. Wang, L., et al., A Secure Link State Routing Protocol for NDN. *IEEE Access*, 2018. 6: p. 10470-10482.
62. Wu, J., et al., A Hierarchical Security Framework for Defending Against Sophisticated Attacks on Wireless Sensor Networks in Smart Cities. *IEEE Access*, 2016. 4(4): p. 416-424.
63. Aazam, M. and E.-N. Huh. Fog computing and smart gateway based communication for cloud of things. in *Future Internet of Things and Cloud (FiCloud)*, 2014 International Conference on. 2014. IEEE.
64. Sifalakis, M., et al. An information centric network for computing the distribution of computations. in *Proceedings of the 1st ACM Conference on Information-Centric Networking*. 2014. ACM.
65. Song, F., et al., Smart collaborative caching for information-centric IoT in fog computing. *Sensors*, 2017. 17(11): p. 2512.
66. Arianfar, S., P. Nikander, and J. Ott. On content-centric router design and implications. in *Proceedings of the Re-Architecting the Internet Workshop*. 2010. ACM.
67. He, Y., et al., Software-defined networks with mobile edge computing and caching for smart cities: A big data deep reinforcement learning approach. *IEEE Communications Magazine*, 2017. 55(12): p. 31-37.
68. Yan, Q., et al., Software-defined networking (SDN) and distributed denial of service (DDoS) attacks in cloud computing environments: A survey, some research issues, and challenges. *IEEE Communications Surveys & Tutorials*, 2016. 18(1): p. 602-622.
69. Huo, R., et al., Software defined networking, caching, and computing for green wireless networks. *IEEE Communications Magazine*, 2016. 54(11): p. 185-193.
70. Liu, W.-X., et al., Content popularity prediction and caching for ICN: A deep learning approach with SDN. *IEEE access*, 2018. 6: p. 5075-5089.
71. Jmal, R. and L.C. Fourati, An OpenFlow architecture for managing content-centric-network (OFAM-CCN) based on popularity caching strategy. *Computer Standards & Interfaces*, 2017. 51: p. 22-29.
72. Ravindran, R., et al. Towards software defined icn based edge-cloud services. in *Cloud Networking (CloudNet)*, 2013 IEEE 2nd International Conference on. 2013. IEEE.
73. Wang, X., et al., Cache in the air: exploiting content caching and delivery techniques for 5G systems. *IEEE Communications Magazine*, 2014. 52(2): p. 131-139.
74. Wang, X., et al., A survey of green mobile networks: Opportunities and challenges. *Mobile Networks and Applications*, 2012. 17(1): p. 4-20.
75. Liang, C., F.R. Yu, and X. Zhang, Information-centric network function virtualization over 5G mobile wireless networks. *IEEE Network*, 2015. 29(3): p. 68-74.
76. Monserrat, J.F., et al. Rethinking the mobile and wireless network architecture: The METIS research into 5G. in *Networks and Communications (EuCNC)*, 2014 European Conference on. 2014. IEEE.

77. Woo, S., et al. Comparison of caching strategies in modern cellular backhaul networks. in *Proceeding of the 11th annual international conference on Mobile systems, applications, and services*. 2013. ACM.
78. Naeem MA, S.A.N., Suhaidi Hassan, IP-Internet Data Dissemination Challenges and Future Research Directions. *Journal of Advanced Research in Dynamical and Control Systems* 2018. 10(Special Issue): p. 1596-1606.
79. Lei, K., et al., An NDN IoT Content Distribution Model With Network Coding Enhanced Forwarding Strategy for 5G. *IEEE Transactions on Industrial Informatics*, 2018. 14(6): p. 2725-2735.
80. Jin, T., et al. BlockNDN: A bitcoin blockchain decentralized system over named data networking. in *2017 Ninth International Conference on Ubiquitous and Future Networks (ICUFN)*. 2017. IEEE.
81. van Adrichem, N.L. and F.A. Kuipers. NDNFlow: Software-defined named data networking. in *Proceedings of the 2015 1st IEEE Conference on Network Softwarization (NetSoft)*. 2015. IEEE.
82. Mahmood, A., et al., Efficient caching through stateful SDN in named data networking. *Transactions on Emerging Telecommunications Technologies*, 2018. 29(1): p. e3271.
83. Reali, G., et al., Genomics as a service: A joint computing and networking perspective. *Computer Networks*, 2018.
84. Femminella, M., G. Reali, and D. Valocchi. Genome Centric Networking: a network function virtualization solution for genomic applications. in *2017 IEEE Conference on Network Softwarization (NetSoft)*. 2017. IEEE.
85. Shannigrahi, S., et al. NDN-SCI for managing large scale genomics data. in *ICN*. 2018.
86. Puzhavakath Narayanan, S., et al. Reducing latency through page-aware management of web objects by content delivery networks. in *ACM SIGMETRICS Performance Evaluation Review*. 2016. ACM.
87. Rossini, G. and D. Rossi, Evaluating CCN multi-path interest forwarding strategies. *Computer Communications*, 2013. 36(7): p. 771-778.
88. Nakajima, H., et al., Performance Evaluation of Partial Deployment of an In-Network Cache Location Guide Scheme, *Breadcrumbs*. *IEICE Transactions on Communications*, 2016. 99(1): p. 157-166.
89. Ren, J., et al. Magic: A distributed max-gain in-network caching strategy in information-centric networks. in *2014 IEEE conference on computer communications workshops (INFOCOM WKSHPS)*. 2014. IEEE.
90. Cho, K., et al. Wave: Popularity-based and collaborative in-network caching for content-oriented networks. in *Computer Communications Workshops (INFOCOM WKSHPS)*, 2012 IEEE Conference on. 2012. IEEE.
91. Wang, Y., M. Xu, and Z. Feng. Hop-based probabilistic caching for information-centric networks. in *2013 IEEE Global Communications Conference (GLOBECOM)*. 2013. IEEE.
92. Khattak, H., et al., LeafPopDown: Leaf Popular Down Caching Strategy for Information-Centric Networking. *INTERNATIONAL JOURNAL OF ADVANCED COMPUTER SCIENCE AND APPLICATIONS*, 2018. 9(2): p. 148-151.
93. Bernardini, C., T. Silverston, and O. Festor. MPC: Popularity-based caching strategy for content centric networks. in *2013 IEEE international conference on communications (ICC)*. 2013. IEEE.
94. Lee, S.-W., et al. Cache capacity-aware CCN: Selective caching and cache-aware routing. in *2013 IEEE Global Communications Conference (GLOBECOM)*. 2013. IEEE.
95. Faheem, M.; Gungor, V.C. Energy efficient and QoS-aware routing protocol for wireless sensor network-based smart grid applications in the context of industry 4.0, *Applied Soft Computing*, Volume 68, 2018, Pages 910-922.
96. Faheem, M.; Gungor, V.C., MQRP: Mobile sinks-based QoS-aware data gathering protocol for wireless sensor networks-based smart grid applications in the context of industry 4.0-based on internet of things, *Future Generation Computer Systems*, Volume 82, 2018, Pages 358-374.
97. Faheem, M.; Butt, R. A.; Raza, B.; Ashraf, M. W.; Ngadi, M. A; Gungor, V. C. A multi-channel distributed routing scheme for smart grid real-time critical event monitoring applications in the perspective of Industry 4.0, *International Journal of Ad Hoc and Ubiquitous Computing (IJAHUC)*, Vol. 32(4), 2019,
98. M. A. Hail, M. Amadeo, A. Molinaro, and S. Fischer, "Caching in named data networking for the wireless internet of things," in *2015 international conference on recent advances in internet of things (RIoT)*, 2015, pp. 1-6.
99. M. A. M. Hail, M. Amadeo, A. Molinaro, and S. Fischer, "On the performance of caching and forwarding in information-centric networking for the IoT," in *International Conference on Wired/Wireless Internet Communication*, 2015, pp. 313-326.
100. S. Zhang and J. Liu, "Optimal Probabilistic Caching in Heterogeneous IoT Networks," *IEEE Internet of Things Journal*, vol. 7, pp. 3404-3414, 2020.
101. J. Gao, L. Zhao, and L. Sun, "Probabilistic caching as mixed strategies in spatially-coupled edge caching," in *2018 29th Biennial Symposium on Communications (BSC)*, 2018, pp. 1-5.
102. S. Vural, P. Navaratnam, N. Wang, C. Wang, L. Dong, and R. Tafazolli, "In-network caching of Internet-of-Things data," in *2014 IEEE International Conference on Communications (ICC)*, 2014, pp. 3185-3190.
103. J. Pfender, A. Valera, and W. K. Seah, "Performance comparison of caching strategies for information-centric IoT," in *Proceedings of the 5th ACM Conference on Information-Centric Networking*, 2018, pp. 43-53.
104. R. Amer, M. M. Butt, and N. Marchetti, "Optimizing Joint Probabilistic Caching and Channel Access for Clustered D2D Networks," *arXiv preprint arXiv:2003.02676*, 2020.
105. C. Gündoğan, J. Pfender, P. Kietzmann, T. C. Schmidt, and M. Wählisch, "On the impact of QoS management in an Information-centric Internet of Things," *Computer Communications*, 2020.
106. D. Gupta, S. Rani, S. H. Ahmed, and R. Hussain, "Caching Policies in NDN-IoT Architecture," in *Integration of WSN and IoT for Smart Cities*, ed: Springer, 2020, pp. 43-64.
107. M. Amadeo, C. Campolo, G. Ruggeri, G. Lia, and A. Molinaro, "Caching Transient Contents in Vehicular Named Data Networking: A Performance Analysis," *Sensors*, vol. 20, p. 1985, 2020.