

North East Linguistics Society

Volume 28 *Proceedings of the North East Linguistic Society 28 -- Volume One: Papers from the Main Sessions*

Article 20

1998

Locality and Inert Case

Martha McGinnis
MIT

Follow this and additional works at: <https://scholarworks.umass.edu/nels>



Part of the [Linguistics Commons](#)

Recommended Citation

McGinnis, Martha (1998) "Locality and Inert Case," *North East Linguistics Society*. Vol. 28 , Article 20.
Available at: <https://scholarworks.umass.edu/nels/vol28/iss1/20>

This Article is brought to you for free and open access by the Graduate Linguistics Students Association (GLSA) at ScholarWorks@UMass Amherst. It has been accepted for inclusion in North East Linguistics Society by an authorized editor of ScholarWorks@UMass Amherst. For more information, please contact scholarworks@library.umass.edu.

Locality and Inert Case*

Martha McGinnis

MIT

1. Introduction

The claim I argue for here is that movement to subject position is constrained by structural locality. I begin with the familiar observation that there is a correlation between c-command and movement: the structurally highest argument is the one that moves to an available subject position. This generalization has been captured under various theories of the constraints on syntactic dependencies, including Relativized Minimality (Rizzi 1990) and economy conditions on movement (Chomsky & Lasnik 1993, Chomsky 1995). I will also discuss a range of exceptions to the generalization, in which the higher argument is ineligible for movement, allowing the lower one to move instead. I will take the position that what renders an argument ineligible for movement is a form of inherent case.

Within the generative tradition, inherent case was first defined as θ -related, rather than a property of the structural configuration (Chomsky 1981). Chomsky (1986) proposes that an argument with inherent case remains in the minimal domain of its θ -assigning head. By current approaches, where XP-movement is always to a position outside the minimal domain of the θ -assigner, this proposal is tantamount to saying that an inherently case-marked argument remains in its base position.¹ This view of inherent case has since been used to explain restrictions on which argument moves to the subject position (e.g. Belletti & Rizzi 1988, Baker 1996). Of course, certain inherently case-marked arguments can move just like arguments with structural case, for example in Icelandic (Zaenen, Maling & Thráinsson 1985). I explicitly adopt the assumption that there are two kinds of inherent case: quirky case, which is visible for A-movement, and inert case, which is not. Structural case also differs from inherent case in that it can trigger verb agreement and alternate morphologically depending on where it is checked. For example, a structurally case-marked object will typically appear as accusative in an active structure, where it checks case within the (extended) verb phrase, and as nominative in a passive structure, where it checks case on Tense. Arguments with quirky or inert case fail to trigger verb agreement, and have the same morphological realization regardless of where they appear. However, quirky case, like structural case, is visible for A-movement, while inert case is not.

* Thanks go to Elena Anagnostopoulou, Noam Chomsky, Alec Marantz, Léa Nash, and David Pesetsky for their comments and suggestions, as well as to audiences at MIT and NELS. This work was partially supported by a NSF Research Training Grant (DIR 9113607) awarded to MIT.

¹ It should be noted that this restatement no longer captures the relevant facts in Chomsky (1986).

This paper addresses a range of A-movement phenomena that fall into roughly two groups: those that involve movement of the highest argument, and those that involve movement of a lower argument. By locality, the constituent that moves to a given position is the closest eligible one (1a). Thus a lower argument can cross over a higher argument only under one of two conditions. First, the lower one can become equally close to the targeted position (1b). Secondly, the higher one can itself be ineligible for movement, making a lower argument the closest eligible one (1c). There is evidence that all three situations arise in natural language. I will focus here on evidence that a higher argument can be rendered ineligible for movement by a kind of inert inherent case, with the result that it neither moves itself, nor blocks movement of a lower argument.

(1) a. Shortest move

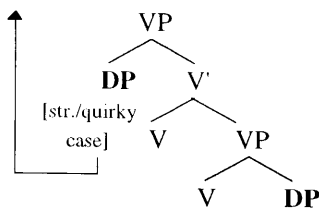

b. Equidistance

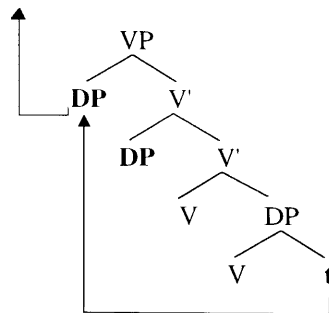

c. Inert case

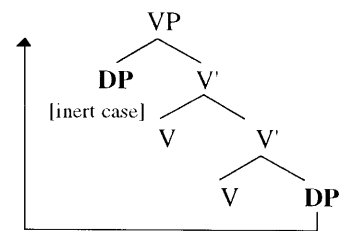

2. Three Kinds of Case

Let's begin with a review of some facts concerning double object constructions. Binding asymmetries between direct and indirect objects have been taken to arise from their position in an articulated structure such as the one in (2a), rather than a flat structure like (2b) (Barss & Lasnik 1986, Larson 1988, Marantz 1993).²

(2) a.

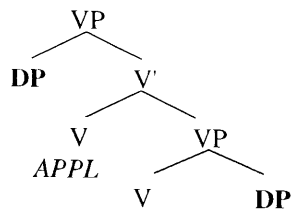

b.



There is evidence from a number of languages that a non-prepositional indirect object c-commands a direct object. In fact, Marantz (1993) has argued that this is the universal c-command relation between a goal or benefactive indirect object, and a theme or patient direct object. This relation arises from the fact that a theme or patient is merged in the minimal domain of the base verb, while a goal or benefactive argument is merged in the specifier of a light applicative verb, which is above the base VP for semantic reasons. (3)-

² By standard assumptions, the c-command asymmetry between the two objects could also be captured by a single VP projection, with one object as specifier and the other as complement. Under Minimalist assumptions, however, the specifier and complement of a head are equidistant from a higher position. My thesis is that the c-commanding argument is in fact closer to a higher position, so I adopt the structure (2a), with a light applicative verb (*APPL*) associated with the oblique argument.

(7) provide evidence for this c-command relation in a range of different languages. An indirect object quantifier can bind a direct object pronoun, but not vice versa, in English (3), Swahili (4), and Albanian (5). An indirect object can bind a direct object reflexive, but not vice versa, in Georgian (6) and Icelandic (7).

- (3) a. I read **each author** his book.
 b. *I read **its author** each book.
- (4) a. Ni-li-m-som-e-a **kila mwandishi** kitabu chake.
 SP-pst-OP-read-APPL-fv each writer his book
 ‘I read for **each author** his book.’
 b. * Ni-li-m-som-e-a **mwandishi wake** kila kitabu.
 SP-pst-OP-read-APPL-fv writer its each book
 ‘I read for **its author** each book.’ (Vicki Carstens p.c., in Marantz 1993)
- (5) a. Agimi ia dha **secilit djalë** pagën e tij.
 A.NOM cl give each boy.DAT pay.ACC his
 ‘Agim gave **to each boy** his pay.’
 b. * Agimi ia ktheu **autorit të tij** secilin liber.
 A.NOM cl return author.DAT its each book.ACC
 ‘Agim returned **to its author** each book.’ (Massey 1992)
- (6) a. nino-m **gela-s** tavisi tav-i anaxa sarķeři.
 N-ERG G-DAT self-NOM show-AOR mirror-in
 ‘Nino_i showed **Gela_j** himself_j in the mirror.’
 b. * nino-m **tav-is tav-s** gela anaxa sarķeři.
 Nino-ERG self-DAT gela.NOM show-AOR mirror-in
 ‘Nino_i showed **himself_j** Gela_j in the mirror.’ (Léa Nash, p.c.)
- (7) a. Ég hafði gefið **konunginum** ambáttina sína.
 I.NOM had given the king.DAT the maidservant.ACC his.REFL
 ‘I had given **the king_i** his_i maidservant.’
 b. * Ég hafði gefið **konungi sínum** ambáttina.
 I.NOM had given king.DAT her.REFL the maidservant.ACC
 ‘I had given **her_i, king_j** the maidservant.’ (Collins & Thráinsson 1996)

When a double object construction is passivized, one of the objects raises to the subject position. Locality predicts that the higher argument will raise to subject, blocking the lower argument from moving instead (8). This state of affairs arises in languages like American English (9), Danish (10), and Chichewa (11). In these languages, only the higher object can raise to the subject position.

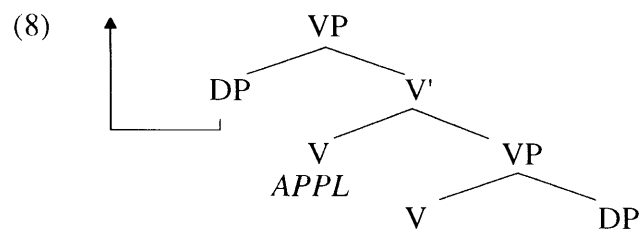

- (9) a. **We** were given a book.
 b. * A book was given **us**.

- (10) a. **Han** blev tilbudt en stilling.
'He was offered a job.'
- b. * En stilling blev tilbudt **ham**.
'A job was offered **him**.' (Falk 1990)
- (11) a. **Mbidzi** zi-na-gul-ir-idw-a nsapato (ndi kalulu).
zebras SP-pst-buy-APPL-pas-fv shoes (by hare)
'The zebras were bought shoes (by the hare).'
- b. * Nsapato zi-na-gul-ir-idw-a **mbidzi** (ndi kalulu).
shoes SP-pst-buy-APPL-pas-fv zebras (by hare)
'Shoes were bought for **the zebras** (by the hare).' (Baker 1988:248)

On the other hand, there are languages in which the lower argument can also raise to the subject position of a passive (12). These include a range of languages, including British English (13), Swedish (14), and Icelandic (15). Note that in English, the raised indirect object has structural case, which shows up as nominative in the subject position (13a). In Icelandic, the same argument has inherent dative case, which remains dative in subject position as well, and fails to trigger agreement on the verb (15a). These languages pose a problem for the simple view of phrase structure and locality we've assumed so far.

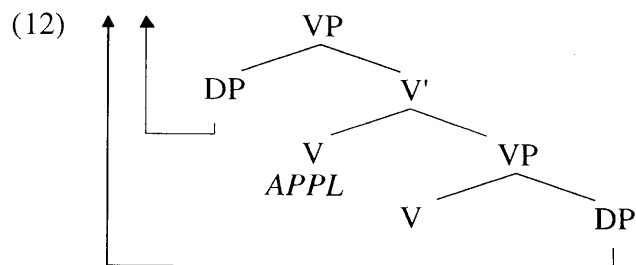

- (13) a. **We** were given a book.
b. A book was given **us**.
- (14) a. **Jon** ble gitt boken.
J. was given the-book
'**Jon** was given the book.'
- b. Boken ble gitt **Jon**.
the-book was given J.
'The book was given (to) **Jon**.' (Holmberg & Platzak 1995:215)
- (15) a. **Ólafi** var gefin bókin.
Olaf.DAT was given.NOM the book.NOM
'**Olaf** was given the book.'
- b. Bókin var gefin **Ólafi**.
the book.NOM was given.NOM Olaf.DAT
'The book was given to **Olaf**.' (Falk 1990)

In fact, in some languages, like Albanian (Massey 1992), *only* the lower argument can raise (16). This argument has structural case, which shows up as nominative in subject position. In Albanian, a quantifier in the raised direct object can bind an indirect object pronoun, but not vice versa. A similar situation arises in Georgian, except that here the

indirect object must also be a PP marked with the postposition *-tvis*, rather than a bare dative DP (17). These languages are also surprising, given Relativized Minimality.

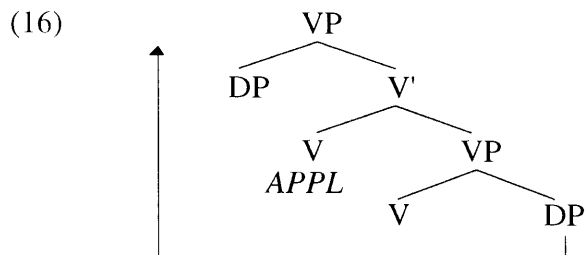

- (17) a. Secili libër iu kthye **autorit** të tij.
 each book.NOM cl returned.NACT author.DAT its
 'Each book was returned to **its author**.'
- b. *Secilit djalë iu dha paga i tij.
 each boy.DAT cl gave.NACT pay.NOM his
 'Each boy was given his pay.'
 (Massey 1992 and p.c.)

- (18) a. es bavšvi nacvenebia **as pediatria-tvis** (dedamisis mier)
 this child-NOM shown-is 100 pediatricians-to (mother by)
 'This child is shown to **a hundred pediatricians** (by its mother).'
- b. ***as pediatria-s** nacvenebia(-t) es bavšvi (dedamisis mier)
 100 pediatricians.DAT shown-DAT.PL this child-NOM (mother by)
 'A hundred pediatricians are shown this child (by its mother).'
- (Léa Nash, p.c)

For the cases in which either argument can raise to subject position, Ura (1996) has argued that the lower argument and the higher argument are equidistant for the purpose of movement. In the structure he proposes, both objects raise into multiple specifiers of the causative light verb at the top edge of the verb phrase. From this position, the two objects are equally close to the subject position, so either one can move there (19).

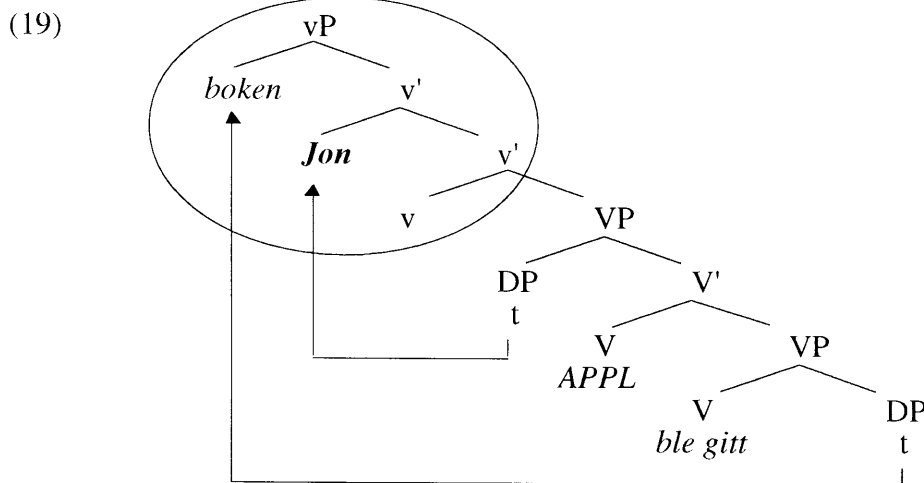

Even if (19) is the correct structure for languages that allow either object to become the subject of a passive, it still fails to explain what prevents the indirect object from raising to subject position in languages like Georgian and Albanian. One proposal that has been

offered for this kind of phenomenon (Belletti & Rizzi 1988, Baker 1996) is that the indirect object has inherent case, which forces it to remain in its base position.

Of course, some inherently case-marked arguments *can* raise to subject position, as we saw in the Icelandic dative passive (15a)—but the higher object in Georgian and Albanian cannot raise, even optionally. If the inherent case solution is correct, then, we have to distinguish between two kinds of inherent case: quirky case, which can move, and inert case, which is invisible for A-movement.³ The difference between Icelandic on the one hand, and Georgian and Albanian on the other, arises from the *type* of inherent case on the higher object of the double object construction. In Icelandic the higher object has quirky case, so it can move, just like a structurally case-marked argument. In Georgian or Albanian the higher object has inert case, which prevents it from undergoing A-movement.⁴

Quirky dative case also seems to be present in both Georgian and Albanian. Both have experiencer verbs with a dative experiencer subject. The fact that the dative, and not the nominative argument is the subject in (20) can be seen from the fact that a quantifier in the dative argument can bind a nominative pronoun, but not vice versa. Likewise, in (21), the dative argument can bind a nominative object reflexive, but not vice versa. This is true regardless of word order.

- (20) a. **Secilit djalë** i kujtohet baba i tij.
 each boy.DAT cl remember father.NOM his
 'Each boy remembers his father.'
- b. ***Babes të tij** i kujtohet secili djalë.
 father.DAT his cl remember each boy.NOM
 'His father remembers each boy.'
- (Massey 1992)

- (21) a. **vano-s** tavis tav-i uqvars.
 V.-DAT self-NOM loves
 'Vano loves himself.'
- b. ***tavis tav-s** vano uqvars.
 self-DAT V.-NOM loves
 'Himself loves Vano.'
- (Harris 1981)

3. Variations in Case Assignment

The interaction of inert case with locality in double-object constructions gives us the right range of possibilities for raising to the subject position of a passive. These facts also give us some idea of the properties of inert case. First, it seems to be an unforced property of the case-assigning head. As we have seen, the higher object has structural case in English, quirky case in Icelandic, and inert case in Albanian and Georgian. These

³ Double object passives in Georgian and Albanian actually seem to involve both inert case on the higher argument and movement of the lower argument through an equidistant position, giving rise to chain condition effects (cf. McGinnis 1997).

⁴ This statement may be too general, given that an indirect object in Georgian can scramble to the left of the logical subject (i). Further study is needed to determine the A/A' status of the dative argument in constructions like (i). If it has moved to an A-position, then it must be accessible for some A-movement.

(i) (?) gusin **čven poštalion-s** dzaylma pexi moučama.
 yesterday our mail-carrier-DAT dog.ERG leg.NOM bite.AOR
 'A dog bit the leg of our mail-carrier yesterday.'

(Nash 1995)

differences seem not to correlate with any differences in semantic role; the higher object can have the same interpretation regardless of its case. To put it another way, the presence of inert case is not forced by the need to produce an interpretable structure. Raising the indirect object is perfectly interpretable, as we can see from the languages where it is possible; when it *is* prevented, it is prevented by an unforced formal property. Let's turn to some facts concerning raising from an embedded clause. These facts support the view that inert case arises without being forced by interpretability requirements. They also suggest that it cannot be forced even to save an ill-formed structure.

Raising in English involves movement of the embedded subject to the matrix subject position, as shown in (22). If the matrix clause contains an experiencer, the embedded subject raises past it to subject position. In fact, the experiencer cannot raise to the subject position. This is similar to the situation in Georgian and Albanian double-object passives, where the lower argument must raise over the higher one.

- (22) a. Sally seemed [*t* to like his picture best].
 b. Sally seemed **to each boy** [*t* to like his picture best].
 c. ***To each boy** seemed *t* [Sally to like his picture best].

The ill-formedness of raising the matrix experiencer in English seems to have nothing to do with the fact that it leaves the embedded subject in the subject position of an infinitival. Raising the experiencer is also impossible when the embedded subject is PRO, as in (23), and when the embedded clause is finite, as in (24).

- (23) a. ?It was suggested **to each boy** [PRO to comb his hair].
 b. * **To each boy** was suggested [PRO to comb his hair].
- (24) a. It seemed **to each boy** [that Sally liked his picture best].
 b. * **To each boy** seemed *t* [that Sally liked his picture best].

In Icelandic, the embedded subject can also raise to the subject of a matrix clause (25a). However, if the matrix clause contains an experiencer, it is the experiencer that raises to subject position (25b). This is exactly what locality predicts. The experiencer is structurally higher than the embedded subject, so it moves to the subject position. Although the nominative argument can appear to the left of the verb in a topicalized position (25c), it cannot be exceptionally case-marked (26), unlike an embedded subject (Thráinsson 1979).

- (25) a. Haraldur virðist [*t* hafa gert þetta vel].
 H.NOM seems to.have done this well
 'Harald seems to have done that well.' (Andrews 1982)
- b. **Mér** virðist *t* [Haraldur hafa gert þetta vel].
 me.DAT seems H.NOM to.have done this well
 'Harald seems to me to have done that well.'
- c. Haraldur virðist **mér** [*t* hafa gert þetta vel].
 H.NOM seems me.DAT to.have done this well
 'Harald seems to me to have done that well.'

- (26) a. Jón telur **mér** virðast Haraldur hafa gert þetta vel.
 J.NOM believes me.DAT to seem H.NOM to.have done this well
 'Jon believes Harald to seem to me to have done this well.'
- b. * Jón telur Harald virðast **mér** hafa gert þetta vel.
 J.NOM believes H.ACC to seem me.DAT to.have done this well
 ('Jon believes Harald to seem to me to have done this well.')

We can give the same account for these facts as we gave for double-object passives. The experiencer in Icelandic has quirky case, making it eligible for movement to the subject position; the experiencer in English raising constructions has inert case, which makes it ineligible for movement and allows movement of the embedded subject past it.⁵

If the explanation I have given for the raising contrast is correct, these facts constitute additional evidence that inert case is not forced by semantic role. The experiencer seems to have the same semantic role in English and Icelandic, but it has inert case in English and quirky case in Icelandic. Moreover, the parallel facts from French suggest that when inert case is unavailable, its presence cannot be forced in order to save an ungrammatical structure.

First, however, the keen observer will have noticed that the experiencer in English is a prepositional phrase, while the experiencer in Icelandic is simply marked with dative case. It might be supposed that this difference is what gives rise to the differences in raising. However, there is evidence from locative inversion that prepositional phrases can be quirky subjects in English, in sentences like *Into the room rolled a ball* (Bresnan 1994, Schütze 1997). If so, then the experiencer's status as a prepositional phrase does not explain its inability to move to the subject position.

Although we have ruled out raising the prepositional phrase itself, something also has to prevent the experiencer from raising out of the prepositional phrase (27a-c). English does allow A-movement out of a prepositional phrase, in pseudopassives. However, Postal (1986) points out that pseudopassivization is impossible when the verb has a clausal complement, as shown in (27d). The facts in (27a-c) could be of the same type. Pesetsky (1995) argues that the clausal complement in examples like (27d) originates between the verb and the preposition, blocking the P+V reanalysis necessary for pseudopassivization. Such a derivation could block reanalysis to the object of *to* in (27a-c) as well.

- (27) a. ***Each boy** seemed to *t* [Sally to like his picture best].
 b. ***Each boy** was suggested to *t* [PRO to comb his hair].
 c. ***Each boy** seemed to *t* [that Sally liked his picture best].
 d. **The priest** was confessed to *t* by Melvin (*that he had sinned).

To resume the discussion of inert case, the examples in (28) show that raising past an experiencer argument in French is interpretable, and grammatical as long as the experiencer is a clitic (28b). However, if the experiencer is a full DP, rather than a clitic, rais-

⁵ There is also an additional argument that the experiencer in an English raising construction has inert case, based on the interaction of locality and binding (cf. fn. 2). The proposal is that movement through an equidistant position rules out binding between the two equidistant arguments. In some cases, provided that the higher argument has inert case, the lower argument can skip over higher one without passing through an equidistant position. Thus binding is permitted, as in (i).

(i) Sally seems to **herself** [*t* to like her son's picture best].

ing past it is ungrammatical (28c). The acceptability of raising the embedded subject past a clitic experiencer suggests that the clitic itself is unavailable for movement to the subject position. We can follow the traditional assumption here that clitic movement involves adjunction of the clitic to a head. From this position it is ineligible for further A-movement, and the embedded subject moves past it without incurring a violation.⁶

- (28) a. Jean semble [*t* avoir du talent].
 J. seems to have of talent
 ('Jean seems to have talent.')
- b. Jean **lui** semble *t_{lui}* [*t_{Jean}* avoir du talent].
 J. to-3sg seems to have of talent
 'Jean seems to him/her to have talent.'
- c. ??? Jean semble **à Marie** [*t* avoir du talent].
 J. seems to M. to have of talent
 ('Jean seems to Marie to have talent.')
- d. * (A) **Marie** semble *t* [Jean avoir du talent].
 to M. seems J. to have of talent
 ('Jean seems to Marie to have talent.') (Marie-Claude Boivin, p.c.)

By contrast with the clitic, a full DP experiencer does block the embedded subject from raising, even though the experiencer cannot itself raise to subject position. We can treat this as an instance where the experiencer has quirky case, which allows it to raise to subject position, and blocks movement of the embedded subject. Unlike Icelandic, however, French does not permit quirky case-marked subjects, so the derivation crashes (28d).

Notice that the French construction in (28c) would be perfectly grammatical if the experiencer could have inert case. In this case the experiencer would be ineligible for movement, so the embedded subject could raise past it to the matrix subject position, just as in English.⁷ The French raising facts can be taken as evidence that inert case is an unforced property of a case-assigning head. We will return to this point later.

So far I have focused on cross-linguistic variation in case properties, showing that a given semantic role can have different case from one language to the next. We have also seen that a given language can have both quirky and inert inherent case, assigned to different semantic roles. The relevant examples were from Georgian and Albanian, which have inert dative case on the higher object of a double object construction. In a different structure, where the dative argument has an experiencer role, it has quirky case. The Albanian examples are given again in (29).

⁶ For at least some speakers, the experiencer is also fine if it is *wh*-moved, as in (i). This suggests that the *wh*-phrase moves first to an A'-position below the matrix subject position, leaving a trace that does not block movement of the embedded subject.

(i) **A qui** est-ce que Jean semble avoir du talent?
 to who is-it that J. seems to have of talent
 'To whom does Jean seem to have talent?'

⁷ Actually, speakers disagree on the grammaticality of examples like (28c). My own consultants are divided on this point, and different judgements are reported in Rouveret & Vergnaud (1980:146) and Chomsky (1995:305). For speakers who accept (28c), I assume that full DP experiencers in raising structures have inert case.

- (29) a. **Secilit djalë** i kujtohet baba i tij.
 each boy.DAT cl remember father.NOM his
 'Each boy remembers his father.' (QUIRKY)
- b. ***Secilit djalë** iu dha paga i tij.
 each boy.DAT cl gave.NACT pay.NOM his
 'Each boy was given his pay.' (INERT)

Given that case assignment is not completely forced by the semantic role of an argument across languages, and given that a language can have both quirky and inert inherent case, it should be possible for the case of a thematic role to vary within a language as well. This possibility appears to be realized in at least one well-known phenomenon, namely psych verbs. Psych verbs canonically have an experiencer and a theme, but some verbs have an experiencer subject, and some an experiencer object. Belletti & Rizzi (1988) argue that the experiencer is always generated in a position c-commanding the theme, which means that in an object-experiencer (ObjExp) construction, the theme raises past the experiencer to subject position.

Pesetsky (1995) argues against Belletti & Rizzi's proposal for a substantial class of ObjExp verbs. He argues that experiencer verbs fall into two classes, depending on the interpretation of the argument that Belletti & Rizzi call the "theme". This argument is thematically higher than the experiencer if it is a causer, and lower than the experiencer if it is the target or subject matter of emotion (T/SM).⁸ Subject-experiencer (SubjExp) verbs have a T/SM argument (30a, 31), while a large class of ObjExp verbs have a causer argument (30b, 32).

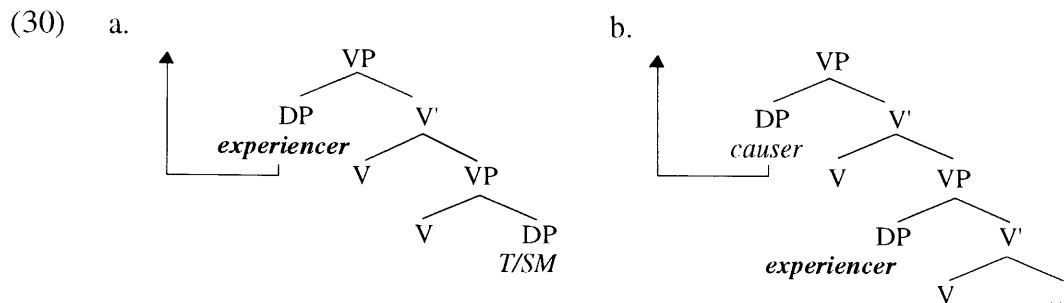

- (31) a. **The paleontologist** liked/loved/adored the fossil.
 b. **Mary** fears ghosts.
- (32) a. The fossil pleased/delighted/overjoyed **the paleontologist**.
 b. Ghosts frighten **Mary**.

Pesetsky's approach is one way of attacking the apparently unforced connection between θ -roles and grammatical relations in psych constructions. He argues that in many cases the alternation between SubjExp and ObjExp verbs is in fact not arbitrary, but instead follows from a finer-grained semantics. However, a residue remains. As he notes, there are also ObjExp verbs that appear not to have a causer argument. These verbs apparently do allow the theme to raise past the experiencer to subject position. The same verbs disallow passivization, and in Dutch and Italian they take the 'be' auxiliary, which usually goes with unaccusative verbs. One possibility is that these verbs are also subject

⁸ Actually, Pesetsky argues that the causer receives its θ -role twice, once in a position below the experiencer, and once above.

to a finer-grained semantics, which will explain their behaviour. Another is that they genuinely have the same semantics as SubjExp verbs, but different case properties.

If the latter approach is correct, then Belletti & Rizzi's analysis is more or less exactly what we want for the ObjExp verbs that lack an external (causer) argument. With SubjExp verbs cross-linguistically, the experiencer has structural or quirky case, which allows it to raise to subject position. As we have seen, there are quirky experiencer subjects (in Georgian and Albanian), and structurally case-marked experiencer subjects (in English). The situation is different with at least some ObjExp verbs, namely those that have no causer argument. In these contexts the experiencer has inert case, so the lower argument raises past it to the subject position (33). Some examples from English and Dutch are shown in (34)-(35). The fact that these verbs cannot passivize is taken as evidence that they lack an external causer argument, and cross-linguistic evidence suggests that the experiencer originates in a position c-commanding the theme (cf. Belletti & Rizzi 1988).

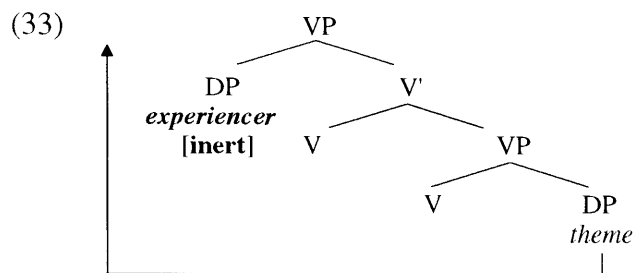

- (34) a. The correct generalization eluded **Pāṇini**.
 b. * **Pāṇini** was eluded by the correct generalization.
 c. His name escapes **me**.
 d. * **I** was escaped by his name. (Perlmutter & Postal 1984)
- (35) a. Die fout is **mij** opgevallen.
 that mistake is me struck
 'That mistake struck **me**.'
 b. * **Ik** ben/werd door die fout opgevallen.
 I am by that mistake struck
 'I was struck by that mistake.' (Hoekstra 1984:185-186)

Psych verbs demonstrate one possibility for intralinguistic variation in case assignment, where an argument with the same semantic role can bear different cases, depending on the verb. Some facts from Georgian point to the complementary situation, where oblique arguments associated with the same verb root can bear different cases, depending on their semantic roles.

There is a class of verb roots in Georgian that can be thought of as unaccusative. They can occur with only a single theme argument, which Harris (1981) has argued to be an underlying object (36a).⁹ However, they also permit the addition of other arguments. In some cases, an agent argument is added, yielding a transitive construction (36b). A dative goal, benefactive, or other indirect argument can also be added. We have already seen some of the facts indicating that this argument c-commands the theme or direct ob-

⁹ The Georgian verb forms in (36) are taken from Aronson (1990).

ject. If an agent is present, the addition produces a double object construction (36c). Otherwise, it produces an unaccusative construction with two non-agentive arguments (36d).

- (36) a. da-i-mal-eb-a
'hide'

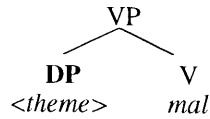

- b. da-∅-mal-av-s
'hide something'

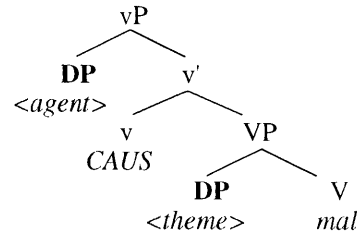

- c. da-u-mal-av-s
'hide something from someone'

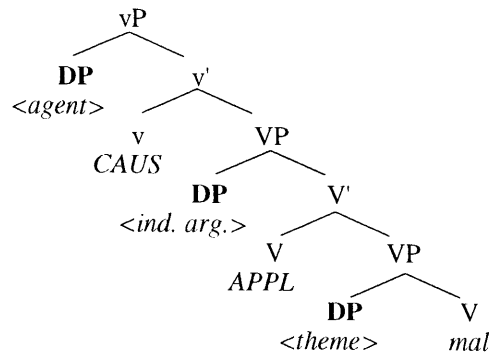

- d. da-e-mal-eb-a
'hide from someone'

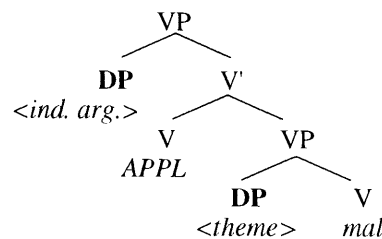

In the Georgian unaccusative construction (36d), the lower <theme> argument raises past the higher one to the subject position, triggering subject-verb agreement (37b) just as in the simple unaccusative (37a). The dative argument cannot raise to the subject position under this interpretation (38a), as shown by the fact that nominative subject agreement is obligatory. This is true regardless of word order. However, the same verb root can occur with an experiencer/malefactive dative argument added to it instead. In this case, the dative argument does raise to subject position, blocking agreement with the plural nominative argument, as in (38b), where the verb has default third-person singular agreement.

- (37) a. **bavšveb-i** imalebi-an.
children-NOM hide-PRES.PL
'**The children** are hidden.'

- b. **bavšveb-i** vano-s emalebi-an.
children-NOM V.-DAT hide-PRES.PL
'**The children** are hidden from Vano.'

(Nash 1995)

- (38) a. deida-s **gela da paṭa** daeḳarg-nen/*daeḳarg-a.
aunt-DAT G.NOM and P.NOM lost-PRES.3PL/lost-PRES.3SG
'**Gela and Pata** were lost to their aunt.'

- b. deideb-s **gela da paṭa** daeḳarg-a/*daeḳarg-nen.
aunts-DAT G.NOM and P.NOM lost-PRES.3SG/lost-PRES.3PL
'The aunts had **Gela and Pata** lost on them.'

(Nash p.c.)

We can conclude that the argument with an indirect object role in (38a) has inert case, so it cannot be raised to subject position.¹⁰ The experiencer argument in (38b) has quirky case, although it appears with the same verb root.

It would seem that inert case is not forced either by an argument's θ -role or by the verb root it appears with. Different cases can be assigned to two arguments either if they have the same θ -role, but occur with different verb roots, or if they have different θ -roles and occur with the same verb root. We can then ask if two arguments can be associated with different kinds of case when they have the same θ -role *and* occur with the same verb root. An example of this kind involves English constructions with *strike* (39). These have been argued to involve raising the subject from a small clause into the matrix subject position (e.g., Rizzi 1986). The matrix experiencer does c-command into the small clause, giving rise to condition C effects in (39b). However, it cannot raise to the subject position, but instead allows the subject of the small clause to raise. We can conclude that the matrix experiencer has inert case.

- (39) a. Mary strikes **me** [as t_{Mary} intelligent].
 b. John strikes **her** [as t_{John} affectionate to Mary]. (*her=Mary)
 c. ***I/me** strike(s) $t_{I/me}$ [as Mary intelligent].

(40) has a similar meaning to (39), except that the subject is an argument of the matrix verb rather than originating in a small clause. The object in (40) appears to have the same experiencer θ -role as the object in (39). Here, however, it cannot have inert case, since it can raise to the subject position of a passive.¹¹ This is apparently another example of an argument with the same θ -role, and occurring with the same verb root, but receiving different case in different syntactic environments.

- (40) a. Mary's intelligence struck **me** the first time I met her.
 b. **I** was struck **t** by Mary's intelligence the first time I met her.

There are a number of possible reasons for the difference between (39) and (40). For instance, it is tempting to try to unite these facts with the discussion of pseudopassives, where a clausal complement blocks the reanalysis of P+V that allows the object of the preposition to undergo movement. One explanation we cannot give for this difference, however, is that inert case is forced in (39) to prevent an ill-formed structure from arising. Such an explanation might work as follows: if the matrix experiencer in (39) received structural case as in (40), it would raise to subject position, yielding the ill-formed structure in (39c). It could be argued that the ill-formedness of this construction arises from the presence of an unlicensed subject in the small clause. However, as we have already seen, inert case cannot be added in order to save an ill-formed structure such as (39c): it must be intrinsically present in the structure.

We have seen languages in which experiencers, goals, benefactives, or other indirect objects do and do not have inert case. Despite this relatively loose correlation of interpretation and case, the two are not completely independent. Notice that we have not seen languages in which agents can have inert case. There are, as far as I know, no at-

¹⁰ The question remains why this argument can occur with inert dative case in an unaccusative structure, but not in a passive, where the indirect object can only be a PP with *-tvis* (cf. (18)).

¹¹ Under the analysis of Pesetsky (1995), *Mary's intelligence* in (40a) would have a θ -position above the structurally case-marked experiencer, blocking the experiencer from raising to the subject position instead.

tested examples of alternations between subject-agent and object-agent verbs, like the alternations between SubjExp and ObjExp verbs. Why might this be?

One answer is provided by work on the semantic compositionality of agents. Marantz (1984), and more recently Kratzer (1996) and Marantz (1997), have pointed out that an agent is separated in a significant way from the rest of the VP. For example, agents are not included in verbal idioms. This has been taken to show that an agent is not assigned a θ -role by the verb, but rather by the verb phrase, composed of the verb and its other arguments. Inherent case, including inert case, must be assigned along with a θ -role, so if the verb does not directly assign a θ -role to an agent, it follows that the verb also cannot assign it inert case.

My goal here was to lay out a range of facts demonstrating the correlation between c-command and movement. We have also seen exceptions to this generalization, which I have explained as arising from the presence of inert case on the higher argument, making it invisible for A-movement. Inert case appears to be an unforced formal property of the case-assigning head, which need not always be associated with a given semantic role or a given verb root. It also cannot be generated simply to save an ill-formed structure. Inert case provides a unified account of certain exceptions to the general correlation between movement and c-command. An inert-case account also reduces the absence of subject-agent/object-agent alternations to the observation that agentive subjects do not carry inherent case. Given this account, we can maintain the strong thesis that movement is constrained by structural locality.

References

- Andrews, A. 1982. The representation of case in Modern Icelandic. In *The mental representation of grammatical relations*, ed. J. Bresnan. Cambridge, MA: MIT Press.
- Aronson, H. I. 1990. *Georgian: A reading grammar*. Corrected ed. Columbus, OH: Slavica.
- Baker, M. 1988. *Incorporation: A theory of grammatical function changing*. Chicago: University of Chicago Press.
- Baker, M. 1996. On the structural positions of themes and goals. In *Phrase structure and the lexicon*, ed. J. Rooryck and L. Zaring, 7–34. Dordrecht: Kluwer.
- Barss, A. & H. Lasnik. 1986. A note on anaphora and double objects. *Linguistic Inquiry* 17, 219–251.
- Belletti, A. & L. Rizzi. 1988. Psych-verbs and θ -theory. *Natural Language and Linguistic Theory* 6, 291–352.
- Bresnan, J. 1994. Locative inversion and the architecture of Universal Grammar. *Language* 70:1, 72–131.
- Chomsky, N. 1981. *Lectures on government and binding*. Dordrecht: Foris.
- Chomsky, N. 1986. *Knowledge of language: Its nature, origin, and use*. Westport, CT: Praeger.
- Chomsky, N. 1995. *The minimalist program*. Cambridge, MA: MIT Press.
- Chomsky, N. & H. Lasnik. 1993. The theory of principles and parameters. In *Syntax: An international handbook of contemporary research*, ed. J. Jacobs, W. Sternefeld, & T. Vennemann. Berlin: Walter de Gruyter. [Reprinted in Chomsky 1995.]
- Collins, C. & H. Thráinsson. 1996. VP-internal structure and object shift in Icelandic. *Linguistic Inquiry* 27, 391–444.
- Falk, C. 1990. On double object constructions. *Working Papers in Scandinavian Syntax* 46, 53–100.

- Harris, A. 1981. *Georgian syntax: A study in relational grammar*. Cambridge: Cambridge University Press.
- Hoekstra, T. 1984. *Transitivity: Grammatical relations in Government and Binding theory*. Dordrecht: Foris.
- Holmberg, A. & Platzack, C. 1995. *The role of inflection in Scandinavian syntax*. Oxford: Oxford University Press.
- Kratzer, A. 1996. Severing the external argument from its verb. In *Phrase structure and the lexicon*, ed. J. Rooryck & L. Zaring, 109–137. Dordrecht: Kluwer.
- Larson, R. 1988. On the double object construction. *Linguistic Inquiry* 19, 335–391.
- Marantz, A. 1984. *On the nature of grammatical relations*. Cambridge, MA: MIT Press.
- Marantz, A. 1993. Implications of asymmetries in double object constructions. In *Theoretical aspects of Bantu grammar*, ed. S. Mchombo, 113–150. Stanford: CSLI Publications.
- Marantz, A. 1997. No escape from syntax: Don't try morphological analysis in the privacy of your own lexicon. *University of Pennsylvania Working Papers in Linguistics* 4.2.
- Massey, V. 1992. *Compositionality and constituency in Albanian*. Ph.D. dissertation, University of North Carolina, Chapel Hill. MIT Occasional Papers 3.
- McGinnis, M. 1997. Reflexive external arguments and lethal ambiguity. To appear in *Proceedings of WCCFL XVI*. Stanford: CSLI Publications.
- Nash, L. 1995. *Portée argumentale et marquage casuel dans les langues SOV et dans les langues ergatives: l'exemple du géorgien*. Ph.D. dissertation, Université de Paris 8.
- Perlmutter, D. & P. Postal. 1984. The 1-Advancement Exclusiveness Law. In *Studies in Relational Grammar 2*, ed. D. Perlmutter & C. Rosen. Chicago: Chicago University Press.
- Pesetsky, D. 1995. *Zero syntax: Experiencers and cascades*. Cambridge, MA: MIT Press.
- Postal, P. 1986. *Studies of passive clauses*. Albany, NY: SUNY Press.
- Rizzi, L. 1986. On chain formation. In *The syntax of pronominal clitics*, ed. H. Borer. Syntax and Semantics 19. New York: Academic Press.
- Rizzi, L. 1990. *Relativized minimality*. Cambridge, MA: MIT Press.
- Rouveret, A. & Vergnaud, J.-R. 1980. Specifying reference to the subject: French causatives and conditions on representations. *Linguistic Inquiry* 11, 97–202.
- Schütze, C. 1997. *INFL in child and adult language: Agreement, case and licensing*. Ph.D. dissertation, MIT. Distributed by MIT Working Papers in Linguistics.
- Thráinsson, H. 1979. *On complementation in Icelandic*. New York: Garland.
- Ura, H. 1996. *Multiple feature-checking: A theory of grammatical function-splitting*. Doctoral dissertation, MIT. Distributed by MIT Working Papers in Linguistics.
- Zaenen, A., J. Maling & H. Thráinsson. 1985. Case and grammatical functions: The Icelandic passive. *Natural Language and Linguistic Theory* 3, 441–483.

Department of Linguistics and Philosophy
 E39–245 MIT
 77 Massachusetts Avenue
 Cambridge, MA 02139 USA

marthajo@mit.edu

