



**Enhancing Public Engagement in Energy
Conservation Measures in Buildings Using Infrared
Thermography**

Allan Hawas

BSc, MSc

A thesis submitted in partial fulfilment of the requirements of
Nottingham Trent University of the degree of Doctor of Philosophy

December 2017

Copyright Statement

This work is the intellectual property of the author. You may copy up to five percent of this thesis for private study, or personal, non-commercial research. Any re-use of the information contained within this document should be fully referenced, quoting the author, title, University, degree level and pagination. Queries or requests for any other use, or if a more substantial copy is required, should be directed in the first instance to the author of the Intellectual Property Rights.

Abstract

One of the priorities to tackle the global warming is to reduce the carbon emissions and energy consumption in buildings. Buildings consume significant levels of energy for heating or air-conditioning in most parts of the world. The drive to enhance the understanding of building envelope and the impact of insulation on energy use, are decisive factors for enhancing public engagement to attain carbon emission and energy consumption reduction towards more sustainable future. This thesis presents a research in enhancing public engagement in energy conservation in the building by using infrared thermography and new methodologies. The thesis consists of three parts, including building thermography survey, innovative educational design and building monitoring.

The first part was investigating the insulation of buildings, by providing the opportunity for the public to carry out thermography survey of their buildings using a low-cost smartphone based infrared camera. This part involved 50 participants, who carried out the thermography survey and conducted three questionnaires. The results show clearly how the study improved the participants' behaviour and engagement in relation to energy consumption in the building. This research resulted in developing a novel approach to enhancing people engagement.

The second part has resulted in developing an innovative physical educational tool. The tool is a building simulator, which is designed to support the teaching of energy consumption in building and the impact of insulation at different school levels. The tool has been tested successfully in the laboratory, school and university with significant results. Some of the results are presented in this thesis, which confirms the effectiveness of the tool in enhancing the understanding of energy consumption in the building.

The last part focused on monitoring of the energy in an existing public building in Nottingham. The monitoring study covered the monitoring of temperature, humidity, insulation efficiency, door operation and audience pattern during a whole winter season. The results have identified significant energy saving potentials by following the suggested recommendations and redesigning the operation of the building and utilising the heat generated by the audience as a sustainable source of energy.

All these parts are correlated to enhancing the public behaviour and engagement in energy conservation in the building. The research was able to help people to identify the areas of issue in their insulation by using low-cost technology, providing a novel approach for people engagement. Moreover, it developed a new educational tool for the education sector to support the teaching of energy and make it more touchable. This is a vivid research, which was able to provide some new tools for people toward better future, and by that achieving the contribution to knowledge.

Dedications

I am dedicating this thesis to five beloved people who have meant and continue to mean so much to me:

Two candles of love, my parents.

A sea of love, my daughter Darya.

An infinite rain of love, my son Baran.

A world of love, my wife Trifa.

Acknowledgements

First, I would like to thank my director of study Professor Amin Al-Habaibeh for his guidance, advice and support throughout my work. He was always available when I needed. I am also grateful for the support I received from my co-supervisor Professor Benachir Medjdoub.

In addition I want to express my thanks to the many people at Nottingham Trent University including academic, technical, administrative and library staff for their assistance and support throughout this work, particularly Dr Fouad Mohammed, Dr Bubaker Shakmak, Mr Arijit Sen, Mr Matthew Garlick and Mr Mark Beeston.

Thanks to D2N2 Growth Hub for the NTU Local Innovation Collaborative Fund (LICF), which funded the equipment of the building monitoring research at Nottingham Playhouse.

I would like to express my appreciation to Nottingham Playhouse team, especially, Ms Stephanie Sirr and Mr Stewart Smith for their collaboration and permission in carrying out the energy monitoring of the case study building.

I would like to convey my heartfelt gratitude to my parents for all their prayers and love, and my dear brothers and sisters for their emotional support and encouragement, which meant a lot for my journey.

Special thanks goes to my lovely wife Dr. Trifa for her endless support, kindness and motivation throughout the whole period of my PhD work and not less thanks for all delicious lunch boxes. Very special thanks is extended to my gorgeous son Baran and my sweet daughter Darya for their understanding when I had to spend so much time working.

Next, I want to mention some relatives who meant a lot to my family and me during this time, thanks for the Elam family, my wife's family and my brothers Dr. Botan and Mr Reza.

Last but not least, I am highly indebted to all mighty God for giving me the power, patience and persistence to overcome all the difficulties during this journey, and eventually managed to accomplish this thesis.

Nottingham, December 2017

Allan Hawas

Publications

The following publications have been published as direct results of this thesis:

- A. Hawas, A. Al-Habaibeh, and B. Medjdoub, “Innovative Design of an Educational Physical Simulation Tool for Investigating Energy Consumption in Buildings for Enhancing Public Engagement,” *Energy Procedia*, vol. 105, no. 0, pp. 2615–2622, 2017.
- A. Hawas and A. Al-Habaibeh, “Innovative concept of an educational physical simulation tool for teaching energy consumption in buildings for enhancing public engagement,” *Energy Procedia*, (accepted).
- A. Al-Habaibeh and A. Hawas, “An educational and research apparatus for simulating thermal performance and energy efficacy of building,” UK Application No: GB1610666.8, T. H. E. P. Journal, “the Patents Journal,” vol. 2014013189, no. 6637, 2016.

Abbreviations

ABM: Agent-based model

ASTM: International standard organisation

DIY: Do it yourself

DOI: Diffusion of Innovation

EPS: Expanded polystyrene

HBI Human- Building Interaction

HVAC: Heating, ventilation and air-conditioning

IR: Infrared

IRT: Infrared Thermography

ISO: International organisation for standardization

LCA: Life cycle assessment

LT: Lock-in thermography

NDE: Non-destructive evaluations

NDT: Non-destructive testing

PT: Pulsed thermography

RdSAP: Reduced Standard Assessment Procedure

SAP: Standard Assessment Procedure

SPT: Social practice theory

TDR: Temperature difference ratio

TTB: Theory of Planned Behaviour

TTM: Transtheoretical model

VIP: Vacuum insulation panels

Table of contents

COPYRIGHT STATEMENT	II
ABSTRACT	III
DEDICATIONS	I
ACKNOWLEDGEMENTS	II
PUBLICATIONS	IV
ABBREVIATIONS	V
TABLE OF CONTENTS	VII
LIST OF FIGURES	XI
LIST OF TABLES	XIV
CHAPTER 1. INTRODUCTION	1
1.1. BACKGROUND	1
1.2. PROBLEM DEFINITION:	4
1.3. AIM AND OBJECTIVES:	5
1.4. THESIS STRUCTURE	6
1.5. SUMMARY.....	8
CHAPTER 2. LITERATURE REVIEW	10
2.1. INTRODUCTION.....	10
2.2. TYPES OF LOW-ENERGY HOUSES	11
2.3. BUILDING INSULATION	13
2.4. AIR LEAKAGE AND AIR TIGHTNESS	18
2.5. BUILDING INSPECTIONS	19
2.5.1. <i>Blower Door measurement</i>	20
2.5.2. <i>Tracer gas methods</i>	21
2.5.3. <i>Building thermography</i>	22
2.6. BUILDING MONITORING.....	27
2.7. PEOPLE BEHAVIOUR AND ENGAGEMENT IN RELATION TO ENERGY CONSUMPTION FOR SPACE HEATING	29
2.8. EDUCATION AND ENERGY CONSUMPTION	34
2.9. GAP IN KNOWLEDGE	37
2.10. SUMMARY	38
CHAPTER 3. METHODOLOGY	40
3.1. INTRODUCTION.....	40

3.2. BUILDING THERMOGRAPHY SURVEY (BUILDING THERMOGRAPHY AND PEOPLE ENGAGEMENT)	40
3.2.1. <i>Material and Method</i>	40
3.2.2. <i>Questionnaires</i>	41
3.2.3. <i>Health and safety</i>	42
3.2.4. <i>Educational session</i>	42
3.2.5. <i>The thermal survey system</i>	46
3.2.6. <i>Data collection procedure</i>	47
3.2.7. <i>The Novel thermographic methodology</i>	48
3.3. PHYSICAL EDUCATIONAL SIMULATION MODEL (INNOVATIVE DESIGN AND PEOPLE ENGAGEMENT)	51
3.3.1. <i>Material and method</i>	51
3.3.2. <i>Experimental work and case studies</i>	52
3.3.3. <i>The installed equipment</i>	52
3.3.4. <i>The connected simulation system</i>	55
3.4. NOTTINGHAM PLAYHOUSE (BUILDING MONITORING AND PEOPLE ENGAGEMENT)	57
3.4.1. <i>Material and Method</i>	57
3.4.2. <i>The installed monitoring equipment</i>	57
3.4.3. <i>The monitoring system, location and time schedule</i>	61
3.5. SUMMARY	66
CHAPTER 4. BUILDING THERMOGRAPHY SURVEY	67
4.1. INTRODUCTION	67
4.2. THERMOGRAPHIC SESSION AND ENHANCING ENERGY AWARENESS AND MOTIVATION	70
4.3. THE THERMOGRAPHIC SURVEY AND IDENTIFICATION OF INSULATION ISSUES	74
4.3.1. <i>Door Insulation</i>	75
4.3.2. <i>Window Insulation</i>	77
4.3.3. <i>Wall insulation</i>	79
4.3.4. <i>Roof Insulation</i>	84
4.3.5. <i>Floor Insulation</i>	86
4.4. ENHANCING THE ENGAGEMENT, AWARENESS AND BEHAVIOUR	87
4.5. LIMITATIONS	92
4.6. SUMMARY	93
CHAPTER 5. PHYSICAL EDUCATIONAL SIMULATION TOOL	95
5.1. INTRODUCTION	95
5.2. DESIGN OF THE SIMULATION MODEL	96
5.3. EXPERIMENTAL WORK.....	101
5.3.1. <i>Energy Efficiency Application</i>	101
5.3.2. <i>The objectives of the experimental work</i>	102
5.3.3. <i>The procedure and condition</i>	102
5.3.4. <i>Results of the experimental work</i>	103
5.4. CASE STUDIES	106
5.4.1. <i>Implementation of the educational simulation tool</i>	106

5.4.2. Case study 1: Primary school.....	106
5.4.3. Case study 2: University.....	111
5.5. SUMMARY.....	115
CHAPTER 6. THE EFFECT OF PEOPLE'S NUMBER AND BEHAVIOUR ON ENERGY PERFORMANCE OF BUILDING: NOTTINGHAM PLAYHOUSE AS A CASE STUDY	116
6.1. INTRODUCTION.....	116
6.2. INDOOR TEMPERATURE	117
6.3. INSULATION EFFICIENCY	121
6.4. OCCUPANTS AS THE SOURCE OF HEATING IN THE BUILDING	126
6.5. INTERACTION BETWEEN OCCUPANTS, BUILDING AND HVAC	130
6.6. RECOMMENDATIONS.....	132
6.7. SUMMARY.....	132
CHAPTER 7. DISCUSSION AND CONCLUSION.....	134
7.1. INTRODUCTION.....	134
7.2. BUILDING THERMOGRAPHY SURVEY	134
7.2.1. <i>The quantitative results</i>	135
7.2.2. <i>The qualitative results</i>	136
7.3. PHYSICAL EDUCATIONAL SIMULATION TOOL.....	138
7.3.1. <i>Experimental work</i>	138
7.3.2. <i>Case studies</i>	139
7.4. NOTTINGHAM PLAYHOUSE (BUILDING MONITORING).....	140
7.5. CONTRIBUTION TO KNOWLEDGE	141
7.6. FINAL CONCLUSION.....	142
7.7. RECOMMENDATION AND FUTURE WORK	143
7.8. SUMMARY.....	143
REFERENCES	144
APPENDICES.....	158
APPENDIX 1: HOME ENERGY EFFICIENCY QUESTIONNAIRE (PRE- TEST)	159
APPENDIX 2: THE INFRARED THERMOGRAPHY SESSION QUESTIONNAIRE	164
APPENDIX 3: HOME ENERGY EFFICIENCY QUESTIONNAIRE (POST- TEST)	167
APPENDIX 4: CONDITIONS FOR USE AND HEALTH AND SAFETY	171
APPENDIX 5: BUILDING ENERGY EFFICIENCY FEEDBACK	173
APPENDIX 6: BUILDING ENERGY EFFICIENCY FEEDBACK.....	175
APPENDIX 7: DEMONSTRATION SESSION	178
APPENDIX 8: ENERGY ACTIVITY	180
APPENDIX 9: ETHICAL CLEARANCE CHECKLIST 01	181

APPENDIX 10: PROFORMA: RESEARCH CONSENT INFORMATION SHEET 01	194
APPENDIX 11: ETHICAL CLEARANCE CHECKLIST 02	200
APPENDIX 12: PROFORMA: RESEARCH CONSENT INFORMATION SHEET 02	213
APPENDIX 14: TABLE 7- 2 THE SOCIODEMOGRAPHIC CHARACTERISTIC DATA	228
APPENDIX 15: THE RESULTS OF THE TRAINING SESSION	233
APPENDIX 16: THE RESULTS OF THE FIRST QUESTIONNAIRE	239
APPENDIX 17: THE RESULTS OF COMPARISON BETWEEN PRE-TEST AND POST-TEST	246

List of figures

Figure 1-1 The structure of the thesis.....	8
Figure 2-1: The solid wall (a) and cavity wall (b).....	14
Figure 2-2: Grenfell Tower in west London after the fire [51].....	16
Figure 2-3: Blower door testing apparatus [65].....	21
Figure 3-1: The structure of the presented research.....	41
Figure 3-2: The educational session for participants.....	43
Figure 3-3: The slides of the educational session, including (a) energy consumption and time, (b) KWH and time, (c) calculation of energy consumption, (d) efficient and non-efficient devices, (e) energy consumption table, (f) energy loss of building envelope and (g) indoor adopted temperature.....	44
Figure 3-4: The slides of the educational session, including (a) thermal image analysis, (b) colour combination options, (c) energy loss of ventilation, (d) door openings, (e) single glasses and (f) air leakage.	46
Figure 3-5: FLIR One attached to iPhone 5.	47
Figure 3-6: The schematic data collection plan.	48
Figure 3-7: Schematic diagram of a novel thermography methodology.	49
Figure 3-8: The educational simulation-building model.....	50
Figure 3-9: Training the householders on the developed simulation-building model.	50
Figure 3-10: A participant using of the thermal camera on the developed simulation model.	51
Figure 3-11: The Kemo Temperature Switch Thermostat DC 12V.....	53
Figure 3-12: The power supply of the simulation model.....	53
Figure 3-13: The power meter of the simulation model.	54
Figure 3-14: A thermocouple K-type.....	55
Figure 3-15: The schematic diagram of the educational simulation system.	56
Figure 3-16: Temperature and humidity data logger type OM-PLTH.....	58
Figure 3-17: Temperature data logger type OM-PLT2.....	59
Figure 3-18: Dual temperature data logger type OM-PLTT.	60
Figure 3-19: Event data logger type OM-CP-Event101A.....	61
Figure 3-20: The schematic illustration of Nottingham Playhouse building combined with images of the locations of the data logger sensors.	62
Figure 3-21: The OM-PLTH is installed in the cafeteria (location A).....	63
Figure 3-22: The OM-PLT2 is installed in the second floor (location B).....	63
Figure 3-23: The OM-PLTH is installed in the auditorium (location C).	64
Figure 3-24: The OM-CP-Event101A is installed on the entrance to the cafeteria (location D).....	65
Figure 3-25: The OM-CP-Event101A is installed on the main entrance (location E).	65

Figure 3-26: The OM-PLTT data logger installed in location F.....	66
Figure 4-1: The reliability of (a) thermography survey and (b) the educational session.....	68
Figure 4-2: The participants' response regarding how helpful the educational session has been in understanding the infrared thermography.....	71
Figure 4-3: The pre- and post-test of participants' response regarding the identification of the cold sources in their houses.	72
Figure 4-4: The pre- and post-test of participants' response concerning the energy measures, which make the biggest saving effect in their homes	73
Figure 4-5: The pre- and post-test of participants' response regarding the need for improvement in their respective house.	75
Figure 4-6: IR images of doors taken by participants, (a) P06, (b) P13, (c) P17, (d) P42, (e) P45, (f) p48 and (g) P50.....	77
Figure 4-7: IR images of windows taken by participants; (a) P12, (b) P23, (c) and (d) P38, (e) P44, (f) P46 and (g) P48.....	79
Figure 4-8: IR images of walls taken by participants; (a-c) P13 and (d-f) P14.	80
Figure 4-9: The IR images of walls taken by participants; (a and b) P18, (c and d) P34, (e) P38 and (f-h) P42.	82
Figure 4-10: The IR images of walls taken by participants; (a) P43, (b-d) P45 and (e and f) P48.	84
Figure 4-11: The IR images of roofs taken by Householders; (a) P17, (b) P18, (c and d) P23, (e) 34, (f) P37 and (g) 38.....	86
Figure 4-12: The IR images of floor, taken by Householders, (a) P32 and (b) P45.	87
Figure 4-13: The pre- and post-test of participants' response regarding their plan to change the way they heat their houses.	88
Figure 4-14 : The IR image of a building taken by participant P49.	90
Figure 4-15: The IR image of a back door.	91
Figure 4-16: The applied model of enhancing people engagement in energy conservation.	92
Figure 5-1: A 3D example of the disassembled building model showing examples of insulation layers and the assembled layered modular building model.....	96
Figure 5-2: The schematic diagram of the apparatus including the building model and the main components of the temperature regulation, monitoring and control systems.	97
Figure 5-3: The installation of the insulation layers to two walls of the building model.	98
Figure 5-4: The installation of the insulation layers to two main walls of the building model.	98
Figure 5-5: The installation of the insulation layers to the roof of the building.....	99
Figure 5-6: The overall system with two building models, with and without insulation, contained within an environmental chamber, which also acts as a carrier container.....	100
Figure 5-7: The overall system with two building models and a removed cover.	100
Figure 5-8: The overall system with two building models, with open cover and an electric fan for air circulation.....	101
Figure 5-9: The temperature profile of the two building models.....	104
Figure 5-10: The heating ON/OFF cycle of the insulated building model.....	104
Figure 5-11: The educational simulation model, consists of (a) a non-insulated and (b) insulated buildings.	105
Figure 5-12: A comparison of energy consumption between the two building models.	105
Figure 5-13: A typical energy activity sheet completed by a pupil.	108
Figure 5-14: The responses of pupils regarding how helpful the session has been to understand the energy saving benefit of insulation.....	109

Figure 5-15: The responses of pupils regarding their experience of using the thermal camera to detect the heat loss of the building models	110
Figure 5-16: The responses of pupils regarding their experience in attending the simulation session.....	110
Figure 5-17: The responses of students regarding how helpful the session has been to understand the energy saving benefit of insulation.....	113
Figure 5-18: The responses of students regarding their experience of using the thermal camera to detect the heat loss of the building models.	114
Figure 5-19: The responses of students regarding their experience in attending the simulation session.....	114
Figure 6-1: Image of Nottingham Playhouse	117
Figure 6-2: The external visual and thermal images of windows at Nottingham Playhouse from 2010 and 2014, where (1) refer to the frame of the windows and (2) to the glasses of the windows.....	118
Figure 6-3: The internal visual and thermal images of windows at Nottingham Playhouse from 2010 and 2014, where (1) refer to the frame of the windows and (2) to the glasses of the windows.....	118
Figure 6-4: The temperature in the auditorium (Location C) from 08/11/2016 to 28/02/2017.	119
Figure 6-5: the temperature in the auditorium (Location C) and the internal temperature at the first floor (Location B) from 08/11/2016 to 28/02/2017.	120
Figure 6-6: The temperature in the auditorium compared with the internal temperature in the first floor during a one-week period.	120
Figure 6-7: internal, external and differential temperature of a windows at the lower floor (Location F) of the building for the period between 24/01 - 13/02/2017.....	121
Figure 6-8: The internal, external and differential temperature of the window (location F) for a whole week period.	122
Figure 6-9: Internal, external and differential temperature during two days period.....	123
Figure 6-10: The internal, external and differential temperature of the wall (Location B) of the building from 24/01/2017 to 13/02/2017.....	124
Figure 6-11: The internal, external and differentiate temperature for the period 02/02 - 03/02/2017.	125
Figure 6-12: The internal, external temperature of the wall (Location B) and the window (Location F) from 24/01/2017 - 13/02/2017.	126
Figure 6-13: relation between the temperature of the cafeteria (Location A), the temperature in the auditorium (Location C) and audience action and existence during four days period.....	128
Figure 6-14: The temperature behaviour in the auditorium during two weeks period.	129
Figure 6-15: Schematic diagram of the relation between the HVAC system, building state and the occupant behaviour and existence.....	131

List of tables

Table 3-1: The specification of the power meter.	54
Table 4-1: The summary of the socio-demographic data the participants.	69
Table 4-2: The building demographic data of the thermographic survey.	70

CHAPTER 1.

INTRODUCTION

1.1. Background

The building sector has a main role to play in applying the EU energy efficiency objectives: circa 40% of the energy use and a third of CO₂ emissions in total are attributable to buildings [1]. The EU adoption of Nearly Zero Energy Buildings throughout from 2020 onwards, will reduce these figures in a significant and sustainable way [2]. Most of the existing buildings across Europe still have not been modernised to advance their energy efficiency, therefore a substantial potential for savings continue existing. To face these challenges different research studies have been undertaken in this area to address diverse possible solutions. Research confirms that thermal insulation is one of the most effective ways to achieve energy conservation in buildings [3]. By improving the insulation, new and renovated buildings will provide an acceptable level of energy conservation. Many types of research have investigated the impact of strengthening the insulation of building envelope [4] [5]. However, careful evaluation is needed for selecting the right thickness of the insulation material due to high insulation costs [6]. While other research determines the optimum insulation thickness of different part of the building envelope in relation to thermal energy conservation [7]. Different insulation materials provide different levels of thermal efficiency, therefore the right selection of material is necessary [8]. Moreover, the type of material and

thickness are depending on each other in order to achieve an optimum insulation selection [9]. Adding insulation in different climate has been implemented [10]–[12]. Different policies and regulations have been adopted worldwide with the aim to improve the thermal performance of buildings. For example, in New Zealand, a mandatory insulation was implemented since 1978, which shows higher internal temperature and decreasing energy consumption [13]. In Germany, obligating new homeowners to carry out wall insulation resulted in a significant impact in increasing the total insulation rate by up to 40% [14].

At the end of October 2012 a new government policy launched in the UK by the Department of Energy and Climate Change. This policy presented the Green Deal Home Improvement Fund, which permits loans for energy saving measures for homes in England, Wales and Scotland [15].

Despite these attentions, many countries around the world have an inefficient old stock of houses that still need improvement. To avoid costly renovations a building diagnostic inspection is necessary to identify the areas of weakness within a building.

Infrared (IR) thermography is one of the most applied methods for quantitative examinations in building diagnostics, e.g. assessment of the thermal performance of a building envelope, missing or defected thermal insulation [16], [17]. IR thermography is one of the non-contact and non-destructive evaluation methods [18]. The method can be applied for inspecting different thermal issues within a building as a post-construction test [19]–[21]. However, the method can be applied to the in-construction test as well for earlier identification of performance issues [22], [23].

Additionally, the thermography is adopted for increasing the role of thermal data collection techniques, which is a large-scale approach for future thermography diagnostic as a kind of Human- Building Interaction (HBI) [24]. By involving, the public in the process the approach will enabling thermal mapping of bigger parts of the cities, particularly the important buildings.

Thermal imaging is used to investigate the behavioural effect of visualisation of heat loss from residential homes and the consequences for energy consumption. By providing thermal images, the study enabled householders to see how the heat escapes from their homes in order to examine the eventual motivational impact on behavioural energy conservation [25]. This visualisation was static and the authors suggest that future work will provide a vivid more dynamic visualisation of heat loss, which is closer to real-time feedback.

The building diagnosis for identifying the insulation issues, including infrared thermography, are costly inspections to carry out for most of the public. At the same time, to convince the public to invest in the improvement of insulation, they need to understand the economic, environmental and comfort benefits of that. For this to happen, powerful methods and tools are required, to identify the areas of problem in an efficient way and provide the opportunity for the public to be engaged in the process. Additionally, providing education will make the process more effective and promote the change of behaviour toward a more sustainable future.

Different educational concepts have been presented to enhance understanding of heat transfer in science subjects in different educational levels [26]–[29]. Enhancing design-based learning in engineering education by using physical models has been applied at the secondary school level [30]. The results showed positive responses from students. However, the suggested educational models had the advantage of being low cost and simple, though they have some limitations in modularity for the user.

As discussed above, teaching and research tools for studying and simulating thermal performance in buildings in most cases are based on a single component or material based systems to test and measure insulation. In other situations, software-based simulation and modelling is used, which is normally based on assumptions and does not fully engage the learners in the training and learning process particularly for the younger generation. Both scenarios fail to engage students and the public in relation to the effect of insulation and

the modification of building features on energy consumption and the temperature of the building, particularly for the younger generation.

There is lack of physical educational simulation tools which can show the building in a new context, which easily and effectively can show the saving potential of improving the insulation, or the high energy consumption as a consequence of bad insulation. To address the limitations in the existing educational and the research tools for the investigation of building performance and energy efficiency, this thesis presents an innovative physical simulation building model [31], which can be used for the teaching of energy consumption in building and the impact of insulation for different educational levels. A patent application has been filed as a result of this research [32]. At the same time, people need to identify the nature and the size of the required improvement before any decision can take place in this direction. The thesis contains a novel investigation, where 50 householders inspected the insulation of their own homes by using a thermal camera to identify the issues. For this to happen, a general methodology for people engagement has been developed to train and engage people to carry out a thermographic survey of their building. This methodology decreases the cost of the survey significantly and increases the degree of involvement. Additionally, this thesis includes a case study where the energy consumption in an existing public building in Nottingham has been monitored during a whole winter season to identify the saving potentials. This part of the research identifies the potential energy savings if the suggested recommendations will be adopted.

1.2. Problem Definition:

The building energy consumption demonstrates a higher level than the expected. The over-consumption is supposed to be caused by the low quality of the construction and the behaviour of occupants. The research will try to find answers to the following questions:

1. How can people be engaged to identify key insulation issues in their buildings by using IR thermography?

2. How can we educate people to carry out IR thermography survey?
3. Would the use of modern technologies enhance people engagement in relation to their energy consumption?
4. Would the use of modern technologies enhance people's energy use awareness?
5. How can we assess people's energy awareness and feeling in relation to the fabric and construction issues in their buildings?
6. Can monitoring of energy consumption in buildings reduce energy consumption?
7. Can people's engagement modify their behaviour to better energy efficiency?
8. How could providing information about the use of the building and its facilities promote to modify people behaviour to better energy efficiency?
9. Can developing simulation educational tools enhance public understanding of the impact of insulation?
10. Can developing simulation educational tools make teaching the subject of building energy enjoyable for the learners?

1.3. Aim and Objectives:

To enhance public engagement and awareness in energy conservation measures by using infrared thermography and novel design.

Objectives:

1. To engage people in identifying key insulation issues in their buildings by using IR thermography.
2. To educate people to carry out IR thermography tests.
3. To know if the use of modern technologies would enhance people engagement in relation to the energy consumption.
4. To find out if the use of modern technologies would enhance people's energy use awareness.

5. To assess people's energy awareness and feeling in relation to the fabric and construction issues in their buildings.
6. To evaluate if monitoring the energy consumption of building reduce energy consumption.
7. To figure out if people's engagement can modify their behaviour to better energy efficiency.
8. To find out how providing information about the use of the building and its facilities could promote to modify people's behaviour to better energy efficiency.
9. To determine if developing simulation educational tools can enhance public understanding of the impact of insulation.
10. To figure out if developing simulation educational tools can make teaching the subject of building energy enjoyable for the learners.

1.4. Thesis Structure

The thesis consists of seven Chapters (Figure 1-1), introduction, literature review, methodology, building thermography survey, design simulation tool, building monitoring and finally discussion and conclusion.

Chapter one is the introduction, which introduces the area of research, outlining the included items and overviewing the gaps in research. Moreover, it includes the aim, objectives, problem definition and the importance of the study.

Chapter two is the literature review, providing a background of the involved research items. It is covering the main topics, including energy consumption in buildings, insulation, thermography, building monitoring and behaviour and engagement in relation to reducing energy consumption in buildings. The Chapter gives an extensive presentation of previous research in this field. It explains the existing challenges in the current literature, including different methodologies to reduce energy consumption in buildings, different methodologies for building diagnostic and different theories for enhancing

behaviour and engagement. Additionally, the Chapter discusses the gap in knowledge, where the gaps in the literature are identified.

Chapter three is describing the design of the methodology, which is divided into three parts. The first part is presenting the methodology of the building thermography survey, which describes the educational session, questionnaires and the implemented procedure for the data collection. The second part is the design of the educational simulation model. It includes an experimental work and case studies of the educational tool in laboratory, school and university. The third part is covering the monitoring of the energy consumption of an existing building (Nottingham Playhouse).

Chapter four presents the results and discussion of the building thermography survey. This Chapter is divided into four sections, including the thermographic session; the thermographic survey and identification of insulation issues; enhancing the engagement and behaviour after carrying out the thermography survey and finally the limitations. It presents of thermal images taken by the participants themselves and their own comments in relation to the insulation issues captured by the thermal camera. The thermal images are classified into five different areas, including wall, window, door, roof and floor.

Chapter five describes the detailed design of the physical simulation model, presenting the innovative concept, including insulation layers and the assembly technique. Moreover, it presents the simulation system. Additionally, the Chapter contains an experimental work and two case studies of experiments carried out using the simulation tool. The description of these procedures and results are also covered. These results are published in two conference papers.

Chapter six covers the monitoring of an existing building (Nottingham Playhouse). It describes the monitoring of the energy consumption in Nottingham Playhouse. The monitoring system includes monitoring of temperature and humidity, door operations, internal and external temperatures,

audience figures and the energy consumption. The presented results show the relationship between building, occupants and the operation of HVAC system.

Chapter seven presents the discussion and conclusion of the results. It gives a summarised discussion and conclusion of Chapter four, five and six. It includes the contribution to knowledge, recommendation and final conclusion.

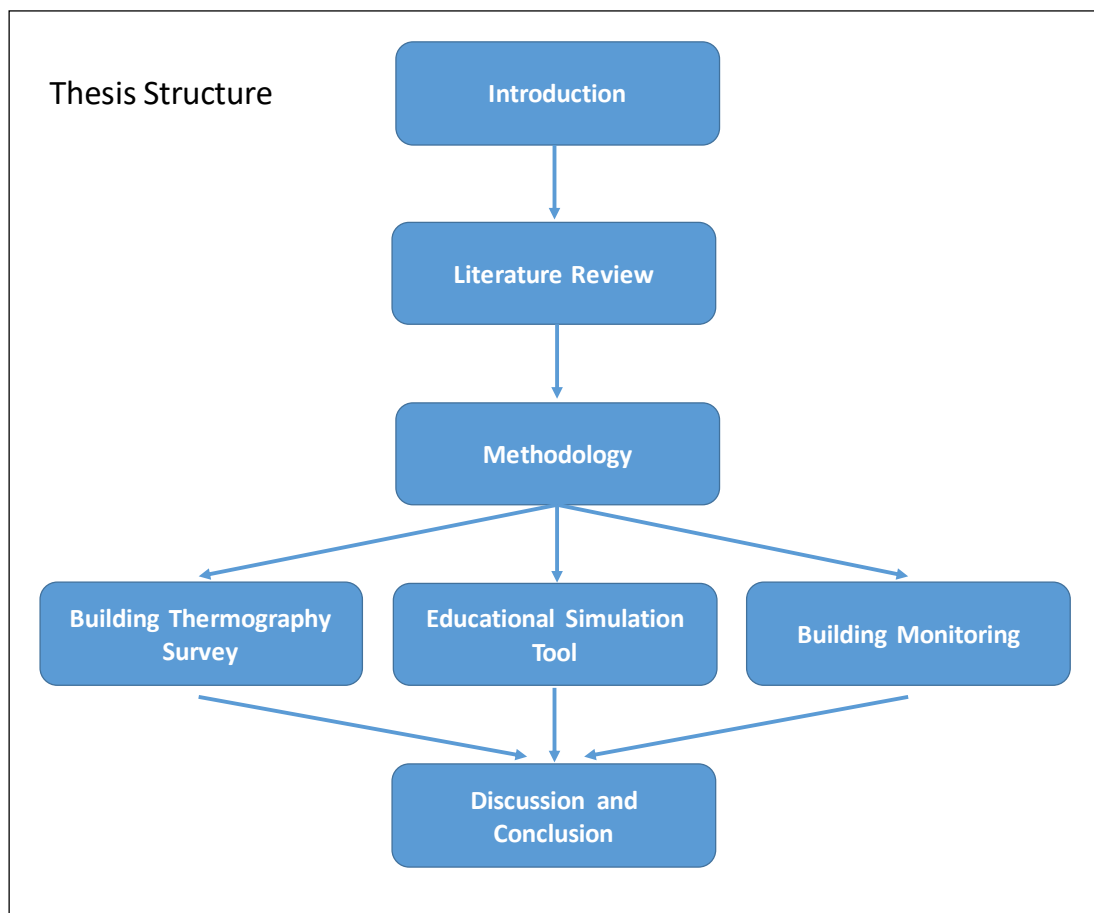

Figure 1-1 The structure of the thesis.

1.5. Summary

The Chapter provides a background to the area of research and giving an overview of the literature in this field. Moreover, it presents the problem definition, where the key issues in this area are highlighted to design the aim and the objective of this research. Additionally, the Chapter includes the structure of the thesis, where all the Chapters are briefly described.

CHAPTER 2.

LITERATURE REVIEW

2.1. Introduction

The European Union has the goal to reduce developed countries' greenhouse gas emissions by 60 to 80 percent (from the 1990 baseline) by 2050 [33]. The thermal performance of the existing building stock in the UK must improve significantly to meet its target by reducing CO₂ emissions by 80% for the same period [34]. In 2008, the UK's 26 million homes were estimated to be responsible for circa 27% of all UK CO₂ emissions [35]. Around 75–85% of the existing building stock in the UK will still be in use by 2050 [36].

At the same time, the International Energy Agency (IEA) expects that by 2035, the global CO₂ emissions will exceed today's levels by 20 percent [37]. According to the BLUE Map scenario, which developed by the IEA aims to reduce the CO₂ emissions by 50% by 2050 will increase the energy efficiency of 38% of the total reduction [38]. The buildings energy use accounts for around 40% in most IEA countries [37].

In the 'Building a Greener Future' policy declaration of 2007, the UK government's target for all the new homes is to achieve the Zero Carbon Standard by 2016 [39]. These standards are based on a "fabric first" approach, which means giving the priority to the building envelope such as increasing the

overall levels of insulation, reducing thermal bridging and making the buildings significantly airtight [40].

Energy consumption in buildings in the EU accounts for about 40% of the total energy consumption [1]. The EU Directive 2010/31 has the goal of reducing energy consumption and carbon emissions by 20% by the year 2020 [2]. The directive also emphasises that all new buildings have to be nearly zero-energy buildings by the same period. One of the prioritized areas to achieve this goal is improving the energy efficiency of buildings, both in the new building and in existing buildings when they will be renovated.

There is a need for the improvement of the public's understanding and engagement in relation to energy consumption in buildings towards more comfortable indoor temperature, energy conservation and sustainability.

However, many countries around the world have an old stock of houses that will still need improvement. This means both a big challenge needs to be tackled and a significant energy saving can be achieved. To engage the public in this process, they need to be educated to understand the comfort, economic and environmental benefits of insulation. At the same time, the householder needs to identify the nature and the size of the required improvement before any decision takes place in this direction. For this to happen, modern technologies have to be the key to provide this opportunity for the householder to make these inspections self. In the thesis, some tools and methods are suggested to help the public in this direction.

2.2. Types of low-energy houses

Low-energy houses have a very wide definition and generally include houses that consume less energy than standard buildings regulated in the national and international building codes. Therefore the term buildings with lower heating demand refer to different types instead of the term low-energy houses which are used for a specific building type in many countries [41].

The types of building with lower heating demand vary in terms and numbers between different countries; however, the following are the most common types:

- Low-energy house
- Ultra house
- Passive house
- Zero-energy house

Low-energy houses are buildings that have a lower heating demand than the standard buildings but have less strict criteria than the other efficient building types and therefore their energy performance lies under the level of the ultra-house. The buildings are illustrious by better insulation of the building envelope, heat recovery ventilation systems and windows and glass facades are faced to the south to increase passive solar heat where the weather so admits [41]. The used term for this type of houses can differ in other countries, for example, the term “Mini-energy houses” is used in Sweden by the responsible organisation, which is the Swedish Centre for Zero-energy buildings [42].

The Ultra houses are illustrious by the same features as low-energy houses but with further focus on the selection of building materials and components with higher thermos-technical qualities and lower U-values [41].

“A passive house is a building, for which thermal comfort (ISO 7730) can be achieved solely by post heating or post-cooling of the fresh air mass, which is required to fulfil sufficient indoor air quality conditions (DIN 1946)” [43].

The standard provides high-performance building envelopes, with excellent insulation capacity, low air leakage rates and low thermal bridging rates, as well as the importance of ventilation and building orientation. Passive House requires for space heating and cooling up to 90% less energy compared with standard building stock and over 75% less energy compared to average new builds. The concept of passive houses provides a truly energy efficient, comfortable and affordable standard at the same time [43]. A Passive House building uses for heating up to 1.5 litres of oil or 1.5 m³ of natural gas (15kWh) for each square metre of living space annually [44]. The UK government’s

target for all the new homes is to achieve the Zero Carbon Standard by 2016 [45]. Normally, the blower door test carries out to measure the airtightness of the buildings before occupancy.

In general, zero-energy buildings are defined as an energetically independent buildings, using solar energy combined with photovoltaic concepts to generate energy, provided with thermal storage systems [41]. In addition to the requested standard for passive houses, zero-energy houses have to distribute an amount of energy to the building that is greater or equal to the amount of lost energy from the building in one year. By generating as much energy as required, the buildings are autonomous. The ability to make accurate calculations of the supply and use of energy improves the control and allows a more sophisticated energy use. To design a building that reaches this energy efficiency and at the same time provides a comfortable level of indoor climate requires that all building envelope and equipped systems be of high quality.

2.3. Building insulation

Generally, there are two types of walls in the UK, solid wall and cavity wall. Until the around the year 1920, the solid wall was the only common external wall type. In a typical solid wall (Figure 2-1-a), the bricks will look in an alternating long-short pattern on the outside, while in the cavity wall (Figure 2-1-b) the bricks have an even pattern, with the long side of the brick appears from the outside. Normally a wall with a thickness of more than 260mm seems to be a cavity wall, which is a characteristic of post-1920 buildings. A cavity wall building consists of two layers of brickwork in its external walls that have a small air-gap in between, which is known as the cavity. According to research, an un-insulated solid wall loses twice as much heat as could be lost through an un-insulated cavity wall [46]. The gap was created to stop damp from permeating through to the inside of the house. Moreover, the air layer also works as an insulation layer and prevents some heat loss. Insulation of solid walls used to be costly and more complicated than the cavity walls, therefore the majority of the existing solid wall buildings in the UK are still un-insulated. In contrast, the cavity walls can easily be insulated by retrofitted the

gap with cavity wall insulation. This carries out by drilling some small holes and pumping in insulation material into the cavities.

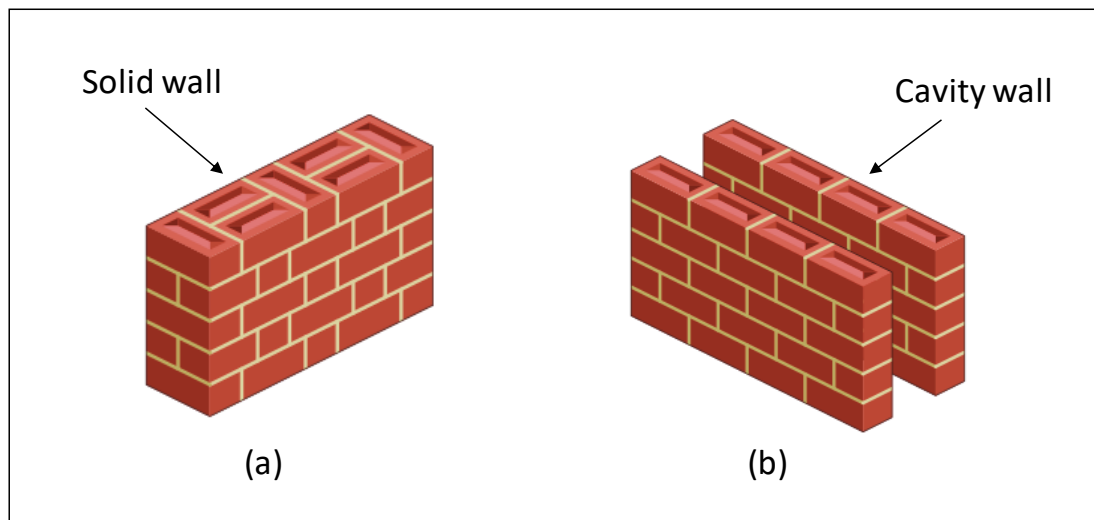

Figure 2-1: The solid wall (a) and cavity wall (b).

Since April 2002, all replacement of windows and doors have come within the norms of the Building Regulations and have to meet certain standards [47]. Generally, old windows, both single and double glazed installed before 2002 are sources for loss of energy in the building. Thermal insulation is one of the most important factors that enhance the energy performance of buildings. With improved insulation, new and renovated buildings will provide an acceptable level of energy conservation. Significant research has been done in this area. For example, Al-Habaibeh et al. [5] presented a case study of an existing university building, where the insulation has been improved, mainly by adding an internal doubled glazing. The energy saving outcome of the refurbishments estimated to about 6 °C in winter, which cover an area of 2172 m². The study compared between thermal images of the building from 2005 and 2010 for before and after respective renovation. The image comparison showed very clear improvement in the thermal insulation performance. Kim et al. [11] compared the impact of adding insulation on energy consumption in cold and hot climate in the USA. Computer simulation tool has been utilised to test the building under two different climatic conditions: cold climate in Michigan and moderate-humid climate in Florida. The results

show that adding insulation in cold climate is highly recommended to reduce the required energy for heating in winter, in contrast to hot climate where the extra insulation cannot make big changes on energy savings of heating. An investigation determined the optimum insulation thickness of different part of the building envelope in relation to thermal energy conservation [7]. Tettey et al. [8] analysed the implications of five different insulation materials on the primary energy use and CO₂ emission required for manufacturing material for a residential building in Swedish context. The selected materials included rock wool, cellulose fibre, expanded polystyrene (EPS), glass wool and foam glass. The energy use and CO₂ emissions required for the production of each material were compared. The results show that changing the insulation material from rock wool, which is the original insulation to cellulose fibre, will result in a saving around 6-7% in the primary energy use and around 6-8% in CO₂ emissions. The study shows even a reduction of the total fossil fuel by 39% for only insulation material production. Yu et al. [9] found that expanded polystyrene is the optimum material type with a thickness of 0.53 to 2.36 cm for external wall insulation in China, based on the life cycle saving, life cycle total cost and payback period. Jönsson et al. [48] assessed and compared the life cycle impacts of three flooring materials: solid wood, vinyl and linoleum on the natural environment in the Swedish climate, by using life cycle assessment (LCA). Three quantitative impact assessment methods were used for the inventory results: the Environmental Priority Strategies in product design, the Environmental Theme and the Ecological Scarcity method. Based on an operation time of one year and an area of 1m², the results show that the solid wood floor is the most environmentally friendly option. La Rosa et al. [49] evaluated the environmental impacts and the thermal insulation performance of four innovative composite material systems for use as an external wall of buildings, by using LCA method. The composite, eco-sandwich contains flax fibres, cork and bio-based epoxy resin that are natural materials produced and tested for evaluation of its thermal conductivity. According to the LCA results, the eco-sandwich shows lower environmental performance in the production phase compared to other traditional materials, but the impact caused by material transportation and insulation will be lower.

The safety factor of insulation materials is another important parameter. The cladding that is used for Grenfell Tower (Figure 2-2) to improve appearance and energy efficiency is a colourful green and blue panels designed to improve insulation and soften the look of the brutalist concrete block. Its dense foam boards coated in zinc rainproof sheets were spaced 30mm apart across the 24-storey building. A huge, large fire broke out in the building on 14 June 2017 and left 71 people dead. According to the investigations, the composite foam sandwich panels helped to spread the fire quickly from the lower floors all the way up the block. As a result, councils across Britain have ripped down the cladding on tower blocks to avoid the risk [50].



Figure 2-2: Grenfell Tower in west London after the fire [51].

Marincioni et al. [52] investigated the influence of reveals on transmission heat transfer coefficient of solid, internal insulated wall dwellings. The results demonstrate that the reveals at the junctions, stand for the most of the transmission heat transfer coefficient, and that increasing internal wall insulation thickness can be less efficient in decreasing the heat loss, while the insulation of the junctions can be the solution.

A study by Aditya et al. [3] has analysed the research and benefits of building insulation in literature. It has found that one of the most effective ways of

energy conservation is building insulation. It has been found to offer significant savings in the residential, commercial and industrial sectors. A study [4] has investigated the effect of strengthening the external insulation level on energy consumption for heating and cooling in buildings with various internal heat gain levels in Seoul, South Korea. It has found that the thermal insulation should depend on whether the building is envelope-dominated or internally dominated to decrease the building heating and cooling energy requirements. Another study has examined the change in outdoor temperature in Cameron and its effect on the indoor climate of buildings [6]. The research has suggested that the thermal insulation technology can be one of the leading methods for reducing energy consumption in new buildings. However, careful evaluation is needed for selecting the right thickness of the insulation material due to high insulation costs.

The implementation of mandatory insulation in New Zealand since 1978 shows higher internal temperature and decreasing energy consumption [13].

Friege [14] has investigated private homeowners' insulation activities in Germany, to evaluate the related new policy options. The survey included 275 homeowners, and the result integrated into an agent-based model (ABM). The study found that the regulation factor, in term of obligating new homeowners to carry out wall insulation has a significant impact in increasing the total insulation rate in Germany by up to 40%, while factors like economical means and information instruments have very limited effect in this context.

Johansson et al. [12] explored the performance of retrofitting of old listed, brick and wood building in Germany by using vacuum insulation panels (VIP). A brick and homogenous wood wall selected to be insulated with VIP externally, and hygrothermal sensors were used for recording of measures. The results indicate an improvement of the thermal resistance of the retrofitted wall.

Hilliaho et al. [10] investigated the impact of added glazing on the indoor temperature of balconies in Finland climate. The study involved temperature monitoring of 22 balconies (17 glazed) and their adjacent flats for circa 10 months' period. The results show that in average, the temperature of glazed balconies compares with unglazed were 5.0 °C contra 2.0 °C higher than the

outside air temperature respectively. The study stressed the effect of three main factors on the glazed balconies' temperatures, firstly the most critical one, which is the structural air tightness, followed by solar radiation and finally the heat loss from an adjacent building to the balcony, which let the balcony to store the heat loss of the building in mid-winter.

Zhang et al. [53] compared the overall energy performance of semi-transparent photovoltaic windows with common energy-efficient windows in the climate of Hong Kong. Recent research of newly constructed building in the UK provides evidence for a significant discrepancy between the predicted thermal performance calculation at the design-stage and that measured by post-construction tests [22].

One of the actions which the UK government adopted to increase public energy awareness is the creation of Standard Assessment Procedure (SAP), which works as a calculation methodology for the energy performance of all new dwellings in the UK. The first edition of SAP was published in 1993 and the present version is SAP 2012. RdSAP 2012 is the version, which is created for existing dwellings. The calculation is built on the energy balance in view of a range of aspects that promote energy efficiency [54].

According to the UK government report in Great Britain, at the end of March 2015, there were 27.4 million homes, 19.4 million of which had cavity walls and 8.0 million had solid walls, 27% of the former had not cavity wall insulation and 96% of the latter had not solid wall insulation respectively. Additionally, 23.9 million homes had a loft, 30% of which were without loft insulation of at least 125mm. The current building regulations raise requirements for new homes to have a roof that allows a maximum heat loss of $0.13 \text{ W/m}^2\text{K}$, which can be provided by an insulation thickness of 300mm. Still, there is significant potential for improvement of many homes to receive insulation, especially for those that have lofts and cavity walls [15].

2.4. Air leakage and air tightness

Air leakage which is also known as air infiltration, when the outside air enter the building, and calls for exfiltration when the inside air escapes out. The air

leakage expresses the volume of air entering or escaping through the building envelope, normally presented in l/s or m^3/h .

The air leakage rate is a measurement of building's tightness.

Air leakage can cause many types of problem like moisture or heat losses. For energy efficient buildings heat losses play an important role; airtight buildings have a lower energy demand. Besides the advantage of saving energy, air tightness minimizes problems as drought and moisture risks and makes the ventilation more precise [55], [56].

Today, advanced building construction materials and technologies have resulted in higher quality building envelopes, which effectively decrease air infiltration rates through building envelopes. Reducing air infiltration rates is extremely important to minimise the heating and cooling costs and at the same time ensure construction quality, the comfort of occupants.

Air leakage is usually detected by so-called Blower Door measurement at a pressure difference of 50 Pa between indoors and outdoors. The generated volume airflow is then defined either as the air change rate n_{50} – relating to the building volume with the unit h^{-1} , or the air permeability q_{50} – relating to the area with the unit $m^3/(m^2h)$ or $l/(s m^2)$ [41].

2.5. Building inspections

To underscore the areas of weakness in building construction and promote increase in its quality, tests of fabric and systems performance carry out in the new buildings [57]. In existing residential buildings a Wireless Sensor Network of temperature transmitters has been used to monitor the energy consumption, in order to investigate the building fabric and behavioural pattern of occupants [58]. The data contribution from sensors network can be analysed by applying the belief network framework, and the implementations involve several different software. In other words for different kinds of data contributions, there are suitable algorithms [59]. Tracer gas decay and co-heating tests are some post-construction procedures that evaluate the building fabric performance, while Pressurisation tests, in situ U-value and infrared thermography are some

procedures that are used under or after the construction process to examine the building air permeability, and the envelope insulating properties [60].

Today, there are many methods for inspection of building quality. Two commonly used techniques for measuring of building envelope airtightness are the fan pressurization known as blower door and tracer gas test methods. Currently, thermography has been applied widely as a successful inspection method. This section includes these three methods.

2.5.1. Blower Door measurement

Blower door measurement was developed first in the 1970s as a research tool. A blower door typically consists of a powerful large fan (variable-speed) mounted in a size flexible panel temporarily set up in a doorway and a manometer (pressure gauge) is used for recording the pressures of the house and the fan (Figure 2-3). A fan that is capable to move air into or out of the building in a controlled fashion to achieve the target pressure differences between the building and the exterior [61]. The manometer is connected to the fan and the outdoors via small diameter pressure tubes to measure the rate of airflow required for keeping the pressure of the building at a certain level. The blower generates exaggerated air leaks, which then can be identified with help of tools such as smoke puffers or infrared cameras, or even by feeling with the back of the hand or the face. Blower door testing performed in agreement with the ASTM and ISO standards requires multiple pressure/air flow rate measurements with a differential pressure range of around 25 Pa to 75 Pa below and above the ambient conditions, to improve the accuracy [62], [63]. A single-zone blower door tests are typically performed by conducting measurements of the flow-rate only at a single pressure (normally 50 Pa [1.0 lbf /ft²]) [64].

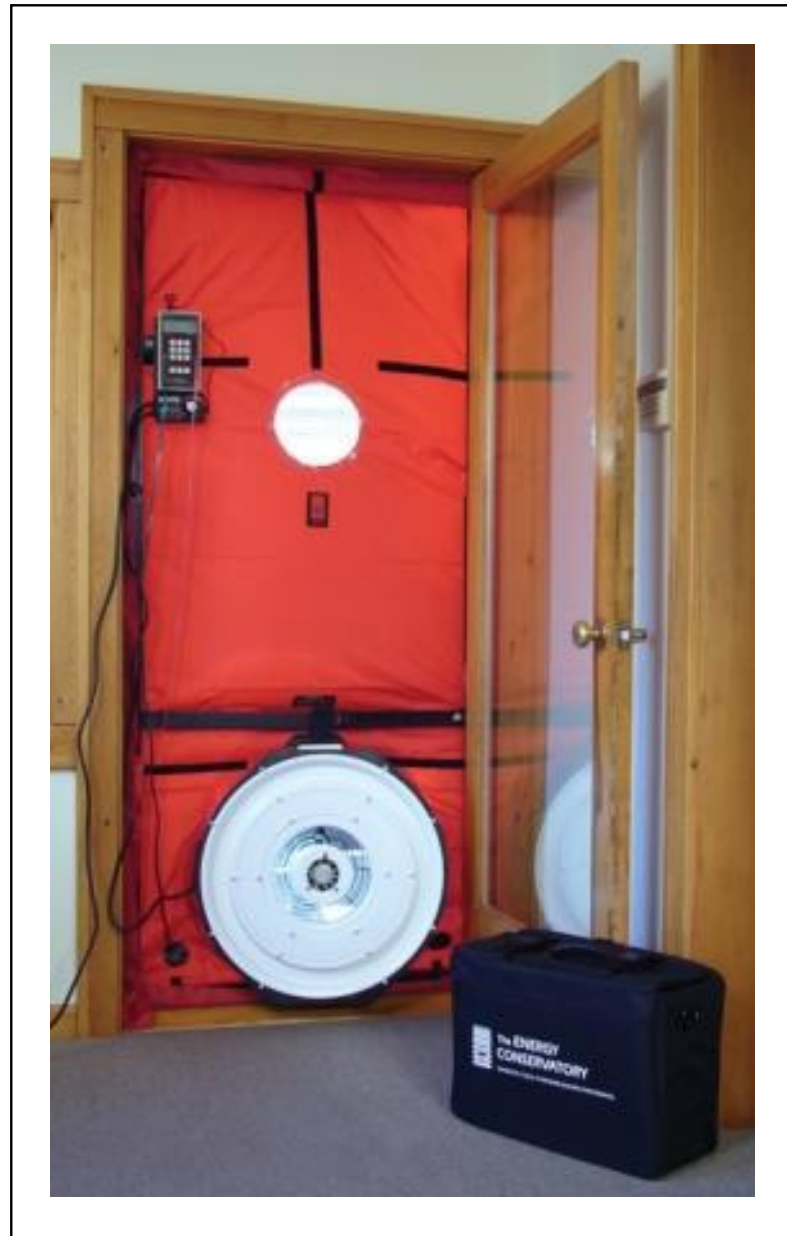

Figure 2-3: Blower door testing apparatus [65].

2.5.2. Tracer gas methods

Tracer gas methods are used to determine leakage of a building under operational conditions [66], [67]. This test method is based on the measurement of tracer gas dilution to calculate the air change within a single zone. A single zone refers to a place or a set of places where the tracer-gas concentration uniformity is guaranteed. The measurement of the tracer gas concentration, and sometimes the volume rate that is injected into the building, allows determining the volume rate of outgoing air of the building. From this,

the volume rate of incoming air can be calculated. ASTM Standard E741-00 [67] describes three techniques of tracer gas test methods, including concentration decay, constant injection and constant concentration. Tracer gas methods are normally more expensive and time-consuming than blower door method [64]. Tracer gas testing appears to be more reliable in calculating the air leakage rate at ordinary operating pressures, however, is sensitive to the tracer gas and other ambient weather conditions [68].

2.5.3. Building thermography

IRT is one of these test tools that have been used widely for many reasons in the building sector. For more than 35 years IR thermography has been applied in building monitoring [69], especially in the investigation and identification of historical structures due to its non-destructive nature [18], [70], [71]. In addition to that, IR thermography is used in combination with other techniques, like geophysical method in the detection of defects in architectural structures [72]. IR can successfully be applied to detect building occupants [59], counting people in a specified area [73] and even detect people's activity characterization and provide a 3D location information of them [74]. These monitoring promotes the better operation of buildings [59], improve safety, security and commercial activities [73], and adds to increase of the comfort and building energy efficiency [74]. Infrared (IR) thermography is used to survey the energy performance of buildings. Among others, it inspects the insulation quality of walls and windows and air tightness around the doors and windows. This inspection identifies the actual required local reparations instead of extensive renovation [16].

The infrared thermography is based on thermal radiation. While the radiation defines a broad range of wavelengths in the electromagnetic field, infrared thermography limits its request to thermal radiation, which includes only the emitted radiation resulted of the temperature of an object. Thermal radiation can be calculated using the Stefan–Boltzmann formula [75], [76]:

$$E_b = \sigma T^4$$

where E_b represents the total emissive power, σ is Stefan–Boltzmann constant ($5.67051 \times 10^8 \text{ W/m}^2 \text{ K}^4$), and T represents the surface absolute temperature (K).

The visualisation of the heat loss from a building indicates by brighter areas where the heat is escaping out when the image is taken from the outside. The areas of heat loss will be dark when the image is taken from the inside which indicates cold points where cold air is entering the building, e.g. through the walls, windows, doors, roofs, etc.

The thermography investigation involves many necessary data, including reflective temperature, emissivity factor, atmospheric temperature and relative humidity. In addition to that, the inspection requests specific environmental conditions.

The temperature difference between the indoor and the outdoor of the inspected building is preferred to be at least $10 \text{ }^\circ\text{C}$ [77]. This can easily be achieved depending on the time of the inspection: night-time during the winter period and day-time during the summer period.

The external environmental condition settings are tracked by the setting of the thermal camera towards the target object. Normally in building diagnostics, the target object is an exposed structural component and the measurement carries out from the interior or exterior of the building. The description of the reflective temperature and emissivity factor enables the data correction of the measurements. Any reflection of the thermographer into the resulting images has to be avoided, which can be achieved when the measurement carries out from an angle of 5° as a minimum of the thermographer to the target object of 50° as a maximum. The temperature conditions, including environmental temperature and relative humidity at the time of inspection, need to be recorded [17].

The thermography inspections include the passive and active approaches. The passive approach of thermography examines the temperature differences of a target structure that exists under standard conditions, but in the active approach of thermography, an external stimulus is used to generate the temperature differences of the structure. External stimulus can involve any

external heat source, e.g. ovens, lamps and hot packs. The active approach in its turn is classified into two types based on the kind of the stimulus, including lock-in thermography (LT) and pulsed thermography (PT) [17].

An IR camera is an advanced system that produces an arrangement of images of the thermal situation and is calibrated to capture the emissive energy of the target surfaces in a combination of various temperature ranges [78]. The emitted radiation from the object is focused via optics onto an IR sensor and then the signal of the electrical response converts into a digital image. The colours combination of a thermal image corresponds to the different temperature distribution of the targeted surface. Different defects can be discovered or visualised by observing abnormal colour combination, such as an increase or decrease of surface temperatures, captured heat rise when a crack, air leakage, moisture accumulation, or when other issues arise. Additional analysis of the thermographic images is often required in order to quantify the nature of the problem and provide accurate evaluations. Infrared thermography is widely applied for quantitative examinations in building diagnostics, e.g. evaluation of the thermal performance of the building envelope, detection of thermal bridging, air leakage or undesired heat loss areas, missing or defected thermal insulation in the building's envelope, sources of moisture. The infrared thermography is also applied for other monitoring and maintenance purposes, such as identification of the location of hot and cold pipes locations within the walls or floors of a building [79]. This method reduces the confusion and saves the time of position deification during pipes' inspection, repair or necessary replacements [78]. Likewise, IRT can be significantly employed for the location identification and condition evaluation of underground utilities [80].

Infrared thermography is one of the most employed tools among the non-destructive testing (NDT) methods for building diagnostics [17]. Because of its non-intrusive nature, the IRT is widely applied for non-destructive evaluation (NDE) in many different areas, including fracture or defect behaviour of metallic materials [81], quantitative evaluation of subsurface defects in reference samples made of Plexiglas [82], for the NDE of composite structures [83], [84].

Kalnas and Jellea applied IRT to validate thermal characteristics of vacuum-insulation panels in walls of a building. The study indicated that the panels should not be covered by weighty construction elements or air-filled spaces, which can affect the results to whether the performance of the vacuum-insulation panels are as designed or not [85].

Asdrubal et al. [20] developed a methodology to quantify the effect of thermal bridges by employing passive IR thermographic survey under controlled climatic conditions. The study suggests a quantitative occurrence factor of the thermal bridge, which is validated using experimental and numerical analysis. Moreover, the study proposed that the quick and in-situ method of infrared thermography could easily be used to identify potential improvements in the building insulation. Zalewski et al. [21] suggested another method for assessment of the quantitative impact of thermal bridges while investigating the effect of a steel frame in a building envelope. By visualisation of the building structure in thermal images, it was able to identify the location of the zones where the thermal bridge is affected by the steel frame.

By using IRT the performance of thermal insulation and other heat loss sources were investigated in two different building types by Martin Ocana et al. [19]. The study showed that the best time for IRT investigation is during the evening for traditional buildings, where the walls have high thermal inertia, while at dawn for modern buildings providing more information.

Mauriello et al. [24] presented an overview of increasing the role of thermal data collection techniques, and the future of thermography diagnostic as a kind of Human- Building Interaction (HBI). The study included a pilot study of the thermographic energy survey, where the participants after a simple training offered to use a smartphone-based thermal camera to explore their environment. The study involved three participants, who freely inspected different environment around them for 4 weeks' period. The study has a long-term vision to evaluate the opportunity of using thermography in combination with DIY volunteers as an interactive tool to scan and identify issues within building infrastructure. Tylor et al. [22] investigated the possibility of inspecting the thermal performance of the building, by using of thermography under the construction process, in order to achieve an earlier identification of the performance issues in new buildings. The thermography can be combined with

pressurisation testing to provide an assessment of fabric energy performance in buildings [86]. Time-lapse thermography can provide a better understanding of thermal behaviour and capture potential building defects [87]. It minimizes the risk of misinterpretation, by improving the differentiation between environmental settings, actual behaviour and building defects. The quantitative thermography to determine U-value [88], [89], can even be achieved by time-lapse methodology [87]. The combination of thermography and computer modelling of building's thermal performance can be used together for identification and assessment of insulation defects in building facades in new buildings [90].

The accuracy measurements of IR camera for evaluation of thermal insulation performance can be improved by identifying suitable periods for measurement of temperature difference ratio (TDR) during the course of a year. A study [91] based on analysing data of temperature and wind speed measurements to determine the ideal period for measurement. In this study, standard weather data of temperature and wind speed were collected from 1980 to 2013 for eight large cities in South Korea (Busan, Daegu, Daejeon, Gwangju, Incheon, Seoul, Suwon and Ulsan). The research has even analysed both the metrics of IR camera and experimentally the error rate of measurement criteria. To get best results, the approach requires temperature differential greater than 10 °C between indoor and outdoor environments and an outdoor wind speed less than 3.0 m/s. Based on these above criteria, the research identified the annual range of measurable hours between 3183 and 1317. Additionally, the ideal measurable periods are between November and March, particularly during early morning, between 01:00 and 09:00. Tylor et al. [23] present a pilot study of using thermography as an in-construction test method for inspection of the quality and thermal performance of new buildings. A ground floor apartment has been selected as a sample for the thermography inspection in a block of 69 apartments in Swansea. Antonyova et al. [92] experimentally measured the thermal conductivity throughout the insulation material of a specific thickness. By using Peltier module, an outside environment temperature of -18°C has been generated on one side of a cuboid section of insulation material. Additionally, the approach allows testing of the internal thermal behaviour of

the material with respect to the thickness and material shape. The method has been applied to several selected insulation materials, and by using statistical methods, the results are particularly useful for determining the efficient thickness when selecting insulation material for building.

2.6. Building monitoring

According to the EU directive 2012/27, new buildings and renovated buildings in the EU have to provide a real-time monitoring and management system by the year 2016, which will include monitoring of electricity, heating and domestic water [93]. A fresh study by Sekki et al. [73] presented the energy consumption in different educational buildings in a city in Finland, shows that even in a cold climate as Finland, the primary electricity consumption is greater than the primary heating consumption in buildings constructed in the 2000s. The newer buildings consume less heating energy, while the newer consume more primary electricity. The study has even shown a wide variation in energy consumption between the buildings without any clear relation to the type or the age of the building.

A monitoring study by Guerra-Santin et al. [60] investigated the performance of the low energy dwellings and consisted of two UK case studies. The focus of this study was on the post-construction stage of the building process and included a review of the construction as well as testes of the fabric and the system performance. The results of the fabric and the system performance inspections were showing a quality of building performance close to the expected calculation. The achieved high building performance depended on the intensive engagement of the design and monitoring teams, which allowed solving of issues that arose under the construction phase. The results highlight the importance of the monitoring process of low energy buildings and specifically lower carbon technologies.

Automated people counting system developed by Amin et al. [73] shows an increase in accuracy. The system used low-resolution infrared combined with visual cameras. Compared with either infrared system or the visual system,

this combination shows significant accuracy improvements, with 3% error when the experiment included more than eight people.

Wang et al. [94] examined properties of occupancy statistically from single occupant offices. The study tried to evaluate outcomes of using occupancy sensors in controlling temperature and/or air quality in building and found that the system has a potential to save energy if a suitable setback policy can be applied during working hours. The results showed also that the vacant interval is exponential, while occupant interval is not, and that the occupancy behaviour has a random pattern.

Yousefi et al. [95] has investigated the impact of occupant behaviour on the energy performance of building envelopes via simulation using occupants' data, the study emphasises the importance of occupants' engagement and the user selection of envelope materials on energy performance.

Santin [96] investigated the relationship between occupant behaviour and building heating energy consumption. He concluded that building energy calculations could include behaviour patterns and different profiles will be created to identify different behaviour. The study even underlines that the number of rooms in use (that are considered for sleeping, studying and working) is an important factor to determine the energy consumption for space heating.

Mahdavi [97] presented a study about some office buildings in Austria, which investigates control-oriented occupant behaviour. The results suggest the ability to identify some patterns of occupant control behaviour, which will work as a function of climatic parameters including the indoor and outdoor environment. The study recommends that different buildings will require different models of typologically distinguished occupancy and control action.

Parys et al. [98] assessed different systems of lighting and blind control in office buildings in Belgium. The systems were shared by four categories of user behaviour. The results of the simulation confirmed that the energy saving potentials by a daylight dimming system decreased by about 10% in a single office in case the user behaviour is accounted for.

Yu et al. [99] reported the implementation of a methodology for identification and improvement of occupant behaviour in existing residential buildings in Japan. The method consisted of three basic data analysis techniques: cluster analysis and classification analysis to identify the general occupant behaviour, and association rules to identify the specific occupant behaviour. In earlier studies, just Cluster analysis was used and also was based on a basic data analysis technique. To show the applicability of the suggested method, the system was used for a set of data that was collected from residential buildings. The results show that the method enables the assessment of building energy-saving potential by enhancement of the user behaviour and offering a deep understanding of building energy consumption patterns [100].

2.7. People behaviour and engagement in relation to energy consumption for space heating

Behaviour in this thesis refers to the use of building space, heating systems and other facilities in the building that can affect the energy consumption for space heating

Influencing the behaviour in order to reach positive outcomes is currently increasingly adopted and today a huge number of publications worldwide is available. Some of these models investigating the behaviour change in general [101] while others emphasise on behaviours related to particular contexts such as climate change [102], environmental behaviour [103] or sustainable consumption [104].

The electricity consumption differs from other kinds of goods because of its nature in being abstract, untouchable, invisible and consumed via different energy services, not directly but in indirect ways [105]. Energy is twice invisible to householders [106]. First, for its nature concept as a product, a social importance or a strategic substance [107], electricity especially is both an invisible and abstract source arriving to the home by often hidden cables. Second, Most behavioural actions that are related to energy use are parts of unremarkable routines and habits [108] that are making it hard for people to combine their specific behaviours to the used energy.

Current technologies make it possible to transform the invisible to the visible condition, and the visualisation can effect on human behaviour significantly [109]. The nature of the visual material in being particularly memorable and salience can let it be especially powerful, when associated with the vivid nature of the visual image [110]. According to a hypothesis of Boholm [111], the visuals may challenge a "positioning power" on the observer's mind, which may be resistant to observations that challenge the emotional state they crop. Compared with the textual material the visuals touch significantly more feat, engagement and concern [112]. The most noticeable difference in the comparative impacts of text / verbal against visual messages comes to their emotional effect. It believes that visuals put people in an emotional position where the text / verbal material stay more logical, rational, and linear [110]. The visual images own a strong capacity to demonstrate risks which are far away from our daily experience and show them subjectively vivid [111].

The building's energy consumption shows a wide range of variation even among buildings that have the same function and placed in similar weather [113]. One of the main factors, which promote to this differentiation, is the occupant behaviour [113], [114]. The way occupants choose their comfort criteria (including thermal, visual, and acoustic) in response to the existing climate condition interrelate with building energy consumption and service systems [113]. A thermal comfort model improved by Humphrey and Nicol [115], is based on a number of surveys has considered that the temperature of occupants' comfort is dynamic and changes with the monthly outdoor air mean temperature. Darby [116] suggests that informing occupants about energy consumption by displays help them to understand how to reduce their energy consumption. Current improvements in feedback technologies and smart meters together have contributed to energy consumption displays for homes use. The finding could enable a significant amount of energy saving for many of householders [117]. Based on the theory of feedback related to energy consumption, effective feedback devices help people to learn themselves the ways to save energy, promote self-efficacy and support, and result in energy conservation [118]. It is expected that the real-time feedback on energy consumption delivers more detailed, valid and reliable data, making

energy saving noticeable and captures people's attention better than any other kind of information [119]. A qualitative study applied by Oltra et al. includes three different research approaches: resumed focus groups, diaries and interviews. The study shows an interaction between a small sample of householders and energy consumption display. The results show that the energy saving potential depends on the grade of involvement which user has with the display, headed by the motivation of user to save energy, previous posture and priority [117]. The psychological model in feedback research presented by Fischer, based on a big number of review studies and original papers shows how and why it works [105]. The study came with a description of the most successful feedback, which has to include the following features combination: it is given over long-term, frequently, presents an appliance-specific breakdown, computerized, interactive and is displayed in an attractive way.

Fischer's study on the effect of feedback on energy consumption, which is based on five review studies and 21 original papers, shows clearly that the feedback stimulates energy-saving behaviour [105]. Despite the attention, occupant behaviour remains a difficult area to investigate due to its complex nature [100], while other researchers consider behaviour as a difficult term to modify [58]. Generally, the behavioural activities that are connected to energy consumption are unremarkable routines and habits [108]. Therefore, it is hard for people to link their specific behaviours to the used energy. Different researchers have used different methodologies to identify and modify the occupant behaviour to improve building energy consumption [99], [100], [120]. Occupant actions like turning on/off building equipment opening/closing windows, turning on/off or dimming lights, turning on/off heating, ventilation and air-conditioning (HVAC) systems are behaviours which also influence the building energy consumption significantly. The occupant discomfort is the main factor behind the occupants' window interaction [57], [121]. Bad air ventilation is also one of these scenarios [58]. Energy conservation programs are involved in investigating user behaviour-changing potential and user engagement. Many of these programs focus on an individual level, and believe that the behavioural energy conservation is directly dependant on the

individual behaviour and engagement of the individual who has full control over their behaviour and according to that decision being taken [99]. Other studies are concentrating on communities and believe that individual will engage and act as a citizen and not as a user only [120]. Creating low carbon communities are experimenting by engagement of people with shared interests, practices, structures or educational level [99], [120].

A research presented by Goodhew et al. [25] has investigated the behavioural effect of visualisation of heat loss from residential homes and the consequences for energy saving using infrared technology. By providing thermal images, the study enabled householders to see how the heat escapes from their homes in order to study the eventual motivational impact on behavioural energy conservation. The research concentrates on a new examination of the behavioural effect, which is related to problem visualisation and the ability to encourage residential energy saving measures through such visualisations. The results show potential energy conservation by using the demonstrated visualisation technology. The study recommends that future work will provide more dynamic visualisations of the heat flows, without identifying a methodology for that. The Social Cognitive Theory by Bandura [122] view human as self-organizing, self-reflecting, proactive and self-regulating rather than as reactive creatures formed and shepherded by environmental factors or driven by inner impulses. The model suggests a dynamic triadic interaction explanation for human functioning, which consists of personal, behavioural and environmental influences and known as reciprocal determinism. The Theory of Planned Behaviour (TPB) can significantly be used for prediction of intention and behaviour [123]. The TPB suggests that behaviour is dependent on individual's intention, which in its turn depends on individual's attitude, subjective norm and perceived behavioural control. According to the theory, behaviour can even be determined directly by perceived behavioural control. The central element in the TPB is the individual's intention to perform a specified behaviour and it is expected to catch the motivational factors that affect a behaviour. Generally, the stronger the intention to involve in a behaviour, the more possible must be its performance [124]. The Transtheoretical model (TTM) of behaviour change

suggests the change as a process of five stages and levels, including Precontemplation, Contemplation, Preparation, Action and Maintenance [125].

The environmentally relevant behaviour model by Matthies [126] differentiates between two types of action, habitual behaviour and conscious decisions. The habitual behaviours are actions made regularly and are not reflected upon, and to these belong the most of the energy consumption activities. For reflection, upon changing of an existing behaviour or for a new norm to take place a conscious decision needs to be taken, and this process calls norm activation. The process consists of three stages, including realizing the existence of the problem, realizing that behaviour is relevant to the problem and finally becoming conscious that there is a possibility to influence the behaviour and its outcomes. The following stage of this model is weighing and evaluating of different motives to take a decision regarding an action. According to the model, there are three kinds of motives, including personal norms, social norms and other motives. The Social practice theory (SPT) is progressively being implemented to explain many of the human behaviours, particularly in relation to energy use and consumption. SPT is a kind of versatile approach where various aspects of the theory are covered. The fundamental vision of SPT is the significant recognition that human practices such as ways of doing, habitual behaviour and routinized behaviour are themselves arrangements in an interaction connection where elements, such as mental and physical activities, norms and values, knowledge, technology use, are forming people's behaviour as a part of their everyday lives [127]. This approach particularly highlights the material perspectives and technology systems within which certain practices occur, illustrating their significant impact upon behaviour, including the production and reproduction forms of practices [128].

The importance of material context and socio-technical systems and their interaction with practices confirm by many kinds of literature such as [129]. According to Smith, the existing practices have the flexibility, which supports routes of development in technological transition to take place. Material contexts and social practices are often themselves perpetuating. Randles and Mander [130] define this flexibility as 'stickiness', explaining that we do rarely

or hardly reflect over social practices, and their inner arrangements and this make them structurally rigid.

SPT proposes an excess of new ways to understand and explain behaviour, and a correspondingly broad variety of possible responses. The central insight is a need to emphasize on social practice rather than on individual behaviour and particularly on the interaction between people's practices and material contexts. This leads to eliminating 'intervening' in 'selections' or decisions and enables reflecting upon why particular practices are taking place ('produced' and 're-produced'), why and how others are avoided, and taking to account the role of technology in how these practices are done and developed [128].

The Diffusion of Innovation (DoI) theory suggests that innovation is an agent of behaviour change, and defining innovation as an idea, action, or object understood as new [131]. Accordingly, it is perceived characteristics of an innovation that determine its degree of adoption better than the attributes of the adopters. The DoI theory suggests four 'primary elements' of behaviour change including innovation, communication channels, social and time systems [131] and has subsequently been broadly applied to areas such as marketing, health and development [132]. According to the DoI theory, the changing of behaviour will occur faster if the innovation is understood as a better solution than the previous alternatives, offering different information exchange relationships opportunity (communication channels), providing diffusion network (social system) and the diffusion of innovation is a process which takes time [131].

2.8. Education and energy consumption

Currently, it is becoming necessary to improve public understanding and engagement regarding energy conservation and sustainability, particularly in the building sector. Additionally, educating pupils, students and researchers about the impact of insulation and further modifications in building features on building energy consumption are becoming a central activity to expand scientific knowledge, public engagement and awareness in this field. This will allow them in the long term to take right decisions regarding energy saving measures.

The educational curriculum for different school levels worldwide highlight the importance of using different scientific equipment, for example, in taking measures, recording data, creating diagrams, increasing the degree of complexity, identifying scientific evidence, etc. The new national curriculum for year six in the UK [133] mentions very clearly the expected development criteria that the pupils have to reach at this school level. Particularly, the key stage 2 level of this curriculum explains these objectives in detail:

- Planning different types of scientific enquiries to answer questions, including recognising and controlling variables where necessary.
- Taking measurements, using a range of scientific equipment, with increasing accuracy and precision, taking repeat readings when appropriate.
- Recording data and results of increasing complexity using scientific diagrams and labels, classification keys, tables, scatter graphs, bar and line graphs.
- Using test results to make predictions to set up further comparative and fair tests.
- Reporting and presenting findings from enquiries, including conclusions, causal relationships and explanations of and degree of trust in results, in oral and written forms such as displays and other presentations.
- Identifying scientific evidence that has been used to support or refute ideas or arguments.

Science and technology education in schools in the 21st century should take benefit of 21st century's technologies. An educational technology concept has been presented by Xie et al. [30] with the aim to improve teaching and learning of engineering design and investigate how the technology can enhance design-based learning in engineering education at the secondary school level.

The study demonstrates new educational tools and proposes how they may support high school students to assume scientific discoveries of heat transfer and engineering designs related to energy-efficient houses. The study highlights a theoretical framework that guides a developed curriculum, educational research, and laboratory implementation.

The study presents the idea of using an innovative technology as both cognitive tools and design tools to advance design-based learning. The concept was focusing on the area of energy and power in thermal systems and consisting of simple physical building models and modelling software. The educational tool and the curriculum units have been examined in three high schools with the participation of about 200 students. The results illustrated positive responses from students. However, the recommended physical models had the advantage of being low cost and simple, but they have some limitations in modularity for the user.

Haglund et al. [28] presented a qualitative educational research, where thermal imagery is used in science subjects at different school levels. The research has focused on the visualisation of heat transfer in chemical and physical processes across all school ages. The results have shown that the thermal imaging in combination with simple well-structured theoretical activities could support the students' thermodynamic learning.

Cabello et al. [134] applied the infrared technology to the field of education, specifically to the learning and understanding of heat transfer for university students. By applying infrared practical exercises the study tried to allow the students to discover and understand the theories, mathematical equations and laws behind the concept of heat transfer and how they are transferred practically. Instead of numerical complexity involved in conduction, convection and radiation of heat transfer the infrared camera visualises the concept and promote intuitive learning to occur. The findings confirm that an infrared camera is a powerful tool, which is able to make the learning and understanding of heat transfer easier and enjoyable, which in turn enhance students' motivation and engagement in the learning process.

A Study presented by Haglund et al. [27] was focusing on analyzing university physics students' interaction with IR cameras and how it helped them to observe phenomena related to thermal radiation. The study explored the students' interactions with infrared cameras in an open-ended laboratory activity in Sweden. The results show that students investigated the reflection of heat radiation on shiny surfaces, e.g. polished metals, windows or a

whiteboard and observed the emissivity of different types of surfaces. Thus, study went further than applying the technology as a temperature probe. Moreover, the students were able to discuss qualities and limitations of IR cameras in contrast to digital thermometers.

Xie et al. [135] demonstrates laboratory applications of how IR imaging can be applied to teach all the basic mechanisms of heat transfer in a real-time and vivid way, provide excellent learning and exploration environment for students that would otherwise be impossible or take too much time. According to the study, IR cameras provide an excellent opportunity to the laboratory by reducing the laborious work, saving time and giving good information about an experiment that can be quickly recognized and absorbed by the human brain. The study suggests a number of experimental applications that can be implemented in laboratory easily. IR visualisation has been applied to chemistry education [29], where a set of minds-on and hands-on experiments developed to use the educational capacity of IR imaging in promoting to inquiry-based learning in chemistry education. All applied experiments are easy to implement and cover one or more science puzzles, which can effectively stimulate students' interest and engagement in exploring scientific phenomena more deeply.

2.9. Gap in knowledge

There is a lack in the literature in relation to energy loss visualisation. The provided visualisation was static and the authors [25] suggested that future work will identify and provide a vivid more dynamic visualisation of heat loss, which is closer to real-time feedback. The building diagnosis for identifying the insulation issues, including infrared thermography are costly inspections to carry out for most of the public. At the same time, to convince the public to invest in the improvement of insulation, they need to understand the economic, environmental and comfort benefits of that. For this to happen, powerful methods and tools are required, to identify the areas of problem in an efficient way and provide the opportunity for the public to be engaged self in the process. Additionally, providing education will make the process more

effective and promote the change of behaviour towards a more sustainable future.

As discussed above, teaching and research tools for studying and simulating thermal performance in buildings in most cases are based on a single component or material based systems to test and measure insulation. In other situations, software-based simulation and modelling is used, which is normally based on assumptions and does not fully engage the learners in the training and learning process particularly for the younger generation. Both scenarios fail to engage students and the public in relation to the effect of insulation and the modification of building features on energy consumption and the temperature of the building, particularly for the younger generation.

There is lack of physical educational simulation tools that can show the building in a new context, which easily and effectively can show the saving potential of improving the insulation, or the high energy consumption as a consequence of bad insulation. Moreover, there are needs for tools to be used for the teaching of energy consumption in building and the impact of insulation for different educational levels.

Additionally, there is a lack of a general methodology for people engagement to train and engage people to carry out a thermographic survey of their building, which can decrease the cost of the survey significantly and increase the degree of involvement.

2.10. Summary

This Chapter introduces the literature review, providing a background of the involved research items. It is covering the main topics, including energy consumption in buildings, insulation, thermography, building monitoring and behaviour and engagement in relation to reducing energy consumption in buildings. The Chapter gives an extensive presentation of previous research in this field. It explains the main challenges in this area, including different methodologies related to reducing energy consumption in buildings, different methodologies for building diagnostic and different theories for enhancing

behaviour and engagement. Moreover, it includes the gap of knowledge, which is identifying the gaps in the literature.

CHAPTER 3.

METHODOLOGY

3.1. Introduction

The research (Figure 3-1) consists of three different parts, including building thermography survey which provides the opportunity for the public to carry out infrared thermography of their buildings (Building thermography and people engagement), development of a Physical educational simulation model to enhance people engagement (Innovative design and people engagement) and finally monitoring the energy consumption at Nottingham Playhouse (Building monitoring and people engagement). This Chapter outlines the methodology of each part of the research, and a more detailed description of these parts are provided in Chapters 4, 5, and 6.

3.2. Building thermography survey (building thermography and people engagement)

3.2.1. Material and Method

The survey is designed to investigate the potential of enhancing people's engagement in energy conservation by providing a low-cost thermal camera for the public to carry out thermographic survey of their own buildings. The study includes three different questionnaires, an educational session (both

theoretical and practical) and finally, a thermographic survey carried out by the participants of their own households.

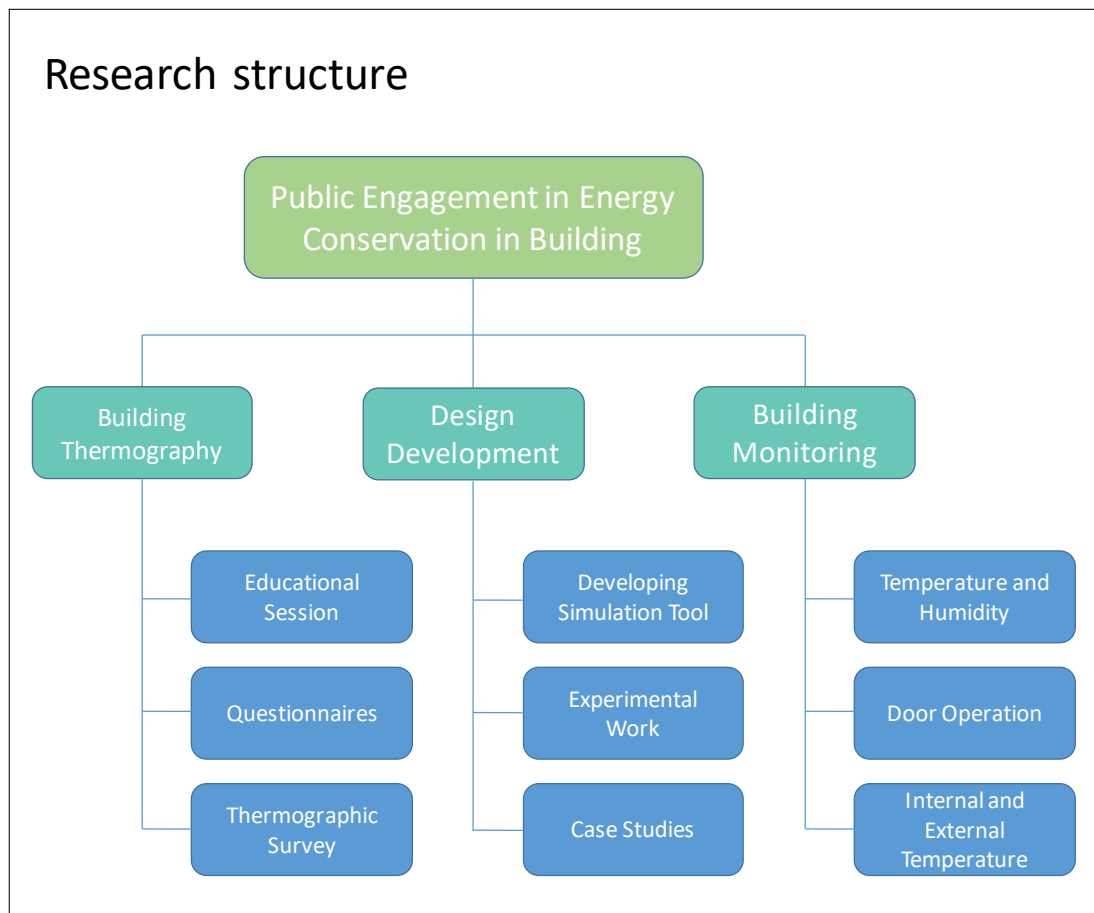

Figure 3-1: The structure of the presented research.

3.2.2. Questionnaires

The study contains three different questionnaires (see appendix 1, 2 and 3), which are designed by the researcher. A pilot study was carried out in advance in order to test the feasibility of the research design and to allow necessary adjustments to take place before the final questionnaire forms [136].

The first questionnaire (pre-test) includes two parts of questions, sociodemographic characteristic part, which covers information about the participant and his/her household, while the second part examines the participants' awareness regarding energy consumption and insulation issues related to their specific household.

The second questionnaire covers the educational session, including participants' evaluation of the theoretical/practical session, what they had learned and their experience in attending the session.

The third questionnaire (post-test) consists of two parts, the first part is a repetition of the second part of the first questionnaire, to compare and assess the participant's energy and insulation awareness related to their own buildings, before and after the thermographic audit. The second part of the questionnaire is related to the participants' thermographic experience concerning their buildings, potential detected defects and potential actions may they plan to take toward any improvement of the performance of their buildings.

3.2.3. Health and safety

The participants have got the necessary instructions regarding health and safety before they collect the thermal survey system. The health and safety instructions included necessary information about participants' safety while they carry out the thermography survey of their building. Only thermal images of their own building from outside were required, while the indoor imagery was optional. The instruction included even technical instruction regarding the optimal conditions for thermography survey, particularly the minimum required temperature difference between indoor and outdoor and the most suitable selected times for thermography.

3.2.4. Educational session

The educational session (Figure 3-2) included theoretical and practical training of how to use the infrared camera and how to carry out a simple thermographic survey. Moreover, the session covered also some general information regarding energy consumption in buildings. The session applied both in groups and in individual forms and lasted between 30-60 minutes at a time.



Figure 3-2: The educational session for participants.

The theoretical part of the session is presented by a number of slides (Figure 3-3 and Figure 3-4). The session provides information about the energy consumption of electrical devices in the building. It explains how different devices consume a different amount of electricity. It is important that the public has a feel of the level of consumption for each device per hour, day, week and year, to gain an overview of their consumption (Figure 3-3-a). At the same time, it is necessary that the public is aware of the duration each device needs to consume one KWH (Figure 3-3-b). Moreover, the number of weeks to consume one KWH for low-energy devices or the number of KWH per day for high-energy devices. Figure 3-3-c explains the relation between watt and kilowatt is essential to know and that

1KWH=1000 watt-hours

To learn how to carry out the calculation of one KWH for different devices, and how to relate that to the number of amps and the voltage system. Figure 3-3-d identifies the energy efficient respective non-efficient devices to enhance

energy awareness. This will help you to make a comparison between energy efficient and non-efficient devices, making calculations to find out what you can save per day, week and year in terms of energy and money (Figure 3-3-e). Learn facts about how much energy is lost through different parts of the building envelope is useful information for planning future renovations (Figure 3-3-f). It is useful to know fact data about heating level adopted by householders in the UK (Figure 3-3-g).

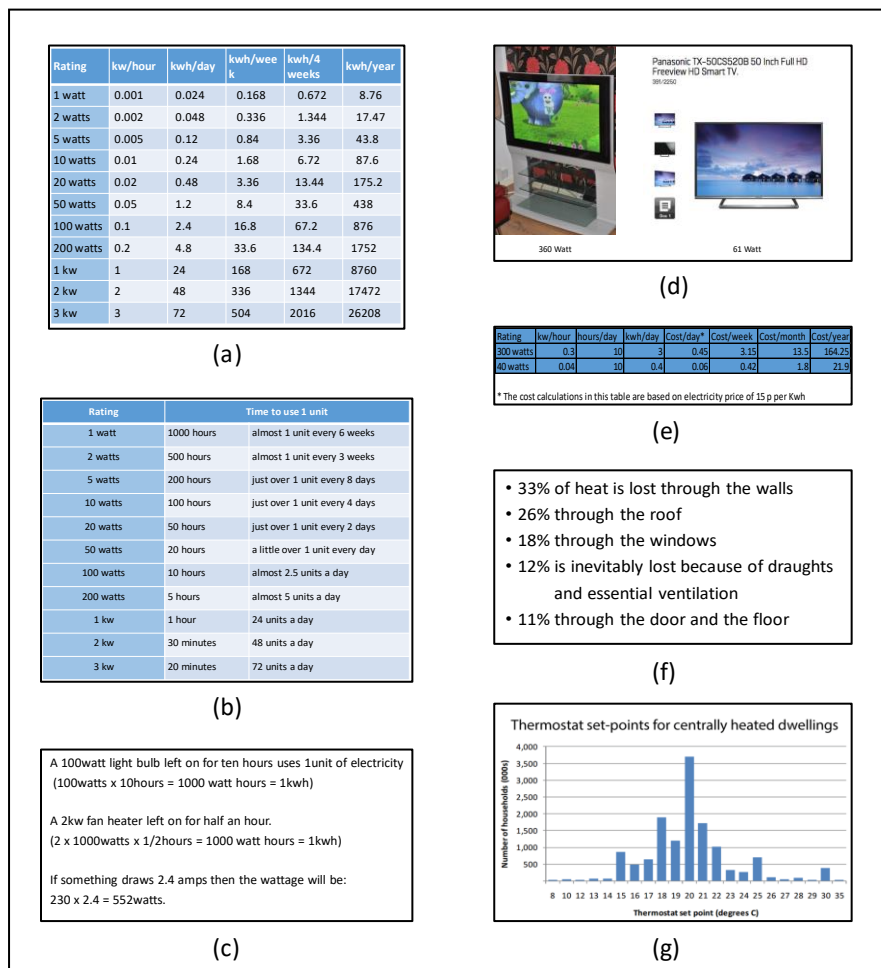

Figure 3-3: The slides of the educational session, including (a) energy consumption and time, (b) KWH and time, (c) calculation of energy consumption, (d) efficient and non-efficient devices, (e) energy consumption table, (f) energy loss of building envelope and (g) indoor adopted temperature.

The session has also explained how to analyse a thermal image, identify the cold and respective warm areas and identify the sources of heat loss within a building envelope (Figure 3-4-a). Moreover, Figure 3-4-b shows how to choose

different colour combinations in order to present the thermal image in the best suitable way. Figure 3-4-c explains that even the ventilation system can be a source of losing energy from a building. Figure 3-4-d shows how openings between a door and frame are sources for losing energy in the building, which can be identified by dark areas in a thermal image, indicating the cold areas when the image is taken from inside a building. Figure 3-4-e explains how single glassed and low-quality double-glassed windows lose energy. The connection between the sections of a building can suffer from air leaking, for example, the connection between the wall and the ceiling (Figure 3-4-f).

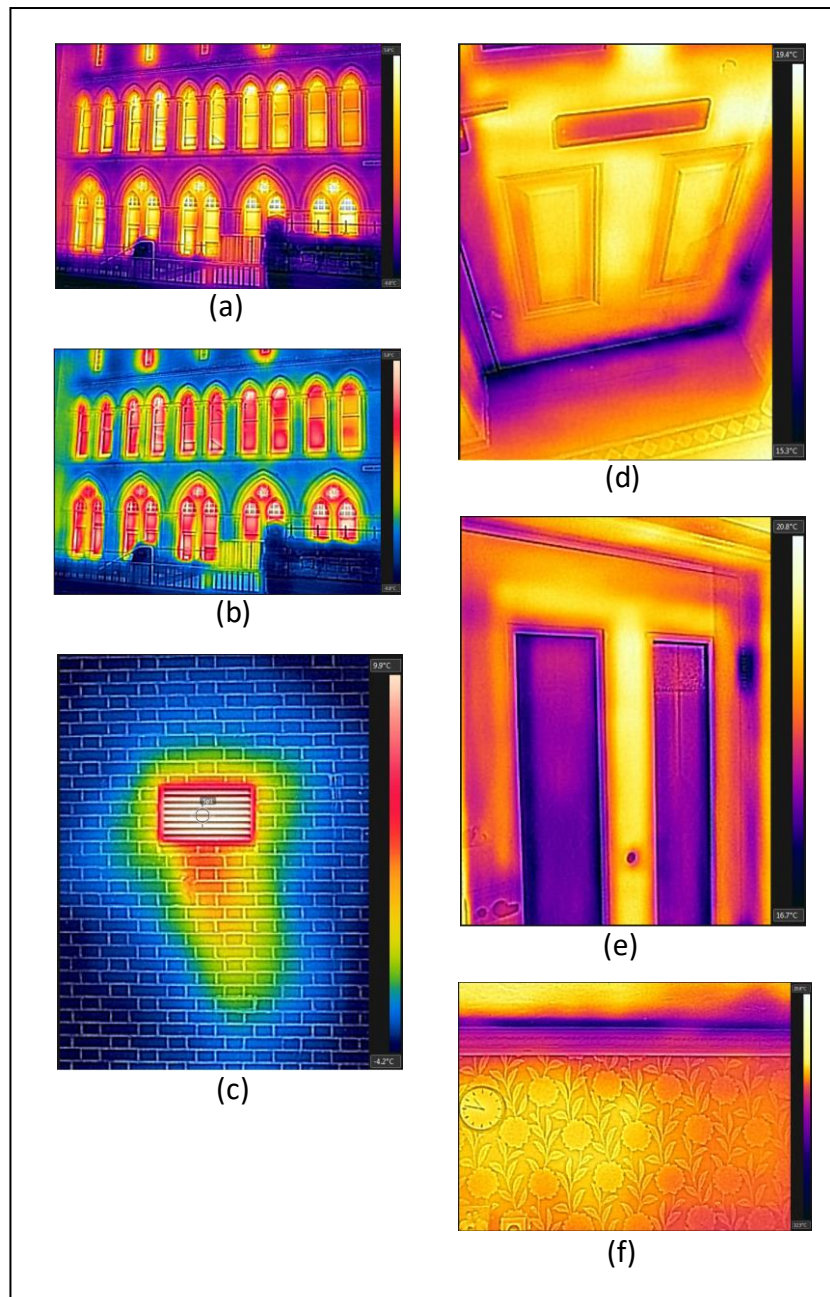

Figure 3-4: The slides of the educational session, including (a) thermal image analysis, (b) colour combination options, (c) energy loss of ventilation, (d) door openings, (e) single glasses and (f) air leakage.

3.2.5. The thermal survey system

The thermal survey system (Figure 3-5) consists of a low-cost smartphone-based thermal camera (FLIR One) connected to a smartphone (iPhone 5). Two identical thermal systems were available to deal with in the study. Further, the survey bag included also a thermometer for monitoring of internal and respective external temperatures, a reflecting vest to be worn while they carry

out the thermographic survey. Additionally, the material provides even a manual of how to use the thermal device. For data protection purpose the smartphone device was modified to block data communication abilities by using a special program and the functions of the device was simplified to work as a camera rather than a smartphone.



Figure 3-5: FLIR One attached to iPhone 5.

3.2.6. Data collection procedure

As the system was an expensive and attractive device, therefore the selection of the samples was limited to participants belonging to Nottingham Trent University. The data collection procedure consisted of three different questionnaires, limited educational session and thermographic survey (Figure 3-6). The participants first had to complete the first questionnaire, before they attend the educational session, which consisted of theoretical and practical training and included general information about energy consumption in buildings, how to use the infrared camera, how to translate a thermal image of a building and how to carry out a thermographic survey by using a thermal camera. Following the educational session, the participants completed the second questionnaire, which covered the evaluation of the educational session. After completing the second questionnaire, the participants carried out the thermographic survey of their household. According to a schedule, the participants collected the thermal system during daytime and returned it back at the next day, to be able to carry out the thermography during the night-time.

When the thermal system was returned back, the captured thermal images were downloaded. At the same time the researcher went through the images together with the participant and discussed the images, the experience and the potential actions which the participant planned to take to improve the efficiency of his or her building. Following the thermographic survey, the participants completed the final questionnaire. The thermographic survey was carried out between 22 February and 31 March 2016 in the city of Nottingham in the UK. The average highest and lowest temperature during that period were 9 °C and 1 °C respectively. Four participants were removed from the survey as they did not attend the educational session and therefore they did not complete the further questionnaires. Fifty householders as the result were able to complete all the questionnaires and took part of the study. Two identical thermal systems were available to deal with in the study, providing an opportunity for two participants to carry out thermographic survey per day.

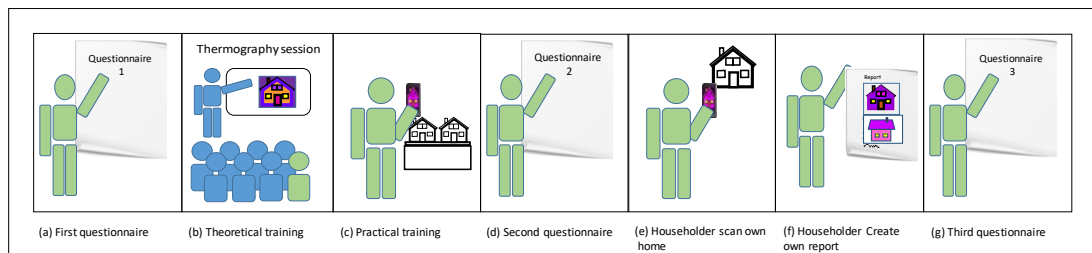

Figure 3-6: The schematic data collection plan.

3.2.7. The Novel thermographic methodology

The study presents a novel methodology for implementation of thermography survey. The novel approach (Figure 3-7) provides a thermography training for householders to be able to carry out their own thermographic survey of their own household without involvement of any expenses. The thermography training consists of two parts, a limited theoretical thermography session, followed by a practical training. The theoretical session includes some general information regarding energy consumption in the building, thermal image analysis, how to use the thermal system and how to carry out infrared thermography. The practical training provides the opportunity for participants to familiarise themselves with the device, feel and explore it and take some

images of the building envelope. The practical thermographic training can be applied on a simulation-building model. In the study, an innovative educational simulation-building model was available to train with, which was developed by the researcher for this purpose (Figure 3-8). The simulation model was used to train the participants on building thermography (Figure 3-9), combined with the use of the thermal system (Figure 3-10). The thermal system consists of a low-cost smartphone-based thermal camera (FLIR One) connected to a smartphone (iPhone 5). The training also aims to increase the householders' awareness and motivation in relation to energy consumption in buildings. The thermographic survey is an exercise for the householders to implement what they have learned in the educational session to carry out an actual thermographic survey and identify the areas of issue in their insulation. The survey is designed to improve the building energy awareness and engagement, particularly in relation to their respective own building. In addition, it is expected to observe some behaviour changes as consequences of the visualised insulation issues. The simulation building model consists of two identical buildings, an insulated respective a non-insulated building, provided with control and monitoring heating systems.

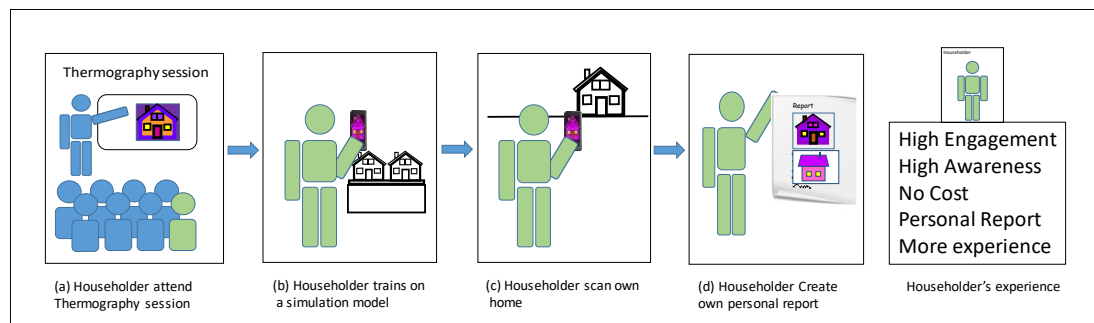

Figure 3-7: Schematic diagram of a novel thermography methodology.



Figure 3-8: The educational simulation-building model.



Figure 3-9: Training the householders on the developed simulation-building model.



Figure 3-10: A participant using of the thermal camera on the developed simulation model.

3.3. Physical educational simulation model (innovative design and people engagement)

3.3.1. Material and method

In order to develop a methodology for people engagement, the researcher developed a physical simulation model to be used as a tool for teaching about energy consumption in building and the impact of insulation. This part of the research consists of an innovative simulation design, experimental work and two case studies. The educational tool has been tested in the laboratory and the results are presented under experimental work. Moreover, the tool is implemented in school and university level and the results are presented in case study one and two respectively.

The proposed modular physical model of the building comprises a modular and layered structural system, which can be easily modified with the introduction of thermal insulating layers, and with an internal and external control of heating and cooling of the building model and the associated control

of the simulated or realistic external environment. This educational kit will enable the teaching of the values of energy and insulation. This is in addition to the architectural and product design learning skills and knowledge that can be gained. The modular design allows insulation layers and building components to be interlocking and interchangeable to allow ease of modification, assembly and disassembly.

The educational building simulation tool, which is tested in this thesis, consists of two identical building models (Figure 3-8), one with insulation providing a U-value of 21.9 w/m².k and one without insulation and has a U-value of 39.8 w/m².k. Both building models are provided with identical equipment and instrumentation, including a power meter with a display, a 14-watt bulb for heating, a K-type thermocouple for monitoring of internal temperatures and thermostat for controlling of internal temperatures. Both thermocouples are connected to data acquisition, which is connected to a PC to monitor and/or record the internal temperature of both buildings. A smartphone infrared camera (FLIR One) attached to iPhone 5 is used to detect the heat loss of the building models and engage the participants.

3.3.2. Experimental work and case studies

The experimental work describes the laboratory test of the physical simulation tool. The tool has been tested in an environmental chamber to create a cold outdoor condition. The experimental work and the results are presented in details in Chapter five.

The educational simulation tool has been tested at primary school level and university, and the results are presented in two separate case studies. The description of the case studies and the results are presented in details in Chapter five.

3.3.3. The installed equipment

Kemo Temperature Switch Thermostat DC 12V

Figure 3-11 shows adjustable electronic temperature switch which has a dimension of ca. 60 x 45 x 25 mm. The sensor (Ø 5 mm) may be connected

with the control electronics via a cable with a length of up to 1 m. This Temperature Switch Thermostat requires a stabilised DC 12V (max. 0.1 A) power input to operate as intended. The operation temperature range is approx. 0 - 100°C [137].

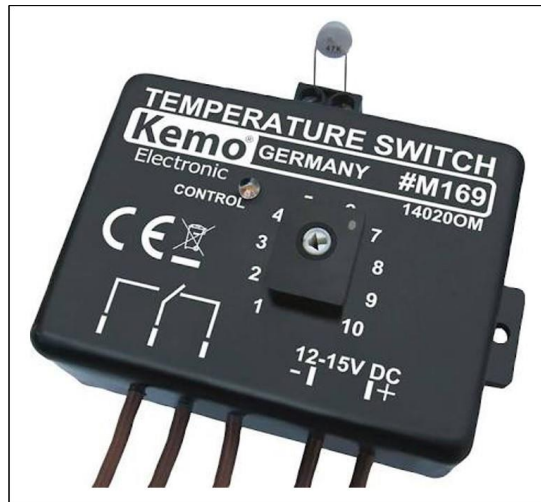

Figure 3-11: The Kemo Temperature Switch Thermostat DC 12V.

Plug in power supply

The output of the selected power supply (Figure 3-12) delivers 12V, 2A and DC. It is small and compact UK plug design. The power supply is fitted with 2.1mm C+VE DC jack plug.



Figure 3-12: The power supply of the simulation model.

Power meter

The system is provided with a power meter (Figure 3-13) to display and count the electricity consumption in each building model. The meter calculates even the cost of consumption. Table 3-1 **Error! Reference source not found.** describes the functions of the meter in details.



Figure 3-13: The power meter of the simulation model.

Table 3-1: The specification of the power meter.

Price Display range	0.000KWh –9999KWh	MPN	Does Not Apply
Real Wattage display	0W ~ 2900W	Current display(amps)	0.000A ~ 13.000A
The set Wattage display	0W ~ 9999W	EAN	Does Not apply
Timing display range	0 second ~ 9999 days	Frequencydisplay	50HZ
Voltage display range	0V~ 9999V	Operating current	13A
Wide Voltage range	230V ~ 250V	Operating voltage	230VAC

Thermocouple

The system is provided with a thermocouple K-type (Figure 3-14). The thermocouple can be connected to data acquisition to present and record the

temperature readings on the PC. It can even be connected to a portable thermometer with the display to show the temperature.

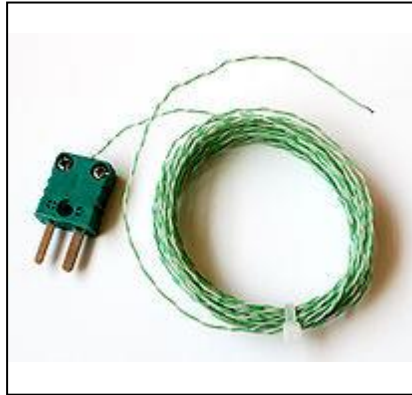

Figure 3-14: A thermocouple K-type.

3.3.4. The connected simulation system

Figure 3-15 illustrates the schematic diagram of the simulation system. Each building model is provided with one or more insulation layers internally or externally. The heating of buildings can be based on a light bulb, an electric resistive heater or a heat pump could be used for heating or cooling (e.g. Peltier effect). The heating system is controlled via a thermostat. The internal temperature is monitored by a temperature sensor, which can be connected to a PC or other portable display systems to show and record real time graph of data. The external temperature could be controlled and monitored by housing the simulation tool in an environmental chamber. To monitor and record the energy consumption for heating, the system could be connected to a power supply via a power meter with display. The heat loss of the building model can be inspected by using an infrared camera to study the building thermal performance in different insulation levels and different climate scenarios.

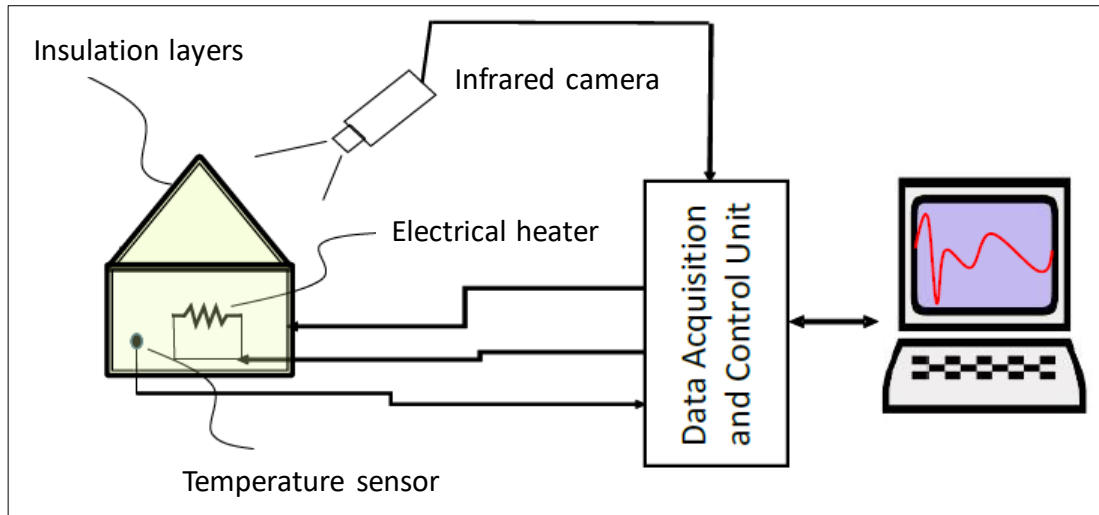

Figure 3-15: The schematic diagram of the educational simulation system.

3.4. Nottingham Playhouse (building monitoring and people engagement)

3.4.1. Material and Method

This part of the study investigated the monitoring of the energy consumption at Nottingham Playhouse to evaluate the previous efficiency improvement of the building and to examine the further potential for energy saving. For more than three months period (during wintertime) the energy consumption, internal and external temperature, internal humidity, energy efficiency of walls and window glasses and the operation of the main entrances were monitored at Nottingham Playhouse. This part of the study, in the line with the rest of the thesis, is investigating the impact of enhancing the public engagement in energy conservation in the building by using modern technology. Moreover, it discusses the relation between the building, occupants and the operation of the building to achieve potential energy saving. Therefore, the area of heat transfer and calculation of HVAC demand of building is not covered in this thesis.

3.4.2. The installed monitoring equipment

All the monitoring data loggers, which are used in this part of the study, are of the type OM-PL Series that are multipurpose devices and can be used for a wide range of logging applications. These data loggers are capable of recording data as fast as once each second or as slow as once each 18 hours. The data logger stops recording when the memory becomes full or rollover for further recording. The start of logging is software selectable to be instant, delayed, or started when the data logger door is closed. Additionally, the data loggers can also be applied for monitoring of high and low alarm events, which specify if the logged data passed above and/or below users' selected threshold. The type OM-PL Series data loggers are designed to store over 10,000 readings.

OM-PLTH

This type of data logger has two internal channels for temperature and humidity (Figure 3-16), which is based on two calculated channels for dew point and wet bulb. It has the capacity to store 21 500 points for temperature only or 10 750 for temperature, humidity and dew points. The range for the operating temperature is between 0 – 60 °C, and 0 to 99.9% for the relative humidity. The accuracy is $\pm 1^\circ\text{C}$ and the resolution is 0.05°C for the temperature respective $\pm 2\%$ and 0.1% for relative humidity.



Figure 3-16: Temperature and humidity data logger type OM-PLTH.

OM-PLT2

This type of data logger has two channels and is designed to measure internal and external temperature (Figure 3-17). It has the capacity to store 21 500 points for single channel only or 10 750 points for each channel. The range for operation temperature is between 0 – 60 °C for the internal sensor and between -40 – 65 °C for the externals. The accuracy is $\pm 0.5^\circ\text{C}$ and the resolution is 0.05°C .



Figure 3-17: Temperature data logger type OM-PLT2.

OM-PLTT

This type of data logger has two external channels (Figure 3-18) and can be used to measure, for example, the temperature of the internal and respective external side of a wall or window. It has the capacity to store 21 500 points for single channel only or 10 750 points for each channel. The range for operation temperature is between $-46 - 150$ °C. The accuracy is ± 1 °C and the resolution is 0.05 °C.



Figure 3-18: Dual temperature data logger type OM-PLTT.

OM-CP-Event101A Event data logging

Event data logging devices (Figure 3-19) detect and record only the time an event takes place but not the duration, e.g. it gives data of the times a door was opened and closed. By knowing the data of an opening event and a closing event; it will be possible to calculate the period of the opening event before the closing event occurs. The device offers 4 Hz reading rate, a 10 year battery life and 406,323 reading storage capacity. These event data loggers are useful for many other applications, for example for monitoring of on/off switching of refrigeration units by the manufacturers. They can detect and record a data point each second and do not need a constant signal. The data collection was configured to take a reading every 5 seconds while an opened door needs circa 10 seconds as a minimum to be closed for the manual main entrance doors and much longer for the automatic doors.



Figure 3-19: Event data logger type OM-CP-Event101A.

3.4.3. The monitoring system, location and time schedule

The installation of the data logger sensors (see Figure 3-20) and the recording of data at Nottingham Playhouse carried out between November 2016 and March 2017. Most of the sensors had been installed at the first stage in November 2016. The researcher has frequently visited the building each 3 weeks to check and follow-up monitoring system. One of the sensors (dual data logger) was found turned off twice because of battery issues, therefore the data recording of that sensors started in December 2016. The door sensors for the main entrance and cafeteria had also been installed in December 2016.

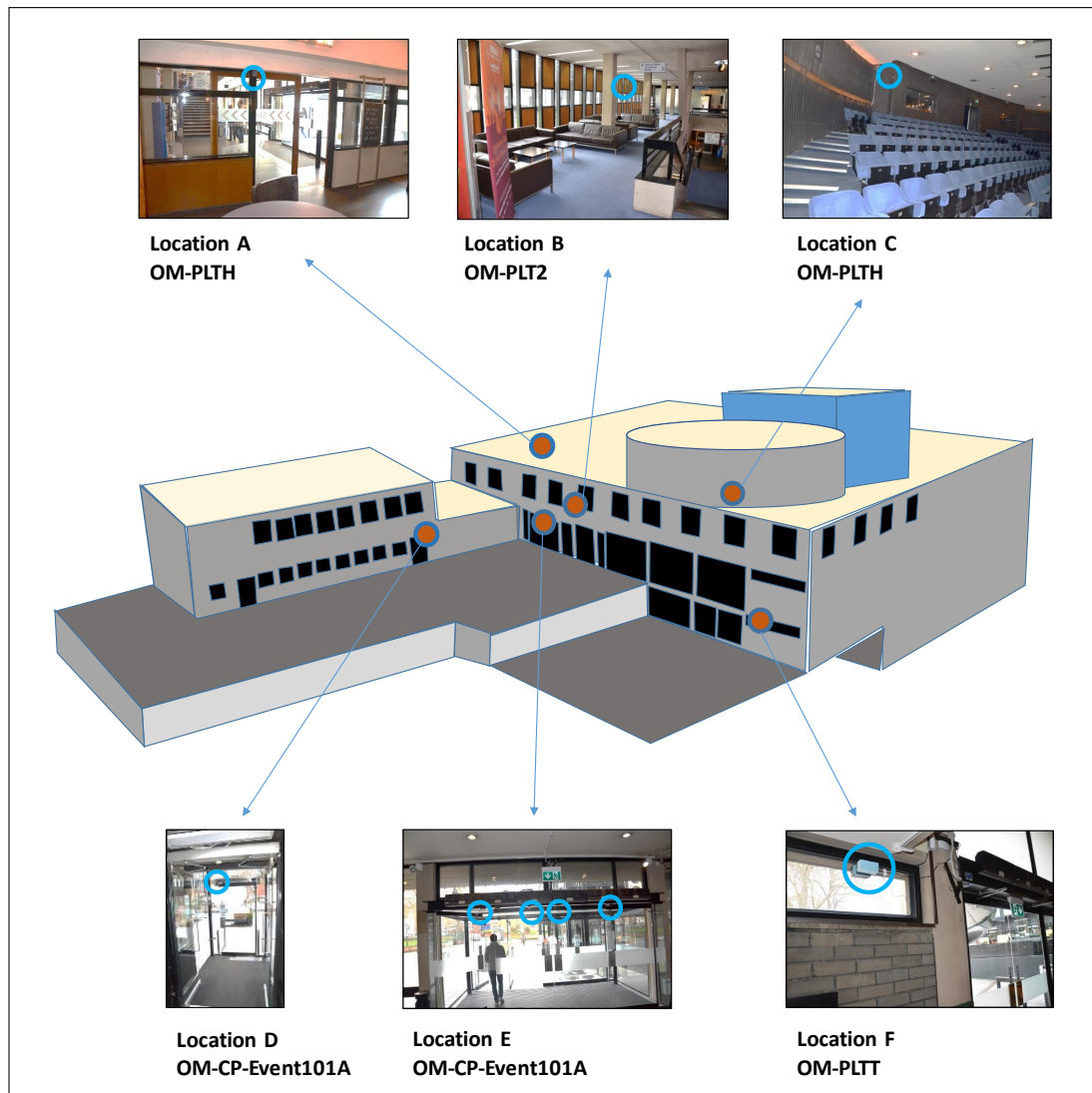

Figure 3-20: The schematic illustration of Nottingham Playhouse building combined with images of the locations of the data logger sensors.

Followings describe the date type, duration, recording interval, location and the objective of each used sensor:

- OM-PLTH (Location A) was installed to measure the temperature and humidity in the cafeteria. The data recording started on November 8th, 2016 and lasted for 113 days, where the data was taken every 15 minutes. This data logger is located on the wall of the cafeteria shared with the reception, close to the main entrance (see Figure 3-21). The location was selected to investigate the impact of visitors' presence and behaviour on the room temperature at that part of the building.

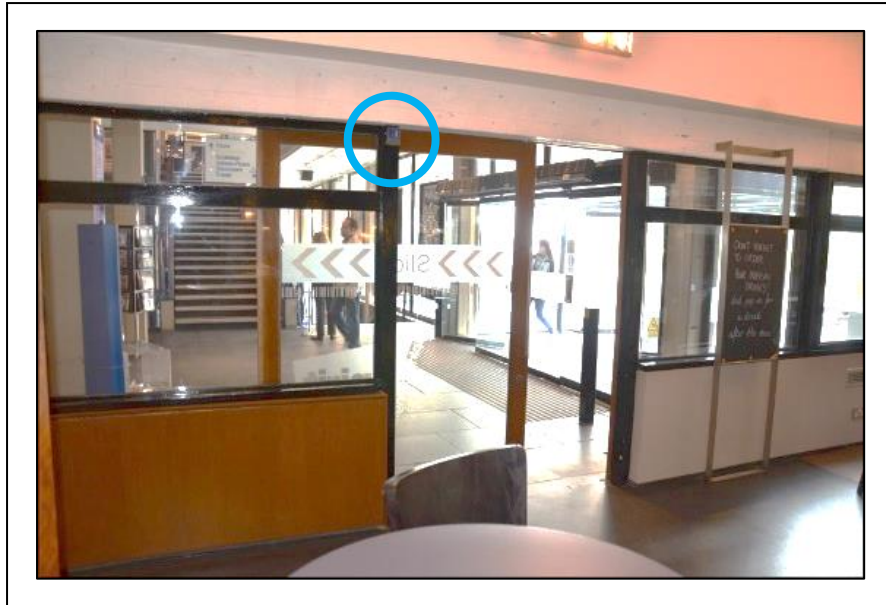

Figure 3-21: The OM-PLTH is installed in the cafeteria (location A).

- OM-PLT2 (Location B) was installed to measure the internal and external temperature to determine the U-value of the walls. The data logger is located on the first floor (Figure 3-22). The data recording started on November 8th, 2016 and lasted for 113 days, where the data was taken every 15 minutes.

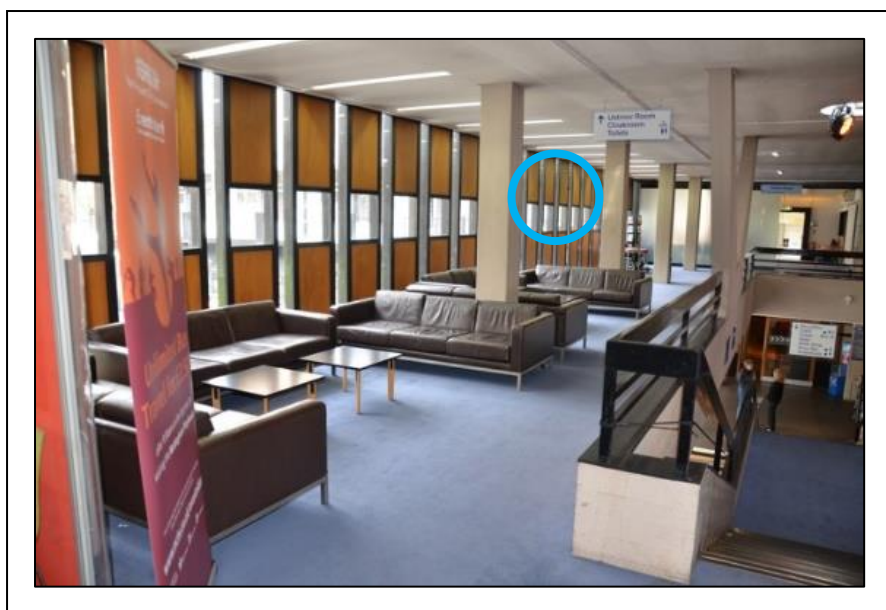

Figure 3-22: The OM-PLT2 is installed in the second floor (location B).

- OM-PLTH (Location C) was installed to measure the temperature and humidity in the auditorium. The data recording started on November 8th, 2016 and lasted for 113 days, where the data was taken every 15 minutes. This data logger is located on the wall of the auditorium, opposite the stage (see Figure 3-23). The location was selected to investigate the impact of audience on the room temperature in the auditorium.

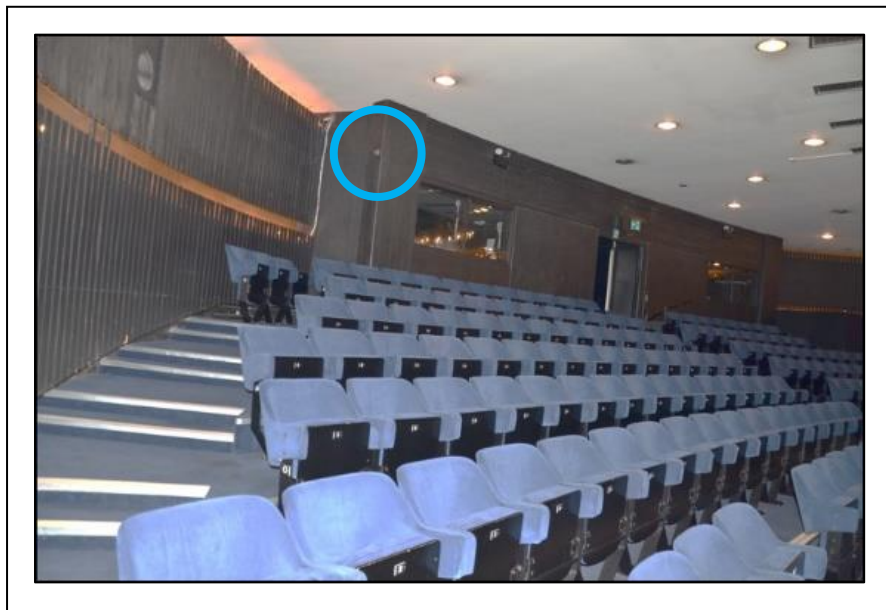

Figure 3-23: The OM-PLTH is installed in the auditorium (location C).

- OM-CP-Event101A (Location D) was installed to record the door actions (open and close) of the cafeteria door and located on the top part of the door frame (see Figure 3-24). The data logging started on December 16th, 2016 and lasted for 104 days. The door actions were monitored to investigate the impact of the operating pattern on the indoor temperature.

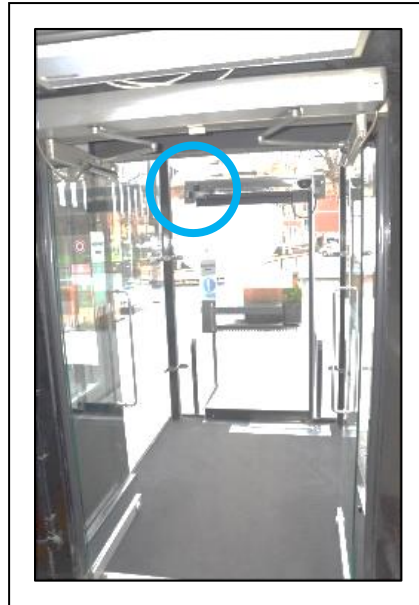

Figure 3-24: The OM-CP-Event101A is installed on the entrance to the cafeteria (location D).

- OM-CP-Event101A (Location E) was installed to record the door actions (open and close) at the main entrance and located on the top part of the door frame (see Figure 3-25). The data logging started on December 16th, 2016 and lasted for 104 days. The door actions were monitored to investigate the impact of the operating pattern on the indoor temperature.



Figure 3-25: The OM-CP-Event101A is installed on the main entrance (location E).

- OM-PLTT (Location F) was installed to measure the internal and external temperature of the windows to determine the U-value of the glasses. This data logger was located on a window at the lower floor (see Figure 3-26). The data recording started on December 20th, 2016 and lasted for 100 days, where the data was taken every 15 minutes.



Figure 3-26: The OM-PLTT data logger installed in location F.

3.5. Summary

The research consists of three different parts and according to this; there is a separate methodology for each part. These three methodologies are presented in this Chapter. The building survey included 50 participants, who trained and carried out the thermography inspection of their own building and at the same time completed three questionnaires. The Chapter presents a novel methodology for people engagement. The results of this part are presented in detail in Chapter four. The developed simulation model is tested in laboratory, school and university. Additionally, this Chapter covers the innovative design of the simulation model. The results of this part are covered in detail in Chapter five. The third methodology is representing the monitoring of Nottingham Playhouse. The energy consumption of the building was monitored during winter 2016/2017. The data collection covers a period of over three months. The results of this monitoring are presented in detail in Chapter six.

CHAPTER 4.

BUILDING THERMOGRAPHY SURVEY

4.1. Introduction

This Chapter is divided into four sections concentrating respectively, on (1) the thermographic session and enhancing energy awareness and motivation after attending the educational session; (2) the thermographic survey and identification of insulation issues; (3) enhancing the engagement and behaviour after carrying out the thermography survey and (4) the limitations. The citation of the participants' comments in this paper is based on a unique identification code (Table 4-1).

The study recruited 50 householders, who completed all the stages of the data collection. Table 4-1 shows the building demographic data of the buildings included in this study, where 42% of the households are owners and 58% are tenants. The biggest group of the properties are semi-detached houses (36%), followed by detached houses (22%). The age of the buildings has a mean of 51.8 and a standard deviation of 29.5, they vary between the newest buildings 16% (0-20 years old) and the oldest buildings 24% (over 80 years old). Most of the buildings have double glazed windows (80%) and the rest are single glazed. At least 50% of the roofs are insulated, while 28% of householders are unsure whether their roof is insulated or not. According to the UK government report in Great Britain, at the end of March 2015, 30% of the homes were without roof insulation [15].

The reliability (Cronbach's Alpha) of the thermography survey questionnaire was 77.4% and 95.1% for the educational session (**Error! Reference source not found.**).

Case Processing Summary			
		N	%
Cases	Valid	50	100.0
	Excluded ^a	0	.0
Total		50	100.0

a. Listwise deletion based on all variables in the procedure.

Reliability Statistics	
Cronbach's Alpha	N of Items
.774	24

(a)

Case Processing Summary			
		N	%
Cases	Valid	50	100.0
	Excluded ^a	0	.0
Total		50	100.0

a. Listwise deletion based on all variables in the procedure.

Reliability Statistics	
Cronbach's Alpha	N of Items
.951	11

(b)

Figure 4-1: The reliability of (a) thermography survey and (b) the educational session.

Table 4-2 illustrates a summary of a sociodemographic characteristic data of the participants and their households, which only include the typical cases.

Table 4-1: The summary of the socio-demographic data of the participants.

0	Age	Educational level	Ownership	Type of property	Age of property	Type of windows	No. Of rooms	No. Of occupants
P02	45-54	Post graduate	Ow ner	Semi-Detached	41-60	Double glazed	3	More
P06	25-34	Post graduate	Ow ner	Terraced	81 or above	Double glazed	4	2
P12	25-34	Post graduate	Rental	Middle floor flat	Do not know	Single glazed	2	1
P13	55-64	Secondary or low er	Ow ner	Detached	41-60	Double glazed	More	2
P14	45-54	Further education	Ow ner	Semi-Detached	61-80	Double glazed	More	2
P17	35-44	B.Sc. or B.A.	Rental	Semi-Detached	81 or above	Single glazed	More	1
P18	25-34	Post graduate	Ow ner	Detached	41-60	Double glazed	More	4
P20	25-34	Post graduate	Rental	Semi-Detached	81 or above	Double glazed	More	4
P22	35-44	Post graduate	Rental	Semi-Detached	0-20	Single glazed	2	4
P23	45-54	B.Sc. or B.A.	Ow ner	Detached	21-40	Double glazed	More	4
P25	25-34	Post graduate	Rental	Middle floor flat	21-40	Double glazed	More	More
P28	25-34	Post graduate	Rental	Top floor flat	Do not know	Double glazed	3	4
P30	35-44	Post graduate	Rental	Top floor flat	21-40	Double glazed	2	1
P33	35-44	B.Sc. or B.A.	Rental	Semi-Detached	41-60	Double glazed	More	3
P34	25-34	Post graduate	Ow ner	Semi-Detached	81 or above	Double glazed	4	3
P37	25-34	B.Sc. or B.A.	Rental	Top floor flat	0-20	Double glazed	2	2
P38	25-34	B.Sc. or B.A.	Ow ner	Semi-Detached	61-80	Double glazed	More	2
P42	25-34	Secondary or low er	Rental	Detached	Do not know	Double glazed	More	4
P43	25-34	Post graduate	Rental	Top floor flat	61-80	Double glazed	3	4
P44	25-34	B.Sc. or B.A.	Ow ner	Terraced	81 or above	Double glazed	More	2
P45	55-64	Further education	Ow ner	Semi-Detached	61-80	Double glazed	More	1
P46	45-54	B.Sc. or B.A.	Ow ner	Semi-Detached	81 or above	Double glazed	More	More
P47	25-34	B.Sc. or B.A.	Rental	Top floor flat	Do not know	Double glazed	3	1
P48	55-64	B.Sc. or B.A.	Ow ner	Detached	41-60	Double glazed	More	3
P49	45-54	B.Sc. or B.A.	Ow ner	Semi-Detached	81 or above	Double glazed	More	4
P50	55-64	Secondary or low er	Ow ner	Detached	81 or above	Double glazed	More	2

* Throughout this paper, this unique code has been applied to mark questions drawn from the questionnaire.

Table 4-2: The building demographic data of the thermographic survey.

Characteristics	Frequency	Percentage
Ownership		
Owner	21	42
Tenant	29	58
Total	50	100%
Property type		
A terraced house	5	10
Detached house	11	22
Semi-detached house	18	36
A flat/ground floor	3	6
A flat/middle floor	5	10
A flat/top floor	8	16
Total	50	100%
Age of the property (Years)		
0-20	8	16
21-40	10	20
41-60	9	18
61-80	6	12
81 or above	12	24
Do not know	5	10
Total	50	100%
Type of windows		
Single glazed	8	16
Double glazed	42	84
Triple glazed	0	0
Total	50	100%
Condition of the loft/attic		
Insulated	25	50
Non-insulated	6	12
Unsure	14	28
Not applicable	5	10
Total	50	100%

4.2. Thermographic session and enhancing energy awareness and motivation

Modern technology can enhance people's energy awareness and motivation toward a more sustainable community. Infrared thermography is one of the most employed tools among the non-destructive testing (NDT) methods for building diagnostics [17]. Therefore, the participants easily were able to carry out a thermographic survey of their buildings. The results confirm that the thermal camera is a really comfortable tool to use for inspection of own building

(94%), is a very effective tool to reveal the heat loss (92%) and is very easy to use (96%) respectively. By offering the householder, a thermographic training and giving them the opportunity to inspect their own building the study provided an active role for participants to be involved in the thermographic process. According to previous literature, the potential improvement of energy awareness depends on the degree of engagement [17]. Moreover, the results show that 82% of participants indicate an improvement of their awareness of the way in which energy is lost from buildings. The educational session has encouraged them to inspect the insulation of their homes (84%). Additionally, the results show that 88% of participants agree or strongly agree that the educational session helped them to understand the infrared thermography (Figure 4-2).

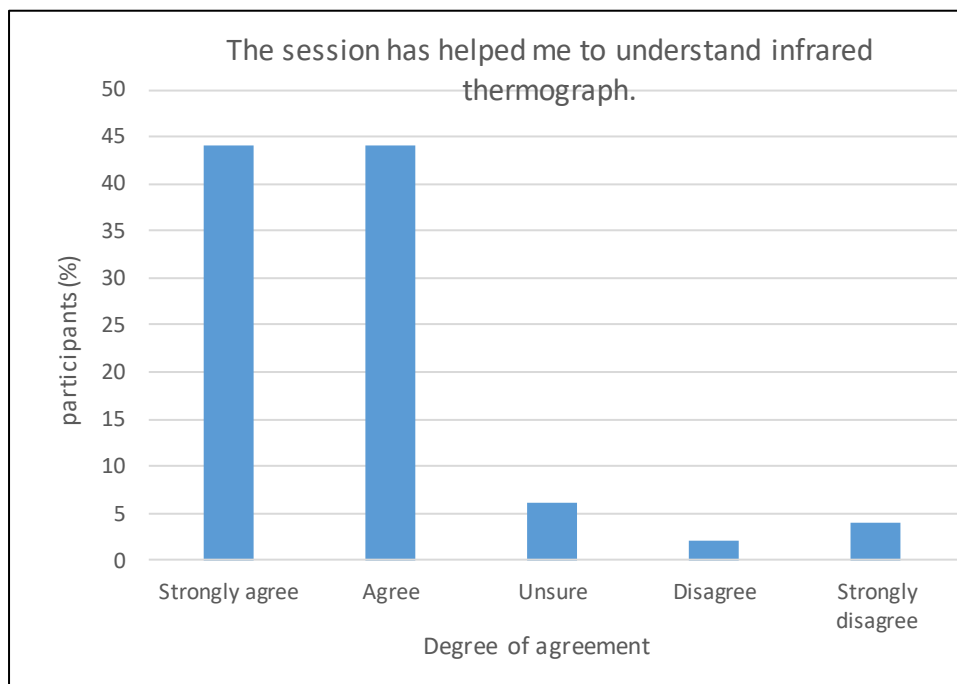

Figure 4-2: The participants' response regarding how helpful the educational session has been in understanding the infrared thermography.

A clear improvement of participants' awareness regarding the identification of the cold sources in their houses observed, after they carried out the thermography survey (Figure 4-3). A comparison between the responses from the first questionnaire (pre-test) and the third (post-test) where only 28% agreed or strongly agreed increased to 81%, indicates an increasing in

awareness by 189%. At the same time results in a reduction of the unsureness by 61%. A comparison between the responses from the first questionnaire (pre-test) and the third (post-test) shows once again a clear improvement of people's awareness concerning the energy measures which make the biggest saving effect in their homes (Figure 4-4). This indicates an increasing of awareness by 100% and in reduction of unsureness by 41%.

According to the reviewed literature, it is very important to realise that the behaviour is linked to the problem (energy consumption) [126]. Many comments from participants in this study express increasing of energy awareness "Learning how much energy certain types of heaters use and how that translates into actual cost on bills" (P42), " I found the comparison between efficient and non-efficient technology very helpful and effective in understanding energy consumption (P06). The session made me also more aware of ways to prevent heat lost" (P18) and "The teaching session gave some very good and simple (almost shocking!) examples of efficient use of electricity, I was surprised how much heat is lost through house walls" (P17).

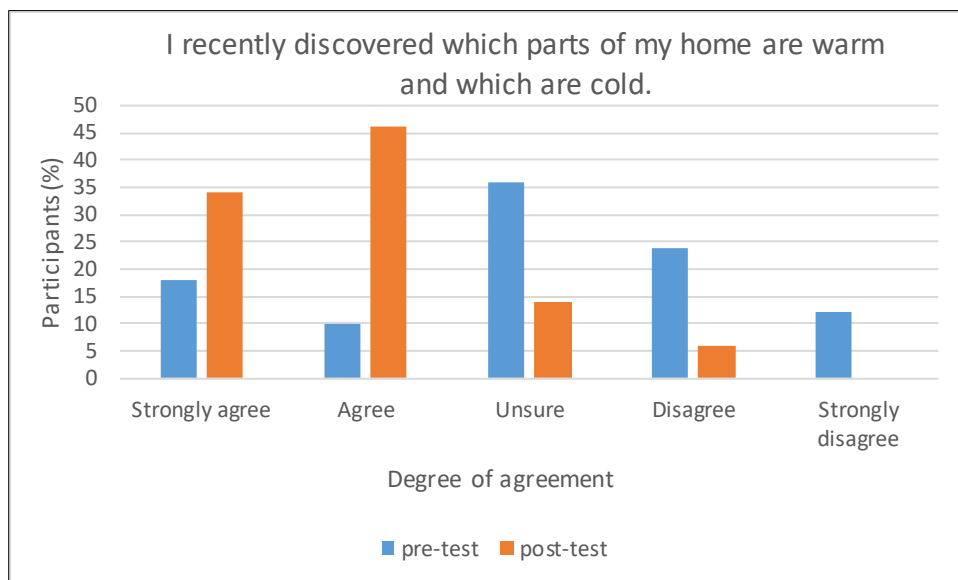

Figure 4-3: The pre- and post-test of participants' response regarding the identification of the cold sources in their houses.

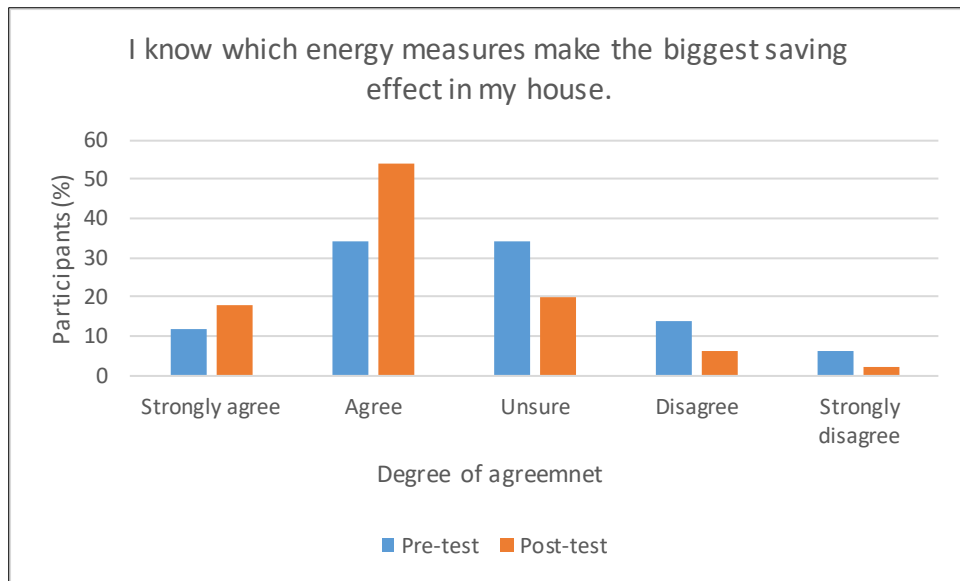

Figure 4-4: The pre- and post-test of participants' response concerning the energy measures, which make the biggest saving effect in their homes

Participants' degree of motivation can be linked to the degree of involvement created by the intervention and participants' previous attitudes [117]. Providing such attractive modern device (FLIR One) to let people inspect their own homes and identify the areas of issue in their insulation may increase their motivation to be engaged in a more sustainable energy consumption. Many of the comments show a significant interest in the thermal camera and the thermal images "This device is quite interesting and amazing because it tells me how and where heat is going out from my room. Now I know how to minimize room-heat loss" (P12), "Teaching session was quite informative. Thermal images revealed that from where the most of the heat is escaping from the house" (P20), "I was very surprised to find that there appears to be more heat loss through the walls than through the roof. I was also very interested to see the improvement in the amount of heat lost through those parts of the walls that I know to be better insulated than other parts" (P48) and "I think the teaching course was good. I already have a background in thermal cameras but it is the first time to use the attached to iPhone, it is brilliant idea" (P02).

Boholm [111] believes that visual images own a strong capacity to demonstrate risks which are far away from our daily experience and show

them subjectively vivid, this impact of the visual image is clearly shown in the following comments:

[The session] made me realise how much we ignore the importance of energy efficiency (P14).

The session made me very curious about the heat lost in my house and I was really intrigued by the infrared camera. (P18)

4.3. The thermographic survey and identification of insulation issues

Infrared (IR) thermography is used to survey the energy performance of building; among others, it inspects the insulation quality of wall and windows and air tightness around the doors and windows. This inspection identifies the actual required local reparations instead of extensive renovation [16].

The results of the thermographic survey are divided into five different areas respectively: Door, window, wall, roof and floor. In this section, only the most typical cases are discussed which constitutes 56% of the participants in this study (Table 4-1). Different defects can be discovered or visualised by observing abnormal colour combination, such as an increase or decrease of surface temperatures, captured heat arise when a crack, air leakage, moisture accumulation, or when other issues rise [80]. The thermal images of the buildings are taken by the householders (participants) and are linked to their own comments. 90% of the participants believe that the thermal camera has helped them to identify insulation defects causing heat loss in their homes. 84% consider that the thermal camera helped them to identify changes they can make to improve the energy efficiency of their homes. 80% of participants agree or strongly agree that their respective house needs improvement (Figure 4-5).

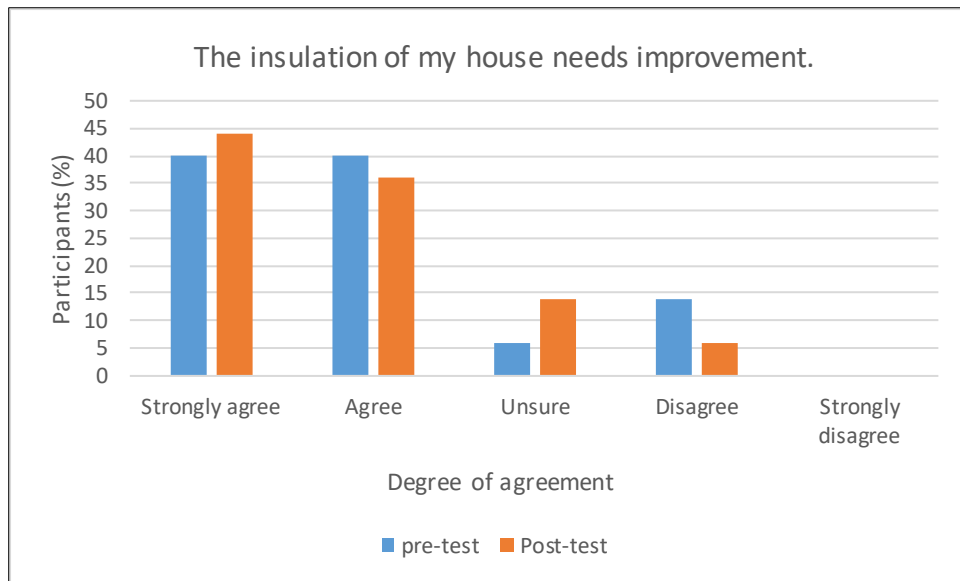

Figure 4-5: The pre- and post-test of participants' response regarding the need for improvement in their respective house.

The comments show that the thermographic survey has enhanced the participants' building energy awareness in general and particularly more awareness increasing is observed concerning the individual's own building and its thermal performance.

Using the camera has helped prove some of my previous ideas about heat loss from my house, and also highlighted things that I was unaware of. For example, heat coming through the walls from my neighbour's house; effects from heating with an open fire; the effectiveness of simply drawing curtains/blinds. (P17)

4.3.1. Door Insulation

Doors and door frames together represent an important part of a building and are inspected widely by the participants in this study. Figure 4-6 (a, b, c, e and f) shows some typical cases of door issues. Gaps around doors are generally a very common problem, even in this study, which mainly depends on the age of the doors in the old homes. Besides the benefit of saving energy, air tightness improvement minimizes problems as drought and moisture risks and makes the ventilation more precise [55], [56]. In most of the cases, the participants tried to implement various measures to reduce the heat loss

through these gaps, e.g. by adding draught excluders around the doors or filling the gaps.

In the short term, I am planning to cover door openings, such as the cat flap and any other small openings around the doors, in order to avoid the heat loss noticed through the thermal camera. (P06)

I intend to insulate... also draft excluders around the doors. (P13)

... I am filling gaps around doors, adding draught strip around doors, (P17)

I am losing heat from around the front door frame, which I plan to reduce by fitting foam insulation strip. (P45)

I may try and improve the draft proofing to the doors ... (P48)

Old doors that installed before 2002 are not included in building regulation [47]. Some of old, external doors in this survey cannot be closed properly, which means loss of heat through these openings between the door and the frame (Figure 4-6-d).

Seeing how even small openings/cracks can leech heat and the importance of properly sealing up things like windows and doors. Our external conservatory door struggles to close and it was very obvious from the images the effect that was having. (P42)

There are even participants, who plan to make drastic improvement of their external doors, by replacing them with new ones (Figure 4-6-g).

The external doors will be replaced with double glazed plastic doors in due course and funds allow. (P50)

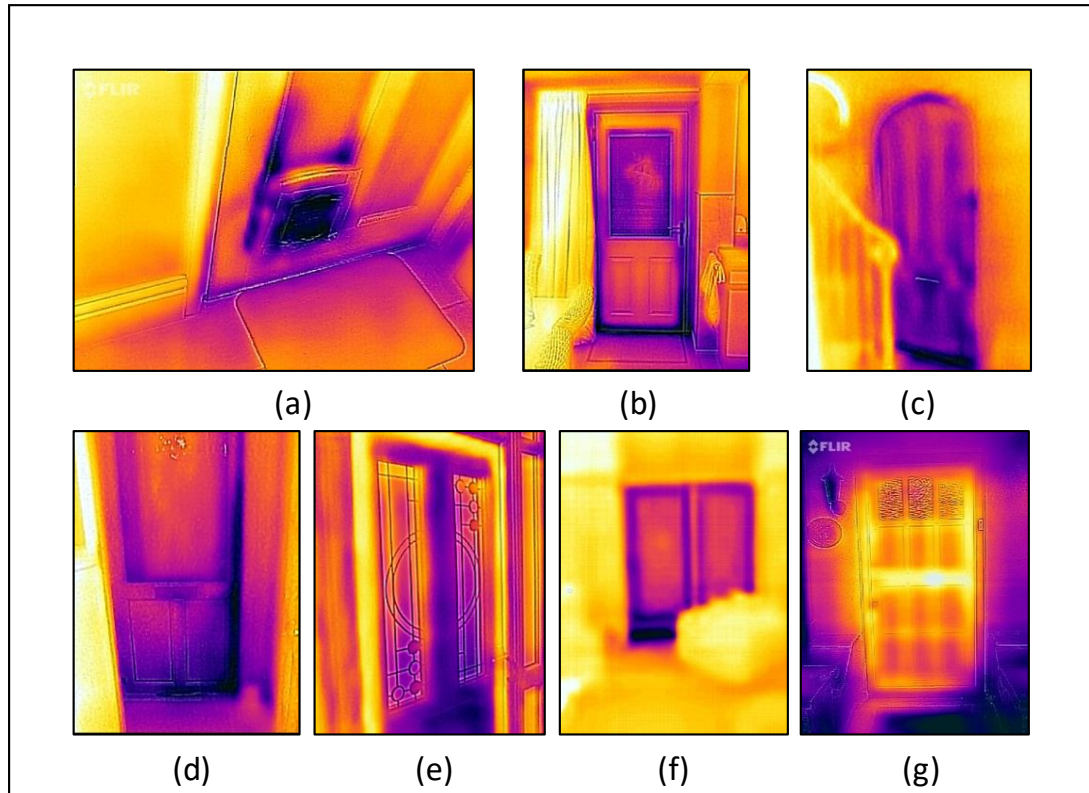

Figure 4-6: IR images of doors taken by participants, (a) P06, (b) P13, (c) P17, (d) P42, (e) P45, (f) p48 and (g) P50.

4.3.2. Window Insulation

Old windows, both single and double glazed (Figure 4-7) and even some low quality new double glazed are sources for loss of energy in the building, but by using curtains at night times the heat loss through the windows can be reduced, and the participants are aware of that now:

As the thermal imaging let me know that most of the heat are escaping from my window (3 pieces' windows), I am trying to use curtains during the night to minimize the heat loss from the window. (P12)

Generally, old double and single glazed windows installed before 2002, can need draught proofing [47]. The potential draught in buildings can account for massive amounts of energy loss, therefore draught proofing can make significant energy saving:

adding draught strip around doors and windows that do not have draught strip, or where old draught strip is worn, installing plastic secondary glazing to more windows and putting up more curtains. (P17)

The nature of the visual image in being particularly memorable and salience can let it be especially powerful, this associated with the vivid nature of the visual image [110]. Some participants feel this power in the thermal image, which convinces them to plan to replace an inefficient window with a new one, which evaluates as a better solution in term of energy saving:

The thermal imaging showed that heat was being lost through the windows ... It may be time to think about replacing my double glazed windows... (P23)

We were thinking about insulating the bay window in the front bedroom which we will definitely do now. ... and think about changing the other windows for better quality ones. (P38)

... change the single glazed window above the front door to a double glazed one. (P44)

Upgrade windows (P46)

Some of the air leaking around the doors and windows can be more complicated, and the household has difficulty to deal with.

... the cold spots around doors and windows I think are to do with design faults which would require fairly major renewal work to remedy. (P48)

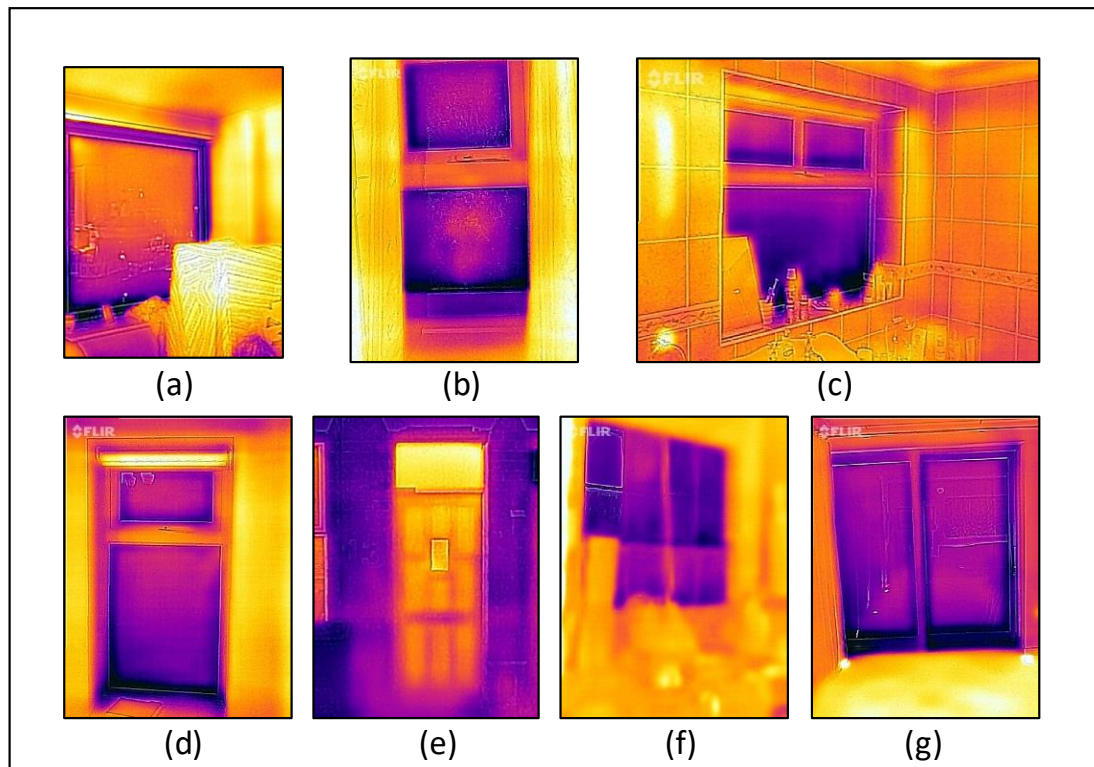

Figure 4-7: IR images of windows taken by participants; (a) P12, (b) P23, (c) and (d) P38, (e) P44, (f) P46 and (g) P48.

4.3.3. Wall insulation

Today, the most of the non-insulated homes in the UK became insulated, especially the ones with cavity walls [15]. Some participants are convinced regarding the benefit of insulating their homes, particularly when the energy loss is significant and it feels cold.

I intend to have the bungalow fully insulated from exterior wall insulation, this is where most of the heat was lost in my property. (P13)

The visualisation of the heat loss from a building indicates by brighter areas where the heat is escaping out when the image is taken from the outside. The areas of heat loss will be dark when the image is taken from the inside which indicates cold points where cold air is entering the building, e.g. through the wall, window, door, roof, etc.

Figure 4-8-a of householder P13, shows a bright image of the house, which indicates significant heat loss through windows, doors and walls. Figure 4-8-b demonstrates two completely dark external walls, which means cold areas.

Figure 4-8-c clearly illustrates a part of the wall at the right side of the window and the whole way below the window completely dark, which again is an indication of cold areas.

Most of the homes that are built before 1919 probably have solid external walls and they lose twice as much heat as cavity ones do [46]. Insulation of solid walls, therefore, has significant potential to save energy.

I plan on having the walls insulated as there are no cavity walls thus lots of heat escaping. (P14)

The thermal image in Figure 4-8-d represents again an inefficient house. Below the window, in Figure 4-8-e the wall is completely dark, which is the absolutely cold non-insulated area. Image Figure 4-8-f shows a completely dark cold external wall, in clear contrast to a bright internal wall and ceiling.

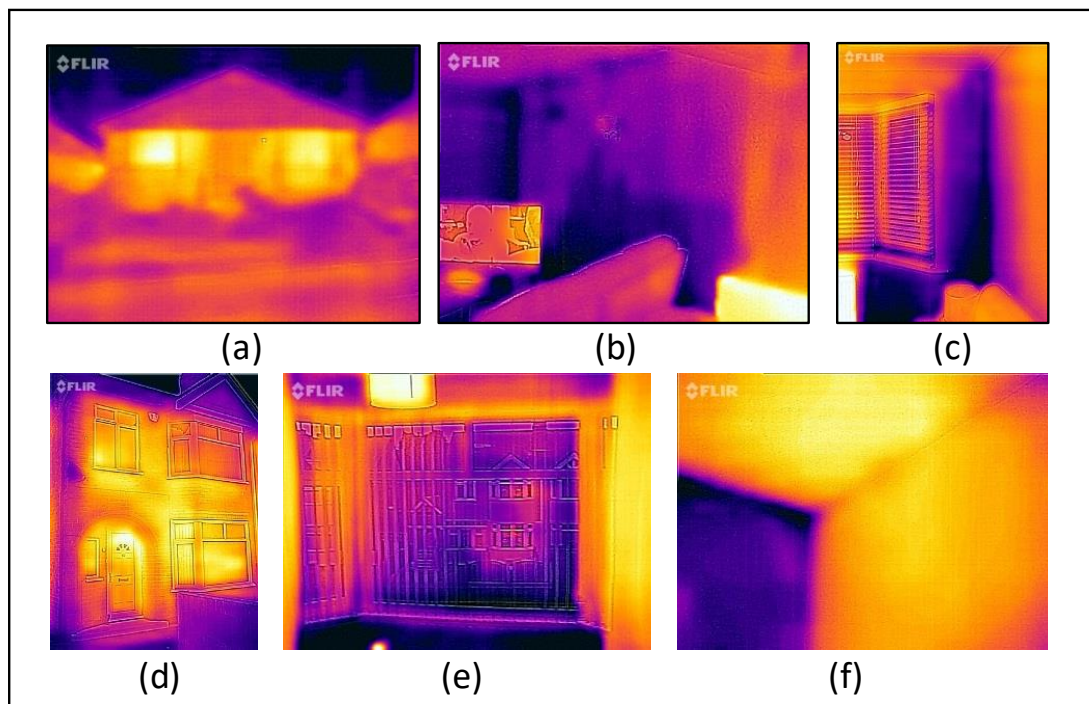

Figure 4-8: IR images of walls taken by participants; (a-c) P13 and (d-f) P14.

Some participants are surprised over the amount of heat, which is lost from their house and thinking about the potential of improving it. The visual images own a strong capacity to demonstrate risks which are far away from our daily experience and show them subjectively vivid [111].

I saw how much heat is being lost through the exterior walls and how much difference it would make to insulate walls. However, this would be financially not viable. (P18)

As image (b) in Figure 4-9 illustrates, the external wall is completely dark, non-insulated wall, in contrast to the internal bright warm wall.

The IR thermography identifies the actual insulation issues and required local reparations instead of extensive renovation [16]. Some participants were able to discover some defect/damage on their wall, which they did not suspect previously, and immediately they try to investigate and solve the issue in a professional way.

I'm going to contact a builder/expert to look into the heat loss in our back bedroom - there was a lot of heat loss at the top of the side wall (all the way across) where the guttering is externally. (P34)

Image (d) in Figure 4-9 represents a dark path at the top side of the window, which is seen as it spreads upwardly, while the thermal image (Figure 4-9-c) of the mentioned window from outside did not show any wall defects.

Again, another participant will investigate a potential defect/damage that was indicated during the thermography:

We will also look at the small front bedroom above the window -there was a lot of heat loss there too. (P38)

The thermal image (Figure 4-9-e) illustrates another dark path above the window, which is spread downward.

To be able to see cold spots on the wall by necked eye, especially in the upper parts, is not easy, and when the thermal image revealed that, the householder became more oriented regarding the source of cold, and further the extent of energy loss in the building.

Seeing darker, cold patches in the corner of a few walls made me realise just how much heat can be lost that way. (P42)

Image (g) in Figure 4-9 shows a dark whole wall, which is a big source of cold, while Figure 4-9-h reveals a cold dark sport on the wall very clearly.

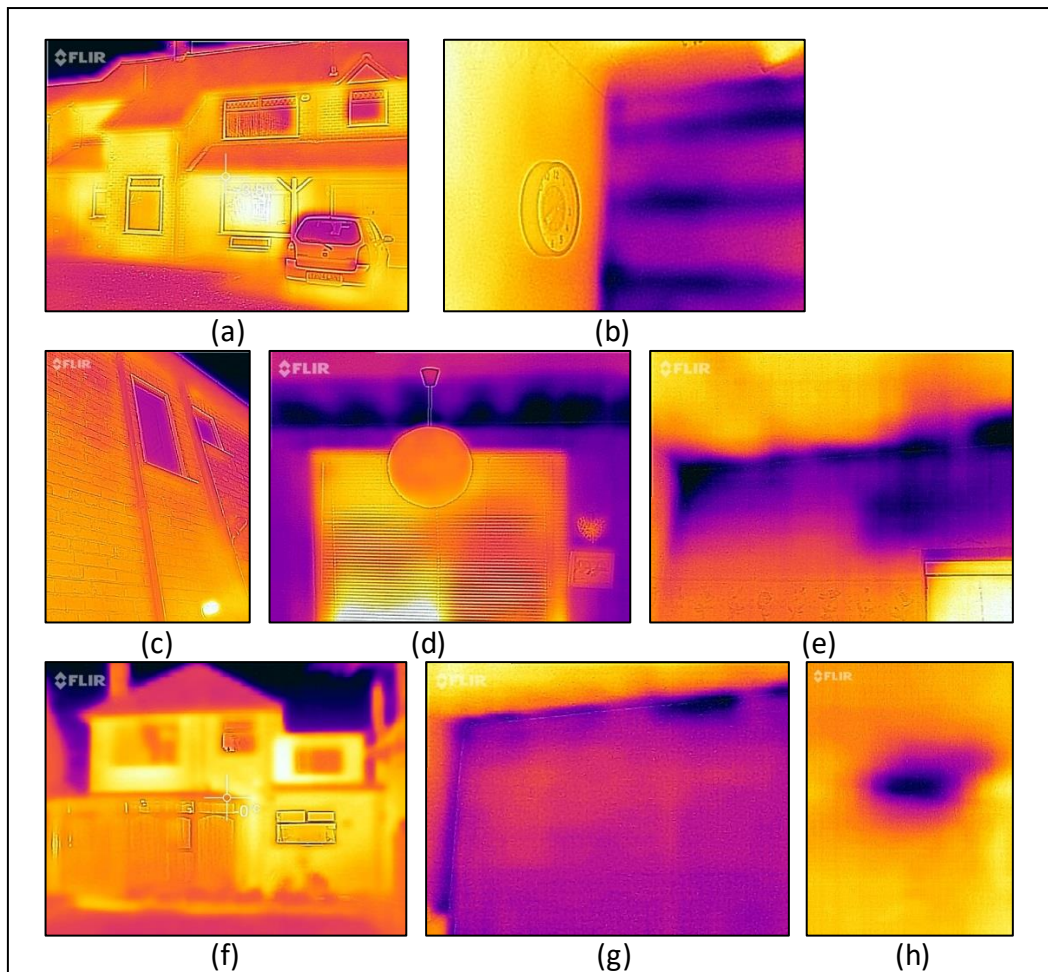

Figure 4-9: The IR images of walls taken by participants; (a and b) P18, (c and d) P34, (e) P38 and (f-h) P42.

Some participants, by revealing cold spots in their walls have got an explanation for why his house is cold and inefficient, e.g.:

... there is cold in many places which make the house cold and inefficient. (P43)

Figure 4-10-a shows many dark cold spots on the wall that is very difficult to identify and quantify by necked eye.

DIY thermography is a good opportunity to inspect the efficiency of an installed insulation, to see if everything is done properly. A participant found an unexpected big dark spot in her lounge (Figure 4-10-b) and a bright area below her window (Figure 4-10-c).

There is a very cold spot near my sofa in the lounge, which I Need to find the cause of and rectify. I have had cavity wall insulation but there are areas of heat loss through the walls, particularly from the radiator below the window in the lounge, where the photo taken outside shows heat loss right through the wall. Unfortunately, there is nowhere else suitable to site the radiator. The insulation needs improving, and there are cold spots on internal walls that need investigating. (P45)

Figure 4-10-b and c demonstrates respectively, a big dark area on the wall, close to the sofa and a bright area below the window, and both represent miss in insulation or a later damage. These defect identifications are difficult for the householder to discover by herself. These issues may need to be investigated by a professional builder/thermographer.

The thermographic survey reveals the missing in an insulation and the heat visualisation does not leave too much space for speculations. The householder discovered easily that the insulation renovation was not done properly (Figure 4-10-f).

It was revealing that in my new extension, which was built 8 years ago, there was a very cold area down one corner where two walls meet which must mean that the builders failed to take the cavity wall insulation right into the corners. (P48)

An improper renovation work always leads to later confusion and dissatisfaction for the householder, when the costly investment is unable to offer an improvement and the householder cannot afford an additional improving investment (Figure 4-10-e and f).

Whilst the thermal imaging has educated me about the weak spots in the insulation of my home I am unsure whether I will take any action as it would require fairly invasive work to the walls. I have already got cavity wall insulation and I think the only way of improving on this would be to line all the walls internally with insulated board. (P48)

The householder goes further and suggests thermography training for the builder to give them a new perspective and a new tool to improve the accuracy of their work.

Thermal imaging would be a useful education tool to demonstrate to builders the impact of their failure to make sure every part of the building is properly insulated. It is easy during the building process for builders to lose sight of the reason why it is important to take care with insulation. If something is not visible when the building is finished builders can be tempted to miss that thing out! (P48)

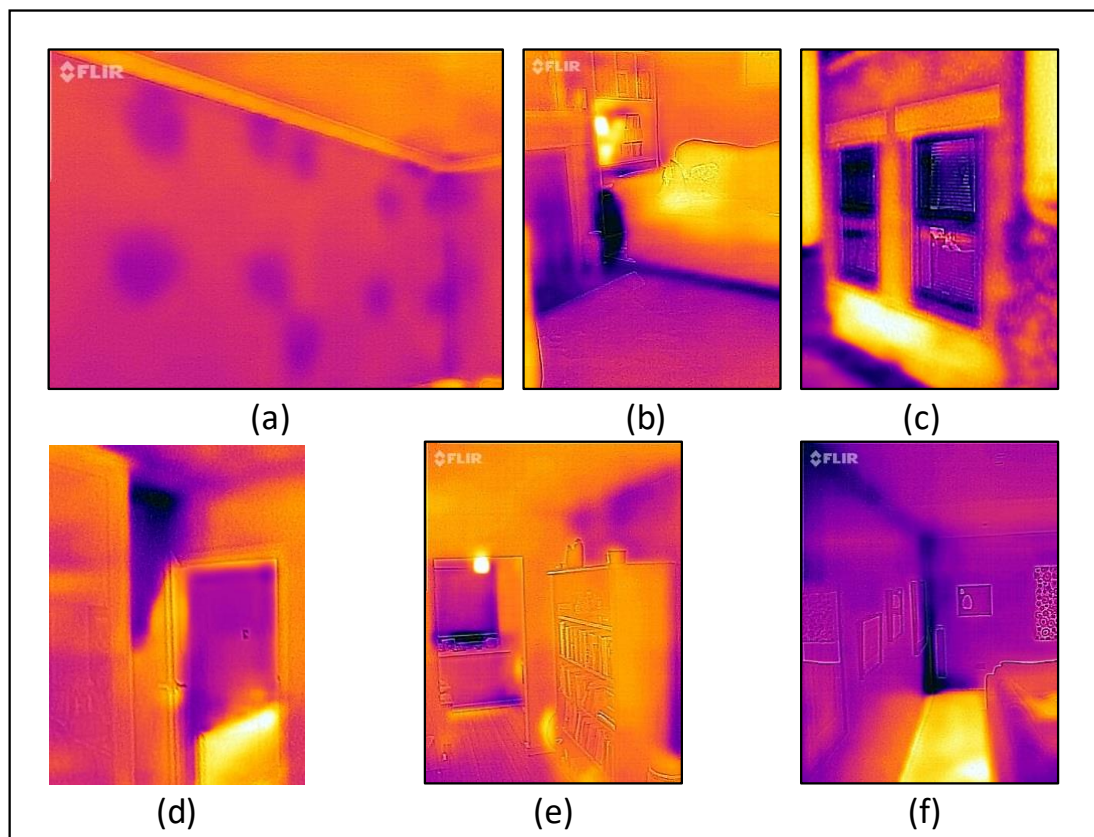

Figure 4-10: The IR images of walls taken by participants; (a) P43, (b-d) P45 and (e and f) P48.

4.3.4. Roof Insulation

Loft hatch is an area within the building where lots of heat can be lost. Therefore it is necessary to make sure that the loft hatch fits snugly and draught proof strips are being fitted around the edges. This issue shows clearly

in the householders' thermal images (a, d, f and g) in Figure 4-11. Some of the householders had identified the loss of heat from their roof during the thermography, and now they became more aware of the need for improvement.

I identified a few places in the attic that were losing lots of heat. It is clear that insulation needs improving in those places. (P18)

While other householders want to take action and solve the defects observed by the thermal images, which again show the power of the visual vivid image to effect the change of behaviour. Current technologies make it possible to transform the invisible to the visible condition, and the visualisation claimed can effect on human behaviour significantly [109].

The thermal imaging showed that heat was being lost through the windows and especially through the hatch door to the roof space. ... I shall certainly see to insulating the roof space hatch door. (P23)

I'm also going to have our loft insulated. (P34)

We will replace the loft hatch and insulate it (P38)

Some tenant householders try to inform the house owner about the insulation issues and ask them to take action to improve it.

I will be asking the owner of the house to consider insulating the attic ceiling/roof. (P17)

Might inform letting agency about my concerns to the roof and walls insulation, how it affects my bills. (P37)

In contrast to the above cases, there are other householders who are happy with the result of their roof inspection.

I'm renting the house, therefore I will not change any insulation, but I will let landlord know that the new loft insulation is made well. (P43)

It would appear that the roof is already adequately insulated. (P48)

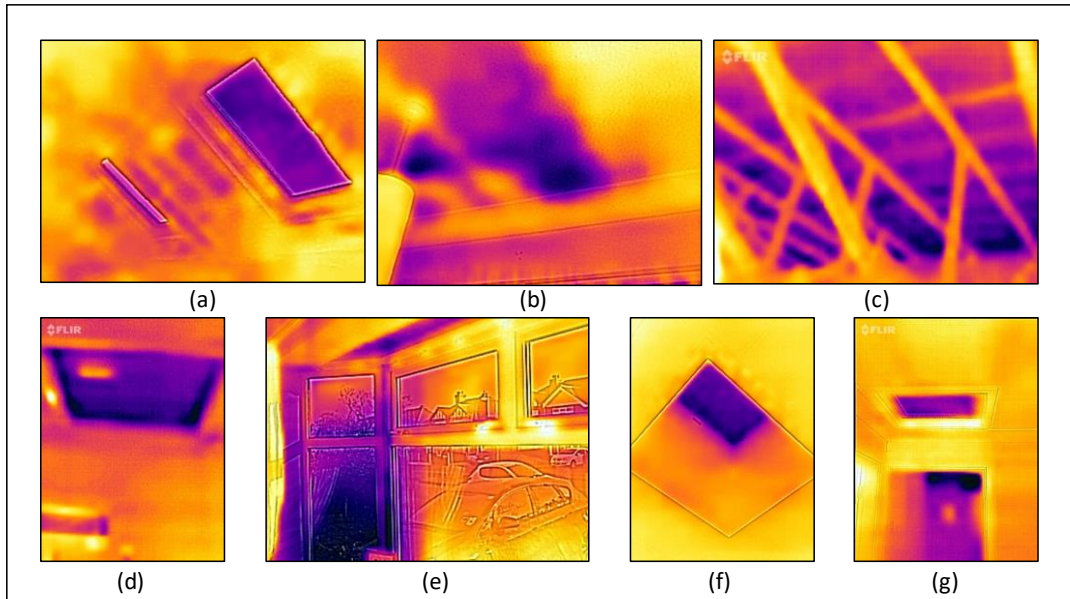

Figure 4-11: The IR images of roofs taken by Householders; (a) P17, (b) P18, (c and d) P23, (e) 34, (f) P37 and (g) 38.

4.3.5. Floor Insulation

Floor stands for a part of the heat loss from the building, even if the amount is less than the other mentioned areas within the building. Some of the householders captured the heat loss during their thermography survey (Figure 4-12), as it can be seen in both thermal images the floor has a dark colour which indicates the coldest areas in the respective image.

... assess the potential thermal bridge on the kitchen floor (P32)

My kitchen floor is clearly not insulated; when I replace the kitchen I will address this (P45).

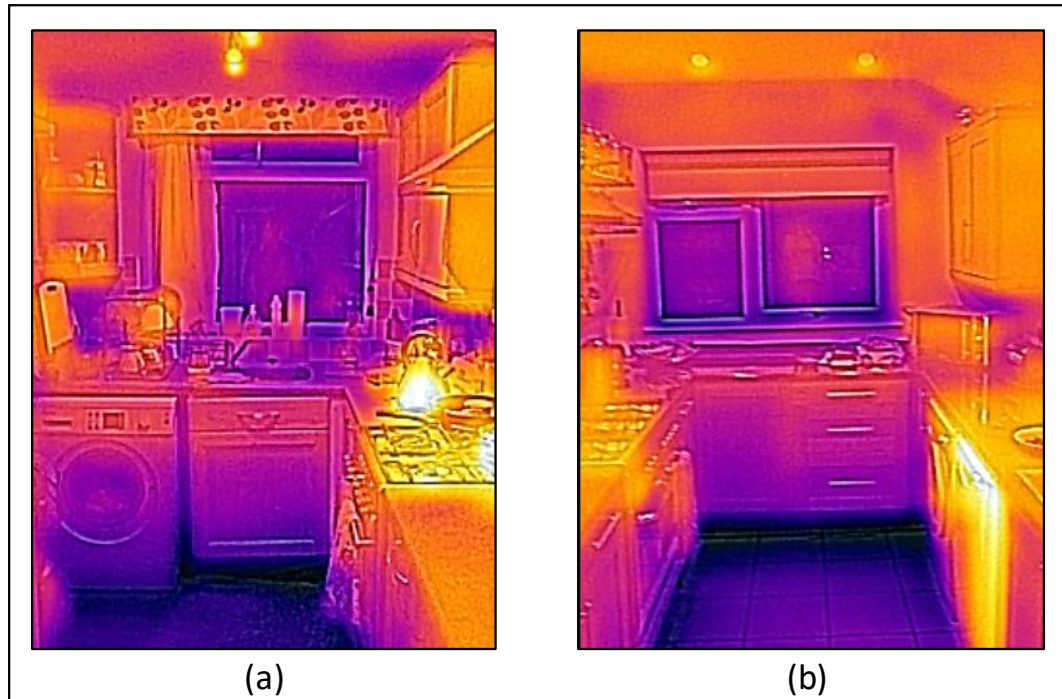

Figure 4-12: The IR images of floor, taken by Householders, (a) P32 and (b) P45.

4.4. Enhancing the engagement, awareness and behaviour

Current technologies make it possible to transform the invisible to the visible condition, and the claimed can affect on human behaviour significantly [109]. 84% of the participants consider that the thermal images convince them that the heat is escaping from their homes. 94% agree or strongly agree that the thermal images helped them to see how much heat was lost from their homes. 84% believe that the thermal imaging has made them think more seriously about the loss of heat from their homes. Based on the theory of feedback related to energy consumption, effective feedback devices help people to learn themselves the ways to save energy, promote self-efficacy and support, and result in energy conservation [118]. A number of participants plans to change the way they heat their houses (Figure 4-13).

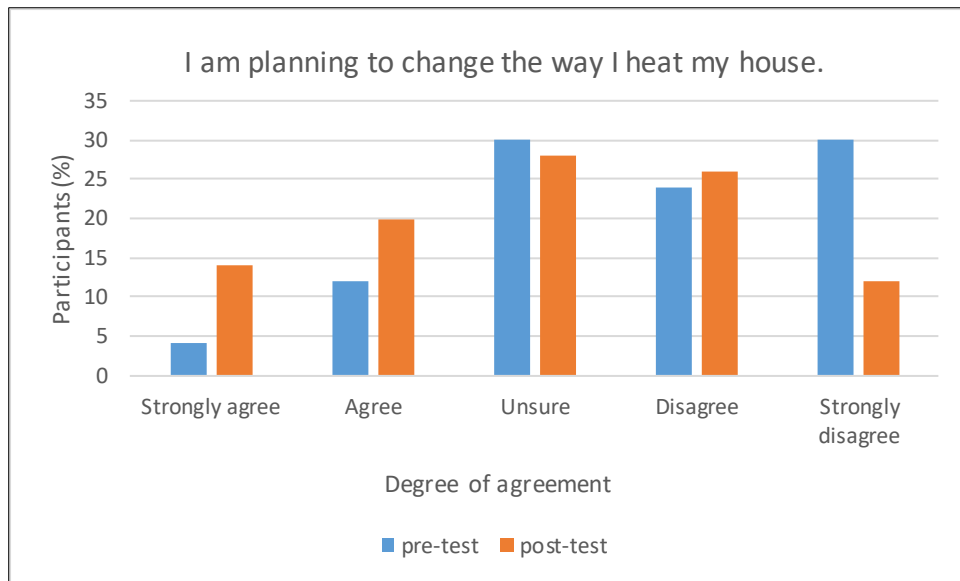

Figure 4-13: The pre- and post-test of participants' response regarding their plan to change the way they heat their houses.

According to psychological model by Fischer, a successful energy feedback device has to present an appliance-specific breakdown, computerized, interactive and displayed in an attractive way [105]. The householders were impressed with the thermal camera and how it helped them to identify the areas of a defect in their insulation in a very easy way (P30, P43 and P47), and it can result in increasing the efficiency of the home and saving of money (P32 and P47).

Using the thermal camera enabled me to detect the areas where the heat escapes, and consequently do something about it to make the house more efficient and ultimately save money. (P47)

For a behaviour change to take place it is essential to understand that the problem is linked to the behaviour [126]. Along with the educational session, the thermographic survey promoted building energy awareness, particularly in relation to the participants own building (P22, P46, P12, P17, P43, etc.).

...the study has created more awareness about the use of energy in the house. (P22)

Thermographic visualisation of heat loss was applied previously for examination of the behavioural changing effects [25]. Different behaviour

changes are observed following the thermographic survey, for example, many of the participants mentioned the use of curtains during the night (e.g. P17, P22 and P46)

I am trying to use curtains during the night to minimize the heat loss from the window. (P12)

Because of increasing awareness and undertaking the thermographic survey the householders became more aware of the way in which they operate the heating of different parts of their homes. The above-reviewed literature suggests that providing visible, real-time, vivid, dynamic energy-related information can promote energy saving behaviour changes and increase awareness and engagements [25].

I am planning to lower the volume of my e-heater so as to warm my room in an energy efficient way (P12).

... will change the sitting of the heater in the corridor to lower temp to decrease the loosed energy, because the place is not well insulated. (P43)

Some householders plan to take necessary actions in order to reduce the losing of energy.

... [also] installing plastic secondary glazing to more windows and putting up more curtains. (P17)

... and purchase some door mats to keep the heat in. (P34)

Will look into future upgrades as and when required repairing. (P33)

Another tenant householder chooses to leave an inefficient house, and this can be an important message for the landlords to improve their rented properties. Generally, the rented properties provide lower energy efficiency standard than owned properties do [14].

I am planning to move out form this House, because I saw a lot of loss energy through the insulation. (P25)

The study has inspired a participant to raise his ambition regarding his future super-efficient home.

Participating in this project has even further boosted my desire to design and build my own super-efficient home! (P17)

In order to match the householders' specific comments with the right images and provide a high standard of research quality, the researchers were forced to take further contact with the participants and discuss the thermal images in details. The following commentary is one of these examples, where the householder was satisfied with the efficiency of his windows and doors. It also shows how the householder got confirmation about the benefit of his secondary door in saving energy, especially when he compares it with his neighbour's (Figure 4-14).

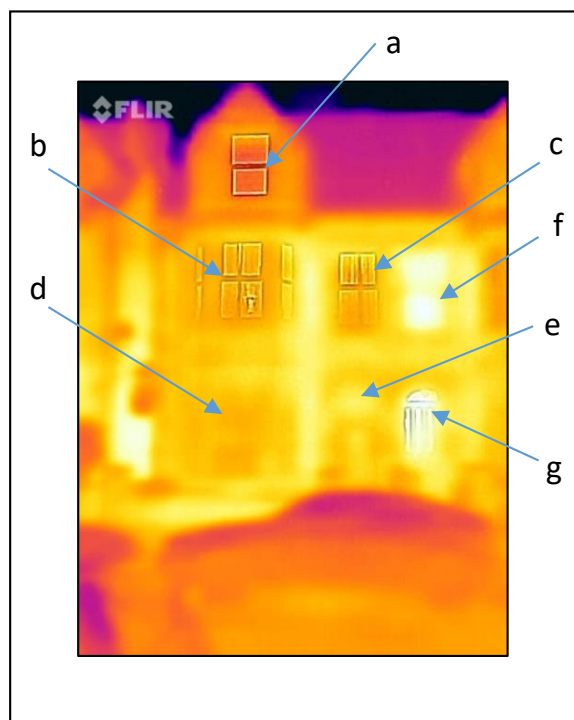

Figure 4-14 : The IR image of a building taken by participant P49.

The thermal images reassured me that my three-year-old double glazing (A, B, C and D) is working well. All the windows were replaced at the same time. At this time of year, the heating is on constantly. [My neighbour] His windows (F) were single glazed. (E) is the 19th Century

main door but there is a second single glazed porch door in front of it. My neighbour's door (G) is identical but he has no porch door in front of it. I was pleased to see that the back door (Figure 4-15) which is a partially single glazed stable door, was fairly good at conserving heat. (P49)



Figure 4-15: The IR image of a back door.

The outcomes of this research can be summarised in Figure 4-16. The participants' energy awareness and motivation have been improved after they attended the educational session. The participants' awareness concerning the condition of their own buildings' insulation has also been improved after they carried out the thermography survey and identified the insulation issues in their own homes. The process, particularly the thermography survey promoted voluntary retrofit future engagement plans and change of behaviour related to daily use of energy towards more sustainable operation of their buildings.

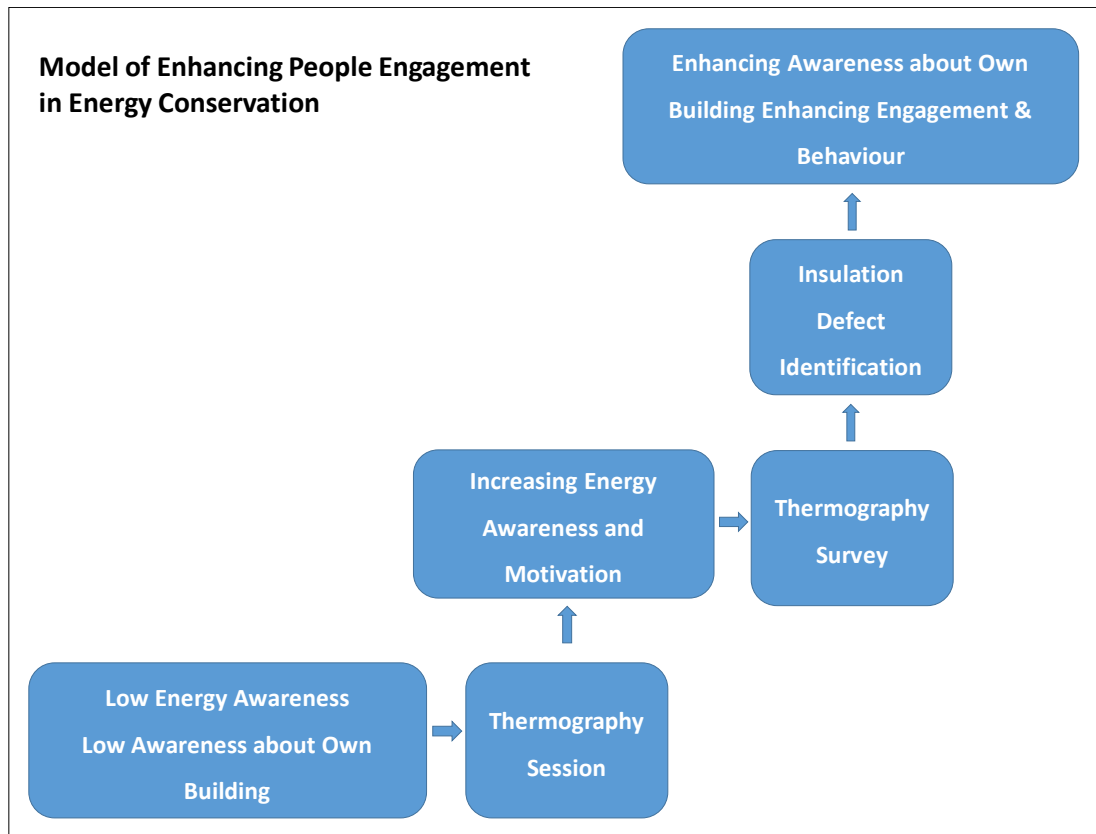

Figure 4-16: The applied model of enhancing people engagement in energy conservation.

4.5. Limitations

Even if the research team is satisfied with the outcomes of this study, there are still some limitation which some of the participants experienced, which in turn may effect on their engagement in some way.

I live in a multi store building that has over 7 floors in total. The task we have is to scan our building from outside that proved to be a bit challenging in my case as I need to stand fare away from the building in order to scan the building totally. This situation is a bit warring me as it may affect the final result. (P28)

Older houses are far more inefficient when it comes to insulation and the options to insulate are far more limited than with newer houses. (P50)

Because of the time limitation of this PhD, the thermography survey was not designed to follow up the participant's renovation plans to get more complete results of the benefit of this research.

4.6. Summary

This Chapter covers the thermographic survey, where 50 participants have got basic training to carry out the thermography survey of their own buildings using a low-cost smartphone based infrared camera. In addition to the thermal images, the participants have submitted three questionnaires in relation to their energy awareness, the thermographic training and the experience of the thermographic survey. The quantitative results of this survey show clearly many improvements in relation to building energy consumption and public engagement. The majority of the participants confirm that the educational session encouraged them to inspect the insulation of their homes. Moreover, the participants mostly agree or strongly agree that the educational session helped them to understand the infrared thermography. The participants indicate an improvement of their awareness of the way in which energy is lost from buildings. The thermal images have convinced the participants that the heat is escaping from their homes. Moreover, the thermal imaging has made them think more seriously about the loss of heat from their homes. Additionally, majority of the participants believe that the thermal camera has helped them to identify insulation defects causing heat loss in their homes.

The qualitative results include many cases and comments combined with thermal images, where the participants discuss different aspects related to their energy consumption, insulation issues, experience, etc. In the same way, the qualitative results confirm significantly the improvement of participants' awareness concerning the identification of the cold sources in their buildings, after carrying out the thermography survey. A comparison between the responses from the first questionnaire (pre-test) and the third (post-test) shows once again a clear improvement of people's awareness regarding the energy measures which make the biggest saving effect in their homes. Some participants feel the power of the visual image, which convinces them to plan to replace an inefficient window with a new one, which evaluates as a better solution in term of energy savings. Many of the comments show a significant interest in the thermal camera and the thermal images. In many cases, the participants identified gaps around doors, which confirm a very common problem in general, which mainly depends on the age of the doors in the old

homes. The participants identified how old windows, both single and double glazed, and even some low quality new double glazed windows, are losing energy in the building. Some participants were able to discover defects/damage on their walls, which they did not suspect previously, and immediately they tried to investigate and solve the issue in a professional way.

CHAPTER 5.

PHYSICAL EDUCATIONAL SIMULATION TOOL

5.1. Introduction

This Chapter provides detailed information of the design of the educational simulation tool. Moreover, it gives a description of the integration system opportunities, which can be adopted by the simulation model. Additionally, the Chapter includes an experimental work and two case studies, where the educational tool has been tested in the laboratory experient, primary school level and university case studies. These results are presented in two published conference papers.

To address the limitations in the existing educational and the research tools for investigation of building performance and energy efficiency and enhance people's engagement in this direction, an innovative system was developed as an educational and research tool for simulation of energy consumption in buildings, comprising of modular building models. The system consists of two buildings, an insulated and a non-insulated (see Figure 3-8). The buildings are designed of modular components and insulation layers with associated heating and cooling systems as an educational, training and research tool. Nevertheless, one of its advantages is to be used to engage the public due to its simplicity.

The results of this part of the study presented by one experimental work and two case studies.

5.2. Design of the simulation model

Figure 5-1 shows a building model without insulation 1 can be improved by adding several layers of insulation to walls 2 and insulation to the roof 3; the building model can be completed with the external roof 4 that contains windows 5. The insulation layers can all be assembled to a complete insulated building 6 with several internal insulation layers, shown as 7 and 8. The original building material and insulation can be designed from a wide range of materials and colours to study the effect of material type and colour on the thermal performance of the model. The building components and insulation layers are designed to be interlocking and interchangeable to allow ease of design, assembly and disassembly by the non-expert user.

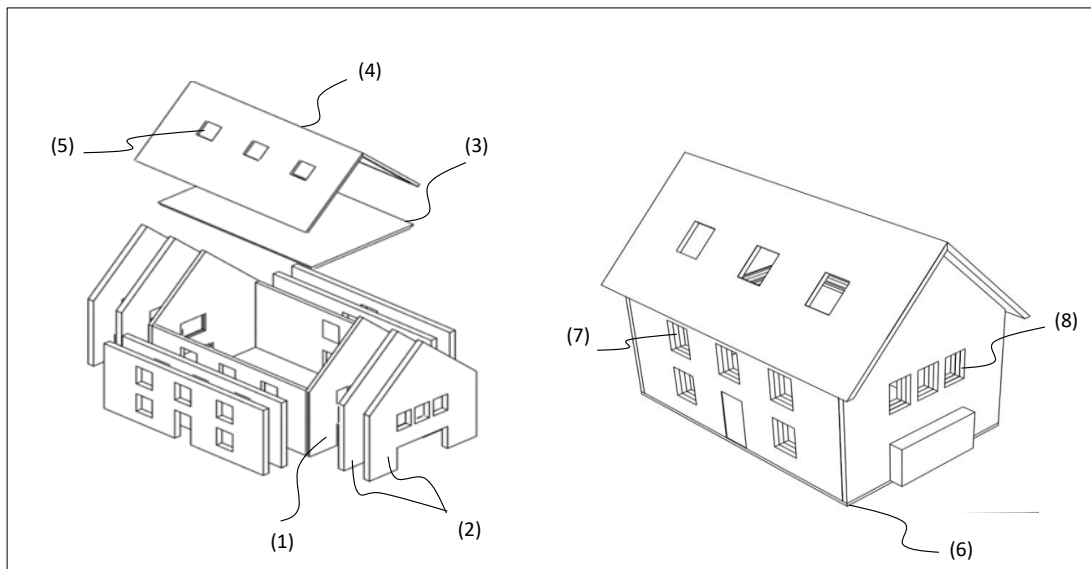

Figure 5-1: A 3D example of the disassembled building model showing examples of insulation layers and the assembled layered modular building model.

Figure 5-2 illustrates a schematic diagram of the concept of operation. The original building model 15 can have one or more insulation layers 16; internally the building could be heated by an electric heater 19 or heated or cooled by means of a heat pump 20; the heat pump, in this case, could be a refrigeration cycle heat pump or in most cases Peltier effect solid state heat pump; a temperature sensor 18 is used to monitor the internal temperature. The

building model is housed in an environmental chamber 14 with simulated weather conditions using an electric heater 12 or a heat pump 17 for heating and cooling. The temperature sensor 21 is used to monitor the external temperature. A light source 13 is used to simulate solar radiation and heat gain. The sensors and actuators control the process that could be semi-automated or fully automated by an interfacing process to a data acquisition and controller device 11 that supports an interfacing to a computer system 9. A power supply and power meter unit 10 can be used to power the actuators and monitor the energy consumption; this can be done independently or via the computer system. Infrared thermography camera 24 is used to monitor the temperature of the building model; this can be done directly or through the material of the environmental chamber with the selection of suitable material that allow all or part of the infrared radiation to be transmitted via the material.

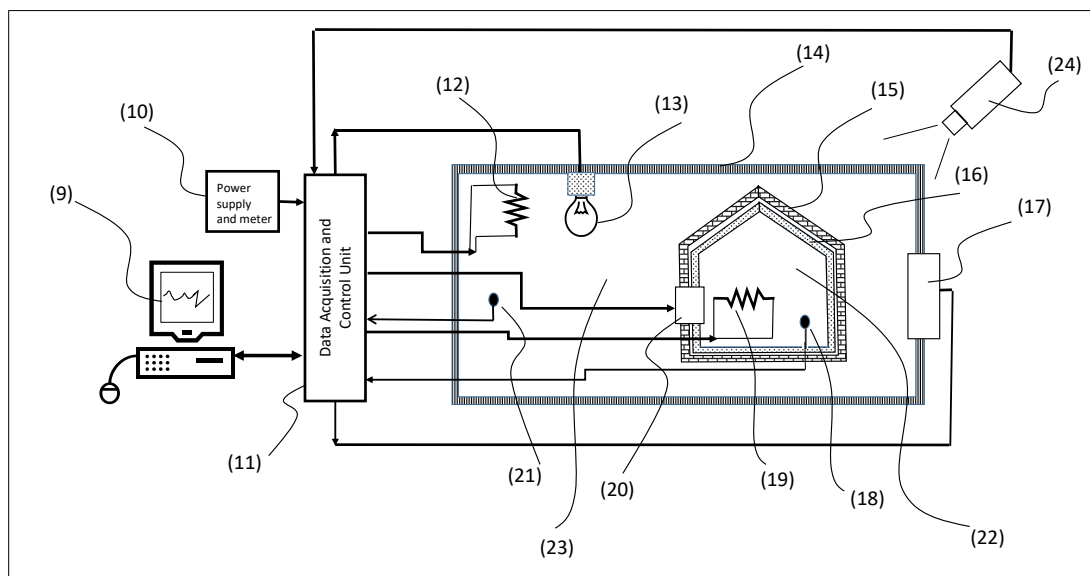

Figure 5-2: The schematic diagram of the apparatus including the building model and the main components of the temperature regulation, monitoring and control systems.

Figure 5-3 demonstrates an example of the assembly process of insulation material of layers 25 and 26 to the original building model 27 to show the assembly process. The insulation can be added in layers using a sliding method as in Figure 5-3; or by using other apparent techniques such as

interlocking design, snap-fit mechanism, mechanical fasteners, magnetic fixtures or tight fitting dimensions.

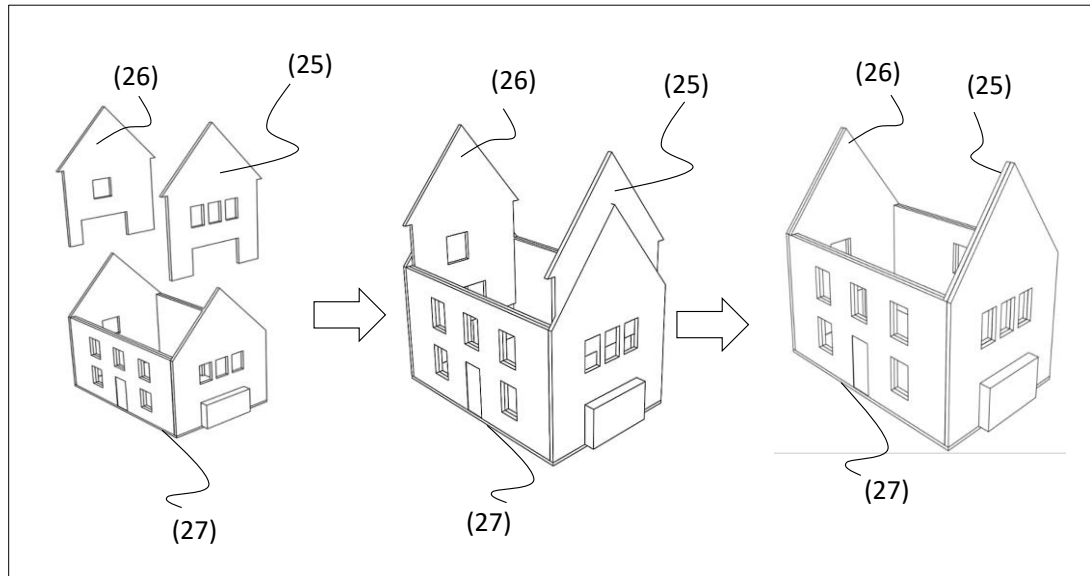

Figure 5-3: The installation of the insulation layers to two walls of the building model.

Figure 5-4, shows a similar installation process of insulation layers 28 and 29 to partially insulated building model 30 which allows full insulation of the walls.

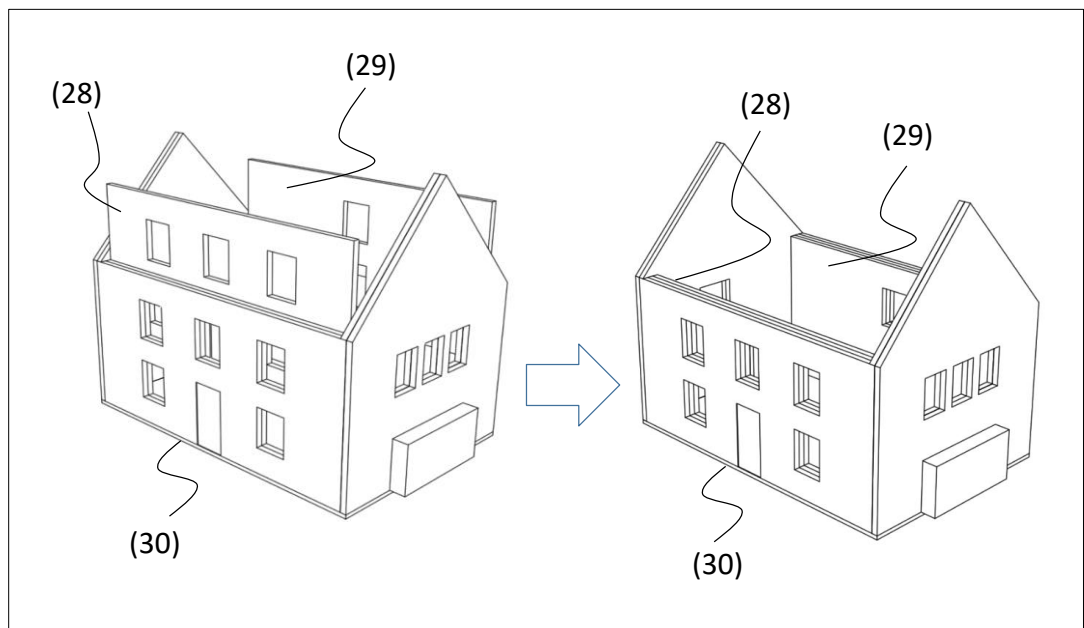

Figure 5-4: The installation of the insulation layers to two main walls of the building model.

Figure 5-5 illustrates the internal roof insulation 32, which is installed below the external roof 31 to the wall insulated building 33 to create a fully insulated building.

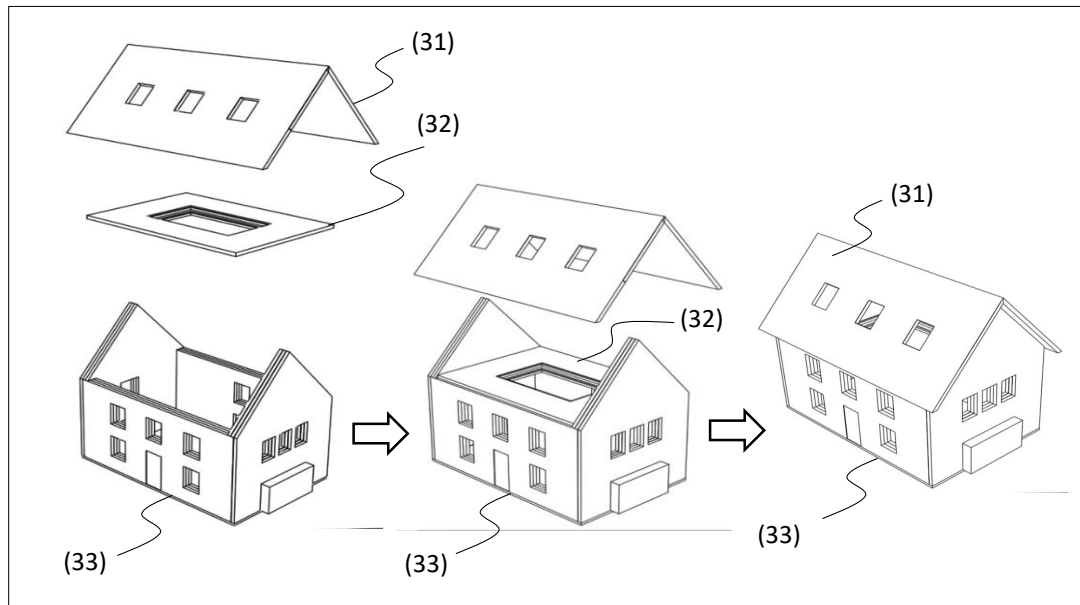

Figure 5-5: The installation of the insulation layers to the roof of the building.

Figure 5-6 represents two building models, a non-insulated building model 36 and an insulated building 37, enclosed within the environmental chamber; the enclosing environmental chamber's cover 35 acts as a holder with a handle 34 to allow the manual transportation of the complete apparatus.

Figure 5-7 shows the practical aspects of attaching the cover 39 to the base of the building models 40 via toggle clips as an example. The base 40 could be designed with different materials to simulate different solar or heat absorption process and to simulate the interaction with the building model. The toggle clips could be replaced by other mechanical or magnetic fasteners.

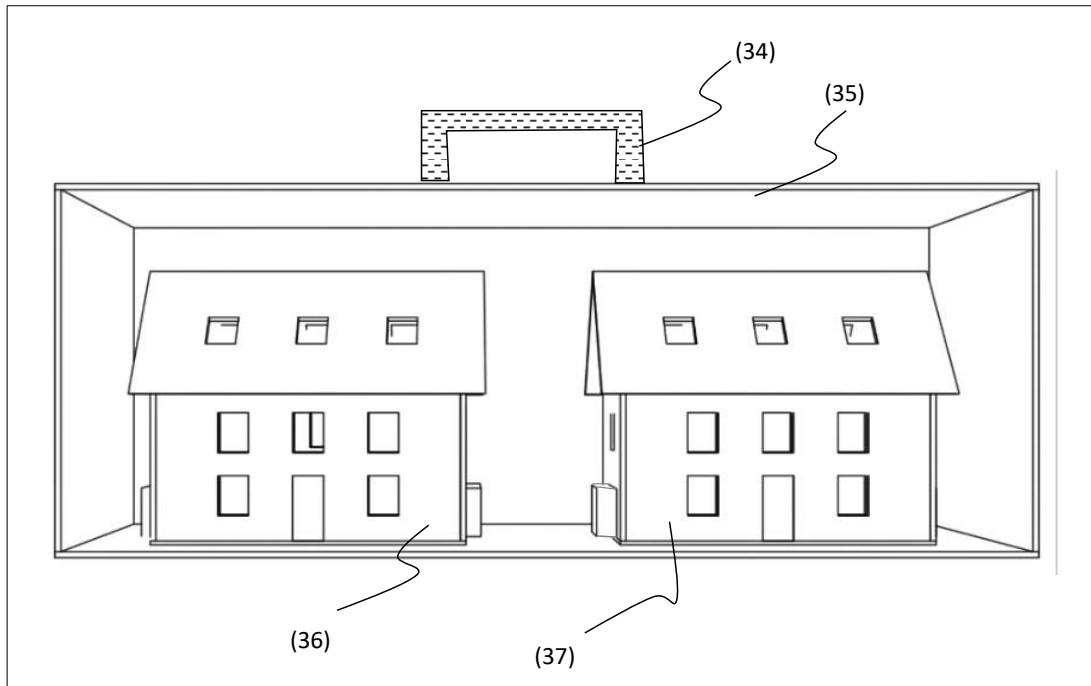

Figure 5-6: The overall system with two building models, with and without insulation, contained within an environmental chamber, which also acts as a carrier container.

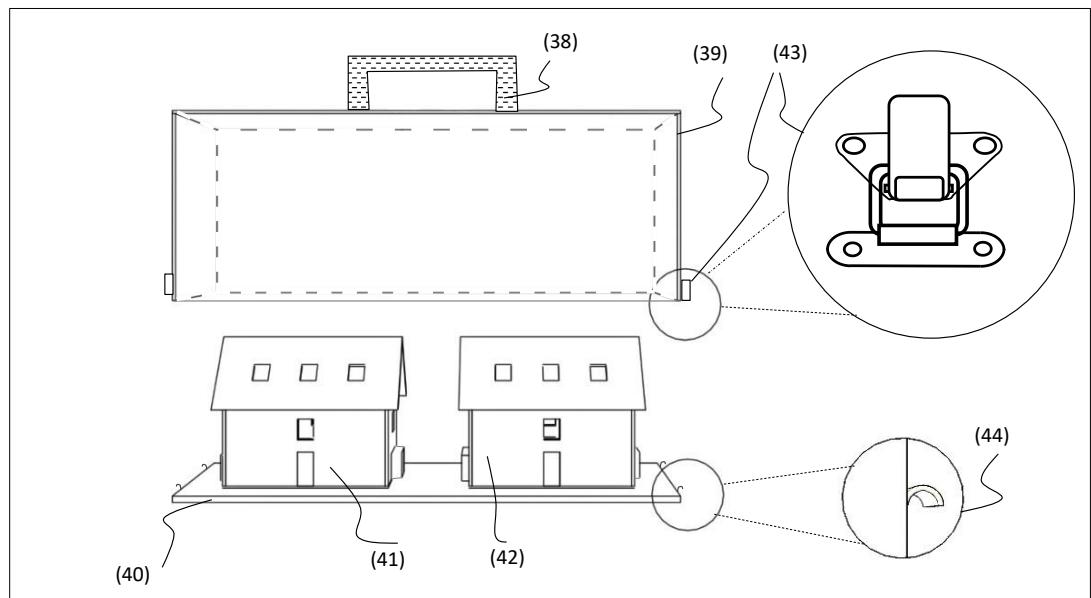

Figure 5-7: The overall system with two building models and a removed cover.

Figure 5-8 represents the use of a fan 46 to provide air circulation to enable the study of the wind speed on heat gain or loss. In this type of work, the platform 45 is detached from the chamber and the external environment around the buildings will be the external environment of the model, which could

be either indoor or outdoor. The fan could be installed on the platform 45 or separately as suitable.

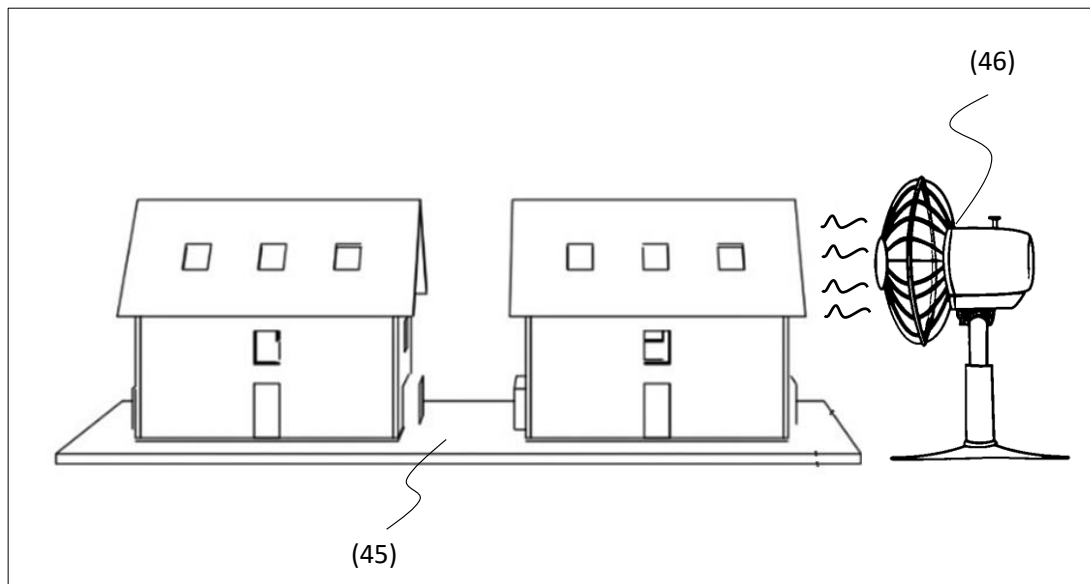

Figure 5-8: The overall system with two building models, with open cover and an electric fan for air circulation.

The design and building process of the model and the insulation layers could help students to design and build their physical model using suitable CAD software and with the help of a laser cutter, the components could be easily manufactured. This process could particularly help product design and architecture students.

5.3. Experimental work

5.3.1. Energy Efficiency Application

Combination of design and technology was applied previously to enhance design-based learning in engineering education at the secondary school level [30]. The developed educational tool presented in this study combined a concept of innovative design with modern technology to improve the teaching of energy consumption in buildings. The schematic diagram, as shown in Figure 5-2, illustrates an example of how the building model could be used to test the energy efficiency. The original building model can have one or more

insulation layers internally. The building could be heated by an electric resistive heater (or a light bulb) or heated or cooled by means of a heat pump (e.g. Peltier effect). A temperature sensor is used to monitor and control the internal temperature. The building model can be housed in an environmental chamber to control and monitor the external environment of the building. The system can be connected to a power supply and a meter to monitor the energy consumption. The system can be monitored by an infrared camera to see the energy loss of the building to study the thermal performance in different climate scenarios and different insulation levels.

5.3.2. The objectives of the experimental work

The experiment had the following objectives:

- Observe the thermal behaviour of the building models.
- Examine the system in a working condition, including the features and materials.
- Examine the learning capacity and accuracy of the educational simulation tool.
- Compare the energy consumption of the insulated and non-insulated building models.
- Determine the energy saving potential of the insulated building model compared to the non-insulated building.
- Determine the fractions of heating-On and heating-Off periods of the building models.
- Identify the energy loss of the building models by using an infrared camera.

5.3.3. The procedure and condition

To compare the energy and temperature difference between the two building models, the house models are placed in a chamber with air conditioning applied to create a cold external temperature of 13 °C. The house models are heated with identical 14-watt halogen bulbs. Power monitoring system is connected to each house model to measure the electricity consumption. The heating system is controlled by a thermostat to turn the heating OFF when the

internal temperature reaches the target room temperature (21 °C). The internal temperature is monitored by two identical thermocouples, to assess the temperature pattern.

5.3.4. Results of the experimental work

The presented concept suggests the idea of using an innovative technology as both cognitive tools and design tools to advance design-based learning. As shown in Figure 5-9, the heating turns ON when the internal temperature inside both houses is the same at 15.3 °C. The temperature inside the insulated house starts to rise rapidly reaching the target temperature just after about 3 minutes. The non-insulated house heats up very slowly, and after about 20 min it reaches steady state at about 17 ° as its highest temperature; with significant steady-state error. After just 15 minutes the temperature in the insulated house became stable at 20.5 °C as the lowest when the heating turned OFF and then reached 21.5 °C as the highest when the heating is turned ON again. The heating ON/OFF cycle has been found to be around 50 seconds long (see Figure 5-10). However, the temperature in the non-insulated house varied between 16.5 and 17.0 °C despite the fact that the heating is turned ON continuously. IR cameras provide an excellent opportunity to the laboratory by saving time and giving good information about an experiment that can be quickly recognized and absorbed by students [135]. The loss of energy from the building was even confirmed by using the infrared camera, which clearly shows a big red area indicating heat loss from the non-insulated building Figure 5-11.

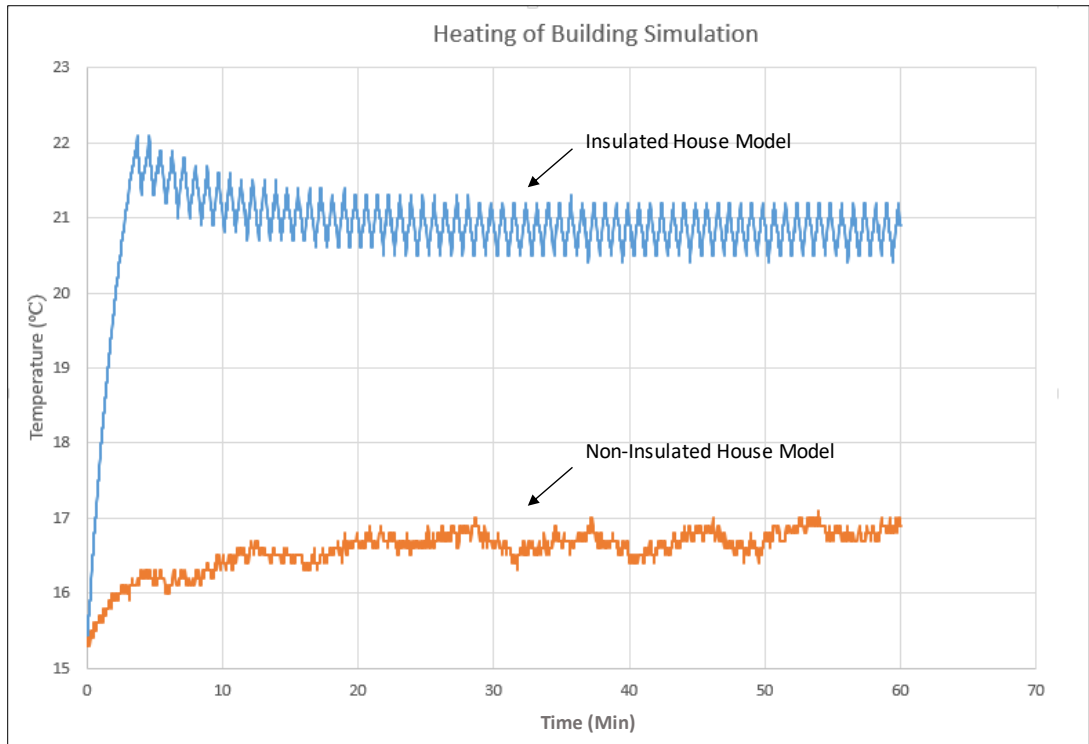

Figure 5-9: The temperature profile of the two building models.

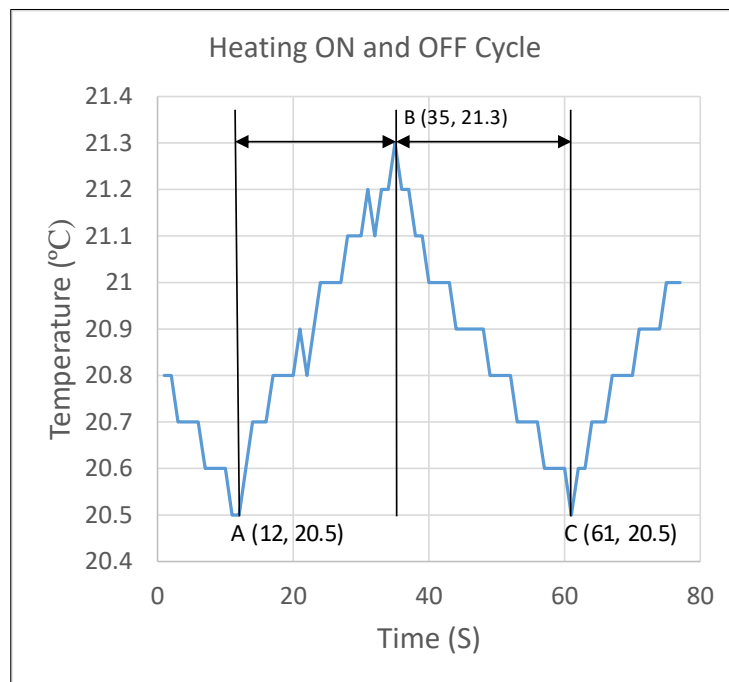

Figure 5-10: The heating ON/OFF cycle of the insulated building model.

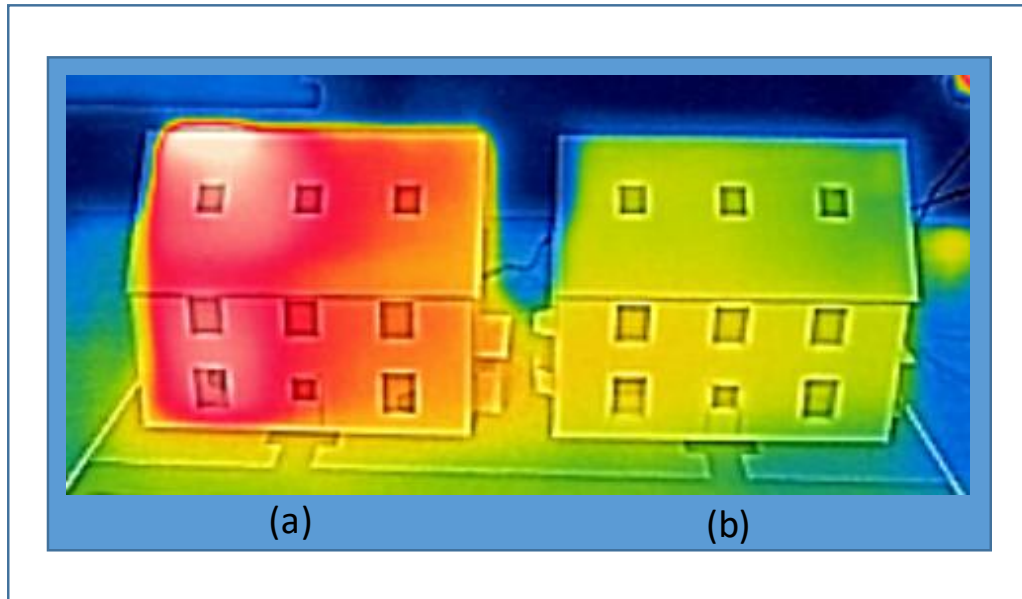

Figure 5-11: The educational simulation model, consists of (a) a non-insulated and (b) insulated buildings.

Figure 5-12 presents the energy consumption of both building model. It has been found that the non-insulated building consumes more than double the energy of the insulated building, despite the fact it never reached the required temperature.

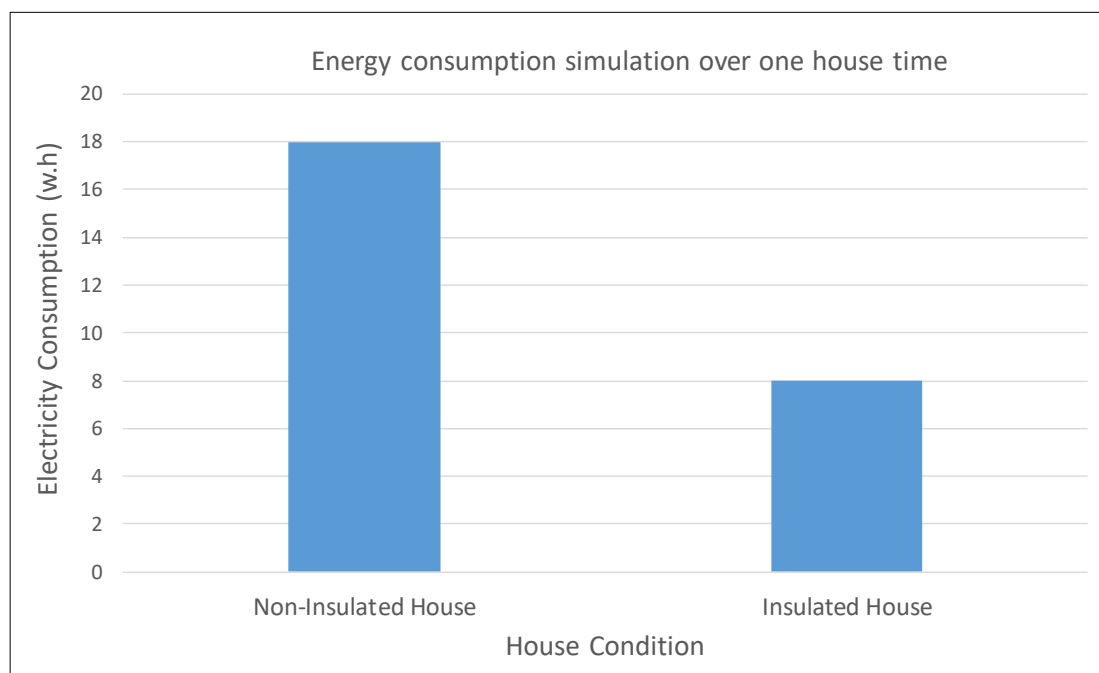

Figure 5-12: A comparison of energy consumption between the two building models.

5.4. Case studies

5.4.1. Implementation of the educational simulation tool

The simulation tool is tested at different educational levels, including primary school and university. The test sessions consisted of three main stages: demonstration and explanation of the system, applying activity for the pupils/students and feedback and the evaluation of the educational tool in relation to its learning outcomes. The design and degree of difficulty of the sessions are planned according to the target group. The levels of the session vary from the basic version which is designed for primary school children to the more advanced version for university and research purpose, based on the researchers' specific objectives.

The educational simulation tool has been tested at primary school level and university, and the results are presented in two separated case studies.

5.4.2. Case study 1: Primary school

The target group for this case study is a year six (10 year old) class with 20 pupils. The demonstration carried out in a regular classroom and was one-hour long. The session consisted of a demonstration of the educational tool and an activity regarding the behaviour of the building models.

5.4.2.1. Learnings outcomes

Based on the national curriculum for year six primary school, the learning activities of the session include the following:

- To record the internal temperature of each building model.
- To record the energy consumption of each building model.
- To identify which building model uses more energy and why.
- To identify which building model reaches the target internal temperature first.
- To figure out which building model is insulated and which one is non-insulated.

- By using an infrared camera, to identify which building model is losing more energy.
- To describe the impact of insulation on energy consumption for heating

5.4.2.2. The procedure

When the demonstration of the educational simulation tool took place, the temperature in the classroom was around 22 degree Celsius; therefore, it required changing the heating setting of the building models to a higher internal temperature (around 10 degrees different). The session has begun by turning the simulation model ON, and during the time, the pupils became familiar with the system and were requested to observe the behaviour of both building models. After 30 minutes, an activity was applied and the pupils were asked to complete an activity sheet related to the behaviour of the building models.

5.4.2.3. Results of case study 1

The heating of both building models turned ON at the same time. After only 3 minutes, the temperature inside the insulated building increased rapidly and reached 32 °C, while the temperature inside the non-insulated building raised slowly and reached a steady state temperature of 31 °C after 20 minutes. The temperature of the insulated building became stable after 15 minutes and reached 34 °C as the highest when the heating was turned ON and then decreased to 33 °C as lowest when the heating was turned OFF. After 30 minutes, when the heating of the non-insulated building was turned ON continuously the internal temperature stabilised between 31.7 °C and 32.2 °C as minimum and maximum respectively.

Figure 5-13 presents an example of the activity sheet, which the participating pupils completed during the activity. The activity sheet works even as a feedback for the teacher to evaluate if the learning outcomes of the session are achieved or not. All the pupils completed all the questions in the activity sheet with 100% correct answers. This is a good evidence which confirms the improvement of the technical skills, which are expected in the national curriculum [133] and shows the opportunity behind this educational tool.

Energy Activity

During the session try to find answer for the following questions, by writing down the right measure or ticking on the appropriate column.

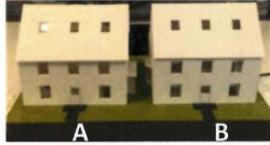

	House Model A	House Model B	
Which house model is insulated?		B ✓	✓
What is the internal temperature of the house models?	32.2 °C	34 °C	✓
What is the used electricity in the house models ?	0.004 kWh	0.003 kWh	✓
Which house model use more energy?	A ✓		✓
By using the thermal camera, which house model losing more heat (energy)?	A ✓		✓

Figure 5-13: A typical energy activity sheet completed by a pupil.

The literature investigates how the technology can enhance design-based learning in engineering education, to use innovative technologies as both cognitive tools and design tools to improve design-based learning [30]. Following the activity session, the pupils were asked to complete a feedback questionnaire to evaluate their participation experience. The results show a significant improvement in understanding the role of insulation in saving energy within the building, 90% of the pupils agree or strongly agree that the session has helped them to understand the energy saving benefit of insulation, as presented in Figure 5-14. Previous research has shown that the thermal imaging in combination with simple well-structured theoretical activities could support the students' thermodynamic learning [28].

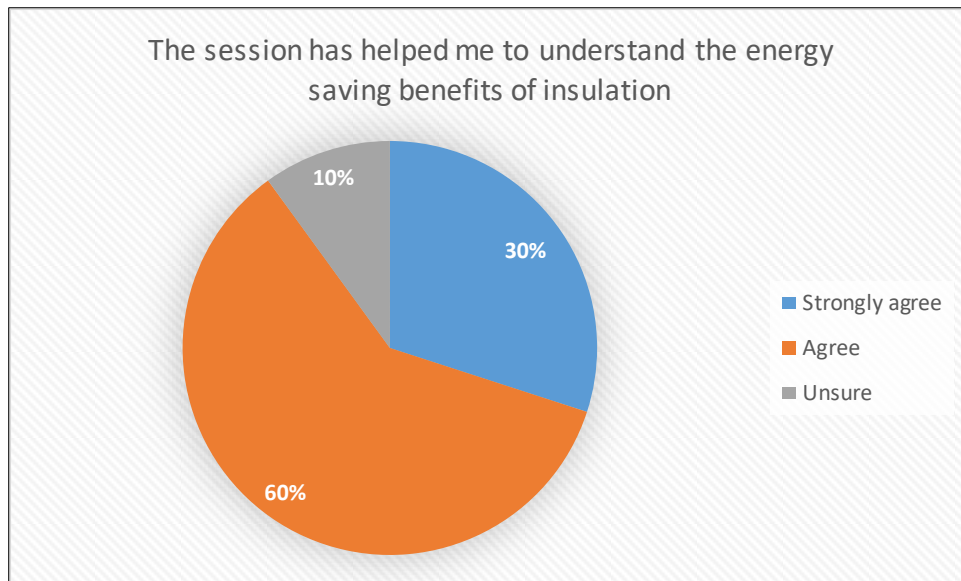

Figure 5-14: The responses of pupils regarding how helpful the session has been to understand the energy saving benefit of insulation.

The IR cameras have successfully been applied in different subjects to visualise the heat transfer in different school levels [27]–[29], [135]. The results show also a positive experience of using the infrared camera to detect the heat loss of an object, 85% of pupils agree or strongly agree that it was easy to use the thermal camera to inspect the heat losses from the building models, see Figure 5-15. The running of the educational simulation system, including the associated instrumentation, creates an enjoyable and scientifically inspiring experience. According to the results, which show that, 75% of the pupils agree or strongly agree that the activity is enjoyable, see Figure 5-16. The literature review [134] confirms these findings that an infrared camera is a powerful tool that supports the understanding of heat transfer. Moreover, it is easy to use and provide an enjoyable experience, which in turn enhance students' motivation and engagement in the learning process.

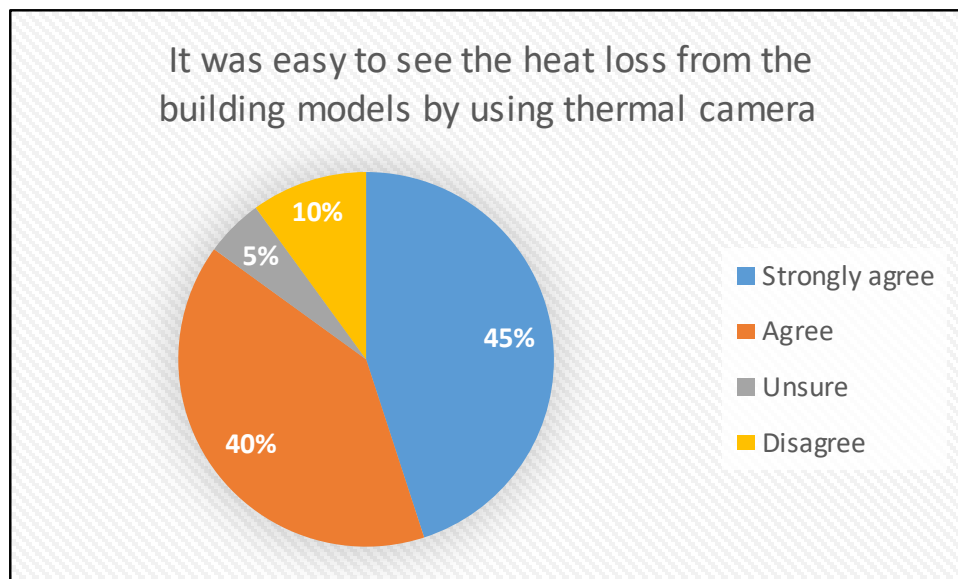

Figure 5-15: The responses of pupils regarding their experience of using the thermal camera to detect the heat loss of the building models

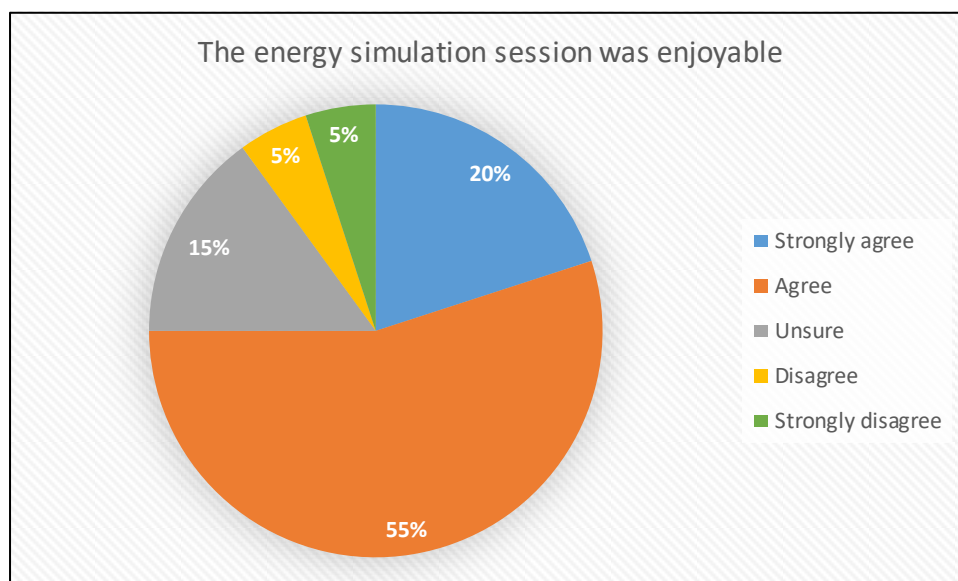

Figure 5-16: The responses of pupils regarding their experience in attending the simulation session.

Regarding “what the pupils have learned” in the educational session, students have expressed different experiences, such as.

- *What insulation is.*
- *That insulation helps to keep heat in*
- *What a temperature and power sensors are.*

- *You can use a thermal camera to see heat and heat loss.*
- *If you have a well insulated house, you lose less energy and be warmer. Also, it will cost less.*
- *That a house with insulation is better to live in than a house with less insulation.*

According to the comments of the head teacher of the school, the features of the tool are effective and simple:

“Very simple, clear and provide good data that is easily accessible for recording and analysis”.

Regarding the message of the educational tool, he explained:

“It was very clear how insulation impacts energy consumption and heat conservation. I could see clearly the impact and the message you were trying to convey. More importantly I could see how our pupils would very easily understand that same message”.

The headteacher has confirmed that this educational tool meets the requirements of the current curriculum. In line with the UK national curriculum [133] the educational tool provides the opportunity for taking measures, recording data, creating diagrams, increasing the degree of complexity, identifying scientific evidence, etc. The results show that the educational simulation is an effective tool to improve the technical skills, awareness and knowledge regarding the impact of insulation and the energy consumption in the building.

5.4.3. Case study 2: University

In this case study the simulation tool was applied on a class of 15 university students, from six different fields of study including undergraduate, master and PhD levels. The demonstration was presented during two hours time as a part of a whole day program of energy challenge (certificate based) activities.

5.4.3.1. Learnings outcomes

For university level, the building model could fulfil a wide range of learning outcomes depending on the subject area, where energy and building is the main theme. However, other learning outcomes could include CAD design, manufacturing, instrumentation, software development, data acquisition, infrared thermography, materials, thermodynamics and heat transfer, etc. Additionally, the concept was recently applied to undergraduate students. In addition to the basic requirements, the students were asked to calculate the following:

- The annual consumed energy for heating for both buildings in terms of cost and the amount in KWh.
- The annual energy lost to the environment for both buildings in terms of cost and the amount in KWh.
- The annual saved energy in the insulated building in comparison to the non-insulated in KWh.
- Selection of the optimal heating setting in relation to indoor comfort temperature and energy consumption.
- By using the thermal camera, identify the critical insulation defect in the insulation.
- Analyse the heating behaviour of both buildings.
- The cost of eventual insulation improvement and the expected payback period.

5.4.3.2. The procedure

The demonstration of the simulation tool took place in a classroom with a room temperature around 23 degree Celsius. To create a building heating scenario the heating setting inside the building models increased to 33 degree Celsius. The experiment has begun by turning both simulation models ON at the same time. During the time the students became familiar with the system and its features and were requested to observe the thermal behaviour of both building models. After 60 minutes, an activity was applied and the students were asked

to answer some questions in an activity sheet related to the behaviour of the building models.

5.4.3.3. Results of case study 2

In total 93% of the students agree or strongly agree that the session has helped them to understand the energy saving benefit of insulation, see Figure 5-17. Previous literature confirms positive responses from students using infrared camera combined with simple physical building models [30]. The results show also a positive experience of using the infrared camera to detect the heat loss of an object, 100% of the students agree or strongly agree that it was easy to use the thermal camera to inspect the heat losses from the building models, see Figure 5-18. The running of the educational simulation system, including the associated instrumentation, creates an enjoyable and scientifically inspiring experience. According to the results, which show that 94% of the students agree or strongly agree that the activity is enjoyable, see Figure 5-19.

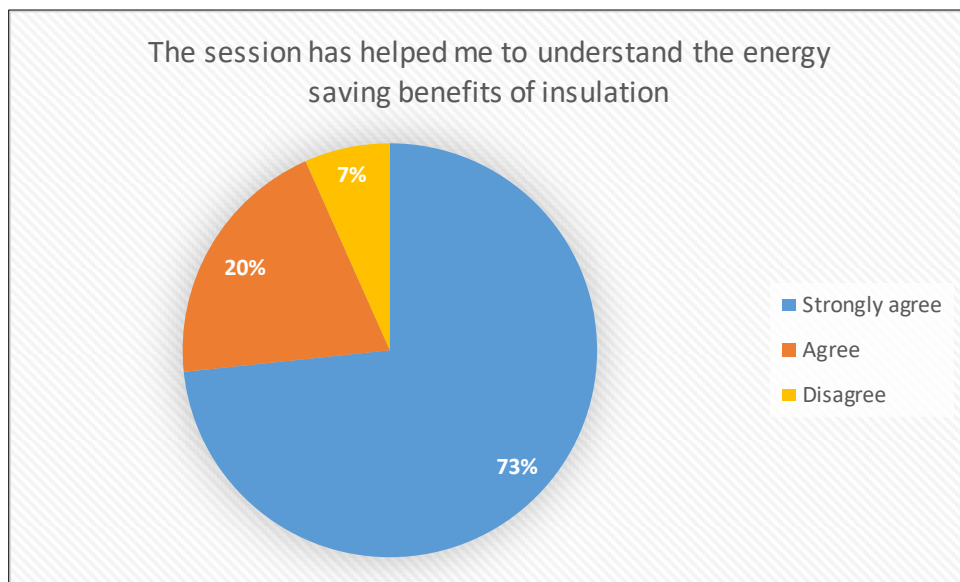

Figure 5-17: The responses of students regarding how helpful the session has been to understand the energy saving benefit of insulation.

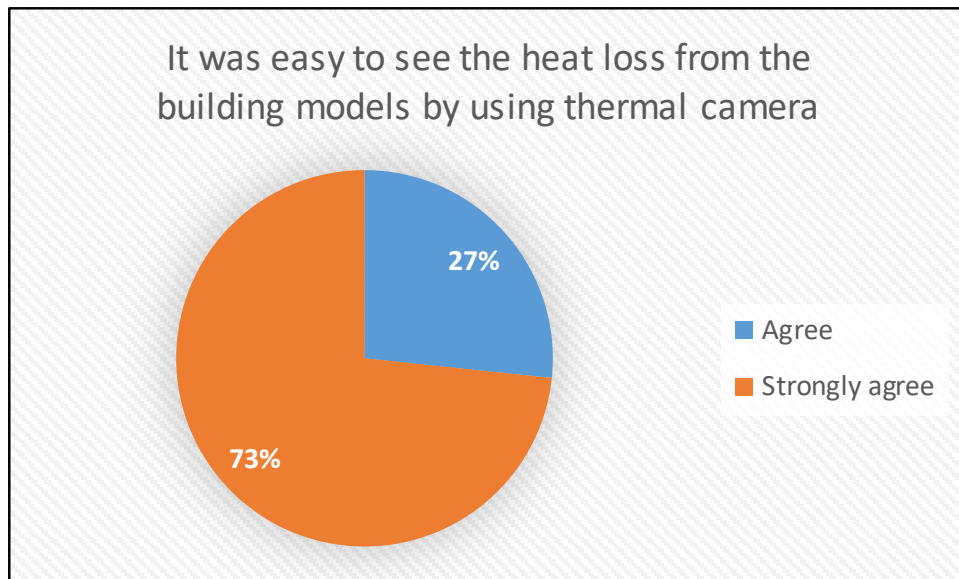

Figure 5-18: The responses of students regarding their experience of using the thermal camera to detect the heat loss of the building models.

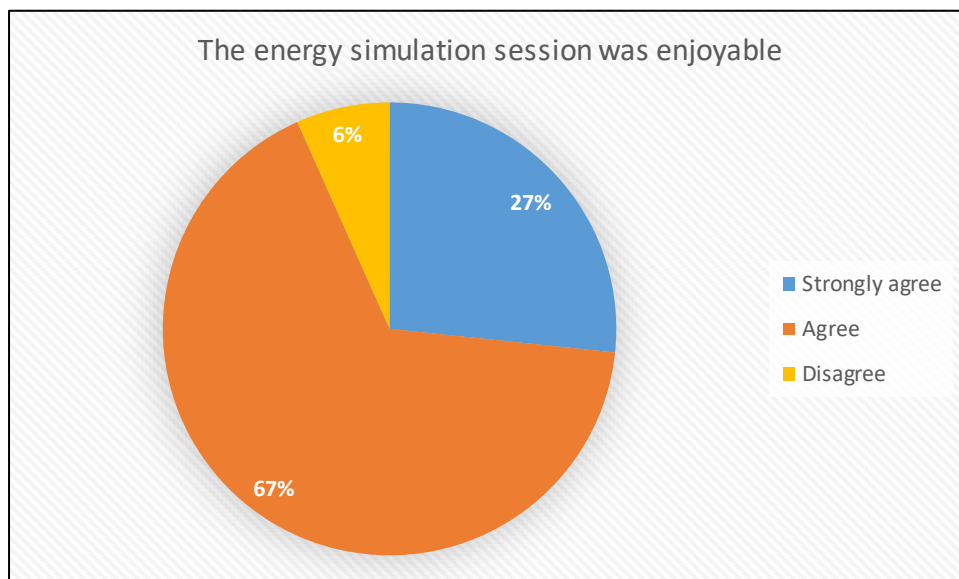

Figure 5-19: The responses of students regarding their experience in attending the simulation session.

Thermal imaging in combination with simple well-structured theoretical activities has been applied previously in supporting the students' thermodynamic learning [28]. Regarding the benefits of this educational kit in achieving the learning outcomes of the session, the university students' feedback has indicated the following benefits from their own experience:

- *Understanding the benefits of insulation in buildings, energy saving and the economic and environmental implications.*
- *How to calculate and measure energy usage in KWH.*
- *The use of the infrared camera and the interpretation of its images to estimate heat losses in a building in order to improve insulation and maximum energy saving.*

Additionally, the responsible lecturer at the university also believes that the tool can contribute to their teaching, and has expressed her interest in purchasing the kit as an educational tool. She has indicated, “*This simulation tool can help in our teaching*”.

5.5. Summary

This Chapter presents the design of the educational model in detail and results of an experimental work and two case studies. The results of the experimental work and the case studies show significant differences between the insulated and non-insulated building models in term of energy consumption and the recorded indoor temperature. Additionally, the indoor temperature stability and the required time to reach the target temperature also experienced big differentiation. The energy loss from the building models is visualised by an infrared camera, which again shows the significant energy saving achieved by providing insulation. It has been found that the non-insulated building consumes more than double the energy of the insulated building, despite the fact it never reached the target temperature.

CHAPTER 6.

THE EFFECT OF PEOPLE'S NUMBER AND BEHAVIOUR ON ENERGY PERFORMANCE OF BUILDING: NOTTINGHAM PLAYHOUSE AS A CASE STUDY

6.1. Introduction

This Chapter presents and analyses monitoring of the energy consumption at Nottingham Playhouse to evaluate the previous efficiency improvement of the building and to examine the further potential for energy saving. Nottingham Playhouse is a theatre in Nottingham (Figure 6-1). For more than three months period (during wintertime) the energy consumption, internal and external temperature, internal humidity, energy efficiency of walls and window glasses and the operation of the entrances were monitored at Nottingham Playhouse. The locations that are mentioned in this chapter are illustrated in Figure 3-20.

This part of the research in line with the rest of the thesis is investigating the impact of enhancing the public engagement in energy conservation in the building by using modern technology. Moreover, it is discussing the relation between the building, occupants and the operation of the building to achieve potential energy saving. Therefore, the area of heat transfer and calculation of HVAC demand of building is not covered in this thesis.

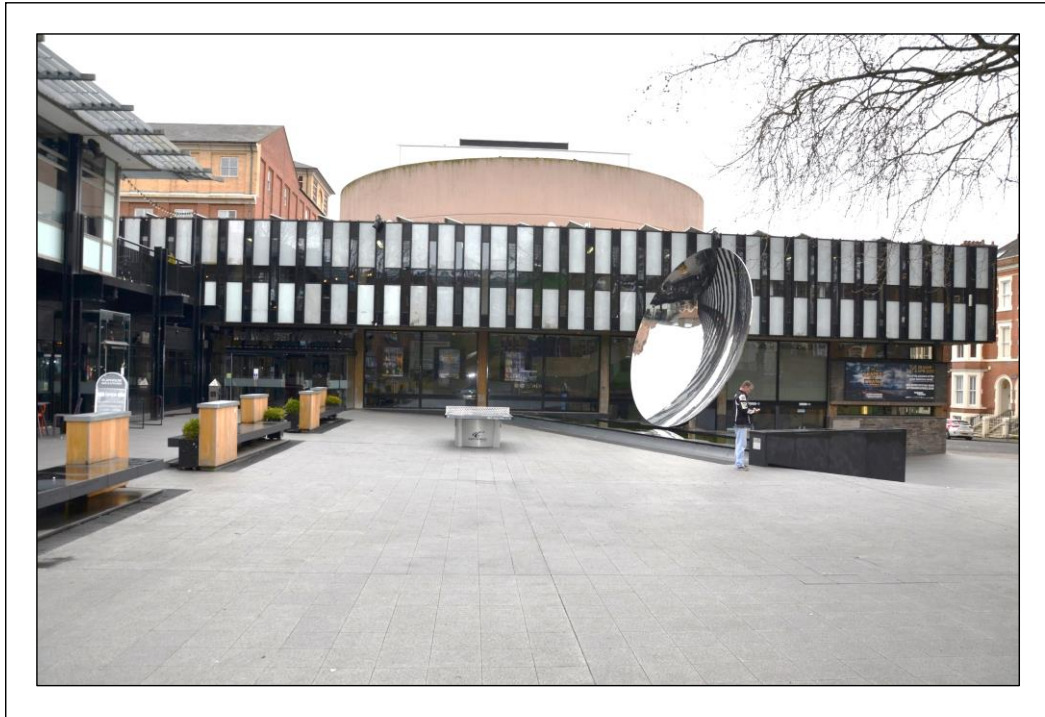

Figure 6-1: Image of Nottingham Playhouse

6.2. Indoor temperature

The reviewed literature confirms that occupancy sensors in controlling temperature and/or air quality in the building has been used to evaluate the potential for save energy [94]. Al-Habaibeh [138] presented a case study, where the insulation efficiency of Nottingham was improved during the last renovation. According to Al-Habaibeh, in 2010 the single glazed windows were one of the major contributors to heat losses. The external thermal image comparison showed a thermal improvement between 2010 and 2014 for before and after respective renovation (Figure 6-2). The external layer of glass of the windows is colder which indicates a much better insulation. The results indicated an improvement about 8 to 10 degrees Celsius. Moreover, the thermal images from inside the building showed that the internal layer of the glass is much warmer after the renovation, indicating a much better insulation (Figure 6-3).

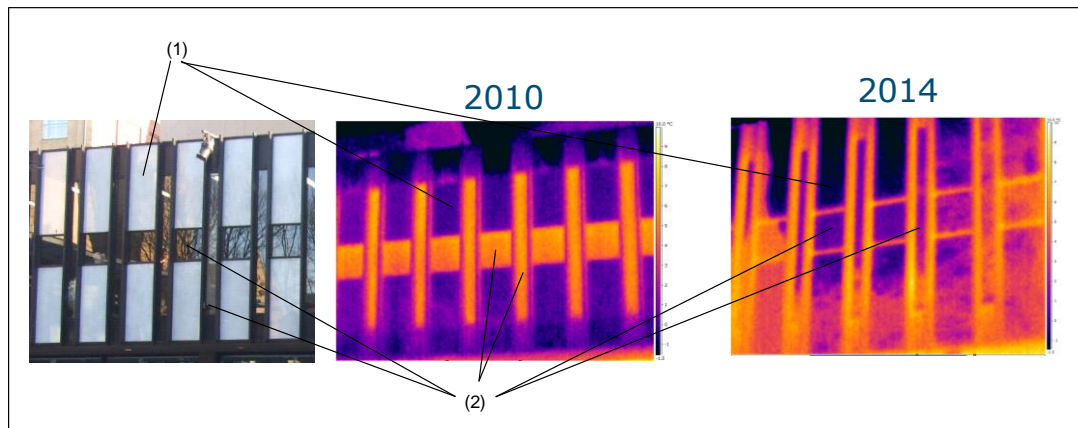

Figure 6-2: The external visual and thermal images of windows at Nottingham Playhouse from 2010 and 2014, where (1) refer to the frame of the windows and (2) to the glasses of the windows.

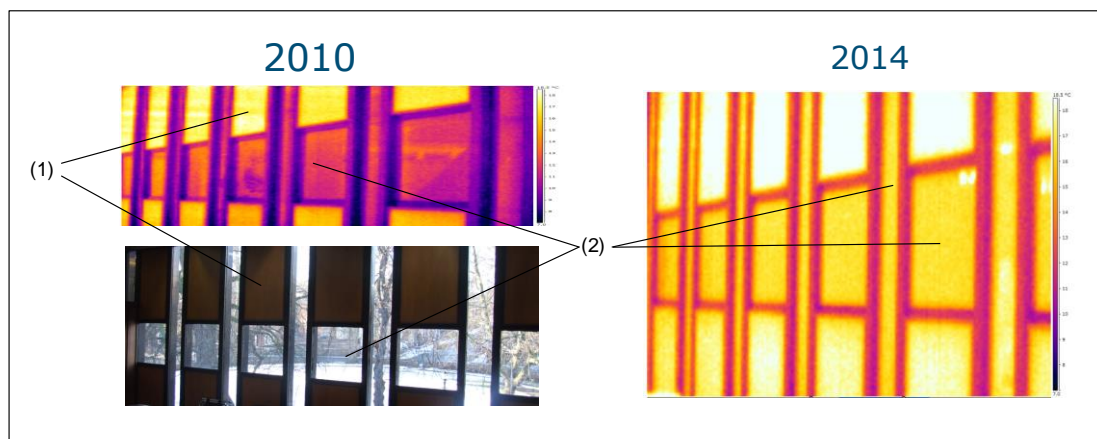

Figure 6-3: The internal visual and thermal images of windows at Nottingham Playhouse from 2010 and 2014, where (1) refer to the frame of the windows and (2) to the glasses of the windows.

Figure 6-4 shows the temperature variation of the auditorium (Location C) from 08/11/2016 to 28/02/2017. The temperature variation has been recorded from a minimum of around 18°C to a maximum of around 24°C degrees. However, the minimum temperature stayed between 19°C and 23°C most of the time. The average recorded external temperature shows different values during different months, 21°C for November and December, 20.5°C for January and 20°C for February as the outdoor temperature became colder gradually. The space is not provided with any cooling or heating system, however, the

infiltration and exfiltration operate during the shows to circulate fresh air and prevent overheating of the room.

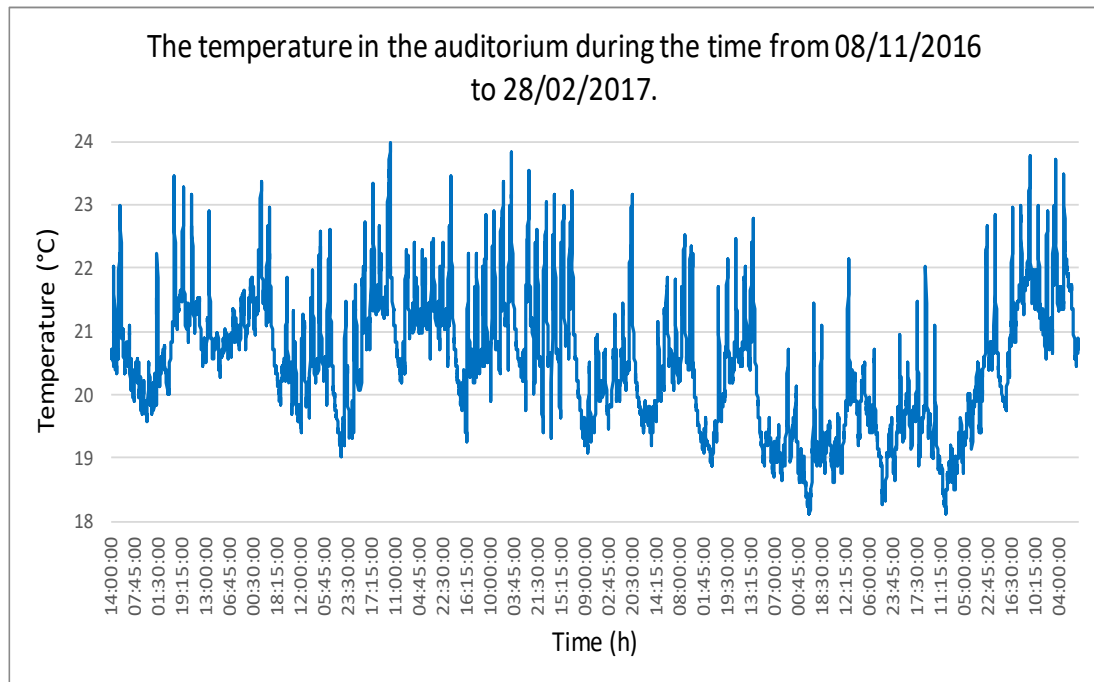

Figure 6-4: The temperature in the auditorium (Location C) from 08/11/2016 to 28/02/2017.

Figure 6-5 shows the temperature of the auditorium (Location C) compared with the internal temperature at the first floor (Location B) during the same recorded period. The graph illustrates a big difference in temperature between these two places, although both follow mostly the same pattern. Figure 6-6 presents the temperature behaviour of these two locations during one week period, where the auditorium has a higher temperature than the first floor. Temperature differences of 2°C as a minimum during daytime and 7°C as maximum during night time and early mornings are observed. The auditorium is cylinder-shaped covered by surrounding building with a limited connection to the outdoor environment, which provides a basic source of heating of the space. The ventilation system is not equipped with any heat recovery system to get the benefit of the air exfiltration process [41].

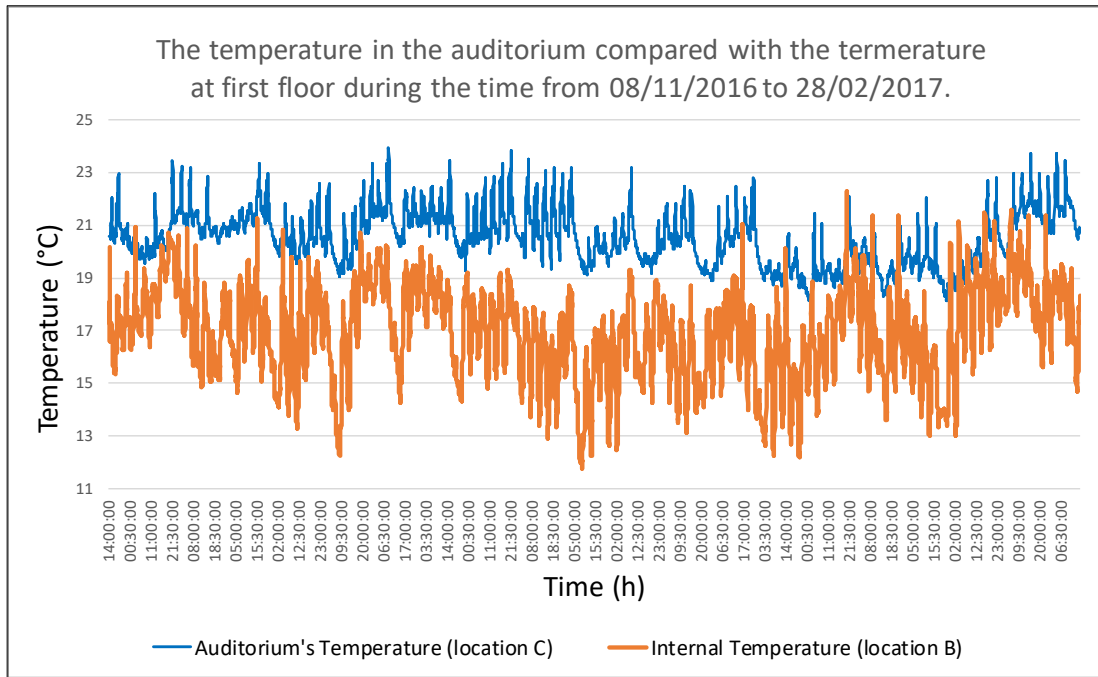

Figure 6-5: the temperature in the auditorium (Location C) and the internal temperature at the first floor (Location B) from 08/11/2016 to 28/02/2017.

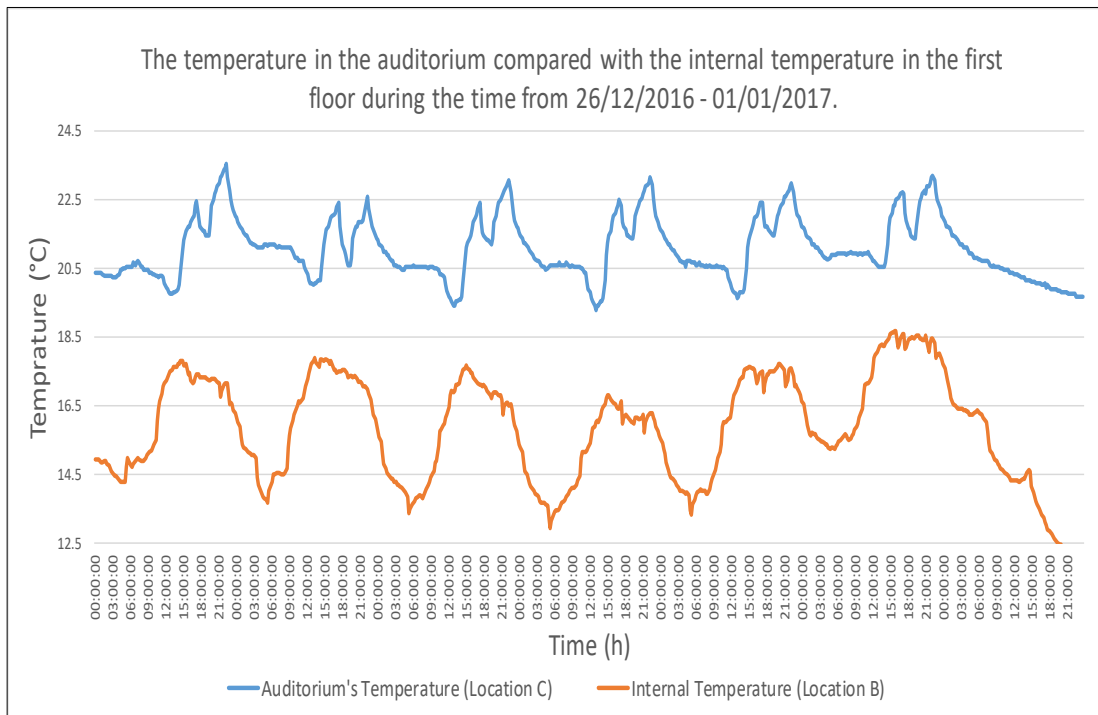

Figure 6-6: The temperature in the auditorium compared with the internal temperature in the first floor during a one-week period.

6.3. Insulation efficiency

Figure 6-7 shows the internal, external and differential temperature of the windows at the lower floor (Location F) of the building from 24/01/2017 - 13/02/2017. The selected location is less affected by the visitors and direct sunlight, which means a more stable reading of both the weather temperature (outdoor) and the heating temperature (indoor). Generally, both graphs have the same clear pattern, a convexity zone at the afternoon when the temperature reaches its highest levels and a concavity zone during the midnight and early morning when the temperature drops down to its lowest levels. However, Sundays show only a whole concavity as the building is closed and the temperature continues low (see Figure 6-8).

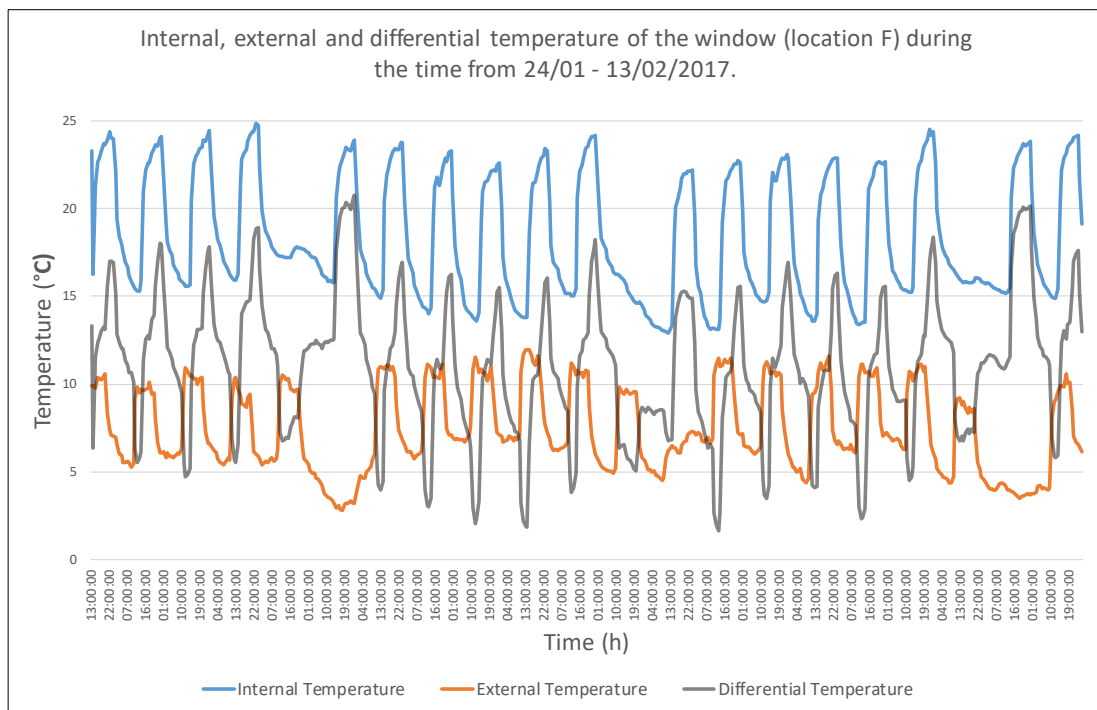

Figure 6-7: internal, external and differential temperature of a windows at the lower floor (Location F) of the building for the period between 24/01 - 13/02/2017.

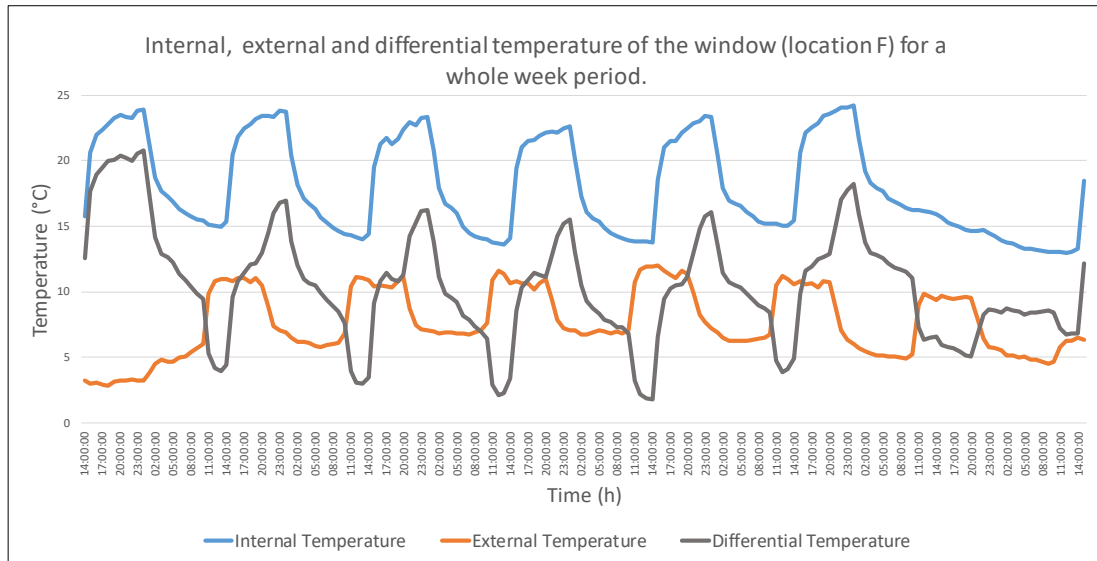

Figure 6-8: The internal, external and differential temperature of the window (location F) for a whole week period.

Figure 6-9 illustrates the temperature behaviour during two days period, which includes more detailed information. The top section of the convexity zone starts around 10:00 o'clock for the external temperature as the result of the raising outdoor temperature whilst for the internal temperature starts around 14:00 when the building is fully warmed up by the heating system. For the external temperature, this section continues until around 20:00 when the outside temperature starts dropping, whilst it continues until midnight for the internal temperature when the heating turns off and the building closes. As the graph shows the insulation confirms a differential temperature between inside and outside of around 10°C in average, which reaches the highest level of around 15°C during the evenings and the lowest level around 2°C during the afternoons. Moreover, both the convexity and concavity pattern of the external temperature record a couple of degrees lower temperature during the Sundays. The fact that the external temperature continues to decrease during the inactive time on Sundays can be an evidence that the external temperature of the window affected by the heating emitted by the building, which means that the building, heating, occupants and the weather are in a dynamic interaction together.

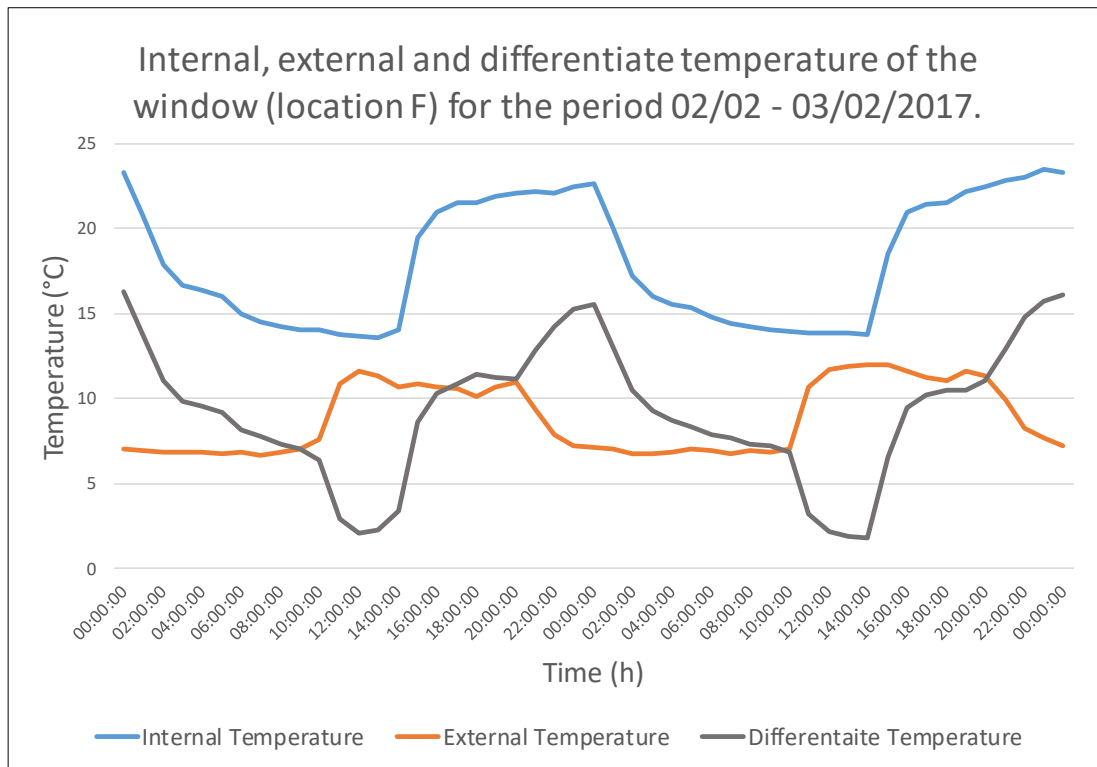

Figure 6-9: Internal, external and differential temperature during two days period.

Figure 6-10 presents the internal, external and differential temperature of the wall at the first floor (Location B) of the building from 24/01/2017 to 13/02/2017. As the location was affected by many factors such as heating system, the solar radiation, body temperature and audience behaviours, therefore the temperature behaviour has shown a clear irregular pattern. Despite the temperature difference, still the internal and external temperatures have mostly followed the same graph pattern, which indicates a clear interlinked relation.

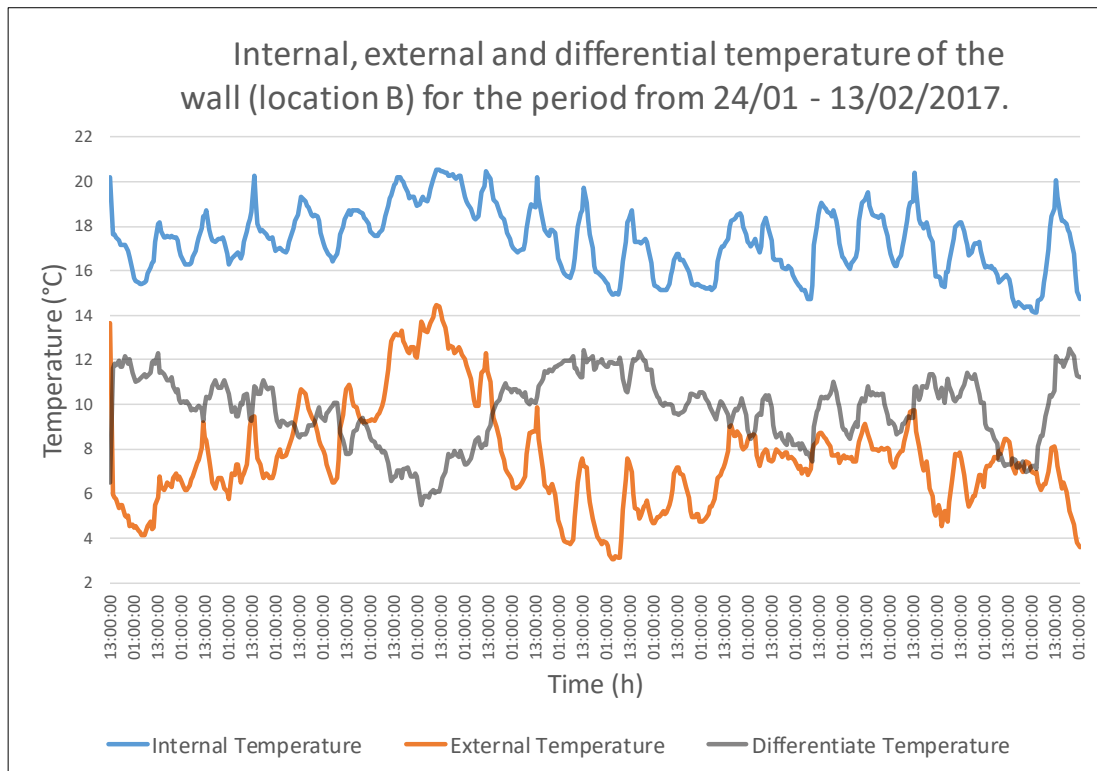

Figure 6-10: The internal, external and differential temperature of the wall (Location B) of the building from 24/01/2017 to 13/02/2017.

Comparison to data collection of the window (Location F), the temperature graphs of the wall (Location B) has not shown a real convexity zone with a wide top. Instead, they only have a sharp slightly higher tops and lacking a clear lowest temperature zone. The differential temperature between the internal and external has an average of around 10°C , which is similar to the value of the window. The lowest differential value is around 6°C and the highest is over 12°C .

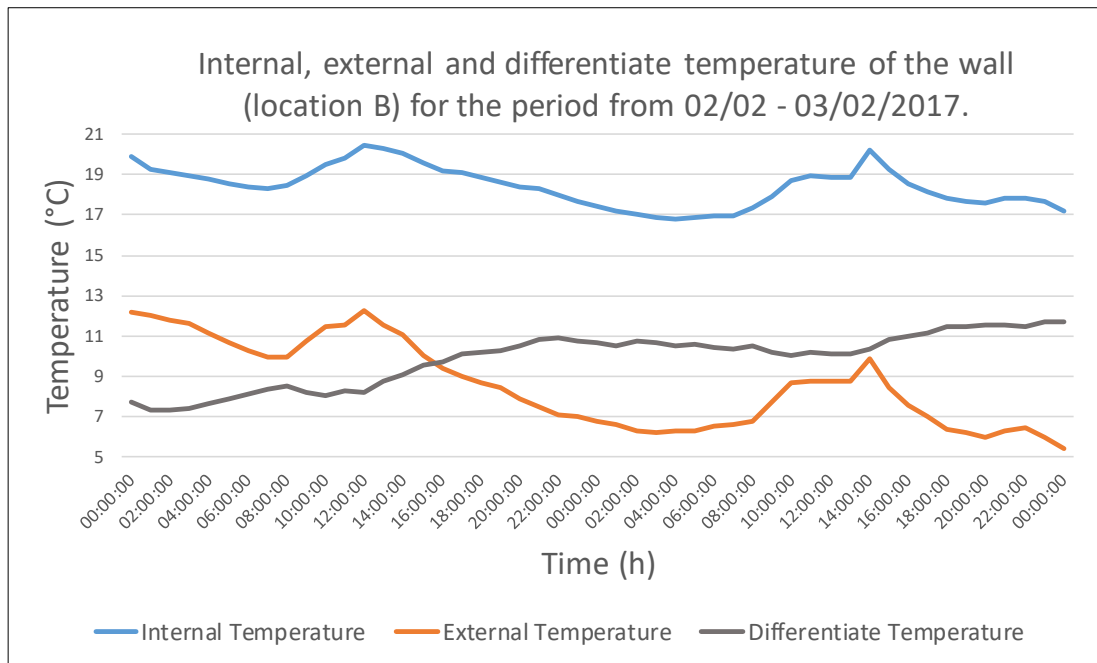

Figure 6-11: The internal, external and differentiate temperature for the period 02/02 - 03/02/2017.

Figure 6-12 presents the internal, external temperature of two different locations, the wall (Location B) and the window (Location F) of the building from 24/01/2017 - 13/02/2017. In general, the temperature data of the window has much wider deviation than those of the wall, particularly the external temperature. As illustrated, the internal temperature of the window has a much higher highest temperature (over 24°C) compared to the highest temperature of the wall (around 20°C) and a lower lowest temperature of under 14°C compared with around 15°C for the wall. Different location of the same building can be influenced by different factors that is why the temperature in these two locations behave differently. As the recording of the wall temperature located in the first floor, above the main entrance area at the ground floor. The area is overcrowded from inside and outside before and after the shows resulted to increasing temperature (heat), which raise and effect these readings. Moreover, the main entrance opening actions, especially for long periods expect to have the same effect as previously noted. Additionally, the design of the wall combined with big windows, which can easily be affected by daylight promoting an unstable pattern. A rapid increasing of temperature when the daylight intensifies, particularly when the sun appears, and a rapid decreasing

of temperature towards sunsets, especially when the sun suddenly disappears in cloudy days.

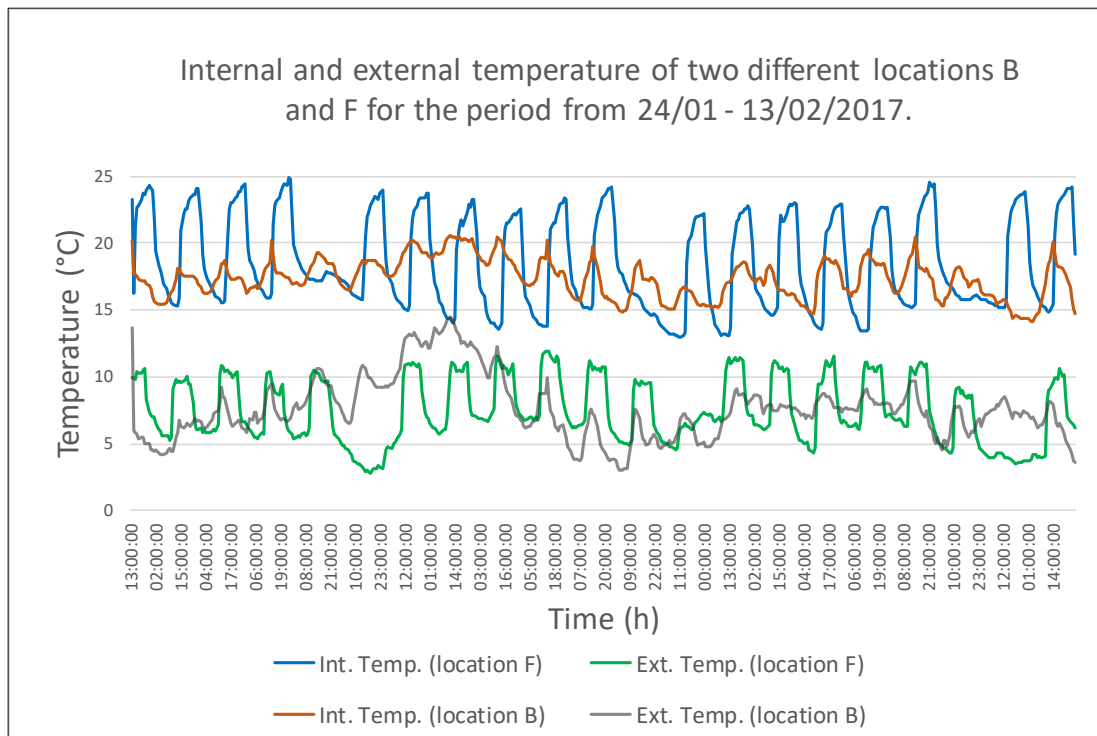

Figure 6-12: The internal, external temperature of the wall (Location B) and the window (Location F) from 24/01/2017 - 13/02/2017.

6.4. Occupants as the source of heating in the building

According to the literature, the occupancy behaviour in the building has a random pattern [94]. Figure 6-13 shows the interaction between the temperature of the cafeteria, the temperature in the auditorium and audience actions and existence during four days period. As presented, the temperature in the cafeteria raises at the start of the day as the heating system starts to operate and the staff and visitors occupy the place (body heating), particularly the audience that later moves to the auditorium where the shows take place. This temperature curve drops down many times through its path, mainly because of the opening of the main door for long periods and the leave of audience from the place, and even slightly because of weather change. The heating at the cafeteria, which is generated by audience present normally, starts raising before the shows, and followed by decreasing of the temperature

when the audience leave the place and move to the auditorium at the showtimes resulting in increasing the temperature there instead. In this way the audiences work as portable heaters providing one of the most sustainable heating sources, not only saving the heating energy, they even leave the place behind them heated for some time. Building energy calculations could include behaviour patterns and different profiles will be created to identify different behaviour, the number of rooms in use and the kind of activities are important factors to determine the energy consumption for space heating [96]. The bigger the number of audience the higher the amount of heat produced. This means that the temperature will drop down when they leave the place, while the re-occupation of the place by the new audience for following shows on the same day promotes to new heating. The ability to identify some patterns of occupant control behaviour, which will work as a function of climatic parameters including the indoor and outdoor environment [97]. Depending on the pattern of the audience number of each show, the kind of performance and the time gaps between these shows, the temperature will increase and decrease accordantly. Although the main entrance doors are left open for long periods before the shows and the decreasing of temperature caused by that, still the amount of produced heat by audiences increase the temperature in the cafeteria. The temperature in the auditorium starts increasing as the audience occupies the place, while the air infiltration/exfiltration results in a decrease of the temperature. Different buildings will require different models of typologically distinguished occupancy and control action [97]. Depending on the number of audience (the produced heat), generally, when the number of audience is low (e.g. 100) the produced heat is less than the cooling effect caused by the ventilation system and this results in decreasing of the temperature in the room by one degree Celsius (Figure 6-13). In contrast, high number of audience is high (e.g. 750), results in a significant heating (around 23.5 °C) overtaking the cooling effect. The correlation calculation (Pearson

correlation coefficient) between audience number and auditorium's temperature between 17-26/12/2016 showed an positive strong correlation.

Correlations

Pearson correlation	0.891
P-value	0.000

The heating behaviour creates different patterns, depending on the audience number for each show and the time gaps between these shows, the temperature increases and decreases accordantly.

Figure 6-14 shows the temperature behaviour in the auditorium during two weeks period, high audience numbers during the first week, resulting in a high temperature of the room and low audience numbers during the second week, resulting in much lower room temperature (Figure 6-14).

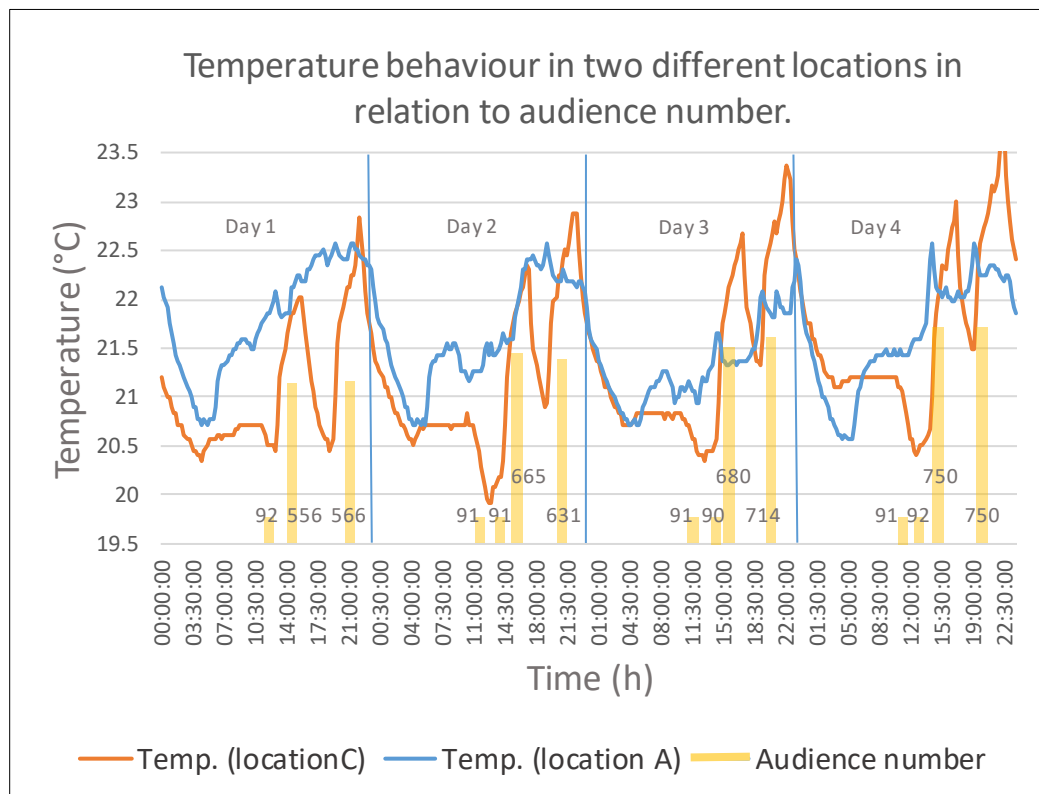

Figure 6-13: relation between the temperature of the cafeteria (Location A), the temperature in the auditorium (Location C) and audience action and existence during four days period.

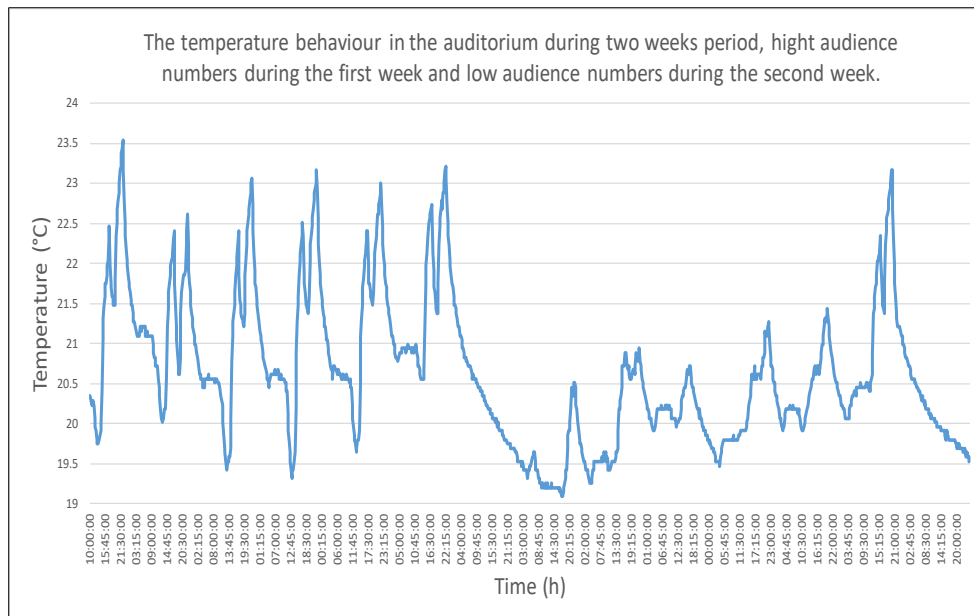

Figure 6-14: The temperature behaviour in the auditorium during two weeks period.

The ability to identify some patterns of occupant control behaviour is important, which will work as a function of climatic parameters including the indoor and outdoor environment [97]. Normally, the heating patterns caused by the audience as the source of heating in the cafeteria and the auditorium, behave against each other, which means that when the audience moves from cafeteria to auditorium, the temperature starts to decrease in the cafeteria while increasing in the auditorium. This can be seen clearly under the shows of third and fourth days, where the temperature increases, decreases and increases again when the audience occupied, left and again re-occupied each place. Normally, after the last show, the heating of the building turns off until the morning of the next working day when the heating turns on again at 7:00 pm. This leads to a decreasing of temperature in the auditorium of around two degrees Celsius before the heating system and the occupancy results in an increase of the temperature again. This leads to a more stable lowest temperature in the auditorium compared to cafeteria, where more factors are involved such as door opening actions, visitors, weather, etc. In other words, the auditorium is a well-insulated building, which keeps the heat for a long time. By enhancement of the occupant's behaviour and offering a deep understanding of building energy consumption patterns a method for assessment of building energy-saving potential can be provided [100].

6.5. Interaction between occupants, building and HVAC

The above discussion explains the dynamic interaction between the HVAC system, building state and the occupant behaviour and existence (Figure 6-15). The occupants' engagement is one of the main factors to achieve a significant energy performance in buildings [95]. The occupants' (audience and actors) behaviour and existence can influence the operation of the HVAC system as a response to discomfort state of the building. Additionally, the state of building can influence the behaviour of occupants to change the operation of HVAC. Moreover, the existence of occupants and their behaviour can promote the change of the building state, which in its turn changes the operation of the HVAC. In other words, to keep a sustainable balance of this dynamic interaction it requires a balance between these involved elements. Building energy calculations could include behaviour patterns and different profiles will be created to identify different behaviour [96]. The way the HVAC system operate depends on the combination of the size of the space, the number of occupants and their behaviour. In other words, the capacity limitations of the room and the HVAC system can regulate the number of occupant or limit their behaviours. Today, the reality shows an unbalance between these elements. The number of rooms in use and the kind of activities are important factors to determine the energy consumption for space heating [96]. The body heat of occupants have to be taken to consideration in design and operation of HVAC systems. The sustainability can force people to alter the building or change the HVAC system to achieve a more comfortable indoor climate.

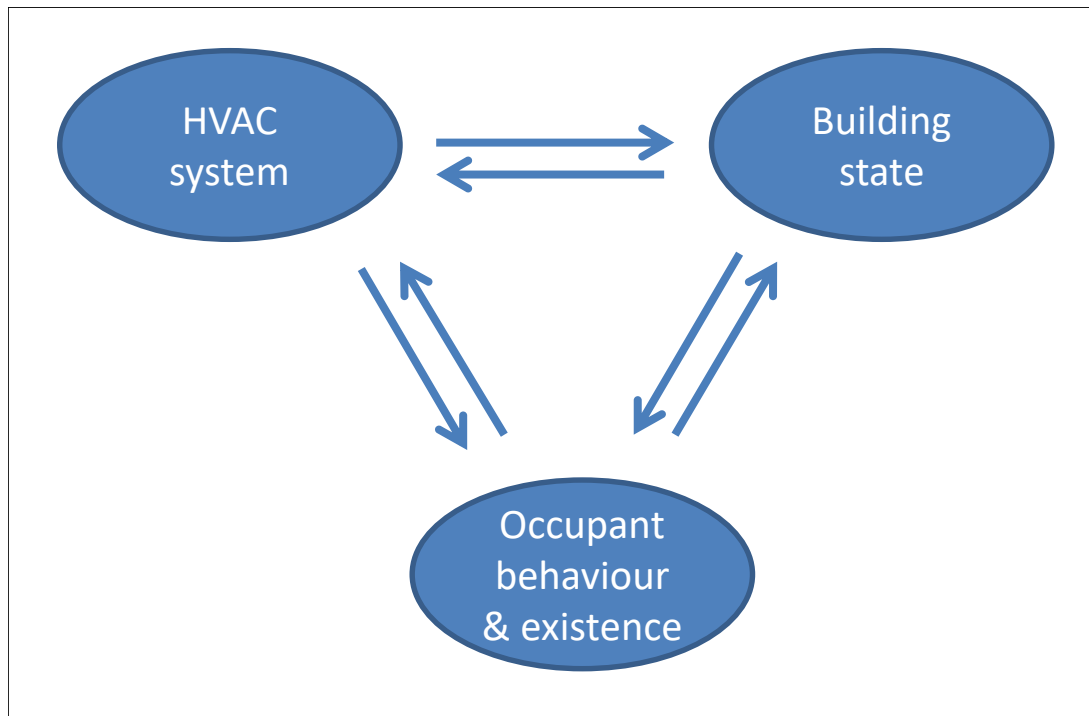

Figure 6-15: Schematic diagram of the relation between the HVAC system, building state and the occupant behaviour and existence.

6.6. Recommendations

The investigation of the heating system at Nottingham Playhouse suggests the following recommendations:

- The operation of HVAC in the auditorium has to be proportional with the level of occupancy and the kind of activity. The design of air infiltration/exfiltration needs to provide different profiles for different patterns of audience.
- Utilise the heat generated by the audience to heat other parts of the building rather than extracting it out through the ventilation system.
- Optimise the heating system by integrating the schedule of occupant patterns in the operation of heating system.
- Optimise the heating system and create a dynamic interaction system between the weather condition, audience pattern and heating.
- Use of curtains at the first floor to avoid the significant amount of heat loss as the wall includes large glazed areas.
- Avoid leaving the main entrance open for long periods.

6.7. Summary

This Chapter confirms the impact of different factors, such as insulation, outdoor climate and people behaviour and existence on the achieved indoor temperature. The auditorium has a much higher temperature than the rest of the building as it is insulated by the surrounded parts of the building. The air infiltration/exfiltration results in decreasing the temperature in the auditorium, when the number of audience is low. The body heat of occupants have to be taken in consideration in design and operation of HVAC system. Moreover, the dynamic interaction between occupants, building and HVAC has to be balanced in order to achieve a sustainable indoor environment. The results have identified significant energy saving potentials. The study confirms that the insulation system provides an acceptable indoor temperature. The investigation identified the lack of an efficient ventilation system, equipped with heat recovery to prevent eventual overheating caused by audience body

temperature and utilising the heat of the air exfiltration [41]. The influence of location on the indoor temperature is also identified. Providing a deep understanding of building energy consumption patterns and enhancement of the user behaviour enables the assessment of building energy saving potential [100]. The study even confirmed the correlation between the audience door actions and the decrease of the indoor temperature, as well as the number of occupants and the room temperature. The study highlights the body heat as a sustainable portable heating source that can be utilised and integrated in the design of indoor heating system.

CHAPTER 7.

DISCUSSION AND CONCLUSION

7.1. Introduction

Buildings energy consumption accounts for about 40% of the total energy consumption in many part of the world. Countries implementing different policies and regulations to control and reduce their energy needs. The EU has the goal of reducing energy consumption and carbon emissions significantly by the year 2020 and 2050. There is a need for the improvement of the public's understanding and engagement in relation to energy consumption in buildings in order to achieve more sustainable future.

This research investigates the enhancing of public engagement in energy conservation in buildings by using modern technologies and methodologies. The design of this research is divided into three parts in correlation, including building thermography survey, innovative educational design and building monitoring.

7.2. Building thermography survey

The first part of this research was investigating the insulation of buildings, by providing the opportunity for people to carry out thermography survey of their own buildings using a low-cost smartphone based infrared camera. This part involved 50 participants, who carried out the thermography survey and

conducted three questionnaires (see appendix 1, 2 and 3). The questionnaires were designed by the researcher himself. Questionnaire-1 (pre-test) includes two parts of questions, sociodemographic characteristic part, which covers information about the participants and their household, while the second part examines the participants' awareness regarding energy consumption in buildings. Questionnaire-2 covers the educational session, including participants' evaluation of the theoretical/practical session. Questionnaire-3 (post-test) consists of two parts, the first part is a repetition of the second part of the first questionnaire, to compare and assess occupants' energy and insulation awareness related to their own buildings. The second part of the questionnaire is related to their thermographic experience of their buildings, potential detected defects and the action they may plan to take toward any improvement of the performance of their buildings.

7.2.1. The quantitative results

The quantitative results of the building thermography survey show clearly many improvements in relation to energy consumption in building and public engagement. Most of the participants (84%) agree or strongly agree that the educational session encouraged them to inspect the insulation of their homes. In the same way, 88% of participants agree or strongly agree that educational session have helped them to understand the infrared thermography. Regarding the thermal camera, 94% of participants feel that it is a comfortable tool to use to inspect own building. The participants indicate an improvement of their awareness of the way in which energy is lost from buildings (82%). The thermal images have convinced the participants that the heat is escaping from their homes (84%). Regarding the power of the thermal images, 94% of participants believe that the thermal images helped them to see how much heat was lost from their homes. Moreover, the thermal imaging has made them think more seriously about the loss of heat from their homes (84%). According to that, 80% of the participants agree or strongly agree that their house needs improvement. Additionally, 90% of the participants believe that the thermal camera has helped them to identify insulation defects causing heat loss in their homes. In the same way, 84% believe that the thermal camera helped them to identify changes they can make to improve the energy efficiency of their

homes. The participants trust that the thermal camera is very effective tool to reveal the heat loss (92%) and is very easy to use (96%).

7.2.2. The qualitative results

The qualitative results include many case studies and comments combined with thermal images, where the participants discuss different aspects related to their energy consumption, building, experience, etc. Even the qualitative results of the building thermography survey confirm significantly the improvement of participants' awareness concerning the identification of the cold sources in their buildings, after carrying out the thermography survey. A comparison between the responses from the first questionnaire (pre-test) and the third (post-test) shows once again a clear improvement of people's awareness regarding the energy measures which make the biggest saving effect in their homes. According to the reviewed literature, it is significantly important to understand that the behaviour is related to the problem (energy consumption) [111]. Many comments express improvement of energy awareness "Learning how much energy certain types of heaters use and how that translates into actual cost on bills". (P42)

Participants' degree of motivation can be related to the degree of involvement created by the intervention and participants' previous attitudes [101]. Providing such attractive modern device (FLIR One) to allow people to inspect their own homes and identify the area of problem in their insulation may increase their motivation to be engaged towards a more sustainable energy consumption.

Some participants feel the power of the visual image [95], which convinces them to plan to replace an inefficient window with a new one, which evaluates as a better solution in terms of energy saving:

The thermal imaging showed that heat was being lost through the windows ... It may be time to think about replacing my double glazed windows... (P23)

I saw how much heat is being lost through the exterior walls and how much difference it would make to insulate walls.... (P18)

According to Fischer, the most successful feedback has to present an appliance-specific breakdown information, computerized, interactive and displayed in an attractive way [105]. Many of the comments show a significant interest in the thermal camera and the thermal images “This device is quite interesting and amazing because it tells me how and where heat is going out from my room. Now I know how to minimize room-heat loss”. (P12)

Most of the homes that are built before 1919 probably have solid external walls and they lose twice as much heat as cavity ones do [46]. Insulation of solid walls therefore has significant potential to save energy.

I plan on having the walls insulated as there are no cavity walls thus lots of heat escaping. (P14)

In many cases the participants identified gaps around doors, which confirm a very common problem in general, which mainly depends on the age of the doors in the old homes.

I am losing heat from around the front door frame, which I plan to reduce by fitting foam insulation strip. (P45)

The participants identified how old windows, both single and double glazed, and even some low quality new double glazed are losing energy in buildings.

The thermal imaging showed that heat was being lost through the windows ... It may be time to think about replacing my double glazed windows... (P23)

Loft hatch is an area within the building where lots of heat can be lost, therefore it is necessary to make sure that the loft hatch fits snugly and draught proof strips are being fitted around the edges

The thermal imaging showed that heat was being lost through the windows and especially through the hatch door to the roof space. ... I shall certainly see to insulating the roof space hatch door. (P23)

Some participants were able to discover some defect/damage in their wall, which they did not suspect previously, and immediately they try to investigate and solve the issue in a professional way.

I'm going to contact a builder/expert to look into the heat loss in our back bedroom - there was a lot of heat loss at the top of the side wall (all the way across) where the guttering is externally. (P34)

We will also look at the small front bedroom above the window -there was a lot of heat loss there too. (P38)

7.3. Physical educational simulation tool

The second part of the research consists of developing an innovative physical simulation system. The system has been developed as an educational and research tool for simulation of energy consumption in buildings, which comprises of modular building models. The suggested modular physical model of the building comprises of a modular and layered structural system, which can be easily modified with the introduction of thermal insulating layers. Additionally, the system provide an internal and external control of heating and cooling of the building model and the associated control of the simulated or realistic external environment. This educational kit will enable the teaching of the values of energy and insulation. The tool has been tested in the laboratory to simulate and control the outdoor and indoor environment. Some of the laboratory data are presented as experimental work. Additionally, the tool has been tested at primary school level and university, and the results are presented in form of two separate case studies.

The results of this part are presented by one experimental work and two case studies.

7.3.1. Experimental work

The experimental work of the educational tool shows significant results. The heating in the insulated building reached the target temperature after a few minutes, while this did not happen for the non-insulated building. The heating in the insulated building was turned off for more than half of the time, but for the non-insulated building was for whole the time on. This heating behaviour is visualised in a very clear way when the light bulb is used as the source of heating. The results of the energy consumption record significant differences

between the insulated and non-insulated house. The insulated building shows more than 50% saving compared to the non-insulated building. Additionally, the thermographic inspection of the educational model visualizes clearly the huge amount of energy loss of the non-insulated building compared to the insulated one.

7.3.2. Case studies

The results of the case studies show significant differences between the insulated and non-insulated building models in term of energy consumption and the recorded indoor temperature. Moreover, the indoor temperature stability and the required time to reach the target temperature are experienced big differentiation. The energy loss from the building models is visualised by an infrared camera, which again shows the significant energy saving achieved by providing insulation. It has been found that the non-insulated building consumes more than double the energy of the insulated building, despite the fact it never reached the required temperature.

7.3.2.1. Case study 1

The results of the first case study confirm the effectiveness of the tool in supporting the teaching of energy consumption in the building. The demonstration session carried out successfully and the activities gave significant results. All the pupils were able to answer all the questions included in the activity sheet correctly. The results show a significant improvement in understanding the role of insulation in saving energy within the building. Additionally, significant numbers of the pupils agree or strongly agree that the thermal camera was easy to use to inspect the heat losses from the building models, and described the activity as enjoyable.

The activity sheet works even as a feedback for the teacher to evaluate if the learning outcomes of the session are achieved or not. This is a good evidence which confirms the improvement of the technical skills, which are expected in the national curriculum [118] and shows the opportunities behind this educational tool.

Regarding “what the pupils have learned” in the educational session, students have expressed different experiences, such as

- *What insulation is.*
- *That insulation helps to keep heat in*
- *What a temperature and power sensors are.*
- *You can use a thermal camera to see heat and heat loss.*

7.3.2.2. Case study 2

The results of the second case study confirm again the efficiency of the educational tool. The university students also showed a positive experience of using the infrared camera to detect the heat loss of an object. The running of the educational simulation system, including the associated instrumentation, creates an enjoyable and scientifically inspiring experience.

Concerning the benefits of this educational tool in achieving the learning outcomes of the session, the university students’ feedback has indicated the following benefits from their own experience:

- *Understanding the benefits of insulation in buildings, energy saving and the economic and environmental implications.*
- *How to calculate and measure energy usage in KWH.*
- *The use of the infrared camera and the interpretation of its images to estimate heat losses in a building in order to improve insulation and maximum energy saving.*

Additionally, the involved lecturer at the university was also convinced that the educational tool can contribute to their teaching, and she indicated that “*This simulation tool can help in our teaching*”.

7.4. Nottingham Playhouse (building monitoring)

The last part focused on monitoring of the energy in an existing public building in Nottingham. The investigation covered the monitoring of temperature,

humidity, door operation and audience pattern during a whole winter season by using different data logger sensors. The internal and external temperature of different parts of the building has been recorded every 15 minutes for more than three months. The door opening/closing actions were also collected for more than three months. The audience figures of each performance during the same period have been recorded. The study highlights the body heat as a sustainable portable heating source that can be utilised and integrated into the design of the indoor heating system. The results of the building monitoring have identified significant energy saving potentials. The study confirms that the insulation system provides an acceptable indoor temperature. The investigation identified the lack of an efficient ventilation system, equipped with heat recovery to prevent eventual overheating caused by audience body temperature and utilising the heat of the air exfiltration. The influence of the location on the indoor temperature is also identified. The study even confirmed the correlation between the audience door actions and the decreasing of the indoor temperature, as well as the number of occupants and the room temperature. This part of the study confirms the impact of different factors, such as insulation, outdoor climate and people behaviour and presence on the achieved indoor temperature. The auditorium has a much higher temperature than the rest of the building as it is insulated by the surrounded parts of the building. The air infiltration/exfiltration results in decreasing the temperature in the auditorium, when the number of audience is low. The body heat of occupants has to be taken into consideration in design and operation of HVAC systems. Moreover, the dynamic interaction between occupants, building and HVAC has to be balanced in order to achieve a sustainable indoor environment.

7.5. Contribution to Knowledge

The following contributions to knowledge have been achieved:

1. An innovative physical educational simulation model has been developed, which can be used for research and teaching about energy consumption in building, to enhance people engagement.

2. A general novel methodology for people engagement has been developed, which is applied in this thesis to enhance people engagement in energy conservation in the building.
3. An innovative design of two building model to show the impact of insulation in the building is developed for the first time.
4. Teaching about energy consumption in building and the impact of insulation has been carried out in school and university in a visual and simple way for the first time by using the developed educational tool.
5. For the first time 50 householder were educated and engaged to carry out a thermographic survey of their own homes.
6. This research makes the thermographic survey for the householder cheaper, more personal, increases energy awareness and provides more involvement and accessibility measures.
7. The research led to the identification of insulation issues in many building, and according to the results, some of the householders showed the interest take action to improve the efficiency.
8. The research was able to improve public's awareness and engagement in relation to energy consumption in buildings by using modern technology.
9. The research was able to change people behaviour to achieve more sustainable energy consumption in the building.
10. The research was able to monitor the energy consumption in an existing building in Nottingham and identify energy saving potentials.
11. The research was able to come with recommendations to improve the energy consumption in an existing building by making the operation of HVAC more effective.

7.6. Final conclusion

Modern technologies (e.g. thermal imagery), innovative design (e.g. the developed educational tool) and methodologies (e.g. the developed novel methodology) are able to enhance public engagement in energy conservation in the building. Moreover, they are even able to improve public awareness and change behaviour toward a more sustainable energy consumption in the

building. The balance between building, occupants and operation of the building can promote an improvement of the building energy performance.

7.7. Recommendation and future work

Because of the time limitation of this PhD, the thermography survey was not designed to follow up the participant's renovation plans to get more complete results of the benefit of this research. The future work can include more participants and cover a longer period to evaluate the actual energy saving and the behaviour change. The future work can provide the opportunity for more dialogue between the researcher and the participants during their thermography survey. Subject to the above time limitation in this research, the developed educational tool has been tested in limited places at school and university levels. The future work will focus on the development of the tool by providing the opportunity for more schools to be involved. The future work at Nottingham Playhouse needs to implement a methodology for identification and improvement of occupant behaviour in relation to energy consumption. Moreover, it will focus on the calculation of the heating and cooling demand of different places of the building in order to design the operation of the HVAC system according to the occupancy figures.

7.8. Summary

Finally, I would like to confirm that the above discussions and conclusions are significant evidences that the contribution to knowledge is achieved in every single part of the research. The correlation between the parts reveals how the building, occupants and the operation of the building can influence each other, and explains how modern technology can enhance the engagement of occupants in reducing the energy consumption in the building.

REFERENCES

- [1] “EU Energy and Transport in Figures, Statistical Pocket Book 2007/2008,” Euro-pean Communities, Brussels, Belgium, 2008.
- [2] EU, “Directive 2010/31/EU of the European Parliament and of the Council of 19 May 2010 on the energy performance of buildings (recast),” *Off. J. Eur. Union*, pp. 13–35, 2010.
- [3] L. Aditya *et al.*, “A review on insulation materials for energy conservation in buildings,” *Renew. Sustain. Energy Rev.*, vol. 73, no. August 2015, pp. 1352–1365, 2017.
- [4] J. Lee, J. Kim, D. Song, J. Kim, and C. Jang, “Impact of external insulation and internal thermal density upon energy consumption of buildings in a temperate climate with four distinct seasons,” *Renew. Sustain. Energy Rev.*, vol. 75, no. January 2016, pp. 1081–1088, 2017.
- [5] A. Al-Habaibeh, G. Anderson, K. Damji, G. Jones, and K. Lam, “Using Infrared Thermography for Monitoring Thermal Efficiency of Buildings- Case Studies From Nottingham Trent University,” *7th Jordanian Int. Mech. Eng. Conf. 27 - 29 Sept. 2010, Amman – Jordan 2.*, no. September, pp. 27–29, 2010.
- [6] M. Kameni Nematchoua, P. Ricciardi, S. Reiter, and A. Yvon, “A comparative study on optimum insulation thickness of walls and energy savings in equatorial and tropical climate,” *Int. J. Sustain. Built*

Environ., 2017.

- [7] F. Gholizadeh, H. R. Saba, and E. Shakeri, "Impact of Insulation on Reduction of Energy Consumption in Buildings Based on Climate in Iran," vol. 14, no. 2, pp. 97–103, 2014.
- [8] U. Y. A. Tettey, A. Doodoo, and L. Gustavsson, "Effects of different insulation materials on primary energy and CO₂ emission of a multi-storey residential building," *Energy Build.*, vol. 82, pp. 369–377, 2014.
- [9] J. Yu, C. Yang, L. Tian, and D. Liao, "A study on optimum insulation thicknesses of external walls in hot summer and cold winter zone of China," *Appl. Energy*, vol. 86, no. 11, pp. 2520–2529, 2009.
- [10] K. Hilliaho, A. Köliö, T. Pakkala, J. Lahdensivu, and J. Vinha, "Effects of added glazing on Balcony indoor temperatures: Field measurements," *Energy Build.*, vol. 128, pp. 458–472, 2016.
- [11] J. Kim and J. W. Moon, "Impact of Insulation on Building Energy Consumption," *Build. Simul. 2009*, pp. 674–680, 2009.
- [12] P. Johansson, C. E. Hagentoft, and A. Sasic Kalagasidis, "Retrofitting of a listed brick and wood building using vacuum insulation panels on the exterior of the facade: Measurements and simulations," *Energy Build.*, vol. 73, pp. 92–104, 2014.
- [13] M. F. L. I. N. Camilleri, "The effect of mandatory insulation on household energy," *Branz*, vol. 130, no. 130, pp. 1–12, 2008.
- [14] J. Friege, "Increasing homeowners' insulation activity in Germany: An empirically grounded agent-based model analysis," *Energy Build.*, vol. 128, pp. 756–771, 2016.
- [15] DECC, "Domestic Green Deal and Energy Company Obligation in Great Britain, Monthly Report," no. September, pp. 1–11, 2015.
- [16] C. a. Balaras and a. a. Argiriou, "Infrared thermography for building diagnostics," *Energy Build.*, vol. 34, pp. 171–183, 2002.
- [17] A. Kylili, P. A. Fokaides, P. Christou, and S. A. Kalogirou, "Infrared

- thermography (IRT) applications for building diagnostics: A review,” *Appl. Energy*, vol. 134, pp. 531–549, 2014.
- [18] N. P. Avdelidis and a. Moropoulou, “Applications of infrared thermography for the investigation of historic structures,” *J. Cult. Herit.*, vol. 5, pp. 119–127, 2004.
- [19] S. Mart, I. Cañas, and I. González, “Thermographic survey of two rural buildings in Spain,” vol. 36, pp. 515–523, 2004.
- [20] F. Asdrubali, G. Baldinelli, and F. Bianchi, “A quantitative methodology to evaluate thermal bridges in buildings,” *Appl. Energy*, vol. 97, pp. 365–373, 2012.
- [21] L. Zalewski, S. Lassue, D. Rouse, and K. Boukhalfa, “Experimental and numerical characterization of thermal bridges in prefabricated building walls,” *Energy Convers. Manag.*, vol. 51, no. 12, pp. 2869–2877, 2010.
- [22] T. Taylor, J. Counsell, and S. Gill, “Energy efficiency is more than skin deep: Improving construction quality control in new-build housing using thermography,” *Energy Build.*, vol. 66, pp. 222–231, 2013.
- [23] T. Taylor *et al.*, “In-construction testing of the thermal performance of dwellings using thermography,” *Smart Innov. Syst. Technol.*, vol. 12, pp. 307–318, 2012.
- [24] M. L. Mauriello, M. Dahlhausen, E. Brown, M. Saha, and J. Froehlich, “The Future Role of Thermography in Human-Building Interaction,” *Proc. 34rd Annu. ACM Conf. Ext. Abstr. Hum. Factors Comput. Syst.*, 2016.
- [25] J. Goodhew, S. Pahl, T. Auburn, and S. Goodhew, “Making Heat Visible: Promoting Energy Conservation Behaviors Through Thermal Imaging,” *Environ. Behav.*, 2014.
- [26] R. Cabello, J. Navarro-Esbrí, R. Llopis, and E. Torrella, “Infrared thermography as a useful tool to improve learning in heat transfer related subjects,” *Int. J. Eng. Educ.*, 2006.

- [27] J. Haglund, E. Melander, M. Weiszflog, and S. Andersson, "University physics students' ideas of thermal radiation expressed in open laboratory activities using infrared cameras," *Res. Sci. Technol. Educ.*, vol. 5143, no. July, pp. 1–19, 2017.
- [28] J. Haglund, F. Jeppsson, E. Melander, A. M. Pendrill, C. Xie, and K. J. Schönborn, "Infrared cameras in science education," *Infrared Phys. Technol.*, vol. 75, pp. 150–152, 2016.
- [29] C. Xie, "Visualizing Chemistry with Infrared Imaging," pp. 881–885, 2011.
- [30] C. Xie, E. Hazzard, and S. Nourian, "Infusing Technology Into Engineering Education," *Eng. Des. Educ. Res. Summit, P-12*, pp. 1–14, 2010.
- [31] A. Hawas, A. Al-Habaibeh, and B. Medjdoub, "Innovative Design of an Educational Physical Simulation Tool for Investigating Energy Consumption in Buildings for Enhancing Public Engagement," *Energy Procedia*, vol. 105, no. 0, pp. 2615–2622, 2017.
- [32] A. Al-Habaibeh and A. Hawas, "An educational and research apparatus for simulating thermal performance and energy efficacy of building," *Patents J.*, vol. 6637 Uk, no. GB1610666.8, 2016.
- [33] European Commission, "Communication from the Commission to the Council, the European Parliament, the European Economic and Social Committee and the Committee of the Regions - Limiting Global Climate Change to 2 degrees Celsius - The way ahead for 2020 and beyond," *Comm. Eur. Communities*, p. Brussels, 2007.
- [34] Parliament of the United Kingdom, "Climate Change Act 2008," *HM Gov.*, pp. 1–103, 2008.
- [35] (Department of Energy & Climate Change) DECC, "Domestic energy fact file 2008," *Energy*, pp. 1–99, 2008.
- [36] A. Power, "Does demolition or refurbishment of old and inefficient homes help to increase our environmental, social and economic

- viability?,” *Energy Policy*, vol. 36, no. 12, pp. 4487–4501, 2008.
- [37] IEA, “World Energy Outlook 2013,” *Paris Int. Energy Agency*, pp. 1–7, 2013.
- [38] “International Energy Agency , ‘ BLUE Map ’ (2010),” 2010.
- [39] DCLG, “Building a Greener Future: policy statement,” p. 25, 2007.
- [40] Zero Carbon Hub, “Defining a fabric energy efficiency standard for zero carbon homes,” *Group*, no. November, 2009.
- [41] S. M. Wirth, “Gebäudetechnische Systemlösungen für Niedrigenergiehäuser,” *Ernst&Sohn*, no. 9783433028445, p. 208, 2002.
- [42] Feby, “Kravspecifikation för nollenergihus, passivhus och minienergihus: Lokaler,” pp. 1–16, 2012.
- [43] W. Feist, “Definition of passive houses,” 2006. [Online]. Available: http://www.passivhaustrust.org.uk/what_is_passivhaus.php.
- [44] PHA, “Active for More Comfort: Passive House,” p. 77, 2014.
- [45] Department for Communities and Local Government, “Next steps to zero carbon homes – Allowable Solutions - Government response and summary of responses to the consultation,” no. July, p. 80, 2014.
- [46] N. Ireland and H. Executive, “External Wall Insulation Pilot Scheme,” no. July, 2013.
- [47] S. Instruments, “2011 No . 1515 BUILDING AND BUILDINGS , ENGLAND AND WALES The Building (Amendment) Regulations 2011,” vol. 2, no. 1515, pp. 1–4, 2011.
- [48] Å. Jönsson, A.-M. Tillman, and T. Svensson, “Life cycle assessment of flooring materials: Case study,” *Build. Environ.*, vol. 32, no. 3, pp. 245–255, 1997.
- [49] A. D. La Rosa *et al.*, “Environmental impacts and thermal insulation performance of innovative composite solutions for building applications,” *Constr. Build. Mater.*, vol. 55, pp. 406–414, 2014.

- [50] Ellie Cambridge and Emma Lake, "What caused the Grenfell Tower fire? How cladding and a Hotpoint fridge contributed to the deadly London blaze," 2017. [Online]. Available: <https://www.thesun.co.uk/news/3805218/grenfell-tower-fire-causes-cladding-fridge-london-blaze/>. [Accessed: 12-Dec-2017].
- [51] BBC, "Greenfell Tower, London," 2017. [Online]. Available: [WWW.bbc.co.uk](http://www.bbc.co.uk). [Accessed: 12-Dec-2017].
- [52] V. Marincioni, H. Altamirano-medina, N. May, and C. Sanders, "Estimating the impact of reveals on the transmission heat transfer coefficient of internally insulated solid wall dwellings," *Under Rev.*, vol. 128, pp. 405–412, 2016.
- [53] W. Zhang, L. Lu, J. Peng, and A. Song, "Comparison of the overall energy performance of semi-transparent photovoltaic windows and common energy-efficient windows in Hong Kong," *Energy Build.*, vol. 128, pp. 511–518, 2016.
- [54] BRE, "SAP 2012 The Government 's Standard Assessment Procedure for Energy Rating of Dwellings," *Energy*, no. March, p. 174, 2014.
- [55] T. Air and T. Testing, "MEASURING AIR PERMEABILITY OF October 2010 Issue," vol. 44, no. 1, pp. 1–32, 2010.
- [56] RDH Building Engineering Ltd, "Air Leakage Control in Multi-Unit Residential Buildings," 2013.
- [57] F. Haldi and D. Robinson, "On the behaviour and adaptation of office occupants," *Build. Environ.*, vol. 43, no. 12, pp. 2163–2177, Dec. 2008.
- [58] A. Lotfi, L. I. Jalil, and A. Al-Habaibeh, "Investigating occupant behaviour to improve energy efficiency in social housing: Case study," *Proc. - 9th Int. Conf. Intell. Environ. IE 2013*, no. July, pp. 124–128, 2013.
- [59] R. H. Dodier, G. P. Henze, D. K. Tiller, and X. Guo, "Building occupancy detection through sensor belief networks," *Energy Build.*, vol. 38, pp. 1033–1043, 2006.

- [60] O. Guerra-Santin, C. Tweed, H. Jenkins, and S. Jiang, "Monitoring the performance of low energy dwellings: Two UK case studies," *Energy Build.*, vol. 64, pp. 32–40, 2013.
- [61] K. Irwin, K. Parker, J. Petersen, R. Troutfetter, I. Walker, and J. Petersen, "ANSI / RESNET / ICC 380-2016 Standard for Testing Airtightness of Building Enclosures , Airtightness of Heating and Cooling Air Distribution Systems , and Airflow of Mechanical Ventilation Systems," 2016.
- [62] ASTM International, "Standard Test Method for Determining Air Leakage Rate by Fan Pressurization 1," *Astm*, 2010.
- [63] International Organization for standardization, *Sistema de gestión de la calidad - Fundamentos y vocabulario ISO 9000:2005*. 2005.
- [64] E. L. Hult, M. H. Sherman, and I. Walker, "Blower-door techniques for measuring interzonal leakage," pp. 1–17, 2014.
- [65] W. State and E. Code, "Building Air Leakage Testing 2012," pp. 10–11, 2012.
- [66] C. J. Ghazi and J. S. Marshall, "A CO₂ tracer-gas method for local air leakage detection and characterization," *Flow Meas. Instrum.*, 2014.
- [67] F. Pressurization, "Standard Test Method for Determining Air Change in a Single Zone by Means of a," *Time*, vol. 00, no. Reapproved 2006, pp. 1–17, 2009.
- [68] T. Patel, C. Mitsingas, J. P. Miller, and T. A. Newell, "Comparison of Blower Door and Tracer Gas Testing Methods for Determination of Air Infiltration Rates Through Building Envelopes at Normal Operating Conditions," *ASME 2011 5th Int. Conf. Energy Sustain. Parts A, B, C*, no. April, pp. 1013–1019, 2011.
- [69] N. P. Avdelidis and a. Moropoulou, "Emissivity considerations in building thermography," *Energy Build.*, vol. 35, pp. 663–667, 2003.
- [70] E. Grinzato, C. Bressan, S. Marinetti, P. G. Bison, and C. Bonacina, "Monitoring of the Scrovegni Chapel by IR thermography: Giotto at

- infrared,” *Infrared Phys. Technol.*, vol. 43, pp. 165–169, 2002.
- [71] E. Grinzato, P. G. Bison, and S. Marinetti, “Monitoring of ancient buildings by the thermal method,” *J. Cult. Herit.*, vol. 3, pp. 21–29, 2002.
- [72] C. Meola, R. Di Maio, N. Roberti, and G. M. Carlomagno, “Application of infrared thermography and geophysical methods for defect detection in architectural structures,” *Eng. Fail. Anal.*, vol. 12, pp. 875–892, 2005.
- [73] I. J. Amin, a. J. Taylor, F. Junejo, a. Al-Habaibeh, and R. M. Parkin, “Automated people-counting by using low-resolution infrared and visual cameras,” *Meas. J. Int. Meas. Confed.*, vol. 41, pp. 589–599, 2008.
- [74] Y. Benezeth, H. Laurent, B. Emile, and C. Rosenberger, “Towards a sensor for detecting human presence and characterizing activity,” *Energy Build.*, vol. 43, pp. 305–314, 2011.
- [75] M. Massoud, *Engineering Thermofluids*. Heidelberg New York: Springer, 2005.
- [76] Y. A. Cengel, *Introduction to thermodynamics and heat transfer*, Second. New York: McGraw-Hill, 1997.
- [77] FLIR Systems AB, “Thermal imaging guidebook for building and renewable energy applications,” 2011.
- [78] C. A. Balaras and A. A. Argiriou, “Infrared thermography for building diagnostics,” vol. 34, pp. 171–183, 2002.
- [79] C. Fan, F. Sun, and L. Yang, “Investigation on Nondestructive Evaluation of Pipelines Using Infrared Thermography testAM infrared caroera,” pp. 339–340, 2005.
- [80] T. Hao *et al.*, “Condition assessment of the buried utility service infrastructure,” *Tunn. Undergr. Sp. Technol. Inc. Trenchless Technol. Res.*, vol. 28, pp. 331–344, 2012.
- [81] E. Z. Kordatos, D. G. Aggelis, and T. E. Matikas, “Composites : Part B

- Monitoring mechanical damage in structural materials using complimentary NDE techniques based on thermography and acoustic emission,” *Compos. Part B*, vol. 43, no. 6, pp. 2676–2686, 2012.
- [82] R. Montanini, “Infrared Physics & Technology Quantitative determination of subsurface defects in a reference specimen made of Plexiglas by means of lock-in and pulse phase infrared thermography,” *Infrared Phys. Technol.*, vol. 53, no. 5, pp. 363–371, 2010.
- [83] S. A. Grammatikos, E. Z. Kordatos, T. E. Matikas, C. David, and A. S. Paipetis, “Current injection phase thermography for low-velocity impact damage identification in composite laminates,” *J. Mater.*, vol. 55, pp. 429–441, 2014.
- [84] M. Genest, M. Martinez, N. Mrad, G. Renaud, and A. Fahr, “Pulsed thermography for non-destructive evaluation and damage growth monitoring of bonded repairs,” *Compos. Struct.*, vol. 88, no. 1, pp. 112–120, 2009.
- [85] S. Edsjø and B. Petter, “Vacuum insulation panel products : A state-of-the-art review and future research pathways,” vol. 116, no. 7465, pp. 355–375, 2014.
- [86] T. Taylor, J. Counsell, A. Geens, S. Gill, and G. Oakley, “Checking ‘ Fabric First ’ Really Works : in - Construction Tests Using Thermography,” *33rd AIVC Conf.*, pp. 138–142, 2012.
- [87] M. Fox, D. Coley, S. Goodhew, and P. De Wilde, “Time-lapse thermography for building defect detection,” *Energy Build.*, vol. 92, pp. 95–106, 2015.
- [88] I. Nardi, S. Sfarra, and D. Ambrosini, “Quantitative thermography for the estimation of the U-value : state of the art and a case study,” *J. Phys. Conf. Ser.*, vol. 547, pp. 1–9, 2014.
- [89] I. Nardi, D. Paoletti, D. Ambrosini, T. De Rubeis, and S. Sfarra, “U - value assessment by infrared thermography : a comparison of different calculation methods in a Guarded Hot Box,” *Energy Build.*, vol. 122,

- pp. 211–221, 2016.
- [90] T. Taylor, J. Counsell, and S. Gill, “Combining thermography and computer simulation to identify and assess insulation defects in the construction of building façades,” *Energy Build.*, vol. 76, pp. 130–142, 2014.
- [91] J. Kim, J. Lee, J. Kim, C. Jang, H. Jeong, and D. Song, “Appropriate conditions for determining the temperature difference ratio via infrared camera,” *Build. Serv. Eng. Res. Technol.*, pp. 1–16, 2015.
- [92] A. Antonyová, P. Antony, and A. Korjenic, “Laboratory measurement of thermal distribution throughout the insulation materials using the Peltier module while managing elimination of external influences,” *Energy Build.*, vol. 128, pp. 336–348, 2016.
- [93] European Parliament, “Directive 2012/27/EU of the European Parliament and of the Council of 25 October 2012 on energy efficiency,” *Off. J. Eur. Union Dir.*, no. October, pp. 1–56, 2012.
- [94] D. Wang, C. C. Federspiel, and F. Rubinstein, “Modeling occupancy in single person offices,” *Energy Build.*, vol. 37, pp. 121–126, 2005.
- [95] F. Yousefi, Y. Gholipour, and W. Yan, “A Study of the Impact of Occupant Behaviors on Energy Performance of Building Envelopes Using Occupants’ Data,” *Energy Build.*, vol. 148, pp. 182–198, 2017.
- [96] O. Guerra Santin, “Behavioural Patterns and User Profiles related to energy consumption for heating,” *Energy Build.*, vol. 43, no. 10, pp. 2662–2672, Oct. 2011.
- [97] A. Mahdavi, A. Mohammadi, E. Kabir, and L. Lambeva, “Shading and lighting operation in office buildings in Austria: A study of user control behavior,” *Build. Simul.*, vol. 1, no. 2, 2008.
- [98] W. Parys, D. Saelens, and H. Hens, “Impact of occupant behavior on lighting energy use,” *Proc. Build. Simul. 2009*, no. Dc, pp. 1143–1150, 2009.
- [99] Z. J. Yu Zhun Jerry, F. Haghghat, B. C. M. Fung, E. Morofsky, and H.

- Yoshino, "A methodology for identifying and improving occupant behavior in residential buildings," *Energy*, vol. 36, no. 11, pp. 6596–6608, 2011.
- [100] Z. Yu, B. C. M. Fung, F. Haghghat, H. Yoshino, and E. Morofsky, "A systematic procedure to study the influence of occupant behavior on building energy consumption," *Energy Build.*, vol. 43, pp. 1409–1417, 2011.
- [101] A. Darnton, *GSR Behaviour Change Knowledge Review Practical Guide*. 2008.
- [102] D. Southerton, A. McMeekin, and D. Evans, "International Review of Behaviour Change Initiatives," *Soc. Res. (New. York)*., 2011.
- [103] R. Hine, J. Peacock, and J. Pretty, "Evaluating the impact of environmental volunteering on behaviours and attitudes to the environment," *Rep. Br. Trust Conserv. ...*, no. April, pp. 1–44, 2008.
- [104] T. Jackson, "Motivating Sustainable Consumption," *A Rev. Evid. Consum. Behav. Behav. Chang. A Rep. to Sustain. Dev. Res. Netw. as part ESRC Sustain. Technol. Program. Cent. Environ. Strateg. Univ. Surrey Guildf.*, vol. 15, no. January, pp. 1027–1051, 2005.
- [105] C. Fischer, "Feedback on household electricity consumption: A tool for saving energy?," *Energy Effic.*, vol. 1, no. 1, pp. 79–104, 2008.
- [106] J. Burgess and M. Nye, "Re-materialising energy use through transparent monitoring systems," *Energy Policy*, vol. 36, no. 12, pp. 4454–4459, 2008.
- [107] B. Sheldrick and S. Macgill, "Local energy conservation initiatives in the UK: Their nature and achievements," *Energy Policy*, vol. 16, no. 6, pp. 562–578, 1988.
- [108] E. Shove, "Comfort, Cleanliness and Convenience," *Soc. Organ. Norm.*, no. Oxford, New York, Berg., 2003.
- [109] S. J. O'Neill, M. Boykoff, S. Niemeyer, and S. a. Day, "On the use of imagery for climate change engagement," *Glob. Environ. Chang.*, vol.

- 23, no. 2, pp. 413–421, 2013.
- [110] H. Joffe, “The power of visual material: Persuasion, emotion and identification,” no. 2006, pp. 84–93, 2008.
- [111] A. Boholm, “Visual images and risk messages: commemorating Chernobyl,” *Risk Decis. Policy* 160, vol. 3, no. 2, pp. 125–143, 1998.
- [112] A. Iyer and J. Oldmeadow, “Picture this: Emotional and political responses to photographs of the Kenneth Bigley kidnapping,” *Eur. J. Soc. Psychol.*, vol. 36, no. 5, pp. 635–647, 2006.
- [113] T. Hong, “Occupant behavior: impact on energy use of private offices,” *ASim 2012-1st Asia Conf. Int. ...*, no. January, 2013.
- [114] A. Menezes, R. M. Tetlow, C. P. Beaman, A. Cripps, D. Bouchlaghem, and R. Buswell, “Assessing the impact of occupant behaviour on the electricity consumption for lighting and small power in office buildings,” 2012.
- [115] M. A. Humphreys and J. F. Nicol, “Understanding the adaptive approach to thermal comfort,” *Education*, vol. 104, no. 1994, pp. 991–1004, 1998.
- [116] S. Darby, “The Effectiveness of Feedback on Energy Consumption a Review for Defra of the Literature on Metering , Billing and Direct Displays,” *Environ. Chang. Inst. Univ. Oxford*, vol. 22, no. April, pp. 1–21, 2006.
- [117] C. Oltra, A. Boso, J. Espluga, and A. Prades, “A qualitative study of users’ engagement with real-time feedback from in-house energy consumption displays,” *Energy Policy*, vol. 61, pp. 788–792, 2013.
- [118] C. Wilson and H. Dowlatabadi, “Models of Decision Making and Residential Energy Use,” *Annual Review of Environment and Resources*, vol. 32, no. 1. pp. 169–203, 2007.
- [119] P. C. Gardner, G.T. & Stern, *Environmental problems and human behavior*, 2:nd ed. Pearson, Boston, 2002.

- [120] R. Tetlow, C. Beaman, A. Elmualim, and K. Couling, "The impact of occupant behaviour on the variation between the design and in-use energy consumption of non-domestic buildings: An experimental approach," *readingconnect.net*, 2012.
- [121] H. B. Rijal, P. Tuohy, J. F. Nicol, M. A. Humphreys, A. Samuel, and J. Clarke, "Development of an adaptive window-opening algorithm to predict the thermal comfort, energy use and overheating in buildings," *Build. Perform. Simul.*, vol. 1, pp. 17–30, 2008.
- [122] A. Bandura, *Social foundations of thought and action: A social cognitive theory*, vol. 1. 1986.
- [123] C. J. Armitage and M. Conner, "Efficacy of the Theory of Planned Behaviour: A meta-analytic review," no. 2001, pp. 471–499, 2001.
- [124] I. Ajzen, "The theory of planned behavior," *Organizational Behav. Hum. Decis. Process.*, vol. 50, pp. 179–211, 1991.
- [125] J. O. Prochaska, C. A. Redding, and K. E. Evers, "The transtheoretical model and stages of change.," *Health behavior and health education: Theory, research, and practice (4th ed.)*. Jossey-Bass, pp. 97–121, 2008.
- [126] E. Matthies, "Wie können PsychologInnen ihr Wissen besser an die PraktikerInnen bringen? Vorschlag eines neuen, integrativen Einflusschemas umweltgerechten Alltagshandelns.[How can psychologists better put across their knowledge to practitioners? Suggesting a new, integr," *Umweltpsychologie*, vol. 9(1), pp. 62–81, 2005.
- [127] A. Reckwitz, "Toward a Theory of Social Practices A Development in Culturalist Theorizing," vol. 5, no. 2, pp. 243–263, 2002.
- [128] J. Morris, "and behaviour change Contents," pp. 1–27, 2012.
- [129] A. Smith, A. Stirling, and F. Berkhout, "The governance of sustainable socio-technical transitions," vol. 34, pp. 1491–1510, 2005.
- [130] S. Randles, R. & Mander, "Practice(s) and Ratchet(s):A Sociological

- Examination of Frequent Flying,” 2009.
- [131] E. M. Rogers, *Diffusion of Innovations*, 5th editio. Free Press, 2003.
- [132] O. Greenhalgh, T., Robert, G., Macfarlane, F., Bate, P. & Kyriakidou, “Diffusion of Innovations in Service Organizations: Systematic Review and Recommendations,” vol. 82, no. 4, pp. 581–629, 2004.
- [133] Department for Education, “Science programmes of study : key stages 1 and 2,” *Dep. Educ. UK Govt.*, no. September, pp. 1–34, 2013.
- [134] R. Llopis, R. Cabello, and E. Torrella, “Infrared Thermography as a Useful Tool to Improve Learning in Heat Transfer Related Subjects *,” vol. 22, no. 2, pp. 373–380, 2006.
- [135] C. Xie and E. Hazzard, “Infrared Imaging for Inquiry-Based Learning,” *Phys. techers*, vol. 49, pp. 368–372, 2011.
- [136] A. C. Leon, L. L. Davis, and H. C. Kraemer, “The role and interpretation of pilot studies in clinical research,” *J. Psychiatr. Res.*, 2010.
- [137] Kemo, “Temperature switch-thermostat 12 V/DC.” [Online]. Available: <https://www.kemo-electronic.de/en/Transformer-Dimmer/Sensors/Modules/M169A-Temperature-switch-thermostat-12-V-DC.php>.
- [138] A. Al-Habaibeh, *Improvement of energy efficiency at Nottingham Playhouse*. 2014.

Appendices

- Appendix 1: Home Energy Efficiency Questionnaire (Pre-test)
- Appendix 2: The Infrared Thermography Session Questionnaire
- Appendix 3: Home Energy Efficiency Questionnaire (Post-test)
- Appendix 4: Conditions for use and Health and Safety
- Appendix 5: Building Energy Efficiency Feedback
- Appendix 6: Building Energy Efficiency Feedback
- Appendix 7: Demonstration Session
- Appendix 8: Energy Activity
- Appendix 9: ETHICAL CLEARANCE CHECKLIST 01
- Appendix 10: Proforma: Research Consent Information Sheet 01
- Appendix 11: ETHICAL CLEARANCE CHECKLIST 02
- Appendix 12: Proforma: Research Consent Information Sheet 02
- Appendix 13: Conference Paper 01
- Appendix 14: Table 7 1 the sociodemographic characteristic data
- Appendix 15: The results of the training session
- Appendix 16: The results of the first questionnaire
- Appendix 17: The results of comparison between Pre-test and Post-test

Appendix 1: Home Energy Efficiency Questionnaire (Pre-test)

This is a questionnaire on energy usage and efficiency in homes in the U.K. It will be used in an investigation into energy consumption and efficiency in the residential sector by Nottingham Trent University.

It will take a short time to complete and your participation will be greatly appreciated.

Thank you

Allan Hawas,

College of Art & Design and Built Environment

Nottingham Trent University

Please read the questions below and complete the answers in adjacent column	Please place a tick through the answer that is the most appropriate for you				
1. Do you own your home?	Yes		No		
2. How old are you?	18-24 Years	25-34 Years	35-44 Years	45-54 Years	55-64 Years 65 Years or above
3. At what level did you complete your education?	Secondary school or lower	Further education or technical college	B.Sc. or B.A.	Post graduate degree	Other
4. What is the type of your home?	A terraced house		Detached house		A flat/ top floor

	End of terrace house	Semi-detached house		A flat/ground floor	
5. How many rooms, including the living room, are there in your home?	1	2	3	4	More
6. How old is your property?	0-20 Years	21-40 Years	41-60 Years	61-80 Years	81 Years or above
7. Is the loft/attic of your home insulated?	Yes	No	Unsure		
8. How many people, including yourself, live in your home?	1	2	3	4	More
9. What is/are the type(s) of windows in your home?	Single glazed	Double glazed	Triple glazed	Do not know	
10. What is your average monthly heating bill in winter?	Less than £25	£25-£44	£45-£64	£65-£84	£85 or more
Please read the questions below and complete the answers in adjacent column	Please place a tick through the answer that is the most appropriate for you				
11. What do you think about the amount you spend on heating compared to the UK average for the size of your home?	Less than average	average	More than average	Do not know	
12. How much is your annual electricity bill?	Less than £25	£25-£44	£45-£64	£65-£84	£85 or more
13. What do you think about the amount you spend on electricity compared to the UK average for the size of your home?	Less than average	Like average	More than average	Do not know	
14. Do you use electricity to heat your home?	Yes	No			

15. Do you use electricity for water heating in your home?	Yes	No			
16. Have you improved the insulation of your home in the last 20 years?	Yes	No	Do not know		
17. At what temperature do you maintain your home in winter?	18 C° or less	19 C°-20 C°	21 C°-22 C°	23 C° or above	Do not know
18. How comfortable do you feel the temperature in your house is?	Very warm	warm	Comfortable	Ok if I wear a jumper	cold

Read the statement in this column and indicate how much you agree/disagree	Please tick your response in the most appropriate column				
	Strongly Agree	Agree	Unsure	Disagree	Strongly Disagree
19. My home is energy efficient, in terms of conserving the heat.					
20. I know which energy measures make the biggest saving effect in my house.					
21. I know how much energy is lost by keeping equipment on standby.					
22. My house is well insulated.					
Read the statement in this column and indicate how much you agree/disagree	Please tick your response in the most appropriate column				
	Strongly Agree	Agree	Unsure	Disagree	Strongly Disagree

23. The insulation of my house needs improvement.					
24. I can identify where exactly warm air escapes from my house.					
25. Most heat loss from my home is through the following:					
a. Roof					
b. Walls					
c. Windows					
d. Doors					
26. I know how energy efficient the equipment in my house is?					
27. I know that I am heating my house in an energy efficient way.					
28. I know that I am using the equipment in my house in an energy efficient way.					
29. I am planning to change the way I heat my house.					
30. I am planning to change the way I use the equipment in my house.					
31. I want to make my house more energy efficient.					
32. I am planning to replace the equipment in my home with more energy efficient items					

33. I recently discovered which parts of my home are warm and which are cold					
--	--	--	--	--	--

Thanks for your help with the questionnaire

Appendix 2: The Infrared Thermography Session Questionnaire

The purpose of this questionnaire is to record how helpful you found the Thermography session.

Read the statement in this column and indicate how much you agree/disagree	Please tick your response in the most appropriate column				
	Strongly Agree	Agree	Unsure	Disagree	Strongly Disagree
1. The session has helped me to understand infrared thermography.					
2. I think that I can now carry out a simple inspection of the efficiency of the equipment in my house.					
3. I am more aware of the ways in which energy is lost from buildings.					
4. The teaching session has encouraged me to inspect the insulation of my home.					
5. I have learned how to use the thermal camera to scan the					

insulation and the equipment in my house.					
6. I feel comfortable to use the thermal camera to scan my house.					
7. The thermal camera is very effective tool revealing where heat is lost					
8. The thermal camera is very easy to use.					
9. The thermal image is very easy to understand.					
10. The thermal image is very powerful to convince me regarding the escaped heat.					
11. I am very interested to scan the insulation of my house.					

12. Please use the space bellow to comment on any other kind of impact of the teaching session or your participation in this study has made on you.



Thanks for your help with the questionnaire

Appendix 3: Home Energy Efficiency Questionnaire (Post-test)

This is a questionnaire on energy usage and efficiency in homes in the U.K. It will be used in an investigation into energy consumption and efficiency in the residential sector by Nottingham Trent University.

It will take a short time to complete and your participation will be greatly appreciated.

Thank you

Allan Hawas,

College of Art & Design and Built Environment

Nottingham Trent University

Read the statement in this column and indicate how much you agree/disagree	Please tick your response in the most appropriate column				
	Strongly Agree	Agree	Unsure	Disagree	Strongly Disagree
1. My home is energy efficient, in terms of conserving the heat.					
2. I know which energy measures make the biggest saving effect in my house.					
3. I know how much energy is lost by keeping equipment on standby					
4. My house is well insulated.					

5. The insulation of my house needs improvement.					
6. I can identify where exactly warm air escapes from my house.					
7. Most heat loss from my home is through the following:					
e. Roof					
f. Walls					
g. Windows					
h. Doors					
Read the statement in this column and indicate how much you agree/disagree	Please tick your response in the most appropriate column				
	Strongly Agree	Agree	Unsure	Disagree	Strongly Disagree
8. I know how energy efficient the equipment in my house is?					
9. I know that I am heating my house in an energy efficient way.					
10. I know that I am using the equipment in my house in an energy efficient way.					
11. I am planning to change the way I heat my house.					
12. I am planning to change the way I use the equipment in my house.					
13. I want to make my house more energy efficient.					

14. I am planning to replace the equipment in my home with more energy efficient items					
15. I recently discovered which parts of my home are warm and which are cold					
16. The thermal camera helped me to identify insulation defects causing heat loss					
17. The thermal camera helped me to identify changes I can make to improve the energy efficiency of my home					
18. The thermal camera helped me to identify how I can alter the way in which I can operate equipment to make my home more energy efficient.					
19. The thermal images helped me to see how much heat was lost from my home.					
Read the statement in this column and indicate how much you agree/disagree	Please tick your response in the most appropriate column				
	Strongly Agree	Agree	Unsure	Disagree	Strongly Disagree
20. The use of thermal imaging has encouraged me to improve the energy efficiency of my home.					

21. Thermal imaging has made me think more seriously about the loss of heat from my home.					
---	--	--	--	--	--

22. After the teaching session and thermal imaging of your house and seeing thermal images, could you please explain what actions you plan to take to improve the insulation of your home or to change the equipment in your home, and the way in which you use, to save energy.

23. Please use the space bellow to comment on any other kind of impact the use of the thermal camera or your participation in this study has made on you.

Thanks for your help with the questionnaire.

Appendix 4: Conditions for use and Health and Safety

Please follow the procedures below when you carry out thermal imaging with a thermal camera.

1. Put on the reflective vest provided with the camera before you go outside to take pictures.
2. Do not stand in the road when you take pictures.
3. Stand in a safe place when you take pictures.
4. Stand on the pavement and do not place the camera on the ground or on a vehicle.
5. Do not stand behind vehicles while you take picture.
6. Handle the equipment with care.
7. Do not drop the equipment.
8. Do not expose the equipment to water, dirt or dust.
9. The thermal camera and the mobile device are fully charged, and further charging is not required.
10. Do not separate the thermal camera from the mobile phone
11. Do not explore the other applications and functions on the thermal camera or the iPhone mobile.
12. Do not try to connect the mobile to Wi-Fi, internet or other devices in an attempt to transfer pictures or for other reasons.
13. Do not lend the equipment, to anyone else.
14. Do not let other adults or children use the equipment.
15. Do not take pictures of people.
16. When you take picture, the difference in the temperature between the inside of your home and the outside must be at least 10 degrees Centigrade.

- 17. Do not carry out thermal imaging in rainy weather.
- 18. Take the pictures during the night and early in the morning (in absence of direct sun-light).
- 19. It is optional to take internal images.
- 20. If you are not sure whether the equipment functions properly, please contact the researcher on the contact information, which you find at the end of the document.

- i. I have read all the health and safety points above and agree with all the terms and condition' above.
- ii. I have observed the equipment (Thermal camera and the iPhone 5 mobile device) being checked for use and that it is in a good working condition.
- iii. I am borrowing the equipment to carry out thermal imaging of my home from outside, and I will bring back the equipment on the next working day, or as agreed with the researcher.

Date: Return Date:

Name: (block capitals)

Address:
.....

Telephone:

E-mail:

Researcher

Mr. Allan Hawas

Phone No. :

0775 740 6732 E-mail: allan.hawas2014@my.ntu.ac.uk

Appendix 5: Building Energy Efficiency Feedback

Please, answer the following questions, your participation will be greatly appreciated.

Pupil / Student

Year class/Level

1. **Please read the following statements and indicate how much you agree/disagree, by ticking your response in the most appropriate answer.**

A. The session has helped me to understand the energy saving benefits of insulation.

Strongly Agree Agree Unsure Disagree Strongly disagree

B. The energy simulation session was enjoyable

Strongly agree Agree Unsure Disagree Strongly disagree

C. It was clear how to monitor the internal temperature on the PC screen

Strongly Agree Agree Unsure Disagree Strongly disagree

D. It was easy to read the real time temperature on the graph

Strongly Agree Agree Unsure Disagree Strongly disagree

E. It was easy to read the energy consumption/energy cost on the power meters

Strongly Agree Agree Unsure Disagree Strongly disagree

F. It was easy to see the heat loss from the building models by using thermal camera

Strongly Agree Agree Unsure Disagree Strongly disagree

2. Which things you have learned in this session?

Appendix 6: Building Energy Efficiency Feedback

Head Teacher

Lecturer Teacher Subject /

Level

Please give us your feedback, by answering the following questions, your participation will be greatly appreciated.

3. Please read the following statements and indicate how much you agree/disagree, by ticking your response in the most appropriate answer.

G. The educational simulation tool will help the students to easily understand the energy saving benefits of building insulation .

Strongly Agree Agree Unsure Disagree Strongly disagree

H. The educational simulation tool makes it clear for the students how heating of buildings works.

Strongly Agree Agree Unsure Disagree Strongly disagree

I. The educational simulation tool makes it easy for students to understand the impact of insulation on the energy consumption of buildings.

Strongly Agree Agree Unsure Disagree Strongly disagree

J. The students have found it easy to understand how the system works.

Strongly Agree Agree Unsure Disagree Strongly disagree

K. The students can use the recorded data by this system to create different diagrams and tables.

Strongly Agree Agree Unsure Disagree Strongly disagree

L. The educational simulation tool can be implemented on our current curriculum

Strongly Agree Agree Unsure Disagree Strongly disagree

M. What do you think is the reasonable price (including VAT) for this educational tool.

£250 or less £251-350 £351-450 £451-550 £551 or more

N. What do you think could be the reasonable price (per session as service) for providing the demonstration of this tool in the schools.

£300 or less £301-500 £501-700 £701-900 £901 or more

4. To what extent do you think the educational simulation tool can help you in your teaching?

5. What do you think about the features of the educational simulation tool?

6. What do you think about the opportunity of using the tool as educational kit in the schools?

7. Which levels/year classes do you think can have benefit of using the tool?

8. Do you have any other comments or suggestions?

9. What additional features you wish this educational tool to have?

10. Do you wish to have the tool in your school?

Thanks for you participation

Appendix 7: Demonstration Session

The aim of this session is to help the pupils to understand the impact of insulation on energy consumption and familiarise them with different scientific control and monitoring features.



Figure 1: The complete building model system connected to a PC.

Learnings outcomes:

By the end of this session the pupils will have the opportunity to:

- Describe the impact of insulation on energy consumption for heating
- Describe the internal temperature of the building models on the graph
- Identify the system or the power meter which use less energy
- Identify which building model is losing more energy by using IR camera

Before I start the session, the system will be connected and ready for the demonstration.

5 min: The session will start with a short introduction of the system and its features, including the insulation layers, heating system, heat sensor, thermocouple and power meter.

5 min: The system will turn ON and it will take some minutes before the heating in the insulated house turns OFF. I will explain the behaviour of internal temperature of the building models on the PC screen, and I will ask the pupils to read the temperature on the graph (I will help them if needed).

5 min: I will give explanations regarding the behaviours of the insulated and non-insulated house, and I will ask the pupils which house they think uses less energy.

5 min: I will explain why the power meter is used in the system, I will ask the pupils to read the energy consumption on the both power meters and identify which one of them record higher energy use.

5 min: I will turn ON the IR camera and let the pupils to use it monitor the building system, and will ask them to identify the difference between the building models in terms of colours, which will be linked to losing of energy.

5 min: Answer questions and repetition.

Appendix 8: Energy Activity

During the session try to find an answer to the following questions, by writing down the right measure or ticking on the appropriate column.



	House Model A	House Model B
Which house model is insulated?		
What is the internal temperature of the house models?	°C	°C
What is the used electricity in the house models ?	KWh	KWh
Which house model uses more energy?		
By using the thermal camera, which house model is losing more heat (energy)?		

Appendix 9: ETHICAL CLEARANCE CHECKLIST 01

- JOINT INTER COLLEGE ETHICS COMMITTEE

ETHICAL CLEARANCE CHECKLIST

College of Art, Architecture, Design and Humanities; College of Science and Technology; and the Centre for Academic Development and Quality (CADQ)

(TO BE COMPLETED FOR *ALL* INVESTIGATIONS INVOLVING PARTICIPANTS)

All staff and PGR students wishing to conduct an investigation involving participants in order to collect new data in either their research projects or teaching activities are required to complete this checklist before commencement. It may be necessary after completion of this form to submit a full application to the Joint Inter College Ethics Committee (JICEC). Where necessary, official approval from the JICEC must be obtained *before* the research is commenced. This should take no longer than one month.

IF YOUR RESEARCH IS BEING CONDUCTED OFF CAMPUS AND ETHICAL APPROVAL FOR YOUR STUDY HAS BEEN GRANTED BY AN EXTERNAL ETHICS COMMITTEE, PLEASE SEND DETAILS TO THE PROFESSIONAL SUPPORT RESEARCH TEAM FOR CONSIDERATION BY THE CHAIR. YOU WILL BE EXPECTED TO PROVIDE EVIDENCE OF APPROVAL FROM THE EXTERNAL ETHICS COMMITTEE AND THE TERMS ON WHICH THIS APPROVAL HAS BEEN GRANTED.

IF YOUR RESEARCH IS TRANSFERRING INTO NOTTINGHAM TRENT UNIVERSITY AND APPROVAL WAS OBTAINED FROM YOUR ORIGINATING INSTITUTION, THERE IS A REQUIREMENT ON THE UNIVERSITY TO ENSURE THAT APPROPRIATE APPROVALS ARE

IN PLACE.

If you believe either of these statements applies to your research, please contact the Professional Support Research Team adbresearch1@ntu.ac.uk with evidence of former approval and the terms on which this approval has been granted.

IT IS THE RESPONSIBILITY OF INDIVIDUAL INVESTIGATORS AND/OR SUPERVISORS TO ENSURE THAT THERE IS APPROPRIATE INSURANCE COVER FOR THEIR INVESTIGATION.

If you are at all unsure about whether or not your study is covered, please contact the Finance & Planning Manager in your Finance team to check.

Name of Applicant:		ALLAN HAWAS	
School:		Art & Design and Built Environment	
Title of Investigation:		Enhancing public engagement in energy conservation measures by using modern technologies	
STAFF	<input type="checkbox"/>	STUDENT	<input checked="" type="checkbox"/> (*if student, please complete)
RESEARCH	<input type="checkbox"/>	CONSULTANCY	<input type="checkbox"/>
Degree Title and Level*:		PHD	
Supervisor (List Lead supervisor first)		1. Professor Amin Al-Habaibeh 1 St 2. Professor Medjdoub Benachir 2 nd 3.	
Briefly outline the objectives of the research. [75 words]			
In this research project a method for improving the building energy consumption will be investigated. The project will enhance people engagement in energy conservation measures by using modern technologies (Infrared thermography).			

People will be educated to use IR to scan their own buildings. At the same time an automated infrared people counting system will be used for the same general objective.

Briefly describe the principal methods, the sources of data or evidence to be used, and the number and type of research participants who will be recruited to the project. [150 words]

The all collected data will be anonymous.

The methodology will focus on enhancing people's engagement in energy conservation measures by using modern technologies (Infrared Thermography). The methodology will consist of the following stages:

- a) Create an educational video and manual for using infrared thermography to scan building to assess insulation.
- b) A questionnaire (pre and post test) will be conducted with samples to study participant's awareness and feelings in relation to the energy issues in the buildings they have monitored.
- c) The selected participants will be given the equipment and they will use the video and manual to learn scan and outline the problems in the buildings they are monitoring.
- d) The number of samples will be around 60 people, who will scan their own homes and complete the questionnaire, including all kind of residency apartments.
- f) The collected data from the Infrared thermography and questionnaires will be analysed and compared to find the effect of the teaching session and public engagement and understanding.

Do you intend to use published research instruments/resources (e.g., questionnaires, scales, psychometrics, vignettes)?

No, we intend to publish the infrared images as suitable in journal papers as examples.

If YES, complete the next 3 questions

If NO, proceed to the next section

Have you included with this application a full electronic copy or link to each published research instrument/resource?

N/A

If you are using published research instruments/resources, do you have permission to use them in the way that you intend to use them?

N/A

What steps will be taken to ensure compliance with the requirements of copyright rules for the use of published scale?

N/A

Are you developing your own research resources/instruments to collect data? [yes](#)

If YES, complete the questions below.

If NO, proceed to the next section.

Briefly describe the research resources/instruments you are developing. [50 words]

There will be three different questionnaires,

- 1- The first questionnaire will be conducted before attending the educational session, to cover participants' energy awareness, insulation facts and behaviour modification in relation to energy saving.

- 2- The second questionnaire will be conducted after the samples attend an educational session about Infrared thermography, to evaluate the excises.
- 3- This third questionnaire will be conducted after participants complete the scanning of their building, to cover peoples energy awareness, insulation facts and behaviour modification in relation to energy saving.

If applicable, please include an electronic copy of your own bespoke/self-developed research instrument(s) that you will use to collect data with this application.

A. Familiarisation with policy - Please answer as appropriate

Please confirm if you are fully acquainted with the policies for guiding ethical research named below:

NTU research ethics policy , and the procedures for ethical approval	Yes <input checked="" type="checkbox"/>	No <input type="checkbox"/>	N/A <input type="checkbox"/>
The guidelines for ethical research promulgated by a professional association, as appropriate	Yes <input checked="" type="checkbox"/>	No <input type="checkbox"/>	N/A <input type="checkbox"/>
NTU Data Management Policy	Yes <input checked="" type="checkbox"/>	No <input type="checkbox"/>	N/A <input type="checkbox"/>
The Regulations for the Use of Computers (see NTU website)	Yes <input checked="" type="checkbox"/>	No <input type="checkbox"/>	N/A <input type="checkbox"/>
Guidelines for Risk Assessment in Research	Yes <input checked="" type="checkbox"/>	No <input type="checkbox"/>	N/A <input type="checkbox"/>

If you answered **NO** to any of these questions, please note that you must study these guidelines and regulations before proceeding to complete the remainder of this form.

B. External Ethical Review – Please answer as appropriate

Has a favourable ethical opinion already been given for this project by any other external research ethics committee ¹ ?	Yes <input type="checkbox"/>	No <input checked="" type="checkbox"/>	N/A <input type="checkbox"/>
---	------------------------------	--	------------------------------

¹ This includes the research ethics committee of another academic institution.

<p>An external research ethics committee means any research committee <i>other</i> than those at Nottingham Trent University. Submission of this form is <i>not</i> a submission to an external research ethics committee.</p>			
<p>Will this project be submitted for ethical approval to any other external research ethics committee²?</p> <p>An external research ethics committee means any research committee <i>other</i> than those at Nottingham Trent University. Submission of this form is <i>not</i> a submission to an external research ethics committee.</p>	Yes <input type="checkbox"/>	No <input checked="" type="checkbox"/>	N/A <input type="checkbox"/>
<p>If you answered YES to either of these two questions, please complete section C sign the declaration at the end of the form and submit it (together with a letter confirming ethical approval from the external committee) before starting any research.</p> <p>If you answered NO to both questions, please proceed to the next section.</p>			

C. Investigators		
<p>Do investigators have previous experience of, and/or adequate training in, the methods employed?</p>	Yes <input checked="" type="checkbox"/>	No** <input type="checkbox"/>

² This includes the research ethics committee of another academic institution.

If involved will junior researchers/students be under the direct supervision of an experienced member of staff?	Yes <input checked="" type="checkbox"/>	No** <input type="checkbox"/>	N/A <input type="checkbox"/>
If involved will junior researchers/students be expected to undertake physically invasive procedures (not covered by a generic protocol) during the course of the research?	Yes** <input type="checkbox"/>	No <input checked="" type="checkbox"/>	N/A <input type="checkbox"/>
Are researchers in a position of direct authority with regard to participants (e.g. academic staff using student participants, sports coaches using his/her athletes in training)?	Yes** <input type="checkbox"/>	No <input checked="" type="checkbox"/>	N/A <input type="checkbox"/>
** If you select ANY answers marked **, please submit your completed Ethical Clearance Checklist accompanied by a statement covering how you intend to manage the issues (indicated by selecting a ** answer) to the JICEC.			

D. Participants		
Vulnerable Groups		
Does your research involve vulnerable participants? If not, go to the next section		
If your research does involve vulnerable participants, will participants be knowingly recruited from one or more of the following vulnerable groups?		
Children under 18 years of age (please refer to published guidelines)	Yes* <input type="checkbox"/>	No <input checked="" type="checkbox"/>
Pregnant women	Yes* <input type="checkbox"/>	No <input checked="" type="checkbox"/>
People with mental illness	Yes* <input type="checkbox"/>	No <input checked="" type="checkbox"/>
Prisoners/Detained persons	Yes* <input type="checkbox"/>	No <input checked="" type="checkbox"/>
Other vulnerable groups please specify: _____	Yes* <input type="checkbox"/>	No <input checked="" type="checkbox"/>

Is a DBS/Overseas Police Check required?	Yes <input type="checkbox"/>	No <input checked="" type="checkbox"/>	
If required, do you have a DBS/Overseas Police Check? <i>Please contact NTU Disclosures, details can be found on the address book.</i>	Yes <input type="checkbox"/>	No <input checked="" type="checkbox"/>	
To the best of your knowledge, please indicate whether the proposed study:			
Involves procedures likely to cause psychological, social or emotional distress to participants	Yes* <input type="checkbox"/>	No <input checked="" type="checkbox"/>	
Is designed to be challenging psychologically in any way	Yes* <input type="checkbox"/>	No <input checked="" type="checkbox"/>	
Exposes participants to risks or distress greater than those encountered in their normal daily life	Yes* <input type="checkbox"/>	No <input checked="" type="checkbox"/>	
<i>Chaperoning Participants</i>			
If appropriate , e.g. studies which involve vulnerable participants, taking physical measures or intrusion of participants' privacy:			
Will participants be chaperoned by more than one investigator at all times?	Yes <input type="checkbox"/>	No* <input type="checkbox"/>	N/A <input checked="" type="checkbox"/>
Will at least one investigator of the same sex as the participant(s) be present throughout the investigation?	Yes <input type="checkbox"/>	No* <input type="checkbox"/>	N/A <input checked="" type="checkbox"/>
Will participants be visited at home?	Yes* <input type="checkbox"/>	No <input checked="" type="checkbox"/>	N/A <input type="checkbox"/>
If you have selected N/A please provide a statement in the space below explaining why the chaperoning arrangements are not applicable to your research proposal:			
<p>Every participants will do their own respective survey of their home use our cameras with our guidelines, and they have to follow the followings:</p> <ul style="list-style-type: none"> • The participants will sign the participate agreement. • The first questionnaire will be conducted before they attend the educational session. • The participants will attend an educational session to learn how to use the Infrared camera to scan building. 			

- After the educational session directly, they will complete the second questionnaire
- After the educational session they will be given the Infrared camera to scan their own homes.
- The third questionnaire will be conducted after they use the Infrared camera and scan their homes.

If you have selected any of the * answers for any question in section D please provide details (50-75 words):

Please take a look to the description above!

Advice to Participants following the investigation

Investigators have a duty of care to participants. When planning research, investigators should consider what, if any, arrangements are needed to inform participants (or those legally responsible for the participants) of any health related (or other) problems previously unrecognised in the participant. This is particularly important if it is believed that by not doing so the participants well-being is endangered. Investigators should consider whether or not it is appropriate to recommend that participants (or those legally responsible for the participants) seek qualified professional advice, but should not offer this advice personally. Investigators should familiarise themselves with the guidelines of professional bodies associated with their research.

E. Observation/Recording - Please answer: yes or no

Does the study involve data collection, or the observation or recording of participants?	Yes <input type="checkbox"/>	No <input checked="" type="checkbox"/>
--	------------------------------	--

Note that data collection includes the re-use of material originally collected for a non-research purpose (e.g. client or student data already in your possession) and includes anonymous data		
Will those contributing to the data collected (or being observed or being recorded), or the appropriate authority, be informed that the data collection, observation or recording will take place?	Yes <input type="checkbox"/>	No <input checked="" type="checkbox"/>
If you have answered NO to question to the first question in section E, because you are not undertaking empirical work, proceed to the declaration at the end of this form. If you have answered NO to question the second question, an application for ethical approval needs to be made to the JICEC.		

F. Consent and Deception - Please answer: yes or no		
Informed Consent & Data Withdrawal	Yes <input checked="" type="checkbox"/>	No <input type="checkbox"/>
Will participants, or the appropriate authority, be fully informed of the objectives, and of all other particulars of the investigation (preferably at the start of the study, but where this would interfere with the study, at the end)?		
Will participants, or the appropriate authority, be fully informed of the use of the data collected (including, where applicable, ownership of any intellectual property arising from the research)?	Yes <input checked="" type="checkbox"/>	No <input type="checkbox"/>
For detained persons, members of the armed forces, employees, students and other persons who may not be in a position to give fully independent consent, will care be taken over the gaining of freely informed consent?	Yes <input checked="" type="checkbox"/>	No <input type="checkbox"/>

If your research involves children under the age of 18 or participants who have impairment of understanding or communication: N/A		
- will consent be obtained (either in writing or by some other means)?	Yes <input type="checkbox"/>	No* <input type="checkbox"/>
- will consent be obtained from parents or other suitable person?	Yes <input type="checkbox"/>	No* <input type="checkbox"/>
- will they be informed that they have the right to withdraw regardless of parental/ guardian consent?	Yes <input type="checkbox"/>	No* <input type="checkbox"/>
For investigations conducted in schools, will approval be gained in advance from the Head-teacher and/or the Director of Education of the appropriate Local Education Authority?	Yes <input type="checkbox"/>	No* <input type="checkbox"/>
For detained persons, members of the armed forces, employees, students and other persons judged to be under duress, will care be taken over gaining freely informed consent?	Yes <input type="checkbox"/>	No* <input type="checkbox"/>
Will participants, or the appropriate authority, be informed of their right to withdraw from the investigation at any time (or before a specific deadline) and to require their own data to be destroyed? Yes		
Deception		
Is deception part of the study? If the answer is no, proceed to section G	Yes <input type="checkbox"/>	No* <input checked="" type="checkbox"/>
If yes, please explain the rationale and nature of deception (50-75 words): <div style="border: 1px solid black; height: 40px; width: 100%;"></div>		
Will participants be de-briefed and the true object of the research revealed at the earliest stage upon completion of the study?	Yes <input type="checkbox"/>	No* <input type="checkbox"/>
Has consideration been given on the way that participants will react to the withholding of information or deliberate deception?	Yes <input type="checkbox"/>	No* <input type="checkbox"/>

G. G. Storage of Data and Confidentiality		
<p>Please see University guidance on https://www.ntu.ac.uk/intranet/policies/legal_services/data_protection/16231gp.html. If you are a member of NTU staff you can obtain direct access to this with your staff username and password. If you are not a member of NTU staff, please request of copy from your supervisor or course leader.</p>		
<p>Does your research need to be compliant with the RCUK Regulations. If yes, please attach your data management plan (please use dmponline.ddc.ac.uk to design your plan based around the funders requirements, if you have any queries please email: ResearchDataManagement@ntu.ac.uk).</p>	<p>Yes <input type="checkbox"/></p>	<p>No <input checked="" type="checkbox"/></p>
<p>Will all information on participants be treated as confidential and not identifiable unless agreed otherwise in advance, and subject to the requirements of the law of the relevant jurisdiction?</p>	<p>Yes <input checked="" type="checkbox"/></p>	<p>No <input type="checkbox"/></p>
<p>Will storage of data comply with the Data Protection Act 1998 and the law of any non-UK jurisdiction in which research is carried out?</p>	<p>Yes <input checked="" type="checkbox"/></p>	<p>No <input type="checkbox"/></p>
<p>Will any video/audio recording of participants be kept in a secure place and not released for use by third parties?</p>	<p>Yes <input checked="" type="checkbox"/></p>	<p>No <input type="checkbox"/></p>
<p>Will video/audio recordings be destroyed within six years of the completion of the investigation?</p>	<p>Yes <input checked="" type="checkbox"/></p>	<p>No <input type="checkbox"/></p>

H. Incentives		
<p>Have incentives (other than those contractually agreed, salaries or basic expenses) been offered to the investigator to conduct the investigation?</p>	<p>Yes** <input type="checkbox"/></p>	<p>No <input checked="" type="checkbox"/></p>
<p>Will incentives (other than basic expenses) be offered to potential participants as an inducement to participate in the investigation?</p>	<p>Yes** <input type="checkbox"/></p>	<p>No <input checked="" type="checkbox"/></p>
<p>** If you select ANY answers marked **, please submit your completed Ethical Clearance Checklist accompanied by a statement covering how you intend to manage the issues (indicated by selecting a ** answer) to the JICEC.</p>		

The design of the participant information sheet/consent form and of any research instrument (including questionnaires, sampling and interview schedules) that will be used, have been discussed with my supervisor(s).

Compliance with Ethical Principles

If you have completed the checklist to the best of your knowledge and selected an answer marked with * or ** your investigation you will need to seek full formal approval from the JICEC.

Please return to completed Ethical Approval Checklist with the following documents as necessary to the Research Team, Maudslay 312, City Campus, or via email adbresearchteam1@ntu.ac.uk:

- A copy of the research tool you are using
- Consent Form (if necessary)
- Data Management Policy (if necessary)
- Risk Assessment (if necessary)

Please note that the ethics form does not abrogate your need to complete a risk assessment

Declaration

I have read the Ethics & Governance Statement

http://www.ntu.ac.uk/research/research_at_ntu/research_integrity/index.html. I confirm that the above named investigation complies with published codes of conduct, ethical principles and guidelines of professional bodies associated with my research discipline.

Signature of Applicant

(Research Student or Principal Investigator)

Date

Signature of Supervisor/Line Manager

(Director of Studies/ATL)

Date

Signature of JICEC Chair

Date

Appendix 10: Proforma: Research Consent Information Sheet 01

NOTTINGHAM TRENT UNIVERSITY

Proforma: Research Consent Information Sheet

Protocol Title: Enhancing public engagement in energy conservation measures by using modern technologies

Principal Investigator Mr. Allan Hawas

Project Group Mr. Allan Hawas, Professor Amin Al-Habaibeh and Professor Medjdoub Benachir

Supported By

What is the purpose of this study?

To investigate if modern technology can enhance people's engagement in energy conservation measures.

What are we asking you?

The questions are designed to investigate the following:

- People's energy awareness in relation to the householder' energy consumption.

- How People respond to use of modern technology like thermal camera to inspect their houses.
- People's engagement in energy consumption measures.
- How People respond to educational session about using of thermal camera in building inspection.
- People's interaction with thermal camera and it's images.

How we would like to use the information provided

We attend to publish the infrared images as suitable in conference and journal papers as examples.

Compliance with the Research Data Management Policy

Nottingham Trent University is committed to respecting the ethical code of conducts of the United Kingdom Research Councils. Thus, in accordance with procedures for transparency and scientific verification, the University will conserve all information and data collected during your interview in line with the University Policy and RCUK Common Principles on Data Policy (<http://www.rcuk.ac.uk/research/datapolicy/>) and the relevant legislative frameworks. The final data will be retained in accordance with the Retention Policy. All data will be anonymised and made available to be re-used in this form where appropriate and under appropriate safeguards.

What are the possible risks or discomforts?

Your participation does not involve any risks other than what you would encounter in daily life. If you are uncomfortable with any of the questions and topics, you are free not to answer.

What are my rights as a research participant?

- You have the right to withdraw your consent and participation at any moment: before, during, or after the interview. If you do wish to withdraw your consent

please contact me using my contact details as above (TIME FRAME).

- You have the right to remain anonymous in any write-up (published or not) of the information generated during this interview.
- You have the right to refuse to answer to any or all of the questions you will be asked.
- You also have the right to specify the terms and limits of use (i.e. full or partial) of the information generated during the interview.
- You have the opportunity to ask questions about this research and these should be answered to your satisfaction.

If you want to speak with someone who is not directly involved in this research, or if you have questions about your rights as a research subject, contact Professor Michael White, Chair for the Joint Inter-College Ethics Committee (JICEC) in Art & Design and Built Environment/Arts and Science at Nottingham Trent University. You can call him at 0115 848 2069 or send an e-mail to michael.white@ntu.ac.uk.

What about my Confidentiality and Privacy Rights?

Participation in this research study may result in a loss of privacy, since persons other than the investigator(s) might view your study records. Unless required by law, only the study investigator, members of NTU staff and the sponsoring organisation [details] have the authority to review your records. They are required to maintain confidentiality regarding your identity.

Results of this study may be used for teaching, research, publications and presentations at professional meetings. If your individual results are discussed, then a code number or a pseudonym will be used to protect your identity.

Audio/visual recordings

Permission to use audio or visual recordings of your participation, for presentations in the classroom, at professional meetings or in publications, is requested below, as this may be necessary to understand and communicate the results.

Any recorded data will be kept confidential and in a secure place in line with the Research Data Management Policy and destroyed in line with the current RCUK/University Guidelines.

Who should I call if I have questions or concerns about this research study?

CONSENT FORM PROFORMA

Dear Research Participant

This is a questionnaire on energy usage and efficiency in homes in the U.K. It will be used in an investigation into energy consumption and efficiency in the residential sector by Nottingham Trent University. It will take a short time to complete and your participation will be greatly appreciated.

You can contact me if you have questions concerning this research study. Please find my contact information at the end of the document.

There are three questionnaires we would like you to answer in three stages. However, you only need to respond to the ones which you want to. There is no time limit on this interview it may be as long or as short as you wish. Mostly every questionnaire last around 10-15 min. Relevant quotations may then be included in the final report. All recordings will be stored securely and remain confidential.

All participation in the project is voluntary. If do you agree to be part of the project, we would like to use the information to develop a report; but your name and identity will remain anonymous. If you decide at any stage, you no longer want to be part of the project, just let us know and we will make sure any information you have given us is destroyed.

This project has been reviewed by, and received ethics clearance through, the Nottingham Trent University Joint Inter College Ethics Committee.

Please read the following statements:

I have read the above project description, and had an opportunity to ask questions about the research and received satisfactory answers to any questions.
I have had sufficient information to decide whether or not you wish to take part in the study.
I understand that I am free to withdraw from the research at any time by informing the researcher of this decision.
I understand that the information I give will be treated in the strictest confidence.
I agree to take part in the study.
I agree that this interview can be recorded.
I understand that quotations, which will be made anonymous, from this interview may be included in material published from this research.
I am willing to participate in an interview as part of this research project.
I understand that anonymized data may be used in other studies in line with the University Research Data Management Policy

I confirm that data obtained from the study can be used in the final research report. I understand that the data will be used anonymously: names, places and identifying details will be changed.

Full Name _____

Date _____

If you have any questions please contact Allan Hawas by

Email: allan.hawas2014@my.ntu.ac.uk or phone No.: 0775 740 6732

In line with the Research Data Management Policy, requests may be made to use data from this study for other projects. If you do not wish your anonymized data to be used for future studies please tick here

Appendix 11: ETHICAL CLEARANCE CHECKLIST 02

- JOINT INTER COLLEGE ETHICS COMMITTEE

ETHICAL CLEARANCE CHECKLIST

College of Art, Architecture, Design and Humanities; College of Science and Technology; and the Centre for Academic Development and Quality (CADQ)

(TO BE COMPLETED FOR *ALL* INVESTIGATIONS INVOLVING PARTICIPANTS)

All staff and PGR students wishing to conduct an investigation involving participants in order to collect new data in either their research projects or teaching activities are required to complete this checklist before commencement. It may be necessary after completion of this form to submit a full application to the Joint Inter College Ethics Committee (JICEC). Where necessary, official approval from the JICEC must be obtained *before* the research is commenced. This should take no longer than one month.

IF YOUR RESEARCH IS BEING CONDUCTED OFF CAMPUS AND ETHICAL APPROVAL FOR YOUR STUDY HAS BEEN GRANTED BY AN EXTERNAL ETHICS COMMITTEE, PLEASE SEND DETAILS TO THE PROFESSIONAL SUPPORT RESEARCH TEAM FOR CONSIDERATION BY THE CHAIR. YOU WILL BE EXPECTED TO PROVIDE EVIDENCE OF APPROVAL FROM THE EXTERNAL ETHICS COMMITTEE AND THE TERMS ON WHICH THIS APPROVAL HAS BEEN GRANTED.

IF YOUR RESEARCH IS TRANSFERRING INTO NOTTINGHAM TRENT UNIVERSITY AND APPROVAL WAS OBTAINED FROM YOUR ORIGINATING INSTITUTION, THERE IS A REQUIREMENT ON THE UNIVERSITY TO ENSURE THAT APPROPRIATE APPROVALS ARE IN PLACE.

If you believe either of these statements applies to your research, please contact the Professional Support

Research Team adbresearch1@ntu.ac.uk with evidence of former approval and the terms on which this approval has been granted.

IT IS THE RESPONSIBILITY OF INDIVIDUAL INVESTIGATORS AND/OR SUPERVISORS TO ENSURE THAT THERE IS APPROPRIATE INSURANCE COVER FOR THEIR INVESTIGATION.

If you are at all unsure about whether or not your study is covered, please contact the Finance & Planning Manager in your Finance team to check.

Name of Applicant:		ALLAN HAWAS	
School:		Art & Design and Built Environment	
Title of Investigation:		Enhancing public engagement in energy conservation measures by using modern technologies	
STAFF	<input type="checkbox"/>	STUDENT	<input checked="" type="checkbox"/> (*if student, please complete)
RESEARCH	<input type="checkbox"/>	CONSULTANCY	<input type="checkbox"/>
Degree Title and Level*:		PHD	
Supervisor (List Lead supervisor first)		<ol style="list-style-type: none"> 1. Professor Amin Al-Habaibeh 1St 2. Professor Medjdoub Benachir 2nd 3. 	
Briefly outline the objectives of the research. [75 words]			
<p>In this research project a method for improving the building energy consumption will be investigated. The project will enhance people engagement in energy conservation measures by using a developed educational simulation tool. Public, including head teachers, teachers, pupils and students will be</p>			

educated and trained about the effect of insulation on the energy consumption in building. The tool will be demonstrated for these public groups to gain their respective feedback to evaluate the impact and efficiency of the educational tool.

Briefly describe the principal methods, the sources of data or evidence to be used, and the number and type of research participants who will be recruited to the project. [150 words]

The all collected data will be anonymous

A system of two building models, including insulation layers is developed for simulation of building energy consumption. The system is equipped with heating control and monitoring system to investigated the effect of insulation on the energy consumption in building. The system will be used as educational tool to teach and train the public to enhance energy consumption in building. The tool will be demonstrated for school leaders, teachers, pupils and students to gain their respective feedback to evaluate the efficiency of the tool and the experience of the demonstration.

The system will be demonstrated in up to 10 schools. The demonstration will be designed for different groups and levels, including school leaders, teachers, pupils and students. A written or oral feedback will be gained from the participants after the demonstration regarding the impact and the efficiency of the educational tool. The collected data will be analysed for investigation and development of the efficiency of the educational tool.

Do you intend to use published research instruments/resources (e.g., questionnaires, scales, psychometrics, vignettes)?

No, we attend to publish the infrared images as suitable in journal papers as examples.

If YES, complete the next 3 questions

<p>If NO, proceed 4 questions</p>
<p>Have you included with this application a full electronic copy or link to each published research instrument/resource?</p> <p>N/A</p>
<p>If you are using published research instruments/resources, do you have permission to use them in the way that you intend to use them?</p> <p>N/A</p>
<p>What steps will be taken to ensure compliance with the requirements of copyright rules for the use of published scale?</p> <p>N/A</p>
<p>Are you developing your own research resources/instruments to collect data? yes</p> <p>If YES, complete the questions below.</p> <p>If NO, proceed to the next section.</p>
<p>Briefly describe the research resources/instruments you are developing. [50 words]</p> <p>An innovative system (Figure 1) of two building models, including heating control and monitoring system is built to investigated the effect of insulation on the energy consumption in building. The system will be used as educational tool to teach and train the public to enhance energy consumption in building. The tool will be demonstrated for school leaders, teachers, pupils and students to gain their respective feedback to evaluate the impact and efficiency of the educational tool.</p>



Figure 1: The complete building model system connected to a PC.

If applicable, please include an electronic copy of your own bespoke/self-developed research instrument(s) that you will use to collect data with this application.

I. Familiarisation with policy - Please answer *as appropriate*

Please confirm if you are fully acquainted with the policies for guiding ethical research named below:

NTU research ethics policy , and the procedures for ethical approval	Yes <input checked="" type="checkbox"/>	No <input type="checkbox"/>	N/A <input type="checkbox"/>
The guidelines for ethical research promulgated by a professional association, as appropriate	Yes <input checked="" type="checkbox"/>	No <input type="checkbox"/>	N/A <input type="checkbox"/>
NTU Data Management Policy	Yes <input checked="" type="checkbox"/>	No <input type="checkbox"/>	N/A <input type="checkbox"/>
The Regulations for the Use of Computers (see NTU website)	Yes <input checked="" type="checkbox"/>	No <input type="checkbox"/>	N/A <input type="checkbox"/>
Guidelines for Risk Assessment in Research	Yes <input checked="" type="checkbox"/>	No <input type="checkbox"/>	N/A <input type="checkbox"/>

If you answered **NO** to any of these questions, please note that you must study these guidelines and regulations before proceeding to complete the remainder of this form.

J. External Ethical Review – Please answer *as appropriate*

<p>Has a favourable ethical opinion already been given for this project by any other external research ethics committee³?</p> <p>An external research ethics committee means any research committee <i>other</i> than those at Nottingham Trent University. Submission of this form is <i>not</i> a submission to an external research ethics committee.</p>	<p>Yes <input type="checkbox"/></p>	<p>No <input checked="" type="checkbox"/></p>	<p>N/A <input type="checkbox"/></p>
<p>Will this project be submitted for ethical approval to any other external research ethics committee⁴?</p> <p>An external research ethics committee means any research committee <i>other</i> than those at Nottingham Trent University. Submission of this form is <i>not</i> a submission to an external research ethics committee.</p>	<p>Yes <input type="checkbox"/></p>	<p>No <input checked="" type="checkbox"/></p>	<p>N/A <input type="checkbox"/></p>
<p>If you answered YES to either of these two questions, please complete section C sign the declaration at the end of the form and submit it (together with a letter confirming ethical approval from the external committee) before starting any research.</p> <p>If you answered NO to both questions, please proceed to the next section.</p>			

<p>K. Investigators</p>		
<p>Do investigators have previous experience of, and/or adequate training in, the methods employed?</p>	<p>Yes <input checked="" type="checkbox"/></p>	<p>No** <input type="checkbox"/></p>

³ This includes the research ethics committee of another academic institution.

⁴ This includes the research ethics committee of another academic institution.

If involved will junior researchers/students be under the direct supervision of an experienced member of staff?	Yes <input checked="" type="checkbox"/>	No <input type="checkbox"/>	N/A <input type="checkbox"/>
If involved will junior researchers/students be expected to undertake physically invasive procedures (not covered by a generic protocol) during the course of the research?	Yes <input type="checkbox"/>	No <input checked="" type="checkbox"/>	N/A <input type="checkbox"/>
Are researchers in a position of direct authority with regard to participants (e.g. academic staff using student participants, sports coaches using his/her athletes in training)?	Yes <input type="checkbox"/>	No <input checked="" type="checkbox"/>	N/A <input type="checkbox"/>
<p>** If you select ANY answers marked **, please submit your completed Ethical Clearance Checklist accompanied by a statement covering how you intend to manage the issues (indicated by selecting a ** answer) to the JICEC.</p>			

L. Participants		
Vulnerable Groups		
Does your research involve vulnerable participants? If not, go to the next section		
If your research does involve vulnerable participants, will participants be knowingly recruited from one or more of the following vulnerable groups?		
Children under 18 years of age (please refer to published guidelines)	Yes <input type="checkbox"/>	No <input checked="" type="checkbox"/>
Pregnant women	Yes <input type="checkbox"/>	No <input checked="" type="checkbox"/>
People with mental illness	Yes <input type="checkbox"/>	No <input checked="" type="checkbox"/>
Prisoners/Detained persons	Yes <input type="checkbox"/>	No <input checked="" type="checkbox"/>
Other vulnerable groups please specify: _____	Yes <input type="checkbox"/>	No <input checked="" type="checkbox"/>

Is a DBS/Overseas Police Check required?	Yes <input type="checkbox"/>	No <input checked="" type="checkbox"/>	
If required, do you have a DBS/Overseas Police Check? <i>Please contact NTU Disclosures, details can be found on the address book.</i>	Yes <input type="checkbox"/>	No <input checked="" type="checkbox"/>	
To the best of your knowledge, please indicate whether the proposed study:			
Involves procedures likely to cause psychological, social or emotional distress to participants	Yes* <input type="checkbox"/>	No <input checked="" type="checkbox"/>	
Is designed to be challenging psychologically in any way	Yes* <input type="checkbox"/>	No <input checked="" type="checkbox"/>	
Exposes participants to risks or distress greater than those encountered in their normal daily life	Yes* <input type="checkbox"/>	No <input checked="" type="checkbox"/>	
<p><i>Chaperoning Participants</i></p> <p>If appropriate, e.g. studies which involve vulnerable participants, taking physical measures or intrusion of participants' privacy:</p>			
Will participants be chaperoned by more than one investigator at all times?	Yes <input type="checkbox"/>	No* <input checked="" type="checkbox"/>	N/A <input type="checkbox"/>
Will at least one investigator of the same sex as the participant(s) be present throughout the investigation?	Yes <input type="checkbox"/>	No* <input checked="" type="checkbox"/>	N/A <input type="checkbox"/>
Will participants be visited at home?	Yes* <input type="checkbox"/>	No <input checked="" type="checkbox"/>	N/A <input type="checkbox"/>
If you have selected N/A please provide a statement in the space below explaining why the chaperoning arrangements are not applicable to your research proposal:			
<p>If you have selected any of the * answers for any question in section D please provide details (50-75 words):</p> <p>The demonstration in the schools that involve children under 18 years of age, will be carried out in present of their own teacher(s). The procedure will be conducted by the investigator and the children possibly will take the only following simple measures:</p> <ul style="list-style-type: none"> • Take thermal images of the building models by a simple, light weight IR camera. • Read a temperature measure on the PC screen. 			

The children will not be involved in any further activities than watching the demonstration, with the present of their own teacher(s).

Advice to Participants following the investigation

Investigators have a duty of care to participants. When planning research, investigators should consider what, if any, arrangements are needed to inform participants (or those legally responsible for the participants) of any health related (or other) problems previously unrecognised in the participant. This is particularly important if it is believed that by not doing so the participants well-being is endangered. Investigators should consider whether or not it is appropriate to recommend that participants (or those legally responsible for the participants) seek qualified professional advice, but should not offer this advice personally. Investigators should familiarise themselves with the guidelines of professional bodies associated with their research.

M. Observation/Recording - Please answer: yes or no

Does the study involve data collection, or the observation or recording of participants?	Yes <input checked="" type="checkbox"/>	No <input type="checkbox"/>
Note that data collection includes the re-use of material originally collected for a non-research purpose (e.g. client or student data already in your possession) and includes anonymous data		

<p>Will those contributing to the data collected (or being observed or being recorded), or the appropriate authority, be informed that the data collection, observation or recording will take place?</p>	<p>Yes <input checked="" type="checkbox"/> X</p>	<p>No <input type="checkbox"/></p>
<p>If you have answered NO to question to the first question in section E, because you are not undertaking empirical work, proceed to the declaration at the end of this form. If you have answered NO to question the second question, an application for ethical approval needs to be made to the JICEC.</p>		

<p>N. Consent and Deception - Please answer: yes or no</p>		
<p>Informed Consent & Data Withdrawal</p>		
<p>Will participants, or the appropriate authority, be fully informed of the objectives, and of all other particulars of the investigation (preferably at the start of the study, but where this would interfere with the study, at the end)?</p>	<p>Yes <input checked="" type="checkbox"/> X</p>	<p>No <input type="checkbox"/></p>
<p>Will participants, or the appropriate authority, be fully informed of the use of the data collected (including, where applicable, ownership of any intellectual property arising from the research)?</p>	<p>Yes <input checked="" type="checkbox"/> X</p>	<p>No <input type="checkbox"/></p>
<p>For detained persons, members of the armed forces, employees, students and other persons who may not be in a position to give fully independent consent, will care be taken over the gaining of freely informed consent?</p>	<p>Yes <input checked="" type="checkbox"/> X</p>	<p>No <input type="checkbox"/></p>
<p>If your research involves children under the age of 18 or participants who have impairment of understanding or communication:</p> <p>Yes</p>		
<p>- will consent be obtained (either in writing or by some other means)?</p>	<p>Yes <input checked="" type="checkbox"/> X</p>	<p>No* <input type="checkbox"/></p>

- will consent be obtained from parents or other suitable person?	Yes <input checked="" type="checkbox"/>	No* <input type="checkbox"/>
- will they be informed that they have the right to withdraw regardless of parental/ guardian consent?	Yes <input checked="" type="checkbox"/>	No* <input type="checkbox"/>
. For investigations conducted in schools, will approval be gained in advance from the Head-teacher and/or the Director of Education of the appropriate Local Education Authority?	Yes <input checked="" type="checkbox"/>	No* <input type="checkbox"/>
. For detained persons, members of the armed forces, employees, students and other persons judged to be under duress, will care be taken over gaining freely informed consent?	Yes <input checked="" type="checkbox"/>	No* <input type="checkbox"/>
. Will participants, or the appropriate authority, be informed of their right to withdraw from the investigation at any time (or before a specific deadline) and to require their own data to be destroyed? Yes		
.		
Deception		
Is deception part of the study? If the answer is no, proceed to section G	Yes <input type="checkbox"/>	No* <input checked="" type="checkbox"/>
If yes, please explain the rationale and nature of deception (50-75 words):		
.		
. Will participants be de-briefed and the true object of the research revealed at the earliest stage upon completion of the study?	Yes <input type="checkbox"/>	No* <input type="checkbox"/>
. Has consideration been given on the way that participants will react to the withholding of information or deliberate deception?	Yes <input type="checkbox"/>	No* <input type="checkbox"/>

O. G. Storage of Data and Confidentiality
<p>Please see University guidance on https://www.ntu.ac.uk/intranet/policies/legal_services/data_protection/16231gp.html. If you are a member of NTU staff you can obtain direct access to this with your staff username and password. If you are not a member of NTU staff, please request of copy from your supervisor or course leader.</p>

Does your research need to be compliant with the RCUK Regulations. If yes, please attach your data management plan (please use dmponline.ddc.ac.uk to design your plan based around the funders requirements, if you have any queries please email: ResearchDataManagement@ntu.ac.uk).	Yes <input type="checkbox"/>	No <input checked="" type="checkbox"/>
Will all information on participants be treated as confidential and not identifiable unless agreed otherwise in advance, and subject to the requirements of the law of the relevant jurisdiction?	Yes <input checked="" type="checkbox"/>	No <input type="checkbox"/>
Will storage of data comply with the Data Protection Act 1998 and the law of any non-UK jurisdiction in which research is carried out?	Yes <input checked="" type="checkbox"/>	No <input type="checkbox"/>
Will any video/audio recording of participants be kept in a secure place and not released for use by third parties?	Yes <input checked="" type="checkbox"/>	No <input type="checkbox"/>
Will video/audio recordings be destroyed within six years of the completion of the investigation?	Yes <input checked="" type="checkbox"/>	No <input type="checkbox"/>

P. Incentives		
Have incentives (other than those contractually agreed, salaries or basic expenses) been offered to the investigator to conduct the investigation?	Yes** <input type="checkbox"/>	No <input checked="" type="checkbox"/>
Will incentives (other than basic expenses) be offered to potential participants as an inducement to participate in the investigation?	Yes** <input type="checkbox"/>	No <input checked="" type="checkbox"/>
** If you select ANY answers marked **, please submit your completed Ethical Clearance Checklist accompanied by a statement covering how you intend to manage the issues (indicated by selecting a ** answer) to the JICEC.		
The design of the participant information sheet/consent form and of any research instrument (including questionnaires, sampling and interview schedules) that will be used, have been discussed with my supervisor(s).		
<i>Compliance with Ethical Principles</i>		
If you have completed the checklist to the best of your knowledge and selected an answer marked with * or ** your investigation you will need to seek full formal approval from the JICEC.		

Please return to completed Ethical Approval Checklist with the following documents as necessary to the Research Team, Maudslay 312, City Campus, or via email adbresearchteam1@ntu.ac.uk:

- A copy of the research tool you are using
- Consent Form (if necessary)
- Data Management Policy (if necessary)
- Risk Assessment (if necessary)

Please note that the ethics form does not abrogate your need to complete a risk assessment

Declaration

I have read the Ethics & Governance Statement

http://www.ntu.ac.uk/research/research_at_ntu/research_integrity/index.html. I confirm that the above named investigation complies with published codes of conduct, ethical principles and guidelines of professional bodies associated with my research discipline.

Signature of Applicant

(Research Student or Principal Investigator)

Date

Signature of Supervisor/Line Manager

(Director of Studies/ATL)

Date

Signature of JICEC Chair

Date

Appendix 12: Proforma: Research Consent Information Sheet 02

NOTTINGHAM TRENT UNIVERSITY

Proforma: Research Consent Information Sheet

Protocol Title: Enhancing public engagement in energy conservation measures by using modern technologies

Principal Investigator Mr. Allan Hawas

Project Group Mr. Allan Hawas, Professor Amin Al-Habaibeh and Professor Medjdoub Benachir

Supported By

What is the purpose of this study?

To gain feedback from public, including school leaders, teachers, pupils and students regarding the impact and the efficiency of an innovative developed educational simulation tool, in order to investigate its efficiency.

What are we asking you?

The participants (head teachers, teachers, pupils or students) who attend the demonstration of the educational tool will be asked to give a written or oral feedback regarding the impact and the efficiency of the educational tool.

How we would like to use the information provided

We intend to publish the infrared images as suitable in conference and journal papers as examples.

Compliance with the Research Data Management Policy

Nottingham Trent University is committed to respecting the ethical code of conducts of the United Kingdom Research Councils. Thus, in accordance with procedures for transparency and scientific verification, the University will conserve all information and data collected during your interview in line with the University Policy and RCUK Common Principles on Data Policy (<http://www.rcuk.ac.uk/research/datapolicy/>) and the relevant legislative frameworks. The final data will be retained in accordance with the Retention Policy. All data will be anonymised and made available to be re-used in this form where appropriate and under appropriate safeguards.

What are the possible risks or discomforts?

Your participation does not involve any risks other than what you would encounter in daily life. If you are uncomfortable with any of the questions and topics, you are free not to answer.

What are my rights as a research participant?

- You have the right to withdraw your consent and participation at any moment: before, during, or after the interview. If you do wish to withdraw your consent please contact me using my contact details as above (TIME FRAME).
- You have the right to remain anonymous in any write-up (published or not) of the information generated during this interview.
- You have the right to refuse to answer to any or all of the questions you will

be asked.

- You also have the right to specify the terms and limits of use (i.e. full or partial) of the information generated during the interview.
- You have the opportunity to ask questions about this research and these should be answered to your satisfaction.

If you want to speak with someone who is not directly involved in this research, or if you have questions about your rights as a research subject, contact Professor Michael White, Chair for the Joint Inter-College Ethics Committee (JICEC) in Art & Design and Built Environment/Arts and Science at Nottingham Trent University. You can call him at 0115 848 2069 or send an e-mail to michael.white@ntu.ac.uk.

What about my Confidentiality and Privacy Rights?

Participation in this research study may result in a loss of privacy, since persons other than the investigator(s) might view your study records. Unless required by law, only the study investigator, members of NTU staff and the sponsoring organisation [details] have the authority to review your records. They are required to maintain confidentiality regarding your identity.

Results of this study may be used for teaching, research, publications and presentations at professional meetings. If your individual results are discussed, then a code number or a pseudonym will be used to protect your identity.

Audio/visual recordings

Permission to use audio or visual recordings of your participation, for presentations in the classroom, at professional meetings or in publications, is requested below, as this may be necessary to understand and communicate the results.

Any recorded data will be kept confidential and in a secure place in line with the Research Data Management Policy and destroyed in line with the current RCUK/University Guidelines.

Who should I call if I have questions or concerns about this research study?

CONSENT FORM PROFORMA

Dear Research Participant

In this research project a method for improving the building energy consumption will be investigated. It will be used in an investigation into energy consumption and efficiency in the residential sector by Nottingham Trent University. The project will enhance people engagement in energy conservation measures by using a developed educational simulation tool. The educational simulation tool is designed to help the teachers to teach and train their pupils or students about the effect of insulation on the energy consumption in building. The tool will be demonstrated in schools, colleges and universities in order to investigate its efficiency. The educational tool will be demonstrated for school leaders, teachers, pupils and students to gain their respective feedback to evaluate the efficiency of the tool.

The demonstration will take around 30 min, followed a short feedback will be gained from the participants. After the demonstration, we would like you to give us a feedback regarding the impact and the efficiency of the educational tool. However, you only need to respond to the ones which you want to. There is no time limit on this feedback it may be as long or as short as you wish. Mostly feedback last around 10-15 min. Relevant quotations may then be included in the final report. All recordings will be stored securely and remain confidential.

You can contact me if you have questions concerning this research study. Please find my contact information at the end of the document.

All participation in the project is voluntary. If do you agree to be part of the project, we would like to use the information to develop a report; but your name and identity will remain anonymous. If you decide at any stage, you no longer want to be part of the project, just let us know and we will make sure any information you have given us is destroyed.

This project has been reviewed by, and received ethics clearance through, the Nottingham Trent University Joint Inter College Ethics Committee.

Please read the following statements:

I have read the above project description, and had an opportunity to ask questions about the research and received satisfactory answers to any questions.
I have had sufficient information to decide whether or not you wish to take part in the study.
I understand that I am free to withdraw from the research at any time by informing the researcher of this decision.
I understand that the information I give will be treated in the strictest confidence.
I agree to take part in the study.
I agree that this interview can be recorded.
As a Head-teacher and/or the Director of Education I agree that my pupils or students take part in the study.
I understand that quotations, which will be made anonymous, from this interview may be included in material published from this research.
I am willing to participate in an interview as part of this research project.
I understand that anonymized data may be used in other studies in line with the University Research Data Management Policy

I confirm that data obtained from the study can be used in the final research report. I understand that the data will be used anonymously: names, places and identifying details will be changed.

Full Name _____

Date _____

If you have any questions, please contact Allan Hawas by

Email: allan.hawas2014@my.ntu.ac.uk or phone No.: 0775 740 6732

In line with the Research Data Management Policy, requests may be made to use data from this study for other projects. If you do not wish your anonymized data to be used for future studies please tick here



Available online at www.sciencedirect.com
SciVerse ScienceDirect

Energy Procedia 00 (2016) 000–000

Energy
Procedia

www.elsevier.com/locate/procedia

The 8th International Conference on Applied Energy – ICAE2016

**Innovative design of an educational physical simulation tool for
investigating energy consumption in buildings for enhancing public
engagement**

Allan Hawas, Amin Al-Habaibeh* and Benachir Medjdoub

*School of Architecture, Design and the Built Environment
Nottingham Trent University, Burton Street, Nottingham, NG1 4BU, UK*

Abstract

Reducing carbon emission and energy consumption in buildings is becoming an important priority on global level. Buildings consume significant amount of energy for heating and air-conditioning in most countries. The drive to enhance the understanding of building insulation and its effect on energy use is critical for improving public engagement to achieve reduced carbon emission towards more sustainable future. This paper presents the design and the development an educational and research simulation tool to study and understand the thermal performance and energy efficiency of buildings. The novel design includes small-scale multi-layered model of buildings where insulation layers can be added to, or removed from, the building model in a modular and interchangeable manner to allow changes to the thermal performance. The results show that this novel model will provide a new educational tool to enhance the understanding of energy consumption and insulation in buildings. The design can be utilised to engage the young generation regarding building insulation and energy efficiency. It also provides an advanced research and teaching tool for energy in buildings, instrumentation and infrared thermography.

© 2016 The Authors. Published by Elsevier Ltd.
Selection and/or peer-review under responsibility of ICAE

Keywords: Building Energy Efficiency; Simulation; Educational Tool; Building Energy Consumption; Thermal Performance; Innovation.

* Corresponding author. Tel.: +44 (0) 1158482564.
E-mail address: Amin.Al-Habaibeh@ntu.ac.uk

Introduction

There is a need to improve public understanding and engagement towards energy conservation and sustainability, particularly in buildings. Moreover, teaching students and researchers the effect of insulation and other changes in building features on energy consumption is becoming essential to improve scientific knowledge and public engagement. Currently there is a lack of useful educational tools in this field in relation to enhancing the understanding of the effect of altering the building envelope in order to improve the energy performance and thermal efficiency. Energy consumption in buildings in the EU accounts for about 40% of the total energy consumption [1]. According to the EU Directive 2010/31, the EU has a goal to reduce energy consumption and carbon emissions by 20% by the year 2020 [2]. The directive also emphasises that all new buildings have to be nearly zero-energy buildings by the same time frame.

However, many countries around the world have an old stock of buildings that will still need improvement. To engage the public in this process, they need to understand the benefits of insulation to their quality of life, particularly in relation to their building's temperature and financial savings. Thermal insulation is one of the most important factors that enhances the energy performance of buildings. With improved insulation, new and renovated buildings will provide an acceptable level of energy conservation. Significant research has been done in this area. For example, Al-Habaibeh et al. [3] has presented a case study of an existing university building, where the insulation has been improved, mainly by adding an internal doubled glazing. The study shows the thermal images of the building from 2005 before the renovation and from 2010 after the improvement, which demonstrates very clear improvement in the thermal insulation performance. Kim et al. [4] has compared the impact of adding insulation on energy consumption in cold and hot climate in USA. Computer simulation tool has been utilised to test the building under two different climatic conditions: cold climate in Michigan and moderate-humid climate in Florida. The results show that adding insulation in cold climate is highly recommended to reduce the energy required for heating in winter, but the insulation might not be effective in moderate weather conditions [4]. Tettey et al. [5] has analysed the implications of five different insulation materials on the primary energy use and CO₂ emission and the results show the difference in insulation capability between 6-7% in relation to primary energy use. Other research work has assessed the life cycle impact of different flooring materials in buildings [6] and the external wall thickness of expanded polystyrene on the life cycle saving, life cycle total cost and payback period [7]. Composite materials as insulation have also been found to be effective [8]. The implementation of mandatory insulation in New Zealand since 1978 shows higher internal temperature and decreasing energy consumption [9].

One of the issues is that it is normally difficult to engage the public in the insulation process and most of the research work stays within the industrial and academic sectors. Some attempts have been made to encourage the public and improve their engagement. A research presented by Goodhew et al. [10] has investigated the behavioural effect of visualisation of heat loss from residential homes and the consequences for energy saving using infrared technology. Using infrared images, the study enabled householders to see how the heat escapes from their homes in order to study the eventual motivational impact on behavioural energy conservation. The research concentrates on the ability to encourage

Allan Hawas^a, Amin Al-Habaibeh^a/ Energy Procedia 00 (2016) 000–000

residential energy saving measures through such visualisations. The results show potential energy conservation by using the demonstrated visualisation technology.

Xie and Nourian [11] has presented an educational concept to improve design-based learning. The focus was on developing simple physical building models and modelling software. The tool and the curriculum units have been tested in three high schools with the involvement of about 200 students, and the results show positive response from the students. However, the suggested physical models have the advantage of being simple and low cost, but they have their own limitations in relation to the lack of modularity for the user. Haglund et al. [12] demonstrates a qualitative educational research using thermal imaging in science education at different school levels. The visualisation of the heat transfer has been applied in physical and chemical processes across all school ages. The results show that the infrared camera in combination with simple well-designed theoretical activities can support their thermodynamic learning. From the above discussion, it is evident that there is a need for a modular and simple physical model of buildings that could benefit the education sector; but at the same time can engage the public and also advance that research in the area of building insulation and efficiency.

The Proposed Building Model

As discussed above, teaching and research tools for studying and simulating thermal performance in buildings in most cases are based on a single component or material based systems to test and measure insulation. In other situations, software-based simulation modelling is used. Both scenarios fail to engage students and the public in relation to the effect of insulation and the modification of building features on energy consumption and the temperature of the building, particularly for the younger generation. This proposed educational tool combines a layer or more of detachable, interlocking and interchangeable insulation, combined with heating and/or cooling of the external and the internal volumes inside and outside the building to study the power consumption and the thermal parameters of the building. Developing the training process on real buildings is costly and time consuming, with difficulty in influencing the external environment. Computer simulation is normally based on assumptions and does not fully engage the learners in the training and learning process particularly for the younger generation. To address the limitations in existing educational and research tools for the investigation of building performance and energy efficiency, an innovative system has been developed as an educational and research tool for energy consumption in buildings, which comprises modular building models. The model consists of modular components and insulation layers with associated heating and cooling systems as an educational, training and research tool. Nevertheless, one of its advantages is that it can be utilised to engage the public due to its simplicity.

The proposed modular physical model of the building, see Figure 1, comprises a modular and layered structural system which can be easily modified with the introduction of thermal insulating layers and with an internal and external control of the heating and cooling of the building model and the associated control of the simulated or realistic external environment. This educational kit will enable the teaching of the value of energy and the usefulness of insulation. This is in addition to the architectural, control, mechatronic and product design learning skills and knowledge that can be gained. The modular design allows insulation layers and building components to be interlocking and interchangeable to allow modification, assembly and disassembly in a simple and easy manner, as shown in Figure 1.

3

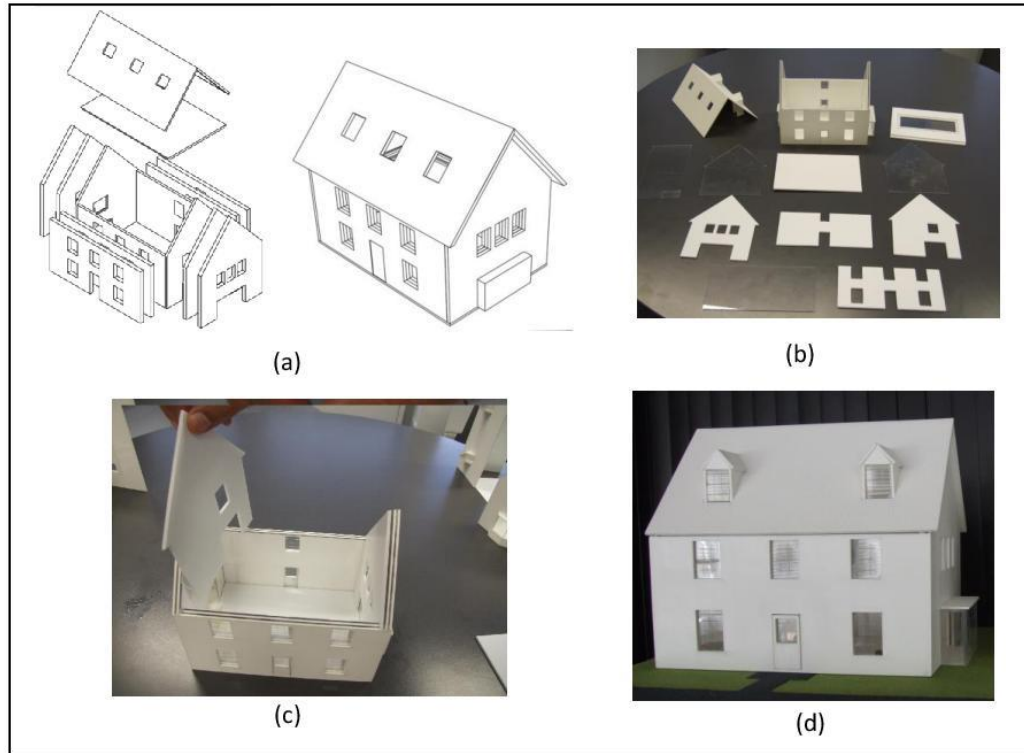

Figure 1: An example of the 3D CAD of the building model and the insulation layers (a), photos of the insulation layers and the physical building of the model (b), the model being assembled (c) and the complete building model when assembled (d).

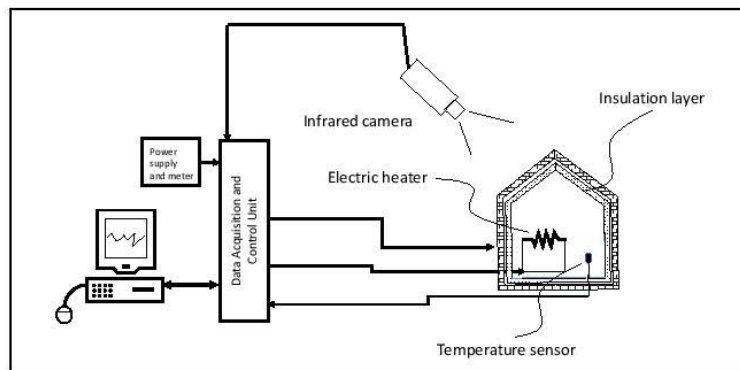

Figure 2: A schematic diagram of a possible application including the heating, monitoring and control systems.

The design and building process of the model and the insulation layers could help students to design and build their physical model using suitable CAD software and with the help of a laser cutter, the components could be easily manufactured. This process could particularly help product design and architecture students.

The Energy Efficiency Experimental Work

The schematic diagram, as shown in Figure 2, illustrates an example of how the building model could be used to test energy efficiency. The original building model can have one or more internal insulation layers. The building could be heated by an electric resistive heater (or a light bulb) or heated or cooled by means of a heat pump (e.g. Peltier effect). A temperature sensor is utilised to monitor and control the internal temperature. The building model can be housed in an environmental chamber to control and monitor the external environment of the building. The system can be connected to a power supply and a power meter to monitor the energy consumption. The system can be monitored by an infrared camera to examine the energy loss of the building and to study the thermal performance in different climate scenarios at different insulation levels.

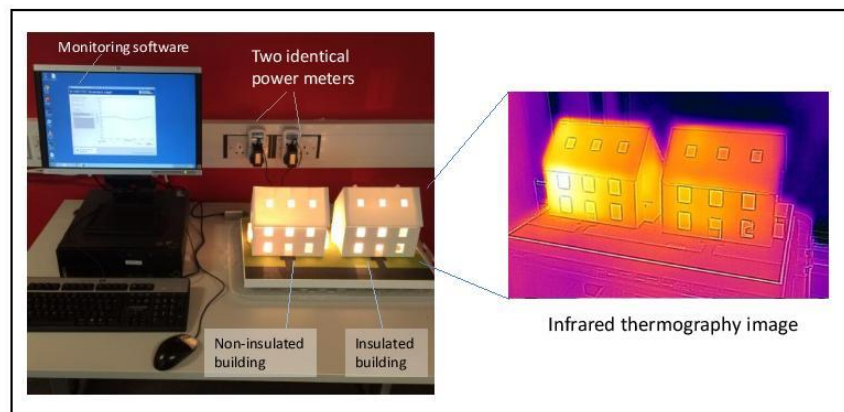

Figure 3: A completed control and monitoring system using two buildings one with insulation and one without insulation and the associated infrared image.

Figure 3 presents the experimental work for two systems; where two power meters are linked to two separate buildings, one with insulation and one without insulation. Two K-type thermocouples are connected to a PC via a data acquisition card for monitoring the temperature of the two buildings. Both building models are heated by identical light bulbs and the temperature is controlled by identical thermostats. Both systems are switched on at the same time and a comparison between the energy consumption and the behaviour is achieved via the identical power meters, see Figure 3. The use of infrared thermography, Figure 3, has indicated clearly that the non-insulated building model has much warmer surface temperature which is an indication of significant heat loss.

Temperature and Power Analysis

To compare the energy and temperature difference between the two building models, the models are placed in an environmental chamber with air conditioning to create a cold external temperature of 13 °C. The house models are heated with identical 14 watt halogen light bulbs. A power monitoring system is connected to each house model to measure the electricity consumption. The heating system is controlled by the means of a thermostat to turn the heating OFF when the internal temperature reaches the room temperature (21 °C). The internal temperature is monitored by two thermocouples to assess the temperature patterns. As shown in Figure 4, initially the heating process is turned ON when the internal temperature readings inside both houses are at the same level of 15.3 °C. The temperature inside the insulated house starts to rise rapidly reaching the target temperature in about 3 minutes. The non-insulated house heats up very slowly, and after about 20 minutes it reaches its steady state level at about 17 °C as its highest temperature; with significant steady state error. After just 15 minutes the temperature in the insulated house becomes stable at 20.5 °C at its lowest when the heating is turned OFF and then reaches 21.5 °C at its highest when the heating is turned ON again. The heating ON/OFF cycle has been found to be around 50 seconds long (see Figure 4). However, the temperature in the non-insulated house varied between 16.5 and 17.0 °C despite of the fact that the heating is turned ON continuously.

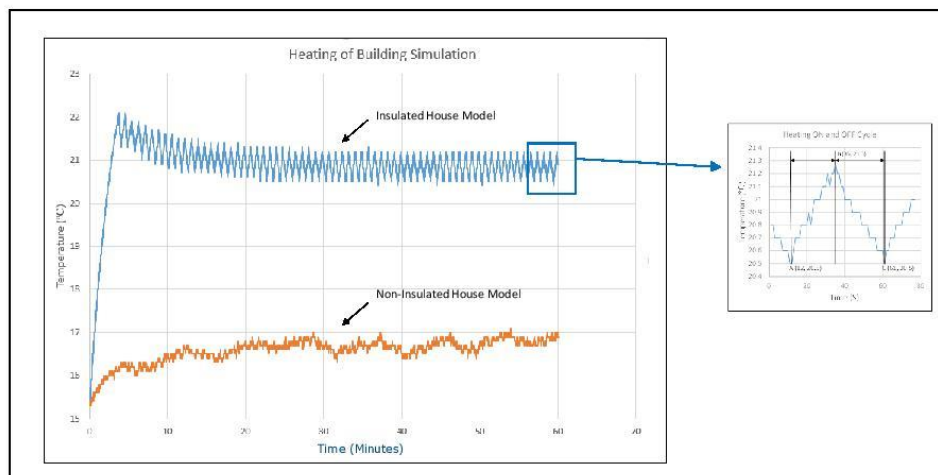

Figure 4: The temperature profile of the two building models.

From Figure 5, when the energy consumption is considered based on the power readings, it has been found that the non-insulated building consumes more than double the energy despite the fact it never reaches the target temperature.

Allan Hawas^a, Amin Al-Habaibeh^a/ *Energy Procedia 00 (2016) 000–000*

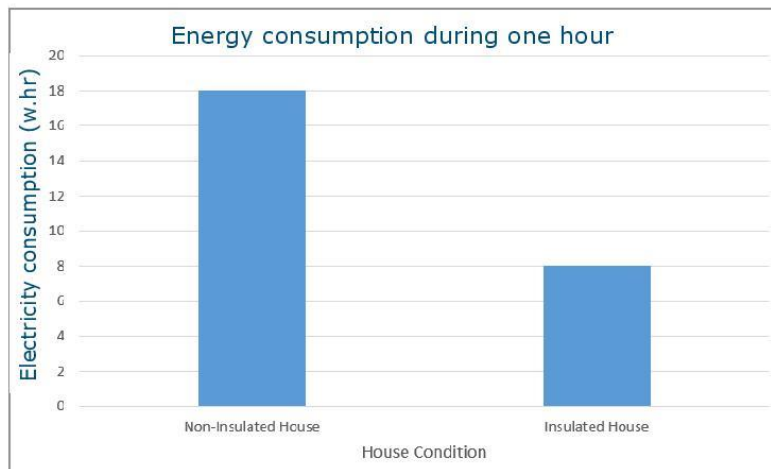

Figure 5: A comparison of energy consumption between the two building models.

Conclusion

Reducing energy consumption in buildings through enhanced insulation is becoming essential to decrease global warming and enhance long-term sustainability. Developing the teaching and training process on real buildings are costly and time consuming, with difficulty in influencing the external environment. Therefore, a new tool was needed to improve public engagement in this area and introduce the concept of building insulation and energy consumption for the educational and public environments to enhance the understanding of the concept. This paper has suggested a novel educational tool which combines a layer or more of detachable, interlocking and interchangeable insulation, combined with heating and/or cooling of the external and the internal volumes inside and outside the building to study the power consumption and the thermal parameters of buildings. Moreover, the proposed kit can be used for advanced building research since it can significantly reduce the cost of the experimental work. This educational kit is expected to enhance public engagement as well as the teaching and learning process in schools and colleges.

References

- [1] "EU Energy and Transport in Figures, Statistical Pocket Book 2007/2008," Euro-pean Communities, Brussels, Belgium, 2008.
- [2] EU, "Directive 2010/31/EU of the European Parliament and of the Council of 19 May 2010 on the energy performance of buildings (recast)," *Off. J. Eur. Union*, pp. 13–35, 2010.
- [3] A. Al-Habaibeh, G. Anderson, K. Damji, G. Jones, and K. Lam, "Using Infrared Thermography for Monitoring Thermal Efficiency of Buildings-Case Studies From Nottingham Trent University," *7th Jordanian Int. Mech. Eng. Conf. 27 - 29 Sept. 2010, Amman – Jordan 2.*, no. September, pp. 27–29, 2010.

Allan Hawas, Amin Al-Habaibeh and Benachir Medjdoub / Energy Procedia 00 (2016) 000–000

- [4] J. Kim and J. W. Moon, “Impact of Insulation on Building Energy Consumption,” *Build. Simul.* 2009, pp. 674–680, 2009.
- [5] U. Y. A. Tettey, A. Dodoo, and L. Gustavsson, “Effects of different insulation materials on primary energy and CO₂ emission of a multi-storey residential building,” *Energy Build.*, vol. 82, pp. 369–377, 2014.
- [6] Å. Jönsson, A.-M. Tillman, and T. Svensson, “Life cycle assessment of flooring materials: Case study,” *Build. Environ.*, vol. 32, no. 3, pp. 245–255, 1997.
- [7] J. Yu, C. Yang, L. Tian, and D. Liao, “A study on optimum insulation thicknesses of external walls in hot summer and cold winter zone of China,” *Appl. Energy*, vol. 86, no. 11, pp. 2520–2529, 2009.
- [8] A. D. La Rosa, A. Recca, A. Gagliano, J. Summerscales, A. Latteri, G. Cozzo, and G. Cicala, “Environmental impacts and thermal insulation performance of innovative composite solutions for building applications,” *Constr. Build. Mater.*, vol. 55, pp. 406–414, 2014.
- [9] M. F. L. I. N. Camilleri, “The effect of mandatory insulation on household energy,” *Branz*, vol. 130, no. 130, pp. 1–12, 2008.
- [10] J. Goodhew, S. Pahl, T. Auburn, and S. Goodhew, “Making Heat Visible: Promoting Energy Conservation Behaviors Through Thermal Imaging,” *Environ. Behav.*, 2014.
- [11] C. Xie, E. Hazzard, and S. Nourian, “Infusing Technology Into Engineering Education,” *Eng. Des. Educ. Res. Summit, P-12*, pp. 1–14, 2010.
- [12] J. Haglund, F. Jeppsson, E. Melander, A. M. Pendrill, C. Xie, and K. J. Schönborn, “Infrared cameras in science education,” *Infrared Phys. Technol.*, vol. 75, pp. 150–152, 2016.

Acknowledgements

The authors would like to thank the technical team at Nottingham Trent University, particularly Mr. Mark Beeston, for their support.

	<p>Biography</p> <p>Professor Amin Al-Habaibeh is a professor of Intelligent Engineering Systems at Nottingham Trent University. He is currently the Director of the Doctoral Training Alliance for Energy (DTA-Energy) within the UK University Alliance universities. Amin is also leading the Innovative and Sustainable Built Environment Technologies research group (iSBET). Amin’s interest includes, in addition to energy, condition monitoring, intelligent systems, sustainable technologies, product design and advanced manufacturing technologies.</p>
---	---

Appendix 14: Table 7- 2 the sociodemographic characteristic data

Characteristics	Frequency	Percentage
Ownership		
Owner	21	42
Tenant	29	48
Age of the occupant (years)		
18-24	2	4
25-34	20	40
35-44	10	20
45-54	10	20
55-64	8	16
65 or above		
Educational level		
Post graduate degree	27	54
B.Sc. or B.A.	14	28
Further education or technical college	5	10
Secondary school or lower	4	8
Property type		
A terraced house	5	10
Detached house	11	22
Semi-detached house	18	36
A flat/ground floor	3	6
A flat/middle floor	5	10
A flat/top floor	8	16

Number of rooms

1		
2	8	16
3	11	22
4	6	12
More	25	50

Age of the property (Years)

0-20	8	16
21-40	10	20
41-60	9	18
61-80	6	12
81 or above	12	24
Do not know	5	10

Type of windows

Single glazed	8	16
Double glazed	42	84
Triple glazed	0	0

Number of occupants in the property

1	8	16
2	14	28
3	9	18
4	12	24
More	7	14

Condition of the loft/attic

Insulated	25	50
Non-insulated	6	12
Unsure	14	28
Not applicable	5	10

Average monthly heating bill in winter (£)

Less than 25	12	6
25-44	28	14
45-64	76	38
65-84	28	14
85 or more	56	28

You evaluation of your heating consumption compared to the UK average

Less than average	6	12
Average	21	42
More than average	14	28
Do not know	9	18

Average monthly electricity bill (£)

Less than 25	4	8
25-44	22	44
45-64	13	26
65-84	4	8
85 or more	7	14

You evaluation of your electricity consumption compared to the UK average

Less than average	8	16
Average	25	50
More than average	9	18
Do not know	8	16

Electrical heating

Yes	16	32
No	34	68

Improvement of the insulation in the last 20

years	22	44
Yes	28	56
No		

The maintain home temperature in winter (°C)

18 or less	9	18
19-20	13	26
21-22	15	30
23 or above	6	12
Do not know	7	14

Home temperature comfortability

Warm	7	14
Comfortable	28	56
Ok if I wear a jumper	12	24
Cold	3	6

Table: summary of the questionnaires

ID*	Participant's age group	Educational level	Ownership	Type of property	Age of property	Type of windows	No. of rooms	No. of occupants
P06	25-34	Post graduate	Owner	Terraced	81 or above	Double glazed	4	2
P12	25-34	Post graduate	Rental	Middle floor flat	Do not know	Single glazed	2	1
P13	55-64	Secondary or lower	Owner	Detached	41-60	Double glazed	5 or more	2
P14	45-54	Further education	Owner	Semi-Detached	61-80	Double glazed	5 or more	2
P17	35-44	B.Sc. or B.A.	Rental	Semi-Detached	81 or above	Single glazed	5 or more	1
P18	25-34	Post graduate	Owner	Detached	41-60	Double glazed	5 or more	4
P23	45-54	B.Sc. or B.A.	Owner	Detached	21-40	Double glazed	5 or more	4
P25	25-34	Post graduate	Rental	Middle floor flat	21-40	Double glazed	5 or more	5 or more
P34	25-34	Post graduate	Owner	Semi-Detached	81 or above	Double glazed	4	3
P37	25-34	B.Sc. or B.A.	Rental	Top floor flat	0-20	Double glazed	2	2
P38	25-34	B.Sc. or B.A.	Owner	Semi-Detached	61-80	Double glazed	5 or more	2
P42	25-34	Secondary or lower	Rental	Detached	Do not know	Double glazed	5 or more	4
P43	25-34	Post graduate	Rental	Top floor flat	61-80	Double glazed	3	4
P44	25-34	B.Sc. or B.A.	Owner	Terraced	81 or above	Double glazed	5 or more	2
P45	55-64	Further education	Owner	Semi-Detached	61-80	Double glazed	5 or more	1
P46	45-54	B.Sc. or B.A.	Owner	Semi-Detached	81 or above	Double glazed	5 or more	5 or more
P47	25-34	B.Sc. or B.A.	Rental	Top floor flat	Do not know	Double glazed	3	1
P48	55-64	B.Sc. or B.A.	Owner	Detached	41-60	Double glazed	5 or more	3
P49	45-54	B.Sc. or B.A.	Owner	Semi-Detached	81 or above	Double glazed	5 or more	4
P50	55-64	Secondary or lower	Owner	Detached	81 or above	Double glazed	5 or more	2

* Throughout this paper, this unique code has been applied to mark questions drawn from the questionnaire.

Appendix 15: The results of the training session

1. The session has helped me to understand infrared thermography

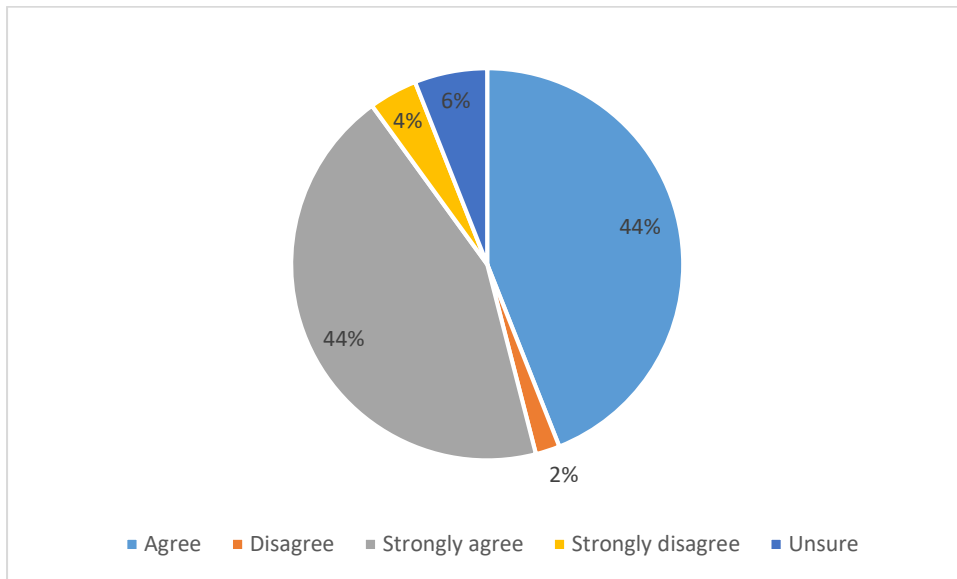

2. I think that I can now carry out a simple inspection of the efficiency of the equipment in my house.

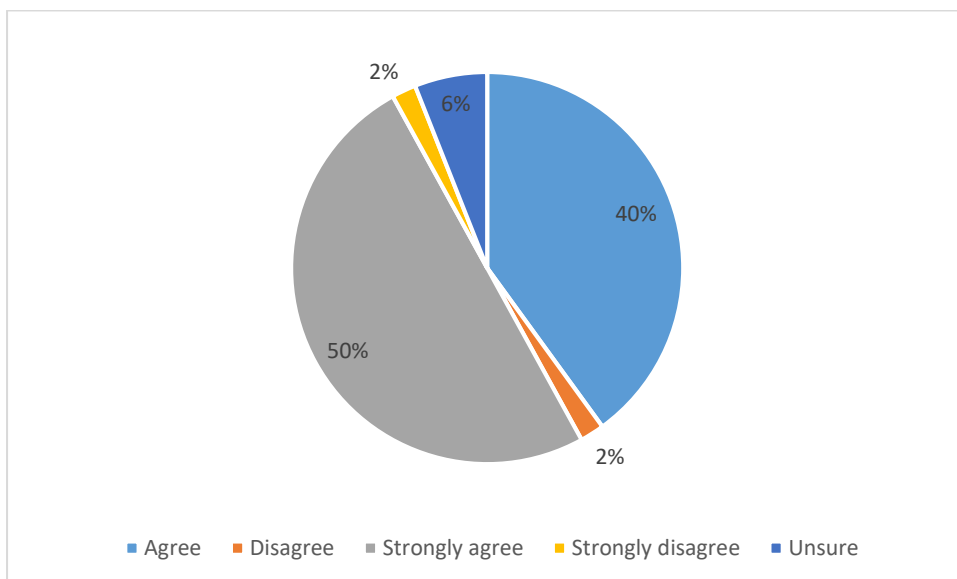

3. I am now more aware of the ways in which energy is lost from buildings.

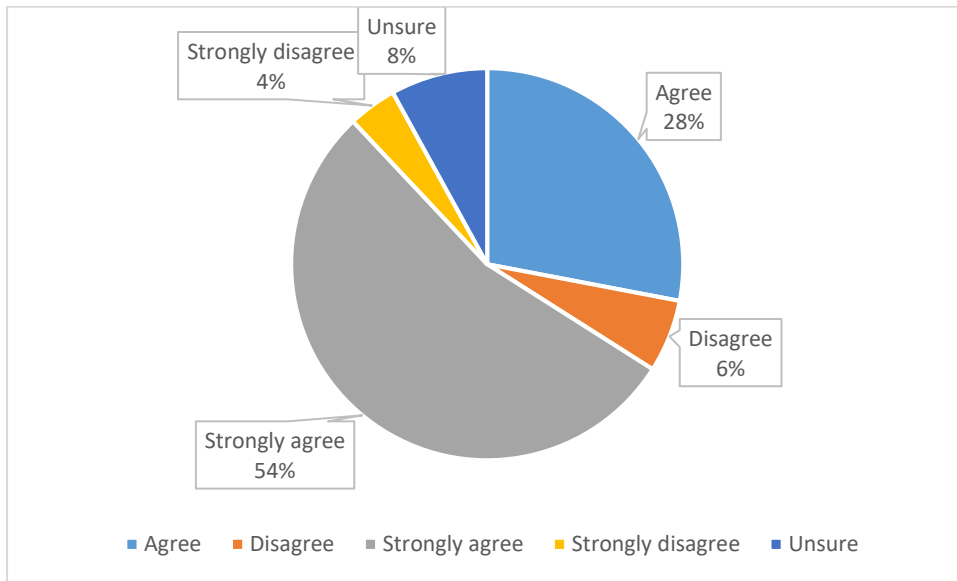

4. The teaching session has encouraged me to inspect the insulation of my home.

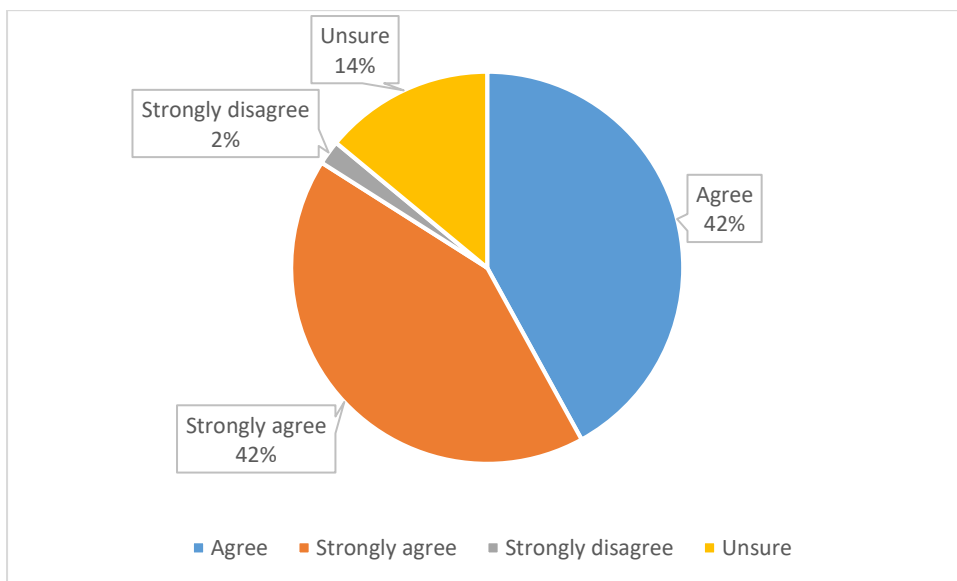

5. I have learned how to use the thermal camera to scan the insulation and the equipment in my house.

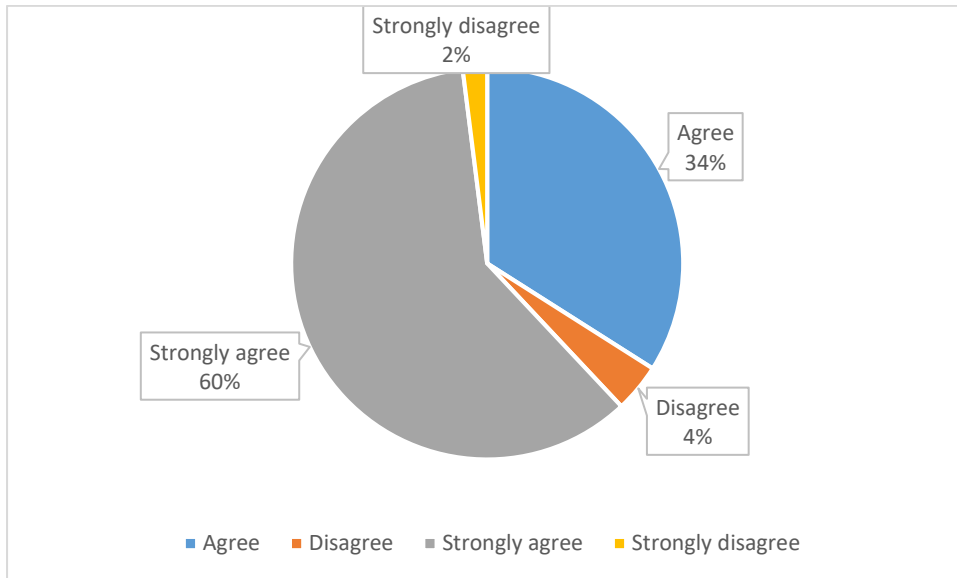

6. I feel really comfortable to using the thermal camera to scan my house.

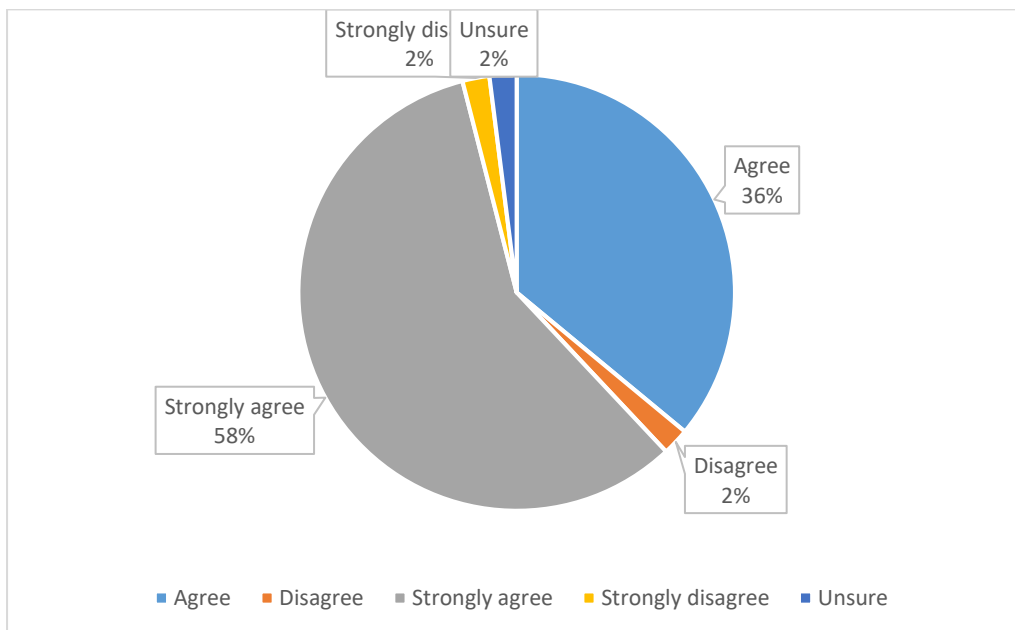

7. The thermal camera is very effective tool revealing where heat is lost.

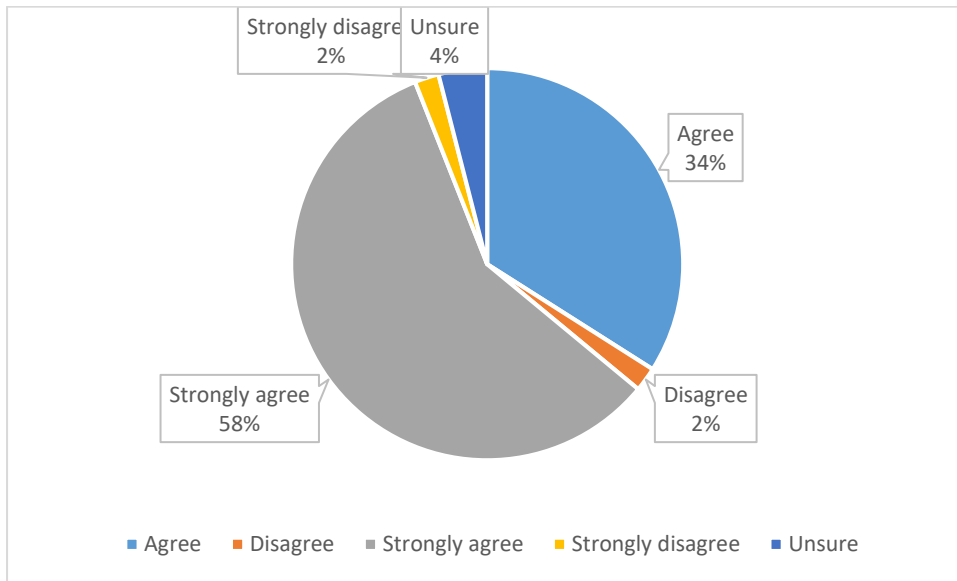

8. The thermal camera is very easy to use.

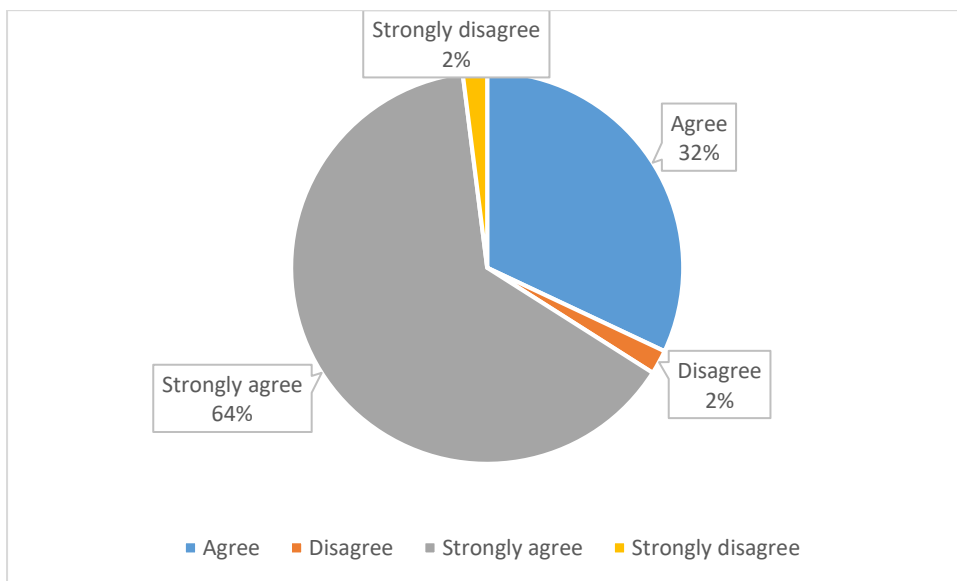

9. The thermal image is very easy to understand.

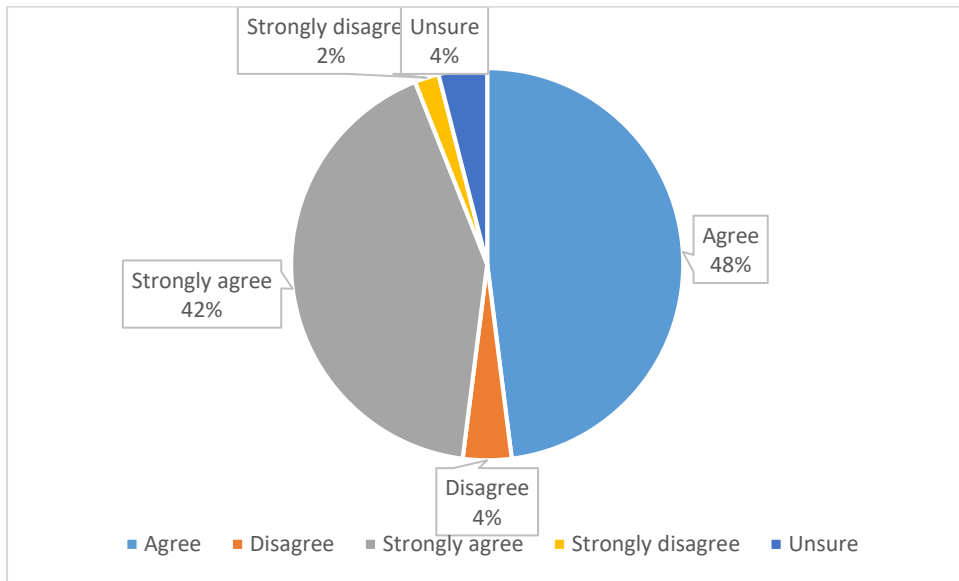

10. The thermal image convinces me that heat is escaping from my home

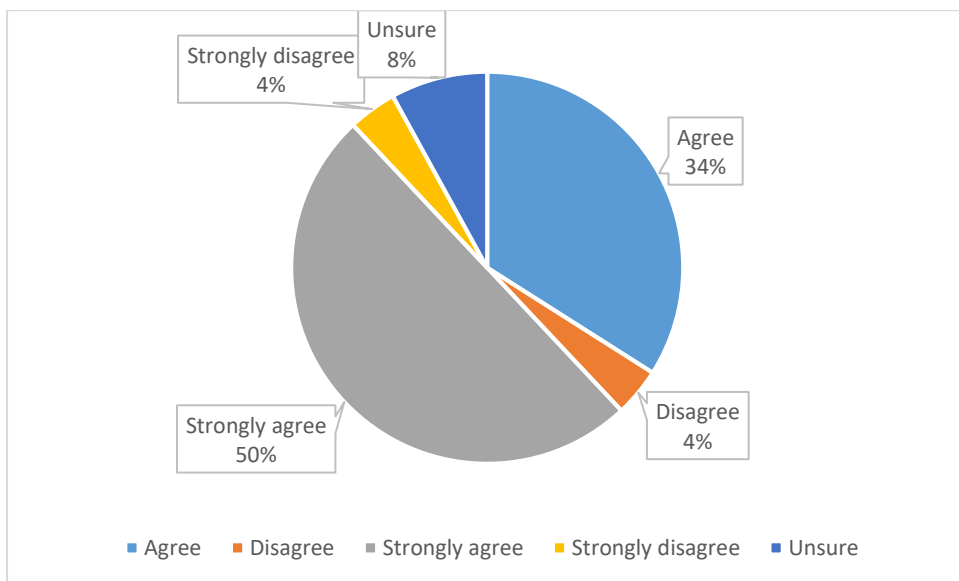

11. I would like to scan the insulation of my house.

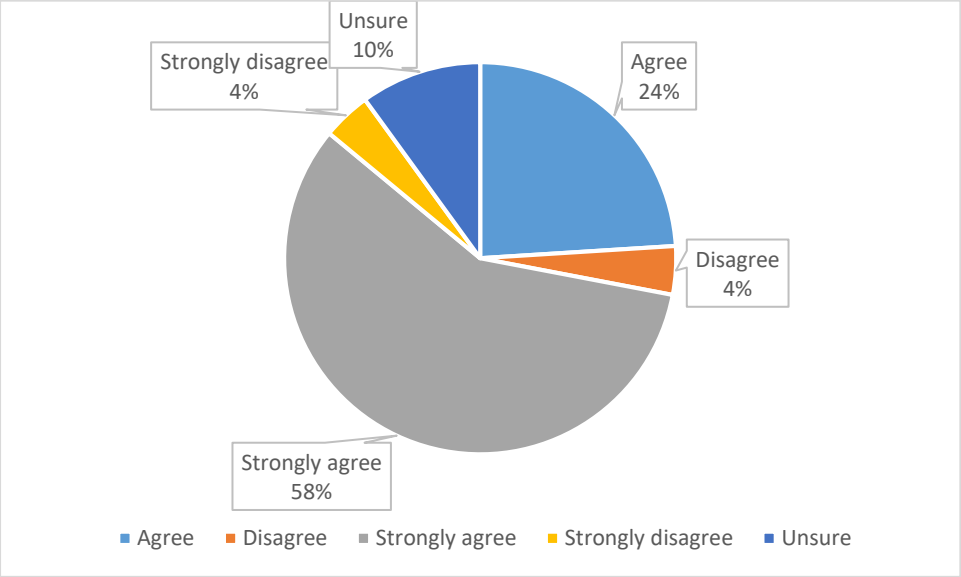

Appendix 16: The results of the first questionnaire

1. Do you own your home?

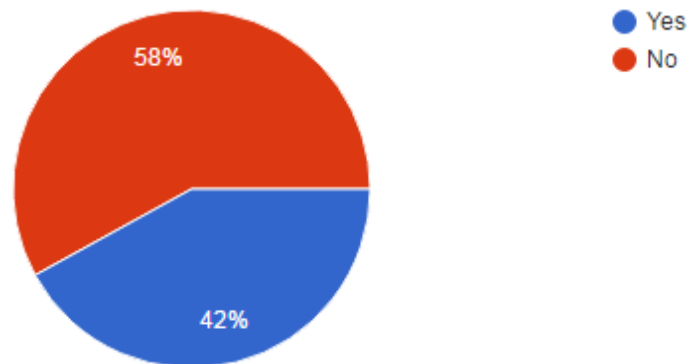

2. How old are you?

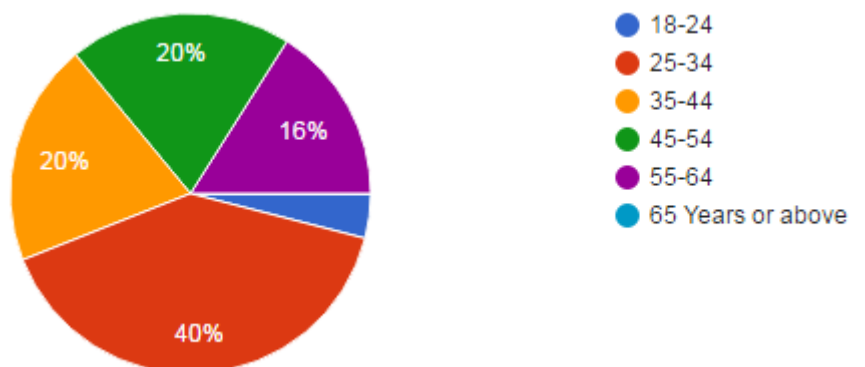

3. At what level did you complete your education?

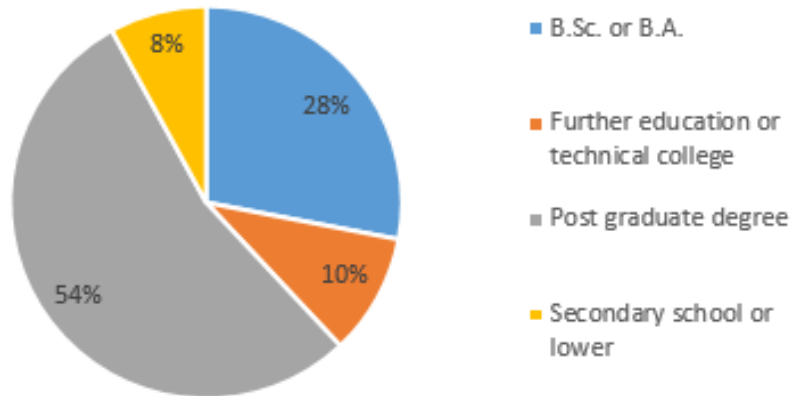

4. What is the type of your home?

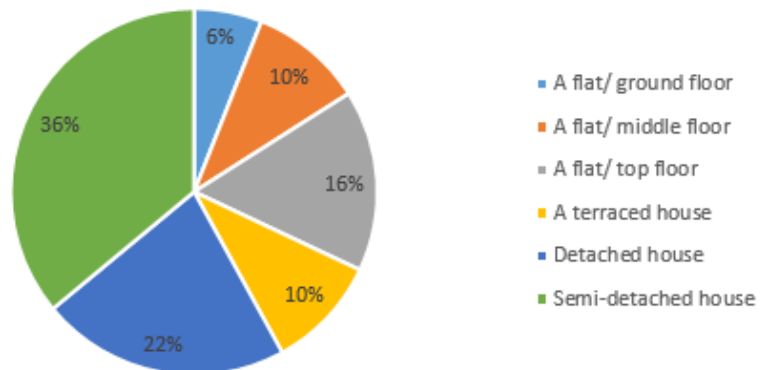

5. How many rooms, including the living room, are there in your home?

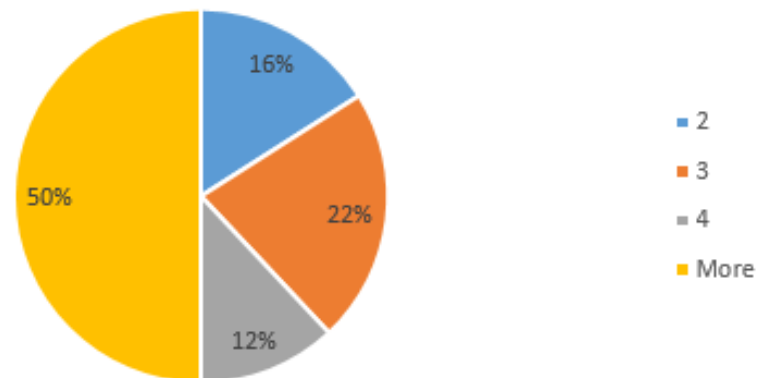

6. How old is your property?

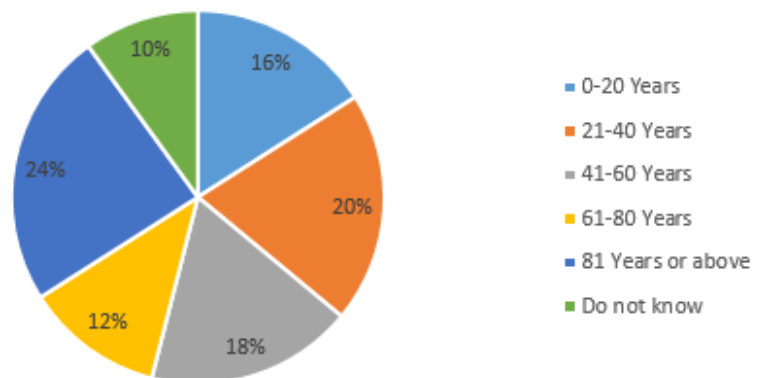

7. Is the loft/attic of your home insulated?

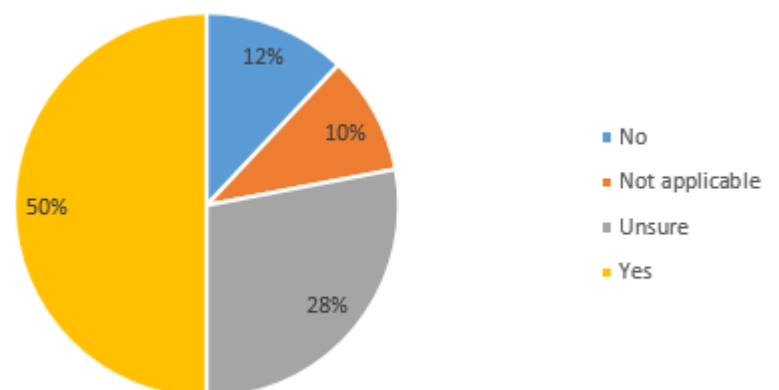

8. How many people, including yourself, live in your home?

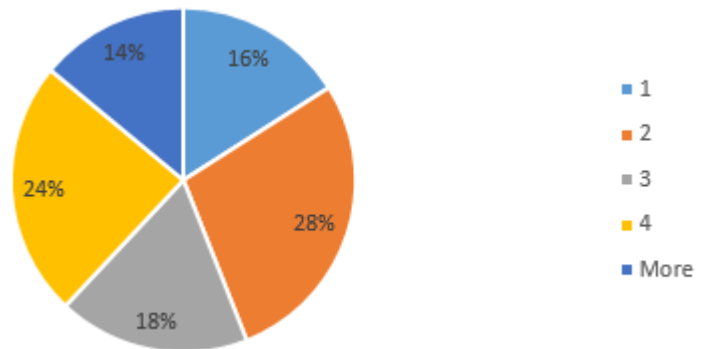

9. What is/are the type(s) of windows in your home?

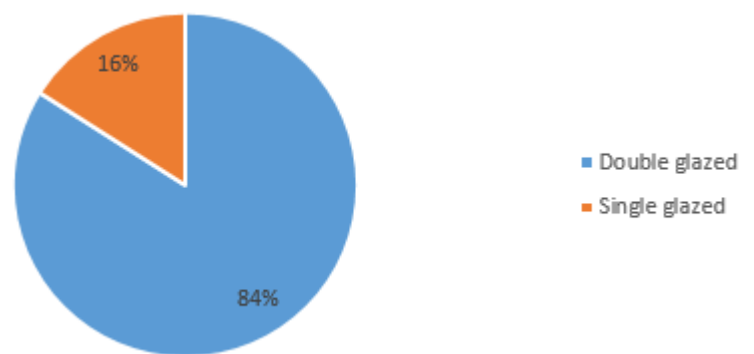

10. What is your average monthly heating bill in winter?

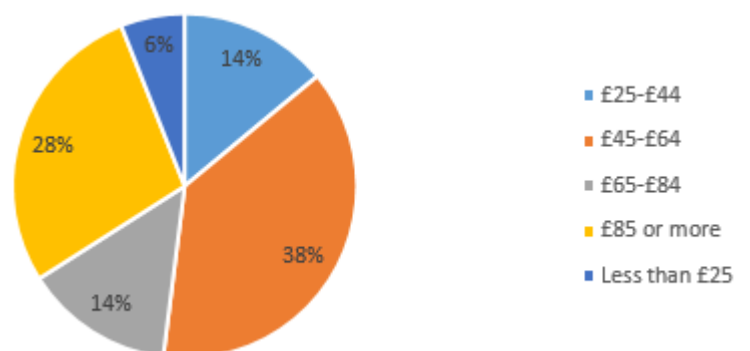

11. What do you think about the amount you spend on heating compared to the UK average for the size of your home?

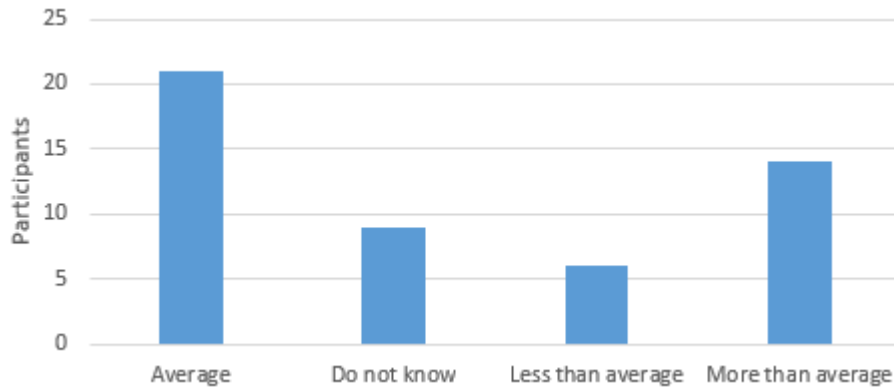

12. How much is your monthly electricity bill?



13. What do you think about the amount you spend on electricity compared to the UK average for the size of your home?

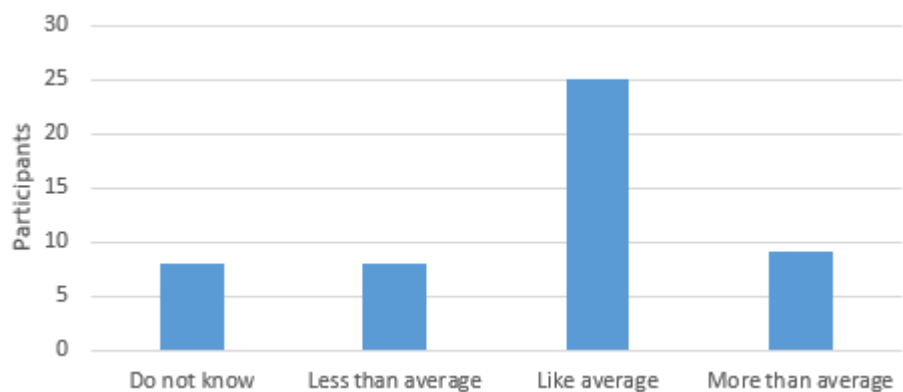

14. Do you use electricity to heat your home?

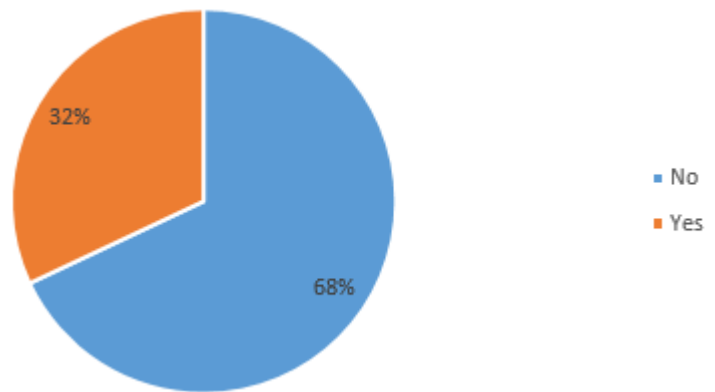

15. Do you use electricity for heating water in your home?

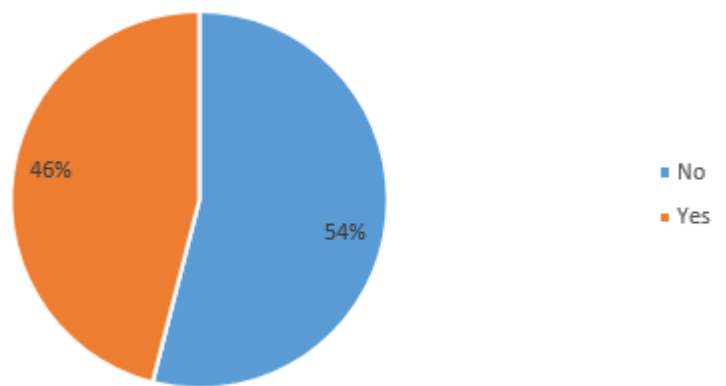

16. Have you improved the insulation of your home in the last 20 years?

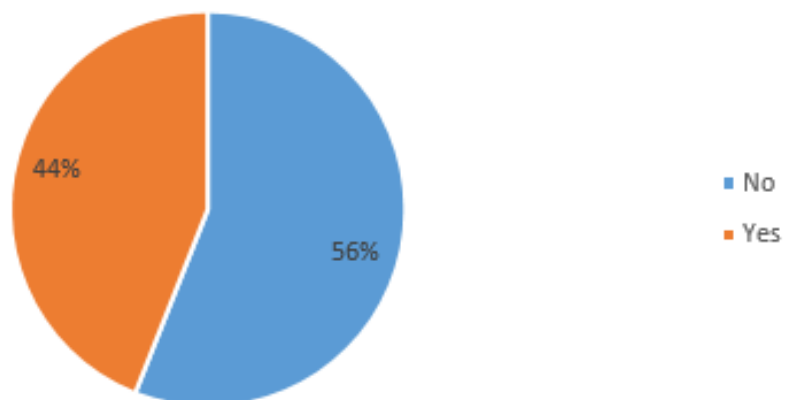

17. At what temperature do you maintain your home in winter?

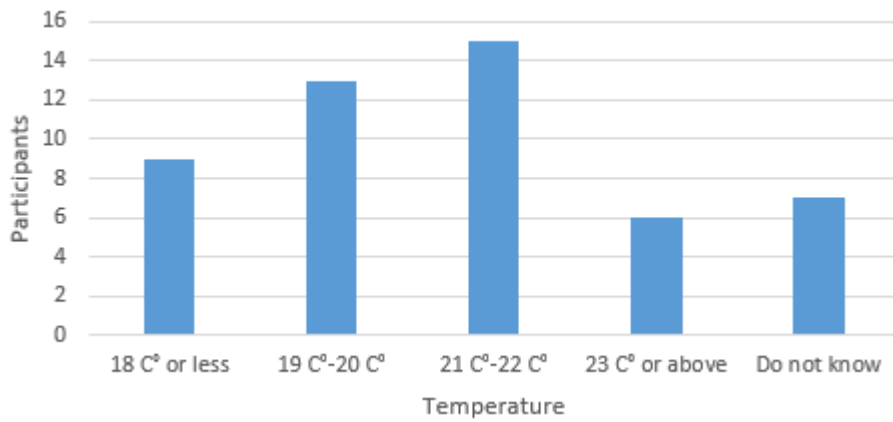

18. How comfortable do you feel the temperature in your house is?

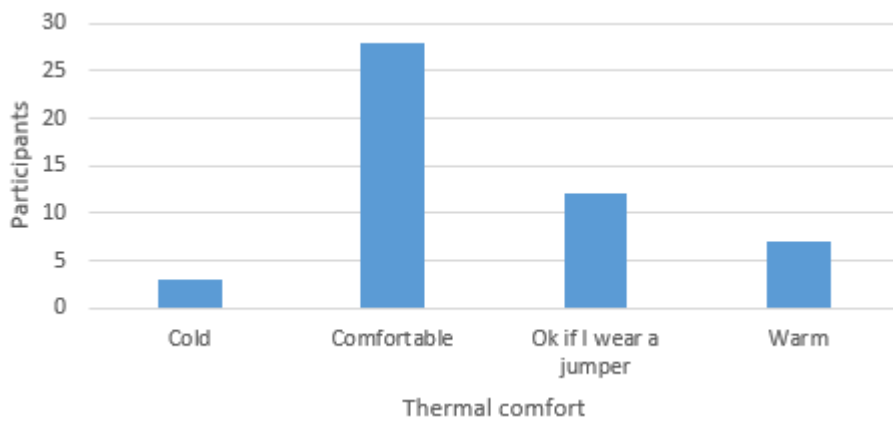

Appendix 17: The results of comparison between Pre-test and Post-test

19. My home is energy efficient, in terms of conserving the heat.

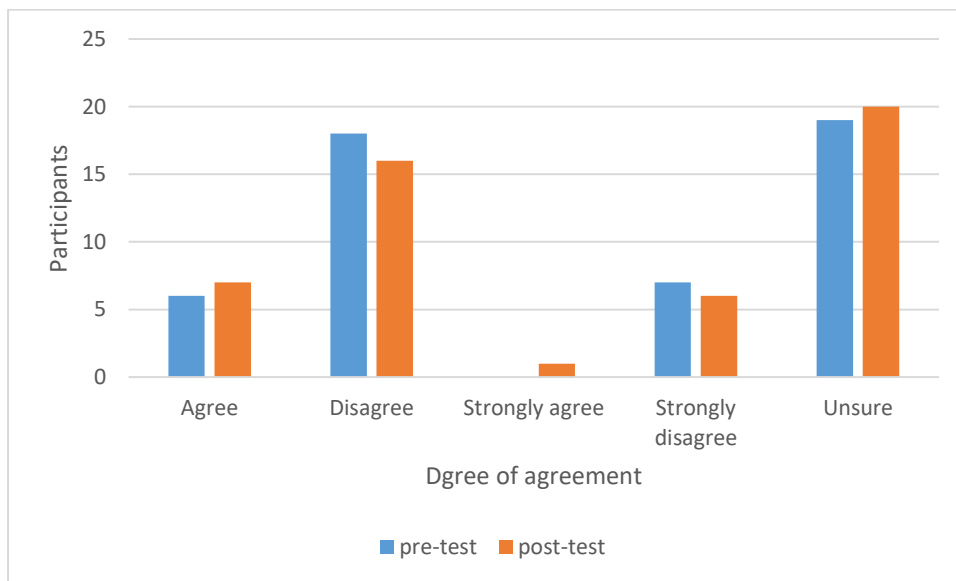

20. I know which energy measures make the biggest saving effect in my house.

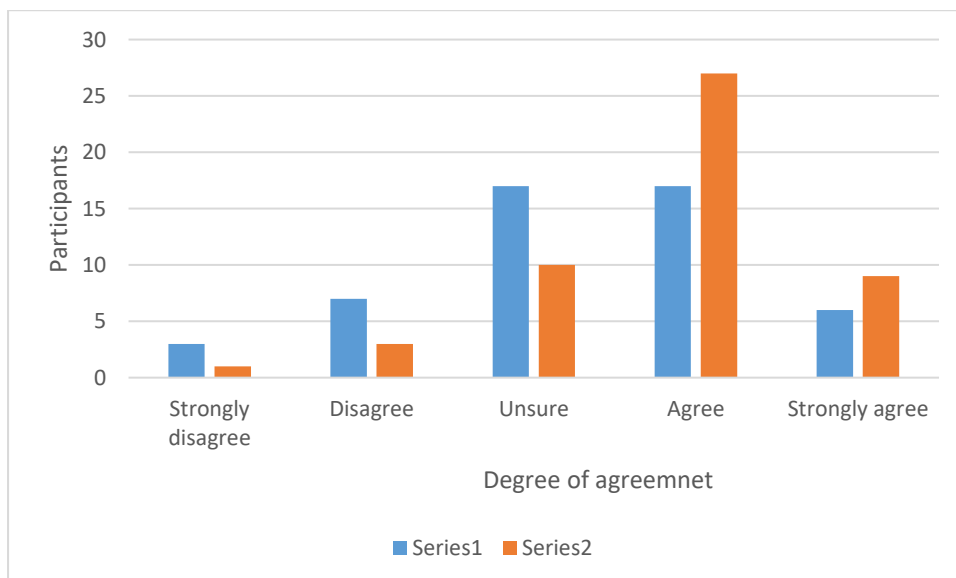

21. I know how much energy is lost by keeping equipment on standby.

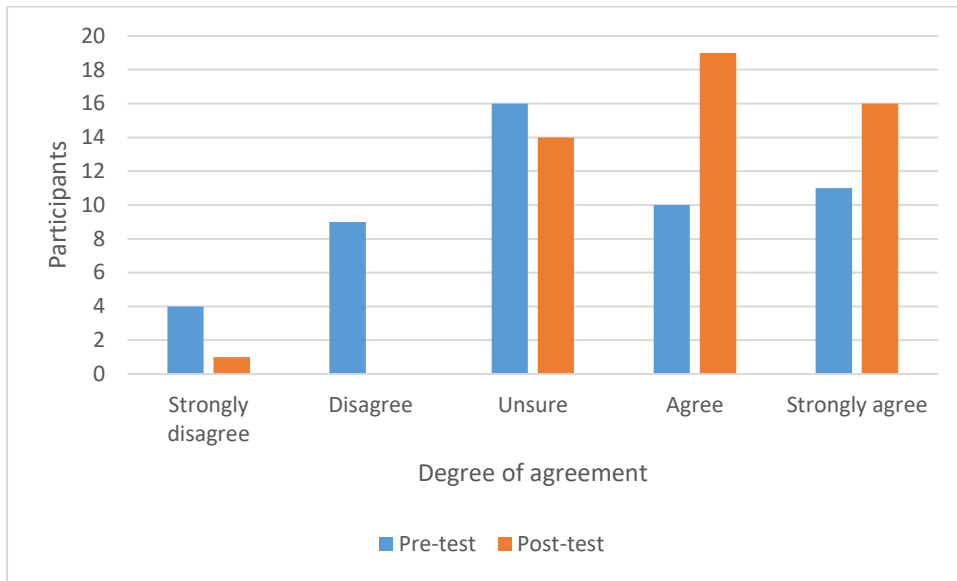

22. My house is well insulated.

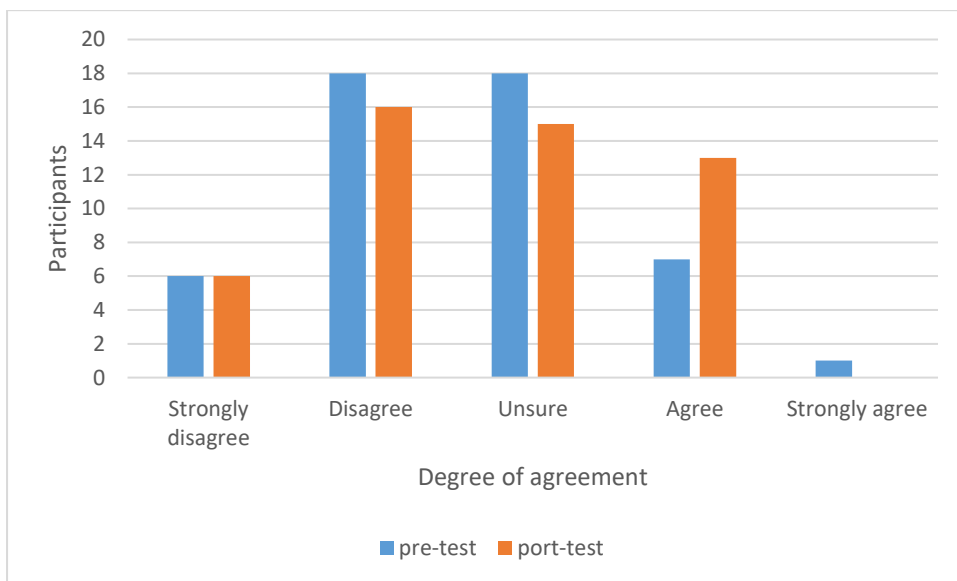

23. The insulation of my house needs improvement.

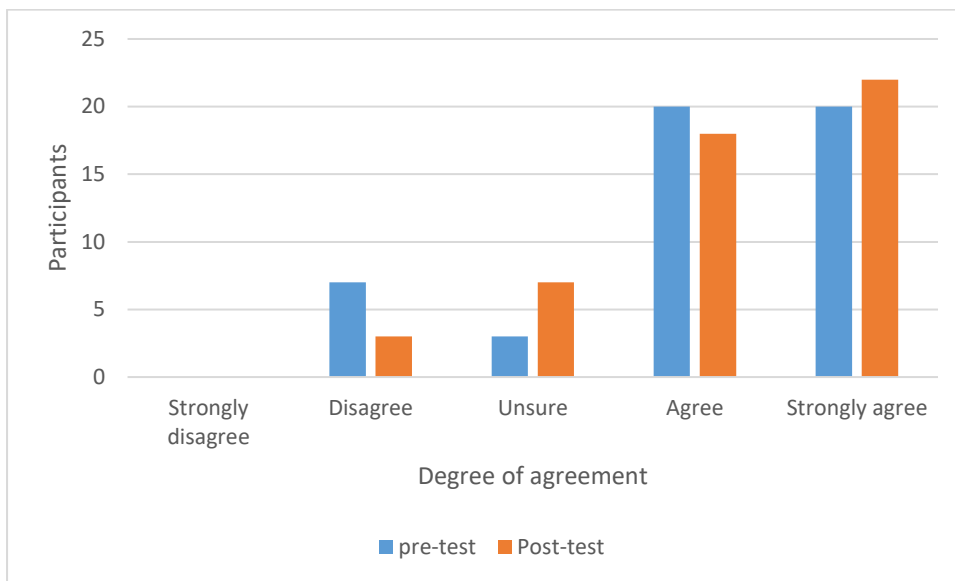

24. I can identify where exactly warm air escapes from my house.

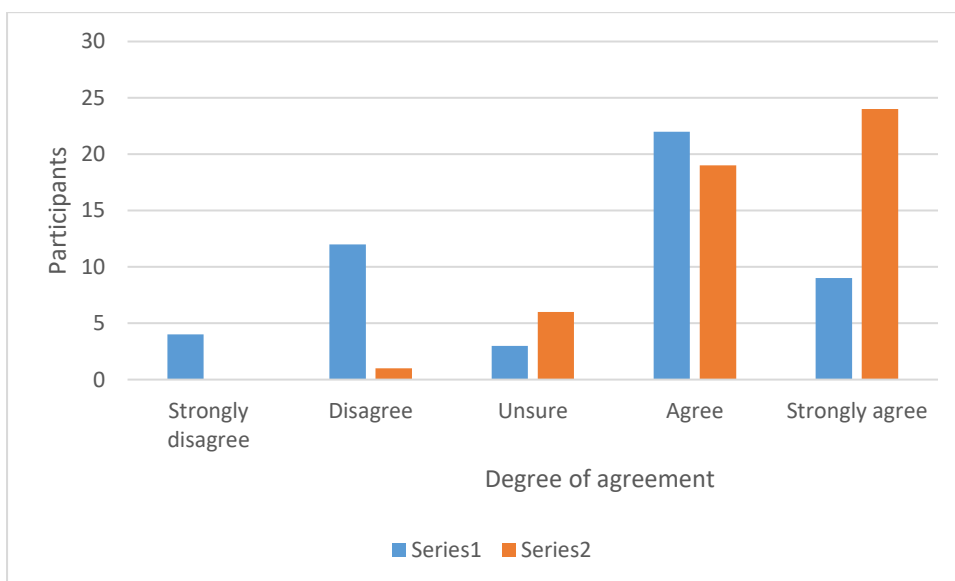

25. Most heat loss from my home is through the roof.

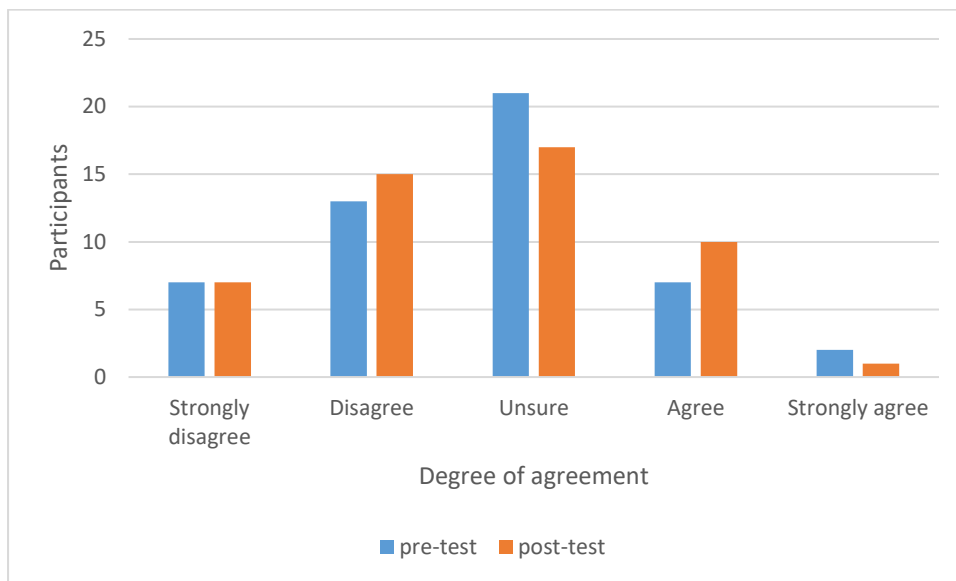

26. Most heat loss from my home is through the walls.

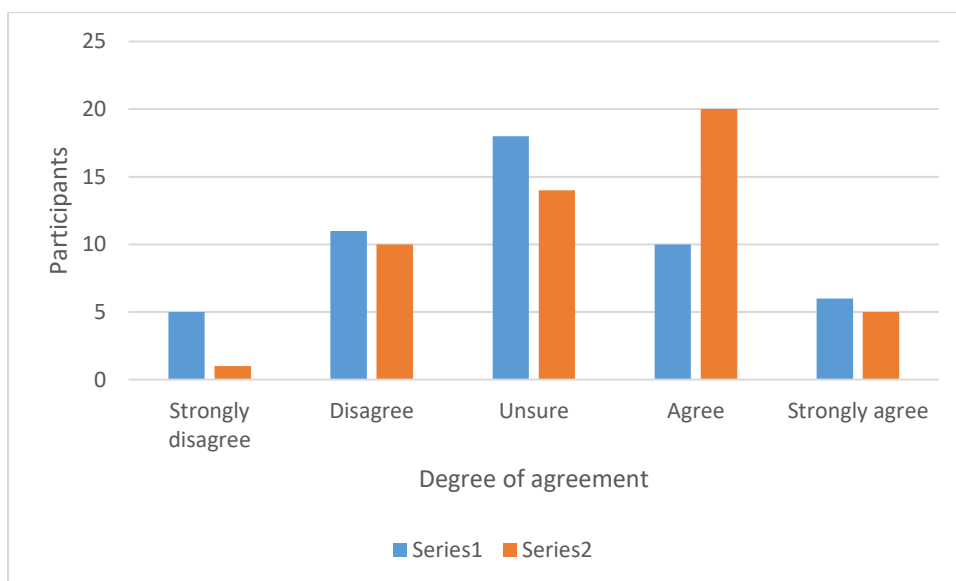

27. Most heat loss from my home is through the windows.

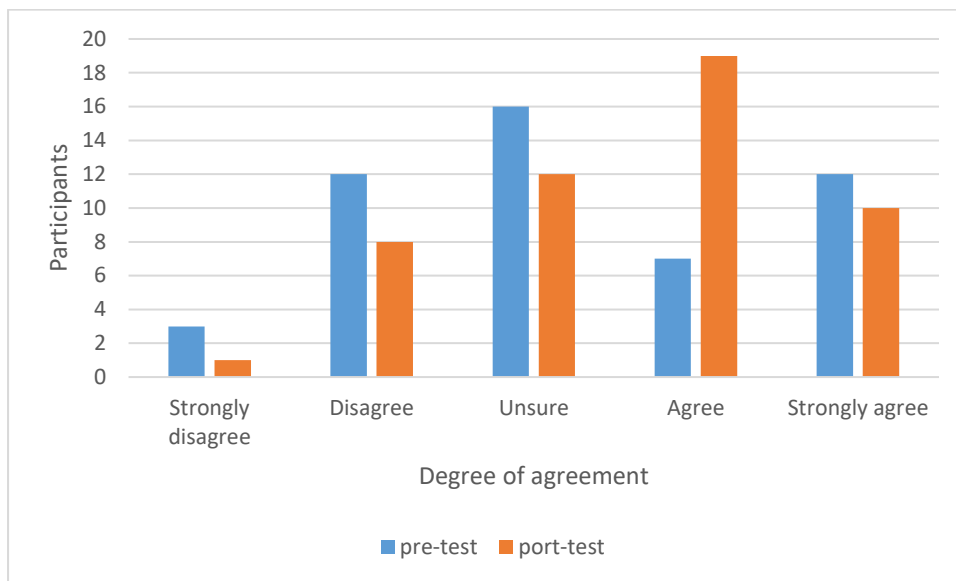

28. Most heat loss from my home is through the doors.

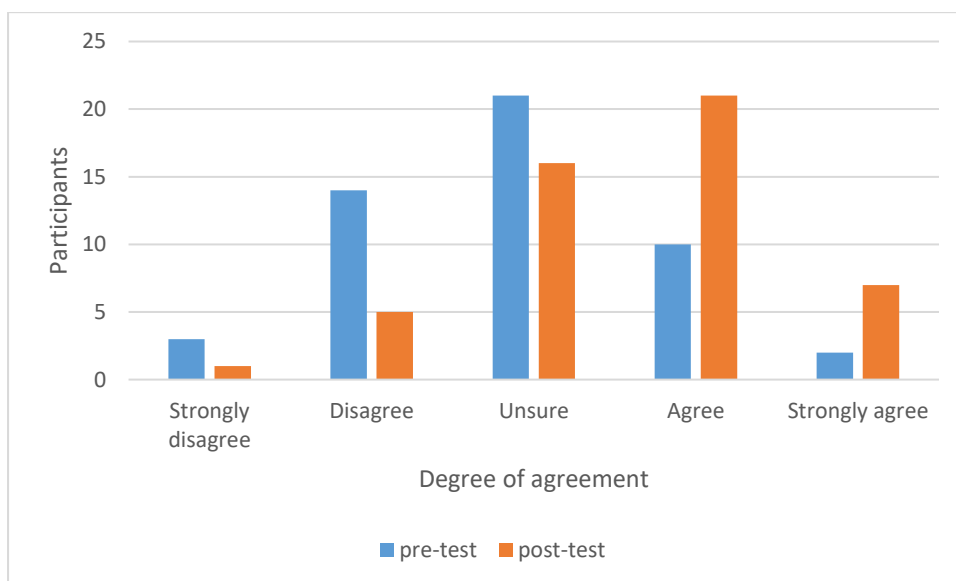

29. I know how energy efficient the equipment in my house is.

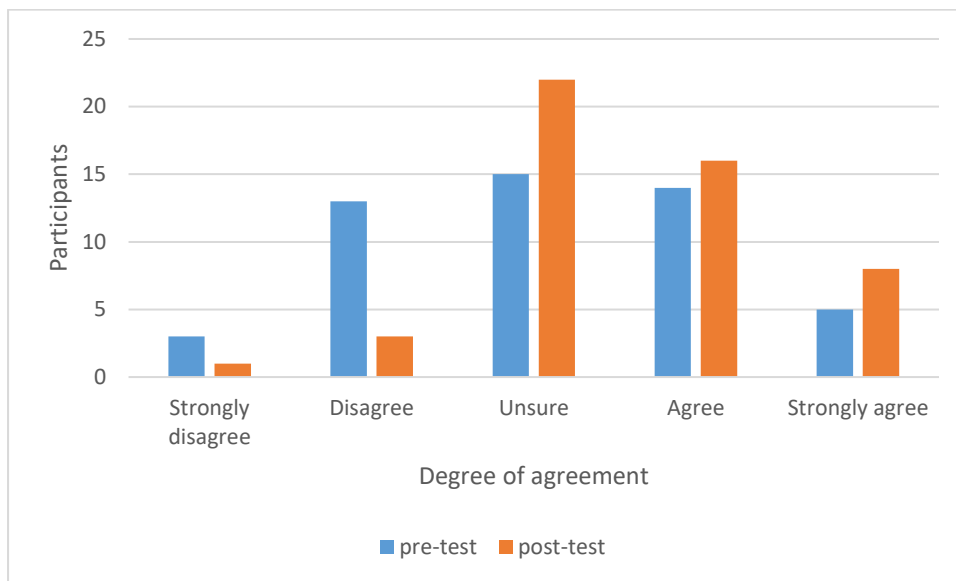

30. I know that I am heating my house in an energy efficient way.

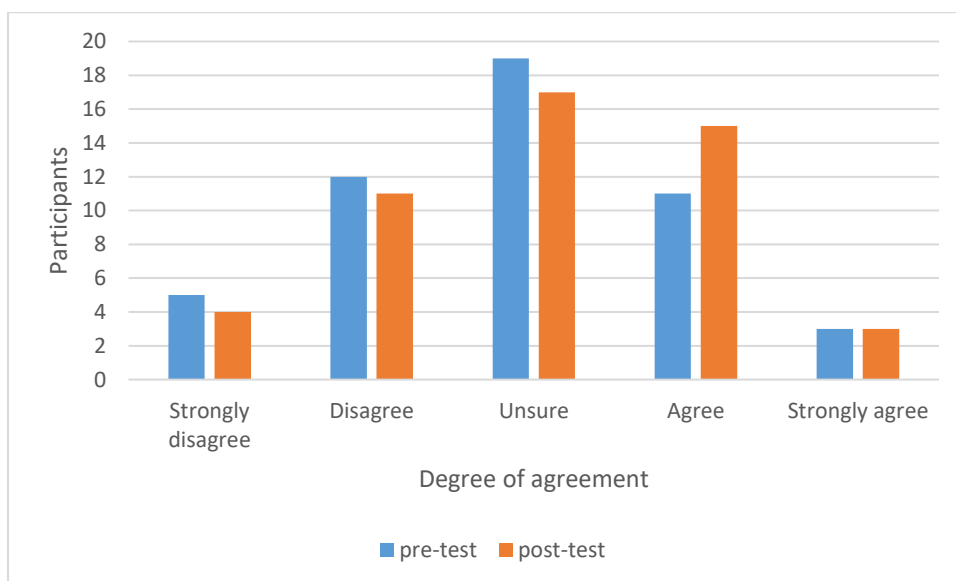

31. I know that I am using the equipment in my house in an energy efficient way.

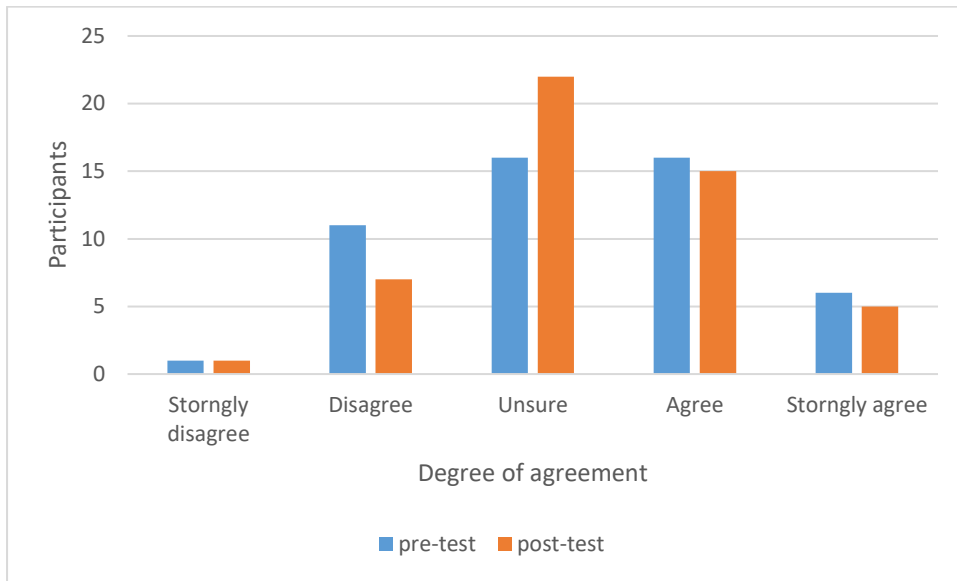

32. I am planning to change the way I heat my house.

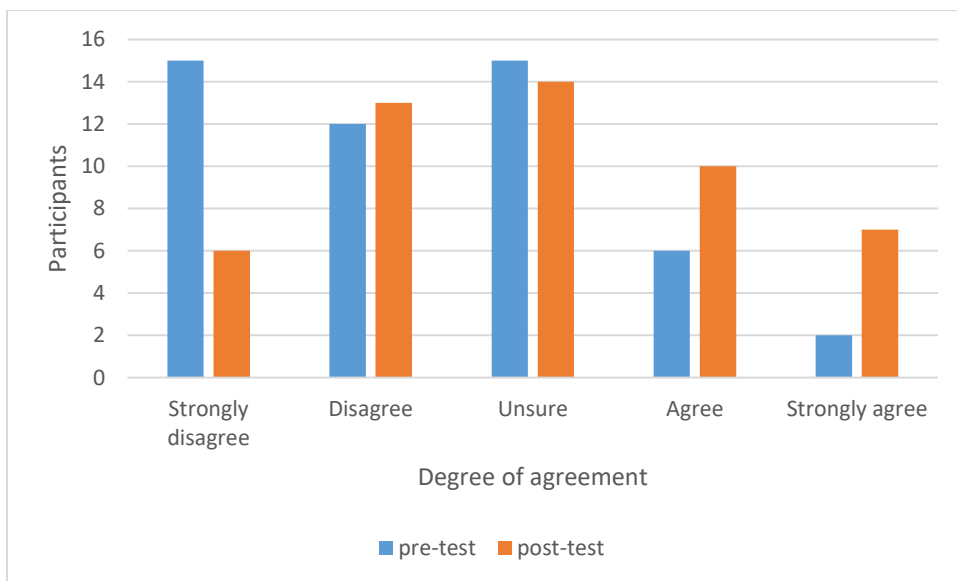

33. I am planning to change the way I use the equipment in my house.

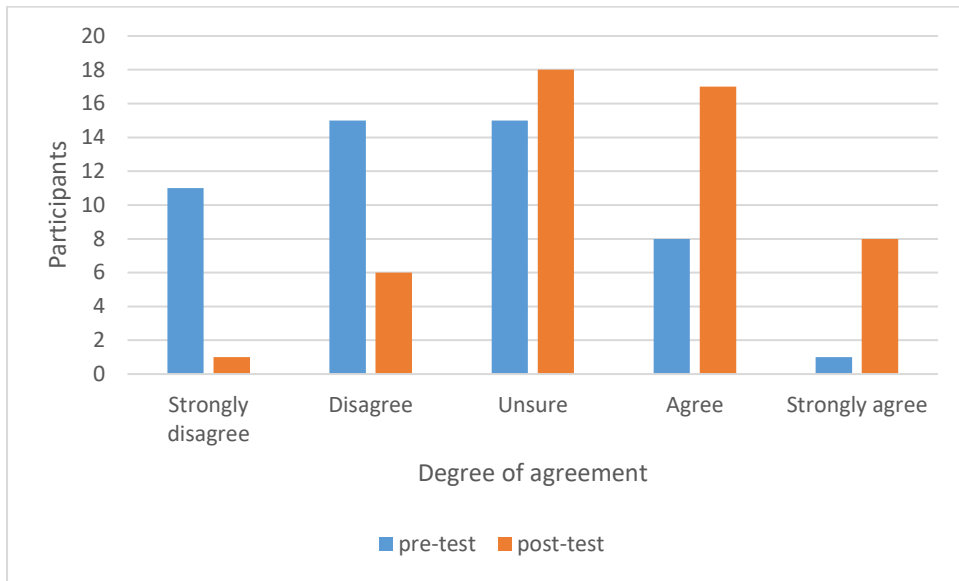

34. I want to make my house more energy efficient.

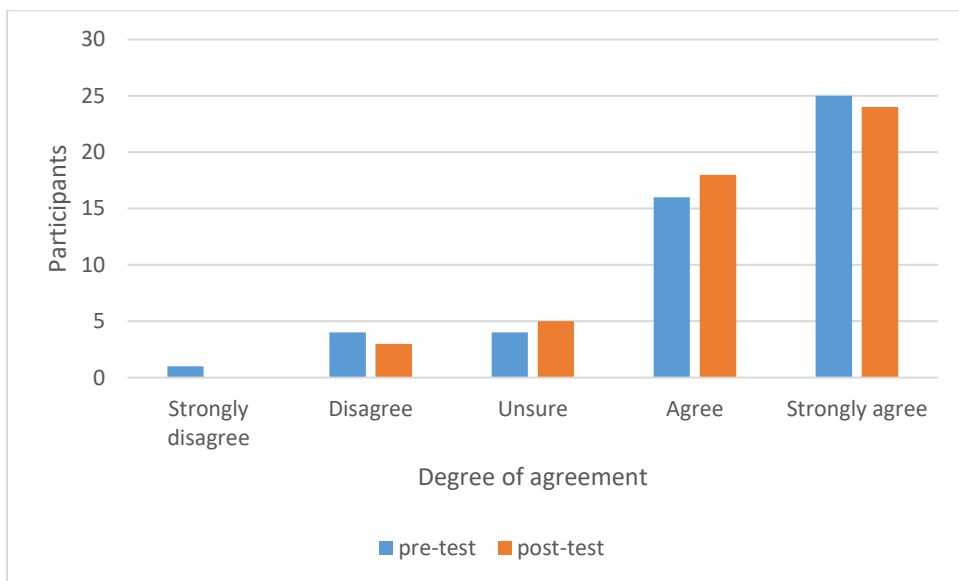

35. I am planning to replace the equipment in my home with more energy efficient items

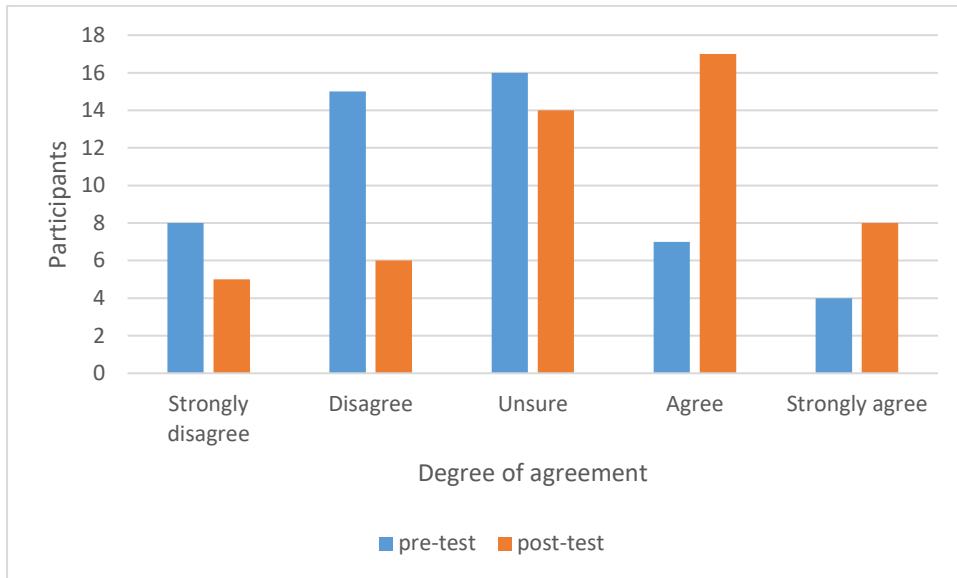

36. I recently discovered which parts of my home are warm and which are cold

