

# Analysis of the IEC 61850 Protocol when used for communication during Maintenance Operations in an Electrical Substation Grid

Dion Njova, Kingsley Ogudo IEEE, and Patrice Umenne *Member, IEEE*

**Abstract**— During Substation maintenance a bay is taken out of service, tested and during testing traffic is generated on the Substation Communication Network (SCN) in a power utility. A model of a Substation Communication Network that is using the International Electrotechnical Commission (IEC) 61850 protocol has been modeled in Optimized Network Engineering Tool (OPNET). IEC 61850 is a protocol that can be used in a power utility to provide interoperability between different vendors of Intelligent Electronic Devices (IED's). Most of the IED's sold by manufacturers for power utility networks support IEC 61850 protocol. The model has three scenarios and they are normal operation of a Substation, maintenance in a Substation and Buszone operation at a Substation. In all the scenarios packet end to end delay of GOOSE, GSSE, SV and MMS messages are monitored. The throughput from the IED under maintenance and the throughput at the Substation RTU end is monitored in the Model. The design of the Substation Communication Network using IEC 61850 will assist when trying to predict the behavior of the network with regards to this specific protocol during maintenance and when there are faults in the communication network or IED's.

**Keywords**—IEC 61850, Intelligent Electronic Devices (IED's), GOOSE messages, Packet delay, Buszone operation .

## I. INTRODUCTION

During maintenance at an Electrical Substation, fault currents are injected to the protection relays to ensure that the system is still functioning properly [1]. The maintenance test will generate alarms, control signals and therefore create traffic in the communication network [1]. One of the scenarios in this paper is to simulate maintenance traffic on an IEC 61850 protocol based communication network and monitor whether the Generic Object Oriented System (GOOSE), Sample Values (SV), Generic Substation State Events (GSSE) and manufacturing message specification (MMS) messaging over the network meet the IEC 61850 standard transfer time requirements. A Busbar fault at an Electrical Substation affects a lot of equipment and can cause tripping on the busbar which will break the circuit as a protection mechanism [2]. The Busbar connects all the bays at an Electrical Substation [3], when there is a busbar fault all the bays and alarms trip at the same time. Indications are sent to the RTU, this creates a huge traffic within a short space of time, at the same time controls are sent to the

breakers to trip. The Buszone operation simulates the busbar trip and it will check if GOOSE, SV, GSSE and MMS messages meet the IEC 61850 standard transfer time for this operation. Normal operation of the Substation is also simulated in this paper and monitors the same IEC 61850 standard transfer time that was monitored for the maintenance and Buszone Operations. The protocol IEC 61850 was created to standardize communication for Substation devices so that all devices from different manufacturers could communicate using the same protocol in power utilities [4]. The IEC 61850 standard is a foundation of engineering networks for Substation Automation by having a set of standard formats [5]. The IEC 61850 is used to achieve interoperability of intelligent electronic devices in the communication method of power based networks [6]. The communication architecture of the IEC 61850 has more benefits from Ethernet communication technology, and it gives it more flexibility [4]. Substations use IEC 61850 for Substation automation, protection function and data acquisition, it is an Ethernet based protocol. Ethernet based communications can handle more data, are faster and more reliable as compared to hardware based communication protocols. Engineers came up with the solution of IEC 61850 protocol in order to solve the problem of interoperability of relays from different manufactures. The IEC 61850 protocol covers all the relay functions such as control, monitoring and protection. This protocol introduces a new way of communication at an Electrical Substation network. IEC 61850 standard has brought innovation to the engineering technique of Substation protection, integration of devices, control, monitoring and testing [7]. Models for Substation automation, protection and control systems are provided by the IEC 61850. The models provided by IEC 61850 are stored in an XML language format that enables the exchange of information with other devices and systems. The Substation Configuration Language (SCL) schema that permits any manufacturer configuration tool to interpret the IEC 61850 files made by a different manufacturer is defined in the standard [8]. GOOSE and SV messages can be used in IEC 61850 protocol over Ethernet [9]. Theoretically IEC 61850 can be mapped to any protocol as in [10]. The communication stack of the IEC 61850 is structured according to the Open Systems Interconnection (OSI) layers, consisting of MMS which lies on the application level, TCP/IP lies on the transport level and ethernet lies on the physical level. The object

---

D. Njova and P. Umenne are with the Department of Electrical and Mining Engineering at the University of South Africa, Johannesburg, South Africa (e-mail: 53113934@mylife.unisa.ac.za; umennpo@unisa.ac.za)

K. Ogudo is with the Department of Electrical & Electronics Engineering Faculty of Engineering and The Built Environment University of Johannesburg, Johannesburg, South Africa (e-mail: kingsleyo@uj.ac.za)

oriented services lie on the application layer. Time-critical services lie on the physical layer. The time critical services are used by GOOSE and SV messages [4]. The substation automation system communication service uses the MMS messages defined in the IEC 61850 standard. MMS is a transmission protocol that can be implemented in Local Area Networks (LAN) and it is most commonly used in utility networks with large data needs, hardware devices and application layer software [6]. To eliminate the processing of the middle layers the GOOSE and SV communicate directly with the Ethernet layer. The connection oriented layer of the MMS can operate over ISO or TCP/IP, the GSSE operates over connectionless ISO service. The data is connected onto an Ethernet data frame using the data type “Ethertype” for the case of GOOSE, TIMESYNC, and SV messages. The data is connected using the data type “802.3” for GSSE and ISO messages [10] as can be seen in Fig. 1. The content carried by GOOSE messages has a maximum delay of 3 ms for data carried between IED’s [11]. Fig. 1 shows IEC 61850 protocol stack.

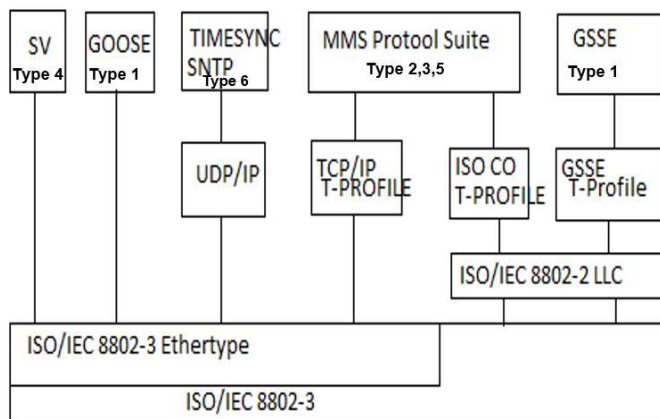

Fig. 1 IEC 61850 Protocol stack [10, 12]

An IEC 61850 device consists of a physical device, which connects to a network and is defined by its network address. Within each physical device there are logical devices. There are logical nodes within a logical device. Logical nodes have elements of data. The IEC 61850 standard has determined a unique name within the element of data. These data names are operationally related to the power system function such as measure, description, status and control. The data elements inside the logical node relate to the specifications of the common data class as per the IEC 61850-7-3[10] standard. The paper in [13] applies the concept of Active distribution Networks (ADN) to low voltage networks. The study in [14] presents a mathematical model of communication in an Active Distribution System (ADS) Substation. There, seven types of IEC 61850 messages were used in the study. The analysis and performance evaluation of the ADS model was done in different scenarios. The conclusion was that priority tagging enhances the ADS Substation Communication Network (SCN). This is because it reduces the SV within the bay network and enhances the performance by reducing end to end delay [14]. In [15] the authors say that limiting the cycle within the bay reduces the data flow on a VLAN scheme and improves network performance. This study is done in OPNET to simulate a

mathematical model for data flow. Simulations done in [16] show that networks with heavy traffic shall use IED’s and switches with priority tagging. Three-layer system communication architecture for smart microgrids has been modelled in OPNET and the results indicate that communication performance of the access layer network improves on a 2000m plain radius as shown in [17]. The star and ring configuration systems have been simulated and compared in OPNET environment and the star system performed better than the ring system [18]. The guide in [19] shows how to use OPNET to simulate and do computer network modelling. The paper is structured in the following way: Section II is the methodology used for simulation and modelling, Section III is the Results and Discussions in this section the results are analyzed and discussed and then finally Section IV comes up with a conclusion based on the analyses of the results.

## II. METHODOLOGY

### A. Substation Communication Network Model

The Substation Communication Network Model in Fig. 2 has 10 nodes that simulate protection IED relays, 10 Ethernet switches that simulate protection relay switches, two backbone switches that are redundant to each other, one gateway switch and one Substation Remote Terminal Unit (RTU). The cable linking the protection IED’s to the IED Switch is a 100BaseT cable. The cable linking the backbone switch, IED switch, gateway switch and the Substation RTU is a 1000BaseX cable. The Substation RTU is basically modelled by a server in OPNET.

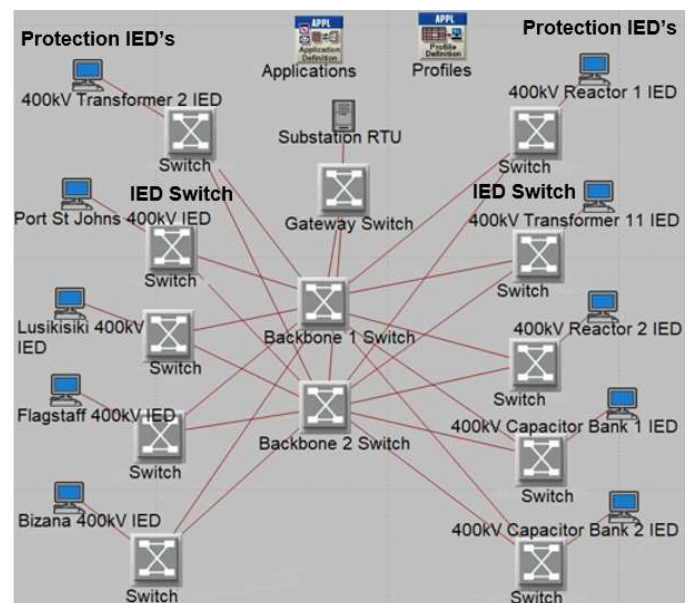

Fig. 2 OPNET Substation Communication Network Model

### B. Simulation Configuration

The Application attributes are first defined in OPNET, this is where the protocol stack of the IEC 61850 is configured as can be seen in Fig. 3. All the message types (GOOSE, GSSE, MMS, Time Sync) to be used are configured here.

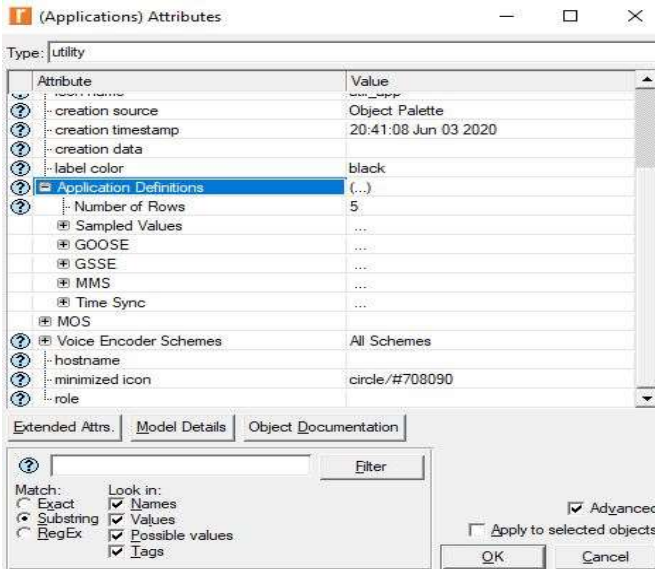

Fig. 3 OPNET IEC61850 Protocol stack Configuration

Fig. 4 shows OPNET Profile settings, this is where IEC 61850 protocol timing settings are done.

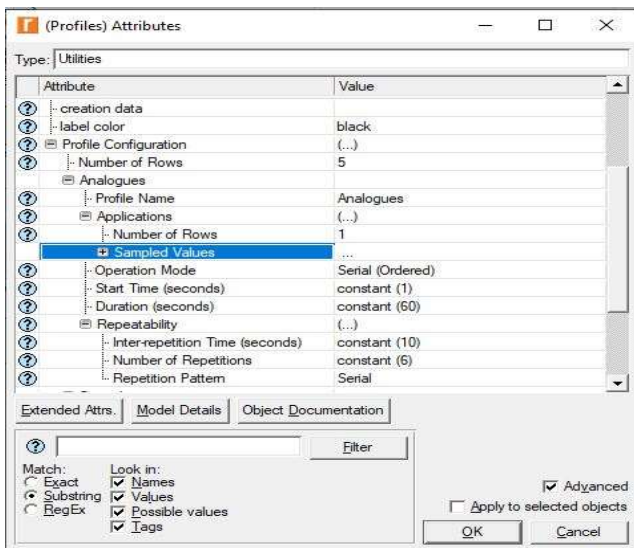

Fig. 4 OPNET Profile settings

Fig. 5 shows the settings for IED Traffic as well as the configuration for the packet size and the inter-arrival time. These settings are further expanded in Fig. 6 and Fig. 7 respectively.

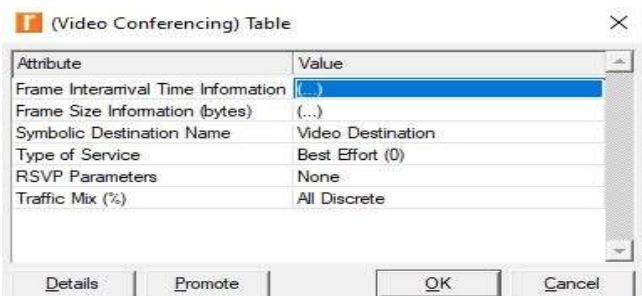

Fig. 5 IED Traffic characteristics Configuration

Sample values are set to 15 frames/sec [20]. Controls/GOOSE packets are set to 204 bytes, indication/GSSE packets are set to 144 bytes, Alarm/MMS packets are set to 144 bytes, time sync packets set to 219 bytes Analogues/SV packets are set to 219 bytes [14, 21].

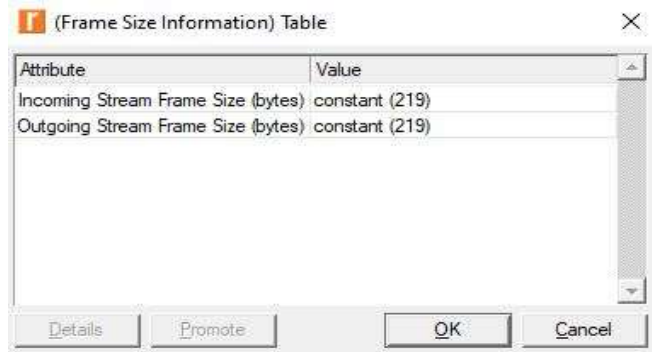

Fig. 6 IED Packet size setting

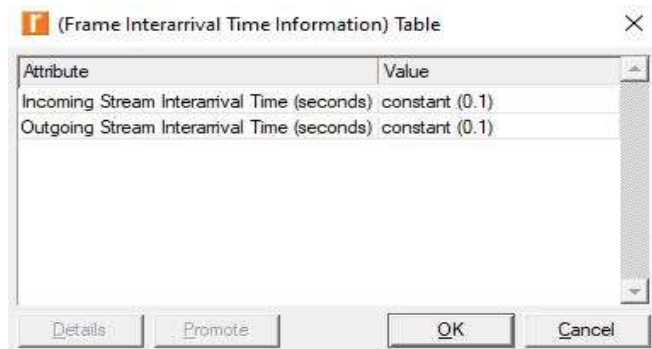

Fig. 7 IED Frame interarrival setting

### III. RESULTS AND DISCUSSIONS

The results are based on three scenarios namely; normal operation of the Substation, maintenance of specific equipment and Buszone operation (Busbar protection). The packet delay analyses are the delay for the GOOSE, GSSE, MMS and SV messages. The throughput at the Transformer IED end and the throughput at the Substation RTU end are also analyzed.

Fig. 8 shows the traffic received at the Substation RTU shown in Fig. 2 in the model. During normal operation of the IED's there is a steady traffic received by the RTU from the 400 kV transformer. There is a slight increase in traffic received at the RTU during maintenance of the 400kV Transformer 11, this is caused by the alarm and control packets sent by the single 400 kV Transformer 11 during testing and maintenance. During buszone operation there is a huge increase in traffic received at the RTU end, this is caused by the alarm and indication packets coming from all the IED devices on the busbar at the same time. The alarm and indication packets are sent to the Substation RTU.

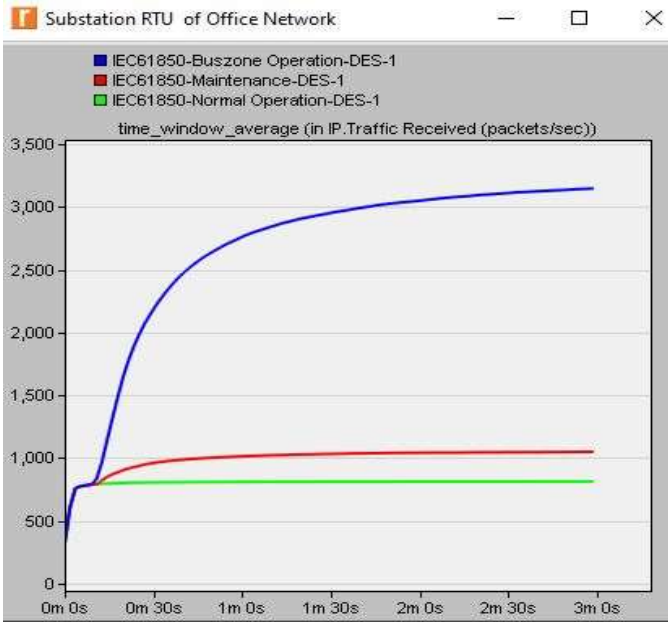

Fig. 8 IP Traffic Received packets/sec at RTU end

Fig. 9 shows the traffic sent by 400kV Transformer 11 IED during different scenarios. At normal operation there is steady traffic sent. During Buszone (alarm and indication packets) and transformer maintenance (alarm and control packets) operations there is a huge increase in the traffic sent from the single 400 kV transformer unit because of the extra packets sent to the RTU. The maintenance operation sends slightly more traffic than Buszone operation from the single entity 400 kV transformer 11, this is because the maintenance operation consists of alarm and control packets for maintenance purposes, while the Buszone operation from the single 400 kV transformer 11 consists mainly of alarm and indicator packets. It is during feedback from the RTU that control signals are sent to the busbar breakers to trip during Buszone operation.

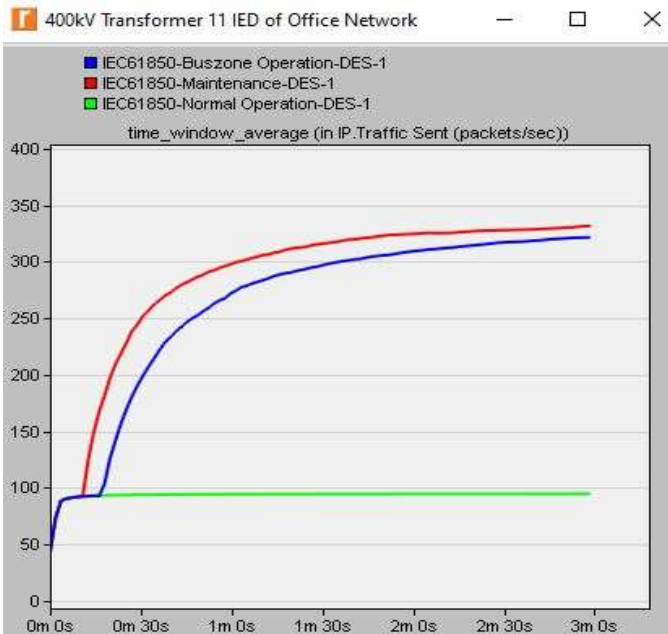

Fig. 9 IP Traffic Sent packets/sec 400kV Transformer 11 IED end

Fig. 10 shows Ethernet delay at different levels of operation on the SCN. Time delay increased during Buszone operation because there is more activity (communication) from all the IED's on the busbar as compared to the maintenance and normal operation.

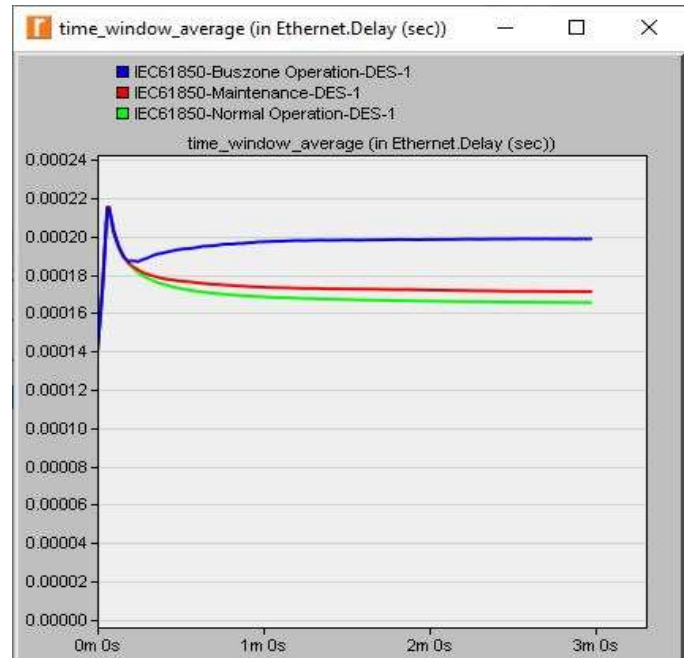

Fig. 20 Ethernet delay/sec

Fig. 11 shows received throughput in (bps) at the Substation RTU end and Fig. 12 shows the sent throughput in (bps) from the single 400kV Transformer 11 IED. There is a corresponding relationship in throughput data between the two figures and the two figures show a stable throughput which indicates the model is operating correctly and data packets are not being dropped. The received throughput at the RTU end exceeds the sent throughput from the 400 kV transformer IED. This is because the RTU receives data from all the devices on the network.

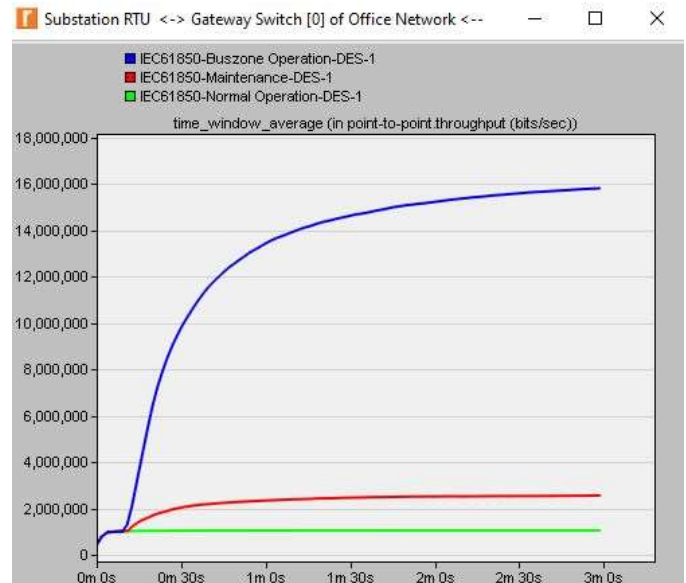

Fig. 31 Received throughput in (bps) at the Substation RTU end

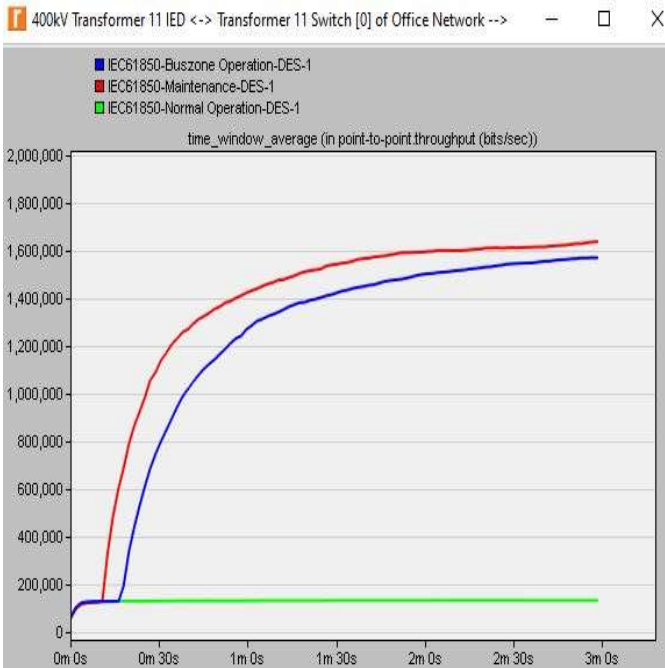

Fig. 42 Sent throughput in (bps) from the 400kV Transformer 11 IED

Studies done in [14] show that GOOSE messages average delay is  $65.2 \mu s$ . Studies done using C programming shows the end to end delay for GOOSE messages is  $58 \mu s$  [22]. Simulations done on network simulator (ns) shows MMS delay as  $0.925 \text{ ms}$  [23]. Table I shows end to end delay studies done in this paper for the GOOSE, GSSE, MMS and SV messages in different operational scenarios in this paper. Maximum end to end delay for GOOSE messages meets the IEC 61850 standard in all the operational scenarios in this paper. The maximum end to end delay for GOOSE messages in this paper is approximately  $0.12 \text{ ms}$ . The maximum delay for GOOSE messages in the IEC 61850 standard is  $1 \text{ ms}$  as in [12, 24]. Maximum end to end delay for GSSE messages meets the IEC 61850 standard in all the operational scenarios in this paper. The maximum end to end delay for GSSE messages in this paper is approximately  $0.4 \text{ ms}$ . The maximum delay for GSSE on the IEC 61850 standard is  $10 \text{ ms}$  [12, 24]. Maximum end to end delay for SV meets the IEC 61850 standard in all the operational scenarios in this paper. The maximum end to end delay for SV messages in this paper is approximately  $0.145 \text{ ms}$ . Maximum delay for SV in the IEC 61850 standard is  $10 \text{ ms}$  [12, 24]. The maximum delay for MMS does not meet the IEC 61850 standard in all the operational scenarios of this paper, for example it fails in type 2 message of the IEC 61850 standard. However, the MMS message in this paper meets the requirements for the type 5 message of the IEC 61850 standard. The maximum delay for event/alarms (type 5) messages in the IEC 61850 standard is  $1000 \text{ ms}$  or slightly more as in [12, 24].

Table I End to end delay

Normal Operation	Minimum packet delay	Average packet delay	Maximum packet delay
GOOSE/Controls	$52.04 \mu s$	$53.90 \mu s$	$112.71 \mu s$
GSSE/Indications	$420.21 \mu s$	$428.02 \mu s$	$438.34 \mu s$
MMS/Alarms	$111.33 \text{ ms}$	$157.64 \text{ ms}$	$1.019 \text{ s}$
SV/Analogues	$142.08 \mu s$	$142.66 \mu s$	$145.81 \mu s$
Maintenance Operation			
GOOSE/Controls	$52.04 \mu s$	$56.93 \mu s$	$117.07 \mu s$
GSSE/Indications	$410.51 \mu s$	$426.67 \mu s$	$438.34 \mu s$
MMS/Alarms	$98.85 \text{ ms}$	$157.97 \text{ ms}$	$1.1836 \text{ s}$
SV/Analogues	$136.03 \mu s$	$142.23 \mu s$	$145.81 \mu s$
Buszone Operation			
GOOSE/Controls	$52.05 \mu s$	$66.54 \mu s$	$128.68 \mu s$
GSSE/Indications	$311.54 \mu s$	$332.45 \mu s$	$348.98 \mu s$
MMS/Alarms	$123.83 \text{ ms}$	$151.60 \text{ ms}$	$462.8 \text{ ms}$
SV/Analogues	$132.31 \mu s$	$139.40 \mu s$	$146.22 \mu s$

#### IV. CONCLUSION

This paper shows the design of a Substation Communication Network (SCN) model and how IEC 61850 protocol is configured in OPNET over the SCN. OPNET is a tool that can be used to simulate real life computer network scenarios.

In this model GOOSE, GSSE, MMS and SV messages are used in the IEC 61850 protocol to communicate within the SCN. The results of the simulation show that with an increase in traffic there is a corresponding increase in the end to end packet delay. The increase in end to end packet delay does not affect the IEC 61850 standard requirements of messaging and data transfer time when it comes to GOOSE, GSSE and SV messages. The model cannot be used for type 2 messages of the IEC 61850 standard, since it failed the message and transfer time requirements of type 2 MMS messages. In general, the MMS message is best used for large packets and in scenarios where timing and long delay will not affect the performance of the system. Since the throughput of the IEC61850 standard is in Mbps, it can be used in power utilities such as ESKOM in South Africa to carry large data packets for IED's. The model can be used to predict network behavior when preparing to do maintenance and fault finding in a SCADA based Electrical Substation using the IEC 61850 protocol for communication.

#### V. ACKNOWLEDGEMENT

We would like to thank the University of South Africa and the University of Johannesburg for its support. In addition, we would like to acknowledge the support received from ESKOM in the form of the TESP grant given to Patrice Umenne in the support of postgraduate students.

#### REFERENCES

- [1] A. Bonetti, N. Ignatovski and S. Fernandez, "Providing an IEC 61850 Counterpart of the Trusty Multimeter - Approaching the Maintenance Procedures for IEC 61850 Substations," 1st Global Power, Energy and Communication Conference (GPECOM), Nevsehir, Turkey, 2019, pp. 440-444, doi: 10.1109/GPECOM.2019.8778541.

- [2] P. Rajagopal and S. Sayapogu, "Effective utilization of SCADA for substation protection and control applications," 13th International Conference on Development in Power System Protection (DPSP), Edinburgh, 2016, pp. 1-5, doi: 10.1049/cp.2016.0120.
- [3] H. Purwanto, H. Prasetya and I. Firdaus, "Implementation of Over Current Relays with Non-Cascade Scheme on Medium Voltage Switchgear as Busbar Protection Study Case in PT PLN (Persero) UIT JBB," 2nd International Conference on High Voltage Engineering and Power Systems (ICHVEPS), Denpasar, Bali, Indonesia, 2019, pp. 1-4, doi: 10.1109/ICHVEPS47643.2019.9011089.
- [4] Terwiesch, C. Ryttoft, H.E Meier, H. Bawa, P. Reinhardt and A. Moglestue (2010, Aug). "Special Report IEC 61850" The corporate technical journal, Available: [Online]. [www.abb.com/substationautomation](http://www.abb.com/substationautomation).
- [5] C. Yang, V. Dubinin and V. Vyatkin, "Automatic Generation of Control Flow From Requirements for Distributed Smart Grid Automation Control," in IEEE Transactions on Industrial Informatics, vol. 16, no. 1, pp. 403-413, Jan. 2020, doi: 10.1109/TII.2019.2930772.
- [6] Z. Zhu, W. Gao, B. Xu, J. Cheng and J. Ye, "Application of IEC61850 for Communication of Distribution Grid Automation," IEEE Sustainable Power and Energy Conference (iSPEC), Beijing, China, 2019, pp. 1395-1400, doi: 10.1109/iSPEC48194.2019.8974870.
- [7] A. Pal and R. Dash, "A Paradigm Shift in Substation Engineering: IEC 61850 Approach". *Procedia Technology*, vol 21, pp. 8-14. Aug, 2015, Available: [Online] <https://doi.org/10.1016/j.protcy.2015.10.003>
- [8] IEEE Substation Committee. "IEEE Recommended Practice for Implementing an IEC 61850-Based Substation Communications, Protection, Monitoring and Control System". IEEE USA, 2017.
- [9] N.H. Ali and M.M. Eissa, "Accelerating the protection schemes through IEC 61850 protocols", International Journal of Electrical Power & Energy Systems, Vol 102, pp.189-200, 2018 [doi.org/10.1016/j.ijepes.2018.04.035](https://doi.org/10.1016/j.ijepes.2018.04.035).
- [10] M. Adamiak, D. Baigent and R. Mackiewicz., " IEC 61850 Communication Networks and Systems in Substations, an overview for users.
- [11] R. B. Scarselli, L. F. Soares and I. M. Moraes, "Evaluating Cryptographic Algorithms in IEC 61850 Networks," 10th International Conference on Networks of the Future (NoF), Rome, Italy, 2019, pp. 9-16, doi: 10.1109/NoF47743.2019.9015196.
- [12] N. H. Ali, B. B. M. Ali, O. Basir, M. L. Othman and F. B. Hashim, "WLAN oriented optimization of process bus in IEC 61850-based substation communication network," 3rd International Renewable and Sustainable Energy Conference (IRSEC), Marrakech, 2015, pp. 1-6, doi: 10.1109/IRSEC.2015.7454979.
- [13] S. Repo et al, "Active distribution network concept for distributed management of low voltage network", IEEE/PES Innovative Smart Grid Technologies Europe (ISGT Europe), October 6-9, 2013, doi: [10.1109/ISGTEurope.2013.6695428](https://doi.org/10.1109/ISGTEurope.2013.6695428).
- [14] T. S. Ustun, M. A. Aftab, I. Ali and S. M. S. Hussain, "A Novel Scheme for Performance Evaluation of an IEC 61850-Based Active Distribution System Substation," in IEEE Access, vol. 7, pp. 123893-123902, 2019, doi: 10.1109/ACCESS.2019.2937971.
- [15] Z. Zhang, X. Huang, B. Keune, Y. Cao and Y. Li, "Modeling and Simulation of Data Flow for VLAN-Based Communication in Substations," in IEEE Systems Journal, vol. 11, no. 4, pp. 2467-2478, Dec. 2017, doi: 10.1109/JSYST.2015.2428058.
- [16] T. S. Sidhu and Y. Yin, "Modelling and Simulation for Performance Evaluation of IEC61850-Based Substation Communication Systems," in IEEE Transactions on Power Delivery, vol. 22, no. 3, pp. 1482-1489, July 2007, doi: 10.1109/TPWRD.2006.886788.
- [17] X. Yang, Y. Wang, Y. Zhang and D. Xu, "Modeling and Analysis of Communication Network in Smart Microgrids," 2nd IEEE Conference on Energy Internet and Energy System Integration (EI2), Beijing, 2018, pp. 1-6, doi: 10.1109/EI2.2018.8582157.
- [18] Xin Yang, N. Das and S. Islam, "Analysis of IEC 61850 for a reliable communication system between substations," Australasian Universities Power Engineering Conference (AUPEC), Hobart, TAS, 2013, pp. 1-6, doi: 10.1109/AUPEC.2013.6725482.
- [19] A.S. Sethi and V.Y. Hnatyshin, "The Practical OPNET User Guide for Computer Network Simulation," New York: Taylor & Francis Group, LLC, 2013, pp.1-380.
- [20] T. Amare, C. M. Adrah and B. E. Helvik, "A Method for Performability Study on Wide Area Communication Architectures for Smart Grid," 7th International Conference on Smart Grid (icSmartGrid), Newcastle, Australia, 2019, pp. 64-73, doi: 10.1109/icSmartGrid48354.2019.8990736.
- [21] Z. Zhang, X. Huang, B. Keune, Y. Cao and Y. Li, "Modeling and Simulation of Data Flow for VLAN-Based Communication in Substations," in IEEE Systems Journal, vol. 11, no. 4, pp. 2467-2478, Dec. 2017, doi: 10.1109/JSYST.2015.2428058.
- [22] D. P. d. Mattos et al., "IEC 61850 Packet Generator for Testing Substation Communication," IEEE PES Asia-Pacific Power and Energy Engineering Conference (APPEEC), Macao, Macao, 2019, pp. 1-5, doi: 10.1109/APPEEC45492.2019.8994338.
- [23] S. M. S. Hussain, M. A. Aftab, F. Nadeem, I. Ali and T. S. Ustun, "Optimal Energy Routing in Microgrids With IEC 61850 Based Energy Routers," in IEEE Transactions on Industrial Electronics, vol. 67, no. 6, pp. 5161-5169, June 2020, doi: 10.1109/TIE.2019.2927154.
- [24] Xin Yang, N. Das and S. Islam, "Analysis of IEC 61850 for a reliable communication system between substations," Australasian Universities Power Engineering Conference (AUPEC), Hobart, TAS, 2013, pp. 1-6, doi: 10.1109/AUPEC.2013.6725482.