

1 **The Southern Ocean ecosystem under multiple climate change stresses - an integrated**
2 **circumpolar assessment**

3

4

5 **Running head:** Southern Ocean ecosystem under climate change

6

7

8 Julian Gutt^{1*}, Nancy Bertler², Thomas J. Bracegirdle³, Alexander Buschmann¹, Josefino
9 Comiso⁴, Graham Hosie⁵, Enrique Isla⁶, Irene R. Schloss⁷, Craig R. Smith⁸, Jean Tournadre⁹,
10 José C. Xavier^{3,10}

11

12 ¹ Alfred Wegener Institute, Helmholtz Centre for Polar and Marine Research, Am Alten
13 Hafen 26, D - 27568 Bremerhaven, julian.gutt@awi.de, +49 471 4831 1333, corresponding
14 author and alexander.buschmann@awi.de

15 ² Joint Antarctic Research Institute, Victoria University of Wellington and GNS Science,
16 Wellington, New Zealand, Nancy.Bertler@vuw.ac.nz

17 ³ British Antarctic Survey, Natural Environment Research Council, Cambridge, UK,
18 tjbra@bas.ac.uk

19 ⁴ Cryospheric Sciences Laboratory, NASA Goddard Space Flight Center, Greenbelt MD
20 20771, U. S. A., josefino.c.comiso@nasa.gov

21 ⁵ Chief Officer, SCAR Life Science, Scott Polar Research Institute, Lensfield Road,
22 Cambridge, CB2 1ER, UK, graham.hosie@iinet.net.au

23 ⁶ Institut de Ciències del Mar-CSIC, Passeig Marítim de la Barceloneta, 37-49, 08003
24 Barcelona, Spain, isla@icm.csic.es

25 ⁷ Instituto Antártico Argentino, Balcarce 290 (C1064AAF), Ciudad Autónoma de Buenos
26 Aires, Argentina, ischloss@dna.gov.ar, CONICET, Argentina & Institut des sciences de la

27 mer de Rimouski, 310, Allée des Ursulines, G5L 3A1, Rimouski, Québec, Canada,

28 irene_schloss@uqar.ca

29 ⁸ Department of Oceanography, University of Hawaii at Manoa, 1000 Pope Road, Honolulu,

30 HI, USA 96822; craigsmi@hawaii.edu

31 ⁹ Laboratoire d'Océanographie Spatiale, IFREMER, ZI de la Pointe du Diable, CS 10070

32 29280 Plouzané, France; Jean.Tournadre@ifremer.fr

33 ¹⁰ Institute of Marine Research, Department of Life Sciences, University of Coimbra,

34 3001-401 Coimbra, Portugal, jccx@cantab.net

35

36

37 **Key words:** sea-ice, ice-shelves, icebergs, warming, ozone depletion, acidification, habitats

38

39

40 **Paper type:** Primary Research Article

41

42 **Abstract**

43 A quantitative assessment of observed and projected environmental changes in the Southern
44 Ocean (SO) with a potential impact on the marine ecosystem shows: (1) large proportions of
45 the SO are and will be affected by one or more climate change processes; areas projected to
46 be affected in the future are larger than areas that are already under environmental stress, (2)
47 areas affected by changes in sea-ice in the past and likely in the future are much larger than
48 areas affected by ocean warming. The smallest areas (<1% area of the SO) are affected by
49 glacier retreat and warming in the deeper euphotic layer. In the future, decrease in the sea-ice
50 is expected to be widespread. Changes in iceberg impact resulting from further collapse of
51 ice-shelves can potentially affect large parts of shelf and ephemerally in the off-shore regions.
52 However, aragonite undersaturation (acidification) might become one of the biggest problems
53 for the Antarctic marine ecosystem by affecting almost the entire SO. Direct and indirect
54 impacts of various environmental changes to the three major habitats, sea-ice, pelagic and
55 benthos and their biota are complex. The areas affected by environmental stressors range from
56 33% of the SO for a single stressor, 11% for two and 2% for three, to <1 % for four and five
57 overlapping factors. In the future, areas expected to be affected by 2 and 3 overlapping factors
58 are equally large, including potential iceberg changes, and together cover almost 86% of the
59 SO ecosystem.

60

61 **Introduction**

62 Life on Earth including those in the Southern Ocean (SO) has always been shaped by
63 variations in climate (Crame, 1989; Clarke & Crame, 1992, 1997; Gutt *et al.*, 2010; Kaiser *et*
64 *al.*, 2013). In addition to natural variability, environmental changes since the mid 20th century
65 are considered to result from anthropogenic impacts on climate (IPCC, 2013). For the SO, the
66 discussion of the anthropogenic contribution, particularly the western Antarctic Peninsula
67 (WAP) area is ongoing (Vaughan *et al.*, 2003, Meredith & King, 2005; Turner *et al.*, 2013a).
68 The reduction in stratospheric ozone (the ‘ozone hole’) over Antarctica as well as an increase
69 in atmospheric greenhouse gas (Solomon, 1999; Thompson & Solomon, 2002; Marshall *et*
70 *al.*, 2006) have been linked to accelerating and southward displaced Westerly winds with
71 implications to atmospheric circulation and ocean currents, ocean stratification, nutrient
72 transport, and sea-ice variability (Stammerjohn *et al.*, 2008; Steig *et al.*, 2009; Turner *et al.*,
73 2009a, 2013b; Thompson *et al.*, 2011; Spence *et al.*, 2012; England *et al.*, 2014). Although
74 our knowledge on Antarctic waters’ biology is incomplete, these processes will affect the
75 organisms in different ways and varying among sites. Moreover, spatial gradients in the
76 impact of marine habitats, e.g., those affected by changing sea-ice dynamics, and relatively
77 stable areas are steeper than in other parts of the world. Impacts on Antarctic marine life can
78 also result from discrete events, e.g. the occasional upwelling of warm water and the collapse
79 of ice-shelves (Gutt *et al.*, 2011; Dinniman *et al.*, 2012).

80
81 Particular efforts have been undertaken to assemble findings on biological responses to
82 climate change (Turner *et al.*, 2009b, 2013a), but did not quantify them. A number of reviews
83 further focused on single processes and on particular organisms or provided overviews,
84 conclusions or concepts (e.g. Clarke *et al.*, 2007; Aronson *et al.*, 2007, 2011; Murphy *et al.*,
85 2007; Brandt & Gutt, 2011; Gutt *et al.*, 2012; Ingels *et al.*, 2012; Mintenbeck *et al.*, 2012;
86 C.R. Smith *et al.*, 2012a; W.O. Smith *et al.*, 2012; Constable *et al.*, 2014; Brandt *et al.*, in

87 press). Notably, to study cumulative effects of multiple stressors has recently been identified
88 as important and one of the 80 priority questions for future research in Antarctica and the
89 Southern Ocean (Rogers & Laffoley, 2013; Kennicutt *et al.*, 2014a,b) since they have never
90 been studied in detail in the SO, defined as the ocean south of the Polar Front according to
91 Sokolov & Rintoul (2009a).

92

93 The effort invested in field studies, experiments, and numerical computations varied between
94 ecosystem components, e.g. between the key stone species Antarctic krill *Euphausia superba*
95 and largely unknown deep-sea animals, charismatic penguins and tiny microbes, predatory
96 crustaceans and squid as well as rarely seen mid-water fish. As a consequence, the awareness
97 of climate-induced ecosystem shifts by scientists, the public and decision makers varies
98 relatively independently of the quality and quantity of the impact itself. An overarching
99 assessment of the magnitude of environmental impacts not only on the ecosystem themselves
100 but also on their goods and services (Rogers *et al.*, 2013), as well as their degree of certainty,
101 such as applied in the IPCC's 5th Assessment Report, Part B: Regional aspects especially
102 polar regions (Larsen *et al.*, 2014), demands comparative approaches across regions, groups
103 of organisms and key ecological processes.

104

105 Our aims are to produce: (1) a qualitative compilation and illustration of important climate-
106 induced environmental changes that potentially have an impact on the Antarctic marine
107 ecosystem, sea-ice increase and decrease, ice-shelf disintegration and iceberg effects,
108 warming, ozone depletion in combination with increased UV-B, and acidification; (2) a geo-
109 referenced mapping of these impacts to show where they occur; (3) calculations of the areas
110 affected; (4) a quantification and mapping of areas affected by multiple environmental
111 impacts; (5) a qualitative assessment of the impairment of affected communities, with the
112 magnitude of the disturbance and regional relevance as key performance indicators. The

113 results refer to changes already-observed and projected for the future. Changing iceberg
114 impact was attributed to the future scenarios, independently of whether such changes have
115 started already or are expected to happen in the future since it is assumed that the impact is
116 long lasting, especially on benthic communities. This study complements the Antarctic
117 Climate Change and the Environment report (Turner *et al.*, 2009b; Convey *et al.*, 2010) and
118 its update (Turner *et al.*, 2013a). It can serve as a basis for a risk assessment of endangered
119 Antarctic marine habitats in the context of regionalisation (Grant *et al.*, 2006; Raymond,
120 2014; Douglass *et al.*, 2014; Gutt *et al.*, 2014) especially when changes reach thresholds,
121 beyond which organisms experience high levels of stress and when habitats experience
122 tipping points.
123

124 **Material and methods**

125 Key coupling processes across the inter-related physical and biological domains are depicted
126 in Fig. 1 and discussed in the Supplementary Information (S1). Phenomena are considered if
127 1) evidence of their existence is available, 2) they have not been observed but assumed to
128 have been happening and 3) they are expected to occur in the future. Relationships among
129 abiotic and biotic factors are coarsely depicted and restricted to those being relevant for the
130 biosphere. The considered environmental components were atmosphere, sea-ice, ocean, ice-
131 sheet and sea-bed. For the biota we considered those living in or at the sea-ice, in the pelagic
132 and benthic zones.

133
134 For the quantitative approach the sizes of the areas exposed to climate change and its effects
135 were taken from the literature or areas were redrawn from the references mentioned using
136 Photoshop (CS5; Adobe), including the determination of multiply affected areas, and using
137 ArcMap (ArcGIS Desktop 10.0, ESRI; "South Pole Lambert Azimuthal Equal Area"
138 projection). Results were rounded to steps of $0.01 \times 10^6 \text{ km}^2$.

139
140 The following sizes have been used: an extension for the SO of $28.47 \times 10^6 \text{ km}^2$ to estimate
141 relative sizes of areas, defined as the area South of the Polar Front with mean positions from
142 Sokolov & Rintoul (2009a) of $42.47 \times 10^6 \text{ km}^2$, minus the Antarctic continent (12.16×10^6
143 km^2 , ArcGIS layers moa-ice), islands ($0.21 \times 10^6 \text{ km}^2$, ArcGIS layer moa-land) and ice-
144 shelves in 2002 ($1.63 \times 10^6 \text{ km}^2$, Clarke & Johnston (2003)). Shelf area not covered by ice-
145 shelves represented $2.97 \times 10^6 \text{ km}^2$ in 2002 (Clarke & Johnston, 2003). Sea-ice cover of 18.3
146 $\times 10^6 \text{ km}^2$ refers to the average maximum extent in September (Comiso, 2010).

147
148 Sea-ice covered areas (Comiso, 2000, updated 2012) were determined for separated seasons
149 between 1979 and 2012. Areas of significant changes were considered when changes

150 exceeded a threshold of 0.015 frac/decade, which is similar to the 0.2 frac/decade in 7.6
151 decades (=0.013 frac/decade) threshold used for the calculation for the future; frac = fraction
152 (values 0-1) of surface covered by sea-ice. Significances were calculated using a 2-sided
153 student's t-test. Season-specific results for observed and projected changes were summed-up
154 to values for the entire year.

155
156 Areas for the cumulative occurrence for the 1992-2012 period of >1 Gt iceberg volume per 1°
157 (latitude) x 2° (longitude) with icebergs <3 km length were calculated using their monthly
158 volume from altimeter data analysis (Tournadre *et al.*, 2012), if occurrence was significantly
159 greater than the noise level. This indicates that at least for one month during the period such
160 icebergs have been present. Occurrences of icebergs >5 km were taken from the areas in the
161 plot of iceberg tracks by Stuart & Long (2011, Fig. 9).

162
163 Increased UV-B was analysed for the three seasonal periods of the thinning of the ozone
164 layer, referred to here after as the ozone hole, it's full development, it's end, and the beginning
165 summer without, to demonstrate that at the end of the winter the ozone hole is well
166 established but high sea-ice cover allows UV-B to penetrate only into a certain proportion of
167 the ocean and that in December the ozone hole is almost closed. For each of the three periods
168 results for three days from three years were merged to cover a high short- and long-term
169 variability. For November these dates had three replicates to provide information on the
170 representativeness of these results. Ozone maps were used from "Environment Canada"
171 (<http://exp-studies.tor.ec.gc.ca/cgi-bin/selectMap>), based on ground-based measurements with
172 adjustments according to results from satellite probes available from World Ozone and
173 Ultraviolet Radiation Data Centre. Sizes of areas with ≥ 250 Dobson units and <80% sea-ice
174 cover were determined (ASI Algorithm SSMI-SSMIS sea-ice concentration were obtained
175 from the Integrated Climate Data Centre, University of Hamburg, Germany;

176 http://icdc.zmaw.de/seaiceconcentration_asi_ssmi.html; Kaleschke *et al.*, 2001; Spreen *et al.*,

177 2008).

178

179 **Results**

180 *Qualitative compilation*

181 Interactions between climate-induced physical and chemical changes and the potential
182 response of marine biota of the SO are complex (Fig. 1, S1). All three large habitats, the sea-
183 ice, the pelagic and benthic zones are affected directly by changes in the four major
184 environment components, atmosphere, sea-ice in its extent and season length, ocean, and
185 icesheet. In addition, non-linear, hardly reproducible and complex indirect effects can be
186 important, e.g. if warming of the atmosphere and changes in the wind regime reduce the sea-
187 ice, primary production and population growth of Antarctic krill are affected and, as a further
188 consequence, energy flux to higher trophic levels and to the sea-floor is modified. Another
189 example is the disintegration of ice-shelves, allowing the phytoplankton to develop in areas
190 previously covered by ice, which later in the year sinks to the bottom and changes an
191 oligotrophic to a "normal" Antarctic system.

192

193 Quantitative data on ecologically relevance environmental changes are compiled in Table 1;
194 the most relevant results are depicted in Figs 2 to 4.

195

196 *Observed and projected ocean warming*

197 Physiological experiments show that a warming of 1 K represents a threshold at which
198 organisms start to respond significantly (Barnes & Peck, 2008; Peck, 2011; Peck *et al.*, 2014).
199 For this reason, we use the 1K threshold to identify SO regions susceptible to physiological
200 impacts. The area of the western Antarctic Peninsula (WAP) in which an increase ≥ 1.0 K in
201 sea-surface temperature (SST) was observed between 1955 and 1998 ($= \geq 0.023$ K p.a.) was
202 0.73×10^6 km² based on Meredith & King (2005), which corresponds to 2.6% of the SO (Figs
203 2a & 4). At 50 m depth, the area of an equivalent warming was only 0.05×10^6 km². The

204 WAP is the region considered to have experienced the highest SST-increase in the SO in the
205 past decades. Reports of a similar warming are known from an adjacent site (Schloss *et al.*,
206 2012). This might be representative of more localities in that area, but warming is not known
207 from other areas of similar extent (see e.g. Gille *et al.*, 2002). The length of the Polar Front
208 was calculated as 32,176 km using mean front positions from Sokolov & Rintoul (2009a).
209 Sokolov & Rintoul (2009b) estimated a 60 km southward shift between 1992 and 2007 with \leq
210 2 K south and \geq 4-5 K north of it, so that the area affected by this warming was 1.93×10^6
211 km^2 , which is 6.8% of the SO (Figs 2a & 4).

212
213 A projection of SST until 2100 shows a warming of >1 K along the northern margin of the
214 SO (Turner *et al.*, 2009b), which would affect an area year-round of $5.87 \times 10^6 \text{ km}^2$ (Figs 3a
215 & 4) representing 20.6% of the SO, $3.26 \times 10^6 \text{ km}^2$ in summer and $4.35 \times 10^6 \text{ km}^2$ in winter.
216 At 200 m depth the area of an equivalent warming was $0.78 \times 10^6 \text{ km}^2$, representing 2.8% of
217 the SO, $0.50 \times 10^6 \text{ km}^2$ in summer and $0.64 \times 10^6 \text{ km}^2$ in winter.

218
219 *Observed changes in sea-ice season length and extent*

220 The area affected by an increase in the length of the sea-ice season (1979 - 1999) was
221 calculated as $2.68 \times 10^6 \text{ km}^2$, whereas the area of decrease was $1.15 \times 10^6 \text{ km}^2$. A 15% ice-
222 concentration cut-off and zeroing out trends with $< 95\%$ confidence level (Parkinson, 2002;
223 Fig. 2b) was applied. These values are equivalent to 34% and 15% area, respectively, relative
224 to the average annual sea-ice area of $7.9 \times 10^6 \text{ km}^2$ (Bracegirdle *et al.*, 2008) or 15% and 6%,
225 respectively, to the maximum sea-ice extent of $18.3 \times 10^6 \text{ km}^2$ (Fig. 4).

226 Areas of significant change in sea-ice extent (1979-2012) vary between seasons from 0.42 to
227 $1.08 \times 10^6 \text{ km}^2$ increase and from 0.06 to $0.58 \times 10^6 \text{ km}^2$ decrease (Table 1 and Fig. 2b).

228 Decrease was highest in summer in the WAP area and Amundsen/Bellingshausen Seas.

229 Increases were observed in the Ross and Weddell Seas as well as in the Indian sector of the

230 SO, which were least obvious in autumn. Merged values from the seasonal data for the entire
231 year result in a $6.06 \times 10^6 \text{ km}^2$ increase and $1.55 \times 10^6 \text{ km}^2$ decrease, which is 33% increase
232 and 9% decrease relative to the yearly average sea-ice cover. Areas of any change were $7.61 \times$
233 10^6 km^2 and affected 42% of the maximum sea-ice extent. Values for the annual mean (ANN)
234 are similar.

235

236 *Projected sea-ice area change*

237 The projection of annual average sea-ice area change between 2004/2023 and 2080/2099
238 calculated by Bracegirdle *et al.* (2008) is a decrease of $2.6 \times 10^6 \text{ km}^2$, which is 33% of the
239 annual average ice-covered area before the 21st century and 14% of its maximum winter sea-
240 ice extent (Fig. 4). Most of this decrease is expected for June to November. If a threshold of
241 $0.1 \text{ frac}/7.6 \text{ decade}$ of the sea-ice concentration is applied similar to the $0.02 \text{ frac}/\text{decade}$ for
242 the past, the year-round affected area is $15.1 \times 10^6 \text{ km}^2$, which is 83% of the maximum sea-
243 ice extent (Fig. 3b).

244

245 *Ice-shelf disintegration and icebergs*

246 The area of ice-shelves collapsed since the 1960s associated with atmosphere and ocean
247 warming east and west of the Antarctic Peninsula is $0.028 \times 10^6 \text{ km}^2$ (Davies *et al.*, 2012),
248 which is 1.7% of the entire habitat (=area) beneath ice-shelves (Figs 2c & 4). Quantitative
249 projections for the future are not available.

250

251 Hints for climate-induced changes in iceberg abundance and, thus, its impact are weak (Long
252 *et al.*, 2002; Gutt *et al.*, 2011). Nevertheless areas potentially affected can roughly be
253 quantified. If a 2 km maximum distance from icebergs $<3 \text{ km}$ long (Tournadre *et al.*, 2013) is
254 taken, where they shape pelagic processes (Vernet *et al.*, 2011), the total area (iceberg area of
255 $0.025 \times 10^6 \text{ km}^2$ plus 2 km ocean around) affected is $0.31 \times 10^6 \text{ km}^2$, which equals 1.1% of the

256 entire SO. Using abundances and sizes of icebergs published by Orheim (1985) and an
257 assumed average diameter in the largest size class of 5 km (measured values not available)
258 this results in $0.5 \times 10^6 \text{ km}^2$. The entire area in which icebergs with a volume of $>1 \text{ Gt}$ per 1°
259 (latitude) $\times 2^\circ$ (longitude) occurred between 1992-2012 (Tournadre *et al.*, 2013) merged with
260 the area of potential occurrence of icebergs $>5 \text{ km}$ observed 1999-2009 (Stuart & Long, 2011)
261 is $20 \times 10^6 \text{ km}^2$, which is 70% of the SO. Most affected are areas off East Antarctica around
262 90° E , off-shore in the Ross and Weddell Seas, and the WAP area. Using the same data, 1.82
263 $\times 10^6 \text{ km}^2$ are potentially affected by icebergs on the shelf, mainly in East Antarctica and
264 WAP, which represents 61% of the entire shelf area.

265

266 *Dynamics of tidewater marine glaciers*

267 Between 1953 (on average) and 2001, most glaciers on the Antarctic Peninsula and South
268 Georgia retreated (212 from 244 and 28 from 36 respectively) (Turner *et al.*, 2009b). If an
269 average cliff length of 1 km is assumed and doubled to 2 km to include side-effects this
270 results in a total of 480 km affected, which is 1.2% of the 39,200 km long Antarctic
271 circumference (from Clarke & Johnston, 2003). If a distance of 2 km perpendicular to the cliff
272 into the ocean, representing the area where calving happens plus side effects is assumed, this
273 gives 1272 km^2 , which is 0.04% of the $<1000 \text{ m}$ deep shelf, which occupies $2.97 \times 10^6 \text{ km}^2$
274 excluding ice-shelf covered areas (Clarke & Johnston, 2003; Fig. 4). For the remaining
275 glaciers along the Antarctic Peninsula "...advances are generally small...", at South Georgia
276 only two advanced (Turner *et al.*, 2009b) and for most of the other Antarctic glaciers climate
277 change driven data are not available.

278

279 *Ozone depletion, increase in UV-B radiation*

280 The areas affected by the ozone hole and covered by $< 80\%$ sea-ice in November, the core-
281 period for this approach, show a variation ranging from $3.92 \times 10^6 \text{ km}^2$ to $5.73 \times 10^6 \text{ km}^2$ for

282 9-15 November, 2009-2011. This amounts for 14 to 20% of the SO. In Fig. 4 the average for
283 this period (three days merged) of $4.53 \times 10^6 \text{ km}^2$ is depicted. The area analysed for October
284 of $5.82 \times 10^6 \text{ km}^2$ reached a maximum mainly due to the high temporal and spatial variation
285 of a generally well-developed ozone hole including the WAP area not far off shore, as well as
286 smaller areas where polynyas occur. The areas affected are mainly situated at the northern
287 margin of the SO. As expected, with $1.14 \times 10^6 \text{ km}^2$ (4% of the SO) affected the areas are
288 much smaller in December.

289

290 *Ocean Acidification*

291 According to the map provided by Orr *et al.* (2005), based on the IS92a "business-as-usual"
292 scenario for future CO₂ emission, our calculations indicate that an area of $28.04 \times 10^6 \text{ km}^2$
293 could become under-saturated with respect to aragonite until the end of the 21st century,
294 which is approximately 98% of the SO pelagic ecosystem, with the southern Ross Sea the
295 only exception. Increase in pCO₂ is most obvious at intermediate water depths between
296 approximately 100 and 700m in large off-shore areas (Hauck *et al.*, 2010, Kawaguchi *et al.*,
297 2013). Benthic systems are most affected in case of a tipping point from saturated to
298 undersaturated conditions on most of the shelves, which represent 2.59% of the entire
299 Antarctic sea-floor habitat and not so much in the naturally undersaturated deep-sea below the
300 carbonate compensation depth.

301

302 *Areas multiply affected by environmental changes*

303 The entire area with one or more of the observed changes is $13.1 \times 10^6 \text{ km}^2$ in size, which
304 amounts to 46 % of the SO (Figs 5a & 6). While areas affected by only one factor (from those
305 analysed here) correspond to 33% of the SO surface, when superposing 2, 3, 4 and 5 factors
306 the areas affected result in 11%, 2%, and <1% of the SO surface, respectively. Some areas
307 north of the Sea-Ice Zone and closer to the continent especially in the Indian sector and in the

308 Amundsen Sea are affected but with a relatively low impact. The most intensively affected
309 area is the Eastern Bellingshausen Sea (Fig. 6). Larger areas intermediately affected by 2 to 3
310 factors lay inshore and offshore in the Ross Sea area. Future changes are projected for almost
311 the entire SO (Figs 5b & 6). This high coverage of 99% ($28.4 \times 10^6 \text{ km}^2$) is due to the
312 expected area-wide shift from aragonite over- to undersaturation. Large areas amounting to 36
313 and 43% of the SO will be affected by the impact of 2 and 3 factors combined, respectively.
314 Much smaller areas representing 9 and 3% of the SO are projected to be affected by 4 and 5
315 factors. The highest impact in this sense occurs off shore in the Amundsen Sea, around the
316 Peninsula and regionally on the shelf of East Antarctica including the Weddell Sea (Fig. 6).
317

318 **Discussion**

319 *Ocean warming*

320 More than 90% of anthropogenic greenhouse gas induced warming is absorbed by the world's
321 ocean, slowing the atmospheric warming response to greenhouse gas forcing (Trenberth &
322 Fasullo, 2013). Model studies suggest that the Southern Ocean (SO) dominates the global
323 ocean heat uptake (Kuhlbrodt & Gregory, 2012). SO waters warmed over the past 50 years
324 affecting the entire water column (Gille, 2002; Purkey & Johnson, 2010). A sea-surface
325 warming above an assumed low physiological limit of 1K has so far only been reported for
326 the WAP and in the adjacent eastern Bellingshausen Sea (Meredith & King, 2005; Schloss *et*
327 *al.*, 2012), which is a region of high diversity and significant ecosystem functioning, e.g. high
328 productivity and growth of krill as an ecosystem service providing food for higher trophic
329 levels represented by apex-predators, which occur globally (e.g., Ducklow *et al.*, 2006;
330 Griffiths, 2010; Murphy *et al.*, 2012). For these reasons it represents an important site to
331 compare with future projections to other regions of the SO where warming is expected. At 50
332 m water depth the area of critical warming shrinks to <10% of that at the surface (Meredith &
333 King, 2005). Peck (2011) reviewed temperature tolerance of benthic invertebrates and
334 extrapolated that most of the studied species could tolerate a warming in the range of 1-3 K.
335 The last time the SO ecosystem experienced climate variations of this scale was during the
336 transition from Mediaeval Warm Period (MWP; until 1287 AD) to the Little Ice Age (LIA;
337 1287-1850 AD) and its transition to modern warming (Bertler *et al.*, 2011). The data from
338 climate archives suggest that in the Ross Sea and adjacent areas in comparison to modern
339 times (average from 1850 AD to today) SSTs during the MWP were warmer, and sea-ice
340 extent as well as marine productivity were reduced. During the LIA, atmospheric
341 temperatures were 2K cooler, with cooler SST, an increase in sea-ice and primary
342 productivity. The reconstruction also suggests that rapid warming events occurred during the
343 warmer periods (Bertler *et al.*, 2011). Support comes from studies, which suggest a large Ross

344 Sea latent heat polynya affected by upwelling of circumpolar deep water and an increase in
345 primary productivity during the LIA (Leventer & Dunbar, 1988; Morales Maqueda *et al.*,
346 2004; Rhodes *et al.*, 2012).

347

348 It has been shown that the behaviours of ecologically relevant species respond more
349 sensitively to warming than their measurable metabolism (Barnes & Peck, 2008). However,
350 some species have not lost the capacity to compensate for chronic temperature increase of >3
351 K, e.g. the fish *Pagothenia borchgrevinki* (Seebacher *et al.*, 2005), which is consistent with
352 hints that the recent temperatures are not the most elevated during the Holocene (Shevenell *et*
353 *al.*, 2011). Cold-adapted benthic species can probably not survive in warmer deeper waters if
354 they are endemic in cold shallow areas. Pelagic species can disperse easier than sessile
355 benthic species into temperature stable areas and survive there. The growth of sponge
356 populations mentioned in the IPCC AR4 (Anisimov *et al.*, 2007) and AR5 (Larsen *et al.*,
357 2014) only refers to exceptionally fast growing and recruiting species in an environment
358 shaped by disturbances (Dayton, 1989; Gutt, 2001), also other sponge species can respond to
359 environmental changes in both ways with exceptionally fast growth and mortality (Dayton *et*
360 *al.*, 2013; Gutt *et al.*, 2013). Micro-evolution can contribute to species adaptation only if the
361 capacity is sufficient to compensate for the relatively fast recent ocean warming (Peck *et al.*,
362 2009a). At the community rather than the species level in-shore habitats were found to be
363 unique, valuable for higher trophic levels (Grange & Smith, 2013), rich in primary production
364 and CO₂-uptake (Arrigo *et al.*, 2008, Quéguiner, 2013) and thus, further warming could result
365 in an above-average loss in habitat diversity and ecosystems services (Grant *et al.*, 2013).

366 Warming can also happen due to upwelling of Warm Deep Water offshore as a consequence
367 of changing wind and current patterns and thus affect biological production processes
368 (Dinniman *et al.*, 2012). A similar warming of the naturally relatively warm Upper
369 Circumpolar Deep Water on the shelf of the WAP (Clarke *et al.*, 2009) could cause a range

370 extension of species, e.g. of king crabs, since their temperature tolerance limit might exactly
371 lay within the range of the T-increase from 1.04 to 1.47K in almost three decades (C.R. Smith
372 *et al.*, 2012b; Griffiths *et al.*, 2013). Locally, a more severe impact could develop, when
373 growing crab populations feed efficiently on hard shelled prey, to which the Antarctic benthic
374 system is not well adapted. It can also not be excluded that non-investigated species have a
375 similar tolerance limit, which lies exactly within a range of a warming of only a very few K.
376 If such species are endemic for the SO they could extend their biogeographic ranges or non-
377 indigenous species might invade the SO as 'aliens' (see Clarke *et al.*, 2005). Such a tipping
378 point, beyond which some species die and others start to immigrate is known for a change
379 from large diatoms to smaller cryophytes observed locally at air temperature of 0 K and
380 reduced salinity (Moline *et al.*, 2004). This could also explain the change from a krill to a
381 salp-dominated pelagic (Atkinson *et al.*, 2008), or perhaps to a copepod dominated system.
382 There has been substantial warming of the Southern Ocean concentrated in the Antarctic
383 Circumpolar Current (Aoki *et al.*, 2003, Böning *et al.*, 2008, Gille 2002, 2008), where surface
384 temperatures have increased by almost a degree but significant increases are recorded at all
385 depths (Aoki *et al.*, 2003, Gille 2008). In the east Antarctic region, 60° - 160°E, Robinson *et*
386 *al.* (2014) found significant increases in zooplankton abundances since 1991 in all
387 oceanographic zones between the sub-Antarctic and the Sea-Ice Zone based on Continuous
388 Plankton Recorder data. There were shifts in dominance towards larger copepods, contrary to
389 the hypothesis that warming will see a shift to smaller warm water species. Even if a warming
390 in the deep Weddell Sea of <0.1K in 24 years as observed by Fahrbach *et al.* (2011) or a
391 maximum of >2K increase to values above 0K predicted for the 2nd half of the 21st century
392 by Hellmer *et al.* (2012) is too weak to affect organisms directly, the resulting changes in the
393 oxygen ventilation of the SO, nutrients flux, or a possible collapse of ice-shelves could have
394 an impact on entire marine communities. The impact at the sea surface and at 50m depth was
395 partly considered moderate since the observed T-increase does not clearly exceed known

396 tolerance limits of most investigated species but first signs of its effects on the plankton and
397 benthic diatoms exist (Longhi *et al.*, 2003). Since species living at 50 m depth can survive in
398 adjacent deeper, non-affected areas, this T-increase was also considered non-critical (Fig. 4).
399 Since expected warming affects only regionally the ice-free relatively homogenous pelagic
400 habitats it is assessed as moderate, but where it happens the effect is most likely severe.

401

402 *Shift of Polar Front*

403 The Southern Ocean fronts are -with exceptions- seen as one of the most effective barriers in
404 the world's ocean (Clarke *et al.*, 2005; Knox, 2007; Thornhill *et al.*, 2008) especially for
405 organisms inhabiting water depths < 500m due to the distinct temperature difference between
406 water masses North and South of it (Sokolov & Rintoul, 2009b). A geographical shift of the
407 Antarctic Circumpolar Current (ACC) fronts between 45° and 60°S by 60 km to the South
408 and, consequently, a warming of 2 to 5.5 K in that area (Sokolov & Rintoul, 2009a) must
409 result in a complete shift in the composition and functioning of the permanent open ocean
410 habitat along the Polar frontal zone, characterised regionally by high primary production
411 (Moore & Abbott, 2000) and diverse pelagic communities (Ward *et al.*, 2003, McLeod *et al.*,
412 2010, Hosie *et al.*, 2014). Due to these reason a modelling approach has projected high
413 species turnover rates in this area (Cheung *et al.*, 2009). Southern Elephant seals *Mirounga*
414 *leonina* along the Southern Ocean fronts seem to respond to changes in environmental
415 conditions in their nutrition physiology and, as a consequence, in the feeding behaviour (Biuw
416 *et al.*, 2007, Costa *et al.*, 2010, McIntyre *et al.*, 2011). Despite the lower limit of the frontal
417 system of <500 m depth, processes and patchiness in the deeper plankton and deep-sea
418 benthos can mirror changes in ecological processes in the euphotic zone (Pollard *et al.*, 2009;
419 Sachs *et al.*, 2009; Veit-Köhler *et al.*, 2011). The discrete and high increase in SST related to
420 a shift of the PF is the reason why this impact is considered as severe to the pelagic system.

421 An assumed buffering effect through carbon flux results in a supposed moderate impact to the
422 deep-sea (Fig. 4).

423

424 *Sea-ice habitat*

425 In contrast to Arctic sea-ice trends, Antarctic sea-ice extent has increased over the recent past
426 due to an increase in the Weddell and Ross Sea regions. The polynyas along the coastal
427 regions around Antarctica are known as ice factories since they are sites of continuous ice
428 production enhanced by strong katabatic winds. A change in wind patterns could cause a
429 reduction in ice production and hence in ice extent. The predictions (e.g., CMIP5) indicate a
430 decline in the Antarctic sea-ice extent in the last 3 decades but this is inconsistent with
431 satellite observations. The latter have shown large declines of sea-ice in the
432 Bellingshausen/Amundsen Seas, but these do not compensate for the increase in other areas
433 (Bracegirdle *et al.*, 2008; Comiso, 2011). This inconsistency can be explained by tele-
434 connections in the Atlantic (King, 2014). Decreases in ice extent may be caused by a warmer
435 ocean that would shorten the length of the sea-ice season and keep the sea-ice cover from
436 expanding as far north as usual and by changing wind patterns. A regional variability also
437 becomes obvious when the period of sea-ice occurrence is split into the time before and after
438 1996 (Bintanja *et al.*, 2013). The forming and melting of sea-ice has a complex temporal
439 pattern including climate-related changes driven by variations in circulation and temperature
440 in both the atmosphere and ocean (Parkinson *et al.*, 2002; Stammerjohn *et al.*, 2008; Willmes
441 *et al.*, 2009; Comiso *et al.*, 2011, Holland & Kwok, 2012). Also when the seasons are
442 separately analysed, the areas with an increase are consistently larger than those with a
443 decrease. An ice core based reconstruction of sea-ice variability over the past 130 years
444 (Sinclair *et al.*, in press) suggests, that sea-ice extent in the Ross Sea region appears to be a
445 relatively recent occurrence.

446

447 The changes so far already had an obvious impact on important pelagic ecosystem
448 components, e.g., phytoplankton (Montes-Hugo *et al.*, 2009), Antarctic krill (Atkinson *et al.*,
449 2008), penguins (Lynch *et al.*, 2012), and seals (Simmonds & Isaak, 2007; Kovacs *et al.*,
450 2012). Most of the biotic relationships are non-linear (Clarke & Harris, 2003), some are
451 direct, some indirect (Trivelpiece *et al.*, 2011), and not all ecosystem functions become
452 limited but benefit. Some species have a capacity to compensate the damage at least partly,
453 e.g. whilst large krill populations at the northern margin of their occurrence shrink, more
454 southerly situated populations undergo a slight increase (Atkinson *et al.*, 2008). Recent
455 reviews suggest there have been cumulative impacts on sensitive pelagic and benthic
456 ecosystems (Flores *et al.*, 2012; C.R. Smith *et al.*, 2012a) but also a certain resilience within
457 the systems was assumed. On average all the IPCC scenarios show some decrease due to
458 atmosphere and ocean warming (although very small in RCP2.6) in extent over the 21st
459 century, see IPCC (2013, Figure 12.28). The future projections analysed here (Bracegirdle *et*
460 *al.*, 2008) show a decrease especially in summer and autumn with a regional focus in the
461 Amundsen-/Bellingshausen Seas and Indian sector of the SO, but not the spatial and temporal
462 pattern as analysed for the past. At an assumed decrease of ice by 25%, a 10% increase in
463 primary production is expected due increased photo-synthetically active radiation in an
464 enlarged open water zone; not only the sea-ice extent but also the length of the sea-ice edge
465 plays an important role, e.g. on krill (Arrigo & Thomas, 2004).

466

467 It can be expected that species with narrow ecological niches and adapted to conditions of the
468 past glacial periods with much reduced primary production (Bonn *et al.*, 1998), suffer more
469 from stress caused by an increase rather than from a decrease in food supply, but
470 opportunistic species with broader tolerances might benefit. At least Dayton (1974) provided
471 hints summarized by Gutt (2006) that a system with high phytoplankton production supports a
472 more simple benthic system that that with a lower phytoplankton (food) supply. Latitudinal

473 studies along a sea-ice gradient on the WAP suggest that macrofaunal species diversity may
474 increase linearly with sea-ice loss on the shelf, while standing crop of macro- and
475 megabenthos may exhibit abrupt changes (or tipping points) as annual sea-ice duration
476 declines (C.R. Smith *et al.*, 2012a). Jones *et al.* (2014) predicted a global decrease by 2100
477 but increases in the SO in benthic biomass, which may result from climate-induced changes in
478 the export flux from the euphotic layer to the specious deep-sea benthos (Brandt *et al.*, in
479 press).

480
481 Species emigrated most likely during the shifts from glacial to interglacial periods and vice
482 versa to areas with favourable conditions (Clarke & Crame, 1992; Clarke, 2003; Thadje *et al.*,
483 2008). They will potentially behave similarly, mobile species, and plankton faster than sessile
484 benthic species, if the changes in the future occur slowly enough, and if refuges with
485 favourable conditions persist in the southernmost marine areas. Gentoo penguins have already
486 been observed to expand southward due to the loss of sea-ice (Lynch *et al.*, 2012), seals are
487 known to have relocated their colonies during holocene temperature shifts (Hall *et al.*, 2006)
488 and to respond to recent changes in ice dynamics in both directions, by an increase and
489 decrease of populations size (Simmonds & Isaak, 2007; Bester, 2014). A specific trophic
490 model with an assumed primary 8% species loss due to ice reduction results in a secondary
491 50% species loss and shows a high sensitivity of the sea-ice related habitat, which, is however
492 less severe than in the Arctic (Mather *et al.*, 2012). The changes in the sea-ice in the past and
493 future have been classified as intermediate (Fig. 4) since they already affected and will
494 continue to affect not all but major ecosystem functions especially within the ice and pelagic
495 habitats. Increases and decreases of season period and extent in the past have been considered
496 equally because either ice-adapted or open-water preferring species will experience
497 corresponding environmental stress.

498

499 *Ice-shelf disintegration*

500 Autochthonous primary production cannot develop below ice-shelves due to the isolation
501 from sunlight with the exception of chemoautotroph communities (Domack *et al.*, 2005a;
502 Niemann *et al.*, 2009; Gutt *et al.*, 2011), thus, most of the life below the ice depends on
503 advective food supply (Sañe *et al.*, 2011a). Benthic heterogeneity below the ice-shelves and
504 close to the ice-shelf edge are shaped by the currents, which act as a food vector and are either
505 flowing from the open water under the ice or vice versa (Barry & Dayton, 1988; Seiler &
506 Gutt, 2007; Gutt *et al.*, 2011). In the latter case resulting oligotrophic conditions being in
507 quality and quantity similar to the deep-sea change radically when the ice-shelves disintegrate
508 (Bertolin & Schloss, 2009; Peck *et al.*, 2009b, Sañe *et al.*, 2011b) but also depend on the
509 formation of polynyas (Cape *et al.*, 2014). Calving of icebergs is a natural phenomenon that
510 happens around the continent depending on the size and advance of the ice-shelves. It can be
511 driven by natural climatological cycles or by the recent ocean and atmosphere warming at
512 both sides of the Antarctic Peninsula. The large ice-shelves had so far been assumed to be
513 stable (Hodgson *et al.*, 2006) but a model experiment suggests that an extension of warm
514 water below the Filchner-Ronne Ice Shelf during the 21th century could destabilize the
515 floating ice masses (Hellmer *et al.*, 2012). Since all organisms ranging from microbes to
516 whales have been observed or are expected to be affected (Bertolin & Schloss, 2009; Raes *et*
517 *al.*, 2010; Gutt *et al.*, 2011; Gutt *et al.*, 2013), including the regional extinction of specifically
518 adapted deep-sea type species, ice-shelf disintegration can be assumed to be among the most
519 severe changes - where it happens - that any marine system in the world could experience.
520 The impact on the entire SO and global marine biodiversity would be severe if deep-sea
521 organism types found in shallow depth turn out to be endemic for some of the isolated under
522 ice-shelf habitats. The shift from an extremely oligotrophic to a normal Antarctic ecosystem
523 must not necessarily be considered as a catastrophe as long as typical high-latitude
524 communities establish in such areas and are not disturbed by further climate-change

525 developments, e.g. land-run-off as a consequence from terrestrial deglaciation (Ashley &
526 Smith, 2000). In addition to the benthic habitat below the ice-shelves, a specific fauna can
527 exist at the subsurface of ice-shelves (Watanabe *et al.*, 2006; Rack, 2012), which can be
528 endangered by further ice-shelf loss. Because the direct impact to the marine ecosystem is
529 locally immense the overall impact was considered severe (Fig. 4).

530

531 *Scouring and drifting icebergs*

532 Calving of icebergs, their impact on the pelagic system and disturbance of benthic habitats are
533 natural phenomena. Average disturbance rates are known to increase regional megabenthic
534 diversity (Gutt & Piepenburg, 2003) and grounded as well as floating icebergs facilitate
535 biological production in the upper 10 m of the pelagic system due to fertilisation and melting
536 (Schwarz & Schodlok, 2009; Vernet *et al.*, 2011). Also, re-suspension of particles and
537 nutrients in the nepheloid layer can be expected but have never been studied. Climate-driven
538 changes in calving rates and the abundance of drifting icebergs (Bindschadler & Rignot,
539 2001; Long *et al.*, 2002) could lead to significant impacts on the marine ecosystem. However,
540 direct observations do not exist.

541

542 Apparently icebergs occur on the shelf and off shore almost everywhere around the continent,
543 with the exception of <1 Gt in 21 years per 1°x2° grid cell in some areas South of the PF off
544 East Antarctic. 44% of the sea-floor area in the eastern Weddell Sea has been disturbed
545 mainly at water depth <250 m by iceberg scouring over decades. This might be representative
546 for the entire Antarctic shelf (Gutt & Starmans, 2001; Fig. 4). Most large icebergs studied by
547 Stuart & Long (2011) remain in coastal waters, with a low abundance in the WAP area, and in
548 the Bellingshausen and Amundsen Seas. Depending on which ice shelves are under future
549 climate stress, changes in the disturbance regime of downstream-situated areas are to be
550 expected (Smale & Barnes, 2008). This might especially happen east of the Antarctic

551 Peninsula, where icebergs drift far northward. Most serious changes can be expected if the
552 Filchner-Ronne Ice Shelf was to disintegrate (Hellmer *et al.*, 2012).
553
554 If only areas of the sizes of icebergs and their surrounding are considered the impact to the
555 ecosystem is relatively small compared to other climate-induced changes. However, the
556 potentially affected habitats, benthic by grounding and pelagic by drifting icebergs, have
557 similar high proportions of the corresponding habitats. Synergistic effects between grounded
558 icebergs, melting of sea-ice and primary production (Arrigo *et al.*, 2002; Arrigo & van
559 Dijken, 2003) and unexpected response at the sea-floor by sponges being key-species in the
560 shallow water ecosystem (Dayton *et al.*, 2013) can not be quantified, but unpredictable
561 tipping points seem to play an important role. On the one hand the shelf benthos is naturally
562 shaped by iceberg groundings and, thus, no decrease in diversity and ecosystem functioning
563 can be expected in case of moderate changes in disturbance, on the other hand the effects are
564 long-lasting. As a consequence iceberg impact on the shelf is assessed as moderate (Fig. 4).
565 The effect in open water is considered non-critical due to its ephemeral and local nature.

566

567 *Tidewater marine glaciers*

568 The quantification of areas affected by tidewater glacier retreat results in comparably small
569 areas. However, due to the proximity to the coast, grounding line or sea-floor, the disturbance
570 by calving from glaciers to the sea-bed morphology, sediment composition and sea-bed
571 inhabitants might locally be more intense than the impact due to ice-shelf disintegration. A
572 high re-suspension of sediments leading to high local turbidity in the water column can be
573 assumed where glaciers ground (Powell *et al.*, 1996; Dawber & Powell, 1997) especially in
574 regions of high habitat complexity and assumed vulnerability (Grange & Smith, 2013). Also
575 the impact of coastal glacier melting and their sediment load limit light availability for
576 phytoplankton growth (Schloss *et al.*, 2014). Independently of the size of the areas affected

577 this impact is considered to be severe (Fig. 4) because of its affect on essential krill habitats
578 and feeding whales (Nowacek *et al.*, 2011), and also because it happens in areas with
579 significant seafloor habitat diversity (Grange & Smith, 2013).

580

581 *Ocean acidification*

582 The physico-chemical interactions shaping the carbonate system in the oceans are nonlinear
583 (Trela *et al.*, 1995), have a considerable temporal and spatial variation (Hauck *et al.*, 2010)
584 and interact with other global changes such as increased irradiance and warming (Gao *et al.*,
585 2012; Li *et al.*, 2012; Torstensson *et al.*, 2013). If current projections are correct 98% of the
586 SO will be undersaturated with respect to aragonite by 2100 AD (Orr *et al.*, 2005). Under the
587 IPCC IS92a scenario, SO wintertime aragonite undersaturation is projected to occur already
588 no later than 2038 (McNeil & Matear, 2008). Additional energetic costs for organisms
589 resulting from the need to build skeletal mass in an ocean with a low aragonite saturation state
590 have to be considered (Watson *et al.*, 2012). Shell dissolution might also lower resistance to
591 predation pressure on shell forming organisms (Gazeau *et al.*, 2013). Key species in the
592 world's ocean pelagic and benthic systems, such as the calcifying coccolithophorids and
593 pteropods, echinoderms and corals are severely affected (Doney *et al.*, 2009; Riebesell &
594 Tortell, 2011; Bednaršek *et al.*, 2012; Wittmann & Pörtner, 2013) and, thus, important trophic
595 interrelationships could change. Also a change in the efficiency of photosynthesis and the
596 biological carbon pump must be expected (Riebesell *et al.*, 2007; Tortell *et al.*, 2009;
597 Hofmann *et al.*, 2011). A large-scale and long-term projection for the SO shows that within a
598 century important krill recruitment habitats could be seriously affected (Kawaguchi *et al.*,
599 2013). Some calcifying plankton will even experience detrimental carbonate conditions
600 earlier than previously thought (McNeil & Matear, 2008; McClintock *et al.*, 2009; Bednaršek
601 *et al.*, 2012; Mattsdotter Bjork *et al.*, 2014). Foraminiferan shell weight has been found to be
602 reduced by 30-35% at the northern margin of the modern SO compared to pre-industrial

603 weights linked to atmospheric CO₂ and ocean pH (Moy *et al.*, 2009). However, some
604 projections point towards a 30 y delay in acidification in the Ross Sea due to sea-ice cover
605 and deep-water entrainment (McNeil *et al.*, 2010), which could allow organisms to adapt
606 eventually through microevolution (Collins *et al.*, 2014) as observed for some species at the
607 global level by Wittman & Pörtner (2013). Indeed, Cummings *et al.* (2011) showed that in the
608 Antarctic bivalve *Laternula elliptica* gene expression might change in response to
609 acidification. Due to the lack of comprehensive data on Antarctic pelagic ecosystems
610 response to acidification this impact is assessed as intermediate. The impact to the benthic
611 systems is also considered intermediate because only the shelves are expected to experience
612 significant changes but these are rich in biomass and are assumed to contribute essentially to
613 ecosystem services especially to remineralisation (Fig. 4).

614
615 Another effect might come from the depletion of seawater borate ions (B(OH)⁴⁻) under
616 increasing absorption of CO₂ (Brewer & Hester, 2009). Borates absorb sound at low-
617 frequency. Under doubling CO₂ ocean concentrations sound at frequencies that are important
618 for marine mammals will travel some 70% farther with assumed but unknown impact to these
619 animals.

620

621 *Increased UV-B impact due to ozone depletion*

622 In our results, the temporal spatial variation of areas exposed to increased UV-B was
623 principally due to the highly dynamic stratospheric ozone hole rather than to variations in sea-
624 ice distribution. As a consequence of the approach to exclude areas where the water column is
625 shielded from UV-B by < 80% sea-ice cover but to include the spatial variation of the ozone
626 hole, the area affected is quite large compared to the other impacts. The analysis considering
627 data from October, November with three replicates, and December shows that the most
628 critical phase starts when elevated UV-B penetrates into the SO due to the melting of sea-ice,

629 but when the ozone hole is still present before it fills in December. A slowly long-term
630 recovering ozone hole is foreseen (Perlwitz *et al.*, 2008), with full recovery maybe achieved
631 by the end of the 21st century (Turner *et al.*, 2013a). Although large marine areas that are
632 affected by the ozone hole are still covered by sea-ice (Lister *et al.*, 2010), in areas of
633 decreasing sea-ice, this might no longer be the case (Moreau *et al.*, in press). Arrigo *et al.*
634 (2003) estimated a loss of only <0.25% on primary production between August and
635 December due to UV-B, but in areas such as the WAP an increase in production related to
636 decreased sea-ice (and therefore, probably more exposure to UV-B) has been evident
637 (Ducklow *et al.*, 2013). While many studies have shown that UV-B negatively affects aquatic
638 organisms, effects on ecosystems remain uncertain (Häder *et al.*, 2007). Mesocosm studies on
639 subantarctic plankton suggest that UV-B has more an effect on plankton composition than on
640 overall biomass (Roy *et al.*, 2006), therefore being an important factor in ecosystem function.
641 In the natural environment, however, the effects could be attenuated by vertical mixing of the
642 water column (Ferreira *et al.*, 2006), the presence of coloured dissolved organic matter as
643 well as the presence of sea-ice (Arrigo *et al.*, 2003), and the synthesis of photoprotective
644 compounds (Helbling *et al.*, 1996; Hernando *et al.*, 2002). When the ice breaks up and a
645 maximum of transparency allows the radiation to penetrate deeply into the clear water,
646 shallow habitats might be severely affected, as is the case for macroalgae and their consumers
647 (Zacher *et al.*, 2007). A variety of other organisms at different life stages, including fish
648 (Karentz & Bosch, 2001; Huovinen & Gómez, 2013) might also be indirectly affected
649 through the food web. Endotherms are everywhere exposed to the increased UV-B radiation
650 where the ozone hole exists when they stay on land or on the ice and might suffer from eye
651 damage (Hemmingsen & Douglas, 1970). With regards to the effects of UV-B on the biomass
652 of key organisms like krill, results are contradictory (Bidigare, 1989; IPCC, 2013), depending
653 also on the yearly variation in the extent of the ozone hole (Mangel *et al.*, 2010). Overall,
654 since UV-B increase happens only for a limited period of the year and has a considerable

655 interannual and short-term variability with the consequence that large areas are not
656 permanently exposed the effect is assumed to be moderate (Fig. 4). Despite weak hints that
657 the ozone hole will slowly close in the next decades not projections are available.
658
659 *Areas multiply affected by environmental changes in a wider context*
660 Areas expected to show environmental changes, assumed to cause potential stress to
661 organisms and impact marine communities, are larger than areas that have already
662 experienced such changes and effects. This is mainly due to a combination of two factors, the
663 shift from aragonite over- to undersaturation in almost the entire SO within the next decades
664 and large areas expected to experience a decrease in sea-ice cover summed-up for all four
665 seasons, in contrast to ocean acidification (Orr *et al.*, 2005) a scenario being specific for both
666 polar regions (for the Arctic see Comiso *et al.*, 2008). The latter is against the still ongoing
667 trend of total sea-ice increase in the SO. Combined impact factors are obvious especially on
668 the shelves since in iceberg disturbance and acidification both, the sea-floor and pelagic
669 habitats are expected to be disturbed or significantly be affected. The areas around and
670 adjacent to the Antarctic Peninsula will remain a hot-spot in changes with respect to
671 superimposed effects but less obvious than in the past due to larger circumpolar inshore and
672 offshore areas expected to get under climate stress.
673
674 Our results offer tools to identify knowledge gaps to help design future studies on climate
675 change impact in the SO ecosystem. In terms of size of areas affected, sea-ice and
676 acidification require substantial attention and efforts to better constrain their effects. Because
677 of their severe impact ice-shelf disintegration and resulting iceberg scouring could also
678 become a focus of future approaches, as well as the added effects of regional warming in
679 unique coastal systems and at the northern margin of the SO. Here we have identified several
680 factors that simultaneously affect a certain area. One of the biggest challenges in this context

681 is to consider their synergic effects on single species and communities (Clarke & Harris,
682 2003). Our spatially explicit area-based concept is a first assessment of the severity of
683 environmental-change impact. However, the magnitude of threads for the loss of habitats is
684 not just a function of the area affected but also of habitat turn-over and physical-biological
685 interactions. The scientific basis especially of conservation ecology must consider
686 biodiversity and productivity hotspots (Myers *et al.*, 2000), their heterogeneity, patterns and
687 locations as well as the spatial overlap with areas of single and multiple factors of
688 environmental change.

689

690

691

692 **Acknowledgements**

693 This study is an output of SCAR's "Antarctic Thresholds - Ecosystem Resilience and
694 Adaptation" (AnT-ERA) and "AntClim21" programs. Thanks are due to John King, Mike
695 Meredith, Claire Parkinson, Peter Fretwell, Zhaomin Wang to provide important data and two
696 anonymous referees for their constructive criticism.

697

698

699 **References**

- 700 Ackley SF, Sullivan CW (1994) Physical controls on the development and characteristics of
701 Antarctic sea ice biology communities - a review and synthesis. *Deep-Sea Research I*, **41**,
702 1583-1604.
- 703 Aoki S, Yoritaka M, Masuyama A (2003) Multidecadal warming of subsurface temperature in
704 the Indian sector of the Southern Ocean. *Journal of Geophysical Research*, **108**, 8081,
705 doi:10.1029/2000JC000307.
- 706 Aronson RB, Thatje S, Clarke A, Peck LS, Blake DB, Wilga CD, Seibel BA (2007) Climate
707 change and invasibility of the Antarctic benthos. *Annual Review of Ecology, Evolution,*
708 *and Systematics*, **38**, 129-154.
- 709 Aronson RB, Thatje S, McClintock JB, Hughes KA (2011) Anthropogenic impacts on marine
710 ecosystems in Antarctica. *Annals of the New York Academy of Sciences*, Issue The Year
711 in Ecology and Conservation Biology, **1223**, 82-107.
- 712 Arrigo KR, Robinson DH, Worthen DL, Dunbar RB, DiTullio GR, VanWoert M, Lizotte M
713 (1999) Phytoplankton community structure and the drawdown of nutrients and CO₂ in the
714 Southern Ocean. *Science*, **283**, 365-367.
- 715 Arrigo KR, van Dijken GL, Ainley DG, Fahnestock MA, Markus T (2002) Ecological impact
716 of a large Antarctic iceberg. *Geophysical Research Letters*, **29**,
717 doi:10.1029/2001GL014160.
- 718 Arrigo KR, van Dijken GL (2003) Impact of iceberg C-19 on Ross Sea primary production.
719 *Geophysical Research Letters*, **30**, 1836, doi:10.1029/2003GL017721.
- 720 Arrigo KR, Lubin D, van Dijken GL, Holm-Hansen O, E. Morrow E (2003) Impact of a deep
721 ozone hole on Southern Ocean primary production, *Journal of Geophysical Research*, **108**,
722 3154, doi:10.1029/2001JC001226.
- 723 Arrigo KR, Thomas DN (2004) Large scale importance of sea ice biology in the Southern
724 Ocean. *Antarctic Science*, **16**, 471-486.

- 725 Arrigo KR, van Dijken G, Long M (2008) Coastal Southern Ocean: A strong anthropogenic
726 CO₂ sink. *Geophysical Research Letters*, **35**, L21602, doi:10.1029/2008GL035624.
- 727 Arrigo KR, van Dijken GL, Bushinsky S (2008) Primary production in the Southern ocean
728 1997-2006. *Journal of Geophysical Research*, **113**, C08004, doi:10.1029/2007JC004551.
- 729 Arrigo KR, Mock T, Lizotte MP (2010) Primary producers and sea ice. In: *Sea Ice* (eds
730 Thomas DN, Dieckmann GS), pp. 283-325, Wiley-Blackwell, Oxford, UK, 2nd edition.
- 731 Ashley GM, Smith ND (2000) Marine sedimentation at a calving glacier margin. *Geological*
732 *Society of America Bulletin*, **12**, 657–667.
- 733 Anisimov OA, Vaughan DG, Callaghan TV, Furgal C, Marchant H, Prowse TD,
734 Vilhjálmsson H, Walsh JE (2007) In: *Polar regions (Arctic and Antarctic). Climate*
735 *Change 2007: Impacts, Adaptation and Vulnerability. Contribution of Working Group II to*
736 *the Fourth Assessment Report of the Intergovernmental Panel on Climate Change* (eds
737 Parry ML, Canziani OF, Palutikof JP, van der Linden PJ, Hanson CE), pp. 653-685,
738 Cambridge University Press, Cambridge, UK.
- 739 Atkinson A, Siegel V, Pakhomov EA *et al.* (2008) Oceanic circumpolar habitats of Antarctic
740 krill. *Marine Ecology Progress Series*, **362**, 1-23.
- 741 Barber-Meyer SM, Kooyman GL, Ponganis PJ (2008) Trends in western Ross Sea Emperor
742 Penguin chick abundance and their relationship with climate. *Antarctic Science*, **20**, 3-11.
- 743 Barbraud C, Gavrilov M, Mizin Y, Weimerskirch H (2011) Comparison of emperor penguin
744 declines between Pointe Géologie and Haswell Island over the past 50 years. *Antarctic*
745 *Science*, **23**, 461-468.
- 746 Barnes DKA, Peck LS (2008) Vulnerability of Antarctic shelf biodiversity to predicted
747 regional warming. *Climate Research*, **37**, 149-163.
- 748 Barry JP, Dayton PK (1988) Current patterns in McMurdo Sound, Antarctica and their
749 relationship to local biotic communities. *Polar Biology*, **8**, 367-376.

- 750 Bednaršek N, Tarling GA, Bakker DC *et al.* (2012) Description and quantification of
751 pteropod shell dissolution: a sensitive bioindicator of ocean acidification. *Global Change*
752 *Biology*, **18**, 2378–2388.
- 753 Bertler NAN, Mayewski PA, Carter L (2011) Cold conditions in Antarctica during the Little
754 Ice Age - Implications for abrupt climate change mechanisms. *Earth and Planetary Science*
755 *Letters*, **308**, 41-51.
- 756 Bertolin ML, Schloss IR (2009) Phytoplankton production after the collapse of the Larsen A
757 Ice Shelf, Antarctica. *Polar Biology*, **32**, 1435-1446.
- 758 Bester MN (2014) Marine Mammals: Natural and Anthropogenic Influences. In: *Handbook of*
759 *Global Environmental Pollution, Vol 1, Global Environmental Change*: (ed Freedman B),
760 doi:10.1007/978-94-007-5784-4-40, Springer Science & Business Media, Dordrecht.
- 761 Bidigare RR (1989) Potential effects of UV-B radiation on marine organisms of the Southern
762 ocean: distributions of phytoplankton and krill during austral spring. *Photochemistry and*
763 *Photobiology*, **50**, 469-477.
- 764 Bindschadler R, Rignot E (2001) "Crack!" in the polar night. *EOS Transactions of the*
765 *American Geophysical Union*, **82**, 497-505.
- 766 Bintanja R, van Oldenborgh GJ, Drijfhout SS, Wouters B, Katsman CA (2013) Important role
767 for ocean warming and increased ice-shelf melt in Antarctic sea-ice expansion. *Nature*
768 *Geoscience*, **6**, 376-379.
- 769 Biuw M, Boehme L, Guinet C *et al.* (2007) Variations in behavior and condition of a
770 Southern Ocean top predator in relation to *in situ* oceanographic conditions. *PNAS*, **104**,
771 13705-13710.
- 772 Blain S, Quéguiner B, Armand L *et al.* (2007) Effect of natural iron fertilization on carbon
773 sequestration in the Southern Ocean. *Nature*, **446**, 1070-1074.

- 774 Bluhm BA, Gradinger RR, Schnack-Schiel SB (2010) Sea ice meio- and macrofauna. In: *Sea*
775 *Ice* (eds Thomas DN, Dieckmann GS), pp. 357-393, Wiley-Blackwell, Oxford, UK, 2nd
776 edition.
- 777 Böning CW, Dispert A, Visbeck M, Rintoul SR, Schwarzkopf FU (2008) The response of the
778 Antarctic Circumpolar Current to recent climate change. *Nature Geoscience*, **1**, 864-869.
- 779 Bonn WJ, Gingele FX, Grobe H, Mackensen A, Fütterer DK (1998) Palaeoproductivity at the
780 Antarctic continental margin: opal and barium records for the last 400 ka. *Palaeogeography*
781 *Palaeoclimatology Palaeoecology*, **139**, 195-211.
- 782 Boyd PW, Arrigo KR, Strzepek R, van Dijken GL (2012) Mapping phytoplankton iron
783 fertilization: Insights into Southern Ocean supply mechanisms. *Journal of Geophysical*
784 *Research*, **17**, C06009, doi:10.1029/2011JC007726.
- 785 Bracegirdle TJ, Connolley WM, Turner J (2008) Antarctic climate change over the twenty
786 first century. *Journal of Geophysical Research*, **113**, D03103, doi:10.1029/2007JD008933.
- 787 Brachfeld S, Domack E, Kissel C *et al.* (2003) Holocene history of the Larsen-A Ice Shelf
788 constrained by geomagnetic paleointensity dating. *Geology*, **31**, 749-752.
- 789 Brandt A, Gutt J (2011) Biodiversity of a unique environment: the Southern Ocean benthos
790 shaped and threatened by climate change. In: *Biodiversity Hotspots* (eds Zachos FE, Habel
791 JC) pp. 503-526, Springer, Berlin.
- 792 Brandt A, Griffiths H, Gutt J *et al.* (in press) Challenges of Southern Ocean deep-sea
793 biodiversity assessment. *Advances in Polar Science*.
- 794 Brewer PG, Hester K (2009) Ocean acidification and the increasing transparency of the ocean
795 to low-frequency sound. *Oceanography*, **22**, 86-93.
- 796 Cape MR, Vernet M, Kahru M, Spreen G (2014) Polynya dynamics drive primary production
797 in the Larsen A and B embayments following ice shelf collapse. *Journal of Geophysical*
798 *Research: Oceans*, **119**, 572-594, doi:10.1002/2013JC009441.

- 799 Charlston RJ, Lovelock JE, Andrea MO, Warren SG (1987) Oceanic phytoplankton,
800 atmospheric sulfur, cloud albedo and climate. *Nature*, **326**, 655-661.
- 801 Cheung WWL, Close C, Kearney K, Lam V, Sarmiento J, Watson R, Pauly D (2009)
802 Projections of global marine biodiversity impacts under climate change scenarios. *Fish and*
803 *Fisheries*, **10**, 235-251.
- 804 Clark GF, Stark JS, Johnston EL, Runcie JW, Goldsworthy PM, Raymond B, Riddle MJ
805 (2013) Light-driven tipping points in polar ecosystems. *Global Change Biology*, doi:
806 10.1111/gcb12337.
- 807 Clarke A (2003) The polar deep seas. In: *Ecosystems of the deep oceans* (ed Tyler PA), pp.
808 239–260, Elsevier, Amsterdam.
- 809 Clarke A, Crame JA (1992) The Southern Ocean benthic fauna and climate change: a
810 historical perspective. *Philosophical Transactions of the Royal Society B*, **338**, 299-309.
- 811 Clarke A, Crame JA (1997) Diversity, latitude and time: Patterns in the shallow sea. In:
812 *Marine Biodiversity: Patterns and Processes* (eds Ormond RFG, Gage JD, Angel MV), pp.
813 122-147, Cambridge University Press, Cambridge.
- 814 Clarke A, Harris CM (2003) Polar marine ecosystems: major threats and future change.
815 *Environmental Conservation*, **30**, 1-25.
- 816 Clarke A, Johnston NM (2003) Antarctic marine benthic diversity. *Oceanography and Marine*
817 *Biology: an Annual Review*, **41**, 47-114.
- 818 Clarke A, Barnes DKA, Hodgson DA (2005) How isolated is Antarctica? *Trends in Ecology*
819 *and Evolution*. **20**, 1-3.
- 820 Clarke A, Murphy EJ, Meredith MP, King JC, Peck LS, Barnes DKA, Smith RC (2007)
821 *Climate Change and the marine ecosystem of the western Antarctic Peninsula*.
822 *Philosophical Transactions of the Royal Society B*, **362**, 149-166.
- 823 Clarke A, Harris CM (2003) Polar marine ecosystems: major threads and future change.
824 *Environmental Conservation*, **30**, 1-25.

- 825 Clarke A, Griffiths HJ, Barnes DKA, Meredith MP, Grant SM (2009) Spatial variation in
826 seabed temperatures in the Southern Ocean: Implications for benthic ecology and
827 biogeography. *Journal of Geophysical Research*, **114**, G03003,
828 doi:10.1029/2008JG000886.
- 829 Cohen AL, McCorkie, de Putron S, Gaetani GA, Rose KA (2009) Morphological and
830 compositional changes in the skeletons of new coral recruits reared in acidified seawater:
831 Insights into the biomineralization response to ocean acidification. *Geochemistry,*
832 *Geophysics, Geosystems*, **10**, Q07005. doi:10.1029/2009GC002411.
- 833 Collins S, Rost B, Rynearson TA (2014) Evolutionary potential of marine phytoplankton
834 under ocean acidification. *Evolutionary Applications*, **7**, 140-155.
- 835 Comiso, JC (2000 updated 2012). Bootstrap Sea Ice Concentrations from Nimbus-7 SMMR
836 and DMSP SSM/I-SSMIS. Version 2. Boulder, Colorado USA: NASA DAAC at the
837 National Snow and Ice Data Center.
- 838 Comiso JC, Parkinson CL, Gersten R, Stock L (2008) Accelerated decline in the Arctic sea
839 ice cover. *Geophysical Research Letters* 35, L01703, doi:10.1029/2007GL031972.
- 840 Comiso JC (2010) Variability and trends of the global sea ice cover. In: *Sea Ice* (eds Thomas
841 DN, Dieckmann GS), pp. 205-246, Wiley-Blackwell Oxford, UK, 2nd edition.
- 842 Comiso JC, Kwok R, Martin S, Gordon AL (2011) Variability and trends in sea ice extent and
843 ice production in the Ross Sea. *Journal of Geophysical Research: Oceans*, **116**, C04021,
844 doi:10.1029/2010JC006391.
- 845 Connell JH (1978) Diversity in tropical rain forests and coral reefs. *Science*, **199**, 302-310.
- 846 Constable AJ, Melbourne-Thomas J, Corney SP *et al.* (2014) Change in Southern Ocean
847 ecosystems I: How changes in physical habitats directly affect marine biota. *Global*
848 *Change Biology*. DOI: 10.1111/gcb.12623
- 849 Convey P, Bindschadler R, di Prisco G *et al.* (2010) Antarctic Climate Change and the
850 Environment. *Antarctic Science*, **21**, 541-563.

- 851 Cook AJ, Fox AJ, Vaughan DG, Ferrigno JG (2005) Retreating glacier fronts on the
852 Antarctic Peninsula over the past half-century. *Science*, **308**, 541-544.
- 853 Costa DP, Huckstadt LA, Crocker DE, McDonald BI, Goebel ME, Fedak A (2010)
854 Approaches to studying climatic change and its role on the habitat selection of Antarctic
855 pinnipeds. *Integrative and Comparative Biology*, **50**, 1018-1030.
- 856 Crame JA (1989) Origins and Evolution of the Antarctic Biota. Geological Society Special
857 Publication, 47, The Geological Society, London.
- 858 Cummings V, Thrush S, Norkko A, Andrew N, Hewitt J, Funnel G, Schwarz A-M (2006)
859 Accounting for local scale variability in benthos: implications for future assessments of
860 latitudinal trends in the coastal Ross Sea. *Antarctic Science*, **18**, 633-644.
- 861 Cummings V, Hewitt J, Van Rooyen A *et al.* (2011) Ocean acidification at high latitudes:
862 potential effects on functioning of the Antarctic bivalve *Laternula elliptica*. *PLoS ONE*, **6**,
863 e16069, doi:10.1371/journal.pone.0016069.
- 864 Davies BJ, Carrivick JL, Glasser NF, Hambrey MJ, Smellie JL (2012) Variable glacier
865 response to atmospheric warming, northern Antarctic Peninsula, 1988-2009. *The*
866 *Cryosphere*, **6**, 1031-1048.
- 867 Dawber M, Powell RD (1997) Epifaunal distribution at Antarctic marine-ending glaciers:
868 influences of ice dynamics and sedimentation: In: *The Antarctic region: geological*
869 *evolution and processes* (ed Ricci RD), pp. 875-884, Terra Antarctica Publication, Siena.
- 870 Dayton PK (1989) Interdecadal variation in an Antarctic sponge and its predators from
871 oceanographic shifts. *Science*, **245**, 1484-1486.
- 872 Dayton PK, Robillard GA, Paine RT (1970) Benthic faunal zonation as a result of anchor ice
873 at McMurdo Sound Antarctica. In: *Antarctic Ecology, Vol. 1* (ed Holdgate MW), pp. 244-
874 258, Academic Press, London.
- 875 Dayton PK, Robilliard GA, Paine RT, Dayton LB (1974) Biological accommodation in the
876 benthic community at McMurdo Sound, Antarctica. *Ecological Monographs*, **44**, 105-128.

- 877 Dayton PK, Kim S, Jarrell SC *et al.* (2013) Recruitment, growth and mortality of an Antarctic
878 hexactinellid sponge, *Anoxycalyx joubini*. *PLoS ONE*, **8**, e56939,
879 doi:10.1371/journal.pone.005639
- 880 Delille B, Jourdain B, Borges AV, Tison JL, Delille D (2007) Biogas (CO₂, O₂,
881 dimethylsulfide) dynamics in spring Antarctic fast ice. *Limnology and Oceanography*, **52**,
882 1367-1379.
- 883 Deming JW (2010) Sea ice bacteria and viruses. In: *Sea Ice* (eds Thomas DN, Dieckmann
884 GS), pp. 247-282, Wiley-Blackwell Oxford, UK, 2nd edition.
- 885 Dinniman MS, Klinck JM, Hofman EE (2012) Sensitivity of Circumpolar Deep Water
886 transport and ice shelf basal melt along the West Antarctic Peninsula to changes in the
887 winds. *Journal of Climate*, **25**, 4799-4816.
- 888 Domack E, Ishman S, Leventer A, Sylca S, Willmot V, Huber B (2005a) A chemosynthetic
889 ecosystem found beneath Antarctic ice shelf. *Eos*, **86**, 269–276.
- 890 Domack E, Duran D, Leventer A *et al.* (2005b) Stability of the Larsen B ice shelf on the
891 Antarctic Peninsula during the Holocene epoch. *Nature*, **436**, 681-685.
- 892 Doney SC, Fabry VJ, Feely RA, Kleypas JA (2009) Ocean acidification: The other CO₂
893 problem. *Annual Reviews of Marine Science*, **1**, 169–192.
- 894 Douglas LL, Beaver D, Raymond B, Constable AJ, Brandt A, Post A, Kaiser S, Grantham
895 HS, Nicoll RA (2014) 10.1. Benthic regional classification. In: *Biogeographic Atlas of the*
896 *Southern Ocean* (eds De Broyer C, Koubbi P, Griffiths, H, Danis B, David B, Grant S,
897 Gutt J, Held C, Hosie G, Huetmann F, Post A, Raymond B, Roper-Coudert Y, Van de
898 Putte A), pp. 414-417, Scientific Committee on Antarctic Research, Cambridge, UK.
- 899 Drinkwater MR, Xiang L (2000) Seasonal to interannual variability in Antarctic Sea ice
900 surface melt. *IEEE Transactions of Geosciences & Remote Sensing*, **38**, 1827-1842.
- 901 Ducklow HW, Baker K, Martinson DG *et al.* (2006) Marine pelagic ecosystem: the West
902 Antarctic Peninsula. *Philosophical Transactions of the Royal Society B*, **362**, 67-94.

- 903 Eicken H (1992) The role of sea ice in structuring Antarctic ecosystems. *Polar Biology*, **12**, 3-
904 13.
- 905 England MH, McGregor S, Soence P *et al.* (2014) Recent intensification of wind-driven
906 circulation in the Pacific and the ongoing warming hiatus. *Nature Climate Change*, **4**, 222-
907 227.
- 908 Fahrbach E, Hoppema M, Rohardt G, Boebel O, Klatt O, Wisotzki A (2011) Warming of
909 deep and abyssal water masses along the Greenwich meridian on decadal time scales: The
910 Weddell gyre as a heat buffer. *Deep-Sea Research II*, **58**, 2509-2523.
- 911 Ferreyra GA, B. Mostajir B, Schloss IR *et al.* (2006) Ultraviolet-B radiation effects on the
912 structure and function of lower trophic levels of the marine planktonic food web.
913 *Photochemistry and Photobiology*, **82**, 887– 897.
- 914 Flores H, Atkinson A, Kawaguchi S *et al.* (2012) Impact of climate change on Antarctic krill.
915 *Marine Ecology Progress Series*, **458**, 1-19.
- 916 Gao K, Xu J, Gao G *et al.* (2012) Rising CO₂ and increased light exposure synergistically
917 reduce marine primary productivity. *Nature Climate Change*, **2**, 519–523.
- 918 Gazeau F, Parker LM, Comeau S *et al.* (2013) Impacts of ocean acidification on marine
919 shelled mollusks. *Marine Biology*, **160**, 2201–2245.
- 920 Gille ST (2002) Warming of the Southern Ocean since the 1950s. *Science*, **295**, 1275-1277.
- 921 Gille ST (2008) Decadal-scale temperature trends in the Southern Hemisphere ocean. *Journal*
922 *of Climate*, **21**, 4749-4765.
- 923 Grange LJ, Smith GR (2013) Megafaunal communities in rapidly warming fjords along the
924 West Antarctic Peninsula: hotspots of abundance and beta diversity. *PLoS ONE* **8**, e77917,
925 doi:10.1371/journal.pone.0077917.
- 926 Grant S, Constable A, Raymond B, Doust S (2006) Bioregionalisation of the Southern Ocean:
927 Report of experts workshop. Hobart, September 2006. WWF-Australia and ACE CRC.

- 928 Grant SM, Hill SL, Trathan PN, Murphy EJ (2013) Ecosystem services of the Southern
929 Ocean: trade-offs in decision-making. *Antarctic Science*, **25**, 603-617.
- 930 Griffiths H (2010) Antarctic marine biodiversity - what do we know about the distribution of
931 life in the Southern Ocean. *PLoS ONE* **5**, e11683, doi:10.1371/journal.pone.0011683.
- 932 Griffiths HJ, Whittle RJ, Roberts SJ, Belchier M, Linse K (2013) Antarctic crabs: invasion or
933 endurance? *PLoS ONE*, **8**, e66981, doi:10.1371/journal.pone.0066981.
- 934 Gutt J (2000) Some "driving forces" structuring communities of the sublittoral Antarctic
935 macrobenthos. *Antarctic Science*, **12**, 297-313.
- 936 Gutt J (2001) On the direct impact of ice on marine benthic communities, a review. *Polar*
937 *Biology*, **24**, 553-564.
- 938 Gutt J (2006) Coexistence of macro-zoobenthic species on the Antarctic shelf: An attempt to
939 link ecological theory and results. *Deep-Sea Research II*, **53**, 1009-1028.
- 940 Gutt J, Starmans A (2001) Quantification of iceberg impact and benthic recolonisation
941 patterns in the Weddell Sea (Antarctica). *Polar Biology*, **24**, 615-619.
- 942 Gutt J, Piepenburg D (2003) Scale-dependent impact on diversity of Antarctic benthos caused
943 by grounding of icebergs. *Marine Ecology Progress Series*, **253**, 77-83.
- 944 Gutt J, Hosie G, Stoddart M (2010) Marine life in the Antarctic. In: *Life in the World's*
945 *Oceans* (ed McIntyre AD), pp. 203-220, Wiley-Blackwell, Oxford, UK.
- 946 Gutt J, Barratt I, Domack E *et al.* (2011) Biodiversity change after climate-induced ice-shelf
947 collapse in the Antarctic. *Deep-Sea Research II*, **58**, 74-83.
- 948 Gutt J, Zurell D, Bracegirdle TJ, Cheung W *et al.* (2012) Correlative and dynamic species
949 distribution modelling for ecological predictions in the Antarctic: a cross-disciplinary
950 concept. *Polar Research*, **31**, 11091, doi:10.3402/polar.v31i0.11091.
- 951 Gutt J, Cape M, Dimmler W *et al.* (2013) Shifts in Antarctic megabenthic structure after ice-
952 shelf disintegration in the Larsen area east of the Antarctic Peninsula. *Polar Biology*, **36**,
953 895-906.

- 954 Gutt J, Barnes DKA, Lockhart SJ (2014) 5.28. Classification and spatially explicit illustration
955 of Antarctic macrobenthic assemblages. In: *Biogeographic Atlas of the Southern Ocean*
956 (eds De Broyer C, Koubbi P, Griffiths, H, Danis B, David B, Grant S, Gutt J, Held C,
957 Hosie G, Huetmann F, Post A, Raymond B, Roper-Coudert Y, Van de Putte A), pp. 422-
958 430, Scientific Committee on Antarctic Research, Cambridge, UK.
- 959 Haas C (2010) Dynamics versus thermodynamics: The sea ice thickness distribution. In: *Sea*
960 *Ice* (eds Thomas DN, Dieckmann GS), pp. 113-151, Wiley-Blackwell Oxford, UK, 2nd
961 edition.
- 962 Häder D-P, Kumar HD, Smith RC, Worrest RC (2007) Effects of solar radiation on aquatic
963 ecosystems and interactions with climate change. *Photochemical and Photobiological*
964 *Sciences*, **6**, 267-285.
- 965 Hall BL, Hoelzel AR, Baroni C, Denton GH, Le Boeuf BJ, Overturf B, Töpf AL (2006)
966 Holocene elephant seal distribution implies warmer-than-present climate in the Ross Sea.
967 *PNAS*, **103**, 10213-10217.
- 968 Harris PT, O'Brien PE (1996) Geomorphology and sedimentology of the continental shelf
969 adjacent to Mac Robertson Land, East Antarctica: A scalped shelf. *Geo-Marine Letters*, **16**,
970 287-296.
- 971 Hauck J, Hoppema M, Bellerby RGJ, Völker C, Wolf-Gladrow D (2010) Data-based
972 estimation of anthropogenic carbon and acidification in the Weddell Sea on a decadal
973 timescale. *Journal of Geophysical Research*, **115**, C03004, doi:10.1029/2009JC005479.
- 974 Helbling EW, Chalkerb BE, Dunlap WC, Holm-Hansen O, Villafañ VE (1996)
975 Photoacclimation of antarctic marine diatoms to solarultraviolet radiation. *Journal of*
976 *Experimental Marine Biology and Ecology*, **204**, 85-101.
- 977 Hellmer HH, Kauker F, Timmermann R, Determann J, Rae J (2012) Twenty-first-century
978 warming of a large Antarctic ice-shelf cavity by a redirected coastal current. *Nature*, **485**,
979 225-228.

- 980 Hemmingsen EA, Douglas EL (1970) Ultraviolet radiation thresholds for corneal injury in
981 Antarctic and temperate zone animals. *Comparative Biochemistry and Physiology*, **32**,
982 593-600.
- 983 Hernando M, Carreto JI, Carignan MO, Ferreyra GA, Gross C (2002) Effects of solar
984 radiation on growth and mycosporine-like amino acids content in *Thalassiosira* sp., an
985 Antarctic diatom. *Polar Biology*, **25**, 12-20.
- 986 Hodgson DA, Bentley MJ, Roberts SJ, Smith JA, Sugden DE, Domack EW (2006)
987 Examining Holocene stability of Antarctic Peninsula Ice Shelves. *EOS Transactions*,
988 American Geophysical Union, **87**, 305-312.
- 989 Hofmann EE, Murphy (2004) Advection, krill, and Antarctic marine ecosystems. *Antarctic*
990 *Science*, **16**, 487-499.
- 991 Hofmann M, Schellnhuber H-J (2009) Oceanic acidification affects marine carbon pump and
992 triggers extended marine oxygen holes. *Proceedings of the National Academy of Sciences*
993 **106**: 3017-3022.
- 994 Holland PR, Kwok R (2012) Wind-driven trends in Antarctic sea-ice drift. *Nature*
995 *Geoscience*, **5**, 872-875.
- 996 Hoppe CJM, Hassler CS, Payne CD *et al.* (2013) Iron limitation modulates ocean
997 acidification effects on Southern Ocean phytoplankton communities. *PLoS ONE* 8(12),
998 doi:10.1371/journal-pone0079890.
- 999 Hosie G, Mormede S, Kitchener J, Takahashi K, Raymond B (2014) 10.3. Near Surface
1000 Zooplankton Communities. In: *Biogeographic Atlas of the Southern Ocean* (eds De Broyer
1001 C, Koubbi P, Griffiths, H, Danis B, David B, Grant S, Gutt J, Held C, Hosie G, Huetmann
1002 F, Post A, Raymond B, Roper-Coudert Y, Van de Putte A), pp. 422-430, Scientific
1003 Committee on Antarctic Research, Cambridge, UK.
- 1004 Huovinen P, Gómez I (2013) Photosynthetic characteristics and UV stress tolerance of
1005 Antarctic seaweeds along the depth gradient. *Polar Biology*, **36**, 1319-1332.

- 1006 IPCC (2013) *Climate Change 2013: The Physical Science Basis. Contribution of Working*
1007 *Group I to the Fifth Assessment Report of the Intergovernmental Panel on Climate Change*
1008 *(eds Stocker TF, Qin D, Plattner G-K, Tignor M, Allen SK, Boschung J, Nauels A, Xia Y,*
1009 *Bex V, Midgley PM). Cambridge University Press, Cambridge, United Kingdom and New*
1010 *York, NY, USA.*
- 1011 Ingels J, Vanreusel A, Brandt A *et al.* (2012) Possible effects of global environmental
1012 changes on Antarctic benthos: a synthesis across five major taxa. *Ecology and Evolution,*
1013 *2*, 453-485.
- 1014 Isla E, Gerdes D, Palanques A, Arntz WE (2009) Downward particle fluxes, wind and a
1015 phytoplankton bloom over a polar continental shelf: a stormy impulse for the biological
1016 pump. *Marine Geology*, **259**, 59-72.
- 1017 Jelmert A, Oppen-Bernsten DO (1996) Whaling and deep-sea biodiversity. *Conservation*
1018 *Biology*, **10**, 653-654.
- 1019 Jenouvrier S, Barbraud C, Weimerskirch H (2005) Long-term contrasted response to climate
1020 of two Antarctic seabird species. *Ecology*, **86**, 2889-2903.
- 1021 Jenouvrier S, Caswell H, Barbraud C, Holland M, Stroeve J, Weimerskirch H (2009)
1022 Demographic models and IPCC climate projections predict the decline of an Emperor
1023 Penguin population. *Proceedings of the National Academy of Sciences USA*, **106**, 1844-
1024 1847.
- 1025 Johst K, Gutt J, Wissel C, Grimm V (2006) Diversity and disturbances in the Antarctic
1026 megabenthos: feasible versus theoretical disturbance ranges. *Ecosystems*, **9**, 1145-1155.
- 1027 Jones DOB, Yool A, Wi C-L, Henson SA, Ruhl HA, Watson RA, Gehlen M (2014) Global
1028 reductions in seafloor biomass in response to climate change. *Global Change Biology*, **20**,
1029 1861-1872.
- 1030 Joughin I, Alley RB (2011) Stability of the West Antarctic ice sheet in a warming world.
1031 *Nature Geoscience*, **4**, 506-513.

- 1032 Kaiser S, Brandão SN, Brix S *et al.* (2013) Pattern, process and vulnerability of Antarctic and
1033 Southern Ocean benthos - a decadal leap in knowledge and understanding. *Marine*
1034 *Biology*, **160**, 2295-2317.
- 1035 Kaleschke L, Heygster G, Lüpkes C, Bochert A, Hartmann J, Haarpainter J, Vihma T (2001)
1036 SSM/I sea ice remote sensing for mesoscale ocean-atmosphere interaction analysis.
1037 *Canadian Journal of Remote Sensing*, **27**, 526-537.
- 1038 Karentz D, Bosch I (2001) Influence of ozone-related increases in ultraviolet radiation on
1039 Antarctic marine species. *American Zoologist*, **41**, 3-16.
- 1040 Kawaguchi S, Ishida A, King R *et al.* (2013) Risk maps for Antarctic krill under projected
1041 Southern Ocean acidification. *Nature Climate Change*, **3**, 843-847.
- 1042 Kennicutt II MC, Chown SL, Cassano JJ *et al.* (2014a) Polar research: Six priorities for
1043 Antarctic science. *Nature*, **512**, 23-25.
- 1044 Kennicutt II MC, Chown SL, Cassano JJ *et al.* (2014b) A roadmap for Antarctic and Southern
1045 Ocean science for the next two decades and beyond. *Antarctic Science*,
1046 doi:10.1017/S0954102014000674
- 1047 King J (2014) A resolution of the Antarctic paradox. *Nature*, **505**, 491-492.
- 1048 Knox GA (2007) *The biology of the Southern Ocean*. CRC Press, Taylor & Francis, Boca
1049 Raton, Florida, USA.
- 1050 Kovacs KM, Aquilar A, Aurioles D, Burkanov V, Campagna C, Gales N (2012) Global
1051 threads to pinnipeds. *Marine Mammal Science*, **28**, 414-436.
- 1052 Kuhlbrodt T, Gregory JM (2012) Ocean heat uptake and its consequences for the magnitude
1053 of sea level rise and climate change. *Geophysical Research Letters*, **39**, L18608,
1054 doi:10.1029/2012GL052952.
- 1055 Kuosa H, Borrman B, Kivi K, Brandini F (1992) Effects for Antarctic sea ice biota on seeding
1056 as studied in aquarium experiments. *Polar Biology*, **12**, 333-339.

- 1057 Haas C (2010) Dynamics versus thermodynamics: The sea ice thickness distribution. In: *Sea*
1058 *Ice* (eds Thomas DN, Dieckmann GS), pp. 113-151, Wiley-Blackwell Oxford, UK, 2nd
1059 edition.
- 1060 Larsen JN, Anisimov OA, Constable A, Hollowed AB, Maynard N, Prestrud P, Prowse TD,
1061 Stone JMR (2014) Polar regions. In: *Climate Change 2014: Impacts, Adaptation, and*
1062 *Vulnerability. Part B: Regional Aspects. Contribution of Working Group II to the Fifth*
1063 *Assessment Report of the Intergovernmental Panel on Climate Change* (eds Barros VR,
1064 Field CB, Dokken DJ, Mastrandrea MD, Mach KJ, Bilir TE, Chatterjee M, Ebi KL,
1065 Estrada YO, Genova RC, Girma B, Kissel ES, Levy AN, MacCracken S, Mastrandrea PR,
1066 White LL), pp. 1567-1612, Cambridge University Press, Cambridge, United Kingdom and
1067 New York, NY, USA.
- 1068 Lenton A, Tilbrook B, Law RM *et al.* (2013) Sea–air CO₂ fluxes in the Southern Ocean for
1069 the period 1990–2009. *Biogeosciences*, **10**, 4037-4054.
- 1070 Leventer A, Dunbar RB (1988) Recent Diatom Record of McMurdo Sound, Antarctica:
1071 Implications for History of Sea Ice Extent. *Paleoceanography*, **3**, 259-274.
- 1072 Li, Y, Gao K, Villafañe VE, Helbling EW (2012) Ocean acidification mediates
1073 photosynthetic response to UV radiation and temperature increase in the diatom
1074 *Phaeodactylum tricornutum*. *Biogeosciences*, **9**, 3931-3942.
- 1075 Lister KN, Lamare MD, Burritt DJ (2010) Sea ice protects the embryos of the Antarctic sea
1076 urchin *Sterechinus neumayeri* from oxidative damage due to naturally enhanced levels of
1077 UV-B radiation. *Journal of Experimental Biology*, **213**, 1967-1975.
- 1078 Long DG, Ballantyne J, Bertoia C (2002) Is the number of icebergs really increasing? *EOS*
1079 *Transactions of the American Geophysical Union*, **83**, 469-474.
- 1080 Longhi ML, Schloss IR, Wiencke C (2003) Effect of irradiance and temperature on
1081 photosynthesis and growth of two Antarctic benthic diatoms, *Gyrosigma subsalinum* and
1082 *Odontella litigiosa*. *Botanica Marina*, **46**, 276-284.

- 1083 Lynch HJ, Naveen R, Trathan PN, Fagan WF (2012) Spatially integrated assessment reveals
1084 widespread changes in penguin populations on the Antarctic Peninsula. *Ecology*, **93**, 1367-
1085 1377.
- 1086 Mangel M, Richerson K, Cresswell KA, Wiedenmann JR (2010) Modelling the effects of UV
1087 radiation on the survival of Antarctic krill (*Euphausia superba* Dana) in the face of limited
1088 data. *Ecological Modelling*, **221**, 2095-2101.
- 1089 Marshall GJ, Orr A, van Lipzig NPM, King JC (2006) The impact of a changing Southern
1090 Hemisphere Annular Mode on Antarctic Peninsula summer temperatures, *Journal of*
1091 *Climate*, **19**, 5388-5404.
- 1092 Mather W, Carscallen A, Romanuk TN (2012) Structure and robustness to species loss in
1093 Arctic and Antarctic ice-shelf meta-ecosystem webs. *Ecological Modelling*, **245**, 208-218.
- 1094 Mattsdotter Björk M, Fransson A, Torstensson A, Chierici M (2014) Ocean acidification state
1095 in western Antarctic surface waters: controls and interannual variability. *Biogeosciences*,
1096 **11**, 57–73.
- 1097 McClintock JB, Angus RA, McDonald MR, Amsler CD, Catledge SA, Vohra YK. (2009)
1098 Rapid dissolution of shells of weakly calcified Antarctic benthic macroorganisms indicates
1099 high vulnerability to ocean acidification. *Antarctic Science*, **21**, 449–456.
- 1100 McIntyre T, Ansorge IJ, Bornemann H, Plötz J, Tosh CA, Bester MN (2011). Elephant seal
1101 dive behaviour is influenced by ocean temperature: implications for climate change
1102 impacts on an ocean predator. *Marine Ecology Progress Series*, **441**, 257-272.
- 1103 McLeod DJ, Hosie GW, Kitchener JA, Takahashi KT, Hunt BPV (2010) Zooplankton Atlas
1104 of the Southern Ocean: The Southern Ocean Continuous Plankton Recorder Survey (1991-
1105 2008). *Polar Science*, **4** (2), 353-385.
- 1106 McNeil BI, Matear RJ (2008) Southern Ocean acidification: A tipping point at 450-ppm
1107 atmospheric CO₂. *Proceedings of the National Academy of Sciences*, **105**, 18860-18864.

- 1108 McNeil B, Tagliabue A, Sweeney C (2010) A multi-decadal delay in the onset of corrosive
1109 'acidified' waters in the Ross Sea of Antarctica due to strong air-sea CO₂ disequilibrium.
1110 *Geophysical Research Letters*, **37**, L19607, doi:10.1029/2010GL044597.
- 1111 Meiners KM, Vancoppenolle M, Thanassekos S *et al.* (2012) Chlorophyll *a* in Antarctic sea
1112 ice from historical ice core data. *Geophysical Research Letters*, **39**, L21602,
1113 doi:10.1029/2012GL053478.
- 1114 Meredith MP, King JC (2005) Rapid climate change in the ocean west of the Antarctic
1115 Peninsula during the second half of the 20th century. *Geophysical Research Letters*, **32**,
1116 L19604, doi:10.1029/2005GL024042.
- 1117 Mintenbeck K, Barrera-Oro ER, Brey T *et al.* (2012) Impact of climate change on fishes in
1118 complex Antarctic ecosystems. *Advances in Ecological Research*, **46**, 351-426.
- 1119 Moline MA, Claustre H, Frazer TK, Schofields O, Vernet M (2004) Alternation of the food
1120 web along the Antarctic Peninsula in response to a regional warming trend. *Global Change*
1121 *Biology*, **10**, 1973-1980.
- 1122 Moline MA, Karnovsky NJ, Brown Z *et al.* (2008) High latitude changes in ice dynamics and
1123 their impact on polar marine ecosystems. *Annals of the New York Academy of Sciences*,
1124 **1134**, 267-319.
- 1125 Montes-Hugo M, Doney SC, Ducklow HW, Fraser W, Martinson D, Stammerjohn SE,
1126 Schofield O (2009) Recent changes in phytoplankton communities associated with rapid
1127 regional climate change along the Western Antarctic Peninsula. *Science*, **323**, 1470-1473.
- 1128 Moore JK, Abbott MR (2000) Phytoplankton chlorophyll distributions and primary
1129 production in the Southern Ocean. *Journal of Geophysical Research*, **105**, C12, 28709-
1130 28722, doi:10.1029/1999JC000043.
- 1131 Morales Maqueda MA, Willmott AJ, Biggs NRT (2004) Polynya dynamics: A review of
1132 observations and modeling, *Reviews of Geophysics*, **42**, RG1004,
1133 doi:10.1029/2002RG000116.

- 1134 Moreau S, Mostajir B, Bélanger S *et al.* (in press) Climate change enhances primary
1135 production of the Western Antarctic Peninsula. *Global Change Biology*.
- 1136 Moy AD, Howard WR, Bray SG, Trull TW (2009) Reduced calcification in modern Southern
1137 Ocean planktonic foraminifera. *Nature Geosciences*, **2(4)**, 276-280.
- 1138 Murphy EJ, Trathan PN, Watkins JL *et al.* (2007) Climatically driven fluctuations in Southern
1139 Ocean ecosystems. *Proceedings of the Royal Society B*, **274**, 3057-3067.
- 1140 Murphy EJ, Cavanagh RD, Hofmann EE *et al.* (2012) Developing integrated models of
1141 Southern Ocean food webs: including ecological complexity, accounting for uncertainty
1142 and the importance of scale. *Progress in Oceanography*, **102**, 74-92.
- 1143 Myers N, Mittermeier RA, Mittermeier CG, da Fonseca GAB, Kent J (2000) Biodiversity
1144 hotspots for conservation priorities. *Nature*, **403**, 853-858.
- 1145 Nicholls KW, Østerhus S, Makinson K, Gammelsrød T, Fahrback E (2009) Ice-ocean
1146 processes over the continental shelf of the southern Weddell Sea, Antarctica: a review.
1147 *Reviews of Geophysics*, **47**, RG3003, doi:10.1029/2007RG000250.
- 1148 Niemann H, Fischer D, Graffe D *et al.* (2009) Biogeochemistry of a low-activity cold seep in
1149 the Larsen B area, western Weddell Sea, Antarctica. *Biogeosciences*, **6**, 2383-2395.
- 1150 Nowacek DP, Friedlaender AS, Halpin PN, *et al.* (2011) Super-aggregations of krill and
1151 humpback whales in Wilhelmina Bay, Antarctic Peninsula. *PLoS ONE*, **6**, e19173,
1152 doi:10.1371/journal.pone.0019173.
- 1153 Orheim O (1985) Attachment 12 Iceberg discharge and the mass balance of Antarctica. In:
1154 *Glaciers, Ice Sheets, and Sea level: Effect of a CO₂-Induced Climatic Change. Report of a*
1155 *workshop held in Seattle, Washington September 13-15, 1984. Prepared for United States*
1156 *Department of Energy, Office of Energy Research, Office of Basic Energy Science, Carbon*
1157 *dioxide Research Division Washinton, D.C. 20545.* (eds Ad hoc Committee on the
1158 Relationship between Land Ice and Sea Level, Committee on Glaciology, Polar Research

- 1159 Board, Commission on Physical Sciences, Mathematics, and Resources) National Research
1160 Council Washington, DC, pp. 210-215, Washington, D.C.
- 1161 Orr JC, Fabry VJ, Aumont O *et al.* (2005) Anthropogenic ocean acidification over the twenty-
1162 first century and its impact on calcifying organisms. *Nature*, **437**, 681-686.
- 1163 Orsi AH, Whitworth III T, Nowlin WD Jr (1995) On the meridional extent and fronts of the
1164 Antarctic Circumpolar Current. *Deep-Sea Research I*, **42**, 641-673.
- 1165 Quéguiner B (2013) Iron fertilization and the structure of planktonic communities in high
1166 nutrient regions of the Southern Ocean. *Deep-Sea Research II*, **90**, 43-54.
- 1167 Parkinson CL (2002) Trends in the length of the Southern Ocean sea-ice season. *Annals of*
1168 *Glaciology*, **34**, 435-440.
- 1169 Peck LS (2011) Organisms and responses to environmental change. *Marine Genomics*, **4**,
1170 237-243.
- 1171 Peck LS, Clark MS, Morley S, Massey A, Rossetti H (2009a) Animal temperature limits and
1172 ecological relevance: effects of size, activity and rates of change. *Functional Ecology*, **23**,
1173 248-256.
- 1174 Peck LS, Barnes DKA, Cook AJ, Fleming AH, Clarke A (2009b) Negative feedback in the
1175 cold: ice retreat produces new carbon sinks in Antarctica. *Global Change Biology*, **16**,
1176 2614-2623.
- 1177 Peck LS, Morley SA, Richard J, Clark MS (2014) Acclimation and thermal tolerance in
1178 Antarctic marine ectotherms. *The Journal of Experimental Biology*, **217**, 16-22.
- 1179 Perlwitz J, Pawson S, Fogt RL, Nielsen JE, Neff WD (2008) Impact of stratospheric ozone
1180 hole recovery on Antarctic climate. *Geophysical Research Letters*, **35**, L08714,
1181 doi:10.1029/2008GL033317.
- 1182 Pollard RT, Salter I, Sanders RJ *et al.* (2009) Southern Ocean deep-water carbon export
1183 enhanced by natural iron fertilization. *Nature*, **457**, 577-580.

- 1184 Powell RD, Dawber M, McInnes JN, Pyne AR (1996) Observation of the grounding-line area
1185 at a floating glacier terminus. *Annals of Glaciology*, **22**, 217-223.
- 1186 Primeau FW, Holzer M, DeVries T (2013) Southern Ocean nutrient trapping and the
1187 efficiency of the biological pump. *Journal of Geophysical Research: Oceans*, **118**, 2547-
1188 2564, doi:10.1002/jgrc.20181.
- 1189 Purkey SG, Johnson GC (2010) Warming of global abyssal and deep Southern Ocean waters
1190 between the 1990s and 2000s: contributions to global heat and sea level rise budgets*.
1191 *Journal of Climate*, **23**, 6336-6351.
- 1192 Quéguiner B (2013) Iron fertilization and the structure of planktonic communities in high
1193 nutrient regions of the Southern Ocean. *Deep-Sea Research II*, **90**, 43-54.
- 1194 Rack FR, Zook R, Levy RH *et al.* (2012) What lies beneath? *Oceanography*, **25**, 84-87.
- 1195 Raes M, Rose A, Vanreusel A (2010) Response of nematode communities after large-scale
1196 ice-shelf collapse events in the Antarctic Larsen area. *Global Change Biology*, **16**, 1618-
1197 1631.
- 1198 Raymond B (2014) 10.2. Pelagic regionalisation. In: *Biogeographic Atlas of the Southern*
1199 *Ocean* (eds De Broyer C, Koubbi P, Griffiths, H, Danis B, David B, Grant S, Gutt J, Held
1200 C, Hosie G, Huetmann F, Post A, Raymond B, Roper-Coudert Y, Van de Putte A), pp.
1201 418-421, Scientific Committee on Antarctic Research, Cambridge, UK.
- 1202 Rhodes RH, Bertler NAN, Baker JA, Steen-Larsen HC, Sneed SB, Morgenstern U, Johnsen
1203 SJ (2012) Little Ice Age climate and oceanic conditions of the Ross Sea, Antarctica from a
1204 coastal ice core record. *Climate of the Past Discussions*, **8**, 215-262.
- 1205 Riebesell U, Schloss I, Smetacek V (1991) Aggregation of algae released from melting sea
1206 ice: implications for seeding and sedimentation. *Polar Biology*, **11**, 239-248.
- 1207 Riebesell U, Schulz KG, Bellerby RGJ *et al.* (2007) Enhanced biological carbon consumption
1208 in high CO₂ ocean. *Nature*, **450**, 545-548.

- 1209 Riebesell U, Tortell PD (2011) Effects of ocean acidification on pelagic organisms and
1210 ecosystems. In: *Ocean Acidification* (eds Gattuso J-P, Hansson L), pp. 99–116, Oxford
1211 University Press, Oxford.
- 1212 Robinson KV, Hosie GW, Pinkerton MH, Hall JA (2014) Continuous Plankton Recorder time
1213 series. New Zealand Aquatic Environment and Biodiversity Report No. 128, Ministry of
1214 Primary Industries, Wellington. 74 pp. ISBN 978-0-478-43226-8
- 1215 Rogers AD, Laffoley D (2013) Introduction to the special issue: The global state of the ocean;
1216 interactions between stresses, impacts and some potential solutions. Synthesis papers from
1217 the International Programme on the State of the Ocean 2011 and 2012 workshops. *Marine
1218 Pollution Bulletin*, **74**, 491-494.
- 1219 Roy, S, Mohovic B, Giancesella SMF, Schloss IR, Ferrario ME, Demers S (2006) Effects of
1220 enhanced UV-B on pigment-based phytoplankton biomass and composition of mesocosm-
1221 enclosed natural marine communities from three latitudes. *Photochemistry and
1222 Photobiology*, **82**, 909-922.
- 1223 Sachs O, Sauter EJ, Schlüter M, Rutgers van der Loeff MM, Jerosch K, Holby O (2009)
1224 Benthic organic carbon flux and oxygen penetration reflect different plankton provinces in
1225 the Southern Ocean. *Deep-Sea Research I*, **56**, 1319–1335.
- 1226 Sañé E, Isla E, Pruski AM, Bárcena MA, Vétion G, DeMaster DJ (2011a) Diatom valve
1227 distribution and sedimentary fatty acid composition in Larsen Bay, Eastern Antarctic
1228 Peninsula. *Continental Shelf Research*, **31**, 1161-1168.
- 1229 Sañé E, Isla E, Grémare A, Gutt J, Vétion G, DeMaster DJ (2011b) Pigments in sediments
1230 beneath a recently collapsed ice shelves: the case of Larsen A and B shelves, Antarctic
1231 Peninsula. *Journal of Sea Research*, **65**, 94–102.
- 1232 Sarmiento JL, Slater R, Barber R, Bopp L, Doney SC, Hirst AC, Kleypas J, Matear R,
1233 Mikkolajewicz U, Manfray P, Soldatov V, Spall SA, Stouffer R (2004) Response of ocean

- 1234 ecosystems to climate warming. *Global Biochemical Cycles*, **18**, GB3003,
1235 doi:10.1029/2003GB002134.
- 1236 Schloss IR, Abele D, Moreau S, Demers S, Bers AV, Gonzalez O, Ferreyra GA (2012)
1237 Response of phytoplankton dynamics to 19-year (1991-2009) climate trends in Potter Cove
1238 (Antarctica). *Journal of Marine Systems*, **92**, 53-66.
- 1239 Schloss IR, Wasilowska A, Dumont D *et al.* (2014) On the phytoplankton bloom in coastal
1240 waters of southern King George Island (Antarctica) in January 2010 : An exceptional
1241 feature? *Limnology and Oceanography*, **59**, 195-210.
- 1242 Schofield O, Ducklow HW, Martinson HW, Meredith MP, Moline MA, Fraser WR (2010)
1243 How do polar marine ecosystems respond to rapid climate change? *Science*, **328**, 1520-
1244 1523.
- 1245 Schwarz JN, Schodlok MP (2009) Impact of drifting icebergs on surface phytoplankton
1246 biomass in the Southern Ocean: Ocean colour remote sensing and *in situ* iceberg tracking.
1247 *Deep-Sea Research I*, **56**, 1727-1741.
- 1248 Seebacher F, Davison W, Lowe CJ, Franklin CE (2005) A falsification of the thermal
1249 specialization paradigm: compensation for elevated temperatures in Antarctic fishes.
1250 *Biology Letters*, **1**, 151-154.
- 1251 Seiler J, Gutt J (2007) Can dead sponges still talk? *Antarctic Science*, **19**, 337-338.
- 1252 Shevenell AE, Ingalls AE, Domack EW, Kelly C (2011) Holocene Southern Ocean surface
1253 temperature variability west of the Antarctic Peninsula. *Nature*, **470**, 250-254.
- 1254 Simmonds MP, Isaac SJ (2007) The impacts of climate change on marine mammals: early
1255 signs of significant problems. *Oryx*, **41**, 19-26.
- 1256 Sinclair KE, Bertler NAN, Bowen M, Arrigo K (in press) 20th Century sea ice trends in the
1257 Ross Sea from a high resolution, coastal ice core record. *Geophysical Research Letters*.
- 1258 Siniff DB, Garrott RA, Rotella YJ, Fraser WR, Ainley DG (2008) Projecting the effects of
1259 environmental change on Antarctic seals. *Antarctic Science*, **20**, 425-435.

- 1260 Smale DA, Barnes DKA (2008) Likely responses of the Antarctic benthos to climate-related
1261 changes in physical disturbance during the 21st century, based primarily on evidence from
1262 the West Antarctic Peninsula. *Ecography*, **31**, 289-305.
- 1263 Smith CR, DeMaster DJ, Thomas C, Sršen P, Grange L, Evrard V, DeLeo F (2012a) Pelagic-
1264 benthic coupling, food banks and climate change on the West Antarctic Peninsula shelf.
1265 *Oceanography Magazine*, **25**, 116-129.
- 1266 Smith CR, Grange L, Honig DL, Naudts L, Huber B, Guidi L, Domack E (2012b) A large
1267 population of king crabs in Palmer Deep on the West Antarctic Peninsula and
1268 potential invasive impacts. *Proceedings of the Royal Society B*, **279**, 1017-1026.
- 1269 Smith WO Jr, Sedwick, PN, Arrigo KR, Ainley DG, Orsi AH (2012) The Ross Sea in a sea of
1270 change. *Oceanography Magazine*, **25**, 90-103.
- 1271 Smith WO Jr, Comiso JC (2008) Influence of sea ice on primary production in the Southern
1272 Ocean: A satellite perspective. *Journal of Geophysical Research*, **113**, C05S93,
1273 doi:1029/2007JC004251.
- 1274 Sokolov S, Rintoul SR (2009a) Circumpolar structure and distribution of the Antarctic
1275 Circumpolar Current fronts: 1. Mean circumpolar paths. *Journal of Geophysical Research -*
1276 *Oceans*, **114**, doi:10.1029/2008JC005108.
- 1277 Sokolov S, Rintoul SR (2009b) Circumpolar structure and distribution of the Antarctic
1278 Circumpolar Current fronts: 2. Variability and relationship to sea surface height. *Journal of*
1279 *Geophysical Research - Oceans*, **114**, doi:10.1029/2008JC005248.
- 1280 Solomon S (1999) Stratospheric ozone depletion on Antarctic ozone. *Reviews of Geophysics*,
1281 **37**, 275-316.
- 1282 Spence P, Saenko OA, Dufour CO, Le Sommer J, England MH (2012) Mechanisms
1283 Maintaining Southern Ocean Meridional Heat Transport under Projected Wind Forcing.
1284 *Journal of Physical Oceanography*, **42**, 1923-1931.
- 1285 Spreen GL, Kaleschke, Heygster G (2008) Sea ice remote sensing using AMSR-E 89-GHz

- 1286 channels. *Journal of Geophysical Research*, **113**, C02S03, doi:10.1029/2005JC003384.
- 1287 Stammerjohn SE, Martinson DG, Smith RC, Yuan X, Rind D (2008) Trends in Antarctic
1288 annual sea ice retreat and advance and their relation to El Niño - Southern Oscillation and
1289 Southern Annular Mode variability. *Journal of Geophysical Research*, **113**, C03S90,
1290 doi:10.1029/2007JC004269.
- 1291 Steig EJ, Schneider DP, Rutherford SD, Mann ME, Comiso JC, Shindell DT (2009) Warming
1292 of the Antarctic ice-surface since the 1957 International Geophysical Year. *Nature*, **457**,
1293 459-462.
- 1294 Stuart KM, Long DG (2011) Tracking large tabular icebergs using the SeaWinds Ku-band
1295 microwave scatterometer. *Deep-Sea Research II*, **58**, 1285-1300.
- 1296 Sturm M, Massom RA (2010) Snow and sea ice. In: *Sea Ice* (eds Thomas DN, Dieckmann
1297 GS), pp. 153-204, Wiley-Blackwell Oxford, UK, 2nd edition.
- 1298 Thatje S, Hillenbrand C-D, Mackensen A, Larter R (2008) Life hung by a thread: endurance
1299 of Antarctic fauna in glacial periods. *Ecology*, **89**, 682-692.
- 1300 Thompson DWJ, Solomon S (2002) Interpretation of recent Southern Hemisphere climate
1301 change. *Science*, **296**, 895-899.
- 1302 Thompson DWJ, Solomon S, Kushner PJ, England MH, Grise KM, Karoly DJ (2011)
1303 Signatures of the Antarctic ozone hole in Southern Hemisphere surface climate change.
1304 *Nature Geoscience*, **4**, 741-749.
- 1305 Thornhill DJ, Mahon AR, Norenburg JL, Halanych KM (2008) Open-ocean barriers to
1306 dispersal: a test case with the Antarctic Polar Front and the ribbon worm *Parborlasia*
1307 *corrugatus* (Nemertea: Lineidae). *Molecular Ecology*, **17**, 5104-5117.
- 1308 Torstensson A, Hedblom M, Andersson J, Andersson MX, Wulff A (2013) Synergism
1309 between elevated pCO₂ and temperature on the Antarctic sea ice diatom *Nitzschia*
1310 *lecointei*. *Biogeosciences*, **10**, 6391-6401.
- 1311 Tortell PD, Payne CD, Li Y *et al.* (2008) CO₂ sensitivity of Southern Ocean phytoplankton.

- 1312 Geophysical Research Letters, **35**, L04605, doi:10.1029/2007GL032583.
- 1313 Tortell PD, Trimborn S, Li Y, Rost B, Payne CD (2009) Inorganic carbon utilization by Ross
1314 Sea phytoplankton across natural and experimental CO₂ gradients. *Journal of Phycology*,
1315 **46**, 433-443.
- 1316 Tournadre J, Girard-Arduin F, Legrésy B (2012) Antarctic icebergs distributions, 2002-
1317 2010. *Journal of Geophysical Research*, **117**, C05004, doi:10.1029/2011JC007441.
- 1318 Tournadre J, Accensi M, Girard-Arduin F (2013) The Altiberg iceberg database, Technical
1319 Report LOS 203-01, IFREMER, BP 70, 29280, Plouzané, FR.
1320 <ftp://ftp.ifremer.fr/ifremer/cersat/projects/altiberg/documentation/altibergreport.pdf>.
- 1321 Trathan PN, Ballard G (2013) Adélie Penguin (*Phygoscelis adeliniae*). In: *Penguins Natural*
1322 *History and Conservation* (eds García Borboroglu P, Boersma PD), pp. 37-57, University
1323 of Washington Press, Seattle U.S.A..
- 1324 Trela P, Sathyendranath S, Moore RM, Kelley DE (1995) Effect of the nonlinearity of the
1325 carbonate system on partial pressure of carbon dioxide in the oceans. *Journal of*
1326 *Geophysical Research*, **100**, 6829-6844, doi: 10.1029/94JC02573.
- 1327 Trenberth KE, Fasullo JT (2013) An apparent hiatus in global warming? *Earth's Future*, **1**, 19-
1328 32.
- 1329 Trevena AJ, Jones GB (2006) Dimethylsulphide and dimethylsulphoniopropionate in
1330 Antarctic sea ice and their release during ice melting. *Marine Chemistry*, **98**, 210-222.
- 1331 Trivelpiece WZ, Hinke JT, Miller AK, Reiss CS, Trivelpiece SG, Watters GM (2011)
1332 Variability in krill biomass links harvesting and climate warming to penguin population
1333 changes in Antarctica. *Proceedings of the National Academy of Sciences*, **108**, 7625-7628.
- 1334 Tynan CT, Ainley DG, Stirling I (2010) Sea ice: a critical habitat for polar marine mammals
1335 and birds. In: *Sea Ice* (eds Thomas DN, Dieckmann GS), pp. 395-423, Wiley-Blackwell
1336 Oxford, UK, 2nd edition.

- 1337 Turner J, Comiso JC, Marshall GJ *et al.* (2009a) Non-annular atmospheric circulation change
1338 induced by stratospheric ozone depletion and its role in the recent increase of Antarctic sea
1339 ice extent. *Geophysical Research Letters*, **36**, L08502, doi:10.1029/2009GL037524.
- 1340 Turner J, Bindshadler R, Convey P *et al.* (2009b) *Antarctic Climate Change and the*
1341 *Environment*. SCAR, Scott Polar Research Institute, Cambridge.
- 1342 Turner J, Barrand NE, Bracegirdle TJ *et al.* (2013a) Antarctic climate change and the
1343 environment: an update. *Polar Record*, **50**, 237-259.
- 1344 Turner J, Maksym T, Phillips T, Marshall GJ, Meredith MP (2013b) The impact of changes in
1345 sea ice advance on the large winter warming on the western Antarctic Peninsula.
1346 *International Journal of Climatology*, **33**, 852-861.
- 1347 Vaughan DG, Spouge JR (2002) Risk estimation of collapse of the West Antarctic ice sheet.
1348 *Climatic Change*, **52**, 65-91.
- 1349 Vaughan DG, Marshall GJ, Connolley WM *et al.* (2003) Recent rapid regional climate
1350 warming on the Antarctic Peninsula. *Climatic Change*, **60**, 243-274.
- 1351 Veit-Köhler G, Guilini K, Peeken I, Sachs O, Sauter EJ, Würzberg L (2011) Antarctic deep-
1352 sea meiofauna and bacteria react to the deposition of particulate organic matter after a
1353 phytoplankton bloom. *Deep-Sea Research II*, **58**, 1983-1995.
- 1354 Vernet M, Sines K, Chakos D, Cefarelli AO, Ekern L (2011) Impacts on phytoplankton
1355 dynamics by free-drifting icebergs in the NW Weddell Sea. *Deep-Sea Research II*, **58**,
1356 1422-1435.
- 1357 Vernet M, Smith KL Jr, Cefarelli AO *et al.* (2012) Islands of ice: influence of free-drifting
1358 Antarctic icebergs on pelagic marine ecosystems. *Oceanography*, **25**, 38-39.
- 1359 Viehoff T, Li A (1995) Iceberg observations and estimation of submarine ridges in the
1360 western Weddell Sea. *International Journal of Remote Sensing*, **16**, 3391-3408.

- 1361 Ward P, Whitehouse M, Brandon M, Shreeve R, Woodd-Walker R (2003) Mesozooplankton
1362 community structure across the Antarctic Circumpolar Current to the north of South
1363 Georgia: Southern Ocean. *Marine Biology*, **143**, 121-130.
- 1364 Watanabe Y, Bornemann H, Liebsch N, Plötz J, Sato K, Naito Y, Miyazaki N (2006) Seal-
1365 mounted cameras detect invertebrate fauna on the underside of an Antarctic ice shelf.
1366 *Marine Ecology Progress Series*, **309**, 297-300.
- 1367 Watson SA, Peck LS, Tyler PA, Southgate PC, Tan KS, Day RW, Morley SA (2012) Marine
1368 invertebrate skeleton size varies with latitude, temperature and carbonate saturation:
1369 implications for global change and ocean acidification. *Global Change Biology*, **18**, 3026–
1370 3038.
- 1371 Willmes S, Haas C, Nicolaus M, Bareiss J (2009) Satellite microwave observations of the
1372 interannual variability of snowmelt on sea ice in the Southern Ocean. *Journal of*
1373 *Geophysical Research-Oceans*, **114**, C03006, doi:10.1029/2008JC004919.
- 1374 Wittmann AC, Pörtner H-O (2013) Sensitivities of extent animal taxa to ocean acidification.
1375 *Nature Climate Change*, **3**, 995-1001.
- 1376 Xavier JC, Louzao M, Thorpe SE *et al.* (2013) Seasonal changes in the diet and feeding
1377 behaviour of a top predator indicate a flexible response to deteriorating oceanographic
1378 conditions. *Marine Biology*, **160**, 1597-1606.
- 1379 Zacher K, Wulff A, Milis M, Hanelt D, Wiencke C (2007) Ultraviolet radiation and consumer
1380 effects on a field-grown intertidal macroalgal assemblage in Antarctica. *Global Change*
1381 *Biology*, **13**, 1201-1215.
- 1382 Ziegler M, Diz P, Hall IR, Zahn R (2013) Millennial-scale changes in atmospheric CO₂ levels
1383 linked to the Southern Ocean carbon isotope gradient and dust flux. *Nature Geoscience*, **6**,
1384 457-461.
- 1385
1386

1387

1388

Figure legends

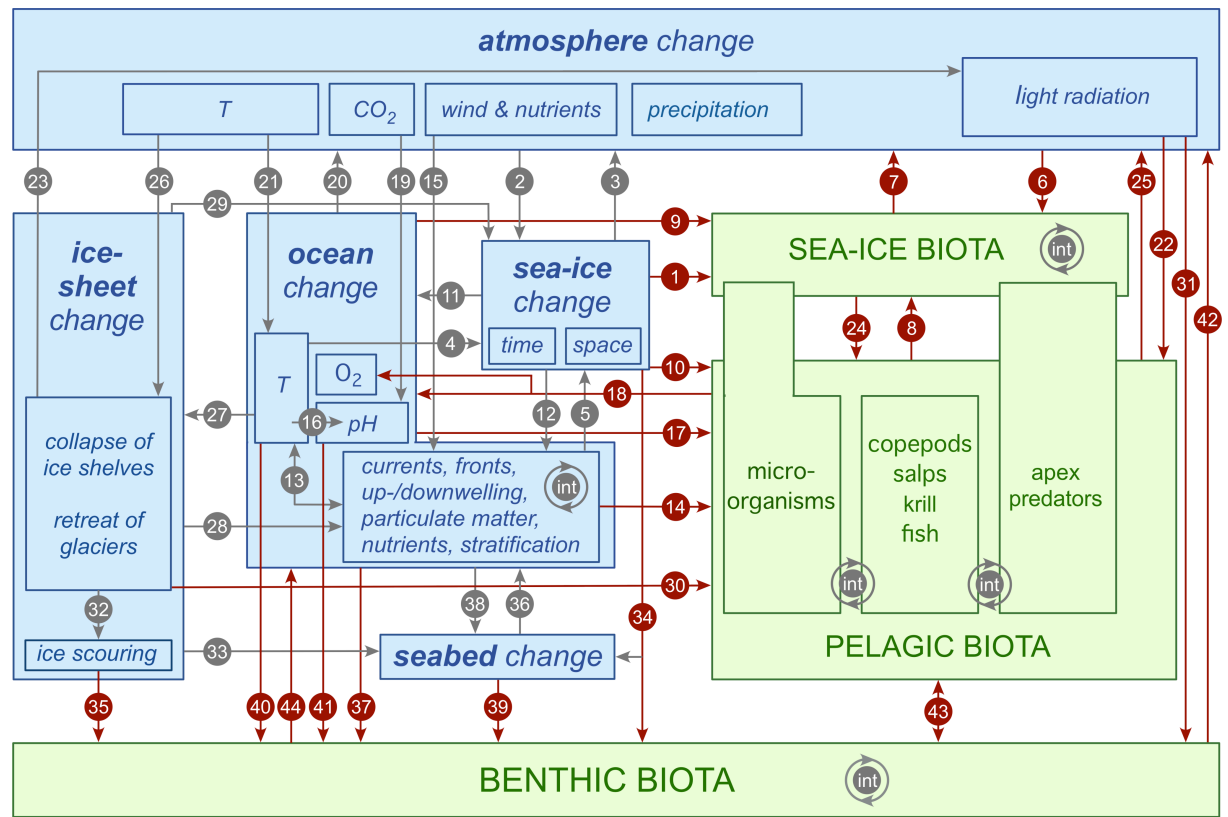
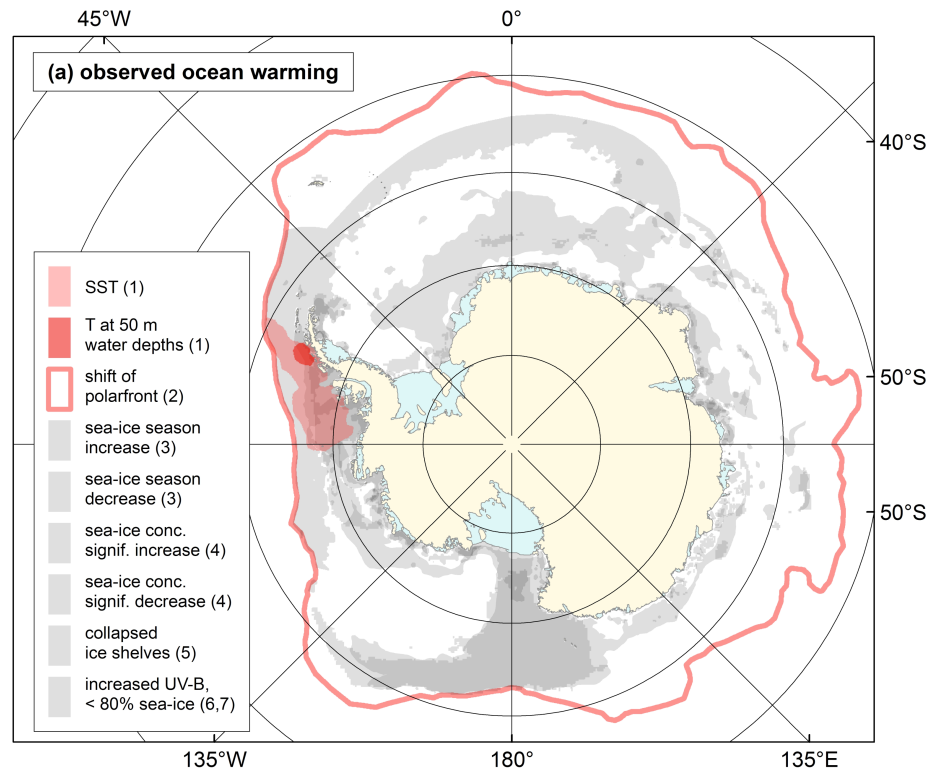
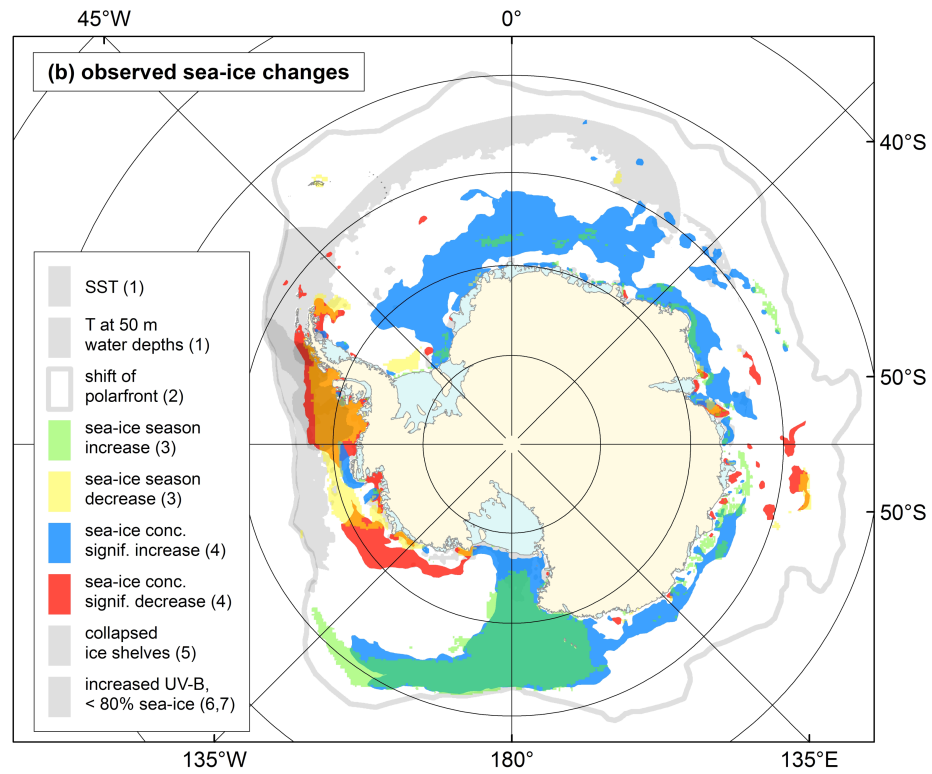
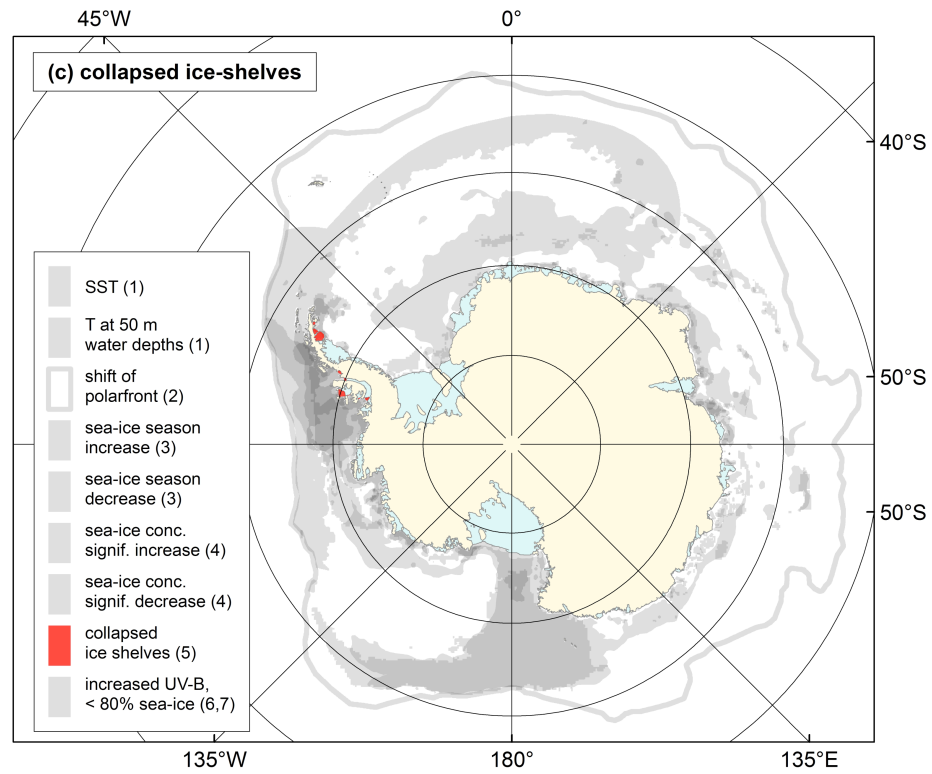

Fig. 1: Relationships between changes in the living and non-living nature of the SO, depicted in a condensed and simplified way. For description of individual links see S1. Arrows indicate directed impact. Interactions between biota and the environment are depicted in red. Links within







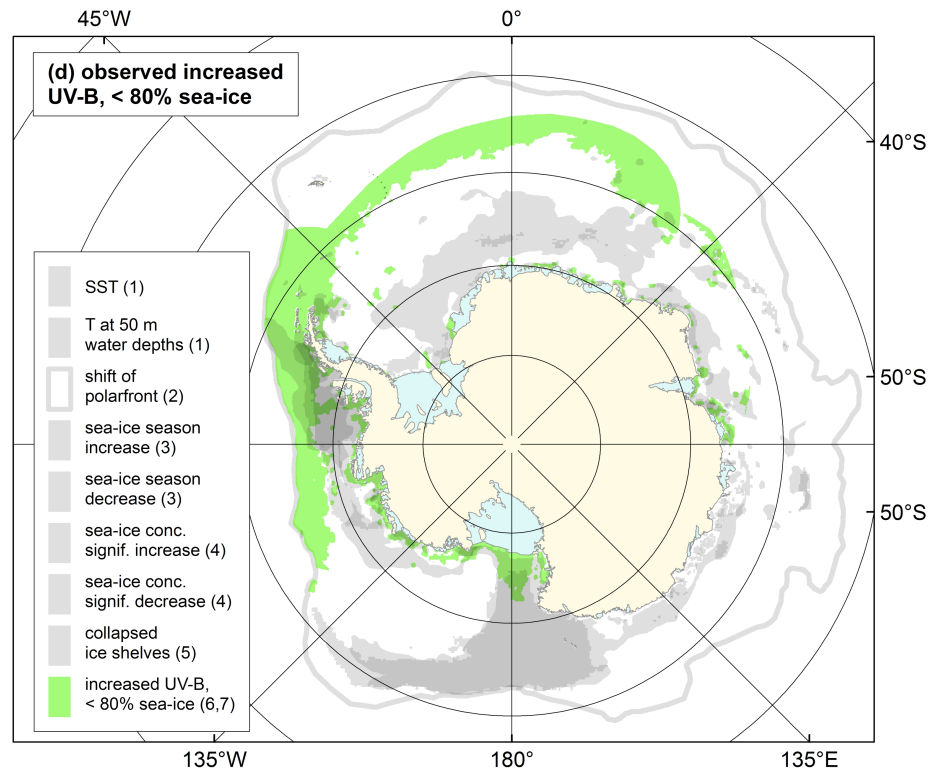
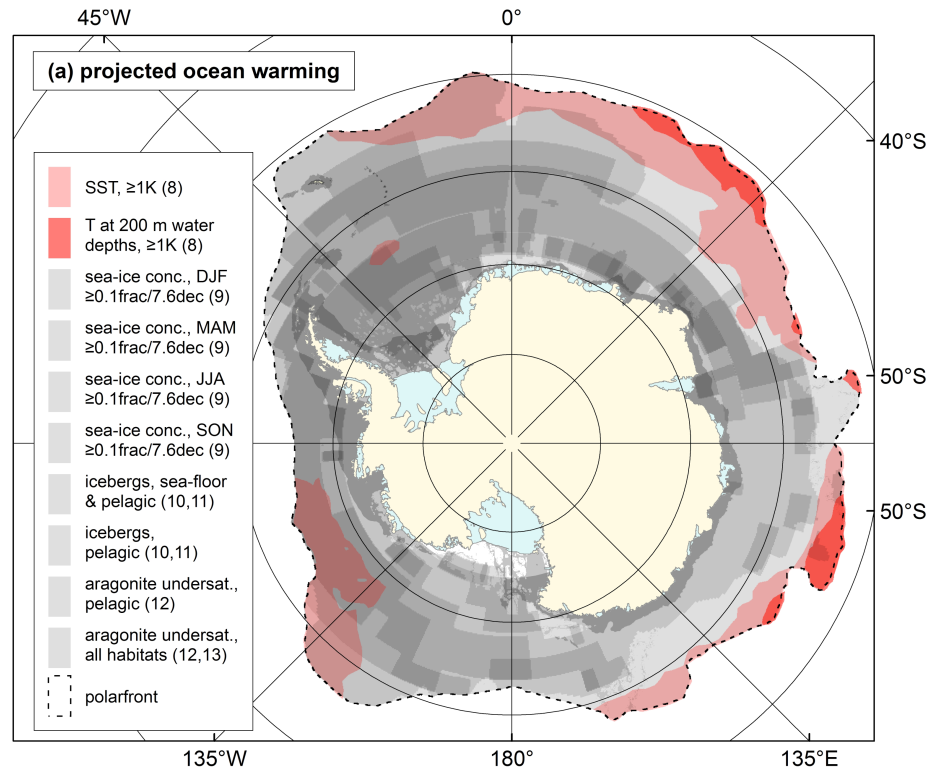
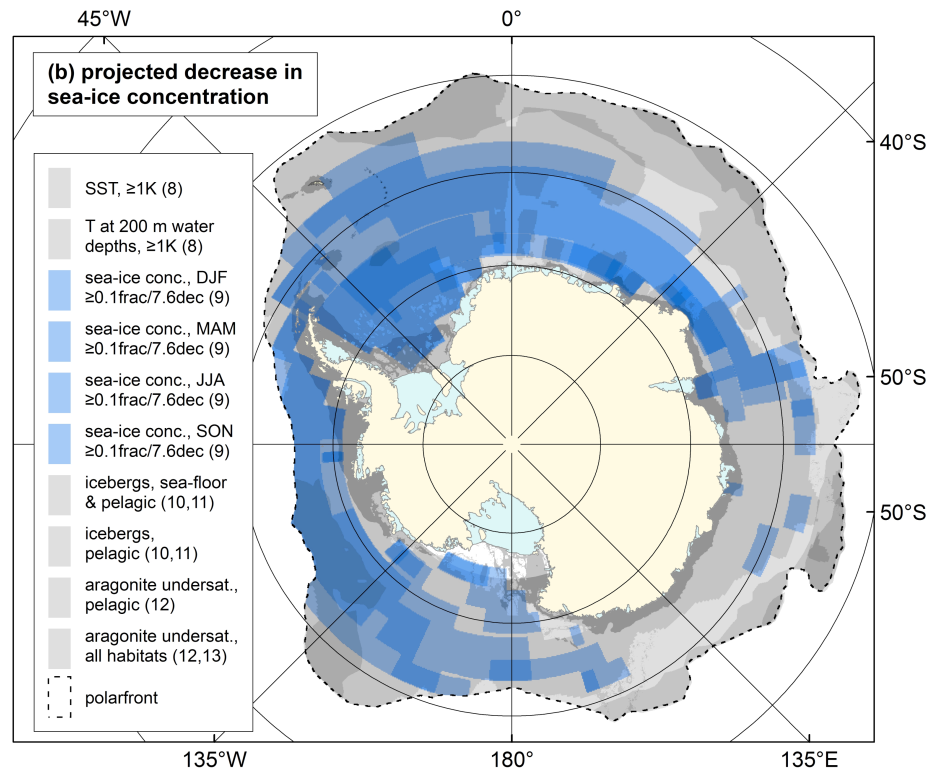
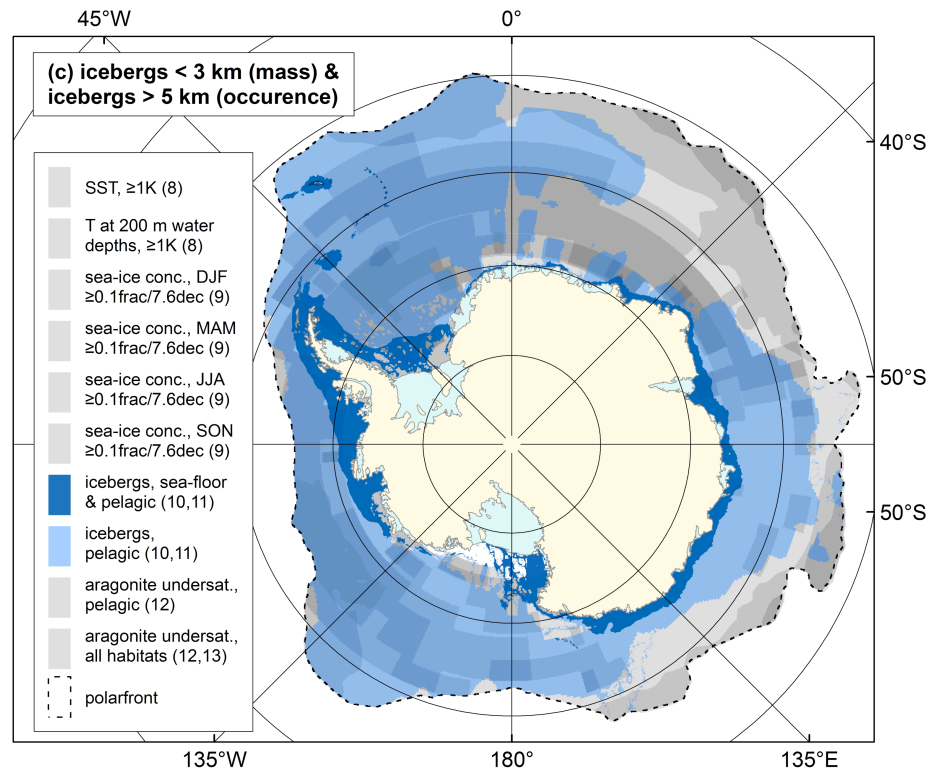

Fig. 2: Areas within the SO affected by observed climate change phenomena (in the past); for references comprising sources of information (coded in parentheses) see Table 1. a) Ocean warming, b) sea-ice changes, c) collapsed iceshelves, d) increased UV-B due to ozone depletion in open water (< 80% sea-ice cover). Specific changes are highlighted by colour; all others for comparison reasons depicted in grey. Polar stereographic projection.







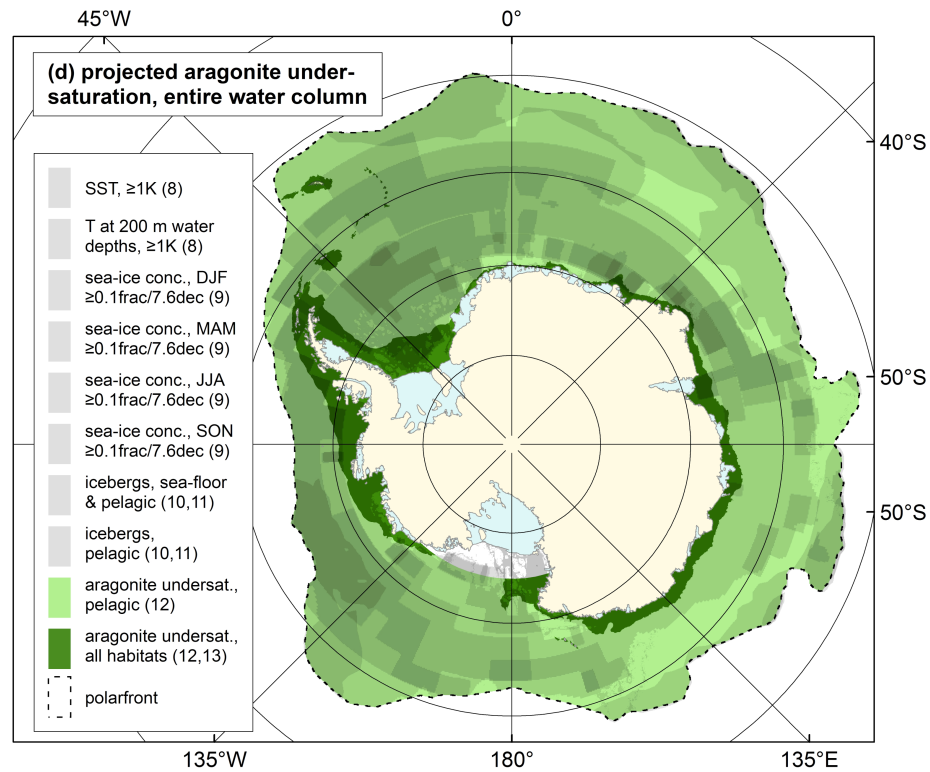

Fig. 3: Areas within the SO affected in the future by projected climate change phenomena (for the future) including iceberg occurrences; for references comprising sources of information (coded in parentheses) see Table 1. a) Ocean warming, b) decrease in sea-ice concentration, c) iceberg occurrences, d) aragonite undersaturation ("all habitats" refers to the impact to both habitats, pelagic and sea-floor. Specific changes are highlighted by colour, all others for comparison reasons depicted in grey. Polar stereographic projection.

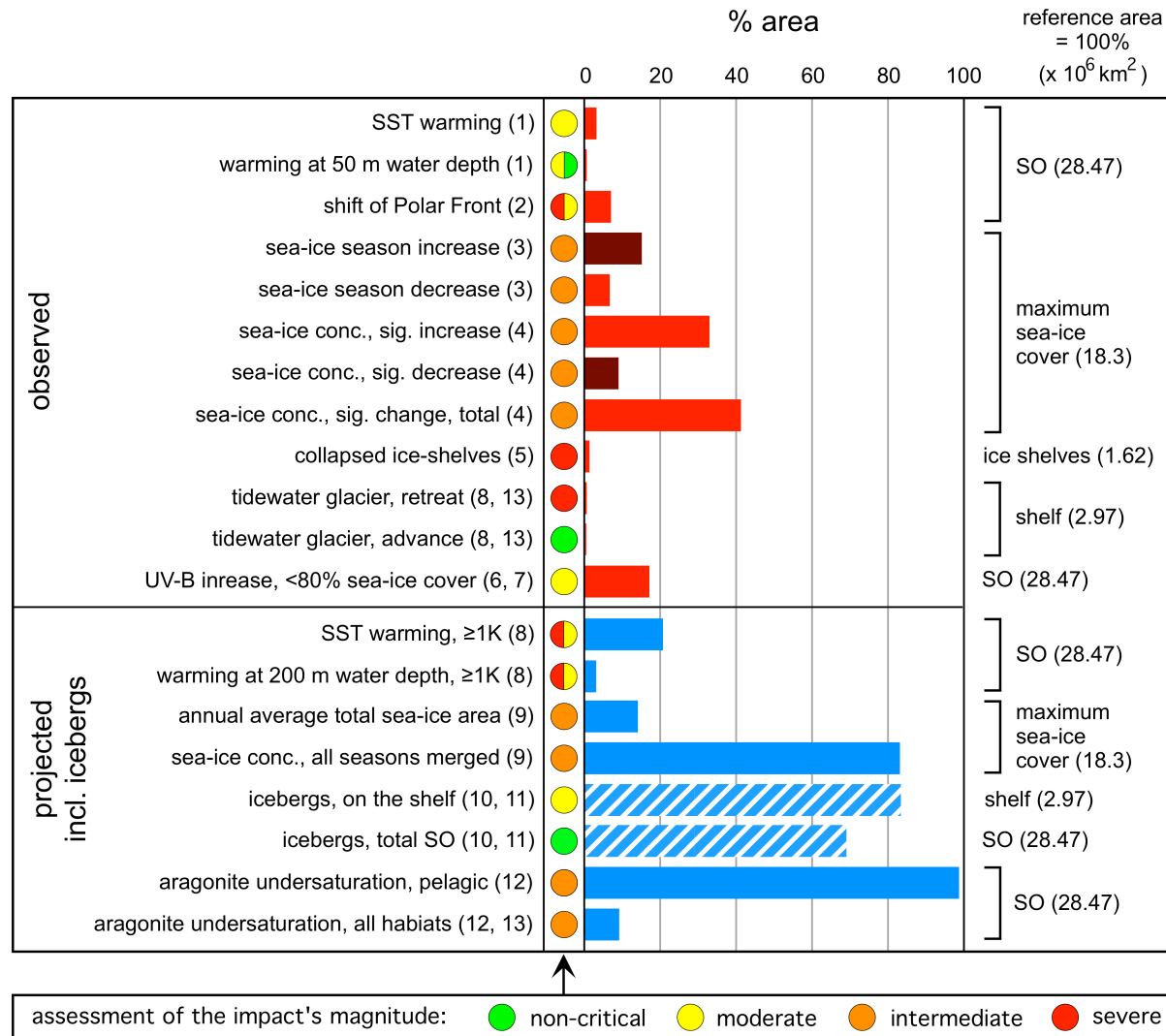
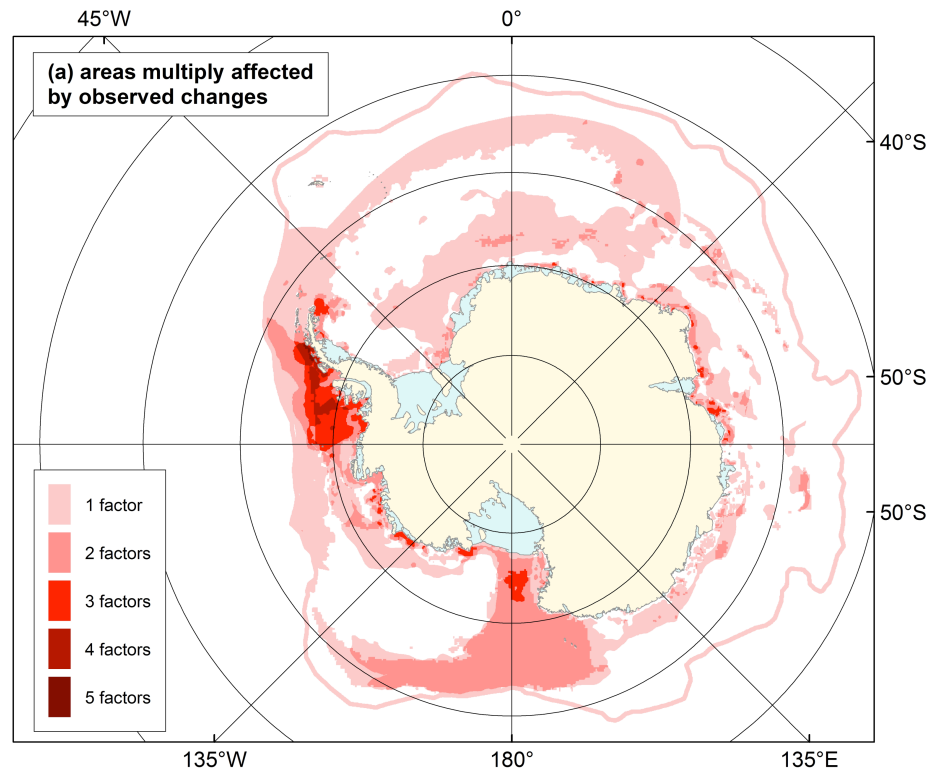

Fig. 4: Quantification of areas affected by observed (past) and projected (future) changes in the SO and qualitative assessment of the impact's magnitude. Observed changes in red, to more polar conditions in dark red; projected changes in blue, potentially affected areas by icebergs in hatched blue. For references comprising sources of information (coded in parentheses) see Table 1.



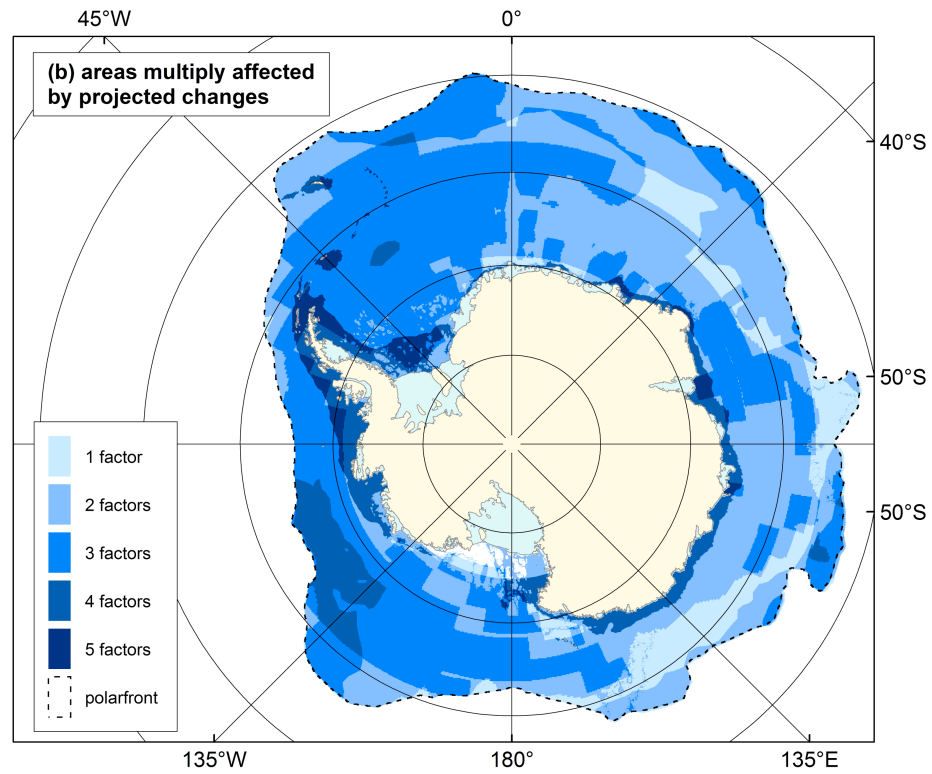

Fig. 5: Areas multiply affected by environmental changes. a) Observed (past) changes, b) projected (future) changes. Polar stereographic projection.

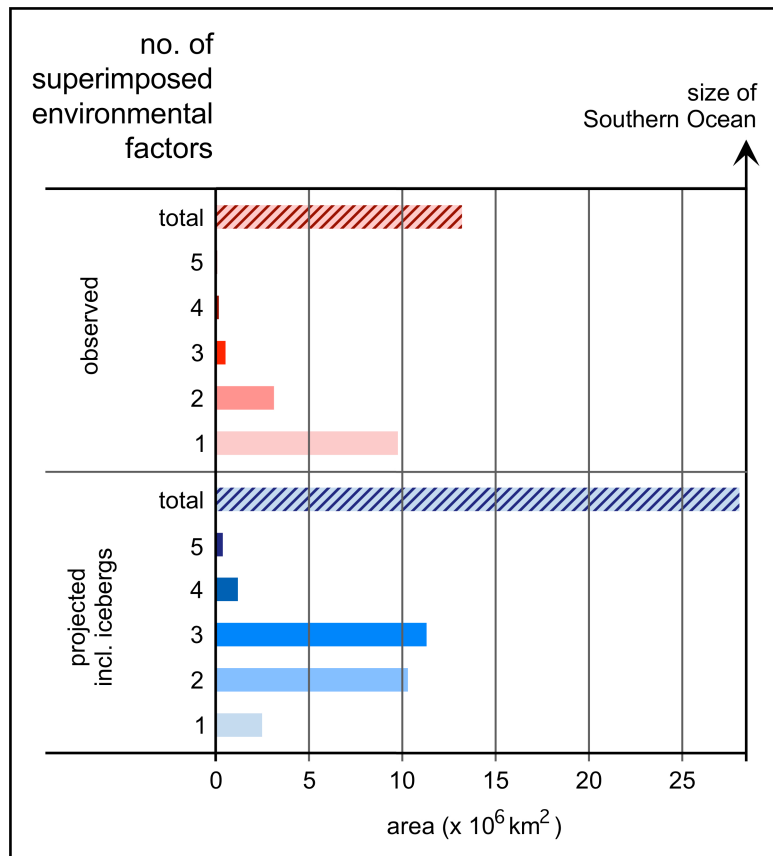

Fig. 6: Quantification of multiply affected areas by observed (past: red) and projected (future including icebergs: blue) environmental changes.

Table 1: Absolute and relative sizes of areas affected by various climate change phenomena. Results with a source code for references are also shown in Fig. 2, 3 and/or Fig. 4.

parameter	source	source code**	Fig	Δ area (10 ⁶ km ²)	Δ area (%)	100% (10 ⁶ km ²)
OBSERVED			2			
SST warming, 1955-1998	Meredith & King, 2005	1	2a	0.73	2.6	28.47 ^a
warming at 50m depth, 1955-1998	Meredith & King, 2005	1	2a	0.05	0.2	28.47 ^a
shift of Polar Front, 1992-2007	Sokolov & Rintoul, 2009b	2	2a	1.93	6.8	28.47 ^a
sea-ice season, 1979-1999, increase	Parkinson, 2002	3	2b	2.68	14.7	18.3 ^b
sea-ice season, 1979-1999, decrease	Parkinson, 2002	3	2b	1.15	6.3	18.3 ^b
sea-ice conc., winter (JJA), 1979-2012, sig. increase	Comiso, 2000			0.88	4.8	18.3 ^b
sea-ice conc., winter (JJA), 1979-2012, sig. decrease	Comiso, 2000			0.08	0.4	18.3 ^b
sea-ice conc., spring (SON), 1979-2012, sig. increase	Comiso, 2000			1.08	5.9	18.3 ^b
sea-ice conc., spring (SON), 1979-2012, sig. decrease	Comiso, 2000			0.06	0.3	18.3 ^b
sea-ice conc., summer (DJF), 1979-2012, sig. increase	Comiso, 2000			0.76	4.2	18.3 ^b
sea-ice conc., summer (DJF), 1979-2012, sig. decrease	Comiso, 2000			0.58	3.2	18.3 ^b
sea-ice conc., autumn (MAM), 1979-2012, sig. increase	Comiso, 2000			0.42	2.3	18.3 ^c
sea-ice conc., autumn (MAM), 1979-2012, sig. decrease	Comiso, 2000			0.35	1.9	18.3 ^b
sea-ice conc., annual mean, 1979-2012, sig. increase	Comiso, 2000			5.18	28.3	18.3 ^b
sea-ice conc., annual mean, 1979-2012, sig. decrease	Comiso, 2000			0.94	5.1	18.3 ^b
sea-ice conc., annual mean, 1979-2012, sig. in- & decrease	Comiso, 2000					18.3 ^b
sea-ice conc., seasons merged, 1979-2012, sig. increase	Comiso, 2000	4	2b	6.06	33.1	18.3 ^b
sea-ice conc., seasons merged, 1979-2012, sig. decrease	Comiso, 2000	4	2b	1.55	8.5	18.3 ^b
sea-ice conc., seasons merged, 1979-2012, sig. in- & decrease	Comiso, 2000	4	2b	7.61	41.6	18.3 ^b
collapsed ice-shelves, since 1960s	Davies <i>et al.</i> , 2012			0.028	1.7	1.62 ^c
	Barnes & Peck, 2008	5	2c			
UV-B increase, <80% sea-ice cover, 10-12 Oct 2009-2011	exp-studies.tor.ec.gc.ca/cgi-			5.82	20.4	28.47 ^a
UV-B increase, <80% sea-ice cover, 7-9 Nov 2009-1011	bin/selectMap &	6, 7	2d	3.92	13.8	28.47 ^a
UV-B increase, <80% sea-ice cover, 10-12 Nov 2009-2011	icdc.zmaw.de/seaiceconcentration_asi	6, 7	2d	4.53	15.9	28.47 ^a
UV-B increase, <80% sea-ice cover, 13-15 Nov 2009-2011	_ssmi.html	6, 7	2d	5.73	20.1	28.47 ^a

UV-B increase, <80% sea-ice cover, 10-12 Dec 2009-2011				1.14	4.0	28.47 ^a
tidewater glacier, retreat	Turner <i>et al.</i> , 2009b; Cook <i>et al.</i> , 2005	8, 13		0.00127	0.004	2.97 ^e
tidewater marine glacier, advance	Turner <i>et al.</i> , 2009b; Cook <i>et al.</i> , 2005	8, 13		≥ 0	4	2.97 ^e
					≥ 0	
PROJECTED (incl. iceberg occurrences*)			3			
SST warming, 2000-2100, summer, ≥1K	Turner <i>et al.</i> , 2009b			3.26	11.5	28.47 ^a
SST warming, 2000-2100, winter, ≥1K	Turner <i>et al.</i> , 2009b			4.35	15.9	28.47 ^a
SST warming, 2000-2100, all year, ≥1K	Turner <i>et al.</i> , 2009b	8	3b	5.87	20.6	28.47 ^a
warming at 200m depth, 2000-2100, summer, ≥1K	Turner <i>et al.</i> , 2009b			0.50	1.8	28.47 ^a
warming at 200m depth, 2000-2100, winter, ≥1K	Turner <i>et al.</i> , 2009b			0.64	2.3	28.47 ^a
warming at 200m depth, 2000-2100, all year, ≥1K	Turner <i>et al.</i> , 2009b	8	3b	0.78	2.7	28.47 ^a
sea-ice conc., summer (DJF), ≥0.1 frac/7.6dec	Bracegirdle <i>et al.</i> , 2008	9	3b	2.43	13.3	18.3 ^b
sea-ice conc., autumn (MAM), ≥0.1 frac/7.6dec	Bracegirdle <i>et al.</i> , 2008	9	3b	3.99	21.8	18.3 ^b
sea-ice conc., winter (JJA), ≥ 0.1frac/7.6dec	Bracegirdle <i>et al.</i> , 2008	9	3b	10.34	56.5	18.3 ^b
sea-ice conc., spring (SON), ≥ 0.1frac/7.6dec	Bracegirdle <i>et al.</i> , 2008	9	3b	8.86	48.4	18.3 ^b
sea-ice conc., all seasons merged, ≥0.1 frac/7.6dec	Bracegirdle <i>et al.</i> , 2008	9	3b	15.14	82.7	18.3 ^b
annual average total sea-ice area, 2004/23 - 2080/99	Bracegirdle <i>et al.</i> , 2008	9		2.6	33	7.9 ^d
icebergs <3km: 1992-2012, >1Gt per 1° (lat) x 2° (long), total SO, in combination with tracked icebergs >5km	Tournadre <i>et al.</i> , 2013 with Stuart & Long, 2011	10, 11	3c	19.91*	69.9*	28.47 ^a
icebergs <3km: 1992-2012, >1Gt per 1° (lat) x 2° (long), on the shelf, in combination with tracked icebergs >5km	Tournadre <i>et al.</i> , 2013 with Stuart & Long, 2011	10, 11	3c	1.82*	61.3*	2.97 ^e
icebergs <3km: 1992-2012, area covered by icebergs <3km	Tournadre, this paper			0.025*	0.1*	28.47 ^a
icebergs <3km: 1992-2012, area covered by icebergs <3km plus 2km radius around	Tournadre, this paper			0.31*	1.1*	28.47 ^a
icebergs (all): iceberg area plus 2km radius around	Orheim, 1985; own assumptions			0.49*	1.7*	28.47 ^a
sea-bed area affected by iceberg scouring	Gutt & Starmans, 2001			1.31*	44.1*	2.97 ^e
aragonite undersaturation, pelagic	Orr <i>et al.</i> , 2005	12	3d	28.04	98.5	28.47 ^a
aragonite undersaturation, all habitats (sea-floor & pelagic)	Orr <i>et al.</i> , 2005; Hauck <i>et al.</i> , 2010	12, 13	3d	2.59	9.1	28.47

^a entire SO

^b sea-ice extent during the beginning of the melt period; in September (Comiso, 2010)

^c ice shelf area 2002 (Clarke & Johnston 2003)

^d average yearly sea-ice concentration (Bracegirdle et al. 2008)

^e shelf area not beneath ice shelves (Clarke & Johnston, 2003)

* area potentially affected

** for cross-reference to figs 2-4.

Supporting information legend

S1: Brief description of individual links between changes in the living and non-living nature of the Southern Ocean depicted in Fig. 1.

Interactions between changing environment and the sea-ice habitat

The sea-ice biota is composed of a variety of small organisms, prokaryotes, protozoans, unicellular algae, and metazoans living inside the ice in brine channels; most if not all of them also occur in the open water (Deming, 2010). In addition, a number of apex predators stay for significantly important periods of their life on the ice, e.g. for resting, mating, birthing, and lactation and thus, also belong to the ice-associated community. Other macro- and microorganisms live in the ice covered open water at the subsurface of the sea-ice being closely or occasionally linked to it (Moline *et al.*, 2008). Life in the sea-ice is mainly shaped by sea-ice physics and biogeochemistry (1), which are driven by the atmosphere especially air temperature and wind (2). Numbers in parentheses refer to relationships in Fig. 1. The latter causes considerable divergent and convergent ice motion (Haas, 2010) with reverse feedback effects to the atmosphere, especially in terms of temperature and radiation, due to the high albedo and insulation quality of the ice (3). Also the ocean, especially its temperature, shapes physical processes in the sea-ice (4). Changes in the fauna and flora as well as nutrients in the ice are initially based on corresponding changes in the underlying water (5, 1). In addition, the ice quality especially resulting from differences in the formation processes and, consequently, in its thickness and age can be of high relevance for life in the ice (Meiners *et al.*, 2012). Independently of climate-induced changes, seasonal variations happen in most biological, physical and chemical variables (Ackley & Sullivan, 1994). Only micro- and macroorganisms living at the ice surface are directly exposed to the atmosphere. At ecological time scales

changes in this exposition can happen if the cloud regime changes, in case of a shift in precipitation (e.g. from snow to rain), accumulation of iron from the atmosphere, in case of wind driven flooding, and when photosynthetically active radiation (PAR) changes (6) or when melting happens and melting ponds develop as a consequence of atmospheric warming (Willmes *et al.*, 2009), which is rare in the Antarctic compared to the Arctic (Drinkwater & Xiang, 2000). For the significance of the snow cover on sea-ice for ecological processes see Sturm & Massom (2010). Ice organisms, like those in the open water and on the sea-bed, consume and produce CO₂ as well as O₂ and the secondary metabolite dimethylsulphonioacetate (DMSP), the precursor of the sulphurous gas dimethylsulfide (DMS). DMS is assumed to stimulate cloud formation and causing a cooling of the atmosphere (Trevena & Jones, 2006; Delille *et al.*, 2007) and can also act as an important feedback system in the climate system. In essence, these algae respond to atmospheric changes, contribute to two of the perhaps most important ecosystem services, CO₂ uptake and O₂ production, and shape the climate system (7) (Charlson *et al.*, 1987). During the period of ice formation the complete inventory of species living later in the ice are potentially trapped from the open water (8) and with their specific development of their populations their species composition changes whilst nutrients decrease (Eicken, 1992; Arrigo *et al.*, 2010). Organisms living temporarily in or rather permanently linked to the habitat at the subsurface of the ice and in the platelet ice below the fast ice are potentially exposed to changes at the ocean-ice interface, especially referring to melting processes (9). This can affect algae, some fish species, copepods, krill (Bluhm *et al.*, 2010) and apex predators (Tynan *et al.*, 2010). Sea-ice distribution and dynamics are assumed to have impacts directly and indirectly through food-web changes on colony viability and breeding success of penguins (1,10) and some sea-birds (Jenouvrier *et al.*, 2005). Emperor penguin populations suffer in the slightly cooling East Antarctic (Jenouvrier *et al.*, 2009, Barber-Meyer *et al.*, 2008, Barbraud *et al.*, 2011), whilst Adélie penguins increased in this region with more intensive marginal sea-ice (Trathan &

Ballard 2013). The ice-preferring Adélie penguins, however, decreased in the west of the Antarctic Peninsula due to changes in chlorophyll-a and krill biomass, those of chinstrap penguins due to unknown reasons (Lynch et al., 2012), whilst small populations of open-water preferring gentoo penguins increased in approximately the same area due to the loss of sea-ice. Also ice-dependent seals are expected to be negatively affected by the decrease in sea-ice through a reduction of the (breeding-) habitat, crabeater and Weddell more, Ross and leopard seal less. Southern elephant and fur seals will respond in ways opposite to the pack ice species, but, as all seals, could also be influenced by changes in shifts in their forage basis (1,10) (Siniff *et al.*, 2008).

Interactions with the pelagic

Spatial and temporal changes in the sea-ice also shape physical processes in the ocean (11), e.g. heat and CO₂ exchange since it isolates (or shields?) the ocean from the atmosphere (3). During sea-ice formation the water column is destabilised by thermohaline convection (12, 13) and dense deep water is formed providing O₂ to the sea-floor on the shelf and in the deep-sea. In reverse, melting and also precipitation can cause a stratification of the upper water layer (12) being essentially important for the development of the phytoplankton bloom (14) (Arrigo *et al.*, 1999). Upwelling of warmer nutrient and carbon rich deepwater are wind-driven (15) and relate to the ozone depletion (Lenton *et al.*, 2013) or results from thermohaline convection (13) (Dinniman *et al.*, 2012). Temperature and pH closely interact with each other (16) and also with pressure, but only the first two of these parameters are climate-sensible.

The open water is the habitat of pelagic organisms ranging from drifting microorganisms (plankton) that contribute considerably to carbon, nutrient and energy cycles, to large gelatinous zooplankton and to mobile animals mostly representing higher trophic levels of

which the great whales are the largest. They all are directly exposed to any changes in the ocean, especially in temperature, CO₂, and, as a consequence pH (17), which also shapes the food sources of the pelagic organisms, including sea-birds (Schofield *et al.*, 2010; Xavier *et al.*, 2013, Jenouvrier *et al.*, 2005). Ocean hydrodynamics also has an effect by acting as the transport vector for food, nutrients, drifting adult organisms (plankton) or developmental stages, e.g. eggs and larvae (14). For the high relevance of advection processes on krill, maybe as an example for many planktonic organisms see Hofmann & Murphy (2004). In case of elevated CO₂ concentrations phytoplankton assemblages are expected to potentially change their composition and increase population growth and, thus inducing feed-back processes on climate (Tortell *et al.*, 2008; 2009). Also interactions with the ozone hole (Tortell *et al.*, 2009) had been shown and with the availability of the micronutrient Fe in a long-term incubation experiment (Hoppe *et al.*, 2013). The ocean contributes to pH-related processes particularly biological CO₂ uptake through assimilation, especially by plants and respiration by animals life (18). Occasionally overseen in the context of climate change and its impact on the biosphere is an essential ecosystem service for most of the life on Earth, that is the production of O₂ by algae. This might increase in the SO due to upwelling processes (Arrigo *et al.*, 2008) and increased strength of stratification (14) (Sarmiento *et al.*, 2004). The ocean and sea-ice also physically interact with the atmosphere, notably through temperature and gas exchange, wind energy, fresh water (e.g. precipitation) and photosynthetically active radiation (PAR) transmission (2, 3, 15, 19, 20, 21).

As in all pelagic systems one of the most important drivers of life in the Southern Ocean (SO) is PAR. Changes in this variable can be expected only if changes in the protection shield happens, i.e. the ozone layer and cloud cover (22). The ice acts as a polar-specific shield at the interface between atmosphere and ocean (2, 1, 23).

In addition, elevated concentration of mineral particles in surface waters must be expected due to deglaciation and due to shifts in precipitation on land causing reduced light availability with consequences for primary production (14) (Schloss *et al.*, 2014) and further through the food chain from krill up to whales (Grange & Smith, 2013). This can only happen where a true coast and a non-glaciated land-interior exists. The second main driver of primary production are nutrients. They can enter the ocean from the surface (15) (Ziegler *et al.*, 2013), be advectively transported or upwelled from the deep to shallower water layers (14). Especially for the SO, micronutrients seem to be of high relevance in addition to macronutrients (Blain *et al.*, 2007; Boyd *et al.*, 2012; Quéguiner, 2013). The main polar-specific and climate-driven factors of the pelagic system are the sea-ice dynamics (10) (Smith & Comiso, 2008), as well as the generally low ocean temperature (17).

Life in the open water can be seeded when sea-ice melts (Kuosa *et al.*, 1992) since some ice-algae contribute to the spring bloom of primary production (24) (Isla *et al.*, 2009) although this need not be necessary (Riebesell *et al.*, 1991). As organisms in the ice, like those in the open water, consume and produce CO₂ as well as O₂ and indirectly the climate gas DMS, thus, they do not only respond to atmospheric changes but contribute to a global atmospheric gas and energy budget (25).

Unique in the Antarctic are the large ice-shelves; their main ecological impact is that they block sun light and, thus, primary production in the water below them (23). Just like the sea-ice they are exposed to warming of the atmosphere (26) and the ocean (27), leading to regional collapse events, east and west of the Antarctic Peninsula (Vaughan & Spouge, 2002; Brachfeld *et al.*, 2003; Domack *et al.*, 2005b; Joughin & Alley, 2011). Both icebergs and cliffs shape current patterns and other small-scale hydrodynamic processes especially in the interplay with tides. Subsequently, they shape primary production in their surroundings by

changing the nutrient regime (28) (e.g. Schwarz & Schodlok, 2009; Vernet *et al.*, 2011; for review see Vernet *et al.*, 2012), which also happen in combination with the wind-driven sea-ice "behaviour" (29, 1) (Arrigo *et al.*, 2002; Arrigo & van Dijken, 2003). These local processes change considerably in case of icebergs calving from the ice-shelf or glacier and their grounding on the shelf, as well as in case of larger disintegration events providing new space for primary production (23, 6, 22) (Cape *et al.*, 2014). This also provide a new habitat for additional pelagic species (30). Ice shelf basal melting can also affect sea-ice expansion (29, Bintanja *et al.*, 2013)

Increased UV radiation as a consequence of ozone hole formation in early spring affects directly all shallow water habitats (6, 22, 31).

Interactions with the benthic habitat

When ice shelves and floating glaciers tongues disintegrate major changes in the water column happen (28) (Nicholls *et al.*, 2009). PAR starts to penetrate into the ocean (23) and supports primary production (Peck *et al.*, 2009b; Cape *et al.*, 2014) with important consequences for the benthic life. A strong increase in the growth of populations initially of pioneer species, later of a larger variety of species can be expected (Gutt *et al.*, 2011, 2013). Deep-sea species assumed to belong to the ice-covered oligotrophic situation are assumed to suffer in the long run.

When ice-shelves collapse, icebergs are produced, drift in the circumpolar current and occasionally run aground or scour the sea-bed (32). This happens mostly down to 250 m but in rare cases also to a maximum of 600 m, where the icebergs shape the intermediate- and small-scale bottom topography (33) (Viehoff & Li, 1995; Harris & O'Brien, 1996).

Depressions of up to 25 m depth are formed, elevations thrown up, sediments mixed and

resorted and nutrients released as well as organic matter resuspended (28). In shallow water similar effects are caused by the sea-ice, especially where ice is ridged or anchor ice is formed (34) (Dayton *et al.*, 1970). The main ecological impact is the devastation of the sea-floor inhabiting fauna (35), in rare cases living organisms can be dislocated (Dayton, 1989; Seiler & Gutt, 2007). Subsequently, the scoured areas provide a pristine substratum for new benthic colonisation. The resulting patterns of different co-existing successional stages are known to have an increased diversity compared to relatively stable and mature communities (Gutt & Piepenburg, 2003). Model-based simulations of the benthic succession after iceberg disturbance on the shelf show that only a strong increase in disturbance would lead to a decreased diversity (Johst *et al.*, 2006). Following the Intermediate-Disturbance-Hypothesis (Connell, 1978), a decrease in disturbance magnitude would lead to a reduced benthic biodiversity because populations of pioneer organisms, which benefit from the lack of competition in the devastated areas, would suffer. The actual disturbance intensity is that 1 m² is devastated once in 340 years (Gutt, 2001). In addition, a changing bottom-near current regime resulting from an increased complexity of the sea-bed morphology due to iceberg scouring (33, 36) might support a more patchy distribution of organisms (37). The new sorting of sediment has potentially also an effect (38, 39), however, in the Antarctic this might not be severe since benthic communities seem to be only weakly related to specific grain sizes (Gutt, 2000; Cummings *et al.*, 2006). All components of the benthos, the micro-, meio- and macrofauna as well as micro- and macroalgae are also potentially exposed to changes in the bottom-near waters at any depths, especially warming (40), acidification (41) and support of food and nutrients (37). The pace of acclimatisation also seems to play an important role (Peck *et al.*, 2014). Maybe an adaptation to acidification otherwise considered as harmful to calcifying organisms is possible (Cohen *et al.*, 2009). The flora and fauna respond especially to changes in the light regime (31), eventually even with a substantial regime shift (Clark *et al.*, 2013), in addition, like microalgae, they shape the chemical composition of the

atmosphere (42) especially by CO₂ uptake and production of DMSP. Since benthic animals do not only depend directly on phytodetritus but also on faecal pellets, dead or living zooplankton and large carcasses, the benthos is also closely linked to the secondary production in the pelagic (43). Small changes in temperature can change the behaviour of water masses (Fahrbach *et al.*, 2011; Purkey & Johnson, 2011). It can for example reduce the ventilation of the deep-sea with oxygen- and nutrient-rich water (Orsi *et al.*, 1995; Primeau *et al.*, 2013), which could cause significant indirect impact to the deep-sea fauna. At a world-wide scale the loss of the great whales is considered to affect biological processes at the sea-floor especially with respect to biodiversity (Jelmert & Oppen-Bernsten, 1996). In the Antarctic, major changes must be expected in case of a shift in the pelagic from a krill to a salp or copepod dominated system with changing quality and quantity of them as food supply for higher trophic levels and their faecal pellets sinking to the sea-bed. In general similar effects can be expected in case of a shift from larger to smaller plankton organisms (Moline *et al.*, 2004). As a consequence of whaling, also in the Antarctic an important reduction of whale faeces and carcasses reaching the sea-floor may have happened. Increased turbidity in the water following deglaciation on land might damage vitally important feeding process of epibenthic filter feeders (Gutt *et al.*, 2011). The benthos including all fractions, of micro-, meio- and macrofauna contributed significantly to remineralisation (44).