



Malik, N. A., Amjal, T., Sant, P. and Ur Rehman, M. (2020) A Tri-Band Implantable Antenna for Biotelemetry Applications. In: 5th International Conference on UK-China Emerging Technologies (UCET), Glasgow, UK, 20-21 August 2020, ISBN 9781728194882 (doi:[10.1109/UCET51115.2020.9205362](https://doi.org/10.1109/UCET51115.2020.9205362)).

This is the author's final accepted version.

There may be differences between this version and the published version. You are advised to consult the publisher's version if you wish to cite from it.

<http://eprints.gla.ac.uk/223278>

Deposited on: 08 October 2020

Enlighten – Research publications by members of the University of Glasgow
<http://eprints.gla.ac.uk>

A Tri-band Implantable Antenna for Biotelemetry Applications

Nabeel Ahmed Malik

Department of Computer Science and
Technology, University of Bedfordshire
Luton, UK
nabeel.malik@study.beds.ac.uk

Paul Sant

Department of Computer Science and
Technology, University of Bedfordshire
Luton, UK
paul.sant@beds.ac.uk

Tahmina Ajmal

Department of Computer Science and
Technology, University of Bedfordshire
Luton, UK
tahmina.ajmal@beds.ac.uk

Masood Ur-Rehman

James Watt School of Engineering
University of Glasgow
Glasgow, UK
masood.urrehman@glasgow.ac.uk

Abstract—In this paper we propose a compact size rectangular implantable tri-band patch antenna for biotelemetry applications. Rogers RT6010 is used as substrate and superstrate material. The resonant frequency is further lowered by using a shorting pin which also reduces patch resistance. For excitation 50-ohm microstrip line is used. The antenna operates in MICS band (402-405) MHz, ISM band (902-928) MHz and (2.4-2.48) GHz at 402 MHz, 915 MHz and 2.4 GHz. The gain of the antenna is 2.05 dBi, 2.67 dBi and 5.39 dBi with bandwidth of 120 MHz, 166 MHz and 190 MHz at relevant frequencies when simulated in a fat layer box. SAR values are within allowable limits. The simulated results show that the antenna is an excellent choice for implantable applications as it can be used for data transmission, wakeup signal and wireless power transfer by using three frequency bands.

Index Terms—Biotelemetry, Patch Antenna, Implantable sensors, Wireless power transfer

I. INTRODUCTION

With recent developments in technology and wireless communication, biotelemetry has gained a lot of attention and has become a major part of our everyday life [1]–[3]. Implantable medical devices and sensors are used in biotelemetry. They are capable of monitoring patient psychological signals in real time which saves a lot of time and money that was previously spent on such facilities in hospitals [4]–[7]. There are a number of such devices including: blood sugar level monitoring, cardiac pacemakers, defibrillators, retinal implants and capsule endoscopy etc. [8]–[14]. All these devices and sensors rely on an antenna for communication with external device to receive and transmit data. So, any issues with overall antenna performance would have a direct impact on system efficiency. At higher frequencies the signal distortion rate increases so the operating frequency of the implantable antenna should be as low as possible. The size of the antenna is also important, but if we decrease the size the resonant frequency will increase to a higher value, so careful consid-

eration needs to be given to these matters. As the antenna has to operate inside the human body, the safety of human body tissue is a big challenge as well. The battery life of implantable devices should be as long as possible so that surgery is not needed very frequently to replace the batteries. On the other hand, wireless power transfer techniques can be used to power the implantable sensors by introducing an extra frequency band for the implantable antenna. More generally the selection of antenna for biotelemetry is a challenging task. According to the literature, several antennas have been proposed for implantable applications. A wideband circularly polarized implantable patch antenna for ISM band medical application was proposed in [15]. A 0.635 mm layer of Rogers RO6010 ($\epsilon_r = 10.2$; $\tan \delta = 0.0023$) is used as substrate and superstrate material. The overall volume of the antenna is 122 mm^3 and it operates at 2.4 GHz. The antenna is simulated in skin layer. Slots are etched in the patch and two shorting pins are used to adjust the resonant frequency. The bandwidth of the antenna is 21%, having a peak gain of -33 dBi. The gain of the antenna is low compared to its relatively large size and higher resonant frequency.

Li Rongqiang, *et al.* presented a compact broadband antenna with dual-resonance for implantable devices in [16]. Rogers 6010 ($\epsilon_r = 10.2$; $\tan \delta = 0.0023$) is used as substrate material with thickness of 0.635 mm. A shorting pin is used to lower the antenna frequency. The size of the antenna is $23 \times 16.4 \times 1.27 \text{ mm}^3$. The antenna shows a peak gain of -34.9 dBi with a bandwidth of 52 MHz at 0.402 MHz when simulated in a skin layer phantom model. The bandwidth of the antenna is quite narrow. A flexible implantable antenna on PMDS substrate is proposed in [17]. The antenna is simulated in a three-layer phantom model. The overall size of the antenna is 242 mm^3 . The bandwidth of the antenna is 500 MHz with a peak gain of -20.8 dBi. A miniaturized implantable Planar inverted F antenna is proposed in [18]. The antenna is designed on a 0.75

mm thick layer of alumina which is also used as superstrate with a thickness of 0.5 mm. A shorting pin is used to lower the antenna frequency. The overall volume of the antenna is 125 mm^3 . The antenna has a bandwidth of 180 MHz with a gain of -4.5 dB at 2.45 GHz. The antenna operating frequency could be lowered when compared to the antennas large size. Shang *et al.* proposed an implantable dual band planar inverted F antenna in [19]. The antenna substrate and superstrate material is Rogers 3010 with a thickness of 0.5. The overall dimensions of the antenna are $9 \times 11 \times 0.5 \text{ mm}^3$. At 402 MHz and 2.4 GHz the peak gain of the antenna is 38.8 dBi and 18.6 dBi whereas the bandwidth is 152 MHz and 170 MHz at relevant frequencies. In this paper we propose an implantable antenna which operates on three frequencies and has small size, high gain and low specific absorption rate (SAR). This paper is structured as follows: Section I details the importance of implantable devices, implantable antennas and recent research on implantable antennas. In section II the design of proposed antenna is given. Section III explains the results and analysis and conclusions are drawn in last section.

II. IMPLANTABLE ANTENNA DESIGN

The antenna patch and ground plane are shown in Fig. 1 (a) and (b). The antenna is designed on a 0.25 mm thick layer of Rogers RT6010 ($\epsilon_r = 10.2$; $\tan \delta = 0.0023$) substrate. The superstrate layer is also used for human body tissue safety and to lower the operating frequency. The superstrate layer material and thickness is same as the substrate. Copper cladding is used for the antenna ground plane and patch material. The antenna is excited by a 50-ohm microstrip line. Overall dimensions of antenna are $6 \times 5 \times 0.5 \text{ mm}^3$. The perspective view of the antenna is shown in Fig. 2(a). Slots are etched onto the patch to elongate the current path which makes physically small antenna an electrically large antenna. The insertion of slots

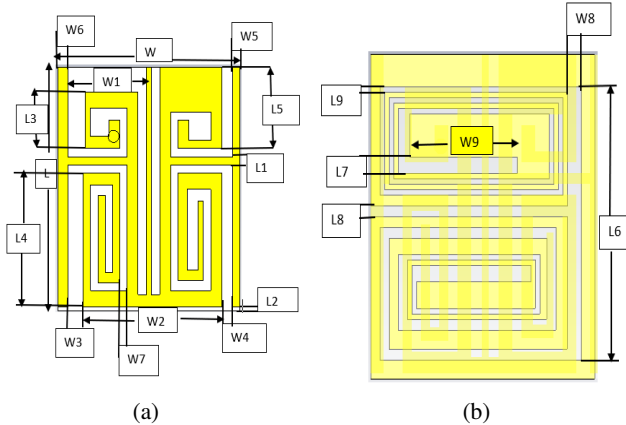

Fig. 1: (a)Antenna patch (b) Antenna ground plane

in the patch introduces more electrical resistance which is reduced by a shorting pin $P(x = -0.97; y = 1.5)$. The shorting pin also helps to lower the operating frequency. Slots are also introduced in the ground plane to adjust the resonant frequency and to achieve the wider bandwidth. Simulation of the antenna

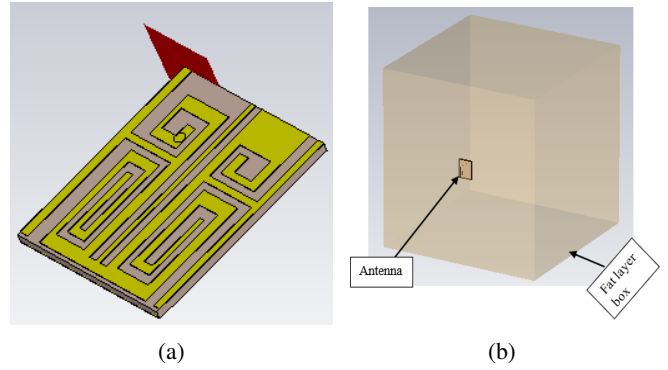

Fig. 2: (a)Antenna perspective view (b) Antenna in fat box

was performed using CST Microwave Studio software. The simulated antenna design is placed inside a $(60 \times 60 \times 60) \text{ mm}^3$ fat layer box to analyze the antenna performance as shown in Fig. 2(b). The antenna detail dimensions are presented in Table I.

TABLE I: Antenna dimensions

Parameter	Unit(mm)	Parameter	Unit(mm)	Parameter	Unit(mm)
L	6	L7	0.3	W4	0.3
L1	0.2	L8	0.2	W5	0.2
L2	0.1	L9	0.9	W6	0.275
L3	1.4	W	5	W7	0.2
L4	2.9	W1	2.151	W8	0.3
L5	2	W2	3.8	W9	2.95
L6	5.05	W3	0.425		

III. RESULTS AND DISCUSSION

The antenna was first simulated in free space and then in a fat layer model. The simulation results are listed below.

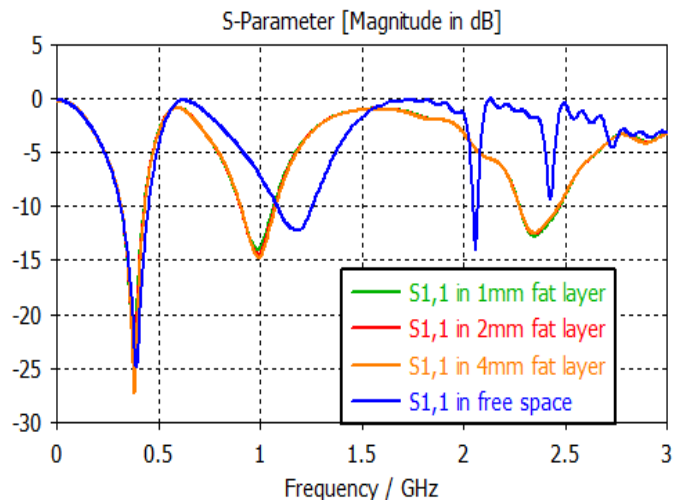

Fig. 3: Antenna return loss plot

A. Return loss (S1,1)

The return loss (S1,1) of an antenna is a measure of antenna transmitted power and reflected back power. The lower the value of S1,1, the lower the reflected back power and the higher the transmitted power. The standard for an antenna to resonate on a specific frequency is that the value of S1,1 should be less than or equal to -10 dB ($S_{1,1} \leq -10$). The return loss of the antenna in free space and in 1mm, 2mm and 4mm fat layer versions is shown in Fig. 3. It can be seen in the Fig. 3 that the antenna is resonating on three frequencies which are 402 MHz, 915 MHz and 2.4 GHz when placed inside the fat layer. The -10 dB bandwidth of the antenna is 120, 166 and 190 MHz at resonant frequencies.

B. Antenna Radiation Pattern and Gain

The radiation pattern of the antenna gets deformed when placed inside a lossy medium like human body tissues. There are a number of parameters which affect the antenna radiation pattern such as power absorption, reflection and refraction from tissue boundaries, antenna bending and antenna positioning inside the body. The 3D radiation pattern of the antenna at 0.402, 0.915 and 2.4 GHz is shown in Fig. 4 (a), (b) and (c) whereas the E-plane and H-plane radiation pattern of the antenna at resonant frequencies is shown in Fig. 5 (a) and (b) when antenna is placed inside fat layer.

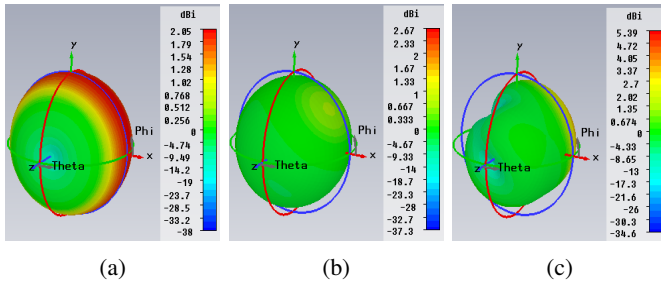

Fig. 4: Antenna 3D radiation pattern (a) at 402 MHz (b) at 915 MHz (c) at 2.4 GHz

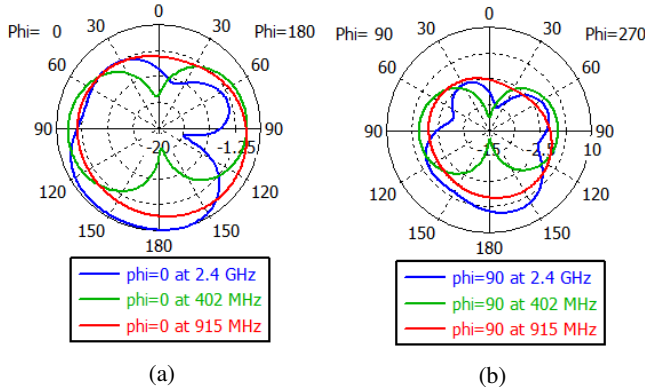

Fig. 5: (a)E-plane radiation pattern of the antenna (b) H-plane radiation pattern of the antenna

It can be seen in Fig. 4 and 5 that the antenna has a omnidirectional radiation pattern which is required in medical implants. The gain of the antenna at 402 MHz is 2.05 dBi, 2.67 dBi at 915 MHz and 5.39 dBi at 2.4 GHz when antenna is simulated in fat layer box.

C. Antenna Current Distribution

The current distribution of the antenna at 402 MHz, 915 MHz and 2.4 GHz is shown in Fig. 6 (a), (b) and (c). The current is more at lower half of the patch at 402 MHz while at 915 MHz the current is more in the patch middle section. The current is more in the left lower part of the patch at 2.4 GHz. If the current path is altered at maximum current position it will effect the resonant frequency by shifting it to a higher or lower value.

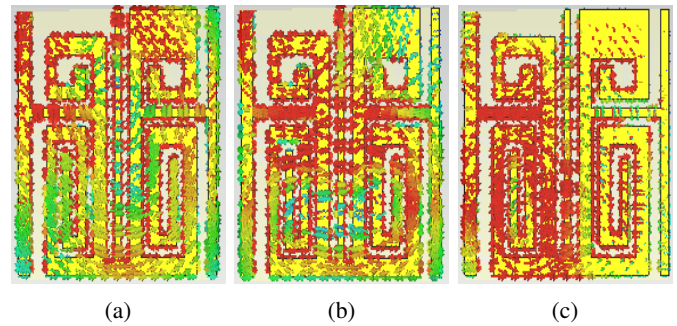

Fig. 6: Antenna current distribution (a) at 402 MHz (b) at 915 MHz (c) at 2.4 GHz

D. Specific Absorption Rate (SAR)

The electromagnetic radiations from the antenna could harm human body tissue. So, the SAR should be within allowed limits. There are two standards that are used for SAR. According to IEEE C95.1-1999 standard the SAR should be less than 1.6 W/kg averaged over 1g cubic volume of tissue and according to IEEE C95.1-2005 standard the SAR should be less than 2 W/kg averaged over 10g cubic volume of the tissue [20]. We have calculated 1g avg. SAR using CST Microwave Studio when input power is 0.5W which is shown in Fig. 7 (a), (b) and (c). The value of SAR at 0.402, 0.915 and 2.4

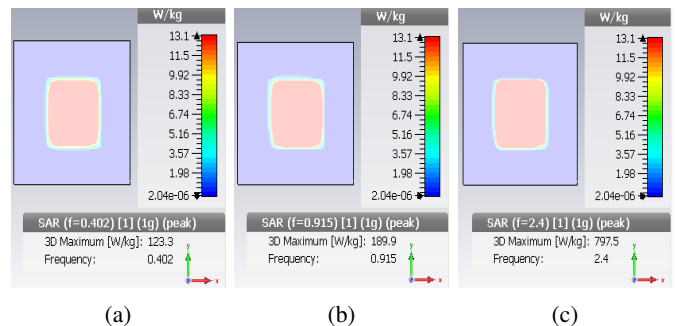

Fig. 7: Antenna 1g avg. SAR (a) at 402 MHz (b) at 915 MHz (c) at 2.4 GHz

TABLE II: Proposed Antenna Comparison with Previous Work

Reference	Size(mm ³)	Frequency(GHz)	Gain(dBi)	Bandwidth (MHz)	Shorting pin used	SAR 1g avg. (W/Kg)
[15]	9.8×9.8×1.27	2.4	-33	540	YES	486
[16]	23×16.4×1.27	0.402	-34.9	52	YES	284.5
[17]	11×11×2	2.4	-20.8	500	NO	356.4
[18]	10×10×1.25	2.45	-4.5	180	YES	113.5
[19]	9×11×0.5	0.402; 2.4	-38.8; -18.6	152; 170	YES	719; 746
Proposed work	6×5×0.5	0.402; 0.915; 2.4	2.05; 2.67; 5.39	120; 166; 190	YES	123.3; 189.9; 797.5

GHz is 123.3 W/kg, 189.9 W/kg and 797.5 W/kg which seems higher than the maximum allowed limits. To meet the SAR requirements the maximum allowed input power at resonant frequencies should be less than 12.9, 8.4 and 2 mW [21]. So, the SAR values for this antenna are within allowed limits. The comparison of proposed antenna with previous work is given in Table II.

IV. CONCLUSION

We have presented a compact size tri-band implantable antenna operating at 402 MHz, 915 MHz and 2.4 GHz for biotelemetry applications. Slots are etched in the patch and ground plane to adjust the operating frequency. Further frequency adjustment and patch resistance reduction was achieved by inserting a shorting pin between the patch and ground plane. The antenna performance was analyzed using a fat layer model. The antenna gives a peak gain of 2.05 dBi, 2.67 dBi and 5.39 dBi with SAR values within permissible limits. The antenna can be used for data transmission, wakeup signal and wireless power transfer by using its three frequency bands. The comparison Table II shows that this antenna is the best choice to be used in implantable medical devices.

REFERENCES

- [1] Q. H. Abbasi, K. Qaraqe, A. Alomainy, and M. U. Rehman, *Advances in body-centric wireless communication: Applications and state-of-the-art*. The Institution of Engineering and Technology, 2016.
- [2] M. Ur-Rehman, M. Adekanye, and H. T. Chattha, "Tri-band millimetre-wave antenna for body-centric networks," *Nano communication networks*, vol. 18, pp. 72–81, 2018.
- [3] S. A. K. Tanoli, M. Rehman, M. B. Khan, I. Jadoon, F. Ali Khan, F. Nawaz, S. A. Shah, X. Yang, and A. A. Nasir, "An experimental channel capacity analysis of cooperative networks using universal software radio peripheral (usrp)," *Sustainability*, vol. 10, no. 6, p. 1983, 2018.
- [4] M. Ur-Rehman, N. A. Malik, X. Yang, Q. H. Abbasi, Z. Zhang, and N. Zhao, "A low profile antenna for millimeter-wave body-centric applications," *IEEE Transactions on Antennas and Propagation*, vol. 65, no. 12, pp. 6329–6337, 2017.
- [5] M. Ur-Rehman, Q. H. Abbasi, A. Rahman, I. Khan, H. T. Chattha, and M. A. Matin, "Millimetre-wave antennas and systems for the future 5g," 2017.
- [6] L. Liu, S. A. Shah, G. Zhao, and X. Yang, "Respiration symptoms monitoring in body area networks," *Applied Sciences*, vol. 8, no. 4, p. 568, 2018.
- [7] B. Dong, A. Ren, S. A. Shah, F. Hu, N. Zhao, X. Yang, D. Haider, Z. Zhang, W. Zhao, and Q. H. Abbasi, "Monitoring of atopic dermatitis using leaky coaxial cable," *Healthcare Technology Letters*, vol. 4, no. 6, pp. 244–248, 2017.
- [8] T. Buchegger, G. Oßberger, A. Reizenzahn, E. Hochmair, A. Stelzer, and A. Springer, "Ultra-wideband transceivers for cochlear implants," *EURASIP Journal on Advances in Signal Processing*, vol. 2005, no. 18, p. 647310, 2005.
- [9] K. Gosalia, G. Lazzi, and M. Humayun, "Investigation of a microwave data telemetry link for a retinal prosthesis," *IEEE Transactions on Microwave Theory and Techniques*, vol. 52, no. 8, pp. 1925–1933, 2004.
- [10] M. C. Shults, R. K. Rhodes, S. J. Updike, B. J. Gilligan, and W. N. Reining, "A telemetry-instrumentation system for monitoring multiple subcutaneously implanted glucose sensors," *IEEE Transactions on Biomedical Engineering*, vol. 41, no. 10, pp. 937–942, 1994.
- [11] D. Wessels, "Implantable pacemakers and defibrillators: device overview & emi considerations," in *2002 IEEE International Symposium on Electromagnetic Compatibility*, vol. 2. IEEE, 2002, pp. 911–915.
- [12] K. Guillory and R. Normann, "A 100-channel system for real time detection and storage of extracellular spike waveforms," *Journal of neuroscience methods*, vol. 91, no. 1-2, pp. 21–29, 1999.
- [13] F. Merli, "Implantable antennas for biomedical applications," EPFL, Tech. Rep., 2011.
- [14] W. G. Scanlon, N. E. Evans, and Z. M. McCreesh, "Rf performance of a 418-mhz radio telemeter packaged for human vaginal placement," *IEEE transactions on biomedical engineering*, vol. 44, no. 5, pp. 427–430, 1997.
- [15] Z. Xia, H. Li, Z. Lee, S. Xiao, W. Shao, X. Ding *et al.*, "A wideband circularly polarized implantable patch antenna for ism band biomedical applications," *IEEE Transactions on Antennas and Propagation*, vol. 68, no. 3, pp. 2399–2404, 2019.
- [16] R. Li, B. Li, G. Du, X. Sun, and H. Sun, "A compact broadband antenna with dual-resonance for implantable devices," *Micromachines*, vol. 10, no. 1, p. 59, 2019.
- [17] Y. Fu, J. Lei, X. Zou, and J. Guo, "Flexible antenna design on pdms substrate for implantable bioelectronics applications," *Electrophoresis*, vol. 40, no. 8, pp. 1186–1194, 2019.
- [18] Q.-H. Wu, X.-W. Xuan, W. Wang, K. Li, and H.-B. Zhao, "A miniaturized implantable planar inverted-f antenna for biotelemetry applications at 2.45 ghz industrial, scientific, and medical band," *Microwave and Optical Technology Letters*, vol. 62, no. 1, pp. 391–396, 2020.
- [19] J. Shang, Y. Yu, and L.-J. Xu, "Compact dual-band implantable planar inverted-f antenna with bandwidth enhancement," *Microwave and Optical Technology Letters*, vol. 62, no. 1, pp. 322–328, 2020.
- [20] Y. Liu, Y. Chen, H. Lin, and F. H. Juwono, "A novel differentially fed compact dual-band implantable antenna for biotelemetry applications," *IEEE Antennas and Wireless Propagation Letters*, vol. 15, pp. 1791–1794, 2016.
- [21] I. A. Shah, M. Zada, and H. Yoo, "Design and analysis of a compact-sized multiband spiral-shaped implantable antenna for scalp implantable and leadless pacemaker systems," *IEEE Transactions on Antennas and Propagation*, vol. 67, no. 6, pp. 4230–4234, 2019.