

## Literature Survey of SAR Algorithm in Photovoltaic System

Nithin T Abraham, K Vinoth Kumar, Vicky Jose, Dona Maria Mathew\*, S Suresh Kumar\*\*

\* Department of Electrical and Electronics Engineering, School of Electrical Sciences, Karunya University, Coimbatore – 641114, Tamilnadu, India

\*\*Department of ECE, Dr. NGP. Institute of Technology, Coimbatore – 641048, Tamilnadu, India

### Article Info

#### Article history:

Received Sep 29, 2013

Revised Dec 2, 2013

Accepted Jan 4, 2014

#### Keyword:

Energy harvesting  
Maximum power point tracking  
Photovoltaic (PV)  
Wireless Sensor Networks

### ABSTRACT

Every solar energy harvester systems have got two sources of energy loss: the MPPT circuit and the dc–dc converter. To increase the efficiency of the PV energy harvester, the energy losses from the MPPT circuit and the dc–dc converter need to be minimized. Here a new MPPT algorithm called successive approximation register is introduced. This MPPT algorithm has got a power down mode and a fast tracking time, to achieve low power consumption and energy savings. With this MPPT algorithm energy losses from the MPPT circuit can be minimized and this technique can be greatly applicable to low power application systems mainly as well as for high power application.

Copyright © 2014 Institute of Advanced Engineering and Science.  
All rights reserved.

### Corresponding Author:

Nithin T Abraham  
Department of Electrical and Electronics Engineering,  
School of Electrical Sciences,  
Karunya University,  
Coimbatore 641114, Tamilnadu, India.  
Email: nithinthamaravelil@gmail.com

## 1. INTRODUCTION

Photovoltaic cells convert solar irradiation directly into electrical energy. They have been widely utilized as energy harvesters in applications like autonomous systems, power plant systems and low power systems such as wireless sensor networks (WSNs). But there are many challenges to harvest energy with PV cells [1]. The main problem is that the PV cells suffer from a low efficiency of approximately 10–40%. Furthermore, the maximum output power from a PV cell changes under changing atmospheric conditions [2]. So in order to maximize the efficiency of the PV energy harvester, a maximum power point tracking (MPPT) technique, which enables the operating point of the PV cells to track the maximum power point, is introduced in PV energy harvesters [3].

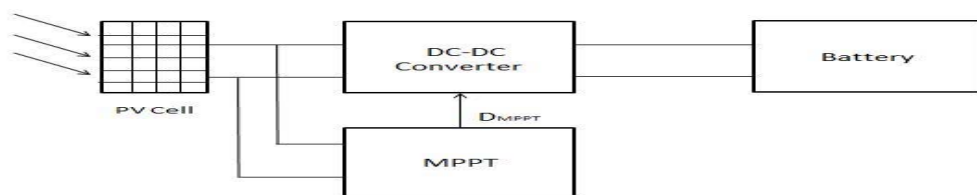

Figure 1. Block diagram of PV energy harvester system

The block diagram of the PV energy harvester is shown in Figure 1. It has got a PV cell, a dc–dc converter, energy storage, and MPPT circuit. Taking into consideration the difference between the previous and current operating points of the PV cell, the MPPT circuit selects its next operating point so as to maximize output power of the PV cell. According to the duty control bits *DMPPT* from the MPPT circuit, the dc–dc converter changes the operating point of the PV cell and it delivers the maximized energy from the PV cell to the energy storage device. The MPPT circuit thus enables the PV energy harvester to deliver the maximum energy under various atmospheric conditions.

PV energy harvester has got two sources of energy loss: the MPPT circuit and the dc–dc converter. So in order to increase the efficiency of the PV energy harvester, it is very necessary to reduce the energy losses from the MPPT circuit and the dc–dc converter. In high-power applications such as solar power plant systems, the MPPT circuit, consumes less than 2% of the generated energy from the PV cell [4]-[8]. This won't be a big problem in large power application but in case of low-power applications such as wireless sensor networks, because the range of the PV cell output is from a few hundred microwatts to a few milliwatts, the energy loss in the MPPT circuit is very much responsible for a significantly larger portion of the generated energy from the PV cell. Therefore, the minimization of energy consumption in the MPPT circuit is the most significant challenge in low-power energy harvesting applications. So in order to solve this problem a new algorithm called successive approximation register is introduced and a power down mode is proposed. The proposed algorithm is an advanced version of hill climbing algorithm with a fast tracking time.

## 2. PROPOSED PV ENERGY HARVESTER

### 2.1. Solar Cell Modelling

PV Cell is modelled using MATLAB and the P-V and V-I characteristics are found out. It is modelled according to the PV Cell equations and it could be seen from Figure 2. Figure 3 shows the P-V and V-I characteristics of the PV Cell. The I-V (current-voltage) curve of a PV string (or module) describes its energy conversion capability at the existing conditions of irradiance (light level) and temperature. Conceptually, the curve represents the combinations of current and voltage at which the string could be operated or 'loaded', if the irradiance and cell temperature could be held constant. The value of a measured I-V curve is greatly increased when it can be compared with the curve predicted by a comprehensive PV model. Models take into account the specifications of the PV modules, the number of modules in series and strings in parallel, and the losses in system wiring [9].

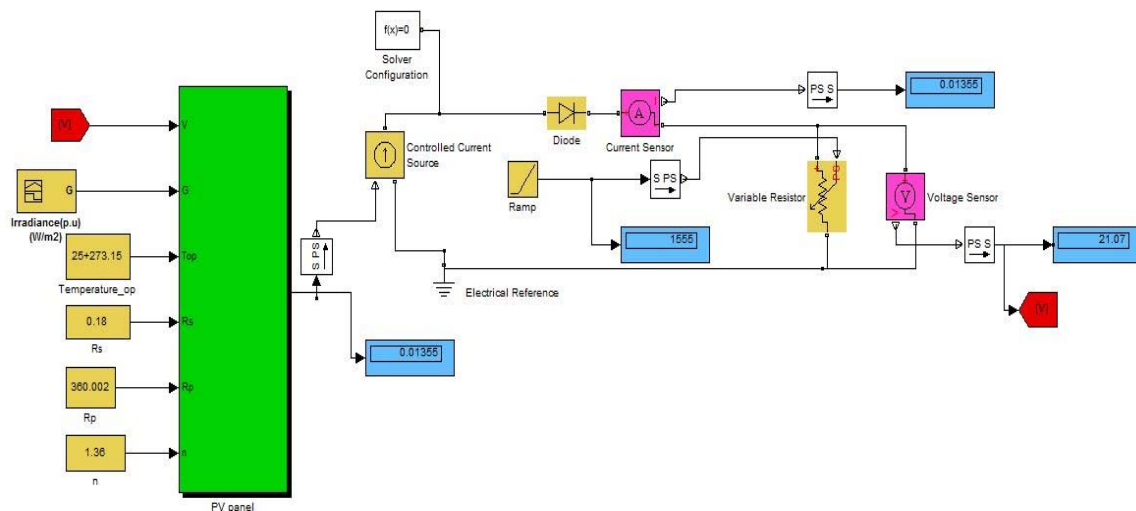

Figure 2. Simulink model of a PV Cell

Other data used by the models include the irradiance in the plane of the array, the module temperature, and array orientation.

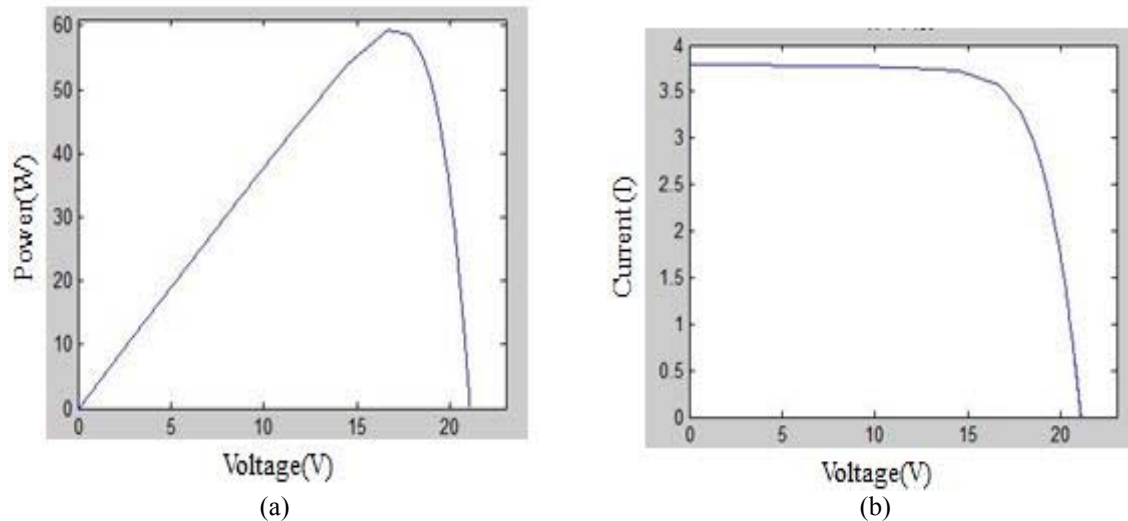

Figure 3. Characteristics of PV Cell, (a) P-V characteristics (b) V-I characteristics

## 2.2. SAR MPPT Algorithm

Optimal value of  $T_{OFF}$  for the power down mode selection is very important so as to reduce the energy consumption by the MPPT circuit. But as the MPPT operation is turned off when the system is in the power down mode, the operating point of the PV cell is different from the ideal MPP at the beginning of the active mode. But in order to reduce waste of the energy delivered in the active mode, a short  $T_{ON}$  is needed.

Flow chart of the proposed SAR MPPT algorithm is shown in Figure 5, which will reduce  $T_{ON}$ . This algorithm is an advanced version of hill climbing algorithm. The SAR MPPT determines the direction of perturbation of  $DMPPT$ , which represents the operating point of the PV cell, using the binary search method of successive approximation. If the value of  $DMPPT$  increases, the operating point moves in such a direction that the output voltage of the PV cell is decreased. Assume that a 4-bit  $DMPPT$  is used in the MPPT operation; it begins by comparing the output power of the PV cell [ $PPV(t-1)$ ] at  $DMPPT = 1000$  and  $PPV(t)$  at  $DMPPT = 1001$ .  $PPV(t)$  and  $PPV(t-1)$  represent the PV output power of the current state and the previous state, respectively. If  $PPV(t) > PPV(t-1)$ , the duty control bits, which determine the next states [ $PPV(t+1)$  and  $PPV(t+2)$ ], are set to  $DMPPT = 1100$  and  $DMPPT = 1101$ . In contrast, if  $PPV(t) < PPV(t-1)$ , the duty control bits of the next states are  $DMPPT = 0100$  and  $DMPPT = 0101$ . This SAR operation starts to decide the MSB bit to an LSB bit. After the completion of the SAR operation, the operating point of the PV cell is located at the MPP and the system enters the power down mode. In the power down mode, the proposed algorithm maintains the final value of  $DMPPT$  and the other operations are suspended, which results in no power consumption in the MPPT circuit during the power down mode.

The tracking time of the MPPT algorithm is the required time to reach the MPP, when the irradiance changes. It can be represented by the MPPT operation cycles. Let us assume that an  $N$ -bit  $DMPPT$  is used in the MPPT operations. The conventional hill climbing algorithm works like an  $N$ -bit digital counter and needs additional 4 cycles to confirm that the PV output power reaches the MPP. Therefore, the conventional hill climbing algorithm requires  $2N + 4$  cycles to reach the MPP in the worst case, whereas the proposed SARMPPT algorithm requires  $2N - 1$  cycles to reach the MPP. In this case, the step size of the conventional hill climbing algorithm is equal to the smallest step size of the SAR MPPT algorithm. Figure 4 shows ideal power tracking graphs for the conventional hill climbing algorithm (4 bit) and the proposed SAR MPPT algorithm (4 bit), and compares their MPPT algorithm during only active mode [10].

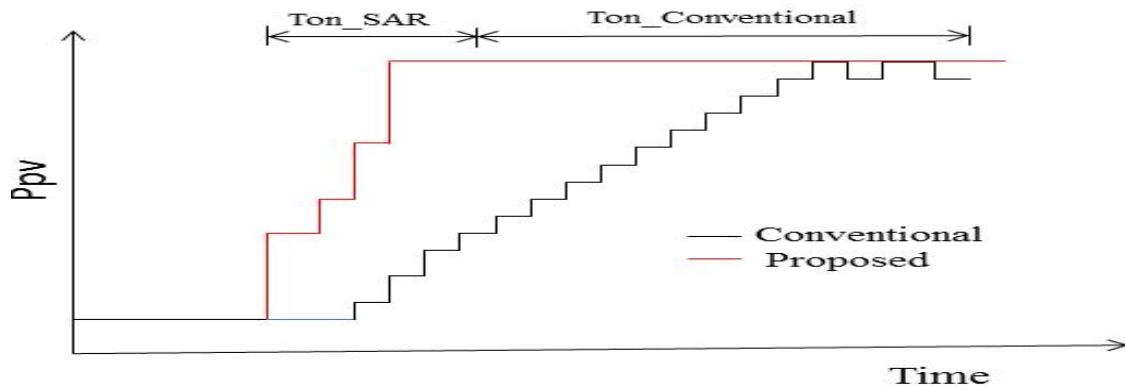

Figure 4. Performance comparison graphs between the conventional hill climbing and the proposed SAR MPPT algorithms

The proposed SAR MPPT algorithm achieves a fast tracking time, no oscillations around the MPP. Furthermore, the enhancement of the MPPT efficiency during active mode improves the entire MPPT tracking efficiency. So by this SAR Algorithm the maximum power point is reached faster when compared with conventional hill climbing algorithm and yet another advantage is that due to the presence of power down mode in this method, when the MPP is achieved then the MPPT circuit gets suspended until there is a large fluctuation in the irradiance level. So by this it is possible to reduce the power consumption by the MPPT circuit [11].

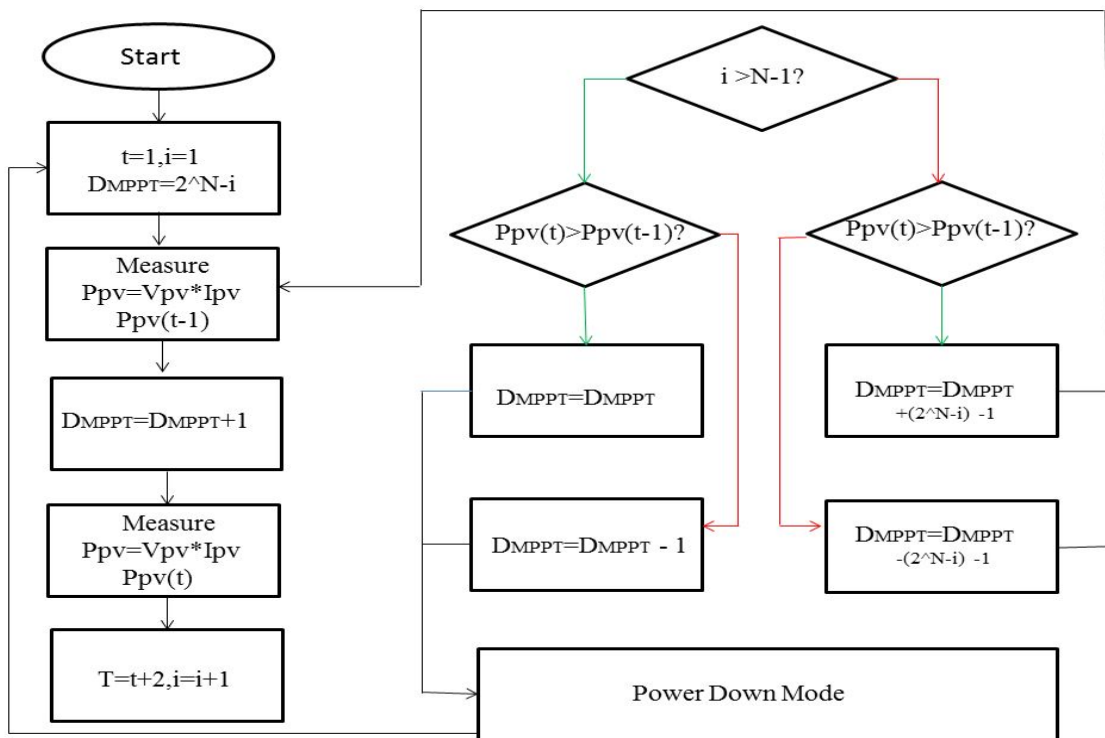

Figure 5. Flowchart for the proposed SAR MPPT algorithm

### 3. RESULTS

The proposed algorithm has been simulated using Matlab/Simulink and the following outputs were obtained. Figure 6 shows the tracking time required for the proposed method and Figure 7 shows the P&O mppt output.

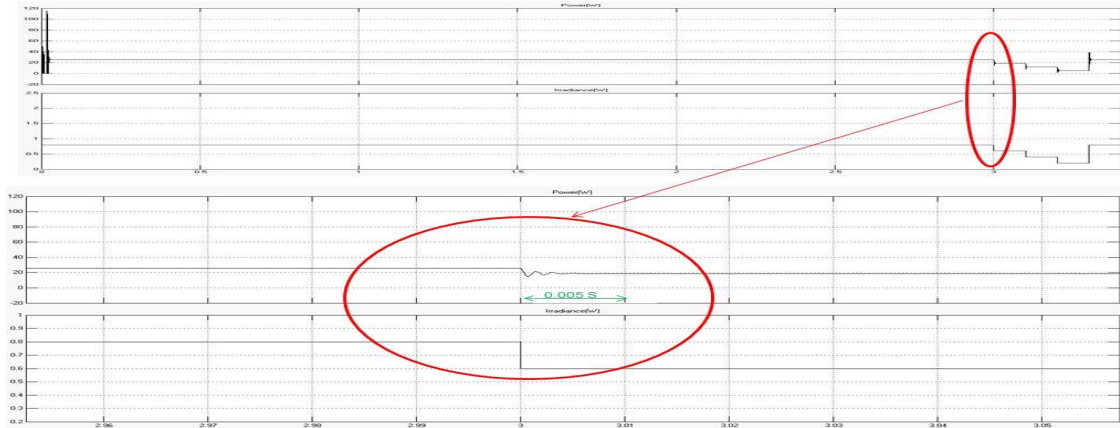

Figure 6. SAR MPPT algorithm output

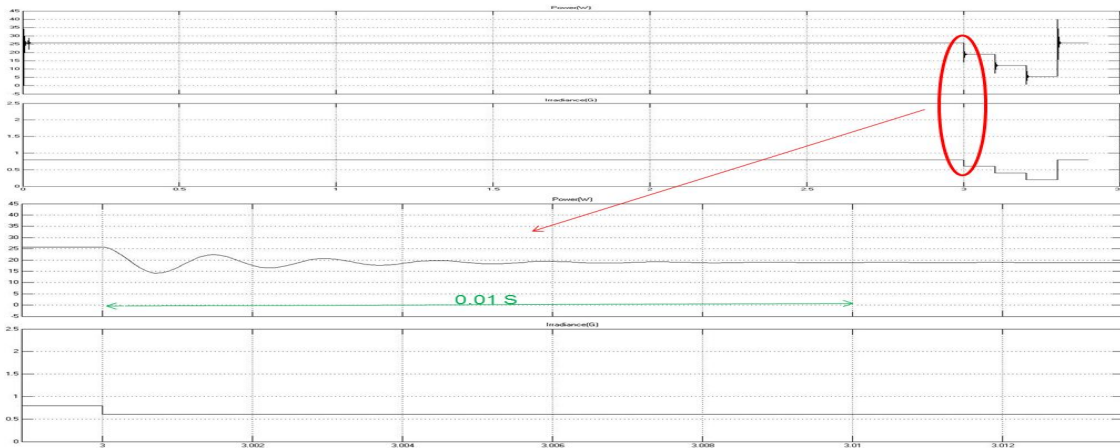

Figure 7. P&O MPPT algorithm output

Table 1 shows the tracking time comparison of SAR algorithm and P&O algorithm. It could be seen clearly the difference in tracking time in both the algorithms and the SAR algorithm is found to be more superior than conventional MPPT algorithms.

Table 1. Performance comparison of SAR and P&O

MPPT	Tracking Time
SAR	0.005
P&O	0.01

### 4. CONCLUSION

A new maximum power point tracking algorithm called successive approximation register algorithm is presented in this paper and its modelling is done using Matlab. The output of the proposed algorithm is compared with conventional hill climbing algorithm and the outputs are verified and the MPPT efficiency is improved from 61.7% to 80.85%. As the MPPT efficiency improved, the energy loss is reduced and thereby the energy stored in the energy storage device is also increased. The proposed SAR MPPT algorithm is

extensible and applicable to low-power applications such as mobile and attachable medical devices and also in solar power generation plants.

## APPENDIX

The MPPT efficiency during the active mode is given by

$$\eta_{MPPT,Active} = \frac{E_{PV}}{E_{MPPT,Ideal}} \text{ during } T_{ON}$$

## REFERENCES

- [1] Hoonki Kim, Sangjin Kim, Chan-KeunKwon, Young-Jae Min, Chulwoo Kim and Soo-Won Kim, "An Energy-Efficient Fast Maximum Power Point Tracking Circuit in an 800- $\mu$ W Photovoltaic Energy Harvester". *IEEE Transactions On Power Electronics*. 2001; 28(6).
- [2] MA Green, K Emery, Y Hishikawa, W Warta, and ED Dunlop. "Solar cell efficiency tables (Version 38)". *Progress Photovoltaics: Res. Appl.* 2011; 19(5): 565–572.
- [3] T Eswaran and PL Chapman. "Comparison of photovoltaic array maximum power point tracking techniques". *IEEE Transactions. Energy Conversion*. 2007; 22(2): 439–449.
- [4] L Zhou, Y Chen, K Guo, and F Jia. "New approach for MPPT control of photovoltaic system with mutative-scale dual-carrier chaotic search". *IEEE Transactions. Power Electronics*. 2011; 26(1): 1038–1048.
- [5] K Ishaque, Z Salam, M Amjad, and S Mekhile. "An improved particle swarm optimization (PSO)-based MPPT for PV with reduced steady-state oscillation". *IEEE Transactions. Power Electronics*. 2012; 27(8): 3627–3638.
- [6] YK Tan and SK Panda. "Optimized wind energy harvesting system using resistance emulator and active rectifier for wireless sensor nodes". *IEEE Transactions. Power Electronics*. 2011; 26(1): 38–50.
- [7] YK Ramadass and AP Chandrakasan. "A battery-less thermoelectric energy-harvesting interface circuit with 35mV startup voltage". *IEEE J.Solid-State Circuits*. 2011; 46(1): 333–341.
- [8] K Eftichios, K Kostas, and CV Nicholas. "Development of a microcontroller-based, photovoltaic maximum power point tracking control system". *IEEE Transactions. Power Electronics*. 2001; 16(1): 46–54.
- [9] G Petrone, G Spagnuolo, R Teodorescu, M Veerachary, and M Vitelli. "Reliability issues in photovoltaic power processing systems". *IEEE Transactions. Industrial. Electronics*. 2008; 55(7): 2569–2580.
- [10] Shmilovitz. "On the control of photovoltaic maximum power point tracker via output parameters". *IEE Proceedings Electrical Power Applications*. 2005; 152(2): 239–248.
- [11] C Hua, J Lin, and C Shen. "Implementation of a DSP-controlled photovoltaic system with peak power tracking". *IEEE Transactions Industrial Electronics*. 1998; 45(1): 99–107.

## BIOGRAPHIES OF AUTHORS



**Mr. Nithin T Abraham** received his B.Tech. Degree in Electrical and Electronics Engineering from Karunya University, Coimbatore, Tamil Nadu, India. Presently he is pursuing M. Tech in Renewable Energy Technologies from Karunya University, Coimbatore, Tamil Nadu, India. His present research interests are Neural Networks and Fuzzy Logic, Special machines, Application of Soft Computing Technique; Renewable Energy based power generation, Automation using PLC.



**Prof. K Vinoth Kumar** received his B.E. degree in Electrical and Electronics Engineering from Anna University, Chennai, Tamil Nadu, India. He obtained M.Tech in Power Electronics and Drives from VIT University, Vellore, Tamil Nadu, India. Presently he is working as an Assistant Professor in the School of Electrical Science, Karunya Institute of Technology and Sciences (Karunya University), Coimbatore, Tamil Nadu, India. He is pursuing PhD degree in Karunya University, Coimbatore, India. His present research interests are Condition Monitoring of Industrial Drives, Neural Networks and Fuzzy Logic, Special machines, Application of Soft Computing Technique. He has published various papers in international journals and conferences and also published four textbooks. He is a member of IEEE (USA), MISTE and also in International association of Electrical Engineers (IAENG).



**Mr. Vicky Jose** received his B.Tech. degree in Electrical and Electronics Engineering from Kerela University, Kerala, India. Presently he is pursuing M.Tech in Power Electronics and Drives from Karunya University, Coimbatore, Tamil Nadu, India. His present research interests are Neural Networks and Fuzzy Logic, Special machines, Application of Soft Computing Technique.



**Ms. Dona Maria Mathew** received his B.Tech. degree in Electrical and Electronics Engineering from Kerela University, Kerala, India. Presently he is pursuing M.Tech in Power Electronics and Drives from Karunya University, Coimbatore, Tamil Nadu, India. His present research interests are Neural Networks and Fuzzy Logic, Special machines, Application of Soft Computing Technique.



**Dr. S Suresh Kumar** received his B.E. degree in Electrical and Electronics Engineering from Bharathiar University, Coimbatore, Tamil Nadu, India in 1992. He has obtained M.E. from Bharathiar University, Coimbatore, Tamil Nadu, India in 1997. He has received doctoral degree from Bharathiar University, Coimbatore, Tamil Nadu, India in 2007. Presently he is working as a Professor and Head of the department for Electrical and Electronics Engineering in Karunya Institute of Technology and Sciences (Karunya University), Coimbatore, Tamil Nadu, India. He is having 17 years of teaching experience from PSG College of technology. His present research interests are Electrical Machines and Power Quality. He has already published 107 papers in international journals and international conferences. He is a member of IEEE (USA), ASE ISCA, MCSI, and MISTE and also in International association of Electrical Engineers.