

## An Optimal LFC in Two-Area Power Systems Using a Meta-heuristic Optimization Algorithm

Mushtaq Najeeb<sup>1</sup>, Muhamad Mansor<sup>2</sup>, Hameed Feyad<sup>3</sup>, Esam Taha<sup>4</sup>, Ghassan Abdullah<sup>5</sup>

<sup>1,3</sup>Electrical Engineering Department, College of Engineering, University of Anbar, Ramadi, Iraq

<sup>2</sup>Department of Electrical Power Engineering, Universiti Tenaga Nasional, Selangor, Malaysia

<sup>4</sup>Computer and Information Technology Center, University of Anbar, Ramadi, Iraq

<sup>5</sup>Electrical Power and Machines Department, Collage of Engineering, Diyala University, Iraq

### Article Info

#### Article history:

Received Apr 5, 2017

Revised May 20, 2017

Accepted Jun 15, 2017

#### Keyword:

LFC

Meta-heuristic optimization

Algorithm (HS)

Integral absolute error (IAE)

MATLAB environment

### ABSTRACT

In this study, an optimal meta-heuristic optimization algorithm for load frequency control (LFC) is utilized in two-area power systems. This meta-heuristic algorithm is called harmony search (HS), it is used to tune PI controller parameters ( $K_p, K_i$ ) automatically. The developed controller (HS-PI) with LFC loop is very important to minimize the system frequency and keep the system power is maintained at scheduled values under sudden loads changes. Integral absolute error (IAE) is used as an objective function to enhance the overall system performance in terms of settling time, maximum deviation, and peak time. The two-area power systems and developed controller are modelled using MATLAB software (Simulink/Code). As a result, the developed control algorithm (HS-PI) is more robustness and efficient as compared to PSO-PI control algorithm under same operation conditions.

Copyright © 2017 Institute of Advanced Engineering and Science.  
All rights reserved.

### Corresponding Author:

Mushtaq Najeeb,  
Electrical Engineering Department, College of Engineering,  
University of Anbar,  
Ramadi, Iraq.  
Email: eng.mushtaq2004@gmail.com

## 1. INTRODUCTION

In parallel power systems operations, load frequency control is in reality one of the most important parts which used to minimize area frequency deviation and keep stable tie-line power [1]. The main matter is how to keep the balance between the active and reactive powers which are transported from the generators to utilizers during a wild grid. The balance between both the active and reactive powers at the two ends of the power system effects directly the frequency and the voltage magnitude at the load side. The objectives of load frequency control (LFC) are to minimize the transient deviations in these variables (area frequency and tie-line power interchange) and to ensure their steady state errors to be zeros [2]. The frequency is highly dependent on the active power while the voltage is highly dependent on the reactive power.

In last decades, a lot of researchers are applied several strategies to give a solution for the load frequency control (LFC) problems [3],[4]. The performance of LFC depends on the feedback controller design in order to maintain the tie line power flow and the system frequency at their scheduled values [5]. The area control error (ACE) is very important part with the LFC loop which is considered as the control output [6]. The output error of ACE in each power system area demonstrates the relative error feedback in the frequency with respect to the flow of tie-line power. To design a proper controller to minimize the ACE value to be zero, PI controller has been used in different fields due to its simplicity. But, the big obstacle of PI controller is tuning its parameters ( $K_p, K_i$ ). The methods are used to tune ( $K_p, K_i$ ) parameters are the Ziegler Nichol's method [7] and trial-and-error approach [8],[9], but these are not efficient with systems have

different load changes in term of multiple interconnected power systems. For this reason and according to the literature survey, Soft-computing techniques such as such as differential evolution [10], practical swarm optimizations [11]-[15], ant colony optimization [16], and genetic algorithms [17],[18] have been widely applied for PI controller tuning in parallel-interconnected power systems.

This research presents an optimal load frequency control (LFC) using PI controller based on harmony search optimization (HS) technique for parallel two-area power system. The two-area power system and LFC loop including the proposed HS-PI controller are modelled using Matlab environment. The integral absolute error (IAE) function is used to determine its minimum value for a step load change. For a good dynamic performance, the robustness of the proposed HS-PI control algorithm is compared with the PI controller based particle swarm optimization (PSO) named PSO-PI controller in terms of time settling, maximum deviation, and peak time.

**2. LFC SIMULINK MODEL WITH PROPOSED CONTROLLER**

The overall power system of two-area power systems including the LFC model and the PI controller is investigated as shown in Figure 1. Each power system has primary and secondary loops respectively and feedback controller.  $OUT_1$  and  $OUT_2$  are the control outputs of the proposed PI controllers respectively;  $DPL_1$  and  $DPL_2$  are the disturbance load changes;  $DW_1$  and  $DW_2$  are represented the frequency changes in each power system. The nominal parameters of the overall power system are given in [19]. An area control error (ACE) is used for each area to reduce its own value to be zero [20], which is defined as:

$$ACE_1 = B_1\Delta\omega_1 + \Delta P_{12} \tag{1}$$

$$ACE_2 = B_2\Delta\omega_2 - \Delta P_{12} \tag{2}$$

where  $\Delta P_{12}$  represents the change in the tie line power plant,  $B_1$  and  $B_2$  are the bias frequencies for each area,  $\Delta\omega_1$  and  $\Delta\omega_2$  represent the frequency deviation for each area.

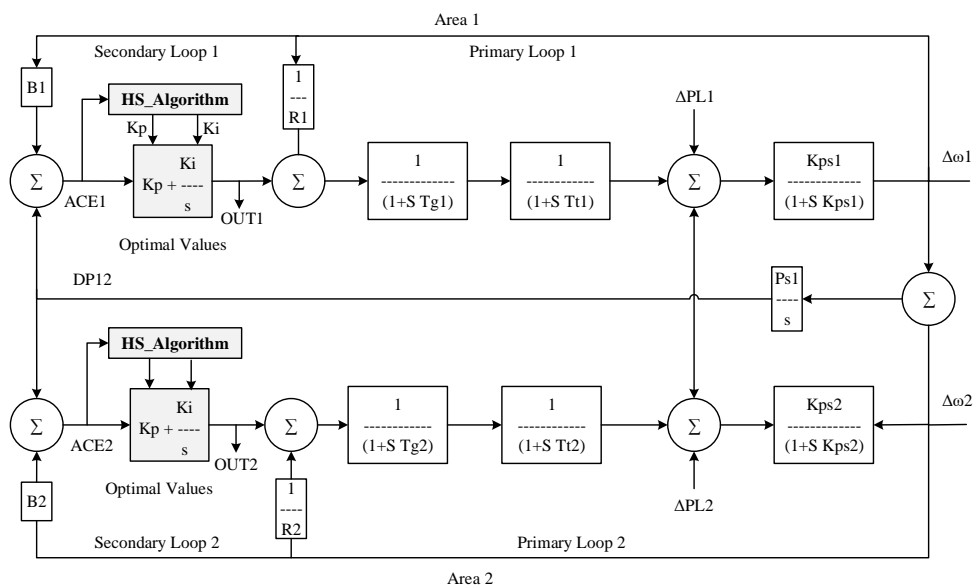

Figure 1. LFC Simulink model with proposed controller

PI controller is one of the popular feedback controller used with the load frequency control for providing an excellent control performance and higher stability. The transfer function of the PI consists of two basic parameters; Proportional (P) and Integral (I). According to [21] and [22], the typical transfer function of the classical PI controller in terms of Laplace domain is described below:

$$G_{PID}(s) = \frac{U(s)}{E(s)} = K_p + \frac{K_i}{s} \tag{3}$$

where,  $U(s)$  and  $E(s)$  are the control signal and the error signal which is the difference between the input and the feedback correspondingly.  $K_p$  is the proportional gain and  $K_i$  is the integration gain. Moreover, the output value of the proposed PID controller is given below which generates the proper control signal to keep the system parameters within the nominal values;

$$out(t) = K_p e(t) + K_i \int_0^t e(t) dt \quad (4)$$

where  $out(t)$  and  $e(t)$  are the control and tracking error signal which is in the form of time domain. For area1:

$$out_1(t) = K_{p1} ACE_1(t) + K_{i1} \int_0^t ACE_1(t) dt \quad (5)$$

For area2:

$$out_2(t) = K_{p2} ACE_2(t) + K_{i2} \int_0^t ACE_2(t) dt \quad (6)$$

### 3. HS ALGORITHM CONCEPT

Harmony search (HS) is a well-known meta-heuristic optimization algorithm inspired by the modern natural phenomena, which was proposed by [23]. The basic process of this algorithm is to produce music tunes through pitching the musical instruments in order to search for a harmony. For the harmony improvisation, musicians try various musical combinations stored in their memory to get an excellent quality. Meanwhile, it is similar to the optimization process by creating a new solution using an objective function in order to improve the quality of the generated solutions. In brief, the optimization process of the harmony search algorithm is shown in Figure 2 which can be concluded in five steps [24],[25]: (1) the HS algorithm parameters are initialized such as the harmony memory size (HMS) which is used to specify the solution vectors number, harmony memory considering rate (HMCR, its range between [0,1]) which is used for the solution vector improvement in the harmony memory as well as the pitch adjusting rate (PAR, its range between [0,1]), and the maximum number of improvisation (MaxI) is used to check the stopping criteria; (2) the harmony memory (HM) is initialized by generating a random set of solutions vectors which are identical to the harmony memory size (HMS); (3) A new solution (harmony) is produced in the improvisation process; (4) the harmony memory is updated to check the new generated solution either it is better or worse than the previous one; (5) the stopping criteria process is tested in this step to check whether the maximum iterations number is satisfied or not. If yes, the HS process will stop and the best selected solution ( $latest k_p, k_i$ ) is returned back. Otherwise, the procedures in steps 3 and 4 are repeated respectively.

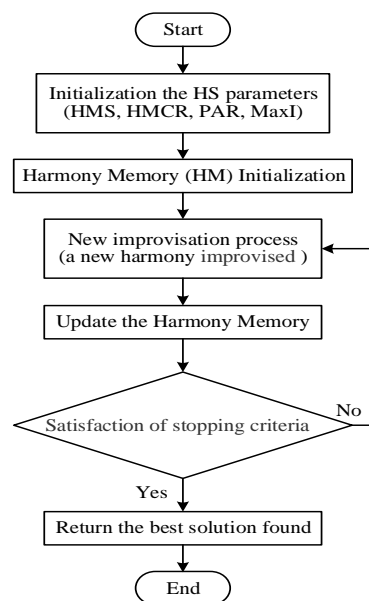

Figure 2. Harmony search algorithm flowchart

#### 4. HS IMPLEMENTATION TO OBTAIN OPTIMAL PI PARAMETERS

In any optimization algorithm, the input vector formula to find the optimal solutions can be defined as;

$$\text{Min. or Max.} = Z(k), k_n \in \mathbf{K}_n; (n = 1, 2, \dots, M) \quad (7)$$

where  $Z(k)$  is the input vector to the optimization algorithm,  $k_n$  is the decision parameter,  $\mathbf{K}_n$  is the lower and upper values of each decision parameter ( $L_{k_n} < \mathbf{K}_n < U_{k_n}$ ), and  $M$  is the total number of decision parameters. Based on equation (7), two decision parameters ( $k_p, k_i$ ) of the input vector  $Z(k)$  are used in this research to provide the optimal solutions from the HS optimization algorithm as shown in Figure 2. In addition, an objective function is required to evaluate the performance of the input vector  $Z(k)$ . Therefore, the integral absolute error (IAE) shown below is applied as an optimization problem at the Simulink time.

$$\text{IAE (min.)} = \int_0^T |e| dt + \int_0^{\text{simulink time}} |ACE1 + ACE2| dt \quad (8)$$

A more explanation of the optimization process for the harmony search algorithm based PI controller is presented as follows:

---

#### Control flow of Harmony Search Algorithm based PI Controller: pseudo code

---

##### Start program:

Definition of *input vector formula* =  $Z(k), k_n \in \mathbf{K}_n; (n = 1, 2, \dots, M)$ ;

Definition of HMS, HMCR, PAR, and MaxI;

Definition the upper and lower boundaries of the decision parameters ( $k_p, k_i$ );

Harmony memory (HM) initialization;

**for**  $i \leq \text{MaxI}$ , if satisfied **do**

**for**  $j \leq \text{number of decision parameters}$ , if satisfied **do**

**if**  $\text{HMCR} > r_1$ , if satisfied **do**

            Choose a decision parameter from the HM;

$k' = [k_p^1 \dots k_p^{\text{HMS}} \text{ or } k_i^1 \dots k_i^{\text{HMS}}]$ ;

**if**  $\text{PAR} > r_2$ , if satisfied **do**

            Adjust the decision parameter by;

$k'_{\text{new}} = (k'_{\text{selected}} + \text{rand})$ ;

**end**

**else**

        Choose a new random decision parameter by;

$k' = \text{rand} * [(\text{upper} - \text{lower}) + \text{lower}]$ ;

**end**

**end for j**

**if** the fitness value  $f(k')$  of the new solution vector <

    the worst fitness value stored in the HM, **do**

        Accept the new solution vector and replaced by the old one,

        then added it to the HM;

**end**

**end for i**

    Return back the best solution found (*latest*  $k_p, k_i$ );

##### End Program

(discussion).

#### 5. RESULTS AND DISCUSSION

The objective of this study is to test the proposed HS-PI control algorithm for LFC in two-area power system and compared it with the results obtained by PSO-PI. MATLAB program has been used to model the overall system shown in Figure 1. To check the effectiveness and robustness of the proposed control algorithm, the step load disturbance  $DPL_1$  is selected to be 0.2 pu while  $DPL_2$  is 0.3 pu for both area1 and area 2 respectively. Table 1 shows the optimal values ( $K_p, K_i$ ) of the optimization process obtained by both algorithms using the objective function (IAE). Tables 2, 3, and 4 give the transient response

specifications for  $ACE_{ij}$ ,  $\Delta\omega_{ij}$ , and  $\Delta P_{ij}$  in terms of settling time, maximum deviation, and peak time. It is noted that the HS-PI controller produces good dynamic performances as compared to PSO-PI. Figures 3 and 4 represent the simulation results for ACE1 and ACE2 respectively for both algorithms, it is very clear that the dynamic characteristics for HS-PI are able to make the steady state error to be zero faster than PSO-PI and the overshoot is minimized as well. Figure 5 shows the  $\Delta P_{12}$  result, the settling time, maximum deviation and peak time are reduced which make the system relatively more stable. Figures 6 and 7 demonstrate the responses for  $\Delta\omega_1$  and  $\Delta\omega_2$ . It is shown that the response of the maximum overshoot and settling time is much better than that one's obtained by PSO-PI.

Table 1. Optimal values of PI tuning using HS and PSO

| PI Parameters      |     | HS_IAE        | PSO_IAE      |
|--------------------|-----|---------------|--------------|
| Area1              | Kp1 | 0.434         | 2.6290       |
|                    | Ki1 | 1.504         | 2.8910       |
| Area2              | Kp2 | 1.092         | 3.8849       |
|                    | Ki2 | 1.144         | 4.2106       |
| Min_IAE            |     | <b>0.0166</b> | <b>0.032</b> |
| Elapsed Time (sec) |     | 22.676        | 29.112       |

Table 2.  $ACE_{ij}$  parameters using HS and PSO based on IAE

|         |      | Settling Time (sec) | Max.deviation (p.u) | Peak Time (sec) |
|---------|------|---------------------|---------------------|-----------------|
| HS_IAE  | ACE1 | 6.45                | 0.0289              | 1.445           |
|         | ACE2 | 7.65                | 0.126               | 1.98            |
| PSO_IAE | ACE1 | 8.75                | 0.0806              | 2.05            |
|         | ACE2 | 9.98                | 0.224               | 3.01            |

Table 3.  $\Delta P_{ij}$  parameters using HS and PSO based on IAE

|         |      | Settling Time (sec) | Max.deviation (p.u) | Peak Time (sec) |
|---------|------|---------------------|---------------------|-----------------|
| HS_IAE  | DP12 | 17.1                | 0.00589             | 2.51            |
| PSO_IAE | DP12 | 19.19               | 0.01561             | 3.11            |

Table 4.  $\Delta\omega_{ij}$  parameters using HS and PSO based on IAE

|         |     | Settling Time (sec) | Max.deviation (p.u) | Peak Time (sec) |
|---------|-----|---------------------|---------------------|-----------------|
| HS_IAE  | Dw1 | 11.089              | -0.00162            | 0.998           |
|         | Dw2 | 6.023               | -0.00489            | 1.231           |
| PSO_IAE | Dw1 | 14.118              | -0.00386            | 1.529           |
|         | Dw2 | 8.245               | -0.010012           | 2.325           |

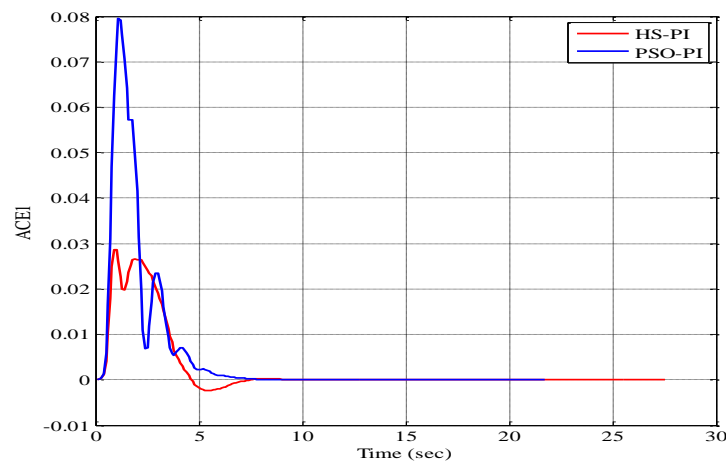

Figure 3. ACE1 using HS and PSO algorithms

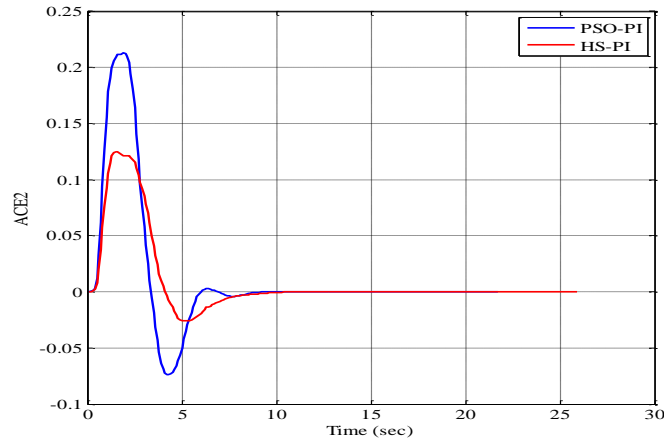

Figure 4. ACE2 using HS and PSO algorithms

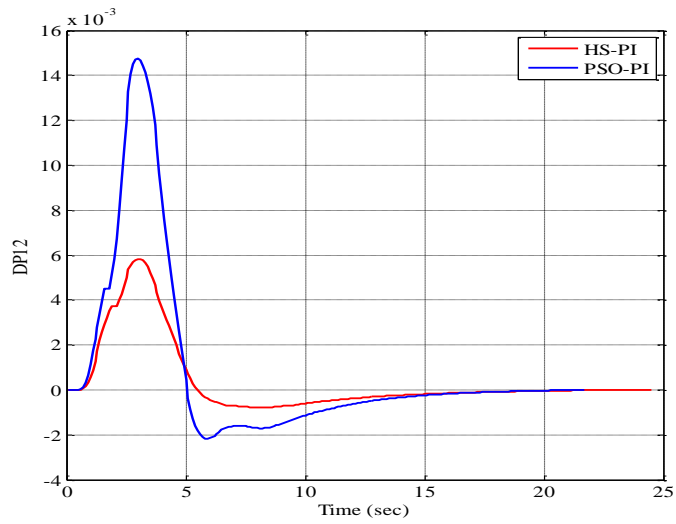

Figure 5.  $\Delta P_{12}$  using HS and PSO algorithms

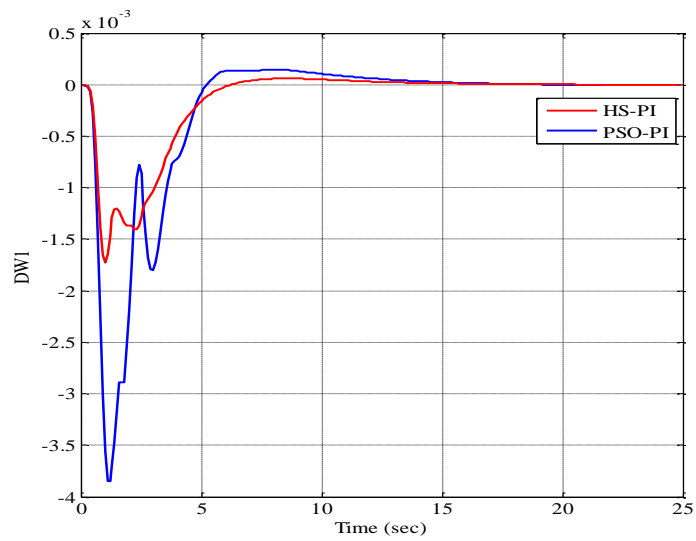

Figure 6.  $\Delta \omega_1$  using HS and PSO algorithms

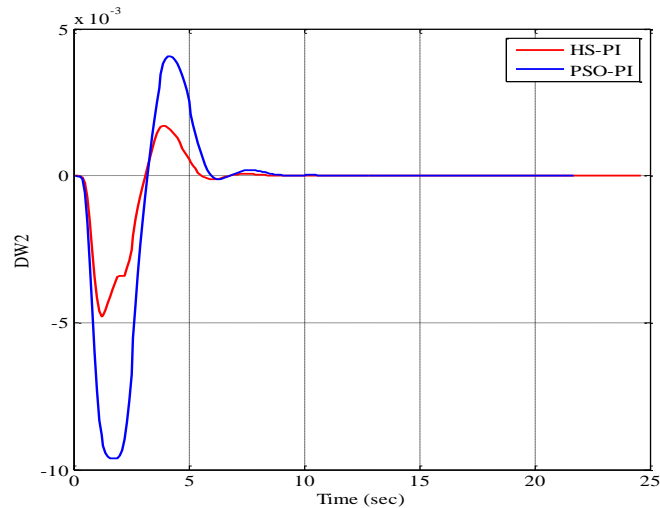

Figure 7.  $\Delta\omega_2$  using HS and PSO algorithms

To demonstrate the effectiveness of the proposed controller using the harmony search optimization algorithm based PI controller. A statistical analysis is done as shown in Figure 8 to display the convergence characteristics of HS-PI as compared to the convergence characteristics obtained by using PSO algorithm based PI (PSO-PI). In both optimization algorithms, same parameters are used like number of iterations, population size, dimension of problem, and the objective function in equation (8). Based on Figure 8, it is clear that the convergence of the proposed HS-PI is faster than PSO-PI. In other words, the obtained response of the overall system is better and robustness under sudden loads changes. In addition, the iteration number for both HS-PI and PSO-PI runs over 80 as described in Figure 8. It is shown that the value of IAE is 0.016 using the HS-PI controller as compared to 0.032 by using the PSO-PI under different loads.

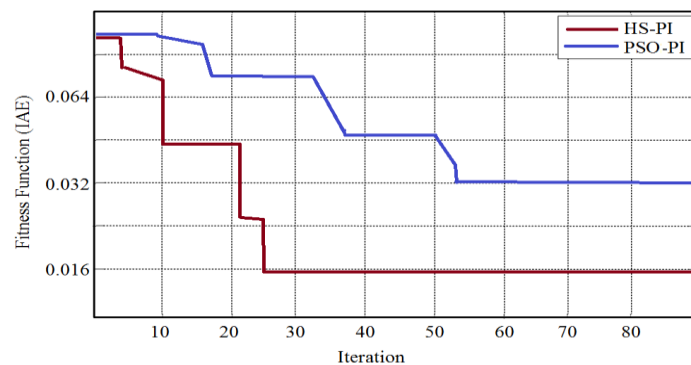

Figure 8. Fitness function based on HS-PI and PSO-PI

## 6. CONCLUSION

In this research, an optimal Harmony-PI controller (HS-PI) has been suggested for LFC in two-area power system in order to increase the system stability and reduce its steady state error under sudden load change. The PI parameters are optimized using harmony search optimization algorithm. The two-area power system including LFC loop and the control algorithm are modelled using Matlab environment. To show the proposed controller performance, the results have been compared with that ones obtained by the PI controller using particle swarm optimization named PSO-PI under same operation conditions. Based on this comparison, the IAE value using HS-PI has been eliminated to 0.01666 as compared to 0.032 of PSO-PI. Further, the robustness of the proposed controller is more stable than PSO-PI controller for the same power system. In addition, it is observed that the dynamic performance of the proposed controller has been improved in terms of settling time, maximum deviation, peak time, and execution time of control algorithm as compared to PSO-PI.

**REFERENCES**

- [1] J. Venkatachalam, *et al.*, "A Particle Swarm Optimization Algorithm for Automatic Generation Control of Two Area Interconnected Power System," *International Journal of Engineering Research & Technology*, vol/issue: 2(6), 2013.
- [2] M. Najeeb, *et al.*, "PID Parameters Improvement for AGC in Three Parallel Connected power Systems," *The National Conference for Postgraduate Research*, Universiti Malaysia Pahang, vol. P075. pp. 544-551, 2016.
- [3] Ibraheem, *et al.*, "Recent philosophies of automatic generation control strategies in power systems," *IEEE Transactions on Power Systems*, vol/issue: 20(1), pp. 346-357, 2005.
- [4] G. A. Salman, "Automatic Generation Control in Multi Area Interconnected Power System Using PID Controller Based on GA and PSO," *Second Engineering Scientific Conference, College of Engineering*, University of Diyala, pp. 297-310, 2015.
- [5] J. Venkatachalam, *et al.*, "Automatic generation control of two area interconnected power system using particle swarm optimization," *Journal of Electrical and Electronics Engineering*, vol/issue: 6(1), pp. 28-36, 2013.
- [6] S. Prakash, *et al.*, "Load frequency control of three area interconnected hydro-thermal reheat power system using artificial intelligence and PI controllers," *International Journal of Engineering, Science and Technology*, vol/issue: 4(1), pp. 23-37, 2011.
- [7] J. G. Ziegler and N. B. Nichols, "Optimum settings for automatic controllers," *Transactions of the ASME*, vol/issue: 64(8), pp. 759/768-759/768, 1942.
- [8] T. C. Yang, *et al.*, "Decentralized Power System load frequency control beyond the limit of diagonal dominance," *International Journal of Electrical Power & Energy Systems*, vol/issue: 24(3), pp. 173-184, 2002.
- [9] V. Donde, *et al.*, "Simulation and Optimization in an AGC System after Deregulation," *IEEE Transactions on Power Systems*, vol/issue: 16(3), pp. 481-489, 2001.
- [10] C. H. Liang, *et al.*, "Study of Differential Evolution for Optimal Reactive Power Dispatch," *IET Generation Transmission and Distribution*, vol/issue: 1(2), pp. 253-260, 2007.
- [11] L. X. Long, *et al.*, "A Bacterial Foraging Global Optimization Algorithm Based On the Particle Swarm Optimization," *IEEE International Conference on Intelligent Computing and Intelligent Systems*, vol. 2, pp. 22-27, 2010.
- [12] A. M. Jadhav, *et al.*, "Performance Verification of PID Controller in an Interconnected Power System Using Particle Swarm Optimization," *2<sup>nd</sup> International Conference on Advances in Energy Engineering (ICAEE), Energy Procedia*, vol. 14, pp. 2075-2080, 2012.
- [13] A. J. Sharmili, *et al.*, "Particle Swarm Optimization based PID controller for two area Load Frequency Control System," *International Journal of Engineering Research and General Science*, vol/issue: 3(2), pp. 772-778, 2015.
- [14] R. Chaudhary, *et al.*, "A Novel Approach to PID Controller Design for Improvement of Transient Stability and Voltage Regulation of Nonlinear Power System," *International Journal of Electrical and Computer Engineering (IJECE)*, vol/issue: 6(5), pp. 2225-2238, 2016.
- [15] N. R. Raju, *et al.*, "Robustness Study of Fractional Order PID Controller Optimized by Particle Swarm Optimization in AVR System," *International Journal of Electrical and Computer Engineering (IJECE)*, vol/issue: 6(5), pp. 2033-2040, 2016.
- [16] M. Dorigo, *et al.*, "Ant Colony optimization: artificial ants as a computational intelligence technique," *IEEE Computational Intelligence Magazine*, vol/issue: 1(4), pp. 28-39, 2007.
- [17] V. Jain, *et al.*, "Modeling and simulation of Load Frequency Control in Automatic Generation Control using Genetic Algorithms Technique," *International Journal of Innovative Science, Engineering & Technology*, vol/issue: 1(8), pp. 356-362, 2014.
- [18] G. Konar, *et al.*, "Two Area Load Frequency Control Using GA Tuned PID Controller in Deregulated Environment," *Proceedings of the International Multi Conference of Engineers and Computer Scientists*, vol. 2, pp. 1-6, 2014.
- [19] M. M. Ismail, *et al.*, "Load Frequency Control Adaptation Using Artificial Intelligent Techniques for One and Two Different Areas Power System," *International Journal of Control, Automation and Systems*, vol/issue: 1(1), pp. 12-23, 2012.
- [20] Ganesh V., *et al.*, "LQR Based Load Frequency Controller for Two Area Power System," *International Journal of Advanced Research in Electrical, Electronics and Instrumentation Engineering*, vol/issue: 1(4), pp. 262-269, 2012.
- [21] M. Shahooth, *et al.*, "An optimized PID parameters for LFC in interconnected power systems using MSL optimization algorithm," *ARPJ Journal of Engineering and Applied Sciences*, vol/issue: 11(19), pp. 11770-11781, 2016.
- [22] M. Hojabri, *et al.*, "An Overview on Microgrid Control Strategies," *International Journal of Engineering and Advanced Technology*, vol/issue: 4(5), pp. 93-98, 2015.
- [23] Z. W. Geen, *et al.*, "A New Heuristic Optimization Algorithm: Harmony Search," *Simulation*, vol. 76, pp. 60- 69, 2001.
- [24] H. Daniyal, *et al.*, "An Efficient Control Implementation for Voltage Source Inverter based Harmony Search Algorithm," *International Journal of Power Electronics and Drive Systems*, vol/issue: 8(1), pp. 279-289, 2017.
- [25] M. Mansor, *et al.*, "An Intelligent Voltage Controller for a PV Inverter System using Simulated Annealing Algorithm-based PI Tuning Approach," *Journal of Engineering and Applied Sciences*, vol/issue: 12(3), pp. 660-669, 2017.



**BIOGRAPHIES OF AUTHORS**

**Mushtaq Najeeb** was born in 1982. He is received his Bachelor degree in Control Engineering (2004) from University of Technology, Baghdad, Iraq. He also has got his Master degree in electrical engineering (2012) from University Tenaga Nasional (UNITEN), Selangor, Malaysia. From 2005 to 2009, he worked as laboratory assistant and tutor at University of Anbar, electrical engineering department, Ramadi, Iraq. Later in 2012, he worked as a lecturer and the coordinator of the same department. His research interests are renewable energy resources, control of power electronics devices, microgrids systems, and optimization algorithms. He is a member of Iraqi Engineers Union since 2005.



**Dr. Muhamad Bin Mansor** received his Bachelor of Electrical Engineering (Hons) from Universiti Teknologi Malaysia, Master of Electrical Engineering Degrees in Electrical Power from Universiti Tenaga Nasional, Malaysia, and Ph.D in Power Electronics from University of Malaya, Malaysia in 2000, 2006 and 2012 respectively. He is currently a senior lecturer in the department of Electrical Power, Universiti Tenaga Nasional (UNITEN), Malaysia. His research interests are Power Electronics (Voltage Sags Compensator, solar, electric vehicle).



**Ghassan Abdullah Salman** was born in Diyala –Iraq 1983. He completed his B.Sc. Electrical power and machines department Diyala University College of Engineering, Iraq in 2005, M. Sc. (Power Systems) from university of technology-Baghdad in 2011. He has working as assistant lecturer in Electrical power and machines department, College of Engineering, Diyala University. His research interests are optimal power system, FACTS & Power Quality.