

## An Efficient Adaptive Noise Cancellation Scheme Using ALE and NLMS Filters

Jafar Ramadhan Mohammed<sup>1</sup>, Muhammad Safder Shafi<sup>2</sup>, Sahar Imtiaz<sup>2</sup>, Rafay Iqbal Ansari<sup>2</sup>, and Mansoor Khan<sup>2</sup>

<sup>1</sup>College of Electronic Engineering, University of Mosul, Mosul, IRAQ

<sup>2</sup>COMSATS Institute of Information Technology (CIIT), Islamabad, Pakistan

---

### Article Info

#### Article History:

Received Jan 31<sup>th</sup>, 2012

Revised Apr 14<sup>th</sup>, 2012

Accepted May 6<sup>th</sup>, 2012

#### Keyword:

Adaptive line enhancer  
Normalized least mean squares  
Sinusoidal noise  
Wideband noise

---

### ABSTRACT

The basic theme of our paper is to implement a new idea of noise reduction in the real time applications using the concepts of adaptive filters. Our model which is presented as one of the solutions is based on two stages of operation with the first stage based on the ALE (Adaptive Line Enhancer) filters and the second stage on NLMS (Normalized Least Mean Square) filter. The first stage reduces the sinusoidal noise from the input signal and the second stage reduces the wideband noise. Two input sources of voice are used; one for the normal speech and the other for the noise input, using separate microphones for both signals. The first signal is of the corrupted speech signal and the second signal is of only the noise containing both wideband and narrowband noise. In the first stage the narrowband noise is reduced by using the ALE technique. The second stage gets a signal with ideally only the wideband noise which is reduced using the NLMS technique. In both the stages the concerned algorithms are used to update the filter coefficients in such a way that the noise is cancelled out from the signal and a clean speech signal is heard at the output.

Copyright © 2012 Institute of Advanced Engineering and Science.  
All rights reserved.

---

### Corresponding Author:

Jafar Ramadhan Mohammed,  
College of Electronic Engineering,  
University of Mosul, Iraq.  
Email: jafarram@yahoo.com

---

## 1. INTRODUCTION

Nowadays, effective communication is necessary to keep up with the fast-developing world. Effective voice communication is the most important part of it. In the prevailing environment, the noise corrupts the speech signal to such an extent, sometimes, that it is almost impossible to recover the original voice message communicated. That noise is usually given the name of background noise, which affects the intelligibility of the speech signal.

To cater the issue of noise effectively we need some new schemes for optimal noise cancellation. In the past, the noise cancellation schemes using two sensors have been proposed in [1], [2] and [3], introducing the concept that a noise source is acquired by the second sensor, which cancels out the unwanted noise from the signal acquired by the first sensor, by destructively interfering with it. Using the same concept, several schemes have been proposed till now, combining the basic adaptive filtering algorithms and implementing them. Work in this regard is still in progress. The two-sensor concept has been used in this paper as well.

A technique based on NLMS, also known as traditional Acoustic Noise Cancellation (ANC) scheme, yielded the cancellation of wideband noise from the corrupted speech signal but didn't address the issue of sinusoidal noise. In real-time environment, sinusoidal noise is added in the speech signal through different sources like ceiling fan, PC fan and engine noise. Sinusoidal noise is thus a significant part of the corrupted signal and its cancellation is vital for acquiring a clean speech signal.

ALE, an existing technique, gained popularity as it gave a better understanding of the spectrum analysis and the behavior of noise in the spectral sense. It is used to cancel out the sinusoidal part of noise in an effective manner. Thus, using the ALE and NLMS filters collectively, the purpose of cancellation of both the wideband and sinusoidal noise is accomplished.

Therefore, a technique, combining the ALE and NLMS filters, proposed in [4] can be effectively implemented for various applications, like reduction of propeller-induced cabin noise during a flight [5], removal of sinusoidal noise in ECG analysis [6], acoustic noise cancellation in i-phone4 and removal of car-motor sound during journey by car [7].

We have implemented the aforesaid technique in real time and analyzed the results. In this paper section II discusses the basic functioning of adaptive filters analyzed on the basis of mean square error. ALE and NLMS, the filters used in the scheme, are explained in section III; followed by simulation in real-time discussed in section IV. The paper concludes with the simulation results discussed in section V.

**2. ANALYSIS USING MEAN SQUARE ERROR**

An important efficiency determining factor of an algorithm, particularly in adaptive filter, is its mean square error. The schematic of a simple adaptive filter is shown in figure 1, in which an input signal  $x(k)$  is multiplied by the filter coefficients  $w(k)$  to yield the output  $y(k)$ . The error signal is obtained by subtracting the output signal of the filter from the desired signal  $d(k)$ . Generally, the objective is to minimize the error signal using effective weight adaptation by the filter, in order to ensure a minimum value of the mean of the squared error signal. The lesser the value of mean square error, the more efficient is the working of the adaptive filter.

Mathematically, the relation between the input and the output in an adaptive filter is given by

$$y(k) = \sum_{m=0}^{M-1} (w_m(k) x(k - m)) = w^T x \tag{1}$$

An error signal  $e(k)$  is termed as the difference between desired signal  $d(k)$  and the output of filter  $y(k)$ .

$$e(k) = d(k) - y(k) \tag{2}$$

$$= d(k) - w^T \tag{3}$$

The coefficients of Weiner filter are obtained by minimizing square function  $E[e^2(k)]$  with respect to vector  $w$ .

$$E[e^2(k)] = E[(d(k) - w^T x)^2] \tag{4}$$

$$= E[d^2(k)] - 2w^T E[xd(k)] + w^T E[xx^T]w = r_{dd}(0) - 2w^T r_{dx} + w^T R_{xx} \tag{5}$$

In equation 5,  $r_{dd}$  is the correlation of the desired signal  $d(k)$ ,  $r_{dx}$  is the cross-correlation of the input and the desired signal and  $R_{xx}$  is the correlation of the input signal  $x(k)$ . We desire a minimum mean square error which would confirm the proper working of the system.

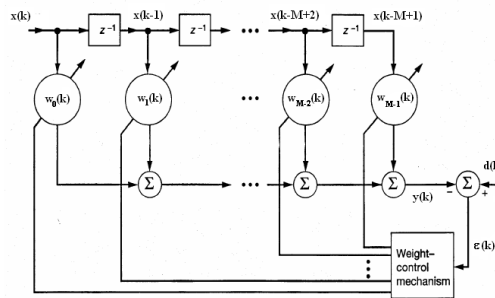

Figure 1. Adaptive filter

### 3. FILTERS USED IN THIS SCHEME

The operation of our proposed scheme is based on two stages; the first stage based on ALE cancels out the sinusoidal noise signal and the second stage uses NLMS to cancel wideband noise from the resultant of the first stage. Figure 2 shows a basic block diagram of the implemented scheme.

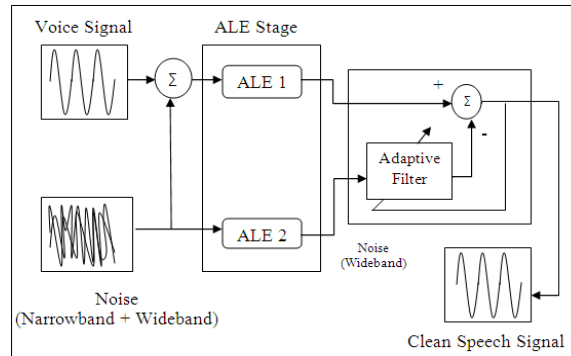

Figure 2. Basic model

The two stages in the basic model are explained below:

ALE or Adaptive Line Enhancer is a technique which is employed to cancel out the ‘sinusoidal’ noise from the input signal. This technique can be used with any of the adaptive filters classified till now and uses a delay in the input signal to cancel out the unnecessary part in it and thus get the desired response.

“Operation of the adaptive line enhancer can be understood intuitively as follows. The delay causes de-correlation between the noise components of the input data in the two channels while introducing a simple phase difference between the sinusoidal components. The adaptive filter responds by forming a transfer function equivalent to that of a narrow-band filter centered at the frequency of the sinusoidal components. The noise component of the delayed input is rejected, while the phase difference of the sinusoidal components is readjusted so that they cancel each other at the summing junction, producing a minimum error signal composed of the noise component of the instantaneous input data alone” [12].

NLMS or Normalized Least Mean Square is a modified form of LMS technique and is used to remove the wide-band noise from the input signal. This modification takes into notice the various fluctuations in the level of signal at the filter’s input. After noticing the fluctuations it will select a “normalized step size parameter”. This process will make the algorithm a “fast converging adaptation algorithm”.

In general, the NLMS algorithm is convergent in the mean square sense if the following condition for adaptation constant  $\tilde{\mu}$  is satisfied:  $0 < \tilde{\mu} < 2$

#### 3.1. Stage I (ALE Filter)

ALE is used to cancel out sinusoidal noise from the speech signal. The figure shown below elaborates the basic working of ALE filter.

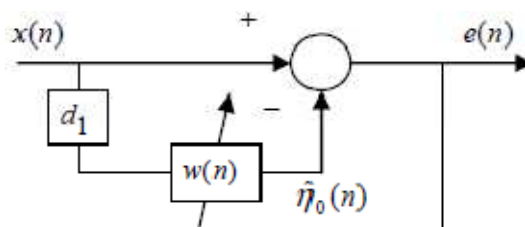

Figure 3. The Adaptive line enhancer (ALE) filter [4]

The input of this filter is a delayed version of the primary signal  $x(n)$ . The delay is set in such a way so as to de-correlate wideband noise in order to cancel out the sinusoidal noise from the primary signal.

The ALE is used in parallel fashion, named as ALE 1 and ALE 2 stage. The ALE 1 stage acts as a primary sensor, acquiring the non-stationary speech signal [8], corrupted by wideband and sinusoidal noise. Mathematically, the signal  $x(n)$  is

$$x(n) = s(n) + \xi_0(n) + \eta_0(n) \quad (6)$$

Here,  $s(n)$  is the speech signal,  $\xi_0(n)$  is the wideband noise and  $\eta_0(n)$  is the sinusoidal (narrowband) noise. The delay  $d_1$  at the ALE 1 stage is kept such that the speech signal and the wideband noise de-correlates with itself, resulting in the correlation of only the narrowband noise, i.e.  $\hat{\eta}_0(n)$  is estimated close to  $\eta_0(n)$  using  $\eta_0(n - d_1)$  by the filter weights  $w(n)$ . Thus, only the sinusoidal noise is cancelled and speech signal along with the wideband noise signal is obtained at the output of ALE 1 stage.

The ALE 2 stage acts as a secondary sensor, acquiring only the noise signal consisting of wideband and sinusoidal noise. The signal at the secondary sensor is given by  $v_1(n)$  as

$$v_1(n) = \xi_1(n) + \eta_1(n) \quad (7)$$

Here,  $v_1(n)$  is the speech signal at the secondary sensor,  $\xi_1(n)$  is the wideband noise and  $\eta_1(n)$  is the sinusoidal (narrowband) noise. At this stage, the delay  $d_2$  is set to be such that only the sinusoidal component of noise remains correlated with itself, so as to give only the wideband noise  $\xi_1(n)$  at the output of ALE 2. Note that *the step-size and the filter length chosen for both the stages should be same* so as to achieve adaptation convergence of the outputs of ALE 1 and ALE 2 stages at the same time.

### 3.2. Stage II (NLMS Filter)

The Normalized Least Mean Square (NLMS) algorithm is a modified form of Least Mean Square (LMS) algorithm and Nagumo and Noda were the first ones to introduce it [9]. In this paper, the NLMS filter is used to remove the wideband noise using the signals obtained at the output of the ALE stages. The NLMS filter is preferred over LMS algorithm because of its particular characteristics of faster convergence, besides a lower mean squared error [10]. The NLMS filter as an adaptive noise canceller is shown in figure 4.

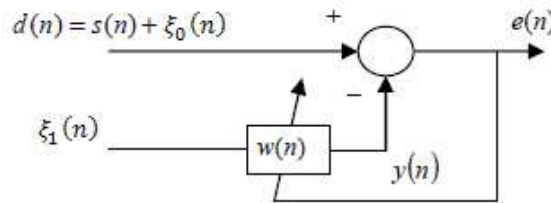

Figure 4. Adaptive noise canceller [4]

In figure 4,  $d(n)$  is the primary input signal having the speech  $s(n)$  and wideband noise  $\xi_0(n)$  as its components. The input to the NLMS filter is  $\xi_1(n)$  which is estimated by the filter weights  $w(n)$ , to be close to  $\xi_0(n)$ , so that only the clean speech signal  $s(n)$  is obtained as the error signal  $e(n)$  that is the final output.

The filter coefficients are updated in NLMS according to [11]

$$\mathbf{w}(n+1) = \mathbf{w}(n) + \frac{\mu}{\|\xi_1(n)\|^2 + \alpha} e(n)\xi_1(n) \quad (8)$$

Here,  $\mu$  is the step-size that controls the convergence speed and stability of the NLMS adaptive filter. In case the input signal is zero at any instant, a small constant  $\alpha$  prevents division by zero in (8).

## 4. MATLAB SIMULATION

The simulation is done in real time, in MATLAB Simulink, using the model shown in figure 5. For the sake of understanding, the diagram is divided into the following stages:

**Stage1: ALE**

In the first stage we have two sections which are ALE 1 and ALE 2. ALE 1 acts as a primary sensor (microphone) in real time environment and its input is only the corrupted speech signal. ALE 2 acts as a secondary sensor whose input is only the noise signal having both wideband and sinusoidal noise. The output of this stage is fed into stage2 for acquiring the final clean speech at the output.

**Stage2: NLMS**

Using the outputs of stage1 this stage removes the wideband noise and gives a clean speech signal as a final output.

The parameters in the simulation are set in such a way so as to get the best results when simulated in different environments. The results shown in this paper are obtained by using the parameters given in table 1.

Table 1. Parameter settings for real-time results

Stage 1 ALE 1	NLMS Adaptive Algorithm	De-correlation delay	350
		$d_1$	Samples
		Number of Tap Coefficients	200
		Step-size $\mu_1$	0.001
Stage 1 ALE 2	NLMS Adaptive Algorithm	De-correlation delay	350
		$d_2$	Samples
		Number of Tap Coefficients	200
		Step-size $\mu_2$	0.001
Stage 2	NLMS Adaptive Algorithm	Number of Tap Coefficients	310
		Step-size $\mu_3$	0.025

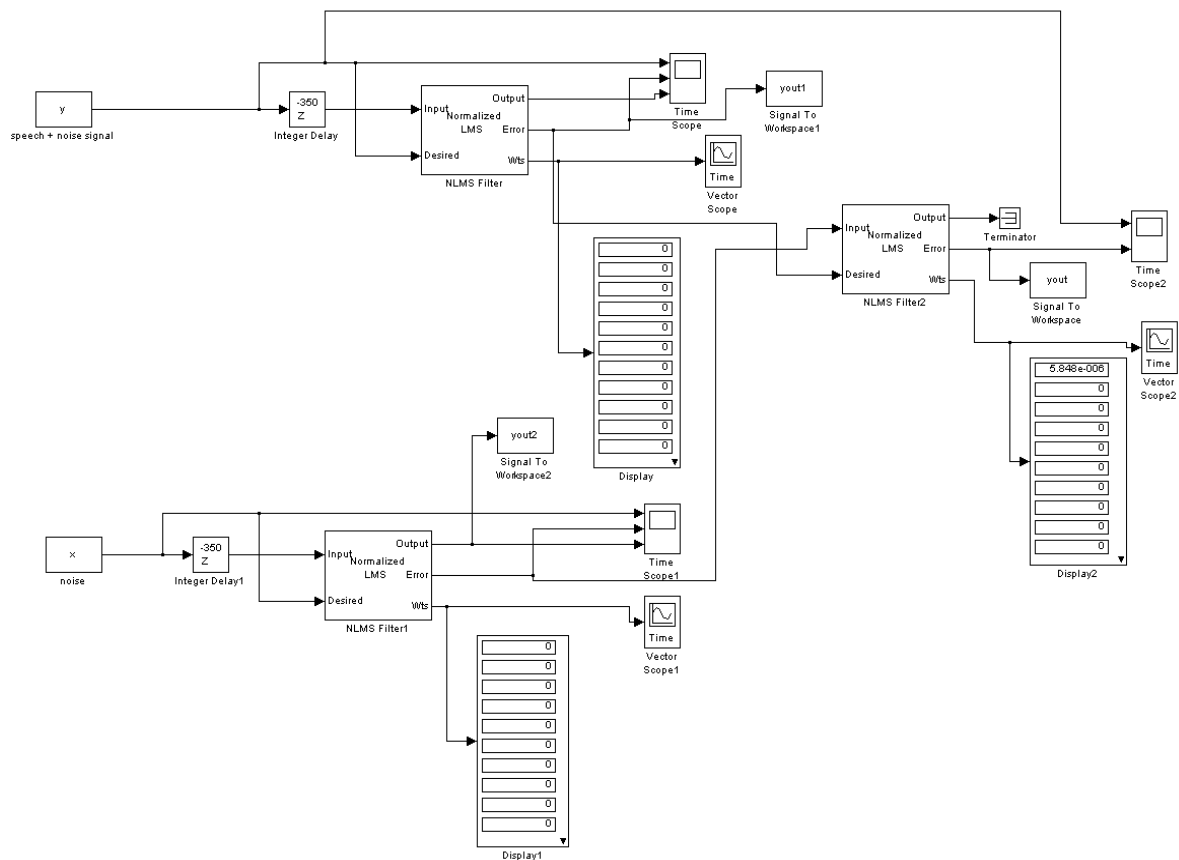

Figure 5. The MATLAB simulink model of the adaptive noise cancellation scheme using ALE and NLMS filters

The model is run using a speech signal of duration of about 5 seconds in real-time at a sampling rate of 8000 Hz.

## 5. SIMULATIONS RESULTS

The simulation model is tested in real-time environment, by acquiring the corrupted speech signal and the noise signal, via a microphone. Figure 6 and 7 show the desired speech signal and the noise signal in the time domain, respectively. From figure 7, it seems that the amplitude of noise signal is quite less, so it will not significantly affect the speech signal, but this is not so. The noise signal, when heard in MATLAB, is of significant amplitude and corrupts the speech signal to a greater extent.

After simulation, the signal obtained in time domain after ALE stage and the NLMS stage, i.e. the final output, is shown in figure 8 and 9, respectively. It is clear from figure 8 that the ALE stage is not successful in removing the wideband noise since the voice is corrupted significantly during the silence period in the speech signal. The residual wideband noise is quite significantly removed from the signal obtained at the output of the NLMS stage, as shown in figure 9. Thus, speech signal is enhanced in clarity and is clearly audible.

The simulation results in time domain of the scheme proposed in [4] are compared with the traditional Acoustic Noise Cancellation (ANC) scheme, with employs only the NLMS stage. The results in figure 10 show that the noise is removed appreciably, but the speech signal is attenuated at certain samples, which is in contrast to the results obtained using both ALE and NLMS filters. Thus, the scheme combining the ALE and NLMS filters produces better results than the traditional ANC scheme when used for real-time simulation.

Figure 11-16 shows the spectrograms of results that are shown in figure 6-10. All results are in correspondence with the aforesaid explanation of the results shown in figures 6-10.

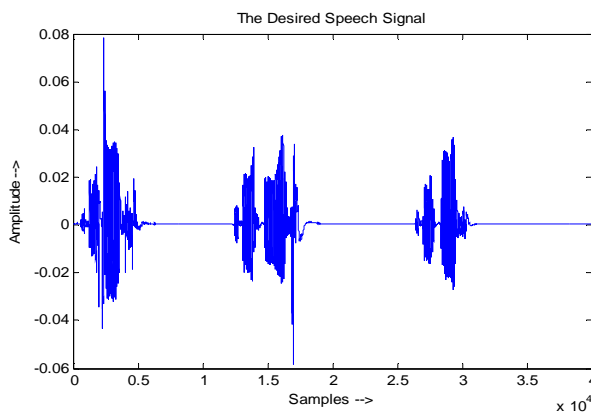

Figure 6. The desired speech signal

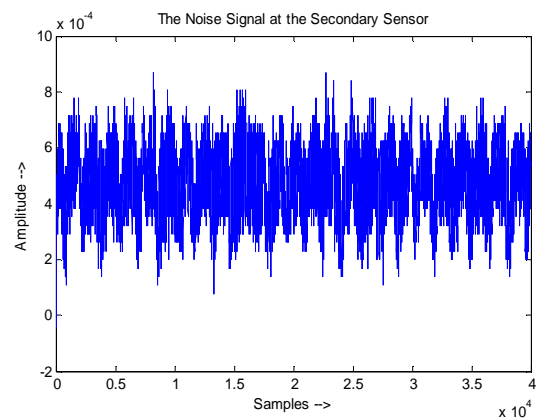

Figure 7. The noise signal

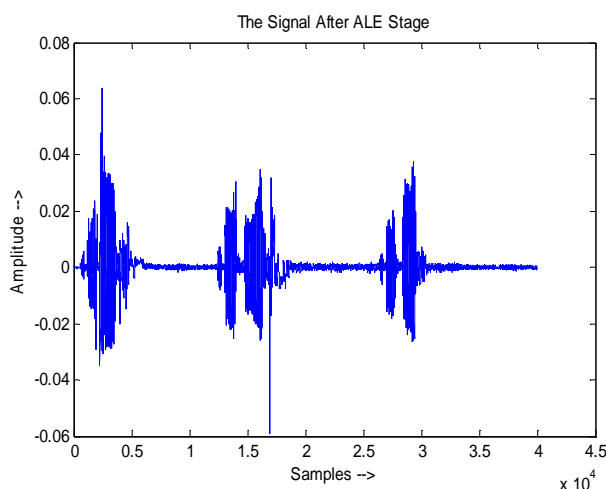

Figure 8. The signal after ALE 1 stage

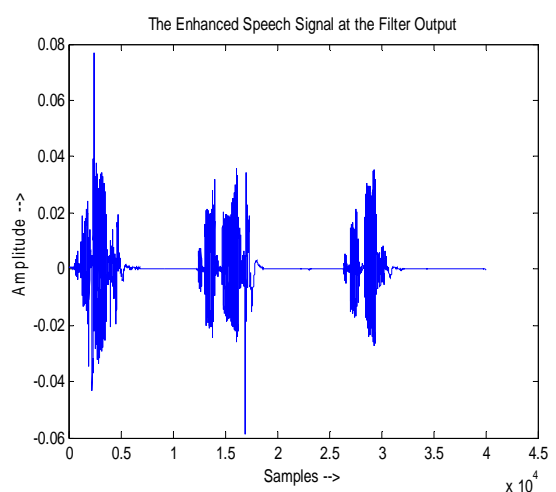

Figure 9. The signal after NLMS stage

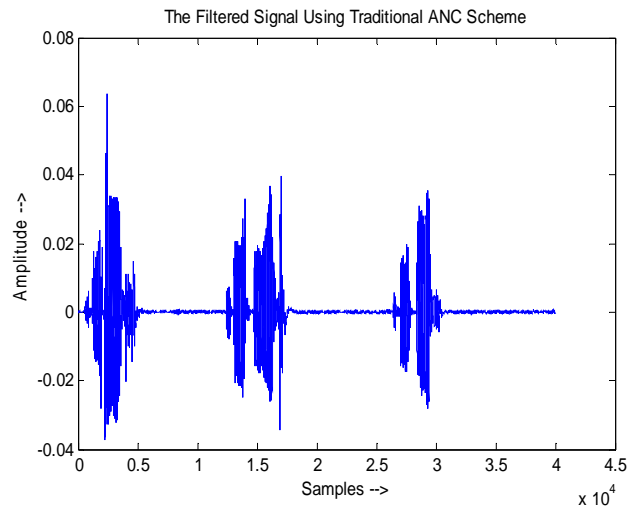

Figure 10. Filtered signal obtained using traditional ANC scheme

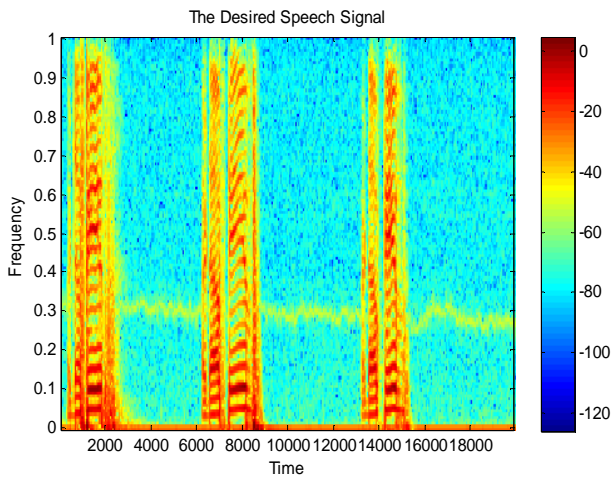

Figure 11. Spectrogram of desired speech signal

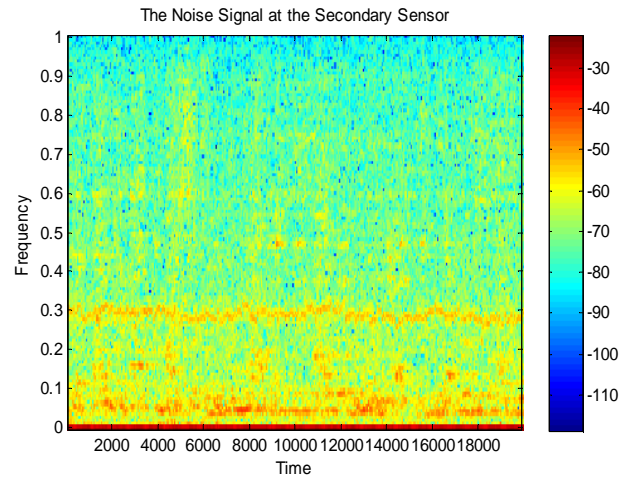

Figure 12. Spectrogram of noise signal

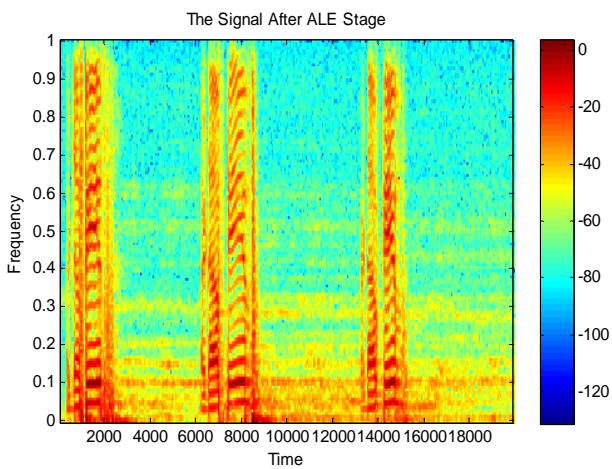

Figure 13. Spectrogram of signal after ALE1

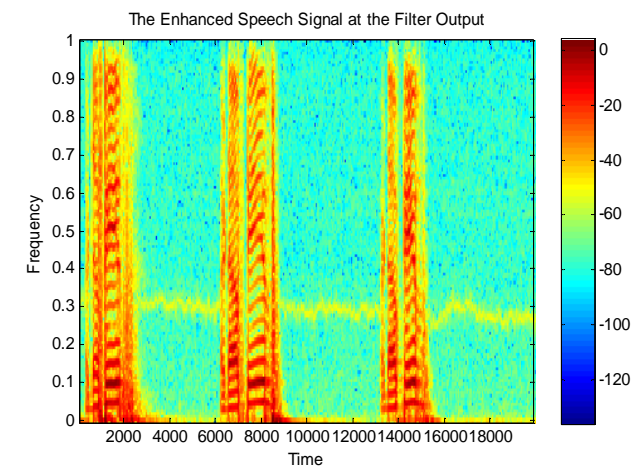

Figure 14. Spectrogram of output signal (after NLMS filter)

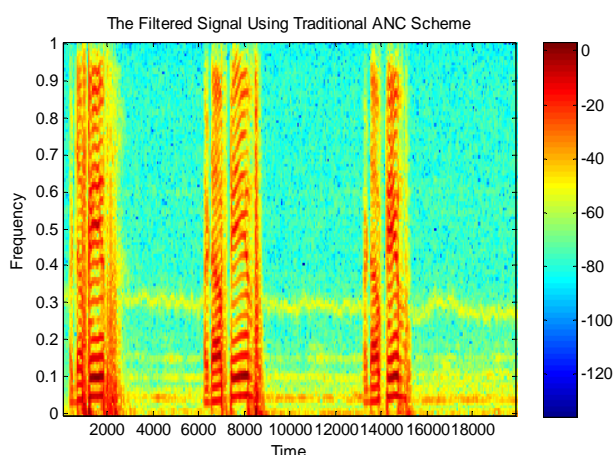

Figure 15. Spectrogram of filtered signal by traditional scheme Based-NLMS only

## 6. CONCLUSION

This paper presents the real-time implementation of the acoustic noise cancellation scheme proposed in [4] using MATLAB Simulink. The speech signal is corrupted by noise having two components; sinusoidal (or narrowband) noise and wideband (or Gaussian) noise. Two stages are employed in order to remove both the noise components. The ALE stage first removes the sinusoidal noise component, both at the primary and the secondary sensor stages, and then the NLMS filter removes the wideband noise from the ALE 1 stage's output signal, thus giving a clean enhanced speech signal at the output. The results are compared with the traditional ANC scheme, operated upon the same corrupted speech signal. The results suggest that ALE and NLMS produce a better clean speech signal as compared to the traditional ANC scheme that uses only the NLMS filter. The results presented in this paper can serve as a benchmark for further research in speech signal processing techniques, in which existing algorithms can be combined in various ways to produce better results for the filtered speech signal.

## REFERENCES

- [1] G. E. Warnaka, L. Poole and J. Tichy, "Active Attenuator", *US Patent number 4, 473, 906* September 25, 1984.
- [2] G.B. Chaplin, "Method and Apparatus for Canceling Vibration", *US Patent number 4,489,441* December 18, 1984.
- [3] A. Burguess, "Active Sound Control: Adaptive", *IEEE Trans. Signal Processing*, December 18, 1981.
- [4] Jafar Ramadhan Mohammed, "A New Simple Adaptive Noise Cancellation Scheme Based on ALE and NLMS Filter", *Fifth Annual Conference on Communication Networks and Services Research (CNSR'07)*, IEEE, 2007.
- [5] S. J. Elliott, P. A. Nelson, I. M. Stothers and C. C. Boucher, "Preliminary results of in-flight experiments on the active control of propeller-induced cabin noise," *Journal of Sound and Vibration* 128, pp. 355-357, 1989.
- [6] S. Haykin, *Adaptive Filter Theory*, Third edition, Prentice Hall, Englewood Cliffs, N.J. 1996.
- [7] Wolfgang Fohl, Jörn Matthies, Bernd Schwarz, "A FPGA-based adaptive noise cancelling system", *Proc. of the 12th Int. Conference on Digital Audio Effects (DAFx-09)*, Como, Italy, September 1-4, 2009.
- [8] N. Sasaoka, K. Sumi, Y. Itoh and K. Fujii, "A New Noise Reduction System Based On ALE and Noise Reconstruction Filter", *Proc. 2005 ISCAS*, pp. 272-275, 2005.
- [9] J. Nagumo and A. Noda, "A Learning Method for System Identification", *IEEE Trans. Automat. Contr.*, vol. AC-12, no. 3, pp 282-287, June 1967.
- [10] B. Widrow and S.D. Stearns, *Adaptive Signal Processing*, Prentice Hall, Inc. Englewood Cliffs, N.J. 1985.
- [11] S. Haykin and T. Kailath, *Adaptive Filter Theory*, Pearson Education (Singapore) Ltd., Indian Branch, Fourth Edition, 2003.
- [12] Sanjeev Kumar Dhull, Sandeep K. Arya, and O.P.Sahu, "Performance Comparison of Adaptive Algorithms for Adaptive line Enhancer", *IJCSI International Journal of Computer Science Issues*, vol. 8, Issue 3, No. 2, May, 2011.