



Recent Advances in Cockpit Aids for Military Operations

K.N. Atkin

Smiths Industries, Aerospace and Defence Systems Ltd. Cheltenham, UK

ABSTRACT

The object of this paper is to review some recent developments in cockpit displays and to suggest the way ahead in areas of new technology.

There is steady progress in most types of display technology but perhaps the most interesting topic is that of flat panels where new display media are promised to compete with the CRT. The paper also covers aspects of Head Up, Head Down and Helmet Mounted Displays.

1. HEAD DOWN DISPLAYS

1.1 High Brightness CRT Display

The predominant medium specified for primary Head Down Displays (HDD) in recent military aircraft is the CRT display with colour fast becoming the norm. The major criticism levelled at the shadow mask CRT of the standard of those now in service is limited brightness when operating in other than a cursive writing mode. There is only so much writing time available in each frame—if the frame refresh rate is too slow, flicker will be apparent. In the cursive mode only the symbology required is written by the electron beam within a given frame time. The writing speed can thereafter be slower, giving brighter symbology than a raster mode where the whole screen is traversed by the beams. A raster picture e.g. video imagery will 'wash out' in the higher ambient light levels to be expected in bubble cockpits of combat aircraft.

The trend away from projected map displays towards digital map systems which output a video signal to a multi-purpose colour display means that it is now necessary

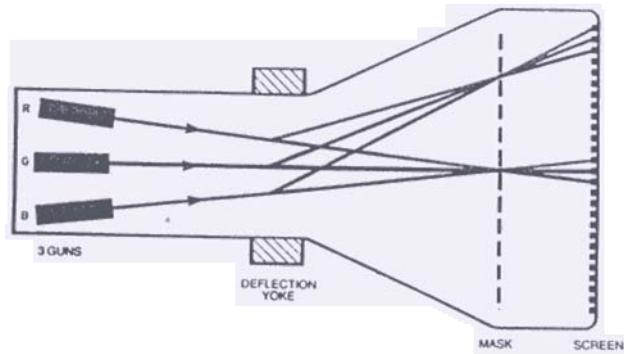

Figure 1 Shadow mask CRT schematic.

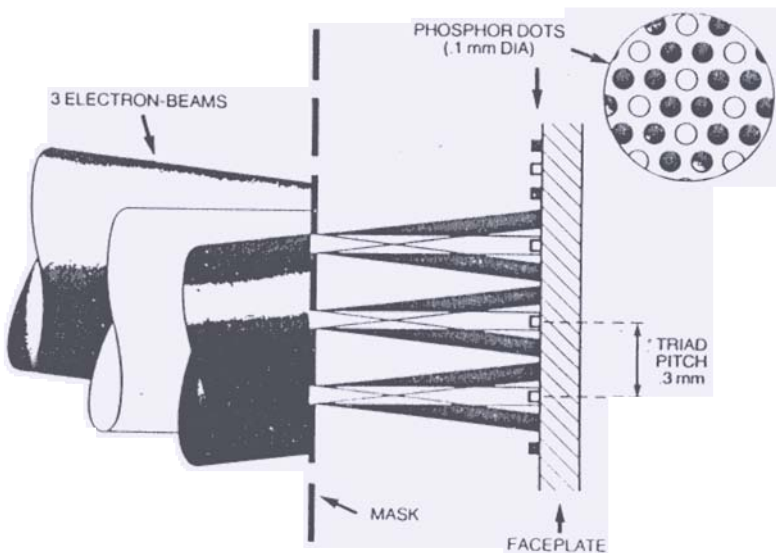

Figure 2. Shadow mask CRT detail.

to show a bright full colour raster picture which will be visible in those high ambient light levels. The CRT must therefore be capable of much higher brightness.

The maximum brightness of the shadow mask tube is limited by a number of factors. The electron beams from the three guns are constrained to fall only on their respective phosphor dots of the screen by the shadow mask as shown in Figs. 1 and 2. In the process the mask absorbs up to 80 per cent of the beam energy. If the beam energy is increased beyond a certain level, the mask gets hot and in the extreme the mask will distort causing misregistration of the beam and the target phosphor dots. Colour distortion and degraded picture readability results.

A new generation of improved rugged CRT has now been developed. There are several improvements in design but the main benefit comes from use of a stretched shadow mask. The mask is pre-tensioned over a rigid frame so that if heated due to a high beam current, much higher temperatures can be reached before distortion

occurs and therefore higher beam currents are practical. The result is that brightness levels 4–5 times higher can be achieved, quite adequate for a colour video picture. The beam spreading causing loss of resolution which is normally associated with higher beam currents is contained by use of a new electron gun design. The first production application of this new technology will be in the night attack version of the AV-8B and F18 for the USMC/USN and the Harrier GR5 for the RAF.

1.2 Flat Panel Displays

There is no doubt that the CRT sets the standard for primary display presentation. However, there is a great deal of money and effort going into development of the flat panel technologies such as Liquid Crystal Displays (LCD), Light Emitting Diodes (LED) and Thin Film Electroluminescent (TFEL).

LCD are non emissive requiring ambient or artificial lighting. LEDs and TFEL are emissive.

There are many different types of liquid crystal materials and the characteristics of these vary considerably. Care in defining the specific type is required before making comparisons.

Essentially Liquid Crystals operate by a re-arrangement of the molecular alignment within the material when a voltage is applied forming shutters or light valves. The shutter variety is most commonly black on white or white on black in appearance. The molecular re-arrangement is frequently combined with an optical element such as a polariser to give the desired blocking effect as shown in Figs. 3 and 4. The light valve types can include colour introduced by dyes within the material or by the use of filters over each pixel. The individual pixels commonly change from opaque to transparent when activated. A triad arrangement of blue, green and red filters over a matrix of adjacent pixels similar to the phosphor dot arrangement of a colour CRT will allow full colour. Backlighting is required. LEDs and TFEL glow and do not require additional lighting, therefore brightness control is by variation of the current applied independent of secondary lighting.

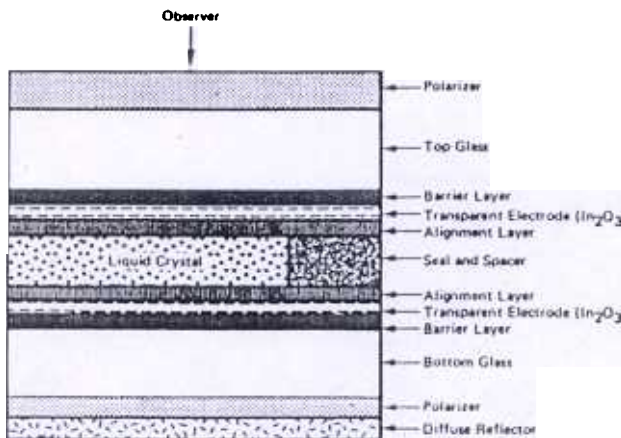

Figure 3. Typical liquid crystal display cell twisted nematic (MI).

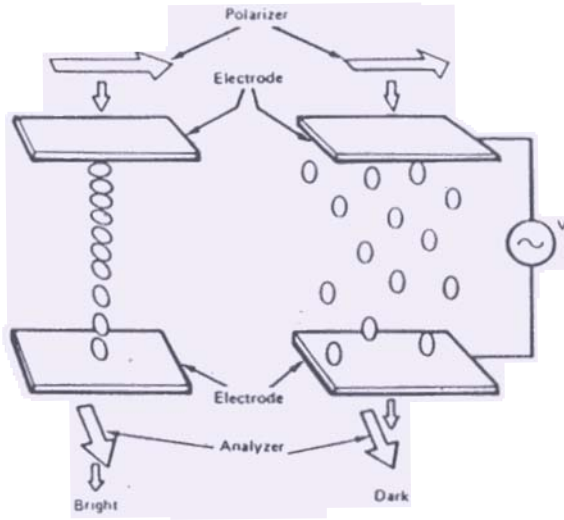

Figure 4. T-N liquid-crystal display operation

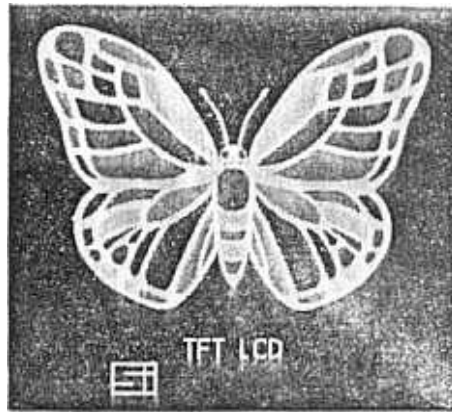

Figure 5 Thin film transistor matrix colour LCD example display (format A)

N1	EGT
- 12 -	- 12 -
- 10 -	- 10 -
- 8 -	- 8 -
- 6 -	- 6 -
- 4 -	- 4 -
- 2 -	
- 0 -	

RP11 . 100



Figure 6. Thin film transistor matrix colour LCD example display (format B).

The perceived benefits of flat panels are reduced weight, volume and power consumption. The bulk of the development effort is directed towards the commercial and domestic market for VDU, TV and Display Board applications. None of the technologies yet competes with the CRT for large area colour cockpit display surfaces and are unlikely to for at least 5 years, although impressive LCD matrix panels which will operate in a benign environment are available (Figs. 5 & 6). They all have significant technical hurdles to overcome. Dependent on the type of flat panel, brightness, contrast, environmental limitations or difficulty in multiplexing a large matrix make them unsuitable as primary flight or video displays in the cockpit at the moment.

The application area where significant penetration of the market in the short term is likely is that of fixed format displays where the flexibility and full colour range of the CRT is not necessary.

An example of such a fixed format display is the stand-by instrument panel utilising LCDs which GEC Avionics has produced. This unit flew successfully in an RAE helicopter in 1986. The LCD cells are arranged in segments against which there are fixed scale markings and in alpha-numeric blocks, where these are appropriate. Such a package absorbs much less space than conventional instruments and could be stored out of sight until needed. LCD displays are non emissive and so rely on ambient light, artificial backlighting or floodlighting to produce adequate brightness and contrast.

Another example of the fixed format display in the LED altimeter/ASI/VSI package produced by Smiths Industries for the Experimental Aircraft Programme (EAP) (Fig. 7). LEDs are arranged around fixed scales to provide pointers together with alpha- numerics, reproducing the layout of an electromechanical pointer dial.

A package of such LED displays for engine instrumentation is currently under development for the MD-88 airliner, (Fig. 8) where it will be several times more reliable than the alternative electromechanical instrument arrangement. The package will also be retrofitted to earlier models of the MD-80 series by a number of airlines.

The examples mentioned effectively reproduce conventional instruments but the application in which these fixed format solid state displays can be uniquely exploited is as secondary displays in locations where the structure of a conventional instrument would be impossible to accommodate. Unusual irregular shapes can be adopted to fill awkward corners of the instrument panel leaving the central areas for primary flight and mission orientated surfaces.

1.3 Flat CRTs

There is no doubt that at some time large area matrix flat panels suitable for cockpit use will come when the physical and chemical limitations of the materials employed are overcome. However the standard to be reached to compete with the CRT is not fixed in time. Not only are new high brightness shadow mask displays available, there is progress in the development of flat or more correctly 'thin' CRTs. Mullard Ltd have produced pre-production versions of their Slimscreen tube which has a novel folded electron beam path (Fig. 9).



Figure 7. Smiths industries experimental aircraft programme LED display.

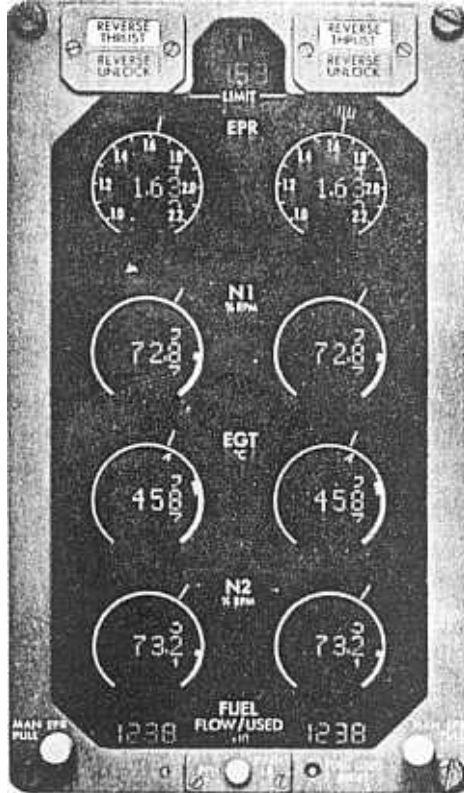

Figure 8. Smiths industries LED engine displays for the MD 80 series.

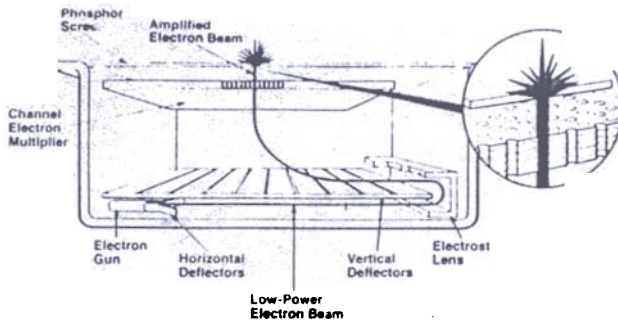

Figure 9. Mullard – Channel electron multiplier thin CR

The electron gun projects a low energy (600 eV) and hence easy to bend modulated beam towards a trough shaped mirror electrode at cathode potential which bends the beam through 180° and directs it across a series of strip electrodes extending the full width of the display area. The voltage on each strip is switched sequentially between 0 and 400V by means of overlapping ramped waveforms. The beam thus traces out a vertical path across the input to the micro channel plate electron multiplier. The gun assembly contains twin deflection plates which provide the line scan.

The channel plate operates at 1400V providing current amplification without affecting the spatial fidelity of the image. The electrons emerging from the micro channel plate are accelerated onto the phosphor by a high potential between the channel plate and the screen (15kV) giving a bright high resolution display. At the moment the display is essentially monochrome although work is going on to develop a colour version. In the meantime, limited colour is available using switched red and green LCD filters in a field sequential mode. The switching speed of the filters is too slow to cope with video or dynamic flight symbology but colour coded alpha-numerics are practical. The current development units have a useable screen area of about $6\frac{1}{4} \times 4\frac{1}{2}$ inches and a depth of less than 2 inches. If development progresses to include full colour there may be more than one alternative to the conventional shadow mask CRT in the future.

2. WIDE FIELD OF VIEW HEAD UP DISPLAYS

2.1 General

In recent years the drive to develop a passive night attack capability for strike aircraft has led to a requirement to display not only symbology but also IR imagery on the Head Up Display (HUD), both for piloting (in combination with Night Vision Goggles) and Target Acquisition.

In order to obtain adequate cues from the HUD picture and avoid a 'tunnel vision' effect, it has been necessary to adopt wider Fields of View (FOV) than the typical 15° Horizontal instantaneous FOV of HUDs which only show symbology.

Flight evaluation has determined that the minimum acceptable horizontal FOV is 20°. There have been two general paths taken to achieve the increased FOV, one associated with modification of existing equipment and the other of new design using diffractive optics.

2.2 Refractive HUD

The former approach has been taken for the night attack version of the AV-8B. Here the customer requirement dictated a solution in which as many of the existing electronics modules as possible should be retained and where mechanical changes should not require significant modification of cockpit structure. The result is a unit which largely retains the existing case and electronics but with redesigned optics. The standard AV-8B HUD is a conventional refractive type in which the FOV is limited by the size of the collimating exit lens and the viewing distance from the design eye position. Had a new larger diameter circular exit lens been used the increase in diameter would cause the HUD structure to infringe the ejection line. Moving the HUD forward (towards the nose of the aircraft) to clear the line would increase the viewing distance and offset the increase in FOV.

In order to avoid this compromise, the idea of truncating the lens was implemented. Here fore and aft portions of the exit lens are chopped off thus retaining the increased width of the lens but constraining the fore/aft increase. (Fig. 10) The increased width of the exit lens also necessitates a wider combiner glass. The net result of these modifications is an instantaneous horizontal FOV of 20° compared with 15° previously.

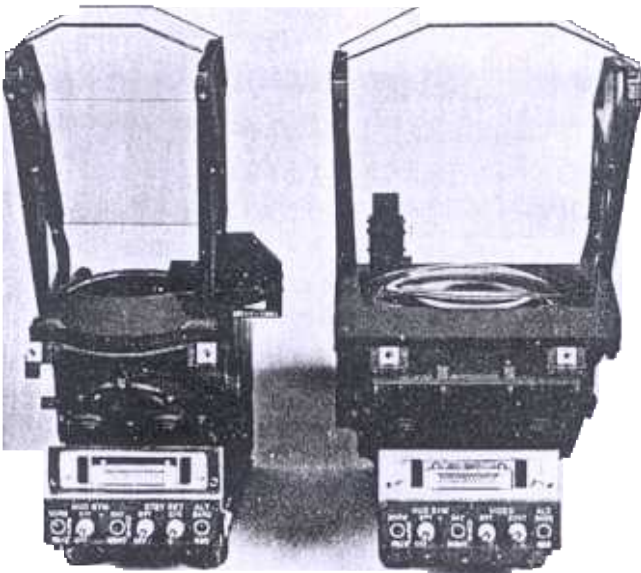

Figure 10. AV8B standard HUD and night attack for H

2.3 Diffractive HUD

The optical arrangement usually includes a diffractive element acting as a mirror collimator tuned to the phosphor of the CRT. That is, optical power is derived from a holographic surface that simulates a curved reflector and not from a refractive lens. There are two distinct variants of optical design, one employs off-axis ray paths to the combiner glass, the other so called quasi-axial paths as shown in Fig. 11. A typical maximum horizontal FOV for either variant is 30° .

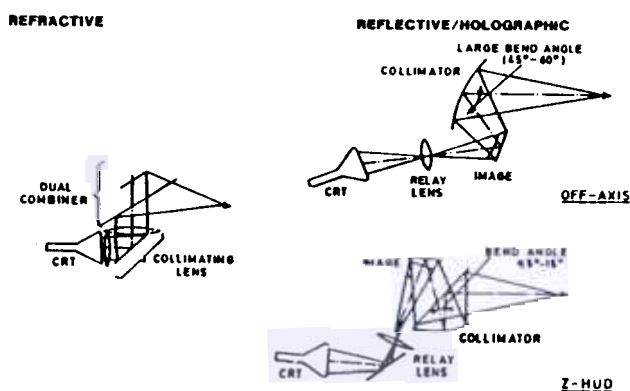

Figure 11 Refractive and reflective 'off-axis' and 'quasi-axial' ray path comparison.

2.4 Off-axis Optics

The off-axis approach looks elegant with a curved combiner glass free of any substantial framework around it, but the large angle between the incident and reflected rays (hence the term off-axis) of the combiner/collimator causes distortions and aberrations which have to be corrected in the relay lens assembly using aspheric lenses and other complex and expensive elements.

Additionally, some forced distortion of the CRT image is necessary to assist with correction. The combiner itself is a collimating element and so has some optical power. The curved shape and need for more than a plain mirror hologram makes the combiner an expensive component. Field of View is limited to a maximum of 30° because some of the optical problems mentioned will result in reduced readability and accuracy of the HUD at larger FOVs.

2.5 Quasi-Axial Optics – ZHUD

The quasi-axial WFOV HUD is typified by the GEC Lantirn design and more recently by the so called ZHUD developed by Smiths Industries in collaboration with RAE, Farnborough and Pilkington PE (Fig. 12). ZHUD employs a geometry in which the incident and reflected ray paths within the optical system subtend only a small angle of less than 10° with the optical axis and this results in a minimum of aberrations generated by the collimator requiring correction in the remainder of the optical system (Fig. 13).

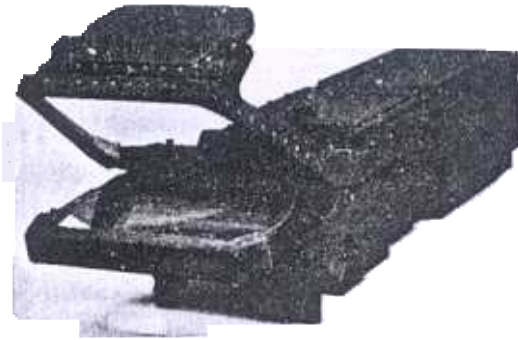

Figure 12. Z HUD.

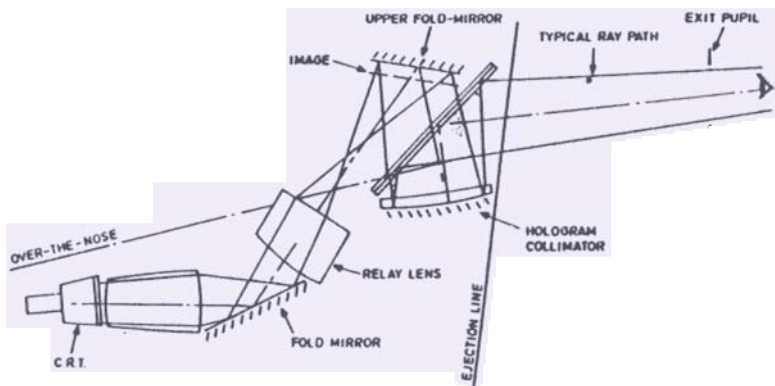

Figure 13. Z HUD optical system.

This results in a simpler and cheaper optical system. Another, primary characteristic of the ZHUD like other 'reflective' HUDs is that it is 'pupil forming'. Just in front of the pilot's eye position is projected an exit pupil. This exit pupil is most easily understood as a kind of invisible porthole. Whilst looking through the porthole the viewer sees the majority of the HUD display, but outside it he sees nothing. ZHUD has a large exit pupil allowing plenty of freedom of movement for the pilot's head.

The source of the ZHUD display is a narrow band phosphor high performance cathode ray tube (CRT) capable of generating very high brightness cursive (stroke written) displays as well as high resolution rasters of a variety of line standards as required. The optical path passes from the CRT through a relay lens system to the top mirror. The relay lens system performs two tasks, first to form an image of the CRT at the correct position for the collimator and secondly to pre-correct for optical aberrations in the collimator. Because of the low level of pre-correction, the relay lens is typically constructed using simple spherical lenses, although other surfaces are

introduced for windscreen correction where this is required. This simplicity of the relay lens is a major factor in minimising optical system costs.

The top mirror is non-transmissive, so protecting the optical axis from solar energy, and is outside the HUD field-of-view. It is configured so as to minimise its subtended angle to the viewer.

From the top mirror, the optical path is transmitted through the holographic combiner, reflected from the collimator back to the combiner where it is then reflected towards the pilot. The quasi-axial configuration of the collimator ensures that at any point on the combiner the ray paths that are required to be transmitted are at different angles from those which need to be reflected. The combiner hologram acts as a selective filter, efficiently reflecting light at only a few wavelengths which correspond to the CRT phosphor. Taking account of the angle sensitive nature of the hologram, the design results in a high efficiency of both combiner transmission and reflection, giving rise to high display brightness.

The combiner is flat and has no optical power, and as there is only one element between the pilot and the outside world, the pilot has a clear distortion free view.

The collimator, like the combiner, is holographic, but differs from the combiner in that it does have optical power and is not required to work in transmission.

Previous WFOV HUD designs have been limited to a total FOV of about $30^\circ \times 22^\circ$ but the robust nature of the ZHUD design means that FOV up to 40° or more are practical while retaining accuracy, good freedom of head movement and a distortion free image.

The ZHUD is currently installed in an RAE Jaguar for evaluation. In this installation it has been necessary to provide a fail safe collimator retraction mechanism which folds the collimator up out of the way during an ejection sequence. This was co-ordinated with Martin Baker and has been approved by the RAF Institute of Aviation Medicine.

The ZHUD is designed for display of WFOV raster video as well as high contrast cursive symbology with plenty of growth potential in the basic concept.

2.6 Collimated Integrated Display

There have been suggestions based on evidence from simulator assessments that speed of interpretation of head down displays would be improved if the pilot did not have to refocus when transferring his eyes from the HUD, which is collimated to infinity, to a normal head down display at a distance of say 22 inches from the eye. The difference in time will be small, but even fractions of a second may count in a combat aircraft.

In order to reduce the delay, the concept of a combined collimated HUD and HDD was arrived at in which the head down element is immediately below the HUD. RAE(F) commissioned the Collimated Integrated Display (CID) in order to investigate the concept in a ground simulator and the test programme should be commencing soon.

It will be interesting to see whether the eye will actually stay focussed at infinity as the transfer of attention from head up to head down takes place when the structure around the CID subtends a major part of the FOV of the eye—particularly if conventional CRT displays are adjacent to the CID. The evaluation may well result in some major re-thinking of the cockpit display mix if the concept proves successful.

3. HELMET MOUNTED DISPLAYS

The new generation of battlefield helicopters such as the AH64 Apache and the Agusta A129 Mangusta are equipped with monocular helmet mounted displays (HMD) for both pilot and gunner.

The Apache HMD is a device with a FOV of 40° and is used to display symbology and the video imagery from a nose mounted FLIR. The steerable FLIR turret is pointed via a head tracking system.

There are some shortcomings in this type of display. Continuous viewing of disparate monocular images between eyes can cause eye strain. Also the eye relief of the combiner glass is rather small, making the assembly difficult to use when such apparel as chemical protection masks or standard spectacles are worn. In this case, the combiner can no longer be positioned close enough to the eye for the pilot to see the total FOV. The 40° FOV of the current generation was imposed by weight and size considerations as well as compromise between FOV and adequate resolution of the image shown.

Driven by customer demands, efforts are now being made in the US and UK to develop binocular systems with an increased FOV and eye relief. Binocular displays include the Hamilton Standard display aimed at the Boeing/Sikorsky entry in the LHX competition. Some novel optics driven by two miniature CRTs are intended to produce a FOV of up to 90°. What is not clear is where sensors such as FLIR giving adequate resolution at such a large FOV will come from.

Other manufacturers known to be developing binocular or bi-ocular displays are GEC with a 40° FOV display exhibiting good eye relief and Hughes with a bi-ocular display driven by one CRT via a beam splitter to a holographic visor combiner. As has been highlighted at a recent RAeS symposium, the compromise between satisfactory helmet mounting characteristics and adequate optical performance is not an easy one and it will be interesting to see how these designs evolve into practical production hardware.

4. CONCLUSIONS

There are numerous detail improvements taking place in display technology. Diffractive Head Up Displays are becoming the 'norm' for aircraft with a night attack role and the new fighters such as EFA and ATF are likely to include such devices.

The drive to develop flat panels capable of competing with the colour CRT is absorbing huge resources. The priority of the mainly Japanese companies involved is

first the commercial and domestic market as was the case with the colour CRT. However, derivations suitable for aircraft use will come. Meanwhile the CRT is evolving and improving ensuring a dominant position as the primary Head Down Display medium for some years.

Flat Panels will be increasingly used as fixed format secondary displays as a replacement for electromechanical instruments.

The needs of the operators of battlefield helicopters is forcing the pace in the development of binocular Helmet Mounted Displays with superior FOVs and human factor characteristics to those of the past.

ACKNOWLEDGEMENTS

The author wishes to express his thanks for the assistance given by GEC Avionics and Mullard Ltd as well as colleagues within Smiths Industries.