

AN INVESTIGATION OF THE PILE NEUTRON  
IRRADIATION OF TETRAMETHYLAMMONIUM CHLORIDE

by

DONALD WINSTON RATHBURN  
B. A., Park College, 1958

---

A MASTER'S THESIS

submitted in partial fulfillment of the

requirements for the degree

MASTER OF SCIENCE

Department of Chemistry

KANSAS STATE UNIVERSITY  
Manhattan, Kansas

1962

LD  
2668  
T4  
1962  
R39  
C.2  
Documents

TABLE OF CONTENTS

INTRODUCTION . . . . .	1
LITERATURE SURVEY . . . . .	4
General . . . . .	4
Previous $N^{14}(n,p)C^{14}$ Studies . . . . .	8
EXPERIMENTAL . . . . .	17
Sample Preparation and Irradiation . . . . .	17
Radiochemical Counting Techniques . . . . .	21
Analysis of the Irradiated Sample . . . . .	25
Determination of Total Carbon- $^{14}$ Activity . . . . .	28
Separation of Evolved Gaseous Activity . . . . .	32
Separation of Non-volatile Components . . . . .	35
RESULTS AND DISCUSSION . . . . .	38
SUMMARY . . . . .	48
ACKNOWLEDGMENTS . . . . .	50
REFERENCES . . . . .	51

## INTRODUCTION

The study of the chemical consequences of atoms formed in nuclear reactions began with the experiments of Szilard and Chalmers (40) in 1934. They demonstrated that the dissipation of energy by the recoiling atom emitted from the compound nucleus following radiative neutron capture was sufficiently great to rupture bonds of many of the associated atoms. Since the pioneering work of Szilard and Chalmers, interest in nuclear transformations has been directed toward an understanding of the chemical reactions that are involved. The study of "hot-atom" chemistry has also been pursued with the purpose of preparing radio-labeled compounds of high specific activity for use in other research studies. These processes are made feasible by the differences in the chemical state of the resulting radioactive atom and the atom from which it was formed.

Libby (35) has defined hot atom chemistry as, "the chemistry of excited atoms formed by nuclear reactions in an otherwise undisturbed medium". Hot atoms may be produced by nuclear reactions in several ways. For the production of non-isotopic atoms, the  $(n,p)$ ,  $(n,\alpha)$  and  $(\gamma,p)$  reactions may be utilized. However, for a study of the chemical state of the radioactivity produced, a conveniently long half-life is usually necessary. By making the appropriate chemical separations, the chemical species into which the radioactive atom is incorporated may be determined.

In normal pile irradiations, the compound being irradiated is usually subjected to both neutron and gamma radiation. The

average energy of the gamma rays in the Oak Ridge graphite reactor has been estimated to be approximately 1 Mev (8). Photons of 1 Mev do not possess sufficient energy to initiate nuclear reactions. However, energies of less than 4 ev are sufficient to break most chemical bonds. Thus the gamma rays possess enough energy to cause bond rupture and radiation damage to the tetramethylammonium chloride sample. This phenomena, however independent of the neutron irradiation, may have a significant effect upon the final state of the recoiling carbon-14 atom. It should be stressed, also, that because approximately 4 ev are necessary to break most chemical bonds, thermal neutrons will not themselves cause bond rupture; their kinetic energy is only about 0.025 ev.

The energy dissipated following neutron capture depends upon the increase in binding energy. This binding energy may be calculated according to the following equation:

$$(B.E.)_n = - [Z^{N^A+1} - (Z^{N^A} + {}_0n^1)] 931 \quad (1)$$

$(B.E.)_n$  is the binding energy in Mev attributable to the captured neutron;  $Z^{N^A}$ ,  $Z^{N^A+1}$  and  ${}_0n^1$  are the masses of the capturing nucleus, the compound nucleus and the neutron, respectively.

The binding energy is defined as the work necessary to disassemble a nucleus into neutrons and protons, or, it is the energy liberated when Z protons and N neutrons combine to form the nucleus,  $Z^N + Z$ . This concept is somewhat analogous to the heat of formation of a chemical compound. In capture reactions

it represents the mass excess that must be lost by the compound nucleus.

In thermal neutron reactions involving very light or heavy nuclei, heavy charged particle emission is likely if the nucleon receives enough energy to penetrate the coulomb barrier. The de-excitation, or particle emission, will impart recoil to the emitting nucleus according to the laws of conservation of momentum and energy. The average recoil energy,  $\bar{E}_m$ , of the product atom when a particle of the mass,  $m$ , is emitted from the compound nucleus may be calculated from:

$$\bar{E}_m = (E_1 + Q) \left(\frac{m}{M}\right) + E_1 \left(\frac{m^2}{M}\right) \quad (2)$$

where  $E_1$  is the energy of the incident particle,  $Q$  is the energy released in the nuclear reaction,  $m_1$  is the mass of the incident particle and  $M$  is the mass of the compound nucleus. Equation (2) is valid only when the mass of the recoil particle is much greater than the mass of the incident particle. The calculations using equation (2) show that the average recoil energy,  $\bar{E}_m$ , of the carbon-14 atom is approximately 40,000 ev, since  $Q = 0.628$  Mev. As mentioned earlier, this is sufficient energy to break the chemical bonds surrounding the nitrogen atom.

Upon recoil the atom moves through the solid matrix at a high velocity. The energy of recoil is dissipated by collisions with other molecules, until sufficiently thermalized to enter into chemical combination.

In this thesis, the radioactive products observed in the

$N^{14}(n,p)C^{14}$  nuclear transformation of tetramethylammonium chloride are reported, and plausible reaction sequences are proposed.

## LITERATURE SURVEY

### General

At present, chemical studies of nuclear reactions have given results from which some broad generalizations can be drawn. However, the results from one system are seldom of much aid in predicting the outcome of other systems. But it is obvious that the principle effect will be bond rupture and atomic dislocation within the crystal.

Two early theories were advanced to explain what happens to the recoiling atom as evidenced by its final chemical state. These theories are the "billiard-ball collision-epithermal collision theory", proposed by Libby (20,21) and the "random fragmentation" or "nest of radicals" theory, proposed by Willard (44).

Originally these theories were developed in order to explain the results obtained from  $(n,\gamma)$  studies of alkyl halides, however, they have been applied fairly successfully to other systems.

In the billiard-ball collision theory, the recoiling atom loses its energy in elastic collisions with other atoms. Libby (20) assumed that the transfer occurs as if the atoms were isolated, as in the gas phase. The fractional energy loss can be calculated from:

$$\frac{E_{\text{loss}}}{E_{\text{initial}}} = \frac{4M_1M}{(M + M_1)^2} \cos^2 \theta \quad (3)$$

where  $M$  and  $M_1$  are the masses of the impinging and the struck atom, respectively, and  $\Theta$  is the angle between their paths after collision. A head-on collision between atoms of nearly equal masses would project the struck atom into the medium with nearly a 50 per cent energy transfer to the struck atom. The recoiling atoms would transfer their respective energies to other atoms and molecules within the medium. The transference of this energy would result in disruption of the lattice, forming a solvent "cage" of radicals and ions. A pear-shaped region would be formed with a volume of the order of  $10^3$  molecules. The recoil atom, being in the solvent cage, would have a high probability of combining with the radicals and/or ions to form various stable chemical species.

If the recoiling atom does not lose its energy by head-on collisions but undergoes a series of glancing collisions and loses its energy a fraction at a time, the recoil atom might escape from the solvent cage without recombining with the radicals in the "cage". When the energy of the recoil atom has decreased until it approaches the bond energies of molecules, inelastic collisions with the molecules become prevalent. In these collisions the struck molecule may dissociate by acquiring internal vibrational energy. The radicals produced might combine with the recoiling atom to form a stable molecule. These reactions were called epithermal reactions by Friedmann and Libby (10). The epithermal reactions were a necessary postulate since the billiard-ball theory predicts that the recoil atoms would recombine

to form the parent molecule. Although investigations have shown that the recoil atom may be incorporated into a parent molecule, many studies have shown that this is not always the case. 10 ev approximately represents the upper range of bond energies, so that when the energy of the recoiling atom drops below this value, epithermal reactions are probable.

In his review of 1955, Willard (44) advanced the "random fragmentation" theory. This theory postulates that the recoiling atom encounters a solvent (or matrix) molecule before traveling a molecular diameter. An elastic collision cannot occur because the struck molecule is backed and surrounded by a close packed wall of other molecules. This results in a dissipation of energy by the breaking of bonds in an indiscriminate manner within the immediate vicinity of the energetic atom. The energetic atom may combine with some of these radicals before it becomes thermalized. Such reactions are called "hot" reactions since they are independent of temperature. However, Willard also proposed a process by which recombination becomes possible following thermalization. Because of the two types of reactions, thermalized and non-thermalized, the "random fragmentation" theory predicts that many different types of products may be formed. This is more in agreement with observed data and represents an improvement over Libby's theory.

Harbottle and Sutin (14) have constructed a model for nuclear reactions in solids based on the "displacement spike" concept, proposed by Seitz and Koehler (36). This model distin-



guishes between reactions in two regions: the hot region (above 0.025 ev) and the thermal regions.

The reactions characterized by the hot region are of two general types; (a) replacement of an atom within a molecule by the recoil atom; and (b) reactions more characteristic of the thermal region but which are modified because of higher temperatures.

The displacement spike theory was originally formulated for monatomic metals, ordered alloys or monatomic valence crystals; therefore, collisions of similar masses are considered. The essentials of this model are summarized below:

- (1) The energy required to displace an atom to an interstitial position in a well-bound solid  $E_d$ , is taken as approximately 25 ev.
- (2) The number of collisions required to reduce the energy below 10 ev for a primary atom of 40,000 ev is about 10.
- (3) Where  $E \lesssim 10$  ev and there is insufficient energy for displacement reactions, inelastic collisions or epithermal reactions are proposed. In this case inelastic collisions are the result of energy being lost as vibrational energy in the struck atom or complex ion.
- (4) The mean free path,  $L$ , of an atom with an energy of 40,000 ev is about  $10 r_s$ , where  $r_s$  is the atomic diameter, and  $L_s$  decreases to  $r_s$  as  $E$  decreases to

$E_d$ .

- (5) The slowing down time, the time necessary for the recoil atom to drop below  $E_d$ , is calculated to be about  $10^{-13}$  seconds.
- (6) The hot-zone in an ionic lattice thus involves a volume of the order of 1000 atoms which remains at a temperature above the melting point (taken as  $1000^\circ$  K.) for  $10^{-11}$  seconds and the radius of this zone,  $r_m$ , is about  $10 r_s$ .

From the above considerations it is apparent that the "displacement spike" theory suggests local high temperature reactions and is useful in qualitatively determining the nature of the reactions.

#### Previous $N^{14}(n,p)C^{14}$ Studies

Since the  $(n,\gamma)$  studies of Szilard and Chalmers, a number of recoil processes have been studied. Of the various nuclear reactions leading to an energetic radioactive atom, the  $(n,\gamma)$  reaction has probably been more thoroughly investigated. This situation has occurred because most elements have at least one isotope with a reasonable cross section for radiative neutron capture and a convenient half-life to allow a study of its chemical state.

In contrast,  $(n,p)$  reactions have not been as thoroughly studied, especially the  $N^{14}(n,p)C^{14}$  process. This is due to the relatively low cross section of nitrogen-14 and the long half-

life of the carbon-14 beta particle making it necessary to irradiate for fairly long periods and utilize rather sensitive instrumentation for counting.

The  $N^{14}(n,p)C^{14}$  studies have been made on nitrogen-containing solids, liquids, gases or aqueous solution of nitrogen-containing compounds. Irradiated solids have always been dissolved in water following irradiation. This dissolution can sometimes aid in interpreting the recoil process. For example, if a solid that contains no oxygen is irradiated, and a final product is obtained containing this atom; the oxygen must arise from the reaction of some species in the solid with water. This simple bit of information is valuable for interpretations and even for the design of mechanisms.

In 1946, Yankwich, Rollefson and Norris (56) reported the first results of a  $N^{14}(n,p)C^{14}$  process in their studies of the irradiation of ammonium nitrate, urea, hydrazinium chloride, aniline and glycine. Similar studies of aqueous solutions of ammonium nitrate, urea and pyridine were also reported. The analysis of the ammonium nitrate revealed that over 90 per cent of the activity was in the form of carbon dioxide and carbon monoxide. However, hydrogen cyanide was found to contain a large fraction of the activity from urea and hydrazinium chloride. The major portion of the activity from glycine was found to be in methanol. The authors reported inconclusive results from their irradiations of aqueous pyridine and aniline.

Yankwich, et al. interpreted their results to indicate that:

(1) carbon dioxide and carbon monoxide are preferentially formed when the irradiated compound contains oxygen and carbon dioxide tends to be formed in greater yields than carbon monoxide; (2) methane appears only in the absence of oxygen and in compounds with a high hydrogen density; (3) hydrogen cyanide is formed only in the absence of high oxygen concentration; and (4) methanol and formic acid occur only in the presence of water.

The disruption of the crystal lattice by the recoiling carbon-14 atom provides a basis for assuming radical formation and the trapping of normally unstable species. Yankwich with Vaughan (57) and Cornman (54,55) irradiated beryllium nitride, ammonium bromide and ammonium sulfate. They concluded that the final products from the irradiation of beryllium nitride provided evidence that the skeletons of complex chemical species were formed and stabilized within the crystal lattice. Likewise, because of the large number of C-H linkages in the products, the authors interpreted this as evidence for the high stability of these linkages within the matrix. In each case the results were interpreted in terms of the radiocarbon species being trapped in the matrix.

Certain other  $N^{14}(n,p)C^{14}$  recoil studies have been made. The principal products from these studies have been tabulated in Table 1. This table also includes reported labelling studies and the percent of the activity isolated in each study.

A number of excellent reviews on hot-atom chemistry are available. Yankwich (53) has discussed in detail the chemical effects of the  $N^{14}(n,p)C^{14}$  recoil process. Wolf (45) has discus-

sed the use of the recoiling carbon-14 atom as a labelling technique. In addition articles of general interest have been authored by Muxart (29), Collinson and Swallow (9) and Brinkman (4).

Table 1. Compounds Irradiated and Principal Products.

Compound	Principal Products	Per cent Isolated	Reference
Acetamide	6% HOAc by basic hydrolysis 8% HOAc by acid hydrolysis 7% Propionic acid by basic hydrolysis 5% Propionic acid by acid hydrolysis	15	48,49
Acridine	3.5% acridine, 0.2% naphthalene, 3% gases, remainder in a polymer	100	47
Alanine	0.2% alanine	NP	46
Aliphatic amines	Benzene target. 1.9% benzene, 3.4% toluene	NP	46
**NH <sub>3</sub>	94% CH <sub>4</sub> (at varying pressures)	~100	51
*NH <sub>3</sub>	Anthracene target. 0.009% anthracene	NP	46
**NH <sub>3</sub>	Methane target. 60% CH <sub>4</sub> , 34% polymeric, 6% C <sub>2</sub> H <sub>6</sub>	100	51
**NH <sub>3</sub> + Ne	~ 97% CH <sub>4</sub>	~ 100	51
**NH <sub>3</sub> + O <sub>2</sub>	90% CH <sub>4</sub> , 6% CO <sub>2</sub>	96	51
**NH <sub>3</sub> + Xe	~ 100% CH <sub>4</sub>	~ 100	51
Ammonium bromide	80% CH <sub>3</sub> NH <sub>2</sub> , 7.5% CH <sub>4</sub> , 6% HCHO, 2% HCN	100	57
Ammonium nicotinate	16% malonic acid, 3% glutaric acid	35	2
Ammonium nitrate	~ 90% CO <sub>2</sub> and CO	100	56
*Ammonium nitrate	> 90% CO <sub>2</sub> and CO	100	56,33
Ammonium oxalate	11% C <sub>2</sub> O <sub>4</sub> H <sub>2</sub>	23	13

\* Liquid or solutions

\*\* Gas phase

NP Data not presented in the cited reference.

Table 1. Cont.

Compound	Principal Products	Per cent Isolated	Reference
Ammonium sulfate	40% CO <sub>2</sub> , 16% CH <sub>3</sub> NH <sub>2</sub> , 16% HCOOH, 13% HCHO	100	54
Aniline	3% aniline	NP	46
Aniline	Inconclusive results	--	56
Aniline	2% CH <sub>4</sub>	23	23
Aniline	Benzene target. 2.5% benzene, 3.2% diphenylmethane	83	23
Aniline	CCl <sub>4</sub> target. 31% CCl <sub>4</sub>	31	15
Aniline <sup>1</sup>	Isopentane target. 9% 3-methyl pentane, 7% 2-methyl pentane, 6% 2,2-dimethylbutane, 28% polymer	100	22
Aniline	Methanol target. 34% CH <sub>4</sub> , 16% CH <sub>3</sub> OH, 9% n-propanol	100	23
Aniline <sup>1</sup>	n-pentane target. 12% n-hexane, 8% 3-methyl pentane, 6% n-heptane, 26% polymer	100	22
Aniline hydrofluoride	Extraction studies	100	23
Aniline oxalate	3% C <sub>2</sub> O <sub>4</sub> H <sub>2</sub> , 8% aniline	11	58
Azobenzene	Stilbene target. As mole fraction of azobenzene increased, so also did the activity in azobenzene. @ 10 & 71.5 mole % azobenzene, small amounts of activity were found in benzalaniline.	100	50
5,6-benzacridine	0.2% 5,6-benzanthracene 4.0% 5,6-benzacridine	4.2	30,31

<sup>1</sup> Libby and MacKay indicated that aliphatic amines yielded similar results, suggesting products were characteristic of solvent. NP Data not presented in the cited reference.

Table 1. Cont.

Compound	Principal Products	Per cent Isolated	Reference
Benzamide	4.1% benzamide, 3.3% aniline	8.4	6
Benzamide	4.1% benzamide, 0.7% acetophenone, 3.8% benzoic acid.	NP	46
Benzanilide	12% CO	22	5
Benzene	4.2% phenol, 1.5% benzamide, 0.9% benzoic acid	9.0	6
Beryllium nitride	26% CH <sub>4</sub> , 19% guanidine, 11% methylhydrazine, 14% CO <sub>2</sub> .	100	52,55
Cyanoguanidine	40% cyanoguanidine, 17% guanidine, 13.5% acetamide, 13% polymeric material	90	18
Ethylamine	7% CH <sub>4</sub> , 22% ethylamine, 12% butylamine	100	23
Ethylamine hydrofluoride	16% ethylamine, 14% n-propylamine, 15% methyl diphenylamine	100	23
4-ethylpyridine	1% 4-ethylpyridine	NP	46
Glycine	50% CH <sub>3</sub> OH	100	56
Hydrazine oxalate	13% HCOOH, 11% C <sub>2</sub> H <sub>2</sub> O <sub>4</sub> , 10% CH <sub>3</sub> NH <sub>2</sub> , Naphthalene target. No measurable ams. incorporated.	45	60
Hydrazinium chloride	71% HCN	100	56
Isoquinoline oxalate	1.5% C <sub>2</sub> O <sub>4</sub> H <sub>2</sub> , 10% isoquinoline	11.5	58
Methylamine	7% CH <sub>4</sub> , 4% C <sub>2</sub> H <sub>6</sub> , 10-20% polymeric	~ 30	51
Methylamine hydrofluoride	16% methylamine, 22% tributylamine	100	23
n-methyl aniline oxalate	4% C <sub>2</sub> O <sub>4</sub> H <sub>2</sub> , 11% N-methylaniline	15	58



Table 1. Cont.

Compound	Principal Products	Per cent Isolated	Reference
2-methyl pyrazine	Benzene target. 1.9% benzene, 1.0% toluene.	3	48
2-methyl pyrazine	1,1-dimethylcyclopentane target. 0.1% 1,1-dimethylcyclopentane	NP	46
2-methyl pyrazine	Trans-1,2-dimethylcyclopentane target. 0.3% trans-1,2-dimethylcyclopentane.	NP	46
2-methyl pyrazine	Trans-1,3-dimethylcyclopentane target. 0.4% trans-1,3-dimethylcyclopentane.	NP	46
2-methyl-pyrazine	Toluene target. 1.6% toluene, 0.3% o-xylene, 0.3% m-xylene, 0.2% p-xylene, 0.5% ethylbenzene.	NP	46
$N1(CN)_2NH_3C_6H_6$	6.7% $C_2H_2O_4$ , 2.5% HCN, 4% m-dinitro benzene	13.8	59
$(NH_4)_2(N1(CN)_4)$	Benzene target. 4.0% benzene.	NP	46
$(NH_4)_2(N1(CN)_4)$	Benzene target. 1.4% benzene.	NP	46
Nicotinamide	3.4% nicotinamide, 0.4% benzoic acid	NP	46
Phenylalanine	5% aspartic acid, 4% HCOOH, 4% glutamic acid	36	1
* Pyridine	Inconclusive results	--	56
Pyridine	$CCl_4$ target. 31% $CCl_4$	31	15
Pyridine oxalate	8% benzene	15	11
Pyridine oxalate	2% $C_2O_4H_2$ , 2% pyridine	4	58
Quinoline oxalate	8% naphthalene, 7% $H_2C_2O_4$	19	12,61

\* Liquid or solutions

NP Data not presented in the cited reference.

Table 1. Cont.

Compound	Principal Products	Per cent Isolated	Reference
Quinoline oxalate	1% $C_2O_4H_2$ , 2% quinoline	3	58
Triphenyl-amine	Extraction studies	100	23
Urea	55% HCN, 40% $CO_2$	100	56

## EXPERIMENTAL

### Sample Preparation and Irradiation

Samples of tetramethylammonium chloride (Eastman Red Label) were recrystallized three times from an ethanol-water mixture and dried in an electric oven at  $130^{\circ}$  C. (27). A quartz ampoule, 8 cm x 2 cm diameter, was treated for 12 hours with chromic acid, washed with distilled water and thoroughly dried in an electric oven. The quartz ampoule was filled with 4.940 grams of tetramethylammonium chloride. The ampoule was connected to a vacuum line with a quartz 10/30 standard taper joint and the system was flushed repeatedly (at least four times) with argon gas to remove all traces of water vapor and oxygen. Between flushings the system was evacuated using a mercury diffusion pump. After the final flushing the system was evacuated to a pressure below one micron and the ampoule sealed off using a hand torch. The ampoule and system were checked repeatedly for leaks using a Tesla coil. Thermal decomposition of the sample during the sealing process was avoided by using a liquid nitrogen trap to surround the main body of the ampoule.

The irradiation of tetramethylammonium chloride was carried out at the Oak Ridge National Laboratories in the ORNL graphite reactor. The neutron flux was reported to be approximately  $5 \times 10^{11} \text{ cm}^{-2} \text{ sec}^{-1}$ , with an accompanying gamma-ray flux of  $4.9 \times 10^5 \text{ r hr}^{-1}$ . The sample was irradiated for a period of 28 days at a temperature less than  $80^{\circ}$  C. Shut-downs for repairs or

maintenance were obviously required during this period; thus continuous irradiation was not maintained. Following the irradiation the sample was stored for a few days at Oak Ridge and then shipped to our laboratory. The sample was stored for one month before the ampoule was opened and analyses made.

The gamma-ray flux present during pile-irradiation induces decomposition. In order to estimate the extent of this damage, it is necessary to know the corresponding G-value. The G-value is the number of molecules decomposed or formed by the absorption of 100 ev of energy. Lemmon, Parsons and Mazzetti (19) have shown that  $-G(\text{CH}_3)_3\text{N}(\text{C}_2\text{H}_5)\text{Cl}$  is 1.7. Since the structure of this molecule is very similar to tetramethylammonium chloride; a value of 1.7 is estimated for calculation purposes.

One roentgen is equivalent to the absorption of approximately 100 ergs per gram of material. The gamma flux for the above irradiation was approximately  $5 \times 10^5 \text{ r hr}^{-1}$ . Thus the energy absorbed by the sample is calculated to be  $5 \times 10^7 \text{ ergs/gm/hr}$ . The sample was irradiated for approximately 670 hours. This shows that the total energy absorbed by the sample was  $3.4 \times 10^{10} \text{ ergs/gm}$  or  $1.68 \times 10^{11} \text{ ergs}$  for the 4.940 gm sample. Converting ergs to electron volts, multiplying by the G-value and the reciprocal of Avogadro's number, the number of moles decomposed is found to be  $3 \times 10^{-3}$  moles. Thus, the per cent of the sample decomposed by gamma rays would be approximately 4.5 per cent.

The specific interest of this irradiation study was to determine the stable chemical species which incorporated the recoil

carbon-14 atoms. The chemical effects produced by the gamma radiation were of secondary importance; however, it did have its effect upon the recombination reactions.

The irradiation of tetramethylammonium chloride results in the formation of four radioactive isotopes: chlorine-36, sulfur-35, chlorine-38 and carbon-14. The first three isotopes are produced by the following nuclear reactions:



In order to circumvent the problem of isolating the carbon-14 activity from the above isotopes, common methods peculiar to radiation work were used for chlorine-38 and chlorine-36. Storage of the sample for a few days allowed the chlorine-38 activity to decay to an insignificant amount. Because of the half-life, the elimination of chlorine-36 by storage is not possible. However, the amount of chlorine-36 induced in the sample was small in comparison with the carbon-14 activity. In addition, the energies of the emitted gamma- and beta-radiation from the chlorine-36 isotope are more energetic than the carbon-14 beta. Thus discrimination counting techniques were easily applied in order to eliminate counting of the chlorine-36 activity.

The presence of sulfur-35 was a serious problem in this study. A large amount of the total activity produced was sulfur-35. In addition, the decay of this isotope occurs by beta emis-

sion, similar in energy to carbon-14. Thus, because of the amount of sulfur-35, the energy of the emitted beta, and its half-life, no simple technique could be applied to the isolation of the carbon-14 from sulfur-35. However, in spite of these difficulties, the presence of the sulfur-35 assisted in the determination of the amount of carbon-14 formed.

The amount of any particular activity, A, induced in a sample can be calculated by using the following equation,<sup>1</sup>

$$A = N\phi\sigma(1 - e^{-\lambda t}) \quad (4)$$

where N is the number of atoms present,  $\phi$  is the neutron flux,  $\sigma$  is the thermal neutron cross section,  $\lambda$  is the decay constant, and t is the period of irradiation. For the  $N^{14}(n,p)C^{14}$  process,  $\sigma$  is 1.75 barns (17), and the half-life of carbon-14 is about 5770 years. (24,25,41). The number of atoms, N, must take into account the isotopic ratio. For example, nitrogen exists naturally as 99.635 per cent nitrogen-14 and 0.365 per cent nitrogen-15 (32).

Using equation (4), the following amounts of activity were calculated to have been produced in a 28 day irradiation of tetramethylammonium chloride:  $6.0\mu\text{C}$  carbon-14,  $51\mu\text{C}$  chlorine-38,  $1.9\mu\text{C}$  chlorine-36 and  $9.5\text{mC}$  sulfur-35.

<sup>1</sup> For long lived isotopes, an approximation of the quantity  $\frac{(1-e^{-x})}{x}$  can be utilized. For very short lived isotopes  $\frac{(1-e^{-x})}{x} \approx 1$ ; the effect of the large cross section of chlorine-35 upon  $\phi$  has been neglected in the calculation of A for carbon-14.

The values calculated above are based on a reported average flux. Thus, the final activities will depend upon the location of the sample in the pile and the operating time of the reactor. In order to establish how much irradiation the sample received it is necessary to know what quantity of activity was induced during irradiation. The method used for obtaining this information will be discussed below.

### Radiochemical Counting Techniques

A number of methods of counting the activity present in tetramethylammonium chloride were utilized. Some of the methods were quite successful; others yielded only fragmentary data and in some cases were of little value.

The carbon-<sup>14</sup> isotope decays by emitting a negatron with a maximum energy of 155 kev. Because of the low energy of this beta particle, the choice of counting technique is somewhat limited. The methods used were: solid counting with a thin end-window Geiger-Müller counter, gas filled proportional counter, gas filled Geiger-Müller counters, Libby gold-foil flow counter, ionization chamber, gas flow strip counter, and liquid scintillation counter.

Solid counting of barium sulfate was attempted early in the study in an effort to measure the amount of sulfur-35 activity and thus compute the radiation dosage received by the sample. Because of the large amount of sulfur-35 in the irradiated sample, the method appeared feasible. However, because of the low

energy of the sulfur-35 beta particle, this method proved unsatisfactory. This study was made using a Baird-Atomic Multiscaler II, Model 132.

The gases formed during irradiation of the tetramethylammonium chloride were measured using a gas filled proportional counter in circuit with a pulse height analyzer. Because of difficulties with this system it was abandoned early in the study. The operation of a gas filled counter depends upon the nature of the counting gas. Small amounts of contaminants, i.e. water vapor, can seriously impair the operation of these tubes. In addition, if the radioactive gas is not identical to the counting gas, its presence must be viewed as a contaminant, thus altering the nature of the counting gas. A more serious problem with gas counting is the quantity of material which can be incorporated into the counter. The volume of gas used is generally in the millimole quantities, thus decreasing the precision of any measurement.

Proportional counting was accomplished using glass counters from the Nancy Woods Laboratories filled with "P-10" gas (10% methane and 90% argon). For counting purposes a Bay Engineering Company amplifier, a B-J Electronics model DS-9 scaler, a RIDL model 33-2 pulse height analyzer, and a John Fluke model 400-BDA power supply were utilized.

Concurrent with the gas-filled proportional counter study, attempts were made to use gas-filled Geiger-Müller tubes. However, both types of counters are subject to the same limitations;



thus this aspect of the study was likewise abandoned in favor of more sensitive methods. The instrumental counting system was the same as for proportional counting except for the omission of the RIDL pulse height analyzer and the use of "Q-gas" instead of "P-10" gas.

In order to obtain some information as to the nature of the gases evolved during irradiation an attempt was made to separate the activities using a Fisher-Gulf model 160 Partitioner gas chromatograph. A Libby gold-foil flow counter was attached to the outlet. However, no conclusive results were obtained from this study. The flow counter was utilized in the same circuit as the gas-filled Geiger-Müller counter with "Q-gas".

The ionization chamber counting technique, using a Cary model-31 vibrating reed electrometer, was utilized for measurement of activities in the gases evolved upon dissolution of the irradiated solid. In a few cases, i.e. urea, where a gaseous product could be utilized, the ionization chamber was employed for radioactivity counting. In the latter case, results were compared with liquid scintillation counting methods. Samples were placed in the counting bulb at atmospheric pressure in an atmosphere of anhydrous carbon dioxide. The activity was measured by the rate of drift method at 105 volts. Serious difficulties were encountered with using this instrument. On occasion, erratic behavior was noted and found to be difficult to explain. In addition, it was necessary to wait for long periods of time between measurements. This was attributed to non-

equilibrium conditions existing within the counting chamber immediately after filling. Erratic behavior could be explained occasionally because of vibration, humidity, etc. In consequence of the problems associated with this technique, it was finally abandoned (except for the gas sample counting noted above).

A number of recoil studies have placed emphasis upon the results obtained from electrophoresis (or electrochromatographic) techniques. An attempt was made to isolate the non-volatile species by this technique. The electrochromatogram was analyzed by using a gas-flow strip counter. Although initially encouraging results were obtained, the method failed to yield any concrete data. The resolution of two peaks of activity was found. However, it was not possible to identify the particular species. This method was abandoned for two specific reasons. The first reason was the problem of sulfur-35 contamination and the impossibility of using large enough samples for further studies after separation. The second reason was the failure to find a suitable solvent for separation. The electrophoresis unit utilized was a Electrophoresis Migration Chamber, Reco Model E-800-2 from Research Equipment Corporation, Oakland, California. The chromatogram scaler was attached to a model 432 Baird-Atomic Ratemeter. A counting gas of 7.3 per cent butane and 92.7 per cent argon was used.

All of the non-volatile components were counted by using liquid scintillation counting techniques. Various gaseous samples were counted after being absorbed on a suitable absorbant.

In most cases the radioactive compound could be dissolved directly into the scintillator solution. All measurements were made using a Packard Tri-Carb liquid scintillation spectrometer. The attenuators were set at 1.0, which caused an amplification of the pulses received from the preamplifiers of about 3,000. The two photomultiplier tubes were operated at an average of 840 volts. The low-level discriminator was set at 10.0 and the high-level discriminator at 50.0. The counting vials consisted of a special low potassium content glass and were always filled with 20 ml of solution incorporating the activity desired. The sample vials were cooled for 5-10 minutes prior to counting.

Certain functional groups are known to cause quenching of the phosphor in the liquid scintillation solution. Each species counted was checked for quenching effects by one or both of the following methods: (a) by diluting the carbon-14 species with liquid scintillator and (b) by adding a known amount of activity to the prepared solution. N,N'-methylphenylthiourea was the only species found to possess significant quenching properties. Calibration curves were prepared when necessary to circumvent this problem.

#### Analysis of the Irradiated Sample

The quartz ampoule was opened under vacuum by means of the apparatus shown in Figure 1 and the gases formed during irradiation were collected. The irradiated solid was transferred to a stoppered pyrex weighing bottle and stored under an argon atmos-

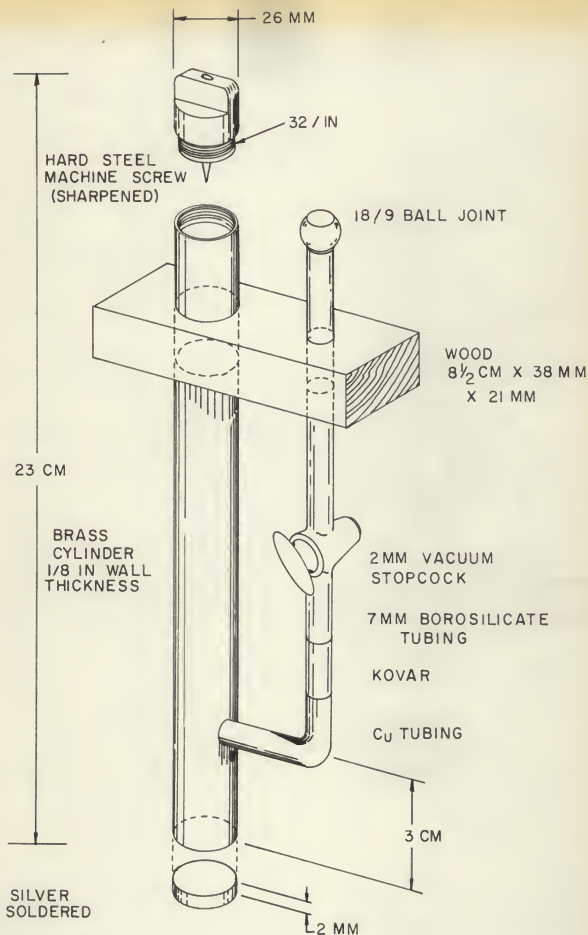

FIGURE I. - ILLUSTRATION OF SAMPLE OPENER

phere. Small pieces of quartz were inseparable from the solid. Later analysis of the solid required dissolution of the solid and decanting of the solution for accurate weighings of the quartz particles.

The sample opener shown in Figure 1 was constructed of thick-walled brass tubing. The ampoule was placed in the brass cylinder and the threaded screw sealed with Apiezon -"W" to provide a vacuum seal. The system was flushed repeatedly with argon and then evacuated to a pressure of less than one micron. The stopcock was then closed and the breaking apparatus removed from the vacuum manifold and shaken until the ampoule was broken by impact on the projecting sharpened steel screw. The breaking apparatus was reconnected to the vacuum line and the manifold evacuated to the stopcock. The gases formed during irradiation were expanded into the manifold and a sample collected for study. Pressure measurements were made using a mercury manometer. The amount of gas evolved and the volume of the system were determined by gas law calculations, assuming ideal behavior.

An aliquot of the gases obtained upon breaking the quartz ampoule was expanded into a gas-filled proportional counter. Total activity determinations in the gas phase revealed that approximately 15 per cent (based on carbon-14 produced) of the carbon-14 activity was present in this gaseous fraction. However, no attempts were made to separate chlorine-36 or sulfur-35 from carbon-14 activity. It is obvious that the total activity in this phase is small insofar as the total induced activity is

concerned, even if the activity present were only carbon-14.

Small samples (10-150 mg) of the irradiated tetramethylammonium chloride were then dissolved in distilled water. Upon dissolution copious foaming and bubbling was observed. In order to establish the distribution of the carbon-14 activity among evolved gases, dissolution was accomplished in an "inverted Y-tube" connected to a vacuum system. The inverted Y-tube is shown in Figure 2. The amount of gas evolved upon solution was measured with a manometer. Separation of particular activities was accomplished by absorption or freezing.

The analysis of the "non-volatile components" was accomplished by the addition of carriers. The carbon-14 activity was then separated by the formation of suitable derivatives and the recrystallization and purification of these derivatives.

#### Determination of Total Carbon-14 Activity

Due to the large cross section for the production of sulfur-35 by the  $\text{Cl}^{35}(\text{n}, \text{p})\text{S}^{35}$  process, the amount of carbon-14 could be fairly accurately determined by utilizing the amount of sulfur-35 produced as an indicator. This "internal-dosimeter" is quite sensitive; since for a 28 day irradiation  $1.58 \times 10^3$  times as much sulfur-35 is produced as carbon-14.

The total carbon-14 activity produced was determined by dissolving a weighed amount of the irradiated sample in distilled water. Activity in the irradiated sample was determined by counting aliquot samples using liquid scintillation techniques.

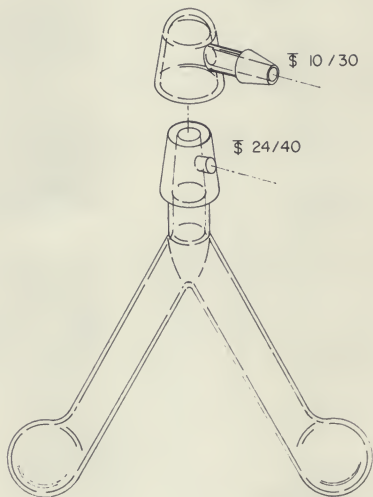

FIGURE 2—INVERTED Y-TUBE

As noted earlier, much of the activity present in the sample was sulfur-35. In order to calculate the amount of carbon-14 present it was necessary to compare the specific activity of the irradiated sample with the expected activity.

$$A_{C14} = A_{total} \left[ \frac{\text{calculated } A_{C14}}{\text{calculated } A_{C14} + A_{S35}} \right] \quad (5)$$

where  $A_{C14}$  is the activity due to the carbon-14,  $A_{S35}$  is the activity due to sulfur-35 and  $A_{total}$  is the total observed activity of the sample. The total activity was found to be  $5.95 \pm 0.6 \mu C$  of carbon-14.

Prior to the liquid scintillation technique mentioned above, three other techniques were studied in an effort to measure the total activity induced in the sample.

The initial method employed was solid counting of the sulfur-35. Attempts were made to precipitate barium sulfate from the irradiated sample and count the sulfur activity. Because of reasons noted on page 21 this method was abandoned.

A second effort was directed toward total combustion of the sample to form carbon dioxide and sulfur dioxide or sulfur trioxide. Combustion attempts were made using a Sargent Micro Combustion Apparatus. A 5 per cent sulfuric acid solution with 3 per cent hydrogen peroxide was used for trapping sulfur dioxide and sulfur trioxide (38). The carbon dioxide absorbing tower contained 15 per cent sodium hydroxide. Numerous attempts were made to combust the sample, but with no success. In each case the sample was oxidized so rapidly that the sample and safety



plugs were blown out of the combustion tube.

The third method was based on the thermal decomposition of silver sulfate and the incorporation of the evolved sulfur dioxide or sulfur trioxide into an ionization chamber for activity measurements. Although the determination of sulfur-35 activity by this method is new, the method was never employed for a study on the irradiated tetramethylammonium chloride. Initially it was assumed that the sulfur-35 activity would be present in the dissolved sample as sulfate. For reasons to be discussed later this initial assumption was found to be incorrect.

Sulfur-35 activity in the form of sulfate may be easily precipitated with silver nitrate. The resulting precipitate was recrystallized and dried using standard techniques. Silver sulfate was then thermally decomposed using the apparatus shown in Figure 3. Crystals of silver sulfate were placed in the quartz ampoule and heated to approximately 1100° C with an oxygen torch. The evolved gases were collected in an ionization chamber. Because of the corrosive nature of the sulfur oxides, it was necessary to coat all gaskets and connections with a silicone lubricant, Dow Corning High vacuum grease.

Silver sulfate decomposes to form sulfur dioxide and oxygen. However, these gases are in equilibrium with sulfur trioxide as shown in the following equations:

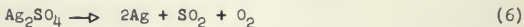

Decomposition of the silver sulfate samples in this study do not occur under equilibrium conditions. However, the amount of sulfur trioxide at 1100° C. is quite small (26).

Table 2 lists the data taken from a series of thermally decomposed samples. The amount of gas formed and the weight of the silver residue show that the method is quantitative. Slight differences in residue weight can be attributed to the formation of silver oxide (28).

#### Separation of Evolved Gaseous Activity

The inverted Y-tube apparatus shown in Figure 2 was utilized for the separation of the gases evolved upon dissolution of the irradiated sample in water. A small manometer was attached to the Y-tube along with an ionization chamber.

In one arm of the Y-tube, 5 ml of water were frozen using liquid air. In order to prevent the cracking of the glass Y-tube it was necessary to "swirl" the liquid during freezing. To facilitate the removal of absorbed gases, the Y-tube was attached to a vacuum pump and freezing of the liquid repeated until all gases were removed. Following the evolution of absorbed gases, the Y-tube was disconnected from the vacuum pump and a weighed quantity of the irradiated sample placed in the other arm. The Y-tube was then replaced on the vacuum line and the system evacuated. Dissolution was accomplished by inverting the Y-tube and allowing the water to flow into the arm containing the irradiated sample.

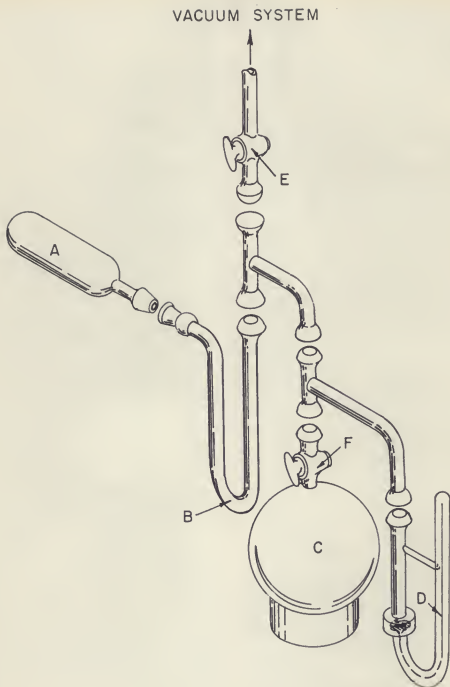

FIGURE 3- GENERATION SYSTEM FOR FILLING IONIZATION CHAMBER WITH  $\text{SO}_3$  A-QUARTZ REACTION TUBE; B-PYREX TRAP; C-STAINLESS STEEL IONIZATION CHAMBER; D-MERCURY MANOMETER; E AND F,- STOPCOCKS

Table 2. Gaseous Products of the Thermal Decomposition of Silver Sulfate at ca. 1100° C.

<u>Ag<sub>2</sub>SO<sub>4</sub> Taken</u>		<u>Gases Evolved</u>		<u>Residue</u>	
gm.	m. moles	mm(Hg)	m. moles <sup>a</sup>	gm.	mg. atom <sup>b</sup>
0.0578	0.185	19.1	0.334	0.0426	0.395
0.0988	0.317	27.0	0.472	--	--
0.2135	0.685	63.6	1.112	0.1540	1.427
0.1580	0.507	--	--	0.1289	1.195
0.1174	0.376	37.4	0.654	0.0818	0.758
0.5052	1.62	180.7	3.16	0.354	3.28
0.4176	1.339	126.4	2.210	0.2932	2.718
0.3480	1.116	112.0	1.958	0.2382	2.208
0.3122	1.001	109.8	1.920	0.2222	2.060
0.3142	1.008	106.5	1.862	0.1994	1.848

(a)  $PV = nRT$  has been assumed. The volume of the system was 325 ml.

(b) Assuming residue is only silver metal.

The volume of the system was previously measured by gaseous expansion techniques, assuming ideal gas law behavior. The ionization chamber was closed off from the described assembly and the pressure within the chamber brought to atmospheric pressure by the addition of argon.

The identification and isolation of the gaseous species was based on cold-trapping techniques. The total activity of a sample was measured. Then a small tube was attached to the ionization chamber and submerged in liquid air. After approximately twenty minutes the activity due to carbon dioxide, hydrogen cyanide and methyl chloride was assumed to have been frozen out in the tube. The ionization chamber was then closed off and the activity due to carbon monoxide and methane was measured.

#### Separation of Non-volatile Components

The non-volatile components were those not evolved upon dissolution of the solid in distilled water. The presence of sulfur-35 in the solid represented the principle problem encountered in the separation of the various activities.

Formaldehyde. A carrier of formaldehyde was added to a solution of the irradiated sample. A methone (dimedon) derivative was prepared; the precipitate filtered, repeatedly recrystallized and dried at 115° C. (16,43). A weighed portion was dissolved in the scintillator solution and counted

Formic acid. A solution containing a sample of the irradiated compound was refluxed with 10 ml of 1.0 M acetic acid and

50.0 ml of a solution prepared by dissolving 100 gms of mercuric acetate in 1 liter of 0.5 M acetic acid. The evolved carbon dioxide was collected in an absorption tower of sodium hydroxide (34,42). The sodium hydroxide was dissolved in distilled water and an aliquot removed for counting.

Methylamine. The first method used for the determination of methylamine was accomplished by the addition of carrier amounts of methylamine and the preparation of a phenylisothiocyanate derivative (37). A weighed portion of the N-N'-methylphenylthiourea was dissolved into the scintillator solution and its activity determined, using calibration curves to correct for quenching effects.

The second method utilized the following procedure. Carrier amounts of methylamine hydrochloride were added to an aqueous solution of the irradiated tetramethylammonium chloride. The solution adjusted to a pH of 9. After shaking and mixing the methylamine was extracted with chloroform, and the resulting chloroform solution dried over anhydrous disodium sulfate. After drying the chloroform solution, anhydrous hydrogen chloride was bubbled through the solution. The resulting methylamine hydrochloride was separated by cooling of the chloroform solution and filtration (57). The methylamine hydrochloride was then oxidized in alkaline potassium permanganate. After oxidation was complete, the carbon dioxide was evolved and absorbed on sodium hydroxide by the addition of concentrated sulfuric acid. The sodium hydroxide was dissolved in distilled water and the activity deter-

mined by liquid scintillation techniques. The activity was also checked by evolving the carbon dioxide using concentrated sulfuric acid and collecting the gas in an ionization chamber.

Urea. A solution of the irradiated sample containing carrier urea was adjusted to a pH of 6.8-7.0 with a phosphate buffer solution (39). Jack bean urease was added and the solution allowed to stand at room temperature for at least 12 hours. The carbon dioxide was evolved upon treatment with sulfuric acid and collected in a sodium hydroxide trap. The sodium hydroxide solution was treated similarly to the previous techniques for counting purposes.

Tetramethylammonium chloride. The radioactivity "retained" by the parent compound was determined by making carrier additions to a solution of the irradiated sample. The tetramethylammonium ion was precipitated using sodium tetraphenylborate to form  $(\text{CH}_3)_4\text{N}^+\text{B}(\text{C}_6\text{H}_5)_4^-$  (7). The precipitate was repeatedly recrystallized from acetone to a constant specific activity. Activity measurements were made using the liquid scintillation counter, employing dilution techniques with the suspensions formed.

Ethanol, methanol, and isopropanol. An aliquot of the radioactive sample was dissolved in distilled water. Carrier amounts of the alcohols were added. Using a distillation column of 60 theoretical plates, (calibrated for methanol-ethanol separation) 1 ml samples were collected (3). Gas chromatographic analysis revealed that the cuts taken contained pure methanol, ethanol, and isopropanol. A benzoate derivative of each was

prepared and activity determined using liquid scintillation counting techniques.

Trimethylamine. A solution of the irradiated sample was made basic with 16 per cent sodium hydroxide. A stream of argon gas was bubbled slowly through the solution and passed through a trap containing hydrochloric acid. Samples of the acid solution were utilized for liquid scintillation counting.

#### RESULTS AND DISCUSSION

The total carbon-14 activity of the irradiated sample was found to be  $5.95 \mu\text{C}$ ., i.e., a specific activity of  $1.2 \mu\text{C}/\text{gm}$ . The total amount of carbon-14 expected was  $6.0 \mu\text{C}$ , based on the carbon-14 half-life of 5770 years and an anticipated irradiation time of 672 hours.

The results obtained by the previously described isolation procedures are given in Table 3. In all cases, the data are based on specific activity measurements. The total activity isolated in this study was approximately 50 per cent of the total carbon-14 activity induced in tetramethylammonium chloride by pile neutron irradiation.

In this work only the final chemical form incorporating the carbon-14 atom has been considered. No attempt has been made to study the chemical species incorporating the sulfur-35, chlorine-36 or chlorine-38.

Following irradiation many chemical forms of the carbon-14 atom are probably present within the solid matrix (54). These



matrix-stabilized species may rearrange, decompose or undergo further reactions when the matrix is destroyed by dissolution of the irradiated compound in water. Thus one way to attempt to arrive at the matrix-stabilized species is through isolation of the carbon-14 containing compounds and, from analyses of the results, to postulate reasonable intermediates. The consideration of a number of such studies can lead to a better understanding and characterization of the matrix-stabilized species resulting from recoiling "hot-atoms".

The recoiling carbon-14 atom may be thermalized within the crystal lattice by at least three processes (49). The first process may occur by trapping of the recoiling atom at a reactive site following thermalization by elastic and inelastic collisions. Three factors should be considered in this process: (1) the energy of the recoiling atom prior to stabilization, (2) the structural aspects of the atom prior to being stabilized, and (3) the possibility of the atom reacting with the bonded atoms of the associated matrix. The second process considers the possibility of forming a matrix-stabilized chemical species in relation to the structural aspects of the entrapment site and a consideration of the energy necessary to form such a species. The factors that must be considered for this process include: (1) the probability of forming a number of species which will result in the formation of stable products, and (2) the manner in which the surroundings will affect the final distribution of the recoil atom among the final products. The third process

involves a consideration of what occurs upon the collapse of the matrix and whether stable compounds will result during subsequent chemical operations. Two factors are necessarily considered in this process: (1) the probability that the intermediate will form a stable compound and (2) whether the compounds can be isolated by available (or known) procedures and the influence such procedures will have upon the distribution of the activity.

Table 3 represents a tabulation of the carbon-14 products obtained from the pile neutron irradiation of tetramethylammonium chloride. It is necessary to supplement this table with some additional explanations.

Previously it had been noted that approximately 15 percent of the activity was found to be present in the gaseous products upon breaking the irradiated ampoule. It was assumed that all of the evolved gaseous activity was due to carbon-14. One experiment has shown that the activity in the gaseous phase was probably not entirely carbon-14. The proportional counters utilized were found to be badly contaminated following initial filling. It is difficult to visualize any carbon species capable of reacting with the silver walls of the counters. In addition, attempts to wash the counters failed to remove the contamination. Thus it appears that some of the activity present in this fraction was probably due to sulfur-35. It appears reasonable to assume that this activity was hydrogen sulfide (or possibly a methyl or dimethyl sulfide).

The amount of gas formed during irradiation was found to be

Table 3. Carbon-14 Distribution Among Various Compounds Isolated.

Final Product	Per cent of Total Activity	
	Average	Values Obtained
CO and CH <sub>4</sub>	0.5	0.6, 0.4
HCN, CO <sub>2</sub> and CH <sub>3</sub> Cl	0.8	0.7, 0.8
Urea	0.0	0.0, 0.0
Formic Acid	0.2	0.25, 0.06
Methylamine	0.0	0.0, 0.0
Trimethylamine	0.0	0.0, 0.0
Formaldehyde	10.8	7.5, 21.2, 3.9
Methanol	2.3	3.0, 1.6
Ethanol	~ 5.9	5.9
Isopropanol	~ 0.2	0.2
(CH <sub>3</sub> ) <sub>4</sub> NC1	13.8	15.8, 11.9
(Formed gases)	(ca. 15.0)	(15.0)

$1.3 \times 10^{-3}$  moles. This result is to be compared with the calculated amount of decomposition expected,  $3 \times 10^{-3}$  moles. It appears reasonable to assume that the gaseous species produced were formed primarily by gamma irradiation.

Dimethylamine does not appear in Table 3 since no direct attempts were made to isolate this activity. However, the absence of this species appears reasonable because of the techniques used in the methylamine and trimethylamine studies. Both of these techniques should have "carried" any activity due to dimethylamine.

The failure to isolate a higher percentage of the carbon-14 products places a limitation upon any proposed mechanism and postulated species formed as a result of the recoiling process. However, the results obtained tend to indicate that the recoiling process can be understood in terms of the formation of methyl, methylene and methyne radicals. The concentration of these radicals is expected to decrease in the order given.

As the recoiling atom becomes thermalized the possibilities for combination increase. Thus, the abstraction of hydrogen atoms by collision processes should increase. In order to explain the results obtained in this study the following reactions are postulated:

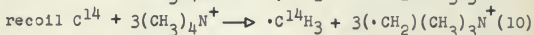
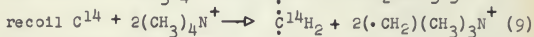
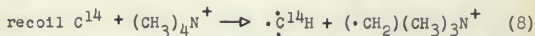

Although the processes indicated are assumed to occur independently of each other, no proof can be advanced to verify this procedure. However, regardless of this aspect, the results would be the same.

The above reactions can also be interpreted in terms of energetics. On the basis of their heats of formation, the methyl radical should be more stable than the methylene and methyne. Also, the methylene should be more stable than the methyne. For this reason the concentration of the methyl radical should be higher than the other two. It is also possible to discuss stability in terms of diffusion rates and the stability of the radicals in respect to the lattice. All of these arguments support the contention concerning the concentration of the radicals in the order noted above.

The formation of a methyl radical by reaction (10) can be viewed as forming an energetic radical. If the radical possessed sufficient energy a substitution of the  $\cdot C^{14}H_3$  for a bonded methyl group should be possible in a "hot" process:

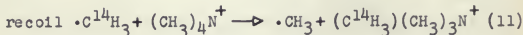

This process is plausible not only on the basis of arguments presented above, but also on the basis of the large number of methyl groups in the parent molecule.

The presence of methanol in the final products can be interpreted as a reaction involving the methyl radical. Methanol can be viewed as arising from the "hot" reaction of a

matrix-stabilized methyl radical with water:



In this case it is necessary to distinguish between a methyl radical that is stabilized and a methyl radical that has already undergone a combination reaction. That is, the methyl radical formed by the recoiling carbon atom can undergo at least two reactions: (1) it can combine with the tetramethylammonium ion by a substitution process, or (2) it can become stabilized within the matrix and react with the solvent upon dissolution.

The formation of a methylene radical can be viewed as undergoing a competitive process similar to the methyl radical. For example, if the methylene were to substitute for a methyl group similar to reaction (11), the resulting species would possess a structure similar to the parent. Thus, by abstracting a hydrogen from the solvent the parent molecule would be reformed. A process similar to this, but yielding a different product also seems possible. The production of an ethyl radical may be postulated by the following process:

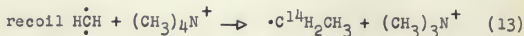

If ethyl radicals became stabilized in the matrix they could react with the solvent to yield ethanol in a manner analogous to reaction (12):

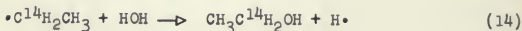

The formation of a matrix-stabilized methylene radical could yield formaldehyde by reacting with the solvent.

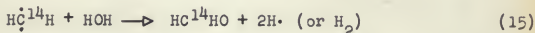

Thus it is possible to view the methylene radical as undergoing competitive reactions in the same manner as the methyl radical.

The methyne radical can be used to explain the occurrence of isopropanol.

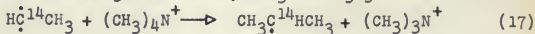
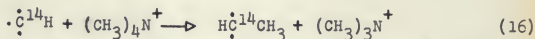

The small amount of isopropanol lends some support to this mechanism. Further, reaction (17) is competitive with

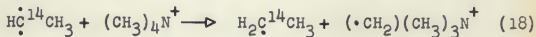

to form a ethyl radical.

The mechanisms proposed for the formation of the ethyl and isopropyl radicals could be investigated by additional work on tetramethylammonium chloride. Degradation studies might possibly establish the position of the carbon-14 atom and thereby give additional support to the mechanisms proposed for the radicals indicated.

The mechanisms suggested for the recoiling carbon-14 atom in tetramethylammonium chloride are in agreement with the requirements of the Seitz-Koehler model. This model predicts a short-lived, low temperature hot spot, only partial fragmentation of

the molecule or molecular ion, and no chemical consequences due to a variation of the recoil energy. In contrast, the Libby model predicts long-lived, high temperature hot-spots which probably result in the complete dissociation of the molecule or molecular ion in the vicinity of the hot atom. In addition, in the Libby model the final chemical state is dependent upon the recoil energy of the atom.

Yankwich and Vaughan (57) have reported their results of the irradiation of ammonium bromide. This molecule is similar to tetramethylammonium chloride, differing only in methyl groups and halide ion. On this basis it would appear possible that a correlation could be obtained by comparing the results of these studies. Table 4 provides a comparison between the present results and those of Yankwich and Vaughan.

In the ammonium bromide study 79 per cent of the activity was found to be present in methylamine (57). However, no activity was found as methylamine in the present investigation of tetramethylammonium chloride. On the basis of the mechanisms outlined above, one might well conclude that only small amounts of radioactivity, if any, should be found as methylamine in the present study, for N-H bonds requisite for an amine group do not exist in the  $(\text{CH}_3)_4\text{N}^+\text{Cl}^-$  case, and to form such bonds would require the virtual stripping of all the methyl groups from the  $(\text{CH}_3)_4\text{N}^+$  ion, followed by the formation of NH or  $\text{NH}_2$  from the N atom (or ion). This same argument would apply as well to the dimethylamine case.



Table 4. Comparison of Final Products from the Irradiation of Ammonium Bromide and Tetramethylammonium Chloride

Final Product	$\text{NH}_4\text{Br}^{(a)}$	$(\text{CH}_3)_4\text{NCl}^{(b)}$
(Gases)	--	(15.0)
$\text{CH}_4$	7.5	} 0.5
$\text{CO}$	1.3	
$\text{HCN}$	2.0	} 0.8
$\text{CO}_2$	1.7	
$\text{CH}_3\text{Br}$ or $\text{CH}_3\text{Cl}$	1.8	
$\text{CH}_3\text{NH}_2$	79.1	0.0
$(\text{CH}_3)_2\text{NH}$	--	0.0
$(\text{CH}_3)_3\text{N}$	--	0.0
$\text{CH}_3\text{NHNH}_2$	0.0	--
$\text{HCHO}$	5.8	10.8
$\text{HCOOH}$	1.3	0.2
$\text{CO}(\text{NH}_2)_2$	0.4	0.0
$\text{CNH}(\text{NH}_2)_2$	0.0	--
$\text{CH}_3\text{OH}$	0.4	2.3
$\text{C}_2\text{H}_5\text{OH}$	--	5.9
$\text{CH}_3\text{CHOHCH}_3$	--	0.2
$(\text{CH}_3)_4\text{NCl}$	--	13.8

{a} Yankwich and Vaughan (see reference 57).

{b} The results of this study.

On the basis of the above experimental results and the postulated schemes for the formation of the various compounds, it is interesting to speculate somewhat further about in what compounds additional radiocarbon activity might be found. From the methanol and ethanol results, it might well be that some 5-10 per cent or so of activity would be found as acetaldehyde. A carrier analysis was not attempted for this compound, since only upon the conclusion of the experimental program was the data analysis made and attempts made to explain the formation of the products observed. Thus, the analysis for acetaldehyde would provide some measure of the utility or correctness of the explanations advanced.

Although this work has been directed toward an understanding of the  $N^{14}(n,p)C^{14}$  recoil process, some information has been gained concerning the  $C^{135}(n,p)S^{35}$  process. The formation of gaseous sulfur moieties was established, although not characterized. In addition, evidence has been offered to indicate that some of the non-volatile sulfur-35 activity present in the irradiated sample was not in the form of sulfate. This information was a by-product of this study and should be of interest to future investigators.

#### SUMMARY

The neutron irradiation of tetramethylammonium chloride produced several chemical species incorporating the carbon-14 atom.

The parent compound, tetramethylammonium chloride, and formaldehyde were found to possess 13.8 and 10.8 per cent of the activity, respectively, of the total activity induced in the sample. Small amounts of activity were found in the form of methanol, ethanol, and isopropanol. Radiation damage, due to the gamma-ray flux during irradiation, was calculated to amount to about 4.5 per cent.

Reaction mechanisms have been postulated on the basis of the radiocarbon species isolated. The recoiling carbon-14 atom was probably incorporated into the isolated species by fragmentation of the parent molecule to form methyl, methylene, and methyne radicals as intermediates.

## ACKNOWLEDGMENTS

The author wishes to express his deepest appreciation to Dr. R. W. Kiser, major instructor, for his interest, instruction and encouragement during the course of this study.

Appreciation is also expressed to Mr. T. W. Lapp for assistance in the sulfur-35 studies using the ionization chamber. The author wishes to acknowledge his appreciation to Dr. A. M. Gawienowski and Mr. Herman Knoche for the use of the electrophoresis equipment.

This research was supported in part by a grant from The Petroleum Research Fund administered by the American Chemical Society. Grateful acknowledgment is hereby made of such fund. The author wishes to thank The Petroleum Research Fund for the award of an "American Chemical Society-Petroleum Research Fund Fellowship", held during the tenure of this work.

Grateful appreciation is also expressed to the U. S. Atomic Energy Commission for partial support of this work.

## REFERENCES

- (1) R. Barbieri, U. Belluco and M. Bruno, Gazz. chim. ital., 87, 1377(1957)
- (2) U. Belluco, R. Barbieri and G. Schiavon, ibid, 88, 78(1958)
- (3) W. G. Berl, "Physical Methods in Chemical Analysis", vol. 3, Academic Press, Inc., Publishers, New York, 1956, p. 433
- (4) J. A. Brinkman, Am. J. Phys., 24, 246(1956)
- (5) F. Cacace, L. Cieri and M. Zifferero, Ann. chim., 47, 892(1957)
- (6) F. Cacace, G. Giacomello and G. Montefinale, Gazz. chim. ital., 89, 1829(1959)
- (7) F. E. Crane, Jr., Anal. Chem., 28, 1794(1956)
- (8) C. G. Collins and V. P. Calkins, Apex. 261, Aircraft Nuclear Propulsions Dept., General Electric Co., Cincinnati, Ohio, p. 18-31. (D. W. Setser, M.S. Thesis, Kansas State University, Manhattan, Kansas, 1958.)
- (9) E. Collinson and A. J. Swallow, Chem. Rev., 56, 471(1956)
- (10) L. Friedmann and W. F. Libby, J. Chem. Phys., 17, 647(1949)
- (11) G. Giacomello, Ricerca Sci., 21, 1211(1951)
- (12) G. Giacomello, U. Croatto and A. E. Maddock, ibid, 21, 1598(1951)
- (13) G. Giacomello and M. Zifferero, Ann. chim., 44, 558(1954)
- (14) G. Harbottle and N. Sutin, J. Phys. Chem., 62, 1344(1958)
- (15) R. E. Hein, D. W. Setser, C. J. Terhaar, S. C. Chang, R. H. McFarland and M. F. Hansen, Science, 125, 195(1957)
- (16) E. C. Horning and M. G. Horning, J. Org. Chem., 11, 95(1946)
- (17) D. J. Hughes and R. B. Schwartz, "Neutron Cross Sections", BNL-325, 2nd Edition, U.S. Government Printing Office, Washington, D.C., July 1, 1958, p. 4.

- (18) T. W. Lapp, "Carbon-14-containing Compounds Produced by the Pile-neutron Irradiation of Cyanoguanidine", M.S. Thesis, Kansas State University, (1961); J. Phys. Chem., 66, 152(1962)
- (19) R. M. Lemmon, M. A. Parsons and F. Mazzetti, "Effects of Ionizing Radiation of Choline Analogs", Lawrence Radiation Laboratory, URCL-3595, p. 10(1956)
- (20) W. F. Libby, J. Am. Chem. Soc., 62, 1930(1940)
- (21) W. F. Libby, ibid, 69, 2523(1947)
- (22) W. F. Libby and C. F. MacKay, ibid, 79, 6366(1957)
- (23) W. F. Libby and A. G. Schrodt, ibid, 78, 1267(1956)
- (24) W. B. Mann, W. F. Marlow and E. E. Hughes, Int. J. Appl. Rad. Isotopes, 11, 57(1961)
- (25) W. B. Mann, W. F. Marlowe, E. E. Hughes, R. M. Reese and V. H. Dibeler, Science, 133, 183(1961)
- (26) G. Marchal, Compt. rend., 176, 299(1923)
- (27) B. J. Masters and T. H. Norris, J. Am. Chem. Soc., 77, 1346(1955)
- (28) G. W. Morey, "Properties of Glass", Reinhold Publishing Corporation, New York, 1938, p. 435.
- (29) R. Muxart, Bull. soc. chim. France, 1956, 1837
- (30) R. Muxart, Compt. rend., 242, 2457(1956)
- (31) R. Muxart and G. Pinte, Bull. soc. chim. France, 1956, 1675
- (32) A. O. Nier, Phys. Rev., 77, 789(1950)
- (33) L. Norris and A. Snell, Nucleonics, 5, 18(1949)
- (34) J. D. Reid and H. D. Weihe, Ind. Eng. Chem., Anal. Ed., 10, 271(1938)
- (35) F. S. Rowland and W. Libby, J. Chem. Phys., 21, 1495(1953)
- (36) F. Seitz and J. S. Koehler, "Displacement of Atoms during Irradiation", Solid State Physics, Vol. II, edited by F. Seitz and D. Turnbull, Academic Press, Inc., New York, 1956. pp. 305-448.

- (37) R. L. Shriner, R. C. Fuson and D. Y. Curtin, "The Systematic Identification of Organic Compounds", 4th ed., John Wiley and Sons, New York, pp. 202-207.
- (38) F. D. Snell and F. M. Biffen, "Commercial Methods of Analysis", 6th Ed., McGraw-Hill Book Company, Inc., New York, 1944, p. 168.
- (39) J. B. Sumner and G. F. Somers, "Chemistry and Methods of Enzymes", 2nd Ed., Academic Press, Inc., New York, 1947. pp. 154-160.
- (40) L. Szilard and T. A. Chalmers, Nature, 134, 462(1934)
- (41) D. E. Watt, D. Ramsden and H. W. Wilson, Int. J. Appl. Rad. Isotopes, 11, 68(1961)
- (42) H. D. Weihe and P. B. Jacobs, Ind. Eng. Chem., Anal. Ed., 8, 44(1936)
- (43) W. Weinberger, ibid, 3, 363(1931)
- (44) J. Willard, Ann. Revs. Nucl. Sci., 3, 1953(1953)
- (45) A. P. Wolf, Int. J. Appl. Rad. Isotopes, 2, 256(1957)
- (46) A. P. Wolf, Angew. Chem., 71, 237(1959)
- (47) A. P. Wolf and R. C. Anderson, J. Am. Chem. Soc., 77, 1608(1955)
- (48) A. P. Wolf, B. Gordon and R. C. Anderson, ibid, 78, 2657(1956)
- (49) A. P. Wolf, C. S. Redvanly and R. C. Anderson, ibid, 79, 3717(1957)
- (50) A. P. Wolf and J. Y. Yang, ibid, 82, 3315(1960)
- (51) A. P. Wolf and J. Y. Yang, ibid, 82, 4488(1960)
- (52) P. E. Yankwich, J. Chem. Phys., 15, 374(1947)
- (53) P. E. Yankwich, Can. J. Chem., 34, 301(1956)
- (54) P. E. Yankwich and W. R. Cornman, Jr., J. Am. Chem. Soc., 77, 2096(1955)
- (55) P. E. Yankwich and W. R. Cornman, Jr., ibid, 78, 1560(1956)

- (56) P. E. Yankwich, G. K. Rollefson and T. H. Norris, J. Chem. Phys., 14, 131(1946)
- (57) P. E. Yankwich and J. D. Vaughan, J. Am. Chem. Soc., 76, 5851(1954)
- (58) M. Zifferero, Ann. chim., 44, 555(1954)
- (59) M. Zifferero, ibid, 44, 563(1954)
- (60) M. Zifferero and L. Cleri, ibid, 46, 105(1956)
- (61) M. Zifferero and I. Masi, ibid, 44, 551(1954)



AN INVESTIGATION OF THE PILE NEUTRON  
IRRADIATION OF TETRAMETHYLAMMONIUM CHLORIDE

by

DONALD WINSTON RATHBURN

B. A., Park College, 1958

---

AN ABSTRACT OF A MASTER'S THESIS

submitted in partial fulfillment of the

requirements for the degree

MASTER OF SCIENCE

Department of Chemistry

KANSAS STATE UNIVERSITY  
Manhattan, Kansas

1962

The pile-neutron irradiation of crystalline tetramethylammonium chloride and the chemical effects of the  $N^{14}(n,p)C^{14}$  nuclear reaction were studied.

Radioactivity measurements were made using liquid scintillation and ionization chamber techniques. Gas filled Geiger-Müller counting, gas filled proportional counting, gas flow counting, and solid sample counting were investigated as potential methods of measuring carbon-14 activity.

"Carrier" techniques were primarily used to isolate the carbon-14 containing species. However, gas chromatographic, electrophoretic, and fractional distillation techniques were also applied.

Some information was obtained concerning the sulfur-35 containing species formed during the irradiation of tetramethylammonium chloride and a method of counting sulfur-35 activity in the form of sulfur dioxide or sulfur trioxide was developed using an ionization chamber.

The isolated radiocarbon-labelled products showed that little activity was present in the form of gaseous products and simple molecules. Formaldehyde and tetramethylammonium chloride were found to contain 10.8 and 13.8 per cent, respectively, of the total induced activity. The total isolated activity represented approximately 50 per cent of the induced activity.

Possible mechanisms for the formation of the isolated products are postulated. The results are interpreted in terms of

the Seitz-Koehler model and compared with the results of previously reported studies of other nitrogen-containing compounds.