

EFFECTS OF A CHANGE IN MOISTURE CONTENT  
OF STORED GRAIN ON BIN PRESSURES

by

ROBERT SEAGO SOWELL

B. S., Mississippi State University  
of Agriculture and Applied Science, 1961

---

A MASTER'S THESIS

submitted in partial fulfillment of the

requirements for the degree

MASTER OF SCIENCE

Department of Agricultural Engineering

KANSAS STATE UNIVERSITY  
Manhattan, Kansas

1963

Approved by:

*J. O. Hodges*  
Major Professor

## TABLE OF CONTENTS

INTRODUCTION.....	1
PURPOSE OF INVESTIGATION.....	3
REVIEW OF LITERATURE.....	3
Pressures in Grain Storage Structures.....	4
Effects of Moisture Content on the Pressures of Stored Grain.....	5
Methods of Determining Pressures on Bin Walls and Floors.....	8
MATERIALS AND METHODS.....	12
Dimensional Analysis.....	12
Equipment.....	14
Test Structure.....	14
Pressure Transducers.....	15
Strain Gages and Strain Gage Instrumentation....	31
Equipment for Increasing Moisture Content of the Grain.....	40
Moisture Determination.....	40
Test Grain used in Investigation.....	49
Procedure.....	49
Calibration of Pressure Transducers.....	49
Tests Holding Moisture Content Constant and Varying the Ratio of Height over Diameter.....	52
Tests Holding h/D Ratio Constant and Varying Moisture Content.....	56
RESULTS.....	58
Calibration of Transducers.....	58
Tests Holding the Moisture Content Constant and Varying the Ratio h/D.....	65
Tests Holding h/D Constant and Varying Moisture Content.....	80
DISCUSSION.....	92

CONCLUSIONS.....	98
SUGGESTIONS FOR FUTURE RESEARCH.....	99
ACKNOWLEDGMENTS.....	102
REFERENCES.....	103
APPENDICES.....	106

## INTRODUCTION

The history of grain storage dates back to 1700 B.C. when Joseph was in charge of the grain storehouses in Egypt. From that time until the late 19th century, little information can be found regarding grain storage structures.

Before mechanization appeared on the farm scene, crop production was very low as compared to that of today. Grain could be stored in barns and sheds along with other farm produce and there was little need for buildings designed especially for grain storage. Today, this situation has greatly changed. The improved plant varieties made possible by the plant scientist, along with mechanized farming, have resulted in a tremendous increase in grain production. Since grain production is seasonal, it is necessary that these large quantities of grain be stored for several months of the year. This storage takes place in various locations and types of structures. These range from small grain bins on the farm to large terminal elevators in our nation's largest cities.

The problem of grain pressures and the design of grain storage structures is one of major concern to design engineers, building contractors, elevator operators, and farmers. With the rising cost of building materials and construction, this problem is increasing in importance today. In Kansas, as well as other grain producing areas of the nation, grain storage structures represent a significant portion of the total investment in farm buildings. For these reasons, it is necessary

that the design engineers be well informed on the requirements of grain storage structures. The better the engineer understands these requirements, the more accurate will be his advice to building contractors, elevator operators and farmers. This leads to the possibility of utilizing new building materials and designing more economically with conventional materials, thus reducing the cost of grain storage structures to a minimum.

Most grain bin designers in the United States use Janssen's formula (15) for designing grain bins and elevators. Dale and Robinson (7), Saul (29), Farrell (8), and Lorenzen (20) have indicated that Janssen's formula is inconsistent in that it does not include the parameter of moisture. Moisture content in stored grain varies with the relative humidity of the air. With an increase in relative humidity, moisture content of grain decreases. From a design standpoint, the latter is probably of little importance; however, previous research has indicated that an increase in moisture content of stored grain results in increased lateral wall and floor pressures. This could result in bin failure.

In 1951, during the floods along the Kansas and Missouri rivers, many bins were flooded and damaged. Water entering the bins caused an increase in pressure large enough to cause failure in bin walls. This gives a magnified view of the effect of a change in moisture of stored grain on bin pressures.

The fact that a change in moisture content of stored grain has an effect on bin pressures is readily accepted; however, no definite relationship between moisture content and bin pressures has been established.

One of the most difficult problems in the study of grain bin pressures is that of separating and measuring vertical and lateral components of bin wall pressure. One of the most generally used methods of determining wall pressures in the past has been that of using mechanical or hydraulic pressure transducers. More recently pressure transducers utilizing variable resistance strain gages have been used. Few of the above mentioned types of pressure transducers were capable of separating and measuring the vertical and lateral wall pressures.

#### PURPOSE OF INVESTIGATION

In order to determine the effects of a change in moisture content of stored grain on bin pressures, it was necessary to develop satisfactory methods for determining bin pressures and to have a knowledge of the pressures of grain at a constant moisture content.

The objectives of this study were:

1. To develop techniques for separating and measuring the vertical and lateral components of interaction forces between grain and walls of storage structures.
2. To determine vertical and lateral pressures on grain bin walls.
3. To determine pressures on floors of grain storage structures.
4. To determine the effects of a change in moisture content of stored grain on the lateral wall, vertical wall and floor pressures in grain storage structures.

#### REVIEW OF LITERATURE

Although research concerning the distribution of pressures in grain storage structures dates back to 1882, only a limited

amount of this literature concerns the effects of moisture on the pressures of stored grain. However, a review of this literature gives an extensive coverage of methods and techniques that have been used to determine pressures on bin walls and floors.

### Pressures in Grain Storage Structures

Several investigators have developed formulas for predicting grain bin pressures. These include formulas by Janssen (15), Airy (1), Rankine and Coulomb, as reported by Taylor (31), and others. The formula developed by Janssen (a German scientist), in 1895, is most commonly used by grain bin designers in the United States. Janssen's formula is of the form:

$$L = WR/\mu (1 - e^{-\mu kh/R}) \quad (\text{eq. 1})$$

where: L = unit lateral wall pressure in pounds per square foot.

W = bulk density of stored material in pounds per cubic foot.

R = hydraulic radius of horizontal section of structure = area/circumference in feet.

h = depth of grain in feet.

$\mu$  = coefficient of friction between stored material and bin wall.

k = ratio of lateral pressure to vertical pressure.

Janssen's formula involves two constants,  $\mu$  and k, which are difficult to determine. There is much controversy over the proper values of these constants for various grains and building materials. Values used for these constants make a significant difference in the pressures predicted by Janssen's equation.

The first recorded experiments dealing with pressures of grain in storage were conducted by Sir Isaac Roberts (25) in

England in 1882. Roberts used four model bins in his experiments. The area of these bins ranged from 41.57 square inches to 374 square inches. Only the floor pressures were determined in these experiments. Results indicated that the floor pressures ceased to increase when the depth of grain reached approximately 2-1/2 times the diameter of the bin. Roberts (26) later ran a similar series of tests using full size bins. Results of the second series of tests agreed with those of the first.

In the late 1800's and the early 1900's, several investigators experimented with grain pressures. Both model and full scale bins were used in these investigations. Those investigators interested in grain pressures during that period were Airy (1), Janssen (15), Toltz, as reported by Ketchum (16), Bovey (4) Ketchum (16) and Lufft (21). Emphasis was placed on the difference in pressures due to still grain and grain in motion. The results of most of these experiments were in fair agreement with Janssen's prediction.

In the 1930's and 1940's, interest in the pressure of grain in storage began to increase. McCalmont (22), McCalmont and Ashby (23), Fordham (9), Kramer (17), and Amundson (2) made investigations to determine pressures of stored grain. The general conclusion was that Janssen's formula was safe for the design of grain storage structures.

#### Effects of Moisture Content on the Pressures of Stored Grain

Most early investigators placed little or no emphasis on the moisture content of stored grain. In 1944, Kramer (17)



found that the angle of repose of rice was greatly influenced by a change in moisture content, especially when it exceeded 16 per cent to 17 per cent. Dale and Robinson (7) made investigations at Purdue University in 1954 to determine the effect of a change in moisture content on the pressure of grain in storage. In the first test, 434 pounds of grain were stored in a model bin. The initial moisture content of the grain was 14 per cent. At the beginning of the test, 144 pounds of grain were supported by the bin floor. Air conditioning equipment was used to add moisture to the grain. After 96 hours of adding conditioned air, the final average moisture content of the grain was 15.4 per cent. The floor load increased to 537 pounds, supporting the entire weight of the grain plus part of the weight of the bin. In a second test 420 pounds of corn at 13 per cent moisture content were wetted to an average moisture content of 16.9 per cent. The maximum lateral pressure increased from 0.31 pounds per square inch to 1.96 pounds per square inch. The floor pressure increased from 0.56 to 2.02 pounds per square inch. Four hundred fifteen pounds of corn at 12.5 per cent moisture were then flooded for ten minutes. Maximum lateral pressures were reached in two hours and were ten times the dry pressures. Results of these tests indicated that when the moisture content of grain was increased from one per cent to 4 per cent, the lateral pressures increased as much as six times and the floor pressures increased as much as four times, and that the pressure on the side walls approached a horizontal line, similar to a liquid. The conclusion drawn by these investigators was that Janssen's formula is not sufficiently accurate for computing the lateral pressure in grain storage.

structures when the moisture content of grain is increased.

In a paper presented in 1959, Saul (29) indicated that grain with a moisture increase of from 11 per cent to 16 per cent, at 60°F, produced a lateral wall load 7 times that measured before increasing moisture. Most of this increase in pressure was eliminated by cooling the grain to 20°F.

Farrell (8) made investigations at Kansas State University in 1953, to determine the effects of flooding the bottom of grain stored in deep bins. A model bin 15-3/4 inches in diameter was used in Farrell's study. As soon as the bottom of stored grain was flooded with water, floor pressures rapidly increased and continued to do so for about 8 hours. Floor pressures continued to increase at a slow rate for approximately 16 hours. At the end of approximately 24 hours, the floor pressures began to decrease. Farrell (8) found that floor pressures due to swelling increased with depth of flooding only until the water stood 12 inches deep in the bin.

In 1960, Lorenzen (20) discussed the effects of a change in moisture content of grain on the ratio of principle pressures in stored grain. In this research, Lorenzen evaluated the effects of moisture on each of the parameters in Janssen's equation. Janssen's equation was then used to determine unit vertical and lateral pressures of grain at various moisture levels. Results indicated that the critical lateral wall pressures occur at normal moisture levels and that lateral wall pressures decrease as the moisture level increases. The latter agrees with the results of Dale and Robinson; however, Dale and Robinson found that the lateral wall pressures increased as the

moisture content of the grain was increased. It must be emphasized that Lorenzen's evaluation was made on grain out of storage. This probably explains the disagreement in the results of these two investigations.

Previous work shows no definite relationship between moisture content and pressure of grain in storage. Since 1950, Lorenzen (20), Saul (29), Farrell (8) and Dale and Robinson (7) have found that a change in moisture effects the properties of grain in storage. They have also indicated that Janssen's equation is inconsistent for determining grain pressures of grain which has experienced a change in moisture content while in storage.

#### Methods of Determining Pressures on Bin Walls and Floors

Various methods of experimental stress analysis have been used to measure pressures in bin walls and floors. Determining pressures in bin walls has proven the more difficult of the two. This is due to the fact that both a lateral and vertical component of force produce pressure in a bin wall. These are difficult to separate.

The first recorded experimental work to determine the pressure of grain in storage was performed by Roberts (25) in 1882. Roberts used model bins 7 inches to 20-3/4 inches in diameter. These bins had floating floors which rested on platform scales. The amount of grain supported by the floor was weighed on these platform scales and it was assumed that this quantity subtracted from the total weight of grain in the

bin was the amount of grain supported by the vertical wall. No provisions were made to determine lateral pressures in the bin walls.

In 1896, Prante, as reported by Ketchum (16) used full scale bins to measure pressures in bin walls. The pressure measuring apparatus consisted of a diaphragm supported on knife edges and connected by a system of levers to a scale pan. Ketchum and Varnes (16), in 1902, used a similar device to determine pressures in model bin walls.

Toltz, as reported by Ketchum (16), used full scale bins, 14 feet square and 65 feet deep, for determining grain bin pressures. A hole 1-1/2 feet by 3 feet was cut in one of the walls near the bottom of the bin. A steel plate was placed in the opening and held rigidly at two ends by steel channels. The pressures on the side walls were measured by measuring the deflection of the plate.

A pressure cell, which used the principle of frictional resistance, was introduced in 1936 by Huntington and Luetzelschwab (13). The cell consisted of a steel diaphragm, two oilite washers, a rotor, and a steel case. Pressure was measured by determining the amount of torque required to turn the rotor at a uniform speed.

In 1934, McCalmont and Ashby (23) used a Whittemore strain gage for measuring lateral pressures in rectangular bin walls. This same type of measuring device was used again in 1945 by Amundson (2), who measured lateral pressures in round bin walls.

Hydraulic pressure diaphragms were first used to determine bin wall pressures in 1900. Jamieson (14) used hydraulic pres-

sure diaphragms to determine pressures in walls of both full scale and model bins. Water was used in the cell and mercury was used in the gage to indicate pressure changes. In 1902 and 1903, Lufft (21) used hydraulic pressure diaphragms similar to those used by Jamieson. A similar device was used again in 1944 by Kramer (17). In 1954, Dale and Robinson (7) used hydraulic pressure diaphragms to determine lateral pressures in round bin walls. These pressure cells were similar to those used earlier, except that oil was used in the gage.

Caughey, Toolles, and Scheer (5) were the first recorded to use variable resistance strain gages to determine pressures in bin walls. Bins used by these investigators were 5 feet high and 18 inches in diameter with holes 6 inches by 6-1/2 inches in the bin wall. Steel plates, bent to the curvature of the inside surface of the bin walls, were fitted loosely into the wall openings. Each of these plates had a 1/2 inch steel rod welded to its center. These rods were clamped at the end to cantilever bars which were welded to the base of the bin. Thin stainless steel bands were placed around the bin and cantilever bars at each opening. The stainless steel bands were then placed under initial tension. Short lengths of lead pipe were placed between the cantilever bars and bin to act as a reaction for the tension in the bands. Variable resistance strain gages were attached to the steel bands to measure the additional strain caused by the pressure of the material on the bin wall against the pressure plates.

In 1953, Saul (28) used variable resistance strain gages to determine pressure in walls of grain bins. Saul worked with

bins 12 feet by 32 feet and 10 feet high. Wood panels, with an area of one square foot, were supported by two 5/8-inch steel rods. The rods were supported at each end by steel beams. The panels were arranged so that pressure exerted by the grain produced bending in the rods. Four variable resistance strain gages were attached to each rod. Two gages were on a plane parallel to the bin wall and two gages were normal to the bin wall. Lateral pressures on the bin walls were measured with gages parallel to the bin walls. With this arrangement of gages, four gages on each panel were measuring lateral wall pressures and four gages were measuring vertical wall pressures. Four gages, all measuring either the lateral or vertical component of wall pressures, were arranged in a Wheatstone bridge in such a way that the change in resistance of the gages on the compression sides of the rod added to the change in resistance of the tension sides of the rod. This resulted in a signal magnified four times that of one strain gage. The Wheatstone bridge arrangement also compensated for temperature effects on the change in resistance of the gages.

Collins (6) used variable resistance strain gages attached directly to the wall of the test structure for the determination of the bin wall pressures. In this investigation, the test bin was made from very thin aluminum. The structure was 3.8 feet in diameter and 12 feet tall. Forty-eight foil strain gages were applied at 14 measuring points along the bin. It was necessary to place strain gages on both the inside and outside of the wall of the bin in order to separate the direct strain from the bending strain. Strain gages were placed both verti-

12

cally and horizontally on the wall of the bin so that both the vertical and lateral components of bin wall pressure could be determined.

Determining pressures in bin floors has not presented as much of a problem as that in bin walls. The most common method used has been a floating floor which was weighed on platform scales. This method has generally given satisfactory results. Other methods which have been used are hydraulic cells and pressure transducers using variable resistance strain gages. One advantage of hydraulic pressure cells and some other types of pressure transducers over platform scales and a floating floor is that pressure can be determined at a given position on the floor. With the other two methods, it must be assumed that the pressure is uniformly distributed over the entire floor or that the floor pressure measured is the average floor pressure.

## MATERIALS AND METHODS

### Dimensional Analysis

A dimensional analysis of the variables effecting grain bin pressures was considered. A functional relationship for grain bin pressures is of the form:

$$L = f_1 (h, D, W, m, \mu, \phi)$$

where:

Force-Length-Time units

L = unit lateral pressure in bin wall	FoLe <sup>-2</sup>
h = depth of grain	Le
D = diameter of bin	Le
W = bulk density of grain	FoLe <sup>-3</sup>
m = moisture content of grain	----
μ = coefficient of friction between grain and bin wall	----
φ = coefficient of friction of grain on grain	----

Five dimensionless "π" terms were obtained from a dimensional analysis of the above relationship. These are:

π<sub>1</sub> = L/WD

π<sub>2</sub> = h/D

π<sub>3</sub> = m

π<sub>4</sub> = μ

π<sub>5</sub> = φ

Wheat and a galvanized sheet metal bin were used throughout this investigation. Therefore, the variables μ and φ were held constant and were dropped from this dimensional analysis resulting in a relationship of the form:

π<sub>1</sub> = f<sub>1</sub> (π<sub>2</sub>, π<sub>3</sub>)

or L/WD = f<sub>1</sub> (h/D, m)

It should be noted here that since both unit vertical wall



pressure (V) and floor pressure (F) have the same dimensions as the unit lateral wall pressure (L), the following relationships would hold. That is:

$$V/WD = f_2 (h/D, m)$$

$$F/WD = f_3 (h/D, m)$$

From the above dimensional analysis it was decided that the test procedure for this investigation would be divided into two series of tests. A first series of tests, holding the moisture content of the grain constant and varying  $h/D$ , was conducted. These tests were followed by a series of tests varying the moisture content of the grain and holding the ratio of depth of grain to diameter of bin constant.

#### Equipment

The equipment used in this investigation consisted of the following:

1. Test structure.
2. Transducers and strain gage equipment for determining bin wall and floor pressures.
3. Equipment for filling and emptying bin.
4. Equipment for increasing moisture content of grain.
5. Equipment for determining temperature of grain.
6. Air oven and scales for drying and weighing grain to determined moisture content.

Test Structure. The test structure was a model bin made

from  $2\frac{1}{2}$  feet x 8 feet sheets of 22-gage galvanized sheet metal approximately 0.22 inches thick (Plate I). The bin was 2 feet in diameter and its total depth was 10 feet. A double row of  $3/16$ -inch rivets was used to fasten the sheet metal together at the connections. The vertical connections were staggered from sheet to sheet. Five vertical bars,  $1/8$  inch x 1 inch, were riveted to the outside of the bin to provide vertical support and prevent buckling of the bin walls.

Two holes were cut in the wall of the bin. A 5 inch x 6 inch hole, with its centroid one foot from the bin floor, was cut in the wall for the fitting of a wall pressure transducer. A second hole, 6 inches x 6 inches, was cut in the bin just above the bin floor. This hole provided an opening for emptying the bin.

Since it was necessary to determine floor pressures, a floating floor was used in this bin (Plate II). The floor was made from perforated material so that air could be circulated through the bin. The diameter of the floor was slightly less than 2 feet so that it could be fitted into the bin. A 3 inch x  $1/2$  inch steel bar was bent to curvature of the bin floor and welded to the perforated material to provide a support for the floor. The floor was mounted on floor pressure transducers and raised 14 inches from the laboratory floor. This resulted in a bin that could be filled with grain to a maximum depth of 8.83 feet.

Pressure transducers. Pressure transducers, utilizing variable resistance strain gages, were used to determine average

#### EXPLANATION OF PLATE I

A drawing of the test bin showing some pertinent dimensions. The location of the floating floor, floor pressure transducers, and hole for wall transducer are also shown.

PLATE I

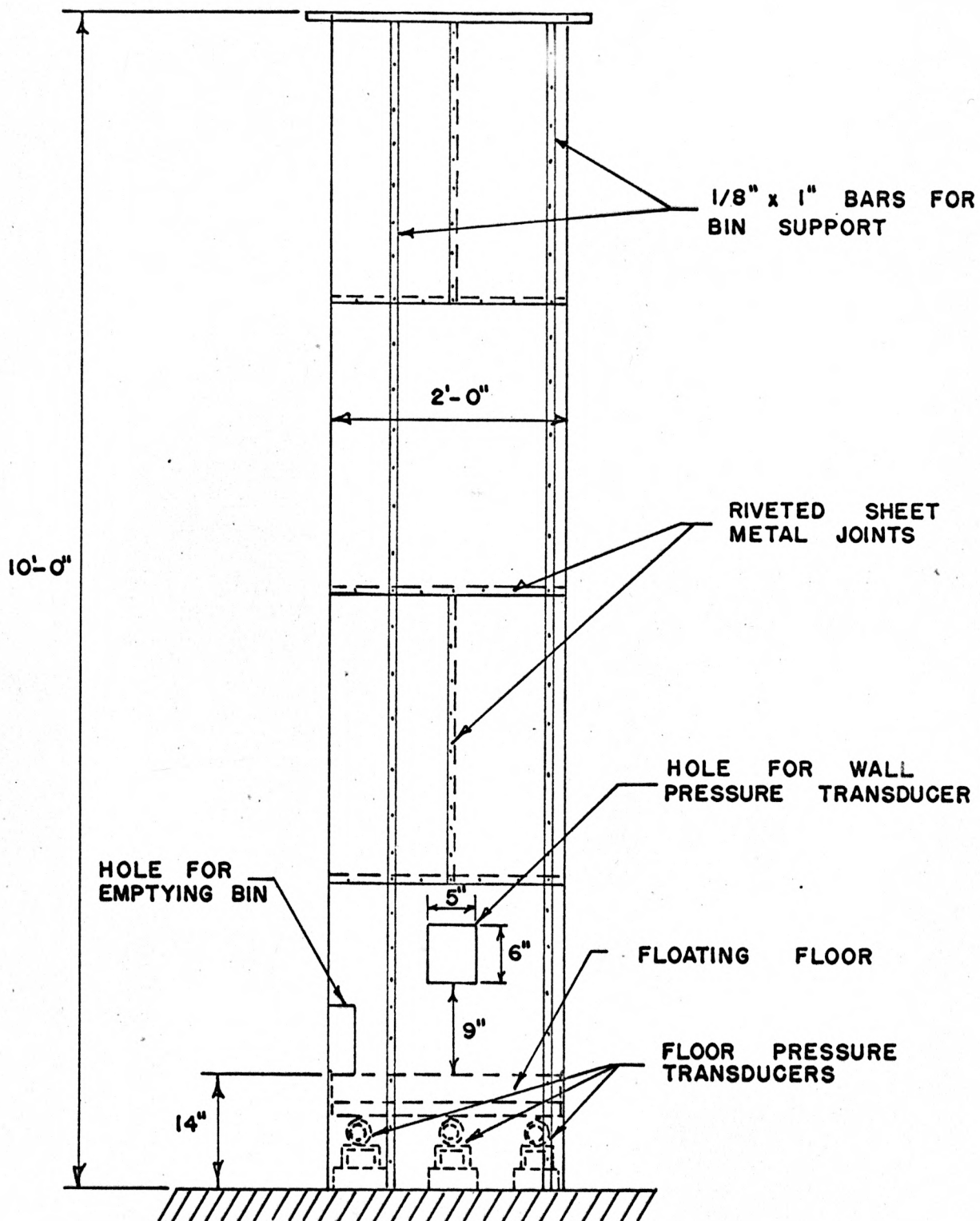

EXPLANATION OF PLATE II

View of perforated floating floor as seen from top  
of bin.

## PLATE II

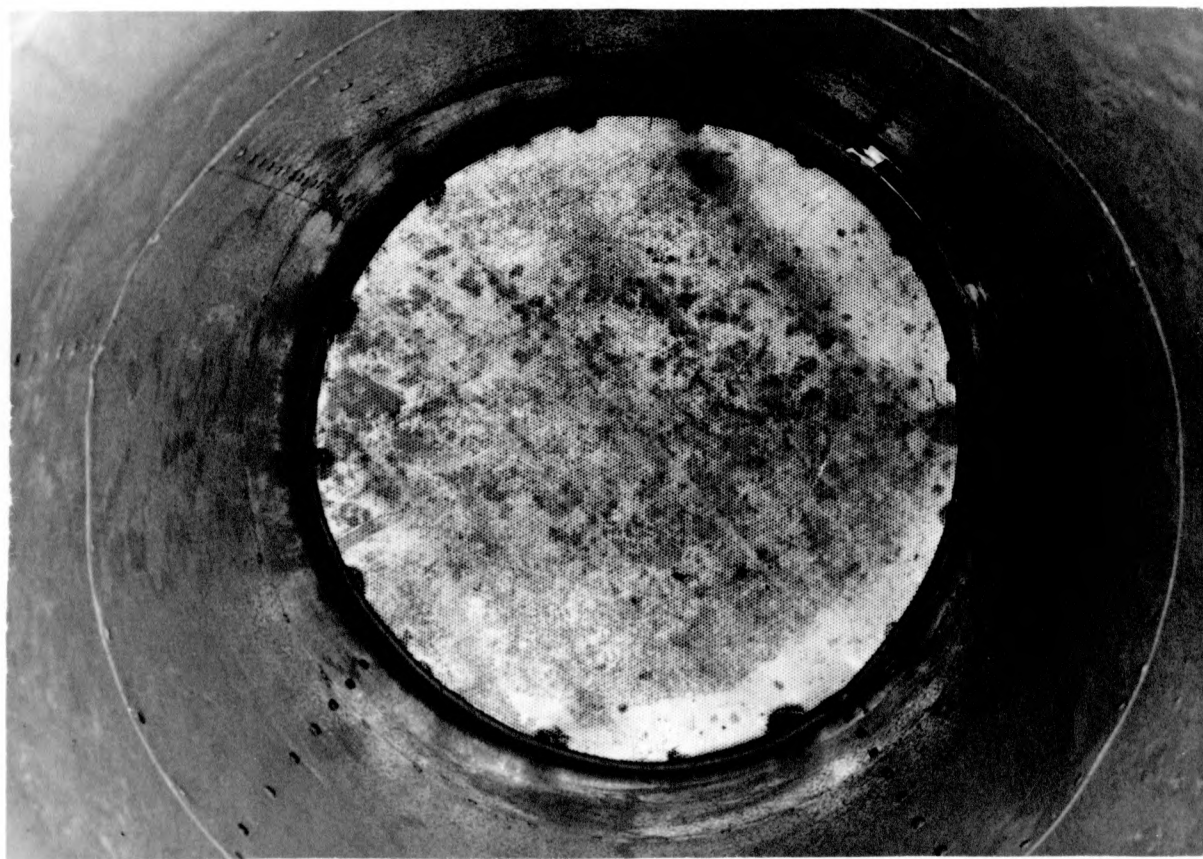

floor pressure. Three circular transducers were placed symmetrically under the bin floor. A one-inch length of pipe was used to construct these transducers. Plates III and IV show a detailed drawing and photograph of one of these transducers. Notice that the pipe is welded to a short length of steel channel for support. Strain gages used in conjunction with these transducers are explained in detail in a later section.

Values for wall pressure predicted from Janssen's equation were used as design values for the design of a wall pressure transducer, for which variable resistance strain gages were used as sensor units. As was previously mentioned, one of the objectives of this investigation was to develop a technique for separating and measuring the vertical and lateral components of bin wall pressure. With this in mind, the pressure transducer shown in Plates V and VI was designed and constructed for experimentally determining bin wall pressures. The transducer consisted primarily of two beams and a pressure plate. Beam "A" (Plate V) was designed to detect lateral wall pressures and beam "B" was designed to detect vertical wall pressures. A plate, 5 inches x 6 inches and approximately the thickness of the bin wall, was bent to the curvature of the bin wall and fastened to the end of beam "B". This plate was fitted into a hole, slightly larger than the plate, cut in the bin wall as was previously stated (Plate VII). Approximately 5 inches from the plate, beam "B" (Plate V) was supported in a cantilever support made of 10 small roller bearings ( $3/8$ -inch outside diameter,  $1/8$ -inch inside diameter and  $1/8$ -inch thick). In addition to providing a support for beam "B", these bearings

#### EXPLANATION OF PLATE III

Drawing of floor pressure transducer showing some pertinent dimensions and location of strain gages. R<sub>1</sub>, R<sub>2</sub>, R<sub>3</sub> and R<sub>4</sub> represent strain gages.



PLATE III

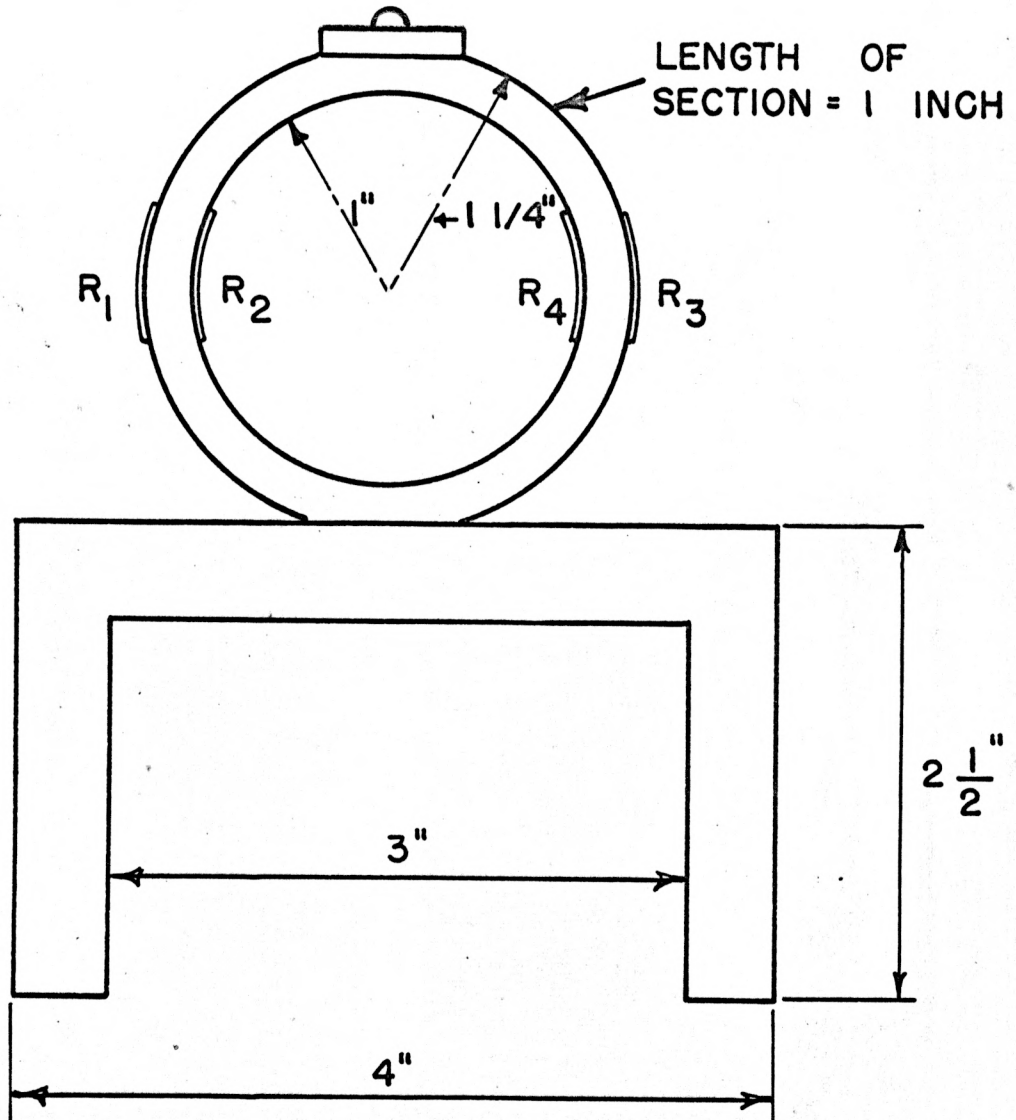

EXPLANATION OF PLATE IV

Photograph of floor pressure transducer. Wax on pipe indicates location of strain gages.

PLATE IV



#### EXPLANATION OF PLATE V

Drawing of wall pressure transducer showing some pertinent dimensions and location of strain gages. R<sub>5</sub>, R<sub>6</sub>, R<sub>7</sub> and R<sub>8</sub> represent strain gages on beam "A" and beam "B".

PLATE V

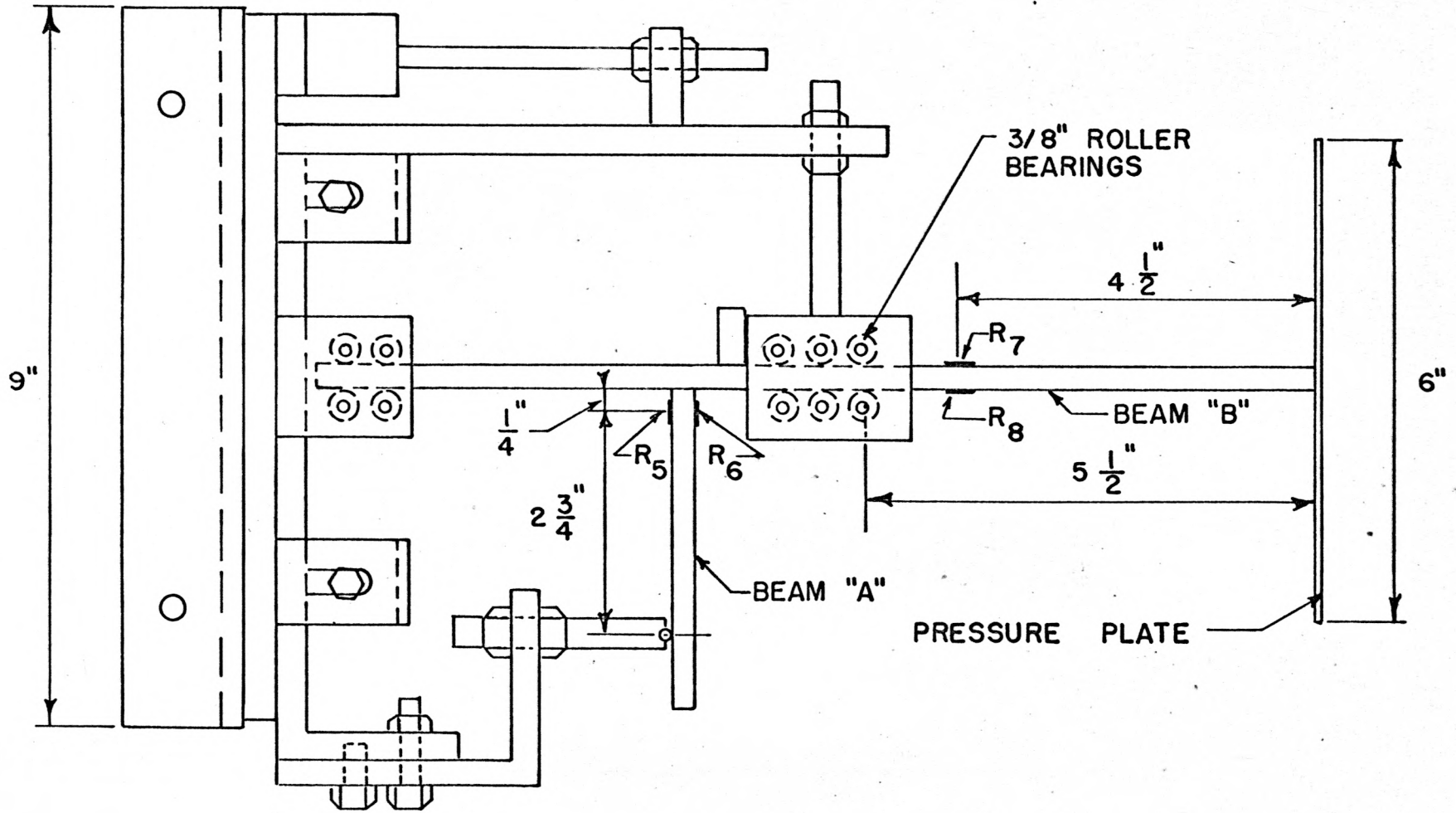

EXPLANATION OF PLATE VI

View of wall pressure transducer mounted in floor stand.

PLATE VI

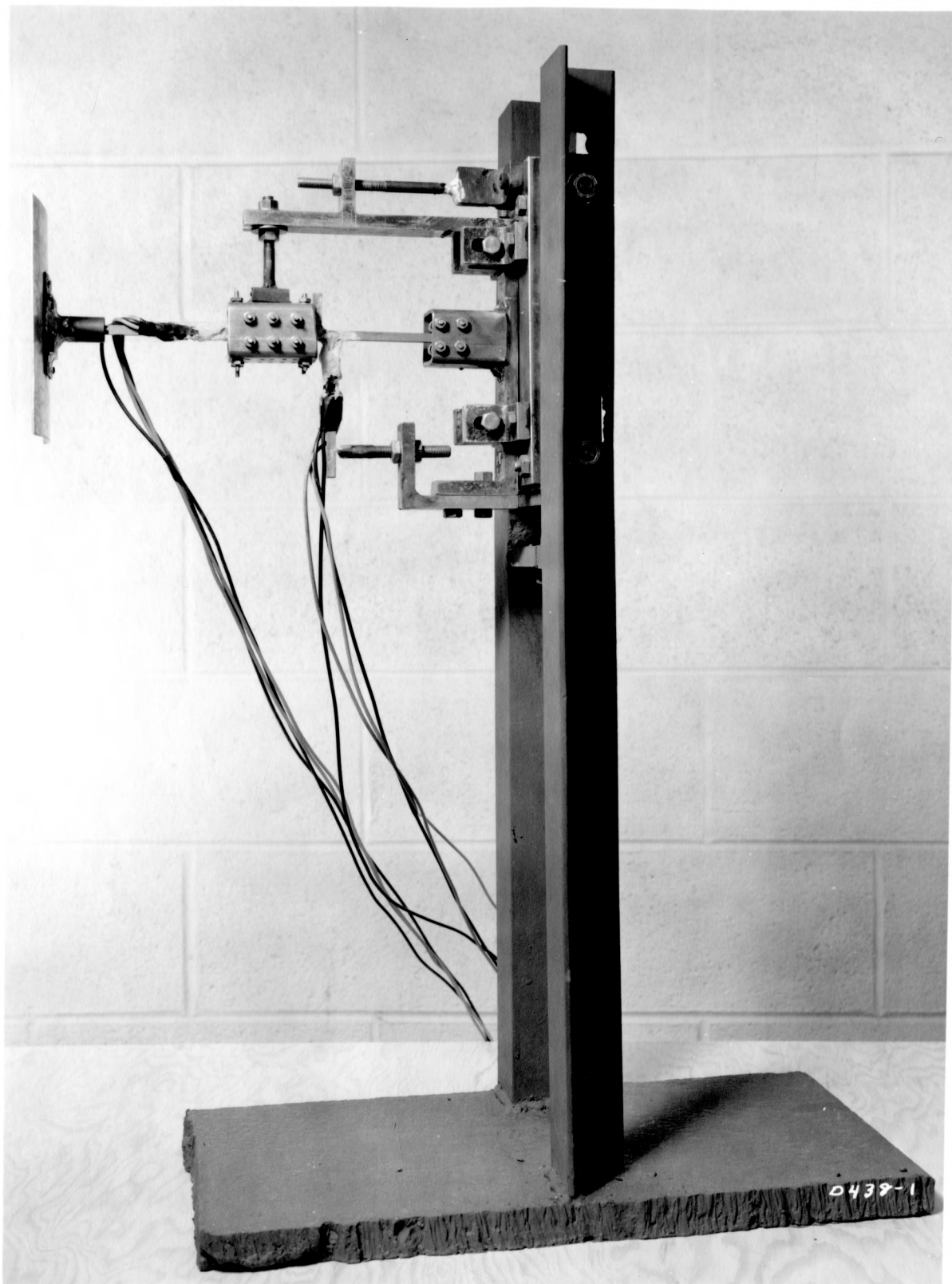

EXPLANATION OF PLATE VII

A close view of pressure plate in bin wall.



PLATE VII



also permitted the beam to move freely in a lateral direction. Beam "B" was then simply supported 3 inches from the cantilever support. Four ball bearings similar to those used in the cantilever support were used in the simple support, again to permit movement in the lateral direction. Beam "A" was welded at right angles to beam "B" immediately behind the cantilever support. A simple support was provided 3 inches from the weld. The lateral component of bin wall pressure produced bending in beam "A" and the vertical component of wall pressure produced bending in beam "B". Variable resistance strain gages were attached to the tension and compression sides of these beams to detect strain produced by bending of the beam. This is explained in detail in a later section.

A number of adjustments were made possible with this transducer so that a good fit of the pressure plate in the bin wall was accomplished. Plate VI shows a photograph of the floor stand used for this transducer. The floor stand was made of a 1 inch x 12 inch x 24 inch steel plate and two 2-1/2 inch x 2-1/2 inch x 1/4 inch angles, 24 inches long. Weights totaling approximately 250 pounds were placed on the floor stand to prevent slippage of the stand due to loads on the transducer.

Strain Gages and Strain Gage Instrumentation. Baldwin SR-4 variable resistance strain gages were used on both the floor transducers and the wall pressure transducer. The gages were all approximately 120 ohms resistance and each gage had a gage factor of approximately 2.0.

Four type A-5 gages were used on each of the floor trans-

ducers. The resistance of the gages was  $119.6 \pm 0.2$  ohms and the gage factor was  $1.98 \pm 1\%$ . Gages were attached to the inside and outside of the pipe (Plate III) 90 degrees from the point of application of the load on the transducer and 90 degrees from center of the bottom of the pipe at the weld. With these transducers under load the two gages on the outside of the pipe were in tension while the two gages on the inside of the pipe were in compression. The magnitude of the negative strain was essentially equal to the magnitude of the positive strain since the gages were placed directly opposite each other on the pipe. After arranging the two gages on the outside of the pipe in series, and the two gages on the inside of the pipe in series, the tension gages and the compression gages were placed in adjacent arms of a two external arm Wheatstone bridge arrangement (Plate VIII). By connecting these in adjacent arms of the bridge, the positive and negative strains were additive. This resulted in a response of approximately four times the actual strain detected by one gage. The Wheatstone bridge arrangement used here also provided the gages with temperature compensation.

Type A-18 Baldwin SR-4 strain gages were used on the beams of the wall transducer. These gages were selected because they were small ( $1/8$  inch wide) and were easily attached to the  $1/4$ -inch beams. The resistance of these gages was  $120.0 \pm 0.3$  ohms and the gage factor was  $1.78 \pm 2\%$ . Two gages were mounted on both beams "A" and "B". Gages were attached to the tension and compression sides of beam "B",  $4-1/2$  inches from the pressure plate and the gages were mounted on beam "A",  $2-3/4$  inches from the simple support (Plate V). The gages on the tension and

#### EXPLANATION OF PLATE VIII

A schematic wiring diagram of the strain gages used in conjunction with floor pressure transducers.  $R_1$ ,  $R_2$ ,  $R_3$  and  $R_4$  represent strain gages located as shown in Plate III.  $R_9$  and  $R_{10}$  represent the internal resistances of the instrument.

PLATE VIII

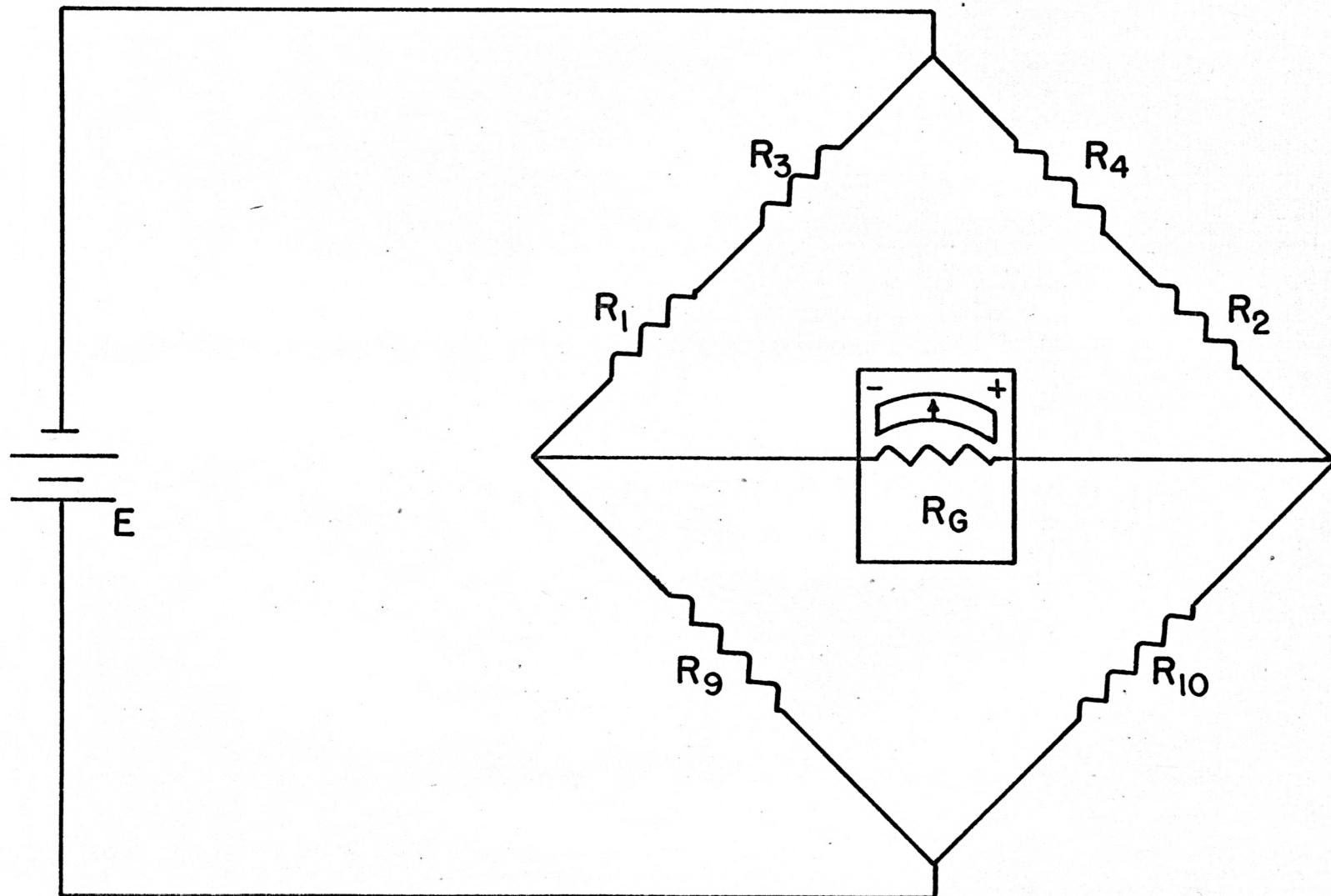

and compression sides were mounted directly opposite each other in each case. A two external-arm Wheatstone bridge arrangement (Plate IX) similar to the one used with the floor transducers, was used. In this case, only one gage was placed in each arm of the bridge. The positive and negative strains due to bending of the beam added in this arrangement. This gave a response twice that detected by one strain gage and provided temperature compensation for the gages. Gages on both beams "A" and "B" were arranged in this manner. It should also be noted that any strain in beam "B" due to compression caused by lateral loads was canceled in this arrangement and only bending strains produced by the vertical wall load were detected.

A Baldwin Type N SR-4 Strain Indicator was used to indicate strain detected by the strain gages employed by these transducers. The gages were connected to the indicator through a Baldwin Multi-channel SR-4 Switching and Balancing Unit (Plate X). The switching and balancing unit was zeroed at the same dial reading for each transducer. In order to be able to zero at the same dial reading, the floor transducers were zeroed on range extender "A" of the indicator and the wall transducer was zeroed on range extender "O". The reason for this was that there were 120 ohms resistance across the leads of gages used on the wall transducer and 240 ohms resistance across the leads from the floor transducer which had two gages connected in series. With the switching and balancing units it was possible to take the strain readings much faster and the zero reading 11,000 was used thus making computations simpler.

#### EXPLANATION OF PLATE IX

A schematic wiring diagram of the strain gages used in conjunction with the wall pressure transducer.  $R_5$ ,  $R_6$ ,  $R_7$  and  $R_8$  represent strain gages located as shown in Plate V.  $R_9$  and  $R_{10}$  represent the internal resistances of the instrument.

PLATE IX

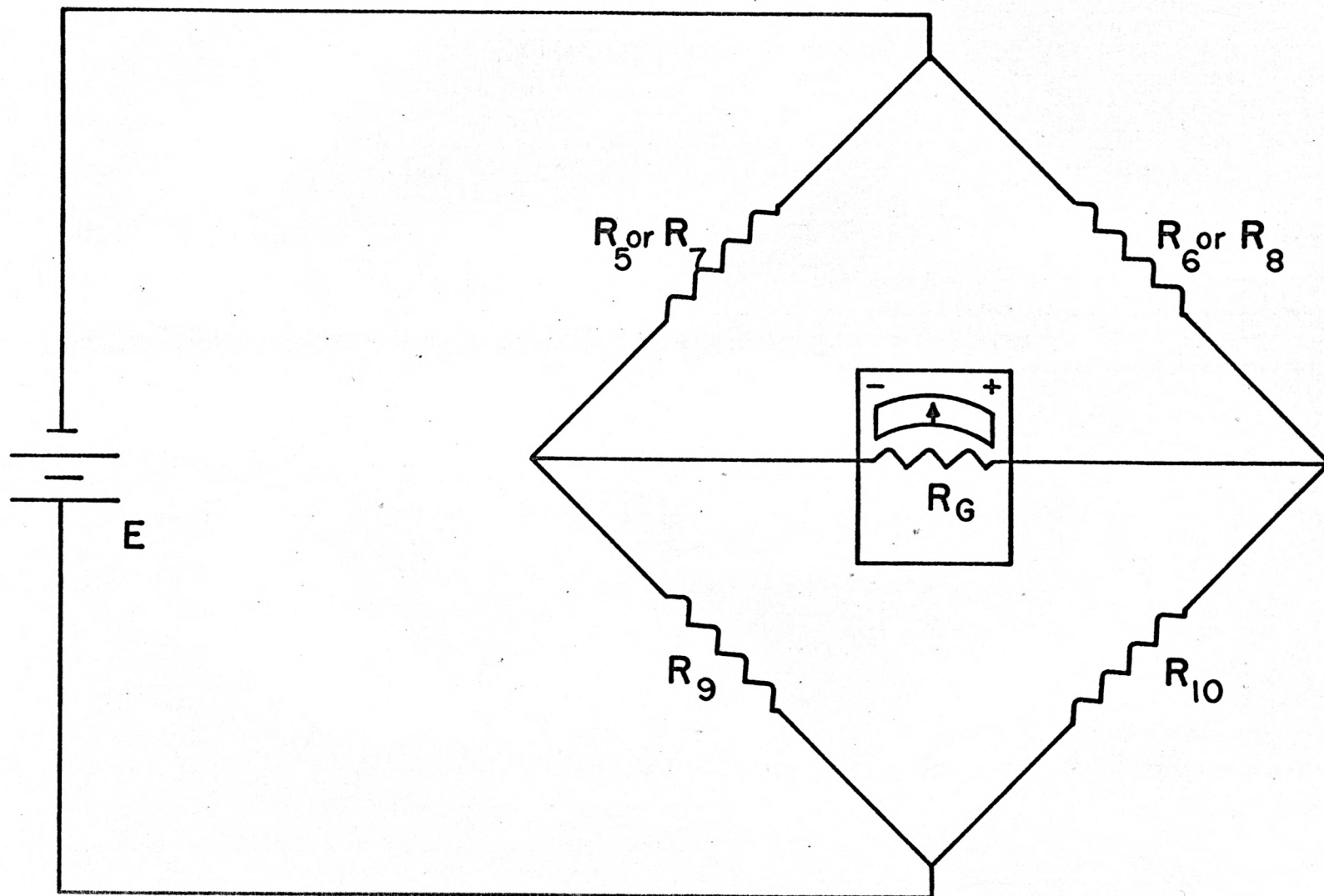



EXPLANATION OF PLATE X

View of SR-4 Portable Strain Indicator and Multi-channel SR-4 Switching  
and Balancing Unit.

PLATE X

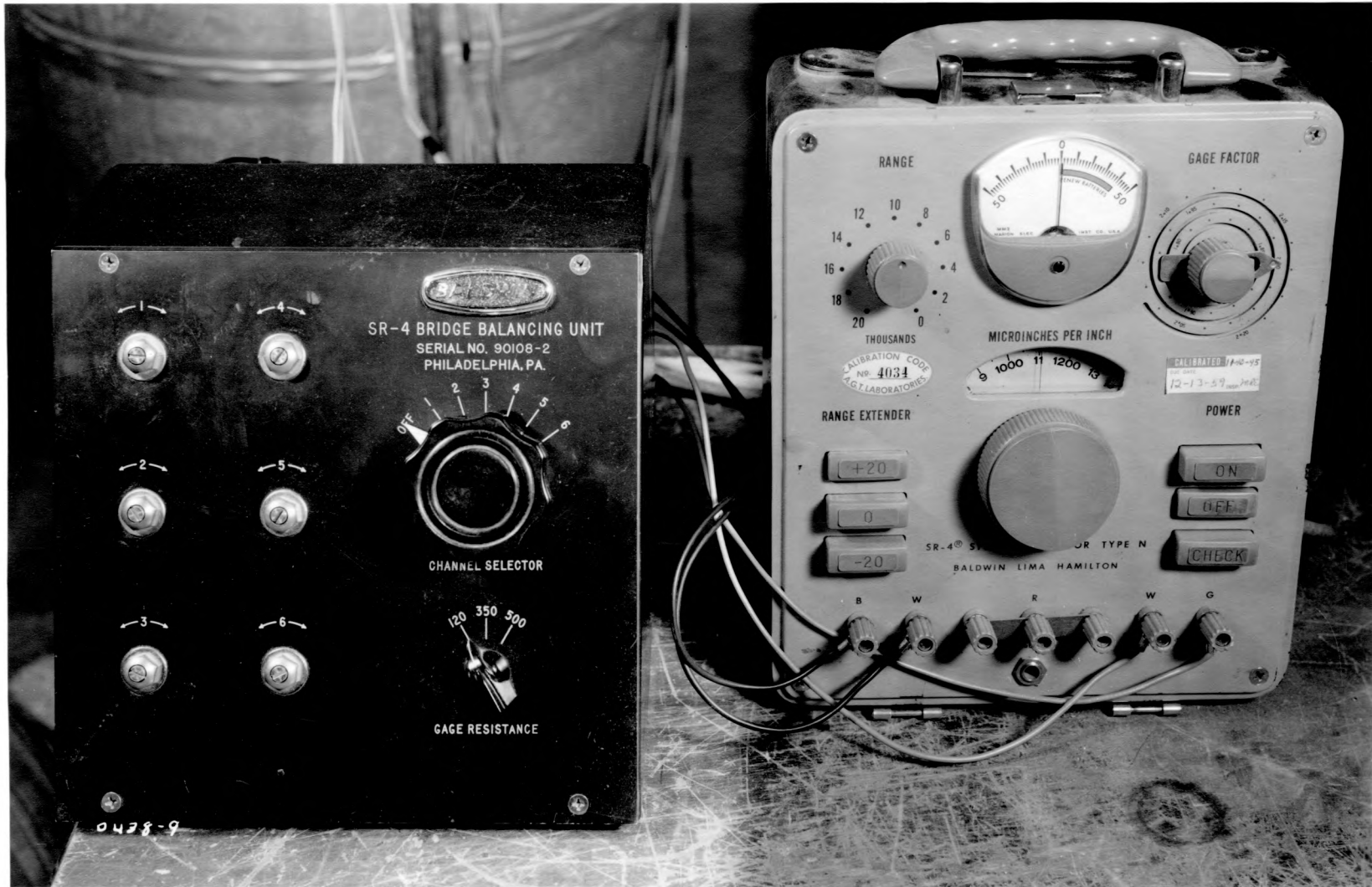

### Equipment for Increasing Moisture Content of the Grain.

The moisture content of grain was increased by adding steam to the system. Steam was supplied by a low pressure steam line in the laboratory. Plate XI shows the steam line from a main valve to the 5-inch duct where it was introduced into the system. Notice the main valve, needle valve for fine adjustment and the steam trap. A magnetic valve, kept open at all times during the tests, is also shown in Plate XI.

Plate XII shows the blower used to circulate air through the grain in a closed system. A 1/3-horsepower electric motor was used to power the blower. In Plate XIII, an overall view of the bin and duct system can be seen. The 5-inch air duct, through which air and steam traveled, can be seen in Plate XIII. Plate XII shows the bin exhaust as it is connected to the intake of the blower. This completes the closed system previously mentioned.

Temperature of the system was observed as moisture was being added. Four thermocouples were placed in the center of the bin at 2-foot intervals starting one-foot from the floor of the bin. One thermocouple was placed in the center of the air duct approximately one foot from the steam entrance and one thermocouple was placed under the floor of the bin. A Brown Recording Potentiometer, switching unit and clock were used to record temperatures hourly (Plate XIV).

Moisture Determination. A standard air-oven was used to dry grain for the determination of the moisture content. Scales which could be read accurately to 0.1 of a gram were used to weigh the moisture samples.

EXPLANATION OF PLATE XI

View of main valve, needle valve, magnetic valve,  
steam trap and entrance of steam line into 5-inch duct.

PLATE XI

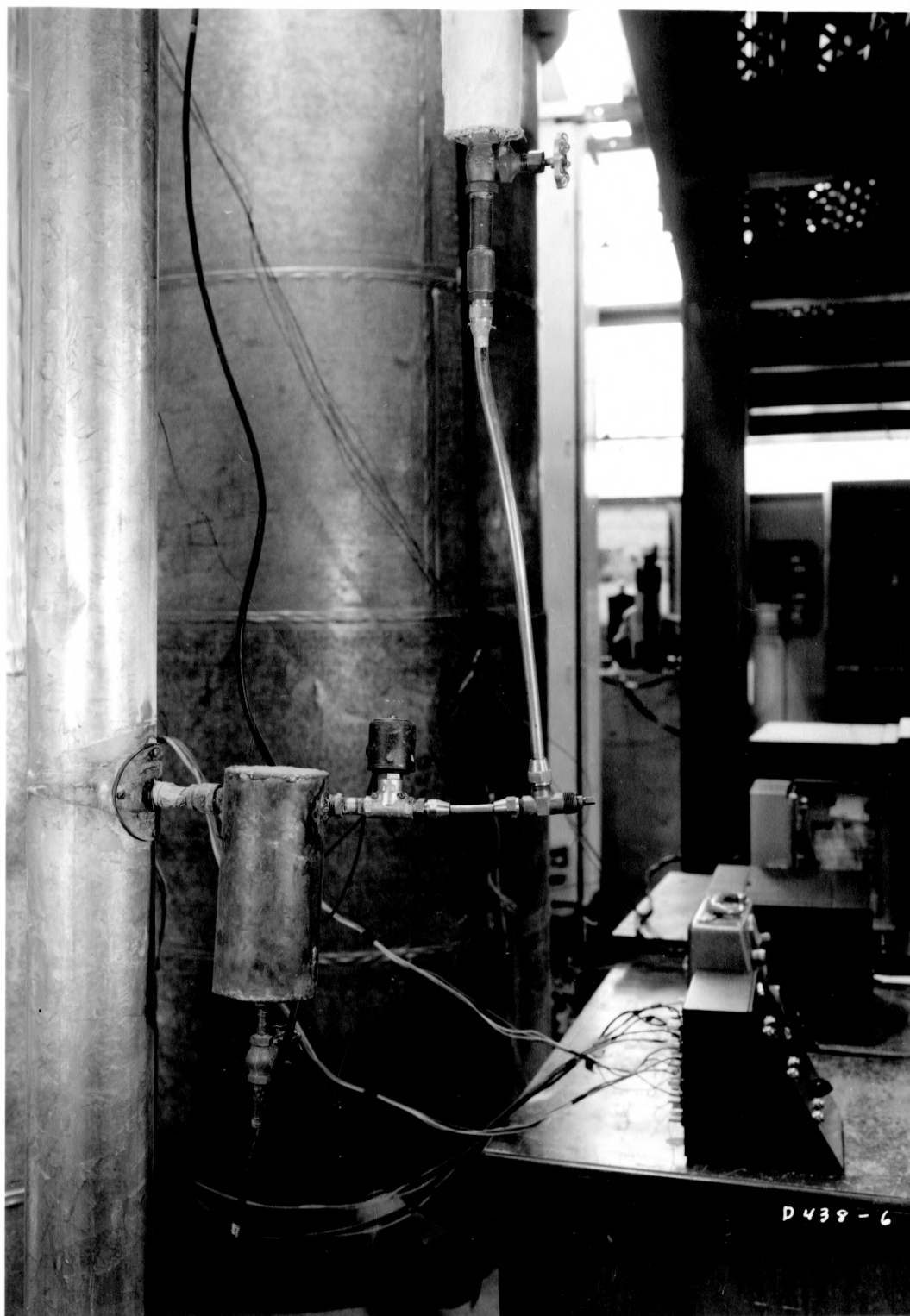

D 439 - 6

EXPLANATION OF PLATE XII

View of blower used to circulate air through bin.

PLATE XII

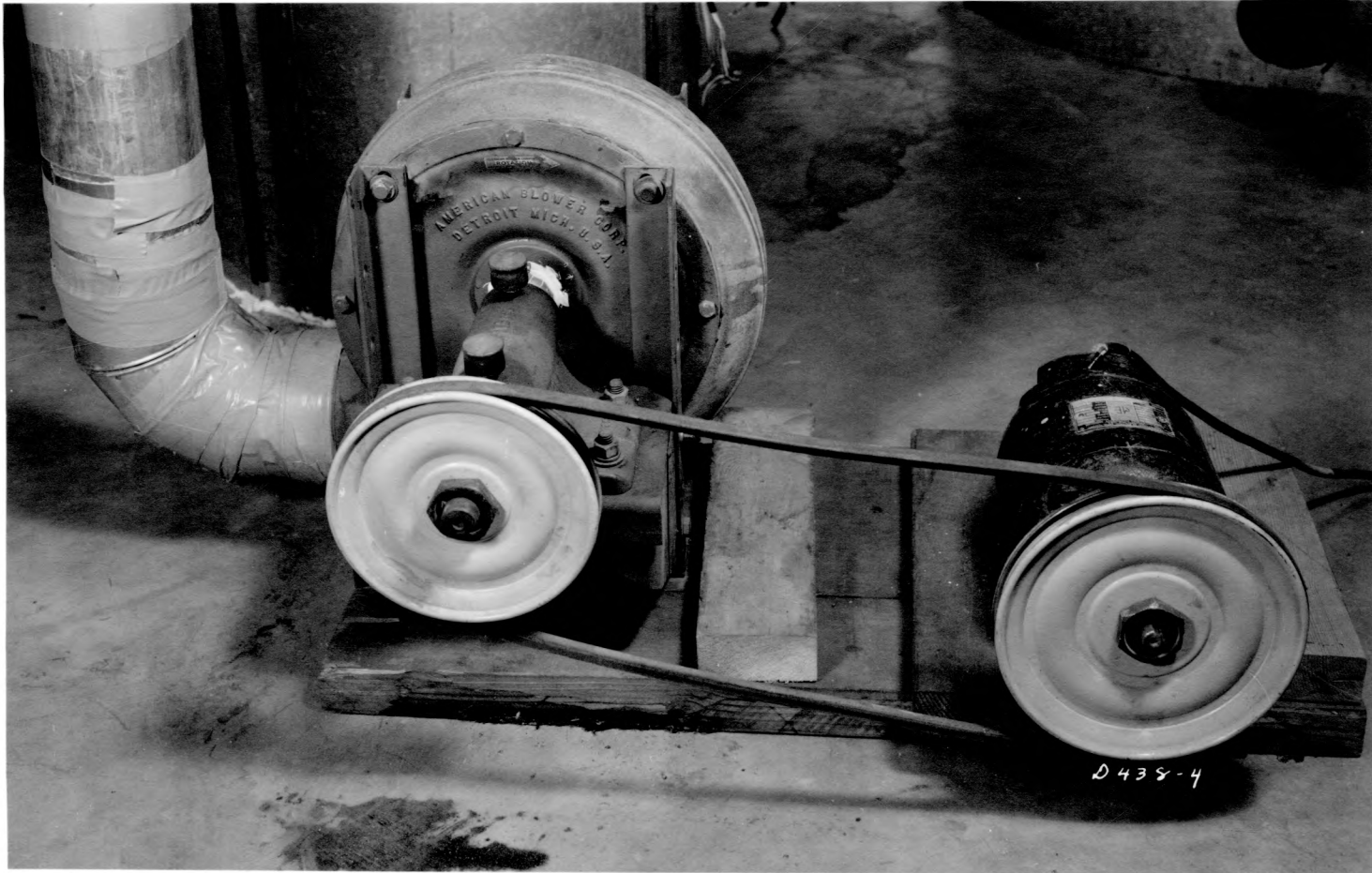

#### EXPLANATION OF PLATE XIII

Overall view of experimental equipment as it appeared during the second series of tests. The wall pressure transducer is shown in foreground. The blower, steam line and 5-inch duct for recirculating air are shown at the right of the bin.



## PLATE XIII



EXPLANATION OF PLATE XIV

View of recording potentiometer, clock, and switching unit used to record temperatures.

PIA TE XIV

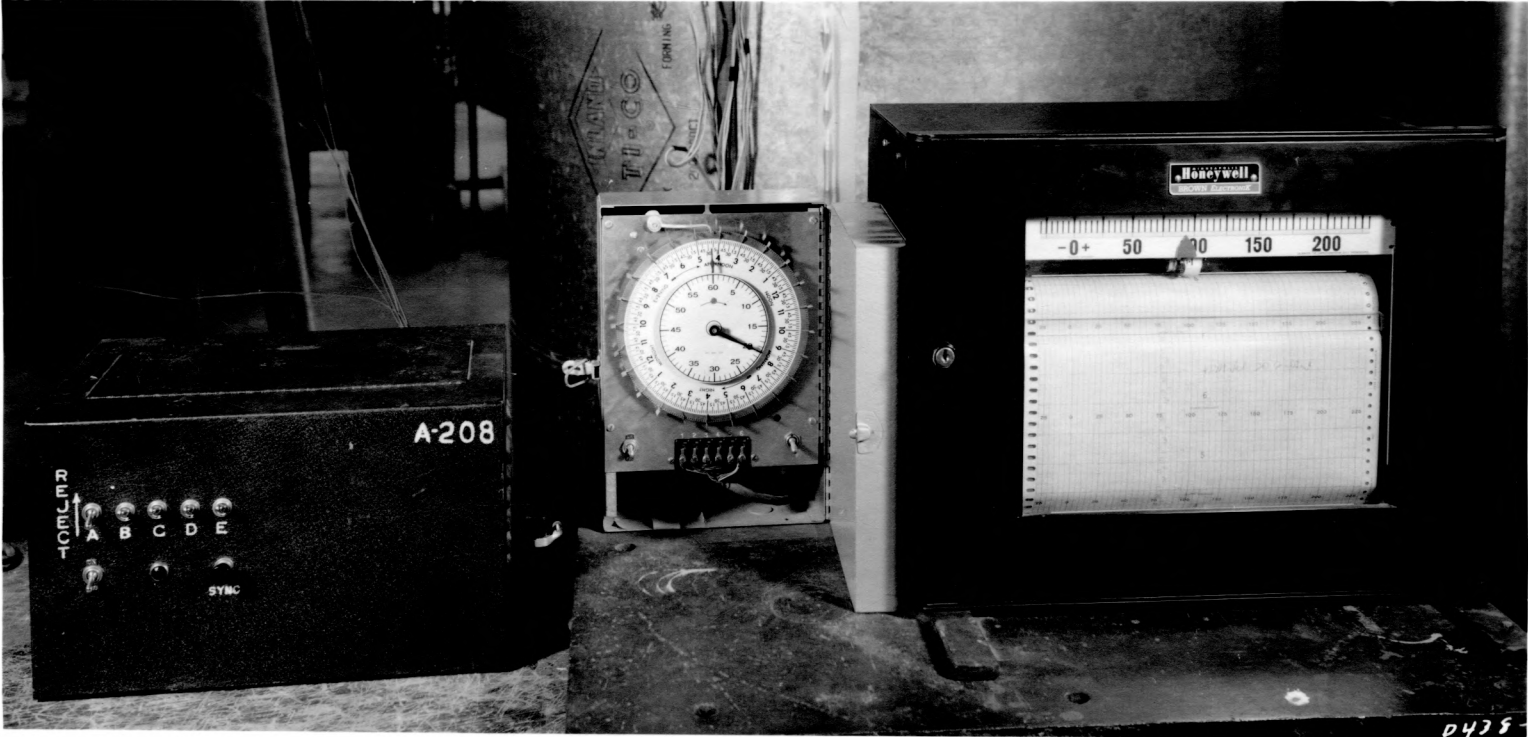

D438

Test Grain used in Investigation. Hard red winter wheat was used as the test material throughout these tests. The wheat used for the first series of tests and a part of the second series of tests had an initial moisture content of 11 per cent (dry basis) and a bulk density of 48 pounds per cubic foot. After this grain was depleted, new wheat with an initial moisture content of 12.9 per cent (dry basis) and a bulk density of 49 pounds per cubic foot was used for the final tests.

### Procedure

Calibration of Pressure Transducers. The floor transducers were calibrated individually by using a calibration stand designed especially for the calibration of these transducers. The calibration stand was made of two parts; one for loading with weights and the other for mounting on platform scales to determine these weights. Plate XV shows this calibration stand being used for the calibration of a floor transducer. The transducer was placed on top of a rigid frame which was mounted on two platform scales. A rack on which weights were mounted was placed on top of the transducers to simulate the type of loading produced by the bin floor. Concrete blocks were used to provide weight for this calibration. The SR-4 indicator was used to indicate strain due to loading and data were taken for strain vs. load for each transducer. These transducers were checked and rechecked so that there was confidence in the calibration.

As may be noticed in Plate XV, the transducer being calibrated is not of the same shape as those seen in Plate III and IV. This transducer was not actually used under the floor of

EXPLANATION OF PLATE XV

View of calibration equipment used for the calibration of floor pressure transducers.

PLATE XV

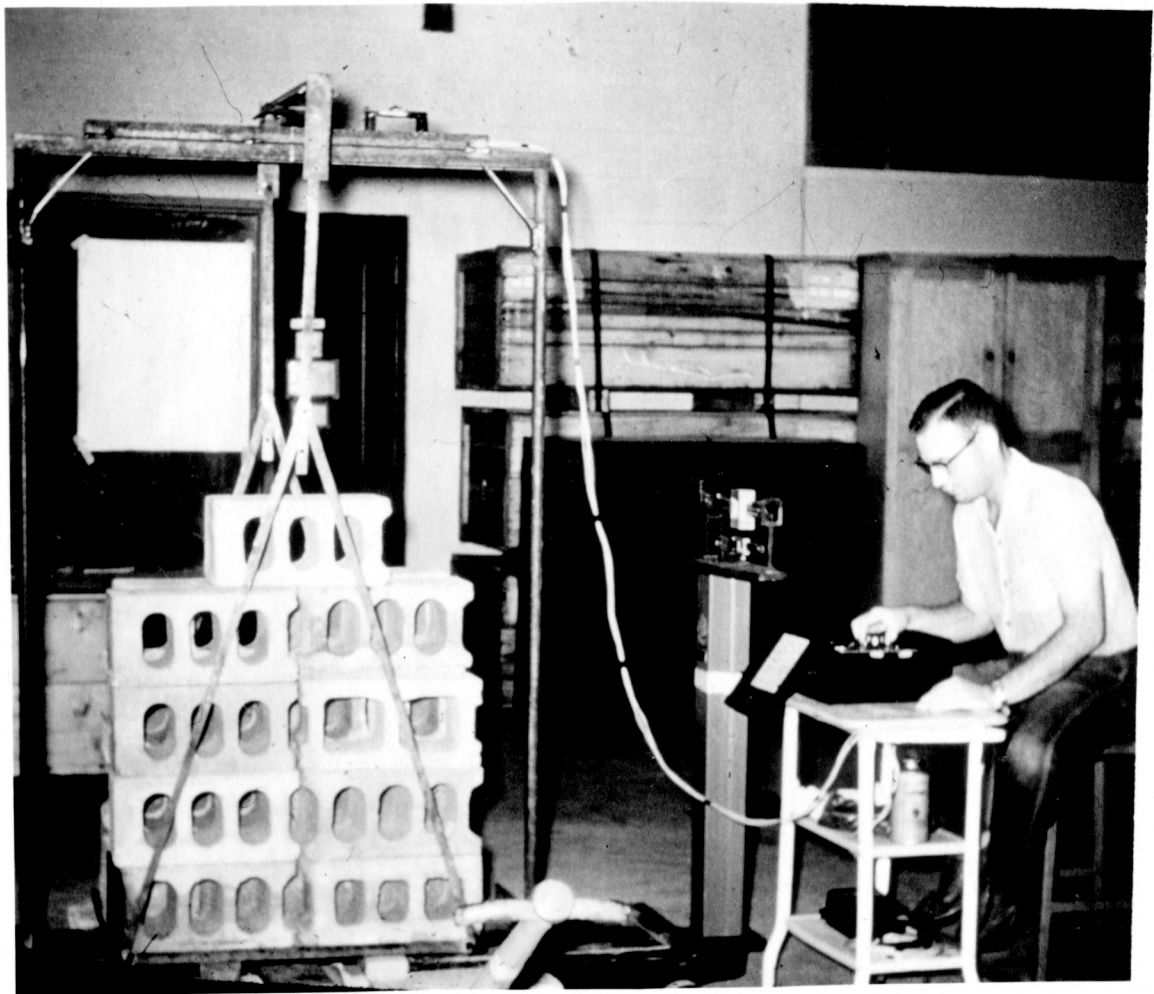

the bin described in this investigation, but in another bin. However, the calibration procedure shown in Plate XV is the same as that used in the calibration of the floor transducer previously described.

The wall transducer was calibrated by mounting the transducer first in its normal position in a vice. Standard weights were tied to the face of pressure plate and the SR-4 indicator was used to determine strain for these various loads. Although the transducer was designed so that a load parallel to the face of the pressure plate produced bending in beam "B" (Plate V), the cantilever support was not strong enough to resist all the bending and some bending was produced in beam "A" due to this loading. Therefore, calibration data were also taken for beam "A" with this type of loading. Beam "A" was then calibrated for a loading normal to the pressure plate or a simulated lateral wall loading. This was accomplished by turning the transducer  $90^{\circ}$  in the vice so that beam "B" of the transducer was in a vertical position. Calibration of beam "A" was then accomplished by placing standard weights on the face of the pressure plate. Care was taken to prevent any bending in beam "B" while calibrating beam "A". The SR-4 indicator was used to indicate strain for various loads on the transducer.

Tests Holding Moisture Content Constant and Varying the Ratio of Height Over Diameter. The first series of tests performed in this study was to determine the pressure in bin walls and floor produced by wheat with constant moisture content and varying h/D ratio. The goals of these tests were:

1. To gain confidence in the wall and floor pressure transducers by repeating tests and attempting to account for total loads.
2. To determine wall and floor pressures at various depths of grain and to compare results with those predicted from Janssen's equation for the same conditions.
3. To determine a relationship between the terms  $F/WD$  and  $h/D$ , with the moisture content of the grain constant. Also a relationship between  $L/WD$  and  $h/D$ , and  $V/WD$  and  $h/D$  was desired.

The first series of tests was performed by filling the bin to depths of approximately one foot intervals and taking pressure readings. A pipe with a graduated scale was used to determine the depth of grain. The pipe (Plate XVI) was graduated in one inch intervals and was read to 1/2-inch accuracy. The pipe was made in a "T" shape so that the grain could be approximately leveled before determining depth. Strain for the various depths was determined by use of the SR-4 Indicator and Switching and Balancing units. Data for pressure vs. depth were taken immediately after filling the bin to a given depth; therefore, no time was allowed for settling of grain. For these tests, the bins were filled from the top with an auger and no set rate of fill or position of auger for fill was used.

In order to determine the actual weight of grain in the bin at a given depth, the entire experimental setup was mounted on a 4 foot x 8 foot platform and the platform mounted on three platform scales. Data were taken for total weight vs. depth of fill. Data were also taken for floor and wall pressures at the same time. Due to the movement of the bin on platform scales the wall transducer was inconsistent and the bin was taken off



EXPLANATION OF PLATE XVI

View of graduated pipe for determining depth of grain.

## PLATE XVI



the scales and put back on the more rigid floor. The data for total load vs. depth were useful as will be indicated later.

Tests Holding  $h/D$  Ratio Constant and Varying Moisture Content. A second series of tests was conducted to determine bin pressure due to a change in moisture content of the stored grain. The first method used to increase the moisture content of the grain was to add water to the grain and recirculate air through the grain in a closed system. Water was stored in a reservoir consisting of a gallon can and was dripped onto the grain through small pin holes in a plastic tube. This method of increasing moisture content proved unsatisfactory as will be discussed more thoroughly in a later section.

It was decided that a more satisfactory method of increasing the moisture content of grain was to use steam. A one-inch steam line was connected from a low pressure steam line in the laboratory to a duct through which air was carried into the grain. This method of increasing the moisture content of the grain proved more satisfactory.

The procedure followed in this second series of tests was to add grain to the bin to a given depth and determine depth and pressure readings. Final pressure readings for given depth of grain were not taken until the grain had settled. Settlement was permitted in this case so that any change in pressure, after steam was added to the grain, would be a direct result of a change in moisture content of the grain. Settlement usually took approximately 12 hours with most of the settlement the first three or four hours. After settlement had essentially stopped the moisture content of the grain was increased.

With the blower operating, steam was added to the system for approximately 24 hours. Care was taken not to let the temperature of the grain exceed 100° F. Steam was then turned off and air was circulated through the grain in a closed system until the temperature of the grain returned to room conditions. This normally took from 24 to 48 hours depending on the depth of grain and the maximum temperature of the system. The maximum temperature and time for adding steam and air were arbitrary and were chosen because they gave moisture increases of approximately 1.5 to 2.5 per cent.

After the temperature of the system had returned to room temperature, pressure readings and moisture samples were taken. Moisture samples were taken from the bin by probing with a probe one inch in diameter. A small hole was cut in the top of the bin so that probing could be accomplished through this hole and the top of the bin would not need to be removed. This hole was simply covered with pressure tape after probing. Moisture samples were taken from two levels in the bin; one approximately 1 to 2 feet below the surface of the grain and the other approximately 2 feet above the bin floor. By probing at least one foot from the wall transducer, pressures were not noticeably affected by probing.

A Baldwin SR-4 indicator and switching and balancing were again used to indicate wall and floor pressures. Since these tests sometimes lasted as long as two weeks, it was necessary to check the strain gage instrumentation for instrument drift. This was accomplished by taking initial strain readings and then reversing the leads from the switching and balancing unit to the indicator. That is, the leads to the terminals marked measuring and

compensating on the indicator were reversed. The leads were also reversed at every pressure reading taken after an increase in moisture of the grain.

An air-oven was used for oven drying moisture samples previously mentioned. The samples, weighing approximately 100 grams each, were carefully weighed and dried in the oven for 72 hours at 100° C. At this time, the samples were taken from the oven and weighed and moisture content was determined. According to Hall (10), the above mentioned direct method of determining moisture content is considered a standard method.

## RESULTS

### Calibration of Transducers

Results of calibrations of the floor transducers are shown graphically in Figures 1, 2, and 3. Since these data so nearly followed a straight line, equations were determined by the slope intercept method. The equations were of the form:

$$\text{Transducer "D"} \quad - \quad P = 0.433e \quad (\text{eq. 2})$$

$$\text{Transducer "E"} \quad - \quad P = 0.424e \quad (\text{eq. 3})$$

$$\text{Transducer "F"} \quad - \quad P = 0.416e \quad (\text{eq. 4})$$

where P = load in pounds and

e = strain in microstrain units.

These equations were used directly to determine the load on each transducer and thus the total floor load or average floor pressure.

Results of calibrations of the wall transducer are shown graphically in Figures 4, 5, and 6. Equations were again

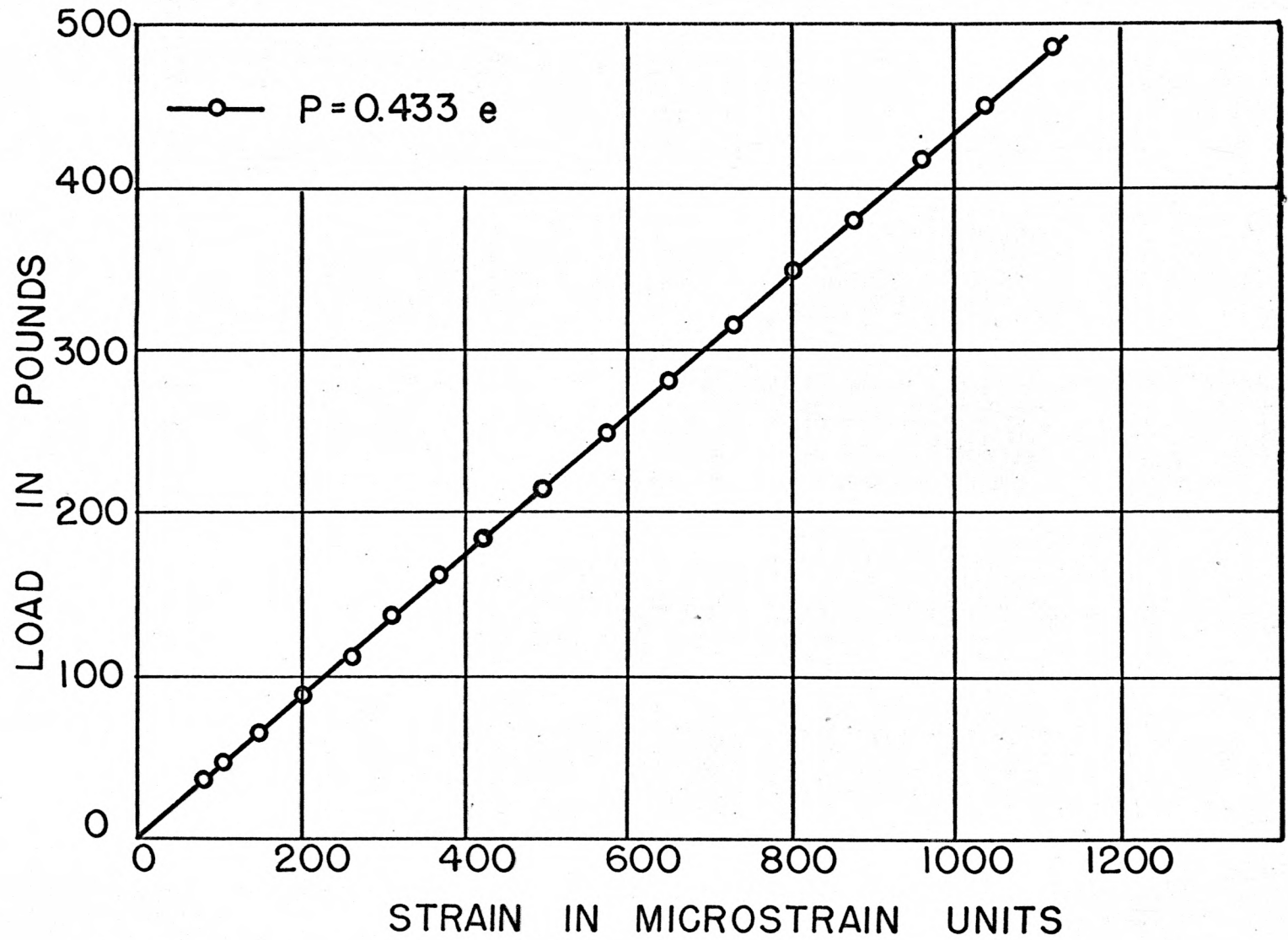

Figure 1. Calibration curve for floor transducer "D", where P = load in pounds and e = strain in microstrain units.

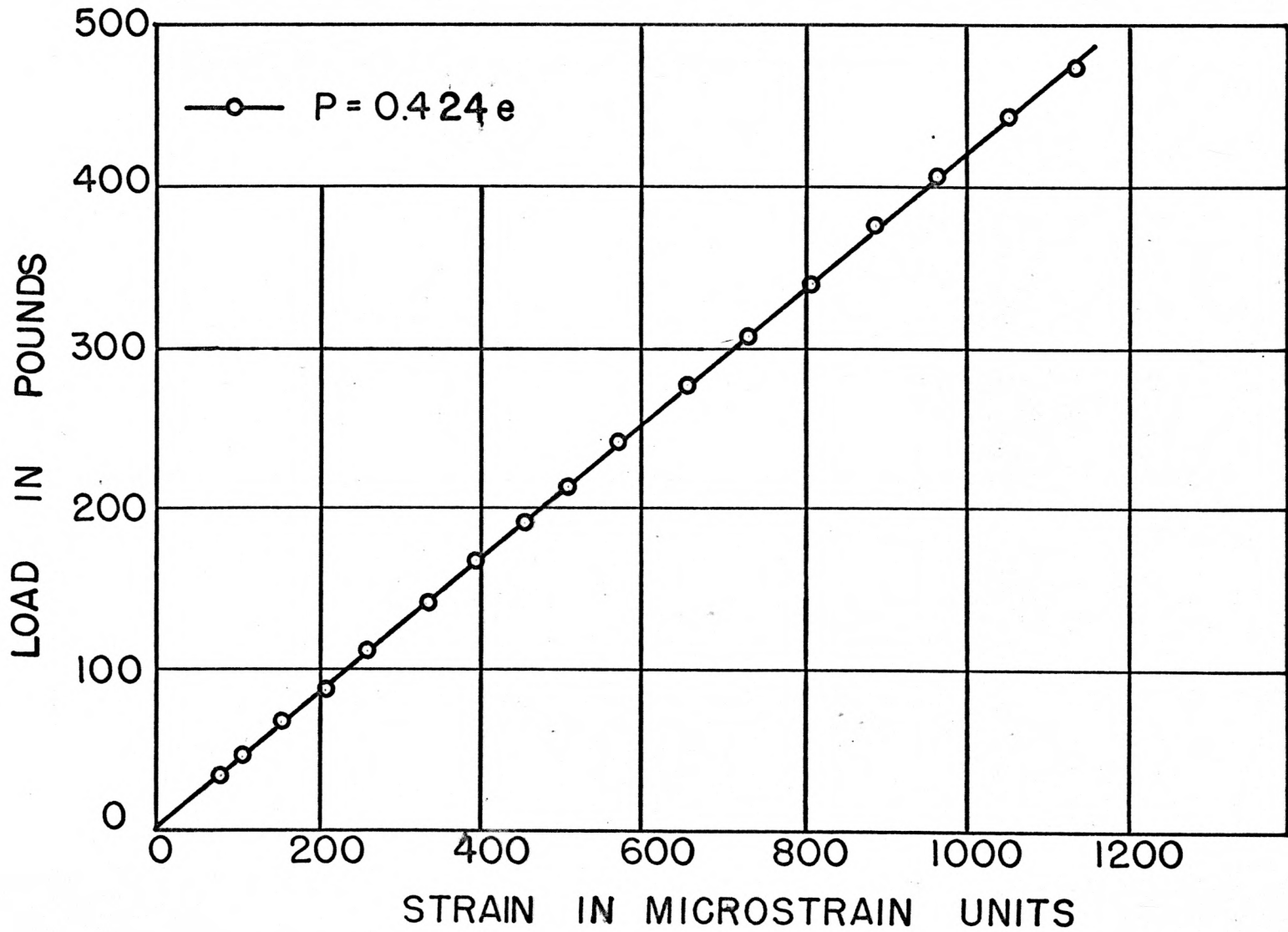

Figure 2. Calibration curve for floor transducer "E" where, P = load in pounds and e = strain in microstrain units.

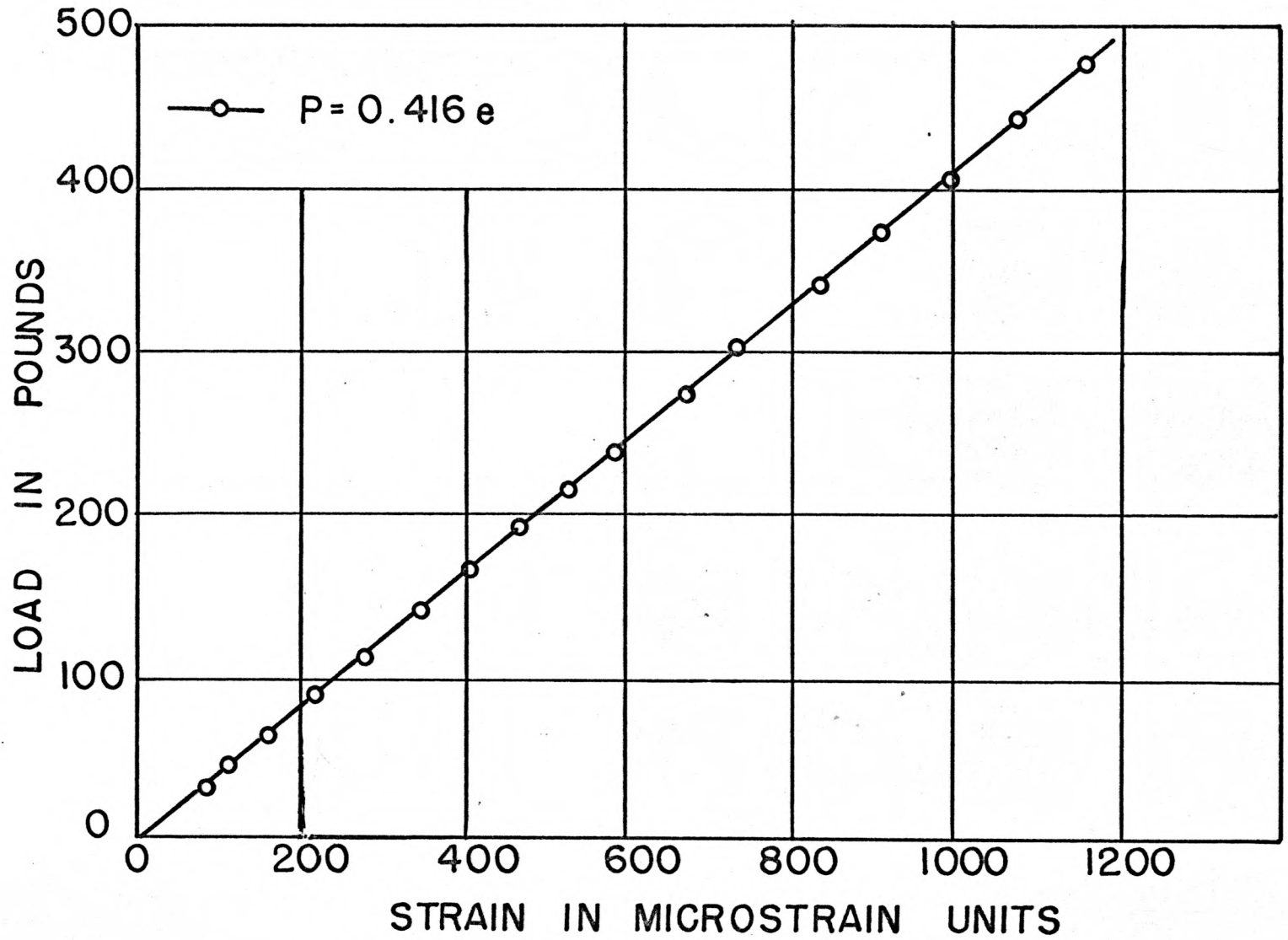

Figure 3. Calibration curve for floor transducer "F", where P = load in pounds and e = strain in microstrain units.



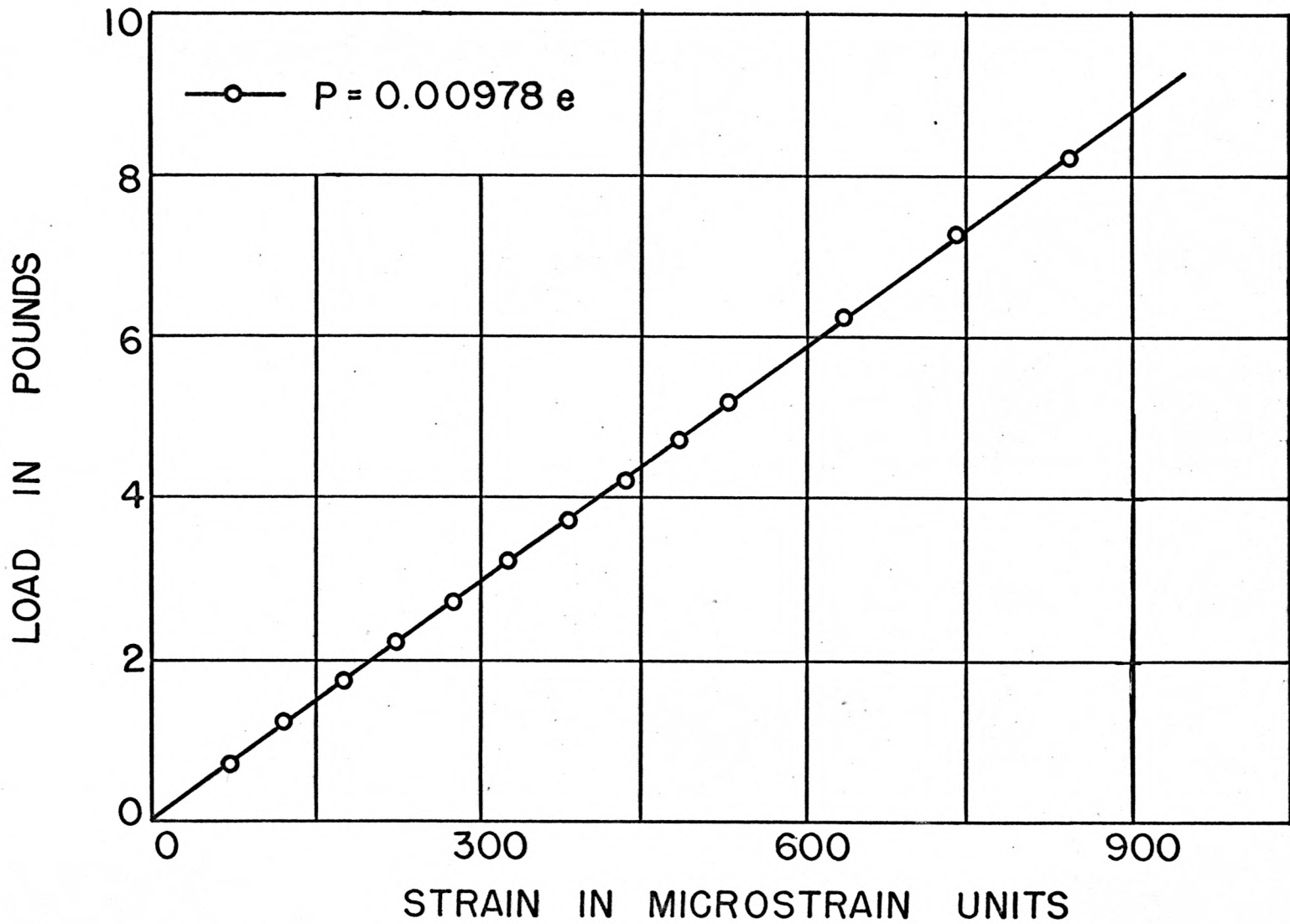

Figure 4. Calibration curve for beam "B" of the wall pressure transducer, where  $P$  = load in pounds and  $e$  = strain in microstrain units.

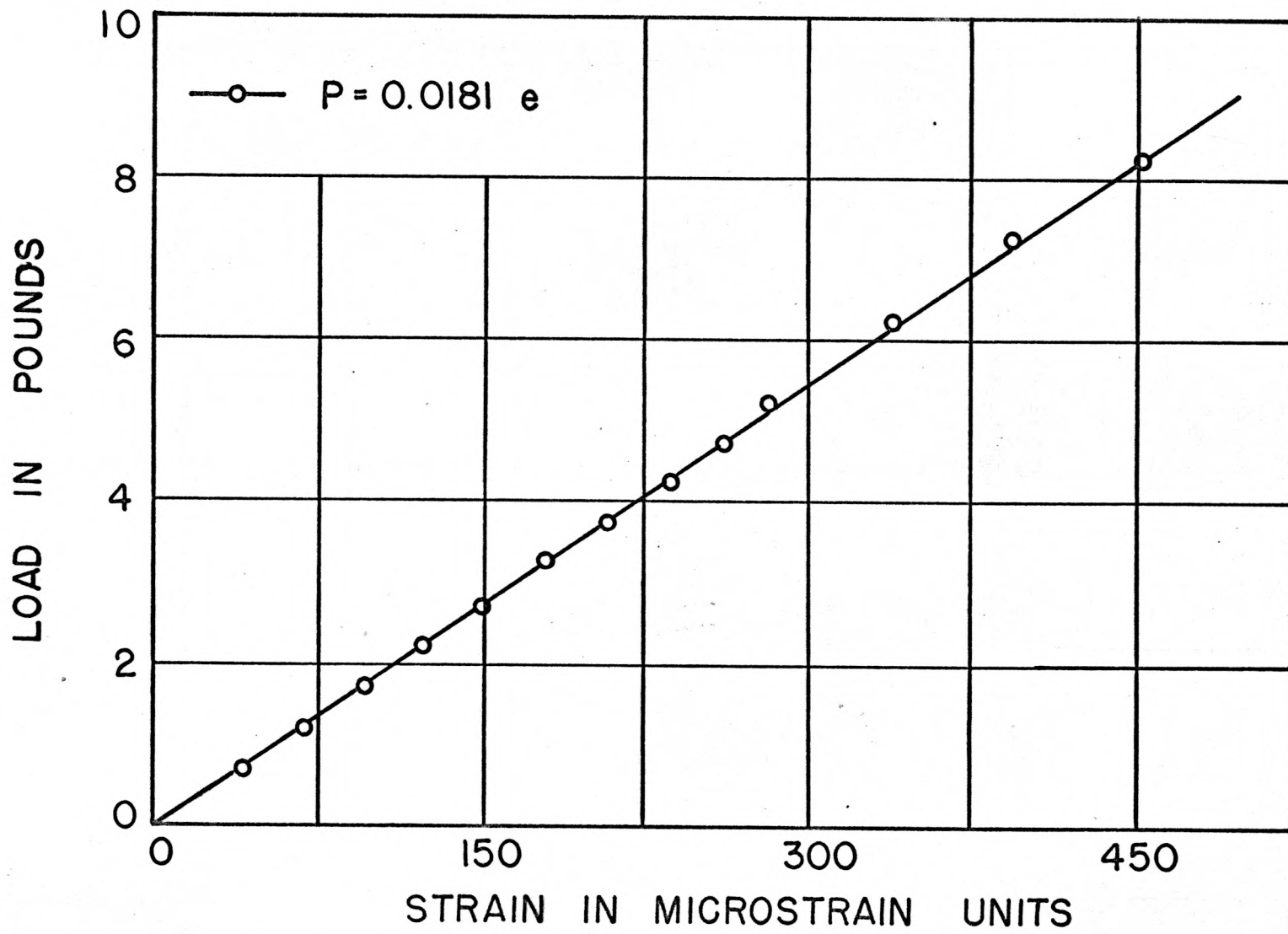

Figure 5. Calibration curve for beam "A" of the wall pressure transducer, due to vertical wall pressures, where  $P$  = load in pounds and  $e$  = strain in microstrain units.

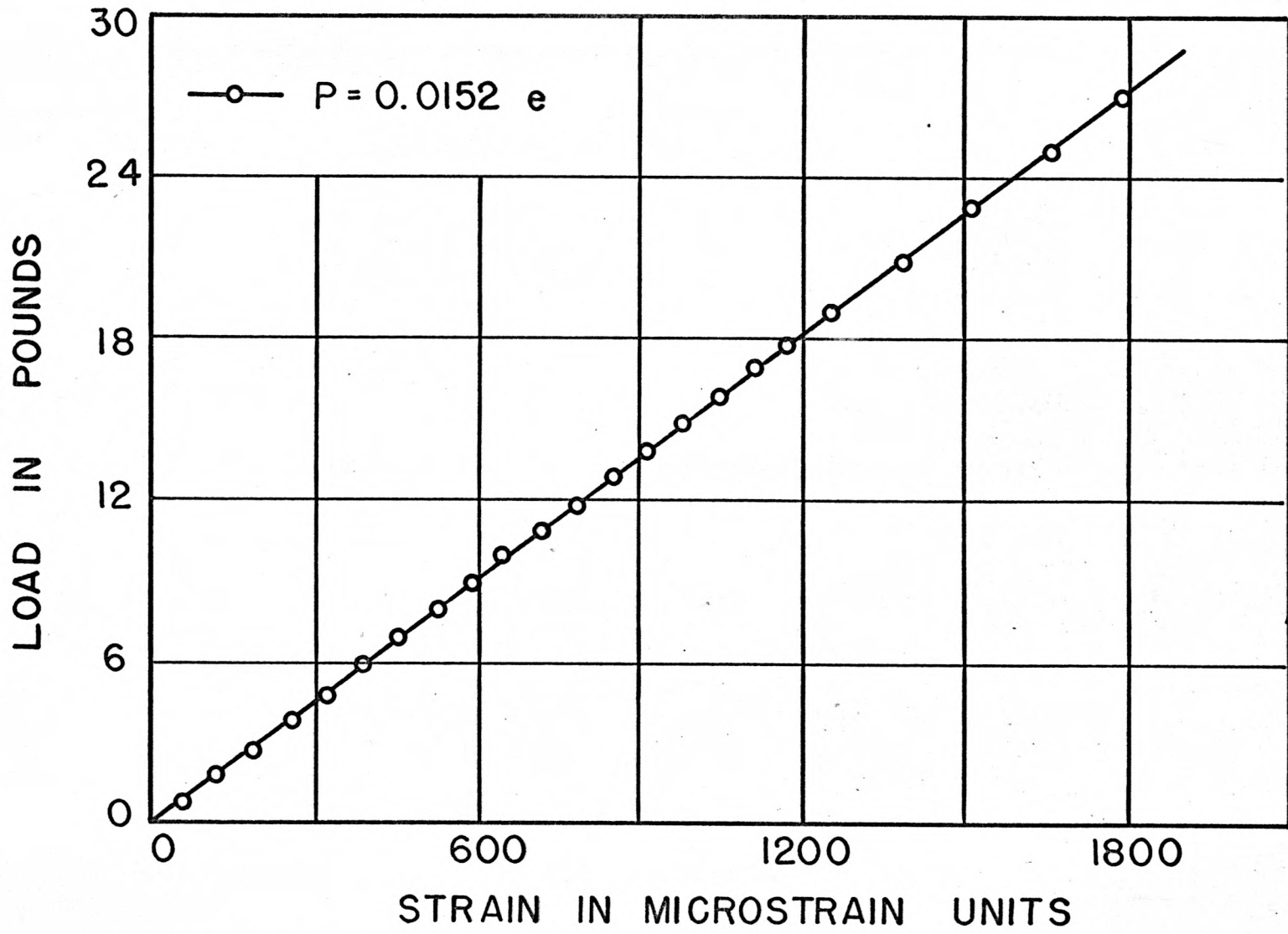

Figure 6. Calibration curve for beam "B" of the wall pressure transducer, due to lateral wall pressures, where  $P$  = load in pounds and  $e$  = strain in microstrain units.

determined by the slope intercept method. The calibration equation for beam "B" (Plate V) due to vertical wall pressure was of the form  $P = 0.00987e$  (eq. 5). This equation was used to determine vertical wall load. In order to determine lateral wall load two calibration curves were necessary. The equation for the curve, shown in Figure 5, for beam "A" due to a vertical load was of the form:

$$P = 0.0181e \quad (\text{eq. 6}).$$

The equation for the curve, shown in Figure 6, for beam "A" due to lateral load was of the form:

$$P = 0.0152e \quad (\text{eq. 7}).$$

To determine the lateral load in the bin wall the procedure was as follows:

1. From strain data,  $P$  on beam "B" due to vertical wall pressure was determined using eq. 5.
2. From  $P$  determined in step 1,  $e$  in beam "A" due to vertical wall pressure was determined using eq. 6.
3. From strain data the total  $e$  in beam "A" was determined.
4. The  $e$  in beam "A" (step 2) due to vertical wall pressure was subtracted from the total  $e$  (step 3) in beam "A". The results gave  $e$  in beam "A" due to lateral wall pressure only.
5. The  $e$  determined in step 4 was used in eq. 7 to determine  $P$  due to lateral wall pressure.

#### Test Holding the Moisture Content Constant and Varying the Ratio $h/D$

Results of tests varying the ratio  $h/D$  and holding the moisture content constant are shown graphically in Plates XVII, XVIII and XIX. Plate XVII shows a plot of the  $\pi$  term  $F/WD$  vs. the  $\pi$  term  $h/D$  for six repetitions in the first series of tests.

EXPLANATION OF PLATE XVII

Effects of varying the  $\pi$  term  $h/D$  on the  $\pi$  term  $F/WD$ . The broken lines indicate the range of scatter of the points in six repetitions.

PLATE XVII

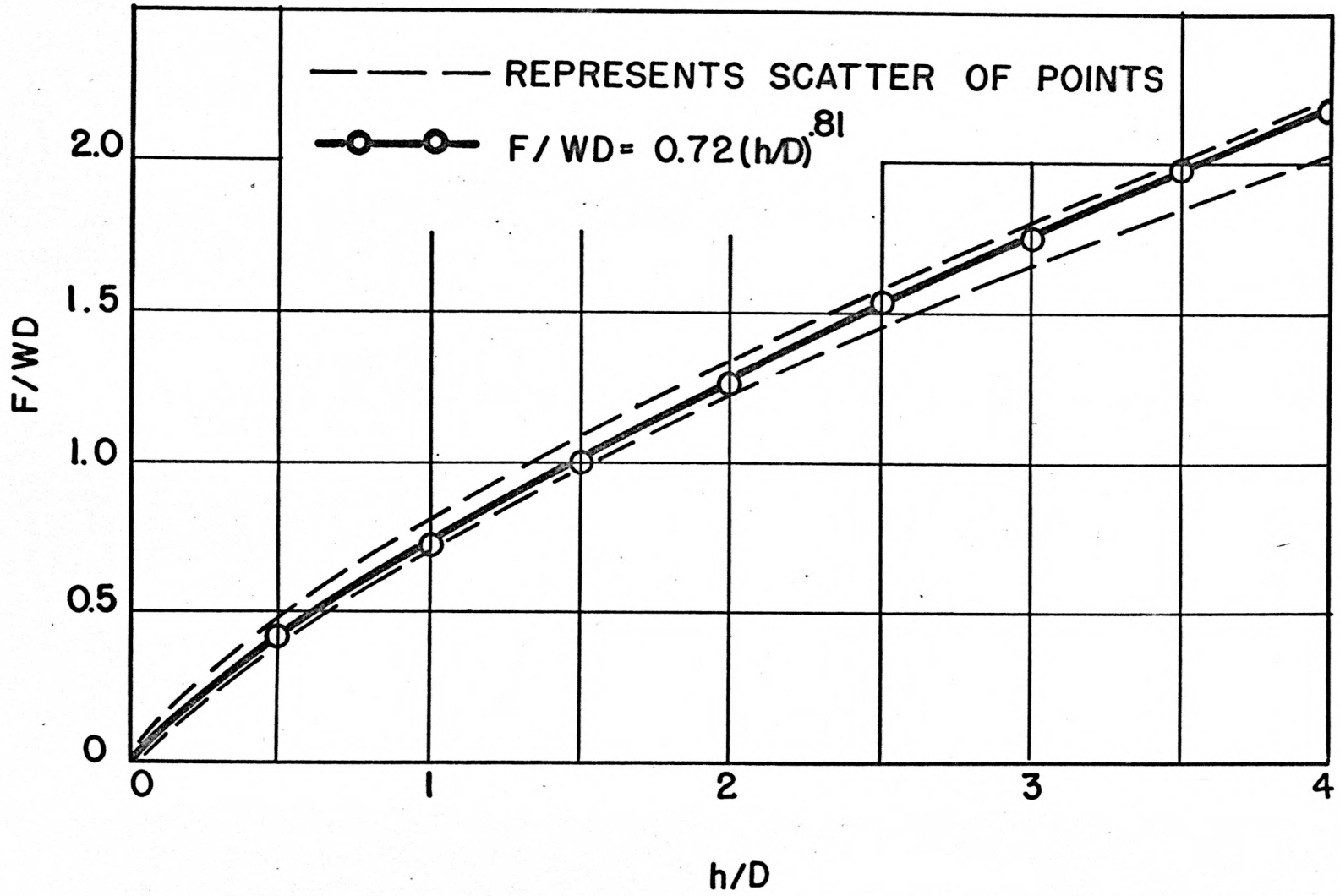

EXPLANATION OF PLATE XVIII

Effects of varying the  $\pi$  term  $h/D$  on the  $\pi$  term  $V/WD$ . The broken lines indicate the range of scatter of the points in six repetitions.

PLATE XVIII

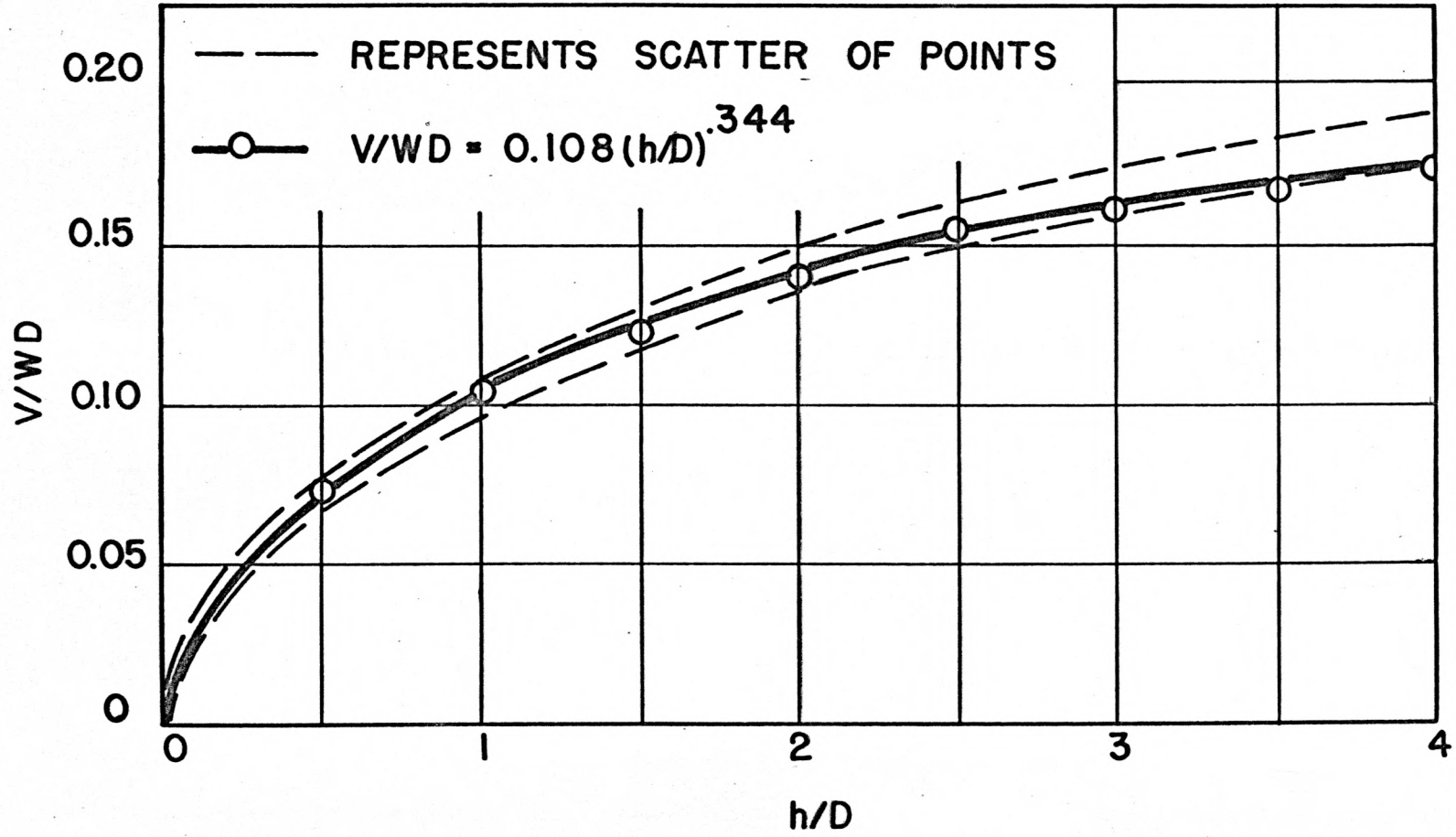



EXPLANATION OF PLATE XIX

Effects of varying the  $\pi$  term  $h/D$  on the  $\pi$  term  $L/WD$ .  
The broken lines indicate the range of scatter of the points  
in six repetitions.

PLATE XIX

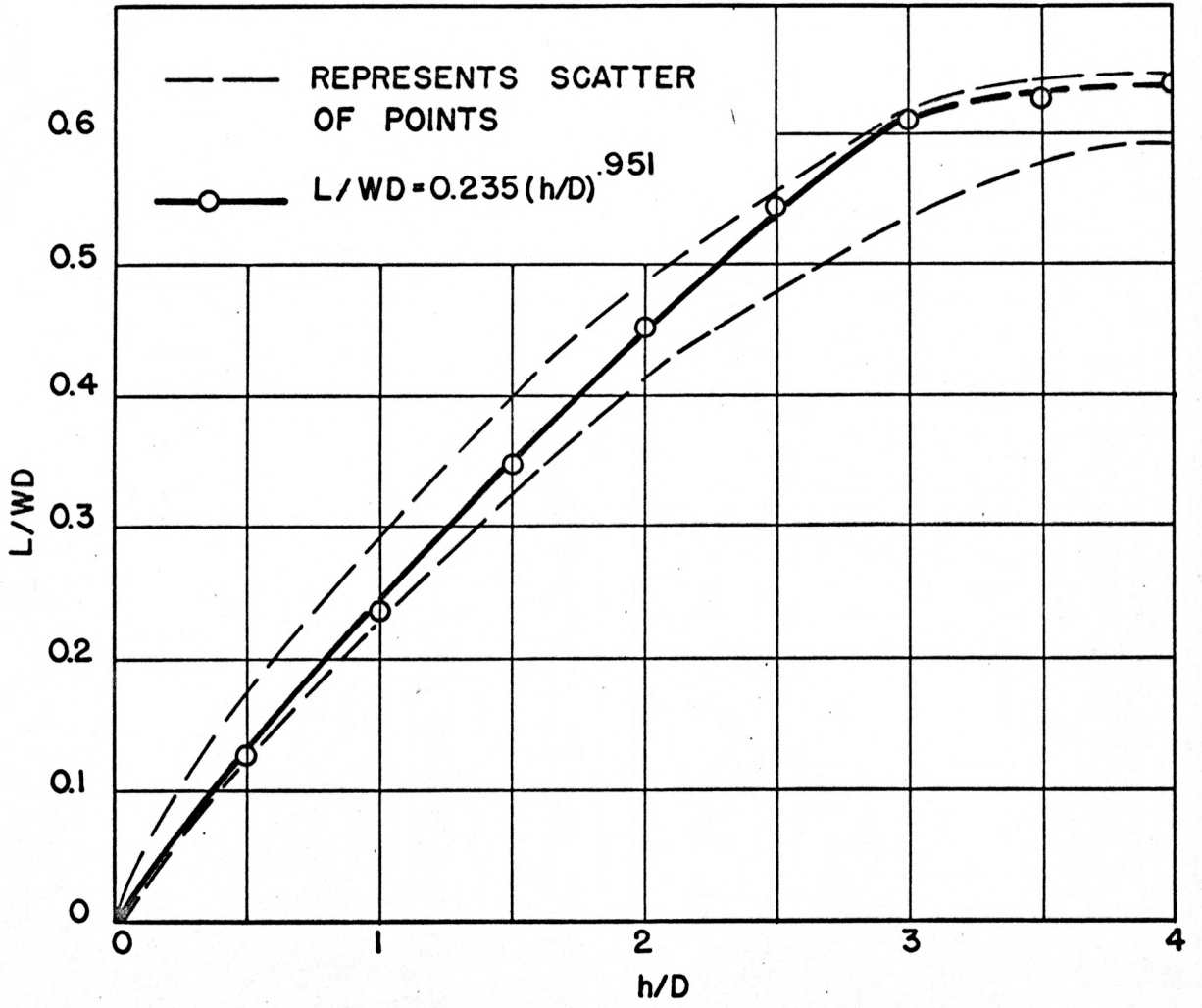

The two broken lines represent the scatter of the data for these six repetitions. If a scatter diagram were drawn for these tests all the data would fall between these two broken lines. It should be noted from Plate XVII that the range of scatter was narrow and that the pressures as detected by the floor transducers were consistent for a given depth of grain from test to test. The method of least squares and curvilinear regression (Figure 7) was used to determine the equation of best fit for these data. The equation determined was of the form:

$$F/WD = 0.72 (h/D)^{.81} \quad (\text{eq. 8}).$$

This equation is represented by the solid line shown as the center curve in Plate XVII.

Plate XVIII shows the graphical results of vertical wall pressure at various depths of fill or in pi terms, a plot of  $V/WD$  vs.  $h/D$ . Again the two outside broken lines represent the scatter of these data. It can be seen from Plate XVIII that the range of scatter was also rather narrow over the range of  $h/D$  of from 0 to 4. The heavy curve between the two broken curves in Plate XVIII represents the equation of best fit for these data as was determined by the method of least squares and curvilinear regression (Figure 8). The equation of this curve was of the form:

$$V/WD = 0.108 (h/D)^{.344} \quad (\text{eq. 9})$$

Data for lateral wall pressure at various depths are represented graphically in Plate XIX. As can be observed from this graph of  $L/WD$  vs.  $h/D$ , the lateral wall pressure varied more from test to test than did either the unit vertical wall pressure or the floor pressure. Although a scatter

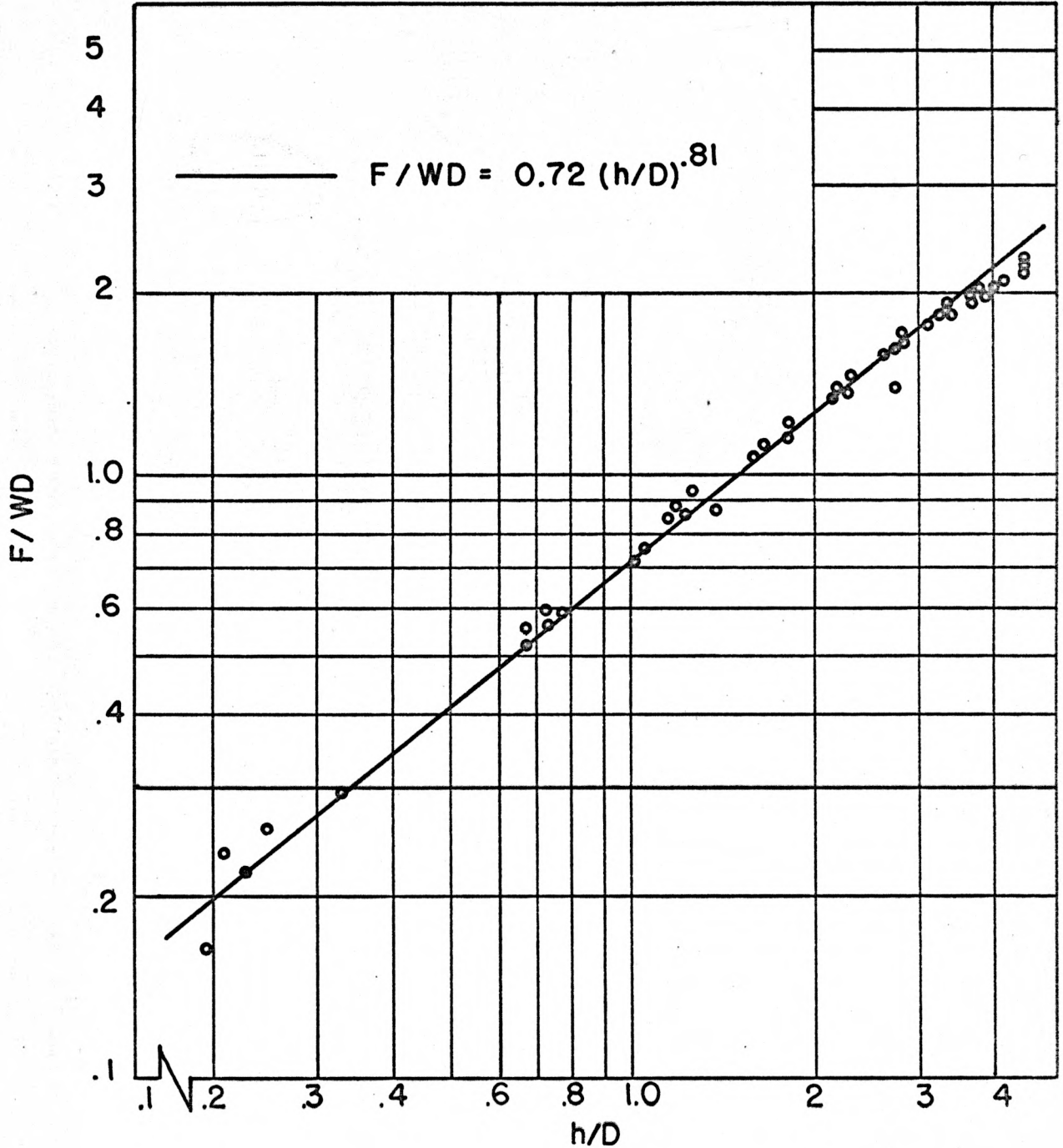

Figure 7. Plot of  $h/D$  vs.  $F/WD$  showing linear regression on logarithmic coordinates.

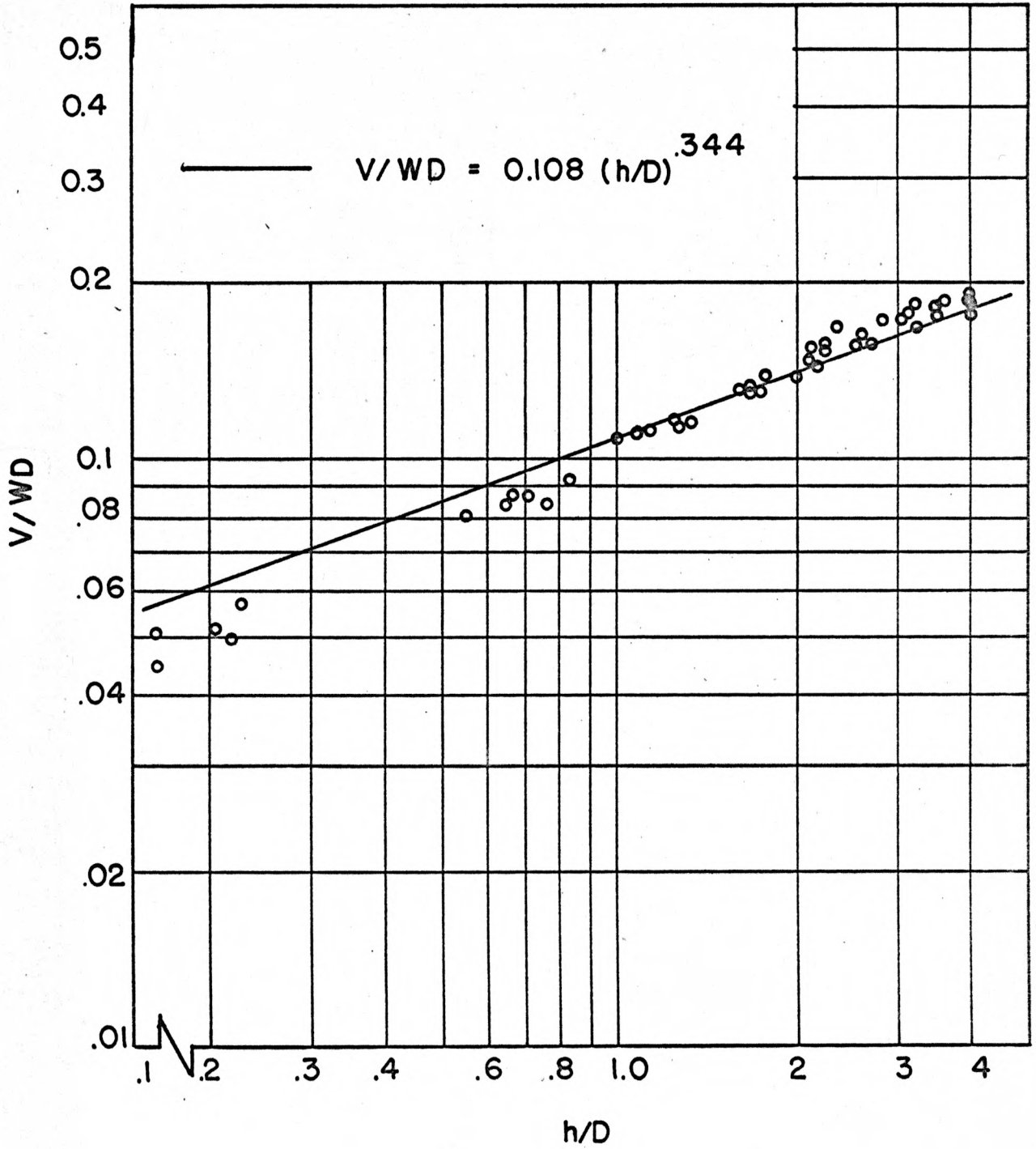

Figure 8. Plot of  $h/D$  vs.  $V/WD$  showing linear regression on logarithmic coordinates.

diagram for these data was rather wide compared to that of Plates XVII and XVIII, these data were probably consistent within the limits of this experimental equipment. Due to a change in the general slope of these data at an  $h/D$  of approximately 3, it was difficult to determine an equation that would fit these data over the entire range of  $h/D$ . An equation of a polynomial form could have been determined. However, it probably would have been of such a degree that it would have meant very little to this study. For these reasons it was decided that an equation would be determined for the range of  $h/D$  from 0 to 3, where the slope tended to change. The equation for the range of  $h/D$  from 0 to 3 was determined by the method of least squares and curvilinear regression (Figure 9) and was of the form:

$$L/WD = 0.235 (h/D)^{.951} \quad (\text{eq. 10})$$

This equation is shown graphically as the heavy solid line in Plate XIX. The heavy broken line in Plate XIX, from  $h/D$  of 3 to 4, represents the line of the best fit for this range as determined by eye. Due to the fact that the range of  $h/D$  from 3 to 4 was so small an equation for this range was thought to be rather insignificant and was not determined.

In an earlier section, it was mentioned that in order to check instrumentation the total weight of grain was determined by weighing on platform scales. Results of wall pressures determined with the bin on platform scales were inconsistent. This was due to the fact that the bin was free to move with respect to the wall transducer thus interfering with actual pressures determined by the wall transducer. For this reason

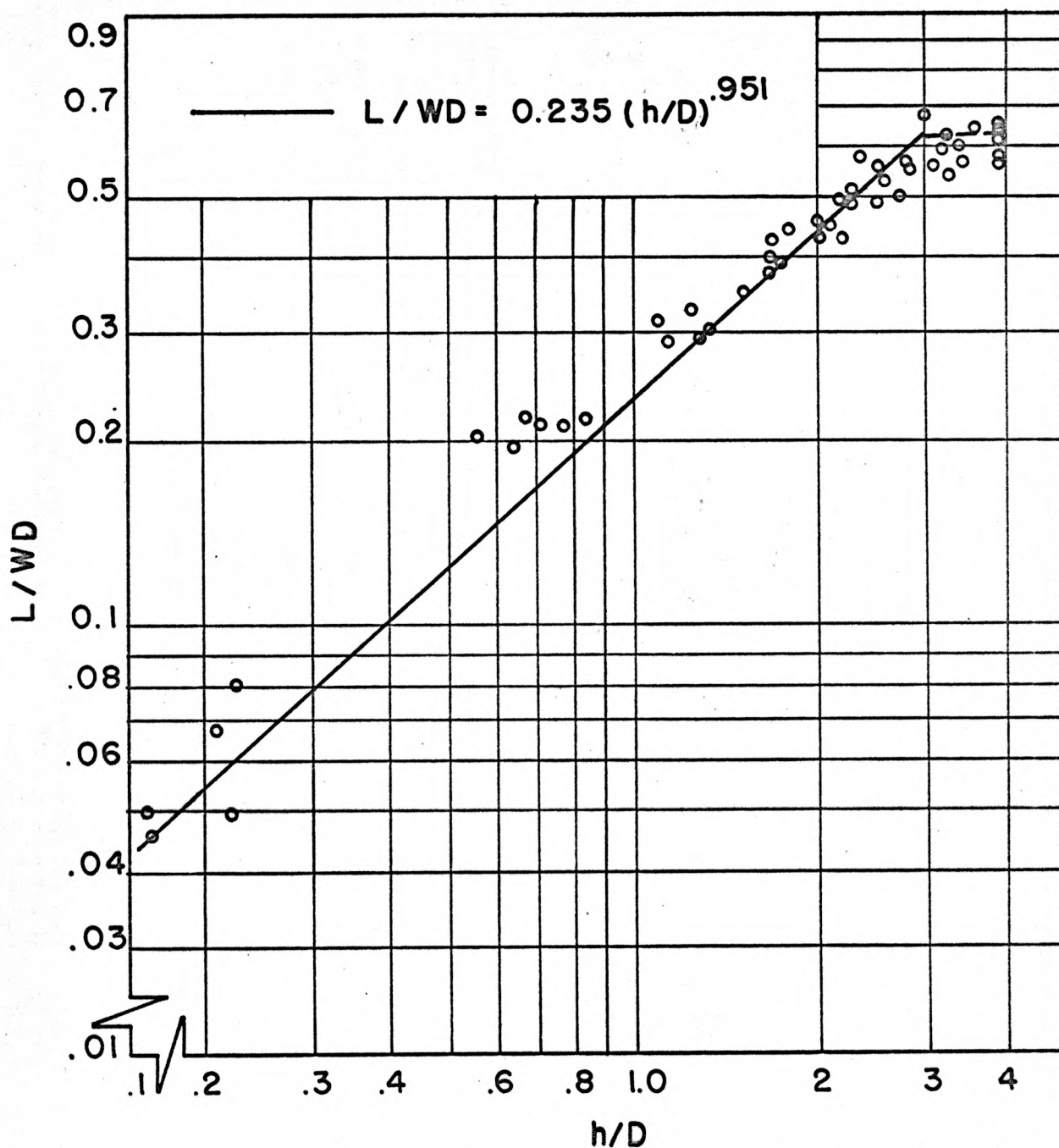

Figure 9. Plot of  $h/D$  vs.  $L/WD$  showing linear regression, from  $h/D$  of 0 to approximately 3, on logarithmic coordinates.

the floor and wall pressures determined with the bin mounted on scales were considered bad data and were not used in this study. The data for total load taken with the bin in this position were analyzed. Two tests were conducted to determine the actual weight of grain in the bin at various depths. In one test, the bin was filled rather slowly and in the second, the bin was filled at a faster rate. Results indicated that there was essentially no difference in the total weight of grain in the bin due to rate of loading. The results of these tests were considered the average weight of grain in the bin for a given depth of fill and were compared with the combined results of floor load and vertical wall load determined in the 6 repetitions of tests varying  $h/D$  and determining pressures. The average total floor load for these 6 repetitions was determined from Plate XVII by determining the floor load in pounds for any given depth. The average vertical wall pressure was determined by planimentering the area under a curve of vertical wall pressure vs. depth. Areas were planimetered from 0 to 1 foot through 0 to 8 feet with increases in area of one foot intervals. This resulted in a total vertical wall load at intervals of from 1 foot to 8 feet. Plate XX shows a comparison of the total load, determined by weighing, and the total load determined by the wall and floor transducers. Notice that these results are in agreement to within 10 per cent in all cases. Plate XX also shows a curve for computed weight of grain vs. depth. This weight was determined by computing the volume in the two foot diameter bin at various depths and multiplying by a bulk density of 48 pounds per cubic foot to determine the weight in the bin. This curve agreed more



#### EXPLANATION OF PLATE XX

Comparison of total load in bin as determined by weighing on platform scales, by wall and floor pressure transducers, and by computing from volume.

PLATE XX

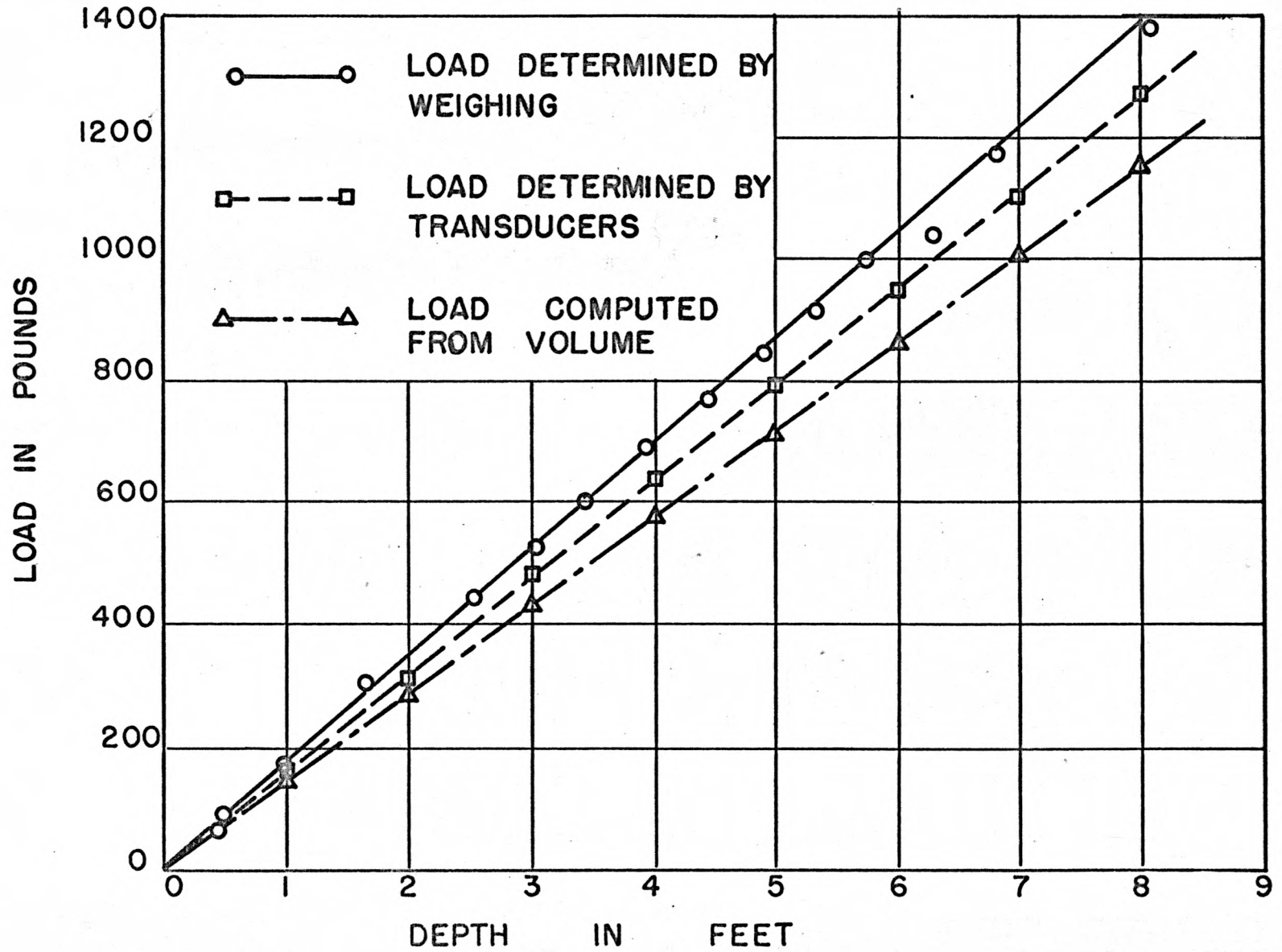

closely with the experimental curve than does the curve determined by actually weighing the grain.

Janssen's prediction formula was used to predict the lateral wall pressure for conditions similar to those in this investigation. Janssen's prediction was compared with results determined in this study. As was previously mentioned, the limitations in Janssen's formula are the selected values for the constants  $\mu$  and  $k$ . Values of pressure at given depths were predicted by using Janssen's equation and two sets of constants. In one case, the values used for these constants were  $\mu = 0.40$  and  $k = 0.60$ . These are the more commonly published values for wheat on steel. In the second case, the constants,  $\mu = 0.25$  and  $k = 0.60$ , were used. A Jenike Shear Test Machine and a sample of the grain and metal used in this study were used to determine the value  $\mu = 0.25$ . Plate XXI shows graphically the results of Janssen's prediction for lateral wall pressures determined in this investigation. Notice that the pressures determined in this investigation compare favorably with Janssen's predictions using the published values of  $\mu = 0.40$  and  $k = 0.60$ , while they compare rather poorly with Janssen's predictions using the published value of  $\mu = 0.25$  and  $k = 0.60$  which was determined by the Jenike Shear Test Machine.

#### Tests Holding $h/D$ Constant and Varying Moisture Content.

Results of the second series of tests with the ratio  $h/D$  constant and moisture content varying are shown in Plates XXII through XXIV. In the first three tests in this series  $h/D$  was held constant at values of 2.41, 3.17, and 3.50. The moisture content was varied

EXPLANATION OF PLATE XXI

Comparison of experimental results for lateral wall pressure with Janssen's prediction using the constants  $\mu = .40$ ,  $k = .60$  and  $\mu = .25$ ,  $k = .60$ .

PLATE XXI

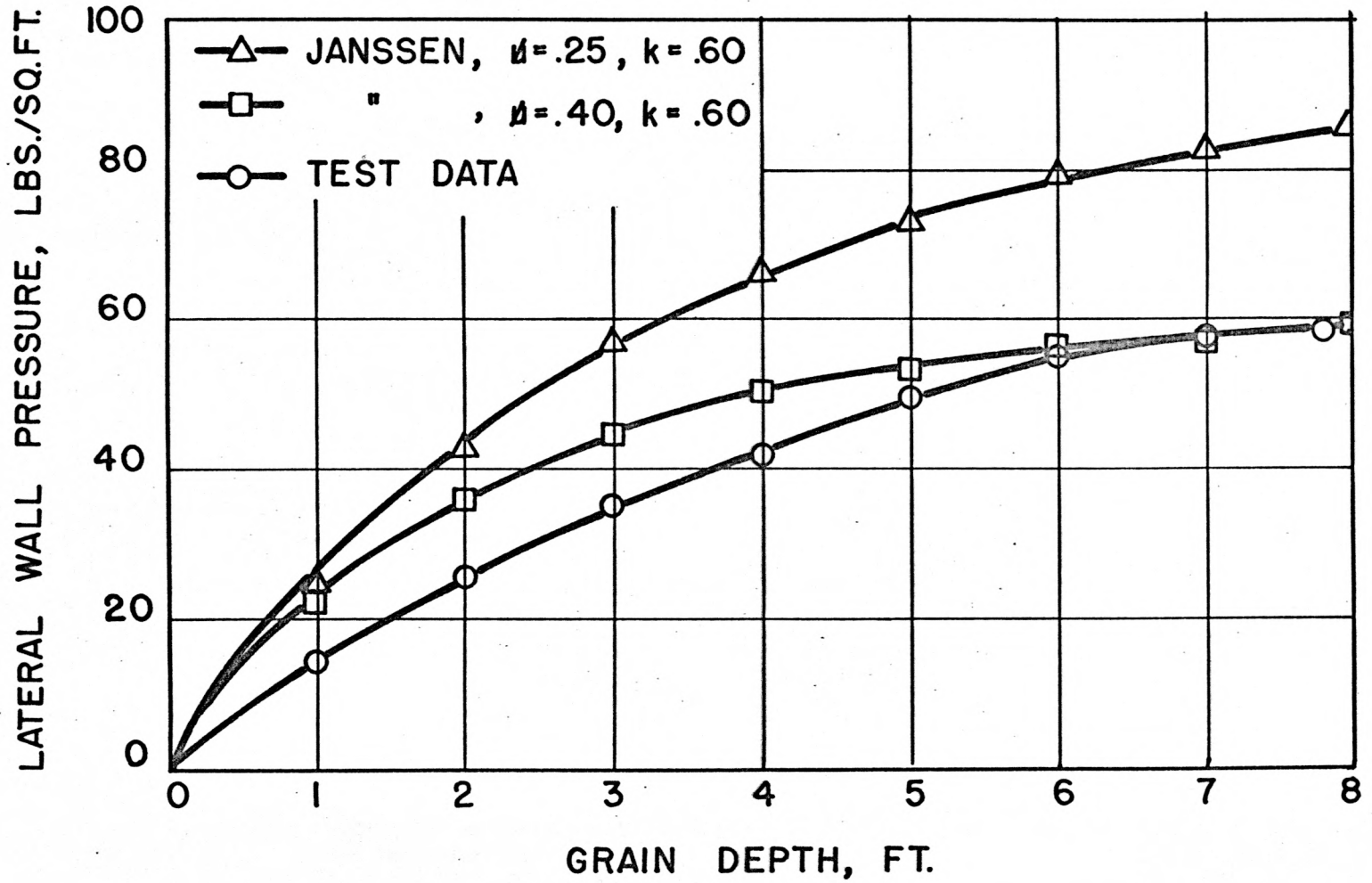

EXPLANATION OF PLATE XXII

Effects of a change in moisture content on  $F/WD$  with  $h/D$  constant at indicated values.

## PLATE XXII

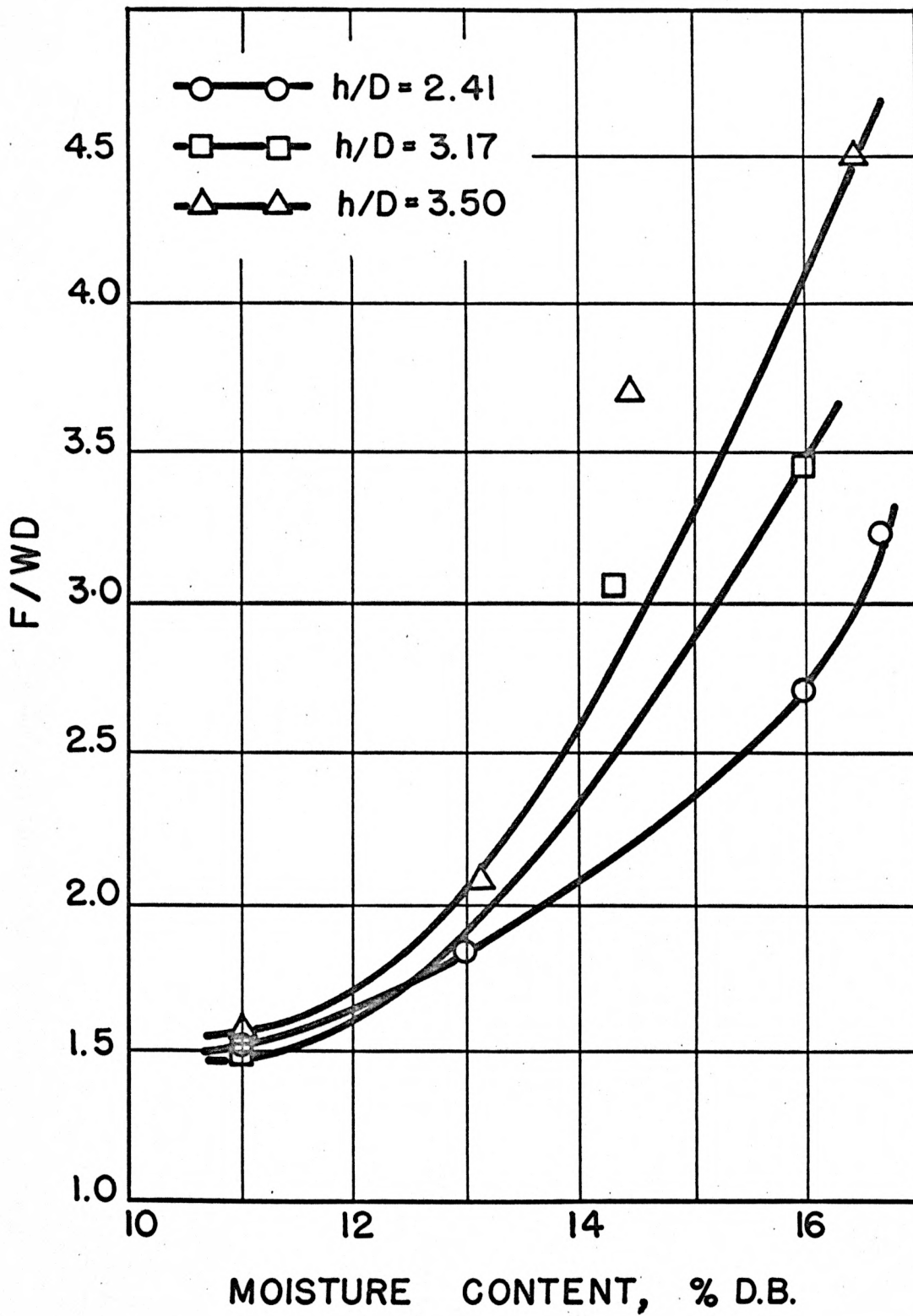

EXPLANATION OF PLATE XXIII

Effects of a change in moisture content on  $V/WD$  with  $h/D$  constant at indicated values.



PLATE XXIII

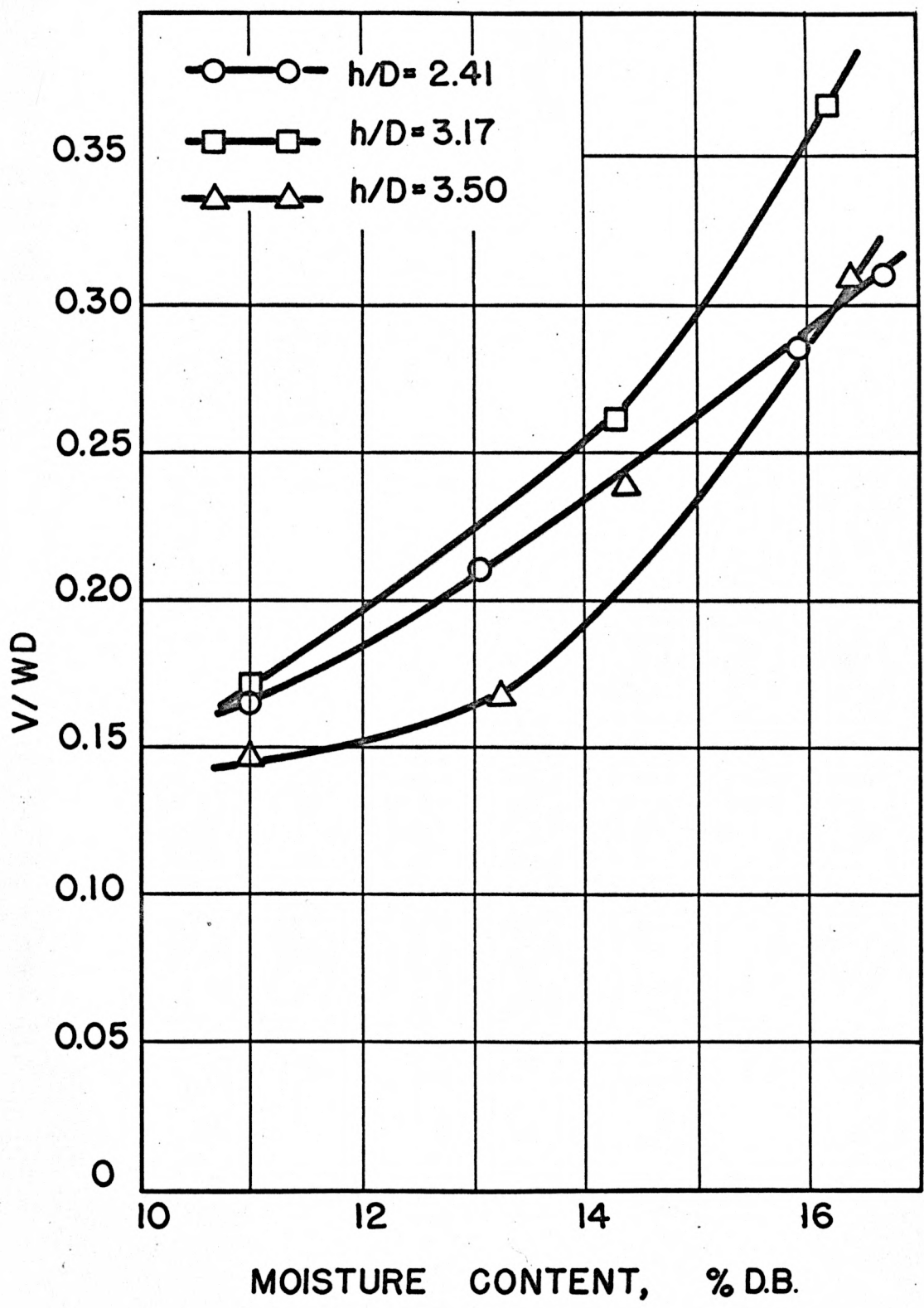

EXPLANATION OF PLATE XXIV

Effects of a change in moisture content on  $L/WD$  with  $h/D$  constant at indicated values.

PLATE XXIV

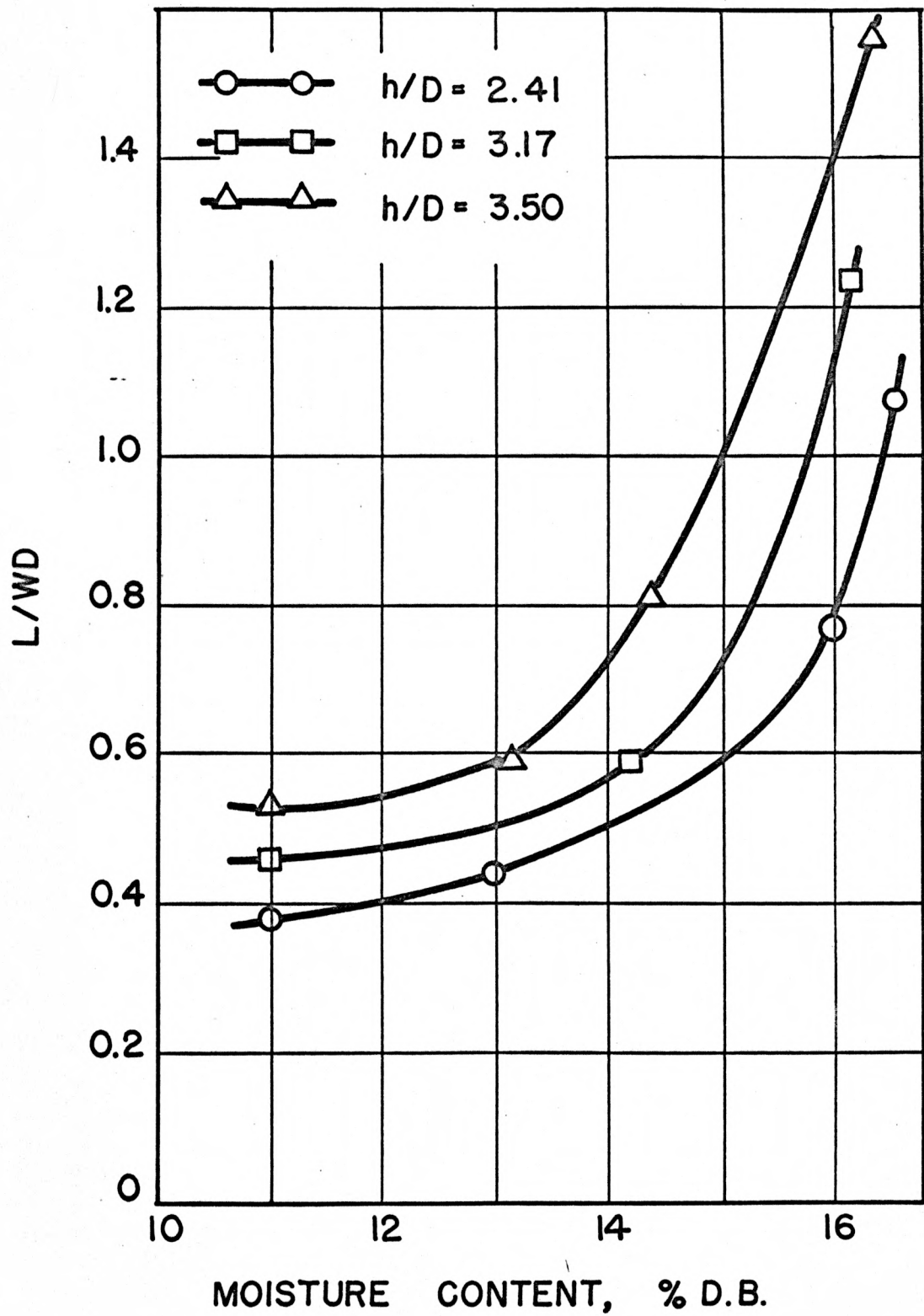

from 11 per cent (dry basis) to approximately 16 per cent (dry basis) in each case.

Plate XXII shows the results of a change in moisture content of approximately 5 per cent on the  $\pi$  term  $F/WD$ . With  $h/D$  constant at 2.41, the term  $F/WD$  increased from 1.54 to 3.24 or increased slightly more than two times due to a change in moisture of from 11 per cent (dry basis) to 16.65 per cent (dry basis). In the second test, with  $h/D$  constant at 3.17, the  $\pi$  term  $F/WD$  increased from 1.51 to 3.48 with an increase in moisture content of from 11 per cent (dry basis) to 15.59 per cent (dry basis). With  $h/D$  constant at 3.50,  $F/WD$  increased from 1.58 to 4.50 due to a change in moisture content of from 11 per cent (dry basis) to 16.42 per cent (dry basis). These results indicated that for these values of  $h/D$  the  $\pi$  term  $F/WD$ , or essentially the average floor pressure, increased from two to three times due to a change in moisture content of approximately 5 per cent. It is interesting to note that the magnitude of the increase in pressure increased as  $h/D$  increased. It should also be noticed that at  $h/D$  values of 3.17 and 3.50 and moisture slightly more than 14 per cent (dry basis), the values of  $F/WD$  did not follow the general trend of curves.

Plate XXIII shows the plot of  $V/WD$  vs. moisture content for the same values of  $h/D$  and moisture content discussed in the previous paragraph. With  $h/D$  constant at 2.41 and a moisture increase of from 11 per cent (dry basis) to 16.65 per cent (dry basis), the term  $V/WD$  increased from .166 to 3.10 for an increase of slightly less than two times.  $V/WD$  increased from .172 to 3.68 due to an increase in moisture content of 5.95 per cent, with  $h/D$  constant

at 3.17. With  $h/D$  constant at 3.50 and a moisture increase of from 11 per cent (dry basis) to 16.42 per cent (dry basis), the term  $V/WD$  increased from .147 to .309. Results indicated that for an increase in moisture content of approximately 5 per cent, the vertical wall pressure increased two times in a downward direction. There was not much difference in the magnitude of this pressure increase for values of  $h/D$  ranging from 2.41 to 3.50.

The results of the effect of a change in moisture content on lateral wall pressures are shown graphically in Plate XXIV. With  $h/D$  constant at 2.41 and an increase in moisture content of from 11 per cent (dry basis) to 16.65 per cent (dry basis), the  $\pi$  term  $L/WD$  increased from .303 to 1.078. A change in moisture content of from 11 per cent (dry basis) to 15.95 per cent (dry basis) produced an increase in the  $\pi$  term  $L/WD$  of from .467 to 1.24 when  $h/D$  was held constant at 3.17. With  $h/D$  constant at 3.50, the  $\pi$  term  $L/WD$  increased from .531 to 1.56 due to an increase in moisture content of from 11 per cent (dry basis) to 16.42 per cent (dry basis). Results of these tests indicated that the lateral wall pressure increased three times due to an increase in moisture content of approximately 5 per cent. The trend was essentially the same in all cases and there appeared to be essentially no difference in the magnitude of the increase in lateral wall pressure at values of  $h/D$  from 2.41 to 3.50.

Plates XXII, XXIII, and XXIV show data for values of  $h/D$  constant at 2.41, 3.17 and 3.50. This  $h/D$  was measured from the bin floor to the top of the grain mass. Therefore  $h/D$ 's measured from the centroid of the wall pressure plate to the top of the grain

mass were actually 0.5 less than those shown in plates XXII, XXIII, and XXIV.

In the fourth test of the second series,  $h/D$  was held constant at 0.79. New wheat, with an initial moisture content of 12.90 per cent (dry basis), was used in this test. The moisture content of the grain was increased from its initial conditions to 15.15 per cent (dry basis). No moisture samples were taken at intermediate levels of moisture content since probing this shallow depth of grain would interfere with pressures determined by the wall pressure transducers. Results of these tests indicated that for the small value of  $h/D = 0.79$ , the floor pressure increased slightly less than two times, the unit lateral wall pressure increased approximately five times, and the vertical wall pressure changed directions and was in an upward direction approximately  $1-\frac{1}{2}$  times the magnitude of the original downward vertical wall pressure. These results are shown in tabular form in Table 1.

Table 1. Data from the fourth test of the second series with  $h/D$  constant at 0.79 and moisture content varying..

Moisture Content per cent (dry basis)	F/WD	V/WD	L/WD
12.90	0.826	0.040	0.077
15.15	1.476	-0.061*	0.376

\* minus sign indicates opposite direction.

The constant  $\pi$  term  $h/D$  referred to in Table 1 was again measured from the bin floor to the top of the grain mass. This resulted in a  $h/D$  ratio of 0.50 from the bin floor to the centroid

of the pressure plate and a h/D ratio of 0.29 from the centroid of the pressure plate to the top of the grain.mass.

#### DISCUSSION

Results of the first series of tests, holding moisture content constant and varying h/D, indicated that the instrumentation was consistent for the six repetitions. In Plate XVII, it may be observed that the spread of data for the floor load in the six tests was very small. Plate XVIII indicates that the spread of data for the unit vertical wall pressure vs. depth also was small but slightly larger than the spread of floor pressure data. The data for unit lateral wall pressure vs. depth were spread over a wider range than either the vertical wall or floor pressure. Since the average floor pressure was determined by observing the total load on the floor, a small spread of data for floor pressure was expected. The wall pressure was determined by a pressure plate 30 inches square. Since this is a rather small area compared with total wall area, the larger spread of data for wall pressure is probably within the limits of the experimental equipment.

Curvilinear regression was used to determine equations for the data in the first series of tests. These equations were of the form  $\pi_1 = C (\pi_2)^k$ . As was previously mentioned it was difficult to determine an equation of this form for lateral wall pressure. This was due to a sudden change in the slope of the data at h/D of approximately three. Although an equation was determined for floor pressure and unit vertical wall pressure over the entire range of h/D, there was a noticeable change in the

slope of the data at  $h/D$  of approximately three. (Figures 7 and 8) The change in slope was not as critical for floor and unit vertical wall pressures as it was for lateral wall pressures (Figure 9) and an equation was determined for these data over the entire range of  $h/D$ , or  $h/D$  from 0 to 4. This change in slope of bin pressures has been observed by previous investigators and some have concluded that there is essentially no increase in floor and unit wall pressures after the  $h/D$  exceeds 2-1/2 or 3. Janssen's equation supports this as there is very little increase in pressures, for wheat on steel, as the  $h/D$  ratio exceeds three.

The total load in the bin was actually weighed on platform scales during this investigation. A curve for weight vs. depth was drawn and compared to a similar curve determined by computing the volume and multiplying by specific weight of wheat. These two curves were then compared with a curve for weight vs. depth which was determined experimentally. The curves (Plate XX) indicated that there was some disagreement in the results. The load as weighed on platform scales was slightly larger than the results of the other conditions. This disagreement was probably due to the fact that the bin was not formed to an exact diameter of two feet and that more packing occurred when filling the bin than when determining the test weight of the wheat. Also the leveling rod probably tended to pack the grain. The load, as determined by the wall transducers, was slightly larger than the other two. This was probably due to the previously mentioned fact that the vertical wall pressure was determined from an area of 30 square inches of wall.



It may be observed in Plate XXI that a comparison of experimental data with Janssen's prediction for lateral wall pressures agrees favorably when the constants  $\mu = .40$  and  $k = .60$  are used; however, the comparison is rather poor when Janssen's equation and the constants  $\mu = .25$  and  $k = .40$  are used. The values  $\mu = .40$  and  $k = .60$  are the more commonly published values for these constants and  $\mu = .25$  was determined by using a sample of wheat and sheet metal used in this investigation and a Jenike Shear Test Machine. The effect that the constant  $\mu$  has on the results of Janssen's equation may be observed in Plate XXI. Results of Plate XXI indicate that Janssen's formula is limited by the values of the constants used. There is much controversy and confusion over the proper values of these constants to use as they are difficult to determine.

In the second series of tests, holding  $h/D$  constant and varying moisture content, the problem of increasing the moisture content of wheat presented difficulty. The first attempt made was to increase the moisture content by slowly adding water to the grain and recirculating air through the grain in a closed system. A 1/4-inch plastic tube was fastened under the top of the bin and small pin holes punched in the tube. This tube was connected to a reservoir, a one gallon can, on top of the bin. The can was filled with water and the water slowly dripped onto the grain as air was being recirculated through the system. A few minutes after water was added to the reservoir, it was observed running out of the bin near the floor. This indicated that the grain could not absorb the water as fast as it was being added. All the holes in

the plastic tube, except two, were then stopped up, so that water could be dropped on the grain at a much slower rate. Very little water actually ran through the grain after water was added at this slow rate. After adding enough water to increase the moisture content 4 per cent to 5 per cent, moisture samples indicated that the moisture content of the wheat had only increased approximately 2 per cent. With a column of grain 4 feet and 10 inches deep, the floor pressure approximately doubled, the lateral wall pressure increased 2-1/2 times and the vertical wall pressure slightly decreased. When the bin was emptied, it was evident that there was a poor moisture distribution of the grain as the grain near the walls of the bin flowed freely out of the bin and a column of wet grain stood in the center of the bin. This column was approximately 6 inches in diameter near the top of the column and increased to approximately one foot in diameter at the bin floor. The grain in this column was very wet, especially near the floor. The moisture content of the grain near the walls of the bin was only slightly greater than at initial conditions. From this experience, it was evident that it was practically impossible to get an even moisture distribution by adding water to grain. Steam, as was previously mentioned, was added to the system and resulted in a fairly uniform moisture distribution throughout the grain mass.

As may be observed from Plates XXII, XXIII, and XXIV, the pressures at initial moisture conditions do not agree with the pressures for comparable  $h/D$  ratios in the first series of tests. The explanation of this was probably due to the fact that there was a change in the friction between the grain and bin wall.

Adding water and steam to the system tended to corrode the walls of the bin. This increased the roughness of the wall and probably increased the coefficient of friction between grain and the bin wall, thus resulting in lower lateral wall and floor pressures.

Results of the series of tests with moisture varying and  $h/D$  constant indicate that the lateral wall pressures increase three times, the floor pressures increase 2-1/2 times, and vertical wall pressures double, with an increase in moisture content of wheat from 11 per cent (dry basis) to 16 per cent (dry basis). The first two observations tend to agree with the conclusions of previous investigators. The increase in unit vertical wall pressure does not agree with findings of previous investigators. According to the laws of static equilibrium, the total floor load plus the total vertical wall load must equal the total weight of grain in the bin. This does not necessarily mean that the unit vertical wall pressure at all depths must decrease in order to counteract this increase in floor pressure. With deep columns of grain and directional wetting as in this investigation, the author believes that these results are completely justifiable. The belief is that as the moisture content of grain is increased and expansion of the grain particles takes place the vertical wall pressure near the bottom of the deep column increases in a downward direction and the vertical wall pressure near the top of the bin decreases and reverses direction so that the resulting unit vertical wall pressure near the top of the bin is in an upward direction. Results of the fourth test in the second series, with a shallow column of grain justify this statement. This means that

somewhere along the column the vertical wall pressure would be zero. Wetting grain from the top tends to form a bridging effect near the surface of the grain. This along with the mass of grain acting down, in a deep column, would tend to resist an upward vertical wall pressure near the bottom of the column. As one progresses from the bottom to the top of the column of grain, weight of grain acting downward would decrease and offer less resistance to the expanding grain particles acting upward. If high moisture air were introduced into the bottom of the bin, the bridging effect at the top of the column would be eliminated, thus eliminating the the resistance of grain moving upward due to bridging at the top.

As may be observed from Plates XXII, XXIII and XXIV, the data for moisture varying and  $h/D$  constant were limited and in some cases rather inconsistent. The limited data came as a result of the long periods of time between tests. The inconsistency was probably due to poor moisture samples. After the moisture content was increased 2 per cent to 3 per cent, the grain became very compacted and difficult to probe to depths of more than one foot or 2 feet. Maximum depths of probing at all times was one foot above the wall transducer. This eliminated any interruption of pressures caused by the probe. Since the moisture samples were not actually taken from the entire depth of grain, these samples were probably not truly representative samples and could account for some inconsistency in the data.

For these reasons, it was decided that an equation for pressure vs. moisture content would not be determined. These data did follow the same general trend and the final moisture samples

were probably fairly representative since the samples were taken as the bin was being emptied.

### CONCLUSIONS

From the information presented the following conclusions were drawn:

1. The experimental methods used to determine bin pressures proved satisfactory for this investigation. The ability of these transducers to give repeat results over six repetitions of tests and the ability of the floor and vertical wall transducers to account for total loads indicated that the instrumentation was consistent and fairly accurate.

2. Janssen's equation is safe for predicting grain bin pressures (at a constant moisture content) provided the proper values of the constants  $\mu$  and  $k$  are used. However, the determination of proper values for these constants is probably as difficult to determine as the determination of bin wall pressures.

3. There is a tendency for grain bin pressures to follow an exponential relationship for  $h/D$  ratios of from 0 to 3. For  $h/D$  from 3 to 4 the slope of this relationship tends to change. This change in slope is more severe for lateral wall pressures than for unit vertical wall or floor pressures.

4. Increasing the moisture content of wheat proved to be a more difficult problem than was expected. It was very difficult to get a uniform moisture distribution throughout the grain by adding water to grain and recirculating air in a closed system. This method resulted in extremely wet grain in the center of the

bin where water was being added and dry grain near the walls of the bin. By adding steam to the system and recirculating air, the resulting moisture content of the grain was fairly uniform.

5. Wheat stored at a low moisture content (11 per cent dry basis) and increased at least 2 per cent, became very compacted as was experienced by the difficulty in probing.

6. A change in moisture content of stored grain has a tremendous effect on bin pressures. When the moisture content of wheat was increased from 11 per cent (dry basis) to 16 per cent (dry basis), the floor pressure increased 2-1/2 times, the lateral wall pressure increased 3 times and the unit vertical wall pressure doubled. This was for h/D ratios of 2.41 to 3.5, measured from the bin floor to the top of the grain mass and a wall pressure transducer at a h/D of 0.5 from the bin floor.

7. Since the unit vertical wall pressures near the bottom of a deep column of grain increase due to an increase in moisture content (for wetting front moving from top to bottom of grain column), the unit vertical wall pressures near the top of the column of grain decreases and changes directions. The unit vertical wall pressure near the top of the column of grain is upward in direction so that the floor load plus total vertical wall load is equal to the total weight of grain in the bin.

8. Janssen's formula is inconsistent with a change in moisture content of stored grain.

#### SUGGESTIONS FOR FUTURE RESEARCH

The various problems encountered in this investigation suggest several areas in which more specific research is needed.

Although a review of literature indicated that investigators have been working with methods of experimentally determining grain bin pressures for over a century and a half, research of this nature should be continued. With new and improved methods such as more sensitive strain gages and highly sensitive strain gage transducers, there is the possibility of more accurately determining grain bin pressures. Results of this investigation indicate the importance of being able to study wall pressures at several locations along the structure rather than at one location on the bin wall. For more significant data, several strain gages or pressure transducers should be placed at intervals along the bin wall.

Future research should consider bins with  $h/D$  ratios greater than four as was used in this case. If this were done on a model basis, deeper bins or smaller diameter bins would be necessary. Either could present problems. A deeper bin could prove difficult to get in a laboratory and a smaller diameter bin would result in smaller pressures which are more difficult to detect.

Research of this nature should be extended to include other grains and other bin materials. With more and more consistent data, of this nature, it is possible that a general equation for bin pressures could be determined. This equation would be for the general case and would include the parameter of a change in moisture content of the stored material.

A method of wetting grain without a change in temperature would be desirable. This could be accomplished by the use of air conditioning equipment. If high humidity air were added to grain, the effect of a change in temperature caused by adding

steam would be eliminated. By eliminating this variable the investigator could be reasonably sure that any changes in pressure were due to a change in moisture content only. A more desirable situation would be that of enclosing the entire test structure in an environmentally controlled chamber. This would give complete control of both temperature and humidity throughout the test.

More basic research concerning the physical and biological responses of grain to an increase in moisture content is needed. This should include individual grain particles in a confined space as well as in unconfined space. A better understanding of the response of the individual grain particle to a change in moisture content would lead to a better understanding of a change in bin pressures due to a change in moisture content of the stored grain.



## ACKNOWLEDGMENTS

The author wishes to express his sincerest appreciation to Dr. T. O. Hodges, Department of Agricultural Engineering for his counsel and guidance in planning and conducting this investigation.

Appreciation is also extended to Dr. G. H. Larson, Head, Department of Agricultural Engineering, and the entire staff of the Department of Agricultural Engineering for their cooperation and assistance in this investigation. The author also appreciates the helpful suggestions received from the U.S.D.A. personnel working with the Off Farm Conditioning, Handling, and Storage of Grain and the Heat Pump Experiment at Kansas State University.

Grateful acknowledgment is expressed for the advice and services rendered by Mr. Richard V. Collins and Mr. Allan Cook of the Butler Manufacturing Company.

And to his wife, Suester, the author expresses his deepest appreciation for her encouragement and sacrifices throughout this study.

## REFERENCES

- (1) Airy, Wilfrid  
The Pressure of Grain. Minutes of the Proceedings of the Institute of Civil Engineers. 131:347-358. 1898.
- (2) Amundson, L. R.  
Determination of Band Stresses and Lateral Wheat Pressures for Cylindrical Grain Bins. Agricultural Engineering, August, 1945, 26: 321-324.
- (3) Barre, H.J., and L. L. Sammet  
Farm Structures. New York: John Wiley and Sons, 1950.
- (4) Bovey, Henry T.  
Experiments on Grain Pressures in Deep Bins and Strength of Wooden Bins. Engineering News, July 14, 1904, 52:32-34.
- (5) Caughey, Robert A., Calvin Toolles, and Alfred C. Sheer.  
Lateral and Vertical Pressures of Granular Materials in Deep Bins. Iowa Engineering Experiment Station Bulletin 172. 1951.
- (6) Collins, Richard V.  
Determination of Pressures in Cylindrical Storage Structures. Paper Presented at Annual Meeting Of A.S.A.E. No. 62-302. 1962.
- (7) Dale, A. C., and R. N. Robinson,  
Pressures in Deep Grain Storage Structures. Agricultural Engineering, August, 1954, 35:570-573.
- (8) Farrell, E. P.  
Vertical Pressures of Dry and Flooded Grains Stored in Deep Bins. Unpublished M.S. thesis, Kansas State College, Manhattan, Kansas, 1953.
- (9) Fordham, A. A.  
The Direct Measurements of Lateral Pressures on Walls of Bins. Engineering, May 14, 1937.
- (10) Hall, Carl W.  
Drying Farm Crops. Reynoldsburg, Ohio. Agricultural Consulting Associates, 1957.
- (11) Hay, W. W.  
Design of Deep Circular Bins. Concrete, June, 1928, 32:43-44.

- (12) Henderson, S. M., and R. L. Perry  
Agricultural Process Engineering, New York:  
John Wiley and Sons, 1955.
- (13) Huntington, W. C., and E. J. Luetzelschwab.  
New Type of Pressure Cell for Granular  
Material. Engineering News-Record  
January 2, 1936, 116:20-22.
- (14) Jamieson, J. A.  
Grain Pressures in Deep Bins. Engineering News,  
March 10, 1904, 51:536-543.
- (15) Janssen, H. A.  
Versucho uber Getreidedruck in Silozellen.  
Zeitschrift des Vereines Deutscher Ingenieure,  
August 31, 1895, 39:1045-1049.
- (16) Ketchum, Milo S..  
The Design of Walls, Bins and Grain Elevators.  
New York: McGraw-Hill Book Co., 1919.
- (17) Kramer, H. A.  
Factors Influencing the Design of Bulk Storage  
for Rough Rice. Agricultural Engineering,  
December, 1944, 25:463-466.
- (18) Langhaar, Henry L.  
Dimensional Analysis and Theory of Models. New  
York: John Wiley and Sons, 1951.
- (19) Lee, George H.  
Experimental Stress Analysis. New York:  
John Wiley and Sons, 1950.
- (20) Lorenzen, Robert T.  
Moisture Effect on Ratio of Principle Pressures  
in Stored Grain. Paper Presented at Annual Meet-  
ing of A.S.A.E. No. 60-423. 1960.
- (21) Lufft, Eckhardt.  
Tests of Grain Pressure in Deep Bins at Buenos  
Aires, Argentina. Engineering News, December 5,  
1904, 52:531-532.
- (22) McCalmont, J. R.  
Measuring Bin Wall Pressures Caused By Arching  
Materials. Engineering News-Record, April 28,  
1938, 120:619-620.
- (23) McCalmont, J. R., and Wallace Ashby.  
Pressure and Load of Ear Corn in Cribs. Agri-  
cultural Engineering, April 1934, 15:123-125,  
128.

- (24) Perry, C. C. and H. R. Lissner.  
The Strain Gage Primer. New York: McGraw-Hill Book Co. 1955.
- (25) Roberts, Isaac.  
The Pressure of Stored Grain. Engineering, October 27, 1882, 34:399.
- (26) Roberts, Isaac.  
Determination of Vertical and Lateral Pressures of Granular Substances. Proceedings of the Royal Society of London, 1884, 36:225-240.
- (27) Ross, I. J., and G. W. Isaacs.  
Forces Acting on Stacks of Granular Material. Transactions of A.S.A.E., 1961, 4:92-96.
- (28) Saul, R. A.  
Measurement of Grain Pressures on Bin Walls and Floors. Agricultural Engineering, April, 1953, 34:231-234.
- (29) Saul, R. A.  
Effect of Bin Design Factors on Pressures of Shelled Corn. Paper presented at Winter Meeting of A.S.A.E., No. 59-820, 1959.
- (30) Stahl, Benton M.  
Grain Bin Requirements. United States Department of Agriculture Circular No. 835, 1950.
- (31) Taylor, Donald W.  
Fundamentals of Soil Mechanics. New York: John Wiley and Sons, 1948.

## APPENDICES

## APPENDIX A

## Derivation of Janssen's Equation

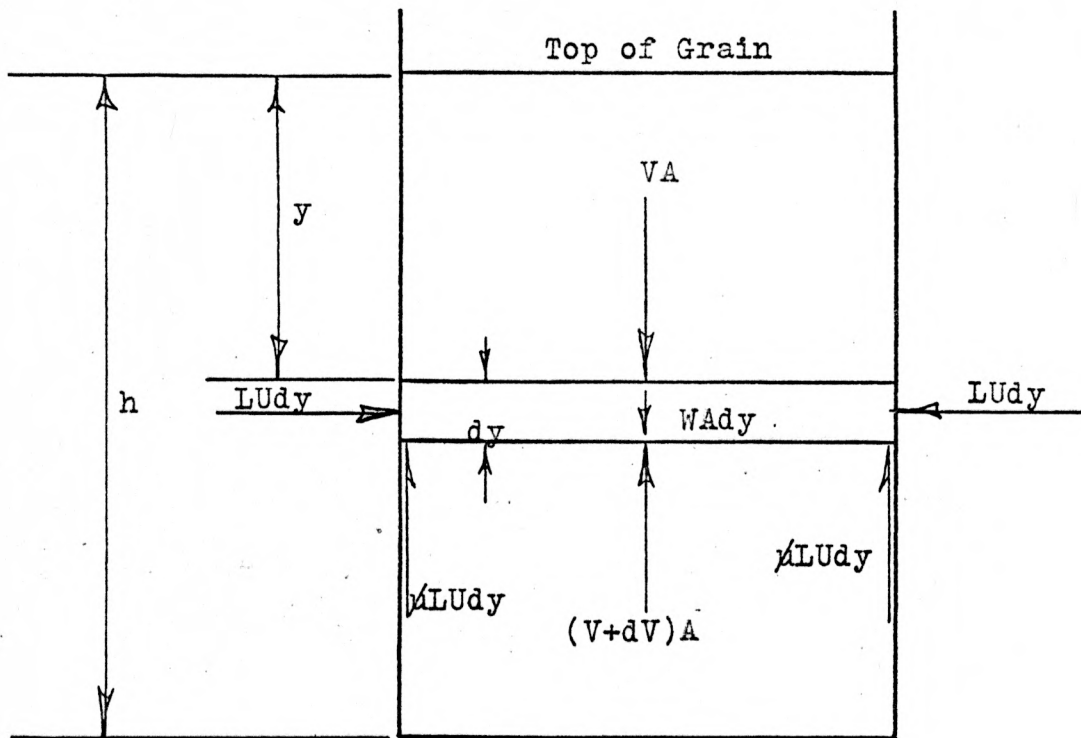

$V$  = unit vertical pressure at any elevation (lbs./ft.<sup>2</sup>)

$L$  = unit lateral pressure at any elevation (lbs./ft.<sup>2</sup>)

$W$  = bulk density of stored material (lbs./ft.<sup>3</sup>)

$A$  = area of horizontal cross sections of bins (ft.<sup>2</sup>)

$h$  = total depths of bin (ft.)

$y$  = depths from top of bin to point under consideration (ft.)

$U$  = inside perimeter of bin (ft.)

$R$  = hydraulic radius of horizontal cross section of bin =  
 $A/U$  (ft.)

$\mu$  = coefficient of friction between stored material and bin wall

$k$  = ratio of lateral to vertical pressures at any point.

Figure 10. Sketch and definition of terms used in the derivation of Janssen's equation.

Assume an element of grain in a bin as shown in Figure 10.

$$\sum V = 0$$

$$VA + VAdy - (V+dV)A - \gamma LUdy = 0$$

$$VA - VA - AdV + (WA - \gamma LU)dy = 0$$

$$AdV = (WA - \gamma LU)dy$$

$$R = A/U, L = kV$$

$$dy = \frac{dV}{W - \gamma L/R} = \frac{dV}{W - \gamma kV/R}$$

Integrating

$$y = R/\gamma k \ln (W - \gamma kV/R) + C$$

when

$$y = 0, V = 0$$

$$0 = -R/\gamma k \ln W + C$$

$$C = R/\gamma k \ln W$$

$$y = -R/\gamma k \ln (W - \gamma kV/R) + R/\gamma k \ln W$$

multiplying by  $-\gamma k/R$

$$-\gamma ky/R = \ln (W - \gamma kV/R) - \ln W$$

$$-\gamma ky/R = \ln \left( \frac{W - \gamma kV/R}{W} \right)$$

$$e^{-\gamma ky/R} = \frac{W - \gamma kV/R}{W} = 1 - \gamma kV/RW$$

$$\gamma kV/RW = 1 - e^{-\gamma ky/R}$$

$$V = WR/\gamma k (1 - e^{-\gamma ky/R})$$

$$\text{or } L = kV = WR/\gamma (1 - e^{-\gamma ky/R})$$

for maximum lateral wall pressure  $y = h$

$$L = WR/\gamma (1 - e^{-\gamma kh/R})$$



APPENDIX B

Condensed Test Data

Table 2. Data from the first series of tests with moisture content constant at 11 per cent (dry basis) and h/D varying.

Repetition	Floor		Wall		
	h/D	F/WD	h/D	V/WD	L/WD
1	0.200	0.163	0.165	0.044	0.050
	0.665	0.558	0.760	0.083	0.212
	1.260	0.945	1.315	0.113	0.303
	1.815	1.228	1.655	0.125	0.371
	2.155	1.401	2.110	0.145	0.442
	2.610	1.587	2.520	0.153	0.487
	3.020	1.748	3.055	0.170	0.559
	3.575	1.928	3.415	0.173	0.566
	3.915	2.035	3.915	0.177	0.578
4.415	2.172	-----	-----	-----	
2	0.125	0.129	0.555	0.079	0.201
	1.055	0.754	1.095	0.110	0.310
	1.595	1.064	1.675	0.132	0.427
	2.175	1.374	2.345	0.166	0.586
	2.845	1.612	3.280	0.182	0.632
	3.780	1.954	3.915	0.188	0.646
	4.415	2.156	-----	-----	-----
3	0.250	0.258	0.230	0.056	0.080
	0.730	0.590	0.645	0.083	0.195
	1.145	0.856	1.145	0.111	0.296
	1.645	1.116	1.625	0.130	0.396
	2.125	1.340	2.155	0.153	0.492
	2.655	1.566	2.585	0.160	0.521
	3.085	1.758	3.145	0.173	0.592
	3.645	1.940	3.585	0.183	0.645
	4.085	2.096	3.915	0.187	0.640
4.415	2.202	-----	-----	-----	
4	0.230	0.222	0.270	0.049	0.050
	0.770	0.590	0.835	0.092	0.218
	1.335	0.870	1.290	0.112	0.295
	1.790	1.240	1.750	0.129	0.395
	2.250	1.364	2.200	0.141	0.427
	2.700	1.614	2.720	0.155	0.550
	3.220	1.834	3.250	0.166	0.542
	3.750	2.050	3.915	0.175	0.570
	4.415	2.206	-----	-----	-----
5.	0.335	0.296	0.210	0.053	0.068
	0.710	0.568	0.710	0.086	0.213
	1.210	0.870	1.125	0.110	0.290
	1.625	1.122	1.685	0.134	0.391
	2.185	1.352	2.270	0.152	0.488

Table 2 (Continued)

Repetition	Floor		Wall		
	h/D	F/WD	h/D	V/WD	L/WD
5	2.770	1.606	2.820	0.168	0.555
	3.320	1.812	3.435	0.179	0.580
	3.935	1.998	3.915	0.185	0.617
	4.415	2.156	-----	-----	-----
6	0.210	0.236	0.165	0.051	0.045
	0.665	0.548	0.665	0.085	0.220
	1.165	0.892	1.250	0.115	0.326
	1.750	1.210	1.790	0.139	0.442
	2.290	1.460	2.270	0.153	0.511
	2.770	1.698	2.800	0.176	0.568
	3.300	1.910	3.335	0.178	0.606
	3.835	2.046	3.915	0.188	0.668
	4.415	2.260	-----	-----	-----

Table 3. Data from first three tests of second series with h/D constant and the moisture varying.

h/D	Moisture Content per cent (dry basis)	F/WD	V/WD	L/WD
2.41	11.00	1.54	0.166	0.383
2.41	13.08	1.84	0.210	0.447
2.41	15.97	2.71	0.285	0.774
2.41	16.65	3.24	0.310	1.078
3.17	11.00	1.51	0.172	0.467
3.17	14.25	3.09	0.262	0.593
3.17	15.95	3.48	0.368	1.240
3.50	11.00	1.58	0.147	0.531
3.50	13.15	2.08	0.167	0.596
3.50	14.40	3.70	0.243	0.818
3.50	16.42	4.50	0.309	1.560

EFFECTS OF A CHANGE IN MOISTURE CONTENT  
OF STORED GRAIN ON BIN PRESSURES

by

ROBERT SEAGO SOWELL

B. S., Mississippi State University  
of Agriculture and Applied Science, 1961

---

AN ABSTRACT OF A MASTER'S THESIS

submitted in partial fulfillment of the

requirements for the degree

MASTER OF SCIENCE

Department of Agricultural Engineering

KANSAS STATE UNIVERSITY  
Manhattan, Kansas

1963

The objectives of this investigation were (1) to develop methods for separating and measuring vertical and lateral components of bin wall pressures, (2) to determine vertical and lateral pressures on grain bin walls, (3) to determine pressure on floors of grain bins, and (4) to determine the effects of a change in moisture content of stored grain on lateral wall, vertical wall and floor pressures.

A functional relationship of the variables affecting grain bin pressures was developed by use of dimensional analysis. The dimensionless pi terms  $L/WD$ ,  $h/D$ , and  $m$  were obtained from an analysis of the lateral wall pressure. For the vertical wall pressure  $V/WD$  replaced  $L/WD$  and for the floor pressure  $F/WD$  replaced  $L/WD$ . The variables included in these pi terms were as follows:

$L$  = unit lateral wall pressure in pounds per square foot  
 $V$  = unit vertical wall pressure in pounds per square foot  
 $F$  = average floor pressure in pounds per square foot  
 $D$  = diameter of bin in feet  
 $W$  = bulk density of grain in pounds per cubic foot  
 $m$  = moisture content of grain.

As a result of this dimensional analysis, two series of tests were conducted. In the first series of tests, the moisture content of the grain was held constant and the ratio  $h/D$  was varied. Values were determined for the pi terms  $L/WD$ ,  $V/WD$  and  $F/WD$ . These tests were followed by a second series of tests varying the moisture content and holding  $h/D$  constant. Values were again determined for the pi terms,  $L/WD$ ,  $V/WD$  and  $F/WD$ .

Equipment used in this study consisted of a model bin, pressure transducers for determining bin wall and floor pressures, and equipment for adding moisture to the grain. Moisture content of the grain was increased by adding steam to the top of the grain mass and recirculating air through the grain in a closed system for a given period of time. The test grain used in this investigation was wheat.

The method of least squares and curvilinear regression was used to develop equations for the bin pressures using the data obtained in the first series of tests. These equations were of the form:

$$F/WD = 0.72 (h/D)^{0.81}$$

$$V/WD = 0.108 (h/D)^{0.344}$$

$$L/WD = 0.235 (h/D)^{0.951}$$

In the first three tests of the second series, the moisture content of wheat was increased from 11 per cent (dry basis) to approximately 16 per cent (dry basis). For these three tests,  $h/D$  was held constant at values of 2.41, 3.17 and 3.50. Results indicated that for deep columns of grain and directional wetting as was used in the tests, the floor pressure increased approximately two to three times, the unit vertical wall pressure increased two times, and the unit lateral wall pressure increased three times. Wall pressures were measured one foot from the floor of the bin, which was two feet in diameter.

A fourth test, with  $h/D$  constant and moisture content varying, was conducted using wheat with an initial moisture content of 12.8 per cent (dry basis) and  $h/D$  constant at 0.79. The moisture content of the wheat was increased to 15.15 per cent

(dry basis). The lateral wall pressure increased approximately five times and the floor pressure increased approximately two times. The vertical wall pressure changed directions and acted in an upward direction with a magnitude slightly greater than the original pressure in the downward direction.

An increase in moisture content of stored grain definitely changes bin pressures to such an extent that bin failure could occur. When wheat is stored in deep columns at a low moisture content and experiences an increase in moisture content of approximately five per cent, lateral wall pressures and floor pressures increase two or three times. The maximum increase in vertical wall pressures occurs at the bottom of a deep column of grain. The magnitude of the increase in vertical wall pressure decreases from the bottom of the top of the grain column. Near the top of the grain column the vertical wall pressure acts in an upward direction so that the sum of the total vertical wall load and the floor load equals the total weight of grain in the bin.