

**Identification and Genetic Analysis of
Metabolic – Transcriptional Interactions
within the Circadian System of *Arabidopsis
thaliana***

Inaugural – Dissertation

Zur

Erlangung des Doktorgrades
der Mathematisch-Naturwissenschaftlichen Fakultät
der Universität zu Köln

vorgelegt von

Koumis Philippou

aus Athen, Griechenland

Köln 2015

Die vorliegende Arbeit wurde am Max-Planck-Institut für Züchtungsforschung Köln, in der Arbeitsgruppe von Dr. Seth J. Davis, Abteilung für Entwicklungsbiologie der Pflanzen (Direktor Prof. Dr. George Coupland) angefertigt.

Prüfungsvorsitzender:

Prof. Dr. Ulf-Ingo Flügge

Berichtersteller:

Prof. Dr. George Coupland

Prof. Dr. Ute Höcker

Tag der mündlichen Prüfung:

20 April 2015

Dedicated to my mother

*and to Prof. Dr. Edgar Wagner who inspired me to
do this work with his enthusiasm in clocks.*

TABLE OF CONTENTS

ABSTRACT	v
ZUSAMMENFASSUNG	vii
THESIS CHAPTERS	x
APPENDIX	xiii
LIST OF FIGURE ELEMENTS AND TABLES	xiv
ABBREVIATIONS	xvii

Abstract

Circadian rhythms are endogenous oscillators of about 24 hours that keep track of time on a daily and seasonal basis. Several endogenous rhythms exist in cells, but if they are to serve a time-keeping function they should satisfy certain criteria. First, they should be able to entrain to the rhythmic environment through *zeitgebers* (German for time givers), such as the daily changes in light and temperature. Second, true biological clocks resist environmental perturbation and maintain a period within the circadian range at different physiological ambient temperatures, a property known as temperature compensation. Peculiarly, the pace of the clock is compensated against changes in ambient temperature, but temperature pulses entrain the clock.

Temperature compensation has long puzzled scientists as biochemical reactions that build the clock are assumed to be temperature dependent. This problem has been addressed by several theories. According to one of these, temperature compensation would be the result of antagonistic processes. Alternatively it has been presented as an integral property of the clock and its components. According to a theory that combines both approaches, temperature compensation would be an integrated property from metabolic and/or transcriptional/translational networks that would together make the central oscillator. If this is correct, then it is expected that metabolic perturbation would alter the circadian period of rhythmic gene expression. To test this I applied chemicals that perturb metabolism (through the antioxidant system of the cell, photosynthesis, respiration and sulfur metabolism) and then monitored changes in rhythmic gene expression. One caveat to this is that oscillators (and networks) compensate. For this, not surprisingly, various authors have reported testing thousands of chemicals in order to find rare ones that are active in circadian assays. Despite this, I found that sucrose and photosynthesis-related chemicals affected the pace of nuclear oscillations in my assays. Moreover, these responses were altered in known circadian mutants, indicating that primary metabolism interacts with the components of the transcriptional/translational oscillator of *Arabidopsis*. In addition to these, I searched for metabolic-circadian interactions by testing several metabolism-related mutants in circadian assays and found that HSP90 has a temperature compensation long-period phenotype. Together these findings indicate that metabolism is part of the mechanism that buffers circadian period length against environmental perturbation.

Primary metabolism has been implicated in the generation of daily rhythms in every model organism used in the research field of chronobiology. Here it is shown that all the genetic components represented in an early model of the transcriptional/translational oscillator of *Arabidopsis* (CCA1, LHY, TOC1 and GI) as well as the main red-light circadian photoreceptor PHYB are required components for sucrose entry to clock action. In more detail, the loss-of-function

phyB-9 mutant showed a circadian phenotype, surprisingly, under blue light when sucrose was not exogenously applied. Sucrose advanced the circadian phase of photosynthetic gene expression, and the *cca1-11* mutant was resistant in this respect. In contrast, the *lhy-21* mutant was temporally oversensitive. The effect of sucrose on rhythmic gene expression was gene specific, as the promoter of *GI* responded to sucrose with period shortening. In contrast to previous reports, I found that the phenotypic response of the *gi-11* mutant to sucrose was light dependent. Most importantly, under blue light the *cca1-11;lhy-21* mutant exhibited robust oscillations so long as sucrose was not supplemented. In addition to these, the *toc1-21* mutant did not exhibit its characteristic short-period phenotype under red light when placed on growth medium that lacked sucrose. These findings and others presented in this work show that nuclear and cytosolic oscillations are coupled to each other in a manner predicted by the *zeitnehmer* model previously proposed for *Neurospora*. In support of this notion, the status of exogenous sucrose during entrainment to light/dark cycles was "remembered" during free run, in the form of sucrose-dependent transients. From this I propose that endogenous sucrose functions as a *zeitgeber* to entrain the clock, which in turn is in agreement to the role of photosynthesis as a *zeitnehmer*.

Redox perturbation can alter clock function. The antioxidant vitamin C and oxidant paraquat altered the circadian period in a light-quality dependent manner. In addition, rifampicin lengthened circadian period and salicylic acid increased oscillatory robustness and shortened circadian period. This later effect of salicylic acid was inhibited by sucrose and was also clock gated, and only took place during the first half of the subjective day in experiments that involved non-parametric entrainment to hormone- and light-pulses. Period lengthening or shortening by these chemicals was correlated to their proposed impact on photosynthetic electron-transport activity. Based on my data and on published circadian effects of other factors that alter the redox state of plastoquinone, I propose that photosynthetic electron transport and the redox state of plastoquinone are involved in light input to the transcriptional oscillator. This could explain the circadian rule of Aschoff according to which circadian period is a function of light intensity. Moreover, coupling between chloroplast-related and nuclear oscillations, as observed in my chemical and genetic assays, produces "traits" predicted by the *zeitnehmer* model. Vitamin C, salicylic acid, sucrose and chloroplastic electron transport chains are proposed here to form multiple *zeitnehmer* loops that entrain and together strengthen input signals to render nuclear oscillations more robust.

Of the "non-circadian" mutants I tested, *hsp90.2-3*, known to be altered for reactive-oxygen-species metabolism and related defense responses, had a temperature compensation long-period phenotype. The preliminary results I report here are suggestive that circadian defects in *hsp90.2-3* are affiliated to metabolism. Last, I discuss the possibility that stress cues, biotic and abiotic, might function as *zeitgebers*. Together metabolism and the clock appear as tightly integrated processes.

Zusammenfassung

Zirkadiane Rhythmen sind endogene Oszillatoren mit einer Periode von etwa 24 Stunden, die sowohl tageweise als auch jahreszeitlich die Zeit messen. Zellen besitzen zwar eine Vielzahl endogener Rhythmen; wenn diese jedoch einer Zeiterfassung dienen sollen, müssen bestimmte Kriterien erfüllt sein. Erstens sollten sie fähig sein, mittels Zeitgebern an den Ablauf der Umgebung wie tägliche Veränderungen von Licht und Temperatur anzukoppeln. Zweitens widersetzen sich echte biologische Uhren umfeldbedingten Störeinflüssen und erhalten auch bei unterschiedlicher physiologischer Außentemperatur die Periode innerhalb des zirkadianen Intervalls. Diese Eigenschaft wird Temperaturkompensation genannt. Auffällig ist hierbei, dass die Geschwindigkeit der inneren Uhr gegen Veränderungen der Außentemperatur ausgeglichen wird, die Uhr jedoch durch Temperaturimpulse gekoppelt wird.

Die Temperaturkompensation hat Wissenschaftler lange Zeit verblüfft, da angenommen wird, dass jene biochemischen Reaktionen, die die Uhr bilden, temperaturabhängig sind. Diesem Problem haben sich mehrere Theorien gewidmet. Gemäß einer dieser Theorien sei die Temperaturkompensation das Ergebnis antagonistischer Prozesse. Alternativ wurde diese als integrale Eigenschaft der Uhr und ihrer Komponenten dargestellt. Einer Theorie folgend, die beide Ansätze miteinander vereint, wäre die Temperaturkompensation eine eingebundene Eigenschaft aus molekularen Stoffwechselnetzwerken und/oder von transkriptionellen bzw. Translationsnetzwerken, die zusammen den zentralen Oszillator bilden würden. Falls dies zutrifft, geht man davon aus, dass Stoffwechselstörungen die zirkadiane Periode der rhythmischen Genexpression verändern würden. Um dies zu überprüfen, habe ich chemische Stoffe eingesetzt, die den Stoffwechsel beeinträchtigen (z. B. mittels antioxidativen Systems der Zelle, mittels Photosynthese, sowie der Atmung und des Schwefelstoffwechsels), um dadurch Veränderungen in der rhythmischen Genexpression zu beobachten. Ein Vorbehalt bei diesem Vorhaben ist, dass Oszillatoren (und Netzwerke) ausgleichend sind. Aus diesem Grund haben verschiedene Autoren – keinesfalls überraschend – berichtet, dass sie Tausende von Chemikalien getestet haben, um die seltenen zu finden, die in zirkadianen Proben aktiv sind. Ungeachtet dessen habe ich entdeckt, dass Saccharose und photosyntheserelevanten Chemikalien den Takt der Zellkernoszillationen in meinen Proben beeinträchtigen. Überdies wurden diese Reaktionen bei bekannten zirkadianen Mutanten verändert, wodurch sie zeigten, dass der primäre Stoffwechsel mit den Komponenten des Transkriptions-/Translationsoszillators der Arabidopsis interagiert. Zusätzlich habe ich nach Wechselbeziehungen zwischen dem Stoffwechsel und dem zirkadianen Rhythmus geforscht, indem ich mehrere stoffwechselbedingte Mutanten in zirkadiane Proben getestet habe. Dabei fand ich, dass HSP90 eine Temperaturkompensations- und

Langzeitphänotyp hat. Zusammengefasst zeigen diese Ergebnisse auf, dass der Stoffwechsel ein Teil jenes Mechanismus darstellt, der die zirkadiane Periodenlänge gegen Umwelteinflüsse puffert.

Der Primärstoffwechsel war an der Erzeugung von Tagesrhythmen eines jeden Organismustyps beteiligt, das in der Chronobiologieforschung benutzt wird. Hier wird gezeigt, dass all jene genetischen Komponenten, die in einem der ersten Modelle des Transkriptions-/Translationsoszillators der Arabidopsis dargestellt wurden (CCA1, LHY, TOC1 und GI), als auch der zirkadiane Hauptrotlichtphotorezeptor PHYB, notwendige Komponenten sind, damit die Saccharoseeinnahme die Uhr aktiviert. Im Einzelnen gesagt, zeigte der Funktionsverlust-phyB-9-Mutant überraschenderweise einen zirkadianen Phänotyp unter blauem Licht, wenn Saccharose nicht exogen zugeführt wurde. Saccharose erzielte eine zirkadiane Phasenverschiebung der photosynthetischen Genexpression und der cca1-11-Mutant zeigte sich in dieser Hinsicht resistent. Dagegen war der lhy-21-Mutant zeitweise übersensitiv. Die Wirkung der Saccharose auf die rhythmische Genexpression war genspezifisch, da der Promotor der GI auf Saccharose mit Periodenverkürzung reagierte. Gegenüber früheren Berichten, habe ich herausgefunden, dass die phänotypische Reaktion des gi-11-Mutanten auf Saccharose lichtabhängig war. Wesentlich wichtiger scheint jedoch, dass der cca1-11;lhy-21-Mutant unter blauem Licht robuste Schwingungen aufwies, sofern Saccharose nicht aufgestockt wurde. Zusätzlich zu diesen Ergebnissen wies der toc1-21-Mutant unter rotem Licht nicht etwa seinen charakteristischen Kurzzeit-Phänotyp auf, als er auf einem Wachstumsmedium, dem es an Saccharose mangelte, gesetzt wurde. Diese und andere in dieser Arbeit vorgestellten Ergebnisse zeigen, dass Zellkern- und zytosolische Schwingungen solcherart miteinander verbunden sind, wie dies bereits das für Neurospora vorgeschlagene Zeitnehmer-Modell prognostiziert hatte. Um diesen Gedanken zu unterstützen, wurde der Status der exogenen Saccharose während der Ankopplung an Licht-Dunkelheit-Zyklen im Freilauf „erinnert“, und zwar in der Form von saccharoseabhängigen transient-Zyklen. Daher schlage ich vor, dass endogene Saccharose als ein Zeitgeber für die Uhrkopplung fungiert, die wiederum mit der Rolle der Photosynthese als ein Zeitnehmer übereinstimmt.

Störeinflüsse auf den Redox-Zustand können die Uhrfunktion verändern. Das antioxidative Vitamin C und das oxidative Paraquat veränderten die zirkadiane Periode in Abhängigkeit von der Lichtqualität. Zusätzlich verlängerte Rifampicin die zirkadiane Periode und Salizylsäure führte zu einer Zunahme der oszillatorischen Robustheit sowie einer Verkürzung der zirkadianen Periode. Letztere Wirkung der Salizylsäure wurde durch Saccharose gehemmt und sogar uhraktiviert und trat nur während der ersten Hälfte des subjektiven Tages auf in Experimenten, die nichtparametrische Ankopplung an Hormon- und Lichtimpulsen beinhalteten. Periodenverlängerung oder –verkürzung durch diese Chemikalien stand in einer Wechselbeziehung zu ihrer erwarteten Auswirkung auf die photosynthetische Elektronentransportaktivität. Auf der Grundlage meines Datenmaterials und bereits aus Publikationen bekannten zirkadianen Wirkung anderer Faktoren, die den Redox-Zustand

von Plastochinonen verändern, schlage ich vor, dass der photosynthetische Elektronentransport und der Redox-Zustand von Plastochinonen an der Lichtrezeption auf den Transkriptionsoszillator beteiligt sind. Dies könnte die zirkadiane Regel von Aschoff erklären, gemäß derer die zirkadiane Periode eine Funktion der Lichtintensität ist. Zudem erzeugt die Kopplung zwischen chloroplastbedingten und Zellkernoszillationen, wie in meinen chemischen und genetischen Proben beobachtet, „Eigenschaften“, die im Zeitnehmer-Modell vorausgesagt wurden. Vitamin C, Salizylsäure, Saccharose und photosynthetische Elektronentransportketten sollen hier vielfältige Zeitnehmerschleifen bilden, die ankoppeln und zusammen die Inputsignale verstärken, um Zellkernoszillationen robuster zu machen.

Von den von mir getesteten „nicht-zirkadianen“ Mutanten zeigte *hsp90.2-3* – bekannt für Veränderungen des Stoffwechsels von reaktiven Sauerstoffspezies, die Abwehrreaktionen hervorrufen – einen Temperaturkompensations- und Langzeitphänotyp. Die vorausgehenden Ergebnisse, die ich hier vorstelle, deuten an, dass zirkadiane Defekte in *hsp90.2-3* in Bezug zum Stoffwechsel stehen. Schließlich erörtere ich die Möglichkeit, dass biotische und abiotische Stressauslöser als Zeitgeber fungieren könnten. Zusammen scheinen Stoffwechsel und Uhr als eng ineinander integrierte Prozesse.

THESIS CHAPTERS

1. INTRODUCTION	1-62
1.1. Circadian rhythms	2
1.2. Features of entrainment	6
1.3. Models for the time-generating mechanism	9
1.4. Transcriptional and metabolic circadian models – paradigms	11
1.4.1. Transcriptional/translational feedback loops in animal cells	12
a. <i>Drosophila</i>	12
b. The mammalian clock	14
1.4.2. <i>Neurospora</i> – a clock with an ongoing dispute	18
a. The <i>FREQUENCY</i> oscillator	18
b. The <i>zeitnehmer</i> model – metabolic oscillations	22
1.5. Ultradian oscillations in circadian systems	25
1.6. Circadian models in <i>Arabidopsis</i>	26
1.6.1. Genetic studies on rhythmic gene-expression in photosynthetic organisms	26
1.6.2. Transcriptional/translational oscillations in <i>Arabidopsis</i> – early to late models	27
1.6.3. Light input	37
a. Phytochromes and cryptochromes in light input to the clock	37
b. ZEITLUPE – a novel blue light photoreceptor	41
c. Gating	43
1.6.4. Entrainment to temperature	45
1.6.5. Sugars, metabolism and cytosolic oscillations are circadian determinants in <i>Arabidopsis</i>	46
1.6.6. Plant hormones in circadian rhythms	51
1.6.7. Sensitivity to hormones is gated: rhythmic hypocotyl elongation and anticipated stress responses	52
a. GA de-represses etiolated growth in the dark	53
b. Auxin promotes rhythmic growth	55
c. Rhythmic stress anticipation	55

1.6.8.	Photoperiodic regulation of carbon fixation and allocation	58
2.	MATERIALS AND METHODS	63-68
2.1.	Materials	64
2.1.1.	Mutant lines	64
2.1.2.	Growth media for plants and chemicals	65
2.2.	Methods	66
2.2.1.	Growth conditions and luciferase imaging	66
2.2.2.	Circadian leaf (cotyledon) movement assays	67
2.2.3.	Data analysis	67
3.	RESULTS	69-107
3.1.	Responses to sucrose	70
3.1.1.	The response of the wild-type to sucrose	70
3.1.2.	The response of the <i>toc1-21</i> mutant to sucrose	78
3.1.3.	The response of the <i>gi-11</i> mutant to sucrose	80
3.1.4.	The response of the <i>phyB-9</i> mutant to sucrose	82
3.1.5.	The responses of the <i>cca1-11</i> , <i>lhy-21</i> and <i>cca1-11;lhy-21</i> mutants to sucrose	83
3.2.	Circadian responses to chemicals that affect metabolism	87
3.2.1.	The effect of salicylic acid on the rhythms of wild-type plants	89
3.2.2.	The response of clock mutants to salicylic acid	99
3.3.	A reverse genetic approach – HSP90	105
4.	DISCUSSION	108-137
4.1.	Summary	109
4.2.	Wild-type responses to sucrose	110
4.2.1.	Transients in circadian parameters are inhibited by sucrose	110
4.2.2.	Supplementary sucrose applied during entrainment is "remembered" during subsequent free run	112

4.2.3.	Sucrose affects robustness of nuclear oscillations in a marker-specific manner	114
4.2.4.	Conclusive remarks on the effect of sucrose on oscillations of wild-type plants	114
4.3.	On genetic-epistasis experiments	115
4.3.1.	The response of the <i>toc1-21</i> mutant to sucrose	115
4.3.2.	The response of the <i>gi-11</i> mutant to sucrose	117
4.3.3.	Sucrose masks the circadian phenotypes of <i>phyB-9</i> under blue light	119
4.3.4.	The responses of the <i>cca1-11</i> , <i>lhy-21</i> and <i>cca1-11;lhy-21</i> mutants to sucrose	120
4.4.	The <i>zeitnehmer</i> model in <i>Arabidopsis</i>	122
4.5.	Perspectives on circadian regulation of carbon metabolism	124
4.6.	Chemical perturbation of chloroplast function is reflected in nuclear oscillations	126
4.6.1.	Vitamin C, salicylic acid, sucrose and electron transport chains form light-dependent rhythmic inputs to the clock – the multiple <i>zeitnehmer</i> model	127
a.	Electron transport chains affect nuclear oscillations	127
b.	The redox state of PQ is correlated with circadian period	129
c.	Oscillations in the vitC concentration, SA activity and photosynthetic electron transport meet certain criteria predicted by <i>zeitnehmer</i> loops	129
4.7.	Periodic stress and the clock regulate each other reciprocally - future insights	131
4.8.	CCA1 and LHY are not redundant in their roles as SA and sucrose sensors	132
4.9.	Why would HSP90.2 be involved in timekeeping	133
4.10.	Conclusive remarks	134
4.11.	Future perspectives	136
5.	BIBLIOGRAPHY	138-171

A P P E N D I X

- Ap.1.** Metabolic oscillations in *Neurospora* – the *zeitnehmer* model
- Ap.2.** The cyanobacterial circadian system is metabolic
- Ap.3.** Circadian metabolic oscillations in mammalian cells
 - Ap.3.1.** Metabolic and cytosolic oscillations
 - Ap.3.2.** Entrainment to metabolic cues
 - Ap.3.3.** Post-translational modifications in the mammalian circadian system that affect protein stability and subcellular localization
- Ap.4.** Ultradian oscillations
 - Ap.4.1.** Plasma membrane electron transport chains with ultradian activity
 - Ap.4.2.** Ultradian oscillations in yeast – the short metabolic cycles
 - Ap.4.3.** Ultradian oscillations in yeast – the long metabolic cycles
 - a.** Description of the long yeast metabolic cycles
 - b.** The role of transcription in driving the long yeast metabolic cycles
 - c.** The role of metabolites in driving the long yeast metabolic cycles
 - Ap.4.4.** Ultradian oscillations in other microorganisms
 - Ap.4.5.** The cell cycle vs. ultradian cycles and outcome
- Ap.5.** Temperature compensation is an integral part of the rhythm
 - Ap.5.1.** Temperature compensation in cyanobacteria, animals and fungi
 - Ap.5.2.** Temperature compensation in *Arabidopsis*
- Ap.6.** Erklärung
- Ap.7.** *Curriculum vitae*

LIST OF FIGURE ELEMENTS AND TABLES

FIGURES

Chapter 1: Introduction

Figure 1.1:	Circadian parameters	5
Figure 1.2:	Principles of Fast Fourier Transform analysis	5
Figure 1.3:	Phase response curves	8
Figure 1.4:	Fluence response curves	9
Figure 1.5:	Transcriptional/translational feedback loops of <i>Drosophila</i>	13
Figure 1.6:	The mammalian transcriptional/translational feedback loops	16
Figure 1.7:	The transcriptional/translational feedback loops of <i>Neurospora</i>	21
Figure 1.8:	The <i>zeitnehmer</i> model in <i>Neurospora</i>	24
Figure 1.9:	The single transcriptional/translational feedback loop model in <i>Arabidopsis</i>	28
Figure 1.10:	The double transcriptional/translational feedback loop model in <i>Arabidopsis</i>	31
Figure 1.11:	The triple transcriptional/translational feedback loop model in <i>Arabidopsis</i>	32
Figure 1.12:	Current transcriptional/translational feedback loop models in <i>Arabidopsis</i> comprised by repressors	36
Figure 1.13:	The GA signaling network regulates rhythmic growth and de-etiolation	54
Figure 1.14:	Photoperiodic regulation of starch metabolism in <i>Arabidopsis</i>	62

Chapter 3: Results

Figure 3.1:	The effect of sucrose on rhythmic expression of the luciferase marker <i>GI::LUC</i> (Col-0)	74
Figure 3.2:	The effect of sucrose on rhythmic expression of the luciferase marker <i>GI::LUC</i> (Ws)	76
Figure 3.3:	The effect of sucrose on rhythmic expression of <i>CAB2::LUC</i> (Ws) under BLc and on <i>TOC1::LUC</i> (Ws) oscillations	77
Figure 3.4:	The effect of sucrose on oscillations of the <i>toc1</i> mutant	79

Figure 3.5:	The effect of sucrose on oscillations of the <i>gi</i> mutant	81
Figure 3.6:	The effect of sucrose on oscillations of the <i>phyB</i> mutant	82
Figure 3.7:	The effect of sucrose on oscillations of the <i>CAB2::LUC</i> (Ws) marker in <i>cca1</i> , <i>lhy</i> and <i>cca1;lhy</i> mutants and the wild-type under blue light	83
Figure 3.8:	The effect of sucrose on oscillations of the <i>CAB2::LUC</i> (Ws) marker in the <i>cca1</i> , <i>lhy</i> and <i>cca1;lhy</i> mutants under red light	85
Figure 3.9:	Chloroplast-related chemicals perturb nuclear oscillations	88
Figure 3.10:	The effect of salicylic acid on promoter::luciferase constructs is marker specific	90
Figure 3.11:	The effect of salicylic acid on the robustness of marker <i>PHYB::LUC</i> (Ws) and on the <i>phyB</i> mutant under monochromatic red or blue light	91
Figure 3.12:	The effect of salicylic acid on circadian period is gated	94
Figure 3.13:	Salicylic acid increases the oscillatory robustness of <i>CCR2::LUC</i> (Ws) through parametric entrainment	96
Figure 3.14:	Salicylic acid-induced period shortening is moderated by sucrose	98
Figure 3.15:	The effect of continuous salicylic acid application on <i>GI::LUC</i> (Ws) in the <i>toc1</i> mutant	100
Figure 3.16:	The effect of salicylic acid on the <i>gi</i> mutant	101
Figure 3.17:	The effect of continuous salicylic acid application on <i>CAB2::LUC</i> (Ws) in the <i>cca1</i> , <i>lhy</i> and <i>cca1;lhy</i> mutants under blue light	104
Figure 3.18:	Leaf movement is affected by the <i>hsp90.2-3</i> mutation at cold temperatures	107
Figure 3.19:	Geldanamycin and the <i>hsp90.2-3</i> mutation similarly affect nuclear oscillations	107
 Chapter 4: Discussion		
Figure 4.1:	Transients	112
Figure 4.2:	<i>TOC1::LUC</i> (Ws) expression is responsive to the photoperiod	125
Figure 4.3:	2,5-dibromo-3-methyl-6-isopropylbenzoquinone does not affect circadian period	128

Appendix figures

Figure Ap.2.1: The circadian system of <i>S. elongatus</i>	2-6
Figure Ap.4.1: Plasma membrane NADPH oxidoreductases (ECTO-NOX proteins) function as plasma membrane oxidoreductases (PMORS)	4-3
Figure Ap.4.2: The short yeast metabolic cycles	4-6

TABLES

Chapter 2: Materials and Methods

Table 2.1: Wild-type and transgenic lines used for luciferase imaging	64
Table 2.2: Mutant lines used for circadian leaf movement assays	65

Chapter 3: Results

Table 3.1: The sucrose status of entrainment is remembered during free run	73
Table 3.2: Sucrose inhibits the period lengthening effect of geldanamycin	106

ABBREVIATIONS

BL :	Blue Light
BLc :	continuous Blue Light
CT :	Circadian Time
DD :	continuous Darkness
DBMIB :	2,5-dibromo-3-methyl-6-isopropylbenzoquinone
DCMU :	3-(3,4-dichlorophenyl)-1,1-dimethylurea
ETC :	Electron Transport Chain
FFT :	Fast Fourier Transform
FRC :	Fluence Response Curve
FRL :	Far-Red Light
FRLc :	continuous Far Red Light
HIR :	High-Irradiance-Response
LD :	Diurnal conditions with Light/Dark cycles
LFR :	Low-Fluence-Response
LL :	continuous Light
noPer :	RAE normalized Period
PRC :	Phase Response Curve
PTM :	Post-translational modification
RAE :	Relative Amplitude Error
RF :	Restricted Feeding
RL :	Red Light
RLc :	continuous Red Light
ROS :	Reactive Oxygen Species
SA :	Salicylic Acid
TTFL :	Transcriptional Translational Feedback Loop
vitC :	vitamin C
VLFR :	Very-Low-Fluence-Responses
WLc :	continuous White Light
ZT :	<i>Zeitgeber</i> Time

Chapter 1

Introduction

1.1. Circadian rhythms

Most living organisms found near the terrestrial surface resonate their activities with the periodic environment as it is determined by the earth's rotation around its axis¹ (Dunlap, 1999). Biological periodicities were first² noticed in the movement of leaves of the tamarind tree and described as long ago as the fourth century BC by Androstheneis. Their endogenous origin was demonstrated two millennia later by de-Mairan who observed them in mimosa plants kept in the dark (de Mairan, 1729). The free running period³ of leaf movement was not calculated until another hundred years had passed (de Candolle, 1832), and because its duration was of about 24 hours, these endogenous rhythms were subsequently named circadian⁴ (from latin *circa* and *dian*; "about one day"). During the last century, several endogenous rhythms in diverse organisms were discovered by researchers. In plants, processes that follow a circadian pattern include growth, photosynthesis, gas exchange, stomatal movement, enzyme activities, and fragrance emission (Cumming and Wagner, 1968). In humans, examples include sleeping habits, body temperature, food intake, and electrolyte excretion⁵ (Aschoff and Wever, 1962; Siffre, 1963; Mills, 1963). Other examples are daily activity of rats (Richter, 1922), pupal enclosion and loco-motor activity in flies, asexual reproduction (conidiation) of *Neurospora* (reviewed in Dunlap, 1999), and rhythmic bioluminescence of *Gonyaulax*⁶ (reviewed in Hastings, 2007). These are only a few examples of endogenous rhythms extensively studied. Today rhythmicity is tracked to the level of molecules and can be genetically and biochemically manipulated. In all of the above cases, true circadian rhythms, whether perceived by the naked eye or through sophisticated techniques, are not imposed by environmental fluctuations, thus they are endogenous.

-
1. The most renowned consequence of this in humans is jet-lag.
 2. This holds "at least in the western canon" (McClung, 2006).
 3. Circadian period is the time interval between consecutive cycles under constant conditions.
 4. Lunar rhythms repeat every month, while ultradian rhythms are substantially faster than 24 hours and measured in minutes or hours. The term circadian was coined by the chronobiologist Franz Halberg in the 1950s. It is attributed to the scholar Henry Nash Smith (Halberg *et al.*, 2003).
 5. Mills (1963) studied Mr. Workman who decided to spend 100 days underground in solitude, from 16th of June to 29th September 1963, in Stump Cross Cavern, near Pateley Bridge, UK. Endogenous rhythms of about 24 hours in electrolyte secretion and sleep habits were reported. In his work Mills also cites and comments on Siffre (1963), who performed a similar attempt and on Aschoff and Weffer (1962) who confined a number of subjects in a deep bunker.
 6. It is now known as *Lingulodinium polyedrum*. The circadian community still uses the old nomenclature.

As anyone who has experienced jet-lag can confirm, its unpleasant symptoms last only briefly. This is due to clock resynchronization, usually referred to as entrainment, between the endogenous oscillations and the rhythmic environment. Entrainment is mediated by perception of changes in light and temperature (termed *zeitgebers* from German for time givers), such as those naturally observed (reviewed in Devlin, 2002 and Dunlap, 2008). Botanists were once more the first to show this with leaf movement⁷, in experiments where the light/dark (LD) cycle was inverted (Hill, 1757). An obvious consequence of entrainment is proper phasing of rhythmic behavior *e.g.* preparing for photosynthesis in the day and the increased respiration at night, which is universally observed in plants. Another well-described consequence of entrainment to light is day-length measurement during photoperiodic responses. The relationship between photoperiodism and the circadian clock was first noted by Bünning (1936) and was later developed into the external coincidence model (Pittendrigh and Minis, 1964), according to which an internal oscillation that controls the photoperiodic response coincides with light during photo-inducible times of the day. Entrainable oscillations and their proper phasing are thus established as integral elements of photoperiodism. It should be mentioned that *zeitgebers* can influence rhythmic traits directly, photosynthesis being the most characteristic example of multiple control from light, temperature, and the clock.

In 1931 Bünning noticed that the free running period of leaf movement was virtually independent of mean ambient temperature (Bünning, 1931). This property termed temperature compensation⁸ was later additionally confirmed for the clocks of animals and unicellular organisms (Sweeney and Hastings, 1960; Bünning, 1973⁹). Given that circadian rhythms stem from biochemical oscillations, temperature compensation has been a puzzling feature in the circadian field, as most reactions are temperature dependent. Clearly, temperature compensation ensures that circadian oscillations are nearly equally fast under both cool and warm days, and any periodicity that is not buffered against temperature is not to be considered circadian (Bünning, 1973¹⁰).

Circadian rhythms are universal, endogenous, and temperature compensated timekeeping mechanisms that are entrained to the rhythmic environment by *zeitgebers*. Circadian systems have been, somehow arbitrarily, assigned with constitutive parts responsible for their attributed properties.

7. Entrainment to temperature cycles was shown later for many organisms (Bünning, 1973; pages 79 and 92).

8. Accordingly, the terms chemical and nutrient compensation are used to describe buffering against chemicals and nutrients respectively, as most will not alter circadian period.

9. See pages 71 to 73.

10. See pages 13 and 14.

These are cell-autonomous oscillators (or central oscillators) that generate rhythmicity in cells, the input pathways that deliver information from *zeitgebers* to the oscillator for entrainment and the output pathways (otherwise "hands of the clock") that mediate rhythmicity to processes of adaptive significance (Hastings *et al.*, 2008; Harmer, 2009).

Common circadian parameters are period, phase, and amplitude (T, Φ and A respectively in fig. 1.1). For practical reasons phase is usually defined as the time point that coincides with the maxima (or minima) of the oscillating procedure relative to a dawn set-point, and is thus the acrophase. It should be clarified that there are two measures for phase and time. Time is measured as the number of cycles (angular time) or in reference to the last entrainment event (*zeitgeber*) that initiated free running conditions (measured usually in hours or days); the former is termed "Circadian Time" (CT) and the later "Zeitgeber Time" (ZT). Period is the time interval between two consecutive points of the same phase and amplitude is the difference between the minima and maxima of the oscillation divided by two (fig. 1.1).

Rhythmicity (fig. 1.2) represents a fourth circadian parameter¹¹ that shows the degree to which an oscillating population is described by sinusoidal curves (*e.g.* Doyle *et al.*, 2002). Using the appropriate software, an experimental curve produced by a rhythmic individual is fitted to a theoretical sin curve via fast fourier transform (FFT) analysis; the degree to which the experimental and its corresponding theoretical curve are fitted to each other is represented by an error value, relative amplitude error (RAE) (fig. 1.2 A, B and C). The later is then taken in consideration in the calculation of the free running period of a given population (normalized Period; noPer). Consequently the mean free-running period of the population is defined largely by those individuals with lower error values. A population is said to oscillate robustly when its constitutive oscillations produce low RAE values and are in phase with each other. To estimate synchrony in many occasions, I used standard deviation (SD) of noPer (SD-noPer), instead of SD of phase, because SD-noPer incorporates RAE values. Thereafter I defined accuracy as an indirect measure of synchrony inversely correlated to SD-noPer (fig. 1.2). Phase, amplitude, and robustness can be measured under free-running conditions under continuous light (LL), in continuous darkness (DD), or under diurnal conditions of LD cycles and/or thermo-cycles; the free running period can only be defined under LL and in DD.

11. See text below, fig.1.2 and chapter "Materials and methods" for robustness being a function of two distinct parameters, rhythmicity and accuracy.

Figure 1.1: Circadian parameters

Circadian parameters are period (T), phase (Φ) and Amplitude (A). An oscillating organism or population is entrained to 12h light/12h dark (12hL/12hD) periods and/or similarly to warm/cold thermo-cycles, and then released into free running conditions of constant ambient temperature and light. Under free running conditions endogenous oscillations persist. White and black bars represent objective day and objective night respectively. Dashed and grey bars represent subjective day and subjective night respectively, under free running conditions.

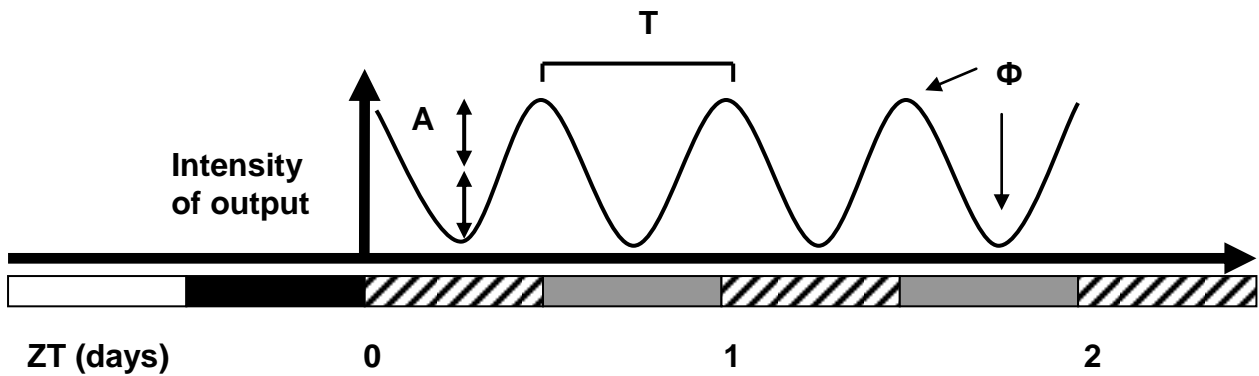

The introduction of the luciferase system in the circadian field has been a turning point that allowed chronobiologists to perform large-scale screens that eventually led to the isolation of clock-genes. That was initially performed in cyanobacteria (Kondo *et al.*, 1993) and then in plants (Millar *et al.*, 1995a). For this purpose, clock-controlled promoters were inserted upstream of a modified luciferase gene and transgenic organisms harboring these constructs were imaged in a large scale with automated systems. Previously, calculation of period, amplitude, and phase was in most cases a laborious act, performed with leaf movement or biochemical assays that demanded several hours of continuous work. One previous exception was experimental work with *Neurospora* that exhibits rhythmic conidiation in race tubes, in which case rhythmicity is revealed in the form of spore bands. Together, an ability to find mutations that alter rhythm generation of phase, period, amplitude, and capacity for over rhythmicity was thus generated.

Figure 1.2: Principles of Fast Fourier Transform analysis

Fast Fourier Transform (FFT) analysis quantifies circadian parameters of rhythmic individuals (**B**, **C**) or rhythmic populations (**E**, **G**). (**A**), (**B**), (**C**): RAE-values describe the degree to which experimental (continuous lines) and theoretical (FFT output; dashed lines) curves are fitted to each other; individuals with RAE-values approaching 1 (square) are less rhythmic than those with RAE-values approaching 0 (filled circle). (**D**), (**E**), (**F**), (**G**): The population described by figures **F** and **G** oscillates more robustly than the

population in **D** and **E**, because in the former SD-noPer (an indirect measure of synchrony) and the mean-RAE values are lower relative to the later. Note that through RAE-normalization the period of a population becomes a function of rhythmicity.

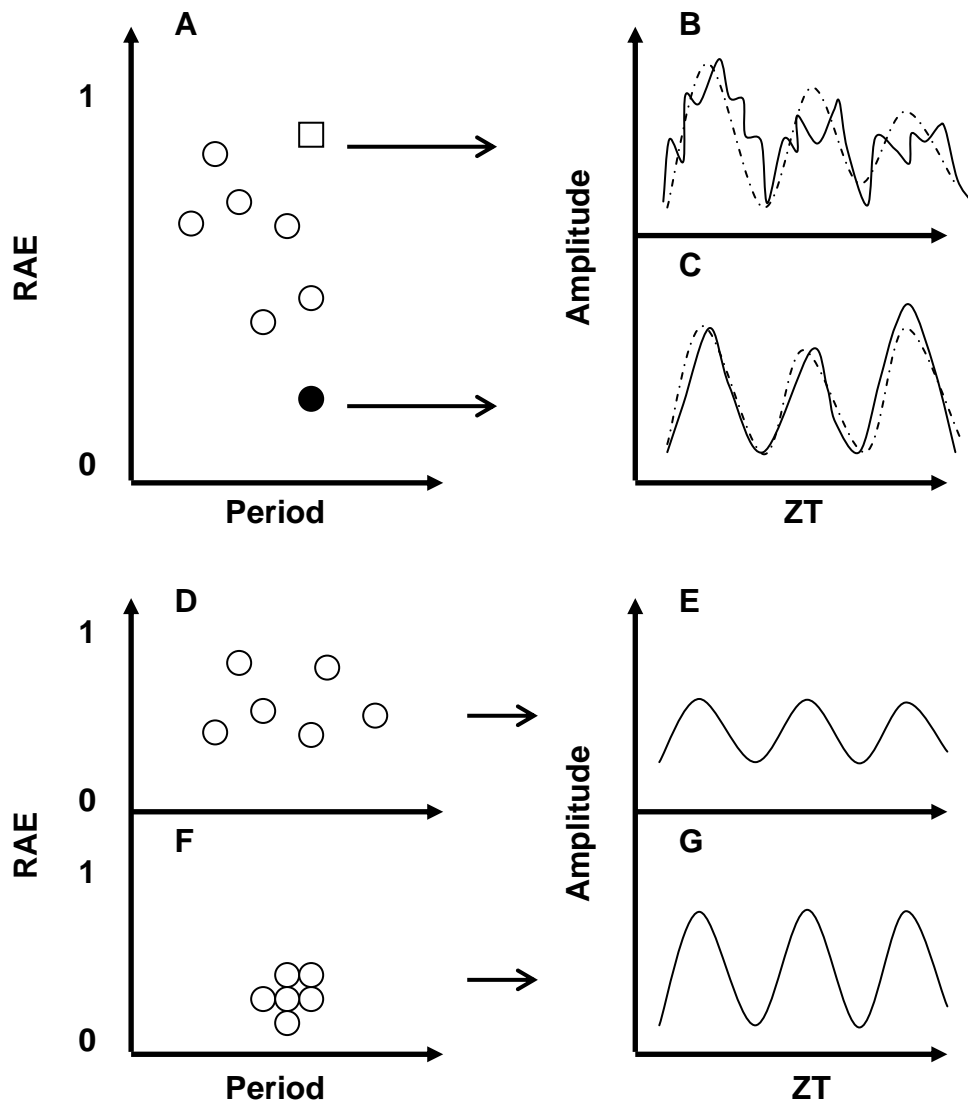

1.2. Features of entrainment

Living organisms experiencing free run can entrain to pulses of *zeitgebers*. This kind of entrainment is referred to as non-parametric entrainment, as opposed to parametric entrainment to LD cycles. Depending on the time that they are applied, pulses can be inactive or induce phase-advances or phase-delays, indicating that different phases of core-oscillations may react antagonistically. This differential sensitivity to parametric entrainment (referred to also as gating) is

usually shown with phase-response curves (PRCs, fig. 1.3). PRCs obtained with temperature pulses are often similar to those observed with light pulses (e.g. Buening, 1973¹²; Covington *et al.*, 2001).

In 1960 Aschoff described a rule (which he named circadian rule; today it is known as the rule of Aschoff) according to which, in a given organism, free-running period changes linearly with the logarithm of light intensity. The length of the free running period decreases with increasing light intensity for organisms active in the light (including green plants) and the reverse relationship is often observed with nocturnal animals; the rule is illustrated with fluence-response curves (FRCs; fig. 1.4) (Buening, 1973¹³). In plants, for example, free running oscillations are faster under continuous white light (WLC) than in DD, and presumably, this may result from the additive antagonistic effect that light has on the clock at different circadian times, as described in PRCs. Evidence in support of this additive-antagonistic relationship has been provided in *Phaseolous*, where the free running period of leaf movement is lengthened and shortened by continuous red (RLC) and far-red (FRLC) light respectively; this is likely because red light (RL) pulses produce PRCs with dominating phase delays whereas far-red light (FRL) pulses yield PRCs with dominating phase advances. It should be clarified that the effect of light on circadian period is relatively small when compared to the strong phase shifts caused by light pulses during non-parametric entrainment (indicated by the aforementioned relationship of light intensity and period being logarithmic). This paradox is somehow lessened again by assuming that at different circadian times continuous light would induce advances or delays that would minimize each other's effect.

FRCs and PRCs have been used in physiological and genetic studies (see chapter 1.6.3, fig. 1.3 and fig. 1.4), which aimed to describe light input and its components. Ultimately in eukaryotes, light input is thought to be mediated by photoreceptors and downstream input pathways that exert their control on the levels or activities of core-clock elements (Wagner *et al.*, 1975; Dunlap, 1999; Devlin, 2002). It should be clarified that light input and light entrainment are not identical entities. Entrainment is achieved with parametric and non-parametric treatments and results in synchronization and phase shifts (PRCs), whereas light input is often measured as changes in amplitude and period. The discrepancy between these two entities¹⁴ was illustrated by entrainment to light in *Arabidopsis*. In this case, light entrainment can take place in mutants that lack the photoreceptors that mediate light input to the clock (Yanovsky *et al.*, 2000; Strasser *et al.*, 2010).

12. See chapters 5 and 6.

13. See page 90.

14. See chapter 1.6.2 for more on this issue (Covington *et al.*, 2001; Kim *et al.*, 2003).

Phase shifts induced by *zeitgebers* are settled in magnitude only after a few cycles have passed. Only then is the period of oscillations relatively stable. This transitory state, first described by Pittendrigh and Bruce in 1959 (Buenning, 1973¹⁵), is said to be caused by transients¹⁶ that describe a state that deviates from the steady state of adapted oscillations. In this work I provide evidence that in *Arabidopsis* entrainment is linked to metabolism, based on the induction of transients by parametric entrainment and their modification by nutrients.

Figure 1.3: Phase Response Curves

Phase Response Curves (PRCs) describe differential sensitivity (gating) to non-parametric entrainment. Light pulses applied during subjective day in DD, when light is expected, do not cause substantial phase shifts. Phase advances (A) or delays (B) are observed when light pulses are applied near subjective dawn or dusk respectively (shown with arrows). Figure C illustrates the PRC of *Arabidopsis* in response to RL or BL pulses (adapted from Covington *et al.*, 2001). Similar PRCs are produced by temperature pulses in several unrelated species (Buenning, 1973). White and gray bars represent subjective day and night respectively.

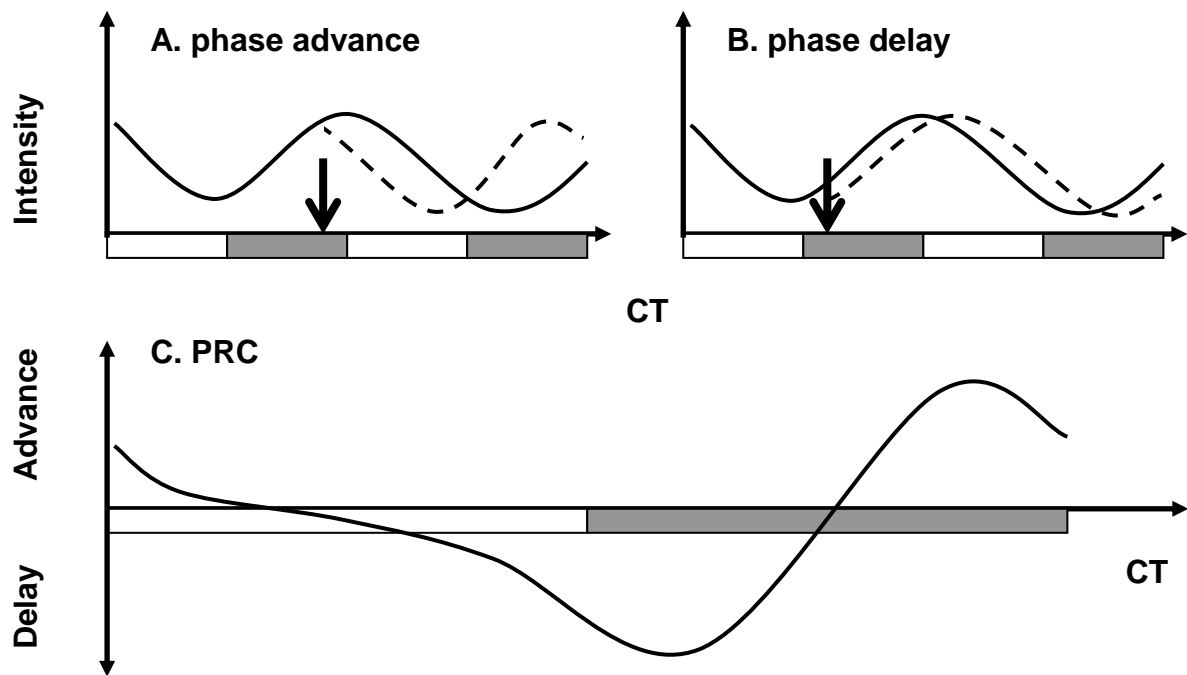

15. See chapter 5.

16. Transients are the reason why the first peak in expression of light-induced genes should be excluded when period is estimated. This peak integrates direct and indirect (via the oscillator) responses to *zeitgebers* and does not represent the properties or the speed of "adapted" (settled) oscillations. It is worth mentioning that transients were disregarded when temperature compensation was first examined in *Drosophila*, leading to false negative results regarding the universality of temperature compensation (Buenning, 1973, page 71).

Figure 1.4: Fluence Response Curves

(A) Fluence-Response-Curves (FRCs) of diurnal (continuous line) and nocturnal (dashed line) animals (adapted after Buening, 1973, p. 90). (B) FRCs introduced genetics to light input studies in *Arabidopsis* (see chapter 1.6.3 for a detailed analysis); the FRC of the wild-type (continuous line) and a of a given mutant (dashed line) are differentiated as shown, consequently the mutation is involved in light input to the clock in a light-fluence-dependent manner.

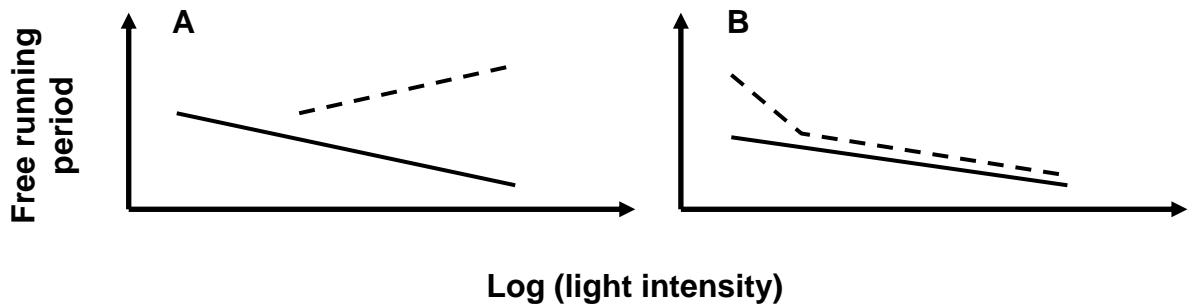

1.3. Models for the time-generating mechanism

The mechanism responsible for generating rhythmicity has been a subject of controversy. As early as 1960¹⁷, two trends could be distinguished. The major difference between them was in the assumed mechanism that would generate central autonomous oscillations, with some directed towards the nucleus and others to the cytoplasm and membranes (Zivkovic, 2011). Both approaches though were in agreement in that central oscillations would result from feedback inhibition¹⁸, whether this would be based on gene expression (Dunlap, 1999) or on membrane properties and ion fluxes (Njus *et al.*, 1974; Adamich *et al.*, 1976¹⁹) or on enzymatic activities and metabolism (chapters 1.4, 1.5, 1.6.5 and additions 1 to 4).

Since the early nineties, and the emergence of new molecular and genetic techniques, research in the circadian field has focused on transcriptional oscillations (Dunlap, 2008; Hastings *et al.*, 2008;

17. That is when the first chronobiological conference was held in Cold Spring Harbor.

18. According to the "limit cycle" model, oscillations result from the feedback mechanism created between a limited number of components; consequently the period is more or less fixed. Alternative theories that have gained ground during the recent years suggest that circadian systems would stem from controlled chaotic attractors and/or biochemical networks (see below).

19. Membranes received attention in this aspect in more recent publications as well; see Nitabach *et al.*, (2005).

MacKay *et al.*, 2011²⁰). Circadian mutants were isolated from cyanobacteria, fungi, insects, mammals, and plants. Soon after, clock genes from the fly were cloned and then from *Neurospora* (reviewed in Dunlap, 2008). Of these genes, several were subsequently found to encode transcription factors. The first transcriptional translational feedback loop (TTFL) was presented for the clock of *Drosophila* (Hardin *et al.*, 1990) and shortly after, for the clock of *Neurospora* (Aronson *et al.*, 1994a). According to TTFL models, oscillations are produced by clock genes whose protein products feedback to regulate their own expression. In this perspective TTFLs are comprised of negative elements that inhibit the expression of positive elements that induce the former. Therefore by definition clock elements regulate each other reciprocally and also feedback on their own expression. From this simple concept, TTFL models have evolved to multiple interlinked transcriptional/translational feedback loops.

Before the emergence of TTFLs, Pavlidis and Kuzman (1969) had proposed a different model according to which circadian rhythms are the result of the coupling of ultradian oscillations. Evidence that these fast oscillations are metabolic was first provided in plants (Wagner *et al.*, 1975; Wagner, 1976; Wagner *et al.*, 2000)²¹ and later in animal cells (Morré *et al.*, 2002). Lloyd and Murray, who performed extensive work with ultradian oscillations of *Saccharomyces cerevisiae*, have expanded this idea of oscillating networks with chaotic dynamics²². They suggested that a controlled chaotic attractor provides a single multi-oscillator capable of tunable outputs of variable frequencies (e.g. ultradian or circadian; see appendix 4), as oppose to the more or less fixed period values predicted by limited-cycle-models where feedback mechanisms are formed between a limited number of positive and negative components (reviewed in Lloyd and Murray, 2007 and Lloyd, 2008). It should be mentioned that compensation against environmental perturbation (e.g. nutrient and temperature compensation) in the network-models is, *per se*, a property of the networks.

Although TTFLs account for a great deal of the accumulated knowledge on circadian rhythms, there have been several inconsistencies suggesting that the model is incomplete. Such an

20. See also Zivkovic (2011) for historical presentation on this subject and the tendency of social structures to reflect on scientific trends.

21. In theory coupled fast oscillations that produce circadian rhythms could also be transcriptional (Paetkau *et al.*, 2006). Fast ultradian oscillations in transcription though are only known in yeast (Tu and McKnight 2006, Lloyd and Murray 2007) that lacks sustained circadian rhythms (Morrow and Raven, 2010) and in protists (Edwards and Lloyd 1980; Marques *et al.*, 1987). Ultradian rhythms and the theoretical provisions and experimental data that link them to circadian rhythms are reviewed in chapter 1.5 and in appendix 4.

22. Despite efforts over the last years sustained circadian rhythms have not been detected in this organism (Morrow and Raven, 2010).

inconsistency is found even before the first TTFL model was presented in experiments with the giant cells of the green alga *Acetabularia*. This organism exhibits oscillations of about one day in photosynthetic capacity and chloroplast shape that persist for several days even when the nucleus is removed. Thus transcription is not required for rhythmicity. However the nucleus determines the phase of the oscillation indicating that a complete circadian system in this organism is not independent of gene expression (reviewed in Buening, 1973²³). In cyanobacteria (*Synechococcus elongatus*) temperature compensated oscillations of about 24 h take place in the dark that eliminates transcription and translation as well as in the presence of transcriptional and translational inhibitors (Tomita *et al.*, 2005). Moreover these oscillations are reconstructed *in vitro* by the sole presence of the KAI proteins (see appendix 2) and ATP, thus in the absence of DNA, transcription and translation (Nakajima *et al.*, 2005).

Recently it was shown that circadian (endogenous, temperature compensated and entrainable) oscillations in the immuno-detected conformational state of peroxiredoxins are present in cultured red blood cells, thus in the absence of nuclei (O'Neill and Reddy, 2011). These same observations were repeated with the obligatory phototrophic green alga *Ostreococcus tauri* in the dark (continuous darkness, like in the case of *S. elongatus*, eliminates gene expression) and in the presence of inhibitors of transcription and translation (O'Neill *et al.*, 2011). Finally it was shown that the peroxiredoxin rhythms are universal and traced also in cyanobacteria, nematodes, flies, and in higher plants (*Arabidopsis*) (Edgar *et al.*, 2012). In all of these organisms, the rhythm in the peroxiredoxin conformational state has not appeared to require TTFLs, as the former persists when the later are blunted by mutation; in this case residual oscillations exhibit altered phase thus metabolic and nuclear oscillations should be coupled to each other (Edgar *et al.*, 2012). These findings are strongly supportive of a circadian system being formed in the coupling of nuclear and cytoplasmic networks.

1.4. Transcriptional and metabolic circadian models – paradigms

In chapter 1.4.1, I review studies that questioned that TTFLs alone would be adequate in describing the circadian system in animal models (in *Drosophila* and in mice). In appendix 2, I provide a brief review on how the TTFL model in the simplest photosynthetic organisms,

23. See page 145. Rhythms in enucleated cells were first discovered by Sweeney and Haxo (1961).

cyanobacteria, has given place to a metabolic model for the circadian oscillator. Chapter 1.4.2 and appendix 1 are extended reviews of the circadian system of *Neurospora*, a model organism that is well described in respect to its metabolic and transcriptional oscillations. Moreover, in the Results and Discussion chapters of this work, I accent that the predictions of the *Neurospora* circadian model proposed by Roenneberg and Merrow (1999), are supported in plants by my numerous clock-metabolic interstiction findings. This is all presented in a historical perspective.

1.4.1. Transcriptional/translational feedback loops in animal cells

a. *Drosophila*

In *Drosophila*, the positive oscillator elements CLOCK (CLK) and CYCLE (CYC) form a heterodimer that binds the E-box cis-elements of *PERIOD* (*PER*) and *TIMELESS* (*TIM*); consequently the later are expressed. Later PER and TIM form heterodimers that feedback to inhibit their own transcription by direct binding to CLK-CYK. Additional feedback loops are formed between CLK and transcription factors PAR DOMAIN PROTEIN1 (PDP1) and VRILLE (VRI). CLK-CYK induces the expression of *PDP1* and *VRI* that bind the same site on the *CLK* promoter competitively, to activate and repress its activity, respectively. Light input is delivered by the cryptochrome (cry) photoreceptor that associates with and targets TIM for degradation via a proteasome pathway that entails the E3 ubiquitine ligase JETLAG (JET); consequently the negative arm of the loop is abrogated for the purpose of entrainment (fig. 1.5; reviewed in Gallego and Virshup, 2007 and in Zheng and Sehgal, 2008).

Transcriptional oscillations alone cannot fully explain the mechanism that produces circadian rhythmicity in flies. First, it was shown that constitutive expression of *PER* or *TIM* mRNAs (in the single *per* and *tim* arrhythmic null mutants, respectively) does not abrogate cycling of PER and TIM proteins and allows behavioral rhythms in locomotor activity. Consequently the transcriptional feedback at the promoters of these genes is dispensable for rhythmicity. Constitutive expression of both of these genes in the double *per;tim* mutant produced similar results (Yang and Sehgal, 2001). Furthermore when the expression of *CLK* was misaligned and over-induced (due to an additional copy of the gene under the control of the *PER* promoter), locomotor activity in the dark was not significantly affected²⁴ (Kim *et al.*, 2002). These observations in *Drosophila* and others in

24. Under LD cycles though, the acute response of mobility to light at dawn was prolonged (Kim *et al.*, 2002). This means that nuclear oscillations are important for proper entrainment of locomotor activity.

cyanobacteria (appendix 2), *Neurospora*, (chapter 1.4.2.b and appendix 1), and mammals (chapter 1.4.1.b and appendix 3) are well in agreement with the emerging trend that a complete circadian system is likely to be formed by coupled oscillating networks from distinct cellular compartments.

Nuclear and cytosolic oscillations are thought to be coupled through post-translational regulation of clock proteins (Haydon *et al.*, 2010; Sanchez and Davis, 2011; Hastings *et al.*, 2008; Froy, 2011). Stability and nuclear translocation of circadian proteins in *Drosophila* are subjected to post-translational regulation by at least three serine/threonine kinases as well as by phosphatases (fig. 1.5) that are also found in the clock-models of plants, mammals and fungi. Protein stability and nuclear translocation of circadian proteins in turn define circadian period. The balanced phosphorylation-dephosphorylation by DOUBLE-TIME (DBT), a member of the CASEIN KINASE1 (CK1²⁵) family, and PROTEIN PHOPHATASE 2A (PP2A²⁶) regulates stability of both PER and CLK, with the phosphorylated forms of the target-proteins being less stable. PER protein is also a substrate for CK2²⁷, whereas TIM is phosphorylated by SHAGGY (SGG²⁸) (reviewed in Gallego and Virshup, 2007).

Figure 1.5:
Transcriptional/translational feedback loops of *Drosophila*

A TTFL is formed between the positive elements CYC/CLK and the negative elements PER/TIM. An additional feedback loop is formed between CYC/CLK and VRI and PDP1 that compete for the same binding site on the *CLK* promoter to repress and activate its expression respectively. Post-translational modifications via phosphorylation (black circles) affect circadian period via controlling nuclear translocation and stability of the clock proteins. Dotted arrows show transcription and translation. Figure adapted after Gallego and Virshup (2007).

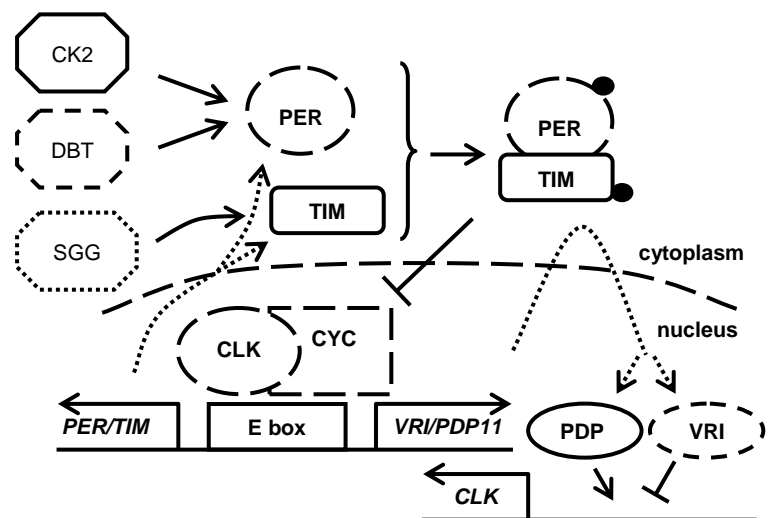

25. Also found in the *Neurospora* (Baker *et al.*, 2012) and mammalian (see appendix 3) circadian models.

26. Also found in the *Neurospora* circadian model (Baker *et al.*, 2012).

27. CK2 affects temperature compensation in *Neurospora* (Mehra *et al.*, 2009) and in plants (Portolés and Mas, 2010).

28. SGG is the the orthologue of the mammalian GLYCOGEN SYNTHASE KINASE-3 (GSK3) that affects nucleoplasmic partitioning and stability of mammalian clock-specific proteins (see appendix 3).

b. The mammalian clock

Following the discovery of the mouse *CLOCK* gene (Vitaterna *et al.*, 1994), the TTFL model for the cellular circadian clock was extended to mammals. Most studies presented below were conducted with mice, unless otherwise mentioned. The mammalian intracellular clockwork involves multiple transcriptional-translational feedback loops. *CLOCK*, a protein with histone acetyltransferase activity (HAT), and its heteromerization partner *BMAL1* that enhances HAT activity of *CLOCK* (Doi *et al.*, 2006), are two basic helix-loop-helix (bHLH) transcription factors that function as the positive arm of the loop. Together they bind E-box enhancers (Gekakis *et al.*, 1998) and act on gene expression by facilitating chromatin remodeling. At the beginning of the circadian day, *CLOCK*-*BMAL1* heterodimers activate rhythmic transcription of the negative elements of the loop comprised by the three *PERIOD* genes (*PER1*, *PER2* and *PER3*) and the two *cry* genes (*cry1* and *cry2*). Later in the day, resulting *PER* and *cry* proteins form complexes that translocate to the nucleus where they provide a negative feedback by interaction with *CLOCK* and/or *BMAL1* to suppress transcriptional activation at E-boxes (Griffin *et al.*, 1999; Kume *et al.*, 1999). Reactivation of gene expression by *CLOCK*-*BMAL1* is restored several hours later, once *PER* and *CRY* have been phosphorylated and targeted for ubiquitinylation and proteasomal degradation (reviewed in: Reppert and Weaver, 2002; Hastings *et al.*, 2008; Froy, 2011). Acetylation of *BMAL1* (Hirayama *et al.*, 2007) and of HISTONE 3 (H3) (Doi *et al.*, 2006) by the *CLOCK* protein, results in transcriptional repression (through recruitment of *cry1* to the *CLOCK*-*BMAL1* complex) and transcriptional activation, respectively.

This mammalian TTFL is accompanied by accessory loops, the best characterized being the one mediated by orphan nuclear receptors RETINOIC ACID RECEPTOR RELATED ORPHAN RECEPTOR α (*ROR* α) and REVERSE ERYTHROBLASTOSIS VIRUS α (*REV-ERB* α). The expression of *ROR* α and *REV-ERB* α , whose promoters contain E-boxes, is activated by *CLOCK*-*BMAL1*; *ROR* α then provides a positive and *REV-ERB* α a negative transcriptional feedback by competing for binding on *REV-ERB* α /*ROR* α response elements (*RORE*) of the *BMAL1* promoter during the night phase, thus closing the accessory loop (Ueda *et al.*, 2002; Preitner *et al.*, 2002; Sato *et al.*, 2004; Ueda *et al.*, 2005). *REV-ERB* α negatively regulates the *BMAL1* promoter by recruiting the well described HISTONE DEACETYLASE COMPLEX 3 (HDAC3), resulting in deacetylation and repression of basal transcription (Yin and Lazar, 2005). This transcriptional circuit produces opposite rhythmic patterns between night expression of *BMAL1* and its E-box-target-genes *PER*, *cry*, *ROR* α and *REV-ERB* α that peak during the day (Preitner *et al.*, 2002; Sato *et al.*, 2004). All the genes discussed here, with the exception of *CLOCK*, are expressed rhythmically (fig. 1.6). Of note, in the

mammalian forebrain, the positive arm of the clock is formed between BMAL1 and NEURONAL PAS DOMAIN PROTEIN 2 (NPAS2) (Reick *et al.*, 2001).

Despite extensive work performed on mammalian TTFLs, several pieces of evidence have emerged indicating that transcription alone is not adequate for the full description of the mammalian circadian clock. This was originally implied by the observation that rhythmic transcription of *PER2* RNA is not required for rhythmicity in *PER2* protein accumulation (Yamamoto *et al.*, 2005), suggesting post-transcriptional regulation. Firm evidence against a purely transcriptional oscillator in mammals was provided later by two independent publications. In the first one, rodent cell lines exposed to extracellular cry proteins engineered to be membrane-permeable were used to show that cry1, cry2, and BMAL1 protein-oscillations were dispensable for proper clock function (measured in the rhythmic activity of the *PER2* promoter). The authors concluded that cry proteins are not necessary for rhythmicity and that scientific research should be focused on the PER proteins instead (Fan *et al.*, 2007). In the second publication, it was found that chemical pretreatment of mouse fibroblasts with α -amanitin and actinomycin-D transcriptional inhibitors, reduced overall and clock-specific RNA synthesis (including that of *PER1* and *PER2*), but did not result in arrhythmia or period lengthening, as would be predicted by the TTFL-model. In contrast, inhibition of transcription caused significant period shortening of rhythmic clock-gene expression (of *BMAL1* and *PER2* promoter activities; Dibner *et al.*, 2009). As the data against a purely transcriptional/translational oscillator accumulated the importance of previously recognized cytosolic oscillations and post-translational modifications in circadian pace-making increased (Gallego and Virshup, 2007; Hastings *et al.*, 2008; O'Neil, 2009).

On several occasions it was shown that cytosolic/metabolic oscillations and TTFLs reciprocally regulate each other. For example, (1) O'Neil *et al.*, (2008) showed that cytosolic cAMP oscillations are not simply driven by nuclear ones, rather the former feedback to define amplitude, phase and circadian period of the later (measured with *PER* gene expression) in the SCN. (2) Similarly, the redox state of the cell affects the positive arm of the mammalian TTFL through induction and suppression of the DNA-binding activities of CLOCK-BMAL1 and NPAS2-BMAL1 heterodimers by NAD(P)H and NAD(P), respectively (Rutter *et al.*, 2001). (3) Recently it was shown that the redox state of the cell is rhythmic and moreover that it regulates CLOCK through the metabolic sensor SIRTUIN 1 (SIRT1), an NAD⁺ dependent deacetylase that binds CLOCK in a circadian manner and counteracts CLOCK HAT activity. Subsequently, through acetylation and deacetylation, the expression of clock-controlled genes (*DBP*²⁹ and *PER2*) and *PER2*³⁰ protein

29. DBP: D-site of albumin promoter binding protein.

stability are rendered sensitive to the redox state of the cell. SIRT1 and CLOCK bind E-boxes to facilitate chromatin remodeling; this has been observed at the *PER2* promoter and, notably, at the promoter of *NICOTINAMIDE PHOSPHORIBOSYL TRANSFERASE (NAMPT)*, the rate limiting enzyme in the synthesis of the SIRT1 cofactor NAD⁺. Based on these findings it was proposed that SIRT1 is as an enzymatic rheostat of CLOCK function, whereby oscillations in the redox state of the cell are coupled to TTFLs (Asher *et al.*, 2008; Nakahata *et al.*, 2008; Nakahata *et al.*, 2009; Ramsey *et al.*, 2009). (4) In addition to these, rhythmic heme biosynthesis and nuclear oscillations are coupled to each other through feedback regulation (Kaasik and Lee, 2004); the coupling mechanism entails negative regulation of the DNA binding activity of NPAS2-BMAL1 by carbon monoxide in a manner that requires heme binding by the two PAS domains of NPAS2 (Dioum *et al.*, 2002).

Figure 1.6: The mammalian transcriptional/translational feedback loops.

Positive elements encoded by *CLOCK* (C) and *BMAL1* (B) induce expression of negative elements *PER* (P) and *cry* (Cr) that feedback to inhibit the former. An additional feedback loop is formed by REV-ERB α (Re) and ROR α (Ro) that compete for the same elements of the *BMAL1* promoter.

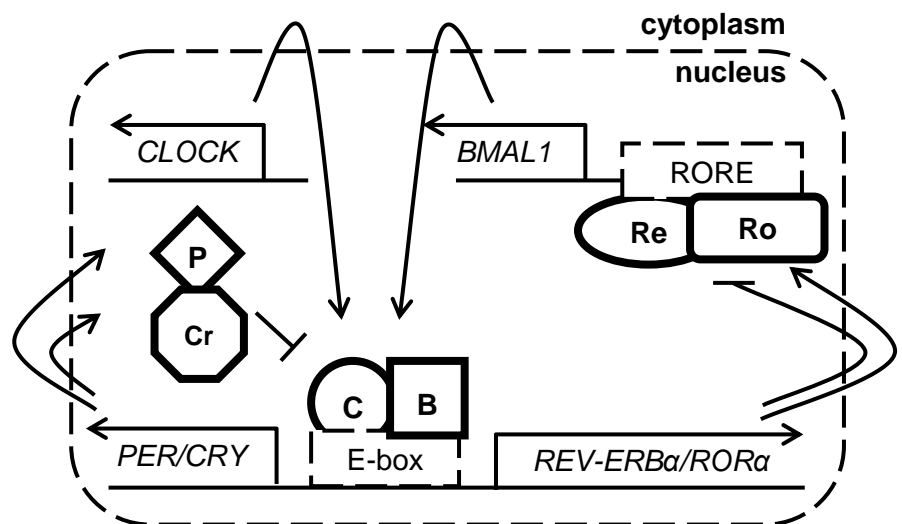

Known post-translational modifications (PTMs) of circadian relevance in mammals are now viewed as steps whereby nuclear oscillations can be coupled to metabolic ones. They include phosphorylation, de-phosphorylation, ubiquitination, sumolation, and acetylation. PTMs regulate

30. Deacetylation of PER2 by SIRT1 results in proteosomal degradation of the former. The enzymes responsible for PER2 acetylation are not known, but CLOCK is an attractive candidate (Asher *et al.*, 2009).

several properties of clock-proteins including stability, intracellular localization and activity (Gallego and Virshup, 2007; Hastings *et al.*, 2008). A number of enzymes are involved in the crosstalk between metabolism and mammalian TTFLs through PTMs. Current knowledge on this issue concentrates around three proteins, the metabolic sensor AMPK³¹, the NAD⁺ dependent deacetylase SIRT1 (mentioned earlier) and the GLYCOGEN SYNTHASE KINASE-3 β (GSK-3 β)³². Mammalian PTMs are reviewed more extensively in appendix 3.

A relationship between metabolism and entrainment in mammals has been known since 1922 when Richter reported that restricted feeding (RF)³³ could entrain locomotor activity in rats (reviewed in Stokkan *et al.*, 2001). Feeding also entrains gene expression in peripheral tissues (Schibler *et al.*, 2003) as well as in certain brain areas (Wakamatsu *et al.*, 2002; Rutter *et al.*, 2001). Interestingly, peripheral tissues from intact animals prefer to entrain to RF over entrainment to LD cycles, shown by the fact that daytime RF of nocturnal lab rodents inverts the phase of circadian gene expression under diurnal conditions; by contrast the SCN³⁴ is entrained by light but not by RF (Damiola *et al.*, 2000; Stokkan *et al.*, 2001).

31. AMP ACTIVATED PROTEIN KINASE (AMPK) is a metabolic sensor of the energy state of the cell (AMP/ATP ratio) that acts in peripheral tissues and in the central nervous system where it potentiates food intake (Minokoshi *et al.*, 2004; Kahn *et al.*, 2005). The circadian role of AMPK seems to be exerted at multiple levels (see appendix 3).

32. GLYCOGEN SYNTHASE KINASE-3 β (GSK-3 β) regulates primary metabolism (reviewed in (Doble and Woodgett, 2003), stability and nucleoplasmic partitioning of CRY2 and PER2 (Harada *et al.*, 2005; Iitaka *et al.*, 2005), connects the known TTFLs to lithium signaling (Yin *et al.*, 2006) and has been proposed to function during metabolic entrainment of peripheral organs to nutrients (Gallego and Virshup, 2007 and Hastings *et al.*, 2008) and likely also to insulin (Doble and Woodgett, 2003).

33. At free will (*ab libitum*) mice, being nocturnal organisms, consume most their food during the night.

34. Early models considered that the SCN is the master oscillator, because at the time the only known example of persistent oscillations (more than 30 days in isolation) was in single cultured neurons from the SCN. In the absence of this brain structure (in cultured cells or in SCN-lesioned mice) rhythmic behavior and gene expression, whether in the periphery or other brain areas, was not sustained for long (Sakamoto *et al.*, 1998; Yamazaki *et al.*, 2000; Akhtar *et al.*, 2002; Reppert and Weaver, 2002). This model was characterized hierarchical because the SCN would deliver rhythmicity to the periphery that could not otherwise sustain oscillations. Eventually persistent oscillations in peripheral tissues were discovered in cultured cells when endogenous promoters were used to monitor gene expression (Yoo *et al.*, 2004). For this reason, the SCN is now viewed as a "master synchronizer" that is entrained to light via a pathway from the retina and sets the time in light-insensitive peripheral organs. Related studies are presented in appendix 3.

1.4.2. *Neurospora* – a clock with an ongoing dispute

a. The *FREQUENCY* oscillator

Following the cloning of the gene *FREQUENCY* (*FRQ*) (McClung *et al.*, 1989) transcriptional feedback loops of the fungal clock were identified and gradually expanded with new components (fig. 1.7). The key players of the *Neurospora* TTFL are, in addition to FRQ, proteins WHITE COLLAR 1 and 2 (WC-1 and WC-2) (Aronson *et al.*, 1994a; Crosthwaite *et al.*, 1997) and FRQ-interacting RNA HELICASE (FRH) (Cheng *et al.*, 2005). The blue-light (BL) photoreceptor WC-1 and its interaction partner WC-2 form a heterodimeric complex via their PAS domains (Linden and Macino, 1997; Ballario *et al.*, 1998; Cheng *et al.*, 2002) named the WHITE COLLAR COMPLEX (WCC) that activates transcription of *FRQ* as part of the minimal oscillator that runs in the dark (Crosthwaite *et al.*, 1997; Froehlich *et al.*, 2002; He *et al.*, 2002). FRQ protein in turn negatively regulates its own expression (Aronson *et al.*, 1994a) by inhibiting binding of WCC on the *FRQ* promoter. The ability of WCC to bind the *FRQ* promoter depends on the phosphorylation state of the protein complex, with the hypo-phosphorylated form being active and vice-versa; FRQ promotes phosphorylation and inactivation of WCC (Schafmeier *et al.*, 2005) by facilitating interaction of the later with Casein Kinase 1 (He *et al.*, 2006; Baker *et al.*, 2009) thus closing the loop. Dephosphorylation and activation of WCC depend on PROTEIN PHOSPHATASE 2A (PP2A) (Schafmeier *et al.*, 2005). The negative arm of the clock³⁵ entails FRH that interacts with FRQ to

35. After FRQ is translated it forms homo-dimers that attract FRH in a stable complex. This complex interacts with the WCC and serves as a platform to introduce regulatory kinases and especially CK1 that stably associates with the complex; CK2 and other kinases are transiently associated. Both WCC, as earlier mentioned, and FRQ are substrates for these regulatory kinases. According to current trends, extensive phosphorylation of FRQ at multiple sites reflects circadian time and perhaps concomitant sequential conformations of the protein form a time dependent platform that facilitates interactions between clock components. For this it is suspected that phosphorylation of FRQ may occur in spatial and temporal clusters that would form charged areas, an idea that would also explain why many individual phosphorylation events seem to lack unique roles. In general, though not always, mutations that prevent phosphorylation tend to increase stability of FRQ and result in period lengthening. Accordingly, progressive phosphorylation switches FRQ from being predominantly nuclear where it represses WCC, to being cytoplasmic and susceptible to ubiquitination and proteasome mediated degradation (reviewed in Baker *et al.*, 2012). Noteworthy early in subjective night FRQ functions as a positive regulator of WCC in the cytoplasm; FRQ at this time is stabilized by phosphorylation. Later as subjective dawn approaches additional phosphorylation events

form the FRQ-FRH Complex (FCC) that stabilizes FRQ (Cheng *et al.*, 2005). This oscillator termed FRQ/WCC or FWO was described primarily in the dark, but it also mediates light input and it is required for compensation against temperature and nutrients (reviewed in Morgan *et al.*, 2001, in Liu and Bell-Pedersen, 2006 and in Baker *et al.*, 2012).

Light perception and temporal organization of gene expression are linked together via the WCC. Sequence analysis of the WC-1 protein revealed that one of its three PAS domains belongs to a specialized class known as a light – oxygen - voltage (LOV) domain (He *et al.*, 2002) that is associated with sensing of respective environmental cues (recent review in Belozerskaya *et al.*, 2012). WC-1 binds flavin-adenine dinucleotide (FAD) via the PAS/LOV domain to become photoactive, a property required for binding of WCC to the Light Responsive Elements (LREs) of the *FRQ* promoter in response to BL³⁶ (He *et al.*, 2002; Froehlich *et al.*, 2002). Rapid transcriptional activation of *FRQ* in response to BL then resets the clock in a manner that phase resetting and *FRQ* RNA induction are correlated (Crosthwaite *et al.*, 1995). Notably, the WC-1 PAS/LOV domain is required for light-entrainment and other light responses, but it is dispensable for oscillations in the dark and entrainment to temperature (He *et al.*, 2002).

VIVID (VVD) is a PAS/LOV BL photoreceptor that binds FAD or flavin mononucleotide (FMN) (Schwerdtfeger and Linden, 2003; Cheng *et al.*, 2003). It is required for photoadaptation and proper circadian timekeeping in the light. Photoadaptation refers to the process by which a light-response is gradually returned to the pre-induction state, such as the light transcriptional induction of several genes including, amongst others, *FRQ*, *WC-1* and genes of the carotenoid biosynthetic pathway. Loss-of-function mutations in *VVD* result in prolongation of the inductive effect of light on these genes resulting in a characteristic orange color (Heintzen *et al.*, 2001; Shrode *et al.*, 2001; Schwerdtfeger and Linden, 2003). It has been proposed that this impairment to dissipate light-induced gene expression is the cause of the observed *vvd* clock-phenotypes, such as the exaggerated phase-resetting by non-parametric entrainment and the altered PRCs relative to wild-type. Interestingly, the gate during which the *vvd* mutant is responsive to light is broadened to the extent that it includes the entire subjective day, therefore VVD is required for restriction of light responsiveness in general, both temporal and photoadaptive (Heintzen *et al.*, 2001; Elvin *et al.*, 2005; Schneider *et al.*, 2009). In agreement with the role of VVD in gating responses, *VVD* expression is clock regulated and induced by light in a gated manner (Heintzen *et al.*, 2001). *VVD* is

destabilize FRQ allowing thereby de-repression of WCC and transcriptional activation of *FRQ* (fig. 1.7; see also Gallego and Virshup, 2007 and Baker *et al.*, 2009).

36. All described light responses in *Neurospora* are triggered by BL (Lakin Thomas *et al.*, 1990).

not expressed in dark grown mycelia (Schwerdtfeger and Linden, 2003), whereas in DD it is detected for no more than one cycle (Heintzen *et al.*, 2001; Elvin *et al.*, 2005). These findings and the fact that *vvd* mutations have little if any effect on the conidiation rhythm in DD (Heintzen *et al.*, 2001; Shrode *et al.*, 2001) are in agreement with the assigned role of VVD in light perception and circadian gating.

Expression of VVD in the light requires WC-1 and WC-2 (Schwerdtfeger and Linden, 2003). Subsequently VVD represses homodimerization and thus transcriptional activity of WCC (Hunt *et al.*, 2010), through competitive interactions between the LOV domains of VVD and WC-1 (Malzahn *et al.*, 2010). These findings are suggestive that VVD forms a feedback loop that, in the presence of light, acts in proximity with the minimal oscillator to regulate gating and photoadaptation (reviewed in Baker *et al.*, 2012). In addition to these roles, VVD also regulates parametric entrainment of the conidiation rhythm that, in the wild-type, resets preferably at dusk rather than at dawn. VVD is responsible for this pattern of entrainment by preventing resetting at dawn and then by enhancing *FRQ* mRNA turnover at dusk (Elvin *et al.*, 2005). Consequently, VVD is a negative regulator of WCC that is involved in several major light/circadian responses of *Neurospora*.

The identification of PAS/LOV domains that bind redox-sensing molecules in VVD (Schwerdtfeger and Linden, 2003; Cheng *et al.*, 2003) and in WC-1 (He *et al.*, 2002; Froehlich *et al.*, 2002) is implicit that the reciprocal regulation between these circadian players is susceptible to metabolic regulation (Schwerdtfeger and Linden, 2003; Hunt *et al.*, 2010; Malzahn *et al.*, 2010). This opinion is further supported by genetic and biochemical approaches. Here it is noted that the circadian phenotypes of *vvd* null mutations are dependent not only on the ambient light intensity, but also on available carbon sources and on temperature (Schneider *et al.*, 2009)³⁷. In addition to this, it was recently shown that light input to the FWO employs ROS signaling likely through the regulation of the DNA binding activity of WCC (Belden *et al.*, 2007; Yoshida *et al.*, 2011; see chapter 1.4.2.b and appendix 1 for more details). Consequently the protein products encoded by these genes are related to both the circadian oscillator and metabolism. Together these findings imply that light input to FWO is metabolic.

37. When grown on maltose a *vvd* null strain, unlike *vvd+*, exhibits oscillations in conidiation that range from ultradian to "about one day"; the later are though not circadian as they are not temperature compensated. Noteworthy the period of these oscillations depends on the combined effect of light intensity and temperature, the effect of temperature being stronger with increasing light intensity. This is no surprise given the fact that the phenotypes of *vvd* are generally light-dependent (Schneider *et al.*, 2009).

Figure 1.7: The transcriptional/translational feedback loops of *Neurospora*

FRQ is the negative element of the TTFL. It promotes phosphorylation (filled circles) of the WCC complex that functions as the positive arm of the loop by promoting expression of *FRQ*. Progressive phosphorylation of FRQ regulates its nuclear localization and stability. (A) Near subjective dawn FRQ degradation via the proteasome pathway is stimulated by hyper-phosphorylation, resulting in de-repression of WCC and transcription of *FRQ*. (B) Later FRQ inhibits WCC transcriptional activity. (C) FRQ can also function as a positive regulator of WCC by promoting its cytoplasmic accumulation. FRQ degradation is stated with the faded gray symbols (adapted after Gallego and Virshup, 2007).

A. Subjective dawn

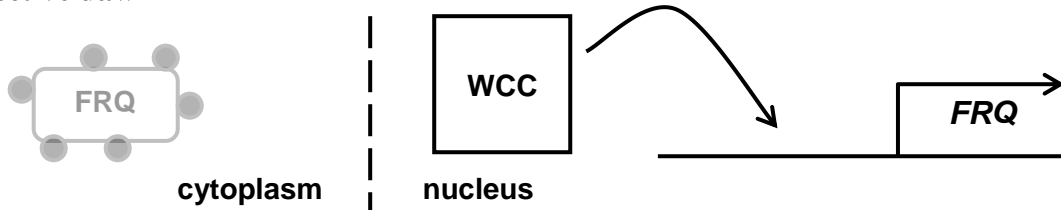

B. Subjective morning

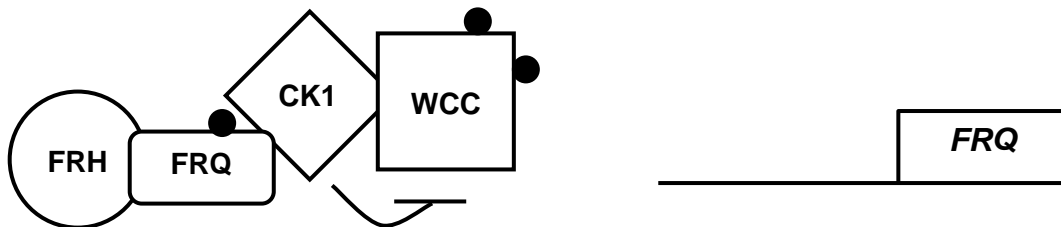

C. Subjective night

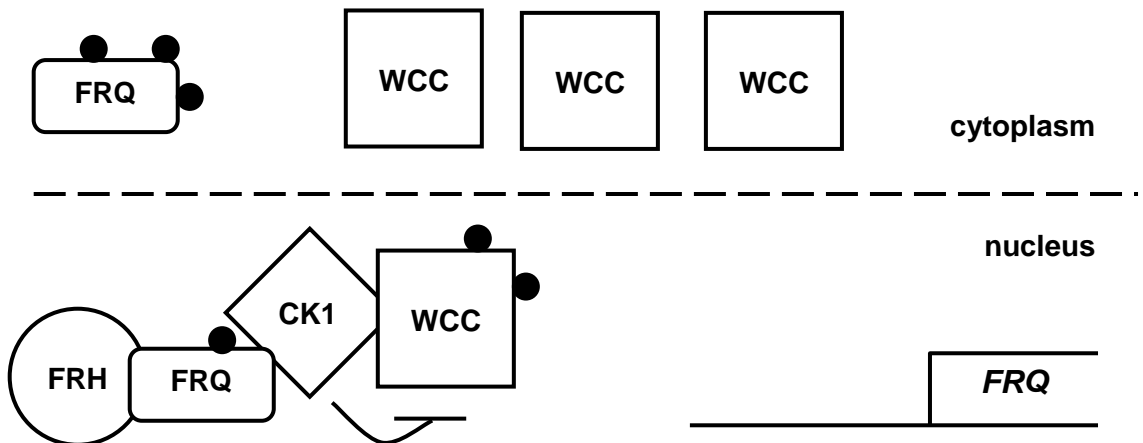

b. The *zeitnehmer* model – metabolic oscillations

The FRC/WCC oscillator cannot explain all findings accumulated regarding the *Neurospora* clock. Most importantly, the FRC/WCC model cannot explain the residual oscillations observed in *frq*, *wc-1*, and *wc-2* null mutants. Based on these oscillations, termed "frequenceless" (FLOs; oscillations in the absence of a complete and functional FRQ/WCC oscillator), Merow *et al.* (1999) proposed that metabolism is central for circadian timekeeping in *Neurospora*. Experiments against a purely transcriptional/translational oscillator are reviewed in appendix 1, including current knowledge on the residual FLOs and the sensitivity of the circadian system to metabolic perturbation by chemicals, nutrients and mutation. In brief, the repetitiveness and amount of accumulated data on the FLOs (Dragovic *et al.*, 2002; Granshaw *et al.*, 2003; Correa *et al.*, 2003; Cristensen *et al.*, 2004; de Paula *et al.*, 2006; Lombardi *et al.*, 2007; Yoshida *et al.*, 2008; Brody *et al.*, 2010; Yoshida *et al.*, 2011) show that transcription and translation alone are not adequate in describing the central oscillator of *Neurospora*; moreover the nature of the FLOs in the above studies, whether they are ROS-related or glucose-dependent or involved in primary metabolism, is indicative that they are driven by metabolism.

Lipids had received great attention and were involved quite early in research around metabolic oscillations. The *cel* (Brody and Martins, 1979; Mattern and Brody, 1979; Mattern *et al.*, 1982) mutant that is compromised in synthesis of saturated fatty acids due to a deficiency in fatty acid synthetase activity and the *chol-1* mutant (Lakin-Thomas, 1996; Lakin-Thomas, 1998; Lakin-Thomas and Brody, 2000) that is defective in the synthesis of the phospholipid phosphatidylcholine, both exhibit long-period phenotypes and loss of temperature compensation below 22°C on minimal growth medium (in the absence of palmitic acid and choline respectively). Moreover these mutations alleviate from the arrhythmia imposed by *frq* and *wc* loss-of-function mutations, as long as growth conditions are again minimal. Recovered oscillations in *frq chol-1* and *frq cel* are though incomplete, as they are "blind" (unresponsive to light) and compromised for the temperature compensation response (see references above and Lakin-Thomas and Brody, 2000).

In the wild-type, oscillations were found to be resilient to changes in ambient temperature and growth medium composition. By contrast, the *cel* and *chol-1* mutants exhibited both temperature and nutrient compensation phenotypes (period is sensitive to fatty-acid levels), indicating that temperature compensation is affiliated to metabolism (see also Roenneberg and Merrow, 1999 and the review of Morgan *et al.*, 2001). It is noteworthy, that exposure to certain fatty acids lengthened circadian period of *cel* and that this effect was reversed by metabolic perturbation that targets mitochondria, including mitochondrial mutations, respiration-inhibitor antimycin and non-fermentable carbon sources. These findings suggest that part of the oscillator is located in the

mitochondria and that lipid metabolism or even membrane composition in *Neurospora* are involved in circadian timekeeping (Lakin-Thomas *et al.*, 1990 and Brody, 1992). Mutants that affect amino-acid synthesis also caused circadian phenotypes (Lakin Thomas *et al.*, 1990). Of these the *cys-9* mutant exhibits both temperature- and nutrient-compensation phenotypes in a manner that suggested that the circadian defect is not the result of auxotrophy. This is because other cysteine auxotrophs do not exhibit circadian phenotypes (Onai and Nakashima, 1997). Given the fact that *cys-9* encodes for the NADPH-dependent thioredoxine reductase (NTR) of *Neurospora*, it is possible that the redox state of the cell to which NTR is sensitive (Gelhaye *et al.*, 2005) is of circadian relevance in *Neurospora*.

Recently it was shown that in *Neurospora* ROS levels are under the control of both the clock and light. The TTFL regulates ROS oscillations through ROS-generating NADPH Oxidases (NOX) and ROS-destroying catalases. Most importantly, this control was shown to be reciprocal (Yoshida *et al.*, 2011). Interestingly, ROS mimic the effect of light on the absorption spectrum of WC-1 and on the ability of WCC to bind DNA *in vitro*. For this light input to the clock may employ ROS signaling (Belden *et al.*, 2007; Yoshida *et al.*, 2011). The same is perhaps true for entrainment, because the *superoxide dismutase 1 (sod-1)* strain is hypersensitive to light entrainment relative to the wild-type (Yoshida *et al.*, 2008).

Conclusively the experiments described here showed that metabolism is a driving force of circadian rhythmicity. In particular energy metabolism in mitochondria and/or its byproducts (*e.g.* ROS) and/or the molecules that sum metabolic pathways of energy transduction (redox molecules), the metabolic map as it is defined by various states of lipid metabolism and/or lipid signaling or even membrane composition in mitochondria (on the basis of Mitchell's chemiosmotic theory of electron transduction; Mitchel, 1957), are somehow important for proper timekeeping in *Neurospora*.

Roenneberg and Merrow proposed a model for the clock of *Neurospora* comprised of two interacting oscillators, based on residual and incomplete recovered oscillations of *frq* and *wc* mutants (fig.1.8). These are the FRQ/WCC oscillator and metabolic oscillations (FLOs). According to this model the FRQ/WCC oscillator is required for compensation against both temperature fluctuations and metabolic variation, but it is not central in the sense that it does not generate rhythmicity, rather it is part of a rhythmic light input pathway towards a central, temperature-entrainable, metabolic oscillator. In this model the TTFL is given *zeitnehmer* properties (German for "time taker"), meaning that the role of the transcriptional loop is not to "generate time" but to entrain and provide sustainability by receiving *zeitgeber* signals (light entrainment). According to the *zeitnehmer* model, isolated metabolic oscillations are temperature dependent and thus cannot ascribe for temperature compensation. As transcription is also temperature dependent, temperature

compensation should result from the interaction/coupling between the two temperature dependent oscillators. The model predicts that single mutations should exhibit both temperature- and nutrient-compensation phenotypes (e.g. the *cel* and *chol-1* mutants, see references above; *vvd* null strain, Schneider *et al.*, 2009), because these responses would share a common mechanism³⁸ (Roenneberg and Merrow, 1998; Roenneberg and Merrow, 1999; Merrow *et al.*, 1999). Iwasaki and Dunlap (2000) proposed a similar model that however does not assign peripheral roles to either of the two interacting oscillators. In support of these models it was recently demonstrated that a strain lacking all functional *FRQ*, *WC-1*, *WC-2* and *VVD* genes is still entrained to temperature cycles (Hunt *et al.*, 2012). Moreover, based on the epistatic relationships between *period 2* (*prd-2*), *prd-3* and *prd-6*³⁹ with *frq* alleles, it was suggested that interactions between the two oscillators would be mediated by these genes to generate temperature compensated circadian rhythms (Morgan *et al.*, 2001).

Figure 1.8: The *zeitnehmer* model in *Neurospora*

The models of Merrow *et al.* (1999) and Iwasaki and Dunlap (2000) for the oscillator of *Neurospora* consist of interacting metabolic and nuclear oscillations. Both research groups assign temperature entrainment to the metabolic FLOs and light entrainment to the FRQ/WCC oscillator. Merrow *et al.* (1999), unlike Iwasaki and Dunlap (2000), do not assign central properties to the FRQ/WCC oscillator.

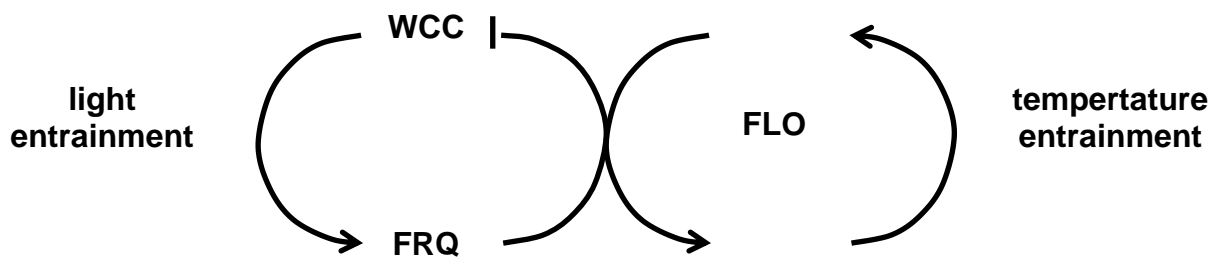

38. In this work I show that *Arabidopsis* mutants with temperature compensation phenotypes (Gould *et al.*, 2006) are also defective in their nutrient compensation response. Based on this finding and others presented in the Results and Discussion chapters, I will claim that the *zeitnehmer* model developed in *Neurospora* applies in *Arabidopsis* as well.

39. These are not alleles; they are distinct genetic loci. They are unrelated to the *PERIOD* genes of animals.

1.5. Ultradian oscillations in circadian systems

An alternative hypothesis on the mechanism of the circadian rhythm, one that can be experimentally connected to membranes and the redox state of plant and animal cells, was proposed by Pavlidis and Kautzmann (1969). They suggested that coupling of ultradian oscillations could generate circadian rhythms. Evidence in favor of this in plants was provided in *Chenobodium rubrum* as it exhibits circadian oscillations in adenine and pyridine nucleotide ratios (energy charge and redox state, respectively) and ultradian oscillations in the levels of the respective nucleotides. High frequency oscillations of 12 to 15 hours in metabolic reactions (observed for steps of glycolysis, of tricarboxylic-acid cycle and of the oxidative pentose-phosphate cycle) are, according to the model, not simply separated in distinct compartments, but also coupled as nucleotide ratios. A feedback mechanism is formed because rhythmic enzymatic activities responsible for oscillations of the energy charge and of the redox state of the cell are under the control of these ratios. According to this theory, temperature compensation would be a property of metabolic networks that couple the ultradian and temperature-dependent metabolic pathways in the form of circadian ratios of nucleotides; in this membranes would be central for timekeeping (reviewed in Wagner *et al.*, 1975; Wagner, 1976 and Wagner *et al.*, 2000) on the basis of Mitchell's chemiosmotic theory of electron transduction (Mitchel, 1957).

Recent studies dealing with ultradian oscillations and their connection to circadian rhythms and metabolism are presented in appendix 4. Of these it is worth mentioning the link between ultradian and circadian oscillations as it is revealed by certain plasma membrane oxidoreductases (PMORs), designated EKTO-NOX. When COS cells are transformed with cDNAs encoding different forms of ECTO-NOX proteins that vary in their ultradian enzymatic periodicities (in NADPH oxidation), then the circadian period of a metabolic biomarker (activity of glyceraldehyde-3-phosphate dehydrogenase) is equal to the ultradian period multiplied by 60 (*i.e.* genetically determined ultradian periodicities of 22, 24, 36 or 42 minutes in NADPH oxidation result in circadian periodicities of 22, 24, 36 and 40 to 42 hours respectively in glyceraldehyde-3-phosphate dehydrogenase activity; Morr e *et al.*, 2002). This is perhaps the most striking example whereby ultradian and circadian periodicities are linked to each other. Concepts in favor of such a relationship are reviewed by Lloyd and Murray (2007).

1.6. Circadian models in *Arabidopsis*

1.6.1. Genetic studies on rhythmic gene-expression in photosynthetic organisms

Early efforts to track transcriptional-translational oscillations in photosynthetic organisms proved rather laborious, but not fruitless. Research with the dinoflagellate *Gonyaulax* revealed that the clock controls most of its activities, including transcriptional (Brigitte *et al.*, 1983) and translational processes (reviewed in Hastings, 2007). Translational control was originally implied by the observation that the levels of LUCIFERASE-BINDING PROTEIN (LBP; required for the bioluminescence reaction) oscillate, when *LBP* transcript levels are constant (Hastings, 2007). Translational control was then shown by Mittag *et al.* (1994) who isolated a clock controlled translational regulator (CCTR) from crude extracts of *Gonyaulax* that specifically binds to UG repeats at the 3'UTR of the *LBP* mRNA in a circadian manner. Later the 3'UTR of the *Gonyaulax LBP* was used to identify potential clock regulators in the green alga *Chlamydomonas* (Iliev *et al.*, 2006). However, these marine microorganisms are not easily cultivated, at least not to the point that they can be genetically manipulated. High-throughput genetic screens for clock mutants were rendered possible for the first time with the cyanobacterium *Synechococcus elongatus* after a bacterial luciferase gene was introduced downstream of the rhythmic promoter of the *psbAI* gene, that encodes a photosystem II protein (Kondo *et al.*, 1993). Arrhythmic strains and period mutants were isolated with this approach and that provided an input to establish a molecular genetic and biochemical basis for circadian rhythms in a photoautotroph (Kondo *et al.*, 1994).

A series of publications on pea (Kloppstech, 1985), wheat (Nagy *et al.*, 1988), bean (Tavladoraki *et al.*, 1989), spinach (Oelmüller *et al.*, 1995) and *Arabidopsis* (Millar and Kay, 1991) established that light-harvesting chlorophyll a/b binding proteins (LHCB, also called CAB) are expressed rhythmically. Of these only *Arabidopsis* was suitable for large-scale forward-genetic screens (Somerville and Koornneef, 2002), but still this was rendered possible only after Millar *et al.* (1992) introduced the firefly luciferase system into the circadian field. They showed that when the promoter of the *CAB2 (LHCB1*1)* gene is used to drive luminescence from individual transgenic seedlings, luminescence is rhythmic and can be detected with a camera, allowing period of transcriptional rates to be estimated in a large scale. This system was later used to identify the first circadian mutant in plants, the *timing of cab expression1 (toc1)* mutant (Millar *et al.*, 1995a) and also to characterize circadian phytochrome-dependent photo-transduction pathways (Millar *et al.*, 1995b).

1.6.2. Transcriptional/translational oscillations in *Arabidopsis* – early to late models

In the model organism *A. thaliana*, a network of genetically interacting transcription factors and proteins of unknown function form multiple TTFLs that effect overall plant circadian responses. A TTFL was initially identified between the TOC1 protein [Strayer *et al.*, 2000; also known as PSEUDO RESPONSE REGULATOR1 (PRR1)] and two closely related MYB transcription factors, CIRCADIAN CLOCK ASSOCIATED (CCA1) and LATE ELONGATED HYPOCOTYL (LHY) (Schaffer *et al.*, 1998; Wang and Tobin, 1998). These transcription factors regulate each other reciprocally; CCA1 and LHY bind the evening element (EE) of the promoter of *TOC1* to repress its expression, whereas according to early genetic evidence TOC1 was at first considered to be a positive regulator of *CCA1* and *LHY* expression as part of the positive arm of the loop. These observations led to the proposal that the central oscillator in *Arabidopsis* is a TTFL formed between CCA1, LHY and TOC1 (fig. 1.9; Alabadi *et al.*, 2001).

A role of TOC1 in transcriptional regulation has been suspected since the cloning of the gene, because the encoded protein is localized in the nucleus and shares motifs with known transcription factors, such as the CCT domain [found in CONSTANS (CO), CO-like and TOC1 proteins] (Strayer *et al.*, 2000). The role of TOC1 in transcriptional regulation is also supported by independent studies through immuno-precipitation techniques, whereby TOC1 was traced on the promoters of *CCA1* (Pruneda-Paz *et al.*, 2009) and of *GENOMES UNCOUPLED5* (*GUN5*, an ABA receptor; Legnaioli *et al.*, 2009). Loss-of-function mutations (Alabadi *et al.*, 2001) and over-expression of TOC1 (Makino *et al.*, 2002), both result in lower levels of *CCA1* and *LHY* transcripts relative to wild-type, indicating that TOC1 is not only a potential activator of these genes, but a repressor as well. It is now known that its activation role is indirect and that repression of *CCA1* and *LHY* by TOC1 is direct (Gendron *et al.*, 2012). It is worth mentioning that a lot of efforts⁴⁰ were put in elucidating the exact mechanism by which TOC1 regulates *CCA1* and *LHY* expression, because the early TTFL models depended on this mechanism. Direct DNA-binding of TOC1 was eventually confirmed;

40. Pruneda-Paz *et al.* (2009) showed that TOC1 associates with the *CCA1* promoter *in vivo*, but in that work *in vitro* assays did not confirm binding; it was thus assumed that TOC1, then not known to have a DNA binding ability, is recruited to *CCA1* via a yet unknown factor. A candidate was CCA1 HIKING EXPEDITION (CHE) (Pruneda-Paz *et al.*, 2009), but CHE and TOC1 regulate *CCA1* expression antagonistically (Imaizumi, 2010). Gendron *et al.* (2012) resolved this by showing direct binding of the TOC1-CCT domain to the *CCA1* and *LHY* promoters. TOC1 thus represses *CCA1* and *LHY* directly (Gendron *et al.*, 2012); of note, repression was attributed to the pseudo-receiver (PR) domain of TOC1 (Gendron *et al.*, 2012).

notably, TOC1 and CO proteins bind the same TGTG motif through their CCT domains (Gendron *et al.*, 2012).

Several findings are in favor that TOC1 and LHY/CCA1 form a TTFL: (1) as expected of TTFL clock-components, their expression is rhythmic and out of phase by approximately half a day; transcripts levels of *LHY* and *CCA1* peak at dawn (Wang and Tobin, 1998; Green and Tobin, 1999; Green *et al.*, 2002; Mizoguchi *et al.*, 2002; Kim *et al.*, 2003), while *CCA1* and *LHY* accumulate soon after and are not detected later in the day (Wang and Tobin, 1998; Kim *et al.*, 2003); conversely *TOC1* RNA levels peak at dusk (Strayer *et al.*, 2000) and the protein later in the night (Más *et al.*, 2003b). (2) Clock components, in addition to their reciprocal control, feedback to regulate their own expression. This was first shown for *CCA1* and *LHY* as their ectopic over-expression led to downregulation (and/or loss of rhythmicity) of the endogenous *CCA1* and *LHY* genes respectively (Wang and Tobin, 1998; Shaffer *et al.*, 1998; Kim *et al.*, 2003). Feedback regulation of *TOC1* on its own expression was illustrated, when the free running period of *TOC1* RNA accumulation was found to be shortened by the *toc1-1* point mutation (Strayer *et al.*, 2000). (3) The idea of a TTFL between *CCA1*, *LHY* and *TOC1* is further supported by the fact that they are localized in the nucleus (Wang *et al.*, 1997; Strayer *et al.*, 2000; Carré and Kim, 2002).

Figure 1.9: The single transcriptional/translational feedback loop model in *Arabidopsis*

The single-loop model is comprised of the *CCA1/LHY* transcription factors and *TOC1* that regulate each other reciprocally forming a TTFL that produces a circadian period. The positive elements *CCA1/LHY* have a dual role, also mediating expression of output. Dotted and continuous arrows show evening- and day-phased events respectively. Red arrows show transcription and blue translation. Green lines show transcriptional regulation and yellow shapes light input. The figure is adapted after Alabadi *et al.* (2001).

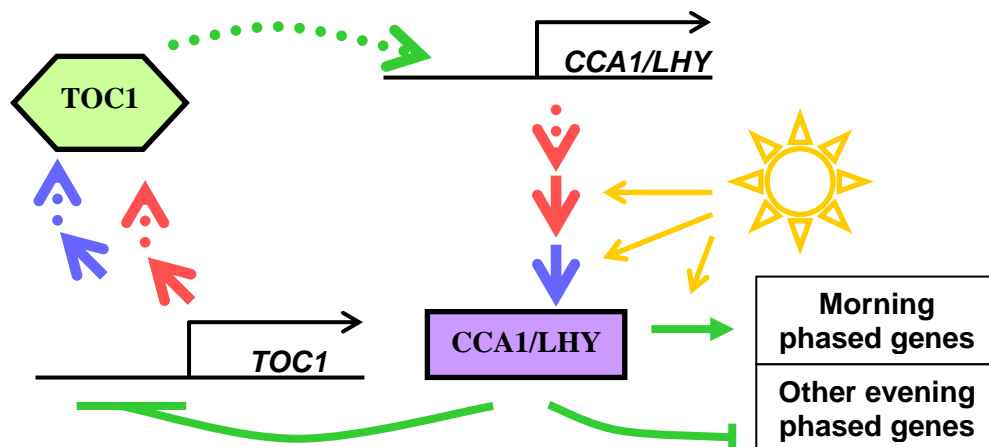

A series of observations placed TOC1 centrally in the TTFL model. First, the *toc1-1* point mutation causes a short-period phenotype both under WLC (Millar *et al.*, 1995a; Alabadi *et al.*, 2001) as well as in the dark (Somers *et al.*, 1998b; Strayer *et al.*, 2000) and rhythms with diverse phases are affected in this respect. Then, the short-period phenotype of *toc1-1* is independent of fluence-rate during free run and it is not specific to the *zeitgeber* used for entrainment (light or temperature cycles) (Somers *et al.*, 1998b), indicating that TOC1 operates closer to a central oscillator rather than within input pathways. The interpretation of these findings was later challenged, as phenotypes of the *toc1-2* null mutant (and of *TOC1-RNAi* lines in support) depend on light quality. In these experiments RLC caused the mutant to become arrhythmic, while under BLC the mutant exhibited a short-period phenotype indicating that TOC1 might not be unrelated to light input pathways after all (Más *et al.*, 2003a). The centrality of TOC1 was questioned independently, as it appears that TOC1 is dispensable in the root, where it is not required for proper clock function and entrainment (James *et al.*, 2008).

As progress was achieved the single-loop model was not adequate to explain all of the accumulated data. A few of these are as follows: (1) oscillations of *TOC1*, *LHY* and *CCA1* transcripts dampen after three cycles in the absence of light (Wang and Tobin, 1998; Schaffer *et al.*, 1998; Strayer *et al.*, 2000). Therefore oscillations in the levels of these proteins do not account for several rhythmic processes observed in DD. (2) Constitutive expression of components of a central clock should abolish periodicity of diverse rhythms under free running conditions; *CCA1* (Wang and Tobin, 1998) and *LHY* (Schaffer *et al.*, 1998) were initially assigned properties of central clock components based on this notion, whereas later it was claimed that TOC1 over-expression causes arrhythmia as well (Makino *et al.*, 2002; Más *et al.*, 2003a). In opposition to this, oscillations in transcript levels of *EARLY FLOWERING3 (ELF3)* were found in plants that over-express *LHY*. It was concluded that additional genes, and potentially additional feedback loops, might exist⁴¹ (Hicks *et al.*, 2001). (3) A problem with the single-loop model was that it could not explain non-parametric entrainment, as described in PRCs (Kim *et al.*, 2003). In brief, according to the simple TTFL model entrainment to light should be mediated through the induction of the light responsive genes *CCA1* and *LHY*⁴². Light-induction of *LHY* (Kim *et al.*, 2003) and entrainment to light-pulses (Covington *et*

41. Alternative explanations can be given though, as arrhythmia is nothing more than the lack of detectable rhythms.

42. In etiolated seedlings *CCA1* and *LHY* expression is acutely induced by light pulses (Martínez-García *et al.*, 2000; Wang *et al.*, 1997), whereas *TOC1* expression is not (Makino *et al.*, 2001). TOC1 was thought of as

al., 2001) are though not correlated to each other, as the former is maximal at dawn and the later in the middle of the subjective night. Conclusively, non-parametric entrainment should not be mediated by the light-responsive elements represented in the single TTFL model. Moreover the *cca1-1;lhy-21* double mutant entrains to LD cycles and re-entrains faster than the wild-type in jet-lag experiments (12 hours shift of the LD cycle) (Alabadí *et al.*, 2002; Mizoguchi *et al.*, 2002; Kim *et al.*, 2003), whereas a mutant that lacks all three CCA1, LHY and TOC1 proteins is capable of resetting to dusk signals (Ding *et al.*, 2007). These findings together and independently establish that entrainment can take place without this corresponding TTFL. (4) Another paradox with the single-loop model was that oscillations of the *cca1-1;lhy-21* mutant do not dampen immediately implying clock function in the absence of these genes for at least three cycles (Alabadí *et al.*, 2002; Mizoguchi *et al.*, 2002; Locke *et al.*, 2005b; Locke *et al.*, 2006; Ding *et al.*, 2007). A recent publication even reported robust and sustained oscillations from the *cca1-1;lhy-21* double mutant (Lu *et al.*, 2009) in support of a multiple loop model. (5) In addition to these, over-expression (Makino *et al.*, 2002) and loss-of-function mutations of *TOC1* (Alabadí *et al.*, 2001), both have a negative effect on *CCA1* and *LHY* transcript levels, indicating that perhaps interactions between these genes would not be attributed to a unique feedback loop.

Computational analysis confirmed that the single-loop model could not account for a number of additional experimental observations (Locke *et al.*, 2005a; Locke *et al.*, 2005b): (1) importantly, the observed photoperiodic regulation in gene expression (Millar *et al.*, 1996) could not be successfully simulated, because LHY and CCA1 proteins are depleted before the end of the 12 hour light period (Wang and Tobin, 1998; Kim *et al.*, 2003), and thus, the light responsive components of the single-loop model should not be able to track dusk. (2) TOC1 levels reach their minimum just before dawn (Más *et al.*, 2003b), the time when activity of the protein in up-regulating *CCA1* and *LHY* should be at its highest (Locke *et al.*, 2005a). (3) Simulation models (Locke *et al.*, 2005a) failed to compromise the short-period phenotypes of *cca1* and *lhy* single mutants to the inverse phase relationship between *TOC1* and *CCA1/LHY* expression (Green and Tobin, 1999; Mizoguchi *et al.*, 2002; Alabadí *et al.*, 2002). (4) The aforementioned responsiveness of the *cca1-1;lhy-21* mutant to parametric light entrainment could not be simulated as all entries of light input in the mutant were deleted. These inconsistencies led Locke and coworkers to propose the next model (fig. 1.10) that incorporates an additional "evening TTFL", formed between TOC1 and an unidentified "Y" component. In this model TOC1 is a repressor of "Y" that feedbacks to induce *TOC1* expression

unrelated to light perception also because of the aforementioned light-fluence-independent short-period phenotype of *toc1-1* (Somers *et al.*, 1998b).

(Locke *et al.*, 2005b). Subsequently it was shown that *GIGANTEA* (*GI*) partially fulfills computationally predicted properties of *Y* (Locke *et al.*, 2005b; Locke *et al.*, 2006)⁴³.

Figure 1.10: The double transcriptional/translational feedback loop model in *Arabidopsis*

The two-loop model contains, in addition to *CCA1/LHY* and *TOC1*, elements *X* and *Y*. The evening expressed gene *GIGANTEA* (*GI*) was proposed to be a component of *Y*. This model can explain many experimental findings not satisfied by the single-loop model such as photoperiodic perception and several gene-expression patterns; the observed negative effect of *TOC1*-over-expression on *CCA1* and *LHY* transcripts levels is not satisfied though. Red arrows show gene expression (transcription and translation). Green lines show transcriptional regulation and yellow shapes light input (adapted after Locke *et al.*, 2005b).

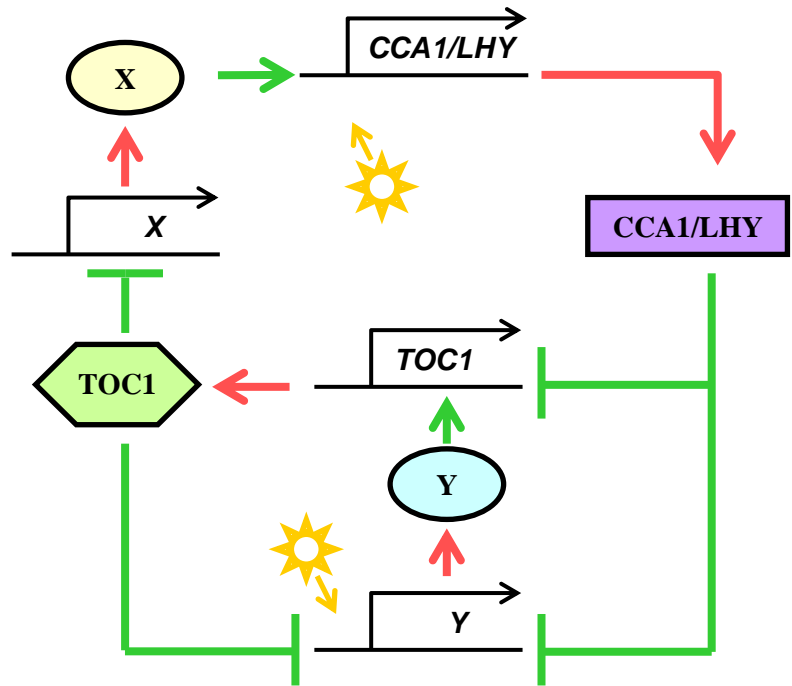

43. According to the two-loop model expression of *Y* should be light regulated and should peak later in the day towards dusk; this property would introduce photoperiodic perception (through the tracking of dusk) and also explain the observed light responsiveness of the *cca1;lhy* mutant. In order to successfully simulate the accumulated experimental data the model predicted that *Y* should be negatively regulated by *CCA1* and *LHY*. A consequence of this regulation was that in *cca1;lhy* simulated expression of *Y* was advanced by 12 hours (relative to the wild-type), because the acute peak of *Y* at dawn could not be antagonized by *CCA1* and *LHY* in the double mutant. Such pattern was not known at the time and was recognized in *GI* after analyzing expression of a number of dusk phased clock controlled genes (*in vivo*). This model could explain many experimental findings regarding the expression patterns of central clock components in wild-type and clock mutants, photoperiodism, entrainment and the amplitude phenotypes of *cca1;lhy*. Not all experimental data could be explained though; for instance the fact that *TOC1* over-expression has a negative (not a positive) effect on *CCA1* and *LHY* transcript levels could not be simulated (Locke *et al.*, 2005b).

Figure 1.11: The triple transcriptional/translational feedback loop model in *Arabidopsis*

The figure is adapted after Locke *et al.* (2006) to also include PRR5. Y and X are explained in figure 1.10. The regulatory network is made of the coupling between two-component feedback loops.

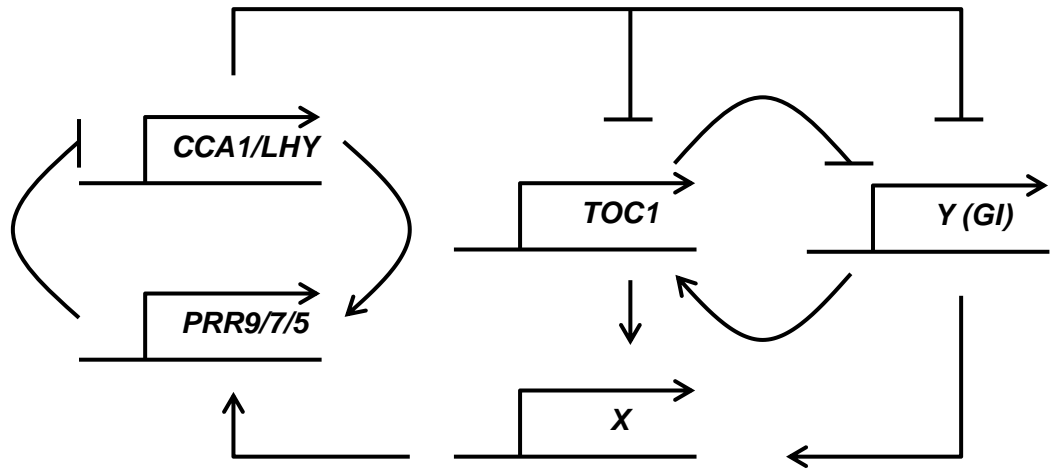

The two-loop model predicted that TOC1 would interact with an unknown factor designated X that would close the phase gap between TOC1 expression in the middle of the night and its activity in up-regulating *CCA1* and *LHY* expression as dawn approaches. *CCA1* HIKING EXPEDITION (*CHE*) was proposed to be X (Pruneda-Paz *et al.*, 2009) as it binds both the TOC1 protein and the *CCA1* promoter, but this idea received criticism as *CHE* does not bind the promoter of *LHY* and the relationship between *CHE* and TOC1 in regulating *CCA1* expression is antagonistic (Imaizumi, 2010). This later inconsistency led Haydon *et al.* (2011) to propose that TOC1 is a negative regulator of *CHE*. It should be pointed out though that the *CHE* transcript reaches its minimum levels before dawn (Pruneda-Paz *et al.*, 2009), precisely when the gap between TOC1 and *CCA1/LHY* expression needed be "filled". Consequently *CHE* could not be X unless its encoded transcript and protein were to be expressed with a considerably large phase difference. An alternative idea is that an additional factor X would modulate transcriptional activity of TOC1 between being a transcriptional repressor and a transcriptional activator (Gendron *et al.*, 2012).

A third feedback loop (fig. 1.11) that functions early in the day has been described between *LHY*, *CCA1* and the *PSEUDO RESPONSE REGULATORS* 5, 7 and 9 (*PRR5*, *PRR7*, *PRR9*) that together with *TOC1/PRR1*⁴⁴ form a gene-family due to their similarity to response-regulators (RRs)

44. *PRR9*, *PRR7*, *PRR5*, *PRR3* and *TOC1/PRR1* are members of the *TOC1/PRR* pseudo-response regulators that were originally identified in *Arabidopsis* data bases due to their sequence similarity to TOC1 (Makino *et*

of two-component-systems⁴⁵. *CCA1* and *LHY* promote the expression of *PRR7* and *PRR9* (Farré *et al.*, 2005) whereas *PRR9*, *PRR7* and *PRR5* are expressed sequentially and suppress expression of *CCA1* and *LHY* through out the day via direct promoter binding (Nakamichi *et al.*, 2010). Consequently in the triple mutant *prr975* transcriptional oscillations are ceased (Nakamichi *et al.*, 2005). Related computational models were first presented by Locke *et al.* (2006) and later by Zeilinger *et al.* (2006) and Pokhilko *et al.* (2010)⁴⁶.

None of the genes represented in the models in figures 1.9 to 1.11 are required singularly for nuclear oscillations. However, mutants with conditional arrhythmic phenotypes are known at three loci. These are *EARLY FLOWERING 3 (ELF3)* (Hicks *et al.*, 1996; McWatters *et al.*, 2000; Covington *et al.*, 2001; Kolmos *et al.*, 2011), *ELF4* (Doyle *et al.*, 2002; McWatters *et al.*, 2007; Kolmos *et al.*, 2009; Wenden *et al.*, 2011) and *LUX ARRHYTHMO (LUX)* (Hazen *et al.*, 2005) that are co-expressed and encode for the components of a circadian-regulated DNA-binding complex, termed EVENING COMPLEX (EC)⁴⁷ (Nusinow *et al.*, 2011). Further analysis revealed that *LUX*, which mediates DNA binding, is bridged by *ELF3* to *ELF4* (Nusinow *et al.*, 2011). These biochemical events match genetic epistasis as *ELF4* is upstream of *ELF3* and *LUX* (Herrero *et al.*, 2012). This lends further support that the EC components affect clock function in concert. In favor

et al., 2000; Matsushika *et al.*, 2000). Their transcripts are expressed sequentially (*PRR9* → *PRR7* → *PRR5* → *PRR3* → *PRR1*) in a manner that could predict the time of the day; this mechanism does not fully describe the nuclear oscillator as it was originally proposed (Matsushika *et al.*, 2000). PRRs share an atypical response-receiver domain (pseudo-receiver domain, PR) and two putative transcriptional domains. The later are an acidic domain and the basic CCT motif conserved within the family of CONSTANS transcription factors (Makino *et al.*, 2000; Strayer *et al.*, 2000) involved in the photoperiodic induction of flowering.

45. Two component systems are found throughout the phylogenetic scale. In *Arabidopsis* they participate in phytohormone, stress and light signaling. In response to environmental signals His-protein kinases undergo phosphorylation at a conserved His residue followed by phosphor-transfer to an Asp site of the protein. The phosphor is then transferred to the His residue of a different phosphor-transfer protein and eventually to an Asp residue in the receiver domain of a third protein, the response-regulator (RR). However, the receiver domains of the *Arabidopsis* PRRs lack the catalytic Asp residue involved in the His to Asp phosphorelay; these receiver domains are thus defined as pseudo-receiver (PR) (reviewed in Hanano and Davis, 2005). Recently it was shown that the PR domain of *TOC1* is a transcriptional repressor (Gendron *et al.*, 2012).

46. The post-translational regulation of clock protein stability (chapter 1.6.3.b) is successfully simulated and correlated with accumulated experimental data by Pokhilko *et al.* (2010) and later by Pokhilko *et al.* (2012).

47. The EC was shown to link the circadian clock to diurnal regulation of hypocotyl growth (Nusinow *et al.*, 2011). It is viewed as a central component of nuclear oscillations in *Arabidopsis*.

of this it was shown that nuclear localization of ELF3 is directed by ELF4 and that all evening complex components are localized in nuclear bodies (Herrero *et al.*, 2012).

Computational analysis has led to the hypothesis that, under diel conditions and in the light, the *Arabidopsis* TTFL is formed by a three-component "repressilator" (fig. 1.12; for a recent review see Bujdoso and Davis, 2013). Simulations based on data from the *elf3* and *elf4* mutant lines (Herrero *et al.*, 2012; Pokhilko *et al.*, 2012) indicate that EC is a direct negative regulator of clock gene expression during the early night (of *LUX*, *ELF4*, *GI*, *TOC1* and *PRR9*). Consistent with that, *LUX* (Helfer *et al.*, 2011), *ELF3* and *ELF4* (Dixon *et al.*, 2011; Herrero *et al.*, 2012) are known to be associated with the *PRR9* promoter and repress its expression. Additionally, *in silico* analysis employing data from the *cca1;lhy* mutant (Pokhilko *et al.*, 2012) and a reduced function allele of *elf3* (Kolmos *et al.*, 2011), indicate that *LHY* and *CCA1* are direct negative regulators of the EC components. This connection is consistent with the finding that *CCA1* is a transcriptional repressor that binds to the promoters of *ELF4* (Li *et al.*, 2011) and *ELF3* (Lu *et al.*, 2012). These computational and biochemical approaches confirm preceded genetic studies suggesting that the TTFL components in *Arabidopsis* are connected to each other via negative/repressive interactions (fig. 1.12). These include the aforementioned negative regulation of *CCA1* and *LHY* expression by the *PRR* proteins throughout the day (Nakamichi *et al.*, 2010), followed by inhibition of the *PRR* genes by the rise of the EC in the early night and of EC genes by *LHY* and *CCA1* later as dawn approaches (see references above). Certain positive interactions, such as the effect of *ELF3* and *ELF4* on the expression of *CCA1* and *LHY* [as observed in *elf3* (Kolmos *et al.*, 2011) and *elf4* (Kolmos *et al.*, 2009)], are attributed to a double-negative connection. Similarly, the observed positive effect of *CCA1* and *LHY* on expression of *PRR9* and *PRR7* (fig. 1.11 and 1.12) is supported by genetic and biochemical data and thus cannot be excluded (Farré *et al.*, 2005). This could also be attributed to a double-negative mechanism (Pokhilko *et al.*, 2012).

In the model proposed by Pokhilko *et al.*, (2012) (fig. 1.12.b), *TOC1* is a repressor of *CCA1* and *LHY* around dawn. This approach reconciles more accurately experimental data and simulations regarding the *prp9;prp7* and *zeitlupe (ztl)* circadian mutants and removes the necessity for the controversial (Imaizumi, 2010) factor X⁴⁸. The work of Gendron *et al.*, (2012), who showed that *TOC1* binds *CCA1* and *LHY* promoters to inhibit their expression, provides strong support to the

48. X was introduced to explain the extreme delayed positive effect of *TOC1* on *CCA1* and *LHY* expression (fig. 1.10 and Locke *et al.*, 2005b). Subsequently, assigning a negative role for *TOC1* in *CCA1* and *LHY* expression resulted in improved simulations of the *prp7;prp7* and *ztl* mutants without having the need for a factor X (Pokhilko *et al.*, 2012).

model. It is worth mentioning that the observed downregulation of *LHY* and *CCA1* transcripts in *toc1* loss-of-function mutants (which led to the initial idea that TOC1 is a positive regulator of *CCA1* and *LHY*; Alabadi *et al.*, 2001) is not in contrast to the change of sign of TOC1 action, as this downregulation is explained by the elevation of the remaining *CCA1* and *LHY* inhibitors (PRR9, PRR7 and PRR5) in the simulated *toc1* mutant (Pokhilko *et al.*, 2012). It was further shown (Pokhilko *et al.*, 2012) that loss-of-function (Alabadi *et al.*, 2001) and over-expression (Makino *et al.*, 2002) mutations of *TOC1* do not affect *CCA1* and *LHY* expression similarly, as previously thought, as long as the effect of the mutations is measured at dawn, when TOC1 is predicted to be the major inhibitor of these genes (Pokhilko *et al.*, 2012). To conclude, changing the sign of TOC1 action on the expression of *CCA1* and *LHY* improved the fitness between current experimental data and computational models and explained several inconsistencies of the previous models.

In the model of Locke *et al.*, (2005b), light directly regulates the TTFL through the Y factor. The later in the model of Pokhilko *et al.*, (2012) is removed and light input is delivered, amongst other entries (see fig. 1.12.b), through the light-dependent regulation of ELF3 stability. This involves the destabilization of ELF3 during the night by CONSTITUTIVE PHOTOMORPHOGENIC 1 (COP1) E3 ubiquitin ligase and perhaps the light-dependent regulation of ELF3 stability by GI and F-box proteins⁴⁹ (Yu *et al.*, 2008). Experimentation and computer simulations with the *cca1;lhy* double mutant are in favor of this (Pokhilko *et al.*, 2012).

Inhibition of *ELF4* and *ELF3* by the EC (Kikis *et al.*, 2005; Helfer *et al.*, 2011) creates a negative feedback loop that accounts for residual oscillations in the *cca1;lhy* mutant (Pokhilko *et al.*, 2012). These are though not self-sustained. The current model of the "repressilator" lacks adequate activators required for robustness of the oscillatory network (Bujdoso and Davis, 2013). In my work here, I addressed the possibility that metabolic (reviewed in chapter 1.6.5) and hormonal oscillatory feedback (chapter 1.6.6) may play such a role in providing rhythm sustainability in wild-type plants and in the *cca1;lhy* mutant. It is noteworthy, that none of the existing models can explain sustained oscillations in the *cca1;lhy* mutant, as described here (in the Results chapter) and in Lu *et al.*, (2009). The importance of metabolic oscillations in rhythm sustainability is placed in a context predicted by the *zeitnehmer* model (Morrow *et al.*, 1999).

49. GI binds and stabilizes the F-box protein ZTL under BL; these dissociate after dusk allowing thereafter TOC1 degradation mediated by ZTL (Kim *et al.*, 2007; see also chapter 1.6.3.b). The observed binding of GI to ELF3 (Yu *et al.*, 2008) led Pokhilko *et al.*, (2012) to assume that GI would regulate ELF3 (and thus the EC) and TOC1 similarly, by bringing F-box proteins into their vicinity.

Figure 1.12: Current transcriptional/translational feedback loop models in *Arabidopsis* comprised by repressors

The figures are adapted after respective publications. Colored red and blue lines represent transcriptional regulation, inhibition and activation respectively. Light input entries are represented with purple letters and lines. The observed effect of GI and ZTL on TOC1 protein stability (chapter 1.6.3.b) is omitted for clarity.

A. The model of Herrero *et al.*, (2012)

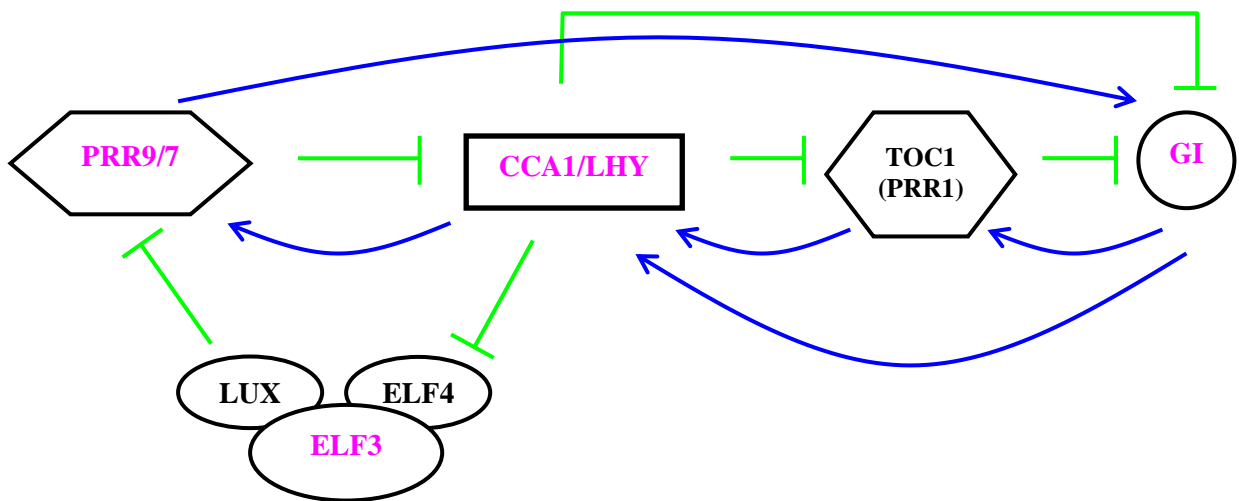

B. The model of Pokhilko *et al.*, (2012) – the "repressilator"

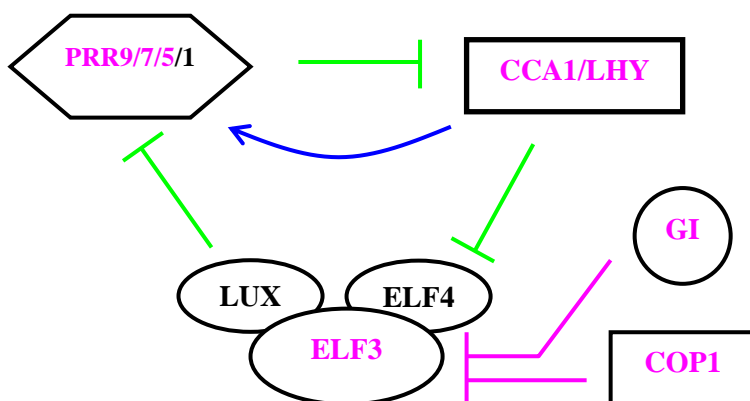

1.6.3. Light input

Apart from being the energy source for plants and the predominant *zeitgeber*, light is also an environmental signal during development and photomorphogenesis. Light is also a stress factor that induces production of Reactive Oxygen Species (ROS) at the chloroplastic Electron Transport Chains (ETC) capable of causing damage and cell death.

Different classes of photoreceptor molecules monitor light from UV-B to the near infrared. The UV-B part of the spectrum is perceived by the UV RESISTANCE LOCUS 8 (UVR-8) photoreceptor (Heijde and Ulm, 2012), phytochromes maximally absorb RL and FRL and the cryptochromes, the phototropins, and members of a third gene-family that includes ZTL (see below) are the UV-A/BL sensors (Kami *et al.*, 2010). Phytochrome, cryptochrome and phototropin classes are composed of distinct members whose expression, stability and/or biochemical properties are functions of light intensity and quality. These two environmental parameters provide important spatial information, resulting from the fact that photosynthetic pigments absorb RL and BL, allowing green and far-red enriched light to pass to the lower levels of the canopy (reviewed in Kami *et al.*, 2010). Light intensity and quality also contain temporal information, as the red portion of the spectrum and the RL/FRL ratio are not constant through out the day⁵⁰.

Genetic analysis employing FRCs (fig. 1.4) and PRCs (fig. 1.3) has revealed that non stressful photomorphogenic UV-B light entrains the clock through the UV-B photoreceptor UVR-8 and its interacting signaling partner COP1. These are specific for entrainment to UV-B and appear dispensable for entrainment to white light (Fehér *et al.*, 2011; Heijde and Ulm, 2012). Similar genetic studies and biochemical approaches described below established the importance of phytochromes, cryptochromes (chapter 1.6.3.a), and of ZTL (chapter 1.6.3.b) in light input to the clock in respect to light quality and intensity; genetic data on circadian gating of phototransduction pathways in *Arabidopsis* are also presented (chapter 1.6.3.c).

a. Phytochromes and cryptochromes in light input to the clock

In *Arabidopsis* the family of phytochromes is comprised of five members, phytochromes A to E (phyA-phyE) (Sharrock and Quail, 1989; Clack *et al.*, 1994). These form homodimers through their carboxyl-terminal regions while their highly conserved amino-terminal regions bind the chromophore, an open tetrapyrrolic ring that during light absorption undergoes isomerization, leading to structural changes of the photoreceptor and ultimately to signal transduction. The unique

50. At dawn and dusk there is more RL in the atmosphere.

photochromic properties of phytochrome⁵¹ are responsible for its regulatory functions. Phytochrome, purified or *in vivo*, exists in one of two reversible conformations, the RL absorbing Pr form and the FRL absorbing Pfr form. Upon absorption of RL the Pr form is converted to the biologically active Pfr form that can be converted back to Pr by FRL or by dark thermal reversion. Phytochromes also exhibit a secondary absorption peak in the UV-A/BL region. Consequently the action spectra of phytochrome-induced responses exhibit maxima at the RL, FRL and UV-A/BL range. phyA being light sensitive is responsible for mediating responses to low-light intensities, though it is involved in distinct photomorphogenic, gravitropic and phototropic responses under high intensities of RL as well. Due to its unique photochemical properties phyA is also responsible for perception of FRL, because in this case a small portion of active Pfr is formed at equilibrium. In contrast to phyA, phytochromes B to E proteins are generally more stable *in vivo* and mediate responses to higher fluence-rates (Smith *et al.*, 2000; Kami *et al.*, 2010).

Due to the availability of phytochrome mutants, distinct modes of actions (responses to light shown on the range of inductive Pfr values) can be monitored separately. The classic Low-Fluence-Response (LFR) mode is characterized by RL/FRL photo-reversibility and has been attributed to phyB (though photo-reversibility is a property of all phytochromes); these responses are usually observed with light pulses of 10 to 1000 $\mu\text{Mol m}^{-2}$. Very-Low-Fluence-Responses (VLFR) require as little as 100 pMol m^{-2} and are mediated by both RL and FR light, they are thus not photo-reversible; subsequently, VLFRs were ascribed to phyA that is photosensitive and forms the active Pfr form even under FRL. The High-Irradiance-Response (HIR) mode is defined based on the law of reciprocity that is said to be valid when at equal total fluence continuous light and light pulses have the same effect. Otherwise, when the light pulse cannot substitute for continuous light, reciprocity failure occurs, defining a HIR; this mode has been observed so far only with FRL and is accordingly associated with phyA (Casal *et al.*, 1998; Kami *et al.*, 2010).

Cryptochromes are UV-A/BL light photoreceptors that are structurally related to DNA-repairing photolyases. The *Arabidopsis* genome encodes for two cryptochrome photoreceptors, cry1 and cry2, while a third cryptochrome implicated in DNA repair mechanisms (cry3) may not represent a photosensory photoreceptor. Two chromophores have been elucidated as a pterin and a flavin adenine nucleotide (Cashmore *et al.*, 1999; Lin and Todo, 2005; Kami *et al.*, 2010). Recently it was shown that BL favors formation of the biologically active state of the flavin (a flavosemiquinone) that is then shifted to the biologically inactive state (fully reduced flavin) by

51. Use of singular instead of plural is still accustomed, according to the classic studies that preceded cloning of distinct phytochrome molecules.

green light; in agreement with these photochemical properties, green light attenuates developmental responses to BL that are attributed to cryptochromes (floral induction, hypocotyl growth and anthocyanin accumulation; Bouly *et al.*, 2007; Banerjee *et al.*, 2007). *cry2* is negatively regulated by BL⁵² (Lin *et al.*, 1998), whereas green light temporally rescues *cry2* from BL mediated degradation (Bouly *et al.*, 2007). Cryptochromes sense BL with respect to fluence-rate, with *cry1* and *cry2* perceiving broad and low intensities of BL respectively during photomorphogenetic responses (Lin *et al.*, 1998). One current hypothesis is that the BL to green light ratios in the canopy are perceived by cryptochromes, just like phytochromes sense the RL/FRL ratios (Sellaro *et al.*, 2010). It should also be mentioned that the *cry1;cry2* mutant is not blind to green light, therefore other photosensory mechanisms are expected to be involved in plant responses to green light (Zhang *et al.*, 2011).

Functional specialization of different photoreceptors within light input to the clock was assigned in genetic studies that described the FRCs of photoreceptor mutants. The general concept behind this is that photoreceptors exhibit long-period phenotypes at distinct intensities and qualities of light (fig. 1.4 B)⁵³. *phyA* was shown in this manner to be the low-fluence photoreceptor, whereas *phyB* functions as the dominant RL photoreceptor and *cry1* the dominant BL photoreceptor (reviewed in Devlin, 2002 and in Sanchez *et al.*, 2011). The *phyA* and *phyB* mutants exhibit long-period phenotypes under low- and high-light intensities respectively. In agreement with this the *phyA;phyB* double mutant has a long-period phenotype under all light intensities tested and consequently the roles of *phyA* and *phyB* in RL input to the clock are complementary with respect to light intensity. With experiments of this kind it was further shown that *phyA*, in addition to its role in RL signaling, mediates circadian perception at low intensities of BL; moreover it was shown that BL signaling to the clock does not involve *phyB*⁵⁴ (Somers *et al.*, 1998a; Devlin and Kay, 2000). This has been questioned though because the carboxyl-terminal region of *phyB* (responsible for the photoreceptor's His-kinase activity) is dispensable for the complementation of the short-period phenotype of a null *phyB* mutation under RLc, but not under WLc (Palágyi *et al.*, 2010). This was interpreted as that *phyB* mediates circadian perception of light qualities other than RL. Based on

52. The same effect is caused by UV-A and green light.

53. One cannot help noticing (fig. 1.4) that according to the Aschoff rule the photoreceptor mutants assigned with input at low intensities are more sensitive to light than the wild-type. This is a mathematical consequence resulting from a long-period phenotype restricted at low-light intensities and is manifested as steeper (relative to those of the wild-type) FRCs of the mutants.

54. Here I show that the *phyB* mutant has a conditional circadian phenotype under BLc. The condition that unmasks the phenotype is metabolic.

FRC-phenotypes, *cry1* mediates light input to the clock at low and high but not at intermediate intensities of BL. Then the role for *cry2* in light input to the clock is revealed only in the *cry1;cry2* double mutant that exhibits the long-period phenotypes at all light intensities, including intermediate ones. Cryptochromes are also involved in RL input to the clock, mostly at low-light intensities (Somers *et al.*, 1998a; Devlin and Kay, 2000). Based on these findings and given that cryptochromes do not absorb at the RL region of the spectrum, *cry1* was placed downstream of *phyA* during circadian perception of low fluence-rates of RL (Devlin and Kay, 2000). In agreement with this notion it was found that cryptochromes can be substrates of the kinase activity⁵⁵ of *phyA* (Ahmad *et al.*, 1998; Más *et al.*, 2000). It should be mentioned that both phytochromes and cryptochromes pose light-regulated kinase activities but their physiological relevance remains to be established (reviewed in Kami *et al.*, 2011).

The circadian phenotypes of *phyA*, *phyB*, *cry1* and *cry2* mutants indicate that these photoreceptors are involved in light signaling to the clock. Despite this, the quadruple *phyA;phyB;cry1;cry2* mutant is capable of photic parametric entrainment and exhibits circadian regulated leaf movement under WLC (Yanovsky *et al.*, 2000). The same observations were recently repeated with the quintuple phytochrome mutant (Strasser *et al.*, 2010). These findings show clearly that in *Arabidopsis* the photoreceptors are not integral elements of the core clock and most importantly that photic parametric entrainment can take place without them. One explanation for this could be that other photoreceptors mediate light signals to TTFLs. More alternatives can be considered though, as recent literature has provided several examples to support the idea that metabolic oscillations interact with TTFLs and thus could entrain them. This opinion is supported by findings in *Neurospora*, cyanobacteria and in mammals reviewed here (see also additions 1, 2 and 3) as well as by several works conducted with *Arabidopsis* discussed below (paragraph 1.6.5).

55. Phytochromes are considered to be serine-threonine kinases that may have descended from bacterial His-kinases of two component systems (Yeh and Lagarias, 1998; Vierstra and Davis, 2000). This kinase-signaling mode remains to be established for plant phytochromes. Other well described phytochrome signaling cascades are defined by light-induced interactions between Pfr and members of the PHYTOCHROME INTERACTING (PIF) family (Castillon *et al.*, 2007).

b. ZEITLUPE – a novel blue light photoreceptor

Several publications have established that ZEITLUPE (ZTL)⁵⁶ is a novel circadian photoreceptor. Together with *LOV-KELCH-PROTEIN 2 (LKP2)* and *FLAVIN BINDING KELCH REPEAT F-BOX 1 (FKF1)* they form a small gene family due to their common domain structure⁵⁷. All three proteins contain a Light-Oxygen-Voltage (LOV) domain at their amino-terminal region similar to the LOV flavin-binding domain of known BL photoreceptors, such as the phototropins and the *Neurospora* WC-1 protein (Somers *et al.*, 2000).

The involvement of ZTL within light-input pathways was first suggested based on the fluence-rate dependent long-period phenotypes of *ztl* mutants. Such a phenotype is enhanced at low fluence-rates of monochromatic BLc or RLc (Somers *et al.*, 2000). Interestingly, period lengthening in the mutant is exacerbated in the dark, indicating that ZTL does not function exclusively in the light (Somers *et al.*, 2004). Even though flavin binding at the LOV domain has not been demonstrated so far, there is strong evidence that ZTL is a photoreceptor because a mutation (C28A) that would compromise the proteins photochemical activities attenuates its observed binding to GI in response to light (Kim *et al.*, 2007). In this work, it was shown that the role of ZTL is to promote degradation of TOC1 at night and that BL inhibits this function by promoting binding of GI to ZTL (Kim *et al.*, 2007; see below for more details). Additional evidence in favor of ZTL being a BL circadian photoreceptor was provided by findings that a mutation located in the protein's LOV domain alters the slope of FRCs under BLc, but not under RLc (thus ZTL works in a light-quality specific manner; Kevei *et al.*, 2006). It should be clarified though that ZTL activity is not restricted to BL signaling, as the fluence-rate dependent period-phenotypes of other *ztl* mutants are observed also under RLc (Somers *et al.*, 2000; Somers *et al.*, 2004; Kevei *et al.*, 2006). This indicates that ZTL, not having any domains that would confirm RL absorption, functions downstream of other photoreceptors or pigments, and in support of this, phyB (and cry1) interacts with ZTL in a yeast-two-hybrid system (Jarillo *et al.*, 2001).

It has been proposed that the role of ZTL in clock function is distinct from its role in photomorphogenetic responses. Circadian phenotypes of *ztl*-mutants are observed in the dark and under BLc or RLc, but their hypocotyl-length is only affected under RLc. Moreover in the light (RLc

56. ZTL was isolated in a genetic screen; unlike most single clock mutants that show a moderate short period phenotype, *ztl* mutants exhibit an extreme long-period phenotype (Somers *et al.*, 2000).

57. The LOV domain is followed by an F-box motif and carboxyl-terminal kelch repeats (Somers *et al.*, 2000); F-box motives target specific substrates for ubiquitination and subsequent proteolytic degradation, whereas kelch repeats are known to facilitate protein-protein interactions.

or BLc) the long-period phenotypes *ztl* loss-of-function mutations are moderated at higher fluence-rates, whereas, by contrast, hypocotyl-length phenotypes are exacerbated at high fluence rates of RL⁵⁸ (Somers *et al.*, 2000; Somers *et al.*, 2004; Kevei *et al.*, 2006). These findings are also indicative that during photomorphogenetic responses ZTL activities are restricted downstream of RL photoreceptors.

The *lkp2* mutant does not display any circadian phenotypes while the *fkf1* mutant causes only subtle circadian effects. The *fkf1* mutation though exacerbates the long-period phenotype of *ztl*, while a circadian role of *LKP2* becomes evident only in a mutant *ztl;fkf1* background, manifested as decreased oscillatory robustness in the expression of clock- and clock-controlled-genes (Baudry *et al.*, 2010). These observations suggest that FKF1 participates in the regulation of TTFLs and that circadian period is buffered against transcriptional perturbations resulting from *lkp2* mutations.

Oscillations of ZTL protein levels are established via a post-transcriptional mechanism. This is because *ZTL* transcript levels are constant (Somers *et al.*, 2000), whereas the ZTL protein peaks at dusk (Kim *et al.*, 2007). Moreover ZTL is involved in the course of BL input to the clock through the post-translational regulation of several other clock proteins. A central role of ZTL in regulating circadian period is through the targeted proteasome-dependent degradation of TOC1 (Más *et al.*, 2003b) and of PRR5 (Fujiwara *et al.*, 2008). PRR5 and TOC1 proteins peak at dusk (Fujiwara *et al.*, 2008), they are found in the nucleus (Strayer *et al.*, 2000; Fujiwara *et al.*, 2008) and when mutated they both result in similar short-period phenotypes (Nakamichi *et al.*, 2005). Together these findings are well in agreement with the proposal that PRR5 facilitates transportation of TOC1 in the nucleus (Wang *et al.*, 2010). Degradation of TOC1 via ZTL occurs at night when expression of TOC1 is maximal (Mas *et al.*, 2003b). This function of ZTL is counteracted not only by the PRR5-mediated translocation of TOC1, but also by other proteins represented in the *Arabidopsis* TTFL models, such as GI and PRR3 (see references below). During the late day TOC1 is temporally rescued from ZTL-mediated degradation through the binding of GI to ZTL (Kim *et al.*, 2007); this interaction is enhanced under BL, requires a potentially photoactive LOV domain in ZTL, and stabilizes not only TOC1, but ZTL as well (that is otherwise downregulated in *gi* mutants). As their interaction is light-dependent, GI and ZTL dissociate after dusk allowing thereafter TOC1 degradation (Kim *et al.*,

58. Closer examination in Somers *et al.* (2000) and (2004) is indicative that perhaps the roles of ZTL in clock-responses and photomorphogenesis might not be so distinct from each other. This is because *ztl* mutants produce steeper FRCs than the wild-type in both cases; an interpretation of this is that the mutants are oversensitive to light. As ZTL is a photoreceptor this could mean that ZTL antagonizes light signaling pathways.

2007). Consequently oscillations in the levels of TOC1 are amplified through the light-mediated interaction of ZTL with GI. Later in the night TOC1 is stabilized through its interaction with PRR3 that competes with ZTL for binding to the N-terminus of TOC1. The interaction between PRR3 and TOC1 is enhanced by their phosphorylation. In agreement with these, TOC1 and PRR3 have similar temporal expression patterns (even though they are co-expressed only in the vascular system) and deficiencies in either protein result in similar short-period phenotypes (Para *et al.*, 2007; Fujiwara *et al.*, 2008). Collectively, ZTL is a circadian BL photoreceptor whose stability is regulated at the post-translational level by BL and oscillations in GI, as part of a mechanism that establishes robust rhythms in the levels of the TOC1 protein, required for proper clock function.

c. Gating

Gating of rhythmic gene expression in *Arabidopsis* was first observed for the acute response of *CAB2* to light (Millar and Kay, 1996) and then with PRCs (fig. 1.3); under DD the acute response of *CAB2::LUC*⁵⁹ expression is restricted during the subjective day (Millar and Kay, 1996), whereas PRC depict that the clock is responsive to BL or RL pulses predominantly during the night, when advances and delays are observed around subjective dusk and dawn respectively (Covington *et al.*, 2001; see also Locke *et al.*, 2005b). The mechanism behind gating is not clarified; it has been genetically connected to *EARLY FLOWERING3 (ELF3)* (McWatters *et al.*, 2000; Covington *et al.*, 2001) and to *TIME FOR COFFEE (TIC)* (Hall *et al.*, 2003), and in theory it could also be affected by the rhythmic expression of phytochromes and cryptochromes (described in Tóth *et al.*, 2001) as well as by their nucleoplasmic partitioning (references listed below).

In *Arabidopsis* photoreceptor transcripts accumulate rhythmically under LL and consequently photoreceptors are both upstream and downstream of the central oscillator. Rhythmicity in the expression of the photoreceptor genes that affect the clock (*phyA*, *phyB*, *cry1* and *cry2*) is also observed with the promoter::luciferase system that represents transcript-synthesis-rate. In the dark, these transcriptional oscillations dampen or their rhythmic amplitude is decreased, therefore, not surprisingly, coupling of photoreceptor-gene-expression to the clock requires light. Interestingly, the phase by which the circadian-photoreceptors are expressed is correlated to their sensitivity to light.

59. *CAB2::LUC* is the construct comprised of the *CAB2* promoter fused to the firefly luciferase. Similarly to *CAB2* expression, the acute light induction of *CCA1* mRNA in etiolated plants (Wang *et al.*, 1997) and of LHY protein in LD grown seedlings (Kim *et al.*, 2003) are also gated; the maximum acute induction coincides with maximum expression of respective genes under free running conditions in every case.

phyA and *cry2* both encode for the light labile photoreceptors that are maximally transcribed close to the end of the day, while *phyB* and *cry1* that encode for the light stable photoreceptors peak during the first half of the subjective day (Tóth *et al.*, 2001; Bognár *et al.*, 1999⁶⁰). The significance of this observation in the establishment of gating has not been investigated.

In dark grown *Arabidopsis* and tobacco seedlings, phyA and phyB proteins are initially located in the cytosol in the dark Pr form. Upon illumination the proteins translocate to the nucleus where they form speckles⁶¹ (first observed by Yamaguchi *et al.*, 1999 and Kircher *et al.*, 1999). phyB nuclear translocation in *Arabidopsis* (Sakamoto and Nagatani, 1996) and subsequent nuclear speckle formation (observed in tobacco, Kircher *et al.*, 1999) exhibit R/FR reversibility and therefore they are characteristic of the LFRs attributed to phyB. Translocation and nuclear speckle formation of phyA in *Arabidopsis* are triggered by both RL and FRL pulses (VLFRs) as well as by continuous FRLc (FR-HIR) (Kim *et al.*, 2000). These publications show that nuclear translocation of a phytochrome species and its attributed modes of action are well correlated, and indicate that phytochrome signaling involves, at least in part, nuclear translocation and phytochrome-mediated changes in gene-expression. It is noteworthy, that nuclear speckle formation anticipates dawn and for this it is very likely that the speckle formation and nucleoplasmic partitioning of phytochromes are under circadian control (Kircher *et al.*, 2002). Conclusively, nucleoplasmic partitioning and speckle formation of phyA and phyB could, like rhythmic photoreceptor gene-expression, be involved in the mechanisms that establish gating.

The *ELF3* gene, now viewed as part of the oscillator (fig. 1.12), is required for proper circadian gating of light input. The loss-of-function mutant *elf3-1* is aphotoperiodic in regard to flowering time and exhibits light-dependent arrhythmia. In constant darkness, however, the mutant exhibits limited signs of clock function. Similarly to this light-dependent phenotype of *elf3-1*, over-expression of ELF3 results in light-dependent period lengthening (Hicks *et al.*, 1996; Covington *et al.*, 2001). Keeping these in mind and the observation that temperature cycles can bypass the requirement for normal ELF3 circadian function, it was proposed that ELF3 affects the oscillator specifically through

60. Bognár *et al.* (1999) reported some interesting aspects of rhythmic expression of *phyB*. They demonstrated that expression of *phyB* is rhythmic at the level of transcription and of translation in *Arabidopsis* and in tobacco. It was also found that in tobacco overall phyB protein levels do not oscillate. This, according to the authors, could mean that newly synthesized phyB is rhythmic but the phyB pool is too large thus not affected.

61. Speckles are observed in transgenic plants expressing photoreceptor-GUS or more often photoreceptor-GFP protein fusions.

light-input pathways (McWatters *et al.*, 2000). In addition to these conditional phenotypes, *elf3* mutants are also disrupted in circadian gating. This includes gating of acute responses to light (McWatters *et al.*, 2000) as well as gating of light input to the clock, as observed with PRCs (Covington *et al.*, 2001). PRC show that the *elf3-1* mutant is over-responsive to light relative to the wild-type. Therefore ELF3 should mediate gating by inhibiting light input. Interestingly, *ELF3* expression is rhythmic and its peak of expression, in the middle of the night, coincides with a phase of the oscillator that is oversensitive to light (when light pulses are applied at this time, rhythmicity is lost in the *elf3-1* mutant, whereas in the wild-type phase shifts change sign; see fig. 1.3). These observations indicate that gating is required for rhythmicity that is otherwise lost when unregulated light signals are channeled to the oscillator in the middle of the night (Covington *et al.*, 2001).

1.6.4. Entrainment to temperature

In *Arabidopsis*, daily temperature fluctuations as low as 4°C are potent resetting signals (Somers *et al.*, 1998b). The responsible mechanism and the initial "thermometers" are still largely unknown, reflecting perhaps the fact that most studies addressing entrainment in *Arabidopsis* are focused on light (McClung and Davis, 2010). The effect of temperature is further complicated by the fact that temperature resets the clock without affecting circadian period significantly (see appendix 5 for temperature compensation in *Arabidopsis*). Recently it was shown that downstream events of temperature entrainment involve the *PRR7* and *PRR9* components of the morning TTFL. Of note, these proteins are also implicated in the temperature compensation response (Salomé *et al.*, 2010). The *prp7* and *prp9* mutants do not entrain to 22°C/12°C thermo-cycles and to cold pulses (Salomé and McClung, 2005), but maintain responsiveness to 28°C/22°C cycles; moreover, responsiveness to 22°C/12°C treatments is restored when etiolated seedlings are employed. It should be mentioned that the *prp7;prp9* mutant is capable of photic entrainment, therefore the relationship between *PRR7* and *PRR9* with entrainment is temperature specific. It should not be concluded that these proteins are not involved in light input pathways though, because oscillations in the double *prp7;prp9* mutant are arrested in the dark (Salomé and McClung, 2005; Salomé *et al.*, 2010).

Recently it was shown that *ELF3* is required for entrainment of etiolated seedlings to temperature cycles, but this gene is not considered to be a temperature *zeitnehmer* because it does not regulate gating to warm treatments in the dark (Thines and Harmon, 2010). These findings show that the functional role of *ELF3* in the *Arabidopsis* TTFL is not solely restricted to light conditions.

1.6.5. Sugars, metabolism and cytosolic oscillations are circadian determinants in *Arabidopsis*

In *Arabidopsis* cytosolic oscillations and changes in the concentration of metabolites contribute to oscillator function and possibly rhythm generation (reviewed in Haydon *et al.*, 2010; Sanchez and Davis 2011). One of the earliest publications that demonstrated experimentally feedback regulation between nuclear and metabolic oscillations in *Arabidopsis* came from the Webb lab (Dodd *et al.*, 2007). They showed that oscillations in cyclic adenosine diphosphate ribose (cADPR), a molecule that is derived from NAD⁺, are not simply under the control of TTFLs, rather they feedback to regulate circadian period and amplitude of central TTFL-components. The starting point of this study was to examine the relationship between cytosolic oscillations and clock function, in particular of Ca₂⁺ oscillations and its upstream signaling component cADPR. To do so, a time course of the *Arabidopsis* transcriptome in the absence of supplementary sucrose was obtained⁶², because sucrose is known to inhibit Ca₂⁺ oscillations (Johnson *et al.*, 1995). Subsequently, a significant overlap was observed between the cADPR- and the ensuing circadian-controlled transcriptomes. cADPR levels were then shown to be rhythmic and drive Ca₂⁺ oscillations, because the later were inhibited by nicotinamide, an inhibitor of the former; in agreement with this, cADPR and Ca₂⁺ oscillations peak with similar phase during the day. Nicotinamide, unlike inhibitors of calcium signaling, also lengthens the period and increases amplitude of *TOC1*, *CCA1*, and *LHY* expression, indicating that cADPR regulates nuclear oscillations via a downstream pathway that does not employ calcium⁶³. A

62. Circadian studies during the last 15 years or so have been conducted in the presence of supplementary sucrose due to the requirement of energy from the luciferase transgene used for rhythmic gene expression analysis (see references below).

63. The work of Dodd *et al.* (2007) clearly shows that Ca₂⁺ oscillations do not feedback on TTFL function. It is very likely though that, through Ca₂⁺ oscillations, metabolic and rhythmic signals are transferred to gene expression and photoperiodic responses (reviewed in Haydon *et al.*, 2010; Dodd *et al.*, 2010). Firstly, cytosolic Ca₂⁺ oscillations are inhibited by sucrose and require light whereas in the chloroplast they are only observed in the dark (Johnson *et al.*, 1995), thus Ca₂⁺ oscillations could potentially incorporate information regarding the state of energy metabolism. Secondly, under short-days (8hL/16hD) cytosolic calcium reaches maximum levels just before dusk, whereas under long-days (16hL/8hD) dusk coincides with lower calcium concentration relative to midday peaks, thus Ca₂⁺ oscillations could potentially mediate photoperiodic information to their downstream targets (Love *et al.*, 2004; Dodd *et al.*, 2010). It was further proposed that dual regulation of calcium oscillations by TTFLs (Xu *et al.*, 2007) and by light is involved in the photoperiodic regulation of circadian phase, in the context of an external coincidence model. According to

reciprocal feedback was proposed between TTFLs and cADPR oscillations as the later were abolished in CCA1 over-expressing plants.

Poly-ADP-ribosylation, a post-translational modification implicated in stress signaling, is well correlated to circadian function and period. The *tej* mutant being deficient in poly-ADP-ribose glycohydrolase (PARG) activity accumulates more pADPr polymers than the wild-type and exhibits a long-period phenotype. Accordingly, inhibitors of poly-ADP-ribosylation, that would decrease the amount of pADPr polymers, shorten period in both the *tej* mutant and in the wild-type. The circadian phenotype of *tej* is light-independent indicating that the role of TEJ in timekeeping is likely central and not found in light input pathways (Panda *et al.*, 2002). This was the first report in *Arabidopsis* assigning homeostatic cellular function to poly-ADP-ribosylation that is otherwise induced in response to stress such as heat, high-light, drought and ROS; under such stress conditions NAD⁺ breakdown is used for production of pADPr polymers resulting in high energy consumption, increased respiration and consequently ROS formation (de Block *et al.*, 2005). In 2002 Panda *et al.* concluded that the long-period phenotype of *tej* would result from altered posttranslational poly-ADP-ribosylation of a clock protein, but today after the work of Dodd *et al.* (2007), an alternative explanation could involve ROS and energy homeostasis, as defined by NAD⁺ (a precursor of both cADPR and pADPr polymers). In support of this, *tej* exhibits enhanced activity of transgenic luciferase relative to wild-type (Panda *et al.*, 2002)⁶⁴, indicating altered energy homeostasis in the mutant.

During the last decade, a great deal of knowledge has accumulated concerning the role of stress and hormone signaling in clock function (see chapters 1.6.6. and 1.6.7) and the possibility that poly-ADP-ribosylation and stress hormone ABA affect the clock through metabolites such as NAD⁺ and cADPR has been considered (Sanchez *et al.*, 2011). The relationship of ABA signaling to cADPR and poly-ADP-riboseylation was pointed out in independent studies⁶⁵ that dealt with stress signaling.

this model activity of a rhythmically expressed transcription factor would be sensitive to light directly via calcium dependent signaling networks of phosphorylation, degradation and/or activation/repression (Dodd *et al.*, 2010). Interestingly, Ca²⁺ oscillations are lost in the *cca-11* mutant.

64. *tej* is the Sanskrit word for bright.

65. In one of these studies the involvement of cADPR in ABA signaling was suspected due to the significant overlap (25%-30%) between the ABA- and cADPR-regulated transcriptomes; accordingly, it was shown that the ADPR cyclase activity is induced by ABA (Sánchez *et al.*, 2004). In a second publication, de Block *et al.* (2005) proposed a mechanism whereby stress, energy consumption, redox and ADP-ribosylation are interconnected. The authors observed that a transgenic line with reduced poly-ADP-ribosylation capacity is resistant to a broad range of abiotic stresses relative to wild-type and suggested that the resistance phenotypes

Now it remains to be clarified if ABA, ADP-ribosylation, and cADPR affect circadian rhythms in concert.

Sucrose has been used extensively in circadian assays that measure rhythmic transcriptional rates because of the ATP requirements of the luciferase enzyme. By contrast, flowering time experiments are usually performed on soil grown plants without supplementary sucrose. Aiming to investigate this discrepancy Knight *et al.* (2008) observed that sucrose had a minor period shortening effect (of less than 0.8 hours) on leaf movement rhythms of *Arabidopsis* and that the late-flowering *sensitive to freezing6 (sfr6)* mutant was resistant to sucrose in this respect. In addition to its small period effect on leaf movement, sucrose also caused a significant increase in expression of *CCA1*, *TOC1* and *GI*, whereas the *sfr6* mutant was again resistant or less sensitive to sucrose relative to wild-type. Despite the small sucrose-dependent long-period phenotype of *sfr6* (restricted in the presence of sucrose), it is significantly altered in clock-specific gene-expression (Knight *et al.*, 2008). This implies that the plant clock is resilient to large changes in the expression of TFL components. It should be mentioned that even though the period-shortening effect of sucrose on rhythmic leaf movement is small (Knight *et al.*, 2008), it has been reproduced independently with *GI::LUC* (Dalchau *et al.*, 2011). These studies together with others described below, show that sugars exert control on clock function.

Photosynthates such as maltose that is exported from the chloroplast and sucrose that is the main sugar exported from green tissues accumulate rhythmically under diurnal conditions and under continuous light (Lu *et al.*, 2005). In addition to this, sucrose has been implicated in entrainment by a number of independent publications, demonstrating that metabolism is not simply a circadian output, but instead it feeds back via rhythmically accumulated metabolites. In one of these publications Blaesing *et al.* (2005) observed that a high proportion of carbon-responsive (induced or repressed) genes is circadian regulated and is in resonance with the endogenous oscillations of sugar solutes, indicating that sugars contribute to diurnal transcriptional patterns. Additional evidence for the role of sugars in driving oscillations was provided by experiments with the *phosphoglucomutase (pgm)* mutant that does not accumulate starch and exhibits amplified oscillations in sugar content relative to wild-type (Gibon *et al.*, 2004). In the *pgm* mutant the percentage of carbon-responsive

would stem from reduced energy consumption (NAD⁺ and ATP) by the process of ADP-ribosylation (de Block *et al.*, 2005). An alternative hypothesis was presented by Vanderauwera *et al.* (2007) in a third study who found that in this same transgenic line ABA content and signaling were upregulated relative to the wild-type in response to high-light induced stress. It was proposed that the mutant is resistant to abiotic stresses due to the enhanced ABA signaling.

genes that are rhythmic as well as the amplitude in their oscillation was increased relative to wild-type, as expected if sugars contribute to rhythmic gene expression. Principal component analysis identified sugars and the circadian clock as being the two most significant inputs that drive rhythmic gene expression. Of note, it was shown that global gene expression is more responsive to sugar depletion during the night rather than to sugar excess during the day (Blaesing *et al.*, 2005).

It was reported that exogenously applied sucrose exhibits "*antizetgeber*" properties because it prevents parametric entrainment of morning genes in the root. It was then shown that the root and areal tissues are responsive primarily to those *zeitgebers* that they normally encounter; aerial tissues are preferably entrained by light in a manner that is not altered by supplemented sucrose, whereas by contrast, the root-clock is not only sucrose-responsive but also light-insensitive as it does not obey to the rule of Aschoff (oscillations in roots are equally fast under LL and in DD). In addition to these, photosynthesis-inhibitor DCMU was shown to disturb expression of morning-phased genes in the root but not in the shoot. Based on these the authors proposed that the root clock is synchronized by a photosynthesis-related signal, possibly sucrose, from the shoot⁶⁶ (James *et al.*, 2008). Evidence of the role of sucrose in entrainment was provided by a third publication again from the Webb lab. They showed that sucrose triggers and re-entrains oscillations in clusters of *Arabidopsis* seedlings that were previously entrained and then kept in the dark for 60 to 72 hours. The response to sucrose required GI⁶⁷ that was thus proposed to permit metabolic input to circadian timing in *Arabidopsis* (Dalchau *et al.*, 2011). When considered together, these works are suggestive that sucrose accumulates rhythmically due to photosynthesis during the subjective (or objective) day and contributes to entrainment. Notably, carbon assimilation can set the *Arabidopsis* clock (Haydon *et al.* 2013). The idea that photosynthesis is a "receptor" becomes particularly interesting given the fact that the quadruple *phyA;phyB;cry1;cry2* (Yanovsky *et al.*, 2000) and the quintuple phytochrome mutants (Strasser *et al.*, 2010) are capable of photic entrainment. Therefore it remains to be seen whether, similarly to cyanobacteria (Rust *et al.*, 2011), photic entrainment in higher plants is initiated at the photosynthetic electron transport chain, in agreement with the emerging trend that events downstream of energy transduction affect TTFLs.

66. They even they even made an analogy between the fact that in mammals RF entrains peripheral tissues but not the light-sensitive SCN, and their findings that a metabolic-photosynthetic signal entrains the root but not the light responsive clock in the shoots (James *et al.*, 2008).

67. Dalchau *et al.* (2011) performed imaging of clusters of seedlings. Here I show that imaging of individual seedlings yields different results.

The aforementioned experiments of James *et al.* (2008) with DCMU point specifically to that direction by demonstrating the involvement of electron transport in entrainment of the *Arabidopsis* clock. In addition to this, it was recently shown that retrograde signaling and the functional state of chloroplasts control amplitude and phase of nuclear oscillations; mutations in a putative RNA-binding protein CLOROPLAST RNA BINDING (CRB) that exhibit altered chloroplast morphology, a distinct pale phenotype and are deficient in chlorophyll synthesis, were shown to result in increased amplitude and delayed expression of *LHY* and *CCA1* (though period length was not affected). Mutations in *GENOMES UNCOUPLED1* (*GUNI*) and *STATE TRANSITION7* (*stn7*) involved in retrograde signaling, had a similar effect on expression of *CCA1*, indicating that the circadian phenotypes of *CRB* mutants stem from an overall dysfunction of chloroplasts rather than being a consequence of specific signaling events downstream of CRB (Hassidim *et al.*, 2007). Moreover, the fact that the *stn7* mutant exhibits a circadian phenotype is implicit that electron transport in *Arabidopsis* is a circadian determinant, because *stn7* encodes for a Ser/Thr kinase that phosphorylates the major light harvesting complex LHCII, as part of the mechanism that controls partitioning of the later between photosystem I (PSI) and PSII. This could be tested through mutations in *stn7* that are known to cause over-reduction of the PQ pool (Bellafiore *et al.*, 2005). If the redox state of the PQ pool were to be of circadian relevance it could mean that photosynthetic electron transport is a universal feature of entrainment in photosynthetic organisms (see appendix 2 for the involvement of PQ in entrainment of the clock of cyanobacteria). Conclusively, the publications reviewed here are suggestive of a link between photosynthetic ETCs and photic entrainment of nuclear oscillations in higher plants. It is now more feasible than ever, after the publications of O'Neill *et al.* (2008)⁶⁸ in mammals, of Rust *et al.* (2011)⁶⁹ in cyanobacteria, of Yoshida *et al.* (2011)⁷⁰ in *Neurospora* and the publications with *Arabidopsis* described here and in chapter 1.3 (regarding the universal peroxiredoxin rhythms; Edgar *et al.*, 2012), that the redox state and the energy charge of the cell, defined as nucleotide ratios, are employed during entrainment throughout the phylogenetic scale.

68. They showed that synchrony of neurons depends on cAMP oscillations.

69. They showed that the PRC obtained by altering the ATP/ADP ratio *in vitro* was similar to the PRC observed in living cells treated with pulses of darkness; KaiC phosphorylation was used to assess the rhythm in both cases.

70. They showed that light input to the clock of *Neurospora* employs ROS.

1.6.6. Plant hormones in circadian rhythms

Microarray expression analysis has demonstrated that the plant transcriptome is rhythmic. Early findings suggested that expression of about 6% (Harmer *et al.*, 2000) to 15% (Edwards *et al.*, 2006) of the genes in *Arabidopsis* oscillate on a circadian basis, but more recent estimations raise this percentage between 30% and 40% (Covington *et al.*, 2008). In these same studies cluster analysis indicated that primary and secondary metabolism are rhythmic (Harmer *et al.*, 2000; Edwards *et al.*, 2006). Due to the high proportion of rhythmic gene expression, reaching up to 89% when diurnal microarray data sets are considered (Michael *et al.*, 2008b), rhythmic transcription alone is no proof that a process is also rhythmic, rather transcriptional oscillations in *Arabidopsis* are inherent.

System-wide analysis has shown that hormone-responsive and circadian regulated genes overlap in a greater proportion than expected by chance, predicting that hormone and stress responses are anticipated; this analysis included genes responsive to ABA, brassinosteroids, auxin, gibberellins, ethylene, methyl jasmonate and salicylic acid (SA) (circadian data sets: Covington and Harmer, 2007; Covington *et al.*, 2008 and Legnaioli *et al.*, 2009; diurnal data sets: Mizuno and Yamashino, 2008; see also Sanchez *et al.*, 2011 for a recent review). A series of publications dealing with hormone signaling has proven this transcriptome-based prediction. First, several responses to hormones, such as auxin, ABA and GA, are gated by the circadian clock at specific times of the day (Covington and Harmer, 2007; Legnaioli *et al.*, 2009; Arana *et al.*, 2011). Then, levels of ABA (Lee *et al.*, 2006) and brassinosteroids (Bancos *et al.*, 2006) oscillate under LD cycles, whereas under free running conditions auxin (Jouve *et al.*, 1999) and ethylene levels (Thain *et al.*, 2004) are also rhythmic, peaking in the middle of the day. Rhythmicity in hormone levels results from transcriptional regulation of respective biosynthetic pathways in the case of ABA, auxin and brassinosteroids and from posttranscriptional regulation in the case of ethylene; it is noteworthy that the clock controls transcription of enzymes performing the rate limiting steps of ABA and brassinosteroid biosynthesis, whereas auxin signaling is rhythmic at multiple levels from biosynthesis, transport and inactivation to hormone binding to receptors and signal transduction thereafter (Thain *et al.*, 2004; Bancos *et al.*, 2006; Covington and Harmer, 2007; Covington *et al.*, 2008; Rawat *et al.*, 2009).

In addition to being clock-controlled some hormones feedback on clock function regulating several parameters of circadian rhythms. Exogenously applied brassinosteroids shorten circadian period and in agreement with this brassinosteroid-defect mutants exhibit long-period phenotypes (under both LL and DD; Millar *et al.*, 1995a; Hanano *et al.*, 2006); ABA application lengthens

circadian period and accordingly an ABA-deficient mutant exhibits a short-period phenotype⁷¹; cytokinin application delays phase particularly in DD whereas cytokinin-hypersensitivity lengthens circadian period in the dark; exogenously applied ethylene has little if any effect on circadian parameters even though several ethylene related mutants show altered circadian phase and periodicity under distinct light conditions (Hanano *et al.*, 2006). Finally auxin application does not affect circadian function at physiological concentrations, though it reduces amplitude of certain circadian luciferase-markers (Hanano *et al.*, 2006; Covington and Harmer, 2007). Collectively pharmacological and genetic approaches have shown that brassinosteroid-, ABA- and cytokinin-related signaling pathways exert feedback regulation on clock function. Here I show that SA application shifts the phase of the clock in a gated manner. Below the studies that have dealt with the gating of hormonal responses (ABA, GA and auxin) by the circadian clock are reviewed.

1.6.7. Sensitivity to hormones is gated: rhythmic hypocotyl elongation and anticipated stress responses

Under free running conditions hypocotyl elongation is rhythmic with maximum growth⁷² observed near the end of the subjective day (Dowson-Day and Millar, 1999). Under short-day conditions maximal growth is shifted 8 to 12 hours earlier, just before dawn, underlying the importance of events of coincidence between the endogenous clock and external periodic environmental parameters in the regulation of growth (Nozue *et al.*, 2007). This coincidence is achieved through dual regulation, by light and the clock, of transcriptional regulators PHYTOCHROME INTERACTING FACTOR4 (PIF4) and PIF5 that promote growth. In more detail, *PIF4* and *PIF5* transcript levels are regulated by CCA1 and peak in the day, whereas PIF4 and PIF5 proteins are sharply downregulated by light at dawn, resulting in maximum diurnal growth at the end of the night. These events promote rhythmic growth that is lost in the *pif4pif5* double mutant. It is noteworthy, that PIF4 and PIF5 together with the light activated transcription factor

71. The phenotype is though observed under LL and in DD, whereas the response to ABA is restricted in DD (Hanano *et al.*, 2006).

72. In this chapter the term growth refers to hypocotyl elongation that is distinct from increase of biomass.

ELONGATED HYPOCOTYL5 (HY5) are required for rhythmic growth (Nozue *et al.*, 2007) and at the same time they are part of the developmental network responsible for de-etiolation⁷³.

Rhythmic growth and de-etiolation are subjected to hormonal regulation. Accordingly, PIF4-downstream targets include a set of genes associated with GA, auxin, brassinosteroids, ethylene and cytokinins (Nomoto *et al.*, 2012). The relationship between rhythmic growth and hormones is further indicated by transcriptome analysis that revealed a coincidence between maximum growth under short-days and the expression of genes involved in GA, auxin, brassinosteroids and ABA signaling (all of which are important to growth) (Michael *et al.*, 2008a). Our current knowledge on hormonal regulation of rhythmic growth is focused on auxin and GA; circadian studies dealing with ABA on the other hand focus more on water relations and carbon fixation and allocation (see below).

a. GA de-represses etiolated growth in the dark

GA regulates de-etiolation and diurnal growth through HY5, PIF4 and PIF5 proteins, which are known to be involved in both processes (Nozue *et al.*, 2007; Alabadí and Blázquez, 2008; Alabadí *et al.*, 2008; Arana *et al.*, 2011). The importance of GA in de-etiolation was discovered when Alabadí *et al.* (2004) observed that deficiency in GA biosynthesis and signaling promotes de-etiolation in the dark. This would mean that GA is a negative regulator of de-etiolation (Alabadí *et al.*, 2004). In addition to this, GA is important for rhythmic growth. Mutations that result in enhanced GA-signaling cause arrhythmic growth or expansion of the growth period into the objective day (Arana *et al.*, 2011). GA inhibits de-etiolation by stimulating degradation of DELLA proteins in the dark. These in turn function as integrators of light and hormonal signals to negatively regulate PIF4 and PIF5, and positively regulate HY5. Together this promotes photomorphogenesis (*i.e.* growth inhibition) (Alabadí and Blázquez, 2008). As shown in figure 1.13, in the dark GA releases PIF4 from DELLA-mediated repression resulting in promotion of growth (de Lucas *et al.*, 2008), whereas in the light phytochrome signaling reduces bioactive GA levels (reviewed in Kami *et al.*, 2010 and in Alabadí and Blázquez, 2008), thus favoring accumulation of DELLA proteins and growth-repression (Achard *et al.*, 2007). In addition to these, phyB contributes to growth inhibition in the light by reducing stability of PIF4 (de Lucas *et al.*, 2008). The mechanisms responsible for these interactions are well described⁷⁴. The extensive regulation of GA-signaling by the clock⁷⁵ likely accounts for the

73. PIF4 and PIF5 promote etiolated growth whereas HY5 promotes photomorphogenesis (reviewed in Alabadí and Blázquez, 2008).

74. The effect of GA on DELLA stability requires a group of GA-receptors, termed GID1, that interact with DELLA proteins in a GA-dependent manner, leading to the degradation of DELLAs via the ubiquitin

observed gated effect of GA on growth. Of note, under short days GA application de-represses from DELLA-mediated growth repression specifically in the night (thus in a gated manner; Arana *et al.*, 2011), that is when diurnal growth reaches its maximum (Nozue *et al.*, 2007; Alabadí and Blázquez, 2008). Collectively, GA contributes to the diurnal growth pattern observed under short-days and to etiolated growth in the dark via the same network components (fig. 1.13).

Figure 1.13: The GA signaling network regulates rhythmic growth and de-etiolation

Factors and regulatory events that promote photomorphogenesis are drawn with purple and those that promote etiolated growth in the dark are drawn with blue. Dashed lines show circadian regulation. See text for details.

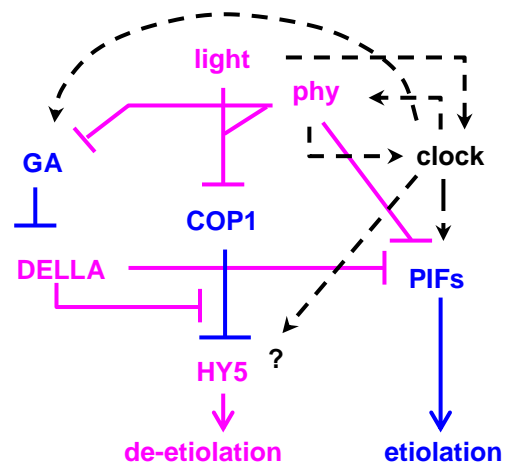

pathway (Griffiths *et al.*, 2006). DELLA proteins do not bind DNA and inhibit transcriptional activity of PIF proteins by direct binding, to promote photomorphogenesis (de Lucas *et al.*, 2008; Feng *et al.*, 2008); for the same reason DELLAs promote accumulation of HY5 post-transcriptionally by increasing its stability. HY5 on the other hand (like several other light activated transcription factors) is down-regulated by the COP1 E3 ubiquitin ligase (Alabadí *et al.*, 2008; Alabadí and Blázquez, 2008) that is central in suppressing the default de-etiolation program in the dark (reviewed in Huq, 2006 and Kami *et al.*, 2010).

75. Several steps of the GA signaling network described above oscillate diurnally. These steps include the expression of genes encoding GA-biosynthetic enzymes (Covington *et al.*, 2008) and the levels of DELLA proteins and of *GIDI* transcripts (Arana *et al.*, 2011). Additionally, in the light (thus in a diurnal fashion) phytochromes and cryptochromes inhibit COP1 via unknown mechanisms, preventing thereafter degradation of light signaling components (Huq, 2006; Kami *et al.*, 2010). Recently *in silico* analysis suggested that several additional steps in GA signaling are rhythmic, including transcriptional regulation of *GIDI* expression (Marín-de la Rosa *et al.*, 2011) and of DELLA targets due to the high incidence of E-box cis-elements (found in promoters of dawn-phased genes; Michael *et al.*, 2008a) at their promoters (Gallego-Bartolomé *et al.*, 2011).

b. Auxin promotes rhythmic growth

The involvement, requirement to be exact, of auxin in rhythmic growth depends on auxin transport and auxin production (Jouve *et al.*, 1999). The later is rendered rhythmic through the tissue specific MYB-like transcription factor REVEILLE1 (REV1) (Rawat *et al.*, 2009). PIF4 and PIF5 growth-related downstream gene-targets overlap significantly with auxin-regulated genes, suggesting that the effect of auxin on rhythmic growth may be exerted through these proteins. Genetic assays aiming to test this hypothesis are indicative that indeed PIF4 and PIF5 modulate the effect of auxin on growth, though the exact nature of this control is not yet understood (Nozue *et al.*, 2011). Based on the epistatic relationships and dose response curves to auxin of mutants lacking or over-expressing CCA1, LHY, PIF4, PIF5, and RVE-1, it was proposed that auxin regulates growth via two rhythmic pathways. The first pathway modulates auxin responsiveness and involves CCA1 upstream of *PIF4* and *PIF5* and the other pathway is dependent on RVE-1 upstream of auxin production (Nozue *et al.*, 2007; Rawat *et al.*, 2009; Nozue *et al.*, 2011).

Arabidopsis seedlings are not equally sensitive to auxin around clock time, as the effects of the hormone on growth under short-days and on amplitude of rhythmic transcription⁷⁶ are gated. Auxin sensitivity reaches its maximum at the end of the objective or subjective night. At subjective dawn abrupt changes in auxin responsiveness coincide with the onset in the expression of negative regulators of auxin signaling⁷⁷ that peak later in the day. Interestingly, the expression of transcription factors that activate responses to auxin reach maximum at this time also, indicating that sensitivity to auxin is gated because of the concerted action of positive and negative rhythmic signaling components (Covington and Harmer, 2007). It is noteworthy, that under short-days sensitivity to auxin (Covington and Harmer, 2007) and maximum growth (Nozue *et al.*, 2007) occur simultaneously at around dawn.

c. Rhythmic stress anticipation

Abiotic stress can be the direct result of the daily rhythmic exposure to *zeigebers* and for this it is no surprise that stress and hormone signaling pathways are rhythmic. Consequently several drought-, salt-, cold- and heat-regulated genes and genes involved in the dissipation of

76. A synthetic luciferase rhythmic marker was used in these experiments conducted under free running conditions.

77. These include transcriptional inhibitors as well as enzymes responsible for auxin inactivation through amino acid conjugation.

photosynthetic ROS have a higher degree of clock regulation than expected by chance (Harmer *et al.*, 2000; Kreps *et al.*, 2002; Covington *et al.*, 2008). For example, the clock regulates the expression of several genes of the methyl-erythritol-phosphate (MEP) pathway in plastids, the rate limiting pathway in the production of isoprenes such as chlorophylls, tocopherols, carotens and the phytohormones ABA and GA. Seven out of eight and ten out of twelve genes involved in tocopherol and carotenoid biosynthesis respectively are rhythmic and most of these are phased in the morning. As tocopherols and carotenoids prevent formation of ETC-derived ROS, it is likely that they are synthesized rhythmically to protect from ROS production on a daily basis (Covington *et al.*, 2008).

Another example of repetitive stress is the daily exposure to heat and cold. Resistance to these stress inducing factors is gated by the clock (observed in cotton seedlings) so that extreme heat- or cold-treatments are tolerated best at subjective dawn and dusk, respectively. Moreover in *Arabidopsis* seedlings heat-induced transcripts peak by average at dawn and cold-induced transcripts at dusk, indicating that the observed anticipation/gating in resistance to heat- and cold-treatments (in cotton) may result from rhythmic gene expression (see Covington *et al.*, 2008 and references therein). The circadian clock controls cold-responsive genes through the *C-REPEAT BINDING FACTOR 1/DEHYDRATION RESPONSIVE ELEMENT BINDING 1* (CBF1/DREB1) family of transcription factors that, as implied by their name, regulate a set of genes (termed the CBF/DREB1 regulon) that provide not only freezing tolerance but also resistance to salt and drought; for the purpose of this the CBF/DREB1 regulon contains a considerable amount of ABA targets, though CBF/DREB1 transcription factors act independent of ABA signaling. Interestingly expression of CBFs is enhanced by a low RL/FRL ratio (increased FRL) that is typical of dawn and dusk particularly at higher latitudes. Together these findings (reviewed in Sanchez *et al.*, 2011) indicate that the clock and phytochrome signaling at dusk prepare plants for the oncoming night on a daily basis.

A third well-described example of anticipated stress concerns the stress hormone ABA that plays a major role in the determination of water relations. Stomatal aperture in *Arabidopsis* is a rhythmic output, with opening occurring at dawn and closing before dusk (Dodd *et al.*, 2005). ABA promotes stomatal closure notably in a gated manner, with the hormone being less effective in the morning as if its role is to protect against water loss specifically in the heat of the afternoon (Robertson *et al.*, 2009). Recently it was shown that ABA signaling and drought-dehydration responses are linked to the clock via TOC1 (Legnaioli *et al.*, 2009). A connection between ABA and TOC1 was initially implied by the observation that mis-regulated rhythmic genes in *TOC1* mutant lines (*TOC1* over-expressing and in the *toc1-21*) are enriched with ABA-regulated genes involved in dehydration responses. It was also found that TOC1 levels in the wild-type, in *toc1-21* (a null

mutation) and in a TOC1 over-expressing line are correlated to drought-sensitivity and to responsiveness to exogenous ABA⁷⁸. Further investigation revealed that TOC1 binds the promoter and inhibits expression of *GENOME UNCOUPLED 5 (ABAR/GUN5)* that encodes an ABA receptor, explaining the dehydration-related phenotypes of these TOC1 mutant lines. Interestingly ABA and ABAR exert a positive feedback on ABA-signaling in a gated manner, by inhibiting expression of *toc1* specifically during the day (Legnaioli *et al.*, 2009). These findings together are suggestive that gating of ABA signaling by the clock is important for cellular homeostasis under dry environments or even in response to daily fluctuations in water availability.

In addition to its well-described role in water relations, ABA is also involved in the regulation of carbon metabolism. The crosstalk between ABA and carbon metabolism is underlined by the fact that ABA-deficient and ABA-insensitive mutants, compromised in biosynthesis and signaling of ABA respectively, are allelic to several mutants identified in genetic screens for altered responses to sugars⁷⁹. Subsequently, several well described ABA-deficient and ABA-insensitive mutants were also found to be insensitive to high levels of sugars not tolerated by wild-type plants (Rook *et al.*, 2006). Sugars being the product of carbon fixation are central in the regulation of photosynthesis and resource allocation via feedback mechanisms. High sugar levels inhibit photosynthetic gene expression and induce starch biosynthetic genes. By contrast, sugar depletion results in expression of genes required for photosynthesis and mobilization of stored carbohydrates (Koch, 1996). Notably, ABA and high sugar levels affect carbon metabolism similarly, in that both compromise photosynthetic gene expression and promote expression of starch biosynthetic genes. This finding, together with the sugar-insensitive phenotypes of the aforementioned ABA-related mutants, designates that ABA and sugars similarly affect carbon metabolism (Rook *et al.*, 2006). For this it was originally proposed that sugars feedback on carbon metabolism (fixation, allocation and storage)

78. The TOC1 over-expressing line was found to be oversensitive and the *toc1-21* resistant to dehydration stress. The TOC1 over-expressing line was also less responsive than the wild-type and *toc1-21* to ABA mediated stomatal closure.

79. Genetic approaches that aimed to identify components of sugar responses in plants led to the identification of several mutants that fall in one of four categories; these are the *glucose-insensitive (gin)* mutants (Zhou *et al.*, 1998) and *sugar-insensitive (sis)* mutants (Laby *et al.*, 2000) that tolerate high glucose and sucrose concentrations in the growth medium respectively, the *sucrose-uncoupled (sun)* mutants (Dijkwel paper 1997) that are impaired in the sucrose-mediated suppression of photosynthetic gene expression and the *impaired sucrose-induction (isi)* mutants in which the sugar-induced expression of starch biosynthetic genes is reduced (Rook *et al.*, 2001). Interestingly, all of these screens identified mutants that were subsequently shown to be compromised in ABA synthesis and/or signaling (Rook *et al.*, 2006).

through ABA signaling (Arenas-Huertero *et al.*, 2000). An alternative hypothesis was presented by Rook *et al.* (2001) who presented evidence that ABA enhances the ability of tissues to respond to sugar signals⁸⁰. The connection between light (photosynthesis) and ABA signaling is further supported by the observed proximity between cis-elements responsive to light and ABA at the promoters of photosynthetic genes. As the effects of light and ABA on photosynthetic gene expression are opposite, the proximity between these promoter elements is suggestive that the respective signaling cascades are competitive in the regulation of photosynthesis (Rook *et al.*, 2006). Based on these findings, Rook *et al.* (2006) suggested that signaling pathways responsive to light, CO₂ fixation and ABA are linked as part of the compensatory mechanism that balances CO₂ uptake and water loss by stomata. Notably ABA and stress signaling entail cADPR (Sánchez *et al.*, 2004) and poly-ADP-ribosylation (de Block *et al.*, 2005; Vanderauwera *et al.*, 2007) that in turn affect not only energy metabolism but also homeostatic clock function (Panda *et al.*, 2002; Dodd *et al.*, 2007). For this reason cADPR and poly-ADP-ribosylation are good candidates for mediators of diurnally anticipated stress responses. Interactions between ABA and the clock in this case would stretch beyond anticipated stress responses to serve homeostatic regulation (see starch metabolism below).

From the above it becomes easily featured that in *Arabidopsis* the clock, through gating of auxin (Covington and Harmer, 2007), ABA (Legnaioli *et al.*, 2009) and GA (Arana *et al.*, 2011) responses, orchestrates various hormonal/stress-related signals and environmental cues, such as the photoperiod and the increased water turgor pressure and photosynthate availability that occur at dawn, to regulate growth (Nozue *et al.*, 2007). Several genetic, genomic and biochemical studies from the recent literature described above, point out PIF4 as being central in the integration of these hormonal and environmental signals.

1.6.8. Photoperiodic regulation of carbon fixation and allocation

"Most studies addressing the effect of sugars in plants are divided into feast and famine programs, reflecting responses to excessive sugar and to sugar starvation (Koch, 1996)" (taken from Blaesing *et al.*, 2005). Both of these conditions are stressful and the first attempt to describe sugar-effects within the concentration limits of endogenous oscillations in *Arabidopsis* was performed by Blaesing *et al.* (2005) through the study of the *pgm* mutant. Under diurnal conditions *pgm* shows

80. This opinion was based on the observation that expression of starch biosynthetic genes was synergistically induced by exogenous sucrose and ABA, but not by ABA alone.

amplified oscillations in sugar content relative to wild-type and for this its phenotypes are thought to provide a measure of the effects that result from changes in endogenous sugar levels. Sugar content in *pgm* is higher during the day relative to the wild-type and lower during the night. Consequently, due to sugar depletion every night, the mutant undergoes starvation. This approach revealed that global gene expression is more responsive to falling sugar levels near the end of the night and after dusk rather than to high sugar content during the day (Blaesing *et al.*, 2005).

Because of its timing and due to the requirement for sugar depletion, transcriptional reprogramming in response to sugar depletion is reminiscing of the stressful effect caused by extension of the night beyond objective dawn. At this time, depletion of sugars represses growth (measured as expansion of organs; Thimm *et al.*, 2004; Gibon *et al.*, 2004; Graf and Smith, 2011) and induces a gene-expression profile that would promote nutrient and cell wall break-down and at the same time would inhibit cell wall modifications and anabolic procedures such as nitrogen and carbon assimilation and nutrient biosynthesis (Thimm *et al.*, 2004). Interestingly, this transcriptional reprogramming also entails changes in the expression of genes involved in synthesis and sensing of ABA, cytokinins⁸¹ and ethylene (Thimm *et al.*, 2004). Genes implicated in ABA and ethylene synthesis and sensing are induced, whereas genes involved in cytokinin synthesis are repressed, indicating that the transcriptional reprogramming to starvation (similarly induced by night extensions and by the *pgm* mutation) may predispose towards growth inhibition and senescence at the same time (Thimm *et al.*, 2004).

The importance of hormones in dealing with starvation-induced stress is also implied by the observed crosstalk between sugar signaling and responsiveness to ABA (Rook *et al.*, 2006; chapter 1.6.7.c) and ethylene⁸² (Smalle *et al.*, 1997; León and Sheen, 2003; Ellison *et al.*, 2011). All of these data raise two questions. First, could periodic stress entrain (and would it then be called a *zeitgeber*)? I predict this given the interplay between hormones, metabolites and the clock. Second, could the effect of sugars on the clock, similarly to the effect of hormones (and of *zeitgebers*), be gated. This is also a prediction as sugar-starvation is initiated near dawn. Interestingly, Gibon *et al.* (2004)

81. ABA and cytokinins also affect circadian function (Millar *et al.*, 1995a; Hanano *et al.*, 2006; chapter 1.6.7).

82. Noteworthy in light grown plants that are not supplemented with sucrose, ethylene signaling promotes hypocotyl elongation which is moderated in the dark or when plants are placed on growth medium that contains sucrose. The crosstalk between sucrose and ethylene signaling is also underlined by the fact that exogenously applied sucrose (tested under blue light) stimulates ethylene emission from *Arabidopsis* seedlings (Smalle *et al.*, 1997; Ellison *et al.*, 2011).

proposed that the levels of sugars at this time are of photoperiodic significance. They claimed that the small differences in sugar context at the end of the night between plants grown under short-day (less sugars) and long-day (more sugars) conditions are partly responsible for the photoperiodic differences in growth and biomass of *Arabidopsis*⁸³. Conclusively, rhythmic sugar levels and their photoperiodic variation could be held responsible for the photoperiodic growth-patterns of *Arabidopsis* (Gibon *et al.*, 2004), through their effect on growth-related hormone signaling (chapter 1.6.7) and global gene expression (Blaesing *et al.*, 2005).

Despite the aforementioned differences in sugar context observed at the end of the night between short- and long-day grown plants, severe starvation-induced stress in the lab in both cases is avoided. This is because the linear rate of starch degradation during the night is subjected to photoperiodic regulation, slowing down when days become shorter (fig. 1.14). Photoperiodic regulation of carbon metabolism is also observed during the day, as more photosynthate is partitioned towards starch synthesis during shorter days relative to longer ones⁸⁴; this happens likely because the longer the night, the more starch is needed to avoid starvation-induced stress prior to dawn. Collectively, in order to optimize growth carbon metabolism is subjected to photoperiodic regulation during the day (starch accumulation) as well as during the night (starch degradation), (Gibon *et al.*, 2004).

Several observations have demonstrated the involvement of the circadian clock in the photoperiodic regulation of the rate of starch degradation at night. First, skeleton photoperiods (midday dark treatments) do not disturb the match between the time required for starch exhaustion and the duration of the night. This is indicative of circadian regulation, as the ineffectiveness of skeleton photoperiods is a classic test and a hallmark of circadian rhythms whenever an "hour glass mechanism" is suspected. Then the rate of starch degradation is such that under 28h (14hL/14hD) or under 17h T-cycles (8.5hL/8.5hD) starch is exhausted 24 hours after the previous dawn. At this time expression of rhythmic genes that mark subjective dawn coincides with the onset in the expression of genes that mark carbon starvation, when plants are released into DD. This means that a circadian pacemaker regulates carbon metabolism at night, because starch exhaustion and starvation occur every 24 hours even when plants are entrained to non-circadian cycles. Interestingly, when the *cca1-11; lhy-21* short-period mutant is grown under 24h T-cycles it displays patterns in starch degradation

83. They proposed that short-day grown plants are smaller relative to long-day grown plants, because in the former sugar depletion before dawn directs photosynthates towards starch biosynthesis at the expense of other anabolic processes during the first part of the next light period.

84. Despite this, more starch is accumulated by dusk when days become longer (fig. 1.14).

and in expression of starvation markers that are similar to those observed in wild-type plants, when the later are grown under 28h T-cycles; on the other hand, when the *cca1-11;lhy-21* double mutant is placed under 17h T-cycles, that approaches the duration of its free running oscillations, starvation is avoided. These findings further support the idea that the match between the duration of the night and the time required for starch degradation is attributed to the circadian clock rather than to an "hour glass" mechanism (Graf *et al.*, 2010). Consistent with these, wild-type and *cca1-11;lhy-21* plants grow best under T-cycles that match their free running period, 24h and 20h T-cycles respectively, likely because starvation-induced stress is avoided. By contrast, the short-period mutant *toc1-21* and the long-period mutant *ztl-3* grow best under 24h T-cycles leading Graf *et al.* (2010) to propose that optimal growth requires correct anticipation of dawn rather than a match between the free running period and the length of the T-cycle. In other words, a photoperiodic mechanism allows plants to anticipate dawn in order to avoid depletion of sugars before dawn and consequently starvation and growth inhibition; the authors added in proof that exogenously applied sucrose corrects growth inhibition imposed by T-cycles that deviate from the free running period in the wild-type (Graf *et al.*, 2010; see also Graf and Smith, 2011). The same experiments were also commented by Haydon *et al.* (2011) who concluded that starch metabolism is directed from the morning loop. To summarize, photoperiodic regulation of starch metabolism is exerted at the level of starch degradation at night as well as at the level of photosynthate partitioning during the day between immediate usage and storage for night growth (reviewed in Graf and Smith, 2011)⁸⁵.

Several observations when combined are implicit of the involvement of ABA signaling and of carbon metabolism in the homeostatic-photoperiodic function of carbon partitioning that happened during the day. First, the ability of sugars to mediate a transcriptional reprogramming at both dawn and dusk (Blaesing *et al.*, 2005) indicates that metabolism, in addition to being subjected to photoperiodic control, has the potential of mediating photoperiodic regulation itself. Of note, the importance of metabolism in photoperiodic regulation through calcium oscillations (that could incorporate metabolic information; see chapter 1.6.5) has been considered in the literature (reviewed in Haydon *et al.*, 2010 and in Dodd *et al.*, 2010). Second, the engagement of ABA in homeostatic clock function (meaning not stress related) is implied by the participation of NAD⁺ derived

85. At the moment photoperiodic regulation of starch accumulation during the day is less understood relative to the photoperiodic regulation in starch mobilization during the night. Of note, photoperiodic regulation of starch synthesis should not be confused to the well described short-term regulation of photosynthate partitioning during the day (i.e. the aforementioned effect of sugars on photosynthetic gene expression and starch biosynthetic genes; reviewed in Koch, 1996 and Rook *et al.*, 2006).

metabolites of circadian relevance (such as cADPR and perhaps also ADPribose polymers; Dodd *et al.*, 2007; Panda *et al.*, 2002) in ABA signaling (Sánchez *et al.*, 2004; de Block *et al.*, 2005; Vanderauwera *et al.*, 2007). Third, the likelihood that ABA is involved in the homeostatic mechanisms that affect carbon metabolism is further supported by the observation that ABA and sugar signaling pathways intersect (Rook *et al.*, 2001); noteworthy, the involvement of ABA in photoperiodic responses, induction of flowering to be exact, has been considered in the literature (Barth *et al.*, 2006).

Figure 1.14: Photoperiodic regulation of starch metabolism in *Arabidopsis*

Photoperiodic regulation of starch metabolism is exerted at the level of starch degradation at night as well as at the level of photosynthate partitioning during the day between immediate usage and storage for night growth. Under short-days (dashed

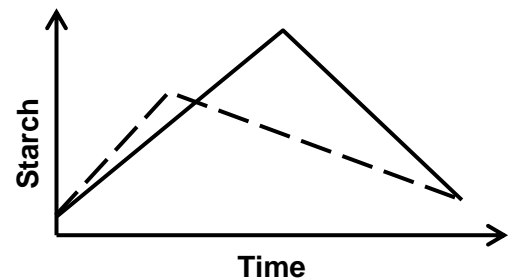

line) the rate of starch synthesis in the day is higher relative to long-days (continuous line; compare the two slopes), even though eventually more starch is accumulated by dusk of long-days relative to short ones. Photoperiodic regulation partitions more photosynthate towards starch synthesis during shorter days relative to longer ones. The rate of starch degradation is such that stressful carbon starvation is avoided by dawn under both short- and long-days. Objective dusk coincides with peaks in starch accumulation. The figure is adapted after Gibon *et al.* (2004), Graf *et al.* (2010) and Graf and Smith (2011).

In this thesis I present my studies to provide genetic evidence that CCA1 and LHY, expressed at dawn and previously shown to affect starch metabolism (Graf *et al.*, 2010), as well as all the genes represented in the model of Locke *et al.*, (2005b; fig. 1.10), are required for mediating sugar signals to nuclear oscillations. Importantly, these signals are relevant to parametric entrainment (results chapter). I have also observed a correlation between photosynthetic electron transport and circadian period. This can explain the rule of Aschoff. I also propose that stress and hormone signaling, in particular ROS and SA, could function as *zeitgebers*. I also provide insights on the importance of the known TTFLs and of hormones in the regulation of photosynthate partitioning during the day.

Chapter 2

Materials and Methods

2.1. Materials

2.1.1. Mutant lines

Mutants and transgenic lines used in this lines used in this study are listed in table 2.1 (lines used for luciferase imaging) and table 2.2 (lines used for leaf movement).

Table 2.1: Wild-type and transgenic lines used for luciferase imaging

Line	Ecotype	Luciferase marker	Reference
Wild type (wt)	Ws	<i>CCR2</i>	Doyle <i>et al.</i> , (2002)
wt	Ws	<i>CCA1</i>	Doyle <i>et al.</i> , (2002)
wt	Ws	<i>CAB2</i>	Hall <i>et al.</i> , (2001)
wt	Ws	<i>LHY</i>	McWatters <i>et al.</i> , (2007)
wt	Ws	<i>TOC1</i>	McWatters <i>et al.</i> , (2007)
wt	Ws	<i>GI</i>	Ding <i>et al.</i> , (2007)
wt	Ws	<i>PHYB</i>	Tóth <i>et al.</i> , (2001)
<i>toc1-21</i>	Ws	<i>CAB2</i>	Ding <i>et al.</i> , (2007)
<i>toc1-21</i>	Ws	<i>GI</i>	This study
<i>cca1-11</i>	Ws	<i>CAB2</i>	Ding <i>et al.</i> , (2007)
<i>lhy-21</i>	Ws	<i>CAB2</i>	Ding <i>et al.</i> , (2007)
<i>cca1-11;lhy-21</i>	Ws	<i>CAB2</i>	Ding <i>et al.</i> , (2007)
<i>gi-11</i>	Ws	<i>CAB2</i>	Gould <i>et al.</i> , (2006)
<i>gi-11</i>	Ws	<i>CCA1</i>	This study
<i>gi-11</i>	Ws	<i>PHYB</i>	This study
<i>phyB-9</i>	Col-0	<i>GI</i>	Oh <i>et al.</i> , (2004)
<i>hsp90.2-3</i>	Col-0	<i>GI</i>	This study

Table 2.2: Mutant lines used for circadian leaf movement assays

Line	Ecotype	Reference
<i>hsp90.2-3</i>	Col-0	Hubert <i>et al.</i> , (2003)
<i>RbohD</i>	Col-0	Tissier <i>et al.</i> , 1999; Torres <i>et al.</i> , 2002
<i>RbohF</i>	Col-0	Tissier <i>et al.</i> , 1999; Torres <i>et al.</i> , 2002
<i>rcd1</i>	Col-0	Overmyer <i>et al.</i> , 2000
<i>pad4</i>	Ws	Feys <i>et al.</i> , 2001
<i>eds1</i>	Ws	Parker <i>et al.</i> , 1996
<i>lsd1</i>	Ws	Jabs <i>et al.</i> , 1996
<i>fmo1</i>	Col-0	Mishina and Zeier, 2006

2.1.2. Growth media for plants and chemicals

All media used for plant growth was bought from DUCHEFA. Murashige&Skoog (MS) basal salts used for plant growth, entrainment and luciferase imaging was prepared as follow:

1. 4.4 g/L MS
2. 0.5 g/L 2-N-morpholino-ethanesulfonic acid (MES)
3. 1% (w/v) phytoagar
4. When sucrose was used this was added to a final concentration of 3%.

pH was adjusted to 5.7 with KOH and sterilized in an autoclave for 20 minutes at 121°C. Chemicals mentioned above and solvent (DMSO or water) were eventually added to the indicated concentrations.

Chemicals listed below were purchased from SIGMA. Whenever water was used as solvent (vitC and paraquat) Millipore grade filtered water was used. Stock solutions were as follow:

1. Salicylic acid (SA) : 350mM in DMSO
2. 3-(3,4-dichlorophenyl)-1,1-dimethylurea (DCMU) : 20mM in DMSO
3. 2,5-dibromo-3-methyl-6-isopropylbenzoquinone (DBMIB) : 20mM in DMSO
4. Vitamin C (vitC) : 250 mM in dH2O
5. paraquat : 5mM in dH2O
6. rifampicin : 40mg/ml in DMSO
7. geldanamycin : 5mM or 10mM in DMSO

2.2. Methods

2.2.1. Growth conditions and luciferase imaging

Seed was surface-sterilized (with ethanol followed by bleach solution) and sown on 1% agar (pH 5.7) containing Murashige and Skoog plant salt mixture (MS, Murashige and Skoog, 962) and sucrose 3% w/v or no sucrose as indicated and then stratified at 4°C for 3 days. Seedlings were entrained during growth to 12 hours light/12 hours dark (12hL/12h/D) photoperiods under a fluence rate of WL at 100 μ E and a constant temperature of 21°C. Six-day old seedlings were transferred in 96-well imaging microtiter plates (Perkin Elmer, Juegesheim, Germany) containing sucrose 3% w/v or no sucrose as indicated; transfer took place during the second half of the objective day before dusk. This system allows rhythm imaging from single seedlings. The microtiter plates were placed in a luminescence scintillation counter (TopCount NXT, Perkin Elmer) at objective dusk for luciferase imaging according to standard protocols (Southern and Millar, 2005; Hanano *et al.*, 2006). Plants received a dark period of 12 hours that corresponds to the objective night and then entered free running conditions under monochromatic RLc or BLc at the low fluence rate (\sim 2 μ E) provided by constructed LEDs. Alternatively an additional entrainment event was applied in the TopCount before the onset of free run.

2.2.2. Circadian leaf (cotyledon) movement assays

Circadian period can be measured by video imaging of leaf movement under a range of ambient temperatures without having to perform *Agrobacterium* transformation. Seedlings were entrained under 12hL/12hD (100 μ E WL) for 5 days before transfer to 25-compartment plates (BIBBY STERILIN, UK) (20 seedlings per plate). The seedlings were transferred on agar blocks (approximately 1cm²x0.5cm) in a vertical position. Agar blocks were then placed in the top 20 compartments of the plates and water was added in the bottom 5 compartments to avoid moisture loss. The plates were then sealed and placed for an additional entrainment event in the growth cabinets. Care was taken so that plants in plates were always kept in a vertical position. Imaging took place the next day starting at objective dusk under low light intensity (low intensity WLc, average 15 μ E, lighting from the sides) and 12°C, 16°C or 21°C for 7 days. The images were taken with video cameras every 30 minutes using METAMORPH. The rhythms of the cotyledon movements were analyzed in METAMORPH. A general threshold was applied when analyzing each plate, which allowed detection of as many of the leaves on the plate as possible over the time course. Regions were defined for each leaf and the (x,y) pixel coordinates corresponding to the spatiotemporal pattern of each leaf was measured (Edwards *et al.*, 2005). The data were logged into EXCEL spreadsheets and analyzed as described below.

2.2.3. Data analysis

Luminescence levels were quantified and graphically depicted using the macrosuites TopTempII and Biological Rhythms Analysis Software System (BRASS) (Southern and Millar, 2005). Cotyledon movement was recorded with METAMORPH. Period length and relative amplitude of error (RAE) were subsequently estimated using the fast Fourier transform–nonlinear least squares (FFT–NLLS) program (Plautz *et al.* 1997). From these, RAE-normalized period (noPer) of a rhythmic population is calculated as described below.

For time course images (*e.g.* fig.3.1 A), a threshold of 100 counts per second (cps) in average luminescence was applied unless otherwise mentioned. FFT-NLLS took place with remaining plants. For each period value presented, the portion of plants that generated a RAE value lower than 0.6 was obtained and from that period values that fell out of the noPer \pm 3*SD range were excluded as outliers. Thereafter accuracy was defined by its inverse correlation to the standard deviation of the resulting noPer. Direct-rhythmicity was defined by its inverse correlation to the average of RAE

values. Indirect rhythmicity was defined by its inverse correlation to the average of RAE values where plants rejected by BRASS were assigned with a value of 1. For estimation of rhythmicity period- and RAE- outliers were removed in that order using the $av \pm 3*SD$ criterion; period outliers were calculated from the subpopulation that produced a RAE lower than 0.9 and the ensuing population was used to estimate RAE outliers after RAE values greater than 0.9 were returned in the corresponding files. Statistical tests of multiple independent and combined replicates were carried out with one-factor anova. Each time window analyzed with FFT-NLLS included three oscillatory peaks. Consecutive time windows were apart approximately by one cycle and are described in figures 1, 2 and 3.

To quantify expression of luminescence of marker *PHYB::LUC* (ws) data from TopTempII files was first restricted between 24 and 96 hours. Overall luminescence was then averaged by TopTempII, as an automated process, for each plant separately. Expression-outliers were thereafter defined as plants that emitted by average less luminescence than a certain value (ranging between 15 and 30cps; value varied between experiments) during this time period. After expression-outliers were removed, timing of the 1st circadian peak was defined for each oscillating population by visual inspection of respective graphs from TopTempII. Average luminescence at that time point was then used to assess the effect of SA on expression of the marker. Plants that produced luminescence greater than average luminescence + 3*SD at this time were removed as outliers. A certain SA concentration is included in the graphs and the analysis, as long as it was represented in at least two independent experiments.

Chapter 3

Results

3.1. Responses to sucrose

3.1.1. The response of the wild-type⁸⁶ to sucrose

The majority of *Arabidopsis* circadian experiments using the luciferase-promoter system (Millar *et al.*, 1995) have been conducted with plants growing on medium supplemented with high levels of sucrose (3% w/v). This is because of a previous perception that the original luciferase construction generated a protein limited in energy from ATP. On the other hand, metabolism, known to be under circadian control (e.g. Harmer *et al.*, 2000), also determines circadian function via metabolites in just about every model organisms used in the circadian field of research⁸⁷. For these reason, I was intrigued to test if sucrose affects circadian oscillations. Given the new generations of luciferase vectors available in *Arabidopsis*, this is now a feasible question to test. While this project was in progress the effect of sucrose in circadian assays under WLC and in the dark was published (Knight *et al.*, 2008; Dalchau *et al.*, 2011). For this reason I will focus here on the effect of sucrose on rhythmic gene expression under monochromatic BLc and RLc. I wished to identify luciferase markers whose rhythmicity would not be much dependent on the sucrose status of the growth medium in order to continue with genetic assays.

I assessed the effect of sucrose on oscillation speeds of *CAB2::LUC* (Ws), *GI::LUC* (Ws) and *GI::LUC* (Col-0) under monochromatic BLc and RLc. For this, I compared oscillations of the markers in the presence and absence of 3% w/v supplementary sucrose. The marker *CAB2::LUC* (Ws) did not produce oscillations in the absence of sucrose, and for this reason, it was assayed with a sucrose gradient; these data will be discussed separately. In the remaining experiments, I observed a period shortening effect of sucrose addition (fig. 3.1, 3.2 and 3.3). This is similar as that reported by others in WLC experiments (Knight *et al.*, 2008; Dalchau *et al.*, 2011). I also noticed that, in the absence of supplementary sucrose, circadian period was gradually shortened over time. By contrast, when sucrose was added in the growth medium, oscillations were rendered equally fast between consecutive time windows of the FFT analysis. Consequently, the period-shortening effect of sucrose was temporal [restricted during the first time window (1st-tw)] for *CAB2::LUC* (Ws) (under

86. "Wild-type" is referred to transgenic plants carrying promoter:luciferase transgenes.

87. The circadian effect of metabolites in *Arabidopsis* (Panda *et al.*, 2002; Dodd *et al.*, 2007; James *et al.*, 2008; Knight *et al.*, 2008; Dalchau *et al.*, 2011) in mammals (Asher *et al.*, 2008; Nakahata *et al.*, 2008; Nakahata *et al.*, 2009; Ramsey *et al.*, 2009), in cyanobacteria (Rust *et al.*, 2011; see appendix 2 for an extensive review) and in *Neurospora* (see appendix 1) is well described.

BL; fig. 3.3) or moderated over time for *GI::LUC* (under BLc or RLc; fig. 3.1 and 3.2). In every case, sucrose caused a permanent phase shift that persistent by the end of the experiment.

Temporal instability in terms of period length, termed transients, was first reported by Pittendrigh and Bruce in 1959 (Buening, 1973 and fig. 4.1); they were observed in response to non-parametric entrainment to light pulses and changes in ambient temperature and consequently they are a "byproduct" of entrainment. Here I report that such transients are inhibited by supplementary sucrose. For this I subjected plants to various combinations of sucrose treatments during growth/entrainment (with 12 hour WL/12 hour DD treatments) and during luciferase imaging under BLc⁸⁸. Against my expectations, I observed that the sucrose status of entrainment was "remembered" during the free run, in that the transients that took place during free run were inhibited not only by sucrose application, but also when sucrose was applied only during the preceding entrainment process (thus, the free run took place without supplementary sucrose). Specifically I noticed that when the treatment suc 0%→0% (plants never exposed to sucrose) was subjected, the accuracy of the marker *GI::LUC* (Col-0) (fig. 3.1 E, G) increased with time (SD-noPer during the 1st-tw=2.57h; 2nd-tw=1.27h), whereas with the treatment suc 3%→3% (plants always exposed to sucrose), accuracy was relatively stable between examined time windows (SD-noPer during the 1st-tw=0.95h; 2nd-tw=0.74h). By contrast, when sucrose was applied only during entrainment (treatment suc 3%→0%), these transients in accuracy were again inhibited (SD-noPer during the 1st-tw=1.82h; 2nd-tw=1.51h). Consequently the sucrose status of entrainment was "remembered" during free run, confirming my hypothesis that transients in circadian parameters (here, accuracy) are a quantitative measure of the effect of sucrose on parametric entrainment. Similar results were obtained in four independent experiments as well as from the combined data of all experiments.

On several occasions, treatment suc 3%→0% yielded intermediate values in circadian parameters relative to those obtained with treatments suc 0%→0% and suc 3%→3% during the initial time window of the FFT analysis. When data from six independent BL experiments conducted with *GI::LUC* (Col-0) were combined, these intermediate values were scored for period (3.39×10^{-53} <p< 1.53×10^{-7} ; fig. 3.1 C, G; see also table 3.1 that refers to the same data as figure 3.1), accuracy (fig. 3.1 E, G; see SD-noPer in table 3.1) and indirect rhythmicity (4.48×10^{-16} <p< 0.01; table 3.1); I observed the same for indirect rhythmicity (5.54×10^{-13} <p< 2.2×10^{-4} ; table 3.1) and accuracy (fig. 3.3

88. Initially I performed these tests under BLc, because under BLc robust oscillations are produced irrespective of the status of supplementary sucrose; this is important because I could then calculate the effect of sucrose on circadian period that reflects the actual state of the oscillator and not the output process or luciferase activity.

B; table 3.1) of the marker *CAB2::LUC* (Ws), when data from seven independent experiments were combined. In addition to these results, the period of *CAB2::LUC* (Ws) acquired intermediate values in a data set that combined four experiments entailing an additional entrainment event of BL (period \pm SE during 1st-tw: suc 0% \rightarrow 0%=28.64 \pm 0.29h; suc 3% \rightarrow 0%=27.11 \pm 0.16h; suc 3% \rightarrow 3%=25.95 \pm 0.07h; $3.78 \times 10^{-9} < p < 4.03 \times 10^{-4}$). These findings further showed that the sucrose status applied during parametric entrainment is "remembered" and suggest that supplementary sucrose affects parametric entrainment of both markers described.

I next focused on the effect of supplementary sucrose during the free run. As expected, due to the ATP requirement of luciferase, application of exogenous sucrose during the free run increased the mean luciferase signal; however, this was accompanied by a tendency to reduce oscillatory robustness. In more detail, even though the accuracy of *GI::LUC* (under BLc in fig. 3.1 E, G and 3.2 E; G under RLc in fig. 3.1 F, H and 3.2 F, H), as well as accuracy of *CAB2::LUC* (under BLc in fig. 3.3 B), were increased by sucrose addition, accuracy was increased over time (between time windows; SD-noPer decreased) only if free run was performed in the absence of sucrose. Consequently, when the effect of sucrose on accuracy was assessed by comparison between the treatments suc 0% \rightarrow 0% and suc 3% \rightarrow 3%, the aforementioned positive effect of sucrose on the accuracy of the marker *CAB2::LUC* (Ws) (fig. 3.3 B, compare panels with consecutive time windows) was temporal and restricted during the 1st-tw, whereas the positive effect of sucrose on the accuracy of *GI::LUC* oscillations was moderated over time [Columbia: under BLc in fig. 3.1 E, G and under RLc in 3.1 F, H; Wassilewskija: under RLc in fig. 3.2 F, H. Under BLc, shown in fig. 3.2. E, G, I did not detect any transients in accuracy of *GI::LUC* (Ws), perhaps because the "no sucrose control" was assessed only with the treatment suc 3% \rightarrow 0% which would inhibit transients].

Sucrose-dependent transients were recorded for rhythmicity. The indirect rhythmicity of examined circadian markers under the indicated light conditions increased with time only if sucrose was not supplemented during free run, whereas in the presence of sucrose, indirect rhythmicity was either constant between time windows [*CAB2::LUC* (Ws) and *GI::LUC* (Col-0) under BL] or even decreased over time (*GI::LUC* markers under RL). The result of these sucrose-dependent transients was that sucrose increased the indirect rhythmicity of the marker *GI::LUC* (Col-0) only temporally (Student's t-test: under BLc during the 1st-tw $p=1.38 \times 10^{-10}$ and during the 2nd-tw $p>0.14$; under RLc during the 1st-tw $p=4.72 \times 10^{-10}$ and during the 2nd-tw $p>0.05$ or sucrose decreased rhythmicity) and even decreased the indirect rhythmicity of the marker *GI::LUC* (Ws) in later time windows under RLc (2nd-tw, $p=2.51 \times 10^{-5}$; 3rd-tw, $p=9.05 \times 10^{-7}$). Similar results were scored with direct rhythmicity of the *GI::LUC* markers. The indirect rhythmicity of the marker *CAB2::LUC* (Ws) was increased by sucrose only temporally (suc 3% \rightarrow 0% vs. suc 3% \rightarrow 3%; 1st-tw, $p=5.54 \times 10^{-13}$; 2nd-tw, $p=0.17$), or

this effect was moderated over time (suc 0%→0% vs. suc 3%→3%), depending on the experimental details. Collectively, these experiments show clearly that sucrose can potentially decrease the robustness of oscillations, especially in later time windows. Moreover all of these examples define sucrose-dependent transients that show that supplementary sucrose affects the clock and not the controlled process or the enzymatic activity of the luciferase transgene.

Having described the effect of sucrose on oscillations of the *GI::LUC* and *CAB2::LUC* markers, I proceeded with similar tests using markers *CCA1::LUC* (Ws), *LHY::LUC* (Ws), *CCR2::LUC* (Ws) and *TOC1::LUC* (Ws). *CCR2::LUC* (Ws) oscillations exhibited a requirement for sucrose and the same was observed for oscillations of the *LHY::LUC* (Ws) marker in two preliminary experiments, one under RLc and one under BLc (not shown). Sucrose shortened circadian period in all of these cases [*CCA1::LUC* (Ws) under BLc, shown in fig. 3.5 C, and *TOC1::LUC* (Ws) under RLc in fig. 3.3 D], except for the marker *TOC1::LUC* (Ws) under BLc (fig. 3.3 C). It is noteworthy that oscillations of the later were reported to be resistant to sucrose under WLc in the literature (Dalchau *et al.*, 2011). Moreover, I confirmed that the effect of sucrose on period of *CCA1::LUC* (Ws) under BLc is temporal and observed the same in preliminary experiments for *TOC1::LUC* (Ws) under RLc and for *LHY::LUC* (Ws) under BLc (not shown).

Table 3.1: The sucrose status of entrainment is remembered during free run

Treatment suc 3%→0% yielded intermediate values in circadian parameters relative to those obtained with treatments suc 0%→0% and suc 3%→3% during the initial time window of the FFT analysis (figures 3.1 and 3.3). The indirect measure of mean RAE was calculated after plants discarded by FFT analysis were assigned with a RAE value of 1. SD-noPer is the SD of the RAE-normalized period after FFT analysis was performed.

Marker – circadian parameter		suc 0%→0%	suc 3%→0%	suc 3%→3%
<i>GI::LUC</i> (Col-0)	period	30.61±0.20h	28.37±0.14h	25.34±0.06h
	Mean RAE (indirect measure)	0.29±0.02h	0.24±0.01h	0.17±0.005h
	SD-noPer	2.57h	1.82h	0.95h
<i>CAB2::LUC</i> (Ws)	Mean RAE (indirect measure)	0.56±0.05	0.36±0.02	0.18±0.01
	SD-noPer	1.83h	1.39h	0.88h

Figure 3.1: The effect of sucrose on rhythmic expression of the luciferase marker *GI::LUC* (Col-0)

Seedlings were entrained for six days under WL and then placed in 96-well-microplates during the second half of the objective day; the sucrose status is indicated. Plates were placed in a TopCount luminometer at dusk of the same day and plants entered free running conditions under monochromatic BLc (A, C, E, G) or RLc (B, D, F, H) at the next dawn (ZT 0h). Panels A and B show the time-course of average luminescence from representative experiments, while the rest show combined data from the independent experiments (six experiments under BLc and three under RLc). In panels E and F RAE and circadian period are paired for all the plants that generated an FFT output (RAE<0.9; see Methods). In panels G and H mean-RAE and noPer of populations are paired after plants rejected by BRASS were assigned with a value of 1; later time windows are represented by smaller symbols. Error bars represent SE in all panels except for the horizontal bars in G and H that represent SD of noPer. In A, B, G and H vertical error bars are smaller than the symbols.

Under RLc FFT analysis was performed during the time windows 06-101 h (1st-tw), 31-126 h (2nd-tw) and 56-151 h (3rd-tw) (beginning of free run was initiated at 0 h, as indicated in the figures). Under BLc, FFT analysis was performed during the time windows 06-96 h (1st-tw) and 31-121 h (2nd-tw). The interval of period values allowed by the BRASS software during FFT analysis was set between 15 and 45 h for RL experiments and between 15 and 40 h for BL experiments. Error bars represent SE.

Sucrose-mediated period shortening (C, D) and the increase in accuracy (E, F, G, H) were moderated with time. Sucrose increased rhythmicity only temporally (G, H). The effect of time (between time windows) on these parameters was sucrose-dependent (G, H).

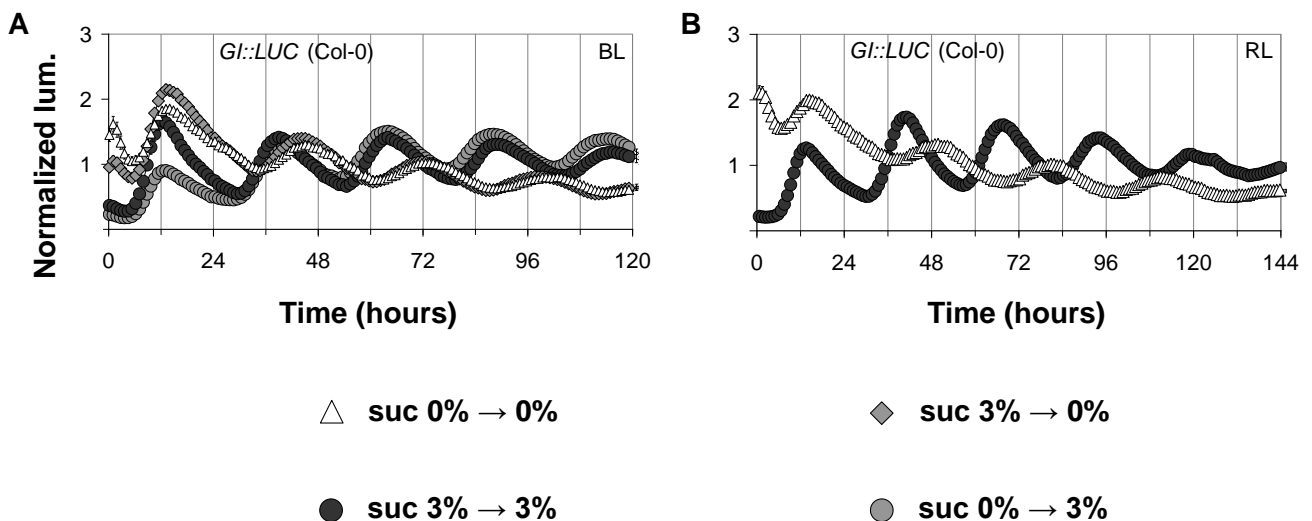

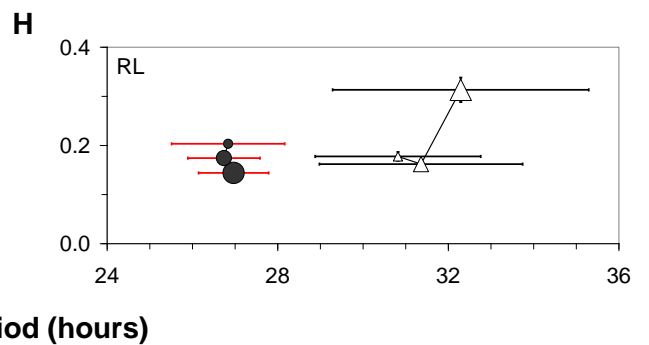
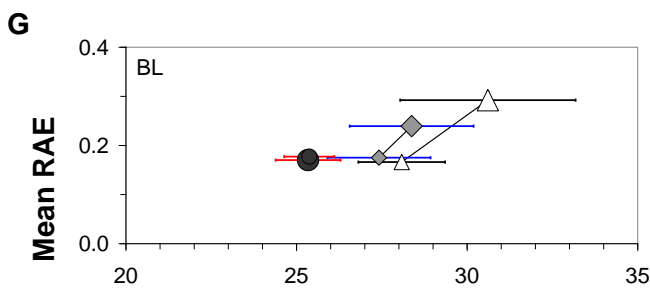
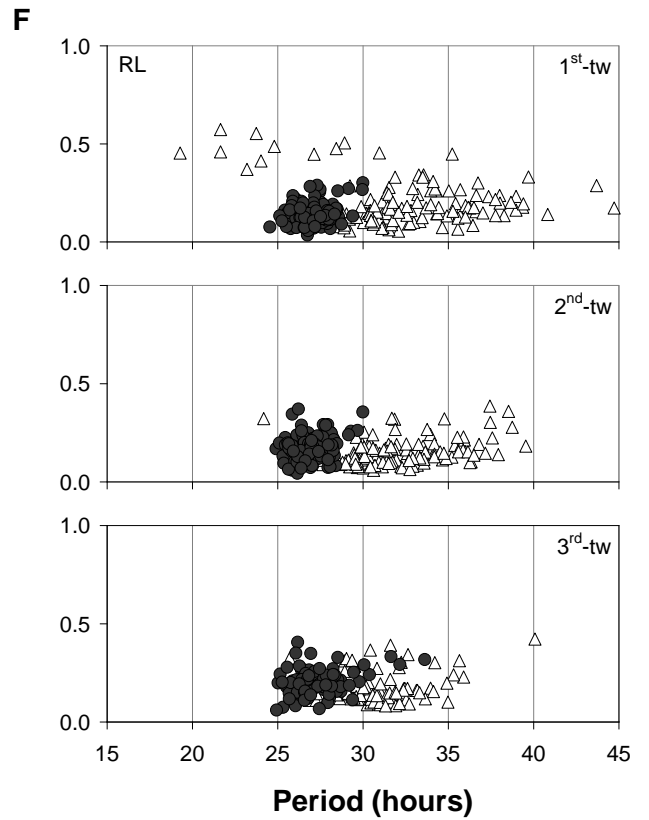
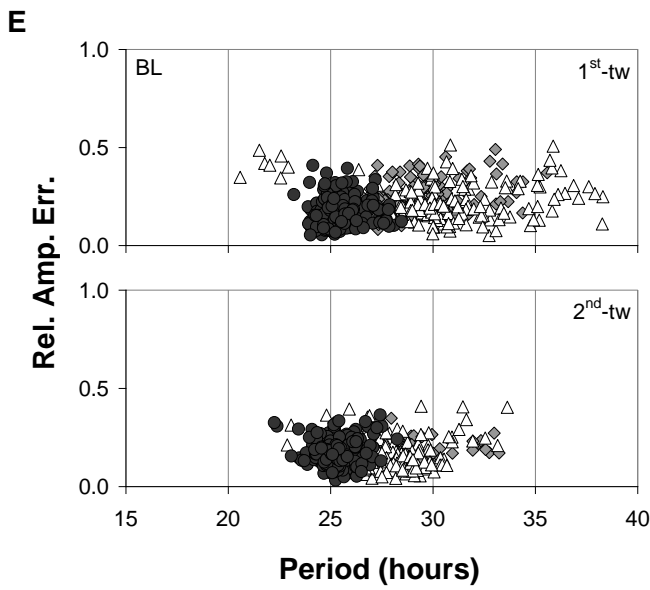
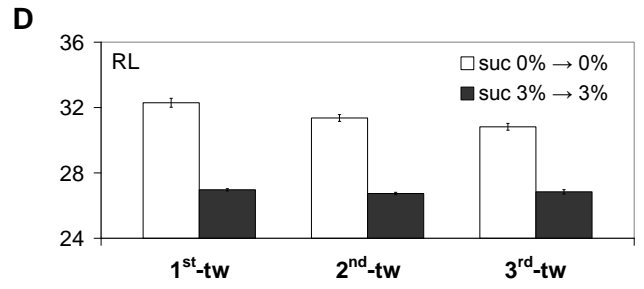
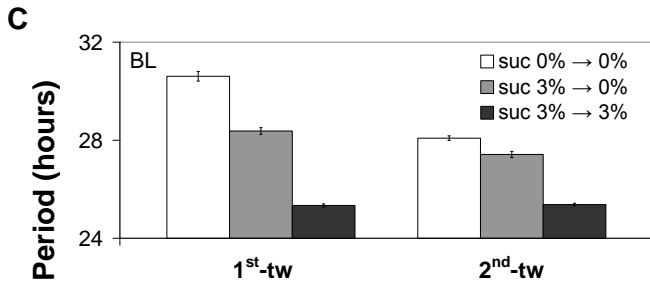

△ suc 0% → 0%

◆ suc 3% → 0%

● suc 3% → 3%

● suc 0% → 3%

Figure 3.2: The effect of sucrose on rhythmic expression of the luciferase marker *GI::LUC* (Ws)

Seedlings were grown and entrained under WL as described in figure 3.1. Two independent experiments were performed under BLc (A, C, E, G) and two under RLc (B, D, F, H). The vertical/horizontal axes, error bars, symbols and FFT analysis are as described in figure 3.1.

Sucrose shortened the circadian period (C, D) and this effect was moderated with time; in both cases, the effect of time on circadian period was sucrose-dependent (see also G and H). Under RLc, the effect of time (comparison between time windows) on the robustness of oscillations was sucrose-dependent (F, H). Under BLc, I did not detect any transients in oscillatory robustness, likely because the treatment suc 0%→0% was not performed (see text for more details).

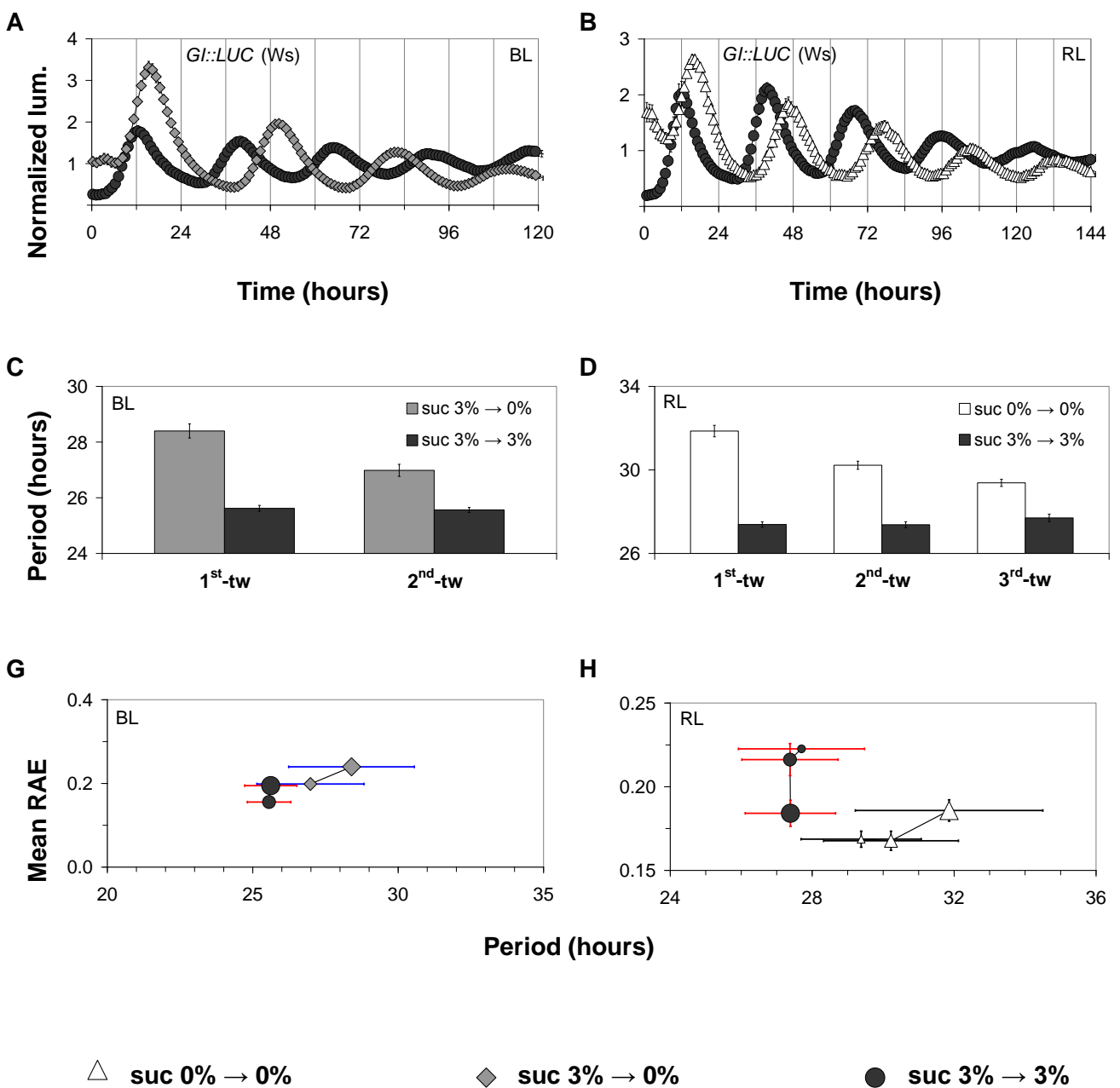

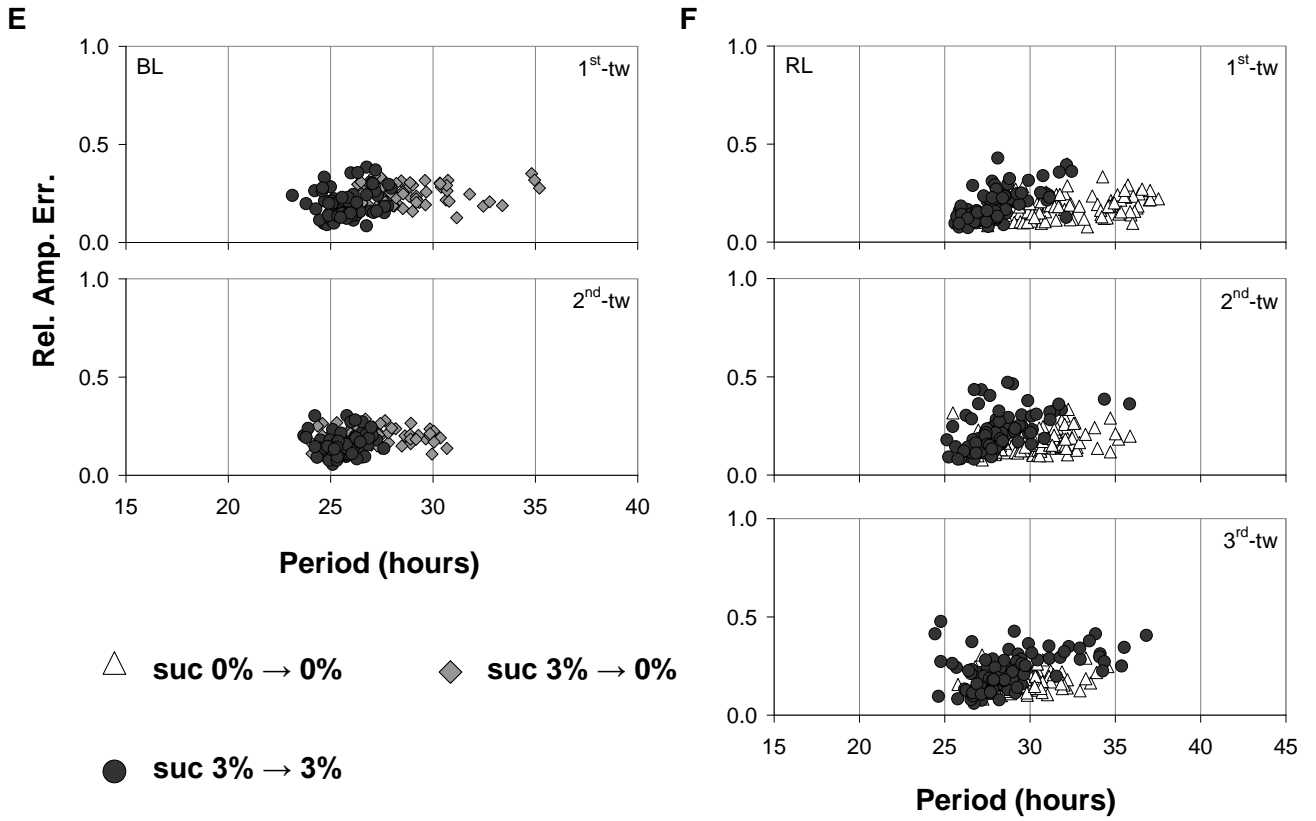

Figure 3.3: The effect of sucrose on rhythmic expression of *CAB2::LUC* (Ws) under BLc and on *TOC1::LUC* (Ws) oscillations

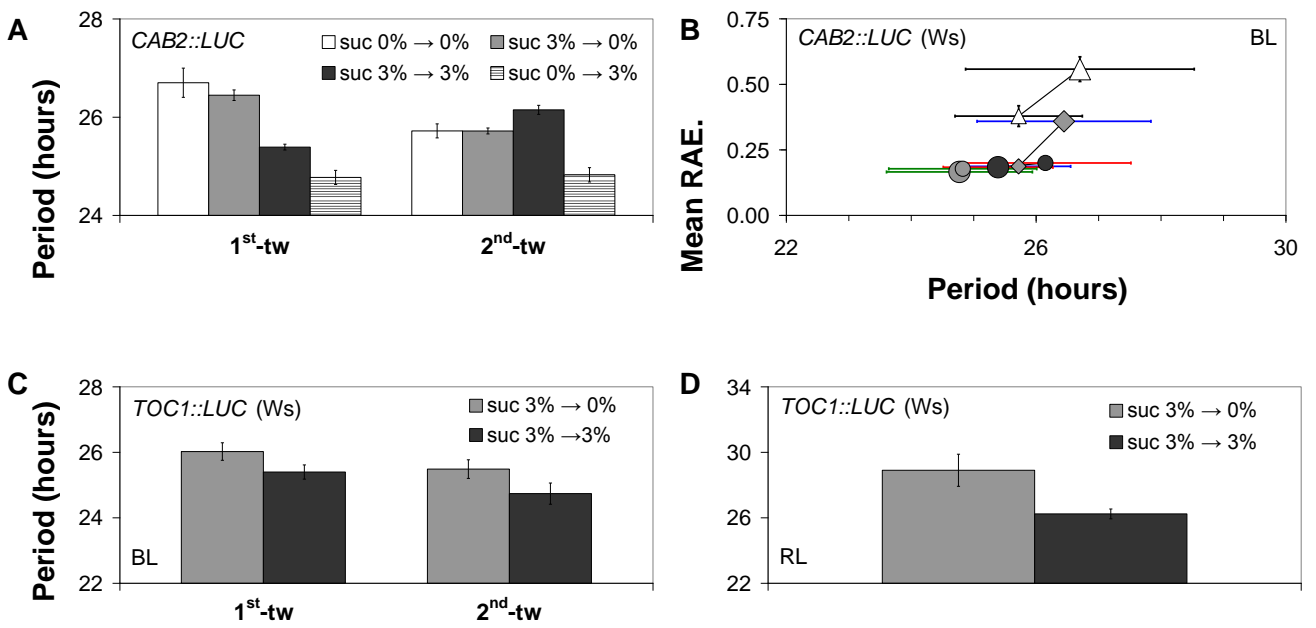

Figure 3.3: Seedlings were grown and entrained as described in figure 3.1 for BLc. The vertical/horizontal axes, the error bars and the symbols used in **B** are as described in figure 3.1. All four sucrose shifts were conducted with this marker. FFT analysis was performed during the time windows 21-96 h (1st-tw) and 46-121 h (2nd-tw) (beginning of free run took place at 0 h). The interval of period values allowed by the BRASS software during FFT analysis was set between 15 and 35 h.

(**A**) Sucrose temporally shortened the circadian period of the marker *CAB2::LUC* (Ws). Plants that received the suc 0%→3% treatment produced the strongest period response to sucrose. The effect of time on the circadian period (comparison between time windows) was sucrose-dependent. (**B**) Robustness (indirect rhythmicity and accuracy) was increased by sucrose; sucrose-dependent transients in robustness are shown. (**C, D**) Sucrose shortened the circadian period of the marker *TOC1::LUC* under RLc (one of two experiments shown in **D**) but not under BLc (in independent experiments and their combined data in **C**). noPer is shown as large open symbols (large circles: with sucrose; large rhomboids: no sucrose).

3.1.2. The response of the *toc1-21* mutant to sucrose

The *toc1-21* loss-of-function mutation shortens period (Strayer *et al.*, 2000; Alabadí *et al.*, 2001) of circadian oscillations and exhibits distinct circadian phenotypes under RLc and BLc. The mutation also causes *CAB2::LUC* and *CCR2::LUC* oscillations to dampen under RLc, but oscillations persist under BLc, although with decreased amplitude (Más *et al.*, 2003a). Consequently, TOC1 contributes to light-dependence on rhythmicity. I also noticed that oscillations in *toc1-21* were more robust under BLc when compared to those under RLc (compare fig. 3.4 A with B), but I was able to detect weak oscillations under RLc in the mutant using the marker *GI::LUC* (Ws) instead.

Importantly, despite the observed dampening, these oscillations [*GI::LUC* (Ws) in *toc1-21* under RL] produced an FFT output in three consecutive time windows. The *toc1-21* mutant then appeared more sensitive to sucrose-mediated period shortening and surprisingly its short-period phenotype was sucrose dependent and could not be detected in the absence of supplementary sucrose (fig. 3.4 B and D). The sucrose-dependent phenotype of *toc1-21* under RLc was persistent across three time windows indicating that sucrose-dependent long-term circadian responses are altered in the mutant. In contrast, the short-term circadian consequences of the *toc1-21* mutation were sucrose-independent. This is because the mutation advanced the first circadian peak (fig. 3.4B) irrespective of the sucrose status during free run.

Under BLc, the sucrose-related circadian phenotypes of *toc1-21* were similar, but less severe, relative to those observed under RLc. The short-period phenotype in this case [measured with the

timing of the third peak of *CAB2::LUC* (Ws) during free run, fig. 3.4 C] was not restricted in the presence of sucrose, but was enhanced by it; moreover, the mutant appeared more sensitive to sucrose than the wild-type.

Figure 3.4: The effect of sucrose on oscillations of the *toc1-21* mutant

Seedlings were grown and entrained as described in figure 3.1. Figures represent combined data from three independent experiments under BLc with the marker *CAB::LUC* (Ws) (C) and from two experiments under RLc with the marker *GI::LUC* (Ws) (D). Representative experiments under BLc (A) and RLc (B) are also shown. FFT analysis was performed as described in figure 3.3 for BL experiments and as described in figure 3.1 for RL experiments. Error bars represent SE. Under RLc, oscillations in the *toc1-21* mutant dampened gradually (B), while under BLc they were maintained until the end of the experiment (A). Under RLc, the short-period phenotype of the *toc1-21* mutant was restricted on growth medium that contained sucrose (D); similarly, the phenotype was enhanced by sucrose under BLc (shown indirectly in C with the timing of the third circadian peak). The mutant was more sensitive than the wild-type to sucrose-mediated period shortening under both light conditions.

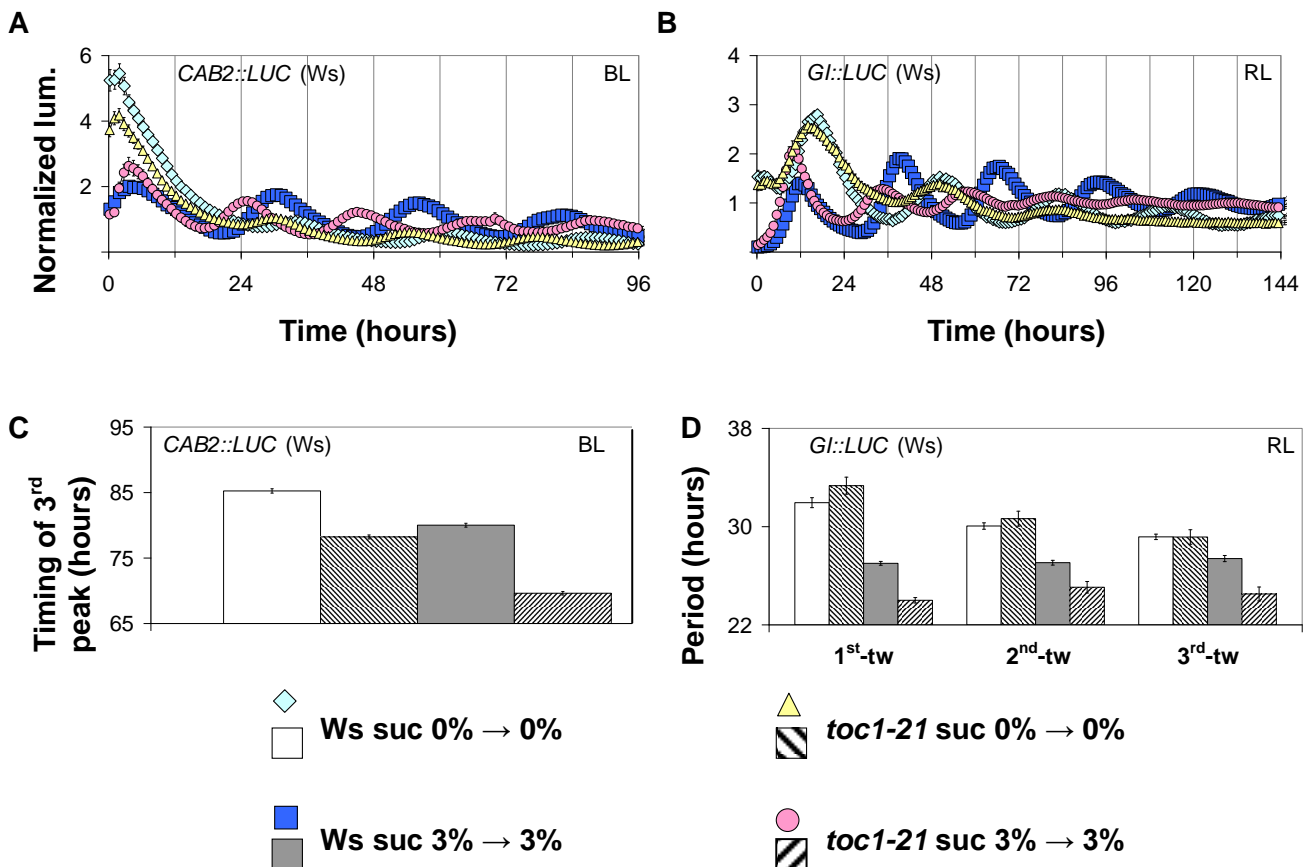

3.1.3. The response of the *gi-11* mutant to sucrose

The *gi-11* mutant produced oscillations that were less robust relative to those of the wild-type, irrespective of light quality and the sucrose status during free run (fig. 3.5 A and C). A previous study that tested oscillations of the marker *CCR2::LUC* in this mutant under monochromatic BLc or RLc (in the presence of sucrose; Martin-Tryon *et al.*, 2007) reported similar findings. To my surprise, despite the lack of persistent rhythms in the *gi-11* population under RLc (fig. 3.5 A; see both *gi-11* curves, with and without sucrose), individual seedlings of *gi-11* produced an FFT output. This is suggestive that the lack of detectable oscillations in the population-graphs of *gi-11* was due to the lack of synchrony between individual seedlings, which was confirmed by visual inspection of the respective data files. Oscillations under RLc were tested with the marker *GI::LUC* (Ws) and under BLc with *CCA1::LUC* (Ws) and *CAB2::LUC* (Ws). Under BLc, reproducibility was achieved during the 1st-tw only. For this reason, comparisons between RLc and BLc experiments refer to this time interval.

Under RLc, the *gi-11* mutant exhibited sucrose-dependent phenotypes and responses [marker *GI::LUC* (Ws) in fig. 3.5 B] that were opposite those seen with BLc [marker *CCA1::LUC* (Ws) in fig. 3.5 D; marker *CAB2::LUC* (Ws) in fig. 3.5 E]. In more detail, (1) under RLc, the *gi-11* mutant was oversensitive to sucrose in terms of period shortening while under BLc it was resistant and (2) under RLc, sucrose increased the accuracy of the *gi-11* mutant and the opposite was observed under BLc, where sucrose decreased the accuracy of the mutant. Notably, in the latter case, the mutant, known for its lack of robust oscillations (Martin-Tryon *et al.*, 2007), was less accurate than the wild-type only if sucrose was supplemented. (3) Under BLc, sucrose moderated the short-period phenotype, whereas under RLc, a short-period phenotype was observed only if sucrose was exogenously applied.

A series of observations were suggestive that GI has a distinct role during metabolic entrainment to sucrose under RL. Firstly, in the presence of sucrose, the mutant showed a short-period phenotype that was moderated over time, whereas in the absence of supplemented sucrose, there was a long-period phenotype that was enhanced over time (fig. 3.5 B). These observations define a phenotype in transients; notably, the *gi-11* mutant did not exhibit the characteristic period-transients (fig. 3.5 B) described earlier for the wild-type under RLc with the suc 0%→0% treatment. Secondly, the *gi-11* mutant was oversensitive (more than three-fold) relative to wild-type in terms of short-term circadian responses to sucrose, seen in the sucrose-mediated advance of the first circadian peak (phase difference \pm SD is 10.43 \pm 2.07h for the mutant versus 3.1 \pm 1.11h for the wild-type; fig. 3.5 A). Both phenotypes, in terms of transients and phase, demonstrate that GI is part of a pathway

that mediates metabolic signals to the clock during entrainment to RL because phase and, as earlier explained, transients result from entrainment. In agreement with these, previously GI was proposed to act within light-input pathways (Park *et al.*, 1999; Locke *et al.*, 2006), via phyB signaling in particular (Huq *et al.*, 2000).

Figure 3.5: The effect of sucrose on oscillations of the *gi-11* mutant

GI affects sucrose signaling to nuclear oscillations in a light quality-dependent manner. Seedlings were grown and entrained as described in figure 3.1. Plants were exposed to the same sucrose status during entrainment and during free run (A, B, E) or were entrained in the presence of sucrose (C, D). FFT analysis was performed as described in figure 3.3 for BL experiments and as described in figure 3.1 for RL experiments. Two independent experiments were performed under RLc with the marker *GI::LUC* (Ws) (B), two under BLc with the marker *CCA1::LUC* (Ws) (D) and four under BLc with the marker *CAB2::LUC* (Ws) (E). Representative experiments are shown in A and C, while panels B, D and E show combined data from the independent experiments. Large black symbols in D represent average values of the respective populations. Error bars represent SE in all figures except for the colored bars in B that represent SD of noPer. In B later time windows are represented by smaller symbols.

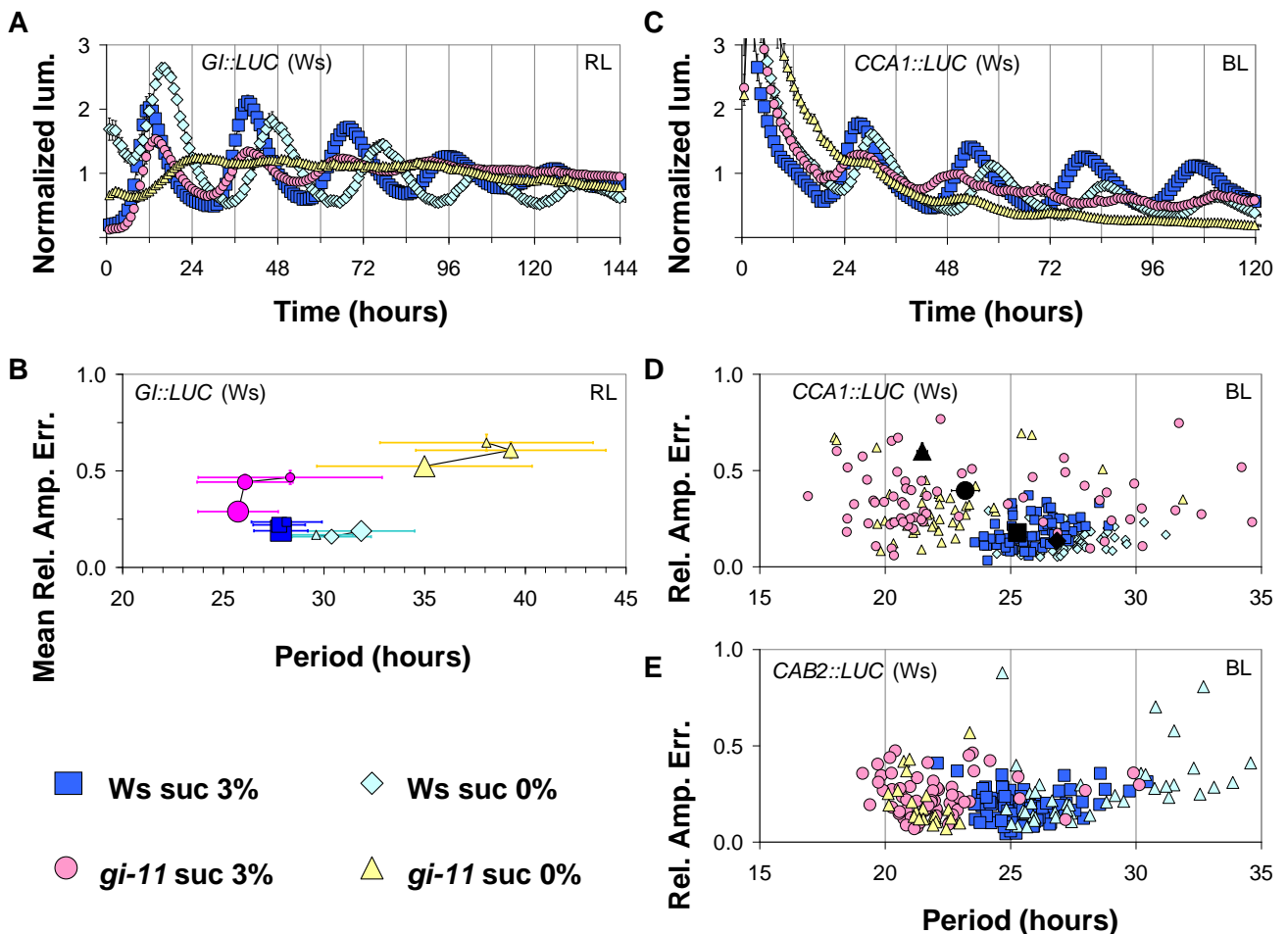

3.1.4. The response of the *phyB-9* mutant to sucrose

phyB is known to be the RL photoreceptor in circadian responses. The involvement of *phyB* in BL input to the clock was genetically excluded with experiments that failed to detect period phenotypes in *phyB-1* under a wide range of fluence rates in the presence of exogenous sucrose (Somers *et al.*, 1998a; Devlin and Kay, 2000). By contrast, I found that, under BLc, the loss-of-function mutant *phyB-9* had a sucrose-dependent short-period phenotype (masked by sucrose; fig. 3.6 A). This phenotype was scored during an early time window of the analysis (defined in fig. 3.1) and was not reproducibly observed later than that. Sucrose similarly affected *phyB-9* phenotypes under RLc. I observed the known weak long-period phenotypes of loss-of-function alleles under RLc (Somers *et al.*, 1998a; Delvin and Kay 2000; Palágyi *et al.*, 2010) with *phyB-9* in the presence of sucrose and further showed that, in the absence of sucrose, this phenotype is attenuated or even reversed to a short-period phenotype in some experiments. Similar phenotypes were scored with the timing of the third circadian peak, which was delayed by the mutation only in the presence of sucrose, whereas in the absence of sucrose, peaks were advanced or not affected by the mutation (fig. 3.6 B).

Figure 3.6: The effect of sucrose on oscillations of the *phyB-9* mutant

The *phyB-9* mutant showed similar sucrose-dependent period phenotypes under BLc (A) and under RLc (B). Growth and entrainment of seedlings and FFT analysis were performed as described in figure 3.1. Error bars represent SE.

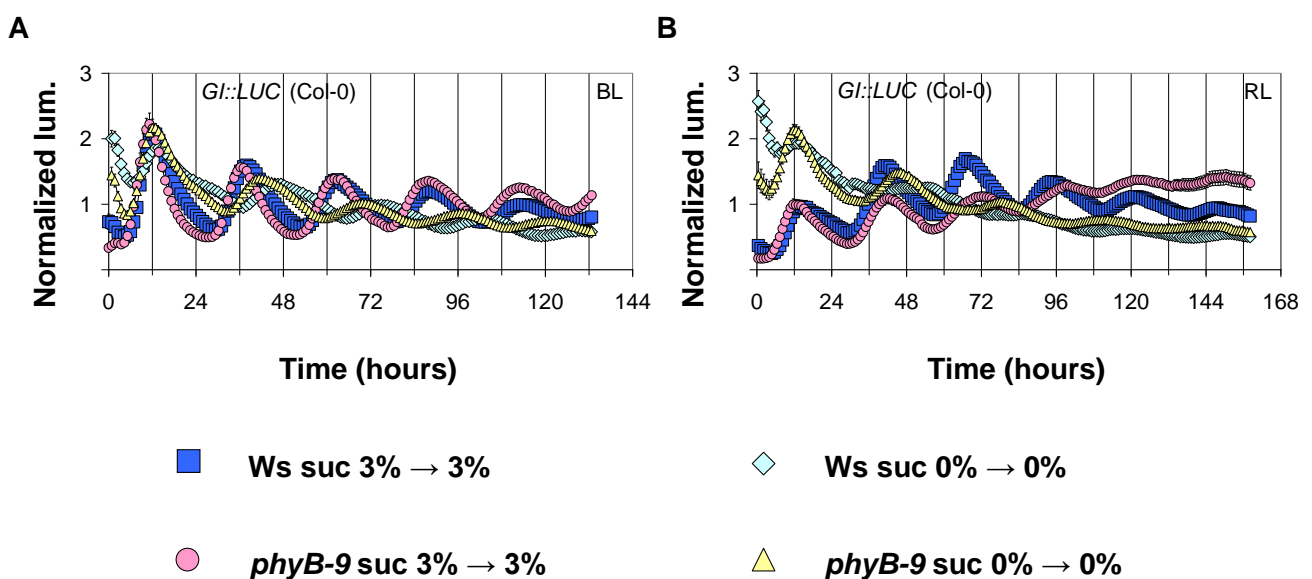

3.1.5. The responses of the *cca1-11*, *lhy-21* and *cca1-11;lhy-21* mutants to sucrose

The single *cca1-11*, *lhy-21* and double *cca1-11;lhy-21* mutants that harbor respective null alleles (Green and Tobin, 1999; Hall *et al.*, 2003) were analyzed under RLc and BLc with marker *CAB2::LUC* (Ws). Visual inspection of the TopTemp graphs surprisingly showed that under BLc the double mutant produced robust oscillations, as long as there was no supplementary sucrose added during free run (fig. 3.7 D). Quantification of rhythmicity revealed that the mutant was equally rhythmic to wild-type with treatment suc 0%→0% (Student's t-test for differences in indirect rhythmicity between mutant and wild-type, $p=0.90$) and less rhythmic with any other treatment (suc 3%→0% $p=4.90 \times 10^{-6}$, suc 3%→3% $p=1.31 \times 10^{-8}$, suc 0%→3% $p=1.65 \times 10^{-8}$). In addition this, the mutant was to my surprise more accurate than the wild-type as long as plants were never exposed to supplementary sucrose (fig. 3.7 E). Under RLc, the mutant did not produce robust oscillations, and this was not modified by exogenous sucrose (fig. 3.8).

Together, these results show that, under BLc, the *cca1-11;lhy-21* mutant expresses a sucrose-sensitive oscillator whose sustainability depends on and requires cytosolic sucrose-related oscillations. Moreover, the fact that the phenotypes described here in oscillatory robustness (measured by the transcriptional rate rhythm) are dependent on the sucrose status during entrainment [*e.g.* the low rhythmicity phenotype of *cca1-11;lhy-21* is observed with treatment suc 3%→0% ($p=4.90 \times 10^{-6}$) but not with treatment suc 0%→0%], suggests that metabolic oscillations entrain nuclear ones (see chapter 4.4. for more on this issue). Whether oscillations of the *cca1-11;lhy-21* mutant are sustained over time under WLc is a subject of controversy in the literature (see Lu *et al.*, 2009 and references below). My findings show that sucrose could be the source of this controversy, as authors that used sucrose reported gradual dampening in the oscillations of *cca1-11;lhy-21* (see Materials and Methods of Alabadí *et al.*, 2002; Mizoguchi *et al.*, 2002; Ding *et al.*, 2007; Locke *et al.*, 2005b), while authors that used less sucrose reported sustained oscillations (Lu *et al.*, 2009). Of note, none of these studies addressed the effect of sucrose in circadian rhythms.

Figure 3.7: The effect of sucrose on oscillations of the *CAB2::LUC* (Ws) marker in *cca1-11*, *lhy-21* and *cca1-11;lhy-21* mutants and the wild-type under blue light

Growth and entrainment of wild-type (wt) and mutant (mut) seedlings were performed as described in fig. 3.1. FFT analysis for panels B, C and E was performed as described in fig. 3.3, only in E the minimum period value allowed by the BRASS software during FFT analysis was lowered from 15 to 12 h. Error bars

represent SE. The *cca1-11* mutant was resistant to sucrose-mediated period shortening and over-resistant (sucrose lengthened circadian period) during the late time window (A, B). The *lhy-21* mutant was temporally oversensitive to sucrose-mediated period shortening (C). The *cca1-11;lhy-21* double mutant was robustly rhythmic in the absence of supplementary sucrose (D). Sucrose increased the accuracy of the wild-type but decreased the accuracy of the *cca1-11;lhy-21* double mutant.

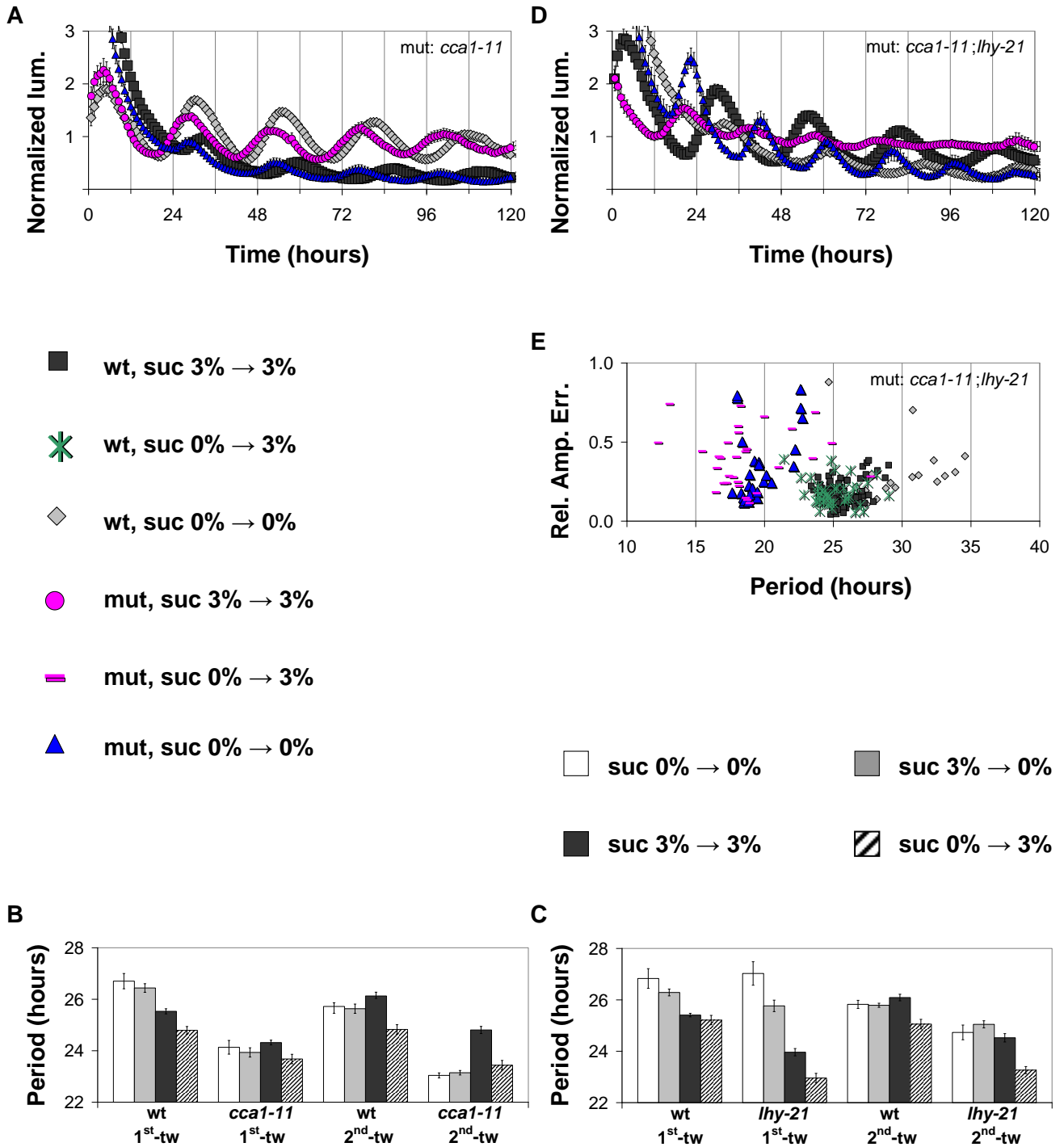
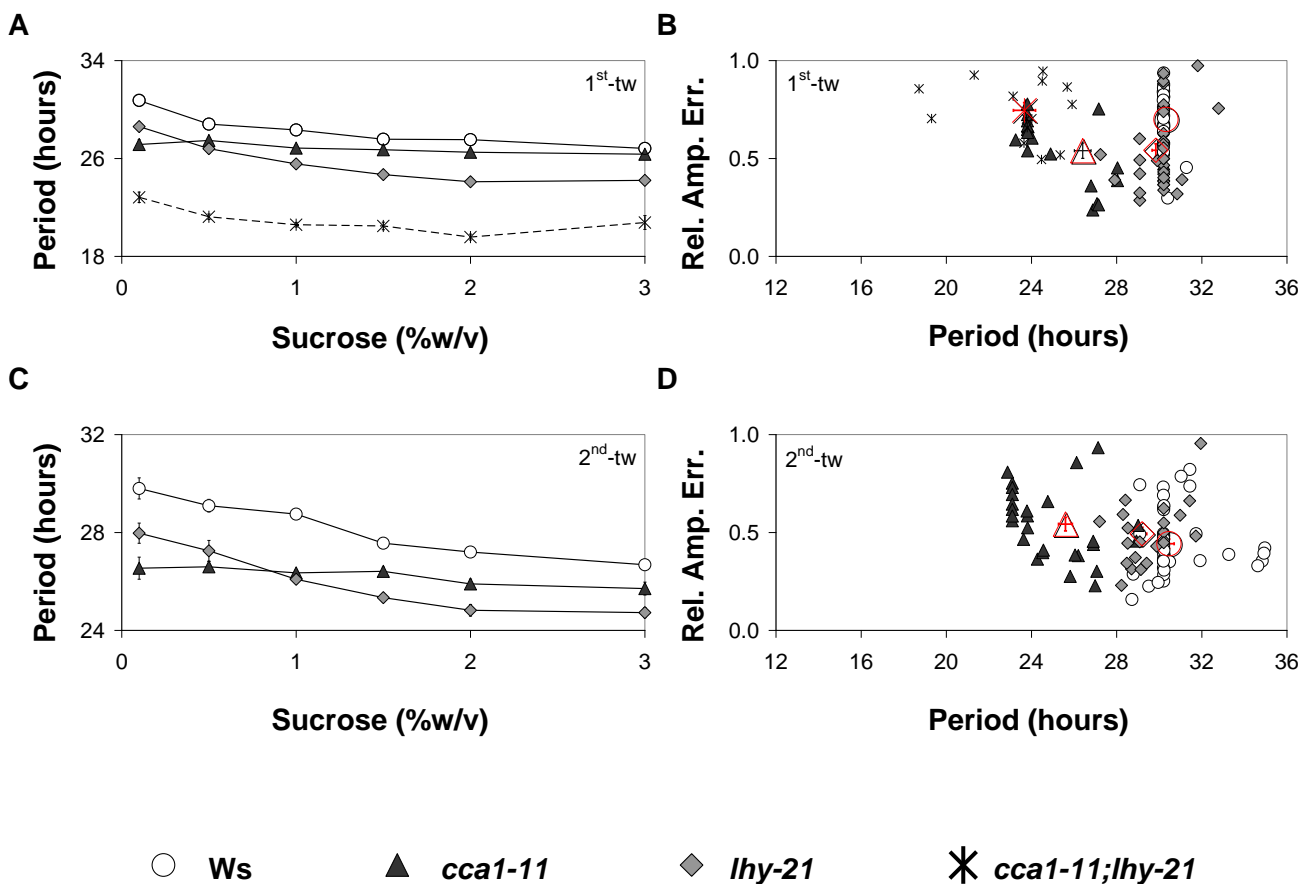

Figure 3.8: The effect of sucrose on oscillations of the *CAB2::LUC* (Ws) marker in the *cca1-11*, *lhy-21* and *cca1-11;lhy-21* mutants under red light

Growth and entrainment of seedlings were performed as described in fig. 3.1. FFT analysis in panels **A** and **B** was performed during the time window 16-116h (1st-tw) and in panels **C** and **D** during the time window 46-146 h (2nd-tw, approximately one wild-type oscillation from the 1st-tw) for. For the *cca1-11* and *lhy-21* single mutants and their wild-type controls, the period interval required by the BRASS program was set between 15 and 35 h. For the *cca1-11;lhy-21* double mutant this interval was extended between 12 and 35 h. The wild-type produced almost identical (**A**) or identical results (**B**) in both intervals; thus, the data of the single and double mutants were comparable to each other. In panels **B** and **D** (no sucrose), the RAE and circadian period were paired for plants that generated an FFT output (RAE<1 instead of 0.9). Large symbols represent the average RAE and noPer of the populations. In panels **A** and **C**, the effect of sucrose is shown with sucrose response curves. Experiments of figure 3.8 were designed and analyzed by the author of this work and performed by Mr. Zisong Ma and Mrs. Amanda Davis who worked at the MPIZ at the time.



Sucrose-related phenotypes and responses of the single *cca1* and *lhy* mutants were not severely affected by light quality. In every case, *cca1-11* was related to long-term and *lhy-21* to short-term circadian responses to sucrose. In more detail, under BLc, the *cca1-11* mutant was resistant to sucrose during the 1st-tw and over-resistant (sucrose lengthened the circadian period) during the 2nd-tw (fig. 3.7 A and B). Similarly, under RLc, *cca1-11* plants were less sensitive relative to wild-type to sucrose in terms of period shortening (almost resistant) and the short-period phenotype of the mutant was moderated by sucrose. This is shown in the sucrose dose-response curves (SRCs, showing period as a function of sucrose concentration) of wild-type and the *cca1-11* mutant that converge towards high concentrations of sucrose (1st-tw in fig. 3.8 A; 2nd-tw in 3.8 C). The FFT output produced in the absence of sucrose (fig. 3.8 B and D) was consistent with these results. Similar to what was observed under BLc, these phenotypes of *cca1-11* under RLc were persistent between time windows. Therefore, CCA1 is involved in long-term circadian responses to sucrose. The *lhy-21* mutant under BLc was oversensitive to sucrose period shortening (fig. 3.7 C) during the 1st-tw and consequently at this time, and then only, the short-period phenotype of the mutant required sucrose to appear. Under RLc, the SRCs of *lhy-21* were parallel to those of the wild-type (fig. 3.8 A and C), indicating that in this case LHY does not affect responsiveness to sucrose. On the other hand, FFT analysis of the oscillations conducted with the suc 0%→0% treatment showed that the short-period phenotype of the mutant was essentially absent (fig. 3.8 B) during the 1st-tw but reappeared during the 2nd-tw (fig. 3.8 D). Consequently, the phenotype of *lhy-21* was dependent on sucrose, but only temporally. It is noteworthy that the phenotypes of the single mutants were opposite to each other, in that *cca1-11* was persistently resistant or over-resistant (BLc) or less sensitive (RLc) than the wild-type to sucrose, whereas the *lhy-21* mutant was temporally over-responsive to sucrose (at least under BLc). Under BLc, the *cca1-11;lhy-21* mutant was not resistant to sucrose (fig. 3.7 D and E). Therefore, the *cca1-11* mutation is not epistatic to the *lhy-21* mutation. In addition to these, the short-period phenotypes of the single and the double mutants were not additive (as previously shown), perhaps supporting that CCA1 and LHY can act synergistically (Lu *et al.*, 2009; Yakir *et al.*, 2009).

3.2. Circadian responses to chemicals that affect metabolism

A chemical approach was used to investigate the potential crosstalk between TTFLs and metabolism. ROS and redox-related chemicals from a small library were exogenously applied on 6 day old seedlings in microtiter plates and the effect of the chemicals on rhythmicity was monitored via the promoter:*luciferase* system. For this I tested chemicals affecting the thioredoxin and glutaredoxin systems (inhibitor of glutathione synthesis buthionine sulfoximine and inhibitor of thioredoxin reductase chlorodinitrobenzene), respiration inhibitors (antimycin A, rotenone and inhibitor of respiratory alternative oxidase salicylhydroxamic acid), oxidants (menadione, paraquat, butylhydroperoxide) and antioxidants (vitamin C and dithiocarbamate). I also tested the phytohormone SA, norbornadiene (inhibitor of ethylene perception), diphenylene iodonium (inhibitor of plasma membrane NADPH oxidases involved in the hypersensitive reaction during pathogen recognition), photosynthesis inhibitor DCMU and butanedione monoxime (ROS inducing inhibitor of cytoplasmic streaming). Bioluminescence was measured in an automated luminometer (Packard TopCount) and rhythmic traces were subsequently scored with FFT-NLLS. Various markers were used on medium that contained sucrose, while some experiments were later conducted without sucrose. Chemicals that altered the noPer of marker *GI::LUC* (Ws) on medium that contained sucrose are shown in figure 3.9 A. The antioxidant vitC shortened the period of the rhythmic marker under RLc and in the dark, but no effect was observed under BLc. The inhibitor of organellar transcription rifampicin lengthened the circadian period in more than five experiments conducted with various protocols, two in the dark (fig. 3.9 A), two under BLc and one under RLc (not shown). The inhibitor of photosynthetic electron transport DCMU lengthened the circadian period under monochromatic RLc and under monochromatic BLc. Figure 3.9 B shows the effect of the oxidant paraquat on the period of the markers *GI::LUC* (Ws) and *CCR2::LUC* (Ws) under monochromatic light. Under RLc, paraquat shortened the period of the marker *GI::LUC* (Ws), while it lengthened the period of the marker *CCR2::LUC* (Ws). Under BLc, paraquat lengthened the period of circadian oscillations in two independent experiments, one conducted with the marker *GI::LUC* (Ws) and one with the marker *CCR2::LUC* (Ws).

Figure 3.9: Chloroplast-related chemicals perturb nuclear oscillations

The differences in period discussed below were always greater than 1 hour. In (A) and (B), the controls are colored dark blue or red according to the light conditions used during the free run. (A) The effect of SA, vitC, rifampicin and DCMU on the circadian period of marker *GI::LUC* (Ws) is shown. SA 1 mM shortened the circadian period. VitC (white bars: 2 mM; dashed bar: 3 mM) shortened the circadian period of the marker under RLc and in the dark; oscillations were not affected under BLc (not shown). Rifampicin (150 μ g/ml) lengthened the circadian period of the marker in the dark and under monochromatic light [not shown; in one experiment under BLc and in one under RLc with the marker *GI::LUC* (Ws) and in one with the marker *CCR2::LUC* (Ws) under BL]. DCMU (white bars: 5 μ M; vertically dashed white bar: 7.5 μ M; horizontally dashed gray bars 10 μ M) lengthened circadian period under RLc and under BLc. (B) The effect of paraquat (white bars: 7.5 μ M; gray bars: 10 μ M) on the circadian period markers *GI::LUC* (Ws) and *CCR2::LUC* (Ws) is presented. Under RLc, paraquat lengthened the period of marker *CCR2::LUC* (Ws) (in three experiments), and shortened the period of marker *GI::LUC* (Ws) (in two out of three experiments). Under BLc, paraquat increased the period of circadian oscillations in two independent experiments; one experiment was conducted with the marker *GI::LUC* (Ws) and one with the marker *CCR2::LUC* (Ws). (C), (D), (E), (F) The effect of SA on circadian parameters of various markers under RLc+BLc. Plants received two dawn events in the presence of SA, one in a WL cabinet and one in a luminometer, and were then released into free running conditions. Each marker was tested for responsiveness to SA in two to four experiments. The circadian period was shortened inconsistently between experiments, but when the results were combined, the descriptive (not RAE normalized) circadian period of the markers *GI::LUC* (Ws) (C) and *CCA1::LUC* (Ws) (D) was shortened by SA. Accuracy and rhythmicity were always increased by SA at 1 mM. The markers *GI::LUC* (Ws) and *TOC1::LUC* (Ws) were the most responsive to SA when accuracy was measured. The markers *TOC1::LUC* (Ws) and *CCR2::LUC* (Ws) were the most responsive to the SA-mediated increase of rhythmicity as they responded to SA at 0.5 mM when the data from independent experiments were combined.

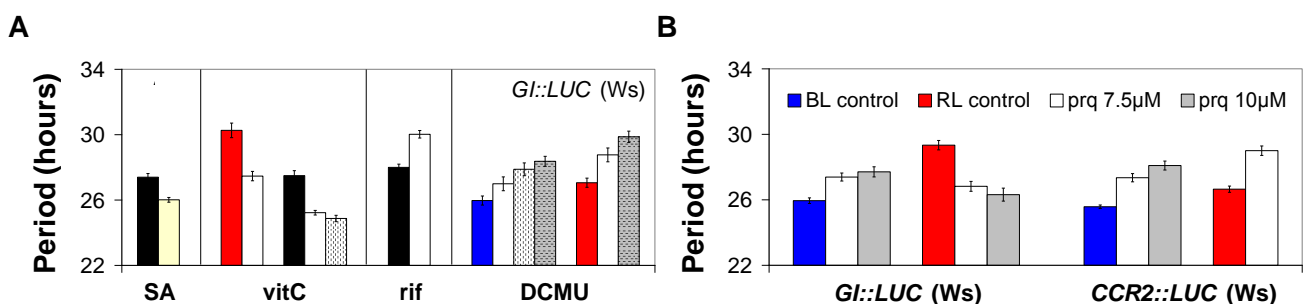

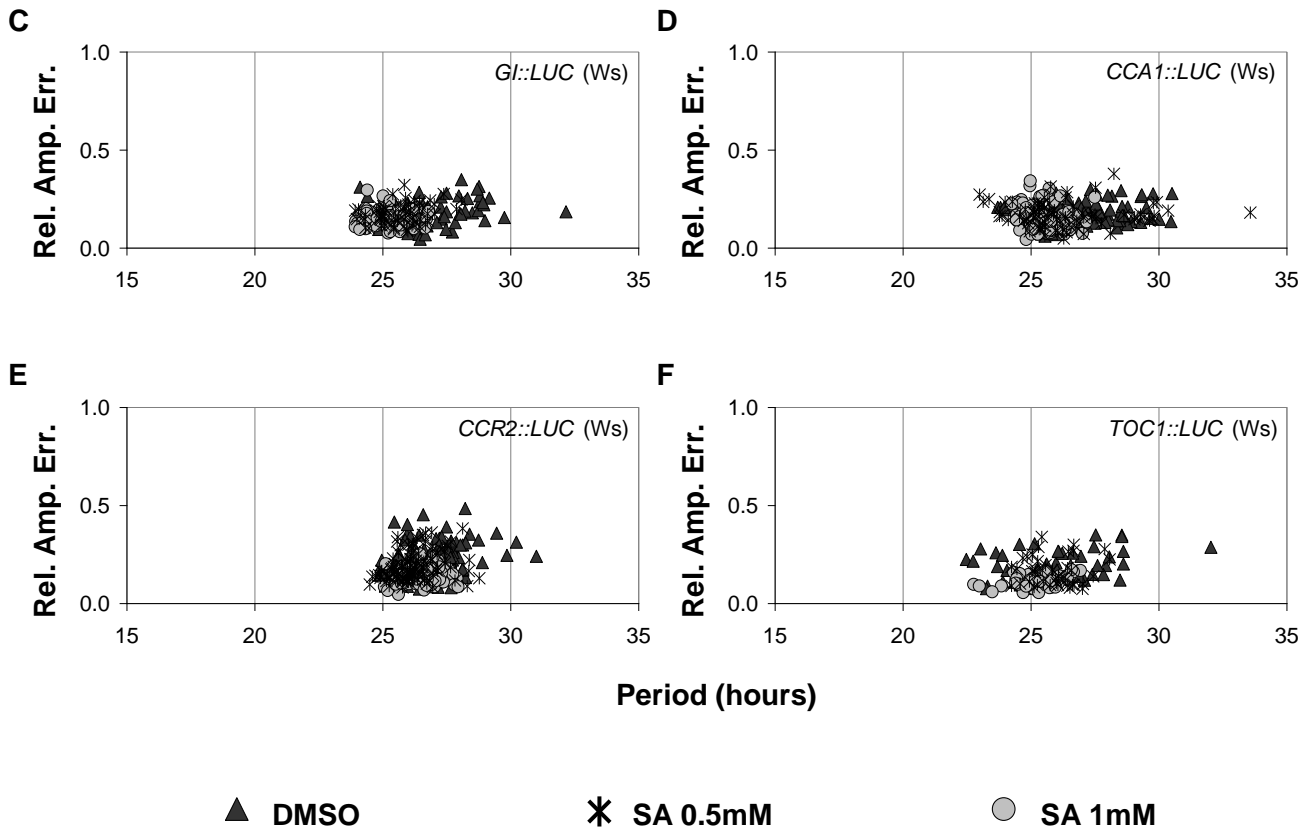

3.2.1. The effect of salicylic acid on the rhythms of wild-type plants

Under continuous RL+BL (a "synthetic" WLC), the stress hormone SA shortened the period of the rhythmic markers tested, including *GI::LUC* (Ws), *CCA1::LUC* (Ws), *CCR2::LUC* (Ws) and *TOC1::LUC* (Ws). This was inconsistent between experiments (all markers were tested in two to four experiments). When the results from independent experiments were combined, the period shortening effect of SA was statistically significant for the markers *GI::LUC* (Ws) and *CCA1::LUC* (Ws) (fig. 3.9 C and D). This contradicts a previous report according to which SA does not act on circadian rhythmicity (Hanano *et al.*, 2006). Notably, in the experiments shown in figures 3.9 C to F, SA increased the robustness of oscillations of all four markers tested. SA at 1 mM increased the rhythmicity of oscillations of the rhythmic markers in every experiment, while SA at 0.5 mM increased the rhythmicity only of the markers *TOC1::LUC* (Ws) and *CCR2::LUC* (Ws). Accuracy was always increased by SA at 1 mM, while SA at 0.5 mM reproducibly increased the accuracy of the markers *GI::LUC* (Ws) and *TOC1::LUC* (Ws). The effect of SA on accuracy suggests that SA affects the clock through entrainment pathways.

Figure 3.10: The effect of salicylic acid on promoter::luciferase constructs is marker specific

Plants were entrained on medium with sucrose and then placed on medium with sucrose or without and the indicated SA concentrations. (A), (B) Under RLc (A) and under BLc (B), SA increased the expression of *PHYB::LUC* (Ws), and the effect was enhanced by supplementary sucrose. Similar results were obtained from individual experiments and the combined data are shown. Under RLc, bars represent the luminescence of the acute peak that followed dawn (t-test for differences in average luminescence between SA and DMSO treated plants on medium with sucrose: SA 0.5 mM, $p=4.3 \times 10^{-4}$; SA 1 mM, $p=5.6 \times 10^{-8}$); under BLc, bars represent the luminescence of the first circadian peak (SA 0.1 mM, $p=0.03$; SA 0.5 mM, $p=3.9 \times 10^{-6}$; SA 1 mM, $p=6.7 \times 10^{-12}$). (C), (D) SA increased the expression of *TOC1::LUC* (Ws) (C) and decreased the expression of *GI::LUC* (Ws) (D) under RLc+BLc. Therefore the effect of SA on luciferase activity, being marker-specific, could not be dependent on luciferase activity alone.

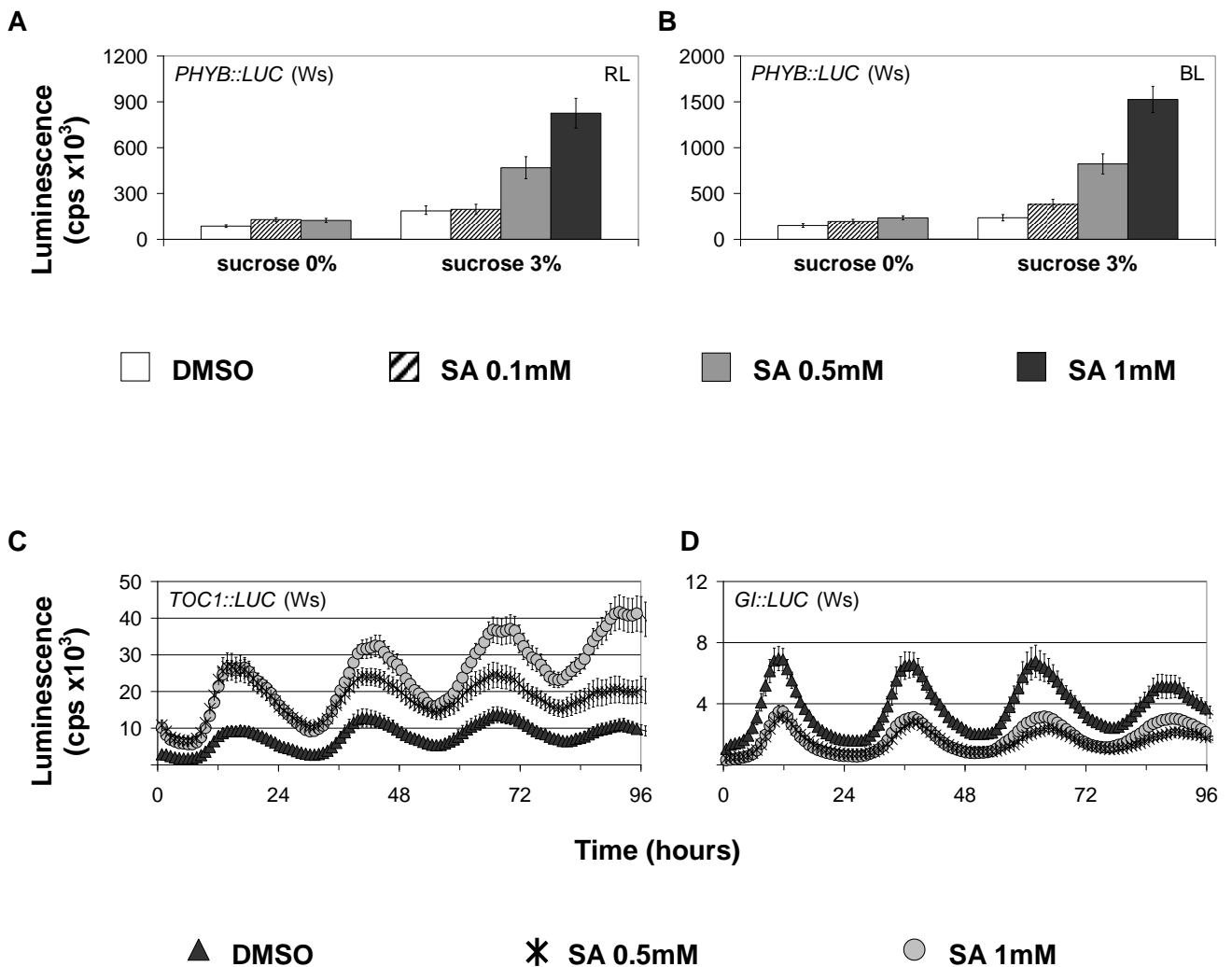

I next tested the effect of SA on *PHYB::LUC* (Ws) expression. SA increased the expression of the marker under RLc + BLc (not shown), as well as under monochromatic light RLc or BLc (fig. 3.10 A, B; see experiments conducted in the presence of 3% sucrose). I reasoned that the SA-mediated induction of the marker *PHYB::LUC* (Ws) could not depend on luciferase activity alone, since SA changed luminescence in a marker-specific manner. Under WLc, expression of the marker *TOC1::LUC* (Ws) (fig. 3.10 C) was increased by SA, while expression of the markers *GI::LUC* (Ws) (fig. 3.10 E) and *CCA1::LUC* (Ws) (not shown) was decreased. Interestingly, the inductive effect of SA on the expression of *PHYB::LUC* (Ws) was enhanced by supplementary sucrose (fig. 3.10 A and B). This cannot solely be attributed to luciferase activity since SA favors alternative respiration and thus inhibits the production of respiratory ATP (reviewed in Rivas-San Vicente and Plasencia, 2011).

Visual inspection of the timecourse graphs that assessed the effect of SA on rhythmic gene expression suggested that, amongst all markers tested, *PHYB::LUC* (Ws) was the most responsive to SA in terms of oscillatory robustness. Previously, the promoter of *phyB* was shown to be under circadian control (Bognár *et al.*, 1999), but this oscillation was found to be weak (Toth *et al.*, 2001). In my experiments (conducted in the presence of supplementary sucrose), a *PHYB::LUC* (Ws) transgenic marker produced weak oscillations that were greatly strengthened by SA application (fig. 3.11 A and B). Under RLc, SA induced robust oscillations because it increased rhythmicity and accuracy (fig. 3.11 A), while under BLc SA had a greater impact on rhythmicity (fig. 3.11 B) rather than on accuracy.

Figure 3.11: The effect of salicylic acid on the robustness of marker *PHYB::LUC* (Ws) and on the *phyB-9* mutant under monochromatic red or blue light

Under RLc (A) and BLc (B), SA increased the robustness of *PHYB::LUC* (Ws) oscillations. Plants were entrained for one cycle under monochromatic light before being released into free running conditions in the presence of sucrose and DMSO or SA, as indicated. Experiments were repeated twice with similar results. Under RLc (A), SA increased oscillatory robustness due to an increase in indirect rhythmicity (t-test DMSO vs. SA: SA 0.5 mM, $p=4.8 \times 10^{-3}$ and 5.2×10^{-4} , SA 1 mM, $p=7.5 \times 10^{-7}$ and 7.9×10^{-12}) and accuracy (SA 1 mM). Under BLc (B), SA had a greater impact on indirect rhythmicity (t-test DMSO vs. SA: SA 0.5 mM, $p=0.03$ and 0.04 , SA 1 mM, $p=1.5 \times 10^{-5}$ and 0.01), rather than on the accuracy of the rhythmic marker. (C), (D) Transgenic plants expressing the *GI::LUC* (Col-0) construct were placed in 96-well microplates containing growth medium without sucrose and DMSO or SA, as indicated. The *phyB-9* mutant was less sensitive than the wild-type to SA-mediated phase advance under RLc (C). Under BLc the *phyB-9* mutant was less sensitive

(D) than the wild-type to SA-mediated period shortening when plants were previously entrained in the presence of supplementary sucrose (prior to SA application); the mutant was though resistant in this respect when plants were never exposed to sucrose (E). Additional entrainment events were not applied. FFT analysis of (D and E) did not include the first circadian peak and spanned at least three cycles.

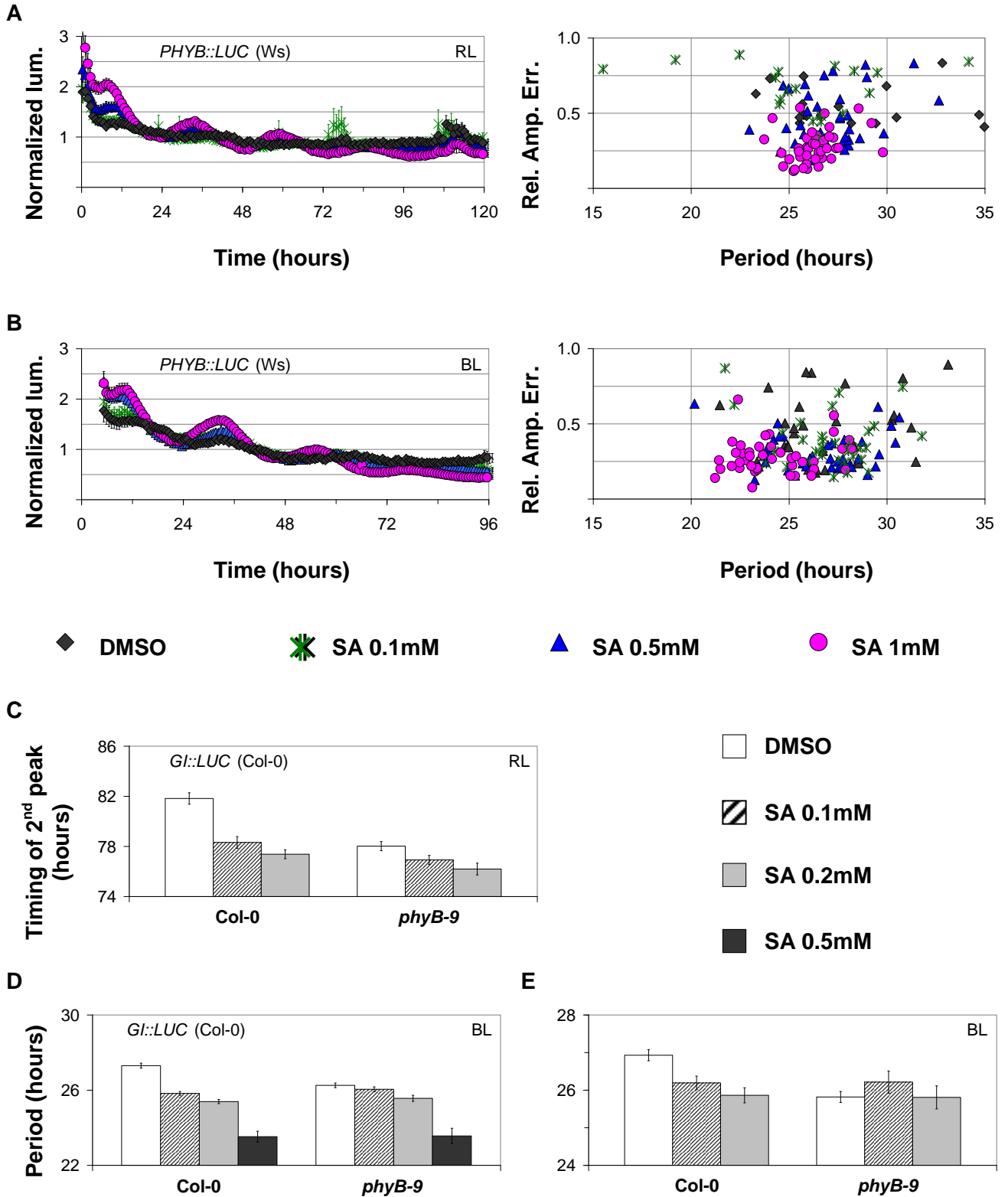

Taken together, these results are indicative that SA acts on rhythmic transcription through light and/or entrainment pathways. This is notable given my findings on the effects of SA application on accuracy of the *PHYB::LUC* (Ws) promoter. To examine this further, I subjected plants to parametric and non-parametric entrainment in the presence and absence of SA (experiments were conducted in the presence of supplementary sucrose). In the non-parametric-entrainment experiments, I tested circadian responses to SA in a time-course, because sensitivity to the hormones ABA, GA and auxin were previously reported to be gated by the biological clock (Covington and Harmer, 2007; Legnaioli *et al.*, 2009; Arana *et al.*, 2011; see also Robertson *et al.*, 2009). Plants expressing the marker *GI::LUC* (Ws) were grown and entrained for 5 days under WL and at a constant temperature of 22°C, before entering continuous darkness at dusk. Every three hours, a subset of plants was retrieved and subjected to non-parametric entrainment with 3-hour light pulses (WL) on growth medium that contained SA at 1 mM or DMSO (SA solvent). The chemical pulse was slightly shorter than the light pulse (by 15 minutes). At the end of each light/chemical pulse, plants were placed in 96-well microplates (without SA or DMSO) and luminescence was monitored in continuous darkness. Four light-chemical pulses were applied between ZT0 and ZT12 hours and the time-course experiment was repeated twice. In both experiments, the effect of SA on circadian period (SA treated plants vs. DMSO treated plants) was gated and restricted during the first half of the subjective day (fig 3.12, data combined from two independent experiments). Notably, in one of the experiments, SA application altered circadian period only during the first morning pulse. Two more experiments conducted with a different protocol produced similar results (not shown). In these experiments, plants were grown and entrained for 5 days as described above, and then placed in 96-well microplates that contained SA or DMSO during the second half of the objective day. At objective dusk, the plates were placed in continuous darkness at 22°C and parametric entrainment to light pulses (1 hour in the first experiment and 3 hours in the second) was applied every 3 hours during a time course between ZT0 and 12 hours; each plate was subjected to a single pulse and then placed in the TopCount for visualization. Visual inspection of oscillating curves from these experiments showed that the timing of circadian peaks was advanced by the end of each experiment irrespective of the timing of the light pulse because SA was continuously applied. Nevertheless, the effect of SA on the timing of the second peak after release in the dark was gated and restricted or enhanced once more by light pulses applied during the first half of the subjective day. To conclude, plants were more sensitive to SA during the first half of the day in all four experiments conducted with non-identical protocols.

Figure 3.12: The effect of salicylic acid on circadian period is gated

Plants were grown and entrained for 5 days under WL and then released into continuous darkness at dusk. A subset of plants was retrieved every three hours between ZT0 and ZT12 and received a light pulse on medium with 3% sucrose and either DMSO or SA. The combined data from two independent experiments for RAE-normalized period are presented in the figure. Individual experiments yielded similar results. The effect of SA was gated and restricted during the first half part of the day or during the first morning pulse in two experiments (t-test on combined data: ZT0-3 hours, $p = 3.15 \times 10^{-3}$; for all other pulses, $p \geq 0.19$). DD corresponds to the DMSO control that did not receive chemical or light pulses. Similar results were found in two other experiments conducted with different protocols (see text).

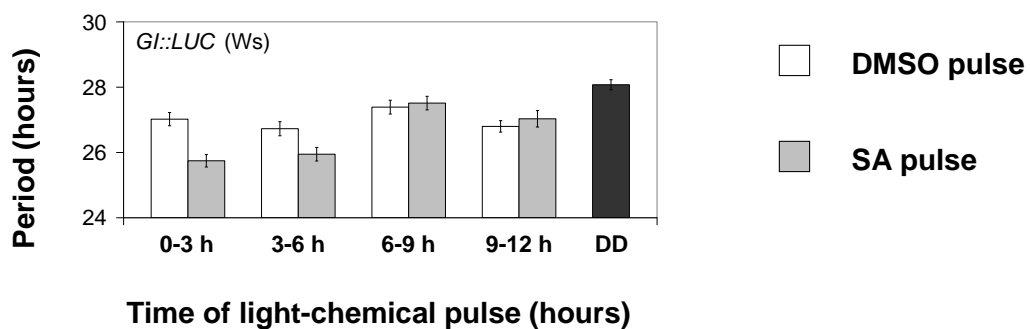

I then examined the effect of continuous SA application on oscillations under parametric entrainment. Plants expressing the marker *CCR2::LUC* (Ws) (fig. 3.13) or *GI::LUC* (Ws) (not shown) were placed in 96-well microplates with various SA concentrations or DMSO and entrained under WL for 1, 2 or 3 days, or not at all (0 days). Luminescence was monitored in a TopCount luminometer in the dark, starting at the last objective dusk (lights off at ZT 12 hours followed by DD). Surprisingly, oscillations gradually dampened (fig. 3.13 A) with every entrainment event unless SA was applied. Moreover, the circadian phase of the DMSO-control plants was delayed by consecutive entrainment events in 96-well microplates, but in the presence of SA, the phase was independent or even advanced with each entrainment event (fig. 3.13 A and B). Accuracy and direct (fig. 3.13 A) and indirect rhythmicity (inversely correlated to the y axis in fig. 3.13 B) of DMSO-control plants expressing either marker were decreased after each entrainment event in 96-well microplates. Again, these parameters were relatively constant (or even increased) by parametric entrainment in the presence of SA. Notably, the DMSO-control population expressing the marker *CCR2::LUC* (Ws) was rendered so arrhythmic by the second entrainment event that direct and indirect rhythmicity had considerably deviated from each other. Direct rhythmicity was not

representative of overall rhythmicity, as FFT analysis discarded arrhythmic plants (fig. 3.13 C), resulting in a seemingly rhythmic population that contradicted the dampening effect of entrainment observed in the time-course curves (fig. 3.13 A). Indirect rhythmicity could, however, explain the entrainment-mediated dampening of oscillations of the DMSO-control populations as it incorporated the FFT-discarded plants. Collectively, the effect of SA on the circadian periodicity of *CCR2::LUC* (Ws) during entrainment in 96-well microplates was confirmed using various measures: with the timing of circadian peaks (fig. 3.13 A and B), with indirect rhythmicity in all three independent experiments tested (fig. 3.13 B shows combined data from these experiments), with direct rhythmicity only after data from all independent experiments were combined (fig. 3.13 A, quantification not shown) and as the percentage of plants discarded by FFT analysis (fig. 3.13 C). The *GI::LUC* (Ws) marker responded similarly as the marker *CCR2::LUC* (Ws) to SA and entrainment when phase and robustness were quantified (not shown) [note that the direct and indirect rhythmicity of the marker *GI::LUC* (Ws) were similar to each other, as the percentage of FFT-discarded plants was always low]. Moreover, SA application by as little as 0.2 mM was adequate to rescue oscillations in *GI::LUC* (Ws) from dampening and prevented phase delays imposed by parametric entrainment. This was in experiments that experienced up to three entrainments events or more (not shown). Together, these data showed that the SA-mediated phase-advance and SA-mediated increases in robustness were enhanced by parametric entrainment in 96-well-microplates, because these parameters were relatively constant and independent of entrainment only if SA was applied.

In my assays, high SA concentrations were toxic and caused chlorosis of plants. This could be attributed to the fact that SA induces the production of ROS (Chen *et al.*, 1993); this was afterall the reason why SA was included in the initial ROS-related chemical screen. I then noticed that *Arabidopsis* plants were more sensitive to SA-mediated chlorosis if SA was applied without adding sucrose. This observation was made while trying to genotype the *PHYB::LUC* transgene with a camera of relatively low sensitivity. To enhance and detect the luminescence signal with this camera, I added SA to the plants being genotyped, because the transgenic marker is positively regulated by SA [*PHYB::LUC* (Ws), fig. 3.10 A and B]; I used the same SA concentration employed in every other experiment but did not add sucrose. To my surprise, the plants being genotyped died, which indicates that sucrose moderates SA-induced toxicity. I then proceeded to test if sucrose modifies the effect of SA in circadian assays as well. I found that, under monochromatic RLc or BLc, sucrose moderated or abolished SA-mediated period shortening [fig. 3.14; for the marker *CAB2::LUC* (Ws), see also fig. 3.17 A and B]. In more detail, sucrose moderated the SA-mediated period shortening of the marker *CAB2::LUC* (Ws) in four experiments under BLc (in one of these experiments, sucrose

moderated the effect of SA on phase and in a fifth experiment I obtained negative results), of the marker *GI::LUC* (Ws) under BLc (in three experiments; combined data in fig. 3.14 A) and under RLc (two experiments in the presence of sucrose and four in its absence were combined in fig. 3.14 B) and of the marker *GI::LUC* (Col-0) under BLc (three experiments with sucrose and seven without were combined in fig. 3.14 C). Similar preliminary results (no replicates available) were obtained under BLc with the markers *CCA1::LUC* (Ws) and *TOC1::LUC* (Ws) and under RLc with the markers *GI::LUC* (Col-0) and *TOC1::LUC* (Ws). These experiments show that sucrose moderates or even inhibits the effect of SA on the circadian period and are in agreement with a previous publication from Hanano *et al.* (2006) that reported that SA does not act on the circadian period in the presence of sucrose. Together, these findings are suggestive that SA affects nuclear oscillations through ETCs.

Figure 3.13: Salicylic acid increases the oscillatory robustness of *CCR2::LUC* (Ws) through parametric entrainment

Plants from synchronized populations received the indicated number of additional entrainment events on medium with sucrose 3% and SA or DMSO in 96-well-microplates. They were then placed in a TopCount luminometer in continuous darkness and at a constant temperature of 21 °C. **(A)** The effect of SA during free run is enhanced by the preceding parametric entrainment events. Panels on the right represent the combined data from three independent experiments that produced similar results to each other. Each panel on the left shows a representative experiment. Note that the y axis in the right panels is negatively correlated to direct rhythmicity and the standard deviation on the x axis is negatively correlated to accuracy. **(B)** Quantification of data shown in **A**. Populations that did not receive the additional entrainment events, are represented by white symbols; darker symbols correspond to additional entrainment events. On growth medium with DMSO (SA solvent) consecutive entrainment events delay phase (timing of the second circadian peak; 0 d vs. 1 d, $p=3.0 \times 10^{-5}$; 0 d vs. 2 d, $p=4.1 \times 10^{-7}$; 0 d vs. 3 d, $p=4.9 \times 10^{-14}$). Phase is rendered independent to entrainment with application of 0.5 mM SA. Application of 1m M SA reverses the effect of entrainment on phase by the third day (0 d vs. 3 d, $p=1.5 \times 10^{-6}$). The SA-mediated increase in indirect rhythmicity (inversely correlated to the y axis) is enhanced by parametric entrainment (compare different symbols with the same color). **(C)** The effect of entrainment and SA on rhythmicity is shown in the percentage of plants discarded by BRASS software. BRASS discarded only 0-2% of plants that did not receive the additional entrainment events before free run. BRASS discarded 25% (from 117 plants) and 27% (from 156 plants) of DMSO-control plants that received two and three additional entrainment events, respectively. In the presence of SA at 1 mM the percentage of discarded plants was always near 0% (in populations numbering 68 to 100 plants). The percentage of discarded plants was kept relatively low on medium with SA at 0.5 mM also.

Figure 3.13

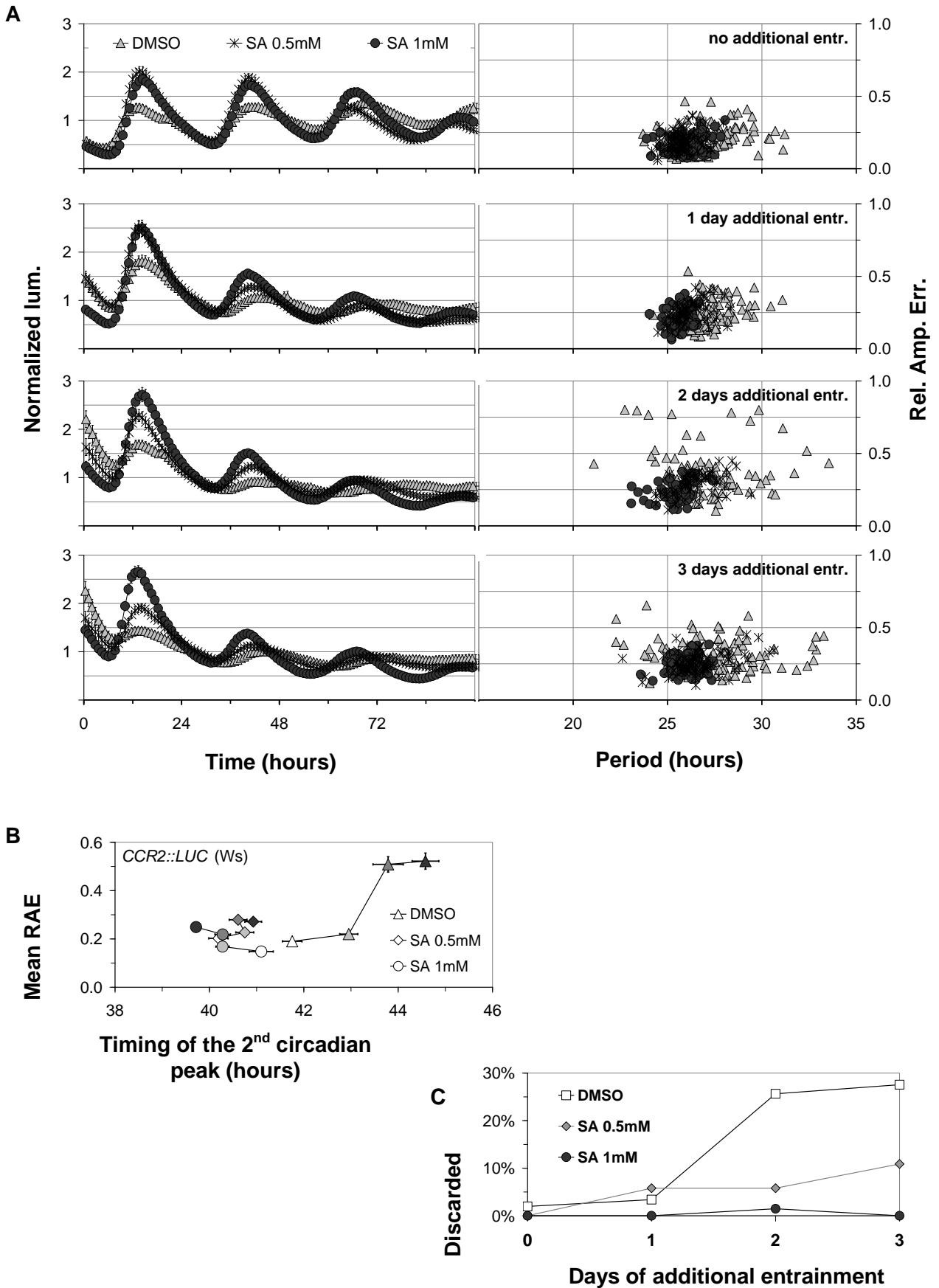
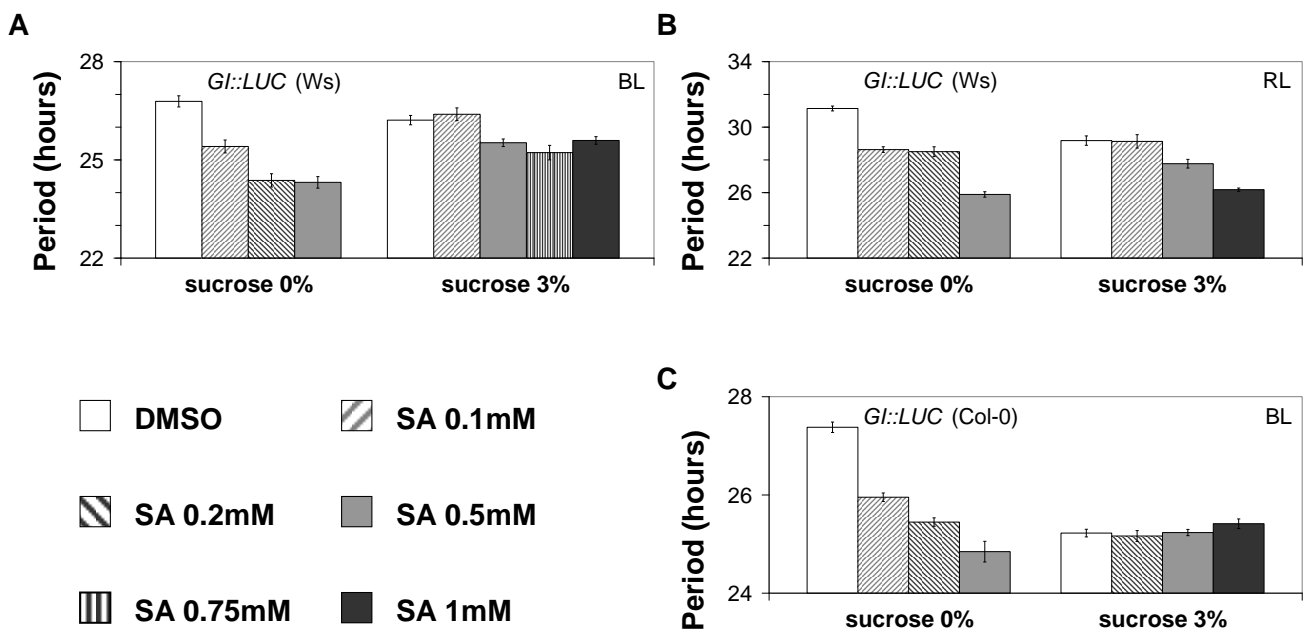

Figure 3.14: Salicylic acid -induced period shortening is moderated by sucrose

Transgenic plants carrying the designated promoter::luciferase markers were grown and entrained under WL before being released into free running conditions under monochromatic BLc or RLc; SA and sucrose concentrations were as indicated. The effect of SA was inhibited or moderated by sucrose. Control-DMSO bars of the marker *GI::LUC* (Ws) under BLc (**A**) represent four experiments without sucrose and three with sucrose. Control-DMSO bars of the marker *GI::LUC* (Ws) under RLc (**B**) represent four experiments without sucrose and two with sucrose. Control-DMSO bars of the marker *GI::LUC* (Col-0) under BLc (**C**) represent seven experiments without sucrose and three with sucrose. Similar results were obtained for the marker *CAB::LUC* (Ws) under BLc (wild-type controls from a representative experiment is shown in fig. 3.17). Similar results were obtained in preliminary experiments (not shown) with the marker *GI::LUC* (Col-0) under RLc, with the marker *CCA1::LUC* (Ws) under BLc and with the marker *TOC1::LUC* (Ws) under RLc and under BLc.



3.2.2. The response of clock mutants to salicylic acid

In order to identify mediators of SA signaling, I performed genetic tests with known clock-mutants (*gi-11*, *toc1-21*, *cca1-11*, *lhy-21* and *cca1-11;lhy-21*) compromised in central clock genes represented in the model of Locke *et al.* (2005b). The *phyB-9* mutant was also tested in this genetic analysis because of the distinct response to SA displayed by the *PHYB::LUC* marker (Figures 3.10 A and B and 3.11A and B) and because the *phyB* mutant is recognized as a mediator of SA signaling during defense responses (Genoud *et al.*, 2002). Plants were grown and entrained according to standard protocols under WL (in the presence of 3% sucrose; see Materials and Methods) and then transferred to 96-well microplates with SA or DMSO during the second half of the subjective day. Subsequently, the plates were placed in a TopCount luminometer at dusk and exposed to free running conditions under monochromatic RLc or BLc the following dawn, in the presence or absence of sucrose, as indicated. In some experiments, plants received one additional entrainment event under monochromatic light before being released into free running conditions.

The *GI::LUC* marker was used to assess the effect of SA on the *phyB-9* (Col-0) mutant. As expected, when oscillations took place in the absence of supplementary sucrose, SA shortened the period of wild-type oscillations. Under BLc, the mutant appeared less sensitive relative to the wild-type in this respect when four independent experiments were combined (fig. 3.11 D). It is noteworthy that the sucrose status of the growth medium during entrainment affected the extent of the phenotype, since when plants were not exposed to sucrose at this time the *phyB-9* mutant was resistant to SA period shortening (figure 3.11 E). Similarly, under RLc, the *phyB-9* (Col-0) mutant was less sensitive relative to wild-type to SA-mediated phase advance in three independent experiments (fig. 3.11 C).

The *toc1-21* mutant was oversensitive to SA in all three experiments performed under RLc. Two of these were conducted on medium without sucrose and with plants expressing the marker *CAB2::LUC* (Ws) (fig. 3.15 A). In these experiments, as expected, in the absence of sucrose, wild-type plants responded to SA with period shortening whereas the mutant responded with a greater magnitude, compared to the wild-type (fig. 3.15 A). The *toc1-21* mutant was additionally found to be oversensitive to SA relative to wild-type when the effect of SA on the robustness of oscillations was considered (including direct rhythmicity, indirect rhythmicity and accuracy; see fig. 3.15 A and the figure legend for numerical data). Similar phenotypes (in terms of period and the robustness of oscillations) were also scored in the third experiment that was conducted on growth medium with sucrose and that used the *CCR2::LUC* marker (Ws) (not shown). Notably, in this experiment, SA shortened the period of *toc1-21* oscillations while, as expected, the wild-type did not respond

similarly to SA due to the presence of sucrose. Under BLc, the *toc1-21* mutant appeared less sensitive than the wild-type to SA-mediated period shortening. This was observed in two experiments performed without sucrose, one with the marker *GI::LUC* (Ws) (fig. 3.15 B) and one with the marker *CAB::LUC* (Ws) (not shown; in these experiments, the mutant was not resistant to SA since the hormone advanced phase). Conclusively, light quality had a significant impact on the SA-related phenotypes of *toc1-21*, the mutant being oversensitive to SA under RLc and less sensitive than wild-type under BLc.

Figure 3.15: The effect of continuous salicylic acid application on *GI::LUC* (Ws) in the *toc1-21* mutant

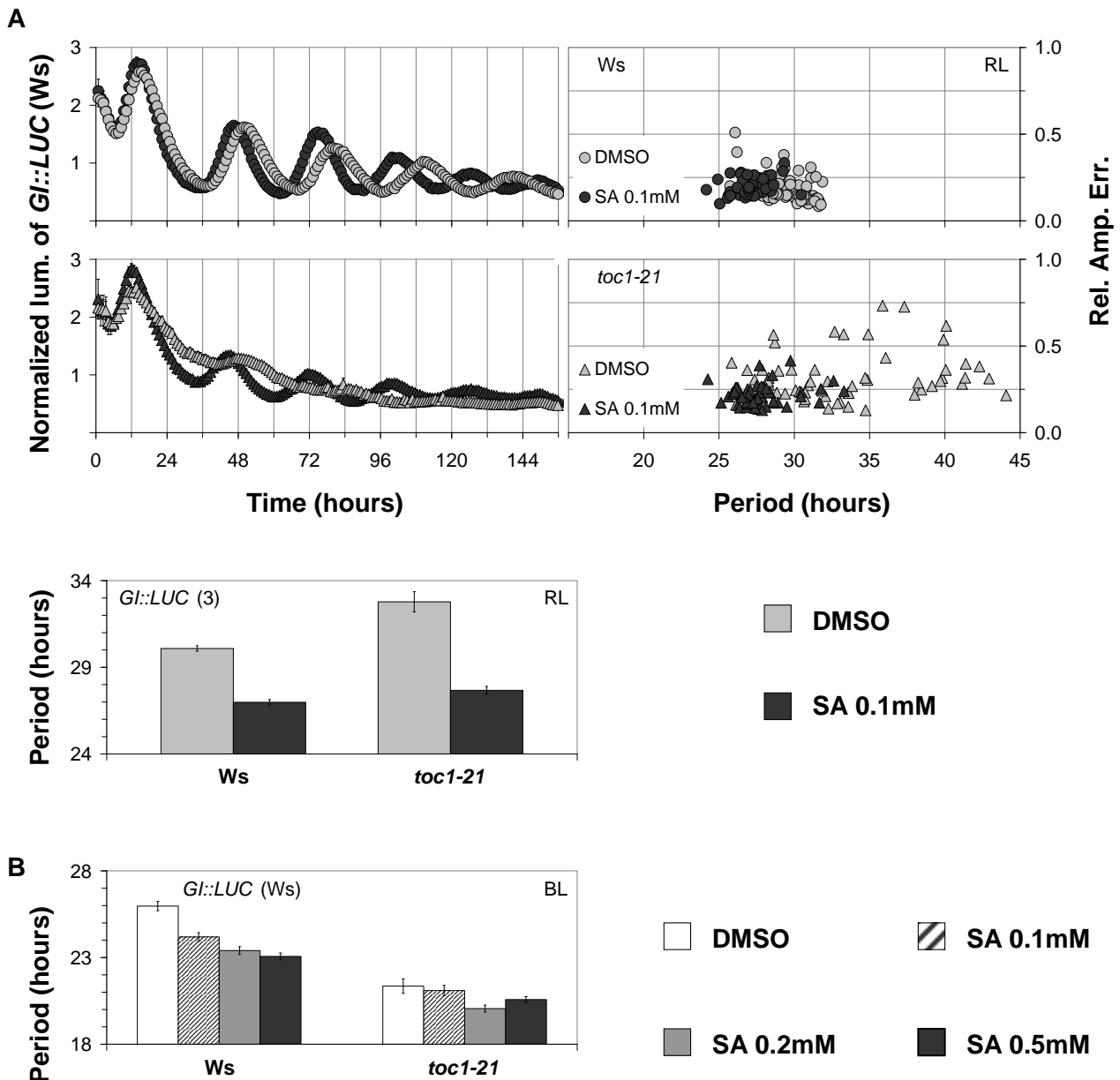

Figure 3.15:

(A) Under RLc, the *toc1-21* mutant was oversensitive to SA relative to the wild-type. The oversensitivity the phenotype was confirmed in three independent experiments. Figure A shows the combined data from two of the experiments that were conducted without supplementary sucrose and with the marker *GI::LUC* (Ws). The mutant was more sensitive than the wild-type to SA for period shortening. In the absence of multiple entrainment events SA did not improve the robustness of oscillations in wild-type (see also fig. 3.13); on the other hand the mutant was oversensitive to SA to the point that, in the absence of additional entrainment events, direct rhythmicity (t-test for DMSO vs. SA 0.1mM: $p=7.1 \times 10^{-7}$), indirect rhythmicity ($p=0.01$) and accuracy (the SD of noPer was unaffected by SA in the wild-type and decreased almost three-fold in the mutant) were increased. A third experiment conducted on medium with sucrose and the marker *CCR2::LUC* (Ws) produced identical phenotypes (not shown).

(B) Under BLc, the *toc1-21* mutant was less sensitive than the wild-type to SA-mediated period shortening. This was reproduced in two experiments conducted without supplementary sucrose, one with the marker *GI::LUC* (Ws) and one with the marker *CAB::LUC* (Ws) (not shown).

Figure 3.16: The effect of salicylic acid on the *gi-11* mutant

On medium that lacks sucrose SA increased expression of marker *PHYB::LUC* (Ws) in two experiments (one conducted under BLc and one under RLc). This response was exacerbated in the *gi-11* mutant. Under RLc, bars represent the luminescence of the acute peak that followed dawn; under BLc, bars represent the luminescence of the first circadian peak that followed the acute peak of dawn.

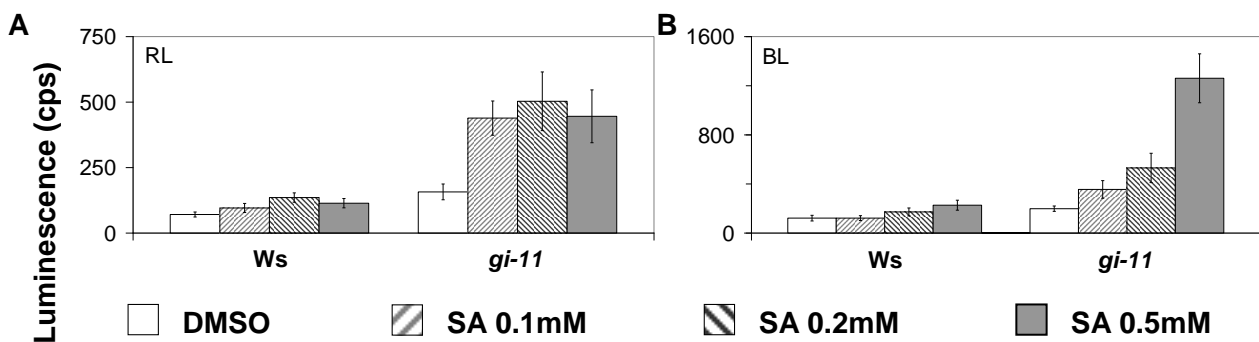

The *gi-11* mutant was assayed with SA under monochromatic RLc or BLc with various markers. When the period was estimated, the response of the mutant to SA was inconsistent between

experiments. The *gi-11* mutant was consistently oversensitive relative to wild-type to SA when the effect of the hormone on expression of the marker *PHYB::LUC* (Ws) was considered (fig. 3.16). The oversensitivity phenotype was scored on medium that did not contain sucrose, likely because in this case the wild-type response to SA was weak (see also fig. 3.10 A and B). The effect of SA on the *gi-11* mutant was reproduced in two experiments, one under BLc and one under RLc, and observed numerous times under WLc. These findings are indicative that GI and phyB might affect responsiveness to SA in concert.

I then tested the single *cca1-11*, *lhy-21* and the double *cca1-11;lhy-21* mutants for their responses to SA (fig. 3.17). This was in the presence or the absence of sucrose under BLc with the marker *CAB2::LUC* (Ws), respectively. Visual inspection of the TopTempII graphs indicated that the *lhy-21* mutant was oversensitive to SA-mediated period shortening. This was particularly evident when sucrose was supplemented, in which case the effect of the hormone was hardly observed in the wild-type (compare timing of the third peak in fig. 3.17 A and C). FFT-NLLS analysis confirmed that the *lhy-21* mutant was more sensitive than the wild-type to SA-mediated period shortening in only two of five such experiments. For this, I calculated the timing of the third peak after release into free running conditions and found that, in four of these five experiments, the *lhy-21* mutant was more sensitive than the wild-type to SA mediated peak advance. Notably, the experiment that did not reproduce the oversensitivity phenotype of *lhy-21* was the only one that did not entail additional entrainment events in the presence of SA. The four experiments that entailed additional entrainment (and thus exposed plants to SA for a longer period of time) were combined and are presented in figure 3.17C. Similar results were obtained in a sixth experiment with the marker *CCR2::LUC* (Ws), as the *lhy-21* mutant was oversensitive relative to wild-type to SA-mediated period shortening (in the presence of sucrose; not shown).

The *lhy-21* oversensitivity phenotype prompted me to test for responses to SA in the *cca1-11* mutant. Three experiments were performed in the presence and three experiments in the absence of supplementary sucrose. In these (fig. 3.17 A) the *cca1-11* mutant did not display any SA-related phenotypes in terms of period or phase (timing of the third peak of oscillations). Consequently, CCA1 does not contribute to SA sensitivity in the same manner as LHY.

I then assessed the effect of SA on the *cca1-11;lhy-21* double mutant in the presence and in the absence of sucrose. The first experiment was conducted without additional entrainment events and produced weak phenotypes (see below). For this and because of the quantitative relationship between SA and parametric entrainment (fig. 3.13), I continued with experiments that entailed one additional entrainment event. Visual inspection of the TopTempII graphs (fig. 3.17 A) suggested that the *cca1-11;lhy-21* mutant was, similarly to the *lhy-21* single mutant, oversensitive to SA-mediated

period shortening relative to wild-type in the presence of supplementary sucrose (whereas the latter is not responsive to SA).

Because in the presence of sucrose oscillations in the *cca1-11;lhy-21* double mutant gradually dampened (fig. 3.7 D; see also Alabadí *et al.*, 2002 for this under BLc), I performed FFT-NLLS during a time window that ended before dampening (between ZT12 and 72 hours). This time window included three oscillations of *cca1-11;lhy-21* and provided a reliable FFT output. FFT analysis confirmed that the *cca1-11;lhy-21* mutant was oversensitive to SA-mediated period shortening in every experiment conducted in the presence of sucrose. In more detail, the wild-type response was less than 0.6 hours (that is less than the 0.9 hour interval that separated consecutive measurements), whereas the mutant responded by 2 to 3 hours in three experiments that entailed an additional entrainment event and by 1.1 hours in the experiment that did not include additional entrainment events. During any fixed time window, the *cca1-11;lhy-21* mutant with an extremely short period phenotype (Mizoguchi *et al.*, 2002; Alabadí *et al.*, 2002; Ding *et al.*, 2007; Locke *et al.*, 2005b; Locke *et al.*, 2006; Lu *et al.*, 2009) would have been exposed to SA for longer than the wild-type, if the duration of exposure is measured as the number of cycles. Such a difference in the duration of exposure to the hormone could easily account for a false positive oversensitivity-phenotype. For this, I repeated FFT-NLLS for a longer time window that extended from 21 to 126 hours (or until 104 hours in one experiment that was shorter). With this approach, I could show that, in the presence of sucrose, the response of the *cca1-11;lhy-21* mutant during the small time window (between 12 and 72 hours, when the mutant was oscillating) was greater than the response of the wild-type during the longer time window (between 21 and 104 or 126 hours), provided though that SA was kept lower than 1 mM (optimal results were obtained with 0.5 mM SA in the experiments that entailed an additional entrainment event; not shown).

Because the wild-type and the mutant were occasionally equally sensitive to SA at 1 mM, and because of the level of subjectivity in the determination of time windows chosen for FFT analysis, I confirmed the oversensitivity phenotype of *cca11;lhy-21* with phase analysis. I calculated the timing of the second and third circadian peaks in these experiments and, as expected, the second and the third peaks produced from the mutant were more responsive to SA than the third peak produced from the wild-type (in all four experiments; see fig. 3.17 D for combined data from experiments that included an additional entrainment event). Therefore, the oversensitivity phenotype of the *cca1-11;lhy-21* mutant to SA did not result from the extreme short period of the mutant and the consequences of the number of cycles in which the plants were exposed to the hormone.

Figure 3.17: The effect of continuous salicylic acid application on *CAB2::LUC* (Ws) in the *cca1-11*, *lhy-21* and *cca1-11;lhy-21* mutants under blue light

Plants were grown and entrained on growth medium that contained sucrose for five days under 12hL:12hD. During the second half of the sixth day plants were placed into 96-well microplates that contained sucrose, SA or DMSO, as indicated. An additional entrainment event was applied in the TopCount with BLc before free run was initiated at ZT0 hours. Sucrose moderated the period-shortening effect of SA (A, B) in the wild-type. In the presence of supplementary sucrose, the effect of SA was moderated in the wild-type but not in the *lhy-21* (C) and *cca1-11;lhy-21* (D) mutants.

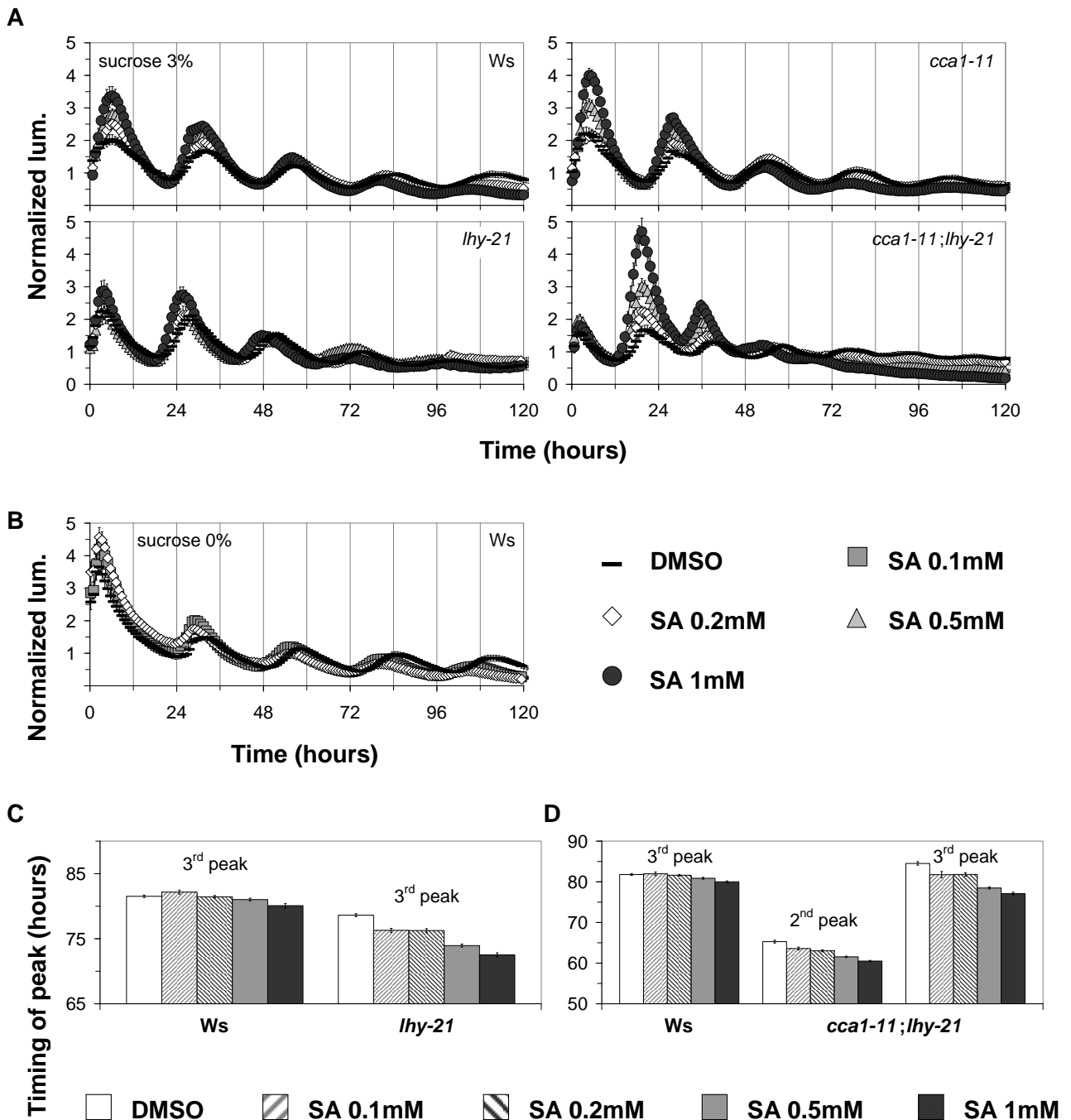

3.3. A reverse genetic approach – HSP90

Having found that nuclear oscillations are perturbed by ROS-related chemicals, I proceeded to investigate whether mutations that affect ROS homeostasis alter circadian parameters. Initially I focused on mutations that would compromise the antioxidant system of the cell; I tested mutant lines that are predicted to be compromised in their antioxidant capacity (see below), for circadian phenotypes with leaf movement assays at 21°C. In this effort, I included mutations involved in sulfur metabolism, because previously it was connected to circadian timekeeping and temperature compensation in *Neurospora* (Onai and Nakashima, 1997; see chapter 1.4.2.b). I also included mutations in genes directly involved in the enzymatic antioxidant system of the cell (thioredoxin system, glutaredoxin system, catalases)⁸⁹ and mutations that compromise protein methionine repair enzymes because they result in time specific ROS alternations (Bechtold *et al.*, 2004). It is noteworthy that sulphur metabolism is coupled to the antioxidant system through thioredoxins and glutaredoxins, the reducing systems that render thiol groups as redox sensors (Rouhier, *et al.*, 2004; Gelhaye *et al.*, 2005). All of the mutants I decided to test (not shown) displayed a wild-type period length in leaf movement at 21°C.

Several researchers have proposed that compensation against environmental perturbation, as observed in circadian (Wagner *et al.*, 1976; Roennenberg and Merrow, 1999) and ultradian (Lloyd and Murray, 2007; Lloyd, 2008) rhythms, is an inherent property of networks. For this I repeated the leaf movement assays under 12°C and 16°C, but did not run into any positive phenotypes (not shown), perhaps due to the extensive redundancy and compensatory properties of antioxidant and metabolic networks.

I then turned my interest to mutations implicated in plant defense mechanisms because it is well established that these affect ROS homeostasis (Torres and Dangl, 2005; Wiermer *et al.*, 2005) and because certain aspects of defense such as the hypersensitive response require photosynthetic pigments (Genoud *et al.*, 2002), which I had suspected to be involved in light input to the clock (the implication of photosynthetic ETC in circadian timekeeping in *Arabidopsis* is discussed in chapter 4). I included mutations in *LESION STIMULATING DISEASE1* (*LSD1*; Jabs *et al.*, 1996; Mateo *et al.*, 2004), *PHYTOALEXIN DEFICIENT4* (*PAD4*; Feys *et al.*, 2001), *ENHANCED DISEASE SUSCEPTIBILITY1* (*EDS1*; Parker *et al.*, 1996), *RESPIRATORY BURST OXIDASE HOMOLOG D*

89. Amongst all the genes of the antioxidant system of plant cells, peroxiredoxins are perhaps the only ones known to this date to affect nuclear oscillations (based on this study and the results of Edgar *et al.*, 2012, see chapter 1.3). I did not include these in my survey.

(*RBOHD*), *RBOHF* (Tissier *et al.*, 1999; Torres *et al.*, 2002), *FLAVIN DEPENDENT MONOOXYGENASE1* (*FMO1*); (Mishina and Zeier, 2006) and the *hsp90.2-3* mutation (Hubert *et al.*, 2003). These mutations are known to perturb antioxidant networks and ROS homeostasis (see references above), but their respective phenotypes are conditional; perhaps this would explain the negative circadian results I obtained with *pad4*, *RbohD*, *RbohF*, *lsd1* and *fmo* mutants, and the inconsistent (between several experiments) long-period phenotype of *eds1*. As such, I did not pursue this hypothesis any further. Of the mutations listed here (see materials and methods table 2.2) only *hsp90.2-3* consistently lengthen circadian period, and did so in a temperature dependent manner, the phenotype being favored at cold temperatures of 12°C (fig. 3.18). I also found that the circadian phenotype of *hsp90.2-3* is phenocopied by geldanamycin application, which is an HSP90 inhibitor (fig. 3.19).

Noteworthy geldanamycin inhibits ATP turnover (binding or hydrolysis) by the HSP90 chaperone (Prodromou *et al.*, 1997; Grenert *et al.*, 1999) thereby interfering with substrate release (Young and Hartl, 2000). The *hsp90.2-3* mutation is also predicted to affect ATP turnover, as the amino-acid substitution is located at the ATP-binding site of the protein; these and other findings have led Hubert *et al.* (2003) to suggest that inhibition of ATP turnover results in instability of HSP90 "clients". The experiments presented in figure 3.19 were conducted in the dark as geldanamycin is light labile. Despite this, I also tested the effect of geldanamycin under monochromatic BLc and preliminary results in these experiments suggest that the effect of geldanamycin on *GI::LUC* (ws) rhythms may be moderated by sucrose (Table 3.2). The effect of sucrose on geldanamycin effectiveness was striking, as in the experiment conducted in the absence of sucrose the inhibitor lengthened circadian period by 14 hours, whereas in the other experiment that was conducted with supplementary sucrose period was lengthened only by 4 hours.

Table 3.2: Sucrose moderates the period lengthening effect of geldanamycin

The period lengthening effect of geldanamycin (7.5µM) on *GI::LUC* (Ws) was severely moderated by sucrose in two preliminary experiments under BLc, one with supplementary sucrose and one without. FFT was conducted between ZT 30 and 145 hours. Interval of period-values allowed by BRASS software during FFT analysis was set between 15 and 45 hours.

	sucrose 3% ($t_{test}=3.82 \cdot 10^{-7}$)	no sucrose ($t_{test}=1.93 \cdot 10^{-11}$)
DMSO control	25.07±0.12	30.06±0.38
Geldanamycin 7.5µM	29.42±0.55	44.07±0.77

Figure 3.18: Leaf movement is affected by the *hsp90.2-3* mutation at cold temperatures

The *hsp90.2-3* shows a long-period phenotype of leaf movement specifically at 12°C. At 16°C the phenotype is either gone or severely moderated, while at 21°C period of rhythmic leaf movement was identical between wild-type and mutant (not shown). Leaf movement experiments are conducted under low light in a growth cabinet (see materials and methods).

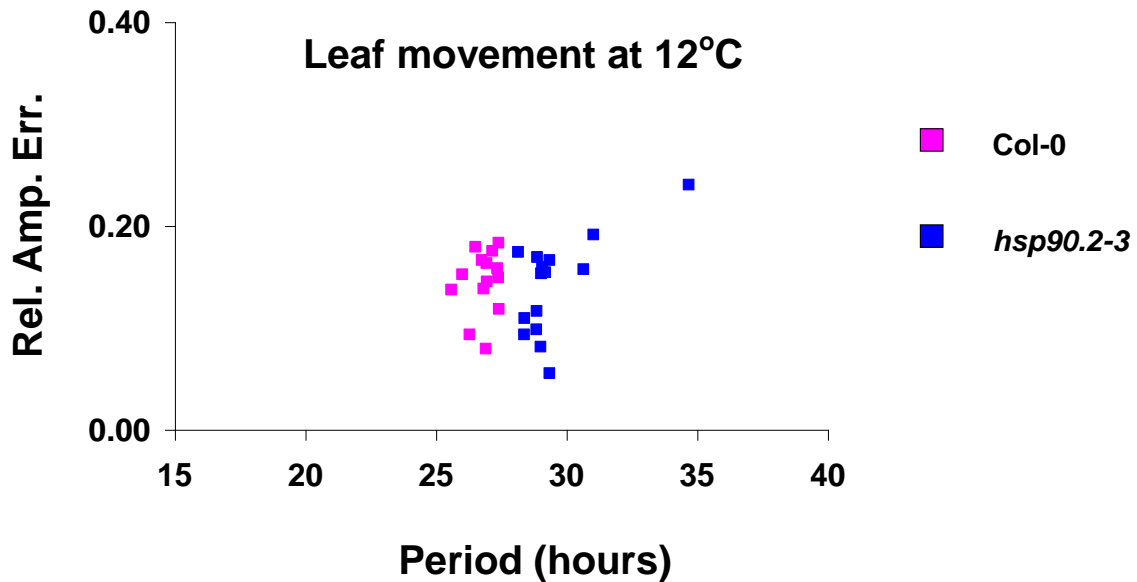
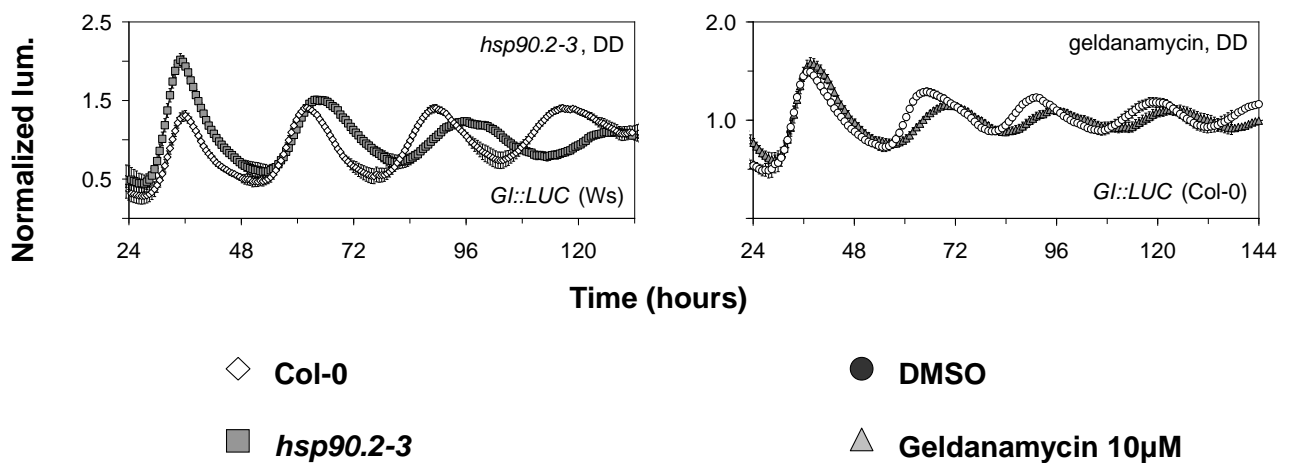

Figure 3.19: Geldanamycin and the *hsp90.2-3* mutation similarly affect nuclear oscillations

The *hsp90.2-3* mutation and *geldanamycin* lengthen circadian period of oscillations of *GI::LUC* markers. Luminescence was recorded in continuous darkness at 21°C.



Chapter 4

Discussion

4.1. Summary

The circadian clock has been recognized as a major coordinator of metabolism in plants (Harmer *et al.*, 2000). However, as I initiated this research, it was not widely accepted that metabolic processes are circadian determinants in *Arabidopsis*. Indeed, classic literature suggests a compensation mechanism whereby oscillator function resists changes in metabolic balances (Buenning, 1973⁹⁰). I showed here that sucrose and chemical perturbation on photosynthetic metabolic processes can have profound effects on clock performance. Notably these are coupled as sucrose availability modulates the effects of oxidant and stress agents, such as salicylic acid, in a manner that suggests that photosynthetic electron transport affects circadian gene expression in the nucleus.

In chapter 3.1.1 I showed that supplemented sucrose, now typical as a community standard, shortens circadian period in a temporal/transient manner; transients on the other hand are dependent on the sucrose status of the growth medium during entrainment indicating that supplementary sucrose perturbs entrainment. This in turn is implicit that endogenous sucrose signals are important to entrainment.

I then applied a chemical-epistasis approach (in chapter 3.1.2 to 3.1.15) to infer the entry points of metabolism to the oscillator. Long-term circadian responses to sucrose were suppressed in the *cca1-11* mutant irrespective of light quality. By contrast, under RL, the *toc1-21* mutant was found to be oversensitive to sucrose. The *cca1-11* and *lhy-21* single mutants were opposite with respect to their sucrose-dependent phenotypes, as the later was affected in short-term circadian responses to sucrose under monochromatic RLc or BLc. More over, under BLc, *lhy-21* was, unlike *cca1-11*, temporally oversensitive to sucrose-mediated period shortening. Under RLc, the *gi-11* mutant exhibited sucrose-dependent phenotypes and responses that were opposite those seen with BLc. Interestingly, the *phyB-9* mutant displayed circadian phenotypes under BLc that were masked by supplementary sucrose. Mutants that are altered in ROS and redox homeostasis were also tested for circadian phenotypes. Of these, an altered-function allele of *HSP90.2* was found to display a temperature compensation long period phenotype. Together these findings reveal multiple links between TTFLs and metabolism in *Arabidopsis*.

It was further shown that the *cca1-11;lhy-21* double mutant is capable of producing robust oscillations that are masked by sucrose application. Based on this, I proposed that the *zeitnehmer* model previously outlined for the clock of *Neurospora* is applicable in *Arabidopsis* as well. This

90. See chapter 9.

notion was further supported by a number of predictions of the model, such as the finding that circadian mutants in *Arabidopsis* are altered for both temperature compensation (previously published) and nutrient compensation (shown here). By definition a *zeitnehmer* loop is comprised of a rhythmic input to a rhythmic process; as the chemicals that affected nuclear oscillations target chloroplasts and affect metabolic pathways with oscillatory potential, I proposed that photosynthesis and nuclear oscillations are coupled to each other in the context predicted by the *zeitnehmer* model.

Having applied chemicals and light treatments that affect the redox state of plastoquinone (PQ) (chapter 3.2), I noticed a correlation between the inferred redox state and periodicity of rhythmic gene expression. Several of the findings presented here, as well as a considerable amount of published data, including the rule of Aschof, can be explained by this correlation. In this discussion I will highlight those findings that support the relationship of metabolism and the clock as one determinant of the effect increasing light intensity has on accelerating periodicity.

4.2. Wild-type responses to sucrose

4.2.1. Transients in circadian parameters are inhibited by sucrose

In Chapter 3 I started by exploring the consequences of sucrose application on luciferase measurements. This was done as historic use of this technology had created an assay protocol with extremely high levels of sucrose to be able to image light from the first-generation of luciferase transgenes (Millar *et al.*, 1995a). With the new luciferase variants typically employed, this is no longer necessary (this study, James *et al.*, 2008; Dalchau *et al.*, 2011), which thus allows for this test. I investigated the effect of sucrose on oscillations of *CAB2::LUC* (ws), *GI::LUC* (ws) and *GI::LUC* (Col) under monochromatic BLc or RLc (fig. 3.1, 3.2 and 3.3). The marker *CAB2::LUC* (Ws) did not produce oscillations in the absence of sucrose under RLc, and for this reason, it was assayed with a sucrose dose-response gradient (fig. 3.8). In all of these experiments, I observed the period shortening effect of sucrose (fig. 3.1, 3.2 and 3.3) previously reported by others (Knight *et al.*, 2008; Dalchau *et al.*, 2011). I also noticed temporal instability or transients in circadian parameters including period, rhythmicity and accuracy; here, temporal instability refers to the changes observed in a circadian parameter after FFT analysis is performed during consecutive time windows that are one cycle apart from each other. These transients were inhibited by sucrose application during free

run, and consequently, the effect of exogenous sucrose on various circadian parameters was temporal [period, accuracy and rhythmicity of the marker *CAB2::LUC* (Ws); rhythmicity of the *GI::LUC* markers] or moderated with time (period and accuracy of the *GI::LUC* markers) (fig. 3.1, 3.2 and 3.3).

Temporal instability of period length, termed transients, was first reported by Pittendrigh and Bruce in 1959 (for more on this issue see fig. 4.1), in response to non-parametric entrainment to light pulses and changes in ambient temperature. Because of this, I hypothesized that transients are a consequence of entrainment. I further investigated this and found that transients depend on the sucrose status of the growth medium used for entrainment (see chapter 4.2.2). This observation supported that transients are indeed a consequence of entrainment and moreover, that sucrose application affected the oscillator through entrainment.

Buenning (1973) presented two possibilities for the origin of these transients. In the first, transients do not affect the actual timekeeper. Rather, they are the result of perturbation of the output after a brief chemical treatment (e.g. oxygen withdrawal or respiration inhibitors). In this case, treated and control subjects (usually plants) soon return to synchronous interactions. In the second, the transients reflect the actual state of the clock, because the treatment that triggered them resulted in a permanent phase shift (even though the effect on period may have been only transient). I assumed that, in this latter case, the oscillator would have been affected indirectly via entrainment pathways, whereas persistent (not transient) period shortening would mean that central events were perturbed directly. In my experiments the effect of sucrose on circadian phase was not temporal. Sucrose caused a permanent phase shift in the oscillations of the *GI::LUC* markers (fig. 3.1 A and B and 3.2 A and B) as well as of *CAB2::LUC* (Ws) (see wild-type controls in fig.3.7 A and D) and consequently, the clock rather than the output pathways was perturbed⁹¹. It should be noted that, even though the effect of sucrose on the period of the *GI::LUC* marker was moderated over time, period shortening was nonetheless persistent (varying between 1.5 to 4 hours during the 2nd-tw), which suggests that in this case sucrose affected the clock through events that are closer to the central oscillator rather than through entrainment pathways. By contrast sucrose shortened the

91. Given the known regulation of photosynthetic genes by sucrose (Koch, 1996) and the fact that the effect of sucrose on period of *CAB2::LUC* (Ws) was only temporal (fig.3.3 A and B), it is reasonable to assume that sucrose inhibits transients in *cab2* expression directly and not via the clock. I would like to stress that this is very unlikely to be the case, because the phase difference caused by sucrose during free run was persistent (lasting for up to 4 or 5 cycles and until the end of each experiment; see wild-type controls in fig.3.4 A and fig. 3.7 A vs. D).

circadian period of *CAB2::LUC* (Ws) only during the 1st-tw, indicating that nuclear encoded photosynthetic gene expression is prone to metabolic cues through entrainment pathways rather than through central events. In chapter 4.2.2 I discussed how I put to the test the hypothesis that exogenously applied sucrose affects entrainment.

Figure 4.1: Transients

Transients, first reported by Pittendrigh and Bruce in 1959, produce PRCs; therefore they reflect the oscillator and not the controlled process. The straight dotted line represents the period length of adapted, non-treated controls. Continuous, dashed and dotted curves show the period of the 1st, 2nd and 3rd cycles respectively, that follow non-parametric perturbation (pulsed increments of temperature or light intensity). Eventually by the third peak oscillations are adapted to the same period length as non-treated controls; this defines a transient effect. See Buening (1973), 3rd edition, pages 77 and 102 for references.

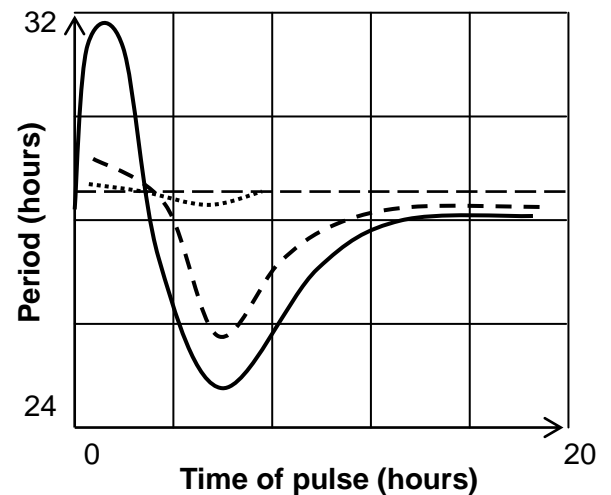

4.2.2. Supplementary sucrose applied during entrainment is "remembered" during subsequent free run

To test my hypothesis that supplementary sucrose affects entrainment, I subjected plants to various combinations of sucrose treatments during growth/entrainment and during luciferase imaging. I chose to perform these tests under BLc, because under this condition robust oscillations did not require sucrose addition. Consequently I observed that the sucrose status of entrainment is "remembered" during free run. This "memory" was noted in the differences between circadian parameters - period, rhythmicity and accuracy - produced by the treatments suc 0%→0% (plants never exposed to sucrose) and suc 3%→0% (plants exposed to 3% w/v sucrose only during entrainment, not during free run) that differed only in the sucrose status during entrainment. In more detail, under BLc transients in the accuracy of *GI::LUC* (col) were observed only when plants were never exposed to sucrose (SD-noPer was halved by the 2nd-tw). By contrast transients were not

observed when sucrose was applied during free run (treatment suc 3%→3%) as well as when sucrose was applied solely during entrainment (treatment suc 3%→0%). Moreover upon several occasions, the circadian parameters scored with the treatment suc 3%→0% were intermediate relative to those obtained with the treatments suc 0%→0% and suc 3%→3%, especially during the 1st-tw of my analysis (table 4.1; see also fig. 3.1 and 3.3)⁹². Together these findings show that the sucrose status of entrainment is "remembered" during free run (even when sucrose had not been further supplemented), suggesting that the sucrose-dependent transients are a quantitative product of entrainment. This in turn was indicative that exogenously applied sucrose functions as an *antizeitgeber* because it inhibits the product of entrainment (transients) in aerial tissues. It is noteworthy, that supplementary sucrose was previously attributed *antizeitgeber* properties based on the fact that it prevented entrainment of the root clock to LD cycles (James *et al.*, 2008). In that study it was shown that short-term circadian responses in aerial tissues are not responsive to sucrose. This is not in contrast to my findings, because transients are by definition a long-term circadian response⁹³. It should also be pointed out that accurate oscillations might result from synchrony between individual oscillations therefore the modification of accuracy-transients by supplementary sucrose further supports the involvement of sucrose in parametric entrainment.

I propose that sucrose affects the marker *GI::LUC* (Col-0) via multiple pathways. Based on the aforementioned *antizeitgeber* properties of sucrose, one of these pathways should depend on entrainment (see also chapter 4.2.1 and fig. 3.1 C). The fact that period shortening in response to sucrose was persistent further suggests that *GI::LUC* oscillations respond to sucrose through central events (see also chapter 4.2.1 and figures 3.1 and 3.2). By contrast, as earlier explained, oscillations of the marker *CAB2::LUC* (Ws) should respond to metabolic cues through pathways that are more related to entrainment rather than to central oscillations.

92. I observed the same for indirect rhythmicity and accuracy (fig.3B) of marker *CAB2::LUC* (Ws), when data from seven independent experiments were combined. In addition to these the period of *CAB2::LUC* (Ws) acquired intermediate values in a data set that combined four experiments entailing an additional entrainment event under BL (not shown).

93. More differences can be traced between this study and that of James *et al.* (2008). First the experimental setup with hydroponically grown seedlings used in that study was different than the one I was using. Then James *et al.*, (2008) showed that sucrose does not affect entrainment of rhythmic transcript levels in shoots, whereas I used luciferase activity that represents rhythms in transcriptional rate. The major difference between the two studies is that James *et al.* (2008) were measuring sucrose sensitivity with short-term circadian responses whereas I was measuring long term circadian responses.

4.2.3. Sucrose affects robustness of nuclear oscillations in a marker-specific manner

Sucrose has been used in circadian assays that measure rhythmic transcriptional rates because it amplifies the luciferase signal. However, this was accompanied by a tendency to reduce oscillatory robustness (described in fig. 1.2). To be more exact, even though oscillations of the *GI::LUC* and of the *CAB2::LUC* (Ws) markers were rendered more robust by supplementary sucrose, oscillatory robustness was increased over time provided that sucrose was not supplemented (see chapter 3.1.1 for a more detailed analysis). Consequently the effect of sucrose (assessed by comparison between the treatments suc 0%→0% and suc 3%→3%) on oscillatory robustness (accuracy and rhythmicity) was temporal for the marker *CAB2::LUC* (Ws), whereas it was temporal (rhythmicity) or moderated (accuracy) over time for the *GI::LUC* markers; interestingly, under RLc rhythmicity of the marker *GI::LUC* (Ws) was decreased by sucrose application in later time windows. These experiments show clearly that supplementary sucrose can potentially decrease robustness of oscillations especially in later time-windows.

In addition to the *GI::LUC* and *CAB2::LUC* markers, I also tested the effect of sucrose on *CCA1::LUC* (Ws), *LHY::LUC* (Ws), *CCR2::LUC* (Ws) and *TOC1::LUC* (Ws). *CCR2::LUC* (Ws) oscillations exhibited a requirement for sucrose and the same was observed for marker *LHY::LUC* (Ws) in two preliminary experiments, one under RLc and one under BLc (not shown). Sucrose shortened the circadian period in every case except for the marker *TOC1::LUC* (Ws) under BLc (fig. 3.3); the latter was reported to be resistant to sucrose under WLc in a previous report also (Dalchau *et al.*, 2011). Moreover, I confirmed that the effect of sucrose on period of *CCA1::LUC* (Ws) under BLc is temporal and observed the same in preliminary experiments for *TOC1::LUC* (Ws) under RLc and for *LHY::LUC* (Ws) under BLc (not shown).

4.2.4. Conclusive remarks on the effect of sucrose on oscillations of wild-type plants

1. The effect of sucrose on circadian parameters period, accuracy and rhythmicity was transient (temporal, restricted during the early time windows of FFT analysis) for oscillations of the marker *CAB2::LUC* (Ws) and moderated (but persistent) over time for oscillations of the *GI::LUC* markers. Sucrose application permanently advanced circadian phase suggesting that in every case the clock, and not the output pathway (or luminescence activity), was affected. Transients (temporal instability) in period, accuracy and rhythmicity were inhibited by sucrose application during free run. These findings show clearly that supplementary sucrose affects nuclear oscillations.

2. Treatment suc 3%→0% yielded intermediate values in circadian parameters relative to those obtained with treatments suc 0%→0% and suc 3%→3% (table 3.1). Consequently, in my experiments the sucrose status of entrainment was "remembered" during free run suggesting that supplementary sucrose affected the entrainment process. The "memory" of the sucrose status during entrainment was also reflected in the transients: under BLc transients in the accuracy of the *GI::LUC* (Col-0) marker were inhibited when sucrose was applied solely during entrainment. This later observation is indicative that the sucrose-dependent transients are a quantitative product of entrainment and that exogenously applied sucrose functions as an *antizeitgeber* in aerial tissues.

3. I propose that *GI::LUC* (Col-0) expression is responsive to sucrose via multiple pathways, one that is dependent on entrainment (due to the *antizeitgeber* properties of sucrose and its aforementioned "memory" effect) and one that is more central (due to the persistent sucrose-mediated period shortening). By contrast, oscillations of the marker *CAB2::LUC* (Ws) should respond to metabolic cues through pathways that are more related to entrainment rather than to central oscillations, because the effect of sucrose on circadian period was in this case temporal.

4.3. On genetic-epistasis experiments

4.3.1. The response of the *toc1-21* mutant to sucrose

The *toc1-21* (fig. 3.4) loss-of-function mutation shortens the period (Strayer *et al.*, 2000; Alabadí *et al.*, 2001) of circadian oscillations and exhibits distinct circadian phenotypes under RLc and BLc: the mutation causes *CAB2::LUC* and *CCR2::LUC* oscillations to dampen under RLc, but oscillations persist under BLc, although with decreased amplitude (Más *et al.*, 2003a). My findings are in agreement with this (compare fig. 3.4 A with B), but I was able to detect weak oscillations under RLc in the mutant using the marker *GI::LUC* (Ws). Because TOC1 is a negative regulator of *GI* (Makino *et al.*, 2002; Locke *et al.*, 2006), I reasoned that increased expression of *GI* in the *toc1-21* mutant might account for these oscillations under RLc. This cannot be the case, because despite the positive effect of the *toc1-21* mutation on the transcriptional rate of *GI*, shown in the expression of *GI::LUC* (Ws), the normalized amplitude of the rhythmic marker was similar in the mutant and in the wild-type (not shown). Moreover, *GI* transcript levels are not severely altered in the *toc1-21* mutant under WLc (Martin-Tryon *et al.*, 2007). Together, these data indicate that *GI::LUC* oscillations are less affected by the *toc1-21* mutation relative to *CCR2::LUC* or *CAB2::LUC*

oscillations, because of the hierarchy between these genes. The dampening effect of the *toc1-21* mutation is more severe for events that are more downstream from the mutation than the on core-oscillator rhythms.

Under BLc, the sucrose-related circadian phenotypes of *toc1-21* were similar, but less severe relative to those observed under RLc. This is based on the observation that the short-period phenotype of the mutant was enhanced by or restricted in the presence of sucrose under BLc and RLc, respectively. Moreover, the mutant appeared more sensitive to sucrose-mediated period shortening than the wild-type irrespective of light quality.

The aforementioned discrepancy between short-term (phase) and long-term (transients) circadian responses to sucrose is supported by the sucrose-related phenotypes of the *toc1-21* mutant as I observed them under RLc. The sucrose-dependent phenotype of *toc1-21* under RLc was persistent across three time windows indicating that long-term circadian responses to sucrose are altered in the mutant. In contrast, the short-term circadian consequences of the *toc1-21* mutation were sucrose-independent, as the mutation advanced the first circadian peak irrespective of the sucrose status during free run.

Endogenous levels of sucrose, the major photosynthate exported from green tissues, are circadian regulated (Lu *et al.*, 2005). James *et al.* (2008) proposed that sucrose or a sucrose-related signal entrains a TOC1-independent root-clock. In my experiments, *TOC1* was genetically dispensable under RLc for a normal circadian period so long as sucrose was not supplemented (fig. 3.4 D). Similarly, under BLc *TOC1* was less important in the absence than in the presence of sucrose (based on the magnitude of the *toc1-21* period phenotype; fig. 3.4 C). These experiments together are suggestive that TOC1 is rendered pleonastic (or less important) when the clock is allowed to entrain to sucrose signals, which is seen in the root (James *et al.*, 2008), or in the absence of supplemented sucrose (fig. 3.4). In this later case, endogenous sucrose-related signals are not blunted (this is known for calcium oscillations for example; Johnson *et al.*, 1995) and could therefore serve entrainment. These findings raise the question as to what purpose a gene like *TOC1* serves if related phenotypes are induced by a state as artificial as supplementary sucrose. An answer could come from studying the clock of etiolated seedlings, because there is a possibility that TOC1 is dispensable there as well (Kikis *et al.*, 2005; Wenden *et al.*, 2011). Importantly, in these plants, the carbon supply during germination is not driven by rhythmic photosynthesis, but this does not mean that carbon fluxes are arrhythmic; current knowledge in the literature is limited on this subject (Kikis *et al.*, 2005; Thines and Harmon, 2010; Wenden *et al.*, 2011).

The idea that TOC1 is rendered pleonastic when entrainment shifts to a metabolic mode is further supported by my finding that SA, known to improve photosynthetic performance (see chapter

4.6), alleviated the differences between the circadian curves of *toc1-21* and of the wild-type under RLc (fig. 3.15 A).

4.3.2. The response of the *gi-11* mutant to sucrose

Under RLc the *gi-11* mutant exhibited sucrose-dependent phenotypes and responses [marker *GI::LUC* (Ws) in fig. 3.5 B] that were opposite those seen with BLc [marker *CCA1::LUC* (Ws) in fig. 3.5 D; marker *CAB2::LUC* (Ws) in fig. 3.5 E]. In more detail, (1) under RLc, the *gi-11* mutant was oversensitive to sucrose in terms of period shortening while under BLc it was resistant and (2) under RLc, sucrose increased the accuracy of the *gi-11* mutant and the opposite was observed under BLc, where sucrose decreased the accuracy of the mutant. Notably, in the latter case, the mutant, known for its lack of robust oscillations (Martin-Tryon *et al.*, 2007), was less accurate than the wild-type only if sucrose was supplemented. (3) Under BLc, sucrose moderated the short-period phenotype of the *gi-11* mutant, whereas under RLc, a short-period phenotype was observed only if sucrose was exogenously applied.

When the *gi-11* mutant was subjected to the suc 0%→0% treatment under RLc, it did not exhibit the characteristic period-transients described earlier for the wild-type (fig. 3.5 B)⁹⁴. Consequently, GI should be involved in a light-input pathway during metabolic entrainment to RL, because as earlier explained the sucrose-dependent transients are related to entrainment. Moreover the calculation of the sucrose-mediated advance of the first circadian peak (a short-term circadian response that as such should relate to entrainment and/or light input) revealed that the *gi-11* mutant was oversensitive to sucrose (more than three-fold) relative to the wild-type (see Results chapter and fig. 3.5 A). These findings are well in agreement with the assigned role of GI within light input pathways (Park *et al.*, 1999; Locke *et al.*, 2006) and phyB signaling (Huq *et al.*, 2000)

Under RLc both short-term and long-term circadian responses were affected by the *gi-11* mutation. Short-term circadian responses were altered in that the mutant was oversensitive to sucrose relative to the wild-type when the effect of sucrose was measured with the timing of the 1st circadian peak (fig. 3.5 A). Similarly long-term circadian responses were affected because several phenotypes of the *gi-11* mutant were persistent across time windows; in more detail the *gi-11* mutant was

94. Consequently the mutant showed a short-period phenotype that was moderated over time in the presence of supplementary sucrose and a long-period phenotype that was enhanced over time in the absence of supplementary sucrose (fig. 3.5 B).

oversensitive relative to wild-type to sucrose for period shortening (fig. 3.5 B) and to sucrose-mediated increase of oscillatory robustness (fig. 3.5 A), rhythmicity in particular (not shown). By contrast, Dalchau *et al.*, (2011) proposed that *gi-11* is resistant to the long-term circadian response to sucrose (induction of oscillations in the dark). Due to this discrepancy, I looked closer at the data from Dalchau *et al.* (2011) and noticed that luciferase imaging had been conducted with clusters of seedlings. This would indeed mask latent oscillations of individual *gi-11* seedlings if they were out of phase with each other, as I have observed under RLc. Consequently, *gi-11* would appear resistant to the long-term sucrose response when it can potentially be oversensitive. Of note, in that study, the *gi-11* mutant did appear responsive to sucrose, in terms of the acute induction of *CAB2::LUC*. From the above, it should be made clear that *gi-11* can be both oversensitive and resistant to sucrose, depending on light quality. The aforementioned light-specific phenotypes of *gi-11* were restricted to period and accuracy whereas rhythmicity was defined more by the *gi-11* mutation rather than light quality (fig. 3.5 B and D). To conclude, the light-specific phenotypic responses of *gi-11* to sucrose are indicative that GI has distinct roles under BLc and under RLc.

Previously, Martin-Tryon *et al.* (2007) proposed a similar conclusion based on their findings that (in the presence of sucrose) the phenotypes of *gi-201* regarding period and of *gi-200* regarding circadian amplitude (similar to what I quantify as robustness) are dependent on light quality. My findings further add to this, that the light-specific roles of GI are related to sucrose. GI was previously thought to be connected to sucrose specifically in the dark because sucrose induced oscillations in the marker *CAB2::LUC* (Ws) in the wild-type, but not in *gi-11* (Dalchau *et al.* 2011). Moreover, in this work, *gi-11* had a sucrose-independent long-period phenotype under continuous light, indicating that the putative GI-sucrose interaction is not active in the light. The same was concluded based on the observation that, in continuous light, sucrose failed to shorten the circadian period in both the wild-type and *gi-11* (this was attributed to the fact that high light intensity masks responses to sucrose due to the effect of light on photosynthate production). By contrast, I found that under low fluence rates (in which case photosynthate production is limited) *gi-11* has long- and short-term circadian phenotypes, that depended on the combination of the sucrose status and light quality. It is possible therefore that under WLc (presented by Dalchau *et al.*, 2011), the BL-specific effect of sucrose on *gi-11* was eliminated by the RL-specific effect, as these are opposite to each other (fig. 3.5). My data on period and accuracy are suggestive that GI is not only involved in sucrose signaling to nuclear oscillations in the light, but also that GI has distinct roles in sucrose sensing under monochromatic BLc and RLc.

4.3.3. Sucrose masks the circadian phenotypes of *phyB-9* under blue light

phyB is known to be the RL photoreceptor in circadian responses. The involvement of *phyB* in BL input to the clock was genetically excluded with experiments that failed to detect period phenotypes in *phyB-1* under a wide range of fluence rates in the presence of exogenous sucrose (Somers *et al.*, 1998a, Devlin and Kay, 2000). In contrast, I found that under BLc the loss-of-function mutant *phyB-9* had a sucrose-dependent short-period phenotype (masked by sucrose; fig. 3.6 A). This phenotype was temporal and enhanced or restricted during the initial time window of the FFT analysis in independent experiments. Interestingly, *phyB* is related to several responses to BLc including certain aspects of de-etiolation (growth inhibition, cotyledon expansion and anthocyanin accumulation), as well as vegetative growth (root greening) and phototropism (reviewed in Kami *et al.*, 2010). It is thus reasonable that *phyB* additionally contributes to BLc inputs to the clock.

I reproduced the known weak long-period phenotypes of loss-of-function alleles under RLc (Somers *et al.*, 1998a, Devlin and Kay 2000, Palágyi *et al.*, 2010) with *phyB-9* in the presence of sucrose and further showed that, in the absence of sucrose, this phenotype is absent, or even reversed to a short-period phenotype in some experiments. Similar phenotypes were scored with the timing of the third circadian peak that was delayed by the mutation only in the presence of sucrose, whereas in the absence of sucrose, peaks were advanced or not affected by the mutation (fig. 3.6 B). Sucrose affected the phenotypes of *phyB-9* under BLc and under RLc similarly, as the mutation advanced circadian peaks only in the absence of supplementary sucrose.

The importance of *phyB* in BL input to the clock is furthered by the finding that the *phyB-9* mutant was less sensitive to SA-mediated period shortening relative to the wild-type under BLc (fig. 3.11 D). In these experiments, growth and entrainment were performed with supplementary sucrose, whereas SA application during free run was conducted on growth medium that was not supplemented with sucrose. Because the phenotype of the *phyB-9* mutant under BLc was masked by sucrose (fig. 3.6 A) and because of the implication of sucrose (chapter 3.1.1) and SA (fig. 3.12 and 3.13) in entrainment, I proceeded to investigate the effect of *phyB-9* in entrainment to BL. For this I tested the response of the *phyB-9* mutant to SA in a second set of experiments that did not entail sucrose during entrainment. In these the *phyB-9* mutant was resistant to SA (fig. 3.11 E), and consequently, the extent of the phenotype was dependent on entrainment conditions (compare fig. 3.11 D with E). These experiments show that *phyB* is not only involved in BL input to the clock, but also in entrainment to BL.

4.3.4. The responses of the *cca1-11*, *lhy-21* and *cca1-11;lhy-21* mutants to sucrose

The *cca1-11*, *lhy-21* and *cca1-11;lhy-21* mutants that harbor respective null alleles (Green and Tobin, 1999; Hall *et al.*, 2003) were analyzed under RLc and BLc with marker *CAB2::LUC* (Ws). Visual inspection of the TopTemp graphs surprisingly showed that under BLc the double mutant produced robust oscillations, as long as there was no supplementary sucrose added during free run (fig. 3.7 D). The quantification of rhythmicity revealed that the mutant was equally rhythmic to wild-type with treatment suc 0%→0% and less rhythmic with any other treatment⁹⁵. In addition to this, the mutant was more accurate than the wild-type so long as the plants had not been previously exposed to supplementary sucrose (fig. 3.7 E). Under RLc, the mutant did not produce robust oscillations, and this was not modified by exogenous sucrose (fig. 3.8). Together, these results show that, under BLc, the *cca1-11;lhy-21* mutant expresses a sucrose-sensitive oscillator whose sustainability depends on and requires cytosolic sucrose-related oscillations. Moreover, the fact that these phenotypes in oscillatory robustness (measured by the transcriptional rate rhythm) are dependent on the sucrose status during entrainment, suggests that metabolic oscillations entrain nuclear ones.

Whether oscillations of *cca1-11;lhy-21* are sustained over time under WLc is a subject of controversy in the literature. My findings show that sucrose could be the source of this controversy, as authors that used sucrose 3% reported gradual dampening in the oscillations of *cca1-11;lhy-21* (see Materials and Methods of Alabadi *et al.*, 2002, Mizoguchi *et al.*, 2002; Ding *et al.*, 2007; Locke *et al.*, 2005b), while authors that used less sucrose reported sustained oscillations (Lu *et al.*, 2009). The role of sucrose in the rhythm sustainability of *cca1-11;lhy-21* is not mentioned in any of these publications.

Sucrose-related phenotypes and responses of the single mutants were not severely affected by light quality (see fig. 3.7 for BLc data and fig. 3.8 for RLc data). In every case the *cca1-11* mutation had long-term consequences (phenotypes did not change between time windows) whereas the *lhy-21* mutation was related to short-term circadian responses. It is noteworthy that the phenotypes of the single mutants were opposite to each other, in that *cca1-11* was persistently resistant or over-resistant (BLc) or less sensitive (RLc) than the wild-type to sucrose, whereas the *lhy-21* mutant was temporally over-responsive to sucrose (at least under BLc). Under BLc, the *cca1-11;lhy-21* mutant was not resistant to sucrose (fig. 3.7 D and E), therefore, the *cca1-11* mutation is not epistatic to the *lhy-21* mutation. In addition to these, the short-period phenotypes of the single and the double

95. With treatment suc 3%→0% $p=4.90 \times 10^{-6}$; suc 3%→3% $p=1.31 \times 10^{-8}$; suc 0%→3% $p=1.65 \times 10^{-8}$.

mutants were not additive (as previously shown), indicating that in this respect *CCA1* and *LHY* act synergistically (Lu *et al.*, 2009, Yakir *et al.*, 2009), rather than in parallel.

Circadian rhythms in the absence of transcription and translation have been repeatedly shown for photosynthetic organisms. The oldest example comes from cells of the giant algae *Acetabularia* that exhibit rhythms in photosynthetic capacity and chloroplast shape for several days after the nucleus is removed (reviewed in Buening, 1973). Cyanobacteria exhibit temperature-compensated circadian rhythms in the presence of chemical inhibitors and in continuous darkness that do not allow transcription and translation (Xu *et al.*, 2000; Tomita *et al.*, 2005). In addition to this, the cyanobacterial clock was reconstructed *in vitro* in all its properties - sustainability, temperature compensation and entrainment - by the sole presence of KAI proteins and adenine phosphate nucleotides in solution (thus in the absence of DNA, transcription and translation; Nakajima *et al.*, 2005; Rust *et al.*, 2011). Subsequently, in the dark and in the presence of inhibitors of transcription and translation, the phototrophic green alga *Ostreococcus tauri* (O'Neil *et al.*, 2011) was found to exhibit temperature-compensated circadian rhythms in the immuno-detected conformational states of peroxiredoxins. As well, the peroxiredoxin rhythm was also observed in transgenic *Arabidopsis* plants whose nuclear clock was blunted by over-expression of the TOC1 protein (Edgar *et al.*, 2012). Similarly, the described TTFLs are dispensable for circadian rhythmicity in flies (Yang and Sehgal, 2001; Kim *et al.*, 2002; see also chapter 1.4.1) and in *Neurospora* (Lakin-Thomas and Brody, 2000; de Paula *et al.*, 2006; see also paragraph 1.4.2.b). In addition to these, a purely transcriptional oscillator has been excluded in mouse fibroblasts, because pretreatment with transcriptional inhibitors, instead of slowing the clock down as would have been predicted by the TTFL model, resulted in period shortening (Dibner *et al.*, 2009; see also O'Neil, 2009). This issue is more settled for human red blood cells that lack nuclei and exhibit the peroxiredoxin rhythm (O'Neil and Reddy, 2011). Given the central role attributed to the CCA1/LHY/TOC1 oscillator (Locke *et al.*, 2006; Zeilinger *et al.*, 2006; Ding *et al.*, 2007; Pokhilko *et al.*, 2010), it is very unlikely that the transcriptional network is fully functional in the double *cca1-11;lhy-21* mutant (see also Ding *et al.*, 2007). With this in mind, as well as the observed rhythmicity of the mutant in the absence of sucrose (fig. 3.7 D), TTFLs should not be an absolute requirement for rhythmicity at the circadian range, at least not under BL. Alternatively, the centrality of CCA1 and LHY within the oscillator should be questioned or additional unknown factors would compensate for their loss in the *cca1-11;lhy-21* mutant. These data confirm the prediction of Dodd *et al.* (2007) that in *Arabidopsis* cytosolic metabolic oscillations should contribute to rhythm generation.

4.4. The *zeitnehmer* model in *Arabidopsis*

Mathematical modeling (Roenneberg and Merrow, 1998, 1999), confirmed experimentally in *Neurospora* (Merrow *et al.*, 1999), has led to the identification of certain criteria that define *zeitnehmer* loops⁹⁶. These are (1) rhythmicity *per se* of a biochemical pathway (the *zeitnehmer*) that perceives *zeitgeber* signals and then (2) through coupling to a central oscillator the provision of rhythm-sustainability and (3) compensation against external perturbations, metabolic and changes in temperature; (4) the coupling process also ensures a period within the circadian range. It was pointed out by the authors that certain aspects of the *zeitnehmer* model are also satisfied by the TTFLs of *Drosophila* (Roenneberg and Merrow, 1998, 1999; Merrow *et al.*, 1999).

Several findings presented in this work, when combined with others in the literature, demonstrate that the CCA1/LHY/TOC1 TTFL of *Arabidopsis* meets all four of the aforementioned criteria that define a *zeitnehmer* loop. First, the model requires that oscillations in separate sub-cellular compartments should be coupled if they are to entrain each other. Several publications have shown that in *Arabidopsis* nuclear and diverse cytosolic oscillations are indeed coupled to each other. Interactions of this sort were initially implied by the circadian phenotype of the *tej* mutant (Panda *et al.*, 2002) that accumulates more pADPr polymers and could therefore be altered for several related metabolites, including those involved in energy/redox (ATP and NAD⁺) and ROS homeostasis (de Block *et al.*, 2005), as well as ABA (Vanderauwera *et al.*, 2007), and its potential signaling partner (Sanchez *et al.*, 2004) cADPR. A reciprocal regulation has also been proposed for cytosolic oscillations of cADPR and the CCA1/LHY/TOC1 oscillator (Dodd *et al.*, 2007). Cytosolic peroxiredoxin rhythms are no exception, as their phase is altered when the TOC1 protein is over-expressed (Edgar *et al.*, 2012). The data presented in this thesis are in agreement with the notion that nuclear and cytosolic oscillations are coupled and further expand our knowledge regarding the entry points of metabolic signals, through the characterization of sucrose circadian responses in the wild-type (fig. 3.1, 3.2 and 3.3) and mutants (fig. 3.4, 3.5, 3.7, and 3.8) represented in the two loop model (Locke *et al.*, 2005b). Most importantly the coupling between cytosolic sucrose-related signals and nuclear oscillations is underlined by several findings presented here, especially the sucrose-dependent robustness phenotype of the *cca1-11;lhy-21* mutant under BLc. This phenotype can be explained assuming that, under BLc, transcriptional rhythms are driven by both nuclear and cytosolic oscillations. In the *cca1-11;lhy-21* mutant, nuclear oscillations are severely impaired and in

96. The *zeitnehmer* model for the circadian clock of *Neurospora* is shown in figure 1.8. It consists of coupled nuclear and cytosolic-metabolic oscillations.

the presence of sucrose so would be cytosolic ones, leading to the known dampening phenotype of the mutant (Alabadi *et al.*, 2002; Mizoguchi *et al.*, 2002; Locke *et al.*, 2005b; Locke *et al.*, 2006; Ding *et al.*, 2007). Consequently, in the absence of sucrose (under BLc), *CAB2::LUC* transcriptional rhythms of the *cca1-11;lhy-21* mutant are mainly driven by residual cytosolic oscillations. These findings demonstrate that the dual regulation of *CAB2::LUC* rhythms by TTFLs and sucrose satisfies the second criterion of the *zeitnehmer* model, that of rhythmic sustainability through the coupling procedure. In agreement with this, supplementary sucrose has the potential of reducing the robustness of *CAB2::LUC* (Ws) and *GI::LUC* oscillations during free run (see paragraph 4.2.3). Another prediction of the *zeitnehmer* model in *Acetabularia*, *Drosophila* and *Neurospora* (Roenneberg and Merrow, 1999; Merrow *et al.*, 1999 and references therein) is that when TTFLs are eliminated, residual metabolic oscillations continue to run. The observed sucrose-dependent robustness phenotype of the *cca1-11;lhy-21* mutant (fig. 3.7 D) confirms this prediction in *Arabidopsis* as well.

A fundamental requirement of the *zeitnehmer* model is the perception of *zeitgebers* through a rhythmic *zeitnehmer* biochemical pathway, as described in the first criterion (see above). It is well-established that the three loop model (Locke *et al.*, 2006) has several entries for light input, such as LHY and CCA1 at dawn (even though this is not correlated to parametric and non-parametric entrainment; Kim *et al.*, 2003) and GI at dusk. Another well-characterized entry point of light to TTFLs is the *zeitnehmer* ELF3 that is required for rhythmicity in continuous light (McWatters *et al.*, 2000). Here it is shown that the *Arabidopsis* TTFL has several entry points of a rhythmically synthesized potential metabolic *zeitgeber*, sucrose; interestingly, all the genes represented in the two loop model are potential sucrose sensors (fig. 3.4 to 3.8).

The fourth criterion (period in the circadian range) is clearly satisfied by the extreme short-period phenotype of the *cca1-11;lhy-21* mutant that falls down to 18.5 h or in the presence of the hormone salicylic acid to 17 h (and occasionally even less; fig.3. 17). The third criterion is confirmed by the fact that all of the mutants represented in the two loop model (Locke *et al.*, 2005b) show both temperature compensation (Gould *et al.*, 2006) and nutrient compensation phenotypes (fig. 3.4, 3.5, 3.7, and 3.8). Firstly, the short-period phenotype of the *toc1-21* mutant was enhanced by or restricted in the presence of sucrose under monochromatic BLc (fig. 3.4 C) and RLc, respectively (fig. 3.4 D). Moreover, the *toc1-21* mutant was more sensitive than the wild-type to sucrose regarding period shortening (fig. 3.4) and was previously shown to have a temperature compensation phenotype that is enhanced at high temperatures (Salomé *et al.*, 2010). Secondly, the phenotypes of the *cca1-11* and *lhy-21* mutants were opposite, not only with respect to sucrose (*cca1-11*: persistently resistant or over-resistant; *lhy-21*: temporally over-sensitive; fig. 3.7 and 3.8), but

also with respect to temperature, with the *cca1* and the *lhy* phenotypes being more important at lower and at higher temperatures, respectively (Gould *et al.*, 2006; Salomé *et al.*, 2010). Finally, the *gi-11* mutant, required for wild-type period at 12°C and 27°C, but not at 17°C (Gould *et al.*, 2006), exhibited sucrose-dependent phenotypes in accuracy and period that were modified by light quality (fig. 3.5). Markedly, these phenotypes were opposite between RLc and BLc, implying a complex interplay between light, metabolism and TTFLs in the establishment of robust and compensated rhythms. Together, these results provide strong evidence that the *zeitnehmer* model proposed for *Neurospora* applies to *Arabidopsis* as well. It is noteworthy that in both organisms the *zeitnehmer* TTFL is linked to reproduction, *i.e.* induction of flowering (Fowler *et al.*, 1999) and rhythmic conidiation.

4.5. Perspectives on circadian regulation of carbon metabolism

Circadian regulation of carbon metabolism has been an intensive field of study, and the role of the *CCA1/LHY* morning loops in this respect has proven crucial (Graf and Smith, 2011; Haydon *et al.*, 2011). Carbon partitioning towards starch reserves during the day and utilization at night are under photoperiodic control, ensuring that plants will not suffer starvation during the night and that carbon allocation during the day is balanced between storage supplies and immediate usage for anabolic reactions. Consequently, through this, photoperiodic growth regulation is optimized (Gibon *et al.*, 2004; Graf *et al.*, 2010).

During the night, photoperiodic regulation of carbon metabolism is exerted in the rate of starch degradation, whereas during the day in the proportion of the photosynthate partitioned into starch. (see fig. 1.14 and Gibon *et al.*, 2004). Of note, unlike photoperiodic regulation of starch metabolism at night, the events that allow photoperiodic regulation of starch metabolism during the day are not well understood (and should not be confused with the well-described short-term regulation of photosynthesis and starch synthesis by photosynthesis products; Graf and Smith, 2011). Graf *et al.* (2010) proposed that the photoperiodic regulation of starch mobilization at night requires proper anticipation of dawn, rather than a match between the duration of endogenous and forced cycles, so that depletion of sugars during the night and consequently starvation and growth inhibition are avoided. This is because a mismatch between the endogenous and forced LD cycles impairs growth in the *cca1;lhy* mutant, but not in the *toc1* or *ztl* mutants that are deficient in night-phased clock proteins. My findings, although they do not address photoperiodic regulation, are indicative that

potentially all the genes represented in the two loop model, originally brought out to explain photoperiodism (Locke *et al.*, 2005b) in gene expression (Millar and Kay, 1996) and floral induction (Mizoguchi *et al.*, 2005), are sucrose sensors and could therefore be involved in photoperiodic regulation of starch metabolism and photosynthesis. This idea is in agreement with my proposal that, in *Arabidopsis*, metabolic and nuclear oscillations are coupled to each other for the purposes of entrainment. The data presented here add to those of Graf *et al.* (2010) and Dalchau *et al.* (2011), in that nuclear oscillations are capable of tracking the metabolic status both at dawn (via CCA1 and LHY; fig. 3.7 and 3.8) and at dusk (via TOC1 and GI, fig. 3.4 and 3.5, respectively). This is a prerequisite if TTFLs (serving a *zeitnehmer* function in this case) are to mediate photoperiodic information to metabolic oscillations. Here I note my findings that the expression of *TOC1* is highly responsive to photoperiod (fig. 4.2).

Figure 4.2: *TOC1::LUC* (Ws) expression is responsive to the photoperiod

Photoperiodic regulation of *TOC1::LUC* (ws) expression is shown. Imaging took place on agar with 3% sucrose. One additional entrainment event was applied before transfer at objective dusk into a top-count luminometer. Luminescence was monitored under photoperiodic conditions that were always as indicated. Anticipation during the day is delayed under 4hL:20hD and 8hL:16hD relative to longer photoperiods. The pattern of expression of the marker contains three peaks, one acute peak at dawn, one acute peak at dusk (not seen with 4hL:20hL) and a circadian peak in the night; the relative amplitude of the later two is also under photoperiodic regulation. Black circles: 4hL:20hL; gray circles: 8hL:16hL; cyan rhombs: 12hL:12hL; purple triangles: 16hL:8hL.

White and black bars represent objective day and night respectively. Experiments were repeated twice with similar results (Philippou and Davis, unpublished data).

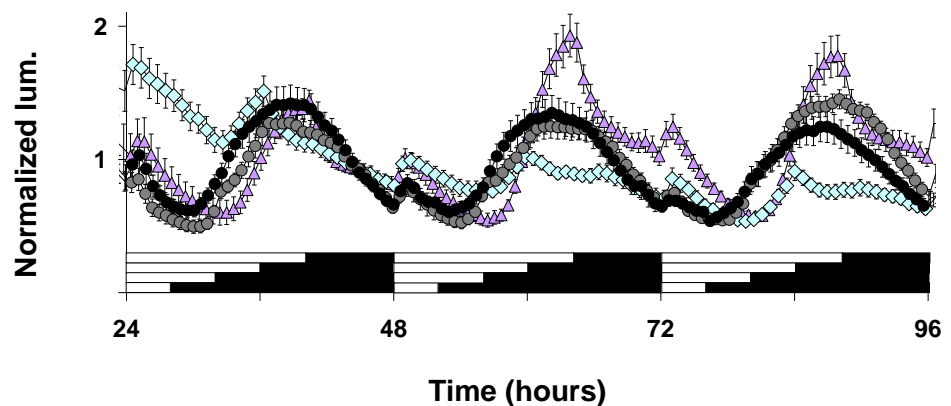

4.6. Chemical perturbation of chloroplast function is reflected in nuclear oscillations

The pace of the clock is resilient to most chemicals, as several hundreds or even thousands of compounds needed be tested for a single positive score (e.g. Tóth *et al.*, 2012). This, and the fact that all the chemicals that caused a circadian effect in my study are related to perturbations on chloroplast function (fig. 3.9 A), is suggestive that photosynthesis and electron transport chains (ETCs) exert an input to nuclear oscillations. In more detail: (1) the inhibitor of organellar transcription rifampicin lengthened the circadian period in the dark as well as under continuous light. Previously, Vanden Driessche *et al.* (1970) and Mergenhagen and Schweiger (1975) reported that rifampicin does not affect rhythmic oxygen evolution from individual cells of the unicellular algae *Acetabularia*. (2) The antioxidant vitC and (3) the oxidant paraquat altered the circadian period in a light quality- and marker-specific manner. The importance of vitC in photosynthesis is underlined by its high concentration in chloroplasts (20-300 mM) and by its photo-protective activities manifested in the regulation of the redox state of photosynthetic electron carriers, in the direct or enzymatic detoxification of ROS and in the role of vitC as an enzymatic cofactor during thermal dissipation of excess excitation energy (reviewed by Smirnov, 2000). Paraquat is a non-selective contact herbicide that generates ROS by accepting electrons from PSI and transfers them to molecular oxygen [interestingly, several *gi* mutants are resistant to paraquat-induced oxidative stress (Kurepa *et al.*, 1998), but it is not known if this constitutes a circadian phenotype]. (4) DCMU, which lengthened circadian period in my experiments, is known to shift the PQ pool to its oxidized state as it inhibits photosynthetic electron transport chains upstream of PQ. (5) The relationship of SA to chloroplasts has been noted in several studies. First, the major biosynthetic pathway of the hormone, the isochorismate pathway, is located in chloroplasts (Chen *et al.*, 2009). Moreover, SA is increased after exposure to high light (Chang *et al.*, 2009) and contributes to acclimation and photosynthetic energy dissipation through photorespiration (Mateo *et al.*, 2004) and through the induction of the antioxidant molecule glutathione (Mateo *et al.*, 2006) and likely also of vitC (Chang *et al.*, 2009). Further investigation led Mühlenbock *et al.* (2008) to propose that *LSD1*, *PAD4* and *EDS1*, all genes of the SA pathway in biotic stress responses, form a homeostatic switch downstream of the PQ pool that regulates defense mechanisms and acclimation to high light through ROS and ethylene signaling. This network has emerged as a type of hormonal crosstalk during biotic and abiotic stress responses (see also Huang *et al.*, 2010). Genetic studies have shown that endogenous SA levels affect photosynthetic electron transport under low light conditions as well. This has been investigated with low and high SA content mutants in which photosynthetic electron transport is impaired, resulting in decreased efficiency of PSII and increased non-photochemical energy

dissipation relative to wild-type under low light conditions (Mateo *et al.*, 2006). Consequently, SA is involved in photosynthetic homeostatic regulation under non-stressful conditions as well. In addition to these, application of SA at low concentrations improves photosynthetic performance in mustard seedlings (reviewed in Rivas-San Vicente and Plasencia, 2011) and alleviates the negative effects of several abiotic stresses in diverse plant species, likely due to the induction of the antioxidant system (reviewed in Horváth *et al.*, 2007). The protective role of SA through the induction of antioxidants has been an extensive field of study and was addressed by several publications that followed Horváth *et al.*, (2007)⁹⁷; it is noteworthy, that on numerous occasions (cited below with bold letters) the application of SA at low concentrations improved photosynthetic performance after exposure to the stressful conditions. All of these studies reviewed here have established a relationship between chloroplast function and the compounds that caused a circadian effect in this work (fig. 3.9 A). Based on this correlation, and as isolating chemicals that perturb the oscillator are rare, I believe that chemical perturbation of photosynthetic electron transport and chloroplast function were reflected in nuclear oscillations.

4.6.1. Vitamin C, salicylic acid, sucrose and electron transport chains form light-dependent rhythmic inputs to the clock – the multiple *zeitnehmer* model

a. Electron transport chains affect nuclear oscillations

The role of ETCs in the regulation of a given process can be shown with distinct experimentation. Yabuta *et al.* (2007) claimed that vitC levels are under the regulation of photosynthetic ETCs rather than of sugars, because DCMU and sucrose both had a negative impact on the accumulation of vitC after exposure to continuous light. This argument is based on the fact that, similarly to DCMU, photosynthates inhibit photosynthesis (Koch, 1996). The involvement of ETCs in the regulation of a given process has also been demonstrated through the controlled manipulation of the redox state of PQ by chemicals and light quality. In more detail, treatment of

97. These publications are as follow: (1) salt induced stress in chamomile (Kováčik *et al.*, 2009), mungbean cultivars (**Nazar** *et al.*, 2011), tomato (**Poór** *et al.*, 2011; Gémes *et al.*, 2011), mustard (**Yusuf** *et al.*, 2012), burclover (**Palma** *et al.*, 2013) and in wheat (**Al-Whaibi** *et al.*, 2012; Mutlu and Atici 2013; Li *et al.*, 2013); (2) heavy metal toxicity in maize (**Krantev** *et al.*, 2008; **Wang** *et al.*, 2009), pea (**Popova** *et al.*, 2009) and in mustard (**Yusuf** *et al.*, 2012); (3) chilling stress in tomato (**Duan** *et al.*, 2012) and (4) heat induced stress in *Arabidopsis* (Alonso-Ramirez *et al.*, 2009; **Khan** *et al.*, 2013) and wheat (Kolupaev *et al.*, 2012).

low light-grown plants with the inhibitors of photosynthetic ETCs DCMU or DBMIB elicits similar effects on the redox status of the PQ pool as light enriched with the wavelengths 700 nm (FRL) or 680 nm (RL), respectively (DCMU and FRL cause the oxidation and DBMIB and RL the reduction of PQ). An antagonistic effect between these factors is therefore indicative that a process is sensitive to signals derived from PQ (Pfannschmidt *et al.*, 2009). It was demonstrated in this manner that acclimation to high light is controlled by the redox state of the PQ pool, through the induction of the antioxidant system of the cell (Karpinski *et al.*, 1999) and through the aforementioned SA signaling gene network (Mühlenbock *et al.*, 2008). In addition to these, DCMU and DBMIB were used to show that in cyanobacteria light-induced reduction of the photosynthetic ETCs is responsible for phase resetting in a process that involves, amongst other, quinone binding by redox sensitive proteins (Ivleva *et al.*, 2005; Ivleva *et al.*, 2006; Wood *et al.*, 2010; see also appendix 2).

My findings that the photosynthesis inhibitor DCMU and SA at low concentrations (known to favor photosynthetic electron transport; Rivas-San Vicente and Plasencia, 2011) have opposite effects on the circadian period are indicative that nuclear oscillations are under the regulation of ETCs. The fact that the period-shortening effect of SA is inhibited by sucrose (see fig. 3.14 and wild-type controls in fig. 3.17) further supports this notion, as photosynthates inhibit photosynthetic activity (Koch, 1996). Moreover, my preliminary results (fig. 4.3) show that under BLc, DBMIB and DCMU (fig. 3.9 A) do not perturb the clock synergistically; consequently, the latter should lengthen the circadian period through its effect on the redox state of the PQ pool.

Figure 4.3: 2,5-dibromo-3-methyl-6-isopropylbenzoquinone does not affect circadian period

DBMIB, unlike DCMU (fig. 9A) did not disturb rhythmic expression of *GI::LUC* (Ws) under BLc in a preliminary experiment. Consequently DCMU and DBMIB do not affect the clock synergistically and the former would lengthen circadian period through its effect on the redox state of PQ in the chloroplasts.

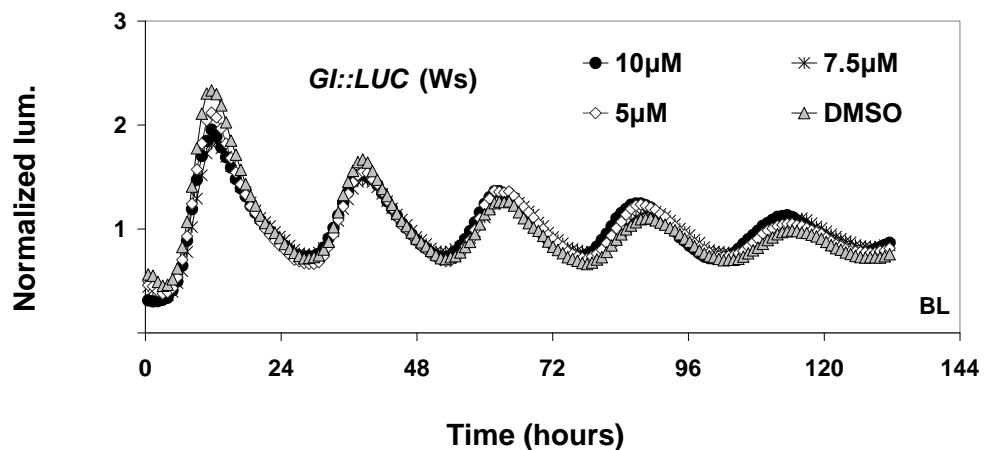

b. The redox state of PQ is correlated with circadian period

Chemical and light treatments (summed in 4.6.1.a and below) act on circadian period in a manner predicted by their effect on the redox state of plastoquinone; a reduced state would favor period shortening. In agreement to this, Wenden *et al.* (2011) showed that oscillations under RLc are faster relative to oscillations under FRLc. Factors that reduce the PQ pool (RLc vs. FRLc) and exert a protective role during photosynthesis through the regulations of PSII (SA, see chapter 4.6; vitC, reviewed in Smirnoff, 2000; see also Karpinski *et al.*, 1999) induce period shortening, whereas factors that cause oxidation of the PQ pool (DCMU and FRL, Mühlenbock *et al.*, 2008; DD or lowering light intensity, Oswald *et al.*, 2001) promote period lengthening (see also fig. 3.9). Together, these studies and my data (fig. 3.9) showed a positive correlation between circadian period length and electron transport downstream of PSII. Based on this correlation, I propose the following: (a) ETCs entrain nuclear oscillations; my experiments show a connection between sucrose (paragraph 4.2.2), SA and entrainment (fig. 3.12 and fig. 3.13) and are in agreement with this idea; (b) ambient light intensity defines the circadian period as predicted by the rule of Aschoff and FRCs, through the observed (Oswald O *et al.*, 2001) effect of fluence rate on the redox state of PQ. In agreement with this hypothesis, James *et al.* (2008) showed that the root clock, lacking photosynthetic activity, does not obey the rule of Aschoff. I stress that the proposed correlation between photosynthetic electron transport and the circadian period of nuclear oscillations are not contradicted by the proposed period-shortening effect of sucrose on nuclear oscillations (e.g. Dalchau *et al.*, 2011). This is because sucrose acts on the phase, not the period, of *CAB2::LUC* (Ws) (fig. 3.3 A and B; see also paragraph 4.2.2), which links chloroplasts to the clock in the nucleus. The role of the redox state of PQ proposed here could be further tested through the study of mutations in *STATE TRANSITION7* (*STN7*) that are known to cause over-reduction of the PQ pool (Bellafiore *et al.*, 2005).

c. Oscillations in the vitC concentration, SA activity and photosynthetic electron transport meet certain criteria predicted by *zeitnehmer* loops.

VitC is light induced and accumulates in a diurnal fashion (in tobacco, Dutilleul *et al.*, 2003; in *Arabidopsis*, Tamaoki *et al.*, 2003). Several findings are indicative that the vitC pool is also clock controlled. In *Arabidopsis*, expression of the VTC2 and VTC5 homologues that encode for GDP-L-Gal phosphorylase activity in the ascorbate biosynthetic pathway are both light and clock regulated, whereas the VTC2 transcript is downregulated by vitC supplementation, indicating feedback regulation (Dowdle *et al.*, 2007). This and the observed reciprocal regulation between the vitC pool

and photosynthetic electron transport (Yabuta *et al.*, 2007) are suggestive of a strong oscillatory potential. In this work, it is shown that vitC shortens the circadian period of *GI::LUC* (Ws) (Figure 1A), therefore, rhythmic vitC levels and nuclear oscillations affect one another reciprocally. These findings also specify that vitC levels form a *zeitnehmer* loop, comprised by definition of a rhythmic clock-input pathway (Roenneberg and Merrow, 1999; Merrow *et al.*, 1999; McWatters *et al.*, 2000). Importantly, vitC is found in all cellular compartments, and due to this, it could physically and directly relate to a signal connecting chloroplasts and nuclear oscillations. This signal could be vitC itself or the redox state of the cell that is linked to vitC through reduction by glutathione, NADPH or directly from PSI (Smirnoff, 2000). Noteworthy oscillations in the redox state of the cell [defined by oscillations in NAD(P) nucleotides] were recently proposed to regulate circadian function in mammalian cells (reviewed in Bass and Takahashi, 2011), whereas this view has also been considered in plants (Wagner, 1976; Wagner *et al.*, 1975).

Oscillatory potential is also observed for SA signaling, as implied by the induction of the hormone by light (Genoud *et al.*, 2002) and here displayed in the gated effect of the hormone on the timing of *GI::LUC* (Ws) (fig. 3.12). The resulting system meets all the criteria of the *zeitnehmer* model set out by Roenneberg and Merrow (1999) (see paragraph 4.4). In this model, metabolic rhythms are not simply under the control of TTFLs, rather reciprocal regulation between these compartmentalized oscillations sets the period within the circadian range and serves entrainment, rhythmic sustainability and compensation against environmental perturbation. McWatters *et al.* (2000) further demonstrated that *zeitnehm*ers signal to the clock in a gated manner. The involvement of SA in parametric and non-parametric entrainment, the effect of SA on rhythmic sustainability (fig. 3.13) and the gated effect of SA on circadian timing (fig. 3.12) strongly suggest that this hormone is involved in a *zeitnehmer* loop that entrains nuclear oscillations. The reciprocal regulation between nuclear and metabolic oscillations is further supported by the SA-related phenotypes of the *toc1-21* (fig. 3.15), *phyB-9* (fig. 3.16) and *lhy-21* (fig. 3.17) mutants. Moreover, the inhibitory effect of sucrose on SA-mediated period shortening (fig. 3.14 and fig. 3.17 A vs. B) indicates that SA affects nuclear oscillations through photosynthetic electron transport. Based on the circadian effects of sucrose, SA, DCMU and vitC, I propose that these and/or ETCs form multiple *zeitnehmer* loops with nuclear oscillations that regulate each other reciprocally. All of these oscillations could, in theory, be coupled in the redox state of the cell.

The *zeitnehmer* model could explain the ability of multiple photoreceptor mutants to respond to LD cycles through metabolic entrainment (Yanovsky *et al.*, 2000; Strasser *et al.*, 2010). Alternatively, entrainment in these photoreceptor mutants could be attributed to ZTL. ZTL is an F-box protein that targets TOC1 (Más *et al.*, 2003b) and PRR5 (Fujiwara *et al.*, 2008) for proteasome-

mediated degradation; both of these functions are inhibited under BLc, suggesting a mechanism whereby ZTL acts within light input pathways. Moreover, GI binds ZTL and subsequently inhibits degradation of TOC1, in a manner that requires the absorption of light by a photoactive ZTL protein (Kim *et al.*, 2007). These findings confirm the preceding genetic studies that connected GI (Park *et al.*, 1999; Locke *et al.*, 2005b) and ZTL (Somers *et al.*, 2000; Somers *et al.*, 2004; Kevei *et al.*, 2006) with light input to the clock. Despite this relationship established between GI and ZT with light input to the clock, a relationship between these proteins and light entrainment (a distinct from light input entity) has not been found. ZTL alone could not explain entrainment in the multiple photoreceptor mutants, especially under RL where the ZTL photoreceptor is unlikely to be photoactive (Kim *et al.*, 2007) and should therefore be involved in RL input to the clock downstream of other photoreceptors (e.g. phyB; Jarillo *et al.*, 2001). Based on what was presented here, I suggest that studies dealing with entrainment in higher plants should focus more on photosynthetic electron transport.

The involvement of phyB in BL input to the clock had previously been genetically excluded (Somers *et al.*, 1998a; Devlin and Kay, 2000). Here it is shown that sucrose employed in those experiments may have masked the circadian phenotypes of *phyB* mutants (fig. 3.6 A). The role of phyB in BL input to the clock (in the absence of supplementary sucrose) was further supported by the reduced sensitivity of the *phyB-9* mutant to SA (a similar phenotype was observed under RLc as well; fig. 3.11 C, D and E). It is noteworthy that phyB is required downstream of SA during the hypersensitive reaction (production of ROS and subsequently cell death) and expression of pathogenesis-related proteins that accompany biotic stress responses. Interestingly, the hypersensitive reaction after pathogen infection requires light and chlorophyll (Genoud *et al.*, 2002). Consequently, it is possible that SA, phyB and ETCs may affect entrainment (parametric and non-parametric) and defense responses through the same pathways.

4.7. Periodic stress and the clock regulate each other reciprocally - future insights

System-wide analysis has shown that hormone-responsive and circadian regulated genes overlap in a greater proportion than expected by chance, predicting that hormone and stress responses are anticipated (Covington and Harmer, 2007; Covington *et al.*, 2008; Legnaioli *et al.*, 2009; Mizuno and Yamashino, 2008; see also Sanchez *et al.*, 2011 for a recent review). A series of publications dealing with hormone signaling has proven this transcriptome-based prediction correct (see chapter 1.6.6). Noteworthy, responsiveness to auxin, ABA and GA is gated by the circadian

clock at specific times of the day (Covington and Harmer, 2007; Legnaioli *et al.*, 2009; Arana *et al.*, 2011; see chapter 1.6.7). These findings suggest that plants orchestrate responsiveness to hormones around the clock in a fashion that would predict periodic stress imposed by night/dark cycles or simply to restrict hormonal responses at certain times of the day. This idea of anticipated stress was recently expanded to pathogen responses, as the *cca1* loss-of-function mutant is oversensitive to the obligate biotrophic oomycete *Hyaloperonospora arabidopsitis* specifically at dawn. At this time, the oversensitivity phenotype of the mutant coincides with CCA1 expression in wild-type plants and sporulation of the pathogen. Therefore, it is possible that plants anticipate the rhythmic behavior of pathogens (Wang *et al.*, 2011). Alternatively, pathogens anticipate the rhythmic behavior of plants, including the daily dawn-phased stomatal opening (Dodd *et al.*, 2005) required for gas exchange. Whatever the case might be, wild-type plants are more sensitive to pathogen infection at dusk rather than at dawn (Wang *et al.*, 2011). The gated effect of SA presented here is indicative that SA signaling will not only initiate defense mechanisms, but will also enhance the ability of plants to measure time (fig. 3.13) and will also reset the clock (fig. 3.12). Perhaps then, in the wild, pathogens and abiotic stresses would function as *zeitgebers*. If this was the case, then it would connect to my observation that the effect of SA on phase is gated (fig. 3.12), as expected for any *zeitnehmer* pathway⁹⁸. I would also like to stress that this is the first report that shows gated hormonal feedback to the clock, as previous gating responses to ABA, auxin and GA referred to the effects of the hormones on the amplitude, not the timing, of rhythmic processes (Covington and Harmer, 2007; Legnaioli *et al.*, 2009; Arana *et al.*, 2011).

4.8. CCA1 and LHY are not redundant in their roles as SA and sucrose sensors

My findings add to the growing list of evidence that LHY and CCA1 have distinct circadian roles. Previously the short-period phenotypes of single loss-of-function mutants indicated that *CCA1* and *LHY* are redundant, but the extreme short-period phenotype of *cca1;lhy* double mutant suggests that CCA1 and LHY actions are not independent to each other or just additive (Green and Tobin 1999, Mizoguchi *et al.*, 2002, Alabadi *et al.*, 2002). In support of this, it was recently demonstrated that CCA1 and LHY co-localize in the nucleus, form homodimers and heterodimers and are part of

98. Note added in proof from a preliminary experiment: Pathogens amplify oscillations in the *tic* (*time for coffee*; Hall *et al.*, 2003) mutant (Ding Z, Philippou K, Davis SJ, unpublished data). I suspect for this that pathogens or in general stressful conditions may function as *zeitgebers*.

the same large protein complex at dawn (Yakir *et al.*, 2009, Lu *et al.*, 2009), suggesting that the action of the two proteins is synergistic. Accordingly distinct roles of *CCA1* and *LHY* have been proposed at different ambient temperatures (Gould *et al.* 2006) and during biotic stress responses (Wang *et al.*, 2011). Here I show that the effect of SA on circadian rhythms is related more to *LHY* rather than to *CCA1* (fig. 3.17). Additionally *cca1-11* and *lhy-21* have distinct, opposite sucrose-related phenotypes (fig. 3.7 and fig. 3.8), affecting long- and short-term circadian responses, respectively.

4.9. Why would HSP90.2 be involved in timekeeping

HSP90.2 affects an entire network of proteins (Zhao *et al.*, 2005) and several environmental responses (Sangster *et al.*, 2007). Because of this and based on the idea that compensation of period (circadian or ultradian) against temperature is a property of biochemical networks (Wagner *et al.*, 2000; Morgan *et al.*, 2001; Murray *et al.*, 2007; Lloyd and Murray, 2007), it is possible that the temperature compensation phenotype of *hsp90.2-3* is due to network perturbation. Noteworthy, sucrose inhibited the period-lengthening effect of geldanamycin in a preliminary experiment (table 3.1), which suggests that case this hypothesis is right then the networks involved might be metabolic. An alternative explanation was given by Kim *et al.*, (2011) who found that ZTL is a client of HSP90. Interestingly, HSP90 "clients" in plants [e.g. Resistance (R) proteins] as well as in animals (e.g. steroid hormone receptors) are inherently unstable signaling proteins, as they are meant to be degraded upon activation (reviewed in Sangster and Queitsch, 2005). This is easily featured for clock proteins that should be synthesized and "tell" time before being removed.

HSP90 is known for its role as a capacitor of phenotypic variation in *Drosophila* (Rutherford and Lindquist, 1998) and in *Arabidopsis* (Queitsch *et al.*, 2002). In both organisms HSP90 suppresses the consequences of underlying genetic variation on environmentally regulated developmental responses⁹⁹ (Sangster and Queitsch, 2005; Sangster *et al.*, 2008). Consequently "clients" of HSP90 include clock-proteins perhaps because the later link development (e.g. growth and flowering time) to the environment (reviewed in McClung *et al.*, 2006). ZTL is no exception to

99. Presumably this function is relevant to evolutionary processes, as stress compromises the buffering capacity of HSP90 allowing thereafter phenotypic expression of cryptic genetic variation that would be prone to selection under suboptimal environments (Sangster and Queitsch, 2005; Sangster *et al.*, 2008).

this as when mutated hypocotyl growth and circadian period become oversensitive to changes of ambient light intensity (Somers *et al.*, 2000; Somers *et al.*, 2004; Kevei *et al.*, 2006) and of ambient temperature (Edwards *et al.*, 2005). It should be mentioned though that the circadian phenotypes of *ztl* mutants (Edwards *et al.*, 2005) and of *hsp90.2-3* (fig. 3.18 and 3.19) are exacerbated under warm and cold temperatures respectively. Consequently, if the two proteins affect temperature compensation in concert (as implied by their extreme circadian long-period phenotypes not seen in any other single clock mutant) then perhaps the circadian phenotype of *hsp90.2-3* under cold temperatures is due to a "gain of function", meaning that the mutated protein would acquire a temperature dependent role not adopted by wild-type HSP90. This I stress because *hsp90.2-3* is thought of as a gain-of-function mutation (Hubert *et al.*, 2003).

4.10. Conclusive remarks

Sucrose shortens the period of circadian nuclear gene expression. The effect of sucrose on rhythmic photosynthetic gene expression [*CAB2::LUC* (Ws)] is transient. By contrast, the effect of sucrose is persistent, though moderated over time, for oscillations of *GI::LUC* markers. The sucrose status of entrainment is "remembered" during free run, indicating that supplementary sucrose is an *antizeitgeber* that affects parametric entrainment. This in turn is implicit that endogenous sucrose signals might be important for entrainment. Moreover, supplementary sucrose limits oscillatory potential in a marker specific manner indicating that metabolic oscillations are important for rhythm sustainability.

Exogenous sucrose employed in luciferase assays modifies the known phenotypes of well described circadian mutants in *Arabidopsis*¹⁰⁰. Noteworthy, robust oscillations in the *cca1-11;lhy-21*

100. Sucrose input is downregulated in the *cca1-11* mutant (that is resistant to supplementary sucrose relative to the wild-type) and up-regulated in the *toc1-21* mutant (that is oversensitive to supplementary sucrose). Noteworthy, under RLc the short-period phenotype of the later is restricted in the presence of exogenous sucrose; similarly, its phenotype is enhanced by sucrose application under BLc. The *lhy-21* mutant is temporally oversensitive to exogenous sucrose under BLc. Under RLc the *gi-11* mutant exhibits sucrose-dependent phenotypes and responses that are opposite those seen with BLc (the mutant is oversensitive to supplementary sucrose under RL and resistant under BL). Interestingly, the *phyB-9* mutant displays circadian phenotypes under BLc that were previously masked by supplementary sucrose. Long-term circadian responses to sucrose are altered in the *cca1-11* mutant, but not in the *lhy-21* mutant, under RLc as well as

double mutant were previously masked by supplementary sucrose; this is indicative that the coupling between nuclear and cytosolic oscillations provides rhythm sustainability. These results further show that nuclear and metabolic oscillations are coupled through known circadian elements.

SA increases oscillatory robustness in a manner that depends on parametric entrainment. Moreover it shortens circadian period and this effect is gated with maximum responsiveness during the first half of the subjective day. The period shortening effect of SA is moderated by sucrose, indicating that SA affects nuclear oscillations through photosynthetic electron transport. Circadian mutants show distinct responses to SA¹⁰¹.

The circadian phenotypes of the *phyB-9* mutant under BLc are masked by supplementary sucrose. Moreover, the response of the mutant to SA under BL is dependent on the sucrose status of entrainment, indicating that phyB and sucrose affect BL input to the clock and entrainment to BL in concert.

Circadian period of nuclear gene expression is not compensated against chemicals that target photosynthesis and chloroplasts. This includes SA, vitC, paraquat, sucrose, DCMU and rifampicin. Chemical and various light treatments (as shown here and in the literature) act on circadian parameters in a manner predicted by their effect on photosynthetic electron transport and on the redox state of plastoquinone; a reduced state favors period shortening. The data presented here regarding the effect of chemicals on circadian period and a considerable amount of published data, including the rule of Aschoff, can be explained by this correlation.

The circadian system of *Arabidopsis* is tightly linked to metabolic control. Metabolic and nuclear oscillations are coupled to each other in the context set by the *zeitnehmer* model that predicts that rhythmic metabolic input pathways affect central oscillations in a gated manner to provide rhythm sustainability, a period within the circadian range and compensation against metabolic perturbation (shown here) and against changes in ambient temperature.

Of the "non-circadian" mutants tested, *hsp90.2-3*, known to be altered for reactive-oxygen-species metabolism and related defense responses, had a temperature compensation long-period phenotype. Preliminary results are supportive to one hypothesis that circadian defects in *hsp90.2-3* are affiliated to metabolism.

under BLc; in addition to these, under RLc I was able to show that long-term circadian responses are altered in the *gi-11* and in the *toc1-21* mutants; short term circadian responses to sucrose are not altered in the later under RLc.

101. Under BLc the *lhy-21* and the *cca1;lhy-21* mutants are oversensitive and the *toc1-21* less sensitive to SA than the wild-type in circadian assays; moreover, under RLc the *toc1-21* mutant is oversensitive to SA.

4.11. Future perspectives

Nuclear oscillations in *Arabidopsis* are thought of as being driven by TTFLs that form a "repressilator" (fig. 1.12). An interpretation of this is that the plant clock model lacks adequate activators to be rationally defined (reviewed in Bujdoso and Davis, 2013). Here it is shown that positive interactions could be attributed to metabolic oscillations, likely photosynthesis. Moreover, it is shown through genetic-epistasis approaches that long-term circadian responses to sucrose are altered in the *cca1-11* and the *toc1-21* mutants. Based on the sucrose dependent phenotypes of these mutant lines, TOC1 could be a negative regulator and CCA1 could be a positive regulator of long-term circadian responses to sucrose, but knowledge on the biochemistry of these putative interactions is required for them to be established. This hypothesis on the roles of TOC1 and CCA1 in metabolic input to TTFLs fits well into the "repressilator" model, explaining the sucrose-related phenotype of the *toc1-21* mutant. Expanding the *toc1-21* mutant would be oversensitive to sucrose relative to wild-type not only because it lacks the negative mediator of metabolic input TOC1, but also due to the observed up-regulation of the putative positive element CCA1 at dawn (Pokhilko *et al.*, 2012). I would refrain from combining the sucrose-related phenotypes of the single *cca1-11* and *lhy-21* mutants with the current models because in these *CCA1* and *LHY* are considered redundant, when the sucrose-related phenotypes of the respective mutants are opposite. The *cca1-11;lhy-21* mutant on the other hand is well described by the "repressilator" model. This mutant appeared responsive to supplementary sucrose, despite the lack of CCA1. Alternatively the responsiveness of the *cca1-11;lhy-21* mutant to sucrose could be attributed to the extreme phase advance of evening-phased clock genes including that of *TOC1* (reported in Pokhilko *et al.*, 2012). These issues are worth investigating when the metabolic input to the TTFLs of *Arabidopsis* is considered in computational models. These findings are also indicative that the "repressilator" is capable of tracking the metabolic status at both dawn (through CCA1 and LHY) and dusk (through GI and TOC1), providing insights on the photoperiodic regulation of starch metabolism.

Putative biochemical interactions between metabolism and the TTFLs could be found in the literature. A connection between circadian rhythmicity and metabolism is indicated in the structure of the promoters of *CCA1* and *LHY* that contain G-box sequences (Martínez-García *et al.*, 2000), known to respond to diverse environmental stimuli, including light and redox changes (Vranová *et al.*, 2002). Interestingly, TOC1 associates with the G-boxes of *CCA1* and *LHY* (Gendron *et al.*, 2012). For these reasons, and given the sucrose-related phenotypes of the *toc1-21*, *lhy-21* and *cca1-11* mutants, it is worth investigating whether the repression of *CCA1* and *LHY* expression by TOC1 is prone to redox regulation. Protocols for testing redox regulation of gene expression through G-

boxes (e.g. Shaikhali *et al.*, 2012) and for the association of TOC1 to the G-boxes of *CCA1* and *LHY* (Gendron *et al.*, 2012) are available. Another metabolic input to the TTFLs of *Arabidopsis* might connect to TOC1/PRR pseudo-response regulators and their pseudo-receiver domains; this is implied in the recent finding that the pseudo-receiver domain of the cyanobacterial clock protein KaiA binds quinones and thus senses the redox state of the cell as defined by photosynthetic electron transport (Wood *et al.*, 2010).

The present work is the first report connecting phyB signaling to BL input to the clock, and moreover, supports that phytochromes mediate entrainment. That the circadian phenotypes of the *phyB-9* loss-of-function mutant were masked by sucrose application raises the possibility that phyB signaling under BLc is dependent on photosynthetic electron transport. In agreement to this hypothesis is a proposal by Salomé *et al.*, (2013) that the sensor governing the newly defined circadian responses to iron defines a novel retrograde pathway that involves phytochromes and the functional state of chloroplasts. The importance of photosynthetic electron transport and of the redox state of plastoquinone in the regulation of TTFLs could be further investigated through the study of mutations in *STATE TRANSITION7* (*STN7*) that are known to cause over-reduction of the PQ pool (Bellafiore *et al.*, 2005).

Bibliography

- Achard P, Liao L, Jiang C, Desnos T, Bartlett J, Fu X, Harberd NP.** (2007). DELLAs contribute to plant photomorphogenesis. *Plant Physiol.*, 143(3): 1163-72.
- Adamich M, Laris PC, Sweeney BM.** (1976). In vivo evidence for a circadian rhythm in membranes of *Gonyaulax*. *Nature*, 261(5561): 583-5.
- Ahmad M, Jarillo JA, Smirnova O, Cashmore AR.** (1998). The CRY1 blue light photoreceptor of *Arabidopsis* interacts with phytochrome A in vitro. *Mol. Cell.*, 1(7): 939-48.
- Akhtar RA, Reddy AB, Maywood ES, Clayton JD, King VM, Smith AG, Gant TW, Hastings MH, Kyriacou CP.** (2002). Circadian cycling of the mouse liver transcriptome, as revealed by cDNA microarray, is driven by the suprachiasmatic nucleus. *Curr. Biol.*, 12(7): 540-50.
- Alabadí D, Blázquez MA.** (2008). Integration of light and hormone signals. *Plant Signal. Behav.*, 3(7): 448-9.
- Alabadí D, Gallego-Bartolomé J, Orlando L, García-Cárcel L, Rubio V, Martínez C, Frigerio M, Iglesias-Pedraz JM, Espinosa A, Deng XW, Blázquez MA.** (2008). Gibberellins modulate light signaling pathways to prevent *Arabidopsis* seedling de-etiolation in darkness. *Plant J.*, 53(2): 324-35.
- Alabadí D, Gil J, Blázquez MA, García-Martínez JL.** (2004). Gibberellins repress photomorphogenesis in darkness. *Plant Physiol.*, 134(3): 1050-7.
- Alabadí D, Oyama T, Yanovsky MJ, Harmon FG, Más P, Kay SA.** (2001). Reciprocal regulation between TOC1 and LHY/CCA1 within the *Arabidopsis* circadian clock. *Science*, 293(5531): 880-3.
- Alabadí D, Yanovsky MJ, Más P, Harmer SL, Kay SA.** (2002). Critical role for CCA1 and LHY in maintaining circadian rhythmicity in *Arabidopsis*. *Curr. Biol.*, 12(9): 757-61.
- Alonso-Ramírez A, Rodríguez D, Reyes D, Jiménez JA, Nicolás G, López-Climent M, Gómez-Cadenas A, Nicolás C.** (2009). Evidence for a role of gibberellins in salicylic acid-modulated early plant responses to abiotic stress in *Arabidopsis* seeds. *Plant Physiol.*, 150(3): 1335-44.
- Al-Wahaibi MH, Siddiqui MH, Basalah MO.** (2012). Salicylic acid and calcium-induced protection of wheat against salinity. *Protoplasma*, 249(3): 769-78.
- Arana MV, Marín-de la Rosa N, Maloof JN, Blázquez MA, Alabadí D.** (2011). Circadian oscillation of gibberellin signaling in *Arabidopsis*. *PNAS*, 108(22): 9292-7.

- Arenas-Huertero F, Arroyo A, Zhou L, Sheen J, León P.** (2000). Analysis of Arabidopsis glucose insensitive mutants, *gin5* and *gin6*, reveals a central role of the plant hormone ABA in the regulation of plant vegetative development by sugar. *Genes Dev.*, 14(16): 2085-96.
- Aronson BD, Johnson KA, Loros JJ, Dunlap JC.** (1994a). Negative feedback defining a circadian clock: autoregulation of the clock gene frequency. *Science*, 263(5153): 1578-84.
- Aschoff J, Wever R.** (1962). Spontanperiodik des Menschen bei Ausschluss aller Zeitgeber. *Naturwissenschaften*, 15: 337-342.
- Asher G, Gatfield D, Stratmann M, Reinke H, Dibner C, Kreppel F, Mostoslavsky R, Alt FW, Schibler U.** (2008). SIRT1 regulates circadian clock gene expression through PER2 deacetylation. *Cell*, 134(2): 317-28.
- Baker CL, Kettenbach AN, Loros JJ, Gerber SA, Dunlap JC.** (2009). Quantitative proteomics reveals a dynamic interactome and phase-specific phosphorylation in the *Neurospora* circadian clock. *Mol. Cell*, 34(3): 354-63.
- Baker CL, Loros JJ, Dunlap JC.** (2012). The circadian clock of *Neurospora crassa*. *FEMS Microbiol. Rev.*, 36(1): 95-110.
- Bass J, Takahashi JS.** (2011). Circadian rhythms: Redox redux. *Nature*, 469(7331): 476-8.
- Bechtold U, Murphy DJ, Mullineaux PM.** (2004). Arabidopsis peptide methionine sulfoxide reductase2 prevents cellular oxidative damage in long nights. *Plant Cell*, 16(4): 908-19.
- Ballario P, Talora C, Galli D, Linden H, Macino G.** (1998). Roles in dimerization and blue light photoresponse of the PAS and LOV domains of *Neurospora crassa* white collar proteins. *Mol. Microbiol.*, 29(3): 719-29.
- Bancos S, Szatmári AM, Castle J, Kozma-Bognár L, Shibata K, Yokota T, Bishop GJ, Nagy F, Szekeres M.** (2006). Diurnal regulation of the brassinosteroid-biosynthetic CPD gene in Arabidopsis. *Plant Physiol.*, 141(1): 299-309.
- Banerjee R, Schleicher E, Meier S, Viana RM, Pokorny R, Ahmad M, Bittl R, Batschauer A.** (2007). The signaling state of Arabidopsis cryptochrome 2 contains flavin semiquinone. *J. Biol. Chem.*, 282(20): 14916-22.
- Barth C, De Tullio M, Conklin PL.** (2006). The role of ascorbic acid in the control of flowering time and the onset of senescence. *J. Exp. Bot.*, 57(8): 1657-65.

- Baudry A, Ito S, Song YH, Strait AA, Kiba T, Lu S, Henriques R, Pruneda-Paz JL, Chua NH, Tobin EM, Kay SA, Imaizumi T.** (2010). F-box proteins FKF1 and LKP2 act in concert with ZEITLUPE to control Arabidopsis clock progression. *Plant Cell*, 22(3): 606-22.
- Bellaïfiore S, Barneche F, Peltier G, Rochaix JD.** (2005). State transitions and light adaptation require chloroplast thylakoid protein kinase STN7. *Nature*, 433(7028): 892-5.
- Belozerskaya TA, Gessler NN, Isakova EP, Deryabina YI.** (2012). *Neurospora crassa* Light Signal Transduction Is Affected by ROS. *J. Signal Transduct.*, 791963.
- Blaesing OE, Gibon Y, Günther M, Höhne M, Morcuende R, Osuna D, Thimm O, Usadel B, Scheible WR, Stitt M.** (2005). Sugars and circadian regulation make major contributions to the global regulation of diurnal gene expression in Arabidopsis. *Plant Cell*, 17(12): 3257-81.
- de Block M, Verduyn C, De Brouwer D, Cornelissen M.** (2005). Poly(ADP-ribose) polymerase in plants affects energy homeostasis, cell death and stress tolerance. *Plant J.*, 41(1): 95-106.
- Bognár LK, Hall A, Adám E, Thain SC, Nagy F, Millar AJ.** (1999). The circadian clock controls the expression pattern of the circadian input photoreceptor, phytochrome B. *PNAS*, 96(25): 14652-7.
- Bouly JP, Schleicher E, Dionisio-Sese M, Vandenbussche F, Van Der Straeten D, Bakrim N, Meier S, Batschauer A, Galland P, Bittl R, Ahmad M.** (2007). Cryptochrome blue light photoreceptors are activated through interconversion of flavin redox states. *J. Biol. Chem.*, 282(13): 9383-91.
- Bujdoso N, Davis SJ.** (2013). Mathematical modeling of an oscillating gene circuit to unravel the circadian clock network of *Arabidopsis*. *Front. Plant Sci.*, 4: 3.
- Buenning E.** (1931). Untersuchungen über die autonomen tagesperiodischen Bewegungen der Primärblätter von *Phaseolus multiflorus*. *Jahrb. Wiss. Bot.*, 75: 439–480.
- Buenning E.** (1936). Die endogene Tagesrhythmik als Grundlage der photoperiodischen Reaktion. *Ber. Dtsch. Bot. Ges.*, 54: 590–607.
- Buenning E.** (1973). *The Physiological Clock*. 3rd ed. (New York: Springer-Verlag).
- de Candolle AP.** (1832). *Physiologie Végétale* (Paris: Bechet Jeune).
- Carré IA, Kim JY.** (2002). MYB transcription factors in the Arabidopsis circadian clock. *J. Exp. Bot.*, 53(374): 1551-7.

- Casal JJ, Sanchez RA, Botto JF.** (1998). Modes of action of phytochromes. *J. Exp. Bot.*, 49(319): 127-138.
- Cashmore AR, Jarillo JA, Wu YJ, Liu D.** (1999). Cryptochromes: blue light receptors for plants and animals. *Science*, 284(5415): 760-5.
- Castillon A, Shen H, Huq E.** (2007). Phytochrome Interacting Factors: central players in phytochrome-mediated light signaling networks. *Trends Plant Sci.*, 12(11): 514-21.
- Chang CC, Slesak I, Jordá L, Sotnikov A, Melzer M, Miszalski Z, Mullineaux PM, Parker JE, Karpinska B, Karpinski S.** (2009). Arabidopsis chloroplastic glutathione peroxidases play a role in cross talk between photooxidative stress and immune responses. *Plant Physiol.*, 150(2): 670-83.
- Chen Z, Zheng Z, Huang J, Lai Z, Fan B.** (2009). Biosynthesis of salicylic acid in plants. *Plant Signal. Behav.*, 4(6): 493-6.
- Chen Z, Silva H, Klessig DF.** (1993). Active oxygen species in the induction of plant systemic acquired resistance by salicylic acid. *Science*, 262(5141): 1883-6.
- Cheng P, He Q, He Q, Wang L, Liu Y.** (2005). Regulation of the *Neurospora* circadian clock by an RNA helicase. *Genes Dev.*, 19(2): 234-41.
- Cheng P, He Q, Yang Y, Wang L, Liu Y.** (2003). Functional conservation of light, oxygen, or voltage domains in light sensing. *PNAS*, 100(10): 5938-43.
- Cheng P, Yang Y, Gardner KH, Liu Y.** (2002). PAS domain-mediated WC-1/WC-2 interaction is essential for maintaining the steady-state level of WC-1 and the function of both proteins in circadian clock and light responses of *Neurospora*. *Mol. Cell. Biol.*, 22(2): 517-24.
- Clack T, Mathews S, Sharrock RA.** (1994). The phytochrome apoprotein family in *Arabidopsis* is encoded by five genes: the sequences and expression of PHYD and PHYE. *Plant Mol. Biol.*, 25(3): 413-27.
- Covington MF, Harmer SL.** (2007). The circadian clock regulates auxin signaling and responses in *Arabidopsis*. *PLoS Biol.*, 5(8): e222.
- Covington MF, Maloof JN, Straume M, Kay SA, Harmer SL.** (2008). Global transcriptome analysis reveals circadian regulation of key pathways in plant growth and development. *Genome Biol.*, 9(8): R130.

- Covington MF, Panda S, Liu XL, Strayer CA, Wagner DR, Kay SA.** (2001). ELF3 modulates resetting of the circadian clock in *Arabidopsis*. *Plant Cell*, 13(6): 1305-15.
- Crosthwaite SK, Dunlap JC, Loros JJ.** (1997). *Neurospora* *wc-1* and *wc-2*: transcription, photoresponses, and the origins of circadian rhythmicity. *Science*, 276(5313):763-9.
- Crosthwaite SK, Loros JJ, Dunlap JC.** (1995). Light-induced resetting of a circadian clock is mediated by a rapid increase in frequency transcript. *Cell*, 81(7): 1003-12.
- Cumming BG, Wagner E.** (1968). Rhythmic processes in plants. *Annu. Rev. Plant Physiol.*, 19: 381-416.
- Dalchau N, Baek SJ, Briggs HM, Robertson FC, Dodd AN, Gardner MJ, Stancombe MA, Haydon MJ, Stan GB, Gonçalves JM, Webb AA.** (2011). The circadian oscillator gene *GIGANTEA* mediates a long-term response of the *Arabidopsis thaliana* circadian clock to sucrose. *PNAS*, 108(12): 5104-9.
- Devlin PF.** (2002). Signs of the time: environmental input to the circadian clock. *J. Exp. Bot.*, 53(374): 1535-50.
- Devlin PF, Kay SA.** (2000). Cryptochromes are required for phytochrome signaling to the circadian clock but not for rhythmicity. *Plant Cell*, 12(12): 2499-2510.
- Dibner C, Sage D, Unser M, Bauer C, d'Eysmond T, Naef F, Schibler U.** (2009). Circadian gene expression is resilient to large fluctuations in overall transcription rates. *EMBO J.*, 28(2): 123-34.
- Dijkwel PP, Huijser C, Weisbeek PJ, Chua NH, Smeekens SC.** (1997). Sucrose control of phytochrome A signaling in *Arabidopsis*. *Plant Cell*, 9(4): 583-95.
- Ding Z, Doyle MR, Amasino RM, Davis SJ.** (2007). A complex genetic interaction between *Arabidopsis thaliana* *TOC1* and *CCA1/LHY* in driving the circadian clock and in output regulation. *Genetics*, 176(3): 1501-10.
- Dioum EM, Rutter J, Tuckerman JR, Gonzalez G, Gilles-Gonzalez MA, McKnight SL.** (2002). *NPAS2*: a gas-responsive transcription factor. *Science*, 298(5602): 2385-7.
- Dixon LE1, Knox K, Kozma-Bognar L, Southern MM, Pokhilko A, Millar AJ.** (2011). Temporal repression of core circadian genes is mediated through *EARLY FLOWERING 3* in *Arabidopsis*. *Curr. Biol.*, 21(2): 120-5.

- Doble BW, Woodgett JR.** (2003). GSK-3: tricks of the trade for a multi-tasking kinase. *J. Cell Sci.*, 116: 1175-86.
- Dodd AN, Gardner MJ, Hotta CT, Hubbard KE, Dalchau N, Love J, Assie JM, Robertson FC, Jakobsen MK, Gonçalves J, Sanders D, Webb AA.** (2007). The Arabidopsis circadian clock incorporates a cADPR-based feedback loop. *Science*, 318(5857): 1789-92.
- Dodd AN, Kudla J, Sanders D.** (2010). The language of calcium signaling. *Annu. Rev. Plant Biol.*, 61: 593-620.
- Dodd AN, Salathia N, Hall A, Kévei E, Tóth R, Nagy F, Hibberd JM, Millar AJ, Webb AA.** (2005). Plant circadian clocks increase photosynthesis, growth, survival, and competitive advantage. *Science*, 309(5734): 630-3.
- Doi M, Hirayama J, Sassone-Corsi P.** (2006). Circadian regulator CLOCK is a histone acetyltransferase. *Cell*, 125(3): 497-508.
- Dowdle J, Ishikawa T, Gatzek S, Rolinski S, Smirnoff N.** (2007). Two genes in Arabidopsis thaliana encoding GDP-L-galactose phosphorylase are required for ascorbate biosynthesis and seedling viability. *Plant J.*, 52(4): 673-89.
- Dowson-Day MJ, Millar AJ.** (1999). Circadian dysfunction causes aberrant hypocotyl elongation patterns in Arabidopsis. *Plant J.*, 17(1): 63-71.
- Doyle MR, Davis SJ, Bastow RM, McWatters HG, Kozma-Bognár L, Nagy F, Millar AJ, Amasino RM.** (2002). The ELF4 gene controls circadian rhythms and flowering time in Arabidopsis thaliana. *Nature*, 419(6902): 74-7.
- Duan M, Feng HL, Wang LY, Li D, Meng QW.** (2012). Overexpression of thylakoidal ascorbate peroxidase shows enhanced resistance to chilling stress in tomato. *J. Plant Physiol.*, 169(9): 867-77.
- Dunlap JC.** (1999). Molecular bases for circadian clocks. *Cell*, 96(2): 271-90.
- Dunlap JC.** (2008). Salad days in the rhythms trade. *Genetics*, 178(1): 1-13.
- Dutilleul C, Garmier M, Noctor G, Mathieu C, Chétrit P, Foyer CH, de Paepe R.** (2003). Leaf mitochondria modulate whole cell redox homeostasis, set antioxidant capacity, and determine stress resistance through altered signaling and diurnal regulation. *Plant Cell*, 15(5): 1212-26.
- Edgar RS, Green EW, Zhao Y, van Ooijen G, Olmedo M, Qin X, Xu Y, Pan M, Valekunja UK, Feeney KA, Maywood ES, Hastings MH, Baliga NS, Mellow M, Millar AJ, Johnson CH,**

- Kyriacou CP, O'Neill JS, Reddy AB.** (2012). Peroxiredoxins are conserved markers of circadian rhythms. *Nature*, 485(7399): 459-64.
- Edwards KD, Anderson PE, Hall A, Salathia NS, Locke JC, Lynn JR, Straume M, Smith JQ, Millar AJ.** (2006). FLOWERING LOCUS C mediates natural variation in the high-temperature response of the Arabidopsis circadian clock. *Plant Cell*, 18(3): 639-50.
- Edwards KD, Lynn JR, Gyula P, Nagy F, Millar AJ.** (2005). Natural allelic variation in the temperature-compensation mechanisms of the Arabidopsis thaliana circadian clock. *Genetics*, 170(1): 387-400.
- Edwards SW, Lloyd D.** (1980). Oscillations in protein and RNA content during synchronous growth of *Acanthamoeba castellanii*. Evidence for periodic turnover of macromolecules during the cell cycle. *FEBS Lett.*, 109(1): 21-6.
- Elvin M, Loros JJ, Dunlap JC, Heintzen C.** (2005). The PAS/LOV protein VIVID supports a rapidly dampened daytime oscillator that facilitates entrainment of the Neurospora circadian clock. *Genes Dev.*, 19(21): 2593-605.
- Ellison CT, Vandenbussche F, Van Der Straeten D, Harmer SL.** (2011). XAP5 CIRCADIAN TIMEKEEPER regulates ethylene responses in aerial tissues of Arabidopsis. *Plant Physiol.*, 155(2): 988-99.
- Fan Y, Hida A, Anderson DA, Izumo M, Johnson CH.** (2007). Cycling of CRYPTOCHROME proteins is not necessary for circadian-clock function in mammalian fibroblasts. *Curr. Biol.*, 17(13): 1091-100.
- Farré EM, Harmer SL, Harmon FG, Yanovsky MJ, Kay SA.** (2005). Overlapping and distinct roles of PRR7 and PRR9 in the Arabidopsis circadian clock. *Curr. Biol.*, 15(1): 47-54.
- Fehér B, Kozma-Bognár L, Kevei E, Hajdu A, Binkert M, Davis SJ, Schäfer E, Ulm R, Nagy F.** (2011). Functional interaction of the circadian clock and UV RESISTANCE LOCUS 8-controlled UV-B signaling pathways in Arabidopsis thaliana. *Plant J.*, 67(1): 37-48.
- Feng S, Martinez C, Gusmaroli G, Wang Y, Zhou J, Wang F, Chen L, Yu L, Iglesias-Pedraz JM, Kircher S, Schäfer E, Fu X, Fan LM, Deng XW.** (2008). Coordinated regulation of Arabidopsis thaliana development by light and gibberellins. *Nature*, 451(7177): 475-9.
- Feys BJ, Moisan LJ, Newman MA, Parker JE.** (2001). Direct interaction between the Arabidopsis disease resistance signaling proteins, EDS1 and PAD4. *EMBO J.*, 20(19): 5400-11.

- Fowler S, Lee K, Onouchi H, Samach A, Richardson K, Morris B, Coupland G, Putterill J.** (1999). GIGANTEA: a circadian clock-controlled gene that regulates photoperiodic flowering in *Arabidopsis* and encodes a protein with several possible membrane-spanning domains. *EMBO J.*, 18(17):4679-88.
- Froehlich AC, Liu Y, Loros JJ, Dunlap JC.** (2002). White Collar-1, a circadian blue light photoreceptor, binding to the frequency promoter. *Science*, 297(5582): 815-9.
- Froy O.** (2011). The circadian clock and metabolism. *Clin. Sci. (Lond)*, 120(2): 65-72.
- Fujiwara S, Wang L, Han L, Suh SS, Salomé PA, McClung CR, Somers DE.** (2008). Post-translational regulation of the *Arabidopsis* circadian clock through selective proteolysis and phosphorylation of pseudo-response regulator proteins. *J. Biol. Chem.*, 283(34): 23073-83.
- Gallego-Bartolomé J, Alabadí D, Blázquez MA.** (2011). DELLA-induced early transcriptional changes during etiolated development in *Arabidopsis thaliana*. *PLoS One*, 6(8): e23918.
- Gallego M, Virshup DM.** (2007). Post-translational modifications regulate the ticking of the circadian clock. *Nat. Rev. Mol. Cell Biol.*, 8(2): 139-48.
- Gekakis N, Staknis D, Nguyen HB, Davis FC, Wilsbacher LD, King DP, Takahashi JS, Weitz CJ.** (1998). Role of the CLOCK protein in the mammalian circadian mechanism. *Science*, 280(5369): 1564-9.
- Gelhaye E, Rouhier N, Navrot N, Jacquot JP.** (2005). The plant thioredoxin system. *Cell. Mol. Life Sci.*, 62(1): 24-35.
- Gémes K, Poór P, Horváth E, Kolbert Z, Szopkó D, Szepesi A, Tari I.** (2011). Cross-talk between salicylic acid and NaCl-generated reactive oxygen species and nitric oxide in tomato during acclimation to high salinity. *Physiol. Plant.*, 142(2): 179-92.
- Gendron JM, Pruneda-Paz JL, Doherty CJ, Gross AM, Kang SE, Kay SA.** (2012). *Arabidopsis* circadian clock protein, TOC1, is a DNA-binding transcription factor. *PNAS*, 109(8): 3167-72.
- Genoud T, Buchala AJ, Chua NH, Métraux JP.** (2002). Phytochrome signalling modulates the SA-perceptive pathway in *Arabidopsis*. *Plant J.*, 31(1): 87-95.
- Gibon Y, Bläsing OE, Palacios-Rojas N, Pankovic D, Hendriks JH, Fisahn J, Höhne M, Günther M, Stitt M.** (2004). Adjustment of diurnal starch turnover to short days: depletion of sugar during the night leads to a temporary inhibition of carbohydrate utilization, accumulation

of sugars and post-translational activation of ADP-glucose pyrophosphorylase in the following light period. *Plant J.*, 39(6): 847-62.

Gould PD, Locke JC, Larue C, Southern MM, Davis SJ, Hanano S, Moyle R, Milich R, Putterill J, Millar AJ, Hall A. (2006). The molecular basis of temperature compensation in the *Arabidopsis* circadian clock. *Plant Cell*, 18(5): 1177-87.

Graf A, Schlereth A, Stitt M, Smith AM. (2010). Circadian control of carbohydrate availability for growth in *Arabidopsis* plants at night. *PNAS*, 107(20): 9458-63.

Graf A, Smith AM. (2011). Starch and the clock: the dark side of plant productivity. *Trends Plant Sci.*, 16(3): 169-75.

Green RM, Tingay S, Wang ZY, Tobin EM. (2002). Circadian rhythms confer a higher level of fitness to *Arabidopsis* plants. *Plant Physiol.*, 129(2): 576-84.

Green RM, Tobin EM. (1999). Loss of the circadian clock-associated protein 1 in *Arabidopsis* results in altered clock-regulated gene expression. *PNAS*, 96(7): 4176-9.

Grenert JP, Johnson BD, Toft DO. (1999). The importance of ATP binding and hydrolysis by hsp90 in formation and function of protein heterocomplexes. *J. Biol. Chem.*, 274(25): 17525-33.

Griffiths J, Murase K, Rieu I, Zentella R, Zhang ZL, Powers SJ, Gong F, Phillips AL, Hedden P, Sun TP, Thomas SG. (2006). Genetic characterization and functional analysis of the *GID1* gibberellin receptors in *Arabidopsis*. *Plant Cell*, 18(12): 3399-414.

Griffin EA Jr, Staknis D, Weitz CJ. (1999). Light-independent role of *CRY1* and *CRY2* in the mammalian circadian clock. *Science*, 286(5440): 768-71.

Halberg F, Cornélissen G, Katinas G, Syutkina EV, Sothorn RB, Zaslavskaya R, Halberg F, Watanabe Y, Schwartzkopff O, Otsuka K, Tarquini R, Frederico P, Siggelova J. (2003). Transdisciplinary unifying implications of circadian findings in the 1950s. *J Circadian Rhythms.* ;1(1): 2.

Hall A, Bastow RM, Davis SJ, Hanano S, McWatters HG, Hibberd V, Doyle MR, Sung S, Halliday KJ, Amasino RM, Millar AJ. (2003). The *TIME FOR COFFEE* gene maintains the amplitude and timing of *Arabidopsis* circadian clocks. *Plant Cell*, 15(11): 2719-29.

Hall A, Kozma-Bognár L, Tóth R, Nagy F, Millar AJ. (2001). Conditional circadian regulation of *PHYTOCHROME A* gene expression. *Plant Physiol.*, 127(4): 1808-18.

- Hanano S, Davis SJ.** (2005). Pseudo-response regulator genes “tell” the time of day: multiple feedbacks in the circadian system of higher plants. In *Endogenous Plant Rhythms, Annual Plant Reviews*, 21:25-56.
- Hanano S, Domagalska MA, Nagy F, Davis SJ.** (2006). Multiple phytohormones influence distinct parameters of the plant circadian clock. *Genes Cells*, 11(12): 1381-92.
- Harada Y, Sakai M, Kurabayashi N, Hirota T, Fukada Y.** (2005). Ser-557-phosphorylated mCRY2 is degraded upon synergistic phosphorylation by glycogen synthase kinase-3 beta. *J. Biol. Chem.*, 280(36): 31714-21.
- Hardin PE, Hall JC, Rosbash M.** (1990). Feedback of the *Drosophila* period gene product on circadian cycling of its messenger RNA levels. *Nature*, 343(6258): 536-40.
- Harmer SL.** (2009). The circadian system in higher plants. *Annu. Rev. Plant Biol.*; 60: 357-77.
- Harmer SL, Hogenesch JB, Straume M, Chang HS, Han B, Zhu T, Wang X, Kreps JA, Kay SA.** (2000). Orchestrated transcription of key pathways in *Arabidopsis* by the circadian clock. *Science*, 290(5499): 110-3.
- Hassidim M, Yakir E, Fradkin D, Hilman D, Kron I, Keren N, Harir Y, Yerushalmi S, Green RM.** (2007). Mutations in CHLOROPLAST RNA BINDING provide evidence for the involvement of the chloroplast in the regulation of the circadian clock in *Arabidopsis*. *Plant J.*, 51(4): 551-62.
- Hastings JW.** (2007). The *Gonyaulax* clock at 50: Translational control of circadian expression. *Cold Spring Harb. Symp. Quant. Biol.*, 72: 141-4.
- Hastings MH, Maywood ES, O'Neill JS.** (2008). Cellular circadian pacemaking and the role of cytosolic rhythms. *Curr. Biol.*, 18(17): 805-815.
- Haydon MJ, Bell LJ, Webb AA.** (2011). Interactions between plant circadian clocks and solute transport. *J. Exp. Bot.*, 62(7): 2333-48.
- Haydon MJ1, Mielczarek O, Robertson FC, Hubbard KE, Webb AA.** (2013). Photosynthetic entrainment of the *Arabidopsis thaliana* circadian clock. *Nature*, 31;502(7473): 689-92.
- Hazen SP, Schultz TF, Pruneda-Paz JL, Borevitz JO, Ecker JR, Kay SA.** (2005). LUX ARRHYTHMO encodes a Myb domain protein essential for circadian rhythms. *PNAS*, 102(29): 10387-92.

- He Q, Cha J, He Q, Lee HC, Yang Y, Liu Y.** (2006). CKI and CKII mediate the FREQUENCY-dependent phosphorylation of the WHITE COLLAR complex to close the Neurospora circadian negative feedback loop. *Genes Dev.*, 20(18): 2552-65.
- He Q, Cheng P, Yang Y, Wang L, Gardner KH, Liu Y.** (2002) White collar-1, a DNA binding transcription factor and a light sensor. *Science*, 297(5582): 840-3.
- Heijde M, Ulm R.** (2012). UV-B photoreceptor-mediated signalling in plants. *Trends Plant Sci.* 17(4): 230-7.
- Heintzen C, Loros JJ, Dunlap JC.** (2001). The PAS protein VIVID defines a clock-associated feedback loop that represses light input, modulates gating, and regulates clock resetting. *Cell*, 104(3): 453-64.
- Helfer A, Nusinow DA, Chow BY, Gehrke AR, Bulyk ML, Kay SA.** (2011). LUX ARRHYTHMO encodes a nighttime repressor of circadian gene expression in the Arabidopsis core clock. *Curr. Biol.*, 21(2): 126-33.
- Herrero E, Kolmos E, Bujdoso N, Yuan Y, Wang M, Berns MC, Uhlworm H, Coupland G, Saini R, Jaskolski M, Webb A, Gonçalves J, Davis SJ.** (2012). EARLY FLOWERING4 recruitment of EARLY FLOWERING3 in the nucleus sustains the Arabidopsis circadian clock. *Plant Cell*, 24(2): 428-43.
- Hicks KA, Albertson TM, Wagner DR.** (2001). EARLY FLOWERING3 encodes a novel protein that regulates circadian clock function and flowering in Arabidopsis. *Plant Cell*, 13(6): 1281-92.
- Hicks KA, Millar AJ, Carré IA, Somers DE, Straume M, Meeks-Wagner DR, Kay SA.** (1996). Conditional circadian dysfunction of the Arabidopsis early-flowering 3 mutant. *Science*, 274(5288): 790-2.
- Hill HD.** (1757). *The Sleep of Plants*. (London: R. Baldwin).
- Hirayama J, Sahar S, Grimaldi B, Tamaru T, Takamatsu K, Nakahata Y, Sassone-Corsi P.** (2007). CLOCK-mediated acetylation of BMAL1 controls circadian function. *Nature*, 450(7172): 1086-90.
- Horváth E, Szalai G, Janda T.** (2007). Induction of Abiotic Stress Tolerance by Salicylic Acid Signaling. *J. Plant Growth Regul.*, 3(26): 290-300

- Huang X, Li Y, Zhang X, Zuo J, Yang S.** (2010). The Arabidopsis LSD1 gene plays an important role in the regulation of low temperature-dependent cell death. *New Phytol.*, 187(2): 301-12.
- Hubert DA, Tornero P, Belkhadir Y, Krishna P, Takahashi A, Shirasu K, Dangl JL.** (2003). Cytosolic HSP90 associates with and modulates the Arabidopsis RPM1 disease resistance protein. *EMBO J.*, Nov 3;22(21): 5679-89.
- Huq E.** (2006). Degradation of negative regulators: a common theme in hormone and light signaling networks? *Trends Plant Sci.*, 11(1): 4-7.
- Huq E, Tepperman JM, Quail PH.** (2000). GIGANTEA is a nuclear protein involved in phytochrome signaling in Arabidopsis. *PNAS*, 97(17): 9789-94.
- Hunt SM, Thompson S, Elvin M, Heintzen C.** (2010). VIVID interacts with the WHITE COLLAR complex and FREQUENCY-interacting RNA helicase to alter light and clock responses in *Neurospora*. *PNAS*, 107(38): 16709-14.
- Iitaka C, Miyazaki K, Akaike T, Ishida N.** (2005). A role for glycogen synthase kinase-3beta in the mammalian circadian clock. *J. Biol. Chem.*, 280(33): 29397-402.
- Iliev D, Voytsekh O, Schmidt EM, Fiedler M, Nykytenko A, Mittag M.** (2006). A heteromeric RNA-binding protein is involved in maintaining acrophase and period of the circadian clock. *Plant Physiol.*, 142(2): 797-806.
- Imaizumi T.** (2010). Arabidopsis circadian clock and photoperiodism: time to think about location. *Curr. Opin. Plant Biol.*, 13(1): 83-9.
- Ivleva NB, Bramlett MR, Lindahl PA, Golden SS.** (2005). LdpA: a component of the circadian clock senses redox state of the cell. *EMBO J.*, 24(6): 1202-10.
- Ivleva NB, Gao T, LiWang AC, Golden SS.** (2006). Quinone sensing by the circadian input kinase of the cyanobacterial circadian clock. *PNAS*, 103(46): 17468-73.
- Jabs T, Dietrich RA, Dangl JL.** (1996). Initiation of runaway cell death in an Arabidopsis mutant by extracellular superoxide. *Science*, 273(5283): 1853-6.
- James AB, Monreal JA, Nimmo GA, Kelly CL, Herzyk P, Jenkins GI, Nimmo HG.** (2008). The circadian clock in Arabidopsis roots is a simplified slave version of the clock in shoots. *Science*, 322(5909): 1832-5.

- Jarillo JA, Capel J, Tang RH, Yang HQ, Alonso JM, Ecker JR, Cashmore AR.** (2001). An Arabidopsis circadian clock component interacts with both CRY1 and phyB. *Nature*, 410(6827): 487-90.
- Johnson CH, Knight MR, Kondo T, Masson P, Sedbrook J, Haley A, Trewavas A.** (1995). Circadian oscillations of cytosolic and chloroplastic free calcium in plants. *Science*, 269(5232): 1863-5.
- Jouve L, Gaspar T, Kevers C, Greppin H, Degli Agosti R.** (1999). Involvement of indole-3-acetic acid in the circadian growth of the first internode of Arabidopsis. *Planta*, 209(1): 136-42.
- Kaasik K, Lee CC.** (2004). Reciprocal regulation of haem biosynthesis and the circadian clock in mammals. *Nature*, 430(6998): 467-71.
- Kahn BB, Alquier T, Carling D, Hardie DG.** (2005). AMP-activated protein kinase: ancient energy gauge provides clues to modern understanding of metabolism. *Cell Metab.*, 1(1): 15-25.
- Kami C, Lorrain S, Hornitschek P, Fankhauser C.** (2010). Light-regulated plant growth and development. *Curr. Top. Dev. Biol.*, 91: 29-66.
- Karpinski S, Reynolds H, Karpinska B, Wingsle G, Creissen G, Mullineaux P.** (1999). Systemic signaling and acclimation in response to excess excitation energy in Arabidopsis. *Science*, 284(5414): 654-7.
- Kevei E, Gyula P, Hall A, Kozma-Bognár L, Kim WY, Eriksson ME, Tóth R, Hanano S, Fehér B, Southern MM, Bastow RM, Viczián A, Hibberd V, Davis SJ, Somers DE, Nagy F, Millar AJ.** (2006). Forward genetic analysis of the circadian clock separates the multiple functions of ZEITLUPE. *Plant Physiol.*, 140(3): 933-45.
- Khan MI, Iqbal N, Masood A, Per TS, Khan NA.** (2013). Salicylic acid alleviates adverse effects of heat stress on photosynthesis through changes in proline production and ethylene formation. *Plant Signal. Behav.*, 8(11). pii: e26374.
- Kikis EA, Khanna R, Quail PH.** (2005). ELF4 is a phytochrome-regulated component of a negative-feedback loop involving the central oscillator components CCA1 and LHY. *Plant J.*, 44(2): 300-13.
- Kim EY, Bae K, Ng FS, Glossop NR, Hardin PE, Edery I.** (2002). Drosophila CLOCK protein is under posttranscriptional control and influences light-induced activity. *Neuron*, 34(1): 69-81.

- Kim JY, Song HR, Taylor BL, Carré IA.** (2003). Light-regulated translation mediates gated induction of the Arabidopsis clock protein LHY. *EMBO J.*, 22(4): 935-44.
- Kim L, Kircher S, Tóth R, Adam E, Schäfer E, Nagy F.** (2000). Light-induced nuclear import of phytochrome-A:GFP fusion proteins is differentially regulated in transgenic tobacco and Arabidopsis. *Plant J.*, 22(2): 125-33.
- Kim TS, Kim WY, Fujiwara S, Kim J, Cha JY, Park JH, Lee SY, Somers DE.** (2011). HSP90 functions in the circadian clock through stabilization of the client F-box protein ZEITLUPE. *PNAS*, 108(40): 16843-8.
- Kim WY, Fujiwara S, Suh SS, Kim J, Kim Y, Han L, David K, Putterill J, Nam HG, Somers DE.** (2007). ZEITLUPE is a circadian photoreceptor stabilized by GIGANTEA in blue light. *Nature*, 449(7160): 356-60.
- Kircher S, Gil P, Kozma-Bognár L, Fejes E, Speth V, Husselstein-Muller T, Bauer D, Adám E, Schäfer E, Nagy F.** (2002). Nucleocytoplasmic partitioning of the plant photoreceptors phytochrome A, B, C, D, and E is regulated differentially by light and exhibits a diurnal rhythm. *Plant Cell*, 14(7): 1541-55.
- Kircher S, Kozma-Bognár L, Kim L, Adam E, Harter K, Schafer E, Nagy F.** (1999). Light quality-dependent nuclear import of the plant photoreceptors phytochrome A and B. *Plant Cell*, 11(8): 1445-56.
- Kloppstech K.** (1985). Diurnal and circadian rhythmicity in the expression of light-induced nuclear messenger RNAs. *Planta*, 165: 502–506.
- Knight H, Thomson AJ, McWatters HG.** (2008). Sensitive to freezing6 integrates cellular and environmental inputs to the plant circadian clock. *Plant Physiol.*, 148(1): 293-303.
- Koch KE.** (1996). Carbohydrate-modulated gene expression in Plants. *Annu. Rev. Plant Physiol. Plant Mol. Biol.*, 47: 509-540.
- Kolmos E, Herrero E, Bujdoso N, Millar AJ, Tóth R, Gyula P, Nagy F, Davis SJ.** (2011). A reduced-function allele reveals that EARLY FLOWERING3 repressive action on the circadian clock is modulated by phytochrome signals in Arabidopsis. *Plant Cell*, 23(9): 3230-46.
- Kolmos E, Nowak M, Werner M, Fischer K, Schwarz G, Mathews S, Schoof H, Nagy F, Bujnicki JM, Davis SJ.** (2009). Integrating ELF4 into the circadian system through combined structural and functional studies. *HFSP J.*, 3(5): 350-66.

- Kolupaev IuE, Iastreba TO, Shvidenko NV, Karpets IuV.** (2012). Induction of heat resistance in wheat coleoptiles by salicylic and succinic acids: connection of the effect with the generation and neutralization of active oxygen forms. *Prikl. Biokhim. Mikrobiol.*, 48(5): 550-6.
- Kováčik J, Klejdus B, Hedbavny J, Backor M.** (2009). Salicylic acid alleviates NaCl-induced changes in the metabolism of *Matricaria chamomilla* plants. *Ecotoxicology*. 18(5): 544-54.
- Krantev A, Yordanova R, Janda T, Szalai G, Popova L.** (2008). Treatment with salicylic acid decreases the effect of cadmium on photosynthesis in maize plants. *J. Plant Physiol.*, 165(9): 920-31.
- Kreps JA, Wu Y, Chang HS, Zhu T, Wang X, Harper JF.** (2002). Transcriptome changes for *Arabidopsis* in response to salt, osmotic, and cold stress. *Plant Physiol.*, 130(4): 2129-41.
- Kume K, Zylka MJ, Sriram S, Shearman LP, Weaver DR, Jin X, Maywood ES, Hastings MH, Reppert SM.** (1999). mCRY1 and mCRY2 are essential components of the negative limb of the circadian clock feedback loop. *Cell*, 98(2): 193-205.
- Kurepa J, Smalle J, Van Montagu M, Inzé D.** (1998). Oxidative stress tolerance and longevity in *Arabidopsis*: the late-flowering mutant *gigantea* is tolerant to paraquat. *Plant J.*, 14(6): 759-64.
- Laby RJ, Kincaid MS, Kim D, Gibson SI.** (2000). The *Arabidopsis* sugar-insensitive mutants *sis4* and *sis5* are defective in abscisic acid synthesis and response. *Plant J.*, 23(5): 587-96.
- Lakin-Thomas PL, Brody S.** (2000). Circadian rhythms in *Neurospora crassa*: Lipid deficiencies restore robust rhythmicity to null frequency and white-collar mutants. *PNAS*, 97(1): 256–261.
- Lakin-Thomas PL, Côté GG, Brody S.** (1990). Circadian rhythms in *Neurospora crassa*: biochemistry and genetics. *Crit. Rev. Microbiol.*, 17(5): 365-416.
- Lee KH, Piao HL, Kim HY, Choi SM, Jiang F, Hartung W, Hwang I, Kwak JM, Lee IJ, Hwang I.** (2006). Activation of glucosidase via stress-induced polymerization rapidly increases active pools of abscisic acid. *Cell*, 126(6): 1109-20.
- Legnaioli T, Cuevas J, Más P.** (2009). TOC1 functions as a molecular switch connecting the circadian clock with plant responses to drought. *EMBO J.*, 28(23): 3745-57.
- León P, Sheen J.** (2003). Sugar and hormone connections. *Trends Plant. Sci.*, 8(3): 110-6.
- Li G, Peng X, Wei L, Kang G.** (2013). Salicylic acid increases the contents of glutathione and ascorbate and temporally regulates the related gene expression in salt-stressed wheat seedlings. *Gene*, 529(2): 321-5.

- Li G, Siddiqui H, Teng Y, Lin R, Wan XY, Li J, Lau OS, Ouyang X, Dai M, Wan J, Devlin PF, Deng XW, Wang H.** (2011). Coordinated transcriptional regulation underlying the circadian clock in *Arabidopsis*. *Nat. Cell Biol.*, 13(5): 616-22.
- Lin C, Todo T.** (2005). The cryptochromes. *Genome Biol.*, 6(5): 220.
- Lin C, Yang H, Guo H, Mockler T, Chen J, Cashmore AR.** (1998). Enhancement of blue-light sensitivity of *Arabidopsis* seedlings by a blue light receptor cryptochrome 2. *PNAS*, 95(5): 2686-90.
- Linden H, Macino G.** (1997). White collar 2, a partner in blue-light signal transduction, controlling expression of light-regulated genes in *Neurospora crassa*. *EMBO J.*, 16(1): 98-109.
- Liu Y, Bell-Pedersen D.** (2006). Circadian rhythms in *Neurospora crassa* and other filamentous fungi. *Eukaryot. Cell.* 5(8): 1184-93.
- Lloyd D.** (2008). Respiratory oscillations in yeasts. *Adv. Exp. Med. Biol.*, 641: 118-40.
- Lloyd D, Murray DB.** (2007). Redox rhythmicity: clocks at the core of temporal coherence. *Bioessays*, 29(5): 465-73.
- Locke JC, Millar AJ, Turner MS.** (2005a). Modelling genetic networks with noisy and varied experimental data: the circadian clock in *Arabidopsis thaliana*. *J. Theor. Biol.*, 234(3): 383-93.
- Locke JC, Kozma-Bognár L, Gould PD, Fehér B, Kevei E, Nagy F, Turner MS, Hall A, Millar AJ.** (2006). Experimental validation of a predicted feedback loop in the multi-oscillator clock of *Arabidopsis thaliana*. *Mol. Syst. Biol.*, 2:59.
- Locke JC, Southern MM, Kozma-Bognár L, Hibberd V, Brown PE, Turner MS, Millar AJ.** (2005b). Extension of a genetic network model by iterative experimentation and mathematical analysis. *Mol. Syst. Biol.*, 1:2005.0013.
- Love J, Dodd AN, Webb AA.** (2004). Circadian and diurnal calcium oscillations encode photoperiodic information in *Arabidopsis*. *Plant Cell*, 16(4): 956-66.
- Lu SX, Knowles SM, Andronis C, Ong MS, Tobin EM.** (2009). CIRCADIAN CLOCK ASSOCIATED1 and LATE ELONGATED HYPOCOTYL function synergistically in the circadian clock of *Arabidopsis*. *Plant Physiol.*, 150(2): 834-43.
- Lu SX, Webb CJ, Knowles SM, Kim SH, Wang Z, Tobin EM.** (2012). CCA1 and ELF3 interact in the control of hypocotyl length and flowering time in *Arabidopsis*. *Plant Physiol.*, 158(2): 1079-88.

- Lu Y, Gehan JP, Sharkey TD.** (2005). Daylength and circadian effects on starch degradation and maltose metabolism. *Plant Physiol.*, 138(4): 2280-91.
- de Lucas M, Davière JM, Rodríguez-Falcón M, Pontin M, Iglesias-Pedraz JM, Lorrain S, Fankhauser C, Blázquez MA, Titarenko E, Prat S.** (2008). A molecular framework for light and gibberellin control of cell elongation. *Nature*, 451(7177): 480-4.
- Mackey SR, Golden SS, Ditty JL.** (2011). The itty-bitty time machine genetics of the cyanobacterial circadian clock. *Adv. Genet.*, 74: 13-53.
- Makino S, Kiba T, Imamura A, Hanaki N, Nakamura A, Suzuki T, Taniguchi M, Ueguchi C, Sugiyama T, Mizuno T.** (2000). Genes encoding pseudo-response regulators: insight into His-to-Asp phosphorelay and circadian rhythm in *Arabidopsis thaliana*. *Plant Cell Physiol.*, 41(6): 91-803.
- Makino S, Matsushika A, Kojima M, Oda Y, Mizuno T.** (2001). Light response of the circadian waves of the APRR1/TOC1 quintet: when does the quintet start singing rhythmically in *Arabidopsis*? *Plant Cell Physiol.*, 42(3): 334-9.
- Makino S, Matsushika A, Kojima M, Yamashino T, Mizuno T.** (2002). The APRR1/TOC1 quintet implicated in circadian rhythms of *Arabidopsis thaliana*: I. Characterization with APRR1-overexpressing plants. *Plant Cell Physiol.*, 43(1): 58-69.
- Malzahn E, Ciprianidis S, Káldi K, Schafmeier T, Brunner M.** (2010). Photoadaptation in *Neurospora* by competitive interaction of activating and inhibitory LOV domains. *Cell*, 142(5): 762-72.
- Mergenhagen D, Schweiger HG.** (1975). The effect of different inhibitors of transcription and translation on the expression and control of circadian rhythm in individual cells of *Acetabularia*. *Exp. Cell Res.*, 94(2): 321-6.
- Marín-de la Rosa N, Alabadí D, Blázquez MA, Arana MV.** (2011). Integrating circadian and gibberellin signaling in *Arabidopsis*: possible links between the circadian clock and the AtGID1 transcription. *Plant Signal. Behav.*, 6(9): 1411-3.
- Marques N, Edwards SW, Fry JC, Halberg F, Lloyd D.** (1987). Temperature-compensated ultradian variation in cellular protein content of *Acanthamoeba castellanii* revisited. *Prog. Clin. Biol. Res.*, 227A: 105-19.

- Martin-Tryon EL, Kreps JA, Harmer SL.** (2007). GIGANTEA acts in blue light signaling and has biochemically separable roles in circadian clock and flowering time regulation. *Plant Physiol.*, 143(1): 473-86
- Martínez-García JF, Huq E, Quail PH.** (2000). Direct targeting of light signals to a promoter element-bound transcription factor. *Science*, 288(5467): 859-63.
- Más P, Alabadí D, Yanovsky MJ, Oyama T, Kay SA.** (2003a). Dual role of TOC1 in the control of circadian and photomorphogenic responses in *Arabidopsis*. *Plant Cell*, 15(1): 223-36.
- Más P, Devlin PF, Panda S, Kay SA.** (2000). Functional interaction of phytochrome B and cryptochrome 2. *Nature*, 408(6809): 207-11.
- Más P, Kim WY, Somers DE, Kay SA.** (2003b). Targeted degradation of TOC1 by ZTL modulates circadian function in *Arabidopsis thaliana*. *Nature*, 426(6966): 567-70.
- Mateo A, Funck D, Mühlenbock P, Kular B, Mullineaux PM, Karpinski S.** (2006). Controlled levels of salicylic acid are required for optimal photosynthesis and redox homeostasis. *J. Exp. Bot.*, 57(8): 1795-807.
- Mateo A, Mühlenbock P, Rustérucci C, Chang CC, Miszalski Z, Karpinska B, Parker JE, Mullineaux PM, Karpinski S.** (2004). LESION SIMULATING DISEASE 1 is required for acclimation to conditions that promote excess excitation energy. *Plant Physiol.*, 136(1): 2818-30.
- Matsushika A, Makino S, Kojima M, Mizuno T.** (2000). Circadian waves of expression of the APRR1/TOC1 family of pseudo-response regulators in *Arabidopsis thaliana*: insight into the plant circadian clock. *Plant Cell Physiol.*, 41(9): 002-12.
- McClung CR.** (2006). Plant circadian rhythms. *Plant Cell*, 18(4): 792-803.
- McClung CR, Davis SJ.** (2010). Ambient thermometers in plants: from physiological outputs towards mechanisms of thermal sensing. *Curr. Biol.*, 20(24): R1086-92.
- McClung CR, Fox BA, Dunlap JC.** (1989). The *Neurospora* clock gene frequency shares a sequence element with the *Drosophila* clock gene period. *Nature*, 339(6225): 558-62.
- McWatters HG, Bastow RM, Hall A, Millar AJ.** (2000). The ELF3 zeitnehmer regulates light signalling to the circadian clock. *Nature*, 408(6813): 716-20.

- McWatters HG1, Kolmos E, Hall A, Doyle MR, Amasino RM, Gyula P, Nagy F, Millar AJ, Davis SJ.** (2007). ELF4 is required for oscillatory properties of the circadian clock. *Plant Physiol.*, 144(1) :391-401.
- Mehra A, Shi M, Baker CL, Colot HV, Loros JJ, Dunlap JC.** (2009). A role for casein kinase 2 in the mechanism underlying circadian temperature compensation. *Cell*, 137(4): 749-60.
- de Mairan J.** (1729). *Observation botanique.* *Hist. Acad. Roy. Sci.*, 35–36.
- Merrow M, Brunner M, Roenneberg T.** (1999). Assignment of circadian function for the *Neurospora* clock gene frequency. *Nature*, 399(6736): 584-6.
- Merrow M, Raven M.** (2010). Finding time: a daily clock in yeast. *Cell Cycle*, 9(9): 1671-2.
- Michael TP, Breton G, Hazen SP, Priest H, Mockler TC, Kay SA, Chory J.** (2008a). A morning-specific phytohormone gene expression program underlying rhythmic plant growth. *PLoS Biol.*, 6(9):e225.
- Michael TP, Mockler TC, Breton G, McEntee C, Byer A, Trout JD, Hazen SP, Shen R, Priest HD, Sullivan CM, Givan SA, Yanovsky M, Hong F, Kay SA, Chory J.** (2008b). Network discovery pipeline elucidates conserved time-of-day-specific cis-regulatory modules. *PLoS Genet.*, 4(2): e14.
- Millar AJ, Carré IA, Strayer CA, Chua NH, Kay SA.** (1995a). Circadian clock mutants in *Arabidopsis* identified by luciferase imaging. *Science*, 267(5201): 1161-3.
- Millar AJ, Kay SA.** (1991). Circadian Control of *cab* Gene Transcription and mRNA Accumulation in *Arabidopsis*. *Plant Cell*, 3(5): 541-550.
- Millar AJ, Kay SA.** (1996). Integration of circadian and phototransduction pathways in the network controlling CAB gene transcription in *Arabidopsis*. *PNAS*, 93(26): 15491-6.
- Millar AJ, Short SR, Chua NH, Kay SA.** (1992). A novel circadian phenotype based on firefly luciferase expression in transgenic plants. *Plant Cell*, 4(9): 1075-87.
- Millar AJ, Straume M, Chory J, Chua NH, Kay SA.** (1995b). The regulation of circadian period by phototransduction pathways in *Arabidopsis*. *Science*, 267(5201): 1163-6.
- Mills JN.** (1964). Circadian rhythms during and after three months in solitude underground. *J. Physiol.*, 174:217-231.

- Minokoshi Y, Alquier T, Furukawa N, Kim YB, Lee A, Xue B, Mu J, Foufelle F, Ferré P, Birnbaum MJ, Stuck BJ, Kahn BB.** (2004). AMP-kinase regulates food intake by responding to hormonal and nutrient signals in the hypothalamus. *Nature*, 428(6982): 569-74.
- Mishina TE, Zeier J.** (2006). The Arabidopsis flavin-dependent monooxygenase FMO1 is an essential component of biologically induced systemic acquired resistance. *Plant Physiol.*, 141(4): 1666-75.
- Mitchell P.** (1957). A general theory of membrane transport from studies of bacteria. *Nature*, 180: 134-136.
- Mittag M, Lee DH, Hastings JW.** (1994). Circadian expression of the luciferin-binding protein correlates with the binding of a protein to the 3' untranslated region of its mRNA. *PNAS*, 91(12): 5257-61.
- Mizoguchi T, Wheatley K, Hanzawa Y, Wright L, Mizoguchi M, Song HR, Carré IA, Coupland G.** (2002). LHY and CCA1 are partially redundant genes required to maintain circadian rhythms in Arabidopsis. *Dev. Cell*, 2(5): 629-41.
- Mizoguchi T, Wright L, Fujiwara S, Cremer F, Lee K, Onouchi H, Mouradov A, Fowler S, Kamada H, Putterill J, Coupland G.** (2005). Distinct roles of GIGANTEA in promoting flowering and regulating circadian rhythms in Arabidopsis. *Plant Cell*, 17(8): 2255-70.
- Mizuno T, Yamashino T.** (2008). Comparative transcriptome of diurnally oscillating genes and hormone-responsive genes in Arabidopsis thaliana: insight into circadian clock-controlled daily responses to common ambient stresses in plants. *Plant Cell Physiol.*, 49(3): 481-7.
- Morgan LW, Feldman JF, Bell-Pedersen D.** (2001). Genetic interactions between clock mutations in *Neurospora crassa*: can they help us to understand complexity? *Philos. Trans. R. Soc. Lond. B. Biol. Sci.*, 356(1415): 1717-24.
- Morré DJ, Chueh PJ, Pletcher J, Tang X, Wu LY, Morré DM.** (2002). Biochemical basis for the biological clock. *Biochemistry*, 41(40): 11941-5.
- Mühlenbock P, Szechynska-Hebda M, Plaszczyca M, Baudo M, Mateo A, Mullineaux PM, Parker JE, Karpinska B, Karpinski S.** (2008). Chloroplast signaling and LESION SIMULATING DISEASE1 regulate crosstalk between light acclimation and immunity in Arabidopsis. *Plant Cell*, 20(9): 2339-56.
- Murashige T, Skoog F.** (1962). A revised medium for rapid growth and bioassays with tobacco tissue cultures. *Physiol. Plant*, 15: 473-497.

- Murray DB, Beckmann M, Kitano H.** (2007). Regulation of yeast oscillatory dynamics. *PNAS*, 104(7): 2241-6.
- Mutlu S, Atici Ö.** (2013). Alleviation of high salt toxicity-induced oxidative damage by salicylic acid pretreatment in two wheat cultivars. *Toxicol. Ind. Health*, 29(1): 89-96.
- Nagy F, Kay SA, Chua NH.** (1988). A circadian clock regulates transcription of the wheat Cab-1 gene. *Genes Dev.*, 2: 376–382.
- Nakahata Y, Kaluzova M, Grimaldi B, Sahar S, Hirayama J, Chen D, Guarente LP, Sassone-Corsi P.** (2008). The NAD⁺-dependent deacetylase SIRT1 modulates CLOCK-mediated chromatin remodeling and circadian control. *Cell*, 134(2): 329-40.
- Nakahata Y, Sahar S, Astarita G, Kaluzova M, Sassone-Corsi P.** (2009). Circadian control of the NAD⁺ salvage pathway by CLOCK-SIRT1. *Science*, 324(5927): 654-7.
- Nakajima M, Imai K, Ito H, Nishiwaki T, Murayama Y, Iwasaki H, Oyama T, Kondo T.** (2005). Reconstitution of circadian oscillation of cyanobacterial KaiC phosphorylation in vitro. *Science*, 308(5720): 414-5.
- Nakamichi N, Kiba T, Henriques R, Mizuno T, Chua NH, Sakakibara H.** (2010). PSEUDO-RESPONSE REGULATORS 9, 7, and 5 are transcriptional repressors in the Arabidopsis circadian clock. *Plant Cell*, 22(3): 594-605.
- Nakamichi N, Kita M, Ito S, Yamashino T, Mizuno T.** (2005). PSEUDO-RESPONSE REGULATORS, PRR9, PRR7 and PRR5, together play essential roles close to the circadian clock of Arabidopsis thaliana. *Plant Cell Physiol.*, 46(5): 686-98.
- Nazar R, Iqbal N, Syeed S, Khan NA.** (2011). Salicylic acid alleviates decreases in photosynthesis under salt stress by enhancing nitrogen and sulfur assimilation and antioxidant metabolism differentially in two mungbean cultivars. *J. Plant Physiol.*, 168(8): 807-15.
- Nitabach MN, Holmes TC, Blau J.** (2005). Membranes, ions, and clocks: testing the Njus-Sulzman-Hastings model of the circadian oscillator. *Methods Enzymol.*, 393: 682-93.
- Njus D, Sulzman FM, Hastings JW.** (1974). Membrane model for the circadian clock. *Nature*, 248: 116-120.
- Nomoto Y, Kubozono S, Yamashino T, Nakamichi N, Mizuno T.** (2012). Circadian clock- and PIF4-controlled plant growth: a coincidence mechanism directly integrates a hormone signaling network into the photoperiodic control of plant architectures in Arabidopsis thaliana. *Plant Cell Physiol.*, 53(11): 1950-64.

- Nozue K, Covington MF, Duek PD, Lorrain S, Fankhauser C, Harmer SL, Maloof JN.** (2007). Rhythmic growth explained by coincidence between internal and external cues. *Nature*, 448(7151): 358-61.
- Nozue K, Harmer SL, Maloof JN.** (2011). Genomic analysis of circadian clock-, light-, and growth-correlated genes reveals PHYTOCHROME-INTERACTING FACTOR5 as a modulator of auxin signaling in Arabidopsis. *Plant Physiol.*, 156(1): 357-72.
- Nusinow DA, Helfer A, Hamilton EE, King JJ, Imaizumi T, Schultz TF, Farré EM, Kay SA.** (2011). The ELF4-ELF3-LUX complex links the circadian clock to diurnal control of hypocotyl growth. *Nature*, 475(7356): 398-402.
- Oelmüller R, Schneiderbauer A, Herrmann RG, Kloppstech K.** (1995). The steady-state mRNA levels for thylakoid proteins exhibit coordinate diurnal regulation. *Mol. Gen. Genet.*, 246(4): 478-84.
- O'Neill JS.** (2009). Circadian clocks can take a few transcriptional knocks. *EMBO J.*, 28(2): 84-5.
- O'Neill JS, Maywood ES, Chesham JE, Takahashi JS, Hastings MH.** (2008). cAMP-dependent signaling as a core component of the mammalian circadian pacemaker. *Science*, 320(5878): 949-53.
- O'Neill JS, van Ooijen G, Dixon LE, Troein C, Corellou F, Bouget FY, Reddy AB, Millar AJ.** (2011). Circadian rhythms persist without transcription in a eukaryote. *Nature*, 469(7331): 554-8.
- O'Neill JS, Reddy AB.** (2011). Circadian clocks in human red blood cells. *Nature*, 469(7331): 498-503.
- Oh E1, Kim J, Park E, Kim JI, Kang C, Choi G.** (2004). PIL5, a phytochrome-interacting basic helix-loop-helix protein, is a key negative regulator of seed germination in Arabidopsis thaliana. *Plant Cell*, 16(11): 3045-58.
- Oswald O, Martin T, Dominy PJ, Graham IA.** (2001). Plastid redox state and sugars: interactive regulators of nuclear-encoded photosynthetic gene expression. *PNAS*, 98(4): 2047-52.
- Overmyer K, Tuominen H, Kettunen R, Betz C, Langebartels C, Sandermann H Jr, Kangasjärvi J.** (2000). Ozone-sensitive arabidopsis rcd1 mutant reveals opposite roles for ethylene and jasmonate signaling pathways in regulating superoxide-dependent cell death. *Plant Cell*, 12(10): 1849-62.

- Paetkau V, Edwards R, Illner R.** (2006). A model for generating circadian rhythm by coupling ultradian oscillators. *Theor. Biol. Med. Model.*, 3: 12-21.
- Palágyi A, Terecskei K, Adám E, Kevei E, Kircher S, Mérai Z, Schäfer E, Nagy F, Kozma-Bognár L.** (2010). Functional analysis of amino-terminal domains of the photoreceptor phytochrome B. *Plant Physiol.*, 153(4): 1834-45.
- Palma F, López-Gómez M, Tejera NA, Lluch C.** (2013). Salicylic acid improves the salinity tolerance of *Medicago sativa* in symbiosis with *Sinorhizobium meliloti* by preventing nitrogen fixation inhibition. *Plant Sci.* 208: 75-82.
- Panda S, Poirier GG, Kay SA.** (2002). *tej* defines a role for poly(ADP-ribosylation) in establishing period length of the arabidopsis circadian oscillator. *Dev. Cell*, 3(1): 51-61.
- Para A, Farré EM, Imaizumi T, Pruneda-Paz JL, Harmon FG, Kay SA.** (2007). PRR3 Is a vascular regulator of TOC1 stability in the Arabidopsis circadian clock. *Plant Cell*, 19(11): 3462-73.
- Parker JE, Holub EB, Frost LN, Falk A, Gunn ND, Daniels MJ.** (1996). Characterization of *eds1*, a mutation in Arabidopsis suppressing resistance to *Peronospora parasitica* specified by several different RPP genes. *Plant Cell*, Nov;8(11): 2033-46.
- Portolés S, Más P.** (2010). The functional interplay between protein kinase CK2 and CCA1 transcriptional activity is essential for clock temperature compensation in Arabidopsis. *PLoS Genet.*, 6(11):e1001201.
- Park DH, Somers DE, Kim YS, Choy YH, Lim HK, Soh MS, Kim HJ, Kay SA, Nam HG.** (1999). Control of circadian rhythms and photoperiodic flowering by the Arabidopsis *GIGANTEA* gene. *Science*, 285(5433): 1579-82.
- de Paula RM, Lewis ZA, Greene AV, Seo KS, Morgan LW, Vitalini MW, Bennett L, Gomer RH, Bell-Pedersen D.** (2006). Two circadian timing circuits in *Neurospora crassa* cells share components and regulate distinct rhythmic processes. *J. Biol. Rhythms*, 21(3): 159-68.
- Pavlidis T, Kauzmann W.** (1969). Towards a quantitative biochemical model for circadian oscillators. *Arch. Bioch. A. Biophys.*, 132: 338-348.
- Pfannschmidt T, Bräutigam K, Wagner R, Dietzel L, Schröter Y, Steiner S, Nykytenko A.** (2009). Potential regulation of gene expression in photosynthetic cells by redox and energy state: approaches towards better understanding. *Ann. Bot.*, 103(4): 599-607.

- Pittendrigh CS, and Minis DH.** (1964). The entrainment of circadian oscillations by light and their role as photoperiodic clocks. *Am. Nat.*, 98: 261–322.
- Plautz JD1, Straume M, Stanewsky R, Jamison CF, Brandes C, Dowse HB, Hall JC, Kay SA.** (1997). Quantitative analysis of *Drosophila* period gene transcription in living animals. *J. Biol. Rhythms*, 12(3): 204-17.
- Pokhilko A, Fernández AP, Edwards KD, Southern MM, Halliday KJ, Millar AJ.** (2012). The clock gene circuit in *Arabidopsis* includes a repressilator with additional feedback loops. *Mol. Syst. Biol.*, 8: 574.
- Pokhilko A, Hodge SK, Stratford K, Knox K, Edwards KD, Thomson AW, Mizuno T, Millar AJ.** (2010). Data assimilation constrains new connections and components in a complex, eukaryotic circadian clock model. *Mol. Syst. Biol.*, 6: 416.
- Poór P, Gémes K, Horváth F, Szepesi A, Simon ML, Tari I.** (2011). Salicylic acid treatment via the rooting medium interferes with stomatal response, CO₂ fixation rate and carbohydrate metabolism in tomato, and decreases harmful effects of subsequent salt stress. *Plant Biol. (Stuttg)*, 13(1): 105-14.
- Popova LP, Maslenkova LT, Yordanova RY, Ivanova AP, Krantev AP, Szalai G, Janda T.** (2009). Exogenous treatment with salicylic acid attenuates cadmium toxicity in pea seedlings. *Plant Physiol. Biochem.*, 47(3): 224-31.
- Preitner N, Damiola F, Lopez-Molina L, Zakany J, Duboule D, Albrecht U, Schibler U.** (2002). The orphan nuclear receptor REV-ERB α controls circadian transcription within the positive limb of the mammalian circadian oscillator. *Cell*, 110(2): 251-60.
- Prodromou C, Roe SM, O'Brien R, Ladbury JE, Piper PW, Pearl LH.** (1997). Identification and structural characterization of the ATP/ADP-binding site in the Hsp90 molecular chaperone. *Cell*, 90(1): 65-75.
- Pruneda-Paz JL, Breton G, Para A, Kay SA.** (2009). A functional genomics approach reveals CHE as a component of the *Arabidopsis* circadian clock. *Science*, 323(5920): 1481-5.
- Pruneda-Paz JL, Kay SA.** (2010). An expanding universe of circadian networks in higher plants. *Trends Plant Sci.*, 15(5): 259-65.
- Queitsch C, Sangster TA, Lindquist S.** (2002). Hsp90 as a capacitor of phenotypic variation. *Nature*, 417(6889):618-24.

- Ramsey KM, Yoshino J, Brace CS, Abrassart D, Kobayashi Y, Marcheva B, Hong HK, Chong JL, Buhr ED, Lee C, Takahashi JS, Imai S, Bass J.** (2009). Circadian clock feedback cycle through NAMPT-mediated NAD⁺ biosynthesis. *Science*, 324(5927): 651-4.
- Rawat R, Schwartz J, Jones MA, Sairanen I, Cheng Y, Andersson CR, Zhao Y, Ljung K, Harmer SL.** (2009). REVEILLE1, a Myb-like transcription factor, integrates the circadian clock and auxin pathways. *PNAS*, 106(39): 16883-8.
- Reick M, Garcia JA, Dudley C, McKnight SL.** (2001). NPAS2: an analog of clock operative in the mammalian forebrain. *Science*, 293(5529): 506-9.
- Reppert SM, Weaver DR.** (2002). Coordination of circadian timing in mammals. *Nature*, 418(6901): 935-41.
- Richter CP.** (1922). A behavioristic study of the activity of the rat. *Comp. Psychol. Monogr.*, 1: 1–55.
- Rivas-San Vicente M, Plasencia J.** (2011). Salicylic acid beyond defence: its role in plant growth and development. *J. Exp. Bot.*, 62(10): 3321-38.
- Robertson FC, Skeffington AW, Gardner MJ, Webb AA.** (2009). Interactions between circadian and hormonal signalling in plants. *Plant Mol. Biol.*, 69(4): 419-27.
- Roenneberg T, Mellow M.** (1998). Molecular circadian oscillators: an alternative hypothesis. *J. Biol. Rhythms.*, 13(2): 167-79.
- Roenneberg T, Mellow M.** (1999). Circadian systems and metabolism. *J. Biol. Rhythms*, 14(6): 449-59.
- Rook F, Corke F, Card R, Munz G, Smith C, Bevan MW.** (2001). Impaired sucrose-induction mutants reveal the modulation of sugar-induced starch biosynthetic gene expression by abscisic acid signalling. *Plant J.*, 26(4): 421-33.
- Rook F, Hadingham SA, Li Y, Bevan MW.** (2006). Sugar and ABA response pathways and the control of gene expression. *Plant Cell Environ.*, 29(3): 426-34.
- Rouhier N, Gelhaye E, Jacquot JP.** (2004). Plant glutaredoxins: still mysterious reducing systems. *Cell. Mol. Life Sci.*, 61(11): 1266-77.
- Rust MJ, Golden SS, O'Shea EK.** (2011). Light-driven changes in energy metabolism directly entrain the cyanobacterial circadian oscillator. *Science*, 331(6014): 220-3.

- Rutter J, Reick M, Wu LC, McKnight SL.** (2001). Regulation of clock and NPAS2 DNA binding by the redox state of NAD cofactors. *Science*, 293(5529): 510-4.
- Sakamoto K, Nagase T, Fukui H, Horikawa K, Okada T, Tanaka H, Sato K, Miyake Y, Ohara O, Kako K, Ishida N.** (1998). Multitissue circadian expression of rat period homolog (rPer2) mRNA is governed by the mammalian circadian clock, the suprachiasmatic nucleus in the brain. *J. Biol. Chem.*, 273(42): 27039-42.
- Sakamoto K, Nagatani A.** (1996). Nuclear localization activity of phytochrome B. *Plant J.*, 10(5): 859-68.
- Salomé PA, McClung CR.** (2005). PSEUDO-RESPONSE REGULATOR 7 and 9 are partially redundant genes essential for the temperature responsiveness of the Arabidopsis circadian clock. *Plant Cell*, 17(3): 791–803.
- Salomé PA, Oliva M, Weigel D, Krämer U.** (2013). Circadian clock adjustment to plant iron status depends on chloroplast and phytochrome function. *EMBO J.*, 32(4): 511-23.
- Salomé PA, Weigel D, McClung CR.** (2010), The role of the Arabidopsis morning loop components CCA1, LHY, PRR7, and PRR9 in temperature compensation. *Plant Cell*, 22(11): 3650-61.
- Sanchez A, Shin J, Davis SJ.** (2011). Abiotic stress and the plant circadian clock. *Plant Signal. Behav.*, 6(2): 223-31.
- Sánchez JP, Duque P, Chua NH.** (2004). ABA activates ADPR cyclase and cADPR induces a subset of ABA-responsive genes in Arabidopsis. *Plant J.*, 38(3): 381-95.
- Sangster TA, Queitsch C.** (2005). The HSP90 chaperone complex, an emerging force in plant development and phenotypic plasticity. *Curr. Opin. Plant Biol.*, 8(1): 86-92.
- Sangster TA, Salathia N, Undurraga S, Milo R, Schellenberg K, Lindquist S, Queitsch C.** (2008). HSP90 affects the expression of genetic variation and developmental stability in quantitative traits. *PNAS*, 105(8): 2963-8.
- Sato TK, Panda S, Miraglia LJ, Reyes TM, Rudic RD, McNamara P, Naik KA, FitzGerald GA, Kay SA, Hogenesch JB.** (2004). A functional genomics strategy reveals Rora as a component of the mammalian circadian clock. *Neuron*, 43(4): 527-37.

- Schaffer R, Ramsay N, Samach A, Corden S, Putterill J, Carré IA, Coupland G.** (1998). The late elongated hypocotyl mutation of *Arabidopsis* disrupts circadian rhythms and the photoperiodic control of flowering. *Cell*, 93(7): 1219-29.
- Schafmeier T, Haase A, Káldi K, Scholz J, Fuchs M, Brunner M.** (2005). Transcriptional feedback of *Neurospora* circadian clock gene by phosphorylation-dependent inactivation of its transcription factor. *Cell*, 122(2): 235-46.
- Schibler U, Ripperger J, Brown SA.** (2003). Peripheral circadian oscillators in mammals: time and food. *J. Biol. Rhythms*, 18(3): 250-60.
- Schneider K, Perrino S, Oelhafen K, Li S, Zatzepin A, Lakin-Thomas P, Brody S.** (2009). Rhythmic conidiation in constant light in vivid mutants of *Neurospora crassa*. *Genetics*, 181(3): 917-31.
- Schwerdtfeger C, Linden H.** (2003). VIVID is a flavoprotein and serves as a fungal blue light photoreceptor for photoadaptation. *EMBO J.*, 22(18): 4846-55.
- Sellaro R, Crepy M, Trupkin SA, Karayekov E, Buchovsky AS, Rossi C, Casal JJ.** (2010). Cryptochrome as a sensor of the blue/green ratio of natural radiation in *Arabidopsis*. *Plant Physiol.*, 154(1): 401-9.
- Shaikhali J, Norén L, de Dios Barajas-López J, Srivastava V, König J, Sauer UH, Wingsle G, Dietz KJ, Strand A.** (2012). Redox-mediated mechanisms regulate DNA binding activity of the G-group of basic region leucine zipper (bZIP) transcription factors in *Arabidopsis*. *J. Biol. Chem.*, 287(33): 27510-25.
- Sharrock RA, Quail PH.** (1989). Novel phytochrome sequences in *Arabidopsis thaliana*: structure, evolution, and differential expression of a plant regulatory photoreceptor family. *Genes Dev.*, 3(11): 1745-57.
- Shrode LB, Lewis ZA, White LD, Bell-Pedersen D, Ebbole DJ.** (2001). *vvd* is required for light adaptation of conidiation-specific genes of *Neurospora crassa*, but not circadian conidiation. *Fungal Genet. Biol.*, 32(3): 169-81.
- Siffre M.** (1963). *Hors du Temps*. Paris: Tulliard.
- Smalle J, Haegman M, Kurepa J, Van Montagu M, Straeten DV.** (1997). Ethylene can stimulate *Arabidopsis* hypocotyl elongation in the light. *PNAS*, 94(6): 2756-61.

- Smirnoff N.** (2000). Ascorbate biosynthesis and function in photoprotection. *Philos. Trans. R. Soc. Lond. B. Biol. Sci.*, 355(1402): 1455-64.
- Smith H.** (2000). Phytochromes and light signal perception by plants - an emerging synthesis. *Nature*, 407(6804): 585-91.
- Somers DE, Devlin PF, Kay SA.** (1998a). Phytochromes and cryptochromes in the entrainment of the *Arabidopsis* circadian clock. *Science*, 282(5393): 1488-90.
- Somers DE, Kim WY, Geng R.** (2004). The F-box protein ZEITLUPE confers dosage-dependent control on the circadian clock, photomorphogenesis, and flowering time. *Plant Cell*, 16(3): 769-82.
- Somers DE, Schultz TF, Milnamow M, Kay SA.** (2000). ZEITLUPE encodes a novel clock-associated PAS protein from *Arabidopsis*. *Cell*, 101(3): 319-29.
- Somers DE, Webb AA, Pearson M, Kay SA.** (1998b). The short-period mutant, *toc1-1*, alters circadian clock regulation of multiple outputs throughout development in *Arabidopsis thaliana*. *Development*, 125(3): 485-94.
- Somerville C, Koornneef M.** (2002). A fortunate choice: the history of *Arabidopsis* as a model plant. *Nat. Rev. Genet.*, 3(11): 883-9.
- Southern MM, Millar AJ.** (2005). Circadian genetics in the model higher plant, *Arabidopsis thaliana*. *Methods Enzymol.*, 393: 23-35.
- Stokkan KA, Yamazaki S, Tei H, Sakaki Y, Menaker M.** (2001). Entrainment of the circadian clock in the liver by feeding. *Science*, 291(5503): 490-3.
- Strasser B, Sánchez-Lamas M, Yanovsky MJ, Casal JJ, Cerdán PD.** (2010). *Arabidopsis thaliana* life without phytochromes. *PNAS*, 107(10): 4776-81.
- Strayer C, Oyama T, Schultz TF, Raman R, Somers DE, Más P, Panda S, Kreps JA, Kay SA.** (2000). Cloning of the *Arabidopsis* clock gene *TOC1*, an autoregulatory response regulator homolog. *Science*, 289(5480): 768-71.
- Sweeney B, and Hastings JW.** (1960). Effects of temperature upon diurnal rhythms. *Cold Spring Harb. Symp. Quant. Biol.*, 25: 87-104.
- Sweeney BM, Haxo FT.** (1961). Persistence of a photosynthetic rhythm in enucleated *Acetabularia*. *Science*, 134: 1361-1363.

- Tamaoki M, Mukai F, Asai N, Nakajima N, Kubo A, Aono M, Saji H.** (2003). Light-controlled expression of a gene encoding l-galactono- γ -lactone dehydrogenase which affects ascorbate pool size in *Arabidopsis thaliana*. *Plant Science*, 164(6): 1111-1117.
- Tavladoraki P, Kloppstech K, Argyroudi-Akoyunoglou J.** (1989). Circadian Rhythm in the Expression of the mRNA Coding for the Apoprotein of the Light-Harvesting Complex of Photosystem II : Phytochrome Control and Persistent Far Red Reversibility. *Plant Physiol.*, 90(2): 665-72.
- Thain SC, Vandenbussche F, Laarhoven LJ, Dowson-Day MJ, Wang ZY, Tobin EM, Harren FJ, Millar AJ, Van Der Straeten D.** (2004). Circadian rhythms of ethylene emission in *Arabidopsis*. *Plant Physiol.*, 136(3): 3751-61.
- Thimm O, Bläsing O, Gibon Y, Nagel A, Meyer S, Krüger P, Selbig J, Müller LA, Rhee SY, Stitt M.** (2004). MAPMAN: a user-driven tool to display genomics data sets onto diagrams of metabolic pathways and other biological processes. *Plant J.*, 37(6): 914-39.
- Thines B, Harmon FG.** (2010). Ambient temperature response establishes ELF3 as a required component of the core *Arabidopsis* circadian clock. *PNAS*, 107(7): 3257-62.
- Tissier AF, Marillonnet S, Klimyuk V, Patel K, Torres MA, Murphy G, Jones JD.** (1999). Multiple independent defective suppressor-mutator transposon insertions in *Arabidopsis*: a tool for functional genomics. *Plant Cell*, 11(10): 1841-52.
- Tomita J, Nakajima M, Kondo T, Iwasaki H.** (2005). No transcription-translation feedback in circadian rhythm of KaiC phosphorylation. *Science*, 307(5707): 251-4.
- Torres MA, Dangl JL.** (2005). Functions of the respiratory burst oxidase in biotic interactions, abiotic stress and development. *Curr. Opin. Plant Biol.*, 8(4): 397-403.
- Torres MA, Dangl JL, Jones JD.** (2002). *Arabidopsis* gp91phox homologues AtrbohD and AtrbohF are required for accumulation of reactive oxygen intermediates in the plant defense response. *PNAS*, 99(1): 517-22.
- Tóth R, Gerding-Reimers C, Deeks MJ, Menninger S, Gallegos RM, Tonaco IA, Hübel K, Hussey PJ, Waldmann H, Coupland G.** (2012). Pteridianin/endosidin 1 is an actin-stabilizing small molecule identified from a chemical genetic screen for circadian clock effectors in *Arabidopsis thaliana*. *Plant J.*, 71(2): 338-52.

- Tóth R, Kevei E, Hall A, Millar AJ, Nagy F, Kozma-Bognár L.** (2001). Circadian clock-regulated expression of phytochrome and cryptochrome genes in *Arabidopsis*. *Plant Physiol.*, 127(4): 1607-16.
- Ueda HR, Chen W, Adachi A, Wakamatsu H, Hayashi S, Takasugi T, Nagano M, Nakahama K, Suzuki Y, Sugano S, Iino M, Shigeyoshi Y, Hashimoto S.** (2002). A transcription factor response element for gene expression during circadian night. *Nature*, 418(6897): 534-9.
- Ueda HR, Hayashi S, Chen W, Sano M, Machida M, Shigeyoshi Y, Iino M, Hashimoto S.** (2005). System-level identification of transcriptional circuits underlying mammalian circadian clocks. *Nat. Genet.*, 37(2): 187-92.
- Vanden Driessche T, Bonotto S, Brachet J.** (1970). Inability of rifampicin to inhibit circadian rhythmicity in *Acetabularia* despite inhibition of RNA synthesis. *Biochim. Biophys. Acta*, 224(2): 631-4.
- Vanderauwera S, De Block M, Van de Steene N, van de Cotte B, Metzlauff M, Van Breusegem F.** (2007). Silencing of poly(ADP-ribose) polymerase in plants alters abiotic stress signal transduction. *PNAS*, 104(38): 15150-5.
- Vierstra RD, Davis SJ.** (2000). Bacteriophytochromes: new tools for understanding phytochrome signal transduction. *Semin. Cell Dev. Biol.*, 11(6): 511-21.
- Vitaterna MH, King DP, Chang AM, Kornhauser JM, Lowrey PL, McDonald JD, Dove WF, Pinto LH, Turek FW, Takahashi JS.** (1994). Mutagenesis and mapping of a mouse gene, *Clock*, essential for circadian behavior. *Science*, 264(5159): 719-25.
- Vranová E, Inzé D, Van Breusegem F.** (2002). Signal transduction during oxidative stress. *J. Exp. Bot.*, 53(372): 1227-36.
- Wagner E.** (1976). Kinetics in metabolic control of time measurement in Photoperiodism. *J. Interdiscipl. Cycle Res.*, 7(4): 313-332.
- Wagner E, Deitzer GF, Fischer S, Frosch S, Kempf O, Stroebele L.** (1975). Endogenous oscillations in pathways of energy transduction as related to circadian rhythmicity and photoperiodic control. *Biosystems*, 7: 68-76.
- Wagner E, Normann J, Albrechtova JTP, Greppin H.** (2000). From cellular micro-compartmentation to inter-organ communication. The kinetic basis for molecular controls in photoperiodism. *Integrated Plant Systems*, University of Geneva 2000 p. 293-309.

- Walz B, Walz A, Sweeney B.** (1983). A circadian rhythm in RNA in the dinoflagellate, *Gonyaulax polyedra* *Journal Comp. Physiol.*, 151(2): 207-213.
- Wang H, Feng T, Peng X, Yan M, Tang X.** (2009). Up-regulation of chloroplastic antioxidant capacity is involved in alleviation of nickel toxicity of *Zea mays* L. by exogenous salicylic acid. *Ecotoxicol. Environ. Saf.*, 72(5): 1354-62.
- Wang L, Fujiwara S, Somers DE.** (2010). PRR5 regulates phosphorylation, nuclear import and subnuclear localization of TOC1 in the *Arabidopsis* circadian clock. *EMBO J.*, 29(11): 1903-15.
- Wang W, Barnaby JY, Tada Y, Li H, Tör M, Caldelari D, Lee DU, Fu XD, Dong X.** (2011). Timing of plant immune responses by a central circadian regulator. *Nature*, 470(7332): 110-4.
- Wang ZY, Kenigsbuch D, Sun L, Harel E, Ong MS, Tobin EM.** (1997). A Myb-related transcription factor is involved in the phytochrome regulation of an *Arabidopsis* Lhcb gene. *Plant Cell*, 9(4): 491-507.
- Wang ZY, Tobin EM.** (1998). Constitutive expression of the CIRCADIAN CLOCK ASSOCIATED 1 (CCA1) gene disrupts circadian rhythms and suppresses its own expression. *Cell*, 93(7): 1207-17.
- Wenden B, Kozma-Bognár L, Edwards KD, Hall AJ, Locke JC, Millar AJ.** (2011). Light inputs shape the *Arabidopsis* circadian system. *Plant J.*, 66(3): 480-91.
- Wiermer M, Feys BJ, Parker JE.** (2005). Plant immunity: the EDS1 regulatory node. *Curr. Opin. Plant Biol.*, 8(4): 383-9.
- Wood TL, Bridwell-Rabb J, Kim YI, Gao T, Chang YG, LiWang A, Barondeau DP, Golden SS.** (2010). The KaiA protein of the cyanobacterial circadian oscillator is modulated by a redox-active cofactor. *PNAS*, 107(13): 5804-9.
- Xu X, Hotta CT, Dodd AN, Love J, Sharrock R, Lee YW, Xie Q, Johnson CH, Webb AA.** (2007). Distinct light and clock modulation of cytosolic free Ca²⁺ oscillations and rhythmic CHLOROPHYLL A/B BINDING PROTEIN2 promoter activity in *Arabidopsis*. *Plant Cell*, 19(11): 3474-90.
- Xu Y, Mori T, Johnson CH.** (2000). Circadian clock-protein expression in cyanobacteria: rhythms and phase setting. *EMBO J.*, 19(13): 3349-57.

- Yabuta Y, Mieda T, Rapolu M, Nakamura A, Motoki T, Maruta T, Yoshimura K, Ishikawa T, Shigeoka S.** (2007). Light regulation of ascorbate biosynthesis is dependent on the photosynthetic electron transport chain but independent of sugars in Arabidopsis. *J. Exp. Bot.*, 58(10): 2661-71.
- Yakir E, Hilman D, Kron I, Hassidim M, Melamed-Book N, Green RM.** (2009). Posttranslational regulation of CIRCADIAN CLOCK ASSOCIATED1 in the circadian oscillator of Arabidopsis. *Plant Physiol.*, 150(2): 844-57.
- Yang Z, Sehgal A.** (2001). Role of molecular oscillations in generating behavioral rhythms in *Drosophila*. *Neuron*, 29(2): 453-67.
- Yanovsky MJ, Mazzella MA, Casal JJ.** (2000). A quadruple photoreceptor mutant still keeps track of time. *Curr. Biol.*, 10(16): 1013-5.
- Yamaguchi R, Nakamura M, Mochizuki N, Kay SA, Nagatani A.** (1999). Light-dependent translocation of a phytochrome B-GFP fusion protein to the nucleus in transgenic Arabidopsis. *J. Cell Biol.*, 145(3): 437-45.
- Yamamoto Y, Yagita K, Okamura H.** (2005). Role of cyclic mPer2 expression in the mammalian cellular clock. *Mol. Cell. Biol.*, 25(5): 1912-21.
- Yamazaki S, Numano R, Abe M, Hida A, Takahashi R, Ueda M, Block GD, Sakaki Y, Menaker M, Tei H.** (2000). Resetting central and peripheral circadian oscillators in transgenic rats. *Science*, 288(5466): 682-5.
- Yeh KC, Lagarias JC.** (1998). Eukaryotic phytochromes: light-regulated serine/threonine protein kinases with histidine kinase ancestry. *PNAS*, 95(23): 13976-81.
- Yin L, Lazar MA.** (2005). The orphan nuclear receptor Rev-erb α recruits the N-CoR/histone deacetylase 3 corepressor to regulate the circadian *Bmal1* gene. *Mol. Endocrinol.*, 19(6): 1452-9.
- Yin L, Wang J, Klein PS, Lazar MA.** (2006). Nuclear receptor Rev-erb α is a critical lithium-sensitive component of the circadian clock. *Science*, 311(5763): 1002-5.
- Yoo SH, Yamazaki S, Lowrey PL, Shimomura K, Ko CH, Buhr ED, Siepkas SM, Hong HK, Oh WJ, Yoo OJ, Menaker M, Takahashi JS.** (2004). PERIOD2::LUCIFERASE real-time reporting of circadian dynamics reveals persistent circadian oscillations in mouse peripheral tissues. *PNAS*, 101(15): 5339-46.

- Yoshida Y, Iigusa H, Wang N, Hasunuma K.** (2011). Cross-talk between the cellular redox state and the circadian system in *Neurospora*. *PLoS One*, 6(12): e28227.
- Young JC, Hartl FU.** (2000). Polypeptide release by Hsp90 involves ATP hydrolysis and is enhanced by the co-chaperone p23. *EMBO J.*, 19(21): 5930-40.
- Yu JW, Rubio V, Lee NY, Bai S, Lee SY, Kim SS, Liu L, Zhang Y, Irigoyen ML, Sullivan JA, Zhang Y, Lee I, Xie Q, Paek NC, Deng XW.** (2008). COP1 and ELF3 control circadian function and photoperiodic flowering by regulating GI stability. *Mol. Cell*, 32(5): 617-30.
- Yusuf M, Fariduddin Q, Varshney P, Ahmad A.** (2012). Salicylic acid minimizes nickel and/or salinity-induced toxicity in Indian mustard (*Brassica juncea*) through an improved antioxidant system. *Environ. Sci. Pollut. Res. Int.*, 19(1): 8-18.
- Zeilinger MN, Farré EM, Taylor SR, Kay SA, Doyle FJ 3rd.** (2006). A novel computational model of the circadian clock in *Arabidopsis* that incorporates PRR7 and PRR9. *Mol. Syst. Biol.*, 2: 58.
- Zhang T, Maruhnich SA, Folta KM.** (2011). Green light induces shade avoidance symptoms. *Plant Physiol.*, 157(3): 1528-36.
- Zheng X, Sehgal A.** (2008). Probing the relative importance of molecular oscillations in the circadian clock. *Genetics*, 178(3): 1147-55.
- Zhou L, Jang JC, Jones TL, Sheen J.** (1998). Glucose and ethylene signal transduction crosstalk revealed by an *Arabidopsis* glucose-insensitive mutant. *PNAS*, 95(17): 10294-9.
- Zivkovic B.** (2011). Circadian clock without DNA - History and the power of metaphor. *Sci. American*, Feb 11, 2011.

Appendix

Appendix 1

Metabolic oscillations in *Neurospora* – the
zeitnehmer model

Ap.1. Metabolic oscillations in *Neurospora* – the *zeitnehmer* model

It is known for quite some time that rhythmicity of conidiation in *frq* and *wc* single null strains is recovered by mutations involved in lipid synthesis (reviewed in Lakin-Thomas *et al.*, 1990). The list of residual FRQ- and WC-independent (FRQ-less; FLOs) oscillations has been expanded by several independent studies over the last decade. In several of these studies rhythmicity was assessed by rhythmic conidiation: (1) rhythmic conidiation of all three *frq*, *wc-1* and *wc-2* single null mutants is rescued by menadion, a reactive-oxygen species stimulator. Noteworthy in the wild-type conidiation is not rhythmic in the light, whereas in these mutants menadion application recovers oscillations regardless of ambient light (Brody *et al.*, 2010). (2) Residual oscillations in the *frq*, *wc-1* and *wc-2* mutants are also induced by terpenes farnesol and geraniol (Granshaw *et al.*, 2003; Lombardi *et al.*, 2007). (3) In the dark, the *wc-1* and *wc-2* mutants are rhythmic provided that glucose is not added in the growth medium (Dragovic *et al.*, 2002) and (4) so is the *frq-10* null mutant when placed in the *sod-1* (*superoxide dismutase 1*) mutant background (Yoshida *et al.*, 2008). FLOs are not restricted to conidiation rhythms and have also been observed at the molecular level: (1) nitrate reductase activity oscillates in *frq-9* and in *wc-1* loss-of-function strains (in the light as well as in the dark; Christensen *et al.*, 2004). (2) Genome-wide analysis revealed three genes (encoding for a bZIP transcription factor that regulates expression of amino acid biosynthetic genes, a predicted 1,4 α glucan involved in glycogen synthesis and an unknown protein) whose expression is rhythmic in the *frq-10* mutant in the dark; the FLO that drives these oscillations is not entirely independent of FRQ as these were faster in the *frq-7* strain (otherwise known as a long period mutant) relative to the wild-type (Correa *et al.*, 2003). (3) In the *frq-10* mutant *catalase-1* transcript-levels oscillate with a period similar to that of the wild-type, surprisingly with increased amplitude in the mutant. (4) None of the *frq*, *wc-1* or *wc-2* genes are required for oscillations of ROS in the dark (Yoshida *et al.*, 2011). (5) In addition to these rhythmic expression of *clock-controlled gene 16* (*ccg-16*) requires WC-1 and WC-2 but not FRQ (de Paula *et al.*, 2006). In several of the occasions mentioned above, the nature of the residual oscillations or the conditions by which they are unveiled are related to metabolism. For instance, ROS are metabolic products that serve as signaling molecules (reviewed in Belozerskaya *et al.*, 2012), whereas farnesol and geraniol are intermediates in the biosynthesis of ergosterol (Karst and Lacroute, 1977) that in yeast is required for resistance to ROS (Schmidt *et al.*, 1999) and is found in ROS generating membranes such as the plasma membrane and the inner mitochondrial membrane (Zinser *et al.*, 1993). Conclusively, the repetitiveness and amount of accumulated data around FLOs show that transcription and translation

alone are not adequate in describing the central oscillator of *Neurospora*. Moreover the nature of the FLOs is indicative that these oscillations are metabolic.

Lipids had received great attention and were involved quite early in research around metabolic oscillations. The role of lipids in circadian timekeeping is underlined by the fact that rhythmic conidiation in *frq* and *wc* single null strains is recovered on minimal growth medium by mutations *cel* (chain elongation) and *chol-1* (choline requiring) that affect lipid synthesis. The *cel* (Brody and Martins, 1979; Mattern and Brody, 1979; Mattern *et al.*, 1982) strain that is compromised in synthesis of saturated fatty acids due to a deficiency in fatty acid synthetase activity and the *chol-1* (Lakin-Thomas, 1996; Lakin-Thomas, 1998; Lakin-Thomas and Brody, 2000) that is defective in the synthesis of the phospholipid phosphatidylcholine, both exhibit long period phenotypes and loss of temperature compensation below 22°C on minimal growth medium. These phenotypes (in long period and temperature compensation) are restored in the single *cel* and *chol-1* mutants by supplementation with palmitic acid and choline respectively. Moreover these mutations alleviate from the arrhythmia imposed by *frq* and *wc* loss-of-function mutations, as long as growth conditions are again minimal. Epistasis in this case is observed as recovery of rhythmicity in the double mutants with a circadian period that approaches that of the *cel* and *chol-1* single mutants. The recovered oscillations in *frq;chol-1* and *frq;cel* are though incomplete. First, they are not responsive to light entrainment (unlike oscillations in wild-type and single *chol-1* and *cel* mutants) and second, *chol-1* mediated recovery of rhythmicity produces oscillations that, unlike those in the wild-type, persist in continuous light, indicating that the recovered oscillations are unresponsive to light in general; moreover the "restored" oscillations are also incomplete with respect to temperature compensation (Lakin-Thomas and Brody, 2000). Consequently a complete circadian system should require both metabolic and nuclear oscillations.

Supplementary lipids that modify the period phenotypes of *cel* and *chol-1* do not change circadian period in the wild-type. By contrast, the *cel* and *chol-1* mutants exhibited both temperature and nutrient compensation phenotypes (period is sensitive to fatty-acid levels) (Brody and Martins, 1979; Mattern and Brody, 1979; Mattern *et al.*, 1982; Lakin-Thomas and Brody, 2000), indicating that temperature compensation is affiliated to metabolism (see also Roenneberg and Mellow, 1999 and Morgan *et al.*, 2001). Interestingly, exposure to fatty acids 18:1, 18:2, 18:3 and saturated fatty acids with 8 to 13 carbons lengthens circadian period of *cel* (Brody and Martins, 1979; Mattern and Brody, 1979; Mattern *et al.*, 1982) and this effect is reversed by the *prd-1* mutation and by metabolic

perturbation that targets mitochondria¹. Supplementary fatty acids that alter the period of *cel* also change the temperature breakpoint below which the temperature compensation phenotype of the mutant appears: fatty acids that lengthen the period of *cel* (12:0, 18:1, 18:2 and 18:3) raise the 22°C temperature breakpoint at 26°C, whereas fatty acids 16:0 and 14:0 reverse or cancel the effect of the former (e.g. at 22°C) in *cel* by lowering the breakpoint at 18°C (Brody and Martins, 1979; Mattern *et al.*, 1982). None of the sugars tested reversed the effect of period lengthening fatty acids, unlike non fermentable carbon courses of which acetate is known to have a similar effect on the 22°C breakpoint as fatty acids 16:0 and 14:0. These findings indicate that non-fermentable carbon courses, lipids and acetate, may perturb circadian rhythms via a common mechanism. Together these findings suggest that part of the oscillator is located in the mitochondria and that lipid metabolism or even membrane composition in *Neurospora* are involved in circadian timekeeping (Lakin-Thomas *et al.*, 1990 and Brody, 1992).

The findings reviewed here, and particularly the fact that the *cel* and *chol-1* mutations are epistatic to *frq* and *wc* null mutations in a manner that is dependent on the composition of the growth medium, indicate that lipid metabolism is involved in circadian timekeeping (references cited above). The same can be concluded from the observation that a third mutation, *phenylalanine requiring* (*phe-1*), causes deficiency in sterol synthesis and shortens circadian period (even in the presence of supplemented phenylalanine). It has been proposed that the temperature compensation response is compromised when the fatty acid biosynthetic pathway is blocked at an early stage, because the *unsaturated fatty acid requiring1* strain (*ufa-1*), that affects lipid metabolism downstream of the *cel* mutation, does not exhibit altered circadian parameters (period at 22°C and at lower temperatures is normal in the *ufa-1* mutant). Flux through the pathway of saturated fatty acid biosynthesis does not seem to be required for normal temperature compensation either, because the *cel* strain shows a wild-type rhythm above 18°C when supplemented with palmitic acid (reviewed in Lakin-Thomas *et al.*, 1990). Lipids are known to be signaling molecules and such a role in the circadian system of *Neurospora* is suggested by the observed altered levels of the lipid signaling molecule diacylglycerol (DAG; a signaling molecule in animal cells) in *chol-1*. Choline depletion in *chol-1* results in up-regulation of rhythmic DAG levels which is likely to be the cause, not a result of period lengthening in *chol-1*. This is because the observed correlation between DAG levels and

1. These perturbations include (1) mitochondrial mutations *olir* (oligomycin resistance) and maternally inherited mutations *mi-2* and *mi-5*, (2) antimycin (inhibitor of mitochondrial cytochrome *c* reductase), (3) non fermentable carbon sources (metabolized exclusively in mitochondria) and (4) supplementary fatty acids 16:0 (palmitic acid) and 14:0 (reviewed in Lakin-Thomas *et al.*, 1990).

circadian period observed in *chol-1* is not universal (*i.e.* it is not observed in *frq* mutants with different periods). Consequently up-regulation of DAG is not a result of period lengthening in general. On the contrary, DAG up-regulation is likely to be the cause of period lengthening in *chol-1* because induction of DAG, whether due to choline-depletion or chemically induced, always lengthens the circadian period of the *chol-1* mutant (Ramsdale and Lakin-Thomas, 2000).

Mitochondrial mutations that perturb energy metabolism shorten circadian period. These mutations include *oli*^r (oligomycin resistance) that affects the DCCD²-binding subunit of the mitochondrial ATP synthetase (Diekmann and Brody, 1980) and several mutations that affect mitochondrial cytochromes³ (reviewed in Lakin-Thomas *et al.*, 1990). Together, these observations provide strong evidence that mitochondrial activity and respiratory electron transport are involved in circadian regulation (Lakin-Thomas *et al.*, 1990; Brody, 1992). This idea is well in agreement with the aforementioned findings regarding the effect non-fermentable carbon sources, lipids and acetate, on the circadian period of *cel*, as well as with the emerging role of ROS in the circadian system of *Neurospora* (presented below).

Several mutations affecting amino acid synthesis shorten circadian period of the conidiation rhythm. These include the aforementioned *phe-1* mutation and mutants that require cysteine or arginine to grow. The mutant *arg-13* is puzzling as other arginine auxotrophs have normal period; similarly, not all cysteine auxotrophs exhibit circadian phenotypes (Lakin Thomas *et al.*, 1990). Circadian rhythms of ten cysteine auxotrophs were investigated by Onai and Nakashima (1997) who found that seven of these were altered for period and/or temperature- and nutrient-compensation. These phenotypes could not be attributed to cysteine deficiency as they varied from strain to strain and most importantly, because one auxotrophic strain did not show any circadian defects at all. The strongest circadian defects were seen in the *cys-9* mutant, that exhibits distinct methionine-dependent phenotypes⁴ and is the only one of the ten cysteine auxotrophs included in that study that

2. Dicyclohexyl carbodiimide (DCCD) is a mitochondrial ATPase inhibitor.

3. These mutations include: (1) the cytochrome *b*-deficient *cyb-2* and *cyb-3* mutations, (2) cytochrome *aa3*-deficient *cyα-5* mutant, (3) *cyt-4*, that is deficient in both cytochromes *b* and *aa3* and is defective in mitochondrial rRNA processing and (4) mutations *mi-2*, *mi-3* and *mi-5* (maternally inherited locus), encoded in the mitochondrial genome, that lead to defects in subunit 1 of the mitochondrial cytochrome *c* oxidase (reviewed in Lakin-Thomas *et al.*, 1990).

4. At low methionine concentrations the period of the *cys-9* mutant was shown to be faster relative to that of the wild-type by 4 to 5 hours, whereas high methionine concentrations caused instability in period length of the mutant. Moreover, the *cys-9* mutant responded to methionine with period lengthening, when the wild-type exhibited nutrient compensation.

was defective in the temperature compensation response. *Cys-9* encodes for the NADPH-dependent thioredoxine reductase (NTR) of *Neurospora*, indicating that the pathway of sulfate assimilation (and perhaps the step between adenosine-5'-phosphosulfate and thiosulfate, substrate and product of NTR respectively) is of circadian relevance (Onai and Nakashima, 1997). To conclude, the involvement of NTR in clock function implies a potential relationship between the redox state of the cell and circadian rhythmicity⁵, temperature compensation in particular. Moreover through *cys-9* it is shown that the mechanisms responsible for temperature- and nutrient-compensation share common elements.

Recently it was shown that ROS levels are under the control of both the clock and light (ROS levels are downregulated by pulses of light, whereas temperature-pulses are inactive in this respect). The TTFL regulates ROS oscillations through ROS-generating NADPH oxidases (NOX) and ROS-destroying catalases⁶ (Yoshida *et al.*, 2011). Most importantly, the control is reciprocal⁷. This is supported by the observed positive correlation between ROS levels, the expression of *frq* and circadian amplitude of conidiation, in experiments where ROS homeostasis was manipulated by pharmacological (oxidants, antioxidants) and by genetic means⁸. ROS might affect TTFLs by regulating the DNA binding activity of WCC, because ROS mimic the effect of light on the absorption spectrum of WC-1 and on the DNA binding activity of WCC *in vitro*; together these findings are also indicative that light input to the clock employs ROS signaling (Belden *et al.*, 2007; Yoshida *et al.*, 2011). The same can be said for entrainment, given the fact that the *sod-1* strain is hypersensitive to light entrainment relative to wild-type (Yoshida *et al.*, 2008).

5. The data of Onai and Nakashima (1997), considered in the context of this review, provide evidence that the redox state of the cell to which NTR is sensitive (Gelhaye *et al.*, 2005) or even lipid metabolism and perhaps sulfolipids are of circadian relevance in *Neurospora*.

6. The FRQ/WCC oscillator regulates overall activity (amplitude) of the NOX enzymes and drives oscillations of the ROS-destroying catalases.

7. It should be kept in mind that most circadian experiments carried out with *Neurospora* employ the conidiation rhythm of the *band* (*bd*, also designated *ras-1*; *rat sarcoma*) strain that persists in race tubes in the dark and under inactive RL, in oppose to non-rhythmic conidiation of the wild-type under the same conditions (Lakin-Thomas *et al.*, 1990). Though of unquestionable value, the *bd* mutation shows significant circadian/metabolic-related phenotypes, such as growth resistance to CO₂ and increased ROS levels (Yoshida *et al.*, 2011). Moreover, WC-1 is a downstream component of RAS signaling that is in turn interconnected with ROS signaling (Belden *et al.*, 2007).

8. ROS can be genetically manipulated in *Neurospora* with the *sod-1* and *NADPH Oxidase-1* (*Δnox-1*) mutants that display high and low ROS levels, respectively.

Conclusively, the experiments described here show that metabolism is a driving force of circadian rhythmicity. In particular energy metabolism in mitochondria and/or its byproducts (*e.g.* ROS) and/or the molecules that sum metabolic pathways of energy transduction (*e.g.* redox molecules), membrane composition, the metabolic map as it is defined by various states of lipid metabolism and/or lipid signaling are somehow important for proper time keeping in *Neurospora*. Based on the findings presented here, and especially the aforementioned conditional, residual and incomplete oscillations of *frq* and *wc* mutants (incomplete in that they are not temperature compensated and entrain to temperature but not to light cycles), Roenneberg and Mellow proposed a model for the clock of *Neurospora* comprised of two interacting oscillators (fig. 1.8). These are the FRQ/WCC oscillator and a metabolic FRQ-less Oscillator (FLO). According to this model the FRQ/WCC oscillator is required for compensation against both temperature fluctuations and metabolic variation, but it is not central in the sense that it does not generate rhythmicity, rather it is part of a rhythmic light input pathway that signals towards a central, temperature-entrainable, metabolic oscillator. In this model the TTFL is given *zeitnehmer* properties (German for "time-taker"), meaning that the role of the transcriptional loop is not to "generate time" but to entrain and provide sustainability by receiving *zeitgeber* signals (light entrainment). According to the *zeitnehmer* model isolated metabolic oscillations are temperature dependent and thus cannot ascribe for temperature compensation. As transcription is also temperature dependent, temperature compensation should result from the interaction/coupling between the two temperature dependent oscillatory networks. The model predicts that single mutations should exhibit both temperature- and nutrient-compensation phenotypes (*e.g.* the, *cys-9*, *cel* and *chol-1* mutants, see references above; *vvd* null strain, Schneider *et al.*, 2009), because these responses would share a common mechanism (Roenneberg and Mellow, 1999; Mellow *et al.*, 1999). Iwasaki and Dunlap (2000) proposed a similar model that however does not assign peripheral roles to either of the two interacting oscillators. In support of these models it was recently demonstrated that a strain lacking all functional *frq*, *wc-1*, *wc-2* and *vvd* genes is still entrained to temperature cycles (Hunt *et al.*, 2012). Moreover, based on the epistatic relationships between *prd-2*, *prd-3* and *prd-6* with *frq* alleles, it was suggested that interactions between the two oscillators would be mediated by these genes to generate temperature compensated circadian rhythms (Morgan *et al.*, 2001; see also chapter 1.4.2.b).

Bibliography

- Belden WJ, Larrondo LF, Froehlich AC, Shi M, Chen CH, Loros JJ, Dunlap JC.** (2007). The band mutation in *Neurospora crassa* is a dominant allele of *ras-1* implicating RAS signaling in circadian output. *Genes Dev.*, 21(12): 1494-505.
- Belozerskaya TA, Gessler NN, Isakova EP, Deryabina YI.** (2012). *Neurospora crassa* Light Signal Transduction Is Affected by ROS. *J. Signal Transduct.*, 791963.
- Brody S.** (1992). Circadian Rhythms in *Neurospora crassa*: The Role of Mitochondria. *Chronobiol. International*, 9(3): 222-230.
- Brody S, Martins SA.** (1979). Circadian rhythms in *Neurospora crassa*: effects of unsaturated fatty acids. *J. Bacteriol.*, 137(2): 912-5.
- Brody S, Oelhafen K, Schneider K, Perrino S, Goetz A, Wang C, English C.** (2010). Circadian rhythms in *Neurospora crassa*: Downstream effectors. *Fungal Genet. Biol.*, 47(2): 159-68.
- Christensen MK, Falkeid G, Loros JJ, Dunlap JC, Lillo C, Ruoff P.** (2004). A nitrate-induced *frq*-less oscillator in *Neurospora crassa*. *J. Biol. Rhythms*, 19(4): 280-6.
- Correa A, Lewis ZA, Greene AV, March IJ, Gomer RH, Bell-Pedersen D.** (2003). Multiple oscillators regulate circadian gene expression in *Neurospora*. *PNAS*, 100(23): 13597-602.
- Diekmann C, Brody S.** (1980). Circadian rhythms in *Neurospora crassa*: oligomycin-resistant mutations affect periodicity. *Science*, 207; 896-898.
- Dragovic Z, Tan Y, Görl M, Roenneberg T, Merrow M.** (2002). Light reception and circadian behavior in 'blind' and 'clock-less' mutants of *Neurospora crassa*. *EMBO J.*, 21(14): 3643-51.
- Gelhaye E, Rouhier N, Navrot N, Jacquot JP.** (2005). The plant thioredoxin system. *Cell. Mol. Life Sci.*, 62(1): 24-35.
- Granshaw T, Tsukamoto M, Brody S.** (2003). Circadian rhythms in *Neurospora crassa*: farnesol or geraniol allow expression of rhythmicity in the otherwise arrhythmic strains *frq10*, *wc-1*, and *wc-2*. *J. Biol. Rhythms*, 18(4): 287-96.
- Hunt S, Elvin M, Heintzen C.** (2012). Temperature-sensitive and circadian oscillators of *Neurospora crassa* share components. *Genetics*, 191(1): 119-31.
- Iwasaki H, Dunlap JC.** (2000). Microbial circadian oscillatory systems in *Neurospora* and *Synechococcus*: models for cellular clocks. *Curr. Opin. Microbiol.*, 3(2): 189-96.
- Karst F, Lacroute F.** (1977). Ergosterol biosynthesis in *Saccharomyces cerevisiae*. *MGG*, 154(3): 269-277.
- Lakin-Thomas PL.** (1996). Effects of Choline Depletion on the Circadian Rhythm in *Neurospora crassa*. *Biological Rhythm Research*, 27(1): 12-30.

- Lakin-Thomas PL.** (1998). Choline depletion, frq mutations, and temperature compensation of the circadian rhythm in *Neurospora crassa*. *J. Biol. Rhythms*, 13(4): 268-77.
- Lakin-Thomas PL, Brody S.** (2000). Circadian rhythms in *Neurospora crassa*: Lipid deficiencies restore robust rhythmicity to null frequency and white-collar mutants. *PNAS*, 97(1): 256–261.
- Lakin-Thomas PL, Côté GG, Brody S.** (1990). Circadian rhythms in *Neurospora crassa*: biochemistry and genetics. *Crit. Rev. Microbiol.*, 17(5): 365-416.
- Lombardi L, Schneider K, Tsukamoto M, Brody S.** (2007). Circadian rhythms in *Neurospora crassa*: Clock mutant effects in the absence of a frq-based oscillator. *Genetics* 175: 1175–1183.
- Mattern DL, Brody S.** (1979). Circadian Rhythms in *Neurospora crassa*: Effects of Saturated Fatty Acids. *J. Bacteriol.*, 139(3): 977-83.
- Mattern DL, Forman LR, Brody S.** (1982). Circadian rhythms in *Neurospora crassa*: a mutation affecting temperature compensation. *PNAS*, 79(3): 825-9.
- Merrow M, Brunner M, Roenneberg T.** (1999). Assignment of circadian function for the *Neurospora* clock gene frequency. *Nature*, 399(6736): 584-6.
- Morgan LW, Feldman JF, Bell-Pedersen D.** (2001). Genetic interactions between clock mutations in *Neurospora crassa*: can they help us to understand complexity? *Philos. Trans. R. Soc. Lond. B. Biol. Sci.*, 356(1415): 1717-24.
- Onai K, Nakashima H.** (1997). Mutation of the *cys-9* gene, which encodes thioredoxin reductase, affects the circadian conidiation rhythm in *Neurospora crassa*. *Genetics*, 146(1): 101-10.
- de Paula RM, Lewis ZA, Greene AV, Seo KS, Morgan LW, Vitalini MW, Bennett L, Gomer RH, Bell-Pedersen D.** (2006). Two circadian timing circuits in *Neurospora crassa* cells share components and regulate distinct rhythmic processes. *J. Biol. Rhythms*, 21(3): 159-68.
- Ramsdale M, Lakin-Thomas PL.** (2000). sn-1,2-diacylglycerol levels in the fungus *Neurospora crassa* display circadian rhythmicity. *J. Biol. Chem.*, 275(36): 27541-50.
- Roenneberg T, Merrow M.** (1999). Circadian systems and metabolism. *J. Biol. Rhythms*, 14(6): 449-59.
- Schmidt CL, Grey M, Schmidt M, Brendel M, Henriques JA.** (1999). Allelism of *Saccharomyces cerevisiae* genes *PSO6*, involved in survival after 3-CPs+UVA induced damage, and *ERG3*, encoding the enzyme sterol C-5 desaturase. *Yeast*, 15(14): 1503-10.
- Yoshida Y, Iigusa H, Wang N, Hasunuma K.** (2011). Cross-talk between the cellular redox state and the circadian system in *Neurospora*. *PLoS One*, 6(12): e28227.

- Yoshida Y, Maeda T, Lee B, Hasunuma K.** (2008). Conidiation rhythm and light entrainment in superoxide dismutase mutant in *Neurospora crassa*. *Mol. Genet. Genomics.*, 279(2): 193-202.
- Zinser E, Paltauf F, Daum G.** (1993). Sterol composition of yeast organelle membranes and subcellular distribution of enzymes involved in sterol metabolism. *J. Bacteriol.*, 175(10): 2853-8.

Appendix 2

The cyanobacterial circadian system is
metabolic

Ap.2. The cyanobacterial circadian system is metabolic

For decades after their description circadian clocks were believed to exist only in eukaryotes, as prokaryotic organization was regarded as too simple to generate a 24-h timing mechanism. However, co-existence of two incompatible biochemical processes – oxygenic photosynthesis and oxygen-sensitive nitrogen fixation – in some unicellular cyanobacteria led to the identification of their temporal "compartmentalization" via endogenous, entrainable and temperature compensated circadian rhythms (reviewed in Mackey *et al.*, 2011).

High-throughput genetic screens for clock mutants were rendered possible in the cyanobacterium *Synechococcus elongatus* after a bacterial luciferase gene was introduced downstream of the rhythmic promoter of the *psbAI* gene, that encodes a photosystem II protein (Kondo *et al.*, 1993). Arrhythmic strains and period-mutants were isolated with this approach (Kondo *et al.*, 1994). Complementation of the mutants with a genomic DNA library of *S. elongatus* led to the identification of a single locus that rescued each of the circadian defects. Within this locus three adjacent genes named *kaiA*, *kaiB* and *kaiC* are organized in two rhythmically expressed transcriptional units of *KaiA* and *KaiBC* (Ishiura *et al.*, 1998). The *Kai* genes were proposed to fulfill criteria and properties expected of clock components. First, *KaiB* and *KaiC* (but not *KaiA*) protein levels oscillate and second, the clock is rendered arrhythmic by deletion of each of the *kai* genes or by over-expression of *kaiA* or *kaiC*. Third, a transcriptional negative feedback between these genes was proposed based on the fact that *kaiC* inactivation or over-expression nullifies the *kaiBC* promoter; *KaiA* was regarded as a positive element in the feedback loop, because inactivation or over-expression of the gene results respectively in low and high levels of arrhythmic *kaiBC* expression (Ishiura *et al.*, 1998; Xu *et al.*, 2000). In addition to its documented role in feedback regulation, *KaiC* is also responsible for phase resetting. This is because temporal over-expression of *KaiC* resets the clock (Ishiura *et al.*, 1998) in a manner that phase resetting and *KaiC* induction are correlated to each other (Xu *et al.*, 2000). Moreover, a *kaiC* mutant termed *prl* (*phase response 1*), fails to entrain to a dark pulse that induces a strong 10 hour phase shift in the wild-type (Kiyohara *et al.*, 2005). Together these findings established the model of Ishiura *et al.* (1998), according to which the basis of the cyanobacterial clock is a TTFL, with *KaiA* and *KaiC* providing positive and negative feedback respectively and *KaiC* levels determining the "state variable" of the clock.

Due to the photoautotrophic nature of *S. elongatus* detection of oscillations in the dark has proven rather laborious and the *kaiABC*-based clock was initially regarded as restricted in the light; this is because expression of output by which rhythms are detected has an absolute requirement for

light (reviewed in Mackey *et al.*, 2011). Eventually it was shown that the clock of *S. elongatus* is not ceased in the dark; for this purpose LD-entrained cultures were exposed to a final night phase of varying duration and then allowed to oscillate in continuous light¹. If the clock is ceased in the dark then ensuing oscillations in continuous light should have been entrained to the last dark-to-light treatment. By contrast, circadian phase was set by the initial LD-entrainment demonstrating that prolonged darkness had not abrogated rhythmicity (Xu *et al.*, 2000). In retrospect this would have been the first firm indication that the prokaryotic clock is not a TTFL, provided that the Kai proteins and RNA levels do not oscillate in the dark (Tomita *et al.*, 2005). Instead, Xu *et al.* (2000) claimed that the levels of KaiC protein oscillated in the dark in their experiments, but it is possible that they were detecting post-translational oscillations in the phosphor-state of KaiC (Tomita *et al.*, 2005). Hints of a non-TTFL based circadian oscillator were provided again by Xu *et al.* (2003) and later by Ditty *et al.* (2005) who showed that the endogenous *KaiBC* promoter is dispensable for normal period and phase of *KaiBC::LUC* expression². Solid proof that the generation of circadian rhythms in cyanobacteria does not require transcription and translation was provided when rhythmicity in the phosphor-state of KaiC was observed in continuous darkness that inhibits overall as well as *kai*-specific gene expression and in the presence of inhibitors of transcription and translation; under these conditions the phosphor-state of KaiC was persistently rhythmic (Tomita *et al.*, 2005), indicating that it may account for the timekeeper responsible for residual oscillations in prolonged darkness (observed by Xu *et al.*, 2000). The phosphor-state of KaiC results from the auto-kinase (Nishiwaki *et al.*, 2000) and auto-phosphatase (Xu *et al.*, 2003) activities of the KaiC protein that are temperature-independent and could therefore hold responsible for temperature compensation (Tomita *et al.*, 2005). Indeed, temperature compensated circadian rhythms in the phosphor-state of KaiC can be reconstructed *in vitro* (thus in the absence of transcription and translation) by the sole presence of KaiA, B and C proteins and ATP (Nakajima *et al.*, 2005). Based on these findings Nakajima *et al.* (2005) proposed that KaiC phosphorylation is the actual molecular timer of *S. elongatus* and added in proof that period-variants of KaiC affect circadian period *in vitro* (KaiC phosphorylation rhythm) and *in vivo* (*KaiBC* promoter-activity) similarly. Terauchi *et al.* (2007) even suggested that the actual "state variable" of the circadian oscillator is the ATPase activity of KaiC that is temperature compensated, oscillates *in vitro* in the presence of KaiA and KaiB and is

1. This is called a "release experiment".

2. The *kaiBC* promoter can be functionally replaced by inducible promoters (Xu *et al.*, 2003) or heterologous promoters that peak 12 hours out of phase from the norm (Ditty *et al.*, 2005), without affecting period or phase of *kaiBC*-promoter-driven luminescence.

directly proportional to the circadian frequencies produced *in vivo* by wild-type KaiC and its aforementioned period-variants.

Oscillations in the phosphor-state of KaiC are reconstructed *in vitro* only if all three Kai proteins are included in the mixture (Nakajima *et al.*, 2005). KaiA alone will increase the steady-state of the KaiC auto-kinase activity, whereas KaiB abrogates the positive effect of KaiA on KaiC auto-phosphorylation; KaiB alone has no effect on KaiC activities (Iwasaki *et al.*, 2002; Williams *et al.*, 2002; Kitayama *et al.*, 2003). With the phosphocycles of KaiC regarded as being the cellular timekeeper (Tomita *et al.*, 2005; Nakajima *et al.*, 2005; Terauchi *et al.*, 2007), KaiC activities and their modification by KaiA and KaiB were studied further and more extensively. Crystallographic, mass-spectrometric and mutational analyses demonstrated three important phosphorylation sites in KaiC, Ser-431, Thr-432 and Thr-426 (reviewed in Mackey *et al.*, 2011). Phosphorylation at these sites is essential because when mutated to Ala that mimics the unphosphorylated state, rhythmicity in *kaiBC* expression is lost (Nishiwaki *et al.*, 2004; Xu *et al.*, 2004). The same is observed when Thr-426 is mutated to Glu that mimics the phosphoblocked state (Xu *et al.*, 2009). These findings are in agreement with the idea that the cyanobacterial clock lies in the phosphor-state of KaiC. Of note, biochemical data obtained *in vitro* and kinetic analysis of the oscillations of the KaiC phosphor-forms at Ser-431 and Thr-432 are suggestive that phosphorylation at Ser-431 provides the negative feedback on KaiC phosphorylation by attracting KaiB to the KaiC-KaiA complex (Rust *et al.*, 2007); Nishiwaki *et al.* (2007) who reconstructed the *in vitro* reactions with mutated KaiC forms that mimic the phosphorylated or dephosphorylated states of Ser-431 and Thr-432 came to similar conclusions and moreover proposed that KaiC phosphorylation enhances the auto-phosphatase activity of KaiC and vice-versa (de-phosphorylation enhances the auto-kinase activity) as part of the clock feedback mechanism. These studies have contributed to the current model of the *S. elongatus* clock that is comprised of a "periodosome"³ made of a KaiC hexamer that sequentially interacts with KaiA and KaiB to produce oscillations in the phosphor-states of KaiC (reviewed in Golden, 2004).

Genetic studies failed to show a relationship between the known photoreceptors and light input to the clock of *S. elongatus*. Two out of the three genes that were eventually connected to light input in *S. elongatus* are potentially redox-sensors (see below). These genes are *circadian input kinase (cika)*⁴ and *light-dependent period A (ldpA)*, that when mutated the ability to reset to dark

3. "Unlike the tag-team relay of eukaryotic clock parts, the cyanobacterial clock components engage in a group hug" [exact sentence taken from Golden (2004)].

4. The involvement of Cika in entrainment is, amongst other findings, supported by the fact that it is required for the observed de-phosphorylation of KaiC in response to dark pulses. This is achieved likely through the

pulses is lost (Schmitz *et al.*, 2000) and the rule of Aschoff is broken (increasing light intensity will not shorten circadian period; Katayama *et al.*, 2003), respectively. Further experimentation (see references below) has verified that the clock of cyanobacteria is entrained to the environment via metabolic cues.

CikA (Mutsuda *et al.*, 2003) and KaiA (Williams *et al.*, 2002) contain PsR domains⁵ that bind quinone analogs such as DBMIB (Ivleva *et al.*, 2006; Wood *et al.*, 2010), whereas LdpA contains two Fe₄S₄ clusters (Ivleva *et al.*, 2005); these properties would allow the respective proteins to sense the redox state of the cell as determined by light and photosynthetic electron transport. At the same time, CikA and LdpA form large complexes with KaiC and KaiA in a circadian manner, a property that would allow the former to mediate entrainment to the periodosome (Ivleva *et al.*, 2005; Ivleva *et al.*, 2006). KaiA, CikA and LdpA are downregulated by DBMIB that is predicted to shift the PQ pool to its reduced state; by contrast, DCMU that would shift the PQ pool to its oxidized form does not change the state of any of these proteins. These experiments with DBMIB and DCMU together with the potential of CikA and LdpA to sense the redox state of the cell and the ability of these proteins to interact with the periodosome indicate that light-induced reduction of the photosynthetic electron transport chain is responsible for phase resetting (Ivleva *et al.*, 2005; Ivleva *et al.*, 2006), *i.e.* these proteins may sense light indirectly through the redox state of PQ. In support of this idea it was shown that PsR-dependent quinone binding by KaiA results in downregulation of the later and thus elimination of the KaiA-mediated KaiC phosphorylation (Wood *et al.*, 2010). It should be mentioned that the effect of DBMIB on CikA and LdpA is post-translational as it persists in the presence of translational inhibitor chloramphenicol; the exact nature of the signal between PQ and these proteins is not clarified to this point (Ivleva *et al.*, 2005; Ivleva *et al.*, 2006).

Recently it was shown that the *in vitro* reconstructed oscillator of KaiC phosphor-cycles is entrained to ATP/ADP ratios in the absence of additional proteins; this means that entrainment of the KaiABC-based clock to the energy state of the cell is intrinsic and does not require any additional signaling pathways. It was further shown that the PRC obtained by altering the ATP/ADP ratio *in*

inhibition of the ATPase activity of KaiC by CikA. Accordingly, CikA is upregulated in the dark and is required for normal resetting to dark pulses; (Schmitz *et al.*, 2000; Ivleva, 2006; Dong *et al.*, 2010). When combined these findings suggest that CikA elevation in response to a dark pulse would promote dephosphorylation of KaiC and phase resetting.

5. PsR: Pseudo Reciever domains found in proteins of two-component regulatory systems but lack catalytic aspartic residues.

in vitro was similar to the PRC observed in living cells treated with pulses of darkness⁶ (Rust *et al.*, 2011). Consequently, it is very likely that in the dark ensuing ADP would function in the place of a *zeitgeber* that inhibits KaiC phosphorylation. To conclude, *S. elongatus* expresses a metabolic clock (fig. Ap.2.1), that as such is entrained to the environment via metabolic cues, like the redox potential of photosynthetic ETCs and the energy state of the cell. Similar trends have emerged from the study of the mammalian clock (see paragraph 1.4.1.b and appendix 3).

Figure Ap.2.1: The circadian system of *S. elongatus*

The circadian system of *S. elongatus* is metabolic and consisted of cycles of phosphorylation of the KaiC protein. According to current trends entrainment is also metabolic. The minimal oscillator in the box is responsible for driving overall gene expression by regulating chromosome compaction. Figure adapted after Tomita *et al.* (2005).

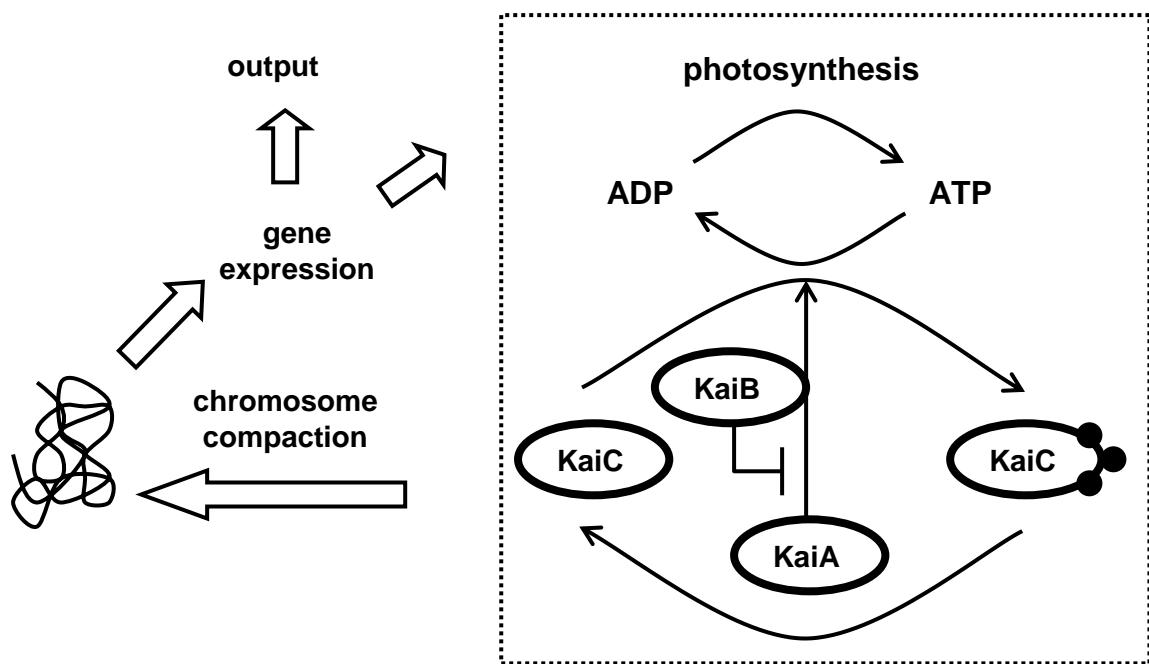

6. KaiC phosphorylation was used to assess the rhythm in both cases.

Bibliography

- Ditty JL, Canales SR, Anderson BE, Williams SB, Golden SS.** (2005). Stability of the *Synechococcus elongatus* PCC 7942 circadian clock under directed anti-phase expression of the kai genes. *Microbiology*, 151(Pt 8): 2605-13.
- Dong G, Yang Q, Wang Q, Kim YI, Wood TL, Osteryoung KW, van Oudenaarden A, Golden SS.** (2010). Elevated ATPase activity of KaiC applies a circadian checkpoint on cell division in *Synechococcus elongatus*. *Cell*, 140(4): 529-39.
- Golden SS.** (2004). Meshing the gears of the cyanobacterial circadian clock. *PNAS*, 101(38): 13697-8.
- Ishiura M, Kutsuna S, Aoki S, Iwasaki H, Andersson CR, Tanabe A, Golden SS, Johnson CH, Kondo T.** (1998). Expression of a gene cluster kaiABC as a circadian feedback process in cyanobacteria. *Science*, 281(5382): 1519-23.
- Ivleva NB, Bramlett MR, Lindahl PA, Golden SS.** (2005). LdpA: a component of the circadian clock senses redox state of the cell. *EMBO J.*, 24(6): 1202-10.
- Ivleva NB, Gao T, LiWang AC, Golden SS.** (2006). Quinone sensing by the circadian input kinase of the cyanobacterial circadian clock. *PNAS*, 103(46): 17468-73.
- Iwasaki H, Nishiwaki T, Kitayama Y, Nakajima M, Kondo T.** (2002). KaiA-stimulated KaiC phosphorylation in circadian timing loops in cyanobacteria. *PNAS*, 99(24): 15788-93.
- Katayama M, Kondo T, Xiong J, Golden SS.** (2003). LdpA encodes an iron-sulfur protein involved in light-dependent modulation of the circadian period in the cyanobacterium *Synechococcus elongatus* PCC 7942. *J. Bacteriol.*, 185(4): 1415-22.
- Kitayama Y, Iwasaki H, Nishiwaki T, Kondo T.** (2003). KaiB functions as an attenuator of KaiC phosphorylation in the cyanobacterial circadian clock system. *EMBO J.*, 22(9): 2127-34.
- Kiyohara YB, Katayama M, Kondo T.** (2005). A novel mutation in kaiC affects resetting of the cyanobacterial circadian clock. *J. Bacteriol.*, 187(8): 2559-64.
- Kondo T, Strayer CA, Kulkarni RD, Taylor W, Ishiura M, Golden SS, Johnson CH.** (1993). Circadian rhythms in prokaryotes: luciferase as a reporter of circadian gene expression in cyanobacteria. *PNAS*, 90(12): 5672-6.
- Kondo T, Tsinoremas NF, Golden SS, Johnson CH, Kutsuna S, Ishiura M.** (1994). Circadian clock mutants of cyanobacteria. *Science*, 266(5188): 1233-6.
- Mackey SR, Golden SS, Ditty JL.** (2011). The itty-bitty time machine genetics of the cyanobacterial circadian clock. *Adv. Genet.*, 74: 13-53.

- Mutsuda M, Michel KP, Zhang X, Montgomery BL, Golden SS.** (2003). Biochemical properties of CikA, an unusual phytochrome-like histidine protein kinase that resets the circadian clock in *Synechococcus elongatus* PCC 7942. *J. Biol. Chem.*, 278(21): 19102-10.
- Nakajima M, Imai K, Ito H, Nishiwaki T, Murayama Y, Iwasaki H, Oyama T, Kondo T.** (2005). Reconstitution of circadian oscillation of cyanobacterial KaiC phosphorylation in vitro. *Science*, 308(5720): 414-5.
- Nishiwaki T, Iwasaki H, Ishiura M, Kondo T.** (2000). Nucleotide binding and autophosphorylation of the clock protein KaiC as a circadian timing process of cyanobacteria. *PNAS*, 97(1): 495-9.
- Nishiwaki T, Satomi Y, Kitayama Y, Terauchi K, Kiyohara R, Takao T, Kondo T.** (2007). A sequential program of dual phosphorylation of KaiC as a basis for circadian rhythm in cyanobacteria. *EMBO J.*, 26(17): 4029-37.
- Nishiwaki T, Satomi Y, Nakajima M, Lee C, Kiyohara R, Kageyama H, Kitayama Y, Temamoto M, Yamaguchi A, Hijikata A, Go M, Iwasaki H, Takao T, Kondo T.** (2004). Role of KaiC phosphorylation in the circadian clock system of *Synechococcus elongatus* PCC 7942. *PNAS*, 101(38): 13927-32.
- Rust MJ, Golden SS, O'Shea EK.** (2011). Light-driven changes in energy metabolism directly entrain the cyanobacterial circadian oscillator. *Science*, 331(6014): 220-3.
- Rust MJ, Markson JS, Lane WS, Fisher DS, O'Shea EK.** (2007). Ordered phosphorylation governs oscillation of a three-protein circadian clock. *Science*, 318(5851): 809-12.
- Schmitz O, Katayama M, Williams SB, Kondo T, Golden SS.** (2000). CikA, a bacteriophytochrome that resets the cyanobacterial circadian clock. *Science*, 289(5480): 765-8.
- Terauchi K, Kitayama Y, Nishiwaki T, Miwa K, Murayama Y, Oyama T, Kondo T.** (2007). ATPase activity of KaiC determines the basic timing for circadian clock of cyanobacteria. *PNAS*, 104(41): 16377-81.
- Tomita J, Nakajima M, Kondo T, Iwasaki H.** (2005). No transcription-translation feedback in circadian rhythm of KaiC phosphorylation. *Science*, 307(5707): 251-4.
- Williams SB, Vakonakis I, Golden SS, LiWang AC.** (2002). Structure and function from the circadian clock protein KaiA of *Synechococcus elongatus*: a potential clock input mechanism. *PNAS*, 99(24): 15357-62.
- Wood TL, Bridwell-Rabb J, Kim YI, Gao T, Chang YG, LiWang A, Barondeau DP, Golden SS.** (2010). The KaiA protein of the cyanobacterial circadian oscillator is modulated by a redox-active cofactor. *PNAS*, 107(13): 5804-9.

- Xu Y, Mori T, Johnson CH.** (2000). Circadian clock-protein expression in cyanobacteria: rhythms and phase setting. *EMBO J.*, 19(13): 3349-57.
- Xu Y, Mori T, Johnson CH.** (2003). Cyanobacterial circadian clockwork: roles of KaiA, KaiB and the kaiBC promoter in regulating KaiC. *EMBO J.*, 22(9): 2117-26.
- Xu Y, Mori T, Pattanayek R, Pattanayek S, Egli M, Johnson CH.** (2004). Identification of key phosphorylation sites in the circadian clock protein KaiC by crystallographic and mutagenetic analyses. *PNAS*, 101(38): 13933-8.
- Xu Y, Mori T, Qin X, Yan H, Egli M, Johnson CH.** (2009) Intramolecular regulation of phosphorylation status of the circadian clock protein KaiC. *PLoS One*, 4(11): e7509.

Appendix 3

Circadian metabolic oscillations in mammalian
cells

Ap.3. Circadian metabolic oscillations in mammalian cells

Ap.3.1. Metabolic and cytosolic oscillations

Several energy and redox related molecules couple cytosolic oscillations with TTFLs in mammalian cells (reviewed in Gallego and Virshup, 2007; Hastings *et al.*, 2008). Metabolites involved in this process include heme, CO (Dioum *et al.*, 2002; Kaasik and Lee, 2004), and adenine nucleotides [*i.e.* cAMP and NAD(P)⁺/NAD(P)H and AMP/ATP ratios; reviewed in Hastings *et al.*, 2008 and in Froy, 2011]. Related studies are presented here (paragraph 5.3.1), together with studies that established that circadian entrainment of the mammalian autonomous oscillator is metabolic (paragraph 5.3.2) and publications that focus on post-translational modifications (PTMs) that affect stability and sub-cellular localization of components of the TTFL (paragraph 5.3.3). These works have contributed to our current understanding of redox-sensitive PTMs as part of the mechanism whereby cytosolic/metabolic oscillations feedback to regulate TTFLs. Consequently, circadian outputs are viewed as indistinguishable from the core timekeeping mechanism¹.

O'Neill *et al.*, (2008) showed that cytosolic cAMP oscillations define amplitude, phase and circadian period of *PER* gene expression in the SCN as well as synchronization between neurons. Amplitude of rhythmic gene expression was shown to depend on cAMP signaling through its known downstream components (*i.e.* HCN channels and the guanine nucleotide-exchange factor EPAC²). Oscillations of cAMP levels and TTFLs interact in peripheral tissues as well (O'Neill *et al.*, 2008). Of note, these events depend on CRE-promoter elements and do not require E-box mediated trans-activation by CLOCK/BMAL1 (Travnickova-Bendova *et al.*, 2002).

CLOCK/BMAL1 and E-box trans-activation are also involved in the crosstalk between cytosolic and nuclear oscillations. Rutter *et al.* (2001) proposed that the heterodimer of BMAL1 with

1. Canonical signaling networks involved in this process are reviewed in Hastings *et al.*, (2008); these include cAMP-dependent and Ca²⁺ dependent kinases, casein kinases, C-Jun aminoterminal kinases, ras-dependent (MAP) kinases and their downstream signaling partners. Many of these networks converge on transcriptional activators such as the CRE-BINDING PROTEIN (CREB) and its co-activators CREB-BINDING PROTEIN (CBP) and p300. CREB/CRE-mediated signaling was originally connected to photic entrainment in neurons of the suprachiasmatic nucleus (SCN), but it is now viewed as part of the pacemaker per se, facilitating both acute (*i.e.* entrainment, through induction of *Per* mRNA; Travnickova-Bendova *et al.*, 2002) and circadian activation (CLOCK-BMAL1-dependent; Sanada *et al.*, 2002; Akashi *et al.*, 2008) of the TTFL.

2. EPAC: EXCHANGE PROTEIN directly ACTIVATED by cAMP.

NEURONAL PAS DOMAIN PROTEIN 2 (NPAS2), a functional analog of CLOCK in the mammalian forebrain (Reick *et al.*, 2001), regulates the redox state of the cell through the induction of LDHA, the A isophorm of lactate dehydrogenase that reversibly catalyses the conversion of pyruvate to lactate in a reaction that consumes NADH. The redox state of the cell was then shown to regulate TTFLs through the modulation of the DNA-binding activities of CLOCK-BMAL1 and NPAS2-BMAL1; induction and suppression of these DNA binding activities were shown to be promoted by [NAD(P)H] and [NAD(P)+], respectively (Rutter *et al.*, 2001).

A series of independent publications have established that the redox state of the cell is coupled to TTFLs through the metabolic sensor SIRT1. This is an NAD⁺ dependent deacetylase that binds CLOCK in a circadian manner and counteracts CLOCK HAT activity. Subsequently, through acetylation and deacetylation, the expression of clock-controlled genes (*DBP*³ and *PER2*) and BMAL1 and *PER2*⁴ protein stability are rendered sensitive to the redox state of the cell. SIRT1 and CLOCK bind E-boxes to facilitate chromatin remodeling; this has been observed at the *PER2* promoter and, notably, at the promoter of *NICOTINAMIDE PHOSPHORIBOSYL TRANSFERASE (NAMPT)*, that encodes for the rate limiting enzyme in the synthesis of the SIRT1 cofactor NAD⁺. Based on these findings it was proposed that SIRT1 is an enzymatic rheostat of CLOCK activity. Consequently, oscillations in the redox state of the cell (observed within the range of circadian or ultradian period) and nuclear oscillations are coupled to each other (Asher *et al.*, 2008; Nakahata *et al.*, 2008; Nakahata *et al.*, 2009; Ramsey *et al.*, 2009).

The formation and DNA binding of NPAS2:BMAL1 is inhibited by CO at physiological concentrations. This response requires binding of heme to the two PAS domains of NPAS2. By contrast, the response of NPAS2:BMAL1 to the redox state of the cell is independent of heme, therefore the formation of NPAS2:BMAL1 and its binding to DNA should be inhibited independently by conditions that favor low redox potential or high CO formation (Dioum *et al.*, 2002). It should be mentioned that the same forebrain regions that express NPAS2 also express heme oxygenase 2, an enzyme that generates CO during heme breakdown. Consequently, the circadian system is rendered sensitive to CO as part of a metabolic feedback that is formed in specific neurons (see Dioum *et al.*, 2002 and references therein). Kaasik and Lee (2004) have reported independently

3. DBP: D-site of albumin promoter binding protein.

4. Acetylation and deacetylation are rhythmic. When de-acetylated, BMAL1 and PER2 are destabilized. The enzymes responsible for PER2 acetylation are not known, but CLOCK is an attractive candidate. Of note, acetylation stabilizes BMAL1 likely because it affects its phosphorylation state (Nakahata *et al.*, 2008).

that rhythmic heme biosynthesis⁵ and nuclear oscillations are coupled to each other through a feedback mechanism that involves PER2 and NPAS2:BMAL1.

Several independent studies have pointed out the role of AMPK in the crosstalk between nuclear and cytosolic oscillations. AMPK is a metabolic sensor of the energy state of the cell (AMP/ATP ratio) that acts in peripheral tissues and in the central nervous system where it potentiates food intake (Minokoshi *et al.*, 2004; Kahn *et al.*, 2005). The circadian role of AMPK seems to be exerted at multiple levels: (1) A mutation in the AMPK γ 3 subunit of AMPK results in increased basal levels of PER1 protein and disrupts the diurnal regulation of the respiratory exchange ratio between day and night (Vieira *et al.*, 2008). (2) AMPK phosphorylates CASEIN KINASE 1 ϵ (CKI ϵ) that is involved in the stability and sub-cellular localization of the PER proteins (see below). AMPK phosphorylates Ser-389 of CKI ϵ , resulting in increased CKI ϵ activity and degradation of PER2 (Um *et al.*, 2007). (3) In addition to these, AMPK phosphorylates and targets CRY1 for degradation (Lamia *et al.*, 2009). (4) Recently it was shown that AMPK enhances the activity of SIRT1 by increasing the levels of NAD⁺ in the cell, resulting in the deacetylation and regulation of downstream effectors (Cantó *et al.*, 2009).

To conclude, several rhythmic metabolites such as CO, heme, cAMP, and molecules whose ratios define the energy state and redox charge of the cell are not regarded simply as outputs. Keeping this in mind and the recent discovery of temperature-compensated and entrainable circadian oscillations in red blood cells that lack nuclei (O'Neill and Reddy, 2011), it becomes very likely that oscillations in the levels of these metabolites carry-out circadian function. Interestingly, ETCs responsible for ultradian oscillations in the levels of redox molecules (see appendix 5) are present in the plasma membrane of red blood cells where they serve a metabolic function (reviewed in Matteucci and Giampietro, 2007). For this, the importance of cytosolic and plasma membrane ultradian oscillations in the generation of circadian rhythms should be re-examined in the context of the theories of Pavlidis and Kauzman (1969) who suggested that coupling of ultradian oscillations could generate circadian rhythms.

5. The expression of the rate limiting enzyme AMINOLEVULINIC ACID SYNTHASE (ALAS1) in heme biosynthesis is rhythmic.

Ap.3.2. Entrainment to metabolic cues

A relationship between metabolism and entrainment in mammals is known since 1922 when Richter reported that restricted feeding (RF)⁶ could entrain locomotor activity in rats (reported in Stokkan *et al.*, 2001). Feeding also entrains gene expression in peripheral tissues (Schibler *et al.*, 2003) as well as in certain brain areas (Wakamatsu *et al.*, 2002; Rutter *et al.*, 2001), *in vivo*. In agreement with these observations, Hirota *et al.*, (2002) found that glucose triggers and thus entrains rhythmic gene-expression also in rat-1 fibroblasts. Since then research performed with cell cultures has helped substantially in elucidating entrainment and core-clock events in mammalian circadian research.

Early models considered that the SCN is the master oscillator, because at the time the only known example of persistent oscillations (more than 30 days in isolation) was in single cultured neurons from the SCN; in the absence of this brain structure (in cultured cells or in SCN-lesioned mice) rhythmic behavior and gene expression, whether in the periphery or other brain areas, was not sustained for long (Sakamoto *et al.*, 1998; Yamazaki *et al.*, 2000; Akhtar *et al.*, 2002; Reppert and Weaver, 2002). This model was characterized hierarchical because the SCN would deliver rhythmicity to the periphery that could not otherwise sustain oscillations. Eventually persistent oscillations in peripheral tissues were discovered in cultured cells that derived from transgenic mice in which the luciferase gene was expressed downstream of the endogenous *PER2* promoter. This luciferase gene construct produced robust oscillations even in SCN-lesioned mice, though these oscillations were asynchronous between tissues and between animals. The authors assumed that in their experiments, unlike previous studies, rhythmicity did not dampen at the periphery because luciferase was driven by the endogenous promoter and/or because their luciferase transgene was fused with part of the *PER2* protein allowing post-transcriptional regulation (Yoo *et al.*, 2004). These findings have contributed to the current understanding of the SCN as a "master synchronizer" that is entrained to light via a pathway from the retina and sets the time in light-insensitive peripheral organs, as opposed to previous theories that regarded the SCN as a "master oscillator" that delivers rhythmicity (Yoo *et al.*, 2004).

6. RF (restricted feeding) as opposed to *ab libitum* (at free will): mice being nocturnal organisms consume most of their food during the night when allowed to feed *ab libitum*.

Peripheral tissues from intact animals are preferably entrained to RF rather than to LD cycles⁷. On the contrary, the SCN pacemaker is not entrained by feeding patterns (Damiola *et al.*, 2000; Stokkan *et al.*, 2001). Experiments with SCN-lesioned mice have shown that the SCN is dispensable for entrainment to RF⁸. To be more precise, the SCN counteracts the phase shifting effect of food on peripheral tissues, as when the hypothalamus–pituitary gland–adrenal (HPA) axis is blocked (by removal of the adrenal glands) phase resetting by daytime RF is accelerated (Le Minh *et al.*, 2001); the connection between the SCN and peripheral clocks was attributed, at least in part, to glucocorticoids secreted by the HPA axis (Balsalobre *et al.*, 2000). Based on these findings it was proposed that the SCN synchronizes peripheral clocks indirectly, by imposing behavioral rest-activity cycles, thus by defining feeding behavior. According to this model, nutrients, metabolites and/or hormonal signals elicited by feeding behavior and/or food processing, and not light, are the principal *zeitgebers*⁹ of peripheral oscillators. The role of the SCN in the entrainment of peripheral organs, in addition to mediating light entrainment through rest-activity cycles, would likely be to provide stability of phase against metabolic perturbation¹⁰, by regulating the daily fluctuations of corticosterone levels through the HPA axis (reviewed in Schibler *et al.*, 2003). For this purpose, the SCN does not possess glucocorticoid receptors and is resistant to both glucocorticoid- (Balsalobre *et al.*, 2000) and RF-mediated resetting (Le Minh *et al.*, 2001).

Evidently, hormonal regulation of metabolic entrainment is not restricted to glucocorticoids (Stokkan *et al.*, 2001) and may also involve insulin. Primary metabolism in peripheral tissues is sensitive to insulin and nutrients through the regulation of the activity of GSK-3 β (reviewed in Doble and Woodgett, 2003) that is in turn involved in entrainment (to serum shock; Yin *et al.*, 2006) and affects circadian phase¹¹ (Itaka *et al.*, 2005) in cultured cells. Interestingly, GSK-3 β and TTFLs

7. This is because daytime feeding of nocturnal lab rodents inverts the phase of circadian gene expression under diurnal conditions (Damiola *et al.*, 2000; Stokkan *et al.*, 2001).

8. Behavior (Stephan *et al.*, 1979) and rhythmic gene expression [in the brain (Wakamatsu *et al.*, 2002) and at the periphery (Hara *et al.*, 2001)] entrain to RF in SCN-lesioned mice.

9. Nutrients are the "principal *zeitgeber*" in the sense that rhythms in peripheral tissues entrain preferably to meals rather than to LD cycles (Damiola *et al.*, 2000; Stokkan *et al.*, 2001).

10. In this manner, immediate re-entrainment in response to non-repetitive midnight snacks is prevented. Food is the major *zeitgeber* at the periphery, whereas the SCN attempts to counteract food induced resetting via the HPA axis, so that random shifts in feeding patterns would not immediately produce lasting circadian physiological consequences (Schibler *et al.*, 2003).

11. Inhibition and over-expression of GSK-3 β activity delays and advances circadian phase of rhythmic gene expression, respectively.

regulate each other reciprocally (reviewed in Gallego and Virshup, 2007) and consequently GSK-3 β is part of a rhythmic metabolic input pathway to the clock¹². Of note, GSK-3 β affects circadian rhythms in *Drosophila* also¹³.

GSK-3 β is a constitutively active kinase whose activity is regulated post-transcriptionally through inhibitory phosphorylation at Ser-9 by multiple pathways (Doble and Woodgett, 2003). Known targets of GSK-3 β of circadian relevance in mammalian cells include the PER proteins, CRY2 and Rev-ERB α (see paragraph 5.3.3). Even though GSK-3 β levels do not oscillate the inhibitory phosphorylation at Ser-9 is rhythmic *in vivo* (in the SCN and in the liver) and in cultured cells, resulting in robust circadian oscillations in enzymatic activity (Iitaka *et al.*, 2005). Signaling pathways that induce phosphorylation of GSK-3 β at Ser-9 include the classical mitogen-activated protein kinase (MAPK) cascade and the phosphoinositide 3-kinase (PI 3-kinase) dependent pathway, the later in response to insulin binding at the plasma membrane of cells in the liver, adipose tissue and muscle. Eventually, insulin-mediated inhibition of GSK-3 β promotes glycogen and protein synthesis likely because GSK-3 β catalyses the phosphorylation and inhibition of glycogen synthase and of eukaryotic protein synthesis initiation factor 2B, respectively (reviewed in Doble and Woodgett, 2003). Keeping these in mind and the fact that glucose and insulin levels in the blood oscillate in a circadian fashion¹⁴ (Morris *et al.*, 2012), it is possible that GSK-3 β is involved in metabolic entrainment of TTFLs in peripheral tissues (Gallego and Virshup, 2007; Hastings *et al.*, 2008). The importance of GSK-3 β in metabolic entrainment is further supported the fact that in cultured cells the inhibitory phosphorylation of GSK-3 β at Ser-9 occurs in response to metabolic perturbation that is known to promote synchrony, such as treatments with cAMP elevating agents and analogs (Fang *et al.*, 2000; Li *et al.*, 2000; Tanji *et al.*, 2002) and in response to serum shock (Yin *et al.*, 2006). Moreover, Rev-ERB α is crucial for synchronizing and maintaining nuclear oscillations in peripheral tissues downstream of GSK-3 β , as a mutated form of Rev-ERB α that is not phosphorylated by GSK-3 β confirms resistance to the synchronization effect of serum shock (see Yin *et al.*, 2006 and paragraph 5.3.3).

12. This is indicative that the *zeitnehmer* model (Roenneberg and Mellow, 1999) applies to mammalian cells.

13. When *SHAGGY* (*SGG*), the orthologue of the mammalian GSK-3 β , is over-expressed then circadian period is shortened. Accordingly, when *SGG* activity is reduced then activity cycles become slower (Martinek *et al.*, 2001).

14. Glucose and insulin levels in the blood could function as *zeitgebers* in the periphery also because they are regulated by the SCN (that is now viewed as a "master synchronizer"; Yoo *et al.*, 2004) and by activity (increased levels during wakefulness and REM sleep; reviewed in Morris *et al.*, 2012).

Despite their apparent differences, it has been proposed that entrainment of SCN neurons to light and entrainment of other mammalian tissues (in the brain and in peripheral organs) to RF could all be mediated by a common mechanism. Such a mechanism may rely upon changes in the redox state of the cell and subsequent changes in the DNA-binding activity of NPAS2-BMAL1 and CLOCK- BMAL1 (see references above). It is easily featured that RF mediates entrainment at the periphery via controlling directly the redox-state of the cell. In the brain though, circulating glucose levels are steady and do not fluctuate diurnally or in response to feeding. This leaves with the option that TTFLs in neurons are entrained by changes in the redox state of the cell in response not to feeding, but to LD cycles (in the SCN) and neural activity (*e.g.* in the forebrain). A mechanism whereby this could be achieved was proposed by Rutter *et al.* (2001). It is known that extracellular glutamate, produced during neurotransmission at areas of increased neural activity, stimulates glycolysis and lactate production in astrocytes. Lactate is then released extracellularly and received from nearby neurons (that depend on lactate for energy) via a diurnally controlled neuron-specific lactate transporter (MCT2). According to the model, the SCN would create diurnal fluctuations in neural activity in response to LD cycles and entrain other brain regions that regulate feeding behavior. Eventually peripheral tissues would also be entrained to the LD cycles (see Rutter *et al.*, 2001 and references therein). Conclusively, the redox state of the cell may connect the appropriate *zeitgebers* to TTFLs in various cell types, such as the light sensitive SCN-neurons, in neurons of the forebrain that respond to glutamate/neural activity and in cells at the periphery that entrain to diurnal fluctuations of reduced fuels and hormonal signals. Consequently, circadian entrainment in mammals, including entrainment to LD cycles, is metabolic. This is no surprise, given the fact that the mammalian autonomous oscillator is, at least in part, also metabolic (see paragraph 1.4.1.b).

Ap.3.3. Post-translational modifications in the mammalian circadian system that affect protein stability and subcellular localisation

Known PTMs of circadian relevance in mammals are now viewed as steps that couple nuclear with metabolic oscillations. They include cycles of phosphorylation/de-phosphorylation, ubiquitination, sumolation and acetylation/de-acetylation. PTMs regulate several properties of clock-proteins including stability, intracellular localization and activity (Gallego and Virshup, 2007; Hastings *et al.*, 2008). Current knowledge on this issue concentrates around well established sensors of energy metabolism; these are AMPK, SIRT1 and GSK-3 β .

It has been suggested that CRY proteins are predominantly located in the nucleus and interact with and translocate each PER protein to the nucleus (Kume *et al.*, 1999). In a study though it was reported that in hepatic cells CRY2 is localized in both the nucleus and the cytoplasm and evidence was provided that nuclear translocation of the protein oscillates and favored by rhythmic phosphorylation at Ser-557 (Harada *et al.*, 2005). More recently it was shown that the formation of a ternary complex between PER, CRY and Casein kinase I ϵ (CKI ϵ) proteins contributes to their cytoplasmic/nuclear partitioning (see below).

CKI ϵ phosphorylates and destabilizes PER1 and PER2 through the recruitment of β TRCP¹⁵ F-box proteins. Subsequently PER1 and PER2 are ubiquitinated and degraded by the proteasome (Eide *et al.*, 2005; Shirogane *et al.*, 2005; Gallego *et al.*, 2006). In addition to these, CKI ϵ mediated-phosphorylation also affects localization of the PER proteins, though it seems that such events vary between cell lines. In *COS-7* cells CKI ϵ binds and phosphorylates all three PER proteins leading to translocation of PER1 and PER3 to the nucleus (Takano *et al.*, 2000), whereas in *HEK-293* cells CKI ϵ -mediated phosphorylation masks the nuclear localization signal of PER1; nuclear entry of the later is also retarded by its interaction with PER2 (Vielhaber *et al.*, 2000). Having different binding sites for CKI ϵ and CRY proteins, PER1 and PER2 function as scaffolds between the former. Consequently, formation of a ternary complex allows overcoming of the CKI ϵ -dependent cytoplasmic retention of PER1 in *HEK-293* cells and leads to phosphorylation of CRY1 by CKI ϵ , though the physiological consequences of the later are unknown (Eide *et al.*, 2002). In addition to these, CKI ϵ also activates BMAL1-dependent transcription in reporter assays (Eide *et al.*, 2002).

Phosphorylation of CRY2 in hepatic cells at Ser-557, in addition to its aforementioned role in nucleoplasmic partitioning, allows subsequent phosphorylation at Ser-553 by GSK-3 β promoting thereafter degradation of CRY2 by a proteasome pathway (Harada *et al.*, 2005). GSK-3 β also phosphorylates and promotes nuclear translocation of PER2 in *COS-1* cells (Iitaka *et al.*, 2005). Yin *et al.* (2006) have shown that certain circadian responses to lithium are attributed to Rev-ERB α and GSK-3 β . GSK-3 β phosphorylates and protects Rev-ERB α against ubiquitin mediated degradation, whereas treatment with lithium inhibits GSK-3 β in this respect; subsequently Rev-ERB α is degraded and *BMAL1* expression is increased in response to lithium¹⁶. A form of Rev-ERB α that lacks the serine residues phosphorylated by GSK-3 β confirms resistance to lithium in cultured cells, as well as

15. β TRCP: β -TRANSDUCIN REPEAT CONTAINING PROTEIN.

16. The authors raised the possibility that the pathways formed between GSK3- β and Rev-ERB α might be of therapeutic interest for patients with bipolar and circadian disorders.

resistance to the synchronization effect of serum shock (on *BMAL1* expression). Consequently, GSK3- β mediated phosphorylation of Rev-ERB α is important for metabolic entrainment.

In several occasions PTMs regulate the activity of BMAL1. Known examples are as follow: (1) the activation of CLOCK-BMAL1 dependent transcription by CKI ϵ mediated phosphorylation (Eide *et al.*, 2002). (2) The inhibitory phosphorylation of BMAL1 at several sites by MAP kinases (Sanada *et al.*, 2002; see also Hastings *et al.*, 2008). (3) CLOCK mediated acetylation of BMAL1 at Lys537 is rhythmic and results in recruitment of CRY1 to CLOCK-BMAL1, promoting thereby transcriptional repression (Hirayama *et al.*, 2007). Of note, SIRT1 mediated deacetylation of BMAL1 destabilizes the later in cultured cells (Nakahata *et al.*, 2008).

Whenever there is a crucial event regulated by phosphorylation, a phosphoprotein phosphatase is also involved. CKI ϵ kinase activity is tightly regulated through inhibitory autophosphorylation, requiring dephosphorylation of up to eight sites at the carboxyl-terminal region for activation (Rivers *et al.*, 1998; Cegielska *et al.*, 1998; Gietzen and Virshup, 1999). The kinase activity of CKI ϵ is stimulated by PROTEIN PHOSPHATASE5 (PP5) that reduces the extent of CKI ϵ phosphorylation. Moreover, through the formation of a ternary complex CRY2 abrogates the positive effect of PP5 on CKI ϵ activity; through this interaction CRY2 modulates the activity of CKI ϵ on PER2 (Partch *et al.*, 2006). Another phosphatase, PP1, stabilizes PER2 by counteracting the effect of CKI ϵ (Gallego *et al.*, 2006). Consequently, phosphorylation of PER2 that leads to its ubiquitination and degradation is tightly controlled.

Degradation of circadian proteins has been investigated extensively. From the examples mentioned above it becomes obvious that phosphorylation destabilizes circadian proteins in several occasions, though this is not absolute (*e.g.* see for the positive effect of GSK-3 β on stability of Rev-ERB α in Yin *et al.*, 2006). Ubiquitination regulates abundance of the CRY proteins via the SCF(Fbx13) ubiquitin ligase complex. Consequently, Fbx13 mutations delay degradation of CRY1 and CRY2 resulting in prolonged CRY-mediated negative feedback and period lengthening (Godinho *et al.*, 2007; Siepka *et al.*, 2007). Accordingly, silencing of Fbx13 has no effect in mouse embryonic fibroblasts lacking both *CRY1* and *CRY2* genes (Busino *et al.*, 2007) indicating that SCF(Fbx13) is related to the clock mainly via CRY protein degradation. In agreement with the role of protein degradation in circadian timekeeping, proteasome inhibitors cause period lengthening in *rat-1* cells (Eide *et al.*, 2005). Recently it was shown that in hepatic cells BMAL1 is sumolated at a highly conserved lysine residue in a circadian manner. Sumolation of BMAL1 requires its heteromerization partner CLOCK, destabilizes BMAL1 and is necessary for proper rhythmicity in cell cultures (Cardone *et al.*, 2005).

Bibliography

- Akashi M, Hayasaka N, Yamazaki S, Node K.** (2008). Mitogen-activated protein kinase is a functional component of the autonomous circadian system in the suprachiasmatic nucleus. *J. Neurosci.*, 28(18): 4619-23.
- Akhtar RA, Reddy AB, Maywood ES, Clayton JD, King VM, Smith AG, Gant TW, Hastings MH, Kyriacou CP.** (2002). Circadian cycling of the mouse liver transcriptome, as revealed by cDNA microarray, is driven by the suprachiasmatic nucleus. *Curr. Biol.*, 12(7): 540-50.
- Asher G, Gatfield D, Stratmann M, Reinke H, Dibner C, Kreppel F, Mostoslavsky R, Alt FW, Schibler U.** (2008). SIRT1 regulates circadian clock gene expression through PER2 deacetylation. *Cell*, 134(2): 317-28.
- Balsalobre A, Brown SA, Marcacci L, Tronche F, Kellendonk C, Reichardt HM, Schütz G, Schibler U.** (2000). Resetting of circadian time in peripheral tissues by glucocorticoid signaling. *Science*, 289(5488): 2344-7.
- Busino L1, Bassermann F, Maiolica A, Lee C, Nolan PM, Godinho SI, Draetta GF, Pagano M.** (2007). SCFFbx13 controls the oscillation of the circadian clock by directing the degradation of cryptochrome proteins. *Science*, 316(5826): 900-4.
- Cantó C, Gerhart-Hines Z, Feige JN, Lagouge M, Noriega L, Milne JC, Elliott PJ, Puigserver P, Auwerx J.** (2009). AMPK regulates energy expenditure by modulating NAD⁺ metabolism and SIRT1 activity. *Nature*, 458(7241): 1056-60.
- Cardone L, Hirayama J, Giordano F, Tamaru T, Palvimo JJ, Sassone-Corsi P.** (2005). Circadian clock control by SUMOylation of BMAL1. *Science*, 309(5739): 1390-4.
- Cegielska A, Gietzen KF, Rivers A, Virshup DM.** (1998). Autoinhibition of casein kinase I epsilon (CKI epsilon) is relieved by protein phosphatases and limited proteolysis. *J. Biol. Chem.*, 273(3): 1357-64.
- Damiola F, Le Minh N, Preitner N, Kornmann B, Fleury-Olela F, Schibler U.** (2000) Restricted feeding uncouples circadian oscillators in peripheral tissues from the central pacemaker in the suprachiasmatic nucleus. *Genes Dev.*, 14(23): 2950-61.
- Dioum EM, Rutter J, Tuckerman JR, Gonzalez G, Gilles-Gonzalez MA, McKnight SL.** (2002). NPAS2: a gas-responsive transcription factor. *Science*, 298(5602): 2385-7.
- Doble BW, Woodgett JR.** (2003). GSK-3: tricks of the trade for a multi-tasking kinase. *J. Cell Sci.*, 116: 1175-86.

- Eide EJ, Vielhaber EL, Hinz WA, Virshup DM.** (2002). The circadian regulatory proteins BMAL1 and cryptochromes are substrates of casein kinase Iepsilon. *J. Biol. Chem.*, 277(19): 17248-54.
- Eide EJ, Woolf MF, Kang H, Woolf P, Hurst W, Camacho F, Vielhaber EL, Giovanni A, Virshup DM.** (2005). Control of mammalian circadian rhythm by CKIepsilon-regulated proteasome-mediated PER2 degradation. *Mol. Cell. Biol.*, 25(7): 2795-807.
- Fang X, Yu SX, Lu Y, Bast RC Jr, Woodgett JR, Mills GB.** (2000). Phosphorylation and inactivation of glycogen synthase kinase 3 by protein kinase A. *PNAS*, 97(22): 11960-5.
- Froy O.** (2011). The circadian clock and metabolism. *Clin. Sci. (Lond)*, 120(2): 65-72.
- Gallego M, Eide EJ, Woolf MF, Virshup DM, Forger DB.** (2006). An opposite role for tau in circadian rhythms revealed by mathematical modeling. *PNAS*, 103(28): 10618-23.
- Gallego M, Virshup DM.** (2007). Post-translational modifications regulate the ticking of the circadian clock. *Nat. Rev. Mol. Cell Biol.*, 8(2): 139-48.
- Godinho SI, Maywood ES, Shaw L, Tucci V, Barnard AR, Busino L, Pagano M, Kendall R, Quwailid MM, Romero MR, O'Neill JS, Chesham JE, Brooker D, Lallanée Z, Hastings MH, Nolan PM.** (2007). The after-hours mutant reveals a role for Fbxl3 in determining mammalian circadian period. *Science*, 316(5826): 897-900.
- Gietzen KF, Virshup DM.** (1999). Identification of inhibitory autophosphorylation sites in casein kinase I epsilon. *J. Biol. Chem.*, 274(45): 32063-70.
- Hara R, Wan K, Wakamatsu H, Aida R, Moriya T, Akiyama M, Shibata S.** (2001). Restricted feeding entrains liver clock without participation of the suprachiasmatic nucleus. *Genes Cells*, 6(3): 269-78.
- Harada Y, Sakai M, Kurabayashi N, Hirota T, Fukada Y.** (2005). Ser-557-phosphorylated mCRY2 is degraded upon synergistic phosphorylation by glycogen synthase kinase-3 beta. *Biol. Chem.*, 280(36): 31714-21.
- Hastings MH, Maywood ES, O'Neill JS** (2008). Cellular circadian pacemaking and the role of cytosolic rhythms. *Curr. Biol.*, 18(17): 805-815.
- Hirayama J, Sahar S, Grimaldi B, Tamaru T, Takamatsu K, Nakahata Y, Sassone-Corsi P.** (2007). CLOCK-mediated acetylation of BMAL1 controls circadian function. *Nature*, 450(7172): 1086-90.
- Hirota T, Okano T, Kokame K, Shirotani-Ikejima H, Miyata T, Fukada Y.** (2002). Glucose down-regulates Per1 and Per2 mRNA levels and induces circadian gene expression in cultured Rat-1 fibroblasts. *J. Biol. Chem.*, 277(46): 44244-51.

- Iitaka C, Miyazaki K, Akaike T, Ishida N.** (2005). A role for glycogen synthase kinase-3beta in the mammalian circadian clock. *J. Biol. Chem.*, 280(33): 29397-402.
- Kaasik K, Lee CC.** (2004). Reciprocal regulation of haem biosynthesis and the circadian clock in mammals. *Nature*, 430(6998): 467-71.
- Kahn BB, Alquier T, Carling D, Hardie DG.** (2005). AMP-activated protein kinase: ancient energy gauge provides clues to modern understanding of metabolism. *Cell Metab.*, 1(1): 15-25.
- Kume K, Zylka MJ, Sriram S, Shearman LP, Weaver DR, Jin X, Maywood ES, Hastings MH, Reppert SM.** (1999). mCRY1 and mCRY2 are essential components of the negative limb of the circadian clock feedback loop. *Cell*, 98(2): 193-205.
- Lamia KA, Sachdeva UM, DiTacchio L, Williams EC, Alvarez JG, Egan DF, Vasquez DS, Juguilon H, Panda S, Shaw RJ, Thompson CB, Evans RM.** (2009). AMPK regulates the circadian clock by cryptochrome phosphorylation and degradation. *Science*, 326(5951): 437-40.
- Le Minh N, Damiola F, Tronche F, Schütz G, Schibler U.** (2001). Glucocorticoid hormones inhibit food-induced phase-shifting of peripheral circadian oscillators. *EMBO J.*, 20(24): 7128-36.
- Li M, Wang X, Meintzer MK, Laessig T, Birnbaum MJ, Heidenreich KA.** (2000). Cyclic AMP promotes neuronal survival by phosphorylation of glycogen synthase kinase 3beta. *Mol. Cell. Biol.*, 20(24): 9356-63.
- Martinek S1, Inonog S, Manoukian AS, Young MW.** (2001). A role for the segment polarity gene shaggy/GSK-3 in the Drosophila circadian clock. *Cell*, 105(6): 769-79.
- Matteucci E, Giampietro O.** (2007). Electron pathways through erythrocyte plasma membrane in human physiology and pathology: Potential redox biomarker? *Biomarker Insights*, (2):321-329.
- Minokoshi Y, Alquier T, Furukawa N, Kim YB, Lee A, Xue B, Mu J, Fofelle F, Ferré P, Birnbaum MJ, Stuck BJ, Kahn BB.** (2004). AMP-kinase regulates food intake by responding to hormonal and nutrient signals in the hypothalamus. *Nature*, 428(6982): 569-74.
- Morris CJ, Aeschbach D, Scheer FA.** (2012). Circadian system, sleep and endocrinology. *Mol. Cell. Endocrinol.*, 349(1): 91-104.
- Nakahata Y, Kaluzova M, Grimaldi B, Sahar S, Hirayama J, Chen D, Guarente LP, Sassone-Corsi P.** (2008). The NAD⁺-dependent deacetylase SIRT1 modulates CLOCK-mediated chromatin remodeling and circadian control. *Cell*, 134(2): 329-40.
- Nakahata Y, Sahar S, Astarita G, Kaluzova M, Sassone-Corsi P.** (2009). Circadian control of the NAD⁺ salvage pathway by CLOCK-SIRT1. *Science*, 324(5927): 654-7.

- O'Neill JS, Maywood ES, Chesham JE, Takahashi JS, Hastings MH.** (2008). cAMP-dependent signaling as a core component of the mammalian circadian pacemaker. *Science*, 320(5878): 949-53.
- O'Neill JS, Reddy AB.** (2011). Circadian clocks in human red blood cells. *Nature*, 469(7331): 498-503.
- Partch CL, Shields KF, Thompson CL, Selby CP, Sancar A.** (2006). Posttranslational regulation of the mammalian circadian clock by cryptochrome and protein phosphatase 5. *PNAS*, 103(27): 10467-72.
- Pavlidis T, Kazuzmann W.** (1969). Towards a quantitative biochemical model for circadian oscillators. *Arch. Bioch. A. Biophys.*, 132: 338-348.
- Ramsey KM, Yoshino J, Brace CS, Abrassart D, Kobayashi Y, Marcheva B, Hong HK, Chong JL, Buhr ED, Lee C, Takahashi JS, Imai S, Bass J.** (2009). Circadian clock feedback cycle through NAMPT-mediated NAD⁺ biosynthesis. *Science*, 324(5927): 651-4.
- Reick M, Garcia JA, Dudley C, McKnight SL.** (2001). NPAS2: an analog of clock operative in the mammalian forebrain. *Science*, 293(5529): 506-9.
- Reppert SM, Weaver DR.** (2002). Coordination of circadian timing in mammals. *Nature*, 418(6901): 935-41.
- Rivers A, Gietzen KF, Vielhaber E, Virshup DM.** (1998). Regulation of casein kinase I epsilon and casein kinase I delta by an in vivo futile phosphorylation cycle. *J. Biol. Chem.*, 273(26): 15980-4.
- Roenneberg T, Merrow M.** (1999). Circadian systems and metabolism. *J. Biol. Rhythms*, 14(6): 449-59.
- Rutter J, Reick M, Wu LC, McKnight SL.** (2001). Regulation of clock and NPAS2 DNA binding by the redox state of NAD cofactors. *Science*, 293(5529): 510-4.
- Sakamoto K, Nagase T, Fukui H, Horikawa K, Okada T, Tanaka H, Sato K, Miyake Y, Ohara O, Kako K, Ishida N.** (1998). Multitissue circadian expression of rat period homolog (rPer2) mRNA is governed by the mammalian circadian clock, the suprachiasmatic nucleus in the brain. *J. Biol. Chem.*, 273(42): 27039-42.
- Sanada K, Okano T, Fukada Y.** (2002). Mitogen-activated protein kinase phosphorylates and negatively regulates basic helix-loop-helix-PAS transcription factor BMAL1. *J. Biol. Chem.*, 277(1): 267-71.
- Schibler U, Ripperger J, Brown SA.** (2003). Peripheral circadian oscillators in mammals: time and food. *J. Biol. Rhythms*, 18(3): 250-60.

- Shirogane T, Jin J, Ang XL, Harper JW.** (2005). SCFbeta-TRCP controls clock-dependent transcription via casein kinase 1-dependent degradation of the mammalian period-1 (Per1) protein. *J. Biol. Chem.*, Jul 22;280(29): 26863-72.
- Siepkas SM, Yoo SH, Park J, Song W, Kumar V, Hu Y, Lee C, Takahashi JS.** (2007). Circadian mutant Overtime reveals F-box protein FBXL3 regulation of cryptochrome and period gene expression. *Cell*, 129(5): 1011-23.
- Stephan FK, Swann JM, Sisk CL.** (1979). Entrainment of circadian rhythms by feeding schedules in rats with suprachiasmatic lesions. *Behav. Neural Biol.*, 25(4): 545-54.
- Stokkan KA, Yamazaki S, Tei H, Sakaki Y, Menaker M.** (2001). Entrainment of the circadian clock in the liver by feeding. *Science*, 291(5503): 490-3.
- Takano A, Shimizu K, Kani S, Buijs RM, Okada M, Nagai K.** (2000). Cloning and characterization of rat casein kinase 1epsilon. *FEBS Lett.*, 477(1-2): 106-12.
- Tanji C, Yamamoto H, Yorioka N, Kohno N, Kikuchi K, Kikuchi A.** (2002). A-kinase anchoring protein AKAP220 binds to glycogen synthase kinase-3beta (GSK-3beta) and mediates protein kinase A-dependent inhibition of GSK-3beta. *J. Biol. Chem.*, 277(40): 36955-61.
- Travnickova-Bendova Z, Cermakian N, Reppert SM, Sassone-Corsi P.** (2002). Bimodal regulation of mPeriod promoters by CREB-dependent signaling and CLOCK/BMAL1 activity. *PNAS*, 99(11): 7728-33.
- Um JH, Yang S, Yamazaki S, Kang H, Viollet B, Foretz M, Chung JH.** (2007). Activation of 5'-AMP-activated kinase with diabetes drug metformin induces casein kinase 1epsilon (CK1epsilon)-dependent degradation of clock protein mPer2. *J. Biol. Chem.*, 282(29): 20794-8.
- Vieira E, Nilsson EC, Nerstedt A, Ormestad M, Long YC, Garcia-Roves PM, Zierath JR, Mahlapuu M.** (2008). Relationship between AMPK and the transcriptional balance of clock-related genes in skeletal muscle. *Am. J. Physiol. Endocrinol. Metab.*, 295(5): E1032-7.
- Vielhaber E, Eide E, Rivers A, Gao ZH, Virshup DM.** (2000) Nuclear entry of the circadian regulator mPER1 is controlled by mammalian casein kinase I epsilon. *Mol. Cell. Biol.*, 20(13): 4888-99.
- Wakamatsu H, Yoshinobu Y, Aida R, Moriya T, Akiyama M, Shibata S.** (2002). Restricted-feeding-induced anticipatory activity rhythm is associated with a phase-shift of the expression of mPer1 and mPer2 mRNA in the cerebral cortex and hippocampus but not in the suprachiasmatic nucleus of mice. *Eur. J. Neurosci.*, 13(6): 1190-6.
- Yamazaki S, Numano R, Abe M, Hida A, Takahashi R, Ueda M, Block GD, Sakaki Y, Menaker M, Tei H.** (2000). Resetting central and peripheral circadian oscillators in transgenic rats. *Science*, 288(5466): 682-5.

- Yin L, Wang J, Klein PS, Lazar MA.** (2006). Nuclear receptor Rev-erbalpha is a critical lithium-sensitive component of the circadian clock. *Science*, 311(5763): 1002-5.
- Yoo SH, Yamazaki S, Lowrey PL, Shimomura K, Ko CH, Buhr ED, Slepka SM, Hong HK, Oh WJ, Yoo OJ, Menaker M, Takahashi JS.** (2004). PERIOD2::LUCIFERASE real-time reporting of circadian dynamics reveals persistent circadian oscillations in mouse peripheral tissues. *PNAS*, 101(15): 5339-46.

Appendix 4

Ultradian oscillations

Ap.4. Ultradian oscillations

Ap.4.1. Plasma membrane electron transport chains with ultradian activity

Plasma membrane oxidoreductase electron transport chains of plant and animal cells (Morré and Morré, 2004) and ultradian oscillations in their activities (Morré and Morré, 1998; Morré *et al.*, 2002a) have been known for quite some time. Terminal oxidases of plasma membrane electron transport chains, termed PMORs, have been proposed to serve a time-keeping function (see references below). A well described category of PMORs are the ECTO-NOX¹ proteins that are located at the cell surface of animal and plant cells. Because there is little if any NAD(P)H at the cell surface, the term NOX [NAD(P)H oxidase] does not designate function, rather it was adopted after "convenient" biochemical assays with pyridine nucleotides as electron donors (Morré, 1998; Morré *et al.*, 1999b; Morré and Morré, 2004). Natural electron donors of ECTO-NOX proteins are plasma membrane hydroquinones that are in turn reduced from cytosolic NAD(P)H (Kishi *et al.*, 1999; Bridge *et al.*, 2000), whereas natural electron acceptors of ECTO-NOX proteins are protein thiols and oxygen (Morré and Brightman, 1991; Brightman *et al.*, 1992; Chueh *et al.*, 1997; Morré *et al.*, 1998; see also fig. Ap.4.1). Noteworthy, in anaerobic cells that lack functional mitochondria ECTO-NOX proteins serve a metabolic function, as they regenerate NAD⁺ from NADH (Larm *et al.*, 1994; Morré *et al.*, 2000)

The NAD(P)H oxidase activity and the protein disulfide-thiol interchange activity of ECTO-NOX proteins oscillate with a period of 24 minutes (Morré and Morré, 1998; Wang *et al.*, 2001; Morré *et al.*, 2002a). Moreover, the NAD(P)H oxidase activity is entrainable and temperature compensated (Morré and Morré, 1998; Morré *et al.*, 1999a; Morré *et al.*, 2002a; Morré *et al.*, 2002b; Morré *et al.*, 2002c) indicating a potential timekeeping role of ECTO-NOX proteins. Such a role is particularly evident in cultured animal cells in which the circadian period of a metabolic biomarker and certain genetically determined ultradian periodicities of ECTO-NOX activities are proportional to each other² (Morré *et al.*, 2002a). This is perhaps the most striking example whereby ultradian and

-
1. ECTO-NOX PMORs should not be confused to the phox-NOX proteins involved in plant host defenses.
 2. In more detail, when COS cells are transformed with cDNAs encoding different forms of ECTO-NOX proteins that display ultradian periodicities of 22, 24, 36 or 42 minutes in NADPH oxidation, circadian periodicities of 22, 24, 36 and 40 to 42 hours are detected respectively, in glyceraldehyde-3-phosphate dehydrogenase activity.

circadian periodicities are linked to each other in the literature; publications in favor of such a relationship are reviewed by Lloyd and Murray (2007).

It is worth mentioning that ultradian ECTO-NOX activity is correlated to ultradian cell growth of plant and animal cells, as both the activity and growth oscillate with a temperature compensated periodicity of 24 minutes (or 22 minutes in HeLa cells) and are stimulated by the same hormones and growth factors (Morré and Brightman, 1991; Morré, 1998; Morré, 2000; Pogue *et al.*, 2000; Wang *et al.*, 2001). Moreover, in animal cells PMORs are related to aging processes (Morré *et al.*, 2000).

Figure Ap.4.1: Plasma membrane NADPH oxidoreductases (ECTO-NOX proteins) function as plasma membrane oxidoreductases (PMORS)

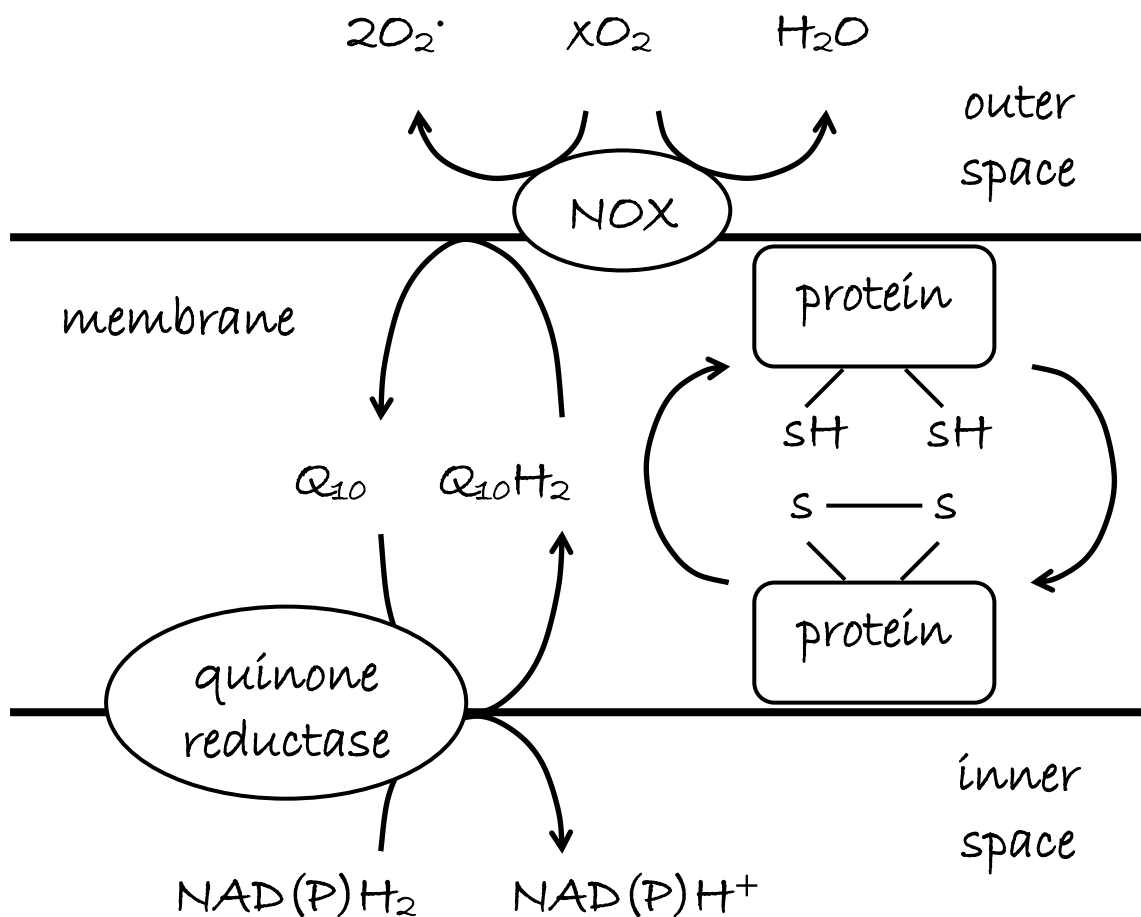

Figure Ap.4.1: Plasma membrane NADPH oxidoreductases (ECTO-NOX proteins) are non-transmembrane proteins that function as terminal plasma membrane oxidoreductases (PMORS). The electron donor is quinone (Q_{10}) that is in turn reduced from intracellular NAD(P)H; notably, the NOX nomenclature is only due to "convenient" biochemical assays that trace enzymatic function in the oxidation of pyridine nucleotides. Natural electron acceptors are oxygen and/or protein thiol groups. ECTO-NOX proteins are present in both plant and animal cells (including red blood cells that function as ROS scavengers for the entire body). In cells that do not perform aerobic respiration ECTO-NOX proteins serve a metabolic function. The NOX activity oscillates with a temperature-compensated period of 24 minutes and is responsive to entrainment and hormones. The values of x are 2 and 1 for the reactions that produce oxygen and water respectively. Figure adapted after Morr  *et al.* (2000).

Ap.4.2. Ultradian oscillations in yeast – the short metabolic cycles

Several ultradian metabolic cycles have been documented in yeast in the form of glycolytic and respiratory oscillations. It has been claimed that glycolytic oscillations, known for more than 60 years, are unlikely to serve any time-keeping function as they are temperature dependent (e.g. Chance *et al.*, 1964; Ghosh and Chance, 1964; Das and Busse, 1985; see also Lloyd *et al.*, 2002 and references therein). Respiratory oscillations on the other hand are more likely to function as clocks, because they are temperature-compensated and as they appear spontaneously in continuous culture they are also entrainable (in a manner implying cell to cell communication) (Murray *et al.*, 2001; Lloyd and Murray, 2007).

Up to date, the budding yeast has not displayed any clear and sustained circadian oscillations (reviewed in Merrow and Raven, 2010). By contrast, ultradian oscillations between glycolysis and respiration, termed yeast metabolic cycles (YMCs), are easily observed in continuous aerobic cultures where the concentration of glucose is limiting for growth (Lloyd and Murray, 2007). The YMC, first observed in 1992 (Satroutdinov *et al.*, 1992), are accompanied by several rhythmic parameters that oscillate in synchrony with a period of 40 to 50 minutes. These cycles can be detected as changes in mitochondrial morphology and energization (Lloyd *et al.*, 2002), as well as with related molecular metabolic oscillations (e.g. oscillations in the redox states of NAD(P)H and glutathione and rhythmic fluxes through the citric acid cycle and the main electron transport chain) (Murray *et al.*, 1998; Murray *et al.*, 1999; Lloyd *et al.*, 2002). Early studies reported rhythmicity also in pH, in the levels of fermentation products (ethanol, acetaldehyde, acetic acid), ATP, stored

carbohydrates (Satroutdinov *et al.*, 1992), H₂S (Sohn *et al.*, 2000) and in the levels of amino acids (Murray *et al.*, 2007). Recently, with the use of mass spectrometry, it was shown that 40 minute oscillations are metabolome-wide and consequently biosynthetic events in cells have a defined order (Murray *et al.*, 2007). The phase of the rhythm and its outputs are defined in reference to the easily monitored cycles of residual dissolved oxygen (RDO) in the continuous culture (Lloyd and Murray, 2007).

Temperature compensated respiratory oscillations are independent of glycolytic oscillations as the former persists under conditions that abolish the later, *i.e.* when ethanol is used as the major carbon source (Keulers *et al.*, 1996a; Murray *et al.*, 2001). Ultradian respiratory oscillations on the other hand dependent on the redox state of the cell, as redox-active reagents, like glutathione and NO⁺-releasing molecules, perturb oscillations, when redox-neutral molecules (such as NO gas and NO⁻-releasing agents) are inactive in this respect (Murray *et al.*, 1998). During high respiration (low RDO, initiated at phase 0°) the inner mitochondrial membrane potential is enhanced by comparison with measurements taken during low respiration (high RDO) (Lloyd *et al.*, 2002); for this the high and low respiration phases (fig. Ap.4.2) are also designated as oxidative and reductive respectively, reflecting the levels of total flavoprotein and the redox states of cytochromes, NAD(P)H (Lloyd *et al.*, 2002) and of the glutathione pool (Murray *et al.*, 1999). Taken together, these findings are suggestive that the metabolic-respiratory cycle is under the control of the oscillating redox state of the cell and of rhythmic mitochondrial activity.

Ultradian rhythmicity is spontaneously achieved in continuous culture in the absence of glucose or when the later is supplied in growth-limiting concentrations. Rhythmicity in this case is dependent on the synchrony between individual cells (Lloyd and Murray, 2007) and arises only within a well defined range of temperature, dilution rate, pH and aeration rate values (Keulers *et al.*, 1996b; Porro *et al.*, 1988; Murray *et al.*, 2001; Futcher, 2006). The fact that synchrony is abrogated when the aeration rate exceeds a certain value suggests that a volatile compound is involved in the synchrony process (Keulers *et al.*, 1996b). Subsequently, H₂S and acetaldehyde fulfilled expected criteria of synchrony compounds, such as rhythmic accumulation and their ability to reset phase (Sohn *et al.*, 2000; Murray *et al.*, 2003). H₂S resets the rhythm by inhibiting respiration, as shown in perturbation experiments where inhibition was always preceded by a rise in H₂S (Sohn *et al.*, 2000). Ethanol has also been considered responsible for the synchronization between cells (reviewed in Futcher, 2006). Together these findings are suggestive that the respiratory cycles are under the control of a metabolic temperature-compensated ultradian oscillator, manifested in the levels of several rhythmic redox-related metabolites that feedback to reset the oscillator.

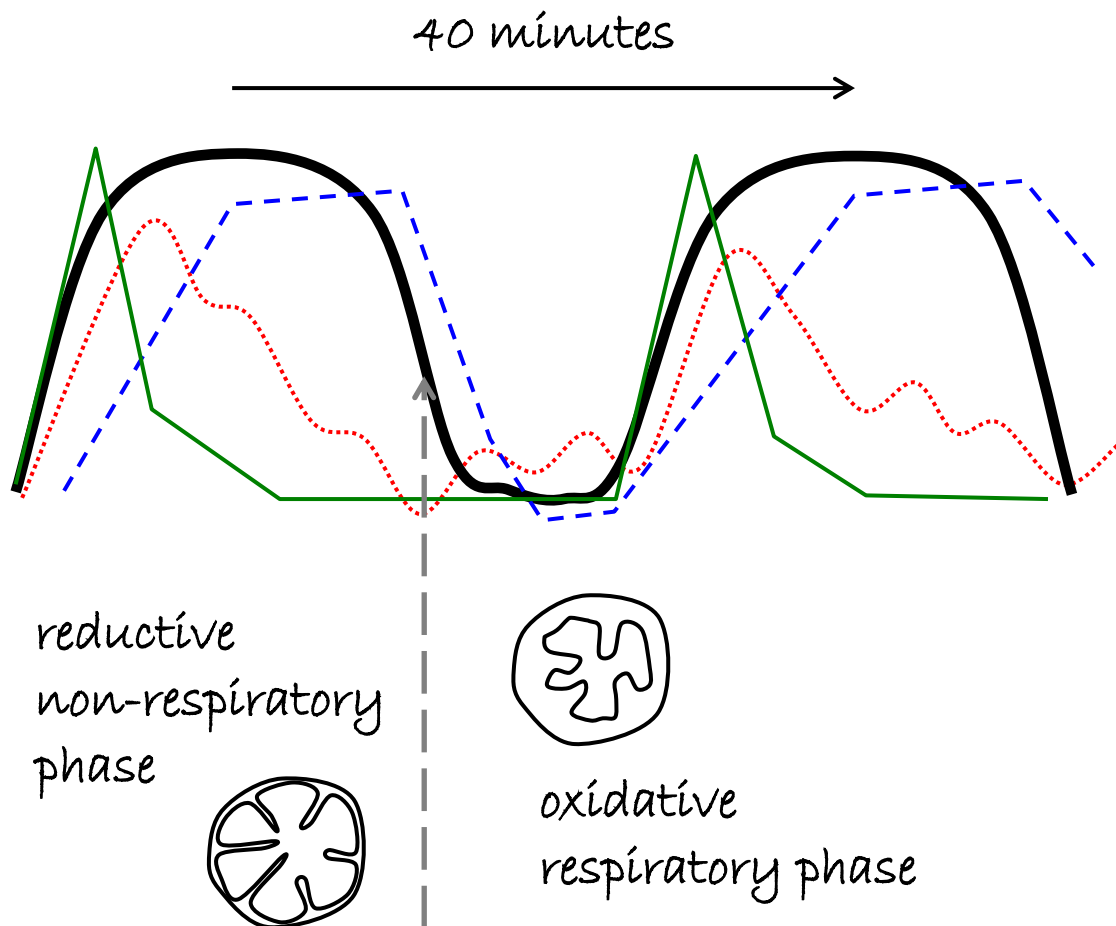

Figure Ap.4.2: The short yeast metabolic cycles

Under glucose limiting conditions yeast cells undergo ultradian oscillations with a period of 40 to 50 minutes (reviewed in Lloyd and Murray, 2007). Their phase is defined in reference to the easily monitored cycles of residual dissolved oxygen (RDO) in the continuous culture (continuous black line). The oscillations are characterized by alternating low and high respiration rates that are synchronized between cells through H_2S (green continuous line) and/or acetaldehyde secreted in the growth medium. Phase 0^0 represents the onset of the respiratory phase (dashed arrow; phase 0^0 is the time point when the first derivative of RDO reaches minimum). Clearly defined cristae are only observed during the non-respiratory phase. During the respiratory oxidative phase a transcriptional program is initiated that results in the accumulation of reducing metabolites in the upcoming reductive phase. DNA replication occurs in the reductive phase when DNA damage is less likely to happen. NAD(P)H and GSH oscillations are shown with the red dotted and the dashed blue lines respectively. Ethanol is produced in the non-respiratory phase and oscillates in parallel to reducing agents (e.g. reduced nicotinamide nucleotides and GSH). Acetaldehyde and pyruvate levels oscillate anti-parallel to ethanol. Of note, 70% of the oscillating metabolites traced with large scale analysis peak in the reductive phase.

Reconstruction of a large scale oscillatory network consisting of the yeast metabolome, transcriptome and the activities of several transcription factors has revealed a biosynthetic program and organization tightly coordinated around the 40 minute cycles. Rhythmic respiration is paralleled by genome-wide transcriptional oscillations involving (1) low amplitude cycles in the transcripts of house keeping genes (such as those encoding for actin and for cytosolic ribosomal proteins), that peak three times during the reductive-oxidative cycle and (2) cycles in the levels of ubiquitin-constituent transcripts of the proteasome, that cluster and peak during the reductive phase. (3) Transcripts of mitochondrial ribosomal proteins and transcripts responsible for mitochondrial biogenesis and respiration peak during the reductive phase, when mitochondria are resting and (4) transcripts associated with cellular reduction (e.g. involved in methionine synthesis and sulfur assimilation) peak during the oxidative phase. In every case the onset of transcription anticipates the process being regulated. For example transcripts whose abundance peak during the oxidative phase are engaged in biosynthetic events required for the establishment of the upcoming reductive phase such as production of ATP, H₂S, NADPH, sulfur assimilation and biosynthesis of several amino acids, including cysteine and methionine. Through this regulation, 70% of the rhythmic metabolites peak in the reductive phase (Klevecz *et al.*, 2004; Murray *et al.*, 2007).

A crucial task of the 40 minute cycles is the temporal regulation of DNA replication so that it coincides with the reductive non-respiratory phase when oxidative damage is less likely to happen. Transcription of the genes encoding the four subunits of the α -DNA-polymerase/primase complex is activated in three clusters, one observed during the second half of the oxidative phase and the other two in the reductive phase. This pattern of expression is consistent with the observation that DNA replication is limited during the reductive phase (Klevecz *et al.*, 2004). Previously Murray and Lloyd proposed that the rhythmic ROS production that follows the energization-rest cycles of mitochondria (Lloyd *et al.*, 2002), would cause cumulative damage to DNA and to other macromolecules and organelles, leading to cellular senescence and apoptotic cell death (Lloyd *et al.*, 2003). This hypothesis links the ultradian clock and aging, or to be more exact, the clock would contribute to longevity if its purpose was to temporally segregate incompatible biochemical reactions that would be futile and thus increase ROS levels and cause oxidative damage to DNA and cellular structures.

Analysis of large scale networks has revealed that the Cbf1-Met⁴-Met²⁸-Met³¹-Met³²-transcription regulatory complex (CMtr) involved in sulfur assimilation, is required for the establishment of the reductive phase, the progression of the cell cycle and likely the ultradian cycles *per se*. Subunits of the CMtr-complex are maximally transcribed in the oxidative phase and soon after their transcriptional activity peaks, resulting in a burst of cellular reduction [NAD(P)H and sulfide] in the next reductive phase (Murray *et al.*, 2007). These events affect the progression of the

cell cycle through the rhythmic accumulation of the sulfur metabolite S-adenosylmethionine (SAM) that is the major methyl donor in the cell. In more detail, the cell cycle will progress provided that the methylation potential of the cell, defined by SAM levels, is permissive, because methylation of macromolecules is required as part of the biosynthetic events that precede cellular division. Accordingly, it has been proposed that when the methylation potential of the cell is low, MET4, a subunit of CMtr, would activate the expression of genes that promote cell cycle arrest (Kaiser *et al.*, 2000). When the methylation potential of the cell is high and permissive for cell division, MET30, an F-box protein, promotes progression through Start via ubiquitination and proteolysis-independent inactivation of MET4 transcriptional activity (Thomas and Surdin-Kerjan, 1997; Kaiser *et al.*, 2000; Patton *et al.*, 2000). Interestingly, once SAM levels are low, non-ubiquitinated active MET4 promotes expression of genes involved in sulfur assimilation, including expression of *MET30*, and SAM production (Rouillon *et al.*, 2000). Consequently a feedback is formed providing a strong oscillatory potential (Murray *et al.*, 2007).

In addition to being under transcriptional regulation, respiratory oscillations are also subjected to translational control through GCN4 (Murray *et al.*, 2007). GCN4 is a transcriptional activator central to the general amino acid control by which metabolism of amino acid-deprived cells is coordinated. Translational de-repression of GCN4 expression occurs under conditions of amino acid deprivation, resulting in full induction of genes participating in every amino acid biosynthetic pathway (Natarajan *et al.*, 2001; Hinnebush, 2005; Murray *et al.*, 2007). During the YMCs GCN4 protein levels and activity oscillate and are antiphase to oscillations of amino acids that peak in the reductive phase. Considering that *GCN4* mRNA levels are constant throughout the YMCs, it has been proposed that amino acids inhibit translation of *GCN4* during the reductive phase, when amino acid levels are high and GCN4 protein levels are low. In addition to their role in GCN4 production, amino acids also inhibit respiration, suggesting that the transcriptional/translational feedback loops formed between GCN4 and amino acids might be involved in the progression of the respiratory cycles³ (Murray *et al.*, 2007). Interestingly, the expression of *MET4* is regulated by GCN4 through general amino acid control (Mountain *et al.*, 1993), suggesting that the YMC is driven by interacting transcriptional and translational networks and rhythmic metabolites that form feedback loops with oscillatory potential.

With their large scale analysis focusing on top oscillatory transcriptional components and their activities, Murray *et al.* (2007) have shown that the yeast respiration cycles are regulated by a

3. It is reasonable to assume that this control is reciprocal as the respiratory cycles provide the energy required for all biosynthetic events, including synthesis of amino acids.

transcriptional/translational core network. It should not be disregarded though, that these processes result in the rhythmic production of several metabolites (H_2S , redox molecules, amino acids, SAM) that in turn feedback on respiration as well as on the activity of the related transcriptional regulators themselves (*CMtr*, *GCN4*). Moreover, a purely metabolic computational model incorporating sulfate assimilation, ethanol degradation and respiration reproduces certain aspects of respiratory oscillations (Wolf *et al.*, 2001). These studies combined have led to the proposal that ultradian timekeeping should not stem from a hierarchical relationship between of transcriptome-proteome-metabolome, rather the later form coupled oscillating networks that provide stable cycles responsible for a biosynthetic program that serves fluctuating energetic demand and separates incompatible processes from each other (Kluevecz *et al.*, 2004; Murray *et al.*, 2007).

Mathematical modeling is suggestive that ultradian oscillations could be coupled via metabolites such as ATP, glutathione and NAD(P)H to generate circadian rhythms that would resist environmental perturbation (Lloyd and Murray, 2007). This view is supported by the aforementioned findings regarding ECTO-NOX proteins in COS cells (Morré *et al.*, 2002a) as well as by the shared properties between the two types of rhythms, such as temperature compensation and the period lengthening effect of lithium (reviewed in Lloyd and Murray, 2007). Lloyd who studied chaotic dynamics of oscillating parameters (in transcription and in the redox state of the cell) in continuous cultures of *S. cerevisiae* proposed that a controlled chaotic attractor provides a single multi-oscillator capable of tunable outputs of variable frequencies (ultradian, circadian), as opposed to the limit cycle model that refers to a more or less fixed period that depends on environmental conditions (reviewed in Lloyd and Murray, 2007 and Lloyd, 2008). Confirmation awaits the discovery of sustained circadian rhythms in yeast.

Ap.4.3. Ultradian oscillations in yeast – the long metabolic cycles

a. Description of the long yeast metabolic cycles

Recently ultradian oscillations of about 5 hours in gene expression and respiration were described in a yeast strain, under continuous and glucose-limiting conditions; these cycles are termed long YMCs and make the timeframe of coordinated intracellular activities (Tu *et al.*, 2005; Tu *et al.*, 2007) in a manner reminiscent⁴ of that of the 40 minutes oscillations (reviewed in Lloyd and Murray, 2007). The long yeast metabolic cycle (long YMC), was initially identified in RDO and then in the reductive potential (NADPH) and in several metabolites, including fermentation products and acetyl-CoA. Eventually it was shown that the long YMC is accompanied by a highly organized transcriptional cycle implicating over half of the yeast genome. Mitochondrial function is important to the long YMC as most periodic genes encode proteins associated with energy and redox related aspects of metabolism. The importance of mitochondria in the establishment of the long YMC is further supported by the fact that amongst the top 100 periodic genes, about two-thirds are nuclear-encoded and are involved in mitochondrial function (Tu *et al.*, 2005). Rhythmic transcription precedes numerous rhythmic metabolic and cellular processes of the long YMC (as it is the case with the short YMC), resulting in temporal accumulation of metabolites. The cycle is divided in three phases with distinct metabolic profiles. These are in temporal order the Oxidative (Ox) phase, the reductive/building (RB) phase and the reductive/charging (RC) phase (Tu *et al.*, 2005).

During the first and shorter Ox phase the metabolome reflects respiratory metabolism. Several intermediates of the tricarboxylic acid (TCA) cycle peak indicating increased flux through the respiratory electron transport chain. NADPH required for protection against the oxidative damage that accompanies respiratory activity and acetyl-CoA that feeds the TCA cycle reach maximum levels at this time. The oxidative burst during acetyl-CoA breakdown, results in oxygen consumption, low RDO levels and increased ATP abundance (Tu *et al.*, 2005). The later enables

4. In brief, transcripts responsible for several biosynthetic processes (e.g. synthesis of amino acids and nucleotides and sulfur metabolism) were shown to be accumulated during the oxidative phase (Ox), whereas during the reductive phase gene expression peaked around two clusters, the reductive-building phase (RB) that includes genes involved in mitochondrial biogenesis, respiration and DNA replication, and the reductive-charging phase (RC) with genes related to ubiquitination and the proteasome system (Tu *et al.*, 2005). A similar gene-expression profile was reported for the short metabolic cycles (Klevecz *et al.*, 2004; Murray *et al.*, 2007).

assembly of the translation machinery that in turn might be important for the progression of the cell cycle (see references below). Moreover, the Ox phase is enriched with transcripts of genes encoding ribosomal proteins and of genes involved in RNA metabolism (such as translation initiation factors, small nuclear RNAs and RNA processing enzymes). Other genes maximally expressed at this time are those involved in sulfur metabolism and uptake and genes implicated in several biosynthetic processes, such as synthesis of nucleotides, of certain amino acids and of heme⁵. Consequently, several precursors of amino-acids and of nucleotides peak at this time and so do amino-acids whose biosynthesis requires NADPH. Several of the aforementioned biosynthetic processes are sensitive to oxidative damage and for this they are initiated transcriptionally at this time and completed later in the reductive (non-oxidative) phase of the YMC. It has been concluded that biosynthetic events that take place in the Ox phase are likely a provision for the upcoming RB phase when structures are built and cells divide (Tu *et al.*, 2005; Tu and McKnight, 2007; Tu *et al.*, 2007).

The RB phase is initiated as respiration is in the process of shutting down, thus RDO levels gradually increase. At this time metabolites associated with high glycolytic flux (e.g. pyruvate and glucose-6-phosphate) rise and fermentation products (ethanol, acetate) peak as cells become dependent on non-respiratory metabolism. During each RB phase about half the cells initiate cell division and genes involved in DNA replication, the cell division cycle and mitochondrial biogenesis reach their maximum expression (e.g. histone, spindle pole and DNA replication genes). In agreement with these, sulfur metabolism that is known to promote cell division is upregulated at this time. This temporal organization ensures that DNA is replicated in a reducing environment; accordingly, during the RB phase mitochondria are duplicated and rebuilt, while they are resting (low respiration rates) (Tu *et al.*, 2005; Tu and McKnight, 2007; Tu *et al.*, 2007). The importance of restricting DNA replication in the reductive phase for genome integrity has been illustrated with growth-rate mutants that allow DNA replication outside of the RB phase and accumulate higher levels of spontaneous mutations relative to wild-type (Chen *et al.*, 2007).

Heme, like DNA, is also protected against oxidative damage due to the temporal segregation of biosynthetic events. During the RB phase the levels of the heme precursor ALA peak, and near by *HEM2* and *HEM3*, that execute the next two steps in heme biosynthesis, reach their maximum expression, illustrating the principle of "just in time synthesis". Consequently, ALA levels and heme synthesis are rhythmic. Heme is a prosthetic group in respiratory cytochromes and being susceptible to oxidative damage it needs to be synthesized rhythmically in the reductive phase after each round

5. This includes *hem1* that encodes for the enzyme that catalyzes the first and rate limiting step in heme biosynthesis.

of intensive respiration (Tu *et al.*, 2007). It is noteworthy that in specialized mammalian neurons heme feedbacks to regulate the TTFL (Kaasik and Lee, 2004), and for this it would be interesting if the same molecule was part of the regulatory networks that drive the long YMC as well.

During the RC phase respiration rates remain low therefore RDO levels are high. At this time metabolism is devoted to the production of acetyl-CoA and NADPH that serve respectively as precursor molecules for the TCA cycle and for protection against oxidative stress in the upcoming Ox phase (Tu *et al.*, 2005); antioxidant GSH is also produced during the RC phase, very likely for the same reason. Genes involved in glycolysis, fatty acid oxidation, the pentose phosphate pathway, ethanol mobilization for the TCA cycle and in breakdown of storage carbohydrates are maximally expressed at this time, it is therefore apparent that production of NADPH (through the pentose phosphate pathway) and acetyl-CoA are regulated transcriptionally. Subsequently, acetyl-CoA and NADPH peak soon after the transition to the next oxidative phase, at the same time when storage carbohydrates are broken down. In agreement with the transcriptional profile of fatty acid oxidation, the abundance of carnitine, an amino acid required for transport of fatty acid to mitochondria from the cytoplasm, peaks during the RC phase (Tu *et al.*, 2005; Tu and McKnight 2007; Tu *et al.*, 2007).

Transcriptional regulation causes oscillations between the two branches of sulfur metabolism. One of these provides the antioxidant GSH and the other provides SAM. The SAM pathway is activated transcriptionally during the RB phase when methylation of histones, DNA, RNA, lipids and of other macromolecules is required, as structures are built in anticipation of cell division. In addition to these, at the end of the RC phase transcriptional regulation channels metabolites from the GSH into the SAM branch. A consequence of this is that GSH levels peak at the end of the RC phase, perhaps in anticipation of the next Ox phase (Tu *et al.*, 2007).

During the RC phase heme oxygenase (that degrades heme) and genes associated with peroxisomal function, the ubiquitination machinery, vacuolar trafficking and autophagy are upregulated, perhaps in anticipation of the next RB phase when structures are built and repaired. Accordingly vacuoles emerge near the shift between the RC and Ox phases (Tu *et al.*, 2005; Tu *et al.*, 2007). Several events observed at this time (peroxisomal gene expression and production of acetyl-CoA and NADPH from non-fermentable carbon courses, like fatty acids and ethanol) are regulated by the transcription factor ADR1 (Young *et al.*, 2003) whose activity peaks during the RC phase (see below, Rao and Pellegrini, 2011).

Tu *et al.* (2007) discuss several temporally orchestrated biosynthetic events such as (1) the coincidence between the synthesis of certain amino acids that require NADPH (e.g. ornithine, proline, homoserine) and high NADPH during the Ox phase, (2) co-regulation of NADPH-independent amino acids (Asp, Asn, Glu) in the RC phase and (3) the common accumulation pattern

of the aromatic side-chain amino acids (phenylalanine, tryptophan, tyrosine; they share a biphasic pattern of expression with a major peak in the RC phase), that likely reflects their interconnected biosynthetic pathways.

Sulfur metabolism, synthesis of nucleotides and amino acids, RNA and DNA metabolism, heme biosynthesis, energy metabolism, catabolic processes and biogenesis, repairmen and recycling of organelles are orchestrated around the long YMC. Several related rhythmic metabolites cluster together when they are synthesized or utilized by a common pathway, often in anticipation of the next phase of the YMC. Collectively, ultradian oscillations serve a timekeeping function by orchestrating processes within the cell (Tu *et al.*, 2007).

b. The role of transcription in driving the long yeast metabolic cycles

The role of transcription factors in the establishment of the long YMC has been the subject of extensive study the last few years. Rao and Pellegrini (2011) used the high-throughput transcriptional data of Tu *et al.* (2005) and provided a purely computational insight regarding the top regulatory transcription factors that control the long YMC. Thirteen transcription factors and a dynamic network between them were identified this way. These transcription factors include (1) ADR1 that is involved in amino acid and non-fermentative metabolism. (2) GCN4 that is central to the general amino acid control. (3) SPT2 that regulates chromatin structure and likely contributes to genome stability. (4) HAP1 that is a heme-dependent oxygen sensor that may be important for the transition between the respiratory and reductive phases of the YMC. (5) The regulatory subunit HAP4 of the HAP complex that is a carbon-responsive global regulator of respiratory gene expression and is involved in mitochondrial biogenesis. (6) BAS1 that is involved in histidine and nucleotide biosynthesis. Transcription factors that regulate the cell cycle were also identified in this study (due to their rhythmic activity), but it cannot be said that these regulate the YMC, as in most cases reported in the literature (presented below) the cell cycle is under the control of timekeepers, not vice-versa.

ADR1 regulates synthesis and transport of amino acids and several modes of non-fermentative metabolism such as utilization of ethanol, of glycerol and of fatty acids (Young *et al.*, 2003). As maximum activity of ADR1 in the RC phase coincides with ethanol utilization and β -oxidation, it is possible that ADR1 drives oscillations of these pathways and consequently oscillations in the levels of NADPH and acetyl-CoA (Rao and Pellegrini 2011). Rao and Pellegrini (2011) proposed that the activity of ADR1 is rendered rhythmic via the anti-parallel (Tu *et al.*, 2007)

oscillations of intracellular glucose levels, because the DNA-binding activity of ADR1 is induced only after the diauxic transition⁶ when glucose has been depleted (Young *et al.*, 2002). This would mean that when glucose runs out, ADR1 is activated and consequently non-fermentable carbon sources are mobilized. In support of this idea most ADR1-dependent genes are glucose-repressed (Young *et al.*, 2003). In addition to these, it was proposed that ADR1 is involved in retrograde signaling, due to the considerable overlap between many ADR1-dependent genes and components of retrograde signaling (Young *et al.*, 2003). This last observation is indicative that a crosstalk between the nucleus and mitochondria is important to the YMC.

GCN4, a master regulator of amino acid synthesis (Natarajan *et al.*, 2001), is more active in the Ox phase of both the short and the long YMC. By contrast, the CMtr complex that controls sulfur assimilation shows highly periodic activity during the short YMC alone (Murray *et al.*, 2007) and was not included in the thirteen regulatory transcription factors identified by Rao and Pellegrini (2011). As sulfur metabolism is rhythmic during both types of respiratory cycles (Murray *et al.*, 2007; Tu *et al.*, 2007), it is possible that CMtr activity is rendered ultradian post-transcriptionally (Rao and Pellegrini 2011), through the known regulation of the CMtr subunit MET4 by GCN4 and the general amino acid control (Mountain *et al.*, 1993).

A transcription factor identified by Rao and Pellegrini (2011) due to its rhythmic activity is SPT2 that regulates Histone 3 (H3) levels and chromatin dynamics during recombination and elongation of transcription (Nourani *et al.*, 2006). The role of SPT2 in driving the long YMC is not quite clear, because on one hand SPT2 is thought of as a transcriptional repressor⁷, but on the other its activity peaks in the Ox phase (Rao and Pellegrini 2011) when genes that promote RNA metabolism are expressed (Tu *et al.*, 2005). During the long YMC rhythmic SPT2 activity is required for genomic stability, because a *spt2* mutant that lowers H3 levels at coding regions exhibits increased recombination events relative to the wild-type (Nourani *et al.*, 2006). If so, it is possible that through SPT2 cells modify chromatin structure and prepare in advance (in the Ox phase) to prevent hyper-recombination in the reductive phase when cells divide.

6. *S. cerevisiae* is a respiro-fermentative yeast that represses respiratory metabolism when growing in medium containing glucose as the sole carbon source, even in an oxygenated environment. Diauxic shift is the metabolic shift from fermentative to respiratory metabolism that occurs as fermentable carbon sources run out and cells turn to ethanol for aerobic growth.

7. When a gene is transcriptionally active then the levels of H3 in that gene drop and because a mutation in *SPT2* lowers H3 levels even further, *SPT2* is considered to be a negative regulator of transcription (see Nourani *et al.*, 2006 and references therein).

In yeast intracellular heme synthesis correlates directly with ambient oxygen tension in the environment. HAP1 is a heme-binding protein (Zitomer *et al.*, 1997; Zhang and Hach, 1999) and a key transcriptional regulator of respiratory cycles (Lelandais *et al.*, 2009) that senses the ambient oxygen tension in the environment and activates the transcription of respiratory genes and of genes that regulate oxidative damage. In an oxygen rich environment the HAP1-heme complex functions as a transcriptional activator, whereas under hypoxic conditions a heme-deficient HAP1 complex suppresses transcription⁸. This dual role of HAP1 is likely to mediate tight transcriptional regulation in response to changing levels of oxygen in the environment (Zitomer *et al.*, 1997; Zhang and Hach, 1999; Hickman and Winston, 2007). Lelandais *et al.* (2009) proposed that HAP1 senses not only ambient oxygen levels but also their ultradian changes. Moreover they suggested that through this mechanism HAP1 regulates the long YMC. This opinion was based on two observations: first, the reductive phase is enriched with nuclear genes that contain cis HAP1 binding elements and encode for mitochondrial proteins. Second, at this time *HAP1* transcript levels and dissolved oxygen reach their maximum levels. Taken together these findings are indicative that HAP1 regulates mitochondrial activity in response to oxygen on an ultradian basis (Lelandais *et al.*, 2009).

Using a subset of the data of Tu *et al.* (2005) Lelandais *et al.* (2009) focused on 626 genes (out of 3552 that represent the ultradian transcriptome and over half of the yeast genome) that are nuclear encoded, directed in mitochondria and thus involved in mitochondrial biogenesis. These genes fall within six temporal clusters termed A to F, two in each RB, RC and Ox phase. Starting from the RB phase when mitochondrial biogenesis is initiated, sequential gene expression in phases A to F clearly reflects the logic of mitochondria construction: during the beginning of the RB phase (phase A=25 minutes) 262 transcripts coding for important mitochondrial proteins (such as those involved in the translation machinery, regulation of translation, assembly factors and protein import) are followed by several transcripts (in phases B and C, 50 minutes each) of structural proteins of the mitochondrial machinery (including respiratory chain components and enzymes of the TCA cycle).

8. In an oxygen rich environment the HAP1-heme complex activates expression of respiratory genes and the *rox1* gene that encodes for a repressor of a set of hypoxic genes. Under hypoxic conditions on the other hand, heme levels drop and subsequently a heme-deficient HAP1 complex represses *rox1* expression, resulting in de-repression of the hypoxic genes. Under hypoxic conditions HAP1 is also a transcriptional repressor of a set of genes involved in ergosterol biosynthesis that requires oxygen; this last function of HAP1 is inhibited by heme in an oxygen-rich environment (Zitomer *et al.*, 1997; Zhang and Hach, 1999; Hickman and Winston, 2007).

Expression of *HAP4*, a carbon responsive global regulator of respiratory gene expression (Forsburg and Guarente, 1989; DeRisi *et al.*, 1997), peaks in phase A (beginning of RB phase; Lelandais *et al.*, 2009). *HAP4* encodes for the regulatory subunit of the HAP complex⁹ (Forsburg and Guarente, 1989), and hence several target-genes of the HAP complex follow in phases B and C; these targets include nuclear encoded genes that are directed in the mitochondria (Lelandais *et al.*, 2009), such as genes encoding subunits for every respiratory chain complex and enzymes of the TCA cycle, as well as nuclear genes involved in the mitochondrial translation machinery (Buschlen *et al.*, 2003). Consequently, *HAP4* is an important factor of mitochondrial biogenesis during the long YMC (Lelandais *et al.*, 2009). However, it is not clear if *HAP4* is required for respiratory oscillations directly as it is for ultradian biogenesis of mitochondria¹⁰.

c. The role of metabolites in driving the long yeast metabolic cycles

Metabolism drives the long YMCs through rhythmically accumulated metabolites such as NADPH and intermediates of sulfur metabolism (Tu and McKnight, 2006¹¹). During the RC phase flux through the phosphate-pentose pathway, dedicated at this time in the production of NADPH¹², is required for the progress of the respiratory cycles, as a mutant strain that is compromised in the pathway's entry-step (catalyzed by glucose-6-phosphate-dehydrogenase) is arrhythmic. Based on

9. The HAP complex is made of four subunits, HAP2, HAP3 and HAP5 that form a trimeric complex required for DNA binding (McNabb *et al.*, 1995; McNabb and Pinto, 2005) and the regulatory HAP4 protein (Forsburg and Guarente, 1989) that is required for transcriptional activation

10. It should be clarified that the long YMC is not a cycle of repeated diauxic shifts. This is because during the YMC ultradian expression of *HAP4* and of targets of the HAP-complex is maximal at the beginning of the RB phase when the respiratory mode of metabolism is shut (Lelandais *et al.*, 2009), whereas during a diauxic shift this same gene-expression profile is observed when respiratory metabolism is initiated (Buschlen *et al.*, 2003).

11. They also suggested that metabolism regulates not only ultradian cycles but also circadian, sleep-awake and even hibernation cycles.

12. The phosphate-pentose pathway generates both NADPH and pentose sugars. In the RC phase though co-regulation of the pathway with two enzymes, transketolase and transaldolase, that convert five-carbon molecules back to glycolytic intermediates is indicative that at this time pentose sugars are channeled towards NADPH production (Tu *et al.*, 2005).

this it was proposed that oscillations in the levels of NADPH and activities of NADPH-dependent enzymes are driving the long YMCs (Tu *et al.*, 2007).

Proper temporal regulation of sulfur metabolism is also important in the establishment of the long YMC (Tu *et al.*, 2007), or perhaps for synchrony between cells (considering that H₂S is a synchronizing agent during the short YMC; Murray *et al.*, 2003; Sohn *et al.*, 2000). The importance of sulfur metabolism in ultradian timekeeping is underlined by several observations: (1) sulfur metabolites accumulate rhythmically ((Tu *et al.*, 2007). (2) Respiratory cycles are lost in a strain that has a partial loss-of-function mutation in cystathione β -synthase, an enzyme that generates H₂S (Singh *et al.*, 2009) and could mediate, in analogy to the short YMC, synchrony between cells. The effect of cystathione β -synthase on respiratory cycles may also be redox-dependent, as the enzyme also functions in the GSH branch of sulfur metabolism (Tu *et al.*, 2007). (3) In a yeast strain that has more mitochondrial DNA than the wild-type sulfur metabolic flux is increased and ultradian period of respiratory cycles is lengthened (Blank *et al.*, 2009).

Evidence for the regulatory role of redox molecules in entrainment of the long YMC comes from the observation that pulses of H₂O₂ and of methionine (a reductant) elicit PRCs reminiscent of curves describing non parametric entrainment of circadian oscillations to light pulses; phase-advances and phase-delays occur at distinct times of the YMC indicating that entrainment is controlled by redox (Chen *et al.*, 2007).

Ap.4.4. Ultradian oscillations in other microorganisms

Circahoralian (of about one hour) respiratory oscillations are well described for *Schizosaccharomyces pombe* and for the soil amoeba *Acanthamoeba castellanii*. In *S. Pombe* and *A. castellanii* circahoralian respiratory cycles are correlated with oscillations in the redox state of mitochondria, in adenine nucleotide pool sizes and in sensitivity to uncouplers, agents that dissociate electron flow from oxidative phosphorylation in mitochondria (Pool *et al.*, 1973; Poole and Salmon, 1978; Edwards and Lloyd, 1978; Edwards and Lloyd, 1980; Bashford *et al.*, 1980; Lloyd, 2008). As expected of "genuine clocks", in both organisms the rhythm is compensated against temperature changes (Lloyd *et al.*, 1982; Marques *et al.*, 1987) and makes the time frame around which intracellular processes are coordinated; thus in addition to the above, in *A. castellanii* total protein and RNA oscillate in phase with respiration (Edwards and Lloyd, 1980; Marques *et al.*, 1987) and the same has been observed in *S. pombe* for fermentation, acidification of the growth medium, DNA

synthesis, levels of cytochromes, activities of enzymes of the respiratory chain, mitochondrial ATPase activity and NADH levels (Poole and Lloyd, 1974; Edwards and Lloyd, 1977; Kippert and Hunt, 2000; Lloyd, 2008). Compensation of the period of circadian oscillations is not restricted to ambient temperature changes and has been documented in yeasts for several growth conditions including the pH, the aeration rate of the culture and for various nutrients, further supporting the role of ultradian oscillations as "genuine clocks" that are able to keep track of time irrespectively of environmental noise (Kippert and Hunt, 2000; Lloyd and Murray, 2007; Lloyd, 2008). Functions for circadian clocks have also been determined in the yeast *Candida utilis* and in several protists as well as in cultured mammalian cells, leading Lloyd and Murray to propose that ultradian timekeeping is a basic universal necessity of coordinated intracellular coherence (Lloyd and Murray, 2005; Lloyd and Murray, 2007).

It is worth mentioning that in *S. pombe* several mutations interfering with signaling pathways involved in global regulation of metabolism and physiology are known to affect ultradian period. Such mutations cause arrhythmia or alter the length of the period and concern (1) factors involved in calcium and lithium signaling that are related to each other via phosphoinositide signaling, (2) major components of the cAMP/protein kinase A pathway and (3) components of the MAP kinase cascade (reviewed in Kippert and Hunt, 2000). Interestingly, these pathways are also involved in circadian time-keeping in mammalian cells (Lloyd and Murray, 2007; Hastings *et al.*, 2008), which suggests a link between circadian and ultradian pacemakers.

Ap.4.5. The cell cycle vs. ultradian cycles and outcome

Synchronous cycles of oxidative respiration are observed in continuous culture when yeast is fed with limiting concentrations of glucose. Under these conditions cells grow slowly but they are not starving as they store carbohydrates in the form of trehalose and glycogen (reviewed in Futcher, 2006). It has been proposed that mobilization of storage carbohydrates and the concomitant oxidative burst during the oxidative phase provide enough energy to assemble the translational machinery (Tu *et al.*, 2005), resulting in increased cyclin levels. In the absence of adequate ATP and robust protein synthesis cyclins would not rise above the level required for S-phase initiation as they are very unstable. Therefore it is possible that the oxidative burst provides the energy (and materials) required for cyclin accumulation and progression of the cell cycle, by allowing high rates of protein synthesis. This model termed *finishing-kick hypothesis* can explain the necessity for a critical size

before cell division, as critical size is equivalent to stored carbohydrates that provide the required energy (Futcher, 2006).

As the cell cycle is in several occasions not temperature compensated (Kippert and Hunt, 2000) it should be conditionally coupled and uncoupled to the ultradian oscillator. In the former case, the energy dependence of cyclin-synthesis provides one explanation for the observed ultradian regulation of cell cycle progression. In synchronous cell cultures a portion of the population is allowed to divide synchronously around specific phases of ultradian cycles. This gated cell division results in that generation time is equal to or a multiple of the ultradian period (a phenomenon also known as "quantized generation times"; see Edwards and Lloyd, 1978 for *A. castellanii*; reviewed in Kippert and Hunt, 2000 for *Paramecium tetraurelia*, *Tetrahymena* and for strains of *S. Pombe*; see Klevecz *et al.*, 2004 and Tu *et al.*, 2005 for *S. cerevisiae*). As for the purpose of this gating, recent studies with *S. cerevisiae* have led to the assumption that the ultradian pacemaker gates DNA replication and cell division away from the Ox phase, when oxidative damage is more likely to happen (for the short YMCs see Klevecz *et al.*, 2004; for the long YMCs see Tu *et al.*, 2005). This hypothesis was confirmed by the observation that the accumulation rate of spontaneous mutations is increased in yeast strains in which cell division is not restricted in the reductive phase (Chen *et al.*, 2007)¹³. Given the fact that sulfur metabolites required for the establishment of the reductive phase also promote cell division, it is possible that the ultradian oscillator and the cell cycle are coupled to each other through sulfur metabolism. SAM could play this role¹⁴ as it is part of the transcriptional-translational-metabolic feedback network that also incorporates top regulatory proteins of amino acid and sulfur metabolism, such as the CMtr complex and GCN4 (Klevecz *et al.*, 2004; Tu *et al.*, 2005; Murray *et al.*, 2007; Tu *et al.*, 2007; Rao and Pellegrini, 2011). Cystathione- β -synthase might be part of this network also because, unlike other enzymes that function within the two branches of sulfur metabolism, it is required for both rhythmic respiration (Tu *et al.*, 2007) and cell-cycle-progression (Blank *et al.*, 2009).

Circadian clocks, like ultradian ones, allow cell division at distinct phases; this has been shown with many microorganisms (in a *Synechococcus* sp., Mori *et al.*, 1996; in *Chlamydomonas reinhardtii*, Goto and Johnson, 1995; in *Euglena gratilis*, Bolige *et al.*, 2005), in several mammalian tissues (see Matsuo *et al.*, 2003; Nagoshi *et al.*, 2004 and references therein) and in the zebrafish

13. Eventually ultradian and circadian rhythms could be linked to cancer, as they both gate cell division cycles to protect DNA from oxidative or ultraviolet light-induced damage, respectively (Chen and McNight, 2007).

14. Other metabolites such as NADPH, GSH, H₂S and ROS could also be involved.

(Dekens *et al.*, 2003). It is not clear why in some cases gating of cell division is enforced by ultradian and in others by circadian clocks. A possible explanation could come from observations on two *Paramecium* species and their rhythmic locomotor activity patterns. *P. tetraurelia* grows faster and shows an ultradian locomotor activity pattern, whereas *P. multimicronucleatum* grows slower and shows a circadian pattern (reviewed in Kippert and Hunt, 2000). For this it is possible that in *Paramecium* species and perhaps other organisms as well, growth rate or any other condition that would confirm a selective advantage would define the predominant clock, ultradian or circadian. The dilemma between ultradian or circadian over the same output, adds to the similarities and relationships between the two kinds of rhythms. The chaotic attractor proposed by Lloyd (2008) would provide a plausible explanation whenever such a dilemma is in order.

Bibliography

- Bashford CL, Chance B, Lloyd D, Poole RK.** (1980). Oscillations of redox states in synchronously dividing cultures of *Acanthamoeba castellanii* and *Schizosaccharomyces pombe*. *Biophys. J.*, 29(1): 1-11.
- Blank HM, Gajjar S, Belyanin A, Polymenis M.** (2009). Sulfur metabolism actively promotes initiation of cell division in yeast. *PLoS One* 4(11): e8018. doi: 10.1371/journal.pone.0008018.
- Bolige A, Hagiwara SY, Zhang Y, Goto K.** (2005). Circadian G2 arrest as related to circadian gating of cell population growth in *Euglena*. *Plant Cell Physiol.*, 46(6): 931-6.
- Bridge A, Barr R, Morr  DJ.** (2000). The plasma membrane NADH oxidase of soybean has vitamin K(1) hydroquinone oxidase activity. *Biochim. Biophys. Acta*, 1463(2): 448-58.
- Brightman AO, Wang J, Miu RK, Sun IL, Barr R, Crane FL, Morr  DJ.** (1992). A growth factor- and hormone-stimulated NADH oxidase from rat liver plasma membrane. *Biochim. Biophys. Acta*, 1105(1): 109-17.
- Buschlen S, Amillet JM, Guiard B, Fournier A, Marcireau C, Bolotin-Fukuhara M.** (2003). The *S. Cerevisiae* HAP complex, a key regulator of mitochondrial function, coordinates nuclear and mitochondrial gene expression. *Comp. Funct. Genomics*, 4(1): 37-46.
- Chance B, Estabrook RW, Ghosh A.** (1964). Damped sinusoidal oscillations of cytoplasmic reduced pyridine nucleotide in yeast cells. *PNAS*, 51: 1244-51.
- Chen Z, McKnight SL.** (2007). A conserved DNA damage response pathway responsible for coupling the cell division cycle to the circadian and metabolic cycles. *Cell Cycle*, 6(23): 2906-12.
- Chen Z, Odstrcil EA, Tu BP, McKnight SL.** (2007). Restriction of DNA replication to the reductive phase of the metabolic cycle protects genome integrity. *Science*, 316(5833): 1916-9.
- Chueh PJ, Morr  DM, Penel C, DeHahn T, Morr  DJ.** (1997). The hormone-responsive NADH oxidase of the plant plasma membrane has properties of a NADH:protein disulfide reductase. *J. Biol. Chem.*, 272(17): 11221-7.
- Das J, Busse HG.** (1985). Long term oscillation in glycolysis. *J. Biochem.*, 97(3): 719-27.
- Dekens MP, Santoriello C, Vallone D, Grassi G, Whitmore D, Foulkes NS.** (2003). Light regulates the cell cycle in zebrafish. *Curr. Biol.*, 13(23): 2051-7.
- DeRisi JL, Iyer VR, Brown PO.** (1997). Exploring the metabolic and genetic control of gene expression on a genomic scale. *Science*, 278(5338): 680-6.

- Edwards SW, Lloyd D.** (1977). Mitochondrial adenosine triphosphatase of the fission yeast, *Schizosaccharomyces pombe* 972h-. Changes in activity and oligomycin-sensitivity during the cell cycle of catabolite-repressed and -de-repressed cells. *Biochem. J.*, 162(1): 39–46.
- Edwards SW, Lloyd D.** (1978). Oscillations of respiration and adenine nucleotides in synchronous cultures of *Acanthamoeba castellanii*: mitochondrial respiratory control in vivo. *J. Gen. Microbiol.*, 108: 197-204.
- Edwards SW, Lloyd D.** (1980). Oscillations in protein and RNA content during synchronous growth of *Acanthamoeba castellanii*. Evidence for periodic turnover of macromolecules during the cell cycle. *FEBS Lett.*, 109(1): 21-6.
- Forsburg SL, Guarente L.** (1989). Identification and characterization of HAP4: a third component of the CCAAT-bound HAP2/HAP3 heteromer. *Genes Dev.*, 3(8): 1166-78.
- Futcher B.** (2006). Metabolic cycle, cell cycle, and the finishing kick to Start. *Genome Biol.*, 7(4): 107.
- Ghosh A, Chance B.** (1964). Oscillations of glycolytic intermediates in yeast cells. *Biochem. Biophys. Res. Commun.*, 16(2): 174-81.
- Goto K, Johnson CH.** (1995). Is the cell division cycle gated by a circadian clock? The case of *Chlamydomonas reinhardtii*. *J. Cell Biol.*, 129(4): 1061-9.
- Hastings MH, Maywood ES, O'Neill JS** (2008). Cellular circadian pacemaking and the role of cytosolic rhythms. *Curr. Biol.*, 18(17): 805-815.
- Hickman MJ, Winston F.** (2007). Heme levels switch the function of Hap1 of *Saccharomyces cerevisiae* between transcriptional activator and transcriptional repressor. *Mol. Cell. Biol.*, 27(21): 7414-24.
- Hinnebush AG.** (2005). Translational regulation of GCN4 and the general amino acid control of yeast. *Annu. Rev. Microbiol.*, 59: 407–50.
- Kaasik K, Lee CC.** (2004). Reciprocal regulation of haem biosynthesis and the circadian clock in mammals. *Nature*, 430(6998): 467-71.
- Kaiser P, Flick K, Wittenberg C, Reed SI.** (2000). Regulation of transcription by ubiquitination without proteolysis: Cdc34/SCF(Met30)-mediated inactivation of the transcription factor Met4. *Cell*, 102(3): 303-14.
- Kishi T, Morr e DM, Morr e DJ.** (1999). The plasma membrane NADH oxidase of HeLa cells has hydroquinone oxidase activity. *Biochim. Biophys. Acta*, 1412(1): 66-77.
- Klevecz RR, Bolen J, Forrest G, Murray DB.** (2004). A genomewide oscillation in transcription gates DNA replication and cell cycle. *PNAS*, 101(5): 1200-5.

- Keulers M, Satroutdinov AD, Suzuki T, Kuriyama H.** (1996b). Synchronization affector of autonomous short-period-sustained oscillation of *Saccharomyces cerevisiae*. *Yeast*, 12(7): 673-82.
- Keulers M, Suzuki T, Satroutdinov AD, Kuriyama H.** (1996a). Autonomous metabolic oscillation in continuous culture of *Saccharomyces cerevisiae* grown on ethanol. *FEMS Microbiol. Lett.*, 142: 253-8.
- Kippert F, Hunt P.** (2000). Ultradian clocks in eukaryotic microbes: from behavioural observation to functional genomics. *Bioessays*, 22(1): 16-22.
- Larm JA, Vaillant F, Linnane AW, Lawen A.** (1994). Up-regulation of the plasma membrane oxidoreductase as a prerequisite for the viability of human Namalwa rho 0 cells. *J. Biol. Chem.*, 269(48): 30097-100.
- Lascaris R, Bussemaker HJ, Boorsma A, Piper M, van der Spek H, Grivell L, Blom J.** (2003). Hap4p overexpression in glucose-grown *Saccharomyces cerevisiae* induces cells to enter a novel metabolic state. *Genome Biol.*, 4(1): R3
- Lelandais G, Saint-Georges Y, Geneix C, Al-Shikhley L, Dujardin G, Jacq C.** (2009). Spatio-temporal dynamics of yeast mitochondrial biogenesis: transcriptional and post-transcriptional mRNA oscillatory modules. *PLoS Comput. Biol.*, 5(6):e1000409.
- Lloyd D.** (2008). Respiratory oscillations in yeasts. *Adv. Exp. Med. Biol.*, 641: 118-40.
- Lloyd D, Edwards SW, Fry JC.** (1982). Temperature-compensated oscillations in respiration and cellular protein content in synchronous cultures of *Acanthamoeba castellanii*. *PNAS*, 79(12): 3785-8.
- Lloyd D, Lemar MK, Salgado EJ, Gould TM, Murray DB.** (2003). Respiratory oscillations in yeast: mitochondrial reactive oxygen species, apoptosis and time; a hypothesis. *FEMS Yeast Res.*, 3(4): 333-9.
- Lloyd D, Murray DB.** (2005). Ultradian metronome: timekeeper for orchestration of cellular coherence. *Trends Biochem. Sci.*, 30(7): 373-7.
- Lloyd D, Murray DB.** (2007). Redox rhythmicity: clocks at the core of temporal coherence. *Bioessays*, 29(5): 465-73.
- Lloyd D, Salgado LE, Turner MP, Suller MT, Murray D.** (2002). Cycles of mitochondrial energization driven by the ultradian clock in a continuous culture of *Saccharomyces cerevisiae*. *Microbiology*, 148: 3715-24.

- Marques N, Edwards SW, Fry JC, Halberg F, Lloyd D.** (1987). Temperature-compensated ultradian variation in cellular protein content of *Acanthamoeba castellanii* revisited. *Prog. Clin. Biol. Res.*, 227A: 105-19.
- Matsuo T, Yamaguchi S, Mitsui S, Emi A, Shimoda F, Okamura H.** (2003). Control mechanism of the circadian clock for timing of cell division in vivo. *Science*, 302(5643): 255-9.
- McNabb DS, Pinto I.** (2005). Assembly of the Hap2p/Hap3p/Hap4p/Hap5p-DNA complex in *Saccharomyces cerevisiae*. *Eukaryot. Cell*, 4(11): 1829-39.
- McNabb DS, Xing Y, Guarente L.** (1995). Cloning of yeast HAP5: a novel subunit of a heterotrimeric complex required for CCAAT binding. *Genes Dev.*, 9(1): 47-58.
- Merrow M, Raven M.** (2010). Finding time: a daily clock in yeast. *Cell Cycle*, 9(9): 1671-2.
- Mori T, Binder B, Johnson CH.** (1996). Circadian gating of cell division in cyanobacteria growing with average doubling times of less than 24 hours. *PNAS*, 93(19): 10183-8.
- Morré DJ.** (1998). NADH oxidase: a multifunctional ectoprotein of the eukaryotic cell surface. In *Plasma Membrane Redox Systems and their Role in Biological Stress and Disease*, edited by Asard H., Bérczi A., and Caubergs pp. 121-156. Kluwer, Dordrecht, The Netherlands.
- Morré DJ.** (2000). Chemical hormesis in cell growth: a molecular target at the cell surface. *J. Appl. Toxicol.*, 20(2): 157-63.
- Morré DJ, Brightman AO.** (1991). NADH oxidase of plasma membranes. *J. Bioenerg. Biomembr.*, 23(3): 469-89.
- Morré DJ, Chueh PJ, Lawler J, Morré DM.** (1998). The sulfonylurea-inhibited NADH oxidase activity of HeLa cell plasma membranes has properties of a protein disulfide-thiol oxidoreductase with protein disulfide-thiol interchange activity. *J. Bioenerg. Biomembr.*, 30(5): 477-87.
- Morré DJ, Chueh PJ, Pletcher J, Tang X, Wu LY, Morré DM.** (2002a). Biochemical basis for the biological clock. *Biochemistry*, 41(40): 11941-5.
- Morré DJ, Lawler J, Wang S, Keenan TW, Morré DM.** (2002b). Entrainment in solution of an oscillating NADH oxidase activity from the bovine milk fat globule membrane with a temperature-compensated period length suggestive of an ultradian time-keeping (clock) function. *Biochim. Biophys. Acta*, 1559(1): 10-20.
- Morré DM, Lenaz G, Morré DJ.** (2000). Surface oxidase and oxidative stress propagation in aging. *J. Exp. Biol.*, 203(10): 1513-21.

- Morré DJ, Morré DM.** (1998). NADH oxidase activity of soybean plasma membranes oscillates with a temperature compensated period of 24 minutes. *Plant J.*, 16(3): 277-284.
- Morré DJ, Morré DM.** (2004). Plasma membrane electron transport. A metabolic process deserving of renewed interest. *Biofactors*, 20(4): 183-7.
- Morré DJ, Morré DM, Penel C, Greppin H.** (1999a). NADH Oxidase Periodicity of Spinach Leaves Synchronized by Light. *Int. J. Plant Sci.*, 160(5): 855-860.
- Morré DJ, Penel C, Greppin H, Morré DM.** (2002c). The plasma membrane-associated NADH oxidase of spinach leaves responds to blue light. *Int. J. Plant Sci.*, 163(4): 543-7.
- Morré DJ, Pogue R, Morré DM.** (1999b). A multifunctional hydroquinone oxidase of the external cell surface and sera. *Biofactors*, 9(2-4): 179-87.
- Mountain HA, Byström AS, Korch C.** (1993). The general amino acid control regulates MET4, which encodes a methionine-pathway-specific transcriptional activator of *Saccharomyces cerevisiae*. *Mol. Microbiol.*, 7(2): 215-28.
- Murray DB, Beckmann M, Kitano H.** (2007). Regulation of yeast oscillatory dynamics. *PNAS*, 104(7): 2241-6.
- Murray DB, Engelen FA, Keulers M, Kuriyama H, Lloyd D.** (1998). NO⁺, but not NO[•], inhibits respiratory oscillations in ethanol-grown chemostat cultures of *Saccharomyces cerevisiae*. *FEBS Lett.*, 431(2): 297-9.
- Murray DB, Engelen F, Lloyd D, Kuriyama H.** (1999). Involvement of glutathione in the regulation of respiratory oscillation during a continuous culture of *Saccharomyces cerevisiae*. *Microbiology*, 145: 2739-45.
- Murray DB, Klevecz RR, Lloyd D.** (2003). Generation and maintenance of synchrony in *Saccharomyces cerevisiae* continuous culture. *Exp. Cell Res.*, 287(1): 10-5.
- Murray DB, Roller S, Kuriyama H, Lloyd D.** (2001). Clock control of ultradian respiratory oscillation found during yeast continuous culture. *J. Bacteriol.*, 183(24): 7253-9.
- Nagoshi E, Saini C, Bauer C, Laroche T, Naef F, Schibler U.** (2004). Circadian gene expression in individual fibroblasts: cell-autonomous and self-sustained oscillators pass time to daughter cells. *Cell*, 119(5): 693-705.

- Natarajan K, Meyer MR, Jackson BM, Slade D, Roberts C, Hinnebusch AG, Marton MJ.** (2001). Transcriptional profiling shows that Gcn4p is a master regulator of gene expression during amino acid starvation in yeast. *Mol. Cell. Biol.*, 21(13): 4347-68.
- Nourani A, Robert F, Winston F.** (2006). Evidence that Spt2/Sin1, an HMG-like factor, plays roles in transcription elongation, chromatin structure, and genome stability in *Saccharomyces cerevisiae*. *Mol. Cell. Biol.*, 26(4): 1496-509.
- Patton EE, Peyraud C, Rouillon A, Surdin-Kerjan Y, Tyers M, Thomas D.** (2000). SCF(Met30)-mediated control of the transcriptional activator Met4 is required for the G(1)-S transition. *EMBO J.*, 19(7): 1613-24.
- Pogue R, Morr e DM, Morr e DJ.** (2000). CHO cell enlargement oscillates with a temperature-compensated period of 24 min. *Biochim. Biophys. Acta*, 1498(1): 44-51.
- Poole RK, Lloyd D.** (1974). The development of cytochromes during the cell cycle of a glucose-repressed fission yeast, *Schizosaccharomyces pombe* 972h⁻. *Biochem J.*, 138(2): 201-210.
- Poole RK, Lloyd D, Kemp RB.** (1973). Respiratory Oscillations and Heat Evolution in Synchronously Dividing Cultures of the Fission Yeast *Schizosaccharomyces pombe* 972h⁻. *Gen. Microbiol.*, 77: 209-220.
- Poole RK, Salmon I.** (1978). The pool sizes of adenine nucleotides in exponentially growing, stationary phase and 2'-deoxyadenosine-synchronized cultures of *Schizosaccharomyces pombe* 972h⁻. *J. Gen. Microbiol.*, 106: 153-164.
- Porro D, Martegani E, Ranzi BM, Alberghina L.** (1988). Oscillations in continuous cultures of budding yeast: a segregated parameter analysis. *Biotechnol. Bioeng.*, 32(4): 411-7.
- Rao AR, Pellegrini M.** (2011). Regulation of the yeast metabolic cycle by transcription factors with periodic activities. *BMC Syst. Biol.*, 5: 160.
- Rouillon A, Barbey R, Patton EE, Tyers M, Thomas D.** (2000). Feedback-regulated degradation of the transcriptional activator Met4 is triggered by the SCF(Met30) complex. *EMBO J.*, 19(2):282-94.
- Satroutdinov AD, Kuriyama H, Kobayashi H.** (1992). Oscillatory metabolism of *Saccharomyces cerevisiae* in continuous culture. *FEMS Microbiol. Lett.*, 77(1-3): 261-7.
- Singh S, Padovani D, Leslie RA, Chiku T, Banerjee R.** (2009). Relative contributions of cystathionine beta-synthase and gamma-cystathionase to H₂S biogenesis via alternative trans-sulfuration reactions. *J. Biol. Chem.*, 284(33): 22457-66.
- Sohn HY, Murray DB, Kuriyama H.** (2000). Ultradian oscillation of *Saccharomyces cerevisiae* during aerobic continuous culture: hydrogen sulphide mediates population synchrony. *Yeast*, 16(13): 1185-90.

- Tu BP, Kudlicki A, Rowicka M, McKnight SL.** (2005). Logic of the yeast metabolic cycle: temporal compartmentalization of cellular processes. *Science*, 310(5751): 1152-8.
- Tu BP, McKnight SL.** (2006). Metabolic cycles as an underlying basis of biological oscillations. *Nat. Rev. Mol. Cell Biol.*, 7(9): 696-701.
- Tu BP, McKnight SL.** (2007). The yeast metabolic cycle: insights into the life of a eukaryotic cell. *Cold Spring Harb Symp Quant Biol.*, 72: 339-43.
- Tu BP, Mohler RE, Liu JC, Dombek KM, Young ET, Synovec RE, McKnight SL.** (2007). Cyclic changes in metabolic state during the life of a yeast cell. *PNAS*, 104(43): 16886-91.
- Thomas D, Surdin-Kerjan Y.** (1997). Metabolism of sulfur amino acids in *Saccharomyces cerevisiae*. *Microbiol. Mol. Biol. Rev.*, 61(4): 503-32.
- Wang S, Pogue R, Morr  DM, Morr  DJ.** (2001). NADH oxidase activity (NOX) and enlargement of HeLa cells oscillate with two different temperature-compensated period lengths of 22 and 24 minutes corresponding to different NOX forms. *Biochim. Biophys. Acta*, 1539(3): 192-204.
- Wolf J, Sohn H, Heinrich R, Kuriyama H.** (2001). Mathematical analysis of a mechanism for autonomous metabolic oscillations in continuous culture of *Saccharomyces cerevisiae*. *FEBS Lett.*, 499(3): 230-4.
- Young ET, Dombek KM, Tachibana C, Ideker T.** (2003). Multiple pathways are co-regulated by the protein kinase Snf1 and the transcription factors Adr1 and Cat8. *J. Biol. Chem.*, 278(28): 26146-58.
- Young ET, Kacherovsky N, Van Riper K.** (2002). Snf1 protein kinase regulates Adr1 binding to chromatin but not transcription activation. *J. Biol. Chem.*, 277(41): 38095-103.
- Zhang L, Hach A.** (1999). Molecular mechanism of heme signaling in yeast: the transcriptional activator Hap1 serves as the key mediator. *Cell. Mol. Life Sci.*, 56(5-6): 415-26.
- Zitomer RS, Carrico P, Deckert J.** (1997). Regulation of hypoxic gene expression in yeast. *Kidney Int.*, 51(2): 507-13.

Appendix 5

Temperature compensation is an integral part of
the rhythm

Ap.5. Temperature compensation is an integral part of the rhythm

In 1931 Buenning noticed that the free running period of leaf movement was virtually independent of temperature (Buenning, 1931). This property termed temperature compensation was later shown to be universal (Sweeney and Hastings, 1960; Buenning, 1973¹), to the point that any periodicity that is not buffered against changes in ambient temperature is not to be considered circadian (Buenning, 1973²). Most biochemical reactions double their speed with an increase of 10°C exhibiting thus a Q_{10} of 2. If the oscillator is made of biochemical reactions then it becomes a kind of a paradox that the Q_{10} of circadian rhythms (measured with frequency or period) is less than 1.2, often less than 1.1 and other times even lower than 1 (in which case increasing temperature slows down the pace of the rhythm that is then said to be overcompensated). The discovery of temperature compensated circadian rhythms in warm blooded animals led to the hypothesis that temperature compensation should be an integral property of the clock rather than the result of separate antagonistic processes (Rowson, 1960; Gibbs, 1981). Publications in favor and against this notion are presented here.

Ap.5.1. Temperature compensation in cyanobacteria, animals and fungi

In cyanobacteria temperature compensated oscillations in ATP hydrolysis were achieved in a tube containing isolated KaiA, KaiB and KaiC proteins and ATP, showing clearly that temperature compensation is inseparable from the time generating mechanism and its components (Tomita *et al.*, 2005). The KaiC auto-kinase, auto-phosphatase (Tomita *et al.*, 2005) and ATPase (Terauchi *et al.* (2007) activities are independent to temperature and could therefore account for temperature compensation.

1. It is worth mentioning that transients were disregarded when temperature compensation was first examined in *Drosophila*, leading to false negative results regarding the universality of temperature compensation (Buenning, 1973, page 71 to 73).

2. See pages 13 and 14 where temperature independent oscillations are attributed to a "genuine clock". In page 73 Buenning states that "circadian oscillations can be used for time measurement because of their surprisingly low dependence on temperature". It is generally accepted that "genuine clocks" serve a timekeeping function because they can keep track of time irrespective of random or seasonal fluctuations in ambient temperature.

In *Drosophila* the interaction between the circadian photoreceptor CRY and the protein complex composed of PER and TIM³ is critical for temperature compensation (Kaushik *et al.*, 2007). Certain physicochemical properties of PER are well correlated to the effect of temperature on circadian period. In one study it was shown that naturally occurring or engineered variations in the number of certain Thr-Gly repeats in the PER protein are linearly related to the effect of ambient temperature on circadian period; three such pairs of repeats represent a conformational monomer that generates a β turn, indicating that temperature compensation is, at list in part, attributed to the structure of PER (Sawyer *et al.*, 1997). The same conclusion was drawn from a second study that suggested that temperature compensation may result partly from competing inter- and intra-molecular PER protein interactions (Huang *et al.*, 1995).

Dibner *et al.* (2009) showed that the clock in mouse fibroblasts is resilient to large scale as well as to clock-specific chemical inhibition of transcription and proposed that a common mechanism may underline compensation against transcriptional variations and changes in ambient temperature. This was inferred based on the observation that the effects of transcriptional inhibitors and of temperature on circadian period were not additive⁴; subsequently it was shown that PER1 is required for both of these compensatory mechanisms (Dibner *et al.*, 2009; see also O'Neill, 2009). Interestingly, the mammalian PER1 gene contains short Ser-Gly repeats (Tei *et al.*, 1997) similar to those found in the *Drosophila* PER protein and in the WC-2 and FRQ proteins of *Neurospora* (see below). So far, these repeats have been linked to temperature compensation only in *Neurospora* and in *Drosophila*, through FRQ and PER respectively.

The *frq-9*, *cel*, *chol-1* (chapter 1.4.2.b) strains and the *vvd* null strain of *Neurospora* show both temperature- and nutrient-compensation phenotypes (Loros and Feldman, 1986; Lakin-Thomas *et al.*, 1990; Schneider *et al.*, 2009; see Morgan *et al.*, 2001 for a review)⁵. Because of this and considering that metabolism is temperature dependent, Roenneberg and Merrow (1999) proposed that the clock is shielded against metabolic and temperature variations via a common mechanism.

3. This interaction is also important for phase resetting in response to non parametric entrainment to light and heat pulses (Kaushik *et al.*, 2007).

4. The period-shortening effect of the transcriptional inhibitors was temperature dependent and attenuated when temperature dropped from 37°C to 33°C, *i.e.* the transcriptional inhibitors were ineffective when cultured cells were exposed to ambient temperatures that were lower than the normal body temperature. This observation cannot be attributed to separate antagonistic processes that would appear to be redundant in warm blooded animals, because internal tissues would never be exposed to such low temperatures *in vivo*.

5. In addition to these it has been shown that temperature compensation and metabolism in *Neurospora* are linked through the thioredoxin system (Onai and Nakashima, 1997).

This opinion was supported by mathematical modeling (Roennenberg and Merrow, 1999), as well as by experimentation (Merrow *et al.*, 1999) that led to the *zeitnehmer* model (see fig. 1.8 and appendix 1). According to this model, temperature compensation is achieved through the coupling between two temperature dependent oscillators, the *zeitnehmer* (FRQ/WCC) light-sensitive oscillator and metabolic oscillations. Roennenberg and Merrow (1999) do not assign central clock properties to the *zeitnehmer* loop; the central oscillator in their model is not compensated against environmental and metabolic perturbation and consequently temperature compensation would not be intrinsic to the time-generating mechanism (*i.e.* metabolic oscillations). By contrast, Iwasaki and Dunlap (2000) have argued that both interacting loops are central. An interpretation⁶ of this stance is that temperature compensation is an integral property of a network-based central oscillator⁷. From these it becomes obvious that the question of whether temperature compensation is intrinsic or not to the oscillator of *Neurospora* reflects the dispute on the oscillator's identity (fig. 1.8).

FRQ is required for normal temperature compensation (reviewed in Lakin-Thomas *et al.*, 1990). Moreover, temperature compensation and thermal stability of FRQ are well correlated to each other, through the study of long period *frq* mutants (Ruoff *et al.*, 2005). Recently it was proposed that normal temperature compensation results from separate (thus not intrinsic to FRQ) temperature-

6. However, in a recent publication Dunlap reported that FRQ phosphorylation is required for proper temperature compensation and based on this he proposed that "*temperature compensation is an independently involved layer that is not intrinsic to a core oscillator*" (Mehra *et al.*, 2009; see below); this opinion clearly reflects the idea that the "core oscillator" would be the FRQ/WCC TTFL alone, not its interactions with metabolic oscillations.

7. The fact that FLOs are incomplete (Lakin-Thomas and Brody, 2000; Granshaw *et al.*, 2003) is in agreement to the notion that a complete circadian system requires a network between transcriptional and metabolic oscillations. Considering the findings of de Paula *et al.*, (2006), regarding a complete entrainable and temperature-compensated circadian pacemaker that drives the expression of *cgc-16* in the absence of FRQ, one might assume that transcription is not part of this network. This however is not the case, because rhythmic expression of *cgc-16* is not independent to either rhythmic transcription or its coupling to metabolic oscillations. The importance of transcriptional oscillations in the FLO that drives the expression of *cgc-16* is clearly shown by the fact that WC-1 and WC-2 are required for these oscillations to occur. Metabolic regulation of *cgc-16* expression on the other hand is implied in the biochemical properties of WC-1 that binds FAD through its LOV domain. Of note, FAD binding to WC-1 is important for entrainment (He *et al.*, 2002; Froehlich *et al.*, 2002), but a relationship of this event to temperature compensation has not been investigated yet.

dependent processes that compete to regulate FRQ stability (Mehra *et al.*, 2009)⁸. In this work it was shown that the long period mutations *chr* (*chr*) and *prd-3*, long known for their gain of function phenotypes in temperature compensation⁹, are hypomorphic alleles of the regulatory β 1 and catalytic α subunits of CK2, respectively. It was further shown that phosphorylation of FRQ by CK2 at distinct sites regulates FRQ stability (reduces FRQ stability specifically at high temperatures) and that through this regulation FRQ stability and circadian period are compensated against changes in ambient temperature¹⁰. This model for temperature compensation assumes that the effect of CK2 on FRQ stability is antagonized by an unknown temperature-dependent antagonistic process (Mehra *et al.*, 2009).

It should be clarified that the presence of separate antagonistic processes that contribute to temperature compensation and are not intrinsic to FRQ, does not necessarily exclude the possibility that FRQ might possess temperature-independent physicochemical properties. On the contrary, evidence that temperature compensation might be inherent to the clock elements of *Neurospora* come first from the fact that the aforementioned Thr-Gly repeats are also present in WC-2 (Linden and Macino, 1997) and in FRQ (McClung *et al.*, 1989) and second, from the observation that the partial loss of temperature compensation alleles *frq-3* and *frq-7* (Lackin-Thomas *et al.*, 1990) map to the immediate flanking regions of the fungal repeats (Aronson *et al.*, 1994b). Morgan *et al.* (2001) noticed a genetic interaction between these repeats and temperature compensation; the interaction is highlighted by the fact that alleles of the *prd-2*, *prd-3* and *prd-6* genes show epistatic relationships specifically with *frq-3* and *frq-7* that lengthen circadian period and at the same time compromise

8. The stability of FRQ has been linked to temperature compensation in a third publication also. A gain of function mutation in checkpoint kinase 2, identified in the short period *prd-4* mutant, resulted in loss of temperature compensation likely because premature phosphorylation of FRQ would increase its degradation rate in the mutant. It was further shown that checkpoint kinase 2 is part of a reciprocal link between the clock and DNA damage (Pregueiro *et al.*, 2006). This is in agreement to the idea that endogenous timekeepers not only predict external cues, but also provide the basis for temporal segregation between incompatible cellular metabolic processes that would otherwise be energetically futile and stressful (Tu *et al.*, 2005; Tu *et al.*, 2007; Lloyd and Murray, 2007; Mackey *et al.*, 2011).

9. The *chr* mutant exhibits extension of the temperature range that temperature compensation is functional. The *prd-3* mutant is overcompensated against fluctuation in ambient temperature.

10. When CK2 activity was compromised (*i.e.* in the *chr* and *prd-3* mutants), FRQ stability was rendered sensitive to ambient temperature (increased stability at higher temperatures), which was then reflected in the overcompensation phenotypes of *chr* and *prd-3* mutants.

temperature compensation (Morgan *et al.*, 2001) and thermal stability of FRQ (Ruoff *et al.* (2005)¹¹. By contrast short-period alleles of *frq* are not related to temperature compensation and do not interact genetically with these *prd* genes. Given the fact that the Thr-Gly repeats have been implicated in protein-protein interactions, Morgan *et al.*, (2001) predicted that the temperature compensation response would involve physical interactions between the PRD genes and FRQ. This prediction is satisfied by the finding of Mehra *et al.* (2009) that the catalytic α subunit of CK2 is PRD-3, but it remains to be seen whether the interaction between FRQ and PRD-3 involves the Thr-Gly repeats of FRQ.

Together, the publications presented here are suggestive that similar mechanisms for temperature compensation, such as those implicating CK2 (see temperature compensation in *Arabidopsis* below) and the Thr-Gly repeats are either conserved or converge in the properties of central clock components across taxa. Moreover, it is possible that temperature compensation is exerted at multiple levels, such as the physicochemical properties of central clock components and the networks they form. This later idea has slowly gained ground, as networks have been held responsible for temperature compensation not only in *Neurospora* (Roennenberg and Merrow, 1999; Iwasaki and Dunlap, 2000), but also in animals (Dibner *et al.*, 2009; O'Neil, 2009), in plants and in yeast¹².

11. This is well in agreement with the observation of Ruoff *et al.* (2005) and of Mehra *et al.* (2009), that when thermal stability of FRQ is compromised, then circadian period is no longer compensated against temperature.

12. Ultradian metabolic oscillations that are either temperature compensated (such as the respiratory cycles in yeast; Murray *et al.*, 2007; Lloyd and Murray, 2007) or temperature dependent (primary metabolism in plants; Wagner *et al.*, 2000), are coupled in the form of temperature compensated networks.

Ap.5.2. Temperature compensation in *Arabidopsis*

Natural variation studies have shown that under non-stressful ambient temperatures (12°C-27°C) 20% to 40% of the period-variance in leaf movement rhythms is genetically determined. A number of qualitative trait loci (QTL) involved in temperature compensation were obtained in these studies that by definition affect circadian period in a temperature specific manner. Analysis of near isogenic lines and sequence comparisons identified previously known circadian regulators as strong candidates for the temperature-compensation QTLs. These included the flowering-time gene *GI*, the F-box protein *ZTL* and the MADS-box transcription factor *FLOWERING LOCUS C (FLC)* (Edwards *et al.*, 2005; Edwards *et al.*, 2006)¹³. Further investigation revealed that loss-of-function mutations of *flc* compromise temperature compensation at warm temperatures (27°C)¹⁴ and that this phenotype is genetically linked to known upstream regulators of FLC involved in pathways that affect flowering-time. In addition to these, *LUX* (see figure 1.12 and chapter 1.6.2), a known FLC target that affects amplitude of circadian rhythms (Hazen *et al.*, 2005; Onai and Ishiura, 2005) and is now viewed as part of the *Arabidopsis* TTFL (Pokhilko *et al.*, 2012; see also figure 1.12 for the role of LUX in the "repressilator"), was proposed to function downstream of FLC in the temperature compensation response, because expression of this gene depends on FLC in a temperature dependent manner (Edwards *et al.*, 2006).

Three studies in *Arabidopsis* argue that temperature compensation is an antagonistic process. In one of these, Gould *et al.* (2006) showed that the short period phenotypes of *cca1* and *lhy* mutants are temperature dependent, with LHY being more important for compensation at warm and CCA1 at cold temperatures. The effect of temperature on circadian phenotypes of the *gi-11* loss-of-function mutant was also tested in this study, because previously *GI* was identified amongst QTLs that affect temperature compensation (Edwards *et al.*, 2005). It was shown that *GI* is dispensable at 17°C, but not at 12°C or at 27°C, for maintaining robust oscillations and a wild-type period value¹⁵ (Gould *et al.*, 2006). Based on the effect of temperature on the expression patterns of *CCA1*, *LHY*, *GI* and *TOC1*¹⁶ in wild-type and in *gi-11* plants, it was proposed that the antagonistic balance between *TOC1* and *LHY*, (whose expression is increased and decreased respectively at elevated temperatures) and their regulation by *GI* are important for the temperature compensation response at warm

13. Of note, circadian assays in these studies were performed in the presence of supplementary sucrose (3%).

14. The short period phenotypes of the *flc* mutants were enhanced at elevated temperatures.

15. Leaf movement and *CAB2::LUC* expression rhythms were used to assess the rhythm.

16. These genes form the two-loop TTFL model established at the time; (Locke *et al.*, 2005).

temperatures. It was also shown that at 17°C GI is dispensable not only for maintaining a wild-type period but also for the normal expression patterns of *CCA1* and *TOC1* genes. This model was further supported by computational simulations (Gould *et al.*, 2006) and confirmed in an independent study where it was shown that the temperature compensation phenotypes of *lhy* and *toc1* loss-of-function mutants are stronger at elevated temperatures (Salomé *et al.*, 2010). The findings of Gould *et al.* (2006) are suggestive that temperature compensation can be attributed to antagonistic process that would not be characterized as "separate" to the TTFL; circadian period in this model would be compensated against changes in ambient temperature due to the formation of transcriptional networks.

Portolés and Mas (2010) found that Casein Kinase 2 (CK2), that was previously shown to affect FRQ stability and temperature compensation in *Neurospora* (Mehra *et al.*, 2009), is also involved in the temperature compensation response in *Arabidopsis*. In this case temperature compensation was attributed to separate antagonistic processes. It was shown that over-expression of the CKB4 regulatory subunit of CK2 compromises temperature compensation specifically at warm temperatures. Accordingly, chemical inhibition of CK2 had the opposite effect, causing overcompensation when temperature was elevated. The concerted action of CK2 and CCA1 in the temperature compensation response was further investigated because CKB4 over-expression moderated several circadian and circadian-related phenotypes of plants that over-expressed CCA1. It was then found that CK2 regulates the DNA binding affinity of CCA1 without affecting CCA1 levels. Together these findings are indicative that CK2 phosphorylates CCA1, inhibiting binding to its target promoters thereafter. As ambient temperature is elevated, the circadian effect of CK2 and the portion of CCA1 that is phosphorylated are increased, but strikingly so is the ability of CCA1 to bind DNA; therefore it is possible that two temperature-dependent antagonistic processes, CK2-mediated inhibition of CCA1 and an unknown process, mediate temperature compensation in CCA1-targets¹⁷. Based on these, the regulatory network described here would function at relatively warm temperatures (Portolés and Mas, 2010)¹⁸. Considering the previous findings of Sugano *et al.* (1999) who showed that LHY, like CCA1, is phosphorylated by CK2, Portolés and Mas (2010) suggested even that the regulatory network described by Gould *et al.* (2006) might be regulated by CK2.

17. These experiments however were performed with plants over-expressing CCA1 and/or CKB4 and should be viewed with skepticism.

18. It should be clarified, that according to Gould *et al.* (2005) the role of CCA1 is more important at cold rather than at warm temperatures, consequently Portolés and Mas (2010) investigated a minor role of CCA1 in temperature compensation.

In the third and most recent publication dealing with temperature compensation in *Arabidopsis*, Salomé *et al.* (2010) showed that the long-period phenotype of the *prr7;prr9* mutant is completely restored at cold temperatures (12°C). Moreover the period of the mutant was found to be overcompensated against temperature (circadian period increased when temperature was elevated); these observations were specific to *PRR7* and 9, as they were not observed in any other clock mutant tested, including the *prr5;prr7* mutant. Given the role of *CCA1* and *LHY* in temperature compensation (Gould *et al.*, 2005), the authors proceeded to discern the epistatic relationships between these genes and *PRR7* and 9. They found that the overcompensation phenotype of the *prr7;prr9* mutant is dependent on the expression of *CCA1* and *LHY*, as when the later were suppressed via artificial microRNAs the circadian period of *prr7;prr9* was rendered independent to temperature. Moreover, it was shown that at warm temperatures (27°C) the extreme long-period phenotype of the *prr7;prr9* mutant is accompanied by miss-regulated expression of *CCA1* and *LHY*¹⁹. By contrast, at cold temperatures, when the long period phenotype of the *prr7;prr9* mutant is lost, the expression of *CCA1* and *LHY* is restored. Together these findings are suggestive that in the wild-type, as ambient temperature rises, the expression of *CCA1* and *LHY* is driven by two separate antagonistic temperature-dependent processes. One of these would involve *PRR7* and *PRR9* and would be dominant at warm temperatures (Salomé *et al.*, 2010; see also Eckardt, 2010). Interestingly, this work demonstrated that in the absence of both *CCA1* and *LHY* rhythmic gene expression is compensated against changes in ambient temperature; this is indicative that these genes are not responsible for the generation of temperature compensation rather they should modulate responsiveness of rhythmic gene expression to changes in ambient temperature.

To conclude, temperature compensation in *Arabidopsis* should be a property of oscillatory networks that incorporate transcriptional oscillations. The term "separate" (referring to separate antagonistic processes) becomes then redundant, if the separate process is incorporated to the oscillatory networks that make the complete oscillator.

19. See also Gould *et al.* (2006) where it is shown that the expression of *CCA1* and *LHY* is moderated at warm temperatures relative to cold ones (especially *LHY* expression); in the *prr7;prr9* mutant by contrast, expression of these genes is increased by a raise in ambient temperature (Salomé *et al.*, 2010).

Bibliography

- Buenning E.** (1931). Untersuchungen über die autonomen tagesperiodischen Bewegungen der Primärblätter von *Phaseolus multiflorus*. *Jahrb. Wiss. Bot.*, 75: 439–480.
- Buenning E.** (1973). *The Physiological Clock*. 3rd ed. (New York: Springer-Verlag).
- Dibner C, Sage D, Unser M, Bauer C, d'Eysmond T, Naef F, Schibler U.** (2009). Circadian gene expression is resilient to large fluctuations in overall transcription rates. *EMBO J.*, 28(2): 123-34.
- Eckardt NA.** (2010). Temperature compensation of the circadian clock: a role for the morning loop. *Plant Cell*, 22(11): 3506.
- Edwards KD, Anderson PE, Hall A, Salathia NS, Locke JC, Lynn JR, Straume M, Smith JQ, Millar AJ.** (2006). FLOWERING LOCUS C mediates natural variation in the high-temperature response of the *Arabidopsis* circadian clock. *Plant Cell*, 18(3): 639-50.
- Edwards KD, Lynn JR, Gyula P, Nagy F, Millar AJ.** (2005). Natural allelic variation in the temperature-compensation mechanisms of the *Arabidopsis thaliana* circadian clock. *Genetics*, 170(1): 387-400.
- Froehlich AC, Liu Y, Loros JJ, Dunlap JC.** (2002). White Collar-1, a circadian blue light photoreceptor, binding to the frequency promoter. *Science*, 297(5582): 815-9.
- Gibbs FP.** (1981). Temperature dependence of rat circadian pacemaker. *Am. J. Physiol.*, 241(1): R17-20.
- Gould PD, Locke JC, Larue C, Southern MM, Davis SJ, Hanano S, Moyle R, Milich R, Putterill J, Millar AJ, Hall A.** (2006). The molecular basis of temperature compensation in the *Arabidopsis* circadian clock. *Plant Cell*, 18(5): 1177-87.
- Granshaw T, Tsukamoto M, Brody S.** (2003). Circadian rhythms in *Neurospora crassa*: farnesol or geraniol allow expression of rhythmicity in the otherwise arrhythmic strains *frq10*, *wc-1*, and *wc-2*. *J. Biol. Rhythms*, 18(4): 287-96.
- Hazen SP, Schultz TF, Pruneda-Paz JL, Borevitz JO, Ecker JR, Kay SA.** (2005). LUX ARRHYTHMO encodes a Myb domain protein essential for circadian rhythms. *PNAS*, 102(29): 10387-92.
- He Q, Cheng P, Yang Y, Wang L, Gardner KH, Liu Y.** (2002) White collar-1, a DNA binding transcription factor and a light sensor. *Science*, 297(5582): 840-3.

- Huang ZJ, Curtin KD, Rosbash M.** (1995). PER protein interactions and temperature compensation of a circadian clock in *Drosophila*. *Science*, 267(5201): 1169-72.
- Iwasaki H, Dunlap JC.** (2000). Microbial circadian oscillatory systems in *Neurospora* and *Synechococcus*: models for cellular clocks. *Curr. Opin. Microbiol.*, 3(2): 189-96.
- Kaushik R, Nawathean P, Busza A, Murad A, Emery P, Rosbash M.** (2007). PER-TIM interactions with the photoreceptor cryptochrome mediate circadian temperature responses in *Drosophila*. *PLoS Biol.*, 5(6): 146.
- Lakin-Thomas PL, Brody S.** (2000). Circadian rhythms in *Neurospora crassa*: Lipid deficiencies restore robust rhythmicity to null frequency and white-collar mutants. *PNAS*, 97(1): 256–261.
- Lakin-Thomas PL, Côté GG, Brody S.** (1990). Circadian rhythms in *Neurospora crassa*: biochemistry and genetics. *Crit. Rev. Microbiol.*, 17(5): 365-416.
- Linden H, Macino G.** (1997). White collar 2, a partner in blue-light signal transduction, controlling expression of light-regulated genes in *Neurospora crassa*. *EMBO J.*, 16(1): 98-109.
- Lloyd D, Murray DB.** (2007). Redox rhythmicity: clocks at the core of temporal coherence. *Bioessays*, 29(5): 465-73.
- Locke JC, Southern MM, Kozma-Bognár L, Hibberd V, Brown PE, Turner MS, Millar AJ.** (2005). Extension of a genetic network model by iterative experimentation and mathematical analysis. *Mol. Syst. Biol.*, 1:2005.0013.
- Loros JJ, Feldman JF.** (1986). Loss of temperature compensation of circadian period length in the *frq-9* mutant of *Neurospora crassa*. *J. Biol. Rhythms*, 1(3): 187-98.
- Mackey SR, Golden SS, Ditty JL.** (2011). The itty-bitty time machine genetics of the cyanobacterial circadian clock. *Adv. Genet.*, 74: 13-53.
- McClung CR, Fox BA, Dunlap JC.** (1989). The *Neurospora* clock gene frequency shares a sequence element with the *Drosophila* clock gene period. *Nature*, 339(6225): 558-62.
- Mehra A, Shi M, Baker CL, Colot HV, Loros JJ, Dunlap JC.** (2009). A role for casein kinase 2 in the mechanism underlying circadian temperature compensation. *Cell*, 137(4): 749-60.
- Merrow M, Brunner M, Roenneberg T.** (1999). Assignment of circadian function for the *Neurospora* clock gene frequency. *Nature*, 399(6736): 584-6.
- Morgan LW, Feldman JF, Bell-Pedersen D.** (2001). Genetic interactions between clock mutations in *Neurospora crassa*: can they help us to understand complexity? *Philos. Trans. R. Soc. Lond. B. Biol. Sci.*, 356(1415): 1717-24.
- Murray DB, Beckmann M, Kitano H.** (2007). Regulation of yeast oscillatory dynamics. *PNAS*, 104(7): 2241-6.

- Onai K, Ishiura M.** (2005). PHYTOCLOCK 1 encoding a novel GARP protein essential for the Arabidopsis circadian clock. *Genes Cells*, 10: 963–972.
- Onai K, Nakashima H.** (1997). Mutation of the *cys-9* gene, which encodes thioredoxin reductase, affects the circadian conidiation rhythm in *Neurospora crassa*. *Genetics*, 146(1): 101-10.
- O'Neill JS.** (2009). Circadian clocks can take a few transcriptional knocks. *EMBO J.*, 28(2): 84-5.
- de Paula RM, Lewis ZA, Greene AV, Seo KS, Morgan LW, Vitalini MW, Bennett L, Gomer RH, Bell-Pedersen D.** (2006). Two circadian timing circuits in *Neurospora crassa* cells share components and regulate distinct rhythmic processes. *J. Biol. Rhythms*, 21(3): 159-68.
- Pokhilko A, Fernández AP, Edwards KD, Southern MM, Halliday KJ, Millar AJ.** (2012). The clock gene circuit in *Arabidopsis* includes a repressilator with additional feedback loops. *Mol. Syst. Biol.*, 8: 574.
- Portolés S, Más P.** (2010). The functional interplay between protein kinase CK2 and CCA1 transcriptional activity is essential for clock temperature compensation in *Arabidopsis*. *PLoS Genet.*, 6(11):e1001201.
- Pregueiro AM, Liu Q, Baker CL, Dunlap JC, Loros JJ.** (2006). The *Neurospora* checkpoint kinase 2: a regulatory link between the circadian and cell cycles. *Science*, 313(5787): 644-9.
- Roenneberg T, Merrow M.** (1999). Circadian systems and metabolism. *J. Biol. Rhythms*, 14(6): 449-59.
- Rowson KS.** (1960). Effects of tissue temperature on mammalian activity rhythms. *Cold Spring Harb. Symp. Quant. Biol.*, 25: 105-13.
- Ruoff P, Loros JJ, Dunlap JC.** (2005). The relationship between FRQ-protein stability and temperature compensation in the *Neurospora* circadian clock. *PNAS*, 102(49): 17681-6.
- Salomé PA, Weigel D, McClung CR.** (2010). The role of the *Arabidopsis* morning loop components CCA1, LHY, PRR7, and PRR9 in temperature compensation. *Plant Cell*, 22(11): 3650-61.
- Sawyer LA, Hennessy JM, Peixoto AA, Rosato E, Parkinson H, Costa R, Kyriacou CP.** (1997). Natural variation in a *Drosophila* clock gene and temperature compensation. *Science*, 278(5346): 2117-20.
- Schneider K, Perrino S, Oelhafen K, Li S, Zatzepin A, Lakin-Thomas P, Brody S.** (2009). Rhythmic conidiation in constant light in vivid mutants of *Neurospora crassa*. *Genetics*, 181(3): 917-31.
- Sugano S, Andronis C, Ong MS, Green RM, Tobin EM.** (1999). The protein kinase CK2 is involved in regulation of circadian rhythms in *Arabidopsis*. *PNAS*, 96(22): 12362-6.

- Tei H1, Okamura H, Shigeyoshi Y, Fukuhara C, Ozawa R, Hirose M, Sakaki Y.** (1997). Circadian oscillation of a mammalian homologue of the *Drosophila* period gene. *Nature*, 389(6650): 512-6.
- Terauchi K, Kitayama Y, Nishiwaki T, Miwa K, Murayama Y, Oyama T, Kondo T.** (2007). ATPase activity of KaiC determines the basic timing for circadian clock of cyanobacteria. *PNAS*, 104(41): 16377-81.
- Tomita J, Nakajima M, Kondo T, Iwasaki H.** (2005). No transcription-translation feedback in circadian rhythm of KaiC phosphorylation. *Science*, 307(5707): 251-4.
- Tu BP, Kudlicki A, Rowicka M, McKnight SL.** (2005). Logic of the yeast metabolic cycle: temporal compartmentalization of cellular processes. *Science*, 310(5751): 1152-8.
- Tu BP, Mohler RE, Liu JC, Dombek KM, Young ET, Synovec RE, McKnight SL.** (2007). Cyclic changes in metabolic state during the life of a yeast cell. *PNAS*, 104(43): 16886-91.
- Wagner E, Normann J, Albrechtova JTP, Greppin H.** (2000). From cellular micro-compartmentation to inter-organ communication. The kinetic basis for molecular controls in photoperiodism. *Intergrated Plant Systems*, University of Geneva 2000 p. 293-309.

Appendix 6

Erklärung

“Ich versichere, dass ich die von mir vorgelegte Dissertation selbständig angefertigt, die benutzten Quellen und Hilfsmittel vollständig angegeben und die Stellen der Arbeit – einschließlich Tabellen, Karten und Abbildungen – , die anderen Werken im Wortlaut oder dem Sinn nach entnommen sind, in jedem Einzelfall als Entlehnung kenntlich gemacht habe; dass diese Dissertation noch keiner anderen Fakultät oder Universität zur Prüfung vorgelegen hat; dass sie – abgesehen von unten angegebenen Teilpublikationen – noch nicht veröffentlicht worden ist, sowie, dass ich eine solche Veröffentlichung vor Abschluss des Promotionsverfahrens nicht vornehmen werde. Die Bestimmungen der Promotionsordnung sind mir bekannt. Die von mir vorgelegte Dissertation ist von Prof. Dr. George Coupland betreut worden.”

Max-Planck-Institut für Züchtungsforschung,
Köln, 09 Februar 2015

Koumis Philippou

Teilpublikationen

Philippou K., Ma Z., Davis AM., Davis SJ. Sucrose application alters circadian rhythms in Arabidopsis in a manner predicted by the zeitnehmer model (manuscript in preparation).

Philippou K., Davis SJ. Salicylic acid application and chloroplast-related chemicals affect circadian rhythms in Arabidopsis (manuscript in preparation).

Ma Z., Philippou K., Queitsch C., Shindo T., Davis AM., Davis SJ. HSP90.2 contribute to thermal entrainment of the Arabidopsis circadian clock (manuscript in preparation).

Tagungen

Posterpräsentation:

Philippou K., Davis S.J. Metabolic-Circadian Interactions.

19th International Conference on Arabidopsis Research, Montreal, Juli 2008.

Appendix 7

Curriculum vitae

Persönliche Daten

Name: Koumis Philippou
Adresse: Agiou Epiktitou 10, 7100, Larnaca, Cyprus
Geburtsdatum: 27.12.1976
Geburtsort: Athen, Griechenland
Nationalität: Zyperer
Familienstand: Ledig

Schulbildung, Studium und wissenschaftlicher Werdegang

1991-1994: Lyzeum „Saint George“, Larnaca.

1996-2001: Universität Athen, Naturwissenschaftliche Fakultät, Institut für Biologie.
Diplomarbeit: Der Standort der *Capparis spiosa* im Garten des Linnaeus.

2001-2004: Wissenschaftlicher Mitarbeiter im Forschungslabor von Prof. Dr. Sophia Rhizopoulou, Universität Athen, Naturwissenschaftliche Fakultät, Institut für Biologie, Lehrstuhl für Botanik.

2004: Socrates/Erasmus-Student, Gaststudent im Forschungslabor von Prof. Dr. Edgar Wagner, an der Albert-Ludwigs-Universität, Fakultät für Biologie.

2004-2005: Praktikum im Forschungslabor von Dr. Seth Davis im Max Planck Institut für Pflanzenzüchtungsforschung, Köln.

- 2005-2008: IMPRS Doktorand am Max Planck Institut für Pflanzenzüchtungsforschung, Köln und an der Universität Köln.
- 2008-2009: Vorbereitungsprogramm für Lehrer des Sekundarschulwesens, Pädagogisches Institut Zypern.
- 2011-2012: Einführendes Lehrgangsprogramm „Mentor“ für Lehrer des Sekundarschulwesens, Pädagogisches Institut Zypern.

Stipendien

- 1996-2001: Durch Erzielen der höchsten Note der zyprischen Studienwettbewerber für die Studieneingangsprüfung für Biologie an griechischen Universitäten (1994), habe ich das Stipendium der staatlichen zyprischen Studienstiftung erhalten.
- 2004: Erhalt des Socrates/Erasmus-Stipendiums für den Besuch der Albert-Ludwigs- Universität.
- 2005: Erhalt des Stipendiums der „International Max Planck Research School“ (IMPRS).

Konferenzen

19. Internationale Konferenz der Arabidopsis-Forschung.
Montreal, Juli 2008, Posterpräsentation.