

Primljen / Received: 8.1.2015.

Ispravljen / Corrected: 31.5.2015.

Prihvaćen / Accepted: 24.6.2015.

Dostupno online / Available online: 10.3.2016.

Copper slag concrete admixed with polypropylene fibres

Authors:



Vijayaprabha Chakrawarthy, MCE

Alagappa Chettiar College of Eng. & Tech., India
Faculty of Civil Engineering
vijayaprabha.struct@gmail.com



Assist.prof. Brindha Darmar, PhD. CE

Thiagarajar College of Engineering, India
Faculty of Civil Engineering
dbrindha@yahoo.co.in



Ashokkumar Elangovan, MCE

Indian Institute of Technology-Madras, India
ashokkumar.structural@gmail.com

Original scientific paper

[Vijayaprabha Chakrawarthy, Brindha Darmar, Ashokkumar Elangovan](#)

Copper slag concrete admixed with polypropylene fibres

A sustainable concrete design has become an imperative requirement for the present-day concrete industry. A part of an extensive research project aimed at studying possibilities for using copper slag (CS) and polypropylene (PP) fibres in concrete is presented and analysed. Measurements were conducted to investigate the workability, density, compressive strength, tensile strength, and micro-structural properties of concrete, as well as the ultimate load carrying capacity of reinforced-concrete beams made of this type of concrete.

Key words:

copper slag, polypropylene (PP) fibres, waste management, mechanical properties, concrete microstructure

Izvorni znanstveni rad

[Vijayaprabha Chakrawarthy, Brindha Darmar, Ashokkumar Elangovan](#)

Beton s bakrenom zgurom i dodatkom polipropilenskih vlakana

Projektiranje održivog betona postao je glavni zahtjev u današnjoj industriji betona. U ovom radu je prikazan i analiziran dio opsežnog istraživačkog projekta koji je usmjeren na istraživanje mogućnosti korištenja bakrene zgure (eng. *copper slag* - CS) i polipropilenskih (PP) vlakana (eng. *polypropylene fibre* - PPF). Ispitivanja su provedena s ciljem utvrđivanja obradljivosti, gustoće, tlačne čvrstoće, vlačne čvrstoće i svojstava mikrostrukture betona te granične nosivosti armiranobetonskih greda izrađenih od takvog betona.

Ključne riječi:

bakrena zgura, polipropilenska (PP) vlakna, gospodarenje otpadom, mehanička svojstva, mikrostruktura betona

Wissenschaftlicher Originalbeitrag

[Vijayaprabha Chakrawarthy, Brindha Darmar, Ashokkumar Elangovan](#)

Beton mit Kupferschlacke und Zusatz von Polypropylenfasern

Die Ausführung nachhaltigen Betons ist in der heutigen Betonindustrie zu einer der Hauptanforderungen geworden. In dieser Arbeit wird ein Teil eines aufwendigen Projekts dargestellt und analysiert, das sich mit Untersuchungen zur möglichen Anwendung von Kupferschlacke (eng. *copper slag* - CS) und Polypropylenfasern (eng. *polypropylene fibre* - PPF) befasst. Die Untersuchungen wurden mit dem Ziel durchgeführt, die Bearbeitbarkeit, die Dichte, die Druck- und Zugfestigkeit und die Eigenschaften der Mikrostruktur des Betons zu ermitteln, sowie die Tragfähigkeit von Stahlbetonträgern, die aus diesem Beton hergestellt sind, zu bestimmen.

Schlüsselwörter:

Kupferschlacke, Polypropylenfasern, Abfallwirtschaft, mechanische Eigenschaften, Betonmikrostruktur

1. Introduction

Copper manufacturing industries produce 0.4 million tons of copper as such, and generate 1.4 million tons of copper slag and 0.41 million tons of gypsum, annually. The increasing cost of waste disposal through combustion and landfills, the depletion of natural resources, and the necessity to ensure sustainable development, have all amplified the need to reuse various materials as substitutes for natural resources [1]. The total content of three oxides (silica, alumina, and iron oxide) in copper slag is 89 %, which exceeds the 70 percentile requirement for natural pozzolans [2]. When used as a cement replacement, the Copper Slag (CS) compares well with the Ordinary Portland Cement, exhibiting an equal and even higher strength [3]. In addition, mechanical properties favourable for aggregate use were established, such as excellent soundness characteristics, good abrasion resistance, and good dimensional stability [4]. The leaching of heavy metals is within permissible levels in copper slag [5]. In cement replacement the slag grinding requires approximately 10 % of energy needed for the Portland cement production, which brings down the overall construction costs [6]. The increase of copper slag in cementing material decreases the mechanical strength of hardened mortars due to low CaO content, especially at early ages [7], which slows down the rate of hydration [8]. The greatest strength gain was noted after 28-90 days [9]. Long term results revealed an equal or higher strength of the Ground Copper Slag (GCS) specimens, without degradation of other properties [10]. One literature source suggests that a modified mix design can be applied by multiplying the constant with the target mean strength, and by applying water correction to water content in order to achieve constant slump [11]. The 40 % copper slag replacement shows a higher compressive strength and tensile strength at 28 days and 56 days for (C25/30) and (C30/37) mixes [12]. The combination of fly ash, copper slag, and granite powder, gives a high-strength potential at 28 days, measured as 51 N/mm² for the (C25/30) mix [13]. The combination of fly ash, silica fume, copper slag, and fibre, acts as hybrid material that increases the flexural toughness, ductility index, and ultimate load carrying capacity [14]. The copper slag can also be used for plastering works with up to 50 % replacement for vertical surfaces, and 25 % replacement for horizontal surfaces [15].

Recent studies have concentrated on making a hybrid material by adding copper slag with silica fume, fly ash, granite powder, and fibres. In this study, a combination of copper slag and fibrillated polypropylene fibre is used to study the effect of both materials on the mechanical and flexural behaviour of the mix.

2. Experimental work

2.1. Materials and mix design

The OPC 43 grade cement conforming to IS 8112-2013 [16] (CEM I 42.5N according to EN 197-1) was used throughout

this program. The copper slag conforming to ASTM C 618-92a [17] was used as fine aggregate replacement. The chemical composition of cement and copper slag [18] is compared in Table 1. The fibrillated polypropylene fibre was added to improve the tensile strength, flexural strength, toughness, impact strength, and failure mode of plain concrete [19]. Table 2 encapsulates characteristics of fibrillated polypropylene fibres conforming to ASTM C 1116-type III [20]. A view of copper slag and polypropylene fibres is presented in Figure 1. The sieve analysis test was conducted in accordance with IS383-1970 [21] in order to determine the particle size distribution and to make comparison with grading requirements given in relevant codes. Grading curves (Figure 2) demonstrate that all proportions have a comparable grading between the grading limit zones I and II, which are used to determine the proportion of coarse aggregate in concrete. The mix design for C25/30 was established according to IS10262-2009 [22]. The mix ratio and water cement ratio is 1:1.7, 1:3.70, and 0.41, respectively. The full scale reinforced concrete beams measuring 3000 X 230 X 300 mm were designed in order to exhibit the flexural and deflection characteristics of copper slag concrete with PP fibres. Cross section details of a reinforced concrete beam are illustrated in Figure 3.

Table 1. Chemical composition of cement and copper slag

Components	Cement [%]	Copper slag [%]
SiO ₂	20.85	33.05
Al ₂ O ₃	4.78	2.79
Fe ₂ O ₃	3.51	53.45
CaO	63.06	6.06
MgO	2.32	1.56
SO ₃	2.48	1.89
K ₂ O	0.55	0.61
Na ₂ O	0.24	0.28
TiO ₂	0.25	0
Na ₂ O	0.05	0.06
SiO ₂ +Al ₂ O ₃ +Fe ₂ O ₃ +CaO	92.2	95.35



Figure 1. Types of materials used: polypropylene fibres (left), copper slag (right)

Table 2. Specification of polypropylene fibre

Product	Synthetic polypropylene fibre
Polymer	100% virgin polypropylene homo-polymer
Construction	multi dimensional fibre
Length	graded 10 mm to 20 mm
Specific gravity	0.91
Melting range	162 - 164 °C
Reactivity	inert-not affected by alkali, acid and cement concrete up to 110 °C
Reaction with concrete	none, inert material giving only micro reinforcement
Strength	500 - 550 N/mm ²
Diamond length	10 - 12 mm
Elongation	15 - 18 %
Thickness	35 - 40 μ

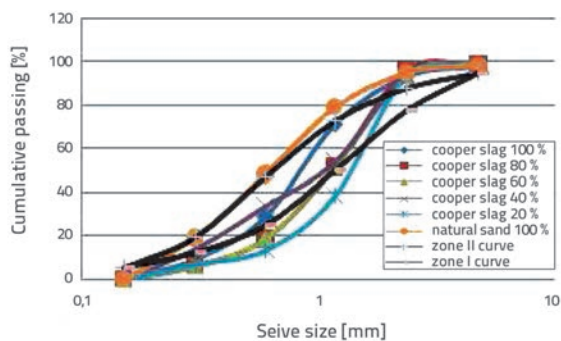

Figure 2. Particle size distribution

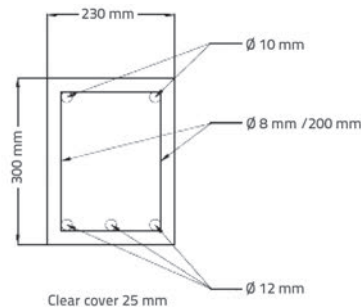

Figure 3. Cross section details of RC beam



Figure 4. Cast cubes, cylinders and reinforced concrete beam mould with reinforcement inside

2.2. Mixing and concreting

Seventeen mix proportions, with different proportions of copper slag and PP fibres, were prepared. The mixtures were designated with individual specimen ID's. Copper slag was replaced with natural sand at four proportions (20 %, 40 %, 60 % and 80 %), and PP fibres was admixed in four percentages (0.2 %, 0.4 %, 0.6 %, and 0.8 %) of the total volume of concrete. Batch quantities are listed for all proportions in Table 3. Tested properties, number of specimens, mould dimensions, and age of testing, are provided in Table 4. Crushed stone aggregates, sand, copper slag, and cement, were mixed in the

stated order. The sulphonated naphthalene based super plasticizer Conplast SP430 conforming to IS 9103:1999 [23] was added and the required water content was respected. When proper blending of ingredients was observed, around 80 % of total water was poured into the mixer and allowed to rotate for 3 minutes. After the random distribution of PP fibres, the remaining water was added. Finally, the ingredients were fully mixed for another two minutes in concrete mixer at high speed to enable even distribution of materials. The workability was measured for each mix before the concrete was placed into the moulds. The moulds were kept oiled and tightened for casting. Concrete was poured into the required mould and properly compacted using a tamping rod. Top surfaces of moulds were evened out by smooth finishing. After 24 hours, the concrete was separated from the moulds and cured for the required period. Cast specimens, and beam mould with reinforcement, are shown in Figure 4.

2.3. Methods

A compression testing machine 2000 kN in capacity was used to test the compressive strength of concrete cubes,

Table 3. Mix proportions

Serial number	Specimen ID	CS	PPF	C	FA	CS	CA	WC	SP	PPF
		[%]		[kg/m ³]						
1	CS11	0	0	363	620	0	1343	148.8	1.81	0
2	CS22	20	0.2	363	495	177	1343	148.8	1.81	1.82
3	CS23		0.4	363	494	177	1343	148.8	1.81	3.64
4	CS24		0.6	363	493	176	1343	148.8	1.81	5.46
5	CS25		0.8	363	492	176	1343	148.8	1.81	7.28
6	CS32		40	0.2	363	371	354	1343	148.8	1.81
7	CS33	0.4		363	371	354	1343	148.8	1.81	3.64
8	CS34	0.6		363	370	353	1343	148.8	1.81	5.46
9	CS35	0.8		363	369	352	1343	148.8	1.81	7.28
10	CS42	60	0.2	363	247	531	1343	148.8	1.81	1.82
11	CS43		0.4	363	247	530	1343	148.8	1.81	3.64
12	CS44		0.6	363	246	529	1343	148.8	1.81	5.46
13	CS45		0.8	363	246	528	1343	148.8	1.81	7.28
14	CS52	80	0.2	363	124	708	1343	148.8	1.81	1.82
15	CS53		0.4	363	124	707	1343	148.8	1.81	3.64
16	CS54		0.6	363	123	705	1343	148.8	1.81	5.46
17	CS55		0.8	363	123	704	1343	148.8	1.81	7.28

CS - Copper slag, PPF - Polypropylene fibre, C - Cement, CA - Coarse aggregate, WC - Water-cement ratio, SP - Superplasticizer

Table 4. Test properties, number of specimens, testing age, dimensions and methods

Test	Number of specimen	Age of testing [days]	Dimensions [mm]	Standards
Slump	----	---	---	IS7320-1974 [24]
Dry density	17	28	150 x 150 x 150	---
Compressive strength	102	7.28	150 x 150 x 150	IS516-1959 [25]
Split tensile strength	52	28	150 x 300	IS5816-1999 [26]
Flexural behaviour of RCC beam	4	28	3200 x 230 x 300	IS456:2000 [27]
Micro structural property	17	28	10 gram sample sieved through a 90 micron sieve	----

and the splitting tensile strength of concrete cylinders. All beams were designed as under-reinforced sections, and were subjected to four-point bending. The load was applied by a separate power pack assembly 500 kN in capacity. A push pull type 500 kN hydraulic jack was attached with the loading frame presenting 500 kN in maximum capacity. The load was applied at 0.1 N/mm² increments via the hydraulic jack piston. The load was transferred from piston to the spreader beam which has two points of contact to the reinforced concrete specimen. The deflection was measured at the mid span and one third of span by using the ±0.01 mm precision linear variable differential transducer (LVDTs).

3. Results and discussion

3.1. Physical properties and fresh state analysis

The low CaO content of copper slag points to a poor cementitious property, but it could have the potential to produce high pozzolans because of high concentration of silica, alumina, and iron oxide. Physical properties presented in Table 5 show that copper slag has a high specific gravity (3.56), i.e. higher than that of sand (2.51), whereas the water absorption values for copper slag and sand amount to about 0.15 % and 1.25 %, respectively. Table 6 shows that the concrete with large copper slag substitution could have larger density values ranging from 2500 kg/m³ to

Table 5. Properties of aggregate

Types of aggregate	Specific gravity	Bulk density [g/cm ³]	Fineness modulus	Water absorption [%]
Sand	2.51	1.42	2.74	1.25
Copper slag	3.56	1.75	3.51	0.15
Coarse aggregate	2.85	1.38	7.61	0.92

2800 kg/m³. It should further be noted that the increase in fibre fraction results in a decrease in the density of concrete. On the other hand, due to its low water absorption, the free water content in concrete mixtures increases with an increase in the copper slag content. It can also be noted that the higher copper slag content shows the signs of segregation and bleeding, which can have a detrimental effect on concrete performance [28]. This could possibly be overcome by adding polypropylene fibres, which control the excess free water content in concrete. Table 6 reveals that the slump values obtained for CS, i.e. 40 % and 60 %, were more or less the same when the PP fibres increased from 0.2 % to 0.6 % and also, an increasing trend line of slump was observed as shown in Figure 5. The network structure of fibrillated fibres reduces the segregation and free water flow in concrete. It absorbs more cement paste due to its larger surface area and decreases the fluidity in concrete. Slump results presented in Table 4 show that clear segregation can not be noted up to the 80 % of copper slag substitution. The PP fibres (0.8 %) exhibits a difficulty in handling, and a rich mass of fibres can be seen in and around the concrete mix.

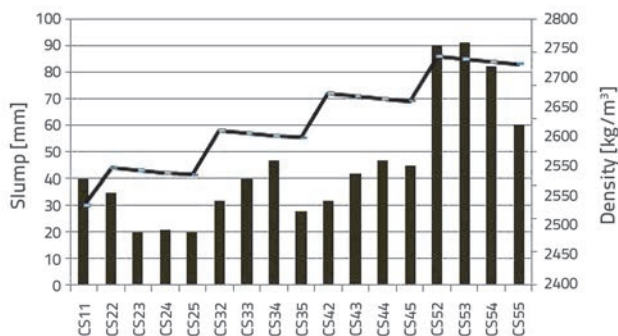

Figure 5. Comparison of slump and density

3.1. Micro structural properties

The hydration of tricalcium silicate (C₃S) is the key reaction in the development of strength in concrete. The hydration of C₃S produces excess CH (calcium-hydrates), which could be consumed by copper slag. Copper slag supplies additional silicate ions (S), which react with CH to form more C-S-H (calcium-silicate-hydrate) gel [29]. SEM images given in Figures 6 to 11 reveal that a denser texture of concrete can be recognized in blended concrete compared to that in the control mix. This dense texture could be associated with the pozzolanic activity and filling property of copper slag. Since copper slag has a medium pozzolanic activity, some unhydrated Ca(OH)₂ is inevitable. The dense

texture indicates that the cement paste is strongly connected to the aggregate matrix and that the reacted component fills the pores among the aggregates. According to SEM images, the 40 % copper slag, and the 0.4 % polypropylene fibre, represent a denser structure when compared to other proportions.

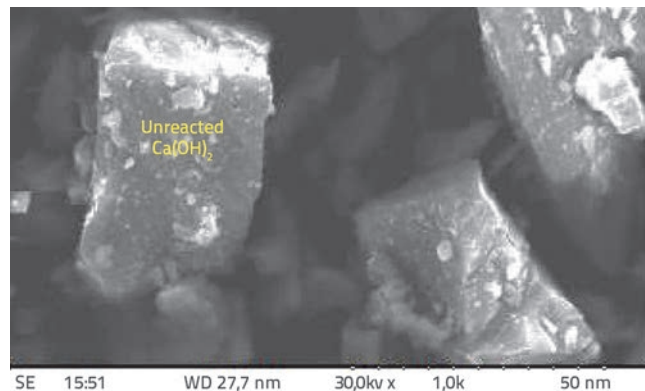

Figure 6. Control concrete (CS11)

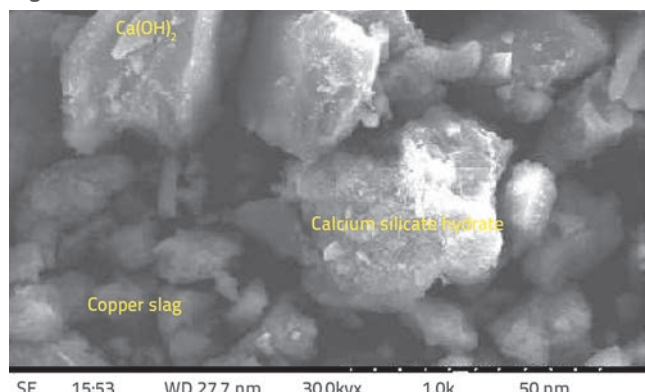

Figure 7. Copper slag 20 %, PP fibre 0,2 % (C21)

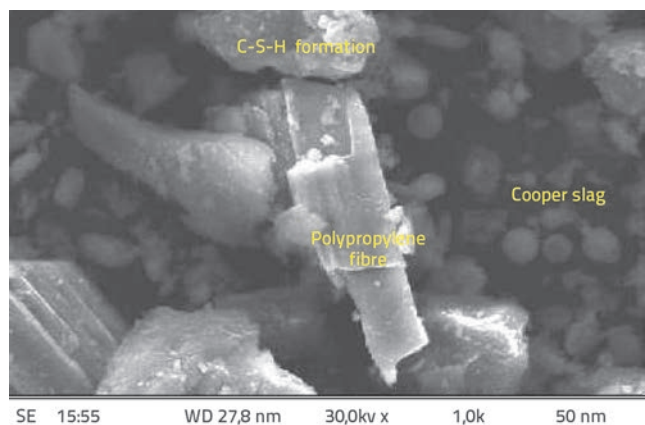

Figure 8. Copper slag 20 %, PP fibre 0,4 % (CS22)

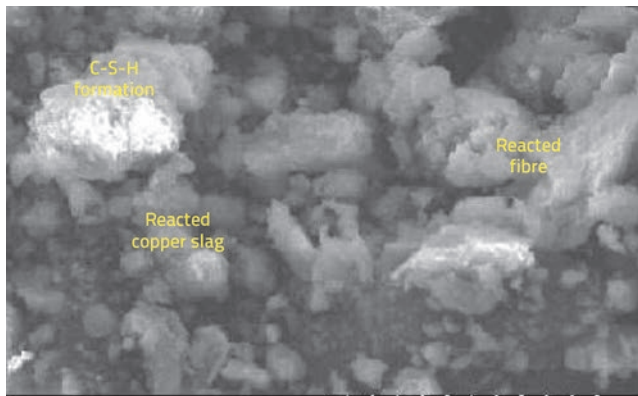

Figure 9. Copper slag 20 %, PP fibre 0,8 % (CS24)

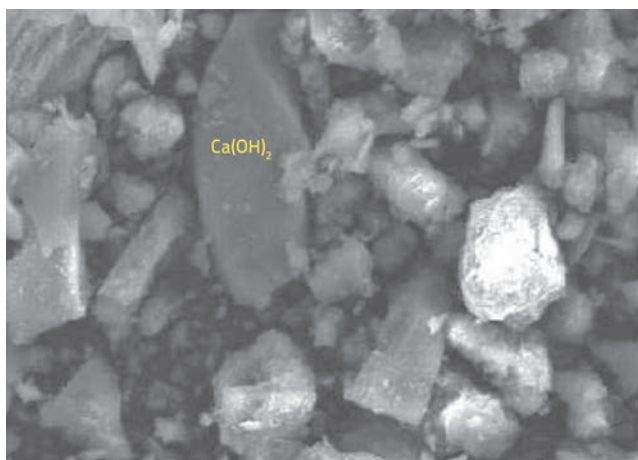

Figure 10. Copper slag 40 %, PP fibre 0,4 % (CS32)

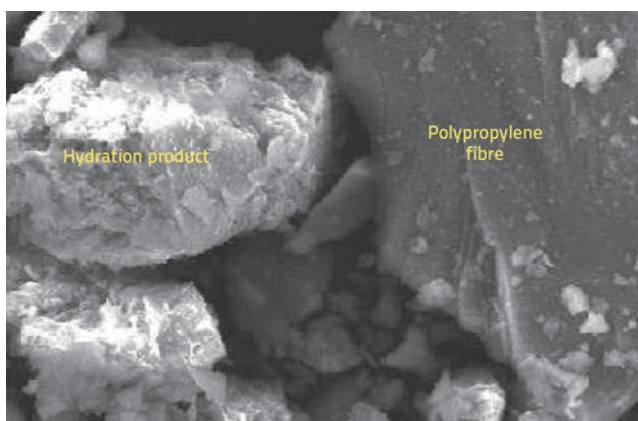

Figure 11. Copper slag 80 %, PP fibre 0,4 % (CS42)

3.2. Compressive strength

Table 6 summarizes the compressive strength values at 7 and 28 days and the splitting tensile strength values

obtained at 28 days. To avoid situations in which test results fall below the characteristic compressive strength, the concrete mix has to be proportioned for the target mean strength f_{ck}' .

$$f_{ck}' = f_{ck} + 1,65s$$

where

f_{ck}' - target mean strength at 28 days [N/mm²]

f_{ck} - characteristic compressive strength at 28 days [N/mm²]

s - standard deviation [N/mm²].

For C25/30 grade concrete the standard deviation value is taken to be 5 MPa as per IS10262-2009.

Generally, a higher amount of slag reduces the early-age strength of concrete but increases the long term strength. From the observed results, it can be seen that the 40 % copper slag shows a high early strength (38.26 MPa) at seven days, which amounts to 90 % of the target mean strength when combined with PP fibres. The CS33 achieved the 46.67 MPa compressive strength at 28 days, which is by 22.1 % greater than the target mean strength. Higher strength values of copper slag concrete were achieved because of good cohesion between the aggregate and cement paste. A combination of copper slag and PP fibres leads to proper distribution of fibres, and hence results in the reduction of pores. However, a higher PP fibres content results in poor performance of concrete. An optimum percentage of PP fibres was identified through the compressive strength results amounting to 0.4 %. Beyond that, the mix requires a strenuous effort to acquire a homogeneous mix without the segregation and balling effect of PP fibres. The PP fibres acts as a reinforcement between the cement and aggregates. Since fibres make the concrete softer and more ductile, the failure pattern of specimens shows no spalling of concrete. Additionally, PP fibres works as a crack arrester in concrete surfaces. When combined with CS, a good surface finish is achieved. Up to 50 % of CS and 0.4 % of PP fibres, with instant free water, make the concrete workable and non-porous, with good particle packing, easy placement, and good finishing. Beyond that, more free water results in the reduction of compressive strength.

Fibres are very well known for high tensile strength [19, 30]. The maximum tensile strength value of 3.537 N/mm² was observed for the CS35 specimen, which is by 31.58 % greater than that of the reference mix. In each copper slag replacement, the PP fibres volume fraction of 0.8 % scores the highest tensile strength. The rate of increase in tensile strength is in the range of 16 % to 32 % when compared to the control mix. The PP fibres dosage beyond 0.6 % shows difficulty in handling. It can therefore be concluded that the PP fibres content of up to 0.4 % gives a sufficient mechanical behaviour when combined with copper slag.

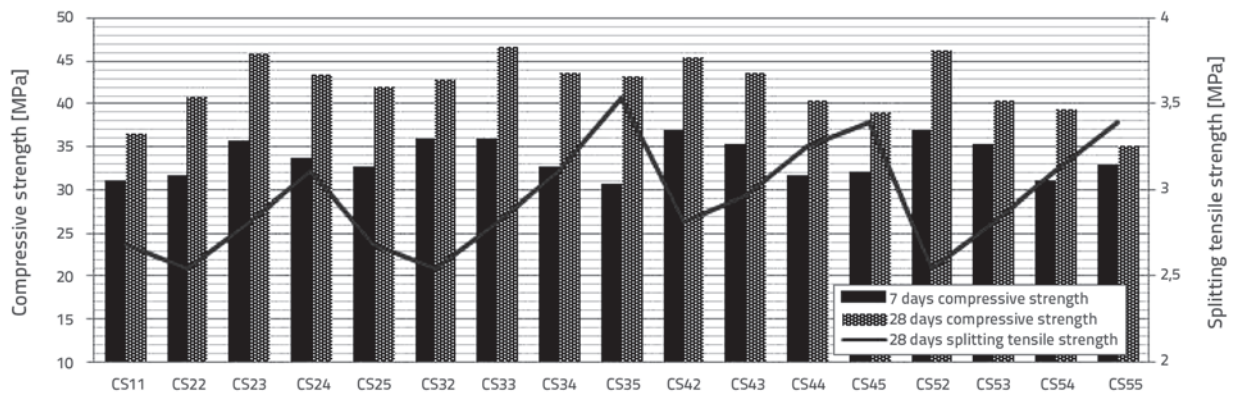

Figure 12. Variation of compressive strength and splitting tensile strength of concrete

Table 6. Fresh and hardened concrete properties

Specimen ID	Copper slag [%]	PP fibres [%VF]	Slump [mm]	Density [kg/m ³]	Compressive strength [MPa]		Splitting tensile strength [MPa]
					at 7 days	at 28 days	at 28 days
CS11	0	0	40	2520.07	31.11	36.59	2.68
CS22	20	0.2	35	2574.976	31.70	40.76	2.54
CS23		0.4	20	2571.636	35.71	45.91	2.82
CS24		0.6	21	2568.296	33.78	43.43	3.11
CS25		0.8	20	2564.966	32.59	41.91	2.68
CS32		40	0.2	32	2631.025	35.85	42.81
CS33	0.4		40	2627.572	36.00	46.67	2.82
CS34	0.6		47	2624.12	32.74	43.70	3.11
CS35	0.8		22	2620.678	30.67	43.11	3.53
CS42	60	0.2	32	2687.073	36.89	45.48	2.82
CS43		0.4	42	2683.508	35.26	43.70	2.97
CS44		0.6	47	2679.944	31.70	40.30	3.25
CS45		0.8	45	2676.389	32.15	38.96	3.39
CS52	80	0.2	90	2743.122	36.89	46.22	2.54
CS53		0.4	91	2739.445	35.26	40.44	2.82
CS54		0.6	82	2735.768	31.11	39.41	3.11
CS55		0.8	60	2732.101	32.89	35.11	3.39

3.3. Flexural performance of reinforced concrete beams

3.3.1. Initial crack and crack pattern

Four RC flexural beams were subjected to the four-point bending test (Figure 13) in order to determine the failure load, mid-span deflection, deflection at one third of the span, and crack patterns. All tested specimens are presented in Figure 14. Crack patterns are shown in Figures 15 to 18. The PP fibres content of 0.4 % was fixed for all beam specimens. The beam containing 20 % of copper slag shows the yield load of 37 kN, which is higher when

compared to other beams. The propagation of cracks in the tension region increases from bottom to top. Cracks maintain their straight path towards the compression zone. Compared with the control beam (CS11), the initial crack loading observed for CS23, CS33, CS43 increased to 71.42 %, 28.57 %, and 14.28 %, respectively. A brittle bending fracture was identified at the top surface of the control concrete, which was not registered in the copper slag concrete. A partial bonding failure can be visualized at the top of the specimen, which leads to separation of the concrete portion from the compression reinforcement. The bonding failure was found to be high and some shear cracks were observed beyond the flexure zone in the control specimen.

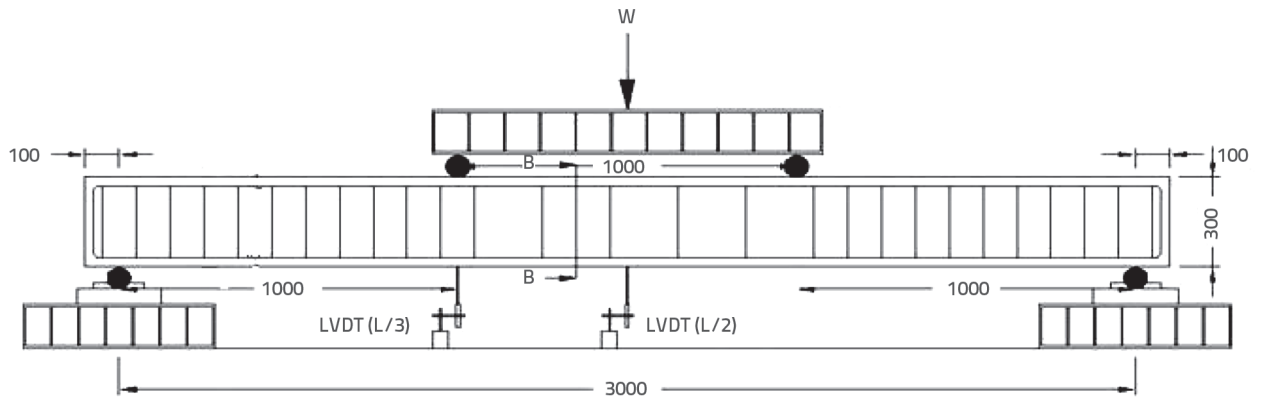

Figure 13. Loading set up for four point bending, dimension in mm

Table 7. Failure loads, deflections and stiffness values

Specimen ID	Load [kN]		Deflection [mm]		Initial stiffness [kN/mm]	Ultimate stiffness [kN/mm]	Energy ductility index (P_u/P_y)	Displacement ductility index (Δ_u/Δ_y)
	Yield	Ultimate	Yield	Ultimate				
CS11	55.44	69.3	8.65	90.45	6.41	0.77	1.25	10.46
CS23	50.82	74.54	4.67	120.2	10.88	0.62	1.47	25.74
CS33	60.06	78.54	10.75	145.3	5.59	0.54	1.31	13.52
CS43	50.82	70.84	6.66	135.2	7.63	0.52	1.39	20.3

But specimens with PP fibres and CS do not show any sign of shear failure below the loading point, as well as in the area of minimum shear reinforcement.



Figure 14. Reinforced concrete prototypes after testing



Figure 15. Crack pattern and failure mode of control beam (CS11)



Figure 16. Crack pattern and failure mode of RC beam for copper slag 20% replacement and PP fibre 0,4%



Figure 17. Crack pattern and failure mode of RC beam for copper slag 40% replacement and PP fibre 0,4%



Figure 18. Crack pattern and failure mode of RC beam for copper slag 60% replacement and PP fibre 0,4%

3.3.2. Load deflection performance

The load deflection curve propagation was linear at the beginning, but it gradually turned to non-linear with an increase in load. This transformation to nonlinear is due to low stiffness of the RC beam as caused by concrete failure in tension zone. The calculated stiffness values and ductility index are presented in Table 7. Generally, the first crack development occurred because of failure observed in concrete. Further increase in load enlarged the crack opening at the bottom, and the nonlinear response became predominant. When the bottom steel yielded, the curve persisted at a flatter profile. The top compressive concrete crushed at the ultimate stage of failure load since the mid span deflection increased rapidly with the decrease in load. All beams were destroyed by the time the tension steel snapped. The load deflection response of the copper slag concrete, as compared to that of the control specimen, is shown in Figure 19.

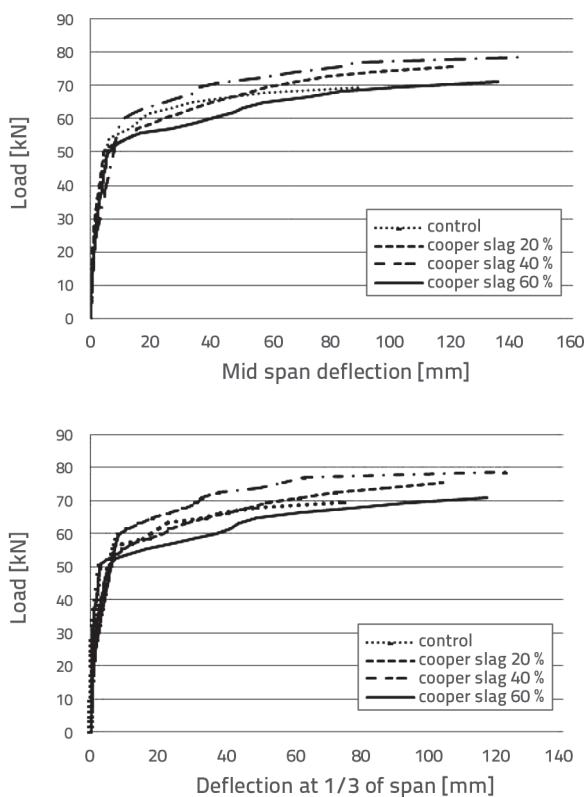

Figure 19. Load deflection response at mid span and one third of span

Similarly, the ultimate load carrying capacity increased to 7.56 %, 13.33 %, and 2.22 %, for CS23, CS33, and CS43, respectively. The deflection value for individual loads is minimum for the CS23 specimen compared to other proportions. In addition, all copper slag prototypes satisfy the serviceability criteria according to which the deflection stays within allowable limits under service load. The maximum 13 % increase in ultimate load carrying capacity was registered for the CS33 specimen. The

beams strengthened with fibres show a higher ductility index compared to the control beam. The ductility performance is not directly influenced by the copper slag replacement. On the other hand, it fills minor gaps in fibre matrix and improves bonding between fibres. Since the fibre addition increases stiffness, it is not surprising that the initial stiffness of CS23 is by 70 % higher than that of the control specimen. In addition, the ultimate stiffness decreases with an increase in the CS content.

4. Conclusion

The combined effect of copper slag and polypropylene fibres on the slump, density, compressive strength, splitting tensile strength, and load carrying capacity of reinforced concrete beams, and on micro structural characteristics, is analyzed in the paper. A lower water absorption property of copper slag contributes to the better workability when added with the PP fibres. Some negative impacts on copper slag like segregation, bleeding, and surface cracking, are compensated by the addition of PP fibres and superplasticizer. The adverse effect of a greater free water content in copper slag concrete can be effectively counteracted by the addition of polypropylene fibre. However, a higher PP fibres content reduces the workability, increases water demand, and lowers the compressive strength. In a bid to achieve good behavioural properties, care should be taken to adopt the PP fibres content of up to 0.4 %. This study reveals that the copper slag admixed with PP fibres exhibits a high 7-day strength amounting to 90 % of the target mean strength. Even the 80 % copper slag replacement does not show any reduction in strength at 28 days, compared to the reference mix. The micro structural characteristics revealed that a dense particle packing texture results from the pozzolanic reaction of copper slag in concrete. Experimental results for reinforced-concrete beams show that the failure of concrete in tension zone, which is referred to as the first crack load, is delayed for all copper slag proportions compared to the control beam. The mechanical, micro-structural, and flexural performance shows that the role of copper slag in sustainable concrete cannot be neglected in future applications. In summary, copper slag can be used at up to 40 %, with up to 0.4 % of polypropylene fibres, without any deleterious effects on concrete properties. In addition, the percentage of replacement can be increased by adopting a proper combination of admixtures.

Acknowledgement

The authors would like to acknowledge the financial support provided through the Technical Education Quality Improvement Program TEQIP-II, as implemented by the National Project Implementation Unit (NPIU) of the Ministry of Human Resource Development, Government of India, which is in charge of implementation of the World Bank assisted projects in technical education.

REFERENCES

- [1] Thyelim, T., Chu, J.: Assessment of the use of spent copper slag for land reclamation, *Waste Management & Research*, 24 (2006), pp. 67-73, <http://dx.doi.org/10.1177/0734242X06061769>
- [2] Al-Jabri, K.S., Hisada, M., Al-Oraimi, S.K., Al-Saidy, A.H.: Copper slag as sand replacement for high performance concrete, *Cement & Concrete Composites*, 31 (2009) 7, pp. 483-488, <http://dx.doi.org/10.1016/j.cemconcomp.2009.04.007>
- [3] Shi, C., Meyer, C., Behnood, A.: Utilization of copper slag in cement and concrete, *Resources, Conservation and Recycling*, 52 (2008) 10, pp. 1115-1120, <http://dx.doi.org/10.1016/j.resconrec.2008.06.008>
- [4] Gorai, B., Jana, R.K., Chand, P.: Characteristics and utilisation of copper slag-a review, *Resources, Conservation and Recycling*, 39 (2003) 4, pp. 299-313, [http://dx.doi.org/10.1016/S0921-3449\(02\)00171-4](http://dx.doi.org/10.1016/S0921-3449(02)00171-4)
- [5] Supekar, N.: Utilization of copper slag for cement manufacture construction management and review, (Sterlite Industries(l) Ltd, Tuticorin, 2007.
- [6] Shi, C., Qian, J.: High performance cementing materials from industrial slags-a review, *Resources, Conservation and Recycling*, 29 (2000) 3, pp. 195-207, [http://dx.doi.org/10.1016/S0921-3449\(99\)00060-9](http://dx.doi.org/10.1016/S0921-3449(99)00060-9)
- [7] Marku, J., Vaso, K.: Optimization of copper slag waste content in blended cement production, *Zastita Materijala*, 51 (2010) 2, pp. 77-80.
- [8] Al-Jabri, K.S., Hisada, M., Al-Saidy, A.H., Al-Oraimi, S.K.: Performance of high strength concrete made with copper slag as a fine aggregate, *Construction and Building Materials*, 23 (2009) 6, pp. 2132-2140, <http://dx.doi.org/10.1016/j.conbuildmat.2008.12.013>
- [9] Mobasher, B., Devaguptapu, R., Arino, A.M.: Effect of copper slag on the hydration of blended cementitious mixtures paper presented at ASCE, *Materials engineering conference on Materials for the new millennium*, Arizona (1996), pp.1677-1686.
- [10] Arino, A.M., Mobasher, B.: Effect of Ground Copper slag on strength and Toughness of Cementitious Mixes, *ACI materials journal*, 96 (1999), pp. 68-74.
- [11] Pazhani, K., Jeyaraj, R.: Study on durability of high performance concrete with industrial waste, *Applied Technologies & Innovations*, 2 (2010) 2, pp. 19-28.
- [12] Reddy, S., Kumar, K.M.: Utilisation of Copper slag as a Partial Replacement of fine aggregate in concrete, *International Journal of Mechanical Engineering and Computer Application*, 1 (2013) 7, pp.140-144.
- [13] Kayathri, K., Vigneshkumar, C., Rani, G.M., Karthick, K.: Effect of Copper slag, Fly Ash and Granite Power as a Partial Replacement in Fine aggregate, *International Journal of Innovative Research in Science, Engineering and technology*, 3 (2014) 5, pp. 439-443.
- [14] Sakthieswaran, N., Ganesan, K.: Flexural performance of concrete beams containing Fly-ash, Silica fume, Copper slag, and Fibres, *Australian Journal of Basic and applied Sciences*, 7 (2013) 8, pp. 886-891.
- [15] Madheswaran, C.K., Ambily, P.S., Dattatreya, J.K., Rajamane, N.P.: Studies on use of Copper slag as Replacement Material for River Sand in building Constructions, *Journal of the Institution of Engineers India: Series A*, 95 (2014) 3, pp.169-177.
- [16] IS 8112:2013-Standard specification for Ordinary Portland Cement 43 grade.
- [17] ASTM C 618-92a, Standard specification for Fly Ash and raw or Calcined Natural Pozzolan for use as a mineral admixture in Portland cement Concrete, ASTM standards, 2012.
- [18] Najimi, M., Pourkhorshidi, S.J.: Durability of copper slag contained concrete exposed to sulfate attack, *Construction and Building materials*, 25 (2011) 4, pp.1895-1905.
- [19] Bagherzadeh, R., Pakravan, H.R., Sadeghi, A.H., Latifi, M., Merati, A.A.: An Investigation on Adding Polypropylene Fibers to Reinforce Lightweight Cement Composites (LWC), *Journal of Engineered Fibers and Fabrics*, 7 (2012) 4, pp. 13-21.
- [20] ASTM C1116-type III -Standard for polypropylene fibre.
- [21] IS 383-1970, Specification for coarse and fine aggregates from natural sources for concrete, Bureau of Indian Standards, New Delhi.
- [22] IS: 10262-2009, recommended guidelines for concrete mix design, Bureau of Indian Standards (BIS), New Delhi, India.
- [23] IS 9103:1999, Specification for admixtures for concrete, Bureau of Indian Standards, New Delhi, India.
- [24] IS 7320:1974, Specification for concrete slump test, Bureau of Indian Standards, New Delhi, India.
- [25] IS: 516-1959, Methods of tests for strength of concrete, Bureau of Indian Standards, New Delhi, India.
- [26] IS 5816: Method of test splitting tensile strength of concrete, Bureau of Indian Standards, New Delhi, India.
- [27] IS: 456 - 2000, Code of practice for Plain and Reinforced Concrete, Bureau of Indian Standards, New Delhi, India.
- [28] Al-Jabri, K.S.: Copper slag as fine aggregate for high performance concrete, *High Performance Structures and Materials III*, 85(2006), pp. 381-389, <http://dx.doi.org/10.2495/HPSM06037>
- [29] Shetty, M.S.: Concrete Technology, 6th edition, S. Chand & Company Ltd, New Delhi, 2005.
- [30] Ramujee, K.: Strength properties of polypropylene fibre reinforced concrete, *International Journal of Innovative Research in Science Engineering and Technology*, 2 (2013) 8, pp. 3409-3413.