



## BAMBOO BICYCLE – PAST OR FUTURE?

Frano Penava<sup>1, \*</sup>, Suzana Jakovljević<sup>2</sup> and Željko Alar<sup>2</sup>

<sup>1</sup>c/o University of Zagreb – Faculty of Mechanical Engineering and Naval Architecture  
Zagreb, Croatia

<sup>2</sup>University of Zagreb – Faculty of Mechanical Engineering and Naval Architecture  
Zagreb, Croatia

DOI: 10.7906/indecs.14.1.7

Regular article

*Received:* 30 December 2015.

*Accepted:* 19 January 2016.

### ABSTRACT

In this article the experiment was carried out to establish tensile strength values of two different bamboo species, which are obtained by the static tensile test. The tensile strength results of two tested species Tonkin Cane and Ku Zhu bamboo are presented and compared with traditional materials used for bicycle frame to determine their suitability for designing a frame. Physiology and other properties of bamboo were elaborated as well. The purpose of this study was to gain more knowledge on bamboo and prove his suitability in use as an alternative for ecologically unacceptable materials. Therefore, application of the natural materials is essential for the sustainable development. The fact that they have unlimited resources the use of bamboo has great potential and this article explains why.

### KEY WORDS

tensile strength, bamboo, bamboo bicycle, Tonkin Cane, Ku Zhu bamboo

### CLASSIFICATION

JEL: L83, L91

\*Corresponding author, *η*: [frano.penava@gmail.com](mailto:frano.penava@gmail.com); +385 97 701 7101;  
Faculty of Mechanical Engineering and Naval Architecture, I. Lučića 5, HR – 10 000 Zagreb, Croatia

## **INTRODUCTION**

The global trend is currently focused on industrial impact on the nature. The climate change, pollution and unsustainability are consequences of current state in the industry. At the end of the 20<sup>th</sup> century, experts concluded that the system is unsustainable. Therefore, elevated raw material prices, non-renewable resources and ecological awareness are forcing the industry to find an alternative material source. Encouraged to develop “green materials”, companies are adapting to new philosophies. They are focusing on the sustainable development, reduction of the energy consumption and preserving the natural environment. These new “philosophies” hasten the development of the natural materials [1]. The scientists have been researching potential use of the natural materials like wood, grass and plants [2-4]. Besides diverse properties, they have shown that they can be used in various forms, such as material itself, natural fibres, or as part of biocomposites. In past few years, the term “eco” gained in importance hence application of the natural materials is increasing. Since the resources are unlimited, the use of the natural materials is showing great potential. One of these materials is bamboo.

The researchers in this project want to test the mechanical properties of bamboo. The main goal was to learn more about bamboo and prove its suitability in use as a replacement for ecologically unacceptable materials. Tensile strength was determined in this project with purpose to establish a value of the mechanical properties so that it can be used as a design material for a bicycle frame.

Over the years, researchers all over the world were experimenting on bamboo, determining their mechanical properties and chemical composition. The most of research is focused on bamboo fibre biocomposites [2, 3] or for constructional purposes [4, 5]. Therefore, due to insufficient knowledge about bamboo intended for bicycle frames, opportunity to complement that knowledge has occurred. Large part of information is unanswered, such as is bamboo good enough for bicycle frame; are the mechanical properties of bamboo species significantly distinct?

To clarify these questions it has been decided to determine a value of tensile strength of two different species.

In this article, tests were carried out on two species of bamboo. The results of tensile strength will be presented and compared with conventional materials used for bicycle frames to determine is tensile strength satisfying for designing a frame. In section two, various materials for bicycle frame will be mentioned. In section three it will be elaborated why is bamboo so interesting. In section four methods of experiments will be explained, while in section five results will be presented and discussed.

## **BICYCLE MATERIALS**

Conventional materials used for a bicycle frames are metals like iron, aluminium, copper and titanium and their alloys. For the commercial uses steel and aluminium alloys proved to be the most popular, thanks to excellent properties-cost ratio. In case of steel, low-alloy steel is used commonly for a bicycle frame and for other components as well, especially chromium-molybdenum based alloys whose tensile strength is around 710 N/mm<sup>2</sup>. Steel frame are stiff and affordable but heavy. Preferable aluminium alloys are 6060 and 7075 due to their suitable properties; they are light and affordable with stiff drive train. Titanium alloys demonstrated exceptional properties and it proved itself as an outstanding material for both frame and components but due to high price it is rarely used for general population [6]. Newest breakthrough for the general population is carbon-fibre composite. Excellent mechanical properties can be achieved by using a carbon fibres embedded in epoxy. Their popularity is increased mostly because of lightweight frames and other components. The amount of their strength is equal to

the strength of titanium alloy, but since the carbon-fibre composites are lightweight their strength-to-weight ratio is higher. Even though they demonstrated excellent properties they do not dominate in the bicycle industry due to expensive manufacture. Besides that, production of the carbon-fibre composite bicycles is not ecological [6, 7].

A bamboo frame is not new to us; they were first patented by British company Bamboo Cycle Ltd. and introduced to the general population in 1894. Year after other companies, like Grunder & Lemisch from Austria, presented their bamboo bicycles [6]. Even though, wooden and bamboo bicycles demonstrated good characteristics, with development of a metal joining methods, metals like steel and aluminium alloys are dominating in the bicycle industry. However, with rise of Green movement, bamboo bicycles are being used again as cheaper and more sustainable alternative to unsustainable metal bicycles.

Companies like Bambooride, BME Design, Craig Calfee Designs and Panda Bikes embraced Green movement philosophy. They offer new-old solution for the bicycle industry – bamboo frames. Since bamboo has fast and sustainable growth, it is being used as a cheap alternative to traditional materials like steel or aluminium alloys. Bamboo bicycles demonstrate great vibrational damping with good stiffness. Beside the fact that it is very comfortable to ride that bicycle; it is made of natural material. As carbon-fibre composite, bamboo is showing high strength-to-weight ratio [7]. According to other studies [8] bamboo has higher tensile strength-to-weight ratio than mild steel and higher compressive strength than concrete [3].

## WHAT IS BAMBOO?

Bamboo is common term that is used for the members of large woody grass. They are part of family Herbaceous grasses and subfamily Bambusoideae. Bamboo has a cylindrical hollow woody culms divided by nodes [3, 4, 9]. Their growth depends on species; some species are short and bushy while some species can grow up to 40 meters. They are resistant to cold temperature, some species can endure  $-20\text{ }^{\circ}\text{C}$ . Beside great resistance, a bamboo grows more rapidly than any wood (biggest growth measured was on the Moso species 1,05 m in 24 hours) and it can be harvested after 3 years. Bamboo is anisotropic composite material with high strength in direction of the fibres, but low in opposite direction. It is estimated that there are around 1250 species; the most of them grow in Asia, America and Africa [5]. Through the past, the bamboo, with more than 1500 commercial applications, played a fundamental role in Asia. It was used as a construction material, dishes, food, biomass, furniture, etc. Bamboo is outstanding constructional material, and holds many advantages over steel, wood, concrete. Production of steel and concrete demands more energy and it is harmful for the environment while bamboo with his fast growth ensures abundance of natural resources (some Moso species achieve height of almost 20 meters in 3 months) [9, 10].

In this project, experiments were made on two species *Pseudosasa amabilis* or Tonkin Cane and *Pleioblastus amarus* or Ku Zhu bamboo.

Tonkin Cane grows in East Asia, in countries like China, Japan and Korea. According to some researchers, this bamboo species has the highest strength from all bamboos due to high density of fibres. Tonkin Cane is often used in sports and aesthetics; thanks to good mechanical properties they are frequently exported to USA and EU for manufacture of fishing rods and skiing sticks. Culms are straight and smooth while they can grow up to 17 meters which makes them suitable for designing purposes [1].

Ku Zhu bamboo grows in East Asia, in China and Japan. They grow up to 7 meters. This species is very resistant; it can endure drought, heat, high humidity and cold weather, also it is resistant to pests and pollution. Unlike Tonkin Cane, Ku Zhu is rarely mentioned and used for commercial purposes.

## CHEMICAL COMPOSITION

Bamboo consists of cellulose, hemicelluloses and lignin. These components make up to 90 % of bamboo weight. Other constituents are proteins, fat, pectin, tannins, pigments and ashes. The physiology of bamboo depends on these constituents, which varies from species to species. The chemical composition of bamboo also varies with age. According to previous studies, with aging bamboo, there was a decline in the proportion of cellulose. Lignin is a constituent who gives stiffness and yellow color to bamboo. Also, a lignin proved to be highly resistant to alkaline actions. Non-cellulose component of bamboo affect on the properties such as density, strength, moisture, and the flexibility [2]. After heat treatment, the chemical composition of bamboo will be changed. Effects of heat on bamboo are still unpredictable. Given the potential of bamboo as a material, more and more scientists deal with this problem [5]. Chemical constituents of bamboo fibre are shown in Figure 1.

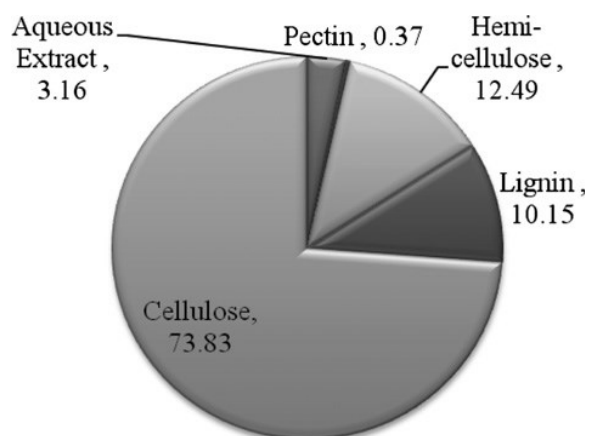

Figure 1. Chemical constituents of bamboo fibre [2].

## MECHANICAL PROPERTIES

The mechanical properties of the bamboo are determined by properties of fibres and matrix. The volume fraction of fibres and mechanical parameters of the phases are the most important factors to determine mechanical properties. However, that is impossible to measure hence mechanical behaviours of bamboo are related to distribution of fibres along the bamboo. According to statistical analysis tensile strength and Young's module are associated to volume variation of fibres [3]. In cross section, fibres are arranged along the entire radial direction. The density of fibres near the outer part of the wall is greater than towards the interior. It is clear that because of such bamboo characteristic, mechanical properties are uneven on cross section. According to studies [3, 11] strength is higher at the bottom of the culm (closer to ground). In addition to that, bamboo demonstrated sensitivity to interlaminar cracking, especially in the middle of the culm wall.

## LABORATORY TESTING

Test materials were acquired from Austrian company Bambooride. Bamboo poles originated from China. After harvest, they were dried for six months in room with 30 % humidity without any chemical treatment. Every pole was cut from bamboo culm older than 3 years. Tonkin Cane was harvested in 2012, while Ku Zhu bamboo was harvested in 2013. Since then they were stored in room with temperature between 20-25 °C and 40-50 % humidity. Bamboo poles are shown in Figure 2.

Experiment was conducted on the University of Zagreb, Faculty of Mechanical Engineering and Naval Architecture at the Department of Materials. The main objective of the research was



**Figure 2.** Bamboo poles.

to compare the results of tensile strength these two species with other conventional materials used for bicycle frame. Tensile strength test was carried out on test machine with the following data: Manufacturer: Heckert, type: WPM, EU 40 MOD, accuracy class: 0,5, test machine is shown in Figure 3 a. The test was carried out on five specimens of Tonkin Cane and five specimens of Ku Zhu bamboo. Tested samples of Tonkin Cane are shown in Figure 3b. Specimens had square cross-section and they were prepared according to [12], similar test on bamboo was made and specimen dimension is used following recommendation in ASTM D143-95. Specimen dimensions are presented in Figure 4. Tests were performed according to norm HRN EN ISO 6892-1 at temperature of 25 °C and loading rate of 10 mm/min.

Diagrams of static tensile test are shown in Figure 5 for Tonkin Cane (sample 2-5) and in Figure 6 for Ku Zhu (sample 18-3). Test results are shown in Table 1 for Tonkin Cane and in Table 2 for Ku Zhu bamboo ( $a_0$  – cross section thickness,  $b_0$  – cross section width,  $S_0$  – cross section surface,  $F_m$  – maximum force,  $R_m$  – tensile strength).

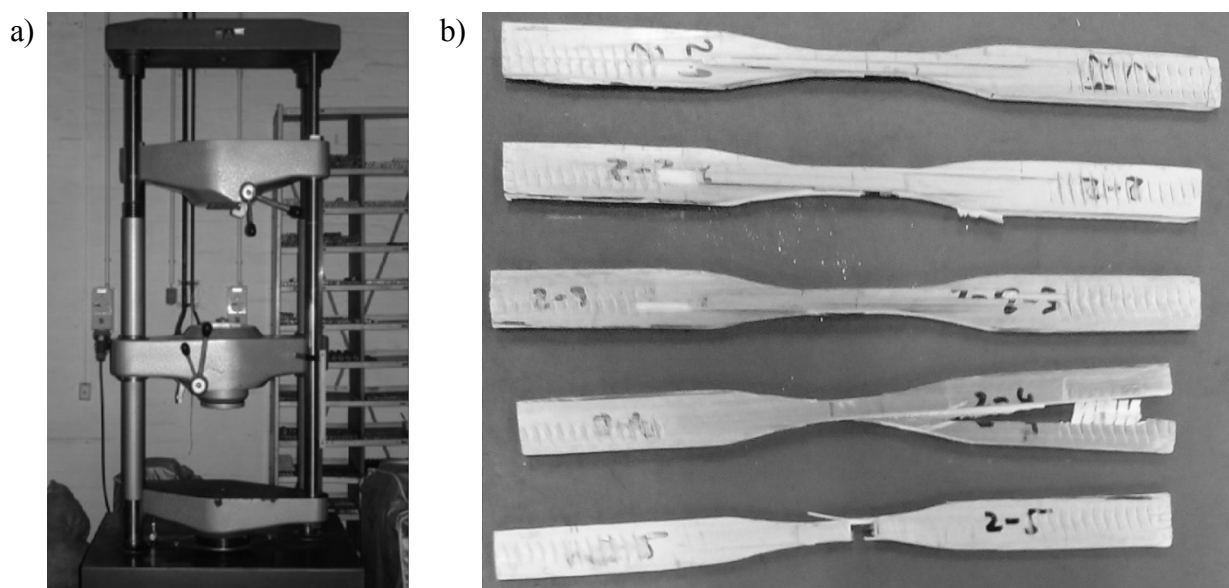

**Figure 3.** a) Test machine b) tested samples.

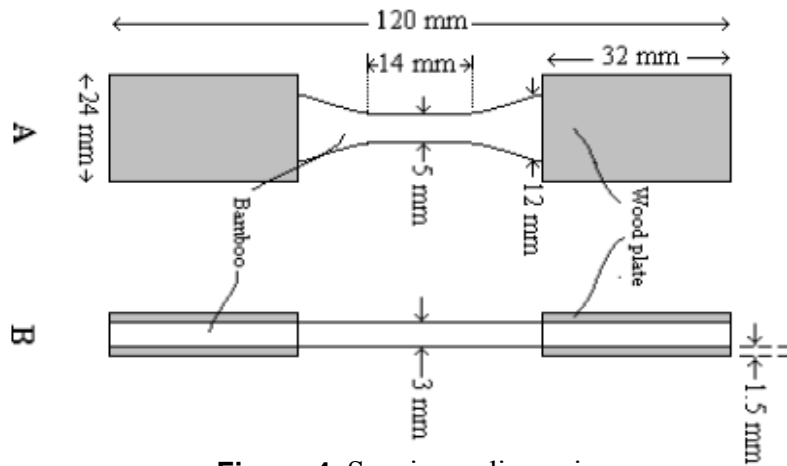

Figure 4. Specimen dimensions.

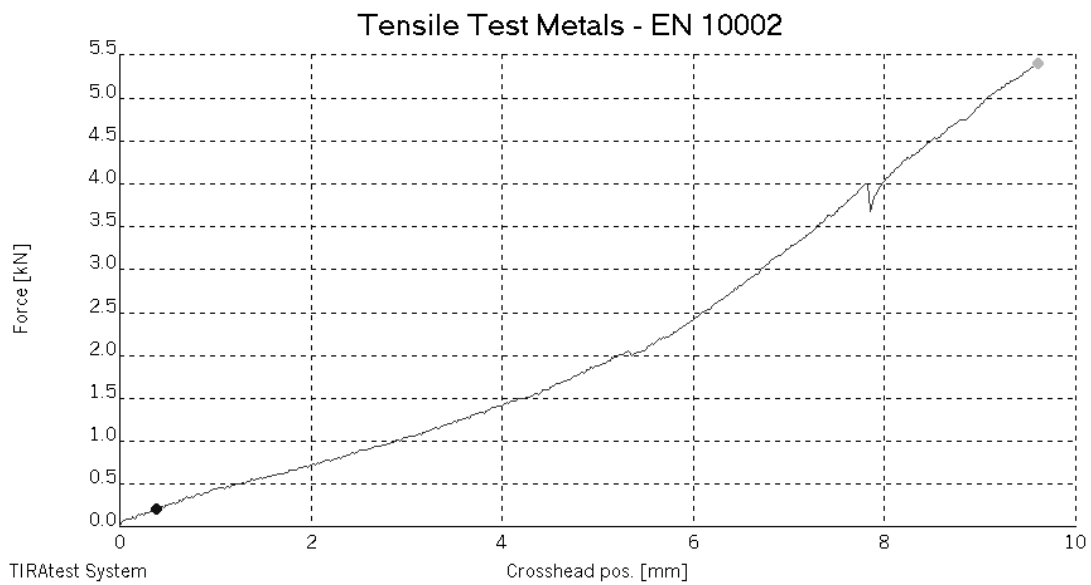

Figure 5. Diagram force-crosshead position for sample 2-5 Tonkin Cane

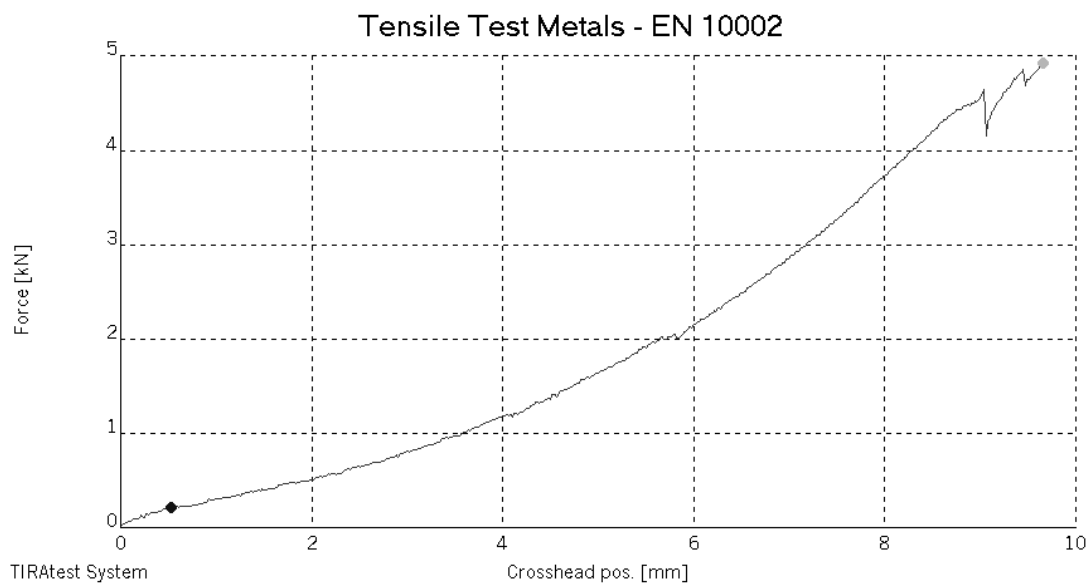

Figure 6. Diagram force-crosshead position for sample 18-3 Ku Zhu bamboo.

**Table 1.** Results of static tensile test for Tonkin Cane.

Number	Sample	$a_0$ , mm	$b_0$ , mm	$S_0$ , mm	$F_m$ , kN	$R_m$ , N/mm <sup>2</sup>
1.	2-1	3,78	5,58	21,09	4,645	<b>220,22</b>
2.	2-2	4,04	5,48	22,14	4,766	<b>215,27</b>
3.	2-3	4,43	5,53	24,5	4,465	<b>182,26</b>
4.	2-4	4,33	4,99	21,61	4,064	<b>188,09</b>
5.	2-5	3,99	5,5	21,95	5,402	<b>246,16</b>
<b>Average</b>		<b>4,114</b>	<b>5,416</b>	<b>22,258</b>	<b>4,6684</b>	<b>210,4</b>

**Table 2.** Results of static tensile test for Ku Zhu bamboo.

Number	Sample	$a_0$ , mm	$b_0$ , mm	$S_0$ , mm	$F_m$ , kN	$R_m$ , N/mm <sup>2</sup>
1.	18-1	4,35	5,35	23,27	4,52	<b>194,22</b>
2.	18-2	4,27	5,35	22,84	4,271	<b>186,96</b>
3.	18-3	4,67	5,3	24,75	4,915	<b>198,58</b>
4.	18-4	4,48	5,38	24,1	4,815	<b>199,77</b>
5.	18-5	4,66	5,2	24,23	4,564	<b>188,35</b>
<b>Average</b>		<b>4,486</b>	<b>5,316</b>	<b>23,838</b>	<b>4,617</b>	<b>193,576</b>

## RESULTS AND DISCUSSION

The objective of this research was to obtain tensile strength values of two bamboo species and determine their adequacy for bicycle frame construction. By observing diagrams in Figure 5 and Figure 6 we can perceive that Tonkin Cane endured higher force than Ku Zhu bamboo. Therefore, we can state the obvious that the mechanical properties differ among bamboo species.

By calculating the average tensile strength of test specimens from Table 1 and Table 2, we can notice that Tonkin Cane has 8 % higher tensile strength than Ku Zhu bamboo. Comparison of tensile strength values and their averages shown in Figure 7 indicates that Tonkin Cane, considering tensile strength, would be better choice for bicycle frame construction.

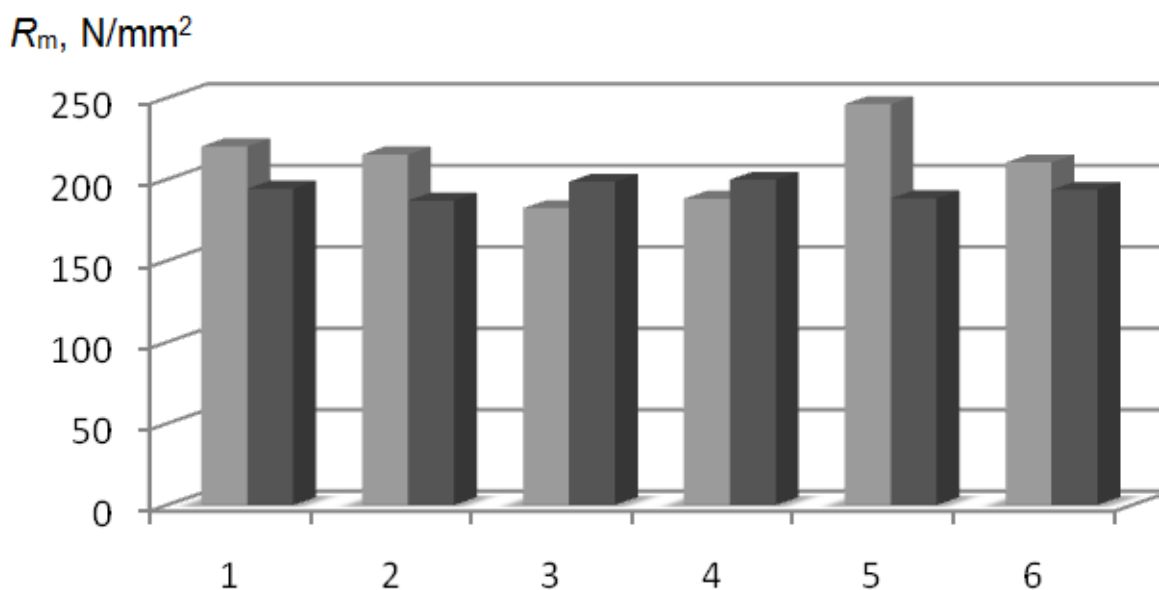
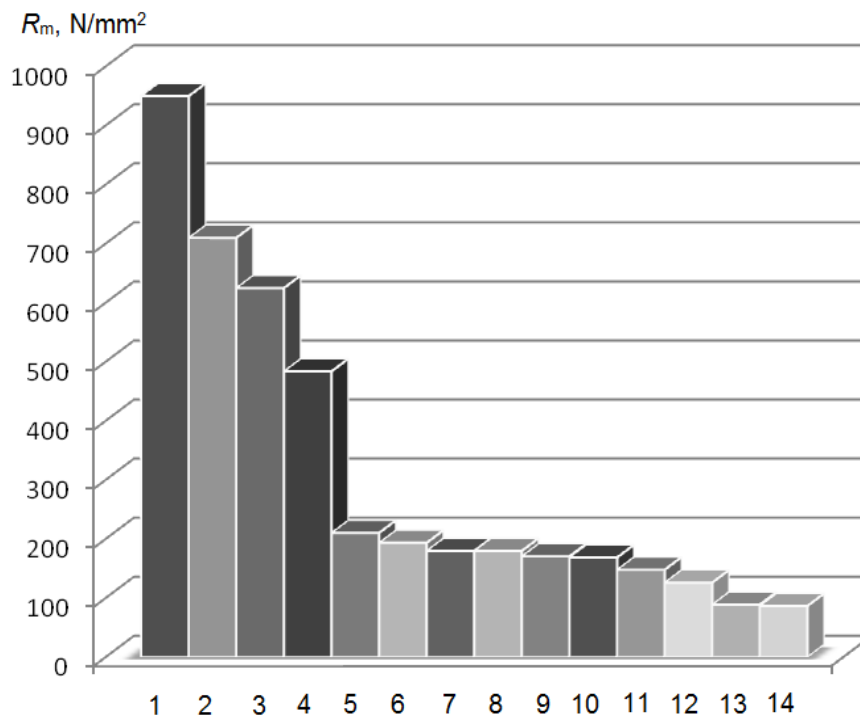

**Figure 7.** Tensile strength comparison of tested samples. Light (dark) greyscale denotes Tonkin Cane (Ku Zhu) bamboo. Numbers 1-5 denote samples and number 6 is their average.

By comparing tested bamboo samples with other materials used for bicycle frame it is evident that the tensile strength of Tonkin Cane and Ku Zhu bamboo is sufficient for bicycle frame construction. Table 3 will elaborate the aforementioned conclusion. In Table 3, technical data gathered from various references, shows that the highest tensile strength has titanium alloys. Tested samples took 5<sup>th</sup> and 6<sup>th</sup> place with higher tensile strength than some aluminum alloys and other bamboo species that were studied in some research [2, 3, 8, 12]. Material with number 10 in Table 3 is one unspecified bamboo, according to [3]. Comparison also included spruce wood, bamboo fibre, epoxy and bamboo fiber and polyethylene composite [2, 8]. Tensile strengths of materials from Table 3 are graphically compared in Figure 8.

**Table 3.** Comparison of tensile strengths between materials used for bicycle frame.

Number	Material	$R_m$ , N/mm <sup>2</sup>	Data source
1.	Ti6Al4V	950	[15]
2.	Steel 25CrMo4	710	[14]
3.	Carbon-fibre composite	625	[6]
4.	Steel S275J0	483,9	[13]
5.	Tonkin Cane	210,4	Experiment
6.	Ku Zhu bamboo	193,6	Experiment
7.	G-AlSi6Cu4	180	[14]
8.	G-ALMg5Si	180	[14]
9.	Calcutta Bamboo	170,72	[12]
10.	Bamboo	168,7	[3]
11.	Zimbabwe Bamboo	148	[8]
12.	BF+PE	126,2	[2]
13.	Spruce wood	89	[8]
14.	BF+EP	86,57	[2]



**Figure 8.** Tensile strength for different samples. Numbers of categories correspond to numbers in the first column in Table 3.



## CONCLUSIONS

In this article, issues related to bamboo were investigated. The conducted research provided valuable information on two bamboo species Tonkin Cane and Ku Zhu bamboo. Based on tests and analysis, it was concluded that tensile strength is different among bamboo species. Tensile strength of Tonkin Cane was proven to be 8 % higher than Ku Zhu bamboo's.

Information gathered in this research helped to compare tensile strength value with other traditional materials used for bicycle frame. The results has shown that Tonkin Cane and Ku Zhu bamboo can be considered as bicycle frame material since they demonstrate higher tensile strength than some alluminum alloys which are already in use for bicycle frame construction.

Modern way of thinking persuaded us to reconsider “primitive” materials as solution for a sustainable future. One of these materials is bamboo, which proved to be a very suitable material from the economic, ecological and sociological aspect.

Overall, a potential and opportunity for new experiments, to evaluate bamboo as design material, are revealed.

## REFERENCES

- [1] Penava, F.: *Application of natural materials in vehicles*. Diploma Thesis. In Croatian. Faculty of Mechanical Engineering and Naval Architecture, Zagreb, 2014,
- [2] Abdul Khalil, H.P.S et al.: *Bamboo fibre reinforced biocomposites: A review*. *Materials and Design* **42**(1), 353-368, 2012, <http://dx.doi.org/10.1016/j.matdes.2012.06.015>,
- [3] Aiping, Z.; Dongsheng, H.; Haitao, L. and Yi. S.: *Hybrid approach to determine the mechanical parameters of fibers and matrixes of bamboo*. *Construction and Building Materials* **35**, 191-196, 2012, <http://dx.doi.org/10.1016/j.conbuildmat.2012.03.011>,
- [4] Esteve-Sendra, C.; Moreno-Cuesta, R.; Portales-Mananos, A. and Magal-Royo, T.: *Bamboo, from Traditional Crafts to Contemporary Design and Architecture*. *Procedia – Social and Behavioral Sciences* **51**, 777-781, 2012, <http://dx.doi.org/10.1016/j.sbspro.2012.08.239>,
- [5] Sharma, B.; Gattoo, A. and Ramage, M.H.: *Effect of processing methods on the mechanical properties of engineered bamboo*. *Construction and Buildings Materials* **83**, 95-101, 2015, <http://dx.doi.org/10.1016/j.conbuildmat.2015.02.048>,
- [6] Van der Plas, R. and Baird, S.: *Bicycle Technology*. Cycle Publishing, San Francisco 2010,
- [7] Haine, C.: *The Urban Biking Handbook: The DIY Guide to Building, Rebuilding, Tinkering with, and Repairing Your Bicycle for City Living*. Quarry Books, Beverly, 2011,
- [8] Gutu, T.: *A Study on the Mechanical Strength Properties of Bamboo to Enhance Its Diversification on Its Utilization*. *International Journal of Innovative Technology and Exploring Engineering* **2**(5), 314-319, 2013,
- [9] Scurlock, J.M.O; Dayton, D.C. and Hames, B.: *Bamboo: an overlooked biomass resource?* *Biomass and Bioenergy* **19**(4), 229 -244, 2000, [http://dx.doi.org/10.1016/S0961-9534\(00\)00038-6](http://dx.doi.org/10.1016/S0961-9534(00)00038-6),
- [10] Gerhardt, M.R.: *Microstructure and mechanical properties of bamboo in compression*. Massachusetts Institute of Technology, Cambridge, 2012,
- [11] Tan, T. et al.: *Mechanical properties of functionally graded hierarchical bamboo structures*. *Acta Biomaterialia* **7**(10), 3796–3803, 2011, <http://dx.doi.org/10.1016/j.actbio.2011.06.008>,

- [12] Ahmad, M. and Kamke, F.A.: *Mechanical Properties of Calcutta Bamboo*. Ph.D. Thesis. Virginia Polytechnic Institute and State University, Blacksburg, Ch.4, 2000, <http://scholar.lib.vt.edu/theses/available/etd-08212000-10440027>,
- [13] Alar, Z.; Mandic, D.; Dugorepec, A. and Sakoman, M.: *Application of Instrumented Charpy Method in Characterisation of Materials*. Interdisciplinary Description of Complex Systems **13**(3), 479-487, 2015, <http://dx.doi.org/10.7906/indecs.13.3.12>,
- [14] Filetin, T.; Kovačiček, F. and Indof, J.: *Properties and application of materials*. In Croatian. Faculty of Mechanical Engineering and Naval Architecture, Zagreb, 2007,
- [15] MatWeb LLC: *ASM Aerospace Specification Metals Inc*. <http://asm.matweb.com/search/SpecificMaterial.asp?bassnum=MTP641>.