

ANALIZA KRETANJA MOTORA S VELIKOM TEMPERATURNOM RAZLIKOM

MOTION ANALYSIS OF FLUIDYNE ENGINES

Vipul Gupta, Ranjeet Singh, Sunny Narayan

Stručni članak

Sažetak: Pumpe su uobičajeni strojarski uređaji koji su postali bitni izvori energije za upravljanje raznih komercijalnih uređaja oko nas. Za upravljanje tim uređajima potrebni su složeni mehanizmi, no mnoge nove pumpe postoje u prirodi i rade bez ikakvih vanjskih izvora energije. U ovom su radu ispitani neki od tih uređaja. Rotacijski motori bez klipova također spadaju u istu kategoriju uređaja koji koriste promjene tlaka za ubrizgavanje goriva. Razmotreni su izrada i način rada tih novih pumpa i učinjene su preporuke za popravljanje dizajna.

Ključne riječi: nove pumpe, motori s velikom temperaturnom razlikom

Professional paper

Abstract: Pumps are common engineering devices which have become important sources of power to operate several commercial devices around us. Operation of these devices need complex mechanisms, however there are many novel pumps which exist in nature and operate without any external source of power. In this paper some of these devices have been reviewed. Liquid piston engines also fall in same category of these devices which use pressure fluctuations to pump fluid. Design and Working of these novel pumps has been discussed and future recommendations made to improve the current designs.

Keywords: Novel Pumps, Fluidyne Engines

1. INTRODUCTION

Apart from manmade pumps nature also has many clever pumps such as human heart, capillary action in plants and neuron pumps in the nerve cells of human cerebrum. Working of these novel pumps has been reviewed herein.

(A) Human impulse: all animals have nerve cells known as neurons present in their cerebrum. These cells transmit nerve impulses from and to the brain which form basis of human reflexes, movements, emotions and senses. Neurons have Na⁺K⁺ATPase which is a protein pump present in neurons of brain. It utilizes energy from ATP molecules to pump 3 sodium ions out of a cell and two potassium ions into the cell. This causes a potential difference across cell membrane called resting potential which is basic cause of nerve impulses transmitted across neurons in human body. These impulses form basis of human stimuli. Action of this natural pump can be seen in the figure no 1[1].

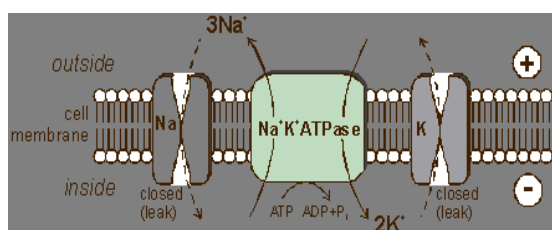

Figure 1. Human Impulse pump

(B) Capillary action: this effect occurs due to cohesive, adhesive forces or surface tension and plays an important role in transportation of water. Capillary action in trees helps to draw water into roots by xylem tissue cells. Xylem cells are made of cellulose molecules which form a chemical bond with water, hence helping in circulation of water in a tree [2].

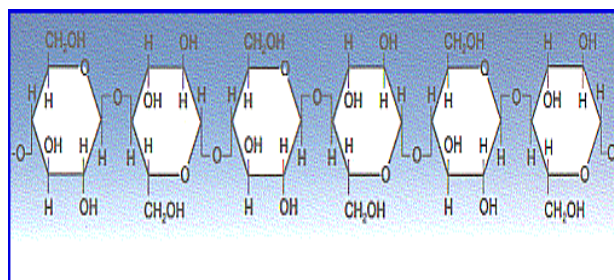

Figure 2. Water cellulose bonding

(C) Human heart-human heart is an excellent example of a natural pump. It has 4 valves namely tricuspid valve, mitral valve, aortic valve and pulmonic valve. Stating from right atrium, blood flows through the tricuspid valve to right ventricle and is sent to lungs for oxygen enrichment by pulmonary artery. From lungs, blood flows through the pulmonary vein to left atrium and from left atrium to left ventricle through

mitral valve. This enriched blood flows to aorta through aortic valve from where it is distributed to whole body. Each valve has a set of flaps which maintain blood flow through it [3].

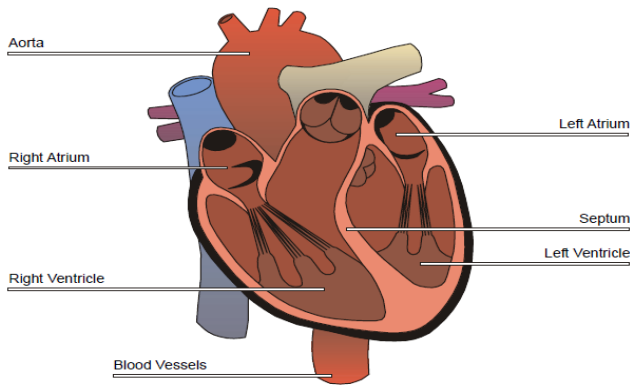

Figure 3. Working of a Human heart

2. BACKGROUND

In actual practice a liquid piston engine can be constructed with two columns of air and fluid connecting at two ends. One of the ends is kept hot whereas the other one is at room temperature. The resulting pressure fluctuations can be used to pump fluid to a certain height. The motion of a fluidyne can be analyzed as a wobbling fluid column synchronous to motion of a See Saw and pendulum where gravity acts as a restoring force to bring back to mean position. Various phases of operation of a fluidyne can be expressed as:

a) **Stage 1**-initially levels of liquid in columns is equal when no heat is applied.

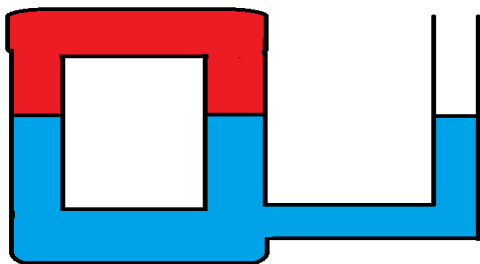

Figure 4. Stages of operation of a fluidyne

b) **Stage 2**- as heat is applied at the hot end; the air at that end is heated up and expands moving towards the cold end through the connecting arm. This pushes the fluid to TDC at the hot end and BDC at the cold end and the fluid out of the output column.

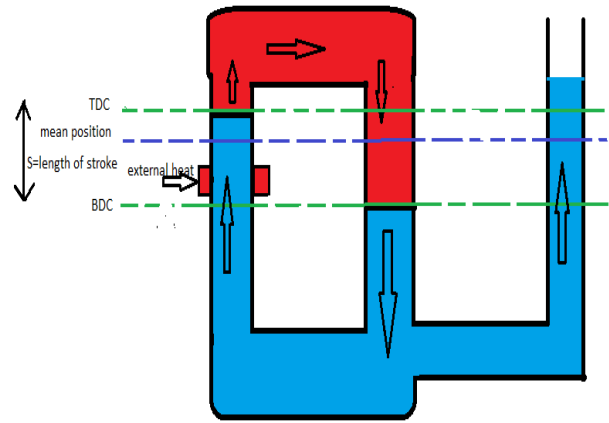

Figure 5. Stages of operation of a fluidyne

c) **Stage 3**-the air comes in contact with fluid at cold end, cools down and contracts. Once the fluid has reached its extreme positions at both columns of the U tube, at the hot side, the inertia of weight of extra risen fluid column tries to bring down the raised level of fluid to its mean position

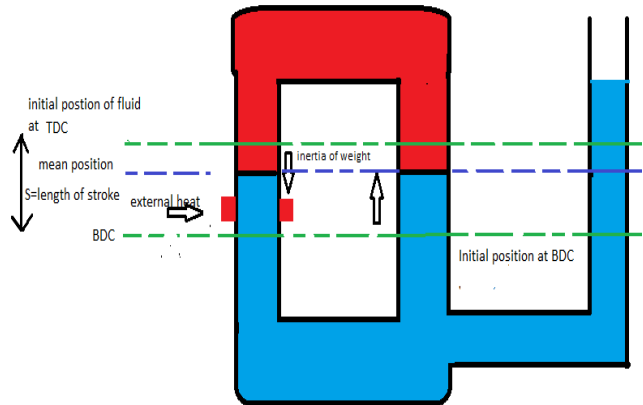

Figure 6. Stages of operation of a fluidyne

d) **Stage 4**-as this happens, the air is again transferred from cold end to hot end through the connecting space, so that level of fluid overshoots mean at hot side and reaches BDC whereas at cold end it reaches the TDC & the fluid is again sucked back in the output column.

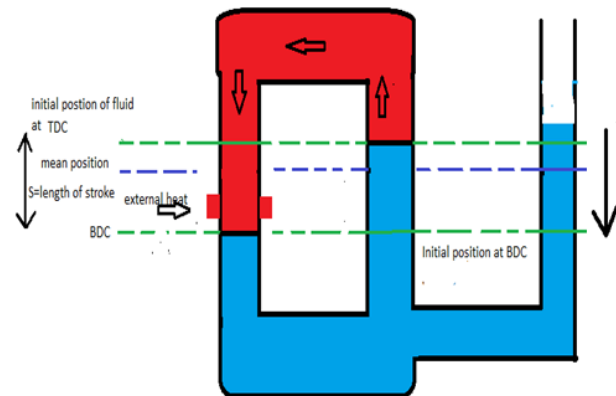

Figure 7. Stages of operation of a fluidyne

e) **Stage 5**-inertia of weight tries again to restore the levels of fluids equal at both ends, so that cycle starts again.

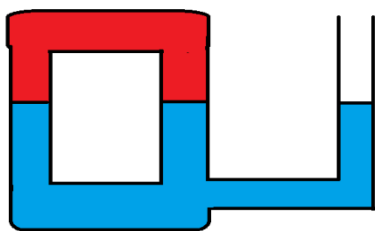

Figure 8. Stages of operation of a fluidyne

Analogous to this cycle, a fluidyne operates in the same way with the left end of U tube acting as a displacer piston, whereas the right end acting as the power piston. Initially most of the air is trapped in hot side of the engine and the top dead centre of cold end corresponds to the bottom dead centre of the hot end[5].

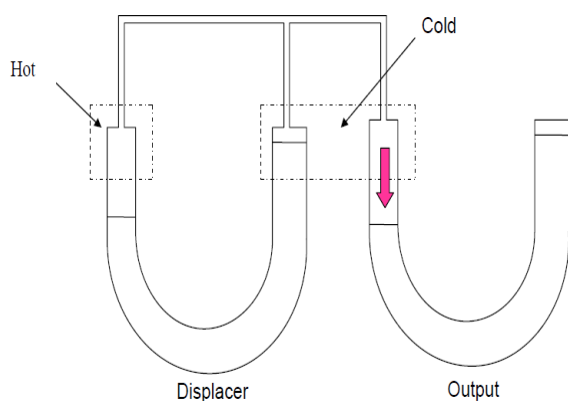

Figure 9. General working of a fluidyne

The temperature of air rises being in contact with hot end, hence its pressure rises which tends to pump fluid out from the output tube. After half of the cycle most of the air is transferred to the cold side of machine and so its pressure falls. The cold surface is at bottom dead center and the fluid is pulled back into the U tube.

3. CONCLUSION

The efficiency of device is found to be in order of 2-6% which is very low due to various poor heat transfer, leakage, viscous and frictional losses. Some measures to improve the efficiency of system are include use of bigger diameter displacer tubes which ensures the greater amount of air flowing between cold and hot side. This can lead to larger amplitude of oscillations due to higher pressure, but smaller compression ratio whereas smaller tubing results in a larger compression ratio. Use of regenerator or use of better heat exchange material can be also be used as means to improve performance.

4. REFERENCES

- [1] <http://www.saylor.org/site/wpcontent/uploads/2011/01/Nervous-System.pdf>
- [2] http://soils.stanford.edu/classes/ges175items/lect-3_water_visual.pdf
- [3] http://thevirtualheart.org/3dpdf/Heart_3d.pdf
- [4] C. D. West, Liquid Piston Stirling Engine, Van Nostrand Reinhold, New York, 1983.
- [5] Ila Milos, Jesse,2004, Design and Development of a small Stirling Engine.

Author contact:

Vipul Gupta, Ranjeet Singh, Sunny Narayan
Mechanical Engineering Department
Indus University,India
rarekv@gmail.com