

University of Nebraska - Lincoln

DigitalCommons@University of Nebraska - Lincoln

Final Reports & Technical Briefs from Mid-America
Transportation Center

Mid-America Transportation Center

2010

Load Rating of Complex Bridges

George Morcouc Ph.D.

University of Nebraska-Lincoln, gmorcouc2@unl.edu

Kromel Hanna Ph.D.

University of Nebraska-Lincoln

Maher K. Tadros Ph.D., P.E.

University of Nebraska - Lincoln, mtadros1@unl.edu

Follow this and additional works at: <http://digitalcommons.unl.edu/matcreports>



Part of the [Civil Engineering Commons](#)

Morcouc, George Ph.D.; Hanna, Kromel Ph.D.; and Tadros, Maher K. Ph.D., P.E., "Load Rating of Complex Bridges" (2010). *Final Reports & Technical Briefs from Mid-America Transportation Center*. 32.

<http://digitalcommons.unl.edu/matcreports/32>

This Article is brought to you for free and open access by the Mid-America Transportation Center at DigitalCommons@University of Nebraska - Lincoln. It has been accepted for inclusion in Final Reports & Technical Briefs from Mid-America Transportation Center by an authorized administrator of DigitalCommons@University of Nebraska - Lincoln.



**Nebraska
Transportation
Center**



**MID-AMERICA
TRANSPORTATION CENTER**



Report # SPR-1(10) P329

Final Report
26-1120-0049-001

Load Rating of Complex Bridges

George Morcous, Ph.D.

Associate Professor

The Charles W. Durham School of Architectural Engineering and Construction

University of Nebraska-Lincoln

Kromel Hanna, Ph.D.

Postdoctoral Research Associate

Maher K. Tadros, Ph.D.

Professor

2010

Nebraska Transportation Center

262 WHIT

2200 Vine Street

Lincoln, NE 68583-0851

(402) 472-1975

"This report was funded in part through grant[s] from the Federal Highway Administration [and Federal Transit Administration], U.S. Department of Transportation. The views and opinions of the authors [or agency] expressed herein do not necessarily state or reflect those of the U. S. Department of Transportation."

Load Rating of Complex Bridges

George Morcous, Ph.D.
Associate Professor
Charles W. Durham School of Architectural
Engineering and Construction
University of Nebraska-Lincoln

Maher K. Tadros, Ph.D.
Professor Emeritus
Civil Engineering
University of Nebraska-Lincoln

Kromel Hanna, Ph.D.
Post Doctoral Research Associate
Civil Engineering
University of Nebraska-Lincoln

A Report on Research Sponsored by

Mid-America Transportation Center

University of Nebraska-Lincoln

July 2010

Technical Report Documentation Page

1. Report No. SPR-1(10) P329	2. Government Accession No.	3. Recipient's Catalog No.	
4. Title and Subtitle Load Rating of Complex Bridges		5. Report Date July 2010	
		6. Performing Organization Code	
7. Author(s) George Morcoux, Kromel Hanna, and Maher K. Tadros		8. Performing Organization Report No. 26-1120-0049-001	
9. Performing Organization Name and Address Mid-America Transportation Center 2200 Vine St. PO Box 830851 Lincoln, NE 68583-0851		10. Work Unit No. (TRAIS)	
		11. Contract or Grant No.	
12. Sponsoring Agency Name and Address Research and Innovative Technology Administration 1200 New Jersey Ave., SE Washington, D.C. 20590		13. Type of Report and Period Covered	
		14. Sponsoring Agency Code MATC TRB RiP No. 23040	
15. Supplementary Notes			
<p>16. Abstract</p> <p>The National Bridge Inspection Standards require highway departments to inspect, evaluate, and determine load ratings for structures defined as bridges located on all public roads. Load rating of bridges is performed to determine the live load that structures can safely carry at a given structural condition. Bridges are rated for three types of loads, design loads, legal loads, and permit loads, which is a laborious and time-consuming task as it requires the analysis of the structure under different load patterns. Several tools are currently available to assist bridge engineers to perform bridge rating in a consistent and timely manner. However, these tools support the rating of conventional bridge systems, such as slab, I-girder, box girder and truss bridges. In the last decade, NDOR has developed innovative bridge systems through research projects with the University of Nebraska-Lincoln. An example of these systems is tied-arch bridge system adopted in Ravenna Viaduct and Columbus Viaduct projects. The research projects dealt mainly with the design and construction of the new system, while overlooking the load rating. Therefore, there is a great need for procedures and models that assist in the load rating of these new and complex bridge systems. The objective of this project is to develop the procedures and models necessary for the load rating of tied-arch bridges, namely Ravenna and Columbus Viaducts. This includes developing refined analytical models of these structures and performing rating factor (RF) calculations in accordance to the latest Load and Resistance Factored Rating (LRFR) specifications. Two-dimensional and three-dimensional computer models were developed for each structure and RF calculations were performed for the primary structural components (i.e. arch, tie, hanger, and floor beam). RFs were calculated assuming various percentages of section loss and using the most common legal and permit loads in the state of Nebraska in addition to AASHTO LRFD live loads. In addition, the two structures were analyzed and RFs were calculated for an extreme event where one of the hangers is fully damaged</p>			
17. Key Words load rating, tied-arch bridge, legal loads, permit loads, rating factor, AASHTO LRFR		18. Distribution Statement	
19. Security Classif. (of this report) Unclassified	20. Security Classif. (of this page) Unclassified	21. No. of Pages 55	22. Price

Table Of Contents

Acknowledgements	iv
Disclaimer.....	v
Abstract.....	vi
Chapter 1 Introduction	1
1.1 Background	1
1.2 Report Organization	3
Chapter 2 Rating Procedures.....	1
2.1 General	1
2.2 Design Load Rating.....	5
2.3 Legal Load Rating.....	7
2.4 Permit Load Rating	9
2.5 Rating Assumptions	13
Chapter 3 Ravenna Viaduct	14
3.1 Analysis Model	14
3.2 Capacity Charts	19
3.3 Rating Factors	24
Chapter 4 Columbus Viaduct	31
4.1 Analysis Models.....	31
4.2 Capacity Charts	40
4.3 Rating Factors	48
Chapter 5 Conclusions	54
References	55

Acknowledgements

This project was sponsored by the Nebraska Department of Roads (NDOR) and the University of Nebraska-Lincoln. The support of the technical advisory committee (TAC) members is gratefully acknowledged. The design team at NDOR Bridge Division is also acknowledged, they spent considerable time and effort in coordinating this project, discussing its technical direction, and inspiring the university researchers. Special thanks to the graduate students participated in this project Eliya Henin and Afshin Hatami.

Disclaimer

The contents of this report reflect the views of the authors who are responsible for the facts and the accuracy of the data presented herein. The contents do not necessarily reflect the official views or policies of the Nebraska Department of Roads, nor of the University of Nebraska-Lincoln. This report does not constitute a standard, specification, or regulation. Trade or manufacturers' names, which may appear in this report, are cited only because they are considered essential to the objectives of the report. The United States (U.S.) government and the State of Nebraska do not endorse products or manufacturers.

Abstract

The National Bridge Inspection Standards require highway departments to inspect, evaluate, and determine load ratings for structures defined as bridges located on all public roads. Load rating of bridges is performed to determine the live load that structures can safely carry at a given structural condition. Bridges are rated for three types of loads, design loads, legal loads, and permit loads, which is a laborious and time-consuming task as it requires the analysis of the structure under different load patterns. Several tools are currently available to assist bridge engineers to perform bridge rating in a consistent and timely manner. However, these tools support the rating of conventional bridge systems, such as slab, I-girder, box girder and truss bridges. In the last decade, NDOR has developed innovative bridge systems through research projects with the University of Nebraska-Lincoln. An example of these systems is tied-arch bridge system adopted in Ravenna Viaduct and Columbus Viaduct projects. The research projects dealt mainly with the design and construction of the new system, while overlooking the load rating. Therefore, there is a great need for procedures and models that assist in the load rating of these new and complex bridge systems.

The objective of this project is to develop the procedures and models necessary for the load rating of tied-arch bridges, namely Ravenna and Columbus Viaducts. This includes developing refined analytical models of these structures and performing rating factor (RF) calculations in accordance to the latest Load and Resistance Factored Rating (LRFR) specifications. Two-dimensional and three-dimensional computer models were developed for each structure and RF calculations were performed for the primary structural components (i.e. arch, tie, hanger, and floor beam). RFs were calculated assuming various percentages of section loss and using the most common legal and permit loads in the state of Nebraska in addition to

AASHTO LRFD live loads. In addition, the two structures were analyzed and RFs were calculated for an extreme event where one of the hangers is fully damaged.

Chapter 1 Introduction

1.1 Background

The National Bridge Inspection Standards requires highway departments to inspect, assess the condition, and calculate load ratings for structures defined as bridges and located on all public roads. Load rating of bridges is performed to determine the live load that structures can safely carry at a given structural condition. According to the Recording and Coding Guide for Structure Inventory and Appraisal of the Nation's Bridges, bridges are rated at three different stress levels, referred to as Inventory Rating (items 65 and 66 of Structural Inventory and Appraisal sheet), Operating Rating (items 63 and 64 of SI&A sheet), and Posting Rating (item 70 of SI&A sheet). Inventory rating is the capacity rating for the vehicle type used in the rating that will result in a load level which can safely utilize an existing structure for an indefinite period of time. Inventory load level approximates the design load level for normal service conditions. Operating rating will result in the absolute maximum permissible load level to which the structure may be subjected for the vehicle type used in the rating. This rating determines the capacity of the bridge for occasional use. Allowing unlimited numbers of vehicles to subject the bridge to the operating level will compromise the bridge life. This value is typically used when evaluating overweight permit vehicle moves. The posting rating is the capacity rating for the vehicle type used in the rating that will result in a load level which may safely utilize an existing structure on a routine basis for a limited period of time. The posting rating for a bridge is based on inventory level plus a fraction of the difference between inventory and operating. Structural capacities and loadings are used to analyze the critical members to determine the appropriate load rating. This may lead to load restrictions of the bridge or identification of components that require rehabilitation or other modification to avoid posting of the bridge (DelDOT 2004).

Load rating is a laborious and time-consuming task as it requires the structural analysis of all primary structural components at different loading conditions. Several tools were developed to assist bridge engineers to perform bridge rating in a consistent and timely manner. Bridge Analysis and Rating System (BARS) is an AASHTO licensed product that is used to analyze and rate structures. This program was developed more than twenty years ago and the code was originally written in FORTRAN to run on Mainframe computers. A newer version BARS-PC was developed in 1993 to be used on personal computers. Several states are using BARS to analyze and rate the bridges, while others are using different products, such as VIRTIS, BRASS, LARS, etc. In Nebraska, LARS and its companion program “Complex Truss” are being used for rating and super-load analyses. However, this program supports only the rating of conventional bridge systems, such as slab, I-girder, box girder and truss bridges.

In the last decade, NDOR has developed innovative bridge systems through research projects with the University of Nebraska-Lincoln. An example of these systems is tied-arch bridge system used in Ravenna and Columbus Viaducts. The research projects dealt mainly with the design and construction issues of the new systems and not with their load rating. Therefore, there is a great need for procedures and models that assist NDOR bridge engineers in the load rating of such complex bridge systems that cannot be rated by the existing commercial programs.

The objective of this project is to develop the analytical models required for load rating of tied-arch bridges and perform rating factor (RF) calculations for a given set of super-loads and section loss percentages. The primary structural components of the Ravenna Viaduct and Columbus Viaduct will be analyzed using three-dimensional models and rated for design loads, legal loads, and permit loads according to the latest AASHTO Load and Resistance Factor Rating (LRFR) procedures. The tables shown below summarize the outcome of the project.

Primary Structural Element	Capacity at Different Section Loss Percentages						Demand													
	0%	10%	20%	30%	40%	50%	DC	P	DW	$(LL+I)_{HL-93}$	$(LL+I)_{HS20}$	$(LL+I)_{N3}$	$(LL+I)_{N3S2}$	$(LL+I)_{N3-3}$	$(LL+I)_{SP1}$	$(LL+I)_{SP2}$	$(LL+I)_{SP3}$	$(LL+I)_{SP4}$	$(LL+I)_{SP5}$	
Floor beams																				
Hangers																				
Tie Beams																				
Arch Pipes																				
Rating Factor																				
$(LL+I)_{HL-93}$	$(LL+I)_{HS20}$	$(LL+I)_{N3}$	$(LL+I)_{N3S2}$	$(LL+I)_{N3-3}$	$(LL+I)_{SP1}$	$(LL+I)_{SP2}$	$(LL+I)_{SP3}$	$(LL+I)_{SP4}$	$(LL+I)_{SP5}$											

1.2 Report Organization

The report is organized as follows. Chapter 2 summarizes the load rating procedures followed in this project. These procedures are in accordance to the AASHTO Manual for Bridge Evaluation, 1st Edition 2008. A description of the applied loads, load factors, and resistance factors is given. Chapter 3 presents the analytical models, capacity calculations, and load ratings of the Ravenna Viaduct. Chapter 4 presents the analytical models, capacity calculations, and load ratings of the Columbus Viaduct. Chapter 5 summarizes the project outcomes and the appendixes list the internal forces and moments in all the structural components of the two viaducts under all loading conditions.

Chapter 2 Rating Procedures

2.1 General

Three load-rating procedures that are consistent with the load and resistance factor philosophy have been provided in Article 6A.4 of the 2008 AASHTO Manual for Bridge Evaluation for the load capacity evaluation of in-service bridges: design load rating (first level evaluation); legal load rating (second level evaluation); permit load rating (third level evaluation). Each procedure is geared to a specific live load model with specially calibrated load factors aimed at maintaining a uniform and acceptable level of reliability in all evaluations. The load rating is generally expressed as a rating factor for a particular live load model, using the general load-rating equation:

$$RF = \frac{C - (\gamma_{DC})(DC) - (\gamma_{DW})(DW) \pm (\gamma_P)(P)}{(\gamma_{LL})(LL + IM)} \quad (6A.4.2.1-1)$$

For the Strength Limit States:

$$C = \phi_c \phi_s \phi_n \quad (6A.4.2.1-2)$$

Where the following lower limit shall apply:

$$\phi_c \phi_s \geq 0.85 \quad (6A.4.2.1-3)$$

For the Service Limit States:

$$C = f_R \quad (6A.4.2.1-4)$$

where:

RF = Rating factor

C = Capacity

f_R = Allowable stress specified in the LRFD code

R_n = Nominal member resistance (as inspected)

DC = Dead load effect due to structural components and attachments

DW = Dead load effect due to wearing surface and utilities

P = Permanent loads other than dead loads

LL = Live load effect

IM = Dynamic load allowance

γ_{DC} = LRFD load factor for structural components and attachments

γ_{DW} = LRFD load factor for wearing surfaces and utilities

γ_p = LRFD load factor for permanent loads other than dead loads = 1.0

γ_{LL} = Evaluation live load factor

ϕ_c = Condition factor

ϕ_s = System factor

ϕ = LRFD resistance factor

The Rating Factor (RF) obtained may be used to determine the safe load capacity of the bridge in tons as follows:

$$RT = RF \times W \quad (6A.4.4.4-1)$$

where:

RT = Rating in tons for truck used in computing live load effect

W = Weight in tons of truck used in computing live load effect

When the lane-type load model (see Figures D6A-4 and D6A-5) governs the load rating, the equivalent truck weight W for use in calculating a safe load capacity for the bridge shall be taken as 80 kips.

Strength is the primary limit state for load rating. Service and fatigue limit states are selectively applied in accordance with the provisions of this manual. Applicable limit states and the corresponding load factors are summarized in table 6A.4.2.2-1.

Table 6A.4.2.2-1—Limit States and Load Factors for Load Rating

Bridge Type	Limit State*	Dead Load γ_{DC}	Dead Load γ_{DW}	Design Load		Legal Load γ_{LL}	Permit Load γ_{LL}
				Inventory	Operating		
				γ_{LL}	γ_{LL}		
Steel	Strength I	1.25	1.50	1.75	1.35	Tables 6A.4.4.2.3a-1 and 6A.4.4.2.3b-1	—
	Strength II	1.25	1.50	—	—	—	Table 6A.4.5.4.2a-1
	Service II	1.00	1.00	1.30	1.00	1.30	1.00
	Fatigue	0.00	0.00	0.75	—	—	—
Reinforced Concrete	Strength I	1.25	1.50	1.75	1.35	Tables 6A.4.4.2.3a-1 and 6A.4.4.2.3b-1	—
	Strength II	1.25	1.50	—	—	—	Table 6A.4.5.4.2a-1
	Service I	1.00	1.00	—	—	—	1.00
Prestressed Concrete	Strength I	1.25	1.50	1.75	1.35	Tables 6A.4.4.2.3a-1 and 6A.4.4.2.3b-1	—
	Strength II	1.25	1.50	—	—	—	Table 6A.4.5.4.2a-1
	Service III	1.00	1.00	0.80	—	1.00	—
	Service I	1.00	1.00	—	—	—	1.00
Wood	Strength I	1.25	1.50	1.75	1.35	Tables 6A.4.4.2.3a-1 and 6A.4.4.2.3b-1	—
	Strength II	1.25	1.50	—	—	—	Table 6A.4.5.4.2a-1

* Defined in the *AASHTO LRFD Bridge Design Specifications*.

Strength I of prestressed concrete bridges was adopted for the load rating of the primary structural components of Ravenna and Columbus Viaducts in this report. According to equation 6A.4.2.1-2, the ultimate capacity of these components should be further multiplied by condition and system factors. The condition factor provides a reduction to account for the increased uncertainty in the resistance of deteriorated members and the likely increased future deterioration of these members during the period between inspection cycles. Since Ravenna and Columbus Viaducts are relatively new structures, this factor was taken 1.0 according to table 6A.4.2.3-1

Table 6A.4.2.3-1—Condition Factor: ϕ_c

Structural Condition of Member	ϕ_c
Good or Satisfactory	1.00
Fair	0.95
Poor	0.85

System factors are multipliers applied to the nominal resistance to reflect the level of redundancy of the complete superstructure system. Bridges that are less redundant will have their factored member capacities reduced, and, accordingly, will have lower ratings. The system factors in table 6A.4.2.4-1 are more conservative than the LRFD design values and may be used at the discretion of the evaluator until they are modified in the AASHTO LRFD Bridge Design Specifications. Therefore, it was decided that a system factor of 1.0 be used in rating all the structural components of Ravenna and Columbus Viaducts.

Table 6A.4.2.4-1—System Factor: ϕ_s for Flexural and Axial Effects

Superstructure Type	ϕ_s
Welded Members in Two-Girder/Truss/Arch Bridges	0.85
Riveted Members in Two-Girder/Truss/Arch Bridges	0.90
Multiple Eyebar Members in Truss Bridges	0.90
Three-Girder Bridges with Girder Spacing 6 ft	0.85
Four-Girder Bridges with Girder Spacing ≤ 4 ft	0.95
All Other Girder Bridges and Slab Bridges	1.00
Floorbeams with Spacing >12 ft and Noncontinuous Stringers	0.85
Redundant Stringer Subsystems between Floorbeams	1.00

For rating concrete components subjected to both axial load and bending moment, the following steps were applied to obtain the rating factor:

1. Develop the interaction diagram, as shown below, using as-inspected section properties.
2. Locate point A that represents the factored dead load moment and axial force.
3. Using the factored live load moment and axial force for the rating live load, compute the live load eccentricity e_1 .
4. Continue from Point A with the live load eccentricity to the intersection with the interaction diagram.
5. Read the ultimate moment and axial capacities from the diagram.

$$6. \text{ Moment } RF = \frac{\text{Moment Capacity} - \text{Factored } M_{DL}}{\text{Factored } M_{LL+DL}}$$

$$\text{Axial } RF = \frac{\text{Axial Capacity} - \text{Factored } P_{DL}}{\text{Factored } P_{LL+DL}}$$

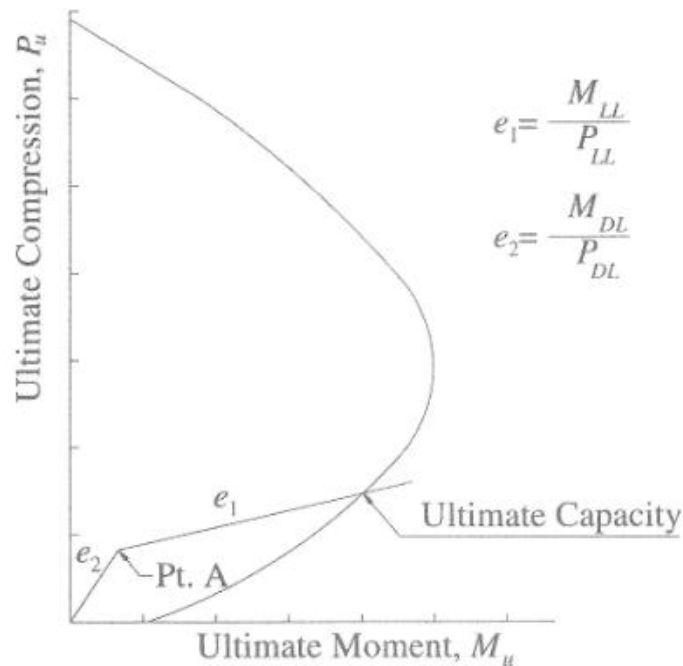

2.2 Design Load Rating

Design load rating is a first-level assessment of bridges based on the HL-93 loading and LRFD design standards, using dimensions and properties of the bridge in its present as-inspected condition. It is a measure of the performance of existing bridges to current LRFD bridge design standards. Under this check, bridges are screened for the strength limit state at the LRFD design level of reliability (Inventory level), or at a second lower evaluation level of reliability (Operating level). Design load rating can serve as a screening process to identify bridges that should be load rated for legal loads per the following criteria:

- Bridges that pass HL-93 screening at the Inventory level will have adequate capacity for all AASHTO legal loads and State legal loads that fall within the exclusion limits described in the AASHTO LRFD Bridge Design Specifications.
- Bridges that pass HL-93 screening only at the Operating level will have adequate capacity for AASHTO legal loads, but may not rate ($RF < 1$) for all State legal loads, specifically those vehicles significantly heavier than the AASHTO trucks.

The figure shown below describes the HL-93 load (truck/tandem and lane loads), while table 6A.4.3.2.2-1 lists the live load factors for both inventory and operation rating levels. A dynamic load allowance of 33% (LRFD Design Article 3.6.2) was applied to the truck/tandem load only, while a multiple presence factor according to LRFD Design Article 3.6.1.1.2 was applied to both truck/tandem and lane loads. It should be noted that the design truck controlled the rating of all the primary structural components of Ravenna and Columbus Viaducts except the floor beams, where the design tandem controlled the rating.

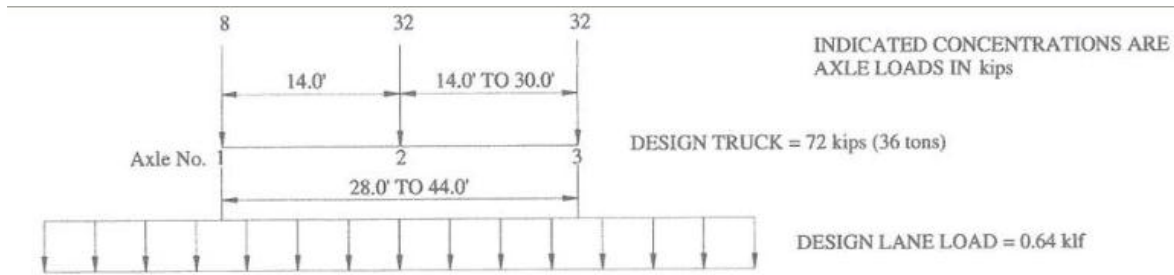
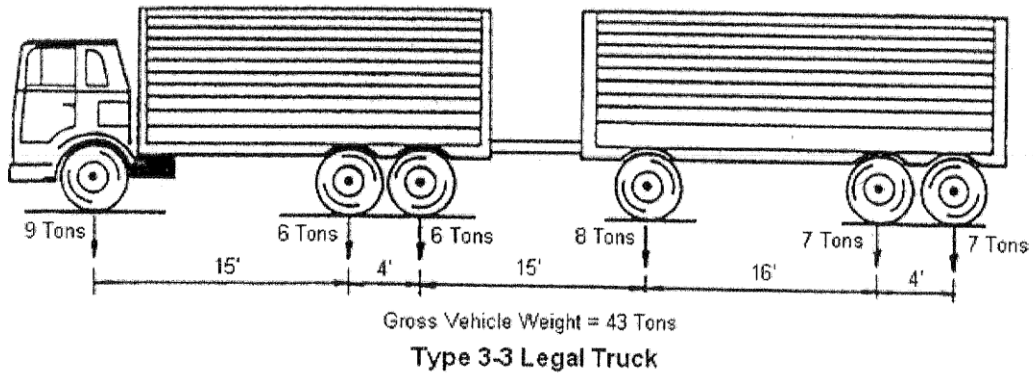
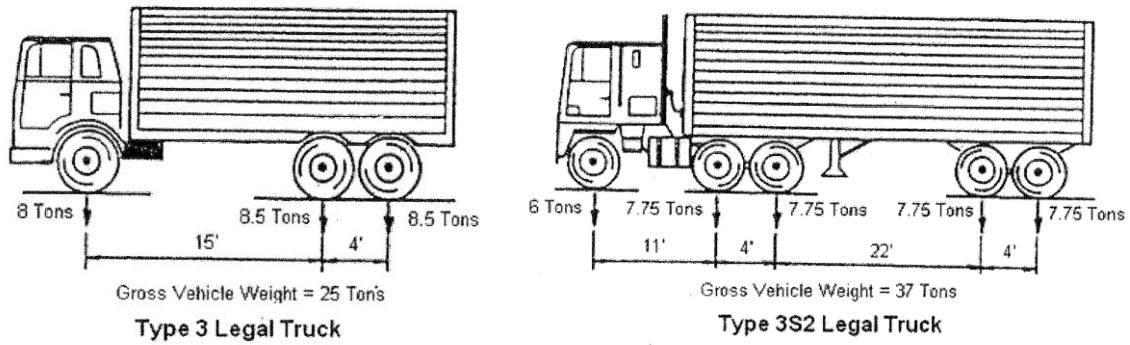

Table 6A.4.3.2.2-1—Load Factors for Design Load: γ_L

Evaluation Level	Load Factor
Inventory	1.75
Operating	1.35

2.3 Legal Load Rating

Bridges that do not have sufficient capacity under the design-load rating shall be load rated for legal loads to establish the need for load posting or strengthening. This second level rating provides the safe load capacity of a bridge for the AASHTO family of legal loads or State legal loads, whichever is greater. The figures that follow present Nebraska legal loads (Type 3, Type 3S2, and Type 3-3), which are heavier than AASHTO legal loads, in addition to the lane-type loading for spans greater than 200 ft (i.e. Columbus Viaduct only).



INDICATED CONCENTRATIONS ARE AXLE LOADS IN kips (75% OF TYPE 3-3)
 LEGAL LANE WEIGHT/ft. = 0.2 klf

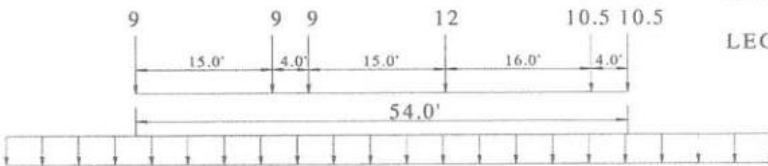

Figure D6A-4—Lane-Type Loading for Spans Greater than 200 ft

Strength is the primary limit state for legal load rating. Live load factors were selected based on the ADTT at the bridge as shown in table 6a.4.4.2.3a-1. The traffic data listed on project drawings indicates that future ADTT on Ravenna Viaduct is 235 and on Columbus Viaduct is 2,087. Based on these data, the live load factor was estimated to be 1.45 for Ravenna Viaduct and 1.70 for Columbus Viaduct. The dynamic load allowance and multiple presence factor of design loads were also applied to the legal loads.

Table 6A.4.4.2.3a-1—Generalized Live Load Factors, γ_L for Routine Commercial Traffic

Traffic Volume (One direction)	Load Factor for Type 3, Type 3S2, Type 3-3 and Lane Loads
Unknown	1.80
$ADTT \geq 5000$	1.80
$ADTT = 1000$	1.65
$ADTT \leq 100$	1.40

Linear interpolation is permitted for other *ADTT*.

2.4 Permit Load Rating

Bridge Owners usually have established procedures and regulations which allow the passage of vehicles above the legally established weight limitations on the highway system. These procedures involve the issuance of a permit which describes the features of the vehicle and/or its load and, in most jurisdictions, which specifies the allowable route or routes of travel. Permits are issued by States on a single trip, multiple trip, or annual basis. Routine or annual permits are usually valid for unlimited trips over a period of time, not to exceed one year, for vehicles of a given configuration within specified gross and axle weight limits. Special permits are usually valid for a single trip only, for a limited number of trips, or for a vehicle of specified configuration, axle weights, and gross weight. Depending upon the authorization, these permit vehicles may be allowed to mix with normal traffic or may be required to be escorted in a manner which controls their speed, lane position, the presence of other vehicles on the bridge.

Permit load rating checks the safety of bridges in the review of permit applications for the passage of vehicles above the legally established weight limitations. This is a third level rating that should be applied only to bridges having sufficient capacity for legal loads. The figure that

follows presents the configurations of the most common permit trucks in Nebraska, which were used in this report. For spans up to 200 ft, only the permit vehicle shall be considered present in the lane. For spans between 200 and 300 ft, an additional lane load shall be applied to simulate closely following vehicles. The lane load shall be taken as 0.2 klf in each lane superimposed on top of the permit vehicle (for ease of analysis) and is applied to those portions of the span(s) where the loading effects add to the permit load effects.

P1

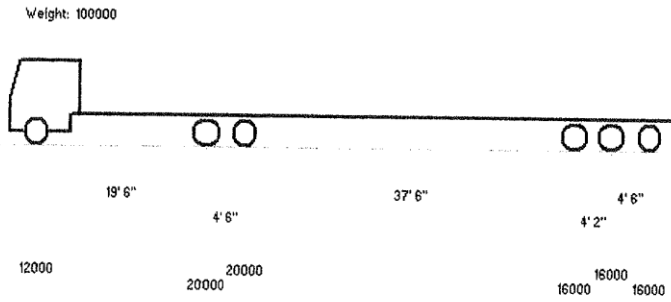

P2

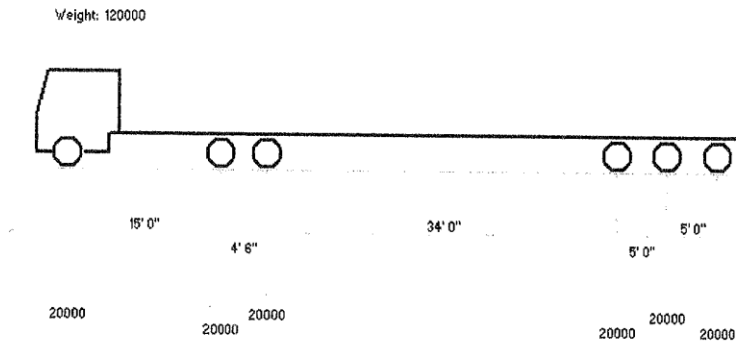

P3

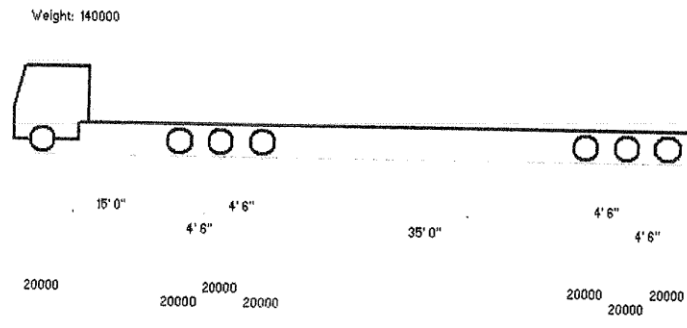

P4

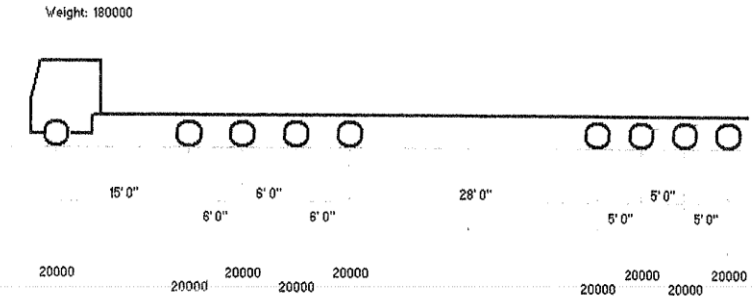

P5

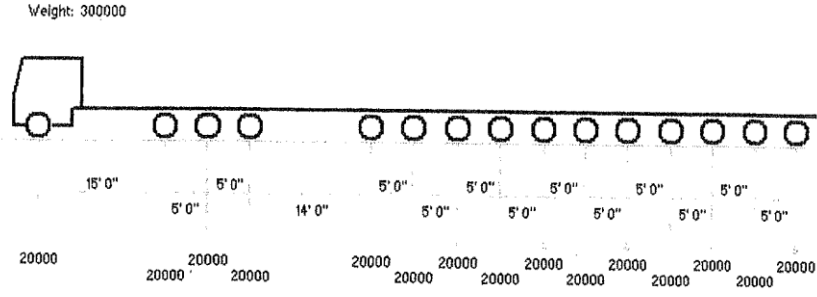

Table 6A.4.5.4.2a-1 specifies live load factors for permit load rating that are calibrated to provide a uniform and acceptable level of reliability. Load factors are defined based on the permit type, loading condition, and site traffic data. Permit load factors given in table 6A.4.5.4.2a-1 for the Strength II limit state are intended for spans having a rating factor greater than 1.0 when evaluated for AASHTO legal loads. Permit load factors are not intended for use in load-rating bridges for legal loads. For the rating of the primary structural components of Ravenna and Columbus Viaducts, it was assumed that permit vehicles will have multiple trips on the bridge with only one lane loaded at a time and will be mixed with other traffic vehicles. Based on the traffic data, the live load factor was estimated to be 1.6 for Ravenna Viaduct and 1.80 for Columbus Viaduct. The dynamic load allowance of design loads was applied to the permit loads with a multiple presence factor of 1.0. For other loading condition, rating factors should be multiplied by the ratio of the new load factor to existing one.

Table 6A.4.5.4.2a-1—Permit Load Factors: γ_L

Permit Type	Frequency	Loading Condition	DF^a	ADTT (one direction)	Load Factor by Permit Weight ^b	
					Up to 100 kips	≥ 150 kips
Routine or Annual	Unlimited Crossings	Mix with traffic (other vehicles may be on the bridge)	Two or more lanes	>5000	1.80	1.30
				=1000	1.60	1.20
				<100	1.40	1.10
					All Weights	
Special or Limited Crossing	Single-Trip	Escorted with no other vehicles on the bridge	One lane	N/A	1.15	
				Single-Trip	Mix with traffic (other vehicles may be on the bridge)	One lane
	=1000	1.40				
	<100	1.35				
	Multiple-Trips (less than 100 crossings)	Mix with traffic (other vehicles may be on the bridge)	One lane	>5000	1.85	
				=1000	1.75	
<100				1.55		

^a DF = LRFD distribution factor. When one-lane distribution factor is used, the built-in multiple presence factor should be divided out.

^b For routine permits between 100 kips and 150 kips, interpolate the load factor by weight and ADTT value. Use only axle weights on the bridge.

2.5 Rating Assumptions

Below is a summary of the assumptions adopted in rating factor calculations:

- All load rating analysis results include a dynamic load allowance of 33% applied to the truck load only and a multiple presence factors of 1.20 for one loaded lane, 1.0 for two loaded lanes, 0.85 for three loaded lanes, and 0.65 for four or more loaded lanes
- Section loss percentages represent the loss in the thickness of the structural steel, reinforcing steel, and prestressing steel. No loss in the concrete section is considered. For example, 20% section loss in the concrete-filled ½” thick arch pipe represents a concrete-filled arch pipe that is 0.4 in. thick.
- The effect of steel confinement on the compressive strength of the filling concrete was considered in calculating the capacity of the arch. Below is an example of calculating the compressive strength of confined concrete. It should be noted that a reduced value of the hoop stress in the pipe is used due to the axial stresses in the pipe.

Thickness of the Tube t (in)	0.5	$f_{22} = \frac{2t}{D_{in}} f_{sp}$
Outside Diameter of the Tube D_{out} (in)	12	
Inside Diameter of the Tube D_{in} (in)	11	
Tube Yield Strength f_y (ksi)	50	$f_{c2} = f_{c0} + 4.1 f_{22}$
*Reduced Tube Hoop Strength f_{yr} (ksi)	9.5	
*Reduced Tube Axial Strength f_{yr} (ksi)	44.5	$\epsilon_{c2} = \epsilon_{c0} \left(5 \frac{f_{c2}}{f_{c0}} - 4 \right)$
Steel Modulus of Elasticity E_s (ksi)	29,000	
Unconfined Compressive Strength f_{c0} (ksi)	8	
Unconfined Concrete Strain ϵ_{c0}	0.00201	
Confining Stress f_{22} (ksi)	0.79	
Confined Compressive Strength f_{c2} (ksi)	11.25	
Confined Concrete Strain ϵ_{c2}	0.0060789	
* Sakino, Nakahara, Morino, and Nishiyama (2004)		

Chapter 3 Ravenna Viaduct

3.1 Analysis Model

The following figures present the general sectional elevation and plan view of Ravenna Viaduct. The analytical model was developed using the as-designed information available in the project specifications. The structural analysis of the viaduct was performed using the structural analysis software SAP2000 Advanced v.14.1.0.

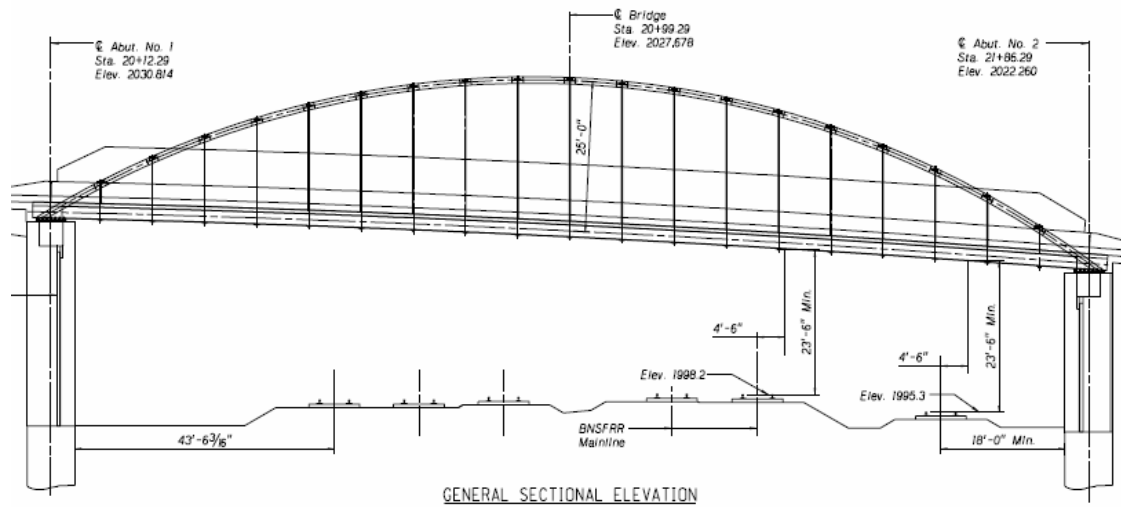

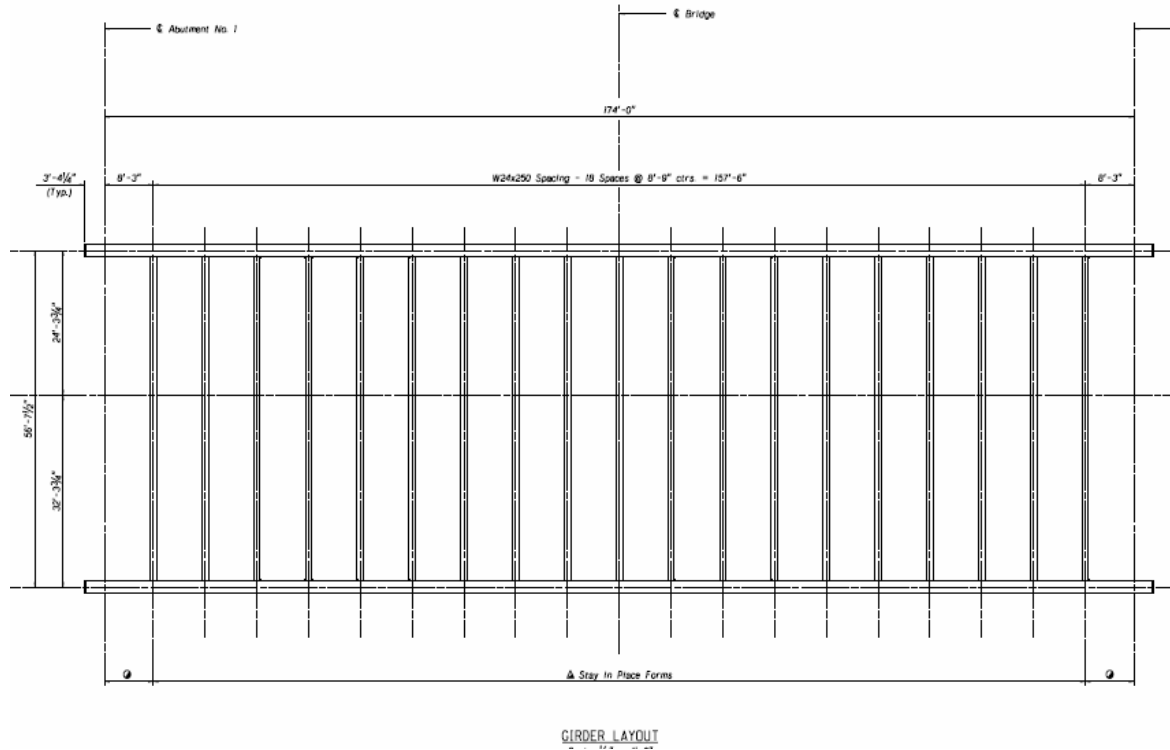

The viaduct was modeled as a 3-D structure using frame elements for ties, arches, cross beams; cable elements for hangers; and tendon elements for post-tensioning strands as shown by the following figure.

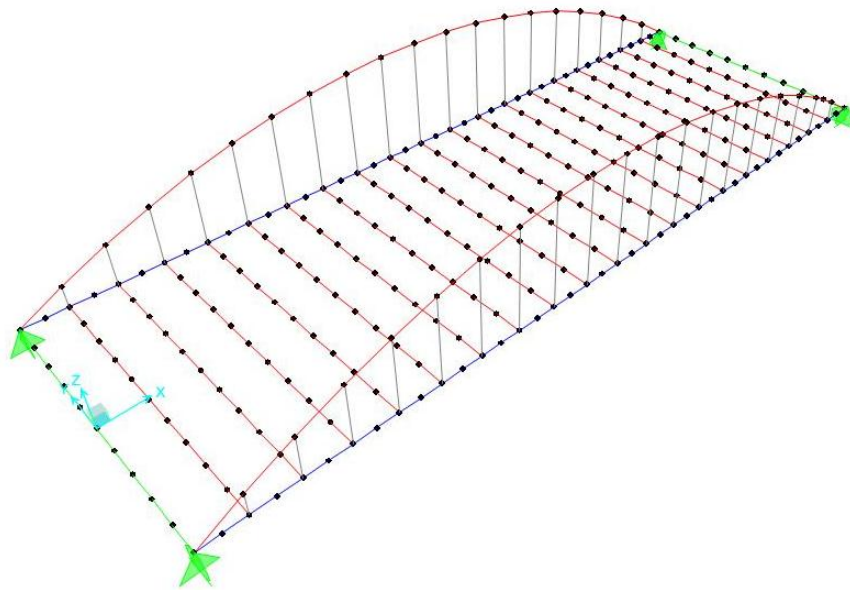

The analysis of the structure was performed in three stages that represent the construction sequence. The section properties and loads applied in each stage are as follows.

Stage I:

- Structure: Arch (steel only), tie (steel only), hangers, and cross beams.
- Loads: Own weight steel structure, metal decking (4 psf) and filling concrete.

Section Name		2Pipes	
Properties			
Cross-section (axial) area	36.1283	Section modulus about 3 axis	99.7292
Torsional constant	1180.6805	Section modulus about 2 axis	322.2696
Moment of Inertia about 3 axis	598.3752	Plastic modulus about 3 axis	131.062
Moment of Inertia about 2 axis	5800.8527	Plastic modulus about 2 axis	430.7594
Shear area in 2 direction	24.1333	Radius of Gyration about 3 axis	4.0697
Shear area in 3 direction	84.2016	Radius of Gyration about 2 axis	12.6713

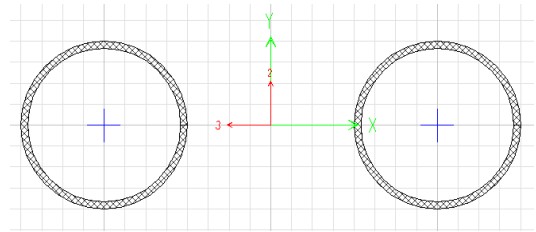

Section Name		Box	
Properties			
Cross-section (axial) area	47.	Section modulus about 3 axis	360.6597
Torsional constant	6599.2821	Section modulus about 2 axis	360.6597
Moment of Inertia about 3 axis	4327.9167	Plastic modulus about 3 axis	414.25
Moment of Inertia about 2 axis	4327.9167	Plastic modulus about 2 axis	414.25
Shear area in 2 direction	23.568	Radius of Gyration about 3 axis	9.596
Shear area in 3 direction	23.568	Radius of Gyration about 2 axis	9.596

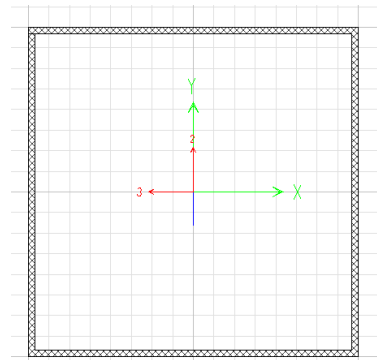

Section Name		HANGER	
Properties			
Cross-section (axial) area	2.4053	Section modulus about 3 axis	0.5262
Torsional constant	0.9208	Section modulus about 2 axis	0.5262
Moment of Inertia about 3 axis	0.4604	Plastic modulus about 3 axis	0.8932
Moment of Inertia about 2 axis	0.4604	Plastic modulus about 2 axis	0.8932
Shear area in 2 direction	2.1648	Radius of Gyration about 3 axis	0.4375
Shear area in 3 direction	2.1648	Radius of Gyration about 2 axis	0.4375

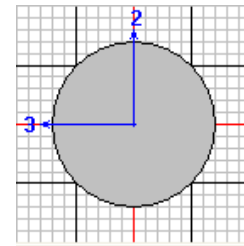

Section Name		W24X250	
Properties			
Cross-section (axial) area	73.5	Section modulus about 3 axis	645.6274
Torsional constant	66.6	Section modulus about 2 axis	109.697
Moment of Inertia about 3 axis	8490.	Plastic modulus about 3 axis	744.
Moment of Inertia about 2 axis	724.	Plastic modulus about 2 axis	171.
Shear area in 2 direction	27.352	Radius of Gyration about 3 axis	10.7476
Shear area in 3 direction	41.58	Radius of Gyration about 2 axis	3.1385

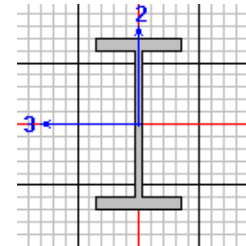

Stage II:

- Structure: Arch (filled with concrete), tie (filled with concrete), hangers, and cross beams.
- Loads: Post-tensioning of ties (2x19-0.6" strands) and weight of 8" thick concrete deck.

Section Name		2Pipes	
Properties			
Cross-section (axial) area	69.3394	Section modulus about 3 axis	141.3209
Torsional constant	1721.4898	Section modulus about 2 axis	601.8223
Moment of Inertia about 3 axis	847.9255	Plastic modulus about 3 axis	570.4662
Moment of Inertia about 2 axis	10832.801	Plastic modulus about 2 axis	2696.9286
Shear area in 2 direction	57.7207	Radius of Gyration about 3 axis	3.4969
Shear area in 3 direction	165.2103	Radius of Gyration about 2 axis	12.4991

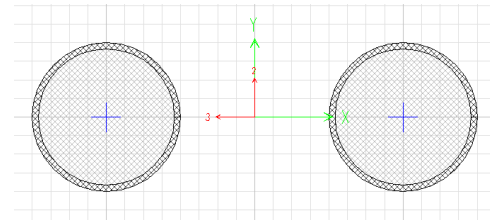

Section Name		Box	
Properties			
Cross-section (axial) area	140.031	Section modulus about 3 axis	702.4196
Torsional constant	14641.683	Section modulus about 2 axis	702.4196
Moment of Inertia about 3 axis	8429.0348	Plastic modulus about 3 axis	3456.
Moment of Inertia about 2 axis	8429.0348	Plastic modulus about 2 axis	3456.
Shear area in 2 direction	110.2889	Radius of Gyration about 3 axis	7.7585
Shear area in 3 direction	110.2889	Radius of Gyration about 2 axis	7.7585

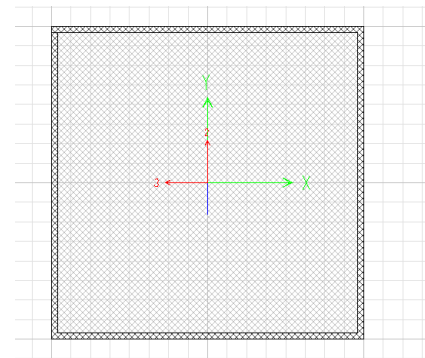

Stage III:

- Structure: Arch (filled with concrete), tie (filled with concrete) and composite with 7.5" deck, hangers, end beams, cross beam composite with 7.5" concrete deck.

- Loads: Wearing surface (20 psf), barriers (0.4 k/ft), and live loads.

Section Name		Box	
Properties			
Cross-section (axial) area	490.089	Section modulus about 3 axis	1532.3835
Torsional constant	28574.396	Section modulus about 2 axis	20584.624
Moment of Inertia about 3 axis	35901.27	Plastic modulus about 3 axis	14612.364
Moment of Inertia about 2 axis	3622894.	Plastic modulus about 2 axis	251264.
Shear area in 2 direction	180.4282	Radius of Gyration about 3 axis	8.5589
Shear area in 3 direction	329.5319	Radius of Gyration about 2 axis	85.9786

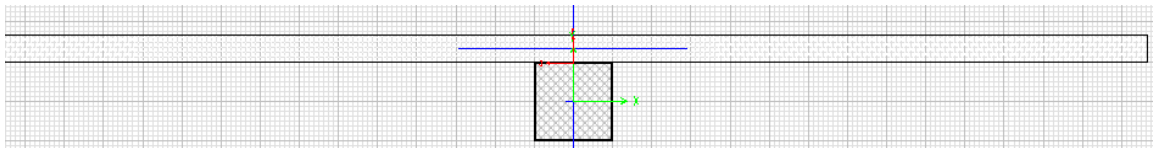

Section Name		FloorBeam	
Properties			
Cross-section (axial) area	171.7706	Section modulus about 3 axis	927.8679
Torsional constant	2823.4561	Section modulus about 2 axis	1639.1664
Moment of Inertia about 3 axis	21322.283	Plastic modulus about 3 axis	2827.809
Moment of Inertia about 2 axis	81138.74	Plastic modulus about 2 axis	19772.746
Shear area in 2 direction	40.6969	Radius of Gyration about 3 axis	11.1415
Shear area in 3 direction	104.2465	Radius of Gyration about 2 axis	21.734

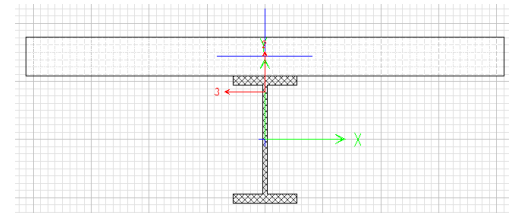

Analysis results for each member in the tied-arch shown below under each load case are given in a companion spreadsheet. The axial forces and bending moment at critical sections were used for load rating.

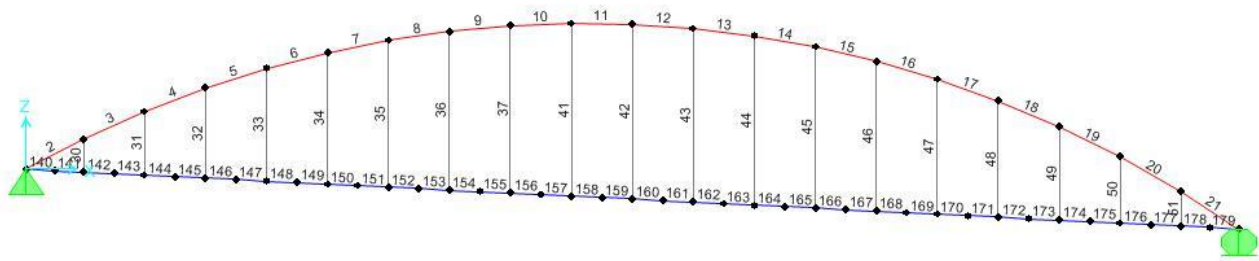

3.2 Capacity Charts

The section capacity of primary structural components of the Ravenna Viaduct was determined assuming section loss percentages ranging from 0% to 50%. These percentages of section loss represent the corrosion that might occur in the steel portion of these components and, consequently reducing the thickness of structural steel and/or the diameter of prestressing strands. Reduction in the concrete dimensions and/or strength was considered negligible and was not included in these percentages. The following figures present the factored and nominal capacity charts for arch, tie, hanger, and floor beam sections respectively. These capacity charts were developed using the strain compatibility approach and the AASHTO LRFD strength reduction factors.

Nominal and Factored Capacity of Ravenna Arch

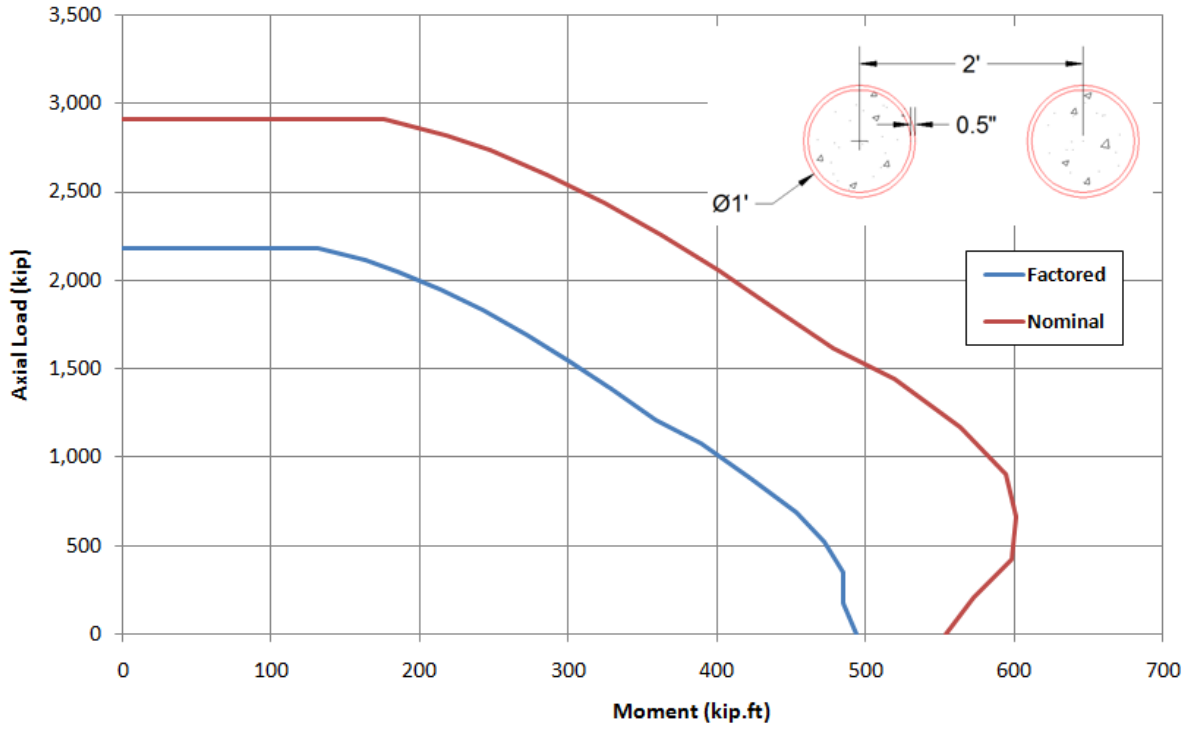

Factored Capacity of Ravenna Arch vs. Section Loss

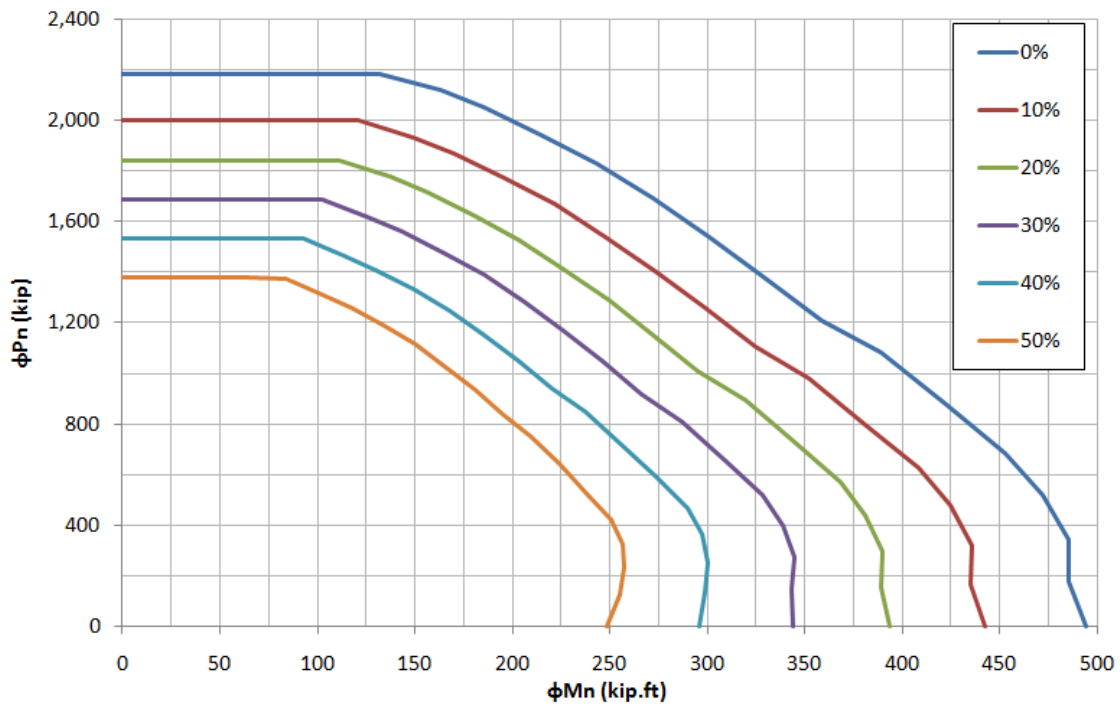

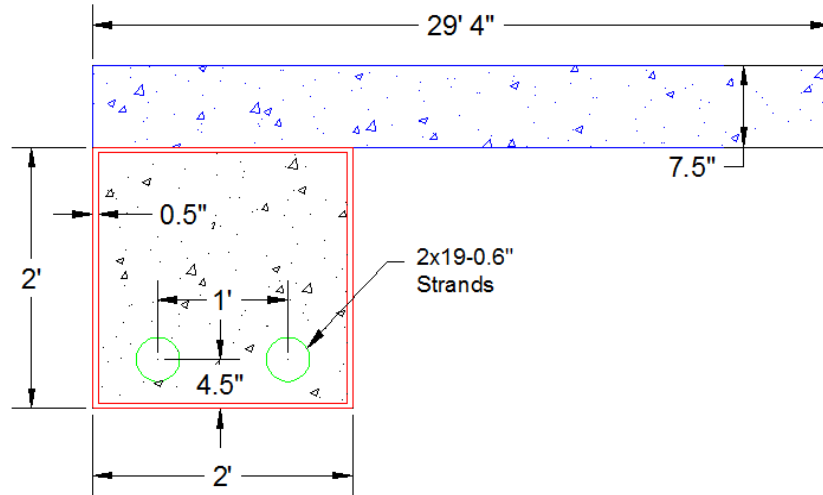

Nominal and Factored Capacity of Ravenna Tie

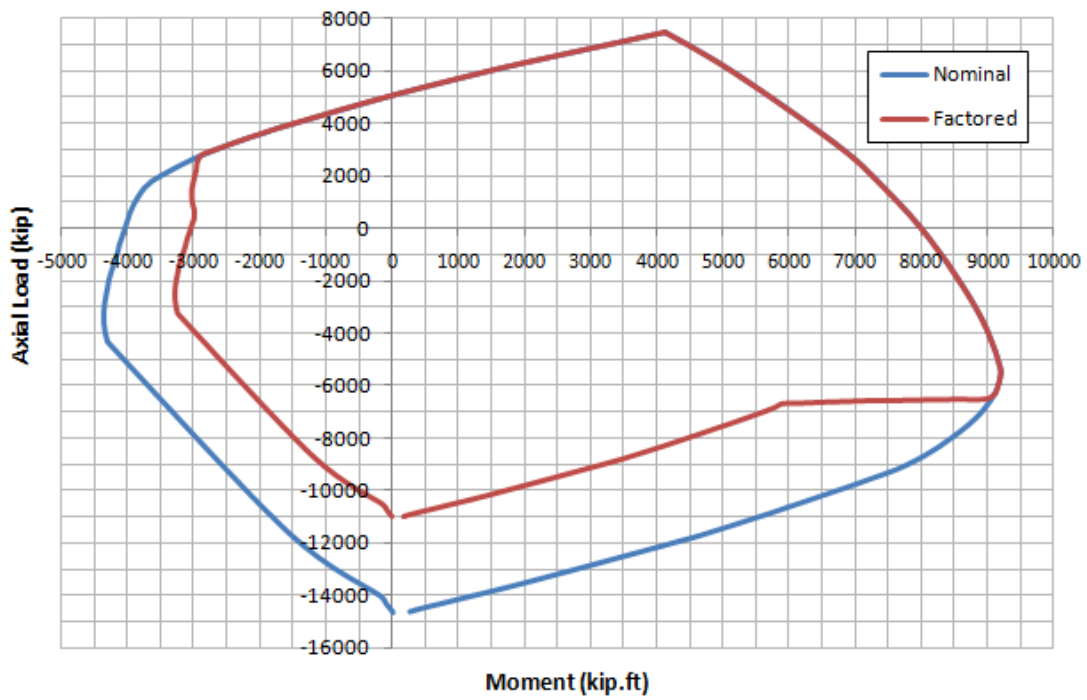

Factored Capacity of Ravenna Tie at vs. Section Loss

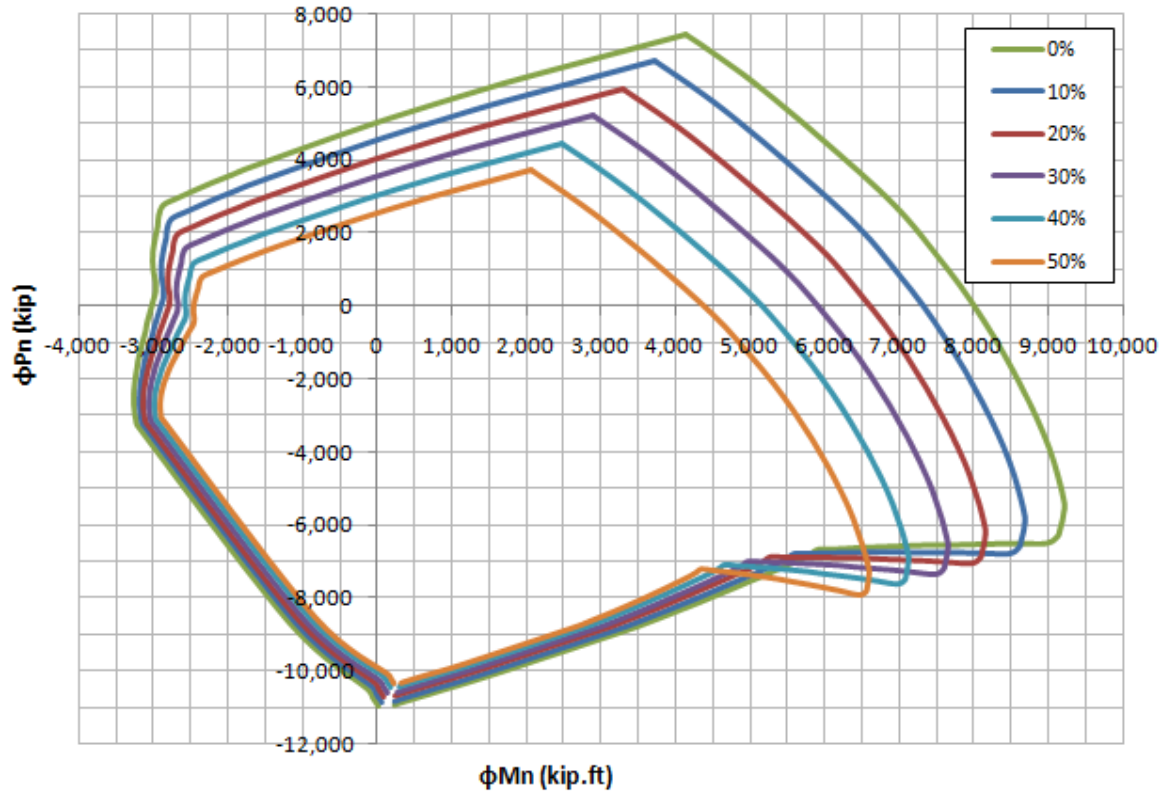

Nominal and Factored Capacity of Ravenna Hanger vs. Section Loss

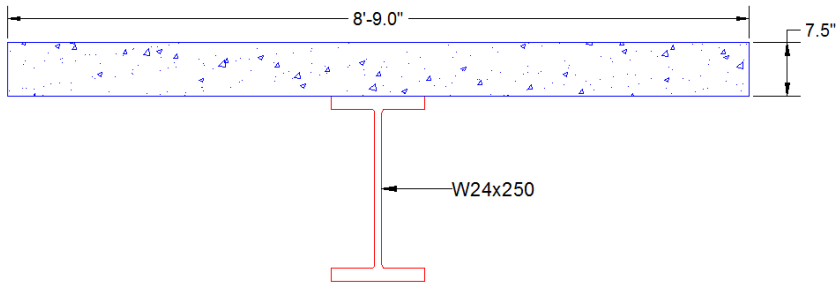
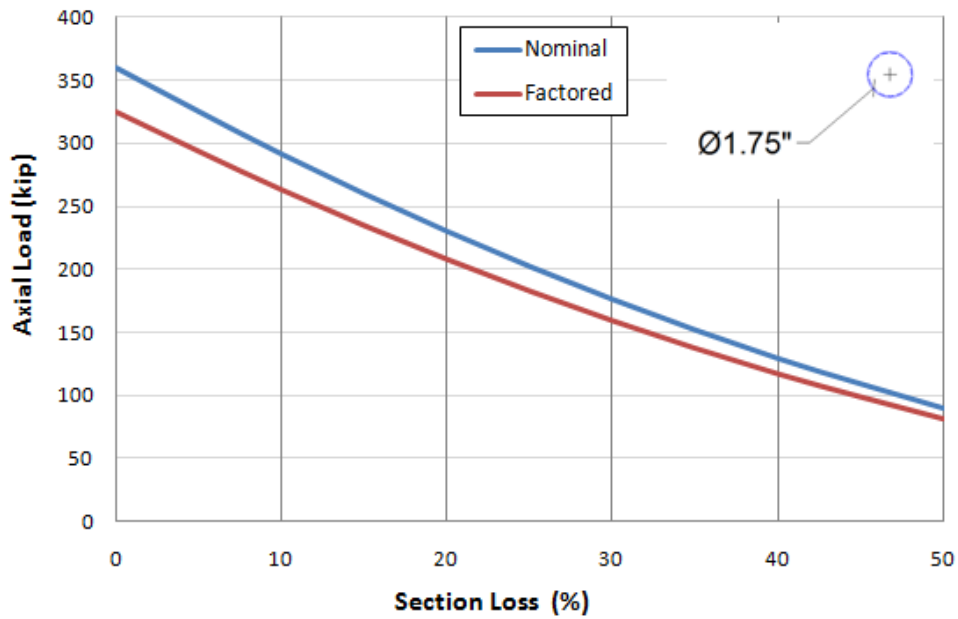

Nominal and Factored Capacity of Ravenna Floor Beams vs. Section Loss

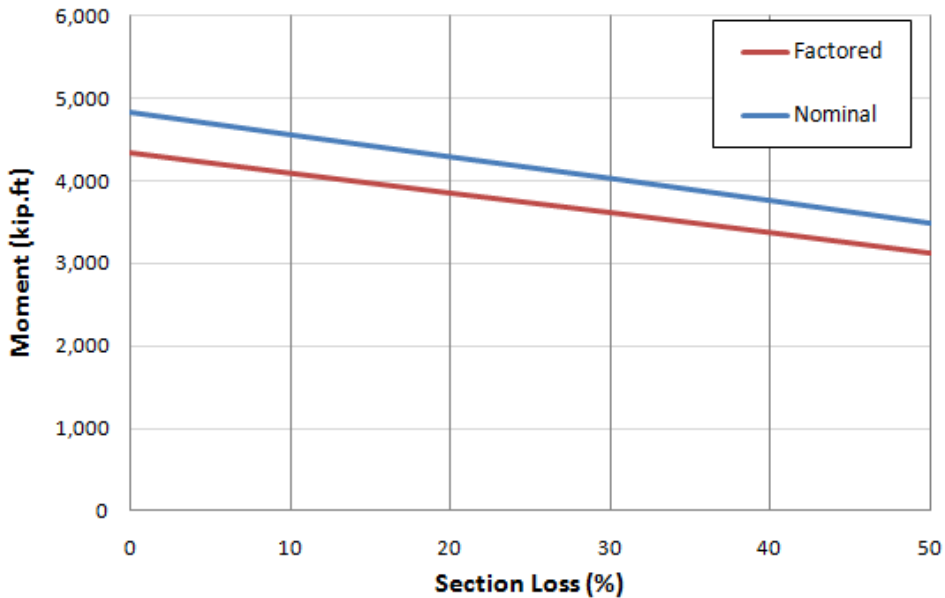

3.3 Rating Factors

The next table lists the capacity of each of the primary structural component of Ravenna Viaduct as well as the demand at the most critical sections based on the 3D analysis.

Primary Structural Element	Capacity at Different Section Loss						Elem. ID	Demand															
	Percentages							DC	P	DW	TOTAL	(LL+I) _{HL-95}	(LL+I) _{HS20}	(LL+I) _{HS}	(LL+I) _{HS22}	(LL+I) _{HS-3}	(LL+I) _{SP1}	(LL+I) _{SP2}	(LL+I) _{SP3}	(LL+I) _{SP4}	(LL+I) _{SP5}		
	0%	10%	20%	30%	40%	50%																	
Floor Beams	M (kip.ft)	4345	4100	3860	3625	3383	3135	N/A	466	0	70	687	1450	1084	889	813	732	650	751	751	751	751	751
	P (kip)	325	263	208	159	117	81	50	49.7	-3.1	6.5	69	27.9	15.9	11.1	15.9	18	10.3	12.5	14.5	18.5	18.5	18.5
Tie Beams (+ve)	M (kip.ft)	7200	6500	5900	5000	4300	3650	172	-316	727	-23	298	2166	1704	1269	1342	1194	659	808	935	1061	1835	1835
	P (kip)	2250	2100	2000	1700	1650	1500	172	777	0	83	1096	360	204	142	205	232	132	159	185	235	394	394
Tie Beams (-ve)	M (kip.ft)	-3000	-2800	-2700	-2500	-2000	-1700	172	-316	727	-23	298	-1579	-1068	-749	-1032	-1121	-560	-691	-789	-991	-1678	-1678
	P (kip)	1900	1850	1800	1700	1600	1500	172	777	0	83	1096	360	204	142	205	232	132	159	185	235	394	394
Arch Pipes	M (kip.ft)	-160	-145	-135	-122	-110	-100	20	-41	-39	-1	-91	-25.0	-16.4	-11.5	-16.0	-17.6	-9.1	-11.1	-12.8	-16.1	-27.2	-27.2
	P (kip)	-2130	-1950	-1780	-1620	-1480	-1320	20	-892	47	-96	-1213	-415.4	-237.3	-165.4	-238.2	-269.9	-154.9	-187.6	-217.3	-277.2	-463.2	-463.2

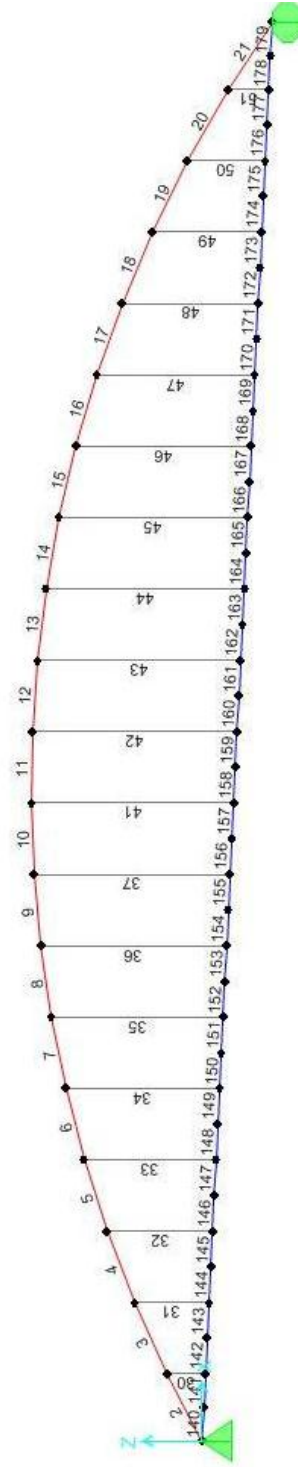

The capacity and demand values were used to calculate the rating factor based on the equation 6A.4.2.1-1 presented in Chapter 2. The table shown below lists the rating factor in ratios and in tons. Section loss percentage, system factor and live load factors used in the calculations are highlighted in yellow and can be easily modified in the spreadsheet as needed.

		Live Load Factors									
System Factor	1.0	1.75		1.45			1.6				
Section Loss	0%	$(LL+I)_{HL-93}$	$(LL+I)_{HS20}$	$(LL+I)_{N3}$	$(LL+I)_{N3S2}$	$(LL+I)_{N3-3}$	$(LL+I)_{SP1}$	$(LL+I)_{SP2}$	$(LL+I)_{SP3}$	$(LL+I)_{SP4}$	$(LL+I)_{SP5}$
Floor beams	M (kip.ft)	1.44	1.93	2.84	3.10	3.45	3.51	3.04	2.87	3.04	3.04
Hangers	P (kip)	5.25	9.21	15.92	11.11	9.82	15.55	12.81	11.04	8.66	5.18
Tie Beams (+ve)	M (kip.ft)	1.82	2.31	3.75	3.55	3.99	6.55	5.34	4.61	4.07	2.35
	P (kip)	1.83	3.23	5.61	3.88	3.43	5.47	4.54	3.90	3.07	1.83
Tie Beams (-ve)	M (kip.ft)	1.19	1.76	3.04	2.20	2.03	3.68	2.98	2.61	2.08	1.23
	P (kip)	1.28	2.25	3.91	2.71	2.39	3.81	3.16	2.72	2.14	1.28
Arch Pipes	M (kip.ft)	1.58	2.41	4.15	2.99	2.71	4.76	3.90	3.38	2.69	1.59
	P (kip)	1.26	2.21	3.83	2.66	2.34	3.70	3.06	2.64	2.07	1.24
Rating in Tons		80	36	25	37	43	50	60	70	100	150
Floor beams	M (kip.ft)	115.3	69.4	70.9	114.8	148.2	175.7	182.5	201.0	304.2	456.4
Hangers	P (kip)	419.8	331.5	398.0	411.2	422.1	777.4	768.7	773.1	865.6	777.4
Tie Beams (+ve)	M (kip.ft)	145.7	83.3	93.8	131.2	171.4	327.3	320.4	323.0	406.6	352.6
	P (kip)	146.6	116.4	140.1	143.7	147.5	273.3	272.2	273.0	307.0	274.6
Tie Beams (-ve)	M (kip.ft)	95.5	63.5	75.9	81.5	87.2	184.0	179.0	182.8	208.0	184.2
	P (kip)	102.1	81.1	97.7	100.1	102.8	190.4	189.7	190.2	213.9	191.4
Arch Pipes	M (kip.ft)	126.7	86.9	103.9	110.5	116.7	237.9	234.0	236.8	268.9	238.8
	P (kip)	101.0	79.5	95.6	98.3	100.8	185.1	183.4	184.7	206.9	185.7

Ravenna Viaduct was also analyzed in case of one of the hangers was totally damaged. This analysis was performed in a two dimensional model by eliminating the hanger at the location of the tie section with the highest bending moment. The next tables list the capacity and demand of each structural member as well as the calculated rating factors.

Primary Structural Element	Capacity at Different Section Loss Percentages						Elem. ID	Demand														
	Percentages							DC	P	DW	TOTAL	(LL+) _{HU-93}	(LL+) _{HS20}	(LL+) _{N3}	(LL+) _{N3-3}	(LL+) _{SP1}	(LL+) _{SP2}	(LL+) _{SP3}	(LL+) _{SP4}	(LL+) _{SP5}		
	0%	10%	20%	30%	40%	50%																
Floor beams	M (kip.ft)	4345	3860	3625	3383	3135	N/A	466	0	70	687	1450	1084	889	813	732	650	751	796	751	751	751
Hangers	P (kip)	325	263	208	159	117	81	75	-5	7	99	44	29	19	26	28	18	22	25	30	43	43
Tie Beams (+ve)	M (kip.ft)	7200	6500	5900	5000	4300	3650	45	-449	699	-30	2173	1683	1244	1363	1257	696	855	997	1145	2037	2037
Tie Beams (-ve)	P (kip)	2250	2100	2000	1700	1650	1500	45	681	0	63	363	206	143	207	234	136	164	190	243	406	406
	M (kip.ft)	-3000	-2800	-2700	-2500	-2000	-1700	45	-449	699	-30	-1580	-1075	-806	-1102	-1186	-599	-740	-845	-1059	-1833	-1833
Arch Pipes	P (kip)	1900	1850	1800	1700	1600	1500	45	681	0	63	363	206	143	207	234	136	164	190	243	406	406
	M (kip.ft)	-340	-305	-275	-245	-225	-200	16	-180	-10	-15	-132	-83	-58	-83	-92	-52	-63	-73	-93	-156	-156
	P (kip)	-1320	-1205	-1140	-1040	-930	-800	16	-839	53	-68	-389	-221	-154	-222	-252	-146	-177	-205	-262	-437	-437

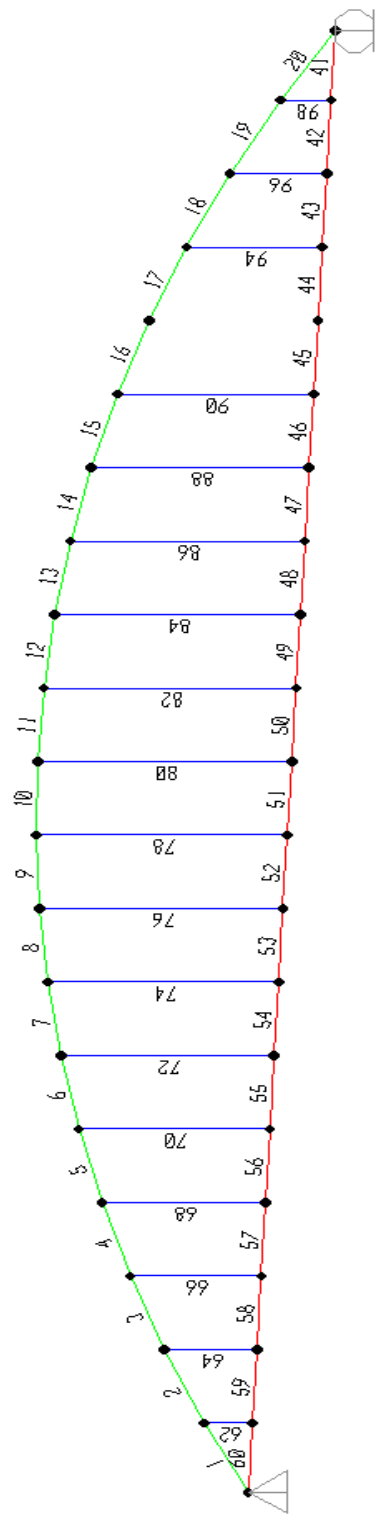

		Live Load Factors									
System Factor	1.0	1.75		1.45			1.6				
Section Loss	0%	(LL+I) _{HL-93}	(LL+I) _{HS20}	(LL+I) _{N3}	(LL+I) _{N3S2}	(LL+I) _{N3-3}	(LL+I) _{SP1}	(LL+I) _{SP2}	(LL+I) _{SP3}	(LL+I) _{SP4}	(LL+I) _{SP5}
Floor beams	M (kip.ft)	1.44	1.93	2.84	3.10	3.45	3.51	3.04	2.87	3.04	3.04
Hangers	P (kip)	2.92	4.51	8.04	5.95	5.51	7.69	6.54	5.67	4.74	3.26
Tie Beams (+ve)	M (kip.ft)	1.87	2.41	3.94	3.60	3.90	6.39	5.20	4.45	3.88	2.18
	P (kip)	2.05	3.62	6.27	4.35	3.84	6.00	4.96	4.28	3.36	2.01
Tie Beams (-ve)	M (kip.ft)	1.12	1.64	2.65	1.94	1.80	3.23	2.61	2.29	1.82	1.05
	P (kip)	1.50	2.65	4.59	3.18	2.81	4.39	3.63	3.13	2.45	1.47
Arch Pipes	M (kip.ft)	0.36	0.57	0.99	0.70	0.62	1.00	0.82	0.71	0.56	0.34
	P (kip)	0.33	0.57	0.99	0.69	0.61	0.95	0.78	0.68	0.53	0.32
Rating in Tons		80	36	25	37	43	50	60	70	100	150
Floor beams	M (kip.ft)	115.3	69.4	70.9	114.8	148.2	175.7	182.5	200.9	304.2	456.3
Hangers	P (kip)	233.4	162.5	201.1	220.1	236.7	384.4	392.7	397.1	473.7	488.6
Tie Beams (+ve)	M (kip.ft)	149.5	86.9	98.5	133.1	167.7	319.3	311.9	311.8	387.8	327.2
	P (kip)	164.3	130.3	156.9	161.1	165.1	300.2	297.7	299.7	335.6	301.3
Tie Beams (-ve)	M (kip.ft)	89.5	59.2	66.1	71.6	77.3	161.4	156.7	160.2	182.5	158.2
	P (kip)	120.2	95.3	114.7	117.8	120.8	219.6	217.8	219.2	245.5	220.4
Arch Pipes	M (kip.ft)	29.0	20.6	24.8	25.8	26.8	50.0	49.3	49.9	56.0	50.3
	P (kip)	26.0	20.6	24.9	25.5	26.1	47.3	47.0	47.3	53.0	47.6

Below are the bending moment diagrams of the arch and tie due to deck weight only before and after the loss of one hanger. These diagrams show the significant increase in the arch moment.

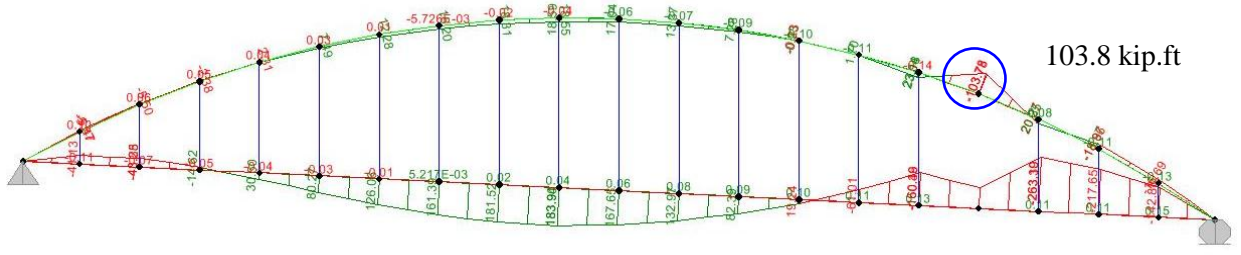
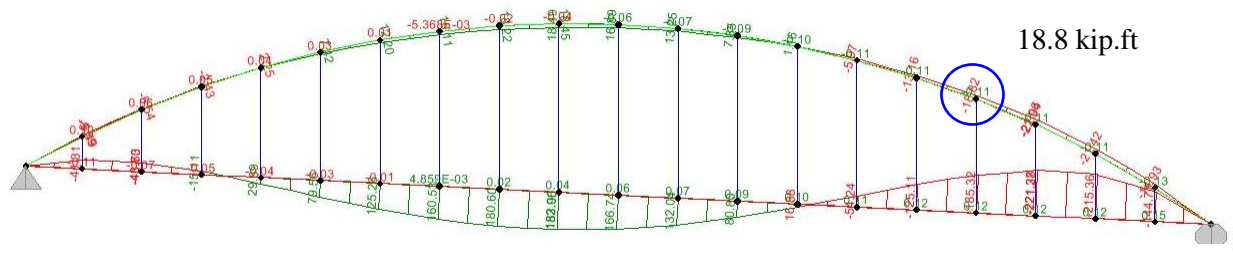

Chapter 4 Columbus Viaduct

4.1 Analysis Models

The figures shown in the following pages present the general sectional elevation and plan view of Columbus Viaduct. The analytical model was developed using the as-designed information available in the project specifications. The structural analysis of the viaduct was performed using the structural analysis software SAP2000 Advanced v.14.1.0.

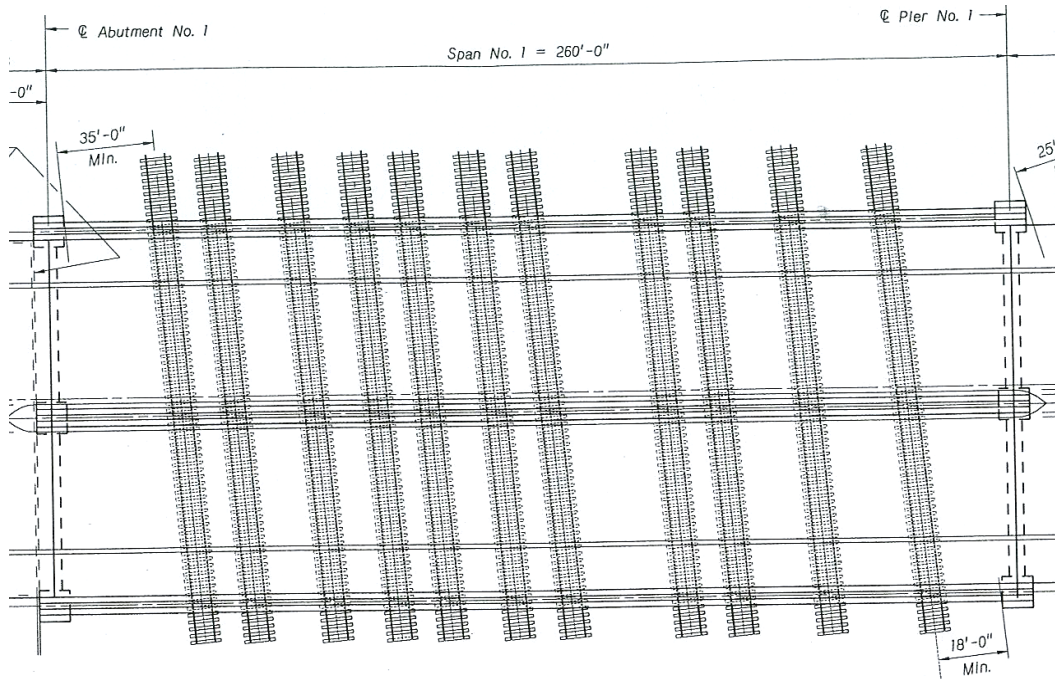

GENERAL PLAN

Scale: 1" = 20'-0"

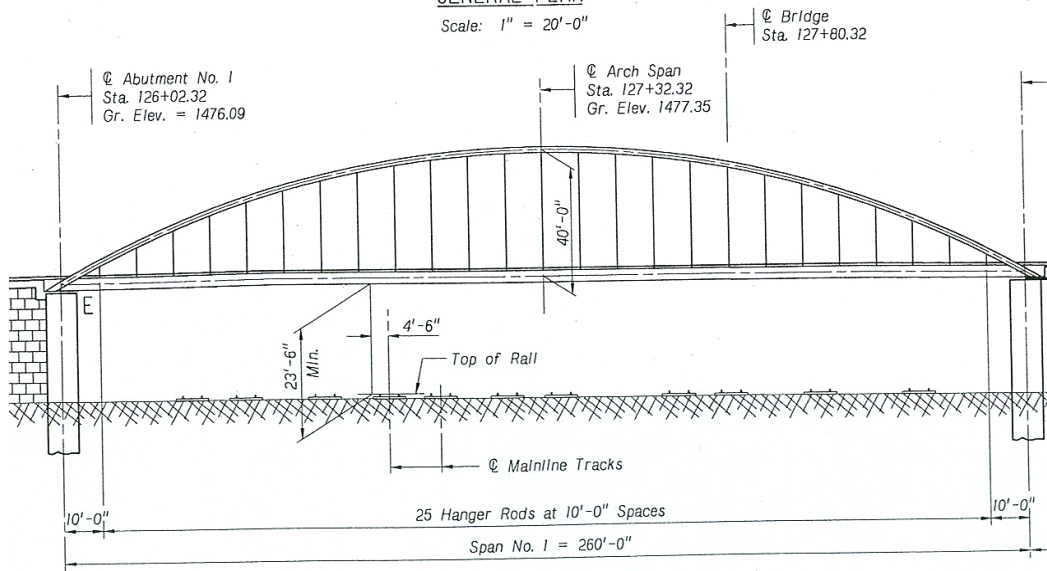

GENERAL ELEVATION

The viaduct was modeled as a 3-D structure using frame elements for ties, arches, cross beams; cable elements for hangers; and tendon elements for post-tensioning strands as shown next.

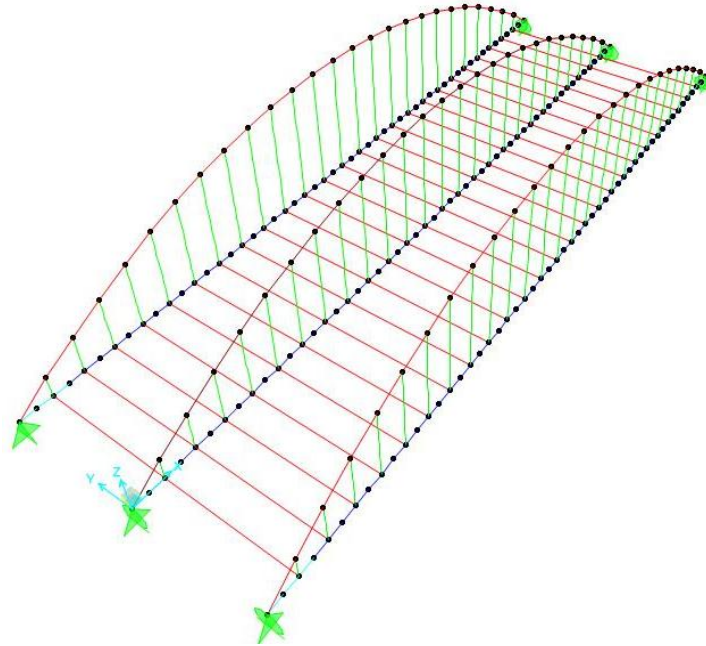

The analysis of the structure was performed in three stages that represent the construction sequence. The section properties and loads applied in each stage are as follows:

Stage I:

- Structure: Arch (steel only), tie (steel only), hangers, and cross beams.
- Loads: Own weight steel structure, metal decking (4 psf) and filling concrete.

Section Name		2Pipes	
Properties			
Cross-section (axial) area	54.9779	Section modulus about 3 axis	234.0377
Torsional constant	4155.4189	Section modulus about 2 axis	737.747
Moment of Inertia about 3 axis	2106.3397	Plastic modulus about 3 axis	303.3903
Moment of Inertia about 2 axis	19919.17	Plastic modulus about 2 axis	983.2552
Shear area in 2 direction	36.6441	Radius of Gyration about 3 axis	6.1897
Shear area in 3 direction	5.936E-13	Radius of Gyration about 2 axis	19.0345

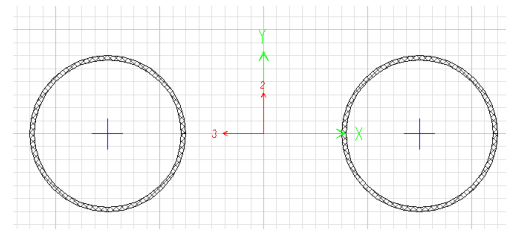

Section Name			
2PipesMid			
Properties			
Cross-section (axial) area	100.5571	Section modulus about 3 axis	407.8032
Torsional constant	7242.7315	Section modulus about 2 axis	1342.6193
Moment of Inertia about 3 axis	3670.2289	Plastic modulus about 3 axis	541.4239
Moment of Inertia about 2 axis	36250.72	Plastic modulus about 2 axis	1798.4194
Shear area in 2 direction	67.3167	Radius of Gyration about 3 axis	6.0414
Shear area in 3 direction	5.945E-13	Radius of Gyration about 2 axis	18.9868

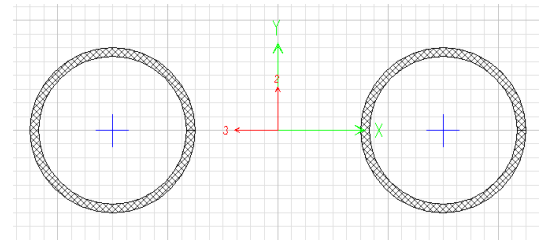

Section Name			
Box			
Properties			
Cross-section (axial) area	59.	Section modulus about 3 axis	498.7431
Torsional constant	11958.281	Section modulus about 2 axis	618.6065
Moment of Inertia about 3 axis	5984.9167	Plastic modulus about 3 axis	555.25
Moment of Inertia about 2 axis	11134.917	Plastic modulus about 2 axis	732.25
Shear area in 2 direction	23.7757	Radius of Gyration about 3 axis	10.0717
Shear area in 3 direction	35.024	Radius of Gyration about 2 axis	13.7378

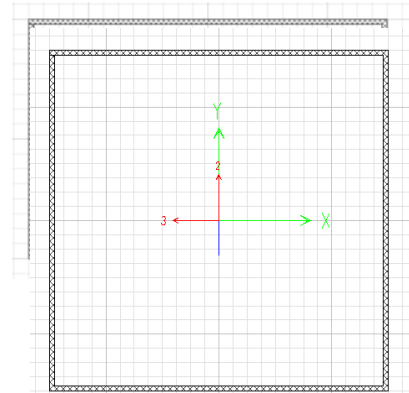

Section Name			
BoxEND			
Properties			
Cross-section (axial) area	71.	Section modulus about 3 axis	828.662
Torsional constant	22628.535	Section modulus about 2 axis	828.662
Moment of Inertia about 3 axis	14915.917	Plastic modulus about 3 axis	945.25
Moment of Inertia about 2 axis	14915.917	Plastic modulus about 2 axis	945.25
Shear area in 2 direction	35.4489	Radius of Gyration about 3 axis	14.4943
Shear area in 3 direction	35.4489	Radius of Gyration about 2 axis	14.4943

Section Name			
HANGER			
Properties			
Cross-section (axial) area	2.4053	Section modulus about 3 axis	0.5262
Torsional constant	0.9208	Section modulus about 2 axis	0.5262
Moment of Inertia about 3 axis	0.4604	Plastic modulus about 3 axis	0.8932
Moment of Inertia about 2 axis	0.4604	Plastic modulus about 2 axis	0.8932
Shear area in 2 direction	2.1648	Radius of Gyration about 3 axis	0.4375
Shear area in 3 direction	2.1648	Radius of Gyration about 2 axis	0.4375

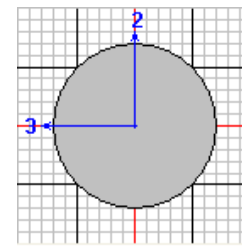

Section Name		W24X162	
Properties			
Cross-section (axial) area	47.7	Section modulus about 3 axis	413.6
Torsional constant	18.5	Section modulus about 2 axis	68.1538
Moment of Inertia about 3 axis	5170.	Plastic modulus about 3 axis	468.
Moment of Inertia about 2 axis	443.	Plastic modulus about 2 axis	105.
Shear area in 2 direction	17.625	Radius of Gyration about 3 axis	10.4108
Shear area in 3 direction	26.4333	Radius of Gyration about 2 axis	3.0475

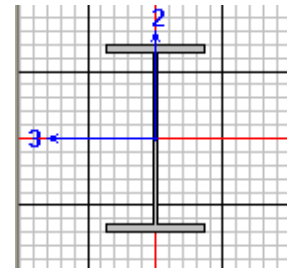

Stage II:

- Structure: Arch (filled with concrete), tie (filled with concrete), hangers, and cross beams.
- Loads: Post-tensioning of ties (2x19-0.6” strands for outside ties and 2x37-0.6” strands for median ties) and weight of 8” thick concrete deck.

Section Name		2Pipes	
Properties			
Cross-section (axial) area	134.3003	Section modulus about 3 axis	392.2137
Torsional constant	7240.4579	Section modulus about 2 axis	1742.3409
Moment of Inertia about 3 axis	3529.9235	Plastic modulus about 3 axis	1925.3233
Moment of Inertia about 2 axis	47043.2	Plastic modulus about 2 axis	9102.1341
Shear area in 2 direction	114.8294	Radius of Gyration about 3 axis	5.1268
Shear area in 3 direction	5.620E-13	Radius of Gyration about 2 axis	18.7159

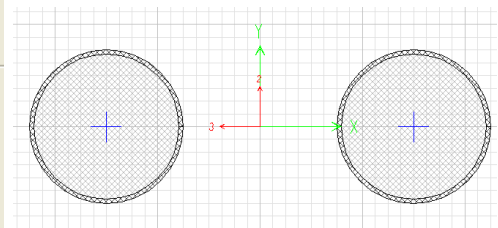

Section Name		2PipesMID	
Properties			
Cross-section (axial) area	171.8798	Section modulus about 3 axis	535.6839
Torsional constant	0.	Section modulus about 2 axis	2241.119
Moment of Inertia about 3 axis	4821.1551	Plastic modulus about 3 axis	1924.2936
Moment of Inertia about 2 axis	60510.21	Plastic modulus about 2 axis	9098.5107
Shear area in 2 direction	125.7934	Radius of Gyration about 3 axis	5.2962
Shear area in 3 direction	125.7934	Radius of Gyration about 2 axis	18.763

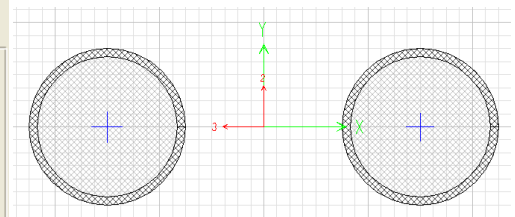

Section Name		Box	
Properties			
Cross-section (axial) area	200.569	Section modulus about 3 axis	1018.8124
Torsional constant	29095.787	Section modulus about 2 axis	1421.486
Moment of Inertia about 3 axis	12225.749	Plastic modulus about 3 axis	5184.
Moment of Inertia about 2 axis	25586.749	Plastic modulus about 2 axis	7776.
Shear area in 2 direction	156.9875	Radius of Gyration about 3 axis	7.8074
Shear area in 3 direction	162.6403	Radius of Gyration about 2 axis	11.2947

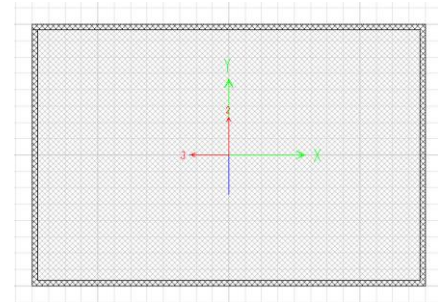

Section Name		BoxEND	
Properties			
Cross-section (axial) area	286.431	Section modulus about 3 axis	2050.4353
Torsional constant	64935.18	Section modulus about 2 axis	2050.4353
Moment of Inertia about 3 axis	36907.83	Plastic modulus about 3 axis	11664.
Moment of Inertia about 2 axis	36907.83	Plastic modulus about 2 axis	11664.
Shear area in 2 direction	231.4441	Radius of Gyration about 3 axis	11.3514
Shear area in 3 direction	231.4441	Radius of Gyration about 2 axis	11.3514

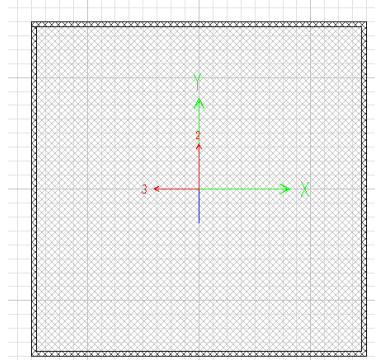

Stage III:

- Structure: Arch (filled with concrete), tie (filled with concrete) and composite with 7.5” deck, hangers, end beams, cross beam composite with 7.5” concrete deck.
- Loads: Wearing surface (20 psf), barriers (0.4 k/ft), and live loads.

Section Name		MedianBox	
Properties			
Cross-section (axial) area	738.3103	Section modulus about 3 axis	1949.9985
Torsional constant	53023.4	Section modulus about 2 axis	48864.27
Moment of Inertia about 3 axis	47414.54	Plastic modulus about 3 axis	21701.623
Moment of Inertia about 2 axis	12582550	Plastic modulus about 2 axis	538226.
Shear area in 2 direction	218.2639	Radius of Gyration about 3 axis	8.0138
Shear area in 3 direction	532.4806	Radius of Gyration about 2 axis	130.5464

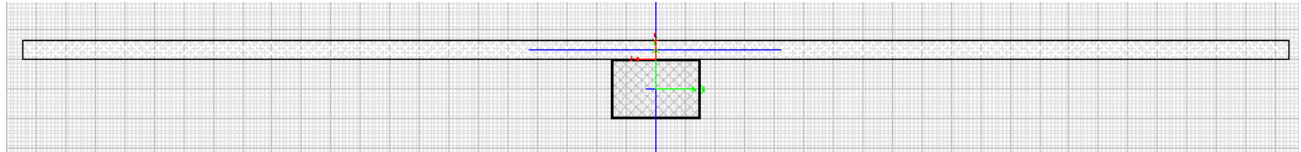

Section Name		MedianBoxEnd	
Properties			
Cross-section (axial) area	808.2414	Section modulus about 3 axis	3491.5446
Torsional constant	87480.19	Section modulus about 2 axis	48901.92
Moment of Inertia about 3 axis	116855.84	Plastic modulus about 3 axis	593891.1
Moment of Inertia about 2 axis	12592245	Plastic modulus about 2 axis	542114.
Shear area in 2 direction	261.8336	Radius of Gyration about 3 axis	12.0242
Shear area in 3 direction	537.0784	Radius of Gyration about 2 axis	124.8191

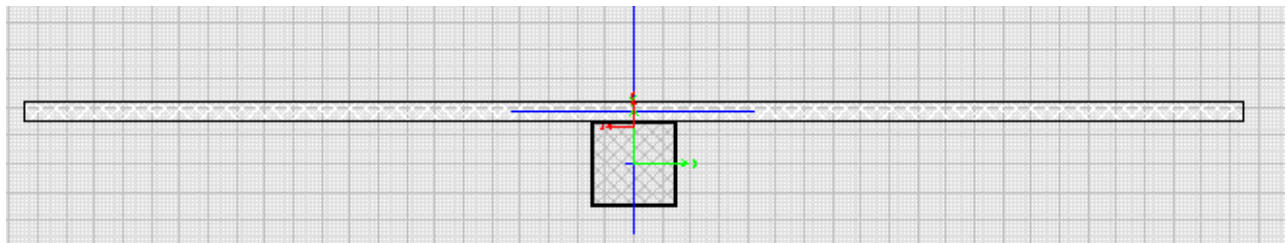

Section Name		OutsideBox	
Properties			
Cross-section (axial) area	474.0345	Section modulus about 3 axis	1815.5731
Torsional constant	46915.69	Section modulus about 2 axis	14121.786
Moment of Inertia about 3 axis	40416.21	Plastic modulus about 3 axis	23055.917
Moment of Inertia about 2 axis	1945276.	Plastic modulus about 2 axis	159576.5
Shear area in 2 direction	202.3154	Radius of Gyration about 3 axis	9.2336
Shear area in 3 direction	320.2887	Radius of Gyration about 2 axis	64.0598

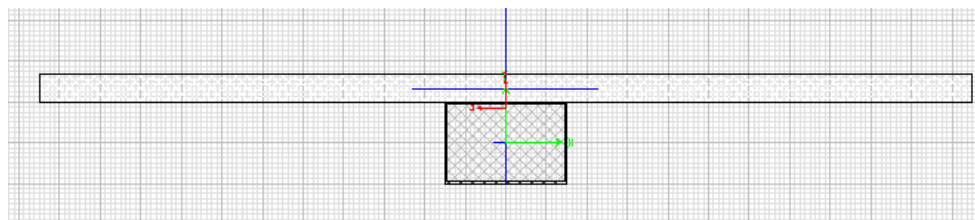

Section Name		OutsideBoxEnd	
Properties			
Cross-section (axial) area	493.9138	Section modulus about 3 axis	2488.875
Torsional constant	61761.04	Section modulus about 2 axis	14145.796
Moment of Inertia about 3 axis	65317.59	Plastic modulus about 3 axis	34965.92
Moment of Inertia about 2 axis	1948583.4	Plastic modulus about 2 axis	161520.5
Shear area in 2 direction	222.7259	Radius of Gyration about 3 axis	11.4998
Shear area in 3 direction	322.5901	Radius of Gyration about 2 axis	62.8107

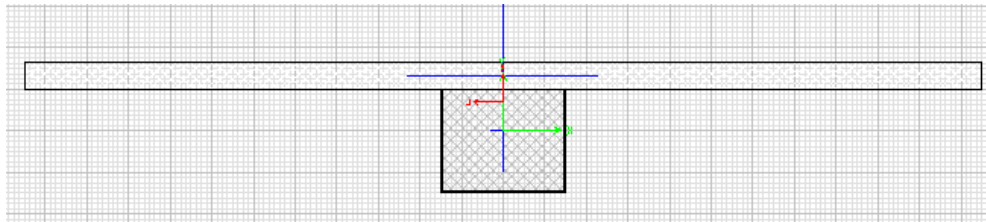

Analysis results for each member in the tied-arch shown below under each load case are given in a companion spreadsheet. The axial forces and bending moment at critical sections were used for load rating.

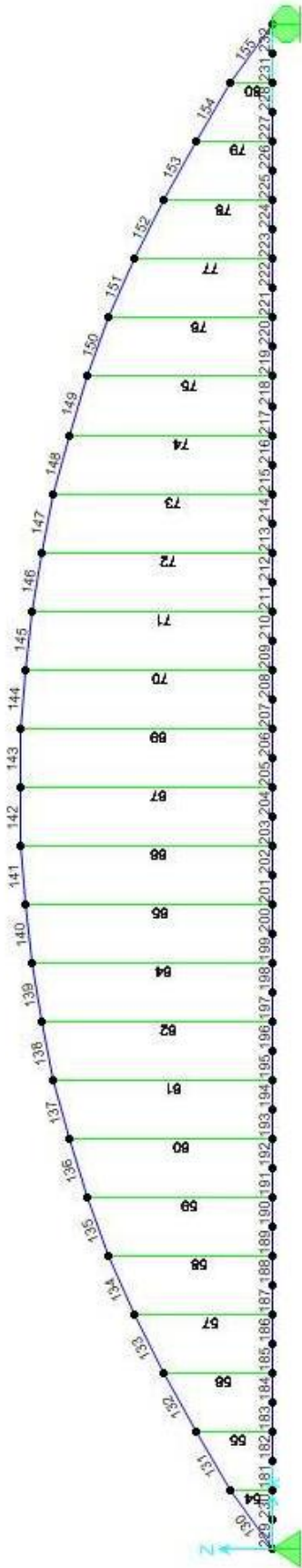

Outside Arch

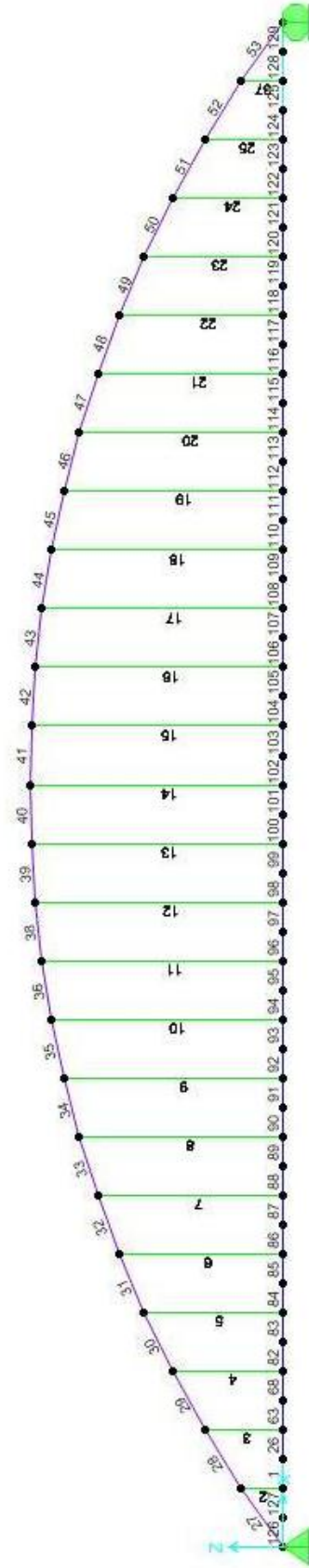

Median Arch

4.2 Capacity Charts

The section capacity of primary structural components of the Columbus Viaduct was determined assuming section loss percentages ranging from 0% to 50%. These percentages of section loss represent the corrosion that might occur in the steel portion of these components and, consequently reducing the thickness of structural steel and/or the diameter of prestressing strands. Reduction in the concrete dimensions and/or strength was considered negligible and was not included in these percentages. The following figures present the factored and nominal capacity charts for arch, tie, hanger, and floor beam sections respectively. These capacity charts were developed using the strain compatibility approach and the AASHTO LRFD strength reduction factors.

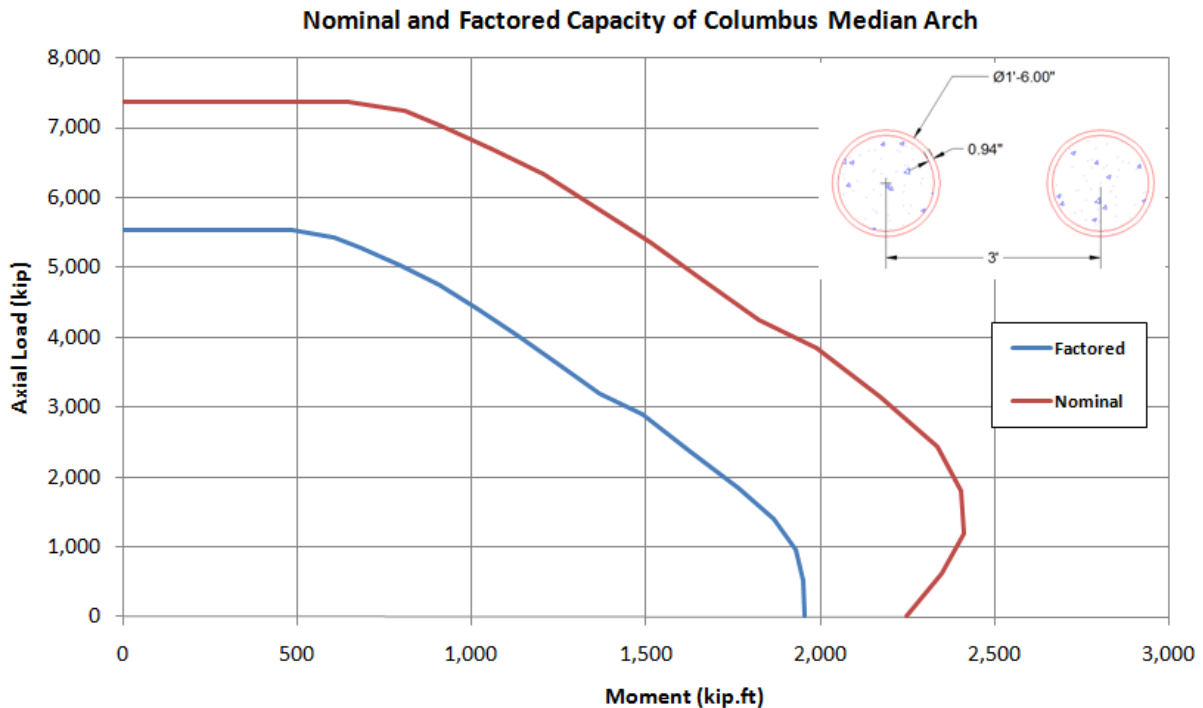

Factored Capacity of Columbus Median Arch vs. Section Loss

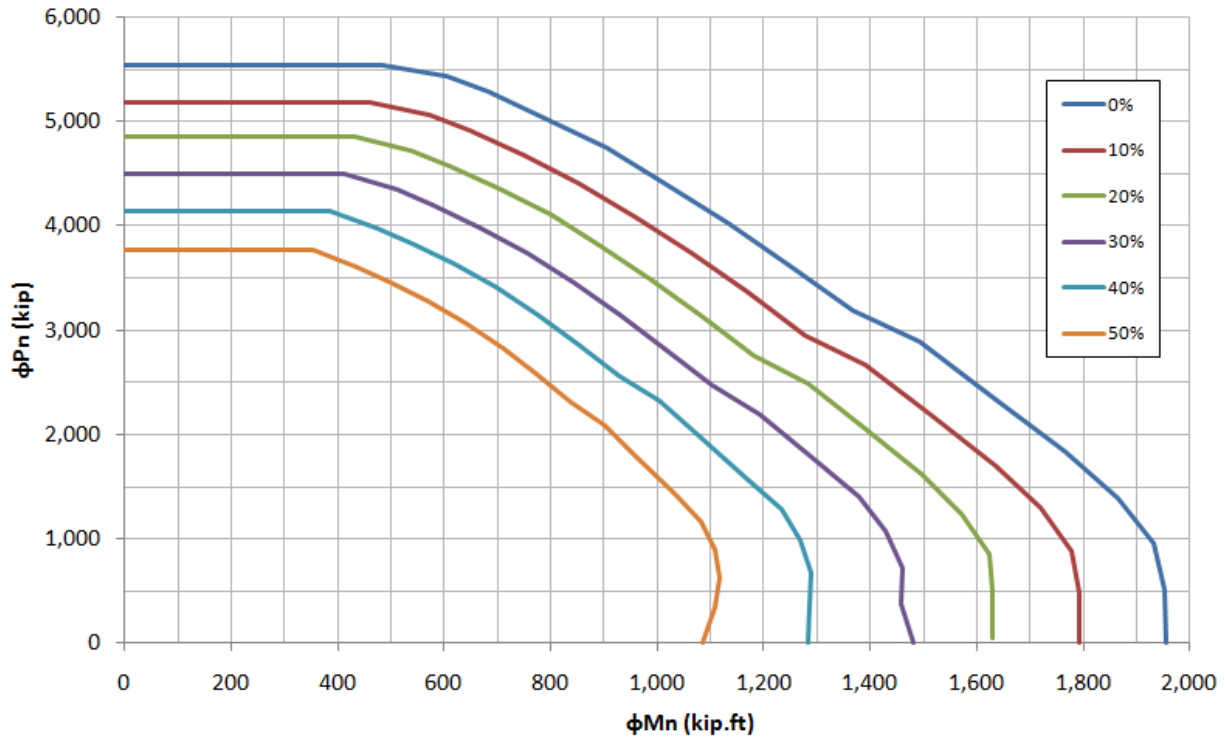

Nominal and Factored Capacity of Columbus Outside Arch

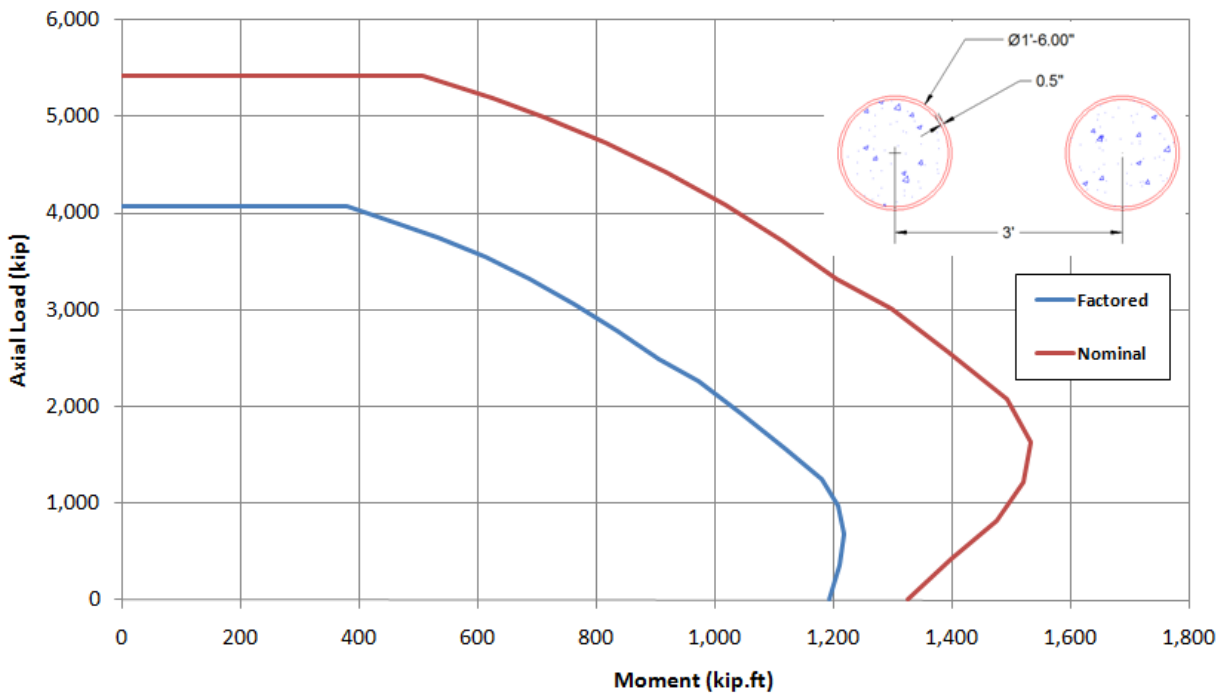

Factored Capacity of Columbus Outside Arch vs. Section Loss

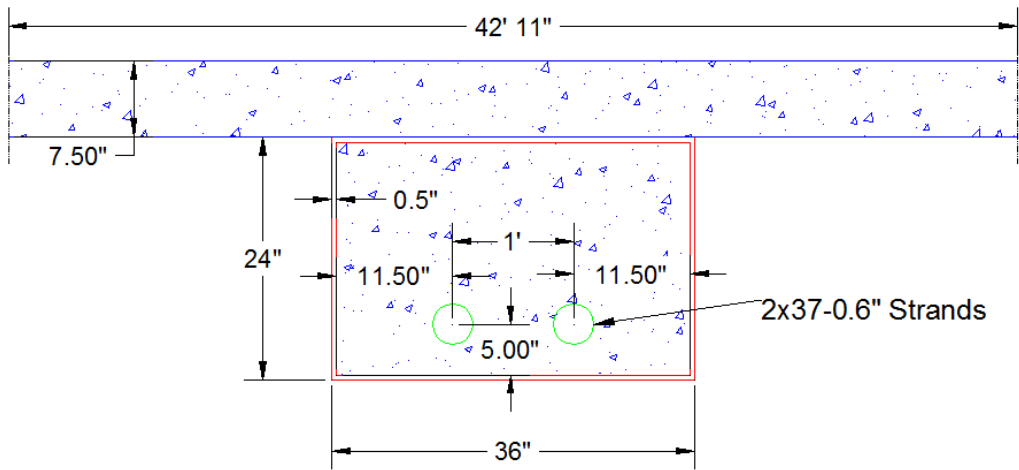
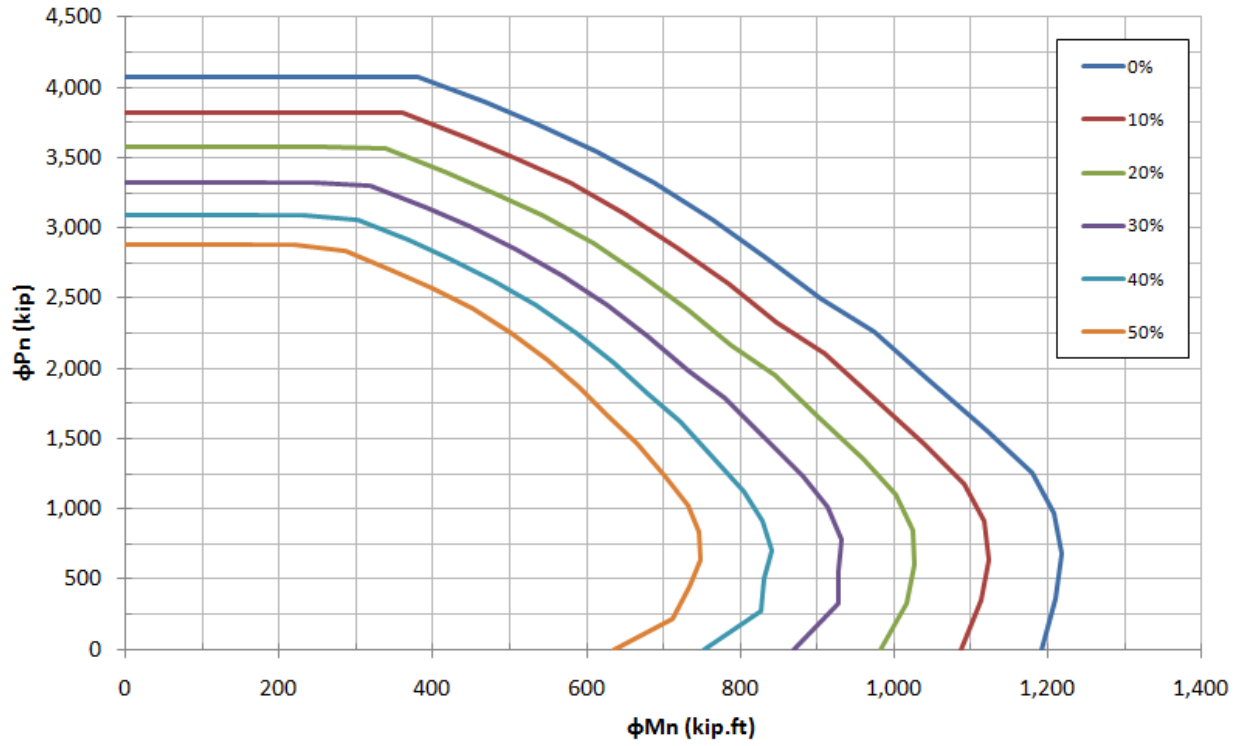

Nominal and Factored Capacity of Columbus Median Tie

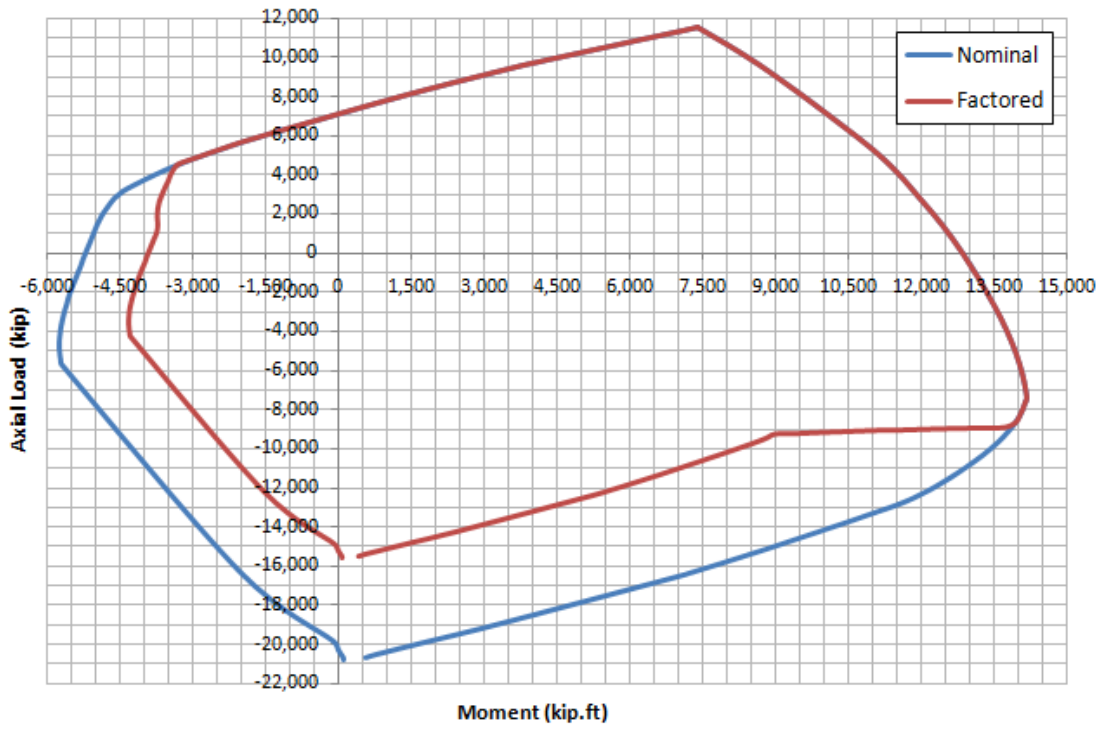

Factored Capacity of Columbus Median Tie vs. Section Loss

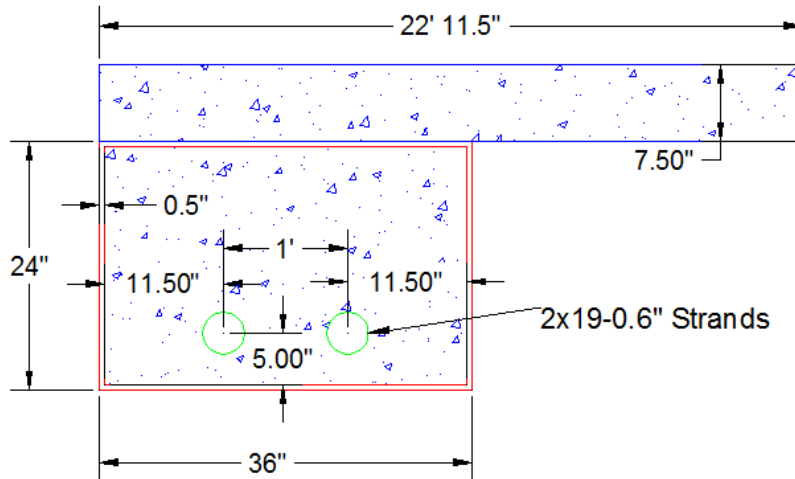
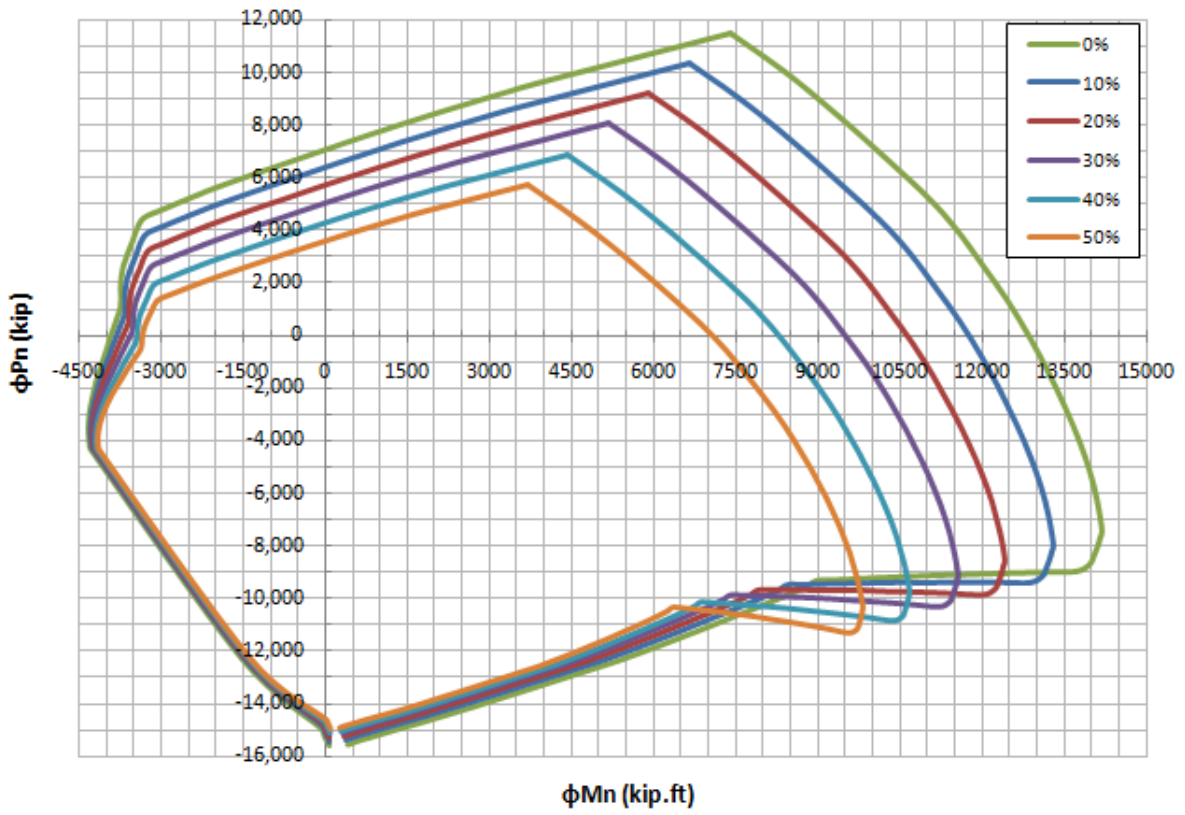

Nominal and Factored Capacity of Columbus Outside Tie

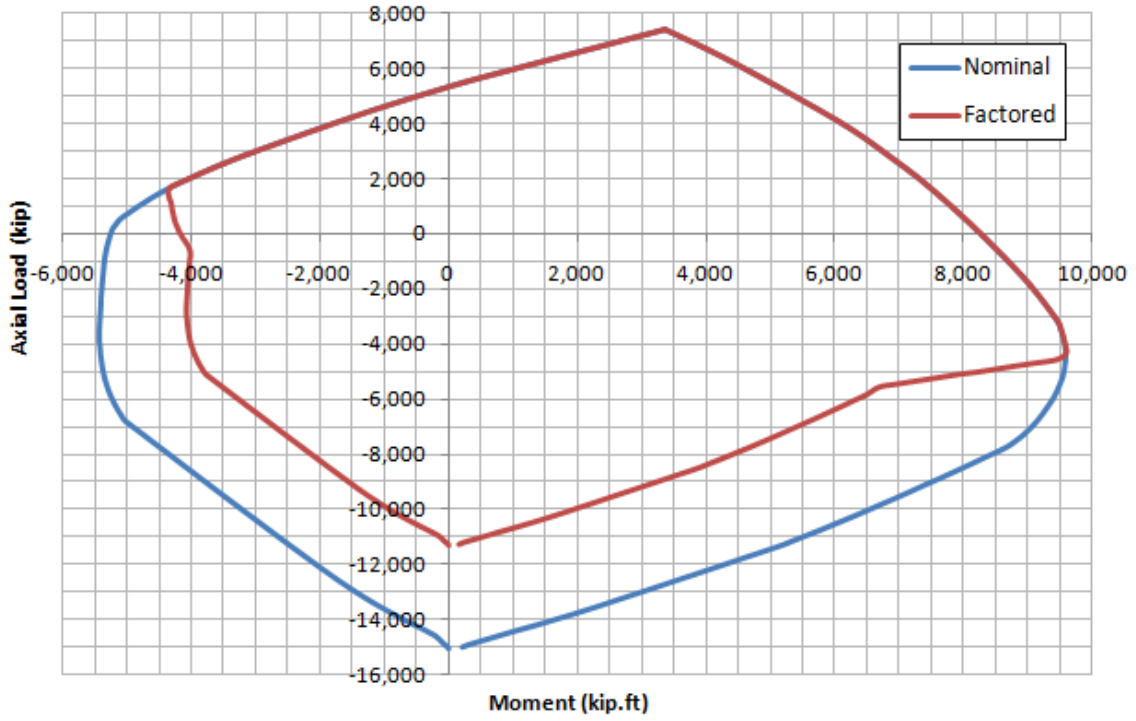

Factored Capacity of Columbus Outside Ties vs. Section Loss

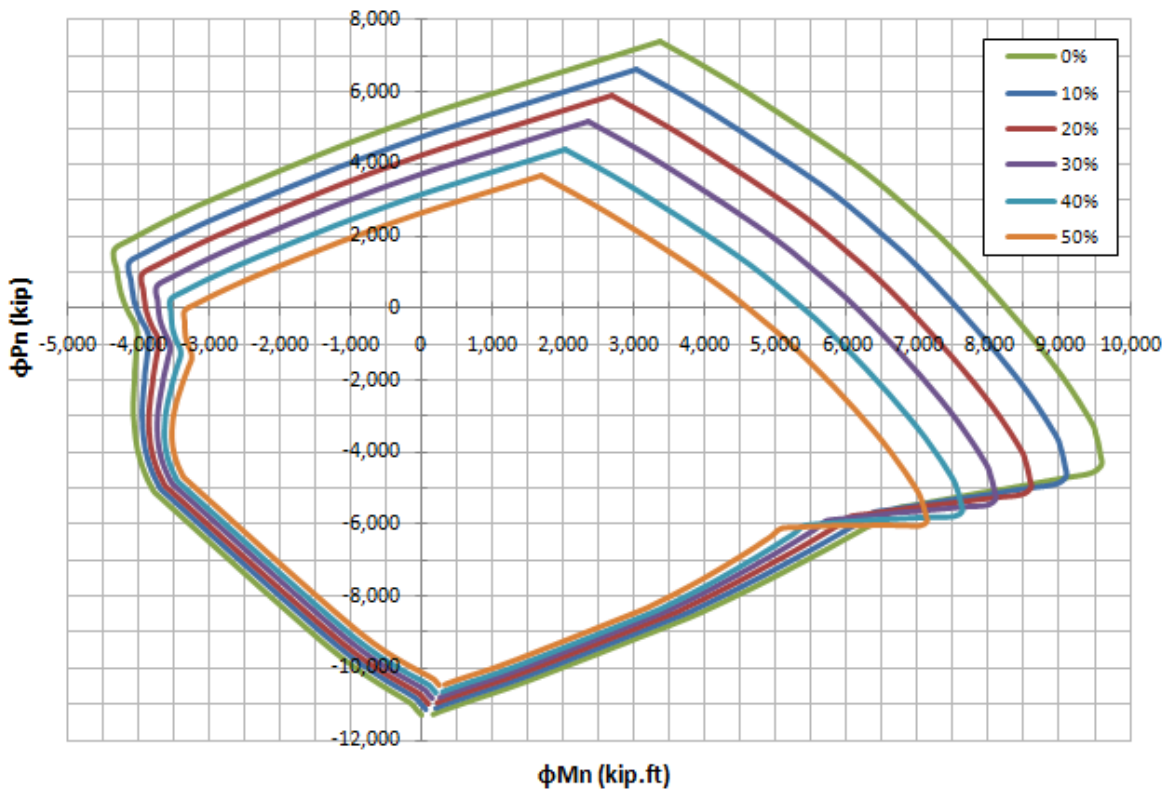

Nominal and Factored Capacity of Columbus Hanger vs. Section Loss

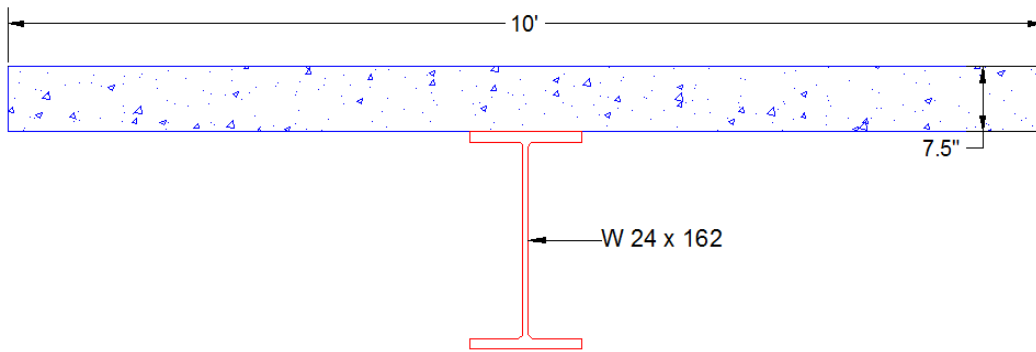
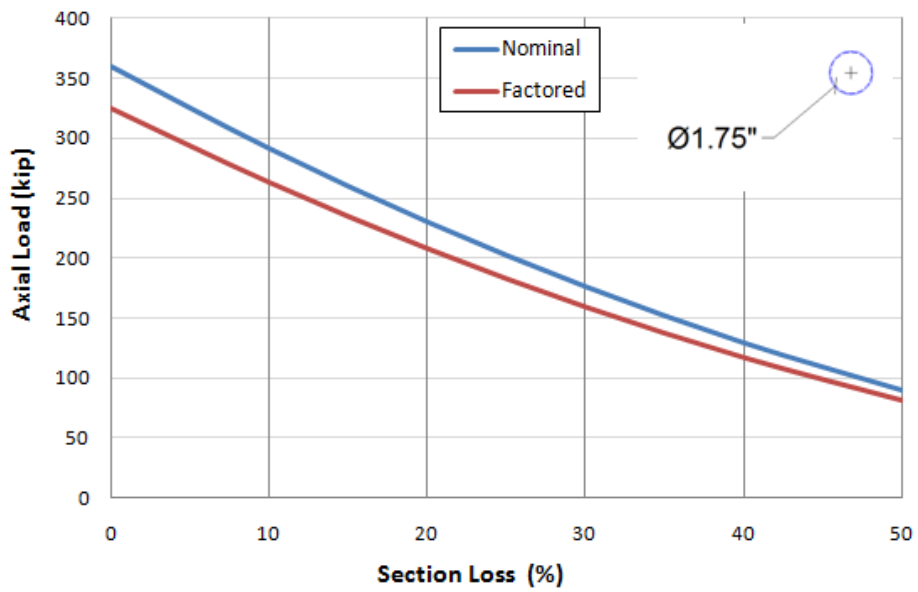

Nominal and Factored Capacity of Columbus Floor Beams vs Section Loss

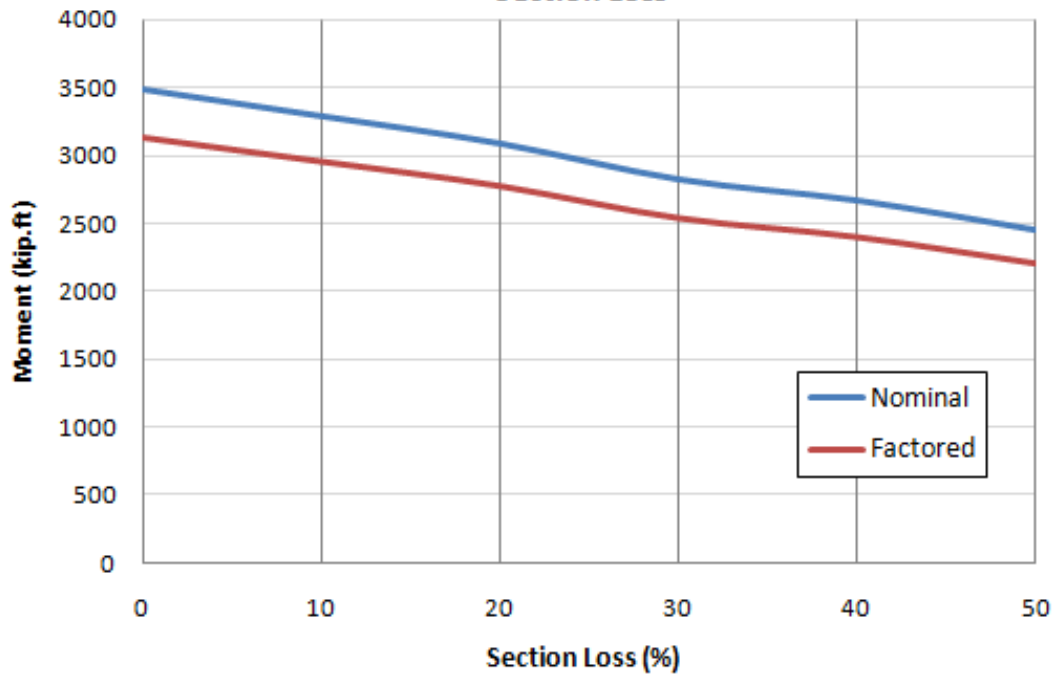

4.3 Rating Factors

The table shown next lists the capacity of each of the primary structural component of Columbus Viaduct as well as the demand at the most critical sections based on the 3D analysis.

Primary Structural Element	Section Loss Percentages							Elem. ID	Demand															
	0%	10%	20%	30%	40%	50%	DC		P	DW	TOTAL	(LL+) _{HL-93}	(LL+) _{HS20}	(LL+) _{N3}	(LL+) _{N3S2}	(LL+) _{N3-3}	(LL+) ₃₋₃₁	(LL+) _{SP1}	(LL+) _{SP2}	(LL+) _{SP3}	(LL+) _{SP4}	(LL+) _{SP5}		
	3134	2958	2777	2541	2402	2207																	N/A	
Floor beams	M (kip.ft)	3134	2958	2777	2541	2402	2207	N/A	277	0	46	415	998.8	700.5	302.7	267.1	249.3	249.3	502.9	589.2	618.6	589.2	589.2	589.2
Hangers	P (kip)	325	263	208	159	117	81	2	109	6	12	161	35	17	12	18	20	21	14	17	19	23	37	37
Outside	M (kip.ft)	7250	6500	5750	5000	4250	3500	190	-298	750	-28	335	2285	1658	1202	1460	1473	1296	1404	1691	1962	2322	3895	3895
Tie Beams (+ve)	P (kip)	2200	2100	2000	1900	1800	1700	190	927	0	83	1283	277	133	92	135	155	162	185	215	243	301	477	477
Outside	M (kip.ft)	-3500	-3100	-2700	-2300	-1700	-1300	190	-298	750	-28	335	-1658	-991	-692	-986	-1110	-1044	-1196	-1414	-1608	-1998	-3233	-3233
Tie Beams (-ve)	P (kip)	2600	2400	2200	2000	1900	1800	190	927	0	83	1283	277	133	92	135	155	162	185	215	243	301	477	477
Outside	M (kip.ft)	900	840	770	710	650	590	142	195	39	10	298	132	98	70	83	83	73	73	90	103	123	222	222
Arch Pipes	P (kip)	-2500	-2400	-2250	-2100	-1950	-1850	142	-926	22	-83	-1259	-282	-135	-94	-137	-157	-164	-188	-219	-248	-307	-486	-486
Median	M (kip.ft)	11500	10500	9250	8000	6750	5500	87	-461	1472	-49	822	3501	2556	1857	2236	2237	1977	1290	1555	1806	2127	3536	3536
Tie Beams (+ve)	P (kip)	4000	3600	3400	3200	3000	2900	87	1553	0	163	2187	457	220	153	223	256	267	183	213	242	299	474	474
Median	M (kip.ft)	-3750	-3500	-3250	-3000	-2250	-1500	87	-461	1472	-49	822	-2516	-1499	-1045	-1495	-1684	-1584	-1089	-1288	-1464	-1819	-2943	-2943
Tie Beams (-ve)	P (kip)	3100	3000	2900	2800	2700	2600	87	1553	0	163	2187	457	220	153	223	256	267	183	213	242	299	474	474
Median	M (kip.ft)	1290	1200	1100	1010	910	800	40	411	95	21	641	249	184	131	157	157	138	82	101	115	138	250	250
Arch Pipes	P (kip)	-3450	-3250	-3050	-2800	-2650	-2450	40	-1556	43	-165	-2148	-472	-227	-158	-231	-265	-276	-189	-220	-250	-309	-490	-490

The capacity and demand values were used to calculate the rating factor based on the equation 6A.4.2.1-1 presented in Chapter 2. The table that follows lists the rating factor in ratios and in tons. Section loss percentage, system factor and live load factors used in the calculations are highlighted in yellow and can be easily modified in the spreadsheet as needed.

		Live Load Factors										
System Factor	1.00	1.75		1.70				1.80				
Section Loss	0%	(LL+I) _{HL-93}	(LL+I) _{HS20}	(LL+I) _{N3}	(LL+I) _{N3S2}	(LL+I) _{N3-3}	(LL+I) _{3-3L}	(LL+I) _{SP1}	(LL+I) _{SP2}	(LL+I) _{SP3}	(LL+I) _{SP4}	(LL+I) _{SP5}
Floor beams	M (kip.ft)	1.56	2.22	5.28	5.99	6.42	6.42	3.00	2.56	2.44	2.56	2.56
Hangers	P (kip)	2.67	5.45	8.04	5.51	4.82	4.59	6.51	5.36	4.79	3.96	2.46
Outside Tie Beams (+ve)	M (kip.ft)	1.73	2.38	3.38	2.79	2.76	3.14	2.74	2.27	1.96	1.65	0.99
	P (kip)	1.89	3.95	5.85	4.00	3.49	3.33	2.75	2.37	2.10	1.69	1.07
Outside Tie Beams (-ve)	M (kip.ft)	1.32	2.21	3.26	2.29	2.03	2.16	1.78	1.51	1.33	1.07	0.66
	P (kip)	2.72	5.67	8.40	5.75	5.01	4.78	3.96	3.40	3.01	2.43	1.53
Outside Arch Pipes	M (kip.ft)	2.60	3.51	5.06	4.27	4.27	4.85	4.58	3.72	3.25	2.72	1.51
	P (kip)	2.51	5.25	7.76	5.33	4.64	4.45	3.67	3.15	2.78	2.24	1.42
Median Tie Beams (+ve)	M (kip.ft)	1.74	2.39	3.38	2.81	2.81	3.18	4.60	3.82	3.28	2.79	1.68
	P (kip)	2.26	4.71	6.97	4.77	4.16	3.99	5.50	4.73	4.16	3.37	2.13
Median Tie Beams (-ve)	M (kip.ft)	1.04	1.74	2.57	1.80	1.60	1.70	2.33	1.97	1.73	1.40	0.86
	P (kip)	1.14	2.37	3.51	2.40	2.09	2.01	2.77	2.38	2.10	1.70	1.07
Median Arch Pipes	M (kip.ft)	1.49	2.02	2.92	2.43	2.43	2.77	4.40	3.57	3.14	2.61	1.44
	P (kip)	1.58	3.28	4.85	3.31	2.89	2.77	3.83	3.29	2.89	2.34	1.48
Rating in Tons		80	36	25	37	43	80	50	60	70	100	150
Floor beams	M (kip.ft)	124.4	79.8	132.1	221.5	275.9	513.2	150.2	153.8	170.9	256.4	384.5
Hangers	P (kip)	213.5	196.1	200.9	203.9	207.3	367.4	325.3	321.5	335.6	396.0	369.3
Outside Tie Beams (+ve)	M (kip.ft)	138.4	85.8	84.6	103.1	118.7	251.1	136.8	136.3	137.1	165.4	147.9
	P (kip)	151.3	142.2	146.2	148.1	150.0	266.4	137.7	142.2	146.8	169.3	160.2
Outside Tie Beams (-ve)	M (kip.ft)	105.7	79.6	81.6	84.6	87.4	172.9	89.1	90.4	92.8	106.6	98.9
	P (kip)	217.2	204.3	209.9	212.7	215.4	382.6	197.8	204.2	210.8	243.1	230.1
Outside Arch Pipes	M (kip.ft)	207.9	126.4	126.5	157.9	183.5	388.2	229.2	223.1	227.4	272.0	226.1
	P (kip)	201.1	189.0	194.1	197.1	199.4	356.0	183.3	188.8	194.5	224.5	212.7
Median Tie Beams (+ve)	M (kip.ft)	139.4	85.9	84.6	103.9	120.7	254.2	229.9	228.9	229.9	278.9	251.7
	P (kip)	181.2	169.5	174.2	176.6	178.9	319.6	275.2	283.7	291.4	336.9	318.8
Median Tie Beams (-ve)	M (kip.ft)	83.1	62.7	64.3	66.6	68.7	135.8	116.6	118.3	121.4	139.6	129.5
	P (kip)	91.3	85.4	87.7	88.9	90.1	160.9	138.6	142.9	146.7	169.7	160.5
Median Arch Pipes	M (kip.ft)	119.2	72.6	72.9	90.0	104.6	221.5	220.0	214.3	219.6	261.5	216.5
	P (kip)	126.1	118.0	121.2	122.6	124.2	221.9	191.3	197.2	202.5	234.0	221.4

The Columbus Viaduct was also analyzed in case of one of the hangers was totally damaged. This analysis was performed in a two dimensional model by eliminating the hanger at

		Live Load Factors										
System Factor	1.00	1.75		1.70				1.80				
Section Loss	0%	(LL+I) _{HL-93}	(LL+I) _{HS20}	(LL+I) _{N3}	(LL+I) _{N3S2}	(LL+I) _{N3-3}	(LL+I) _{3-3L}	(LL+I) _{SP1}	(LL+I) _{SP2}	(LL+I) _{SP3}	(LL+I) _{SP4}	(LL+I) _{SP5}
Floor beams	M (kip.ft)	1.56	2.22	5.28	5.99	6.42	6.42	3.00	2.56	2.44	2.56	2.56
Hangers	P (kip)	2.67	5.45	8.04	5.51	4.82	4.59	6.51	5.36	4.79	3.96	2.46
Outside Tie Beams (+ve)	M (kip.ft)	1.84	3.07	3.38	2.68	2.65	3.24	2.77	2.38	2.01	1.70	1.00
	P (kip)	1.66	5.46	6.35	4.15	3.64	3.22	3.00	2.61	2.31	1.87	1.20
Outside Tie Beams (-ve)	M (kip.ft)	1.18	2.77	3.18	2.14	1.90	2.05	1.72	1.48	1.30	1.05	0.66
	P (kip)	1.66	5.46	6.35	4.15	3.64	3.22	3.00	2.61	2.31	1.87	1.20
Outside Arch Pipes	M (kip.ft)	3.11	7.56	8.56	5.80	5.11	5.43	4.62	3.94	3.48	2.81	1.78
	P (kip)	3.02	10.01	11.41	7.57	6.63	5.86	5.42	4.73	4.19	3.41	2.18
Median Tie Beams (+ve)	M (kip.ft)	1.69	2.34	3.33	2.73	2.70	3.04	4.78	4.08	3.42	2.87	1.68
	P (kip)	2.56	5.42	8.05	5.50	4.77	4.55	6.78	5.86	5.14	4.13	2.60
Median Tie Beams (-ve)	M (kip.ft)	0.80	1.37	2.02	1.41	1.25	1.32	1.92	1.63	1.43	1.15	0.71
	P (kip)	1.27	2.70	4.01	2.74	2.38	2.27	3.38	2.92	2.56	2.06	1.30
Median Arch Pipes	M (kip.ft)	1.20	2.04	1.86	2.10	1.86	1.97	2.86	2.43	2.13	1.71	1.06
	P (kip)	1.18	2.50	3.70	2.52	2.20	2.09	3.12	2.69	2.36	1.90	1.20
Rating in Tons		80	36	25	37	43	80	50	60	70	100	150
Floor beams	M (kip.ft)	124.4	79.8	132.1	221.5	275.9	513.2	150.2	153.8	170.9	256.4	384.5
Hangers	P (kip)	213.5	196.1	200.9	203.9	207.3	367.4	325.3	321.5	335.6	396.0	369.3
Outside Tie Beams (+ve)	M (kip.ft)	147.4	110.4	84.4	99.0	114.0	258.9	138.3	142.8	140.8	169.6	150.6
	P (kip)	132.8	196.7	158.7	153.6	156.6	257.5	149.9	156.4	161.4	187.3	179.8
Outside Tie Beams (-ve)	M (kip.ft)	94.1	99.8	79.5	79.2	81.7	164.0	86.1	88.6	91.0	105.3	99.3
	P (kip)	132.8	196.7	158.7	153.6	156.6	257.5	149.9	156.4	161.4	187.3	179.8
Outside Arch Pipes	M (kip.ft)	248.7	272.1	214.0	214.7	219.7	434.7	231.0	236.6	243.4	281.2	266.5
	P (kip)	241.8	360.5	285.2	280.1	285.2	468.8	271.2	283.5	293.1	341.0	326.7
Median Tie Beams (+ve)	M (kip.ft)	135.0	84.2	83.3	100.9	116.0	243.2	238.8	244.8	239.6	287.1	251.5
	P (kip)	204.5	195.2	201.4	203.3	205.3	363.8	339.0	351.7	359.6	413.5	390.3
Median Tie Beams (-ve)	M (kip.ft)	64.3	49.2	50.5	52.1	53.6	105.7	95.9	97.7	100.0	114.8	107.0
	P (kip)	101.9	97.3	100.3	101.3	102.3	181.3	168.9	175.2	179.2	206.0	194.5
Median Arch Pipes	M (kip.ft)	96.1	73.4	46.5	77.6	80.0	157.4	143.1	145.8	149.4	171.0	159.7
	P (kip)	94.1	90.0	92.6	93.4	94.6	167.4	155.8	161.2	165.2	189.9	179.6

Chapter 5 Conclusions

Based on the analysis results of Ravenna and Columbus Viaducts, and the calculation of rating factors according to the 2008 AASHTO Manual for Bridge Evaluation, the following conclusions are made:

- The primary structural components of Ravenna Viaduct (i.e. arches, ties, hangers, and floor beams) have $RF > 1$ under all design loads, legal loads, and permit loads using load factors of 1.75, 1.45, and 1.6 respectively, and assuming a system factor of 1.0 and section loss of 0%.
- In an extreme event that results in a complete damage of one hanger in Ravenna Viaduct, the RF of the arch will be less than 1 and the bridge need to be closed or posted until the damaged hanger is replaced.
- The primary structural components of Columbus Viaduct (i.e. arches, ties, hangers, and floor beams) have $RFs > 1$ under all design loads, legal loads, and permit loads except P5 using load factors of 1.75, 1.7, and 1.8 respectively, and assuming a system factor of 1.0 and section loss of 0%.
- In an extreme event that results in a complete damage of one hanger in Columbus Viaduct, the RF of the median tie under design load will be less than 1 and the bridge need to be closed or posted until the damaged hanger is replaced. It should be noted that RFs will remain greater than 1 in case of a complete damage of one hanger in the outside arch.

References

- American Association of State Highway and Transportation Official (AASHTO). "The Manual for Bridge Evaluation." 1st edition. 2008.
- American Association of State Highway and Transportation Official (AASHTO). "LRFD Bridge Design Specifications." 4th edition. 2007.
- Delaware Department of Transportation (DelDOT). "Bridge Design Manual." April 2004.
- Nebraska Department of Roads (NDOR). "Concrete Filled Steel Tube Arch." Technical Report SPR-1 (03) 560. July 2006.
- Nebraska Department of Roads (NDOR). "Columbus Viaduct System." Technical Report P303. Feb. 2009.
- Sakino, K., Nakahara, H., Morino, S. and I. Nishiyama. (2004) "Behavior of Centrally Loaded Concrete-Filled Steel-Tube short columns." *ASCE Journal of Structural Engineering* 130(2).