

152
29/1/86

SEA FISHES

MISC
0096



HAND BOOK ON AQUAFARMING 3

पुस्तकालय

LIBRARY

केन्द्रीय मत्स्य विज्ञान संस्थान

Central Marine Fisheries Research Institute

कोच्चि-682 036, (India)

Cochin-682 036, (India)

SEA FISHES
OCEANIC CAGE CULTURE

THE MARINE PRODUCTS EXPORT DEVELOPMENT AUTHORITY

(Ministry of Commerce, Government of India)

MPEDA House, Panampilly Avenue

P.B. No. 4272, Kochi - 682 036, India

Phone : 311979 Fax : 91-484-313361 Telex : (0885) 6288/6648

First Printed 1993
First Reprinted 1997

PREFACE

The Marine Products Export Development Authority has been promoting the commercial aquaculture of shrimp as a means for boosting India's seafood exports. At the same time, it is recognised that in order to have a sustained share in the world seafood market, aquaculture of other species, which are in great demand should also be encouraged. It was in this context that a publication titled SEE FISHES OCEANIC CAGE CULTURE was brought out at the time of INDAQUA '93, India's first aquaculture exposition. The publication has been well received and we are now coming out with a reprint of this publication. We are confident that this publication will continue to generate interest in those who intend to take up aquaculture of these species to exploit the abundant natural resources available in this country for augmenting export production.

Kochi : 682 036
Date :Feb. 1997



(K.B.PILLAI)
Chairman
MPEDA

FOREWORD

Sea farming of several species of fin fishes is becoming very popular. Countries like China, Thailand and Japan are culturing several varieties of fin fishes in floating net cages set up in the sea and India is yet to make a beginning in this direction. It is possible to make use of shallow inshore waters along the main land and sheltered bays in Lakshadweep, Andaman and Nicobar Islands to set up cage culture of some of the species of fin fishes such as sea bass, sea bream and groupers. Therefore, the organising Committee of 'INDAQUA' - the first Aquaculture Show in India decided to bring out this handbook on farming of sea fishes. Dr.P. Bensam, CMFRI and Shri P. Vasudevan, Lakshadweep Silpi Aquaculture Ltd., Cochin have put up a lot of effort to bring out this handbook and I express my warm appreciation to them. The work done by Dr. G. Santhana Krishnan and Mr. M. Viswakumar in publishing this handbook is acknowledged. The generous contribution made by SCICI to print this handbook is deeply acknowledged. I am sure that this handbook will be a useful reference to entrepreneurs in seafarming.



(M. SAKTHIVEL)
Chairman
MPEDA

Kochi - 682 036
February 93

CONTENTS

PART I SEA FISH

P. Bensam

*Central Marine Fisheries
Research Institute, Kochi*

- | | |
|---------------------------|----|
| 1. The Milk Fish | 11 |
| 2. Grey Mulletts | 27 |
| 3. The pearl spot | 37 |
| 4. The Sea Bass | 42 |
| 5. Other Fin Fishes | 54 |

PART II OCEANIC CAGE CULTURE

TECHNO - ECONOMIC OUTLINE 63

G. Santhana Krishnan

*The Marine Products Exports
Development Authority, Kochi - 36*

P. Vasudevan

*Lakshadweep Shilpi Aquaculture Ltd.
Kochi - 24*

Part I
SEA FISHES

P. Bensam

Central Marine Fisheries Research Institute, Kochi - 682 031

THE MILKFISH

1.1 Introduction

The Milkfish (*Chanos Chanos*) is one of the most ideal finfishes for farming in coastal areas. It is commercially important and has many qualities essential for culture. These are : fast growth rate particularly in the first year of its life, wide range of tolerance to temperature, oxygen and salt contents of the water, feeding mostly on algal growth at the bottom of culture ponds and other salt water bodies and freedom from major diseases and parasites. Hence, the Milkfish is cultured on large scale in areas wherever it is known to occur, especially in Indonesia, Philippines and Taiwan, for centuries. The Milkfish culture ponds called "Tambak" ponds are known to be model ones in coastal aquaculture. It is much esteemed as a sea food; and the smoked fish is a great delicacy in South-East Asian countries. Recent annual production are :- Indonesia : 1,28,000 t; Philippines : 2,10,900 t; Taiwan : 37,000 t.

Although this valuable fish is available in India also, its commercial culture has not yet been practised here. But, experimental culture by various governmental agencies has shown that it can be cultured in coastal ponds and pens, with high levels of production.

1.2 Distinctive Characters and Biology

1.2.1 Distinctive characters

The Milkfish has a moderately compressed, spindle - shaped, elongate body (See plate Fig.1) covered with small scales and without scutes along the belly. The mouth is small, without teeth and the snout is longer than the lower jaw which has a small tubercle at its tip.

The dorsal fin is located at about the middle point of the body; but the anal fin is short and situated far behind the dorsal fin base. A lateral line is present and the tail fin is large. The back is olive-green in colour but the belly is silvery. The dorsal, anal and tail fins have dark margins. The usual length of the fish caught from the sea is about 70-110 cm, although it grows upto 180 cm length and weight upto 20 kg.

1.2.2. Biology

The fish is surface moving, usually found in shallow waters near the coast and is caught mainly by drag nets, set nets, scoop nets and traps. Since it does not form regular shoals, it does not contribute to a regular capture fishery anywhere; but is important as a culture resource.

In its early stages of life history, the fish enters estuaries, backwaters, lagoons and rivers which serve as nursery grounds and spend the early part of its life there for about one year or more. But, for attaining sexual maturity and spawning, the Milkfish has to return back to the sea. It spawns annually or biannually close to the coast at about the 5th or 6th year of its life; each time releasing about 3 to 7 million eggs. The larvae, post larvae, fry and fingerlings of the fish (Fig. 1.2.2) are found abundantly in the calm, clear coastal

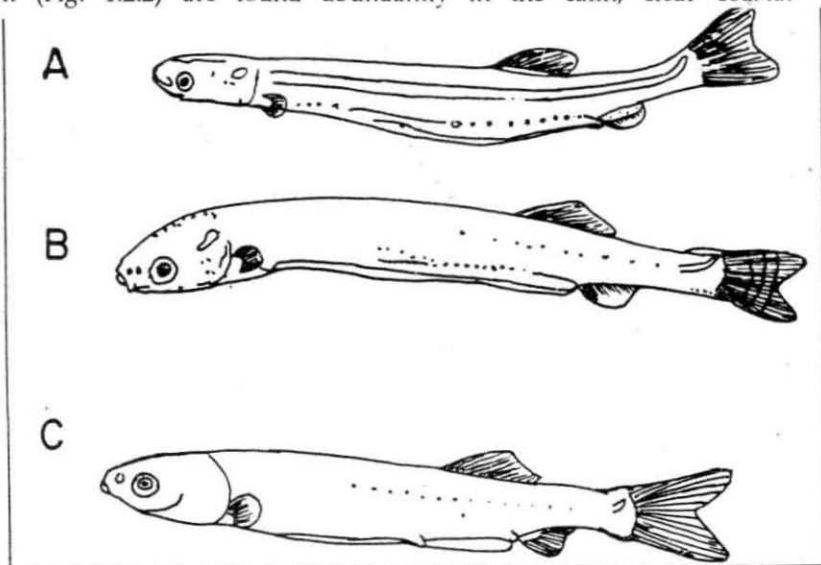

Fig. 1.2.2 A few seed stages of the Milkfish
A. post larvae, B. early fry, C. late fry

waters, particularly near estuaries, lagoons and similar localities where their microscopic and algal food is available in enough quantities. It is from this stage onwards and until about one year that the fish is reared in brackishwater ponds and pens, where the growth rate is upto about 50 cm weighing about 500-800 gm. But, the growth rate in the sea by the end of the first year is slower, only upto about 25 cm.

In culture ponds the Milkfish feeds mostly upon filamentous microalgal growth at the bottom and the associated organisms, besides taking planktonic items and detritus. Also, the fish can take supplementary food like groundnut oilcake, rice, bran, etc.

1.3 Farming Methods

1.3.1 Seed Resources

Since the Milkfish does not mature and breed in confined waters and culture ponds, development of a hatchery technology has been beset with difficulties. Also, even though induced breeding has been achieved and the fertilised eggs can be hatched on an experimental basis, it has been difficult to rear the hatchlings to the stocking size. In view of these reasons the large-scale production of its young ones variously called "seeds", "fry", and "fingerlings" by hatchery technology has not yet been achieved in most countries, except in Taiwan, where 68 million seeds were produced recently through natural spawning of brooders maintained in ponds. But in a country like India, until the hatchery technology is perfected, Milkfish farmers will have to depend upon the natural sources for collection of seeds. In India, the seeds of *Chanos*, measuring 2-7 cm in length occur along the coasts of Orissa, Andhra Pradesh and Tamil Nadu in the east coast as well as Kerala and Karnataka in the west. The fry also occur around the Andaman Group of Islands and the Laccadive Archipelago. Although the spawning grounds of the fish in Indian seas are not yet discovered, yet, year after year immense numbers of the fry appear all along the above areas. The main fry season extends from March to June. A subsidiary season is also present, during October-December. According to a conservative estimate, atleast twenty million seeds of *Chanos* can be collected every year.

Among the various localities, recorded data shows that the Ramathapuram - Tirunelvely zone of Tamilnadu has the maximum abundance of Milkfish seeds. They have a tendency to abound the

clear calm inshore waters of gently sloping beaches including tidal creeks, estuaries, brackishwater bodies and mud flat areas where the temperature is about 23-25° C and salinity varies between 10 and 32‰. There are seasonal variations in their abundance, which is also related to lunar and tidal periodicities. It is reported that the best collections can be made at high tides during full moon and new moon.

1.3.2 Methods of Seed collection

The method of seed collection varies depending upon the localities and circumstances. If the seeds are found in tidal streams or canals near culture ponds, these may be collected and stocked by simply opening the sluice gates during the incoming tide. If the ponds are located away from seed resources centres, small temporary coastal ponds, canals and pits may be prepared for the fry to stay on in them, after the high tide recedes. The fry which are trapped inside may be scooped out by fine meshed dip nets or hand nets. In estuaries and lagoons, drag nets or seine nets may be used to gather the fry to a suitable spot when they may be scooped out.

In mud flat areas with knee or ankle - deep water, a scare - line made of coir rope of about 3-3.5m length with palmyrah leaves attached (Fig. 1.3.2) is dragged below the water surface by two

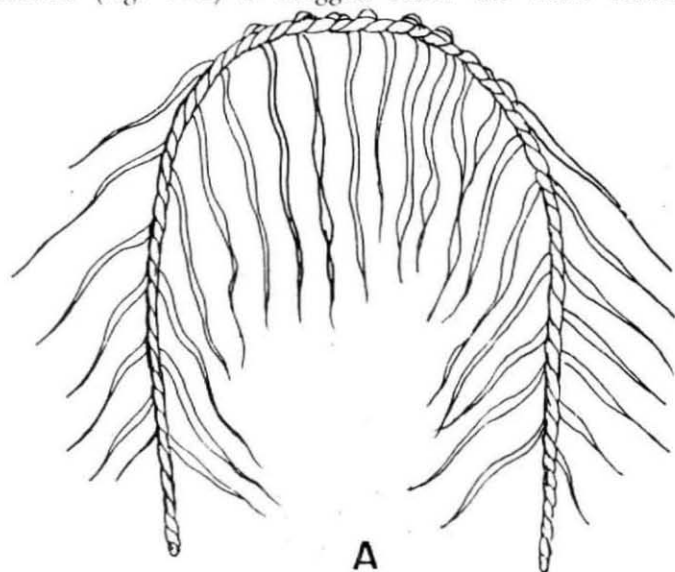

Fig. 1.3.2. Diagram of a "Scareline" used for the collection of Milkfish

persons, followed by another two holding a cloth of 3 m x 4 m loosely above the water surface. The scare-line touches the bottom and fry leap into the cloth behind. In Indonesia, similar, lure lines are strung with plaited strips of coconut and banana leaves. Special fry - congregating structures such as rock walls and artificial canals may also be constructed in order to induce the fry to swarm there, for collection. Fry collections are usually made during the cool hours of early mornings or late evenings.

1.3.3 Transportation of seeds

The captured seeds called "fry" usually measure about 1-3 cm long. They may be identified by a slender body with two black spots on the head and another in the middle of the body. They are tender and move in a characteristic clock-wise manner, a tendency not observed in the fry other fishes. For separation, the fry may be placed in large enamel trays or in a cloth tank called "hapa" (Fig. 1.3.3).

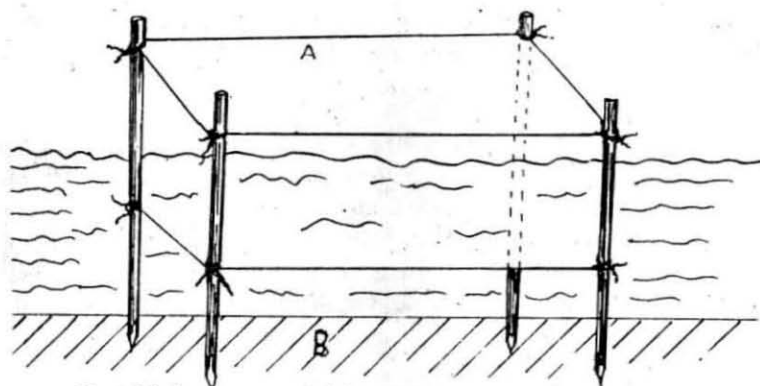

Fig.1.3.3. Diagram of a cloth hapa used for sorting out, acclimatization and conditioning of milkfish fry

Soon after collection the seeds may be "conditioned" by keeping in a limited volume of clear water for definite period without any food when the gut becomes empty and they become accustomed to the limited volume in the container. Since this process involves starvation, it should not be prolonged, in order to avoid mortality.

If the seeds have to be transported to distant areas, it may

be done by keeping them in certain containers with diluted sea water of about 10-15 ppt salinity and at a rate of about 100 fry/1. Traditionally, these containers are : unglazed earthenware jars, tin containers, galvanised cans, wooden buckets, cement troughs, bamboo baskets coated with cement or tar etc., of about 15-30 liters volume for containing 1,500-3,500 fry, according to size. Sometimes so high as 40,000 fry can be packed in large containers. In recent times, the fry are packed in plastic bags containing water and filled with oxygen. Since the fry of Chanos are hardy, in traditional containers the water need be changed only once per day. Change of water is done by carefully pushing a piece of cloth into the middle of the container and removing the water with a cup but without injuring the fry. Since it is advantageous to keep the fry in darkness, the containers are usually covered during transportation. The Milkfish fry are capable of surviving without food for a duration of upto 14 days; and hence no special food is needed. However, in order to reduce mortality, it is advisable to undertake quick transportation. If feeding is absolutely needed, slightly roasted rice flour or finely mashed, hard-boiled chicken yolk may be supplied. Dead and decaying fry will putrefy and make the water foul for the live ones; and hence these will have to be removed.

1.3.4 Nursery rearing of seeds

After bringing the seeds to the site of the nursery ponds, they may be acclimatised to the salinity in the new water medium. Since Milkfish seeds are able to tolerate wide variations in salinity, acclimatisation is effected by adding the brackishwater of the new medium even upto a maximum of ten parts. Infact, in most cases, the seeds are transferred almost directly to the new water medium, without acclimatisation.

The ponds for rearing the fry until they attain the size of a finger (5-7 cm long, called "fingerlings") are called "nuseries" or "fry ponds". These are usually located inside the culture farms (Fig. 1.3.5.1) and are about 1% of their total water area. These range in area from 500 to 5,000 square metres, rectangular in shape and must have provisions for brackishwater supply.

Preparation of the ponds for stocking with the fry has to be started about one or two months in advance. At first the fry ponds are drained of the water for about 10 to 15 days. When the bottom soil becomes dry it is loosened by tilling and raking. Wet and foul-smelling

SEA FISHES

spots in the ponds have to be treated with agricultural lime, in order to prevent decay and production of Hydrogen sulphide gas. These processes will kill small predatory animals present. If found necessary, tobacco waste may be used to kill predators. In some cases, manuring may be done by adding rice bran, oil cake, etc in order to enhance the growth of microscopic blue-green algae at the bottom, which forms the food of the fry.

After the above steps, the depth of water in the fry ponds has to be increased gradually to about 10 cm. Since the fry prefer a shallow water medium, the depth should not be more than 10 cm. A diagonal ditch may be provided from one corner of the pond to the outlet for providing a shelter for the fry during warm days. The water in the fry ponds may be changed twice or thrice every fortnight.

Within about 3-7 days after the above processes, a microscopic complex of blue-green algae, diatoms, bacteria, nematode worms, etc. develop at the bottom of the nurseries, which is called "Lab-Lab". Since the Lab Lab is the food of the growing fry, the stocking operations are usually started when the Lab Lab has grown well.

Stocking is usually undertaken in the cool hours of early mornings or late evenings. Temperature and salinity in the containers are equalised with those in the nurseries by immersing the formers in the water of the latter and by periodically replacing small portions of the water therein with the water from the fry ponds. The fry are stocked at densities of 20-50 per square meter.

Some predatory fishes, crabs, snakes etc may get inside the nurseries inspite of drying the ponds and provision of screens in the water gates. These have to be removed by netting. Predatory birds may be discouraged by erecting poles along the embankments and criss - crossing with strings. One serious cause for mortality of seeds in fry ponds is the sudden reduction of temperature and salinity due to heavy rains. Such an eventuality may be prevented by filling the ponds with brackish-water before the rains.

The fry feed actively on the Lab Lab and phytoplankton and grow rapidly even upto a rate of 1 mm per day. By the end of one month they measure 5-8 cm long and weigh 1.5-5 gm, when they are ready for transfer to the production ponds or pen structures for rearing to marketable condition. They are captured by partially draining the fry ponds at low tides, when the fry usually congregate near the water gates. Usually seine nets are used.

1.3.5 Farming in earthen ponds

The ponds in which the Milkfish fingerlings are reared to

marketable size are called "production ponds" or "rearing ponds". These are usually located within 1 to 3 km from the coast of sometimes even at much more distances; and receive sea water supply via tidal streams canals, ditches etc. (Fig.1.3.5.1). In some cases, water

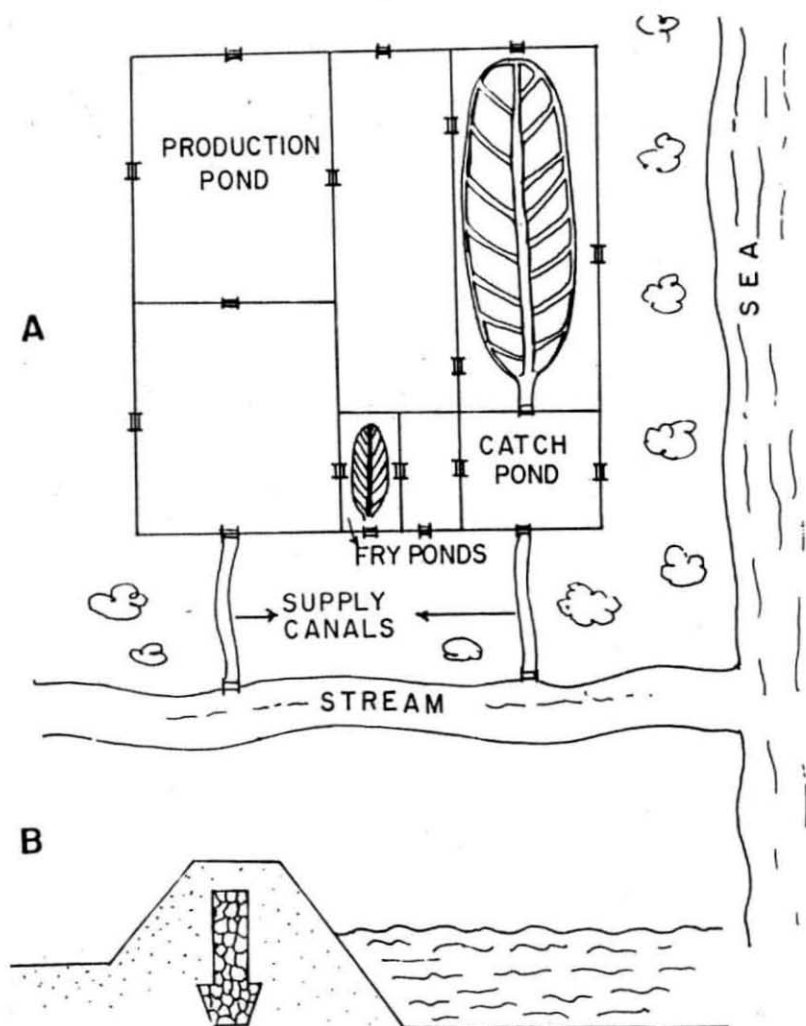

Fig. 1.3.5.1. Diagram of the lay out of a typical earthen pond system for the culture of milkfish (A) and of the cross section of the embankments (B.) Note the system of canals or trenches in a fry pond and a production pond.

supply may be by mechanical pumping. Fresh water may also enter the ponds because of the presence of rivers nearby. The salinity values usually vary between 10 and 35 ppt; but during certain times these values may fluctuate between 0 ppt and 100 ppt or even more. The water temperature usually varies from 24 to 38°C. The production ponds range in area from 0.5 ha to 3 ha and are rectangular in shape, with a water depth ranging from 0.3 to 0.7 m. The best bottom for these ponds is a soft, jelly like, colloidal and biologically active mud containing about 4% humus and large amounts of clay. The silt, sand and clay should be in the proportion of either 64, 32 and 4% or 82, 16 and 2% respectively. Such a mud encourages the growth of the blue-green algae preferred by the Milkfish. To give protection to the fish against extreme conditions of temperature and to facilitate accumulation of fish excreta, a system of canals or trenches may be provided in the ponds.

The simple and typical construction of the wall or embankments for the culture ponds consists of a sloping earthen structure of clay, excavated from the site. In the interior of the embankments, a core of granite stones may be provided for protection (Fig. 1.3.5.1). The

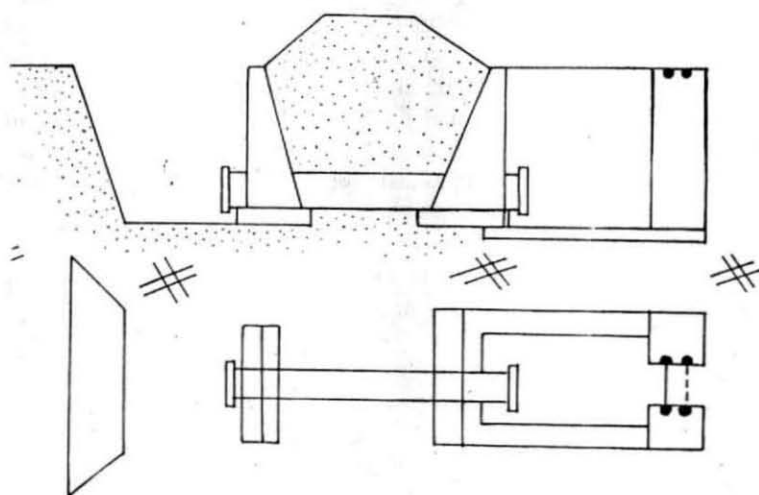

Fig. 1.3.5.2 Diagrammatic representation of a culvert type of sluice (water gate) used in milkfish culture ponds. A: side view, B: top view

water gates in the ponds called sluices for regulating the inflow and outflow of water may be constructed either of concrete or of wood, bamboo, etc (Fig. 1.3.5.2). In the sluices, suitable provisions will have to be made to facilitate complete closure at will by a wooden shutter as well as to operate a mesh screen for allowing the water only but to prevent passage of fish both ways.

About two months before stocking, the production ponds and subjected to preparations for the growth of blue-green algal food for the fish. These are similar to the preparation of the fry ponds, viz., draining of the water, drying, tilling, levelling and raking. Manuring or fertilisation of the ponds is always carried out. Usually, green organic manures are used, such as the leaves and twigs of mangrove plants, rice straw, copralime, rice bran, oilcakes, pig manure, chicken manure etc. The rate of fertilisation usually varies from 500 to 2,000 kg per hectare. Besides organic manures, inorganic fertilisers containing Nitrates, Phosphates and Potassium (NPK) such as Superphosphates, Tripe Superphosphates, Urea, etc. may also be applied at required rates, in order to enhance the production of algal food.

These processes may be repeated 2 to 5 times and sea water is then flown inside the ponds, gradually increasing the depths to about 30 cm, for the growth of the blue-green algal complex at the bottom, called Lab Lab. The bottom of such as well prepared production pond would have a thick growth of the algal complex consisting of *Oscillatoria*, *Phormidium*, *Microcoleus*, *Lyngbia*; and of diatoms like *Navicula*, *pleurosigma*, *Nitzschia* etc. These are the main food of the Milkfish; but other items like filamentous green algae, copepods, mysids etc. are also eaten by the fish.

Stocking of production ponds may be effected after the development of Lab Lab. Usually, fingerlings of 7 to 15 cm length are stocked, at a rate of 2,000 to 10,000 per hectare. Generally, one batch of fingerlings belonging to a single, uniform size group may be stocked. But, in some countries like Philippines, more than one batch belonging to more than a single group are stocked. For example, in the first stocking late fingerlings measuring 10-15 cm at a rate of 5,000 to 7,000/ha; then, after 3-4 weeks, early fingerlings of 7-10 cm at a rate to 15,000-30,000/ha; and still after another 3-4 weeks, late fry and tender fingerlings of 5-7 cm at a rate of 40,000-50,000 may be

stocked. The aim of this kind of "rotation method" of multiple stocking is to harvest the Milkfish at every 3 to 4 weeks intervals throughout the farming season. Each time the larger fish is harvested, the growth of the smaller fish is rapid due to lesser competition for food, space, dissolved oxygen etc.

When the growth of Lab Lab in the ponds decrease or when the algal pastures are overgrazed by the fish, fresh dosage of the manures may be added to the ponds, without adversely affecting the hydrological temporarily for draining the former, manuring it and to grow a fresh supply of Lab Lab before reintroducing the fish. Alternatively, inexpensive supplementary food such as rice bran and various kinds of oilcakes like groundnut, coconut etc, may also be provided.

1.3.6 Farming in pen structures

Inexpensive pen structures for farming the Milkfish are constructed in shallow natural creeks, swamps, lagoons, lakes, bays etc., ranging in depth from 1 to 3 m and having narrow entrances. The bottom in pen culture sites should be of firm clay or mud so that poles and posts can be driven sufficiently deep to make them support the pen structure. Traditionally, the pens are made up of wooden planks, split bamboo, hardware cloth etc. But in recent times, nets made of synthetic material such as nylon, ulstron, polythene, etc.

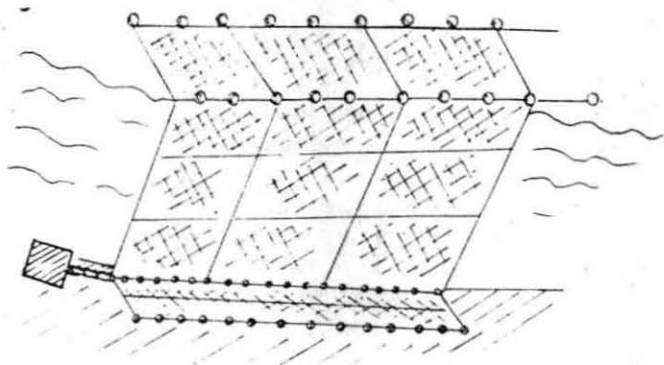

Fig. 1.3.6. Diagrammatic representation of a synthetic net pen structure used for milkfish culture. Note the sinkers, floats lower part of the structure buried in the mud and upper horizontal part of the net floating at the surface.

are used commonly because these are cheap and more durable than wooden materials. Usually areas of the pens range from about

1 to 20 has. A part of the vertical net barrier is buried inside the mud or ground with the aid of a foot rope and small weights, secured to a chain link between concrete sinkers (Fig. 1.3.6). At the upper level, floats are provided on a head rope. A horizontal section of about 2.5 m of the net on the inside of the enclosure is also provided in order to prevent the fish from jumping over the vertical nets. The vertical net is supported by wooden poles, or synthetic bars erected at frequent intervals in the form of a scaffolding. It is also advisable to provide a lattice work of synthetic ropes as a supporting structure for the net barriers. The net work along with foot rope, chain link etc. are assembled on shore, taken to the site by a boat, lowered into position and attached to previously placed and buoyed sinkers. For rearing the fingerlings also at the same site, a nursery pen may be provided with smaller meshed netting and measuring 20 m x 20 m and having a depth of 1 to 1.5 m.

Fingerlings stocked in pens usually feed upon the natural food in the lagoon or lake and no artificial food is provided. Multiple stocking may be practised in pens also.

Culture operation of Milkfish may also be carried out along the sea shore and derelict areas by excavating ponds and lining them with thick polyethylene linings and with water supply by mechanical pumping.

1.3.7 Eradication of predators and pests

In the culture ponds and pen structures, there is a likelihood of certain predatory fishes (*Elops*, *Therapon*, *Polynemus*, *Lates*) crabs (*Scylla*, *Thalamita*, *Portunus*), water snakes (*Cerebrus*) etc., getting inside in their young stages through the mesh screens in the water gates, grow inside the ponds and eat upon the cultured Milkfish. This may be prevented by a leak proof and strong sluice with fine meshed screens for the flow of water only but not the entry of the young ones of the predators. These organisms, if observed to be present in the ponds, may be netted out. Since crabs burrow through and / or cross over the embankments, impetrable structures, such as a core of stones, may be provided. Also certain birds like crows (*Corvus*), Kites (*Haliastur*) etc. may pose problems as pests. These may be discouraged by erecting scare-crows, poles on the embankments or by criss-crossing the ponds with strings or even by net coverings. Larvae of certain insects (Chironomids), Polychaete worms and snails are also pests in culture

ponds. The application of 0.5 ppm Baluscide, lime, Urea, etc. in the initial preparation of the ponds help to reduce their growth.

Since sudden increase or reductions in salinity and temperature are harmful to the fish, especially during drought and rainy seasons, it is helpful to maintain a reservoir of brackishwater by the side of the farming areas, in order to overcome drought and heavy rainfall.

Cultured Milkfish are remarkably free of parasites and disease. However, when there is a sudden decrease in temperature below 15°C accompanied by rains, the fish becomes lethargic, stops feeding and develops a milky discolouration of the skin, a condition described "cold". This condition may be cured by flowing a fresh supply of water with higher temperature, when the fish becomes active again.

1.3.8 Harvesting of farmed Milkfish

The success of growth and production of Milkfish depends upon judicious steps undertaken such as adequate manuring for growth of natural food, regular and efficient water replenishment, precautions against adverse hydrological factors, protection of grow-out structures from damages etc. Milkfish has a higher growth rate in its first year in brackishwater than in the sea. During the first year it grows to the marketable size of 30-45 cm long and 300-800 gm in weight in brackishwater; in the sea during the same period it grows to 25-30 cm only.

The periodicity of harvesting depends upon the number of batches stocked. If only one batch of uniform size is stocked, a single harvesting may be enough. But, if more than one batch of different size groups is stocked, they are harvested by a "rotation method", involving the capture of larger fish in the beginning and leaving out the smaller ones for further growth and harvest after some interval.

For harvesting operations, first it is advisable to drain the water from the culture facility. In the case of pens, the lowest tidal period is best time for harvest while in shore ponds the water may be drained through the exist sluice. If the ponds are very large, it may be necessary to partition them temporarily into many smaller enclosures, to facilitate fishing within. If trenches are provided in culture ponds, it would be easier to gather all the fish inside the trenches by draining the water and then capturing them.

Usually, seine nets are operated for capturing farmed fish. If the length of the net is equal to the width of the pond or pen, repetitions of seining would result in capture of all fishes. When more than one group is stocked, it is advisable to operate gill nets of required mesh size to capture the fish of desired size. If seining operations may sometimes result in the pond or pen mud adhering to the fish, this may be prevented by providing "catch ponds" to which the fishes may be aggregated from the production ponds, before harvesting. In order to ensure better keeping quality of the fish after harvesting, the fish may be made to empty the stomach contents by dragging a large meshed red gill net across the pond four or five times. After about 2-3 hours, the catching net may be operated.

1.3.9 Survival and production

The survival of the fish stocked in culture ponds and pens depends upon the hydrobiological and benthic conditions in the pond as well as on the quality of management resorted to. In many south-east Asian countries, the survival rates in recent times ranges from 80 to 95%, amounting to a production ranging from 250 to 500 kg/ha in one batch stocking procedure. But, in multiple batches stocking, the production may vary from 300 to 1,900 kg/ha; with best yields of upto about 3,000 kg/ha. Taiwanese have been reported to have achieved production levels of 10-12 tonnes/ha in deep water intensive systems.

1.4 Post harvest technology

1.4.1 Marketing

In view of consumer preference for unbruised fish, special care may be taken to ensure that the fish is not injured and that the scales remain intact. For this purpose, the fish may often be dipped in iced water before packing, which will prevent loss of scales during handling. Most of the fish is sold in fresh condition.

1.4.2. Utilisation

The Milkfish is a delicious finfish, usually consumed fresh. Also it is iced and transported to interior markets for sale. It can also be cured by boiling in brine or by smoking. Boiling yields can evaporate of the brine in the form of a paste called "petis", which is sold

as a flavouring ingredient. Smoked Milkfish is a luxury food, especially in countries like Indonesia, Malaysia, Philippines and Taiwan.

1.5 Economics

In India most of the experiments on Milkfish culture has been carried out in coastal earthen ponds and little in net pens. Varying results have been obtained on production; but economics of the experiments have not yet been published. However, by taking into account various possibilities and prospects under efficient management, the following projections on the economics may be considered :-

A. Farming details

| | | |
|-------|-----------------------------------|------------|
| (i) | Water area of the farm | 3 ha |
| (ii) | Size of ponds | 0.5 ha |
| (iii) | Period of culture | 6 months |
| (iv) | Rate of stocking(in numbrs) | 20,000/ha |
| (v) | Survival rate | 75% |
| (vi) | Average weight of fish at harvest | 300 gm |
| (vii) | Average yield per ha per crop | 4,500 kg |
| (vii) | Number of crops per year | Two |
| (ix) | Water supply | Tidal flow |

B. Initial investments

| | <i>Amount in lakhs Rs.</i> | |
|-------|--|-------------|
| (i) | Cost of coastal land | 1.00 |
| (ii) | Cost of excavation and construction etc. @ Rs. 40,000/- pond | 2.40 |
| (iii) | Cost of constructon of ten sluice gates | 0.50 |
| (iv) | Cost of conctruction of a feeder canal | 0.50 |
| (v) | Cost of construction of a shed for monitoring the farm | 0.10 |
| | Total | 4.50 |

C. Operational Costs

| | | |
|-------|---|------|
| (i) | Cost of pond preparation (draining, tilling, raking etc.) | 0.05 |
| (ii) | Cost of manuring, including that of materials | 0.25 |
| (iii) | Cost of seeds | 0.15 |

| | | |
|------------------------|--|--------|
| (iv) | Cost of producing additional feed (Lab Lab) | 0.55 |
| (v) | Cost of supplementary food | 0.25 |
| (vi) | Cost of annual maintenance | 0.30 |
| | Total | 1.55 |
| (vii) | Operational cost for 2 crops per year : | 3.10 |
| D. Fixed costs | | |
| (i) | Staff salary (One Farm Manager @ Rs. 2,500 p.m., Two Watchmen @ Rs. 700 p.m. and one Helper @ Rs. 500 p.m.) | |
| (ii) | Interest on initial investment @ 20% | 0.90 |
| | Total | 1.428 |
| E. Gross income | | |
| (i) | Total production in kg | 27,000 |
| (ii) | Annual revenue @ Rs.25/- per kg of fish | 6.75 |
| (iii) | Total Cost (C+D) | 4.528 |
| (iv) | Net profit | 2.222* |

* If exported to countries like Indonesia, Malaysia and Singapore, the net profit can be easily doubled.

1.6 Prospects

In India, the availability of extensive fallow coastal waters is estimated to be about 14,00,000 ha, of which atleast about 5,00,000 ha can be converted into brackishwater fish culture ponds and pens. Millions of the fry of the Milkfish, estimated to be nearly 20 million, can be collected from centres along the coasts of peninsular India annually. Experiments conducted in recent years have indicated that even without resorting to adequate management procedures, the production can be so high as 450-800 kg/ha or even more. Hence if only management procedures similar to the ones practised in Indonesia, Philippines and Taiwan can be implemented in India also, a total achievable production could be estimated, at a conservative level of 500 kg/ha, as 2,50,000 t/year. The total profit at a rate of Rs. 25/- per kg of fish could be so high as Rs. 6,250 million. Thus in the present context of increasing demand for sea fish, India offers a virgin ground for taking up Milkfish culture on a commercially large scale.

Milk fish

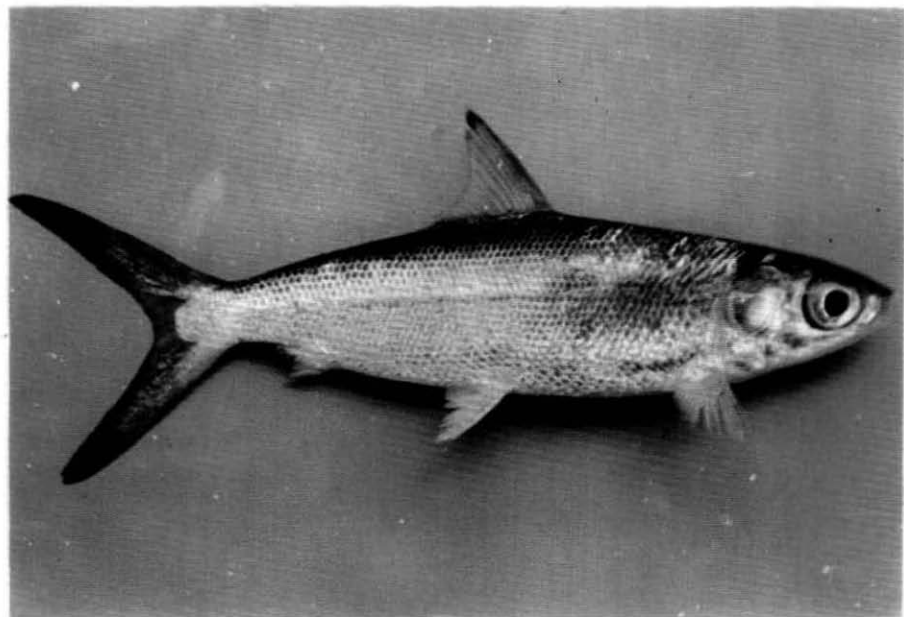

GREY MULLET

2.1 Introduction

Culture of Grey mullets dates back to ancient times and recorded history shows that Egyptians have devised methods for their culture about 2,500 years ago. In Rome, mullet culture ponds were in existence from the first century, yielding high profits. Mulletts are well suited for farming because, like the Milkfish, their food consists of the microscopic algae, decaying organic matter etc. at the pond bottom. They require little supplementary feeding; and once they are stocked and if the hydrobiological conditions are satisfactory, they are bound to thrive well. They are also tolerant to higher temperature and salinity and hence are ideal for farming in tropical countries. The recent annual production are :- Egypt : 9,000 t; Indonesia : 7,600 t; Italy : 3,500 t; Israel : 800 t.

Grey mullets are generally farmed along with other fishes, such as Crabs, Tilapia, Milkfish, Pearl spot, etc. The Milkfish ponds of Indonesia and other countries have a certain percentage of mullets.

2.2 Distinctive characters and Biology

2.2.1 Distinctive characters

These fishes belong to the Family Mugilidae, have a broad and flattened head, a small and terminal mouth, two short dorsal fins and are devoid of a lateral line. In life they have a blue, green or olive coloration on the back, but the sides and the belly are silvery and the body shows 3 to 9 longitudinal streaks. Among 14 valid species, only some are of culture value, such as *Mugil cephalus* (Fig. 2.2.1), which is so widely distributed in tropical and semitropical areas as Korea and Japan in the east to Italy, Israel and Egypt in the west. The other important species (Fig. 2.21) are : *Liza macrolepis*, *L. subviridis* (= *L. dussumieri*), *L. tade*, etc.

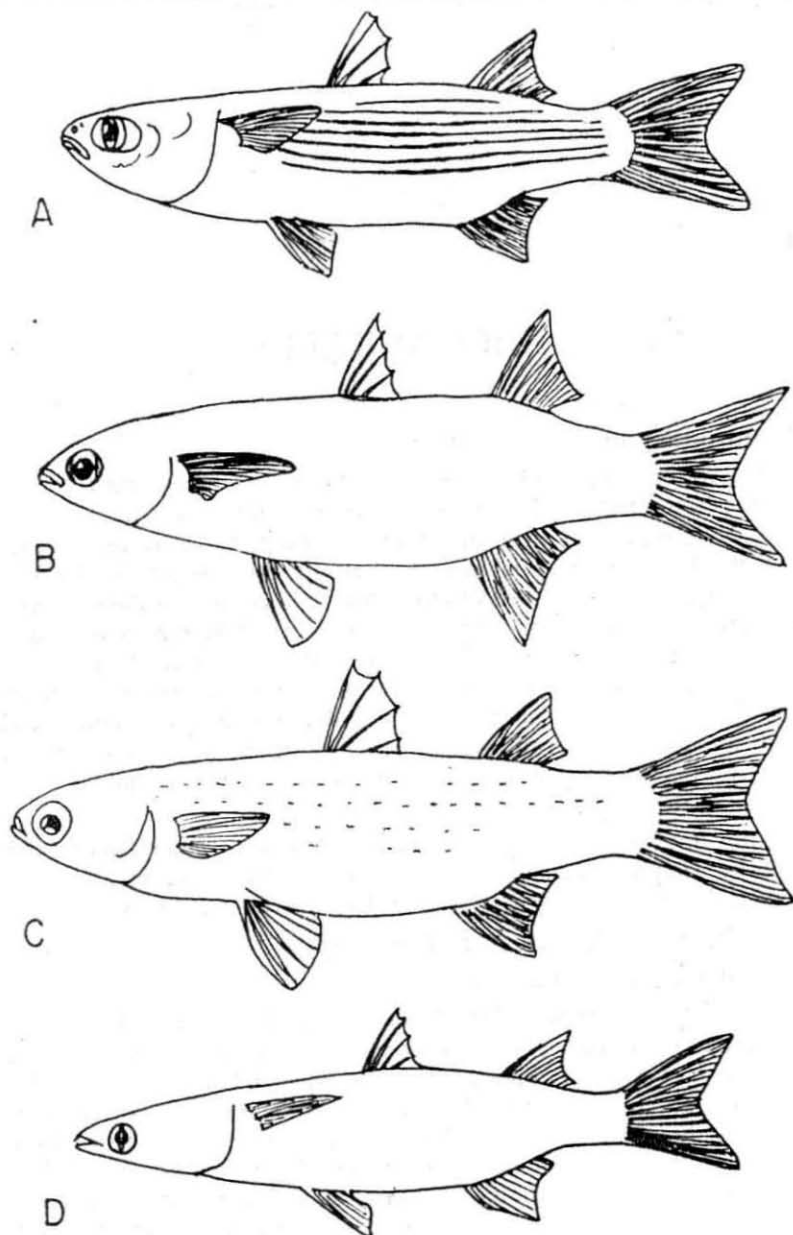

Fig. 2.2.1 Four commercially important culturable Grey mullets of India. A *Mugil cephalus*, B: *Liza macrolepis*, C : *Liza subviridis*, D: *Liza tade*.

Mugil cephalus has a robust body and fatty tissue covering most of the eye. The lips are thin, the lower one having a high knob at the symphysis. The lateral series scales are 38 to 42. It is blue green on back and silvery on sides, shading to white below. There are 6 to 7 indistinct brown bands down the flanks and a dark purple blotch at the base of the pectoral fin. Although this fish grows to a maximum of 90 cm, the common sizes range from 35 to 45 cm.

Liza macrolepis has a moderately robust body and the fatty tissue is only in the form of a rim around the eye. There are 31 to 34 scales in lateral series. It is greenish-grey above and silvery on sides and belly. The body does not have any bands or stripes. It grows to a maximum of 60 cm, with the common size ranging from 25 to 30 cm.

In *L. subviridis*, the fatty tissue covers only the iris of the eye; and there are 27-32 lateral series scales. The body is dark greenish above but white below. It attains 25-30 cm in length. In *L. tade*, the body is slender and elongate and the head is depressed and elongated. The body is greenish-brown above but silvery below; and in adults 5-7 indistinct longitudinal marks are present on the upper half of the body.

2.2.2 Biology

Majority of Grey mullets are marine, inhabiting shallow areas ; but since they have a wide range of tolerance to temperature and salinity, they ascend brackishwater, bays creeks, swamps and estuaries, where they grow rapidly. The adults feed upon the algae, diatoms, crustaceans, decaying organic matter, detritus, etc. found at the bottom; the post larvae, fry and juveniles feed mostly on plankton. For spawning purpose, most of the species have to go back to the sea; and their fry form schools along the coasts and enter estuaries, lagoons, creeks, etc. They grow quickly, some species attaining upto 45 cm in length and 750 gm in weight by the end of the first year. The total life span of most species varies between 2 and 3 years, with maximum growth in the first year of their life.

2.3 Farming Methods

2.3.1 Natural seed resources and collection methods

The seeds of grey mullets (2-3 cm long) are abundant in the

inshore waters, estauries, backwaters, etc. In India the fry of one or the other species of mullets (Fig. 2.3.1) are known to be available throughout the year. As per one conservative estimate, about 4 million seeds can be easily collected each year in India. The best centres

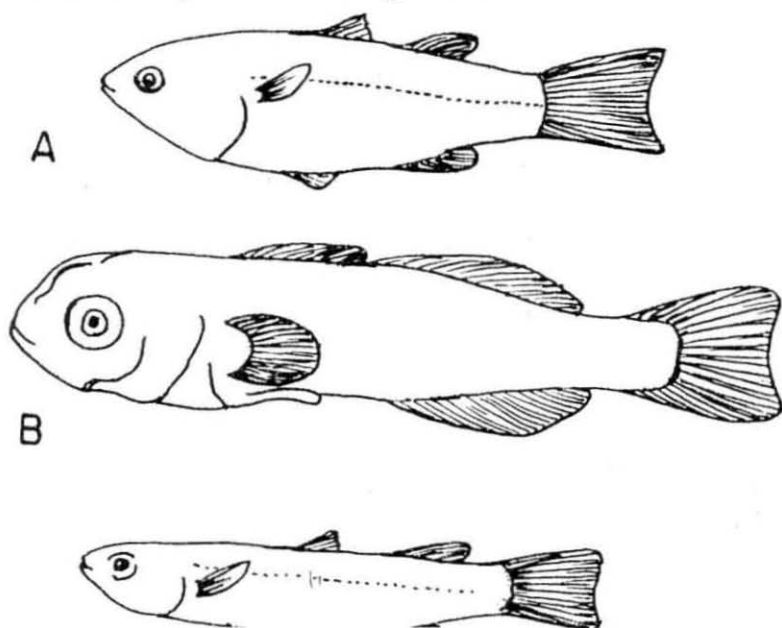

Fig.2.3.1 Sketches of the seeds of three species of Grey mullet. A *Mugil Cephalus*, B: *Liza subviridis*, C: *Lizatade*

for collection are : estaurine regions, lagoons, bay, creeks, inundated fields, mangrove swamps etc. Among the various methods used for the collection of the fry, a simple method is to excavate pits along the banks of estuaries for trapping the fry present in the high tide and their collection by scoop nets when the tide recedes. Also seine nets, short bagged drag nets and similar equipments are used inshore areas for collecting the fry. Sometimes, a scare line with grass or shreds of coconut or palmyrah leaves attached at intervals is used to congregate the fry before their capture (vide Chapter 1.3.2).

Fry of different species of grey mullets resemble one another so closely that it is difficult to segregate them easily at this stage.

However, when they reach juvenile or fingerling stages, they could be identified to the species to which they belong without much difficulty. Hence it is customary to separate the species collected from the natural seed resources at the juvenile or fingerling stages only. However, certain seasonalities have been observed in the occurrence of the seeds of certain species in specific localities. This may be taken advantage of for provisionally determining the identities of the desired species.

If the seeds will have to be stocked in nurseries having very low salinity values, it is advisable to acclimatize the seeds through gradual decrease in salinity, although direct transfer has also been carried out widely. It has been observed that much more than salinity, sudden changes in temperature and low pH affect the survival of the fry. If the fry are to be transported to long distances, it is advisable to condition them for one day.

2.3.2 Hatchery technology for seed production

One significant development achieved in recent times in different parts of the world is the success in artificially inducing breeding in the mullet *Mugil cephalus*, by injecting mullet pituitary extract, human chorionic gonadotropin and/or synthetic hormones such as Synahorin. Mature, 4 to 6 years old females are injected intramuscularly, but males do not require injections, except towards the end of the breeding season. For getting best results, two injections have to be given at an interval of 24 hours. The injected fish is stripped of the eggs or milt, by gently pressing the abdomen. A female *M. cephalus* of 1.5 kg weight can release 1 to 1.5 million eggs.

The eggs are fertilised by mixing them with milt, with water or without water (wet and dry methods respectively). At temperatures of 20-24° C and with aeration, the egg hatch out with in 30 hours. The larvae measure only 2.5-3.5 mm in length and they start feeding on the 4th day after hatching, when they are fed with fertilized oyster eggs and newly hatched oyster larvae. From the 5th or 6th days after hatching, rotifers and copepods and after 20 days the nauplii of the brine shrimp (*Artemia*) are given as food. By about 30 days (1.5 cm) the larvae can be gradually fed with fish paste; and at about 45 days after hatching, the seed measure 3.3 cm and 0.3 gm in weight they are suitable for stocking and accept rice bran and/or wheat flour as food.

In Israel and Taiwan, mullet culturists have succeeded in raising adult *M. cephalus* from eggs.

In India, induced breeding of *Liza troschelli* and *L. macrolepis* has been achieved, although a hatchery technology is yet to be developed. In Hawaii, *M. cephalus* has been made to spawn during out of season, by simulating the conditions of normal spawning. In Taiwan, maturity of pond reared *M. cephalus* is enhanced and they are made to spawn by placing them in different grades of brackishwater. By such methods, the procurement of seeds can be enhanced considerably.

2.3.3 Nursery rearing

At the time of collection, the fry of mullets are small in size and shall not survive successfully if they are stocked directly in production ponds. Hence it is advisable to rear them in nursery ponds so as to make them grow more and reach the fingerling stage when they become sturdy, active enough and ready for stocking in production ponds. Nursery ponds are usually situated inside or near production ponds, range in area from one to ten aereas, rectangular in shape and should receive adequate sea water supply. One or two months before stocking, these ponds may be subjected to preparations, as in the case for Milkfish (Vide Chapter 1.3.2). The fry and fingerlings to be stocked would subsist on the micro algae and associated organisms as well as on the plankton developing in the ponds. Conditioning, acclimatisation and stocking procedures in nurseries are almost similar to those practised for the Milkfish (Vide Chapter 1.3.3 and 1.3.4). If supplementary feeding is needed, rice bran, oil cake, wheat starch, etc. may be supplied, at a rate of 5-7% of body weight.

Apart from the above, special nursery technique are being practised to rear the fry and fingerlings of Grey mullets. In Israel, the fry of *Mugil auratus* are fed on a diet of fish meat and fish flour extruded through a plate with tiny perforations. Survival of the fry is greatly enhanced by fortifying the above diet with algae collected from mullet ponds. Further improvement is achieved by addition of chironomid larvae to the diet, which is believed to enhance growth. In Taiwan, fry of *M. cephalus* are reared in neon-lighted concrete tanks of 20 x 10 x 2 m with green house tops and by feeding with rotifers, oyster trochophores, copepods, etc. In Italy, the fry are first stocked in a series of parallel trenches called "Seragio" with full access to brackish water and freshwater, for rapid growth. By resorting to such techniques, the survival and growth of Grey mullet seeds in nurseries

can be considerably enhanced.

2.3.4 Grow-out systems

Grey mullets are usually cultured in earthen ponds with a clayey and/or muddy bottom, which is biologically more productive than a sandy one. The organic cycle in such areas, with the nutrients in the water and those brought by drainage encouraging the growth of organisms, is ideal for mullets. These ponds are similar to the one used for culture of Milkfish (Chapter 1.3.5). Since mullets grow more rapidly in an admixture of freshwater and salt water rather than in seawater alone, one of the recent developments in pond construction is to make a provision for the same, as done in the Italian "Vallis". In Hawaii, mullets are cultured in tidal ponds with porous walls of coral and basalt. Traditionally, mullet culture pens made up of screens of split bamboo and/or sturdy grass stems were also used in many parts of world, like Japan and Philippines. In modern times, synthetic net pens may be used.

The processes of pond preparation are the same as practised for Milkfish ponds (Chapter 1.3.5), namely draining after a harvest, drying, tilling, raking, levelling, manuring etc. These enhance the growth of the bottom food on which mullets subsist. In the United Arab Republic, the use of phosphate fertilizers has increased mullet production. In Hawaii, the provision of buoyant plastic sheets anchored to the bottom has resulted in the development of luxuriant diatom and algal growth on them and has increased the production of mullets. If found necessary, supplementary feeding of the culture stock may be undertaken with rice bran, oil cakes etc.

The stocking rate may vary depending upon the conditions of stocking such as polyculture with other fishes. In Hong Kong 10,000-15,000 fingerlings of about 7.5 cm are stocked with 1,000-2,000 Chinese Carps/ha. In Taiwan, the ratio is 3,000 mullets, 2,000 Milkfish, 3,250 Chinese Carps and 500 common Carps.

The kinds of predators and the processes of eradicating them are the same as in Milkfish culture ponds (Vide Chapter 1.3.7).

Since mullets attain large size only if allowed to enter fresh waters, particularly in the second year of their life, facilities are provided

in India (West Bengal) for them to migrate to paddy fields or adjoining freshwater canals for fattening.

In culture facilities, diseases are scarce for Grey mullets, although certain Crustacean parasites are reported do infest certain species. Hygienic conditions of the cultured systems as well as efficient water supply coupled with regular monitoring would preclude such conditions.

2.3.5 Growth and production

Grey mullets grow at a very rapid rate in the first year of their life, reaching upto 45 cm in length and 750 gm in weight as in the case of *M. cephalus*. Experiments in India have shown that by adopting improved methods of culture, the production can easily be about 2.2 t/ha for *L. tade* and *L. parsia*. In Hong Kong ponds, the production varies from 2.5 to 3.5 t/ha.

2.3.5 Harvesting

Harvesting procedures are almost the same as in Milkfish culture. In the culture ponds and paddy fields of West Bengal, when the water is drained in the ponds the fishes gather themselves in the trenches or canals present inside the ponds, from where they may be caught by seine nets, drag nets or cast nets.

2.4 Utilisation and Marketing

Grey mullets are mostly consumed in the fresh condition. These may also be iced and transported to interior markets. In States such as Kerala, Karnataka, Goa, Tamilnadu and West Bengal, the mullets are considered as a delicacy and a high class table item.

2.5 Economics of Grey mullet farming in Coastal ponds

As in the case of the other fin fishes, the economics of experimental farming of Grey mullets in India has not yet been published. Based on literature, it may be stated that by resorting to efficient management procedures of pond preparation, fertilisation, water management, etc, a production of upto 6,000 kg/ha can be attained for each crop. From this and the growing demand for Grey mullets, the following projections on the economics may be considered :

A. Farming details

| | | |
|--------|-----------------------------------|------------|
| (i) | Water area of the farm | 3 ha |
| (ii) | Size of ponds | 0.5 ha |
| (iii) | Period of culture | 6 months |
| (iv) | Rate of stocking | 30,000/ha |
| (v) | Survival rate | 75% |
| (vi) | Average weight of fish at harvest | 250 gm |
| (vii) | Average yield per ha per crop | 5,625 kg |
| (viii) | Number of crops per year | Two |
| (ix) | Water supply | Tidal flow |

B. Initial investments**Amount in lakhs Rs.**

| | | |
|-------|--|-------------|
| (i) | Cost of coastal land | 1.00 |
| (ii) | Cost of excavation, construction etc. @ Rs. 40,000/per pond | 2.40 |
| (iii) | Cost of construction of ten sluice gates | 0.50 |
| (iv) | Cost of construction of a feeder canal | 0.50 |
| (v) | Cost of construction of a shed for monitoring the farm | 0.10 |
| | Total | 4.50 |

C. Operational costs

| | | |
|-------|--|-------------|
| (i) | Cost of pond preparation (draining, tilling, raking etc.) | 0.05 |
| (ii) | Cost of manuring, including that of materials | 0.25 |
| (iii) | Cost of seeds | 0.15 |
| (iv) | Cost of producing additional feed (Lab Lab) | 0.55 |
| (v) | Cost of supplementary food | 0.25 |
| (vi) | Cost of annual maintenance | 0.30 |
| | Total | 1.55 |
| (vii) | Operational costs for 2 crops per year | 3.10 |

D. Fixed costs

| | | |
|------|--|--------------|
| (i) | Staff salary (One Farm Manager @ Rs. 2,500 p.m., Two Watchmen @ Rs. 700/- p.m. and one Helper @ Rs. 500/- p.m.) | 0.528 |
| (ii) | Interest on initial investments @ 20% | 0.90 |
| | Total | 1.428 |

E. Gross income

| | | |
|-------|---|--------|
| (i) | Total production in kg. | 33,750 |
| (ii) | Annual revenue @ Rs. 30/- per kg of fish | 10.125 |
| (iii) | Total cost (C + D) | 4.528 |
| (iv) | Net profit | 5.597 |

2.6 Prospects

Grey mullets are one of the most ideal groups for culture in back waters estuaries, coastal ponds etc. Their seeds are available almost throughout the year and artificial propagation has also been achieved in many countries. As such, with the availability of vast stretches of fallow coastal areas in India, it is possible to develop the culture of Grey mullets on a viable, commercial basis.

Also, the unmanaged, traditional system of mullet culture as practised in West Bengal and Goa may be converted into scientific farming in order to further enhance production.

THE PEARL SPOT

3.1 Introduction

The Pearlsport, *Etroplus suratensis*, belonging to the Family Cichlidae is an important brackishwater fish, distributed in India, Srilanka and Pakistan. It is usually available in estuaries, tidal creeks, lagoons, back waters, swamps etc. and attains a length of more than 30 cm and weight of about 1.5 kg. In India it chiefly occurs in the south-west coast, comprising Kerala and Karnataka, where it is considered as a great delicacy and is much in demand. It is also available in Orissa, Andhra Pradesh and Tamilnadu.

3.2 Distinctive characters and Biology

The body of *E. suratensis* is oblong, compressed and elevated (Fig. 3.2). There are small teeth on the jaws, but none on the palate. The dorsal fin is single, with the spinuous portion greater in extent than the soft portion. Lateral line is present in the upper fourth of the body. The colour is light green, with eight oblique bands between the occipital region and the base of the caudal fin. Most of the scales have central white pearly spots. The dorsal, caudal, ventral and anal fins are of a dark leaden colour, but the pectoral fin is yellowish, with a black base. This fish has strong spines on the dorsal and anal fins, which serve to defend it from predators.

The Pearlsport become sexually mature within an year of its life and breeds in confined waters such as ponds, almost throughout the year, without any care or attention. The natural breeding grounds are usually weedy areas with depths ranging from 50 to 100 cm. A female releases upto 6,000 eggs at a time. The eggs are attached to submerged objects like stones, twigs, tiles, bamboo poles, husk,

etc. by the female, after cleaning algae and other growths. The male fertilizes the eggs and the female guards over them during development. The eggs hatch out within seven days. The fry have many vertical bands on the sides of the body and a spot on the caudal peduncle. Fingerlings upto about 5 cm length have a prominent eye spot on the hind part of the dorsal fin.

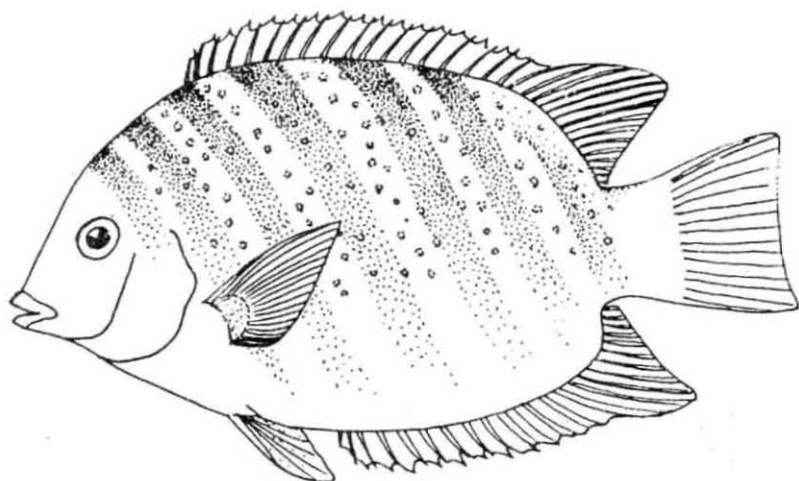

Fig. 3.2 Line drawing of the Pearl spot. *Entroplus*, *Entroplus suratensis*

The early fry feed mostly on zooplankton, the advanced fry on aquatic insect larvae and the juveniles as well as adults feed upon filamentous algae and other vegetable matter, including the hair weed *Spirogyra*. Since *Entroplus* is nonpredaceous, easily adaptable, quick growing and rapidly breeding, it is another fish ideal for coastal aquaculture.

3.3 Farming methods

3.3.1 Natural seed resources and collection methods

The fish has been observed to breed in the backwaters of Kerala throughout the year, with major fry collection seasons during May-June and November-February period and the peak during January.

In Madras, the fry are available almost throughout the year, with major abundance during November to February. In Chilka lake also it breeds all the year round, with two major seasons, during December-February and April-May. The eggs are attached in yellowish, oblong patches, about 18 cm long and about 15cm wide. On an average, there will be 2,000 eggs in each patch, guarded by the parent fish. The hatchlings measure about 5.3 mm in length.

The fry and fingerlings ranging in length from 1.5 to 5 cm may be collected by fine meshed seine nets or purse nets from the breeding grounds. Although the adults are hardy, the fry and fingerlings are delicate and cannot withstand direct transfer from one medium of water salinity to another. Hence, they will have to be conditioned and /or acclimatized gradually. With six hours of conditioning in the original medium and six hours stay in the subsequent grade of water, the seeds can usually be acclimatized.

After acclimatisation, the seeds may be transferred to containers, with aeration and/or water exchange. They have been found to withstand the stresses of transportation to long distances of even 1,500 km by rail.

Although it is quite possible and easy, a hatchery technology for production of the seeds of *Etroplus* has not yet been developed in India.

3.3.2 Grow out systems

If the seeds of *Etroplus* are acclimatised, they can be stocked directly to rearing ponds, without the need for raising them up through nurseries. It is generally cultured in brackishwater ponds such as the ones used for culture of Milkfish and Grey mullets, along with them in polyculture. However owing to the high tolerance and remarkable adaptability of this fish, monoculture of this is a distinct possibility if only attempted by entrepreneurs. Seeds are stocked in varying densities, depending upon the densities of the other fishes stocked. The fry feed upon zooplankton and insect larvae while the fingerlings depend upon filamentous algae and other vegetable matter, which may be grown artificially in separate ponds, for supply to the stocked material.

The stock may be protected from harmful predators such as

certain fishes, crabs, snakes, etc as in the case of the Milkfish (See Chapter 1.3.7). The fish is known to be afflicted by certain bacterial infection namely Epizootic Ulcerative Syndrome, which can be minimised by maintaining good water quality and by ensuring good pond hygiene.

The Pearls spot reaches upto 30 cm in length and 1.5 kg in weight by the end of the first year, when it is ready for marketing. Since the growth decreases after the first year of its life, it is advisable to harvest it by the end of the first year.

3.4 Harvesting and marketing

Harvesting is usually undertaken by draining the water from the ponds and by operating a seine net or a drag net for capturing the fish.

3.5 Economics of farming the Pearls spot

As in the case of other finfishes, the economics of farming the Pearls spot have not yet been published by any agency. But, by taking into account the high demand for this fish in domestic markets such as in Kerala and distinct possibility of its monoculture, the following economic projections may be made :

A. Farming details

| | | |
|--------|-----------------------------------|--------------|
| (i) | Water area of the farm | 3 ha |
| (ii) | Size of ponds | 0.5 ha |
| (iii) | Period of culture | 1 year |
| (iv) | Rate of stocking (in numbers) | 25,000/ha |
| (v) | Survival rate | 80% |
| (vi) | Average weight of fish at harvest | 300 gm |
| (vii) | Average yield | 6,000 kg/ha. |
| (viii) | Number of crops per year | One |
| (ix) | Water supply | Tidal flow |

B. Initial investments

| | | |
|-------|---|------|
| (i) | Cost of coastal land | 1.00 |
| (ii) | Cost of excavation, construction etc. @ Rs. 40,000/ per pond | 2.40 |
| (iii) | Cost of construction of ten sluice gates | 0.50 |

| | | |
|------|--|-------------|
| (iv) | Cost of construction of a feeder canal | 0.50 |
| (v) | Cost of construction of a shed for monitoring the farm | 0.10 |
| | Total | 4.50 |

C. Operational costs

| | | |
|-------|--|------------|
| (i) | Cost of pond preparation (draining, tilling, raking etc.) | 0.05 |
| (ii) | Cost of transplanting and growing filamentous algae for food | 0.25 |
| (iii) | Cost of seeds | 0.25 |
| (iv) | Cost of providing additional algae as food | 0.75 |
| (v) | Cost of annual maintenance | 0.30 |
| | Total | 1.6 |

D. Fixed costs

| | | |
|------|---|--------------|
| (i) | Staff salary (One Farm Manager @ Rs. 2,500 p.m., Two Watchmen @ Rs. 700/- p.m. and one Helper @ Rs. 500/- p.m.) | 0.528 |
| (ii) | Interest on initial investments @ 20% | 0.90 |
| | Total | 1.428 |

E. Gross income

| | | |
|-------|--|--------|
| (i) | Total production in kg. | 18,000 |
| (ii) | Annual revenue @ Rs. 30/- per kg of fish | 5.40 |
| (iii) | Total cost (C+D) | 3.028 |
| (iv) | Net profit | 2.372 |

3.6 Prospects

The Pearlsport is one of the most sought after table fishes especially in Kerala, Karnataka, Goa, Tamilnadu, etc. and there has been an increasing demand for it in the domestic market. But due to one reason or the other, this fish has not yet been cultured on a commercial scale, inspite of the fact that elaborate procedures are not needed for its seed production and culture. It is high time that organised commercial culture and breeding of this fish is implemented, so as to increase its production on a large scale.

4

THE SEABASS**4.1 Introduction**

The "Seabass" or the "Giant perch" , *Lates calcarifer* is of prime quality value fish. Distributed mostly in the central and eastern Indian Ocean region, it is common in Australia, Burma, India, Indonesia, Malaysia, Papua (New Guinea), Phillipines, Singapore and Thailand. In view of its easy adaptability to low saline waters including fresh water, this fish has assumed great value for culture in recent years. Popularly called "*Bhekti*" in India, it is found along both the east and west coasts, but is more common in Bengal region where it is cultured in ponds, canals, bheries and paddy fields.

The latest total annual production from culture is about 7,400 t, of which Indonesia accounts for 43%, Malaysia 22% and Thailand 18%.

4.2 Distinctive characters and biology

The Seabass belongs to the Family Centropomidae. It has an elongate and compressed body, with a deep caudal peduncle (Fig. 4.2). Head is pointed, with a concave dorsal profile, becoming convex in front of the dorsal fin. The mouth is large, slightly oblique and the lower edge of the preopercle is serrated, with a strong spine. The spinuous and soft parts of the dorsal fin are separated by a deep notch. The lateral line extends on to the tail. In juveniles the colour is olive brown above with silver sides and belly while in adults it is greenish or bluish above and silvery below. Neither spots nor bars are present on the body and fins. The eyes are bright pink, glowing at night.

The fish has a wide range of tolerance to temperature and salinity as in the case of the Milkfish and grows to a maximum of upto

200 cm; but the common sizes are 25 to 100 cm. There is no organised capture fishery for this fish anywhere; but is quite often caught in gill nets and seine nets along coastal areas, estuaries, lagoons, etc. It is carnivorous and feeds upon fishes and crustaceans, worm, molluscs, etc. Growth is observed to be faster in the first three months of the first year.

In India the fish is reported to breed along the Muthupet belt in the south-coast and Chilka lake in the East Coast during October - December period. Along Orissa coast, the fish appears to spawn twice, once during October - December and another during January - March. The breeders range from 50 cm and above in size and it is observed that for breeding purpose the fish has to migrate into the sea. The fish in Chilka lake is reported to grow to 28.7, 49.2, 68.7 and 79.7 cm respectively during first four years of growth. In culture ponds it is known to attain 1.5 to 3 kg in the first year and 5 kg in the second year.

4.3 Farming Methods

4.3.1 Natural Seed resources and collection methods

The seeds of this fish are available in coastal areas, intertidal pools, bays, creeks, estuaries, mangrove swamps, etc along the east coast of India during October - December. In Chilka lake, the seeds are available in the channel area and central zone of the lake. The fingerlings usually range in length from 3 to 10 cm and can be collected by small meshed drag nets, shooting nets, scoop nets and cast nets taking advantage of the tides.

4.3.2 Hatchery technology and Seed production

Hatchery production of the seeds of the Seabass has been achieved in Thailand by collecting spawners from the wild. This is followed by breeding the fish in tanks under captivity and production of the first batch of induced-bred fry there in 1973. Subsequently, seed production has been achieved in Singapore. Various aspects of seed production as carried out at Singapore may be considered as follows :-

Spawner characteristics and induced breeding

L. calcarifer matures at the age of about 3 years when it measures about 60 cm to total length (TL). Since it is a protan-

drous hermaphrodite, usually younger fish in the age group of 3 to 5 years (60-120 cm TL and 2-7 kg in weight) are males and older fishes in the group of 4 to 7 years, 110 - 150 cm TL and 3-12 kg are females.

The broodstock for seed production is obtained either by collection from the sea or by raising young ones in floating net cages in the sea. In the former case, a period of six months is required for the fish to recover from the stress of capture as well as for conditioning to the confined environment of the net cages. The stock is kept in such localities in the sea as are sheltered from strong waves of not more than 2 m height and away from strong currents of not more than 1m/sec. The hydrological conditions suitable for the stock are : 28-31°C temperature, 27-31‰ salinity and more than 5 mg/l dissolved oxygen. The holding net cages are of 5 m length (L), 5m width (W) and 3 m height (H) with mesh sizes of 2.5 cm. Stocking density is not more than 10 kg biomass/m². To ensure effective water circulation, the net cages which are fouled are changed every month. The stock is fed with trash fish such as *Upeneus* and *Sciaena* at a rate of 2-3% of body weight. Experience has shown that effective interplay of the sexes and higher fertilization take place only when males and females of the same age group are selected for breeding. However, the sexes of different age groups can be induced to spawn when they are conditioned by keeping them together for a period of 4 to 5 months.

The spawners should be healthy, active and free from parasites, diseases and injuries. They are examined once in 3-4 months for selection to breeding. After selection, the fish is lifted up with a scoop net and its head and eyes are covered with a black hood in order to prevent the fish from struggling while handling. In females, the intraovarian ova are sampled by catheterisation and such to those which contain spherical, nonadhesive ova with a mean diameter of 0.45 mm or more are taken for induced breeding. Among males such of those which ooze out white and creamy milt under gentle pressure with hands are the suitable ones.

Two hormones are used for induced breeding on the Seabass, viz, (a) Luteinising Hormone - Releasing Hormone (LH-RH a) and Human Chorionic Gonadotropin (HCG), both found to be equally effective. The dosage depends upon the maturity condition and weight of the spawner, lower if the maturity is advanced and vice versa.

Since intra peritoneal injections are likely to injure vital internal organs, intra muscular injections are preferred. The usual site is at about 3 to 4 cm below the soft dorsal fin, where a scale is lifted up and needle is inserted into the muscle at about 45° inclination for about 1 cm depth. After injecting, the needle is drawn out gently and the fish is carefully transported to the hatchery in a fibreglass tank, for releasing into the spawning tank.

After hormonal treatment, usually 3 to 6 spawnings are observed within the first six days mostly between 9.00 PM and 2.00 A.M. The first hatching at a water temperature of 27-28°C occurs at about 15½ hours after fertilisation; and by the 16th hour all the eggs are found to hatch out.

Rearing of larvae and fry

The larvae and postlarvae are reared at first in indoor tanks until they metamorphose into fry by about the 20th day after hatching. In the afternoon of the second day after hatching, the mouth is formed and the postlarvae measuring 2.5 mm T L are ready to feed. To begin with the postlarvae are fed with the rotifer *Brachinous plicatilis* by adding the latter at a low density of 2-3/ml of water on the second day in tanks (Fig. 4.3.2)

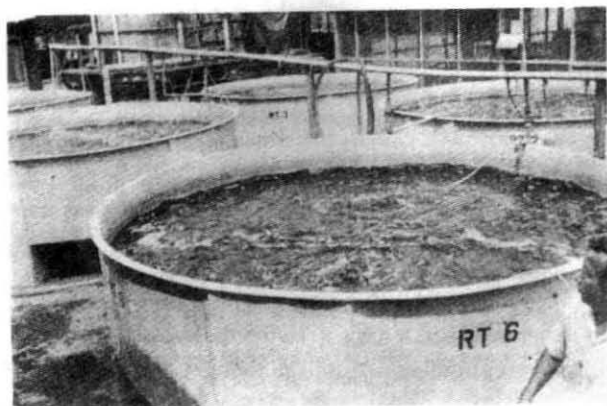

Fig. 4.3.2 A view of the tanks in which the fry of the seabass are reared to fingerling stage, in a hatchery.

By the 11th day, the postlarvae measure about 4.5 mm TL and are ready to accept the nauplii of *Artemia*. The fresh water crustacean *Moina macrura* may also be supplied in small numbers of 0.10 to 0.15/ml from the 18th to the 20th days. In order to serve as the food of rotifers, the microalgae *Chlorella* and *Tetraselmis* are cultured in plastic bags and are added to the rearing tanks. These algae increase the oxygen content of the water and bring down the concentration of ammonia in it and thus serve as "water conditioner" also for rearing the early stages.

In the course of the first 20 days after hatching when they grow to about 8 mm TL, the postlarvae undergo metamorphosis, become pigmented dark in colour with vertical stripes and present a brownish appearance, when they are called "fry". Survival from hatching to the fry stage of rearing is about 35 -42%.

Rearing fry into fingerlings

On metamorphosis into fry by the 20th day when they measure about 7-10 mm TL, they have become stronger and are adaptable to rearing in outdoor tanks and "Hapa" net cages in the sea itself. For outdoor rearing, circular tanks, of 1 to 8 m³ capacity and having 0.8 to 1.0 m height are used. Stocking density varies depending upon size of the fry, 5,000/ m³ for those smaller than 1 cm; 4,000/m³ for those of 1 - 1.5 cm and 2,000/m³ for those of 1.5-2.5 cm TL. Generally, hapa cages are used to rear fry longer than 1 cm. These are made up of soft, knotless nylon material with a mesh size of 0.5 to 1.0 mm, in the dimensions of 1.2m L, 0.6 m W and 0.8 m H. To protect the hapa cages from strong currents in the sea, fibreglass tanks without the bottom are used to enclose them. Survival from the 20th to the 60th day, when the fry attain about 3.5 cm is about 40%. Fry smaller than 1 cm are fed with nauplii and preadults of *Artemia* and *Moina* at rates of 0.25 to 1.0 and 0.15/ml respectively. From the size of 1 to 15 cm, they are fed with minced trash fish alone; and *Acetes*. After 1.5 cm the fry can accept minced meat of trash fish and they are fed to satiation three times a day, morning, late morning and late afternoon, at a rate of 8% of their body weight.

Since the Seabass is cannibalistic, the larger ones eating up the smaller, it is essential to grade them from the fry stage onwards

SEA FISHES

into different size groups. This is effected by using plastic basins with circular perforations of the desired diameteere at the bottom. The fry are reared in this manner in hapa cages in the sea until they attain about 7-10 cm TL, when they are about 2-3 months old. At this stage they are ready for stocking in large meshed grow-out net cages, for commercial culture.

4.3.3. Grow-out systems

Lates calcarifer has been cultured traditionally in brackishwater ponds in Indonesia, Philippines, Taiwan, India etc. But in recent years this fish has been cultured in floating net cages. Also there has been refinement of the pond culture systems, as in Taiwan, where there are about 200 ha of ponds for monoculture alone.

4.3.3.1 Pond culture

Pond culture is undertaken in two stages in Taiwan; a nursery stage in which 2 week-old seeds (about 1.3 cm) are grown to 5-6 cm fingerlings; and a growout stage in which the 5-6 cm fingerlings are grown to the market size of about 600 gm weight. Nursery ponds are small, made of concrete, with a surface area of about 300 m², depth of about 1 m and strongly aerated. These are stocked at a rate of 250 to 300/m². Since the seeds have diverse growth rate, the larger ones, as and when they attain the required size may be segregated and stocked in production ponds. In the nurseries the seeds are fed with live zooplankton, mostly copepods, about 6 times per day.

The production ponds also have concrete walls and a soft bottom, ranging in area from 0.1 ha to a few ha, a water depth of upto 2m and salinity of 5-10%. About one month prior to stocking, the ponds are sundried to eliminate anaerobic conditions and are treated with quick lime at a rate 800-2400 kg/ha. Also, rice bran, chicken castings and similar manure are applied before filling with water to a depth of 1.5 to 2 m. The stocking density varies from 10,000 to 40,000/ha, depending upon the intensity of aeration provided to renew dissolved oxygen in the ponds. The fish are fed with fresh trash fish and small Tilapia at the rate of 10% of the body weight. Pelletized diet also is given. Since the growth during the winter season is slower then during the summer, the farmers in Taiwan stunt the growth of the Seabass by providing minimum food required; and after the winter, they grow the fish to the market condition. Harvesting is done by

draining the ponds and operating nets. With an average survival rate of about 80%, the production rate is upto 100 t/ha or even more. The Seabass may also be cultured in freshwater ponds as the primary species, along with Carps, Eels and the Milkfish, with a production of 26 t/ha.

4.3.3.2 Net cage culture

Intensive commercial culture of the Seabass is carried out at Singapore in floating net cages in the sea.

Selection of sites

The sites for net cage farming should favour the setting up and maintenance of the grow-out structures and the environmental conditions should be optimal for the survival and growth of the fish. Topographically, sheltered areas protected from strong winds and waves are the best. Bays, estuaries, lagoons and inland seas are the ideal ones. The waves should not be more than a height of 0.5 to 1.0 m because stronger waves are hazardous to the farming structures. The water depth should be atleast 2 m more than the height of the cages, in order to facilitate flow of water below the cage for removal of uneaten food, faeces and debris from below the net cages. If the latter is 2-3 m, the water depth should be atleast 5 m. The speed of the currents should be ideally less than 0.5m/ sec and in any case should not exceed 1m/sec, as strong water currents results not only in excessive strain to the farming structures but also distort the nets and affect the growth of the fish stocked. High turbidity can enhance fouling on nets and clogging of gills and lead to suffocation for the fish. Hence, the water should be clear and the turbidity should be less than 5 mg/l. The optimum water temperature should be between 27 and 31°C, dissolved oxygen should be preferably 5 ppm or more, but not less than 4 ppm, optimum salinity should be 26-31‰ ; pH 7.8 to 8.3 and chemical oxygen demand 3 mg/l or less. Areas of excessive phytoplankton growth have to be avoided, as also areas of heavy growth of fouling organisms like barnacles, tunicates, algae and worms. Besides, the farming area should be accessible from the shore.

Construction of rafts and floating net cages

The timbre of *Dryobalanops aromatica* is generally used for

rafts. For suspending a net cage of 5 m x 5 m the logs selected are 7m L, 0.10 m W and 0.07 m H. Suitable bolts, nuts, nails washers and brackets are used for fastening them. The semi diagrammatic representation of such a single unit and the lay out of a farm, with 32 such raft units is shown in Fig. 4.3.3.2.1. For floats, plastic drums of 200 l capacity are used. The number of floats is so adjusted that there is atleast 70% of replacement of water, thus 400 drums for the present farm. The caps of the drums are sealed off with bitumen or fibreglass sealant and the drums as well as the logs are painted with antifouling paint before assembling.

Net cages in Singapore are made of synthetic fibres such as polyamide (PA) and polyethylene (PE). The latter is cheaper, with a higher breaking strength and abrasion resistance than the former. Depen-

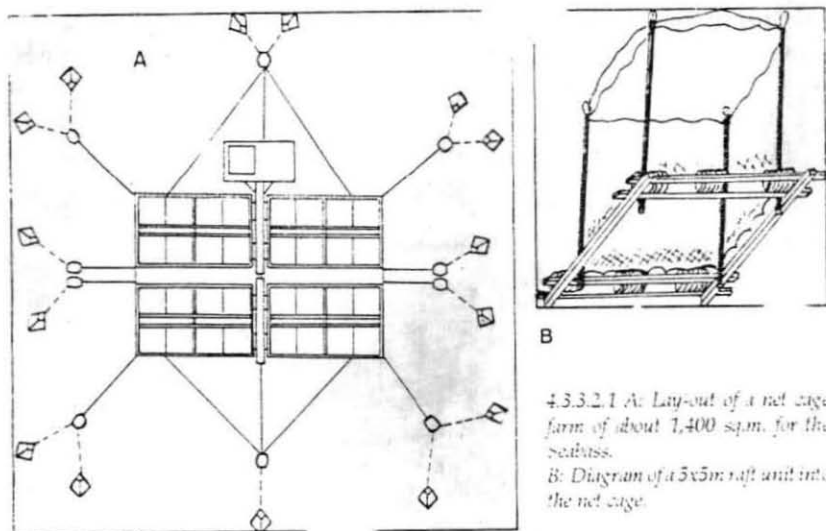

4.3.3.2.1 A: Lay-out of a net cage farm of about 1,400 sqm. for the seabass.

B: Diagram of a 5x5m raft unit into the net cage.

ding upon the sizes of Seabass stocked, three kinds of cages are used in intensive culture, viz, Hapa, Nursery and Production cages. The first two are smaller than the third measuring from 2 m L x 2 m W x 2 m H to 5x5 x 2-3 m H. The hapa are made of knotless netting, while the nursery and production cages are of knotted material. Mesh size of the hapa range from 7 to 10 m.m. and nurseries from 9 to 25 mm, depending upon the size of the fish to be stocked. Production net cages vary from 3-5 m L x 3-5 m W x 2-3 m H, with mesh sizes

of 25 to 50 mm. They are either rectangular or square in shape. For setting up a net cage, it is lowered in water within its raft frame, the main line is secured tightly to each corner of the raft and each bottom corner is fastened to the lower end of a pipe (Fig. 4.3.3.2.1). Photograph of part of a farm constructed is shown in fig. 4.3.3.2.2.

Farming practices

Fingerlings of 7 to 10 cm TL are stocked in hapa, in the range of 100-150/m² and reared for about a month, till they attain the size of 12-15 cm TL. (80-100g.) After 2 to 3 months, the stock measuring 15-20 cm TL and weighing about 200 - 250 g is transferred from the Nursery cages in which the stocking density is 45-50/m² into the production cages at a stocking density of 40/m². In about 3 to 5 months time from stocking in the production cages, the fishes grow to the marketable size of 30-40 cm TL and weight of 600-800g. In cages

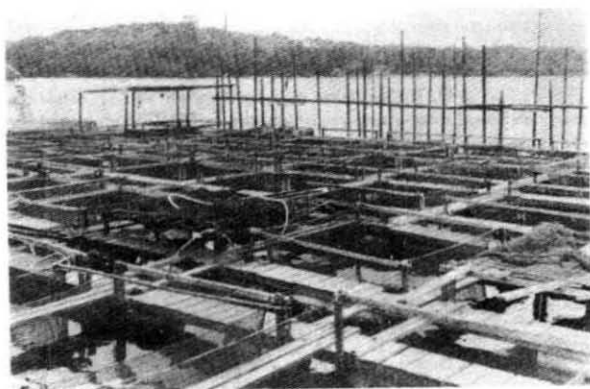

Fig. 4.3.3.2.2 View of part of a commercial net cage culture farm for the Seabass.

the fingerlings are supplied with chopped pieces of trash fishes (about 0.3 to 0.7 cm in size in the case of hapa, 1 cm in nursery cages and up to 2.5 cm in production cages). The rate of feeding in hapa and nurseries is 10% of body weight (BW) whereas fishes of 500 g or more require only about 3% BW. Feeding is done once or twice

in a day, usually in the morning and /or towards the evening at slack tides, to prevent food particles from being washed off. The Food conversion ratio is 4.5:1. In some farms pelleted food made of fish meal, meat meal, soybean/coconut meal, fish oil, vitamin and minerals with 70% protein, 3% fat, 20% binder , 5% micronutrients and 2% antibiotics has been under experimentation. The survival from the hapa stage till harvesting in the production cages is 90-95%.

Maintenance of farms

Marine fouling is the main problem encountered and hence proper maintenance of the net cages, floats and ropes is required. The fouling organisms are mostly barnacles, tunicates and algae, rapid fouling being observed in areas of low tides. Since fouling reduces water circulation and add to the weight of the farm structures, the net cages, floats and ropes are changed once in two or three months, depending upon the intensity of fouling. The fouling organisms are scrapped off and the structures can be used again and again. With such maintenance of the farm structures, their life span has been observed to go up to minimum of five years.

Diseases and therapy

At Singapore, two diseases are found to affect the cultured Seabass; (a) Loss of scales and skin of the head due to infection by the protozoan, *Cryptocaryon irritans* ; and (b) Vibriosis, leading to inflammation and haemorrhage of the affected area. The former is cured by keeping the fish in 220 ppm of formalin for half an hour to one hour. Vibriosis at the early stages can be treated by administering antibiotics such as Sulphonamide or Oxyteracycline for seven days at a rate of 0.5 g/kg of food or even Chloromphenicol at a rate of 0.2g/ kg for four days.

4.4 Harvesting and Marketing

For harvesting, the net cages are hauled up and the fishes are caught by using large scoop nets. A production cage of 5 mL x 5 mW x 3mH has been yielding 600 kg, after 6 to 7 months of culture. A raft unit of 32 such cages, occupying an area of 5000 m² has been yielding 19.2 tonnes per harvest and 38.4t/year. The Seabass is mostly consumed in the fresh condition. When it has to be transported, it is iced and/or frozen and loaded in refrigerated trucks for taking to interior markets.

4.5 Economics

Apart from the traditional practices of harvesting the Seabass from the bheries in West Bengal, resulting from natural stocking, experimental culture of this fish has not been undertaken in India so far, in order to estimate the economics. However, the economics of the net cage farming in Singapore was observed during 1986, as presented below :-

The capital cost of construction of 32 units and a hut was approximately S\$ 60,000 (about Rs.3.2 lakhs). Of this, about 80% of the expenses was on wood, metal, resins, paint, drums and float and 20% was on anchorage. Nursery and production netcage of 5x5x3m had cost \$ 223 and S\$120 respectively. With proper maintenance, the farm had a minimum of 5 years life. In addition to the farm, a boat for transportation, water pumps, a freezer and a few fiberglass tanks were also needed. The recurring expenditure involved the cost of seed at S\$ 2 to 3 per seed for about 1,100 seeds for a nursery unit of 5x5x3m, taking into account 5-10% mortality. Cost of trash fish for feeding ranged from S\$ 0.20 to 0.55/kg. A farm of 5,000m² area had needed four workers including a Supervisor. Miscellaneous expenditures included fuel for boat, maintenance of netcages, paint, bolts and nuts, etc. The total cost is rounded off to S\$ 80,000.

After taking into account the various expense, the cumulative net profit (as in 1986) at the end of first year was nil; second year it was S\$ 41,000/- (Rs. 2.19 lakhs); third year S\$ 1,28,000/- (Rs.6.83 lakhs) fourth year S\$ 2,17,000/- (Rs. 11.57 lakhs) and fifth year S\$ 3,06,000/- (Rs. 16.32 lakhs).

4.6 Prospects

At present in India, the marine finfish species receiving priority attention for experimental culture and breeding in marine sector are the Milkfish *Chanos chanos*, the mullets, (*Mugil cephalus*, *Liza macrolepies*, *Liza* spp and the related ones), *Siganus*, *Etroplus* and the like. Although the Seabass is available in India and is esteemed much more than any of the fishes indicated above, adequate attention has not been paid so far on its propagation and culture, except efforts by the Central Marine Fisheries Research Institute and survey of the seeds and culture by All India Co-ordinated Project on Brackishwater Prawn and Fish Farming during the seventies. That this species could be

successfully bred and cultured in Thailand, Singapore, Taiwan and Philippines lead one to ponder as to why it cannot be bred and cultured in India also. With knowledge on the induced breeding technique available, it is possible to develop induced breeding and seed production in India also. Hence, it is high time now that the Seabass is brought into the list of priority species in the marine sector in India, for breeding and culture. Besides, research projects, preferably pilot ones, on this aspect may also be included in the priority areas of brackish water sector. Since there are good market for the seeds of the Seabass in Philippines and Singapore, it will be possible to export the seeds and to earn foreign exchange for the country. It is worthwhile in this regard for agencies like the Marine Products Export Development Authority to initiate seed production of the Seabass for export.

OTHER FIN FISHES

Other fin fishes suitable for coastal aquaculture are the Groupers (Epinephelidae), the Snappers (Lutjanidae), the Sea breams (Sparidae), the Rabbit fishes (Siganidae) and Sand Whittings (Sillaginidae).

5.1 The Groupers

The Groupers *Epinephelus tauvina* and *E. malabaricus* (See plate Fig.2) of the Family Serranidae have a robust, some what compressed, oval-oblong and elongated body. Body depth is about 3.5 and 3.0 - 3.6 times in standard length respectively. There are 11 spines and 14 to 16 soft rays in the dorsal fin and 18-20 rays in the pectoral fin. A large blackish blotch is present at the base of the last four dorsal spines extending on to the lower part of the fin in *E. tauvina* but absent in *E. malabaricus*, which possesses about five, more or less distinct and slightly oblique, irregular bars on the body. Also in *E. malabaricus* three dark blotches are present on the interopercle. The head and body are greyish, covered with small, dull, orange-red to dark brown spots. They grow to 50-65 cm and to 100 cm respectively. Recent production of groupers by culture are : Thailand : 450 t; Hong Kong : 365t; Singapore : 153t; Malaysia : 143 t.

The Groupers are suitable for culture in net cages, as well as in ponds receiving tidal flow of sea water. Limited success has been achieved in Taiwan on seed production and culture of *E. malabaricus*. The males were injected with Human Chorionic Gonadotropin for stripping and the females were induced to ovulate by hypophysation

Of about 0.2 million eggs spawned, 28% were fertilized and about 69% have hatched giving rise to 38,400 fry. The postlarvae were fed with oyster trochophore larve and later with rotifers, nauplii of the brine shrimp and mysids. In about a month's time these have reached about 1 to 1.5 cm in length and in 3 month's about 8 cm, with an average survival of 14%.

These fingerlings are at first stocked in small concrete ponds of 100 m² with 1 m depth at a rate of 100/m² and are fed with frozen *Gambusia*. Once these reach about 12 cm, these are stocked into production ponds of about 0.2 to 0.3 ha. each, at a density of 40,000/ ha. Under optimum management conditions, the fingerlings grow to 30 cm (600-800 gm) in another 8 months, with 80-90% survival and yielding more than 20t/ha produciton. Feeding is with fresh trash fish.

The methods of culture of the Groupers in net cages are the same as those practised for the Seabass (Vide Chapter 4). In Taiwan, earthen ponds are also used for culture. The production ponds must have vertical concrete dikes, with about 2 m water depth and should have aerators for efficient oxygenation. The water should be crystal clear, have a salinity of 33‰ and a temperature of 16-32° C. If filamentous green algae grow, these should be removed regularly. Also, provisions will have to be made for daily removal of debris and excreta accumulating at the bottom. Under such efficient management procedures (including water quality), there is every possibility of developing Groupe culture on a commercial scale in India also. Based on a 5x5x2 m fixed netcage experimental culture of *E. tauvina* at Mandapam, it has been recently reported that a net income of Rs. 2,193/- can be realised, within a period of 11 months.

5.2 The Red Snapper

The Golden Snapper or Red snapper *Lutjanus johni* is cultured in Malaysia and Singapore. It has a moderately deep body with a straight or slightly convex head profile (See plate Fig.3). The dorsal fin has 10 spines and 3 or 14 soft rays. Longitudinal scales above the lateral line are parallel to it and those below the lateral line are horizontal. The body has a reddish or bronze - silvery colour with a dark spot on each scale, forming a series of dark streaks in the body. A large black blotch may be present above the lateral line

in the junction between spinuous and soft parts of the dorsal. The fish grows to a maximum of about 70 cm; but the common size are 40-60 cm in length. It feeds on bottom living invertebrates and fishes; and inhabits shallow waters and mangrove areas besides the sea upto a depth of about 80m. The recent production from culture are : Malaysia : 120t; Singapore : 61t. The Red snapper is cultured in net cages in the sea; and the methods of its culture are the same as those practiced for the Seabass (Vide Chapter 4).

5.3 The Rabbit fishes

The Rabbit fishes belong to the Family Siganidae and are cultured in certain areas at present' but have high potentials for

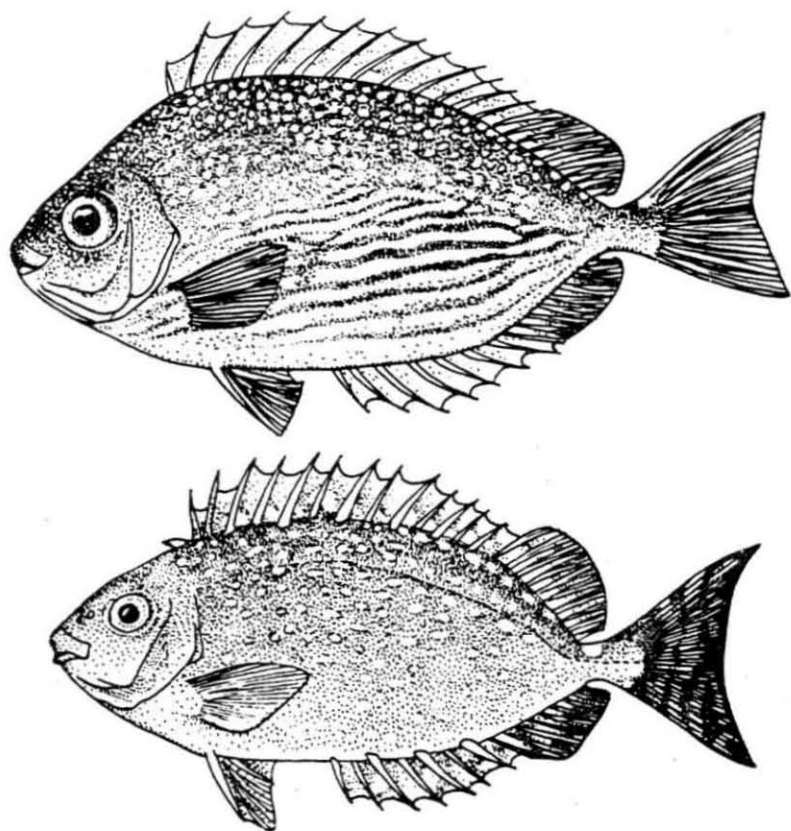

Fig. 5.3. Line drawings of the two species of Rabbit fishes. Upper one *Siganus Javus*; lower one : *S. Canaliculatus*

commercial culture because of high prices in the markets of countries like Singapore, Malaysia, Indonesia, etc. These do not grow more than about 35 cm in length but are relished in South-East Asia as a symbol of good fortune and are sought after during such auspicious periods as the Chinese New Year.

In India, *Siganus Javus*, *S. Canaliculatus* (Fig. 5.3) *S. Lineatus* and *S. vermiculatus* are the most important species. They have a laterally compressed, oval body covered with small scales. Mouth is small, dorsal fin has 13 strong spines and 10 soft rays, preceded by a forward-projecting spine. The pelvic fins have 2 strong spines, separated by 3 soft rays, a unique character. The spines are mildly venomous. Many species associated with corals are brightly coloured. The others are dark and mottled with brown at death. The common sizes are 20-25cm, although they reach upto 45 cm in length. In nature they are found in coral reef areas, mangrove swamps and shallow lagoons. They are able to tolerate a wide range of salinity (17-37 ppt) and some species can be acclimatised to a much lower salinity of 5 ppt. They grow well in temperatures between 23 and 36° C; and are sensitive and are sensitive to low oxygen value below 2 ppm and pH above 9. The juveniles and adults are primarily herbivorous, feeding upon different kinds of benthic algae. Under captivity, they become omnivorous, feeding upon a variety of food of both vegetable and animal origin, including feed pellets.

The seeds are usually collected from the wild, such as reef flat areas by scoop nets, dip nets, seine nets, etc at season. In the recent past some amount of success has been achieved in the induced breeding of a few species. *S. canaliculatus* has been reported to spawn by the end of 9 months in the Red sea from April to August, under the influence of lunar cycle, about 4-7 days after the new moon. The number of eggs spawned is estimated as 3,00,000 - 4,00,000. In Palau, sudden transfer of mature fish from a tank of 90 cm water depth to a shallow tank of only about 20 cm depth has resulted in immediate spawning of *S. canaliculatus*. It has also been induced to breed by injecting Human Chorionic Gonadotropin. The larvae have been fed with a mixture of phytoplankton, rotifers, copepods and the larvae of *Artemia*.

Traditionally, the Rabbit fishes are cultured in brackishwater ponds as in Philippines and embanked lagoons as in Mauritius. In Malaysia, Singapore, Guam, etc. experimental culture has been attempted in floating net cages, pens, ponds and raceway systems. In coastal ponds at Philippines, *Siganus vermiculatus* and *S. canaliculatus* have

been reported to attain the marketable size of 150 gm within 5-7 months. Two-fold increases in the length and ten fold increases in weight over 5 weeks have been reported in the fry fed with algae, fish feed pellets, etc. Formulated feed containing Soya meal, fish meal, maize and vitamin-mineral mix has also resulted in good growth. In Palau, *canaliculatus* cultured in floating has grown faster in areas with good water circulation and fed with trout chow than that fed with algae only.

In India also there are good prospects for developing their breeding and culture on a commercially viable basis if similar attempts are made.

5.4 The Seabreams

The Seabreams (See plate Fig.4) belong to the Family Sparidae. They have an oblong and more or less deep and compressed body. The head is large with a steep or straight upper profile, the snout is scaleless but the cheeks are scaly and the preopercle is without spines or serrations on the margin. The spines on the dorsal, anal and pelvic fins are strong, the dorsal with 10-13 spines. Their colour varies from pinkish or reddish to yellowish or greyish, often with silvery or golden reflections and dark coloured spots, stripes or bars.

Among the various species, the black bream *Acanthopagrus berda*, the yellow bream *A. latus*, *A. bifasciatus*, *Argyrops spinifer*, the Gold lined bream *Rhabdosargus sarba*, etc are important. In *A. berda* and *A. bifasciatus*, the upper profile is straight; in *A. latus* a prominent bugle is present at the eye and in *A. spinifer* the profile is rather stright. In *R. sarba* each scale has a golden centre so as to form longitudinal lines on the body; in *A. bifasciatus* two vertical black bars are present across the head; and in *A. latus* a diffuse dark blotch is present at the origin of lateral line and a dark interorbital band along the opercle. These fishes are bottom-living in habit found on rough and muddy sand grounds in coastal waters, estuaries, bays etc, and are culturable in such localities. They feed on a wide variety of benthic organisms such as worms, molluscs, crustaceans, echinoderms, etc and grow to 45-65 cm in length with the common sizes between 40-55 cm.

Some of these fishes like *A. berda*, *A. Latus* and *R. sarba* have been made to spawn in induced breeding experiments in Taiwan, thus opening up the possibilities for their hatchery seed production and commercial culture in other parts of Southern Asia as well. In Penghu area of Taiwan, net cages similar to the ones used for the Seabass

have been used in the culture of *A. latus*, fed with trash fish diet. Fingerlings of 5-6 cm have been observed to grow to a market size of about 600 gm in 12 months, with upto 90% survival.

In the Mediterranean and nearby countries, the Gilt head bream (*Sparus aurata*) and in Japan the Red breams (*Pagrus major*) have been farmed, the former mostly in coastal impoundments ("Vallis") and the latter in floating net cages. In the case of (*S. aurata*, seeds from natural resources is considered to be the best source because hatchery production has yielded only 16% survival at the stocking condition. Regarding *P. major*, success has been achieved in induced breeding and seed production. In net cages, the seeds of *P. major* are fed on frozen fishes like anchovies and grown to marketable condition in about 12-18 months. The fry and fingerlings are also released in the sea after acclimatisation, in order to enhance the natural population, as a sea ranching exercise.

The Indian Sea breams is one of the important culturable groups of fin fishes, which demand urgent attention in India for induced breeding, seed production and commercial culture in net cages. With the success achieved in Taiwan and other Asian countries on some of the very same species, it is essential to implement research and development projects in India also for breeding and culture of the native species.

5.5 The Sand Whittings

Among the species of Sand Whittings (Family Sillaginidae) available in Indian waters, *Sillago sihama*, *S. chandropus* and *S. vincent* (Fig. 5.5) inhabiting shallow coastal waters, bays, estuaries, etc are important ones for culture. They have an elongate, slightly compressed body tapering from the middle of spinuous dorsal to the head and tail. Two separate dorsal fins are present, the first with 9-12 slender spines. The lateral line is slightly arched. They are silvery grey or whitish in colour, medium in size, growing to less than 50 cm in length and are good food fishes.

The seeds of *S. sihama* are available in good quantities along both the south east and south - west coasts and a few experiments were undertaken on its induced breeding at Mangalore which gave encouraging results. However, success is yet to be achieved on this aspect and on seed production.

Although a few experiments have been carried out on the culture of this fish at Mangalore and Mandapam, serious efforts to develop a culture technology do not seem to have been implemented.

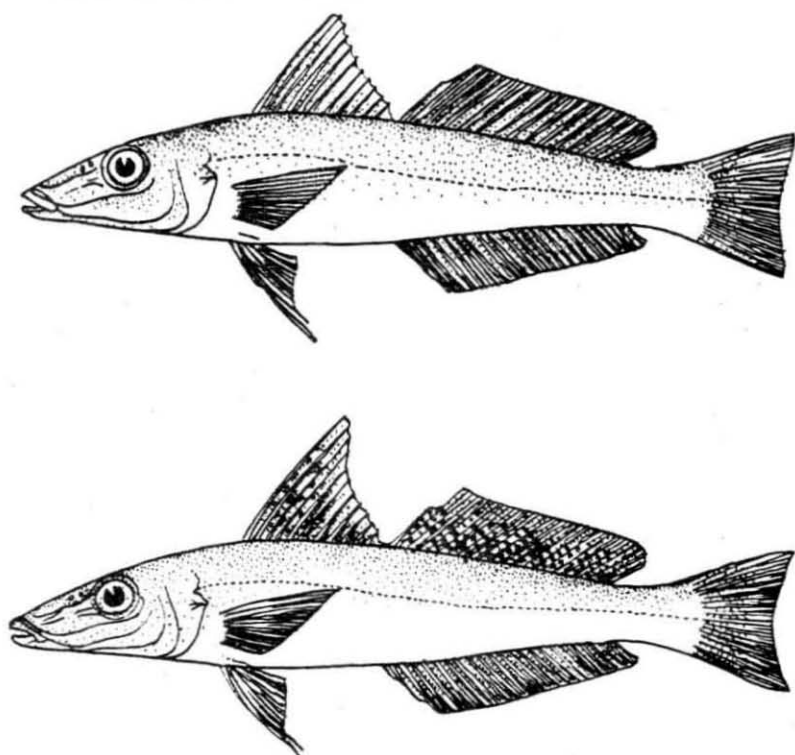

Fig. 5.5. Line drawings of the two species of Sand whittings. Upper one: *Sillago sihama*; Lower one, *S. Vincenti*.

With the vast potential available for its commercial culture, earnest efforts are needed to develop techniques for its seed production and commercial culture.

Fig. 5.1 The Groupers, a group suitable for culture in net cages

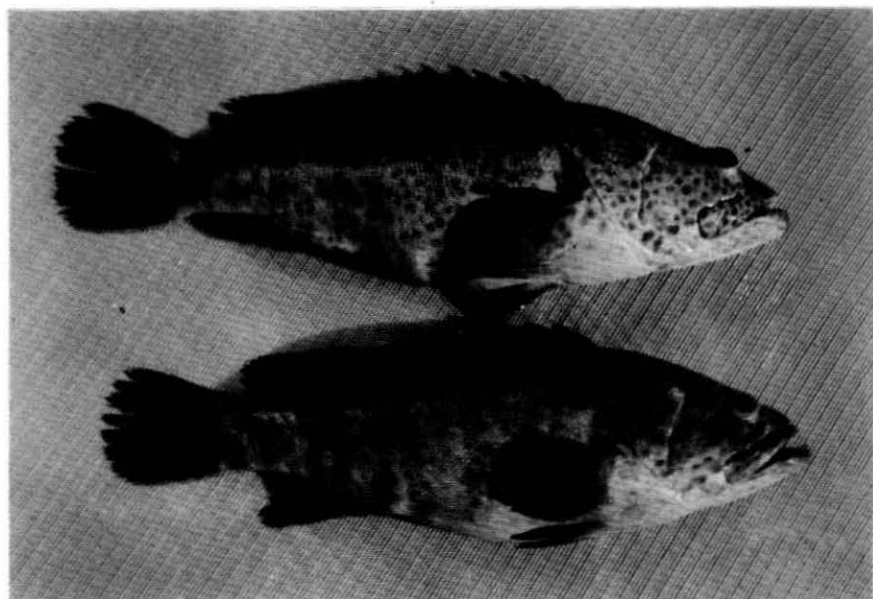

Fig. 5.2 The Red snapper, another valuable fish for culture in net cages

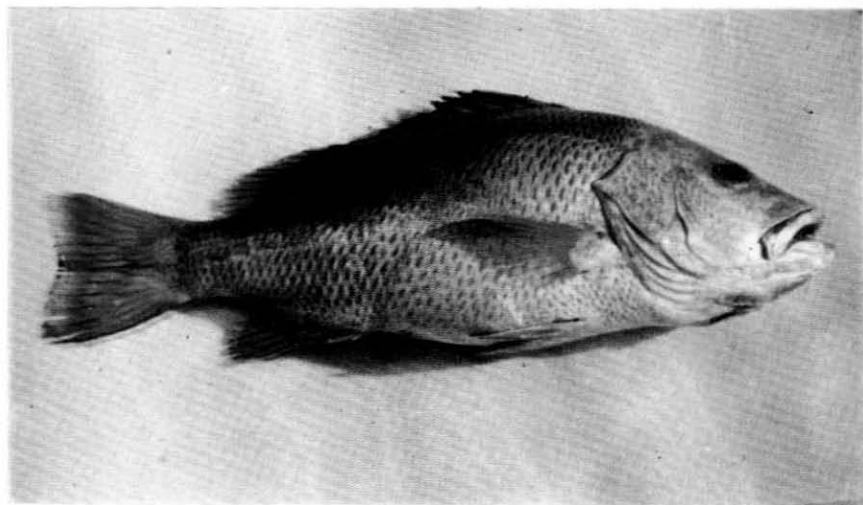
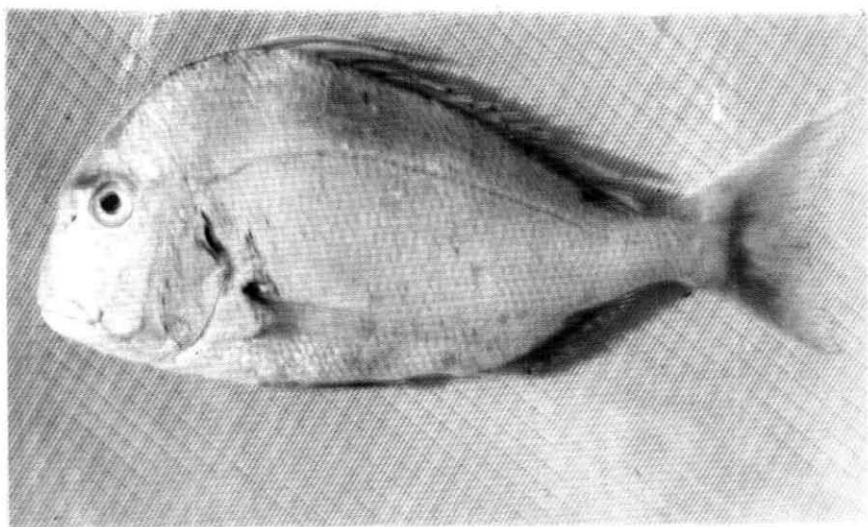

Fig. 5.4 A Sea bream, ideal for culture in net cages



PART II
OCEANIC CAGE CULTURE

G. Santhana Krishnan
*The Marine Products Exports
Development Authority, Kochi - 36*

P. Vasudevan
*Lakshadweep Shilpi Aquaculture Ltd.
Kochi - 24*

OCEANIC CAGE CULTURE FOR SEA BASS AND SEA BREAM IN ANDAMAN WATERS - TECHNO - ECONOMIC OUTLINE

1. General

In recent years there has been rapid expansion in ocean based farms for culturing marine fish. Fish farming has moved from land based farms to quite, sheltered areas and lagoons. Later due to paucity of land locations and possibility of pollution in lagoons and similar sites, off shore farming of marine fish has become very popular.

Since fish is allowed to grow in their natural environment, offshore fishing, provides better quality fish with low mortality, higher growth and causes lesser pollution.

MPEDA could provide required information on the availability of necessary farming technology.

2. Market Potential

European Sea bass (*Dicentrarchus labrax*) and Gilthead Sea bream (*Sparus aurata*) enjoy a high and sustained demand in southern Europe.

In French and Italian markets, on an average, European Sea bass is 15% costlier than Gilthead Sea bream. In Spain and Greece prices are almost the same.

There is substantial gap between supply and demand for European Sea bass and Gilthead Sea bream in Mediterranean countries. This trend is expected to continue for many years as improvement in marine landings is not expected due to overfishing, pollution and natural low survival rate of the species under reference. At present the rate of increase in demand is more than that of production. According to estimates, Mediterranean area consisting of Spain, France, Italy, Greece, Tunisia, Morocco, etc. requires about 42,000 Mt of these fish

SEA FISHES

species annually. By year 2000, 60% of total demand is expected to be met by farmed fish.

Depletion of marine catch due to over fishing, pollution of

Quantity produced in Mediteranian area (Mt)

| Country | 1985 | 1989 | 1992 |
|------------|------|-------|-------|
| Cyprus | - | 80 | 200 |
| Egypt | 1350 | 1800 | 230 |
| France | 175 | 400 | 1000 |
| Greece | 432 | 1450 | 2300 |
| Italy | 2700 | 4450 | 6200 |
| Morocco | - | 300 | 900 |
| Portugal | 252 | 660 | 1050 |
| Spain | 856 | 1850 | 3850 |
| Tunisia | 670 | 1040 | 2200 |
| Turkey | 835 | 1100 | 1800 |
| Yugoslavia | 140 | 310 | 700 |
| Total | 7410 | 13440 | 22500 |

Average prices of European Sea bass (US \$ kg)

| Country | Spain | | | Italy | | | France | | |
|---------|-------|----|----|-------|----|----|--------|----|----|
| Year | 88 | 90 | 92 | 88 | 90 | 92 | 88 | 90 | 92 |
| Average | 18 | 23 | 19 | 20 | 21 | 19 | 20 | 22 | 20 |

ocean waters, industrial effluent, human waste and natural low survival rate in sea, keep the amount of marine catch almost stagnant. This keep price for fish on a higher level, providing excellent scope to serious fish farmers.

Following are some of the other important commercial varieties of fish that can be farmed in deep sea cages.

Greater Amberjack (*Seriola dumerili*)
Dolphin Fish (*Coryphaena hippurus*)
Common Dentex (*Dentex dentex*)
Sharpsnout Sea Bream (*Diplodus puntazzo*)
Giant Sea Perch (*Lates calcarifer*)

3. Technical feasibility

3.1 Farming methods

Frys of European Sea Bass (*Dicentrarchus labrax*) and Gilthead Sea Bream (*Sparus aurata*) will be imported from Europe for the initial period. Frys, weighing 0.5 gms, conditioned for tropical areas will be received in a land based nursery located near the offshore farm location. Frys at this stage are capable of taking pellatised feed. In a period of 4 months, they grow to 50 gms.

Water depth, proximity of land, infrastructure available, turbidity, current speed, wave pattern, wind pattern, pollution etc. are some of the major parameters that determine suitability of the location. Deep sea cages will be moored at a selected site. Fingerlings from nursery are transferred to deep sea cages for on growing. With artificial feed, they grow from 50 cms to 450 gms, within a period of 6 to 7 months, depending on the location selected.

Inorder to empty stomach contents and to improve the meat, fish is subjected to starvation diet for a certain number of days before it is harvested. Depending on size and quantity of fish, harvesting takes 30 to 45 days. Live fish is plunged into iced water, packed in sealed plastic bags and are despatched by air in insulated boxes filled with wet ice. Fish should reach markets within 48 hours after harvesting.

3.2. Technical know-how

Information on availability & technical knowhow for farming can be provided by MPEDA

3.3. Plant & Equipment

Nursery equipment, deep sea cages, supply boat, feeder, etc. are some of the main plant that are required in an offshore farm

project. Various equipment chosen have to withstand sea conditions at location selected. The exact specifications of plant and equipment can be formulated only after a micro survey of the exact location is conducted.

3.4 Raw material and other inputs

Main inputs are fry and fish feed. Both of these are to be imported in the initial stages. Modern feed mills with Japanese know-how are already licenced in India. One of them has started operation near Cochin. Required fish feed is expected to be available locally by 1994. A hatchery for marine fish fry and fingerlings are planned to commence production by the end of 1994. Connected load will be 120 Kw.

3.5 Manpower requirement

The project will require 34 personnel for technical and administrative work.

3.6 Project implementation

Subject to fry deliveries, harvest from a new farm can be taken within 12 months from the date of placing orders for fry and necessary plant and equipment.

4. Financial feasibility

4.1. Capacity & Turnover

Offshore farm will have an annual capacity of about 700Mt of European, Sea Bass and /or Gilthead Sea Bream. During third year of operation rated capacity will be attained with an estimated turnover of Rs. 21.70 crores.

4.2. Capital cost of project

Following cost estimation is worked out. Final project cost can be calculated only after major parameters like, location, water quality, wave and wind pattern, various types of equipment, mode of transportation, etc. are determined after a micro survey of the location.

(Lakh)

| | |
|--|------------|
| Cost of land & it's development | Rs. 3.00 |
| Cost of civil construction | Rs. 32.00 |
| Cost of plant and machinery : Imported | Rs. 390.00 |

| | | |
|--------------------------------|------------|---------------|
| Indigenous | Rs. | 54.00 |
| Electrical installation | Rs. | 7.50 |
| Farming technology | Rs. | 42.50 |
| Misc. Fixed assets | Rs. | 12.00 |
| Preliminary & pre-op. expenses | Rs. | 32.00 |
| Contingency | Rs. | 22.00 |
| <i>Total project cost</i> | Rs. | 595.00 |
| <i>Working capital margin</i> | Rs. | 125.00 |
| Total capital cost | Rs. | 725.00 |

4.3. Estimated cost of production

The initial production will be European Sea Bass. Two harvests are envisaged during the first year. From the second year the average production will be about 700 Mt from three harvests.

Average FOB price of the fish is considered at US \$ 10.00/Kg packed in special boxes and delivered at nearest international airport in India.

| Year of production | 1 | 2 | 3 | 4 | 5 |
|---------------------------------|-------|-------|-------|-------|-------|
| Harvest/year | 2 | 3 | 3 | 3 | 3 |
| Production MT | 400 | 600 | 700 | 700 | 700 |
| Sales (Rs. Crores) | 12.40 | 18.60 | 21.70 | 21.70 | 21.70 |
| Production cost (Rs. Crores) | 11.65 | 15.62 | 17.06 | 16.02 | 15.69 |
| Surplus (Rs. Crores) | 0.75 | 2.98 | 4.74 | 5.68 | 6.01 |