

# **Proceedings of the Second Workshop on Scientific Results of *FORV Sagar Sampada***

Editors

*V.K. Pillai*  
*S.A.H. Abidi*  
*V. Ravindran*  
*K.K. Balachandran*  
*Vikram V. Agadi*



**Department of Ocean Development  
Government of India  
New Delhi  
1996**

© 1996, Department of Ocean Development

Department of Ocean Development (DOD)  
Government of India  
Mahasagar Bhavan, Block No-12  
C.G.O. Complex, Lodi Road  
New Delhi-110 003  
India

ISBN : 81-900656-0-2

### **Citation Styles**

#### *For entire volume*

Pillai, V.K. Abidi, S.A.H., Ravindran, V., Balachandran, K.K. & Agadi, V.V. (Eds.) 1996. *Proceedings of the Second Workshop on Scientific Results of FORV Sagar Sampada*, (Department of Ocean Development, New Delhi), pp. 564.

#### *For individual article*

Goswamy, S.C. & Shrivastava, Y. 1996. Zooplankton standing stock, community structure and diversity in the northern Arabian Sea, In: *Proceedings of the Second Workshop on Scientific Results of FORV Sagar Sampada*, edited by V.K. Pillai, S.A.H. Abidi, V. Ravindran, K. K. Balachandran & V.V. Agadi, (Department of Ocean Development, New Delhi), pp. 127-137.

---

### **Designed and Printed by:**

Publications & Information Directorate  
Council of Scientific & Industrial Research  
Pusa Campus, New Delhi-110 012  
India

## FOREWORD

Since inception in 1984, the *Fisheries and Oceanographic Research Vessel Sagar Sampada*, with sophisticated modern facilities onboard, has undertaken more than 140 cruises all over the Indian Ocean primarily in our Exclusive Economic Zone for fishery and oceanographic survey. Scientists from many institutions have made use of this facility to explore the resource potential in our sea and to understand its correlation with the environmental parameters. These survey and exploration efforts are continuing.

This volume contains many papers which are the outcome of research work carried out onboard '*Sagar Sampada*' during last five years (1989-1993) and presented in a Workshop to evaluate the scientific work. About 60 papers, included in this volume, bring out the results pertaining to environmental assessment, hydrology, productivity estimates, fishery resources availability, fishing technology, pollution monitoring etc. These relate mainly to the Arabian Sea, Bay of Bengal and Lakshadweep, Andaman and Nicobar Islands groups in the EEZ of India. These efforts along with other mission-oriented cruises have yielded valuable information on the fishery resources and their distribution in space and time.

I am sure that the continued efforts of our scientists and researchers and the use of sophisticated facilities onboard *Sagar Sampada* will enhance our understanding of the fisheries resource potential, and its sustained exploitation for the socio-economic benefits of our society.

A.E. Muthunayagam  
Secretary

Department of Ocean Development  
Mahasagar Bhavan  
New Delhi-110 003

New Delhi  
11 June 1996

## PREFACE

**Fishery and Oceanographic Research Vessel (FORV) Sagar Sampada** was acquired by the Department of Ocean Development in December 1984 with the objective of assessment of the living resources in the EEZ of India. With the association of many institutions, mainly CMFRI, CIFT, FSI, etc. **FORV Sagar Sampada** ventured into our waters in January 1985 and the studies are being continued to date, making more than 140 cruises of multi-disciplinary character. With all the modern facilities onboard, variety of studies/observations were made all these years. Achievements of the voyages during 1985-89 were discussed at a Workshop held at Cochin and brought out as a publication entitled '**Proceedings of the First Workshop on Scientific Results of FORV Sagar Sampada**' by CMFRI, Cochin.

Similarly, achievements of the mission oriented cruises during next five years (1989-93) were discussed at the Second Workshop, held during 15-17 February 1994 at Cochin. The Second Workshop highlights the additional information obtained on the fishery resources in relation to environmental factors. A variety of papers were discussed in the Workshop and the present volume is continuation of the earlier publication as '**Proceedings of the Second Workshop on Scientific Results of FORV Sagar Sampada**'. About 60 papers included in this volume present results on physical oceanography (waves, currents, mixing processes etc.), microbiology, hydrology, productivity, plankton distribution and fishery resources (finfish, catfish, carangids, perches, ribbonfish, squids, etc.), trawling methods, gear technology, resources processing and utility, pollution monitoring etc. The above studies indicate the availability of rich resources in the Arabian Sea, Bay of Bengal and around the islands' groups in EEZ of India.

Many people helped particularly from CMFRI, Cochin and CIFT, Cochin to make the Workshop a success and PID [CSIR], New Delhi to bring out this Proceedings in good shape.

V.K. Pillai  
S.A.H. Abidi  
V. Ravindranathan  
K.K. Balachandran  
Vikram V. Agadi

New Delhi  
Date: 11 June 1996

## CONTENTS

Studies of fisheries with the causative environmental factors-optimum utilisation of <i>FORV Sagar Sampada's</i> capabilities A.V.S. Murty	1
Short term variability of ocean responses at the outer shelf off Cochin under a heating regime M.G.Joseph, P.Madhusoodanan & V.V. James	7
Premonsoon current structure in the shelf waters off Cochin C.V.K. Prasada Rao, P.V. Hareesh Kumar & N. Mohan Kumar	19
Intradiurnal variability in thermohaline responses of the shelf waters to atmospheric forcing off Cochin during April 1991 M.G. Joseph & P.Madhusoodanan	25
Upper layer variability off Cochin during pre-onset period of summer monsoon 1992 P.V. Hareesh Kumar & N. Mohan Kumar	33
Confirmatory checks for the internal waves in the coastal waters off Cochin P. G. K. Murthy & N. Mohan Kumar	39
Some aspects of internal waves in the coastal waters off Cochin P.G.K. Murthy & V.V. James	47
Waves groups and spectra in a coastal regime Rao Tatavarti, P.N. Ananth & C.V.K. Prasada Rao	57
Mixing processes and internal wave dynamics on the continental shelf off Cochin R. Tatavarti, N. Mohan Kumar & P.V. Hareesh Kumar	65
Dial variations in temperature, salinity and dissolved oxygen from the neritic waters off Cochin during April (peak summer) G.S.D. Selvaraj, M.S. Rajagopalan & R. Anilkumar	75
Effect of oil spill on the microbial population in Andaman Sea around Nicobar Island Ranu Gupta	85

## *Contents*

Growth of marine yeast on different strength of stress solutes Ranu Gupta	91
Distribution of heterotrophic bacteria around Laccadive Islands V. Chandrika	97
Some observations on primary production and plankton biomass along the continental shelf and slope off the northeast coast of India during January 1989 G.S.D. Selvaraj & V. Srinivasan	103
Diurnal variations in the vertical distribution and abundance of zooplankton in the continental shelf waters off Cochin during April 1991 G.S.D. Selvaraj, K.J. Mathew & Molly Varghese	115
Zooplankton standing stock, community structure and diversity in the northern Arabian Sea S.C. Goswami & Y. Shrivastava	127
Spatial and temporal distribution of chaetognatha from the eastern Arabian Sea M. Srinivasan	139
Distribution and abundance of cladocerans in the eastern Arabian Sea T.S. Naomi, K.J. Mathew, Geetha Antony, T. V. Sathianandan & P.P. Pavithran	149
Studies of planktonic Ostracoda collected from Arabian Sea and Bay of Bengal K.J. Mathew, M. Vijayan, M.S. Rajagopalan & P.P. Pavithran	163
Distribution and abundance of zooplankton in the northern Arabian Sea with reference to oil spill in the Gulf waters K.J. Mathew & K. Solomon	175
Planktonic amphipod distribution in the deep scattering layer of the Exclusive Economic Zone of India S. Revikala	185
Composition of heteropods in the Andaman Sea P.N. Aravindakshan & Rosamma Stephen	193
Ostracods of Andaman Sea Rosamma Stephen & P.P. Meenakshikunjamma	197
Zooplankton standing stock off south of Great Nicobar Island during an oil spill incident and after T.C. Gopalakrishnan, K.K.Chandrasekharan Nair & V.N. Sankaranarayanan	205

## Contents

Pelagic tunicata from the seas around Andaman & Nicobar group of islands P. Dhandapani	217
Quantitative abundance of amphipods around Andaman-Nicobar Islands Molly Varghese, K.J. Mathew, T.S. Naomi, Geetha Antony & K. Solomon	229
Ichthyoplankton from Andaman and Nicobar seas C.B.Lalithambika Devi, Rosamma Stephen, P.N. Aravindakshan & P.P. Meenakshikunjamma	239
Medusae from the sea around Laccadive group of islands (7°-18°N/69° - 76° E) V.Santhakumari	249
Zooplankton abundance in the continental shelf waters of the northeast coast of India K.J. Mathew, K.N. Kurup, T.S. Naomi, Geetha Antony & K. Solomon	257
Distribution and abundance of the genus <i>Vinciguerria</i> (Gonostomatidae) in the DSL of Indian EEZ with a note on the biology of <i>Vinciguerria nimbaria</i> N.G. Menon, N.G.K. Pillai, R.Reghu & K. Balachandran	271
Distribution and abundance of elasmobranchs in the Indian EEZ Grace Mathew, P.Devadoss, E. Vivekanandan, M. Feroz Khan & P.U. Zacharia	285
Finfish resources in the north eastern region in the Indian EEZ N.G. Menon, N.G.K. Pillai, S. Lazarus & P. Nammalwar	295
Catfish resource in the Indian shelf waters N.G. Menon, K. Balachandran, S.G. Raje, P.U. Zachariah, M. Feroz Khan, Y. Appanna Sastry & P. Jayasankar	305
Distribution of finfish resources along southeast coast of India in relation to certain environmental parameters S. Sivakami, P. Marichamy, P. Livingston, G. Gopakumar, R. Thiagarajan, E. Vivekanandan, Kuber Vidyasagar, G.S. Daniel Selvaraj, S. Muthusamy, N.G.K. Pillai & M. Zafar Khan	315
Catch, abundance and some aspects of biology of deep sea fish in the southeastern Arabian Sea M. Feroz Khan, P.U. Zacharia, K. Nandakumaran, S. Mohan, M.R. Arputharaj, D. Nagaraja & P. Ramakrishnan	331

## Contents

Distribution and abundance of carangids along the EEZ India S. Sivakami, P.N. Radhakrishnan Nair, A.A. Jayaprakash, Mohammed Kasim, T.M. Yohannan, M. Sivadas, K.P. Said Koya & P.K. Seetha	347
Threadfin breams and lizard fish resources in the shelf waters of the Indian EEZ K.V.S. Nair, R. Reghu, K. Balachandran, N. Gopinatha Menon, S.K. Chakraborty, P.U. Zacharia, E. Vivekanandan, G. Mohanraj, V.S. Rengaswamy & S.G. Raju	363
Demersal finfish resources in certain areas of the EEZ of southwest and southeast coast of India P. Bensam, V.N. Bande, S. Sivakami, K.V.Somasekharan Nair, N. Gopinatha Menon, Grace Mathew, P. Devadoss, P.Nammalwar, P.U. Zacharia, M. Feroz Khan, P.Jayasankar G. Mohanraj, P. Livingston, V. Gandhi, A. Raju, S. Srinivasarangan, V. Rengaswami & S.G. Raju	375
Perch resources of the shelf waters in the EEZ of India Grace Mathew, G. Gopakumar, S. Lazarus, S.K. Chakraborty, P. Kaladharan, M. Firoz Khan, P. Jayasankar & K.M. Venugopal	387
Finfish resources around Andaman and Nicobar islands N.G.K. Pillai, N.G. Menon, R. Thiagarajan & A. Raju	399
Mesopelagic fishes from equatorial waters contiguous to Indian EEZ A.A. Jayaprakash	405
Distribution, abundance and biology of unicorn cod, <i>Bregmaceros mcclellandi</i> in the deep scattering layers of Indian Exclusive Economic Zone R. Reghu, K. Balachandran, N.G. Menon, E. Vivekanandan, S.K. Chakraborty & P. Devadoss	411
Hydrographic features off northeast coast and Andaman - Nicobar Islands in relation to demersal finfish resources P. Bensam, K.V.Somasekharan, Nair, A. Nandakumar, M.S. Rajagopalan & J. Narayanaswamy	419
Occurrence of ribbonfish in the Indian EEZ P. N. Radhakrishnan Nair, Alexander Kurian, C. Muthiah, S.Lazarus, R. Thiagarajan, M. Zaffar Khan & Prathibha Rohit	429
Oceanic squids- their distribution, abundance and potential in the EEZ of India and contiguous seas K.Prabhakaran Nair, M.M. Meiyappan, R. Sarvesan, Kuber Vidyasagar, G.Syda Rao, K. Sunilkumar Mohamed,	437



## Contents

P.K. Asokan, A.P. Lipton, K. Ramadoss, V.G. Surendranathan, D. Nagaraja & K. Jayabalan	
Cephalopod resources in southeast and northeast coasts of India and Andaman - Nicobar waters	445
V. Kripa, K. P. Nair, Kuber Vidyasagar, G. Syda Rao, A.P. Lipton, K.K. Appukuttan, P.V. Srinivasan, M.E. Rajapandian, P. Natarajan, K. Ramadoss, N. Burayya, K.T. Thomas, P. Achayya, M.M. Bhaskaran & Mathew Joseph	
Demersal resources off northwest coast of India	453
A. Anrose, L. Ramalingam, A.K. Bhargava, G. Nagarajan, V.V. Naik, Vijayanti Rane & M.A. Prabhu Arachi	
Fish biomass estimation by calibrating the echointegrator deflection against catch data	461
S. Natarajan, K.G. Girijavallabhan , A. Nandakumar & R.E. Benjamin	
Evaluation of sampling gear for demersal resource surveys	469
M.R. Boopendranath, P.A. Panicker, V.S. Kakati, S.G. Raje, G.K. Avhad, Paul Pandian, P. Sulaiman, & V.C. George	
Development and performance of a large mesh semipelagic trawl for offshore waters	477
P.George Mathai, V. Vijayan, M.D. Varghese & V.C. George	
Advantages of square mesh codend on the conservation of demersal fisheries in Indian EEZ	483
N.Subramonia Pillai, M.D. Varghese, M.Syed Abbas & H. Krishna Iyer	
Development and performance of 50 m high opening trawl	491
K.K. Kunjipalu, M.R. Boopendranath, P. George Mathai, M.D. Varghese, M. Syed Abbas, N. Subramonia Pillai & V.C. George	
Calibrations of hydro-acoustic instruments onboard <i>FORV Sagar Sampada</i>	499
S. Natarajan, Mohamed Kasim, & G. Gopakumar, V. Ravin- dranathan & A. Ramakrishnan	
Underwater acoustic instrumentation for investigating deep scattering layer	505
S. Natarajan, K.G. Girijavallabhan & M.S. Rajagopalan	
Modified atmosphere storage of fillets from sea bream <i>Argyrozona argyrozona</i>	513
T.K. Srinivasa Gopal, V.N. Nanbiar, K.V. Lalitha, Jose Joseph & P.V.Prabhu	

## Contents

Formation of histamine in Indian mackerel, <i>Rastrelliger kanagurta</i> and mackerel tuna <i>Euthynnus affinis</i> at ambient temperature $10^{\circ}\pm 1^{\circ}\text{C}$ and in ice P.K. Vijayan & K.K. Balachandran	521
Preservation of fish in ice and ice-seawater slurry Francis Thomas, T.S.G. Iyer & K.K. Balachandran	529
Chemical and taste panel evaluation of the mechanically separated flesh of six species of fish V. Muraleedharan, P.A. Perigreen & K. Gopakumar	535
Utilization of unconventional fish resources for surimi preparation V. Muraleedharan, K.P. Antony, P.A. Perigreen & K. Gopakumar	539
Onboard salting of deep-sea fishes and quality of the cured products K. George Joseph, P. Ravindranathan Nair, T.S.Unnikrishnan Nair & Cyriac Mathen	545
Recommendations	553
Subject Index	557
Author Index	561

## **Studies of fisheries with the causative environmental factors - optimum utilisation of *FORV Sagar Sampada*'s capabilities**

A. V.S. Murty\*

Science House, 58-Girinagar, Cochin-682 020

### **ABSTRACT**

Retaining the multidisciplinary character of research, *FORV Sagar Sampada* cruises got evolved into species-wise and sector-wise investigations to obtain complete cyclic pictures of species and sectors over seasons round the year for the EEZ waters of India. The paper aims at further transformation of the system of her cruises into problem-oriented investigations. Specific problems in pelagic fisheries of the waters around India are reasoned out for effective utilization of the unique sea-lab, the *FORV Sagar Sampada*. A rethinking is needed in planning and implementation of cruise programmes towards achieving realistic synthesis of studies of fisheries with the causative environmental factors.

### **INTRODUCTION**

Fisheries of various species and the physical, chemical and biological aspects of the waters around India, particularly off the west coast of India were thoroughly studied by conducting exploratory cruises of various vessels of different organisations from the dawn of independence of India. Valuminous information was added by multinational fleet of research vessels during the IIOE Programme during early sixties.

Indian fishery oceanography gained status in marine sciences ever since the introduction of *R. V. Varuna* in 1960s under the Indo-Norwegian Project. Later it had a considerable boost during FAO/UNDP/IFP programmes in 1970s along the west coast of India. The introduction of the fishery oceanographic vessel *FORV Sagar Sampada* in the Indian waters in the middle of 1980 with modern equipments, brought a dramatic change in the scenario of methodology of investigations at sea.

---

\*Present address: c/o Prof. C.Ayyanna, MIG -19, H.B. Colony, Visakhapatnam-530022.

Starting with multidisciplinary cruises extended to EEZ, the cruise programmes were reoriented to species-wise and sector-wise cruises to cover the EEZ waters in all the seasons of the year, both along east coast and west coast of India. The present workshop consolidates the additional knowledge obtained on the living resources and the concerned environmental factors from the mission-oriented research cruises undertaken by the vessel for the last 4-5 years (1989-'93). The present paper is a visionary into the near future programmes of the vessel by defining the problem-oriented cruises of the fully equipped *FORV Sagar Sampada*: the areas are envisaged where a synthesis could be achieved of the studies of pelagic fisheries with the largely causative factors of the aquatic environment aiming at rational utilisation of this unique sea-lab.

## SPECIFIC ASPECTS OF INVESTIGATIONS

It has been shown that large annual fluctuations in the pelagic fisheries of oil sardine, mackerel and tuna like fisheries are due to environmental factors only (George, 1970; Banerji, 1973). The cumulative knowledge of fisheries from Indian coasts clearly shows the behavioural pattern of fish schools of different categories off the coasts of India. And the behaviour of fish schools suggests the areas of specific scientific investigations to be carried out as a follow-up action.

### Oil sardines

In the past, oil sardine fishery was confined to the west coast of India concentrating the Kerala coast. In recent years, some schools of the species entered the conventional fishing grounds off the east coast of India. Ten years data of oil sardine catches (1975-'84) indicated that the catches crossed 1000 tonne mark off Tamil Nadu coast in 1984, whereas there were no recruits of the species in the fishing grounds of Andhra Pradesh (Dharmaraja *et al.* 1987; Alagaraja *et al.* 1987). However, in the recent years, there has been an increase of this species in landings from the east coast (Luther, 1988). Even on the west coast of India, sardine fishery would not start from the tip of the continent (Cape Comorin). The fishery skips off certain coastline from the tip and starts somewhere from Quilon and gradually extends further north along the west coast. This is a regular feature of oil sardine fishery along the west coast of India.

Since the oil sardines are fast moving migratory fishes confining to the surface and subsurface waters above the thermocline (the mixed layer), and since one cannot expect any drastic changes of water characteristics of temperature, salinity, oxygen or plankton conditions of the mixed layer, some eddy current system in the mixed layer must be single largest causative factor responsible for such a pattern of oil sardine fishery (Murty, 1993). Therefore, the immediately required scientific attempt is to tackle the migration of the species from the point of view of distribution of currents at the surface and subsurface depths.

## **Anchovies**

Anchovies concentrate in the waters of the Gulf of Mannar and Cape Comorin during southwest monsoon season (June-August), as if the fish schools are taking shelter in those waters in order to avoid the vagaries of southwest monsoon along the west coast of India; and as soon as the monsoon ceases, the anchovies move towards west coast of India and spread up to Ratnagiri in the north and Quilon in the south during the rest of the year. Venkataraman (1956) working on anchovies that were recruited to the fishery at Calicut observed from length frequency studies that the fishery was mainly constituted by the first and second year classes and that the same stock is absent from fishing grounds from July to September and then reappeared from October onwards. Relatively stable conditions of the sheltered waters of the Gulf of Mannar during monsoon period are attributed for migration of anchovies to those waters (Narayana Pillai, 1982).

The exact cause of their migration to the Gulf of Mannar waters during the southwest monsoon period requires to be established. The upwelling process along the west coast of India during southwest monsoon period no doubt brings certain amount of instability or turbulence in the waters. Lowered temperatures and oxygen deficiency are also the effects of upwelling.

The *FORV Sagar Sampada* investigations, during July-August 1987 in the Quilon Bank and the Gulf of Mannar (Murty *et al.* 1990), showed a lot of contrast in the T-S diagrams. The Gulf of Mannar waters were found warmer (26°-27°C) and more saline (about 35.5%) than the Quilon Bank waters where the temperature ranged from 26 to 21°C and the salinity from 34 to  $34.6 \times 10^{-3}$ . Moreover, the Gulf of Mannar waters also showed thermal instability having thermal inversions in the subsurface depths of water. Therefore factors other than instability appear to be causative factors for the migration of these fishes to the Gulf of Mannar waters during monsoon period. Therefore, a thorough investigation is necessary to identify the responsible factors.

## **Island group ecosystems**

The Lakshadweep group of islands consist of 27 islands in the Arabian Sea and the Andaman and Nicobar group of islands consist of about 300 islands. It was evident from the records of measurements of phytoplankton concentration, pigment and primary productivity that the coral reef waters are not so productive. The remarkable transparency of coral waters is sufficient testimony to the dearth of phytoplankton (Tranter & George, 1972).

Vast areas of seas around the islands of Lakshadweep and Andaman and Nicobar Islands are lying virtually unexploited. In almost all the inhabited islands, except a few, only subsistence fishing is carried out (Jones & Banerji, 1973; Alagaraja, 1987). The waters around the group of islands are pollution-free with possible multi-ranged scale of eddy currents. There is an urgent need of exploring the island ecosystems with a stress on coral reefs, reef fishes, fishery and the eddy circulations of the island waters. Inclusion of Maldivé group of islands would compliment such exploratory

investigation of these island ecosystems. Such a step would provide a sound data base for exploitation of the untapped marine living resources and the ecosystems of the islands around India.

### Tagging programme

CMFRI scientists gained some experience in tagging experiments on sardine and mackerel in the later half of 1970s (Prabhu & Venkataraman, 1970). While the released number of oil sardine was in hundreds and thousands from different centres along the coast, the recoveries were very poor, counting only in units. The system of tagging requires to incorporate and adopt modern methods. Moreover, the time and place of tagging should suit to the exact purpose of releasing tagged fishes. Tagging for the sake of experimentation was over. It requires a new phase of approach of tagging suitable to the specific environmental conditions which are assumed to govern the movement of fishes. If few fishes are selected from their school and released later into the water after tagging, the movement of such fishes differs from the track of movement of their own group. It is therefore ideal to find out, if not already put into practice elsewhere in other seas, species-appropriate method of tagging a major portion of a school of fishes at a time from a place. Methods should be evolved to follow the tagged fishes at sea instead of recovering the tagged fish from the fishermen later on land.

### FORV SAGAR SAMPADA'S CAPABILITIES

*FORV Sagar Sampada* is the ideal research vessel for conducting such specific problem-oriented cruises. Vessel's endurance at sea is long, exceeding 30 days at a stretch, well equipped with modern gadgets for environmental data collection and analyses on board. However, as the vertical draught of the vessel is 5.6 m with gross tonnage of 2661 tons and with huge super structure, it is risky to cruise in the nearshore waters especially during monsoons. Two or more cadalmin-type of vessels or the medium vessels of Fishery Survey of India can work in succession in the shallow waters in liaison with *FORV Sagar Sampada*. This type of fleet arrangement is necessary for the specific investigations connected with fishes living in shallow waters such as anchovies (10-15 m depth) and the aquatic ecosystems of the islands.

Perhaps the facilities of aquarium tanks on board *FORV Sagar Sampada* can best be utilized for conducting pilot projects of various live fishes. The preferential behaviour of anchovies for the Gulf of Mannar waters than for the Quilon Bank waters during monsoon period can be studied by suitably designing the experiment on board. The maximum size of the anchovie fish is about 100 mm only (UNDP/FAO, 1976). It is relatively easy to handle the live anchovies in aquaria, as they are small in size. Physiological factors of anchovies responding to specific conditions of waters can thus be identified in such preliminary observations on board. Scientists at times may overstay at sea, if their new findings in the cruise demand.

## REFERENCES

- Alagaraja, K 1987. An appraisal of the marine fisheries of Lakshadweep and Andaman & Nicobar Islands, *CMFRI Special Pub. No. 39*: pp.16.
- Alagaraja, K., Yohannan, K.C., Ammini, P.L. & Pavithran, P.P. 1987. An appraisal of the marine fisheries in Andhra Pradesh, *CMFRI Special Pub. No.33*: pp.52.
- Banerji, S.K. 1973. An assessment of the exploited pelagic fisheries of the Indian seas, In: *Proc. Symp. Living Resources of the Seas Around India, (CMFRI Cochin)* 114-136.
- Dharmaraja, S.K., Vijayalakshmi, K, Haja Najumudeen S., Prasad, C.J. Seynudeen, M.B., Anandan, K., Karthikeyan, M. & Balakrishnan, G. 1987. An appraisal of the marine fisheries of Tamil Nadu and Pondicherry, *CMFRI Special Pub. No.34*: pp.63.
- George, P.C. 1970. The present status of our knowledge on the pelagic fisheries of India with suggestions for planned exploitation of the resources, In: *Proc. Symp. on Development of Deep Sea Fishing*. [Government of India, Ministry of Food and Agriculture (Dept. of Agriculture), New Delhi], pp. 119.
- Jones, S. & Banerji, S K. 1973. A review of the living resources of the central Indian Ocean. In: *Proc. Symp. Living Resources of the Seas around India (CMFRI Special Pub. )* 1-17.
- Luther, G 1988. Oil sardine, an emerging new fishery resource along the east coast, *Mar. Fish. Infro. Serv. T & E Ser.* 88: 13-19.
- Mathew, K.J. (Ed), 1990. *Proc. First Workshop on Scientific Results of FORV Sagar Sampada*, (CMFRI, Cochin) pp. 465.
- Murty, A.V.S., 1993. The impact on sardine fishery of the winter surface currents in the north Indian Ocean including the Bay of Bengal and the Arabian Sea - A need for international cooperative study, *J. Aqua. Biol.* 8: 24-29.
- Murty, A.V.S., Gopalakrishna Pillai, N., Zaffar Khan, M., Sanil Kumar, K.V. & Alavandi, S.V. 1990. Variation in fish catches from the continental shelf between Quilon and Gulf of Mannar and its relation to oceanographic conditions during the southwest monsoon period, In: *Proc. First workshop on Scientific Results of FORV Sagar Sampada*, edited by K.J. Mathew, (CMFRI, Cochin) 291-294.
- Narayana Pillai, V., 1982 *Physical characteristics of the coastal waters off the southwest coast of India with an attempt to study the possible relationship with sardines, mackerel and anchovy fisheries*. Ph.D. thesis, University of Cochin, pp. 107.
- Prabhu, M.S. & Venkataraman, G. 1970. Mackerel and oil sardine tagging programme 1966 to 1969, *Bull. Cent. Mar. Fish. Res. Inst.* 17: pp.31.
- Tranter, D.J. & George, J. 1972. Zooplankton abundance at Kavarathi and Kalpeni atolls in the Laccadives, In: *Proc. Symp. Corals and Coral Reefs*, edited by C. Mukundan & C.S. Gopinadha Pillai, (Mar. Biol. Ass. India, Cochin) 239-256.
- UNDP/FAO. 1970. *Pelagic Fisheries Project, Progress Report No.13*: pp. 107.
- Venkataraman, G 1956. Studies on some aspects of the biology of the common anchovy. *Thris.socles mystax* (Bloch and Schneider), *Indian J.Fish.* 3: 311-333.

## **Short term variability of ocean responses at the outer shelf off Cochin under a heating regime**

M.G.Joseph, P.Madhusoodanan & V.V.James

Naval Physical and Oceanographic Laboratory, BMC P.O, Thrikkakara, Cochin-682021

### **ABSTRACT**

The synoptic oceanic variability of the thermohaline fields in response to the surface forcing and currents at the shelf break (9°44'N, 75°42'E and ~100 m depth) off Cochin over a 7 day period (168 hr) during 10-17 April 1991 was documented utilising 3 hourly data ( micom-STD, meteorology and Aanderaa current meter) collected onboard *FORV Sagar Sampada*. The significant ocean response manifested in the progressive increase in the magnitude and range of the sea surface temperature (SST) (30.6° - 32.3°C), peaking higher during 13 - 15 April (maximum on 13 April) due to increased day heating at low wind forcing. An initial gentle increase in the negative gradient (0 to 0.15°C m<sup>-1</sup>) of upper 10 m of the ocean due to afternoon effect reached high during 13 - 15 April (maximum on 13 April). Correspondingly, the surface layer positive gradient (0.001 to 0.004°C m<sup>-1</sup>) due to nocturnal cooling reached maximum on 12 April. Perturbed by the diurnal shoaling and deepening, the mean progression of the mixed layer depth (MLD) (1 - 26 m) showed an initial decrease to the minimum on 13 April and a following increase to the maximum on 17 April in response to the respectively decreasing and increasing wind stress. Surface salinity (34.57 - 34.67 x 10<sup>-3</sup>) varied with a mean progressive increase, while the depth (68 - 95 m) and salinity (35.5 - 35.9 x 10<sup>-3</sup>) of the subsurface salinity maximum decreased to the minimum in response to a probable offshore recession of the shelf waters during 13 - 15 April as suggested by an increase in the offshore flow near bottom.

### **INTRODUCTION**

Recent observations near the southwest coast of India have confirmed the existence of complex variability of ocean parameters like temperature, salinity and currents in response to the changes in the major monsoon and flow regimes and the intervening transitional adjustments. The mean thermohaline and hydrographic variability in the coastal waters of the southwest coast are greatly controlled by the northerly (November - February) and southerly (March - September) currents and the respective



undercurrents in the opposite directions (Darbyshire, 1967; Banse, 1968; Shetye, 1984; Shetye & Shenoi, 1988). The short period/intra-seasonal and diurnal/intra-diurnal perturbations over these seasonal patterns have been related earlier to the forcings by vertical and lateral fluxes of heat, momentum and mass due to synoptic scale air-sea interaction and tidal flows (Joseph *et al.* 1992, 1993; Murthy & Hareesh Kumar, 1991; Shenoi & Antony, 1991; Sanil Kumar *et al.* 1993). Off Cochin and Calicut, the nature of the short period oceanic variability during December (Basil Mathew *et al.* 1991) and February (Madhusoodanan *et al.* 1993) showed significant influences from dominant convective mixing, influx of low saline Bay of Bengal / Equatorial Surface Waters, brought by the prevailing currents and associated thermal inversions. This paper attempts primarily to analyse and describe the short period variability in the atmospheric forcing and responses of the continental shelf waters off Cochin during the spring heating.

## MATERIALS AND METHODS

Time series observations were made onboard *FORV Sagar Sampada* near the continental shelf break off Cochin at  $9^{\circ}44'N$ ,  $75^{\circ}42'E$  and 100 m depth (Fig.1) during 10- 17 April 1991. Three hourly data of temperature and salinity against depth (TSK micom-STD, accuracy:  $\pm 0.05^{\circ}C$ ,  $\pm 0.04 \times 10^{-3}$  and  $\pm 3$  m or  $\pm 0.3$  % of full scale), surface meteorological parameters of pressure (PR), wind speed (WS), direction (WD) (TSK anemometer, accuracy:  $\pm 0.5$  m  $s^{-1}$  and  $\pm 5^{\circ}$ ), dry (DB), wet bulb (WB) and sea surface (SST) temperatures and currents at 2 m and 80 m (Aanderaa current meter, accuracy:  $\pm 0.01$  m  $s^{-1}$  or 2% and  $\pm 7.5^{\circ}$ ) during this period were utilised for the

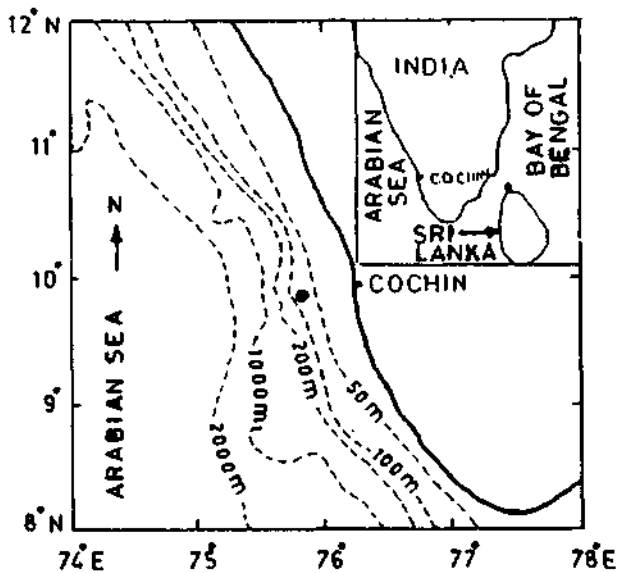

Fig.1 - Station position

analyses. Radiative and turbulent heat fluxes were estimated using standard procedures (Joseph *et al.* 1992). Mixed layer depth (MLD) was analysed from the STD profiles as the shallowest depth with  $0.2^{\circ}\text{C}$  drop in temperature from surface.

## RESULTS AND DISCUSSION

### Prevailing meteorological conditions

Semidiurnal fluctuations in PR (1007 - 1013 mb) (Fig.2a) were found to be superimposed on a long period variation reaching minimum on 12 April and maximum during 14 - 15 April. Wind was predominantly westerly (Figs.2b and 4), with northerly and southerly components, while daytime shifts to easterly/northeasterly components peaked during 13 - 15 April. Variation in the moderate WS ( $0 - 6 \text{ m s}^{-1}$ ) (Fig.2c) showed a decrease to the minimum coinciding with the maximum in PR during 13 - 15 April and a following increase up to 17 April. Relatively low cloudiness (CL, 2 - 5 octa) (Fig.2d) during the period, showed a slight increase during 11 - 15 April, reaching maximum on 14 April. Diurnal ranges in DB ( $27.1^{\circ} - 31.6^{\circ}\text{C}$ ) (Fig.2e) became more during 13 - 15 April, possibly from increased cloudiness and decreased wind forcing.

### Net heat flux and surface layer thermal response

The nature of day-to-day variations in the net surface heat flux ( $Q_N$ ) (Fig.3a) indicates the prominent influence of wind speed on the latent heat fluxes. As a result, the maxima in day heating ( $850 - 897 \text{ W.m}^{-2}$ ) peaked during the days of relatively low winds (13 - 15 April), while nocturnal cooling ( $-73$  to  $-275 \text{ W.m}^{-2}$ ) peaked during the windy days 10, 11, 12, 16 and 17 April (maximum on 12 April). Response to the surface layer heating was apparent in the march of SST ( $30.6^{\circ} - 32.3^{\circ}\text{C}$ ) (Fig.3b) during the period. Earlier observations of higher SST ( $30^{\circ} - 31.5^{\circ}\text{C}$ ) in the deep and shelf waters of the east central Arabian Sea during April (Rao *et al.* 1974) and May/June (Ramesh Babu *et al.* 1991) were also related to net surface heat fluxes only. However, apart from a progressive day-to-day increase in the diurnal mean temperature, the unusual peaking of the afternoon maximum to extremely high values ( $>31.5^{\circ}\text{C}$ ) during 13 - 15 April (highest on 13 April) can only be related to a possible spurt in heat absorption due to a plankton bloom or increase in other suspended sediments for correlating which relevant data were not available. Heating rate increases with decreasing thickness of the mixed layer. The thin surface layer with high temperature as observed on these dates was conducive to rapid growth of plankton causing increase in the heating rate (Zaneveld *et al.* 1981) and the resulting higher surface layer temperature. This has also influenced the time variability of surface transients (positive and negative) as assessed from the difference in temperatures between surface and 10 m ( $\text{SST} - T_{10}$ ) (Fig.3c). Transient thermoclines (negative gradients) ( $0 - 0.15^{\circ}\text{C m}^{-1}$ ) were indicated between 1400 and 1500 hrs on all days, peaking during 13 - 15 April (maximum on 13 April). Surface thermal inversions

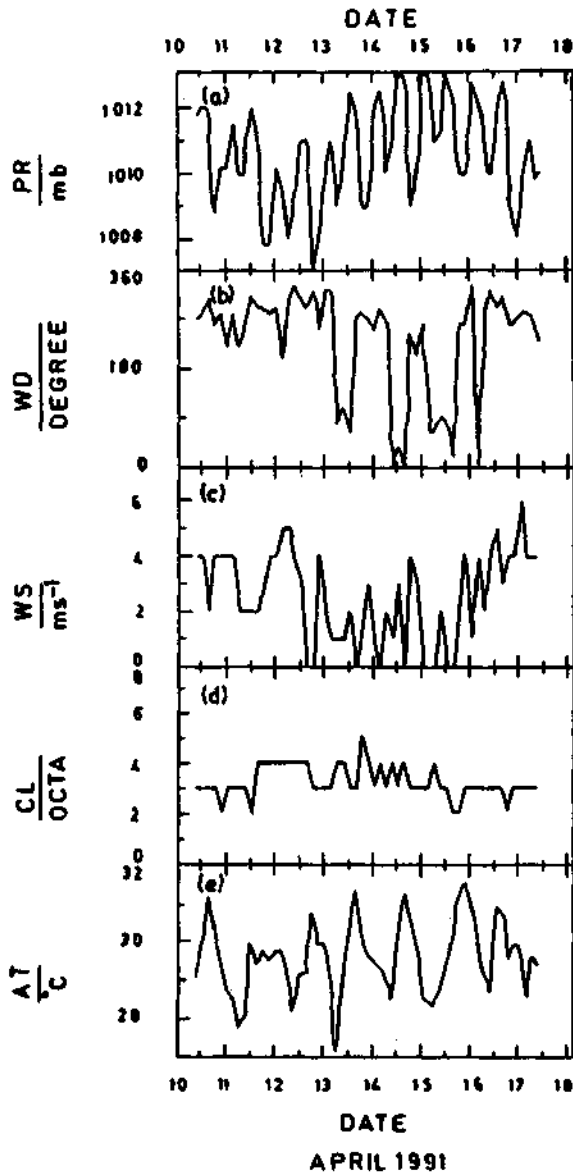

Fig.2 - Time series of: a) pressure (PR), b) wind direction (WD), c) wind speed (WS), d) cloud amount (CL) and e) air temperature (AT)

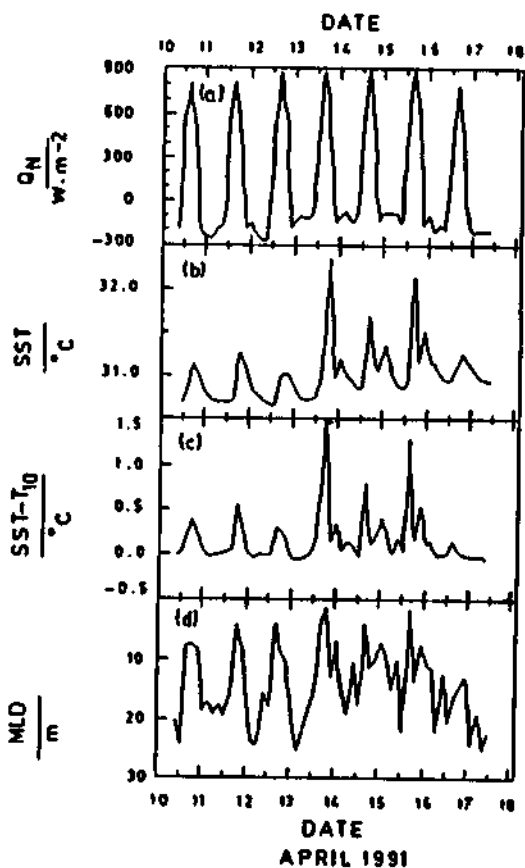

Fig.3 - Time series of: a) net surface heat flux ( $Q_N$ ), b) sea surface temperature (SST), c) transients ( $SST - T_{10}$ ) and d) mixed layer depth (MLD)

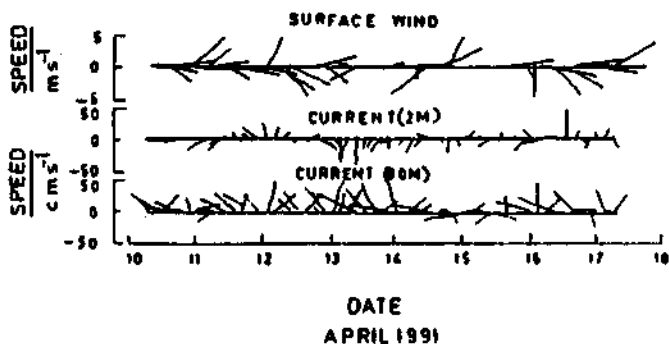

Fig.4 - Time series vector plots of surface wind and currents at 2 and 80 m

(positive gradients) ( $0.001 - 0.004^{\circ}\text{C m}^{-1}$ ) due to nocturnal convections were apparent during 0000 - 0600 hrs on all days except during 14 - 16 April. The resulting variations in MLD (1 - 26 m) (Fig.3d) shows the diurnal ranges to be maximum during 10 - 12 April during which heating/cooling played a dominant role, while extreme shoaling and reduction of diurnal ranges in MLD occurred during 13 - 15 April as a result of heating under low wind forcing and increased cloudiness respectively. However, MLD increase after 15 April resulted from the dominant influence of the increasing wind stress.

### Surface and bottom currents and thermohaline responses

Surface current (at 2 m) ( $5 - 35 \text{ cm s}^{-1}$ ) varied between westerly/southwesterly and northerly/northeasterly/southeasterly directions (Fig.4) with period of rotations greater than semidiurnal / diurnal ranges. Current speed was greater (up to  $50 \text{ cm s}^{-1}$ ) at 80 m where tidal rotations were absent and the dominant current component was northerly, indicating the influence of the northerly undercurrent to be present during this period (Shetye & Shenoi, 1988). At 2 m, U component of current ( Fig 5a ) was weaker ( $0 - 10 \text{ cm s}^{-1}$ ) and varied with semidiurnal / diurnal / long period oscillations and dominant presence of westerly components. V component at 2 m ( $0 - 20 \text{ cm s}^{-1}$ ) (Fig.5b) was dominantly southerly with northerly components peaking on 12 and 16 April. Variation of U component at 80 m (Fig.5c) indicated dominant semidiurnal oscillations, being superimposed on a long period trend, which showed an initial increase in westerly components from 13 April onwards. V component at 80 m (Fig.5d) varied with an increase in northerly speed up to 13 April and a following decrease.

Superimposed by the intradiurnal/diurnal fluctuations of tidal periods, the mean variation of the surface salinity (SS) ( $34.57 - 34.67 \times 10^{-3}$ ) (Fig.6a) suggested a progressive increase from 10 to 17 April with maximum on 13 April and minimum on 15 April corresponding to respective increases in the observed onshore and offshore flows across the continental shelf edge (Fig.5a). Variation in the magnitude of a subsurface salinity maximum (SSM) ( $35.50 - 35.90 \times 10^{-3}$ ) (Fig.6b) due to the intrusion of Arabian Sea High Salinity Water (ASHSW) (Wyrтки, 1971) and the depth of subsurface salinity maximum (DSSM) (68 - 95 m) (Fig.6c) suggested possible influences by the near - bottom current during the period. This was apparent from the fact that a mean decrease in SSM and DSSM during 13 - 15 April possibly resulted from an increase in the offshore component of the near bottom flow (Fig.5c), carrying less saline nearshore waters.

Progressive thermohaline transformations in response to the surface forcing and currents during the period are depicted in Fig.7. The changes in the vertical thermal structure (Fig.7a) reflect the influence of diurnal heating and decreased wind stress especially during 13 - 15 April. During this period, higher SST ( $>31^{\circ}\text{C}$ ) was associated with the shoaling of MLD/thermocline. The continuous presence of a secondary mixed layer (30 - 50 m) of 10 - 30 m thickness, possibly resulted from the internal

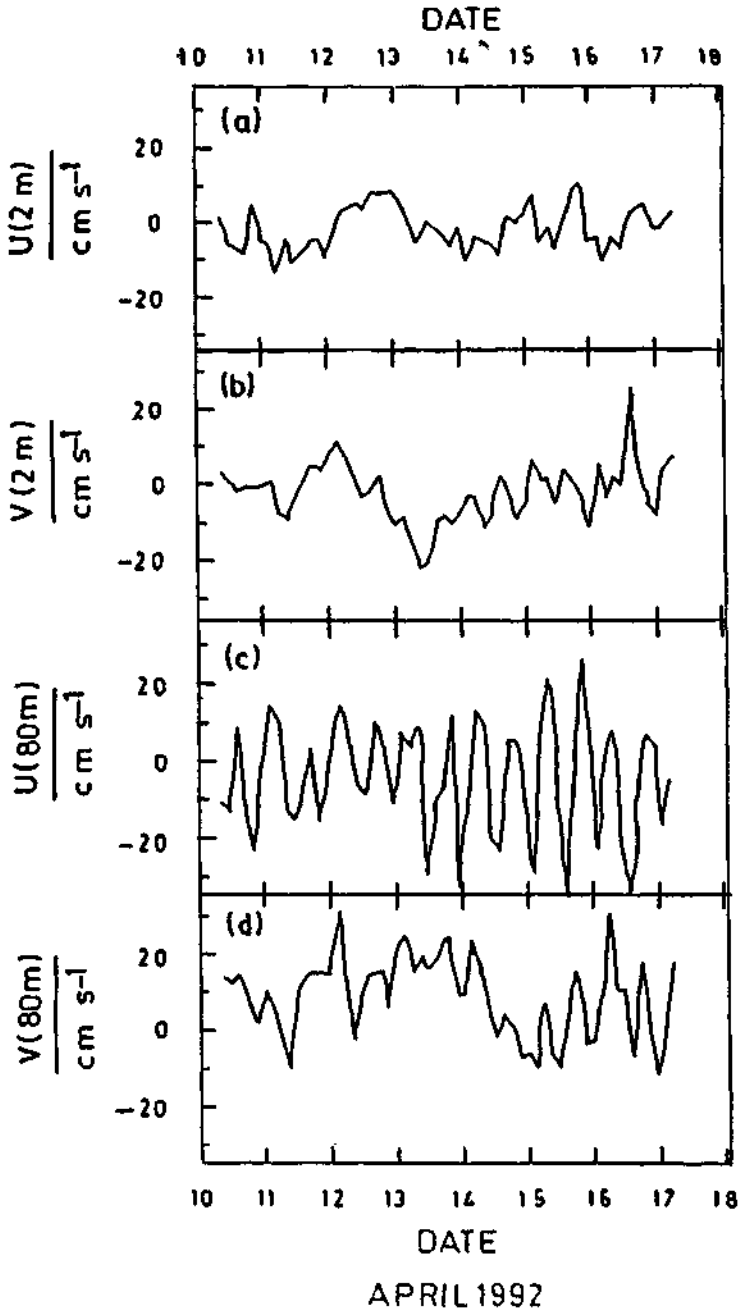

Fig.5 - Time series of U and V components at 2 and 80 m

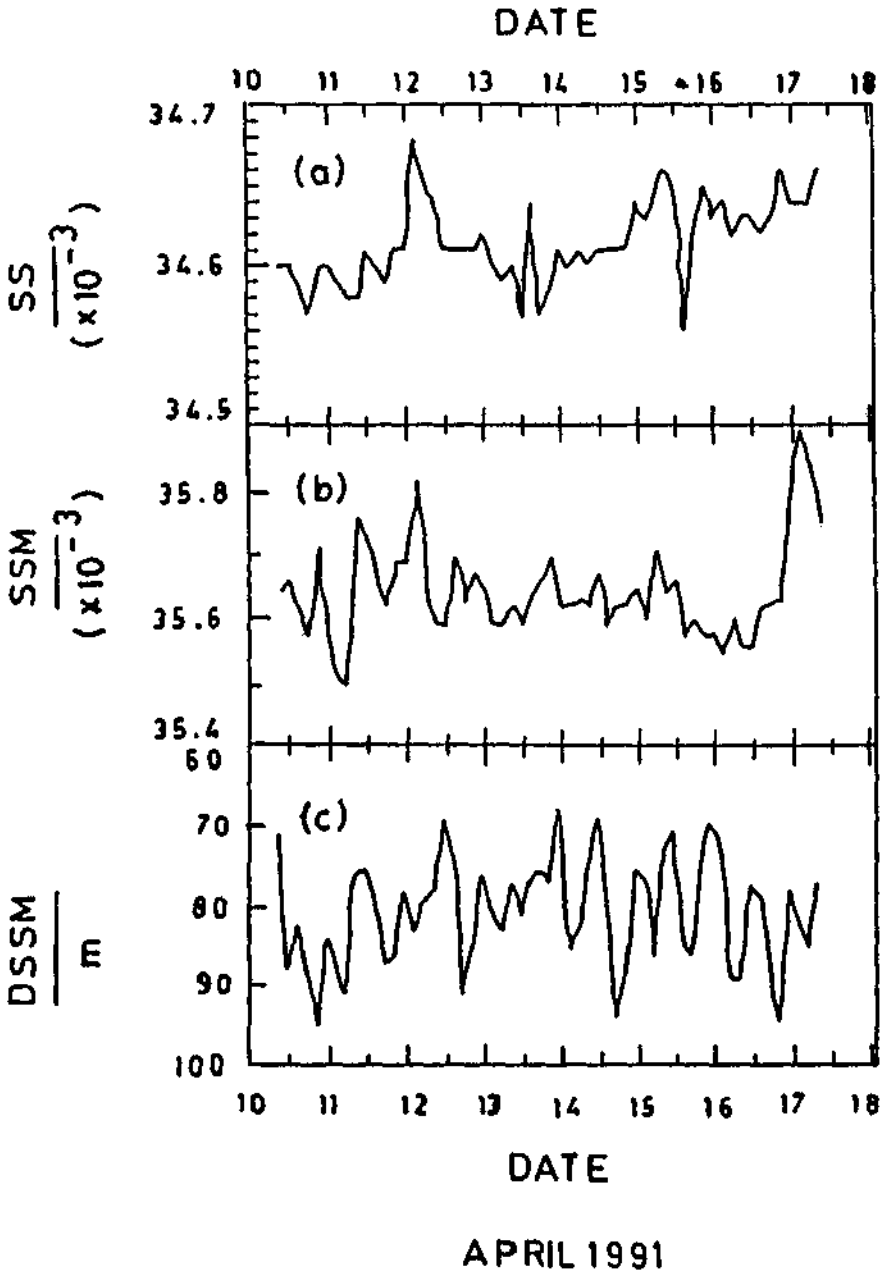

Fig.6 - Time series of: a) surface salinity (SS), b) subsurface salinity maximum (SSM) and c) depth of subsurface salinity maximum (DSSM)

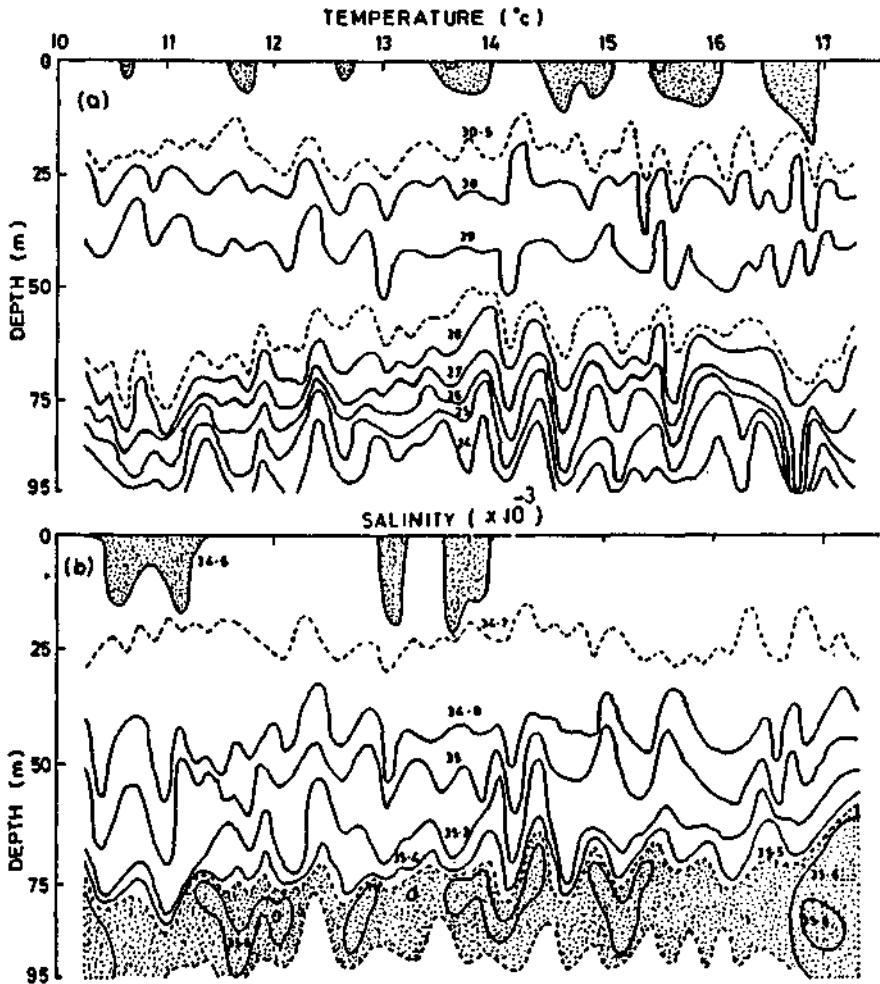

Fig.7 - Time sections of: a) temperature and b) salinity

wave or shear mixing at the top of thermocline. Though such cases of secondary layer(s) have been reported earlier off Bombay in June (Sanil Kumar *et al.* 1993), a different reason was attributed. The influence of wind relaxation, enhanced by the currents is also apparent in the changes of vertical salinity structure (Fig.7b), evident by the decrease in SSM and the shoaling of DSSM during 13 - 15 April (Fig.6).

### CONCLUSION

Analysis of surface forcing and oceanic thermohaline responses at the outer shelf break off Cochin during 10 - 17 April 1991 reveals the following.



Semidiurnal oscillations were superimposed on long period variation in surface pressure, reaching maximum during 13 - 15 April during which the strength of the predominant westerly wind slackened to minimum with easterly/northeasterly components. Day heating (afternoon) peaked ( $Q_N > 890 \text{ W.m}^{-2}$ ) under decreased wind mixing/cooling during 13 - 15 April, while nocturnal cooling increased ( $Q_N > -270 \text{ W.m}^{-2}$ ) under enhanced wind forcing/cooling during 10 - 11 and 16 - 17 April.

The consequent oceanic subsurface responses were significant by the decreasing magnitudes/diurnal ranges of SST, increased magnitudes of thermal inversions and the increased diurnal range of MLD under the windy, less cloudy period of 10 - 12 and 16 - 17 April. Increase in transient thermoclines, reduction in diurnal range/shoaling of MLD under reduced wind forcing/increased cloud conditions characterised the intervening period during 13 - 15 April.

While surface current (2 m) was weaker and variable/rotary, near-bottom (80 m) current was stronger and dominated by northerly components. A progressive increase in SS observed during the period is perturbed by a maximum on 12 April and minimum on 15 April, possibly due to increase in the onshore and offshore flows. Observed decrease in SSM and DSSM during 13- 15 April resulted from the increase in offshore flow near bottom, carrying less saline shelf waters. The transformations in the thermohaline structures clearly reflected dominant influence of wind stress, enhanced by diurnal heating and currents. A secondary mixed layer due to possible internal wave/shear mixing, existing below 30 - 50 m also varied in response to the wind forcing.

### ACKNOWLEDGEMENT

Authors express sincere gratitude to the Director, for the permission to carry out the work. Special thanks are due to Dr. P. V. Hareesh Kumar, for his computer software support and print-out of results. Thanks are also due to the participating scientists and the ship's complement of *FORV Sagar Sampada* during the cruise.

### REFERENCES

- Banse, K. 1968. Hydrography of the Arabian Sea shelf of India and Pakistan and effects on demersal fishes, *Deep-Sea Res.* 15: 45 - 79.
- Basil Mathew, Sanil Kumar, K.V. Hareesh Kumar, P.V. Madhusoodanan P. & James, V.V. 1991. Thermohaline and current structure off Cochin during December 1986, *Indian J. Mar. Sci.* 20: 244 - 248.
- Darbyshire, M. 1967. The surface waters off the coast of Kerala, south-west India, *Deep-Sea Res.* 14: 45 - 79.
- Joseph, M. G., Hareesh Kumar, P.V. & Joseph, M.X. 1992. Deep and shallow water characteristics of mixed layer response to momentum and buoyancy fluxes off Bombay, west coast of India, during winter, *Conti. Shelf Res.* 12 (5/6): 661 - 673.
- Joseph, M. G., Sanil Kumar, K.V. Joseph, M.X. & James, V.V. 1993. Short term variability of hydrography and currents in relation to stability, sound speed and mixing characteristics off Bombay, west coast of India, *Conti. Shelf Res.* 13(10): 1065 - 1082.

- Madhusoodanan, P., Hareesh Kumar, P.V. & Mohan Kumar, N. 1993. Mixing in the Arabian Sea off Calicut during February 1985. *Indian J. Mar. Sci.* 22: 194 - 197.
- Murthy, P. G. K. & Hareesh Kumar, P.V. 1991. Upper ocean thermal response off Karwar to a deep depression. *Conti. Shelf Res.* 11: 239 - 250.
- Ramesh Babu, V., Sastry, J.S. Gopalakrishna, V.V. & Rama Raju, D.V. 1991. Premonsoonal water characteristics and circulation in the east central Arabian Sea. *Proc.Indian Acad. Sci. (Earth Planet. Sci.)* 100(1): 55 - 68.
- Rao, L. V. G., Thomas Cherian, Varma, K.K. & Varadachari, V.V.R. 1974. Hydrographic features of the inner shelf waters along the central west coast of India during winter, spring and summer. *Mahasagar-Bull. Natn. Inst. Oceanogr.* 7: 15 - 26.
- Sanil Kumar, K. V., Hareesh Kumar, P.V. & Joseph, M.X. 1993. Observations and simulations of the mixed layer characteristics off Bombay, west coast of India during the summer monsoon of 1988. *Estuar. Coast. Shelf Sci.* 36: 59 - 69.
- Shenoi, S. S. C. & Antony, M.K. 1991. Current measurements over the continental shelf of India. *Conti. Shelf Res.* 11(1): 81 - 93.
- Shetye, S. R. 1984. Seasonal variability of the temperature field off the southwest coast of India. *Proc. Indian Acad. Sci. (Earth. Planet. Sci.)* 93: 129 - 137.
- Shetye, S. R. & Shenoi, S.S.C. 1988. Seasonal cycle of surface circulation in the coastal North Indian Ocean. *Proc. Indian Acad. Sci. (Earth. Planet. Sci.)* 97: 53 - 62.
- Wyrtki, K. 1971. *Oceanographic Atlas of International Indian Ocean Expedition*, (National Science Foundation, Washington, D C), pp. 531.
- Zaneveld, J. R. V., Kitchen, J.C. & Pak, H. 1981. The influence of optical water type on the heating rate of a constant depth mixed layer. *J. Geophys. Res.* 86: 6426 - 6428.

\* \* \*

## **Premonsoon current structure in the shelf waters off Cochin**

C.V.K. Prasada Rao, P.V.Hareesh Kumar & N.Mohan Kumar  
Naval Physical and Oceanographic Laboratory, Cochin - 682021

### **ABSTRACT**

Premonsoon variability of currents in the shelf waters off Cochin (9° 43'N and 75° 44' E; depth 90m) were studied utilizing the time series data. The surface currents were southerly whereas northwesterly currents were noticed at deeper levels during the premonsoon season. However, the flow was weaker in April compared to that in May. After 27<sup>th</sup> May a substantial increase was noticed in the current speed below the surface homogeneous layer. The dissolved oxygen concentration in the lower layers showed a decreasing trend. Increase in the suspended particle concentration, as revealed from turbidity measurements, is mainly due to offshore transport of the sediment rich coastal waters. All these factors suggest the occurrence of upwelling in this region.

### **INTRODUCTION**

It is well-known that the shelf waters off southwest coast of India experience upwelling which commences during premonsoon (March) and continues till the end of the summer monsoon season (September). During this period the nutrient rich sub-surface waters march upwards which in turn enhance the zoo plankton productivity. To understand the phenomenon of upwelling it is necessary to know the underlying physical processes, viz, the prevailing wind and current systems. Apart from upwelling, knowledge on surface and sub-surface currents are very important for navigation, offshore engineering structures, disposal of wastes, pollutants etc. Information on currents is considered very vital for ocean mixed layer and surface wave modelling, acoustic propagation and tomographic studies. Information on current structure is much lacking for Indian waters and only few observations were reported for the west coast of India (Shenoi *et al.* 1988; Mathew *et al.* 1991; Joseph *et al.* 1993). The monthly mean data available from atlases and ship drift data (Wyrski, 1971; Cutler & Swallow, 1984) were averaged over large grid sizes and hence do not provide the finer details. In this paper the results of the analyses of time-series data on surface and

sub-surface current velocities obtained in the shelf waters off Cochin during premonsoon (April 1991 and May 1992) are presented. Data on turbidity, dissolved oxygen and surface waves which were obtained in the same period are also used.

## MATERIALS AND METHODS

Time-series data collected in two cruises of *FORV Sagar Sampada* during 9-20 April 1991 (cruise # 88) and 22 May to 3 June 1992 (cruise # 101) at  $9^{\circ} 43'N$  and  $75^{\circ} 44'E$  in the shelf waters off Cochin (Fig.1) are utilised for the present study. The depth at the time-series location is around 90m. In both the cruises Aanderaa current meter (Model RCM4 and RCM7) moorings were laid at the stationary position (Fig.1). The CTD and marine meteorological data were collected from *FORV Sagar Sampada*. The ship was anchored close to the mooring location. During the cruise # 101 a Datawell wave directional buoy (WAVEC) was also-moored at this location. Wave phase velocity (derived from peak period) and wave (swell) direction from WAVEC data and dissolved oxygen and total beam attenuation coefficient, which is a measure of the suspended particle concentration from 3 hourly CTD casts pertaining to cruise # 101 are used as supporting information for explaining the prevailing current structure.

## RESULTS AND DISCUSSION

Figure 2 shows time series of hourly averaged cross-shore (U) and along-shore (V) components of the current vectors at 10, 20, 40, 60, and 80 m depths. It is seen that the currents observed during April 1991 are very weak ( $< 25$  cm/s) compared to May-

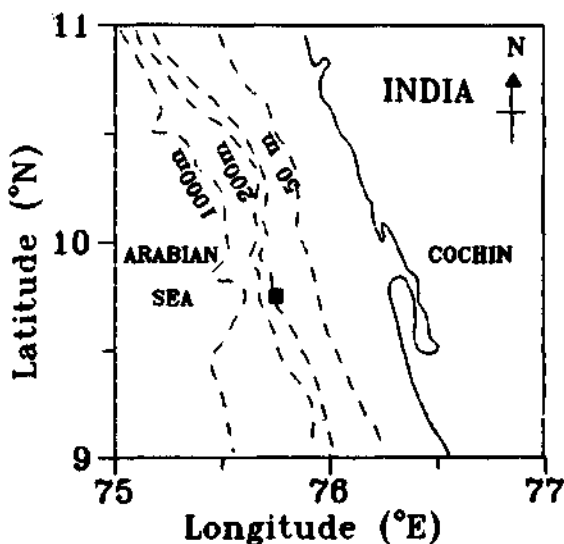

Fig. 1- Station location map

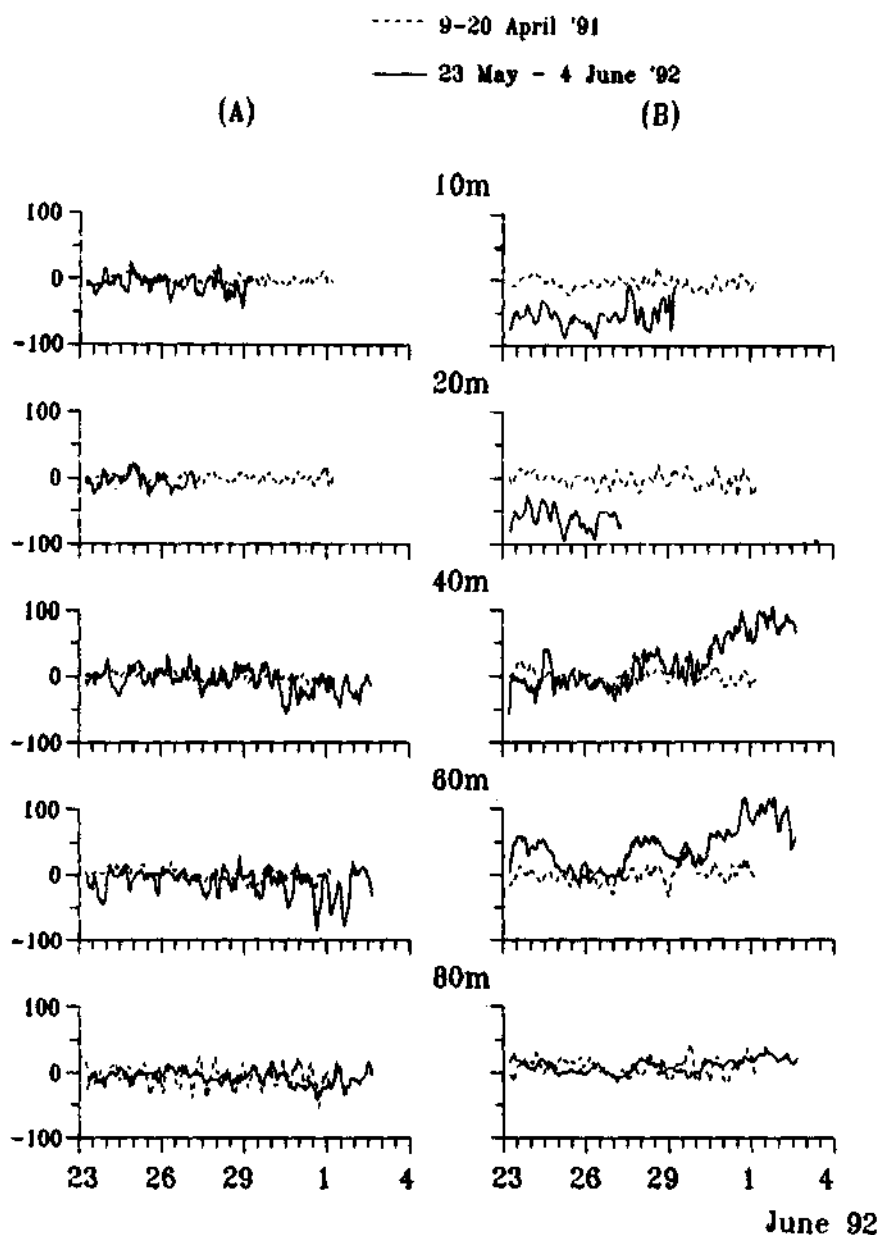

Fig. 2- Hourly time series of- A) cross-shore, U and B) along shore components of currents in cm/s at 10, 20, 40, 60 and 80 m depths during April'91 and May-June'92

June 1992. During the latter period the magnitude of currents ranged between 50-100 cm/s in the near-surface (10 m and 20 m) and exceeded 100 cm/s in sub-surface (40 m and 60 m). At 10 m and 20 m depths the southerly flow (-ve values of V) was noticed whereas north-westerly flow prevailed in the lower layers (40 m, 60 m, 80 m). An increase in current velocity (V at 40 m and 60 m) is conspicuously seen below the surface homogeneous layer after 27 May 1992. Figure 3 presents 1-h averages of current speed (CS) and direction (CD) at 10 m, wind speed (FF), wind direction (DD), wave phase speed (WS) and wave (swell) direction (WD). WS was computed from peak period following linear wave theory. It is seen that the near surface flow is against the swell direction. Further, the correlations between current vs wind and current vs wave are weak ( $<0.1$ ). Relatively better correlation (0.5) is seen when daily (24 h) averages are used suggesting that high frequency components in the current field are not controlled by the local winds. Figure 4 presents 3-h time-series of total beam attenuation coefficient (ext.coef) and dissolved oxygen content at current meter depths. Dissolved oxygen in the sub-surface waters (40, 60 and 80 m) decreased during this period. This is mainly due to the northward flow (Fig.2) which brings low

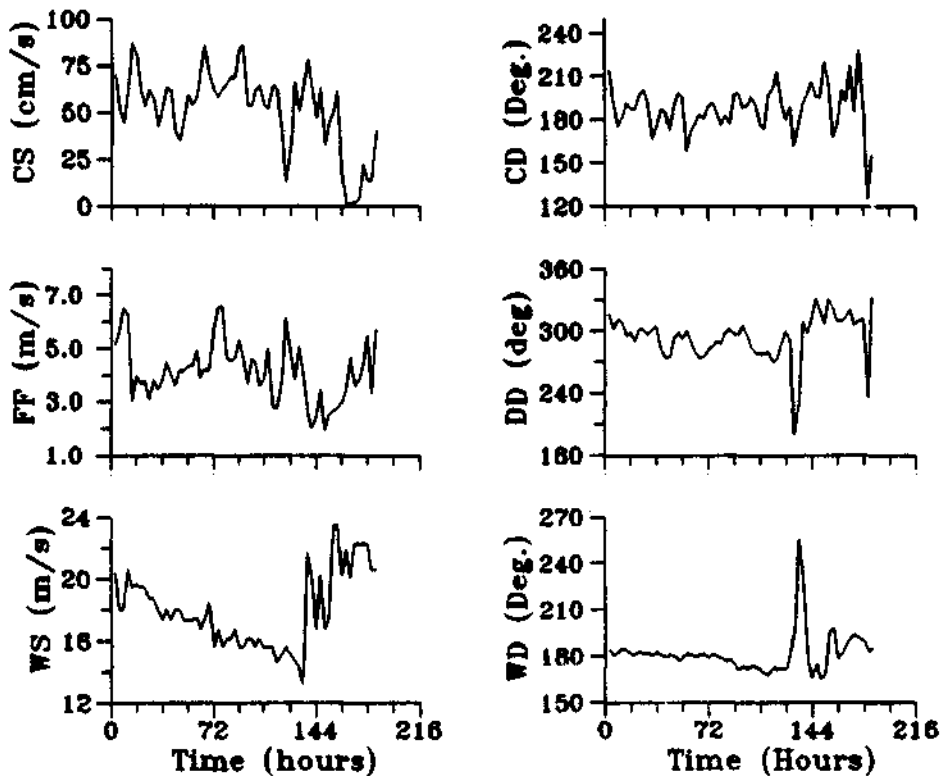

Fig. 3-Hourly time series of current speed (CS) and direction (CD) at 10 m, wind speed (FF) and direction (DD), wave phase speed (WS) and swell direction (WD) from 23 May to 4 June '92

oxygen content water from the equatorial region. The time series of total beam attenuation coefficient at all depths suggests the increase in the suspended particle concentration which might be due to offshore transport (-ve U values) of sediments from the coastal region. The large fluctuations in the oxygen content and total beam attenuation coefficient in the thermocline (40 m) indicate the influence of internal waves.

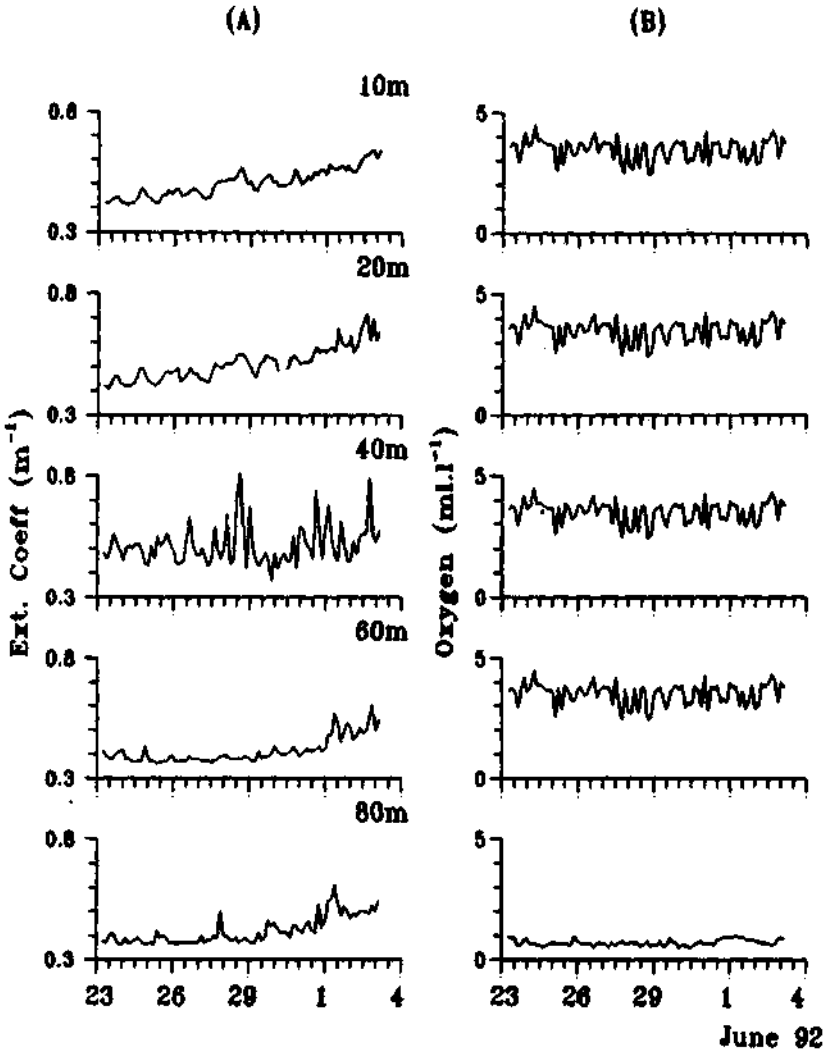

Fig. 4- Three hourly time series of- A) total beam attenuation coefficient (ext. coeff) and B) oxygen concentration (oxygen) at 10,20,40,60 and 80 m depths from 23 May to 4 June '92

## CONCLUSION

Southerly currents in near-surface and north-westerly currents in sub-surface are observed in the shelf waters off Cochin during premonsoon. Currents in April are generally weak compared to May. The observations made in May indicate strong currents at 40 m and 60 m depths (more than 100 cm/s) when compared to near-surface and bottom waters. The northwesterly subsurface currents are responsible for the decrease in the oxygen concentration and increase in the suspended sediment. Low frequency oscillations (24 h mean) in the current field are not correlated with the local winds and waves. The current structure as well as the other features observed suggest the occurrence of upwelling .

## ACKNOWLEDGEMENT

Authors are grateful to Mr. A.S.Ramamoorthy, Director and to the Officer-In-Charge of Sagar Sampada Cell at Cochin for providing necessary facilities for this work.

## REFERENCES

- Cutler A.N. & Swallow J.C. 1984. *Surface currents of the Indian Ocean*, Rep.187, (Institute of Oceanographic Sciences, Wormley, U K).
- Joseph M.G., Sanil Kumar K.V., Joseph M.X. & James V.V. 1993. Short-term variability of hydrography and currents in relation to stability, sound speed and mixing characteristics off Bombay, west coast of India, *Cont.Shelf.Res.* 13: 1065-1082.
- Mathew B., Sanil Kumar K.V., Hareesh Kumar P.V., Madhusoodanan P. & James V.V. 1991. Thermohaline and current structure off Cochin during 1986, *Indian J.Mar.Sci.* 20 : 244-248.
- Shenoi S.C., Antony M.K. & Sunder D. 1988. Nature of the observed oscillatory flows in shelf waters of the western continental shelf of India, *J. Coastal Res.* 4: 617-626.
- Wyrki K. 1971, *Oceanographic Atlas of the International Indian Ocean Expedition*, (NSF, Washington D C) pp.531.

\*\*\*



## **Intradiurnal variability in thermohaline responses of the shelf waters to atmospheric forcing off Cochin during April 1991**

M.G.Joseph & P.Madhusoodanan

Naval Physical & Oceanographic Laboratory, BMC P.O., Thrikkakara, Cochin-682021

### **ABSTRACT**

A typical case study of the intradiurnal variability in the thermohaline features of the continental shelf waters (~100 m) off Cochin in response to the surface forcing was made utilising the hourly data (meteorology and micom-STD). The analysed response of the shelf waters indicated an initial moderate deepening (23 m) in the morning (0800-1000 hrs), subsequent shoaling and progressive afternoon and early morning (1600 hrs on 16 April to 0300 hrs on 17 April) deepening of the mixed layer (ML) due to the respective increase/decrease in the wind forcing and unimodal net surface heating. A secondary mixed layer observed between 40 - 70 m from 1000 hrs on 16 April might be the result of internal wave mixing above the permanent thermocline (60 - 80 m). The variations in the salinity field indicated a progressive increase in the surface salinity ( $34.60 - 34.66 \times 10^{-3}$ ), possibly from advective influence and the presence of a subsurface high salinity core ( $35.56 - 35.90 \times 10^{-3}$ ), whose depth variation (75 - 95 m) was bimodal over the diurnal cycle, implying the possible semidiurnal tidal influence.

### **INTRODUCTION**

Intradiurnal scale variability of ocean responses, especially at a coastal site, affect a number of maritime operations of diurnal interest, like fisheries, anti-submarine warfare or salvage operations to note a few. Unlike the short-term or long-term variability, past investigations on the intradiurnal scale features based on close time series data from the seas around India are very few (Rao, 1960; Rao & Rao, 1962; Rao & Hareesh Kumar, 1987; Hareesh Kumar & Rao, 1989, Murthy & Madhusoodanan, 1987) and dealt with the diurnal ranges in temperatures and inversions in the surface layers off Visakhapatnam, eastern Arabian Sea and off Quilon. Off the southwest coast of Cochin, apart from the diurnal heating and wind mixing, additional effect of tidal advection causing a secondary warming during night has been observed earlier in

February (Vijayarajan & Santha Devi, 1987) and November (Vijayarajan *et al.* 1992). This paper attempts to examine a typical diurnal case for accounting the observed intradiurnal atmospheric forcing by the air-sea fluxes and the resulting oceanic responses in the thermohaline fields off Cochin during the heating season in April.

## MATERIALS AND METHODS

Time series (hourly) observations on hydrographic and meteorological parameters were made on board *FORV Sagar Sampada* from 0600 hrs on 16 April to 0600 hrs on 17 April 1991 at 9°44'N, 75°42'E (depth ~100 m) (Fig.1) near the edge of the continental shelf off Cochin. The hydrocasts were made using TSK micom-STD [accuracy:  $\pm 0.05^\circ\text{C}$ ,  $\pm 0.04 (\times 10^{-3})$  and  $\pm 3$  m or 0.3 % full scale]. Hourly data from records of surface, dry and wet bulb temperatures and of wind (TSK anemometer, accuracy:  $\pm 0.5 \text{ m s}^{-1}$  and  $\pm 5^\circ$ ) were also utilised. Standard procedures (Joseph *et al.* 1982) were followed to compute the radiative and turbulent fluxes of heat.

## RESULTS AND DISCUSSION

### Surface meteorology and air/sea fluxes

The surface pressure (PR) variation (1008 - 1013 mb) (Fig.2A) was bimodal (semidiurnal) with occurrences of maximum, minimum, secondary maximum and secondary minimum at 1000, 1700 and 2300 hrs on 16 April and 0500 hrs on 17 April respectively. Northwesterly/westerly wind (Fig.3A) was dominated by the northerly

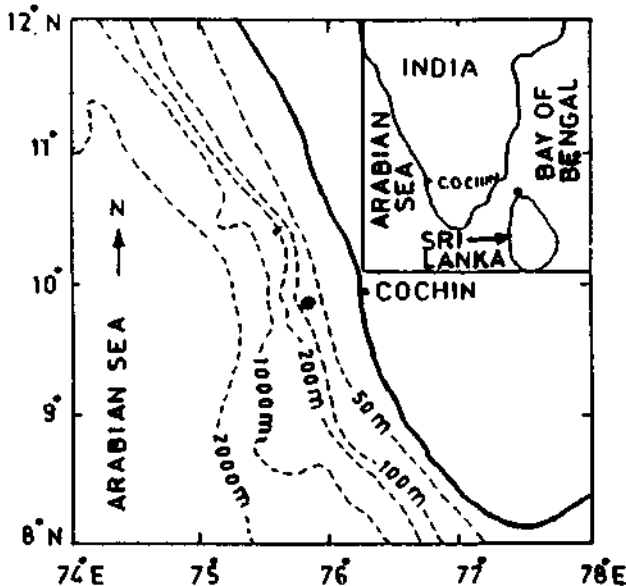

Fig.1 - Station location

component during the diurnal part of 16 April and by westerly component during the early morning hours of 17 April. Multimodal fluctuations in the wind speed ( $3 - 7 \text{ m s}^{-1}$ ) (Fig.2B) showed maximum in the afternoon (1700 - 2000 hrs) and minimum in the forenoon (0700 hrs and 1200 - 1400 hrs respectively) of 16 April. With a moderate cloud cover (2 - 4 octa, Fig.2C), ranging between maximum during 1200 - 1800 hrs on 16 April and minimum during the rest of the duration, the air temperature (DB) ( $28.7^\circ - 31.5^\circ$ ) followed a bimodal fluctuation (Fig.2D), reaching maximum at 1000 hrs, secondary maximum during 1900 - 2300 hrs, minimum at 0600 hrs and secondary minimum at 1600 hrs. The effect of dominant response to the changes in evaporation rate resulting from wind forcing was apparent in the multimodal variation of wet bulb temperature (WB) ( $26.0^\circ - 27.8^\circ\text{C}$ , Fig. 2E). Unlike the observations in February (Vijayarajan & Santha Devi, 1987) and November (Vijayarajan *et al.* 1992), a secondary nocturnal surface warming was not evident and the diurnal cycle of sea surface temperature (SST) ( $30.9^\circ - 31.3^\circ\text{C}$ , Fig.2F) indicated the presence of afternoon (1400 hrs) maximum and early morning (0600 hrs) minimum.

The unimodal cycle of net short wave flux ( $Q_i$ ) ( $0 - 875 \text{ W.m}^{-2}$ ) (Fig.4A) had the maximum at 1200 hrs, whereas the multimodal long wave flux ( $Q_b$ ) ( $-40$  to  $-60 \text{ W.m}^{-2}$ ) (Fig.4B) reached a minimum at 0900 hrs and maximum at 1500 hrs. The changes in the turbulent fluxes depended on dominant influences by wind speed as in the case of latent heat flux ( $Q_e$ ) ( $-60$  to  $-100 \text{ W.m}^{-2}$ ) (Fig.4C) and by air-sea temperature difference as in the case of sensible heat flux ( $Q_s$ ) ( $2$  to  $-7 \text{ W.m}^{-2}$ ) (Fig.4D) with the maximum of heat gain at 1200 hrs and loss at 1800 hrs. The variation in the net surface

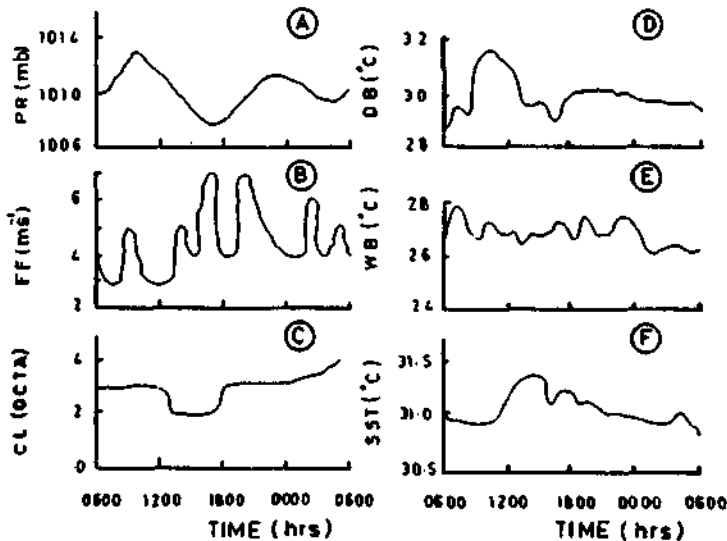

Fig.2 - Hourly march of: A) surface pressure (PR), B) wind speed (FF), C) cloud cover (CL), D) air temperature (AT), E) wet bulb temperature (WB) and F) sea surface temperature (SST) during 16 - 17 April 1991

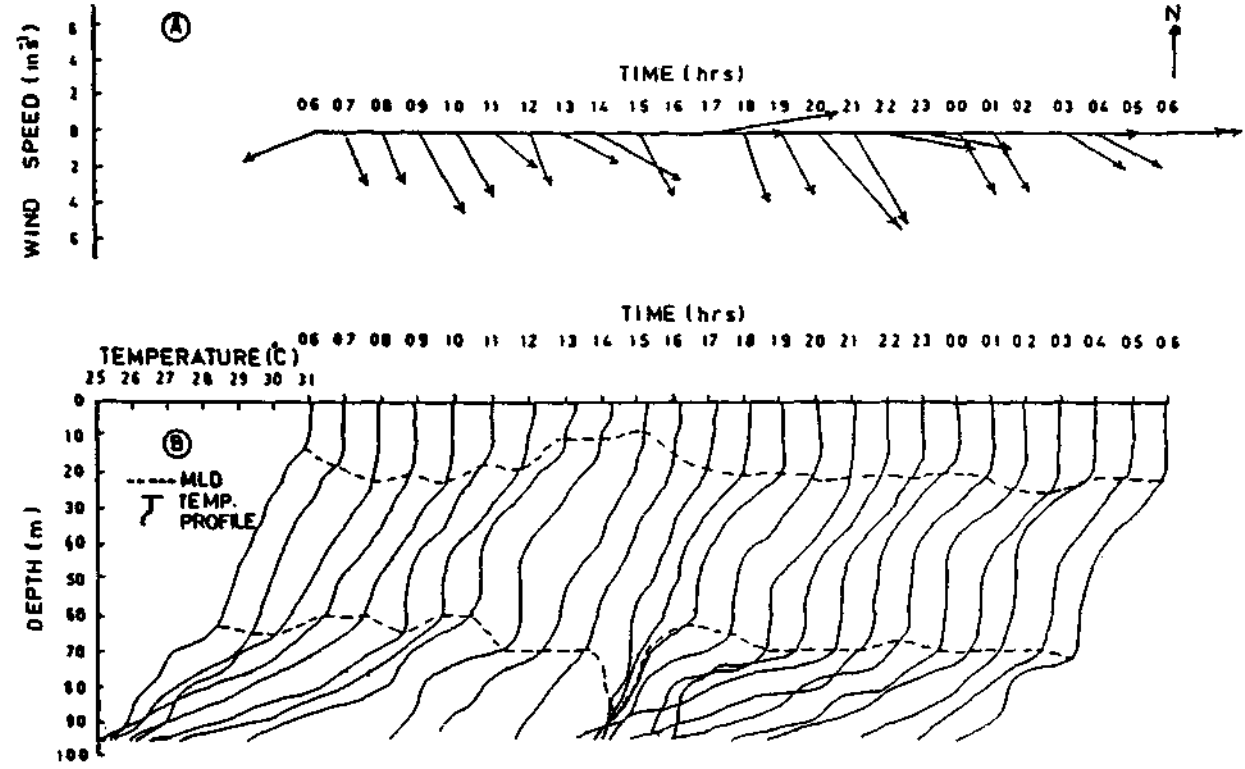

Fig.3 - Hourly progress of: A) wind vectors and B) thermal profiles during 16 - 17 April 1991

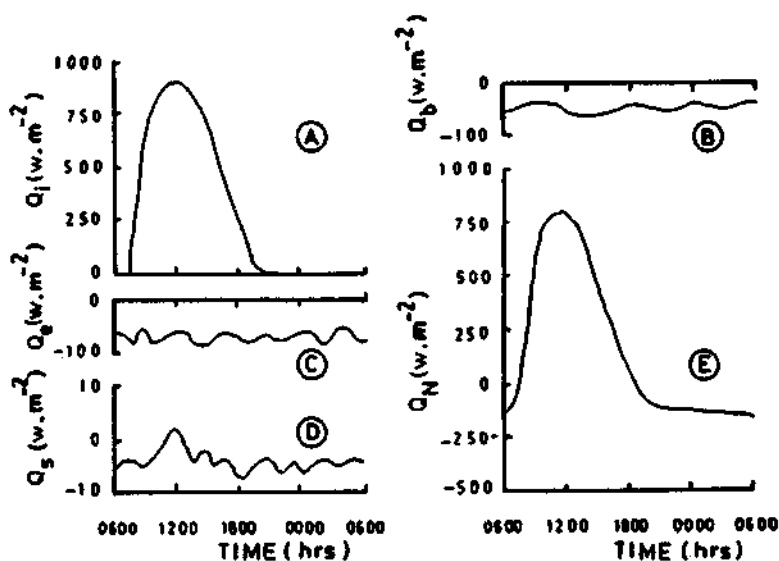

Fig.4 - Hourly march of: A) net short wave flux ( $Q_i$ ), B) long wave flux ( $Q_b$ ), C) latent heat flux ( $Q_e$ ), D) sensible heat flux ( $Q_s$ ) and E) net surface heat flux ( $Q_N$ ) during 16 - 17 April 1991

heat flux ( $Q_N$ ) ( $775$  to  $-150 \text{ W.m}^{-2}$ ) (Fig.4E) was unimodal with maximum heating at 1200 hrs and cooling during 0000 - 0600 hrs.

### Responses of the shelf waters

Prominent intradiurnal responses of the waters at the site are observable in the case of mixed layer (ML) parameters, namely the mixed layer temperature (MLT) (assessed as the depth averaged temperature of ML) and mixed layer depth (MLD) (being the shallowest depth with a  $0.2^\circ\text{C}$  drop from SST). MLT ( $30.7^\circ$  -  $31.0^\circ\text{C}$ , Fig.5A) closely followed the unimodal pattern of SST reaching an afternoon maximum and early morning minimum. MLD (11 - 26 m) (Fig.5B) followed a multimodal pattern with a minimum at 2000 hrs and a progressive increase to the maximum at 0400 hrs on 17 April. While the response of MLT (also of SST) has shown correspondence to the unimodal heating cycle (with a delay in response of 2 hrs), the multimodal cycle of MLD was under dominant response to the wind forcing with a time lag of 1 to 2 hrs, though a combined effect was apparent at noon. The hourly evolution of the vertical thermal profiles (Fig.3B) suggest the erosion of the seasonal thermocline after 1000 hrs on 16 April with the appearance of secondary mixed layer, whose upper limit varied between 38 - 54 m and changes in its thickness (15 - 30 m) showed similarity with those of surface MLD and hence suggested the dominant wind influence. The presence of this may be related to the internal mixing processes in the thermocline.

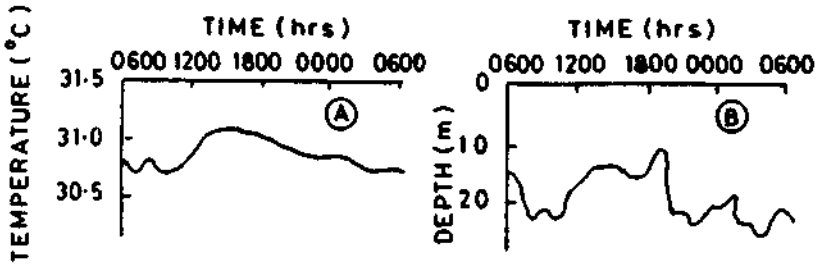

Fig.5 - Hourly march of: A) mixed layer temperature (MLT) and B) mixed layer depth (MLD) during 16 - 17 April 1991

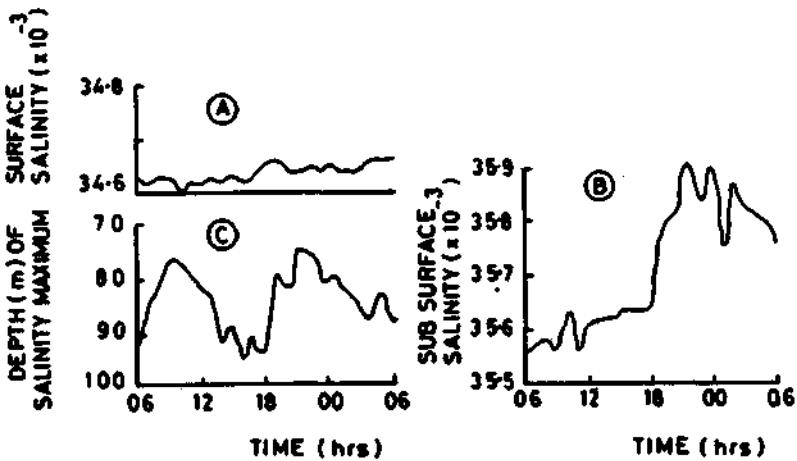

Fig.6 - Hourly march of A) surface salinity (SS), B) subsurface salinity maximum (SSM) and C) depth of subsurface salinity maximum (DSSM) during 16 - 17 April 1991

The fluctuations in surface salinity (SS) ( $34.60 - 34.66 \times 10^{-3}$ ) (Fig.6A) was minimum and showed only a gentle increase over the diurnal cycle to the maximum, owing to the possible increased salinity advection. The magnitude of the subsurface salinity maximum (SSM) ( $35.56 - 35.90 \times 10^{-3}$ ) (Fig.6B) corresponding to the core of Arabian Sea High Salinity Water (ASHSW) (Rochford, 1964; Wyrki, 1971) reached maximum after 1800 hrs. Changes in the depth of subsurface salinity maximum (DSSM) (75 - 95 m, Fig.6C) followed a bimodal pattern, possibly of semidiurnal tidal origin with maxima at 0900 and 2200 hrs and minima at 1400 hrs on 16 April and 0600 hrs on 17 April.

## CONCLUSION

Analysed hourly data on the surface forcings over a diurnal cycle on 16/17 April 1991 at the continental shelf break off Cochin reveals the following. Northwest-erly/westerly wind forcing, less dominant in the forenoon of 16 April, increased

near-persistently in the afternoon to early next morning (17 April) under a bimodal cycle of surface pressure and unimodal afternoon increase in cloud cover. While air temperature varied bimodally with a range of 28.7° - 31.5°C, sea surface temperature (30.9° - 31.3°C) varied unimodally with afternoon (1400 hrs) maximum and early morning (0600 hrs) minimum. The variation in  $Q_N$  (775 to -150  $W.m^{-2}$ ) was unimodal (maximum at 1200 hrs and minimum during 0000 - 0600 hrs) with daytime gain dominated by  $Q_i$  and nighttime loss dominated by  $Q_e$  and  $Q_b$  (multimodal).

The intradiurnal responses in the shelf waters are greatly manifested in the unimodal cycle of mixed layer temperature, closely following the surface heating cycle and the multimodal mixed layer depth with a forenoon minimum, reaching maximum under near-persistent wind forcing through the following afternoon, night and early morning. The probable influence of internal wave mixing was apparent after 1000 hrs on 16 April by the erosion of the seasonal thermocline and the appearance of a secondary mixed layer whose thickness changed in response to surface wind forcing. While possible advective influences effected the progressive increase in surface salinity over the diurnal cycle, a substantial shift from a low salinity ( $<35.6 \times 10^{-3}$ ) to high salinity ( $>35.7 \times 10^{-3}$ ) regime of the SSM due to the influence of ASHSW occurred around 1800 hrs with bimodal depth variation.

### ACKNOWLEDGEMENT

Authors are thankful to the Director for the support given for this work. Thanks are also due to the ship's complement and the fellow scientists of NPOL who were responsible for the data collection on board *FORV Sagor Sampada* during the cruise.

### REFERENCES

- Hareesh Kumar, P. V. & Rao, R. R. 1987. Diurnal variability in the vertical thermal structure of coastal waters off southwest coast of India during May 1985, *Indian J. Mar. Sci.* 16: 71 - 76.
- Joseph, M. G., Hareesh Kumar, P. V & Joseph, M.X. 1992. Deep and shallow water characteristics of mixed layer response to momentum and buoyancy fluxes off Bombay, west coast of India, *Conti. Shelf Res.* 12 (5/6): 661 - 673.
- Murthy, P. G. K. & Madhusoodanan, P. 1987. Diurnal variation of hydrographic conditions in the surface layer off Calicut in February 85. In: *Proc. Symp. Short-term Variability of Physical Oceanographic Features in Indian Seas*, (Naval Physical & Oceanographic Laboratory, Cochin) 67 - 69.
- Rao, C. P. 1960. Diurnal variation of certain meteorological and oceanographic features off Vizag, *Indian J. Met. Geophys.* 11: 35 - 37
- Rao, R. R & Hareesh Kumar, P. V. 1989. On the observed intradiurnal variability in the thermal structure of the upper layers at a station in the eastern Arabian Sea before the onset of summer monsoon-77, *Mausam*, 40: 37 - 42.
- Rao, T. S. S. & Rao, V. C. 1962. Studies on diurnal variation in hydrological condition off the Waltair coast, *J. Mar. Biol. Ass. India*, 4 : 23 - 43.
- Rochford, A. J. 1964. Salinity maximum in the upper 1000 metres of the north Indian Ocean, *Australian J. Mar. Freshwater Res.* 15: 1 - 24.

- Vijayarajan, P. K, Prasada Rao, C. V. K, Mohan Kumar, N & Ananth, P. N. 1992. Nocturnal warming of the nearshore waters off Cochin - A case study, In: *Physical Processes in the Indian Seas*, edited by G. Narayana Swamy, V. Kesavadas & M. K. Antony, (National Institute of Oceanography, Goa, India) 137 - 141.
- Vijayarajan, P. K. & Santha Devi, M. R. 1987. Fine thermal structure of the mixed layer in February off Beypore, In: *Proc. Symp. Short-Term Variability of Physical Oceanographic Features in Indian Seas*, (Naval Physical & Oceanographic Laboratory, Cochin) 73-78.
- Wyrtki, K. 1971. *Oceanographic Atlas of International Indian Ocean Expedition*, (National Science Foundation, Washington, D C) pp. 531.

\* \* \*



## **Upper layer variability off Cochin during pre-onset period of summer monsoon 1992**

P.V.Hareesh Kumar & N.Mohan Kumar

Naval Physical and Oceanographic Laboratory, BMC P.O. Cochin-682 021

### **ABSTRACT**

The role of winds, net air-sea heat flux and surface waves on the variability of mixed layer in the coastal waters (90m) off Cochin during the premonsoon season of 1992 (23 May to 4 June 1992) is examined. Both sea surface temperature (SST) and mixed layer depth (MLD) exhibited diurnal oscillations. An increase in the diurnal range of SST (0.8°C) is noticed towards the end of the observational period. Within the mixed layer, continuous increase in the total beam attenuation coefficient suggests increased concentration of suspended particles, brought by the prevailing southwesterly flow. A one dimensional numerical model was utilised to simulate the observed changes in the mixed layer temperature (MLT) and depth (MLD). A close agreement is noticed between the observed and simulated MLD. However, the model could not simulate the large amplitude noticed in observed MLT after 27 May which was caused by the increase in suspended particle concentration.

### **INTRODUCTION**

Recently more emphasis has been given on the prediction of ocean thermal structure on different time scales, owing to its application on various fields like weather forecasting, acoustic propagation studies, fisheries etc. There are a number of one dimensional numerical models to simulate the thermal structure on short time scales (Miller, 1976; Niiler & Kraus, 1977; Price *et al.* 1986). The objective of this paper is to evaluate the one dimensional model of Miller (1976), which is a modified version of Denman (1973) and Kraus & Turner (1967), model and to explain the mixed layer physics.

### **MATERIALS AND METHODS**

*FORV Sagar Sampada* occupied a stationary position off Cochin (9°43'N and 75°44'E) during the premonsoon season of 1992 (23 May to 4 June 1992) (Fig.1).

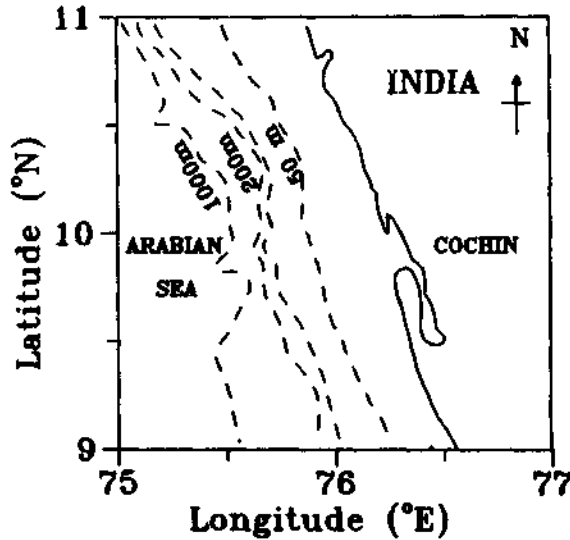

Fig.1- Station location map

Three hourly CTD casts and hourly surface marine meteorological observations including solar radiation were made during this period. Subsurface currents were also obtained (2 minute interval) by deploying an array of RCM4 and RCM7 Aanderaa current meters at 10,20,40,60,80m. Since time series measurements of solar radiation were available from 25 May, analysis was carried out only for this period. Details of the computational procedures of net-air sea flux are given in Hareesh Kumar (1994).

## RESULTS AND DISCUSSION

Hourly time series of wind speed (FF), wave height (H) and net air-sea heat flux (Q) were analysed to understand their role in the variability of sea surface temperature (SST) and mixed layer depth (MLD) (Fig.2). MLD is taken as the deepest depth where a drop of  $0.2^{\circ}\text{C}$  occurs in the individual temperature profile (Staevenson & Niiler, 1983). During this period, wind speed and wave height decreased steadily (FF decreased from  $5.3 \text{ m.s}^{-1}$  to  $2.3 \text{ m.s}^{-1}$  and H decreased from 1.3 m to 1.0 m) favouring calm weather conditions. These factors resulted in the accumulation of heat (positive Q) in the surface layers which in turn stabilised surface layers and limited the depth of daytime mixed layers to  $<10\text{m}$ . On the other hand convective overturning due to net heat loss ( $-200 \text{ W.m}^{-2}$ ) deepened mixed layers to 30m during nighttime. Corresponding to accumulation/depletion of Q, SST also exhibited heating/cooling cycle. A lag of 3 hour is noticed between maximum Q and maximum SST while a lag of 6 hour is noticed between minimum Q and minimum SST. Further, SST continuously increased towards the end of observational period (maximum in SST varied from  $30.25^{\circ}$  to  $31^{\circ}\text{C}$ ). As the mixed layers are shallow (MLD  $<30\text{m}$ ), SST responded

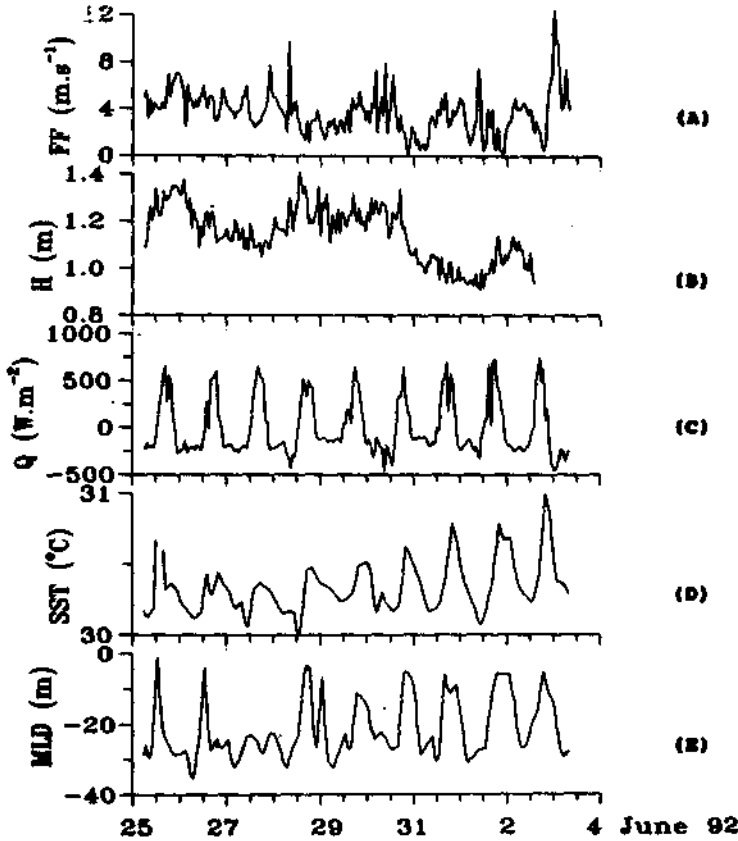

Fig.2- Hourly time series of (A) wind speed, FF; (B) wave height, H; (C) net air-sea heat flux, Q; (D) sea surface temperature, SST; and (E) mixed layer depth, MLD

rapidly with diurnal range ( $\Delta T$ ) upto  $0.8^{\circ}\text{C}$ . The cross correlation ( $r$ ) of MLD and SST with related parameters discussed above revealed that significant relation exist only with net air-sea heat flux ( $r = -0.7$  for MLD and  $0.54$  for SST).

A one-dimensional numerical model (Miller, 1976) was utilised to simulate the depth (MLD) and temperature (MLT) of the mixed layer. The model was forced with hourly meteorological inputs and integrated with 15 minute time steps. Initial conditions were estimated from 0600 hrs on 25 May data and the model was integrated in time to 0600 hrs on 4 June. Extinction coefficient ( $\gamma$ ) and the fraction of wind stress energy ( $m$ ) used in the simulation are  $0.08 \text{ m}^{-1}$  and  $0.0012$  respectively. The observed MLD and MLT were subjected to a three point moving average to remove short period oscillations. Results of the simulation along with observations are presented in Fig. 3. The root mean square (rms) error estimated for MLT and MLD are  $0.13^{\circ}\text{C}$  and  $4.8\text{m}$  respectively. Simulation of MLD showed close agreement with observation, as indicated by the small rms error ( $4.8\text{m}$ ). On the other hand, simulation of MLT was good

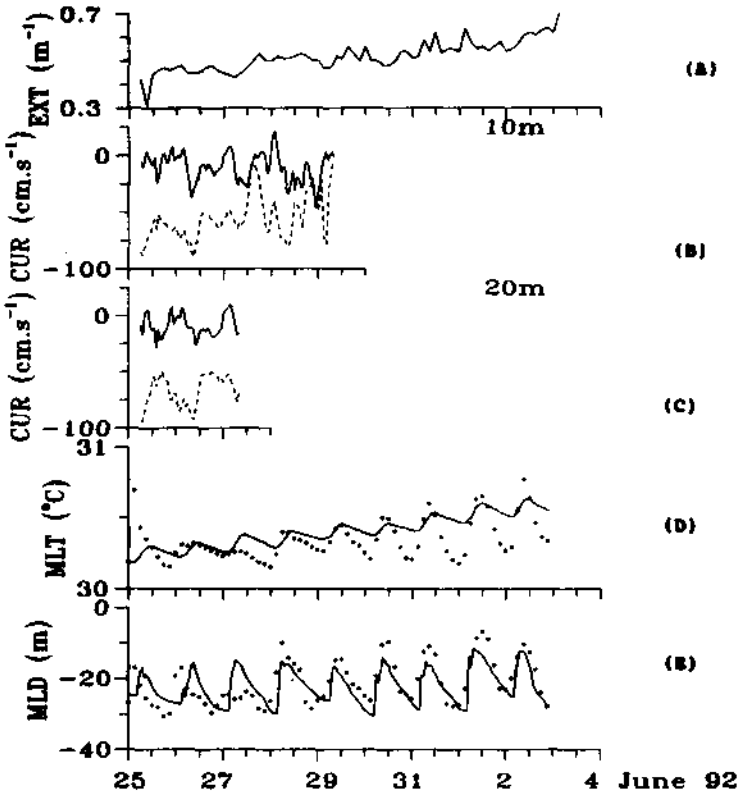

Fig.3- Hourly time series of (A) total beam attenuation coefficient, EXT; (B,C) U (—) and V (---) components of currents at 10 and 20 m depth; (D,E) observed (\*\*\*\*) and simulated (—) mixed layer depth, MLD and mixed layer temperature, MLT

in the first three days (25 May to 27 May). After 27 May large departure was noticed between observed and simulated MLT (maximum of  $0.3^{\circ}\text{C}$ ). This can be explained in terms of increase in the total beam attenuation coefficient (Fig.3A), which is a measure of suspended sediment concentration and prevailing flow pattern (Fig.3 B,C). The flow within the mixed layer is mainly southwesterly as indicated by negative U and V components of currents. This flow brings sediment rich coastal waters into the observational site thereby increasing the turbidity. As the suspended particle concentration of the water increases ( $0.41$  to  $0.65\text{ m}^{-1}$ ) (Fig.3A), penetration of incoming solar radiation decreases leading to accumulation of heat in shallow surface layers (Fig.3C). After sunset, depletion of heat occurred from this shallow layer. The combined effect of these two processes resulted in large temperature range in the surface layer ( $0.8^{\circ}\text{C}$ ). The cross correlation of MLD and MLT with the turbidity coefficient suggested significant relation ( $-0.83$  for MLD and  $0.8$  for MLT). This clearly shows that physical processes causing this large  $\Delta T$  is a three dimensional and the one dimensional model used here cannot be expected to simulate this large  $\Delta T$ .

## ACKNOWLEDGEMENT

Authors wish to express their sincere thanks to the Director for the encouragement received for undertaking the present study. Authors are also thankful to the fishing master and all crews of *FORV Sagar Sampada* for their help in carrying out the operation.

## REFERENCES

- Denman, K.L. 1973. A time dependent model of the upper ocean. *J. Phys. Oceanogr.* 3: 178-184.
- Hareesh Kumar, P.V. 1994. *Thermohaline variability in the upper layers of Arabian Sea*. Ph.D. thesis, Cochin University of Science and Technology, Cochin.
- Kraus, E.B. & Turner, J.S. 1967. A one-dimensional model of the seasonal thermocline, II. The general theory and its consequences. *Tellus*, 19: 98-106.
- Miller, J.R. 1976. The salinity effect in a mixed layer ocean model. *J. Phys. Oceanogr.* 6: 29-35.
- Niiler, P.P. & Kraus E.B. 1977. One-dimensional models. In : *Modelling and prediction of the upper layers of the ocean*. edited by E.B. Kraus (Pergamon Press, New York) 143-172.
- Price, J.F., Weller R.A. & Pinkel, R. 1986. Diurnal cycling: Observations and models of the upper ocean response to diurnal heating, cooling and wind mixing. *J. Geophys. Res.* 91: 8411-8427.
- Stevenson, J.W. & Niiler P.P. 1983. Upper ocean heat budget during Hawaii to Tahiti shuttle experiment. *J. Phys. Oceanogr.* 13: 1894-1907.

\*\*\*

## **Confirmatory checks for the internal waves in the coastal waters off Cochin**

P.G.K.Murthy & N.Mohan Kumar  
Naval Physical and Oceanographic Laboratory  
BMC PO, Thrikkakara, Cochin-682 021

### **ABSTRACT**

The moored current meter data in the stratified water column (40-80 m) and time series STD measurements at a station in the coastal waters off Cochin during April '91 and May/June '92 showed rhythmic fluctuations within internal wave (IW) frequency band. Following consistency checks of IW are applied to these data sets to understand whether the fluctuations are induced by the local IW field. The current meter data are subjected to FFT to know whether their spectral slopes fit into the Garrett & Munk (GM) IW spectrum. These slopes correspond to -1.4 to -1.7 instead of GM slopes of -5/3 to -2.0. The energy aspects of IW are analysed with Fofonoff linear model of IW. The results indicated that the observed IW fit into this model. Although present findings tend to support that the changes in the flow in the stratified waters within the IW frequencies are due to local IW field, still they are to be confirmed by future findings.

### **INTRODUCTION**

Like any other oceanographic phenomena internal waves (IW) can be regarded as ubiquitous in the ocean. They possess varied amplitudes over a broad frequency band, bounded by inertial ( $f$ ) and Brunt-Vaisala ( $N$ ) frequencies (Roberts, 1975). The IW effect significant periodic changes in the pycnocline (stratified) region. But the ocean is such a dynamic medium that, besides IW, other oceanographic processes- such as turbulence- can also induce changes in the pycnocline over similar frequency scales. So, in order to ensure that the observed changes in the stratified water column emerge out of IW it becomes necessary, if not sufficient, to establish consistency relations for the IW in the stratified region. Based on the energy aspects of IW, Fofonoff (1969) developed a linear model and checked the model results with the field measurements of IW. Later Garrett & Munk (1972,1975) fit a statistical universal spectrum for the IW, synthesizing all the available IW measurements. An attempt is made to apply these two models for the present field data sets on IW, generated from current meter

moorings and STD time series measurements off Cochin, to relate the observed fluctuations of currents and temperatures in the stratified water column to the IW.

## MATERIALS AND METHODS

Current meter moorings were conducted from *FORV Sagar Sampada* at a station ( $9^{\circ}43'N$ ,  $75^{\circ}42.6'E$ , depth=100 m) in the coastal waters off Cochin (Fig.1) for 11 days starting from 9 April 1991 (hereafter referred as phase-1) and was subsequently repeated for 13 days from 22 May 1992 (referred as phase-2). The details of mooring operations and sensors used in this program are given in another paper (Murthy & James, 1995). The current meter data, sampled at 2 minute interval, in the stratified water column (40-80 m) were used in this paper. The MICOM STD and CTD systems were deployed three hourly for 7 days and 10 days during phase-1 and phase-2 respectively. These profiles were also used in this investigation.

Based on temperature and salinity data, Brunt-Vaisala/buoyancy frequency ( $N$ ) was computed from

$$N = \left[ \frac{g \delta \rho}{\bar{\rho} \delta z} \right]^{1/2} \quad \dots (1)$$

where  $g$  is acceleration due to gravity,  $\bar{\rho}$  is mean density of water layer and  $\frac{\delta \rho}{\delta z}$  is the density gradient of that layer.

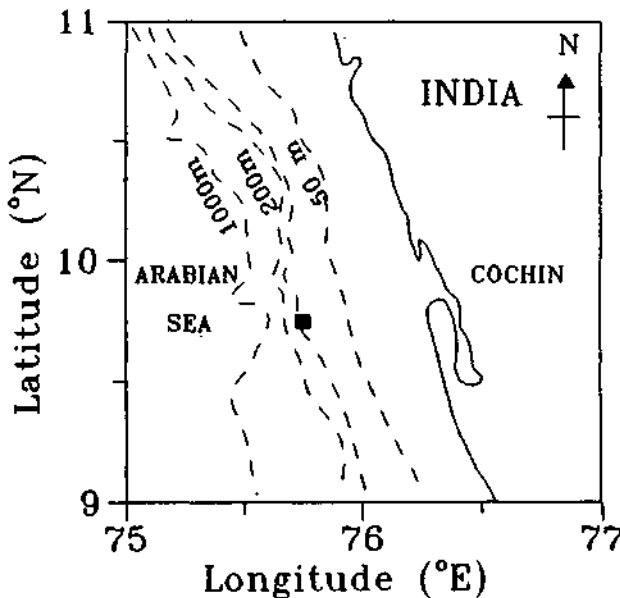

Fig. 1 - Location map showing current meter moorings (■)

In the linear model of IW, Fofonoff (1969) assumes equal partition of potential energy (PE) and kinetic energy (KE) among the IW and ignores the advective and nonlinear effects. He evaluates PE and KE for the IW frequencies ( $\omega$ ) from combinations of inertial frequency ( $f$ ) and Brunt-Vaisala frequency ( $N$ ) values. He develops spectral functions for PE and KE using the fluctuations of temperature and horizontal components (U and V) of currents. The frequency spectra of the energy ratio (PE/KE), obtained from the measurements, are compared with the theoretical values to understand whether the observed changes in temperature, salinity and current at the current meter levels in the stratified waters (within the IW frequencies) are caused by IW dynamics.

The linear model is governed by:

$$\frac{N^2 \left[ \omega^2 - f^2 \right]}{N^2 \omega^2 \left[ \omega^2 + f^2 \right]} = \frac{N^2 P_{\xi}}{P_{uu} + P_{vv}} \quad \dots (2)$$

$P_{\xi}$  - spectral function of vertical displacement of temperature ( $\xi$ ) at any level in the stratified water column,  $P_{uu}$  and  $P_{vv}$  - spectral functions of U and V at the same level ( $\frac{1}{2} N^2 P_{\xi}$  - PE in ergs/g/unit frequency;  $\frac{1}{2} (P_{uu} + P_{vv})$  - horizontal KE in the same units). [ $P_{\xi} = \frac{P_{\theta}}{(dt/dz)^2}$ ];  $P_{\theta}$  - spectral function of temperature fluctuations ( $\theta$ ) at any level within the stratified waters,  $\frac{dt}{dz}$  - mean vertical gradient of temperature at the same level]. Left side of Eq. (2) corresponds to the theoretical values of the model.

## RESULTS AND DISCUSSION

The vertical sections of temperature and salinity, collected using CTD at the moored site for both the phases (Fig.2), clearly reveal periodic fluctuations in the entire stratified water column with diurnal (24 hours) and semidiurnal (12 hours) periods with corresponding amplitudes between 5 m, and 10 m. These amplitudes match well with earlier observations (Sarma *et al.* 1991; Murthy *et al.* 1992). The profiles of  $N$  for phases-1 and -2 (Fig. 2) reflect their typical oceanic nature showing a major peak of 17 cph at 70 m in phase-1 and 40 m in phase-2 which corresponds to the core of the pycnocline. The 30 m shoaling of this peak in phase-2 occurs under the influence of intense upwelling activity at this location. Another peak of 11 cph was also noticed in phase-1 at 25 m due to strong pre-monsoon warming in the upper layers. The temperature gradients and  $N$  values in the stratified water column are also used later in the linear model of IW.

Currents and temperatures (T) at 40, 60 and 80 m from moored sensors are used to document their temporal fluctuations in this analysis. Salinity at these levels are not included as its temporal structure is similar to that of T. Some general features on the flow patterns are discussed by Murthy & James (1995). The currents were resolved into zonal (U) and meridional (V) components. The time series plots of T and U at



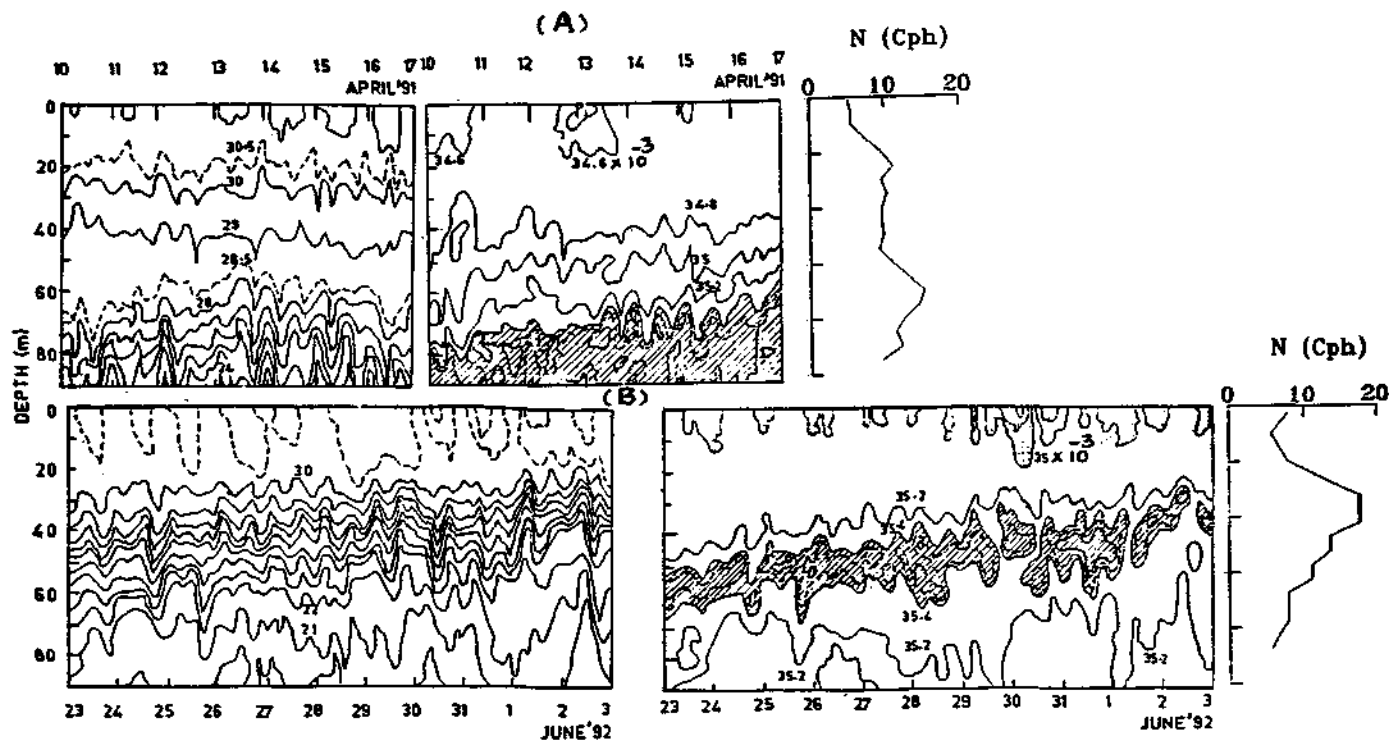

Fig. 2 - Vertical sections of temperature (contour interval- 1 °C; (solid line), 0.5 °C (broken line); salinity (contour interval-  $0.2 \times 10^{-3}$  and profiles of Brunt-Vaisala frequency (N); A) Phase-1, B) Phase-2

selected depths (Fig.3) reveal prominent semidiurnal and diurnal peaks with superimposed oscillations of frequencies exceeding 1 cph. These rapid oscillations are caused, as shown later, by local IW field. The amplitudes of these parameters at 80 m in phase-1 and 60 m in phase-2 increased by 1.5 to 3 times compared to other levels. Also, the water flow at all depths in phase-2 strengthens by 2 to 3-fold compared to phase-1. This strengthening of the flow in the upper 40 m may be attributed to strong wind force in phase-2 (11 m/s against 5 m/s in phase-1).

For an isotropic IW field, viz. IW propagating without any preferred direction, Garrett & Munk (1972, 1975) examined various IW data sets and suggested an optimum range for the spectral slopes of IW which lies between  $-5/3$  and  $-2$ . The current components in the stratified waters were subjected to FFT incorporating Hanning window ( $N=7200-8100$ ,  $m=4096$  with 50% overlapping,  $\Delta t = 2$  min). Their frequency spectra are shown in Fig. 4. Some of the spectral characteristics of the IW are discussed by Murthy & James (1995). Further, the spectral slopes of these parameters (temperature and currents) are found to vary between  $-1.4$  and  $-1.7$  and

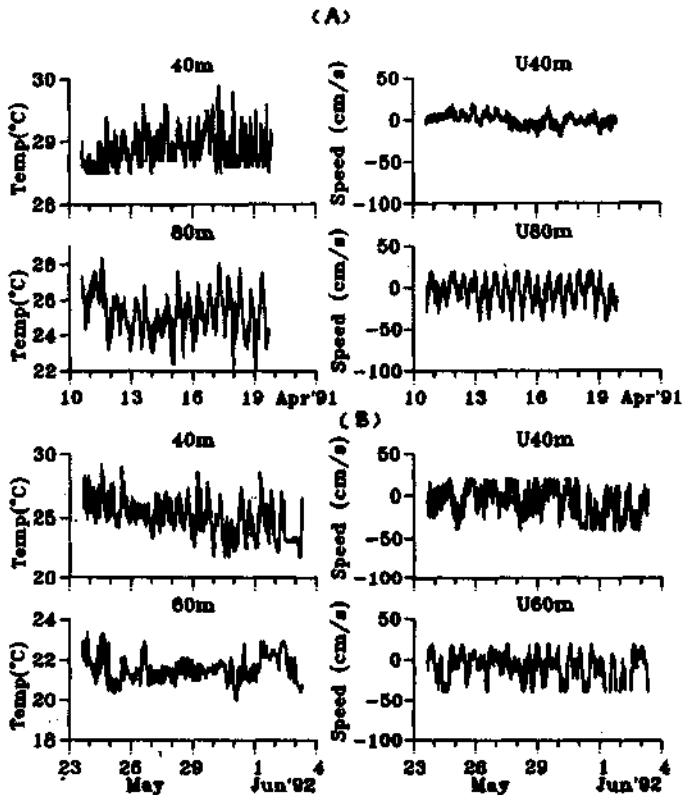

Fig. 3 - Time series plots of temperature and zonal component (U) of currents (subscripts refer to current meter levels); A) Phase- 1, B) Phase-2

increase with depth. Although these slopes are close to the suggested limits by Garrett & Munk (1975), yet they differ by +0.3. These departures are due to more energy in the high-frequency (>1cph) band of IW. It may be noted that the GM slopes are for the deep water IW. Thus, it is to be verified whether (relatively) gentle slopes in present measurements represent the typical nature of shallow water IW or because the IW field is anisotropic.

The results of linear model (Fofonoff) of IW based on theoretical values and measurements are shown in Fig.5. In the linear model theoretical ratio of PE/KE (solid curve) becomes unity in the entire IW frequency band. However, the corresponding ratios from the measurements lie well below the theoretical in the entire frequency of IW. These features suggest that the IW field at this site follows linear model up to 2 to 3 cph and thereafter it fails to support the linear theory of IW (the departures beyond 2 to 3 cph are due to larger  $\zeta$  at high-frequency of IW). This brings out two possibilities. First is that the observed IW beyond 2 to 3 cph may be of nonlinear nature. Further, these findings reveal that the systematic fluctuations in currents and temperatures in the pycnocline regions are seldom associated with either turbulence or instrument noise.

However, there are some basic differences between Fofonoff's and present measurements. Fofonoff used deep water measurements at a depth of 400 m, whereas present measurements are in the upper 80 m of the coastal waters. The IW frequency band at his measurement site is narrow (0.05-0.95 cph) against a wider band (0.015-17

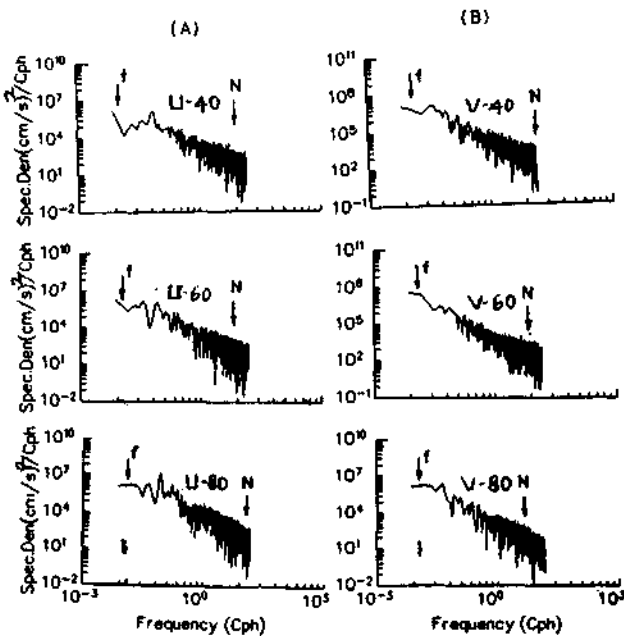

Fig. 4 - Power spectra of currents (vertical bars - 95% confidence limits); A) Phase-1, B) Phase-2

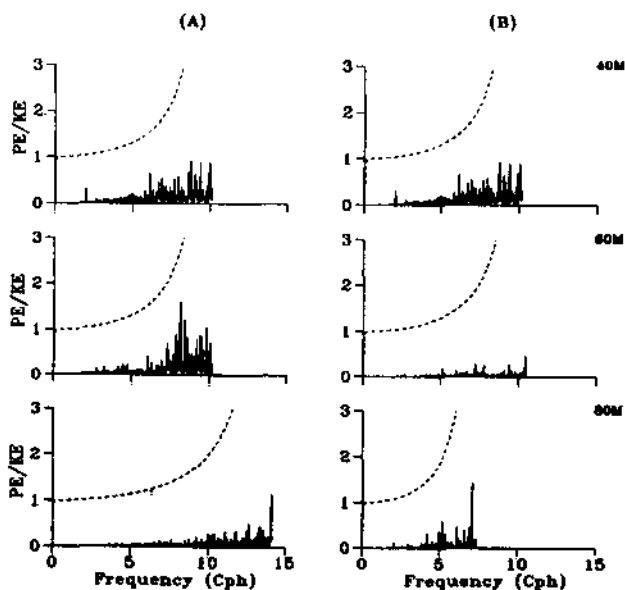

Fig. 5 - Energetics of internal waves (PE - Potential energy, KE - Kinetic energy; —: theoretical curve, - - -: measurements); A) Phase-1, B) Phase-2

cpH) off Cochin. Despite these differences, the dynamics of IW in shallow waters appear to be similar to that in deep waters.

Present results at best can be treated as preliminary work on the IW dynamics off Cochin. Future measurements based on more comprehensive data sets can possibly verify these results.

## REFERENCES

- Garrett, C. & Munk W, 1972. Space-time scales of internal waves. *Geophys Fluid Dyn.* 2: 225-264.
- Garrett, C. & Munk W, 1975. Space-time scales of internal waves: A progress report. *J. Geophys. Res.* 80: 291-297.
- Fofonoff, N.P. 1969. Spectral characteristics of internal waves in the ocean, *Deep-Sea Res.* 16: 58-71.
- Murthy, P.G.K. & James, V.V. 1995. Some aspects of internal waves in the coastal waters off Cochin, (In this volume).
- Murthy, P.G.K., Sharma G.S., James V.V & Suseela K.V, 1992. Internal wave characteristics in the eastern Arabian Sea during summer monsoon, *Proc. Indian Acad. Sci (Earth Planet. Sci.)*, 101: 317-327.
- Roberts, J. 1975. *Internal gravity waves in the ocean*, (Marcel Dekker Inc. New York), pp.263.
- Sarma, Y.V.B., Sarma, M.S.S., Krishnamacharyulu R.J. & Rao, D.P. 1991. Subsurface oscillations at an oceanic station in the Bay of Bengal. *Indian J. Mar. Sci.* 20: 204-207.

## **Some aspects of internal waves in the coastal waters off Cochin**

P.G.K.Murthy & V.V.James

Naval Physical and Oceanographic Laboratory  
BMC PO, Trikkakara, Cochin - 682 021

### **ABSTRACT**

The current meter data sets generated from the moorings at a station in the coastal waters (depth ~100 m) off Cochin during May/June 1992 and winds from an anemograph, installed onboard during this programme, are analysed to document the observed features on the circulation and internal waves (IW). The currents in the entire water column increased by two-fold in May '92 compared to April '91 and the water flow at deeper levels opposed the near surface flow during both the programmes. The water properties in the stratified region (40-80 m) exhibit rhythmic fluctuations in the frequency band of IW. The FFT analysis of the currents in this depth regime reveals that the IW consist of harmonics of 0.02, 0.04 and 0.08 cph in the low- frequency band and 3, 4, 6, 8 and 10 cph in the high-frequency band. The local IW field demonstrates significant diurnal changes with increased activity during nighttime. The coherence computations between winds and currents suggest winds as a possible mechanism for the IW of high-frequency band.

### **INTRODUCTION**

Internal waves (IW) occur in the stratified waters (i.e. pycnocline) of the ocean and propagate with appreciable amplitudes within the inertial and Brunt-Vaisala frequencies. Usually they have no preferred directionality. The IW affect several fields like fisheries, pollution, offshore drilling, ocean fine structure, sediment transport and underwater acoustic propagation. Although studies on IW in Bay of Bengal started long back by La Fond & Purnachandra Rao (1954), no much progress is made thereafter in this field in the seas around India.

The IW are not directly measured but only interpreted from the field measurements. Out of several measurement techniques, time series measurements of oceanic properties/processes from stationary ships/moored instrumented buoys and spatial measurements from drift-buoys are widely used. Using time series temperature

profiles from stationary ships during ISMEX (Indo- Soviet Monsoon Experiment) (Ramam *et al.* 1979) and other programmes (Sarma *et al.* 1991) some properties of the internal tides (i.e. IW of tidal frequencies), including their response to a deep depression off Karwar (Murthy & Hareesh Kumar, 1991) and high-frequency (i.e. >1 cph) IW (Murthy *et al.* 1992) are documented. Short-term moored current meter data sets in the coastal waters around India were analysed by Varkey (1980), Antony *et al.* (1985), Sanil Kumar *et al.* (1989), Rao *et al.* (1991) and Shenoi & Antony (1991) for studying some characteristics and spectral composition of IW. Recently, Mc Phaden & Peters (1992) demonstrated diurnal changes among the IW obtained from moored sensors in the equatorial Pacific.

In this paper recent current data sets, generated from the current meter moorings off Cochin about two weeks for two consecutive years are used to understand the flow characteristics at different depths and some properties of IW, like wave parameters, spectral composition and diurnal activity of the observed IW and coupling between these IW and the local wind field.

## MATERIALS AND METHODS

In one of the field programs a vertical array of 5 recording current meters was moored from *FORV Sagar Sampada* at a station ( $9^{\circ} 43'N$ ,  $75^{\circ} 42.6'E$ , depth ~100 m) in the coastal waters off Cochin (Fig.1) in April 1991. The mooring operations

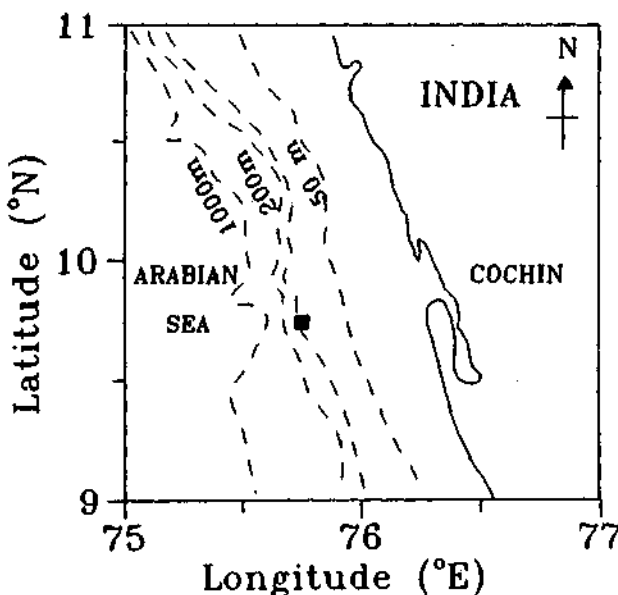

Fig.1 - Location map showing current meter moorings (■)

Table 1 - Details of measurements during Phase-1 (9-19 April '91) and phase-2 (22 May-3 June'92)

Sensor	Depth (m)	Sampling interval (min)	Duration (days)	Parameters	Remarks
Recording current meters	2, 20, 40, 60 & 80	2	11 (Phase-1)	Current speed, direction, temperature, salinity and depth	Depth sensors are not reliable. Salinity sensors at 40 m in phase-1 and 60 m in Phase-2 malfunctioned.
	10, 20, 40, 60 & 80	-do-	13 (Phase-2)	-do-	
STD/CTD	upper (95)	180	7 (Phase-1)	Temperature, and salinity at 1 m interval	Current meters at 10 m and 20 m in Phase-2 worked only in first week
			10 (Phase-2)		
Anemograph	15 m height	-	7 (Phase-1)	Wind speed and direction	Digitized at 10 min. interval
			5 (Phase-2)		

were repeated from the same ship at the same site in May/June 1992. 'I' mooring was done interconnecting the current meters by a 14 mm polypropylene rope. A couple of surface floats, attached to the top current meter, was left at the surface for identification and retrieval of the moorings. The current meters (Aanderaa - RCM4S and RCM7S) fitted with sensors of speed ( $\pm 1$  cm/s), direction ( $\pm 5^\circ$ ), temperature ( $\pm 0.05^\circ$  C), conductivity ( $\pm 0.025$  m mho/cm) and pressure ( $\pm 1\%$  of the range). The ship was anchored in the vicinity of the moorings and MICOM STD recorder (TSK, Japan;  $\pm 0.05^\circ$  C,  $\pm 0.02\%$  &  $\pm 3$  m) and CTD recorder (Sea-Bird, USA;  $\pm 0.01^\circ$  C,  $\pm 0.01\%$  &  $\pm 1.4$  m) were deployed from the ship at 1hr and 3hr intervals respectively. An anemograph (TSK, Japan;  $\pm 0.5$  m/s,  $\pm 5^\circ$ ) was installed on the ship for continuous recording of winds at 15 m above the sea level. The details of the programme are given in Table 1.

## RESULTS AND DISCUSSION

Hourly averaged vector plots for winds and currents are presented in Fig.2 for both phases. The wind field nearly doubles from phase-1 (~5 m/s) to phase-2 (~10 m/s). A similar strengthening is noticed in the currents from phase-1 (30-50 cm/s) to phase-2 (50-100 cm/s), which suggests local winds as the generating mechanism for the currents. Normally, when the tides generate the currents the current vectors depict regular semidiurnal flow reversals (i.e. vectors spreading on either side of time axis at 6 hr intervals). But in this case the currents in phase-1 depict irregular flow reversals

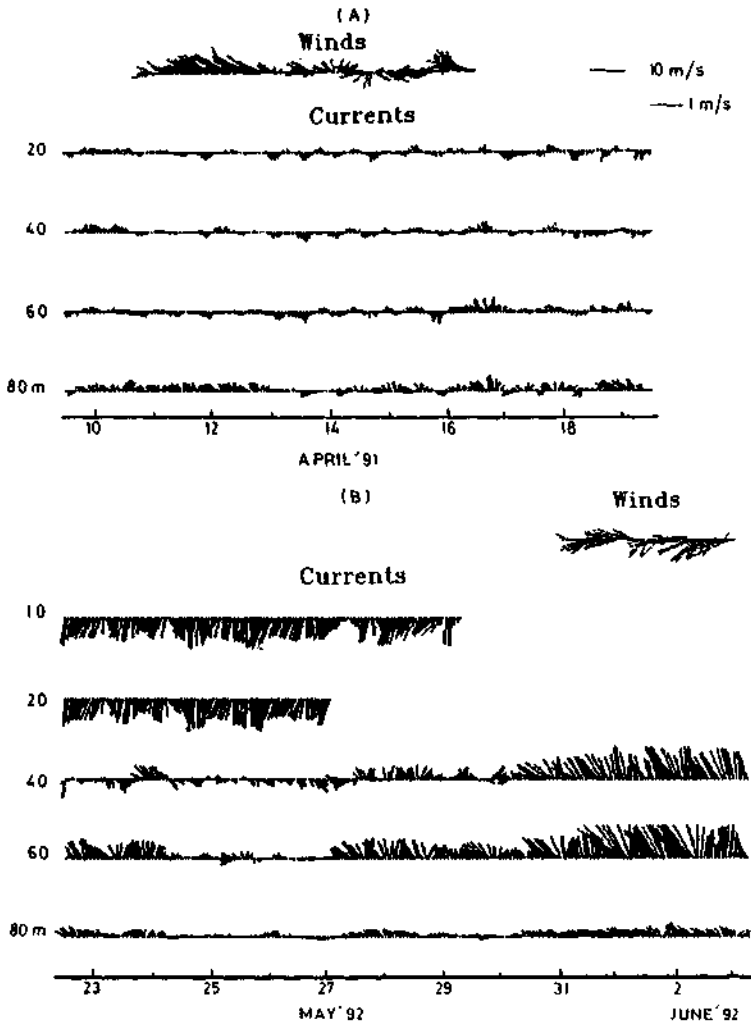

Fig.2 - Vector plots of winds and currents: A) Phase-1, B) Phase- 2



with time, particularly in the upper 40 m and even those flow reversals are not seen in phase-2. These features indicate that the tidal effect at the buoy site might be offset by the wind effect. Strangely, the flow at 80 m in phase-1 strengthens compared to other levels. In both the phases a two-way flow can be noticed depthwise. In phase-1, the water at 2 m flows consistently opposite to that at 80 m and in phase-2, the water flows below and above 40 m oppose each other. In upwelling regions such a flow pattern in the depth regime is a common feature. Thus, these flow patterns suggest a rigorous upwelling activity at the buoy site during May/June.

According to Murthy & Mohan Kumar (1995) the vertical sections of temperature and salinity from CTD measurements indicate internal tides of 1 cpd (cycle per day) and 2 cpd with amplitudes between 5 m and 10 m. From the time series plots of current components they suggest superimposition of high-frequency ( $>1$  cph) IW over the internal tides.

The currents, sampled at 2 min, in the stratified water column (40-80 m) were resolved into zonal (U) and meridional (V) components. After passing through Hanning window these data were subjected to FFT following Welch method (Jenkins & Watts, 1968) for obtaining spectral composition of IW. In order to easily distinguish the harmonics in the low-frequency ( $<1$  cph) and high-frequency ( $>1$  cph) bands, the FFT was done with two different data resolutions [segment length (m) = 4096 data points for low-frequency band and  $m=256$  points for high-frequency band] with 50% overlapping. Figure 3 presents the results along with 95% confidence limits, which are shown as vertical bars. The spectral peaks become important when they exceed the confidence limits. Results based on similar analysis for temperatures and salinities in the stratified waters are not shown in this figure, as they fail to show any additional features.

Within inertial periods (around 3 days in this case) periodic fluctuations in the ocean parameters, such as temperature, salinity, current, etc. at a given depth in the stratified waters can be safely presumed to be caused by IW. Thus within these time scales the ocean parameters can represent the local IW field. The current spectra are red in nature, showing a steady decrease of energy with frequency. However, the frequency spectra of currents - in other words IW - indicate harmonics of 0.02, 0.04, 0.08 and 0.15 cph (see the inset diagram) in the low-frequency band. Out of them, second and third harmonics correspond to the internal tides, which occur due to the interaction of tidal flows with continental slope (Rattray, 1960). The meridional components of currents in phase-2 contain an additional harmonic of inertial frequency (0.015 cph), which is the minimum frequency for the IW. In the high-frequency band of IW significant harmonics are noticed at 4, 8 and 10 cph. Similar analyses, carried out at various places in the seas surrounding India, reported the existence of inertial (Shenoi & Antony 1991; Murthy & Harresh Kumar, 1991), tidal (Ramam *et al.* 1979; Varkey, 1980; Antony *et al.* 1985; Sanil Kumar *et al.* 1989; Rao *et al.* 1991; Sarma *et al.* 1991) and high-frequency (Murthy *et al.* 1992; Sarma *et al.* 1994) harmonics.

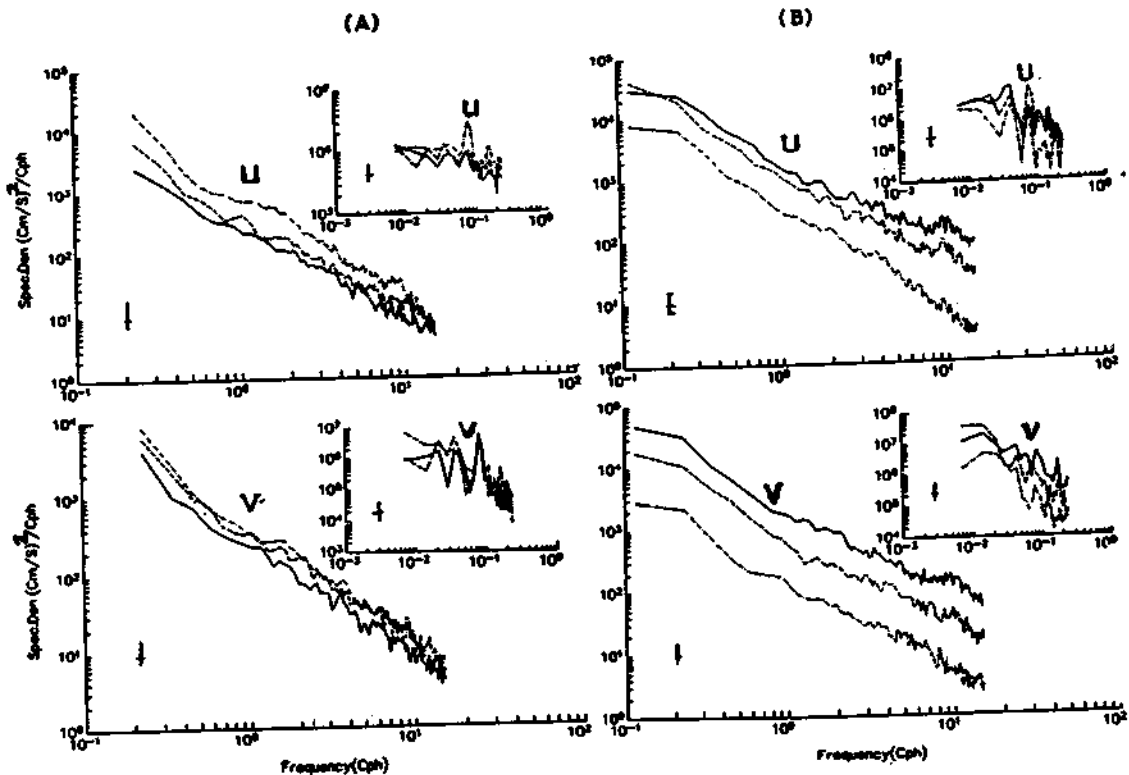

Fig.3 - Power spectra of currents (inset diagram is for low- frequency band of IW; subscripts refer to current meter levels; spectra at 40m: — 60m:---, and 80m: -.-.- vertical bars - 95% confidence limits); A) Phase-1, B) Phase-2

Recently Mc Phaden & Peters (1992) demonstrated diurnal activity for the IW at a station in the equatorial Pacific during May/June 1987. So, a similar analysis is carried out to know whether the observed IW field at the buoy site contains any such diurnal cycles.

The current meter data at different levels were averaged at 2 minute interval for each phase (i.e. 720 data points) and segregated them into two 12 hour slabs corresponding to day (6 AM - 6 PM) and night (6 PM - 6 AM) times. Mc Phaden & Peters (1992) assorted the data into four 6 hour slabs starting from 4 AM. This classification is not found suitable for present measurements. FFT (Welch method) was applied to the data of each 12 hour slab ( $N=360$  data points,  $m=64$ ,  $t=2$  minutes) and results for selected levels are shown in Fig. 4. In general the frequency spectra of the nighttime are found more energetic compared to daytime. The spectra for temperatures and salinities (not shown) also show similar features. The winds and convection produce more rigorous mixing during nighttime than during daytime. As these mechanisms directly activate IW, they can promote more activity among the IW during nighttime. Mc Phaden & Peters (1992) also arrived at similar inferences.

The spectral composition of local winds (not shown) and currents was noticed to be similar which prompted to examine coherence between winds and currents (i.e. IW). Significant coherence between them would suggest the local wind field as responsible for the observed IW.

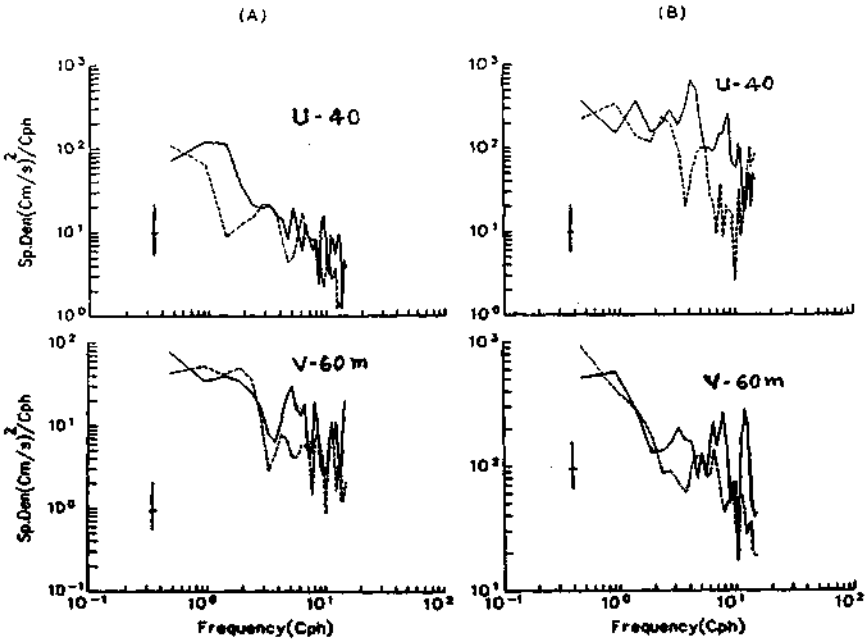

Fig. 4 - Diurnal cycle of IW in the stratified water column [n - nighttime (6PM - 6AM), d - daytime (6AM - 6PM); subscripts refer to current meter levels; spectra for n:— and d:---; vertical bars- 95 % confidence limits]; A) Phase-1, B) Phase-2

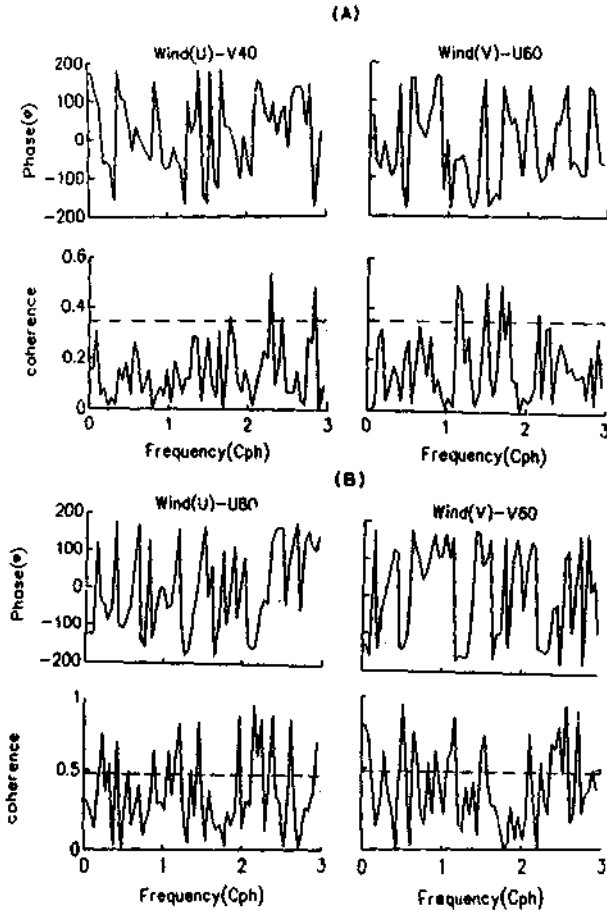

Fig.5 - Frequency spectra of coherence and phase between winds and currents(U-zonal component, V-meridional component; subscripts refer to current meter levels; ---: 95% confidence limits); A) Phase-1. B) Phase-2

The wind records, digitised at 10 minutes interval from the anemograms and the currents, picked up at the same interval, were used for this analysis. The data were smoothened by Hanning window and the coherence and phase between the winds and currents were computed using Welch method (Jenkins & Watts 1968). The results for the selected combinations are presented in Fig.5. The frequency spectra of coherence indicate good coherence (i.e. coherence exceeding confidence limits) at 0.20 and 0.47 cph in the low-frequency band and at 1.0, 1.37, 1.88, 2.3 and 2.4 cph in the high-frequency band. The corresponding phase values mostly lie between  $60^\circ$  and  $120^\circ$  (i.e. positive phase) implying winds leading IW. These results suggest the winds as a possible mechanism for the observed IW in the high-frequency band. Similar results are obtained in the deep waters at a station in the Andaman Sea by Sarma *et al.* (1991) and in the deep waters off Karwar by Murthy *et al.* (1992).

## REFERENCES

- Antony, M.K., Murty, C.S., Reddy, G.V. & Rao, K.H. 1981. Subsurface temperature oscillations and associated flow in the western Bay of Bengal, *Estuar. Coastal Shelf Sci.* 21: 823-834.
- Jenkins, G.M. & Watts, D.G. 1968. *Spectral analysis and its applications* (Holden Day Inc, Oakland) pp.525.
- Krishnamacharyulu, R.J., Sarma, Y.V.B., Sarma, M.S.S. & Rao, L.V.G. 1994. Temperature oscillations in the upper thermocline region - A case study of internal waves off Kalpeni island in the southern Arabian Sea, *Indian J. Mar. Sci.* 23: 14-17.
- La Fond, E.C. & Purnachandra Rao, C. 1954. Vertical oscillations of tidal periods in the temperature structure of the Sea, *Andhra Univ. Memo.* 1: 109-116.
- Mc Phaden, M.J. & Peters, H. 1992. Diurnal cycle of internal wave variability in the equatorial Pacific Ocean, *J. Phys. Ocean.* 22: 1317-1329.
- Murthy, P.G.K. & Hareesh Kumar, P.V. 1991. Response of coastal waters off Karwar to a deep depression, *Cont. Shelf Res.* 11: 239-250.
- Murthy, P.G.K. & Mohan Kumar, N. 1995. Confirmatory checks for the internal waves in the coastal waters off Cochin, *Indian J. Mar. Sci.* (in press).
- Murthy, P.G.K., Sharma, G.S., James, V.V. & Suseela, K.V. 1992. Internal wave characteristics in the eastern Arabian Sea during summer monsoon, *Proc. Indian Acad. Sci. (Earth Planet Sci.)* 101: 317-327.
- Ramam, K.V.S., Murthy, P.G.K. & Kurup, C.K.B. 1979. Thermal structure variation in the Arabian Sea (May-July 1973), *Mausam* 30: 105-112.
- Rao, R.R., Sanil Kumar, K.V. & Mathew Basil 1991. Observed variability in the current field during summer monsoon experiments - Part I: Northern Bay of Bengal, *Mausam*, 42: 17-24.
- Rattray, M. 1960. On the coastal generation of internal tides, *Tellus*, 12: 54-62.
- Sanil Kumar, K.V., Sarma, K.D.K.M., Joseph, M.X. & Viswambharan, N.K. 1989. Variability of currents and thermohaline structure off Visakhapatnam during late 1986, *Indian J. Mar. Sci.* 18: 232-237.
- Sarma, Y.V.B., Sarma, M.S.S., Krishnamacharyulu, R.J. & Rao, D.P. 1991. Subsurface oscillations at an oceanic station in the Bay of Bengal, *Indian J. Mar. Sci.* 20: 204-207.
- Shenoi, S.C. & Antony, M.K. 1991. Current measurements over the western continental shelf of India, *Cont. Shelf Res.* 11: 81- 94.
- Varkey, M.J. 1980. Power spectra of currents off Bombay, *Indian J. Mar. Sci.* 9: 278-280.

\* \* \*

## **Wave groups and spectra in a coastal regime**

Rao Tatavarti, P.N. Ananth & C.V.K. Prasada Rao

Naval Physical & Oceanographic Laboratory, Cochin - 682 021

### **ABSTRACT**

Field data from a WAVEC buoy deployed in coastal waters off Cochin, India during May-June 1992 were used to look at the wave groupiness characteristics in the coastal regime. It was observed from the time series of wave elevations and the computed time series of wave envelopes that the infragravity waves were coupled to the wave envelopes, and are non-stationary. The significant coherence between the infragravity waves and wave groups, coupled with high correlations between the occurrences of wave groups and infragravity waves at non-zero time-lags suggests group forcing. Further, a spectrum of the forced waves was apparent.

### **INTRODUCTION**

Groups, or sequences, of high waves are of interest to coastal engineers and naval architects. A run or group of waves is defined as a sequence of waves, the heights of which exceed a particular level (Goda, 1970). There are several linear theories which predict the wave group statistics, such as the mean group length, given only the energy spectrum. Comparisons of group statistics predicted by these theories with a limited set of numerical simulations have shown that the theories are restricted to a particular range of spectral shapes, some for narrow band spectra and others for broad band spectra (Goda, 1976). However Elgar & Guza (1984) have reported that numerical simulations with a wide variety of test spectra showed that the theories generally have a more restricted range of accuracy than was inferred by the unimodal spectral simulations of Goda (1970). There is also a large and growing literature studying amplitude modulations ( i.e. grouping) which arise as a consequence of non-linearity (Yuen & Lake, 1980). Against this background, it was chosen to compute the measure of groupiness as followed by Kim (1985) and Tatavarti (1989).

Infragravity waves propagating between the offshore and nearshore regions can be generated by high frequency wind waves through different generation mechanisms. Biesel (1952) and Longuet-Higgins & Stewart (1962) showed that narrow band short waves induce a forced long wave bound to the short wave groups such that long wave

depressions occur where the short waves are highest. Momentum flux gradients expel fluid beneath groups of large waves which accumulates under groups of lower waves and a forced or bound wave thus propagates with the incident group. The depressions are coupled with a mean flow opposite to the direction of wave propagation. Beneath a group of low waves, on the other hand, the mean surface level is raised and the flow is positive. A look at the relative variation of the depth-integrated, second-order velocity as a function of time (or space) suggests several features : (i) the magnitude of the second-order wave  $\langle u^2 \rangle$  is much larger under big waves than under small waves since  $\langle u^2 \rangle \propto a^2$  ; (ii) this forced wave is  $180^\circ$  out of phase with the wave group. The response of the infragravity field to wind-wave forcing was studied by Kim (1985) and Elgar & Guza (1985), who demonstrated the importance of the forced motions in the nearshore. Investigations by Kim (1985) and Tatavarti (1989) indicated that both forced (correlated with the envelope of incident wave heights, a measure of the group structure) and free motions were present in their observations at nearshore locations on Canadian beaches. Elgar & Guza (1985) using the NSTS data and employing bispectral analysis suggested that bound waves were present and analysis clearly showed that the incident wind-waves were interacting, resulting in energy transfer with (and presumably to) a wave at the difference frequency. In deeper water the phase between the incident group and the bound wave was found to be near the value predicted by Longuet-Higgins & Stewart (1964) for forced motions.

Non-linear interaction of wind-waves will force a series of second-order motions. If the quadratic forcing excites a motion which is itself a solution to the homogeneous equations of motion a resonant response will occur. In the absence of friction the amplitude of such a response will be infinite. Frictional damping will result in a finite response at resonance and decreasing response as the forcing is further away from satisfying the resonance conditions.

In general the forcing represents a flux of momentum (i.e.p  $u^2$ ) primarily due to incident higher frequency wind-generated waves. This momentum flux will drive a series of motions which are formally second-order but may, in practice, satisfy resonant or near-resonant conditions and thus grow to significant amplitude.

## MATERIALS AND METHODS

WAVEC buoy was deployed in the coastal waters off Cochin, during May-June 1992. The location of the deployment site is about 40 km from the shore at an approximate water depth of 90 m (Fig.1). In order to look at the evolutionary aspects of waves, heave, roll and pitch data were continuously sampled for about one day, (from 1240 hrs on 2nd June to 1120 hrs on 3rd June), with a sampling frequency of 1.28 Hz. This data was divided into segments of 20 min duration each, for further analysis. Of the heave, roll and pitch responses of the WAVEC buoy, only the heave response ( i.e. the surface elevation) is utilized for this study.

Time series of the incident wave envelope (groupiness) may be obtained by first high pass filtering the wave elevation time series. Taking the modulus of this filtered

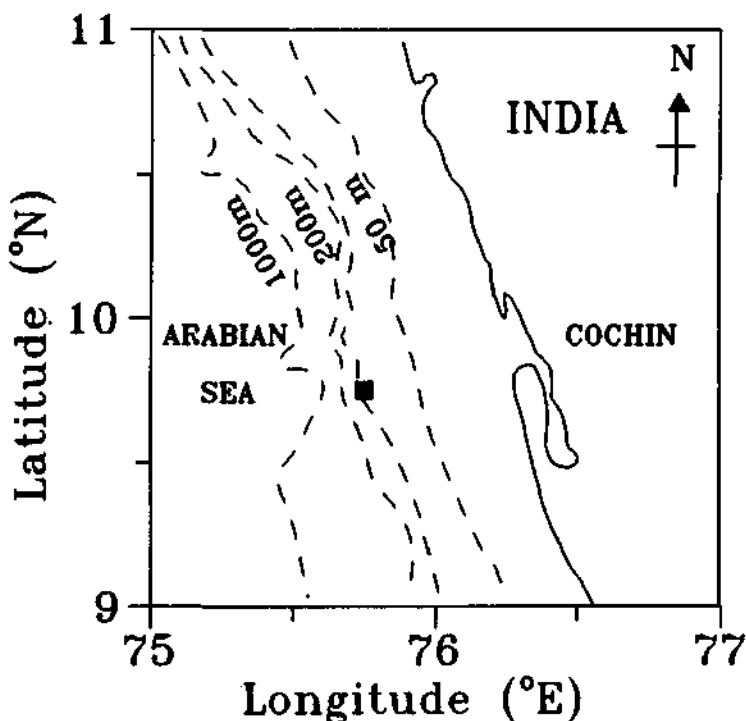

Fig. 1— Location map showing the position of wave observations

series, low passing the new series and removing the mean provides a time series of the envelope. Both high passing and low passing have been done using a Chebyshev band pass filter. The cut offs for the low pass series were 0.05 and 0.1 Hz and those for the high pass series were 0.1 and 0.5 Hz, respectively. This means that the wind waves in the frequency band (0.1 - 0.5 Hz) are considered to be responsible for the groupiness of waves. The basis for the frequency cut offs were the spectral peaks and valleys in the spectra of the raw data.

## RESULTS AND DISCUSSION

Representative time series of the four random segments of the data (Fig. 2) shows that the time series contain both high frequency (spiky data) and low frequency (modulations) components. Representative spectra of the first four segments of the raw data (Fig. 3) show that the energy is not concentrated in any particular frequency band but is varying in the frequency domain suggesting wave evolution and non-stationarity. Although not shown here, the winds were observed to be steadily increasing, from 1 m/s @ 1300 hrs on 2nd June to 5.5 m/s @ 1100 hrs on 3rd June. The fact that the higher frequency components were steadily growing is consistent with the satura-



tion hypothesis of wind-wave coupling. The spectra have approximately 40 degrees of freedom with a 0.01 Hz frequency resolution. Figure 4 shows the mean spectral characteristics of the continuous data, obtained by averaging the spectral densities corresponding to each frequency for all the 20 minute records, during the entire observational period of approximately one day. It is evident from Figs 3 and 4 that considerable change in kinematics of waves is taking place during this period. This

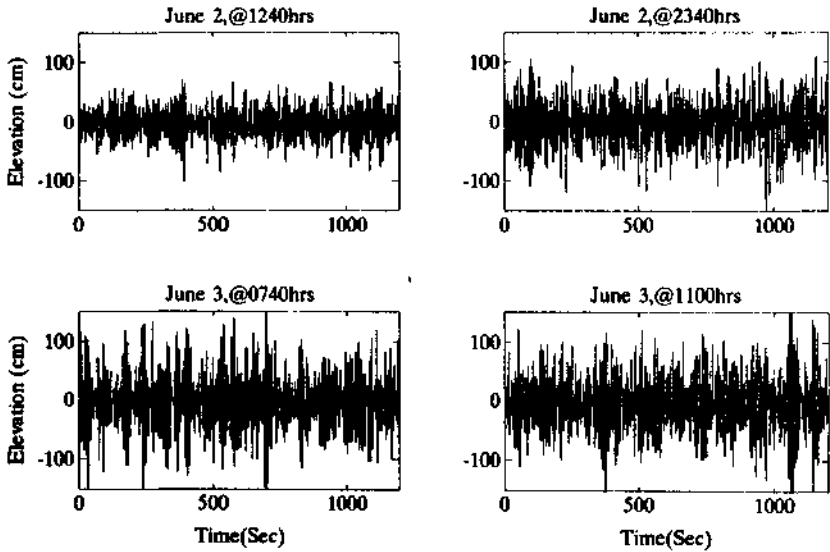

Fig. 2— Representative wave elevation time series

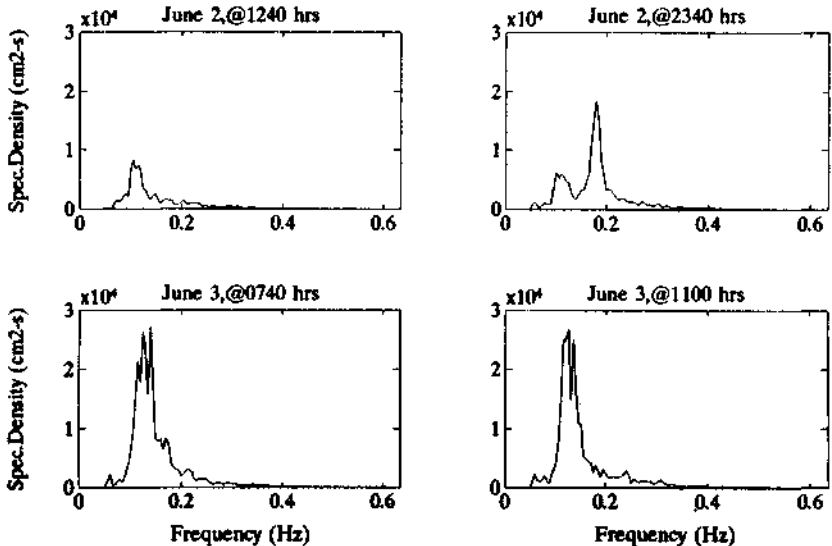

Fig. 3— Spectra corresponding to time series in Fig. 2

leads to speculate that the temporal evolution of spectra might be due to wind-wave interactions and non-linear interactions among different frequency components.

Figure 5 depicts the low frequency time series of the wave elevations corresponding to data @ 1300 hrs on 2nd June. In this, apart from the commonly occurring long period waves of 20 sec, a longer period of the order of minutes is also evident. Figure 6 depicts the time series of the wave groups which also show similar features. Figure 7 showing the spectra of wave groups and low frequency waves is consistent with the

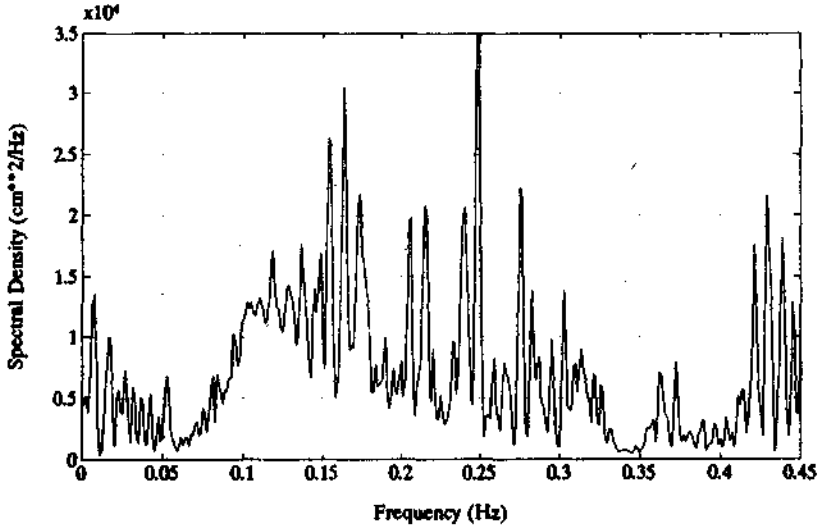

Fig. 4— Mean wave spectral density for the entire observation period

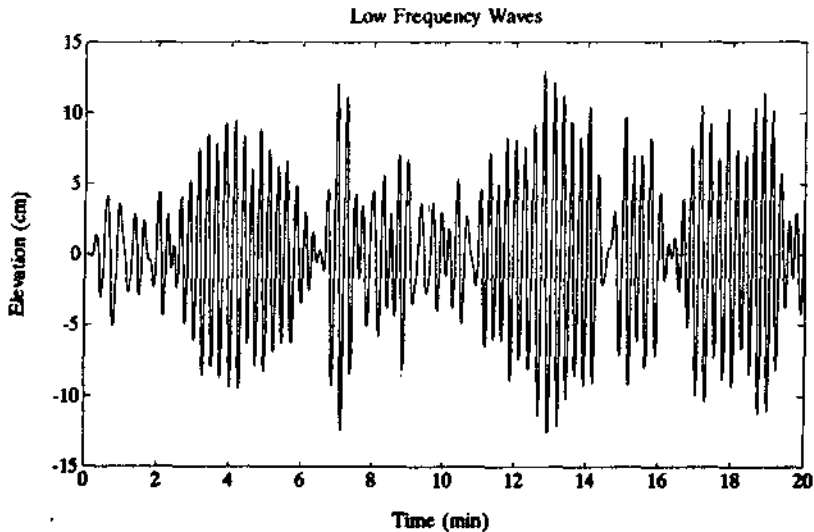

Fig. 5 — Low frequency time series of wave elevations

fact that the characteristics of low frequency waves and wave groups are similar. Figure 8 showing the cross-spectral phase and coherence between the wave groups and low frequency waves suggests that the wave groups and low frequency waves are out of phase and highly coherent in the frequency band of 0.02Hz and 0.04Hz. This is clearly indicative of significant forcing of the low frequency waves by the wave groups. The low frequency waves comprise approximately 70% of the forced response as can be observed in the coherence plot. Figure 9 depicts the cross-correlation

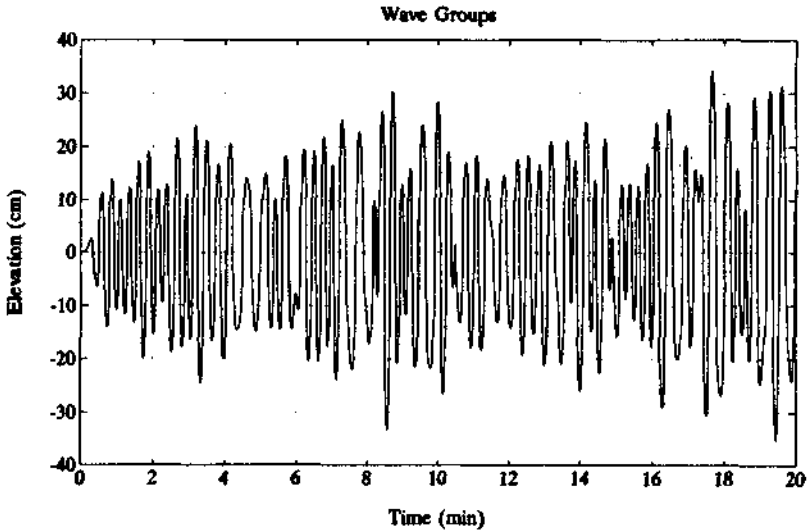

Fig. 6 — Time series of wave groups

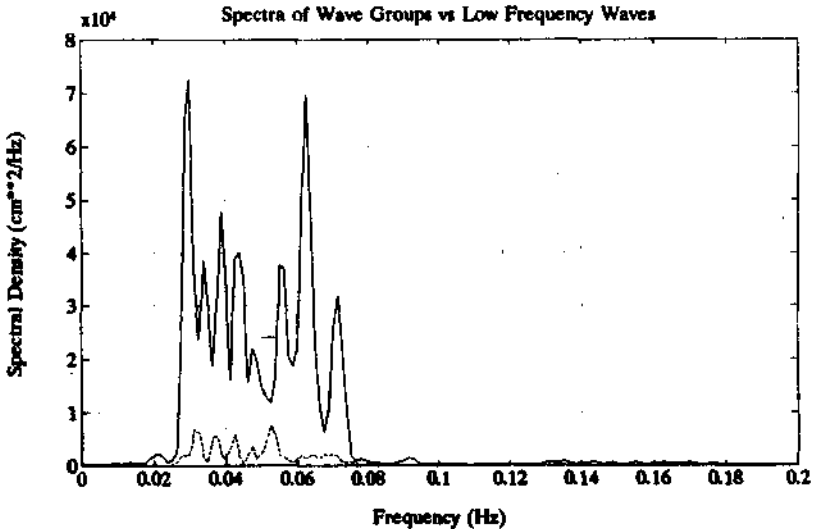

Fig. 7 — Spectra of wave groups (————) and low frequency waves (-----)

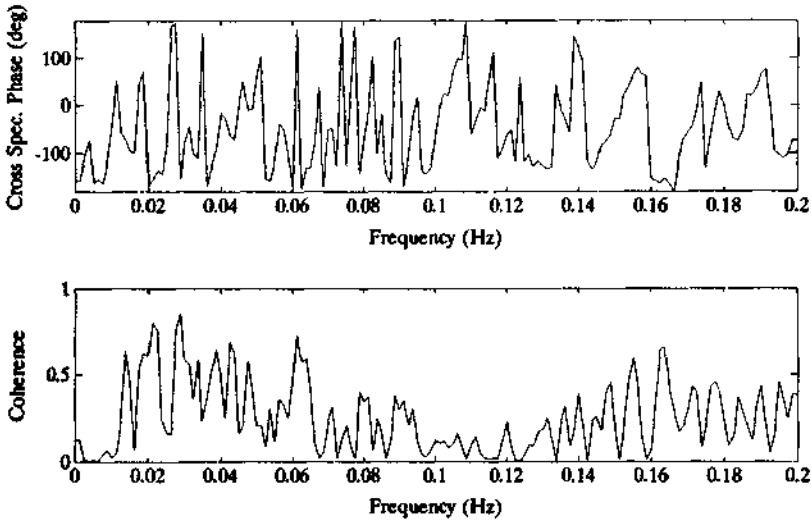

Fig. 8 — Cross spectral phase and coherence between wave groups and low frequency waves

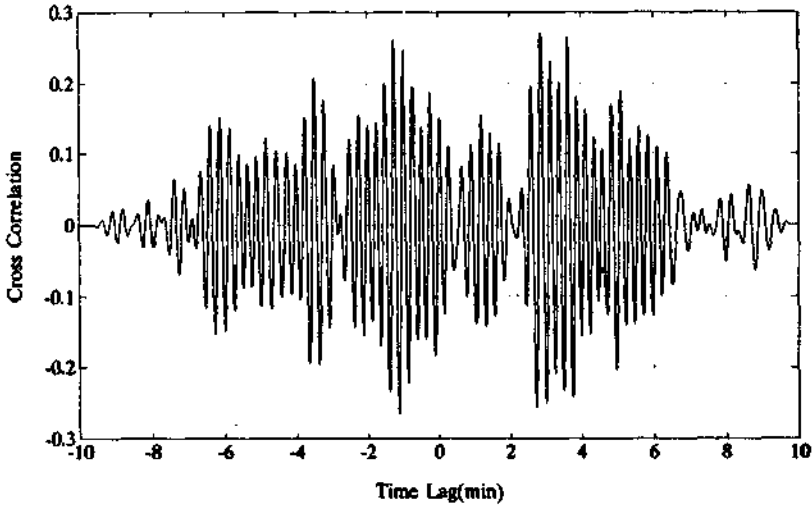

Fig. 9 — Cross correlation between wave groups and low frequency waves

between the groups and the low frequency waves. This suggests that there is a time lag between the forced low frequency waves and the forcing wave envelopes, consistent with the theoretical predictions of Gallagher (1971) and the laboratory experiments of Bowen & Guza (1978) that directional distributions may be another significant cause for the phase coupling between the wave groups and the sea and swell. These results (Figs 8 and 9) are consistent with the observations made by Kim (1985) and Tatavarti

(1989), based on nearshore data, that the forced oscillations associated with wave groups constitute 50-70% of the low frequency wave motions recorded.

## REFERENCES

- Bi'esel, F. 1952. Equations g'en'erales au second ordre de la houle irr'eguli'ere, *La Houille Blanche*, 3: 372-376.
- Bowen, A.J. & Guza R.T. 1978. Edge waves and surf beat, *J. Geophys. Res.* 83: 1913-1920.
- Elgar, S. & Guza R.T. (1985). Shoaling gravity waves: Comparisons between field observations, linear theory and a nonlinear model. *J. Fluid Mech.* 158:47-70.
- Gallagher, B. 1971. Generation of surf beat by non-linear wave interactions. *J. Fluid Mech.* 49: 1-20.
- Goda, Y. 1970. Numerical experiments on wave statistics with spectral simulation, Report (Part and Harhour Res Inst.) Nagase, Yokusuka, Japan). 3-57.
- Goda, Y. 1976. On wave groups, *Proc. Intl. Conf.on Behaviour of Off Shore Structures, BOSS-76*, Trondheim, Norway. Vol.I : 115-128.
- Kim, C.S. 1985. *Field observations of wave groups and long waves on sloping beaches*, M.Sc. thesis, Dalhousie University, Halifax, Canada, pp. 151.
- Longuet-Higgins, M.S. & Stewart, R.W. 1962. Radiation stresses and mass transport in gravity waves, with application to surf beats, *J. Fluid Mech.*, 13: 481-504.
- Longuet-Higgins, M.S. & Stewart, R.W. 1964. Radiation stresses in water waves: A physical discussion with applications, *Deep-Sea Res.*, Vol. 11, (4) : 529-562.
- Tatavarti, V.S.N. Rao. 1989. *The reflection of waves on natural beaches*, Ph.D Thesis, Dalhousie University, Canada, pp. 195.
- Yuen, H.C. & Lake, B.M. 1980. Instabilities of waves on deep water, *Ann. Rev. Fluid Mech.*, 12: 303-334.

\* \* \*

## Mixing processes and internal wave dynamics on the continental shelf off Cochin

R. Tatavarti, N. Mohan Kumar & P.V. Hareesh Kumar

Naval Physical & Oceanographic Laboratory, Thrikkakara, Cochin- 682 021

### ABSTRACT

Field data from an experiment conducted off Cochin during May- June 1992 have been analysed to study the internal wave dynamics and mixing processes. The density structure demonstrated the existence of *varicose* (rising and falling of pycnocline). The available potential (*PE*) and turbulent kinetic energies (*TKE*) were computed to quantify the mixing processes. *TKE* was found to be two orders of magnitude higher compared to *PE*, suggesting the dominance of shear instabilities. The upper water columns were dominated by buoyancy instabilities whereas the lower water columns were found to be dominated by shear instabilities. Internal waves were found throughout the water column with maximum amplitudes (20 m to 30 m) in the pycnocline.

### INTRODUCTION

Internal waves and mixing processes in the ocean are known to be very closely associated. Both the phenomena are capable of generating the other, and play an important role in coastal ocean dynamics. In spite of their importance, very few studies have specifically focussed on the complementary roles of these phenomena.

A kinematic description of oceanic internal waves is usually based on the hypothesis that the wave field is composed of a random sea of linear waves. Based on this hypothesis, Garrett & Munk (1972) have demonstrated the ubiquitous nature of internal waves, which occupy a vast continuum of spatial and temporal scales. Preliminary attempts for a unified treatment of available data on oceanic motions with horizontal scales ranging from a few tens of metres to a few kilometres and temporal scales ranging from the inertial period to the local Brunt-Vaisala period, resulted in the generalized description of internal waves. Excellent reviews of internal waves are given by Olbers (1983) and Müller *et al.* (1978).

For deep ocean internal waves, the most widely known description is the one given by Garrett & Munk (GM) (1972, 1975) and summarized by Munk (1981). The GM

formulation assumes that the ocean has no top or bottom boundary and that the buoyancy frequency [ $N(z)$ ], varies slowly with depth compared with the fluctuations of the waves. This permits the vertical variation of wave amplitude and vertical wavelength to be scaled by  $N(z)$ , which is the WKB approximation. Other models, such as the internal wave experiment (IWEX) model (Müller *et al.* 1978), differ in detail but generally retain the basic tenets of the GM model.

In the upper ocean, say from the surface to 200 m, the GM model is expected to have limited application even discounting the possible effects of strong forcing or dissipation. This is because  $N(z)$  is no longer a slowly varying function and the surface acts as a boundary which can reflect waves. In addition, the motion of the oceanic waters over the continental shelf and slope is influenced by the earth's rotation, the density stratification, the offshore current regime, the sloping bottom topography, and the presence of the coastline. In particular, the topographic constraints of the coastline and shallow sloping bottom give the shelf flow field certain characteristics that differ from those typical of the deep ocean (Allen, 1980; Allen & Denbo, 1984).

Dynamic instability of the high frequency, small-scale portion of the shear spectrum is believed to be a major agent generating diapycnal mixing. Internal waves are the primary mechanism but small horizontal vortices may also be involved. Neglecting double-diffusion, an incompressible stratified fluid supports three modes of motion: upward propagating internal waves, downward propagating internal waves, and horizontal vortices. Horizontal vortices have potential vorticity, unlike internal waves, but have no vertical velocity (to first order) and have no arbitrary vertical structure (Gregg, 1987). Although low frequency, large scale horizontal vortices have long been known, only recently has their possible existence at the same space and time scales as internal waves been realized. Consequently, most observations and models of mechanisms producing turbulence deal only with internal waves. Against this background, it was decided to make simultaneous measurements of temperature, salinity, density and currents on the continental shelf off Cochin in the Arabian Sea. The objectives of these measurements was to ascertain whether the present measurements are consistent with the internal wave dynamics and to examine the physical processes responsible for mixing.

## MATERIALS AND METHODS

A field experiment was conducted in the premonsoon period (May 23 - June 2, 1992) at a location off Cochin (station depth 90 m) on the continental shelf of the Arabian Sea (Fig. 1). During the experiment Aanderaa current meters (RCM 4) and Seabird CTD were used. The current meters were deployed on a vertical 'U' mooring, while the CTD observations were made from *FORV Sagar Sampada*, which was anchored at the same location. The sampling interval was set for 2 min in the Aanderaa current meters. Current meters were deployed at depths of 20 m, 30 m, 50 m, 70 m, and 85 m on the vertical mooring in order to obtain information in the mixed layer, thermocline and the bottom layer of the water column. The designated depths for

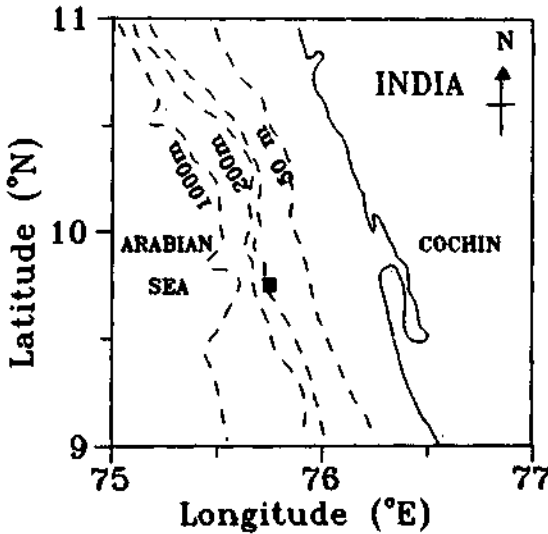

Fig.1- Station location map, off Cochin

current meters were arrived at, after looking at some of the temperature profiles obtained by casting CTD prior to the experiment. The current meters at 30 m and 20 m depths malfunctioned after May 27 and May 29, 1992 respectively. Hence those data were not considered for the analysis. The measurements from CTD (deployed every three hours at the location) and Aanderaa current meter vertical mooring (at depths of 20 m, 30 m, 50 m, 70 m and 85 m at the same location) were analysed to ascertain the role of internal waves and the mixing processes which govern the ocean dynamics.

All spectral computations were performed using a Hanning window with 50% overlap having 54 degrees of freedom and a frequency resolution of  $488 \times 10^{-6}$  cpm. Contours of density (obtained from CTD) were smoothed using the minimum curvature technique. Brunt-Vaisala frequency  $N(z)$  was computed using the relationship:

$$N^2(z) = \frac{1}{2\pi} \frac{g}{\rho_0} \frac{\partial \rho}{\partial z}$$

where  $g$  is acceleration due to gravity,  $\rho_0$  is the average density of the layer of thickness  $\partial z$ . The layer thickness was chosen as 1m. After making confirmatory checks for the existence of the established general internal wave characteristics (Garrett & Munk, 1975; Munk, 1981), the internal wave elevation,  $\zeta$  was computed using the relation

$$\zeta = \frac{\partial p / \partial t}{\partial \rho / \partial z}$$



The available potential energy ( $PE$ ) was obtained from the expression  $PE = N^2(z) \zeta^2$  and the turbulent kinetic energy ( $TKE$ ) from the zonal ( $u'$ ) and meridional ( $v'$ ) components of currents as  $TKE = 0.5(u'^2 + v'^2)$ , where prime ( $'$ ) denotes the perturbation component. The Richardson number  $R_i$  was computed using the known relationship,  $R_i = N^2(z) / (\partial U / \partial z)^2$ , where  $U = (u^2 + v^2)^{0.5}$ .

## RESULTS AND DISCUSSION

Depth-time sections of density computed from CTD observations (Fig. 2) clearly suggest the existence of internal waves, manifested as temporal undulations. The density observations indicated step structures, with vertical dimensions of a few meters to tens of meters. The smaller steps are indicative of diffusive instability and the larger steps of pressure instability. The density field was observed to evolve temporally during the experiment (Fig. 2). The pycnocline was observed to be centred around 40 m, located between 30 m and 50 m. One of the notable features is the upward movement of the isopycnals caused by coastal upwelling. Another significant feature of Fig. 2 is the rising and falling of isopycnals with time in and around the pycnocline region, between 40 m and 80 m depths; i.e., the upper half of the isopycnals region is rising towards right and the lower half of the isopycnals is falling. This is consistent with the *varicose* characteristics which generally appears around the thermocline region (Lighthill, 1978). The latter half of the observations show that the *varicose* has moved upwards presumably due to upwelling. This implies that the trapped modes of internal waves within the *varicose* (Lighthill, 1978) may cause significant mixing in water column.

In an attempt to understand the cause of the *varicose* in the observations, the time series of hourly winds and currents were observed (Fig. 3). As can be noticed, the winds though weak (less than 10 m/s generally) are northwesterly favouring coastal upwelling. At 20 m and 30 m the currents were observed to be southerly and at 70 m and 85 m the currents were observed to be northerly. At 50 m varying current

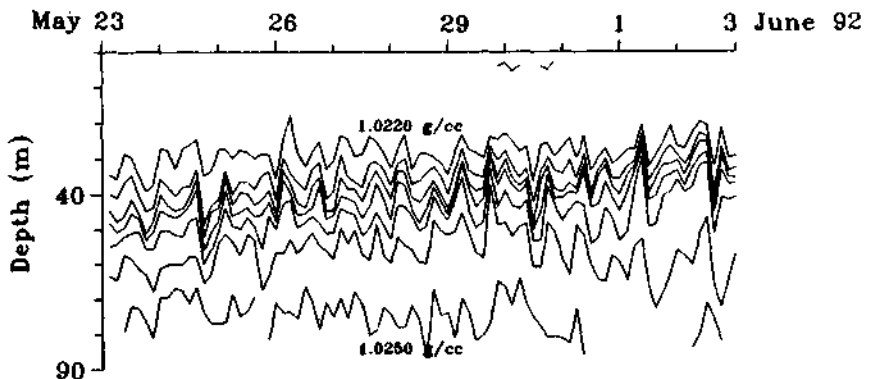

Fig.2- Depth-time sections of density observed using CTD (units are g/cc). The contour interval is 0.0005 g/cc

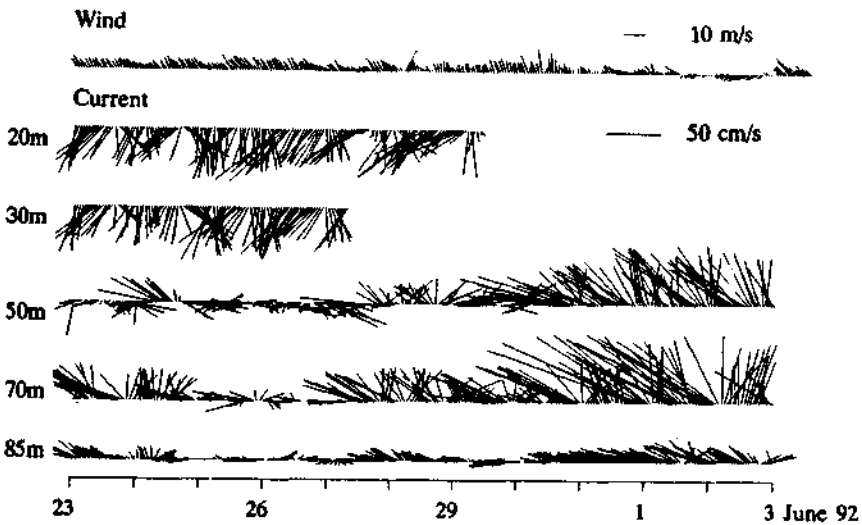

Fig.3- Hourly time series of wind (m/s) and current (cm/s) vectors

directions are observed. Because of the coastal orientation the southerly currents give rise to upwelling from the subsurface waters. In order to strike a dynamic Ekman type equilibrium the current direction should be northerly in the subsurface waters and same was observed here (Fig. 3). Although the exact reason for the sudden increase in magnitude of the northerly currents in the subsurface layers is not understood, the rest of the features like stronger upwelling as is evident in Fig. 2 during the latter half of the experiment and decrease in the depth of the pycnocline during the same period are consistent. Normally oceanic currents in the coastal regime undergo tide induced flow reversals. This feature remains masked in Fig. 3 (at 20 m and 30 m locations), presumably because of the stronger wind forcing. Also due to the alignment of the coast the tidal influence can be observed only as increasing or decreasing current signal strengths. The southerly currents observed in the upper layers may be justified by Ekman response of the wind forcing. Present observations suggest that the inertial forcing due to wind (periodicity  $\sim 72$  hrs) dominates the surficial waters masking the effects of tidal forcing and effects of tidal forcing become apparent in deeper layers, though quantification of these forcings on the water column is not attempted here. This is consistent with Krauss's (1972a, b) observations indicating that inertial motions are the dominant result of winds blowing in shallow waters.

The observed existence of *varicose* may be explained by the fact that surficial waters are influenced by coastal upwelling and the deeper waters are influenced by the northward flowing undercurrent coming from lower latitudes.

The spectral roll-offs shown in Figs 4 and 5 for the  $u$  and  $v$  components of the velocity at various depths are consistent with the internal wave saturation hypothesis. It may be speculated that the internal wave dynamics are responsible for the reddish

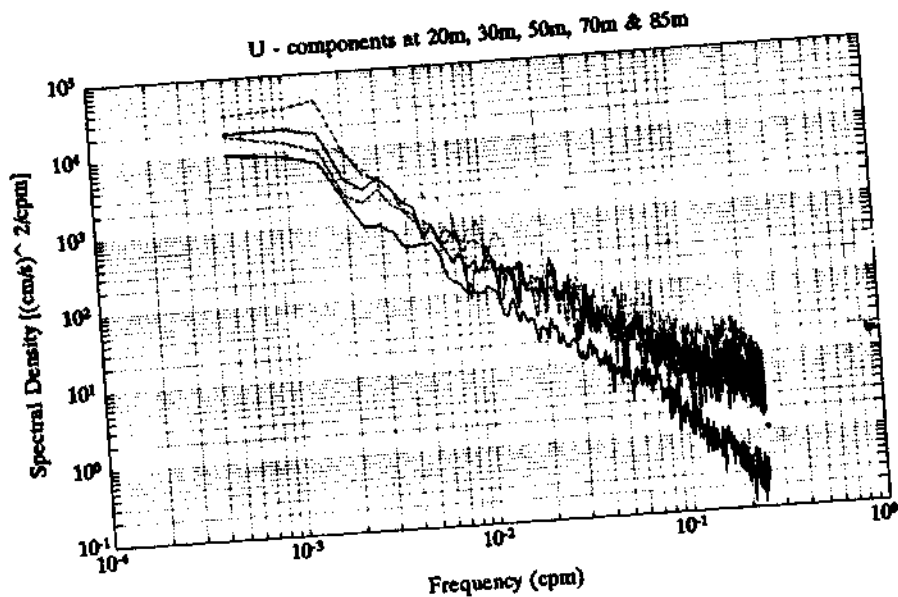

Fig.4- Spectra of the zonal component of the currents at all depths

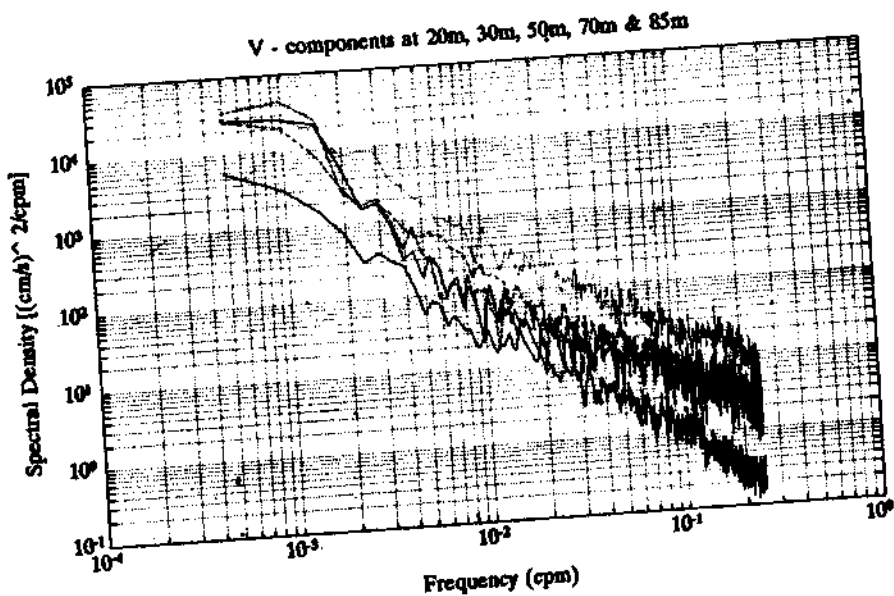

Fig.5- Spectra of the meridional component of the currents at all depths

spectra of the observed current structure. The most dominant energy peak corresponds to the inertial and tidal frequencies in the spectral plots. The almost -2 slopes of the spectra in the internal wave continuum between inertial ( $\sim 72$  hrs) and Brunt-Vaisala periods (6 min) also agree with the Garrett & Munk (1972, 1975) universal spectra slopes.

From the cross-spectral computations between the vertically separated  $u_{20}$  and  $u_{85}$  components (i.e. current sensors at 20 m and 85 m), it was seen that the semi-diurnal tidal frequency signals were well-correlated with a cross-spectral coherence of 0.6 and were  $-180^\circ$  out-of-phase. This suggests that the signals are tidally forced and are propagating in opposite directions. However, the coherence between the alongshore components is much smaller ( $\sim 0.2$ ) at the tidal frequency. The spectral phases of  $v_{20}$  and  $v_{85}$  components of the currents were in quadrature. The general features of the coherence spectra suggests a gradual decrease in coherence with increasing frequency. These observations support the studies of Garrett & Munk (1972), Webster (1972) and Briscoe (1975). The cross-spectral phases and coherences between the  $u, v$  components at different depths indicate that at very low frequencies the internal wave motions are phase coupled with significant coherences. The fact that the cross-spectral phases between the  $u$  components are almost  $180^\circ$  out-of-phase at low frequencies and the cross-spectral phases between the  $v$  components are in quadrature, leads to speculate the existence of different modes in the internal wave structure. This is evident in Figure 6 due to the out-of-phase oscillations of  $\zeta$  at different depths and the varying magnitudes of  $\zeta$  and  $N$  at different depths.

Two instability mechanisms, the shear instability when the vertical shear becomes large enough to overcome the opposing torque of stratification, and the buoyancy instability when the wave fluctuations become large enough to advect heavy water over light producing unstable density gradients, were studied.

Figure 6 shows the time series of computed internal wave elevations and the Brunt-Vaisala frequencies at the depths of deployment of current meters. The ubiquitous nature of the internal waves is reflected in the time series of  $\zeta$  at all depths (Fig. 6). The internal wave elevations are generally of the order of 10 m to 20 m and  $\zeta$  maximum almost coincides with the temporally changing pycnocline. At depths  $>50$  m the falling internal wave elevation time series is consistent with the *varicose*. The buoyancy frequency oscillations are maximum at 30 m and 50 m depths suggesting buoyancy instabilities resulting in mixing. Figure 7 shows the computed turbulent kinetic energy and the available potential energy for mixing at the same depths. The time series plots of *TKE* and *PE* seem to be inversely related, suggesting linear dynamics of the system. Although the internal wave dynamics [ $\zeta(t)$ ] are governed by both *PE* and *TKE*, the turbulent kinetic energy is approximately two orders of magnitude larger compared to the potential energy indicating the importance of the former in mixing processes. *TKE* is maximum at 50 m and 70 m depths. Figure 8 shows the time series of the computed Richardson numbers and the current shear at the designated depths. The current shear is maximum in the bottom layers (i.e.,  $>50$  m depths), correspondingly  $R_i$  is always less than the critical Richardson number (0.25), suggesting that the lower water column is always dynamically unstable resulting in mixing. That is, in the lower water column shear instabilities dominate the convective instabilities (buoyancy instabilities) whereas in the upper water column buoyancy instabilities dominate the shear instabilities (Figs. 7, 8).

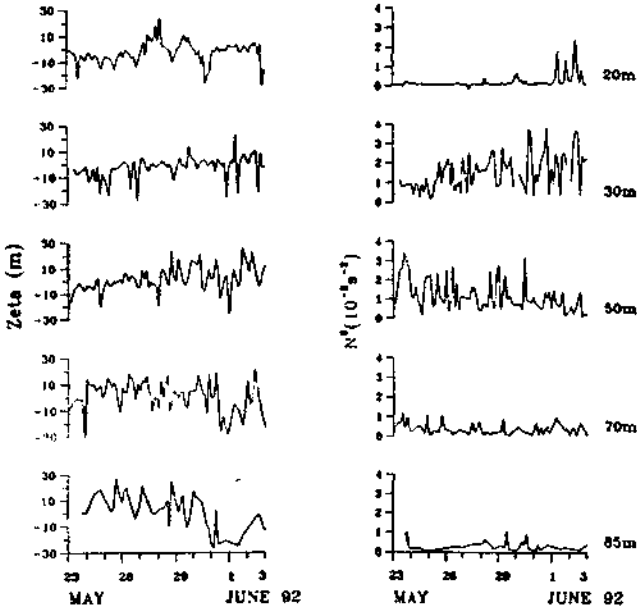

Fig.6- 3-Hourly time series plots of computed internal wave elevations ( $\zeta$ ) and Brunt-Vaisala frequencies [ $N^2(z)$ ]

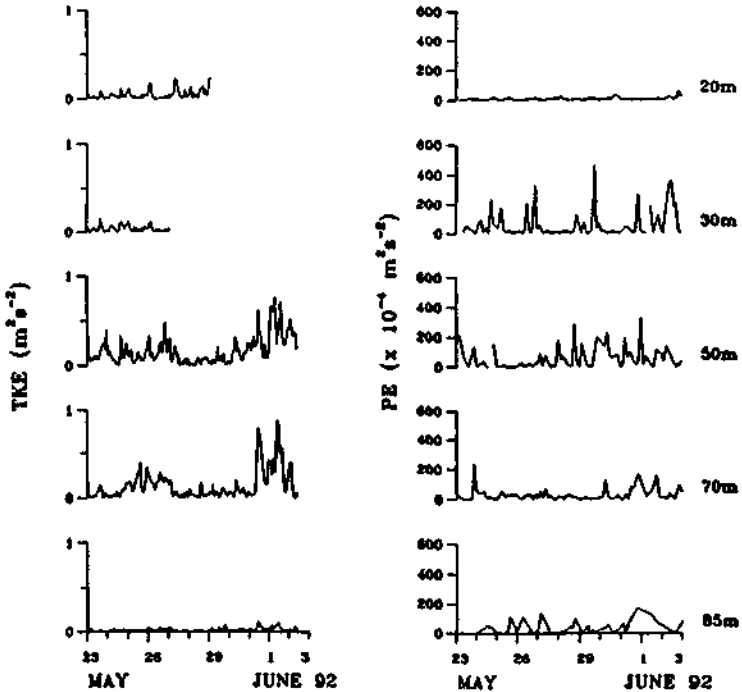

Fig.7- 3-Hourly time series plots of computed turbulent kinetic energies and potential energies

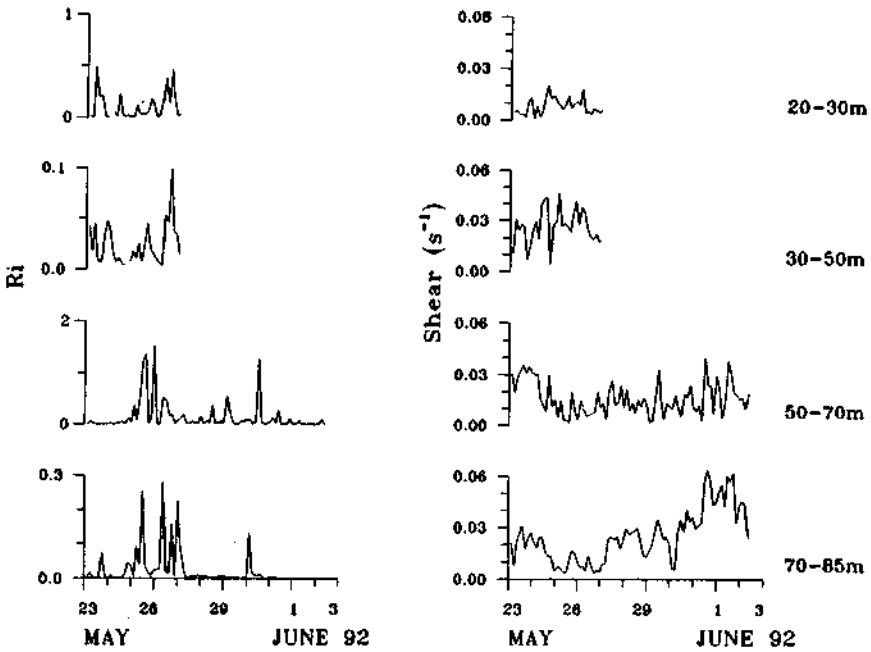

Fig.8- 3-Hourly time series plots of computed Richardson numbers and shear

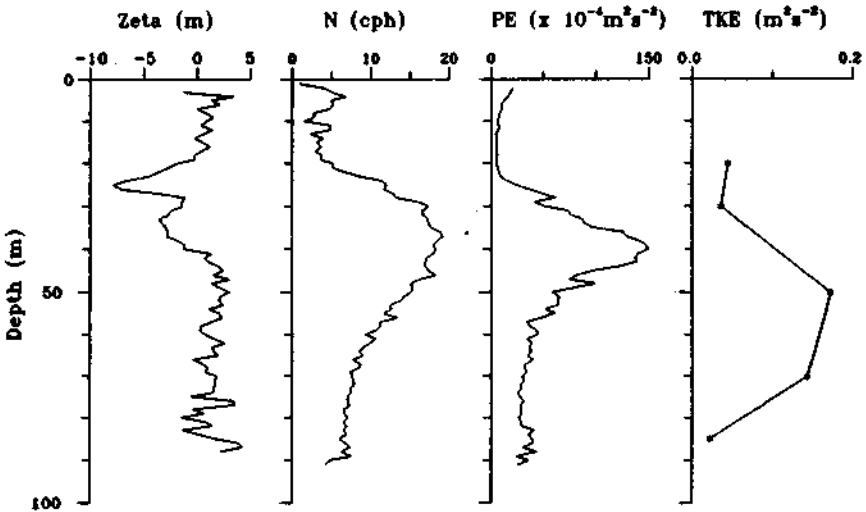

Fig.9- Time averaged profiles of internal wave elevation, Brunt- Vaisala frequency, potential energy and turbulent kinetic energy

Figure 9 which is based on time averages of the different parameters also supports this observation. Two classes of phenomena could be responsible for the observed features. Horizontally and vertically propagating or standing waves could be generated by free convection in the presence of strong mean vertical shear. On the other hand, the observed signal could represent a forced mode resulting from local shear instability of the mean flow. Present observations suggest that a combination of the two phenomena are present.

## CONCLUSION

Present observations from the CTD casts and Aanderaa current meters at a location off Cochin, on the continental shelf at 90 m suggest the existence of internal waves in the entire water column having maximum elevations of 20 m to 30 m. The existence of *varicose* was established, which is capable of supporting trapped modes of internal waves. The internal waves seem to be present in different modes. Quantification of the modal structure was not attempted. The lower water column was dominated by shear instabilities whereas, the upper water column was dominated by buoyancy instabilities. The *TKE* was found to be two orders of magnitude larger than the *PE*, suggesting the dominance of turbulence related phenomena in mixing.

## REFERENCES

- Allen, J.S. 1980. Models of wind driven currents on the continental shelf, *Ann. Rev. Fluid Mech.*, 12: 389-433.
- Allen, J.S. & Denbo, D.W. 1984. Statistical characteristics of the large scale response of coastal sea level to atmospheric forcing, *J. Phys. Ocean.*, 14: 1079-1094.
- Briscoe, M.G. 1975. Preliminary results from the trimoored internal wave experiment (IWEX), *J. Geophys. Res.*, 80: 3872-3884.
- Garrett, C.J.R., & Munk, W.H. 1972. Space-time scales of internal waves, *Geophys. Fluid Dyn.*, 2: 225-264.
- Garrett, C.J.R. & Munk, W.H. 1975. Space-time scales of internal waves: A progress report, *J. Geophys. Res.*, 80(3): 291-297.
- Gregg, M.C. 1987. Diapycnal mixing in the thermocline: A review, *J. Geophys. Res.*, 92: 5249-5286.
- Krauss, W. 1972. On the response of a stratified ocean to wind and air pressure, *Deutsche Hydro. Zei.*, 25: 49-61.
- Krauss, W. 1972. Wind generated internal waves and inertial- period motions, *Deutsche Hydro. Zei.*, 25: 241-250.
- Lighthill, M.J. 1978. *Waves in fluids*, (Cambridge Univ. Press., Cambridge) pp.504.
- Müller, P., Olbers, D.J., & Willebrand, J. 1978. The IWEX spectrum, *J. Geophys. Res.*, 83: 479-500.
- Munk, W.H. 1981. Internal waves and small-scale processes, In: *The evolution of physical oceanography*, (MIT Press, Cambridge), pp. 264-291.
- Olbers, D.J. 1983. Models of oceanic internal wave field, *Rev. Geophys. Space Phys.*, 21(7): 1567-1606.
- Webster, T.F. 1972. Estimates of the coherence of ocean currents over vertical distances, *Deep-Sea Res.*, 19: 35-44.

## **Dial variations in temperature, salinity and dissolved oxygen from the neritic waters off Cochin during April (peak summer)**

G.S.D. Selvaraj, M.S. Rajagopalan & R. Anilkumar

Central Marine Fisheries Research Institute, P.B. No.-1603, Cochin-682 014

### **ABSTRACT**

Dial variations of important hydrographic parameters were studied continuously for 7 days at a 100 m depth station off Cochin. The frequency of observations varied from 1-3 hourly intervals. In surface waters, the ranges in temperature, salinity and dissolved oxygen values recorded during 10-17 April were 30.64°-32.36°C, 34.56-34.68 x 10<sup>-3</sup> and 4.06-4.65 ml/l respectively. The STD profiles in the diurnal study revealed clearly the premonsoon warming (30°-31°C) in the upper 0-30 m depth zone. In the water column up to 50 m depth, mean salinity values ranged from 34.6 to 35 x 10<sup>-3</sup> while dissolved oxygen values were above 4 ml/l. Time series observations on the production and utilisation of dissolved oxygen revealed wide fluctuation from hour to hour. Vertical gradients in the diurnal study indicated the existence of thermocline around 60 m depth with sharp decline in temperature and dissolved oxygen and increase in salinity below 60 m. The diurnal variation on the distribution of temperature and dissolved oxygen exhibited significant rhythmic tidal impulse of a semi-diurnal wave pattern which was more prominent in the bottom layer below 60 m.

### **INTRODUCTION**

Knowledge on the diurnal and day-to-day variations of the oceanographic parameters in different seasons are essential for proper understanding of the dynamics of the marine environment. Although dial variations on the hydrographic parameters are studied from the coastal aquatic ecosystems, similar studies from the open ocean around India are meagre. In the oceanic environment, factors such as seawater temperature, salinity and dissolved oxygen play very important role on the distribution and abundance of pelagic and demersal fishery resources. In recent years, sea-water temperature is considered as one of the important parameters in the remote sensing technology to assess the productive fishing zones of the ocean. One of the major constraints faced with this is the diurnal and day-to-day variations of the parameter.



The present study deals with the diurnal and day-to-day variations of seawater temperature, salinity and dissolved oxygen at different depths in the neritic waters off Cochin during a peak summer.

## MATERIALS AND METHODS

During 10-17 April 1991, time series data were collected at the 100 m depth station off Cochin (09°44'N, 75°42'E) as below:

- 1) Temperature and salinity at three hourly interval from 10 April (0600 hrs) to 16 April (0600 hrs) at 1, 10, 20, 30, 50, 60 and 90 m depths.
- 2) Temperature and salinity at one hour interval from 16th (0600 hrs) to 17th (0600 hrs) at 1,10, 20, 30, 50, 60 and 90 m depths.
- 3) Dissolved oxygen at three hourly interval from 14th (0300 hrs) to 16th (0600 hrs) at 1, 30, 50, 60 and 90 m depths.
- 4) Production and utilisation of dissolved oxygen from 14th (0600 hrs) to 16th (0600 hrs) on the water samples collected at 1 and 30 m depths from the same station.

The seawater temperature, salinity and depth were determined by the Micro computer (MICOM STD PROFILE Instrument); dissolved oxygen by the Standard Winkler-titration method (Strickland & Parsons, 1968) and the productivity of water was calculated.

## RESULTS

The results obtained on the diurnal variation of temperature, salinity and dissolved oxygen for the different depths at three hourly interval for 6 days are presented in Fig. 1 and of temperature and salinity at one hour interval for 25 hours are depicted in Fig. 2.

### Temperature

Sea surface temperature ( at 1 m depth) ranged from 30.64° to 32.36°C showing a variation of 1.72°C in seven days while the bottom temperature at 90 m varied from 22.26° to 27.36°C showing wide variation of 5.1°C (Fig 1). Among the different depths, watermass at 10 m showed the minimum variation of 0.65°C in 7 days of diurnal observation. In general, the bottom layers (60-90m) showed wide variation (>3°C). The overall mean temperature of the 7 days showed the maximum of 30.97°C at surface with gradual decrease up to 60 m and sharp fall below 60 m to the minimum of 24.5°C at 90 m depth.

The day-to-day changes in the daily mean temperature at surface (1 m) varied from 30.8° to 31.2°C with the difference of 0.4°C. At 0-50 m water column, the variation was 0.3-0.4°C while it was 1.4°-1.6°C at 60-90 m depth zone. The study revealed that the diurnal variation observed in 24 hours was not constant on all the 7 days. It varied

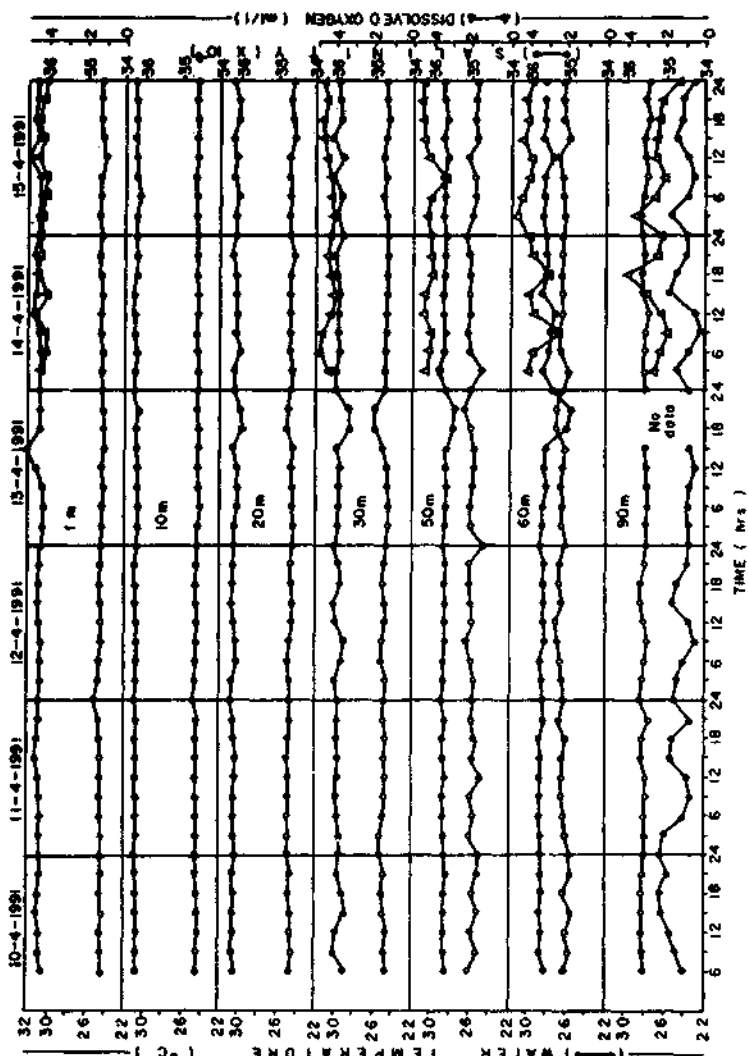

Fig. 1 - Diurnal variation in temperature, salinity and dissolved oxygen at three hourly interval

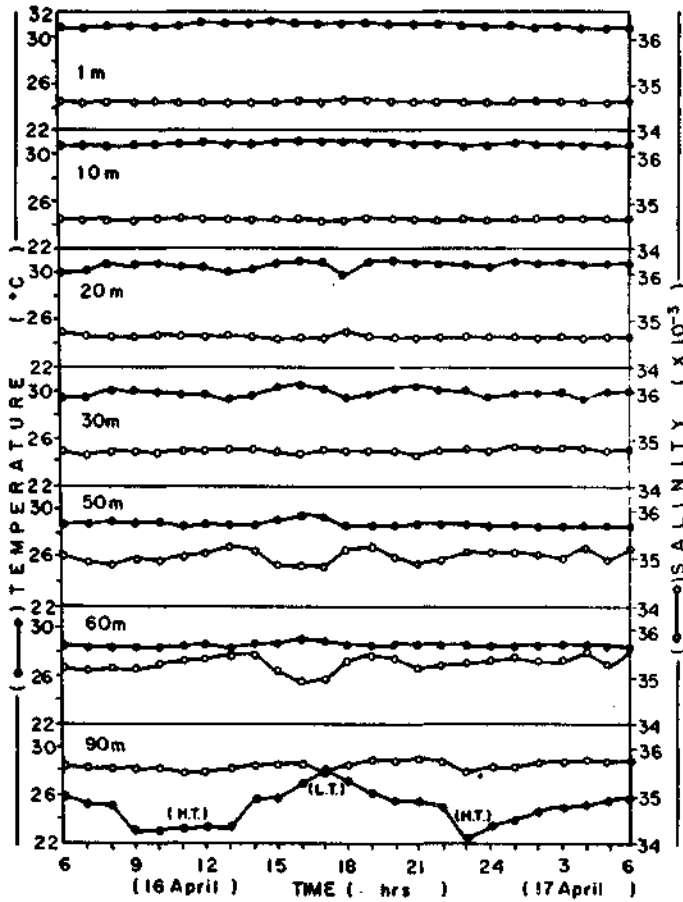

Fig. 2 - Diurnal variation in temperature and salinity at one hour interval

much at different depths in the shelf waters. The variation was higher at 30 m ( $>1^{\circ}\text{C}$ ) and at 60-90 m water column ( $>3^{\circ}\text{C}$ ). The diurnal study carried out at one hour interval for 25 hours showed hour to hour variation in temperature at different depths and it was prominent below 60 m during the diurnal rhythmic rise and fall in temperature (Fig.2).

### Salinity

At surface (Fig.1), salinity ranged from  $34.56$  to  $34.68 \times 10^{-3}$  and at 90 m, it was  $34.98$ - $35.76 \times 10^{-3}$  during the 7 days of observation. The variation showed the minimum ( $0.1 \times 10^{-3}$ ) at 10 m depth. The variation and the overall mean values at different depths showed increasing trend towards bottom with the maximum recorded at 90 m depth. The day-to-day changes in the daily mean values of 7 days and the

hourly changes within 24 hours of the day showed, in general, less variation at 0-30 m. The hour to hour variation in 24 hours was  $<0.4 \times 10^{-3}$  during April and it was relatively very less at 0-10 m.

### Dissolved oxygen

In surface waters, the dissolved oxygen values varied from 4.06 to 4.65 ml/l. Depthwise distribution showed wide variation with increasing trend from surface to bottom. At surface, the daily average values ranged from 4.33 to 4.6 ml/l with the highest mean (4.48 ml/l) recorded at 30 m depth. The oxygen values were always 4 ml/l in the upper 0-50 m water column during April which showed abrupt decline below 60 m. The day-to-day changes also indicated the same trend with high variation at 60 m depth.

The hour to hour variation in the dissolved oxygen values was generally high during diurnal rise and fall in values. The variation was less at 0-30 m water column (0.3-0.6 ml/l) and high between 60 and 90 m depths (1.4-1.6 ml/l). The rise and fall in values at the bottom layer (60-90 m) showed rhythmic periodicity. Time series observations on the production and utilisation of dissolved oxygen in the upper layer (0-30 m) at three hourly interval showed variation from time to time within the day without indicating any diurnal periodicity (Table 1). The production of oxygen varied from 0.0205 to 0.2720 ml/l/h and utilisation from nil to 0.093 ml/l/h.

Table 1- Diurnal variations in the production and utilisation of dissolved oxygen at 0-30 m depth zone (incubation time is 3 hours)

Date	Time (hrs)	Oxygen produced (ml O <sub>2</sub> /l/h)	Oxygen utilised (ml O <sub>2</sub> /l/h)
14 April '91	0600	0.0975	0.0930
	0900	0.0910	0.0140
	1200	0.1415	0.0615
	1500	0.0400	0.0045
15 April '91	0600	0.0665	0.0235
	0900	0.0205	0.0205
	1200	0.1255	0.0
	1500	0.2720	0.0
16 April '91	0600	0.0390	0.0285

## DISCUSSION

The results revealed that the sea surface temperature (SST) was at its daily minimum during early hours (0300-0600 hrs) and the maximum around 1500 hrs of the day (Figs 1 and 2), while such periodicity was not significant at 10-50 m depths. At 60-90 m depths, temperature showed the lowest value around 0900 hrs and the highest around 1500 hrs in general. The diurnal periodicity for the minimum and maximum temperature coupled with wide variation ( $1.72^{\circ}\text{C}$ ) observed during the seven days indicated clearly that the SST was directly influenced by the atmospheric cooling and solar heat radiation. The STD profiles in the diurnal study revealed clearly the premonsoon warming ( $30^{\circ}$ - $31^{\circ}\text{C}$ ) in the upper euphotic zone up to 30 m depth. Hareesh Kumar & Rao (1987) observed a minimum SST of  $29.5^{\circ}\text{C}$  at 0800 hrs and the maximum at 1500 hrs in the inshore waters (<50 m) off southwest coast of India during May 1985. They observed the influence of solar heating in the top 20 m water column in the diurnal study. However, the vertical temperature distribution in the shelf waters may not be totally governed by the local surface heat exchange process alone. Tidal effects, freshwater discharge and ocean currents may also have significant role in it. Vertical temperature profile is therefore expected to exhibit complex patterns in the shelf waters. The wide variation in water temperature recorded especially at 30 m depth in the day-to-day and diurnal observation (Figs.1,2) might be attributed chiefly to the changes in the intensity of summer heating and partly to the changes in the intensity of tidal forces from time to time. The very low variation in water temperature observed at 10 m depth in the present study indicated that the daily rate of solar radiation and nocturnal cooling has immediate effect in the surface layer upto 10 m depth only; while the influence of solar heating attributed upto 30 m depth could be a slow process of heat exchange in the water during summer.

The sharp fall in temperature below 60 m and the wide variation observed in the bottom layer (60-90 m) than in the middle layer (30-60 m) indicated the existence of thermocline around 60 m depth (Fig.3). The indications of diurnal periodicities for the lowest and highest temperature observed at 0900 and 1500 hrs in the diurnal study coupled with the wide fluctuations in temperature, salinity and dissolved oxygen at 60- 90 m water column might be attributed to the influence of high tide (HT) and low tide (LT) respectively.

The hourly variation in temperature, salinity and dissolved oxygen of the middle and bottom layers further indicated that the watermass present in an unit area was not always static, but changes due to the influence of underwater tidal currents in the shelf region. The wide variations observed from hour to hour by the increase in temperature and dissolved oxygen and decrease in salinity values at this station might be due to the influence of low tide currents pushing the lesser saline warm watermass from the inshore shelf region. The variation observed by the decrease in temperature and dissolved oxygen and increase in salinity values might be attributed to the influence of high tide currents bringing the higher saline colder watermass from the oceanic region into this area at the respective depths.

The fluctuation in the day-to-day diurnal variation of temperature and dissolved oxygen noticed among the different days of diurnal observations might be attributed to the different intensities and changing pattern of the mixed type of semidiurnal tides (Fig.4) prevailing in this coast.

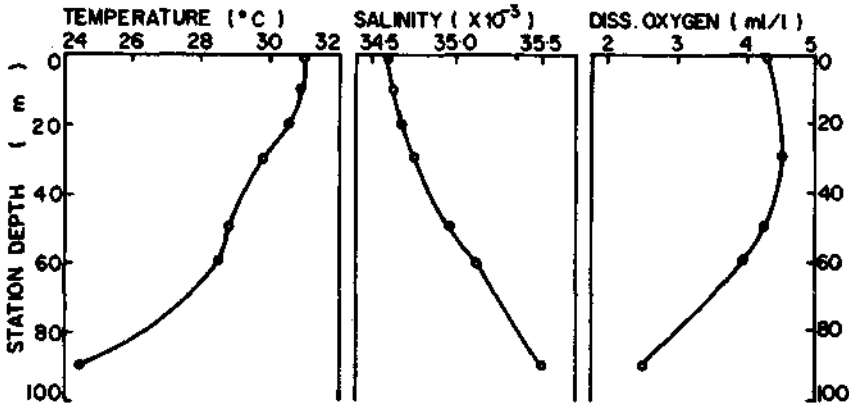

Fig. 3 - Vertical profiles of temperature, salinity and dissolved oxygen

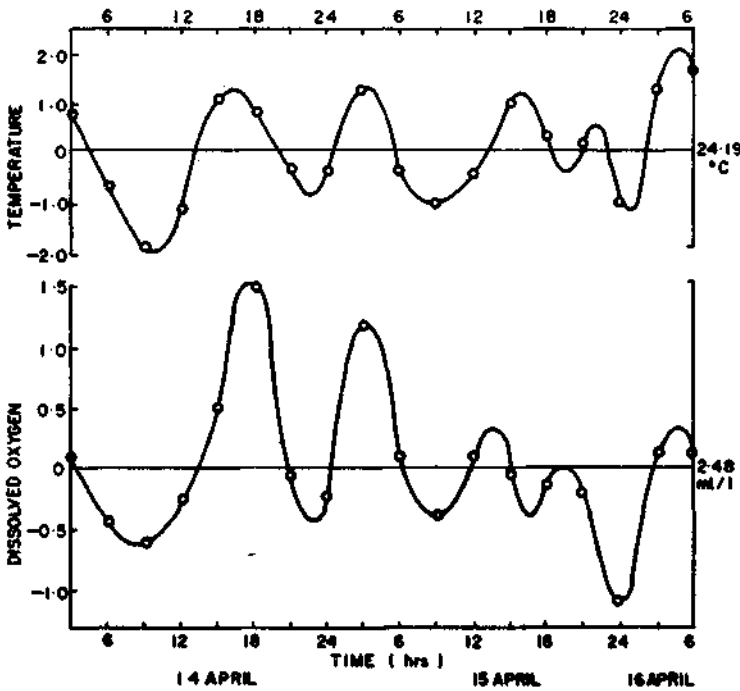

Fig. 4 - Rhythmic diurnal rise and fall in bottom temperature and dissolved oxygen values indicative of mixed semidiurnal wave pattern

The higher level of diurnal variation in salinity recorded between 20 and 50 m depth and another at 60-90 m depth with very low values at 50 - 60 m indicated the possibility of existence of stratification in the water column with different physico-chemical properties and separated by the thermocline. Banse (1968) reported the presence of strong seasonal thermocline in the shelf during late April and early May between 30 and 50 m. Varma *et al.* (1980) observed thermocline at 50 m in late April. According to Somayajulu *et al.* (1980), the seasonal thermocline forms due to intense surface heating and subsequent heat exchange process downwards. The domes/ridges and troughs in the subsurface layers (Fig. 1) indicate the oscillation of internal waves.

The results of the time series experiments conducted on the production and utilisation of dissolved oxygen in the 0-30 m water column at three hourly interval (during 14-16 April) indicated that the rate of production and utilisation of oxygen was varying from hour to hour in a day without any regular diurnal periodicity (Table 1). This revealed that the watermass in the euphotic zone also was changing from time to time, possibly by the influence of tides and currents. When the hourly variation in temperature and salinity was relatively less in the upper 0-10 m water column, the wider variations recorded at 20 m and below could be chiefly due to the influence of tidal oscillation. The relatively low variation in salinity observed at 90 m than at 60 m depth could be due to the fact that the bottom salinity distributed between the inshore shelf and the shelf edge may not have much variation during this premonsoon month as compared to that of 60 m depth.

Apart from the importance of temperature profile and thermocline studies on the distribution of plankton and related fisheries aspects, Somayajulu *et al.* (1980) found that the sound velocity profiles closely resemble the shape of temperature profiles than that of salinity, indicating the marked dependence of sound velocity on temperature structure which could be applied in navigation purposes.

In conclusion, results of the diurnal experiments revealed that the production of oxygen in the water was much higher than its utilisation in the unit area. The availability of higher levels of dissolved oxygen in the euphotic column up to a depth of 50 m at this station (4 ml/l) and the high rate of production of oxygen than utilisation confirmed the existence of a very favourable environment for the biological productivity in the shelf region off Cochin during the premonsoon month of April. Among the different depths studied at this station, the subsurface water column around 10 m depth appeared to be ideal with less of diurnal variation in temperature and salinity. Hence, sea truth data at this depth will be a good indication for remote sensing applications during premonsoon season. Similar studies for the other seasons are desirable.

#### ACKNOWLEDGEMENT

Authors are grateful to Dr. P.S.B.R. James, former Director of CMFRI for providing facilities. Thanks are also due to Dr. P.G.K. Murthy, NPOL, Cochin and his

colleagues for the co-operation extended on board during the collection of basic data; and to Dr. K. Alagaraja of CMFRI for suggestions and encouragement.

### REFERENCES

- Banse, K. 1968. Hydrography of the Arabian Sea shelf of India and Pakistan and effects on demersal fishes, *Deep-Sea Res.* 15: 45-79.
- Hareesh Kumar, P.V. & Rao, R.R. 1987. Diurnal scale variability in vertical thermal structure of coastal waters off south-west coast of India during May 1985, *Indian J. Mar. Sci.* 16: 71-76.
- Somayajulu, Y.K., Gangadhara Rao, L.V. & Varadachari, V.V.R. 1980. Small-scale features of sound velocity structure in the northern Arabian Sea during February-May 1974, *Indian J. Mar. Sci.* 9: 141-147.
- Strickland, J.D.H. & Parsons, T.R. 1968. *A practical handbook of Seawater analysis*, Bull No. 167 (Fish Res. Bd. Canada, Ottawa) pp. 311.
- Varma, K.K., Kesava Das, V. & Gouveia, A.D. 1980. Thermocline structure and watermass in the northern Arabian Sea during February-April, *Indian J. Mar. Sci.* 9: 148-155.

\* \* \*



## Effect of oil spill on the microbial population in Andaman Sea around Nicobar Island

Ranu Gupta

National Institute of Oceanography, Regional Centre, P.O. Box 1913, Cochin - 682 018

### ABSTRACT

The microbial studies of the follow up cruise by *FORV Sagar Sampada* (cruise No. 113), 9 months after the oil spill in the Andaman Sea due to accident of *VLCC Maersk Navigator* revealed disturbance in the natural microbial population. Higher abundance of heterotrophic microorganisms was observed at several coastal stations as well as from greater depths. Oelophilic microorganisms were fairly abundant at some of the stations especially st. 2991 at 400 m and 500 m depths. The presence of oelophilic microorganisms at different stations and greater depths could be indicative of the remanants of the oil spill.

### INTRODUCTION

Seawater contains a range of microorganisms bacteria and fungi, which can utilize oil or a group of hydrocarbons as a source of carbon and energy. Although these microorganisms are not present in sufficient numbers in open sea, they multiply rapidly and increase in number when such substrates are available to them. Thus the presence of these organisms in an environment may indicate contamination of the environment with oil spill and they can be taken as indicator organisms (Gupta, 1990).

Microbial studies of the oil spills in the marine environment has been carried out on some of the major oil spills (Ahearn & Crow, 1980; Atlas, 1981; Atlas & Bronner, 1981). The most studied ones are of the super tanker Amoco Cadiz which grounded near Portsal, France (1978) and IXTOC I spill. In 1980 Atlas *et al.* (1980) reviewed the environmental impact of accidental oil spill in the oceans. Tanker 'Arrow' went aground and it was pronounced even after 5 years of the incident (Vandermeulan & Gordon, 1976).

Danish *VLCC Maersk Navigator* carrying 300000 tonne of light crude from Oman to Japan collided with Singapore registered tanker *Sanko Honour* on 21st January, 1993, while negotiating the narrow passage through the small Indonesian

Islands at the entry point of Malacca strait. The impact ruptured one of its tankers and an estimated 18000 tonne of oil spilled on the sea for several days. Altered by the news that the oil patch was just 16 nautical miles south of Indira Point (IP, Fig.1), survey on its environmental impact was undertaken soon, onboard *ORV Sagar Kanya* (cruise No. 81). This paper presents the results of the microbiological studies during *FORV Sagar Sampada* cruise No. 113 which was the follow up cruise of the former with the objective to examine any eventual permanent ecological damage caused to the marine environment by the above oil spill. Microbiological studies of the water samples from

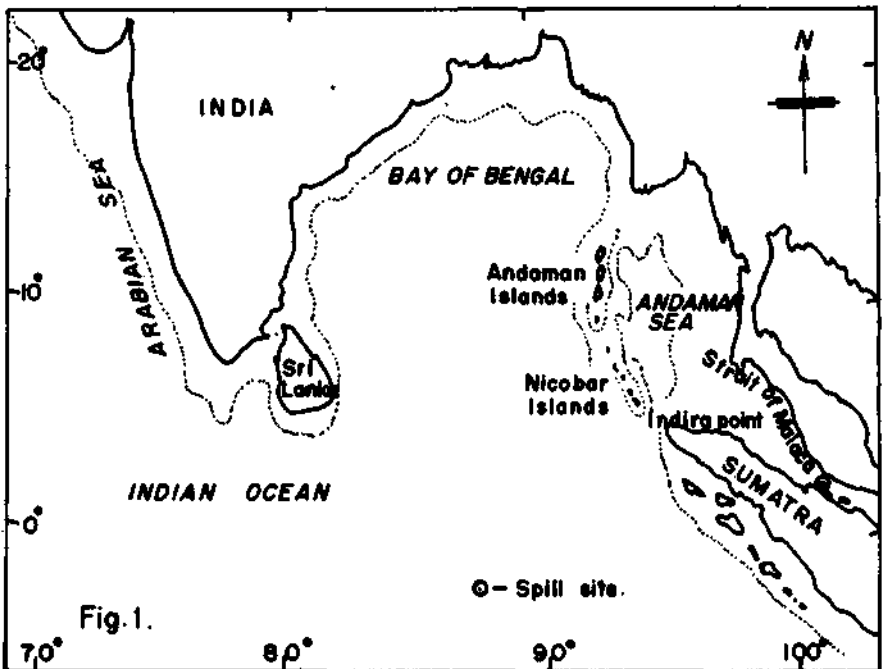

Fig.1 — Oil spill site

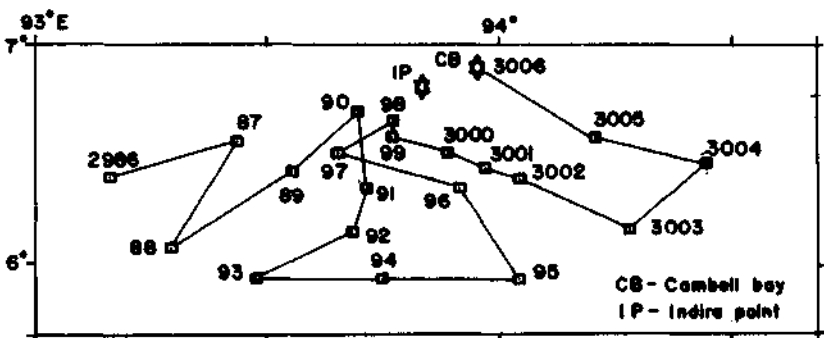

Fig.2 — Station locations in oil spill site

different depths of the water column at 9 stations of Indian EEZ (Fig. 2) in the Andaman Sea (where oil patch was sighted), south of Great Nicobar Island were done. Sediment samples from 6 shallow stations during the cruise and also from the beaches and mangrove area of the Great Nicobar Island were taken for microbiological studies, decaying pneumatophores from mangrove area were also collected. Samples were also screened for the presence of oelophilic microorganisms.

## MATERIALS AND METHODS

Water samples were collected from 9 stations during the cruise (Fig. 2) in Teflon lined well cleaned Rosette sampler from surface down to 50 m depth except at the station no. 2991, the water samples were collected from 400 m and 500 m depths where turbid bands on the CTD screen were observed. From the same station water sample from 300 m depth was collected as reference sample for the former two samples. Sediment was collected by a modified Peterson's grab. Samples from the centre of the sediment lump was taken out aseptically into presterilized plastic bags. Sediments and decaying pneumatophore samples from Magar Nala mangrove and the beaches of Great Nicobar Island were also collected in presterilized plastic bags. Beach no. 1 was 8 km from Campbell Bay (CB) of the Great Nicobar Island and Beach no. 2, 18 km from CB (Fig.2).

Immediately after collection, water samples were filtered (concentrated) on 0.22  $\mu\text{m}$  porosity filter membranes (5 ml for bacteria) and on 0.45  $\mu\text{m}$  porosity filter membranes (100 ml) for fungi. For viable plate counts of total heterotrophic bacteria each of the membrane was placed on Zo- Bells's Marine agar plates (Floodgate, 1984) while for fungi plates with nutrient agar were used with antibiotics to prevent bacterial growth (Uden & Fell, 1968).

For the study of oelophilic microbial population, the filter membranes were impregnated with 1 ml of filter sterilized hydrocarbon (Diesel or 2T super lube oil) (Sorokh *et al.* 1981). The plates were incubated at room temperature  $25^{\circ} \pm 1^{\circ}\text{C}$ , but for the samples collected at st. no. 2991 at 300 m, 400 m and 500 m depths plates were incubated at  $10^{\circ} \pm 1^{\circ}\text{C}$  (*in situ* temperature).

For each sediment sample 1 g of the sample was aseptically taken out from the plastic bag inside a sterile chamber and shaken well with 100 ml presterilized (auto-claved) seawater and allowed to stand for 10 minutes to let the sediment particles settle down. The supernatant was then concentrated on millipore filter membranes of 0.22  $\mu\text{m}$  porosity for bacteria and 0.45  $\mu\text{m}$  for fungi. These filter membranes were placed in plates on nutrient media for bacteria and fungi respectively as stated earlier. All the plates were incubated at room temperature, for 4 days for bacteria and 7 days for fungi. Pneumatophore pieces were washed well with presterilized seawater and planted on nutrient media and incubated at room temperature. Each sample was run in triplicate and for each set blank plates were prepared and incubated in triplicate as controls. The results are the mean of the triplicate samples. Microbial counts are expressed as colony forming units (cfu)/litre of seawater for water samples and cfu/g of sediment samples.

## RESULTS AND DISCUSSION

The nearshore sts. 2986, 2997, 2998, 3004 and 3005 had higher microbial population (Table 1). There were a few oelophilic bacterial and fungal patches at sts. 2986, 2987, 2997, 2998 and 3005 but they showed in high numbers at all the three depths of st. 3004.

Table 1 - Microbial cell density (cfu/litre) of water samples at different stations of *FORV Sagar Sampada* cruise 113

St. no.	Position		Depth (m)	Bacteria (cfu)	Fungi (cfu)	Oelophilic	
	Lat.(N)	Long.(E)				Bacteria (cfu)	Fungi (cfu)
2985	05°45'	92°00'	1	2500	10	-	-
			25	100	110	-	-
			50	500	20	-	-
2986	06°24'	93°06'	1	4000	250	50	120
			40	500	190	60	-
2987	06°34.2'	93°26.25'	1	2600	1000	-	-
			25	6400	5000	20	10
			50	4280	50	-	-
2988	06°05'	93°18'	1	3000	30	-	-
			25	2000	50	-	-
			50	1800	90	-	-
2991	06°41.9'	93°42.76'	300	420	-	-	-
			400	5000	-	1120	-
			500	6000	-	2020	-
2997	05°56.41'	94°3.58'	1	10000	2000	70	-
			25	8000	330	-	-
			50	5000	60	70	-
2998	06°21'	93°55.6'	1	10000	160	-	-
			25	5000	1500	150	-
			50	6000	220	160	60
3004	06°28.3'	94°30.15'	1	10000	1060	1000	200
			25	400	800	6000	360
			50	1700	250	3000	300
3005	06°34'	94°12'	1	8200	160	60	-
			25	7000	480	150	50
			50	7000	60	60	70

At st. 2991 high turbidity was observed on CTD screen at 400 m and 500 m depths but sonar system could not detect anything, thus, as they were expected, bands were of bacterioplankton with 5000 cfu and 6000 cfu and a good number of them (1120 and 2020 cfu) proved oelophilic in nature, while the samples from the reference depth 300 m at the same station had 420 cfu of bacteria and no fungus nor oelophilic microorganism.

Sediment samples were mostly coralline sand. At st. 2999 the samples were only big pieces of dead corals and had no sediments, so they were not processed. At sts. 2990, 2992, 3000, 3001 and 3006 (samples collected near the Campbell Bay) were full of corals but fine coralline sand was also present. These samples yielded up to 35 cfu of bacteria and up to 13 cfu of fungi per gram of sediment sample of which some were oelophilic too (Table 2).

Table 2 - Microbial cell density (cfu/g) of sediment samples at different stations of *Sagar Sampada* cruise 113

St. no.	Position		Bacteria (cfu)	Fungi (cfu)	Oelophilic	
	Lat.(N)	Long.(E)			Bacteria (cfu)	Fungi (cfu)
2990	06°42'	93°43'	25	5	3	1
2992	06°42'	93°42'	15	2	-	-
3000	06°38'	93°47'	35	13	6	4
3001	06°36'	93°47'	3	6	-	-
3006	opp: C.B		18	8	2	-

C.B - Campbell Bay (Fig. 2)

Table 3 - Microbial cell density (cfu/g) of sediment samples of Great Nicobar Island

	Bacteria (cfu)	Fungi (cfu)	Oelophilic	
			Bacteria (cfu)	Fungi (cfu)
<b>Mangrove</b>				
Sample 1	150	30	-	-
Sample 2	80	15	-	-
Beach no. 1	26	15	-	-
Beach no. 2	150	6	100	8

Sample nos. 1 and 2 are from near the Magar Nala bridge Beach no.1 is 8 km from Campbell Bay from the Campbell Bay

Sediment samples from the mangrove area were clayey and provided high bacterial (up to 30 cfu/g) count but one was oelophilic. Beach no.1 was full of coralline sand and yielded some (26 cfu/g) of bacterial and (15 cfu/g) fungal but none oelophilic (Table 3). At beach no. 2 below the coralline sand was fine sand, this yielded good bacterial (150 cfu/g) population and a few fungal (6 cfu/g) with reasonable number of oelophilic (100 cfu/g) ones. Pneumatophores yielded heavy growth of cellulolytic filamentous fungi, *Dendryphiella salina*, *Curvularia* sp. and *Fusarium* sp.

The appearance of oelophilic microbial population at particular stations and at different depths could well be indicative of the remnants of the oil patch transformed into tar balls, sinking at different rates in the water column (Sebastian, 1981). This may be taken as a change or disturbance in their natural population pattern due to the effect of the oil spill.

### ACKNOWLEDGEMENT

The author gratefully acknowledges the help and encouragement from Dr. B.N.Desai, former Director, Dr. V.N.Sankaranarayanan, and Dr. R. Sen Gupta.

### REFERENCES

- Ahearn, D. G. & Crow, S. A. 1980. Yeasts in the North Sea and Amoco Cadiz, *Bot. Mar.* 23: 125-127.
- Atlas, R. M. 1981. Fate of oil from two major oil spills; Role of microbial degradation in removing oil from the Amoco Cadiz and IXTOC I spills, *Environ. Int.* 3: 33-38.
- Atlas, R. M. & Bronner, A. 1981. Microbial hydrocarbon degradation within intertidal zones impacted by the Amoco Cadiz oil spillage. *Proc. Internatl. Symp. Amoco cadiz; Fate and Effects of oil spill.* Centre. Oceanologique de Bretagne, Brest. 251-256.
- Atlas, R. M., Roubel, G. & Haines, J. 1980. Biodegradation of hydrocarbon in mousse from IXTOC I Well blow out. *Proc. Symp. Assessment Environ. Impact Acci. Oil Spills in Oceans.* Aug. 1980. Div. Environ. Chem. Amer. Soc. (Ann Arbor Sci. Publ., Ann Arbor, Michigan), 1-24.
- Floodgate, G. D. 1984. The fate of petroleum in marine ecosystem. In: *Petroleum microbiology.* edited by R. M. Atlas, (Mac Millan Publ. New York) pp. 354-397.
- Gupta, R. 1990. Possible application of microorganisms in monitoring and management of aquatic pollution. In: *Environmental Pollution of Land and Water.* edited by R.C. Dalela. (Publ. Acad. of Environ. Biol. Muzaffarnagar, India) pp. 137-150.
- Sebastian, A. G. 1981. Marine oil spill. In: *Marine pollution diagnosis and therapy.* (Springer-Verlag, Berlin Heidelberg, New York), 74.
- Sorokh, N. A. Ghamnoum, M. A. Ibrahim, A. S. Stretton, R. J. & Randwan, S. S. 1990. Crude oil and hydrocarbon degrading strains of *Rhodococcus rhodochrous*, isolated from soil and marine environment of Kuwait. *Environ. Poll.* 65: 1-7.
- Uden, A. V. & Fell, J. W. 1968. Marine Yeasts. In: *Advances in microbiology of the sea.* edited by M. R. Droop & E. J. E. Wood : (Acad. Press, New York, London) pp 167-198.
- Vandermeulan, J. H. & Gordan, D. C. 1976. Re-entry of 5 years old stranded bunker C fuel oil from a low energy beach into water, sediment and biota of Checlabucto Bay, Nova Scotia. *J. Fish. Board Can.* 33: pp 2202-2210.

## Growth of marine yeast on different strength of stress solutes

Ranu Gupta

National Institute of Oceanography, Regional Centre, P.O. Box 1913,  
Cochin - 682 018

### ABSTRACT

Sixteen isolates of marine yeasts belonging to genera *Candida*, *Debaryomyces*, *Rhodotorula* and *Saccharomyces*, isolated from the (EEZ) of India were screened for their growth on different concentrations of sodium chloride (NaCl). Most of them showed excellent growth at 4% and good growth at 6% NaCl. Species of red yeast *Rhodotorula* lost its pigment production at 6%, except *R. rubra* which grew up to 16% NaCl with faint pigmentation. Six species of genera *Debaryomyces*, *Saccharomyces* and *Rhodotorula* were tested against the stress solutes NaCl (0-16%), potassium chloride (KCl) and sodium sulphate ( $\text{Na}_2\text{SO}_4$ ) at 0.4%, 4% and 8% concentrations. *D. hansenii* and *D. marama* were the most versatile isolates exhibiting excellent growth in all the concentrations of the three stress solutes, while *S. cerevisiae* and *R. glutinis* exhibited good tolerance in NaCl, but failed to do so in KCl and  $\text{Na}_2\text{SO}_4$ .

### INTRODUCTION

Organisms are found living from fresh water to saturated brine (6M NaCl) conditions and are thus confronted with the potential problem of water gain or loss. Particularly among euryhaline osmoconformers, intracellular osmotic pressure may fluctuate greatly (Yancey *et al.* 1982). Cellular growth is generally inhibited by extremes of environmental salinity. However, several species of prokaryotic and eukaryotic microorganisms have acquired the ability to tolerate wide range of salt stress (Brown 1976; Gould 1977). The obligate halophilic bacterium *Halobacterium salinarium*, whose enzymes require 25% NaCl for optimal activity was studied in detail (Holmes *et al.* 1965). Extremely halotolerant *Halomonas* sp. was isolated from tar balls and its cellular fatty acid composition has been studied by Naganuma & Horikoshi (1993). In yeasts the widely distributed species *Debaryomyces hansenii* and *Saccharomyces cerevisiae* were studied in detail (Alder & Gustafsson 1980;

Alder *et al.* 1985; Lars *et al.* 1988). Preliminary studies have been carried out on *Rhodotorula rubra* and *R. glutinis* (Ito & Takada, 1978; Lan, 1990).

This paper presents a general screening of 16 marine yeasts for their capacity to grow on different concentrations of NaCl. Out of the 6 isolates 2 belonging to *Saccharomyces*, 3 to *Debaryomyces* and one to *Rhodotorula* were tested on different concentrations of stress solutes NaCl, KCl and Na<sub>2</sub>SO<sub>4</sub>.

## MATERIALS AND METHODS

Yeast cultures used in the study were isolated from water and mud samples of the EEZ of India during the cruises of *FORV Sagar Sampada* (Gupta & Prabhakaran, 1990). The cultures are maintained as stock culture in the Regional Centre of National Institute of Oceanography, Cochin, India. Screening of the yeast cultures were carried out by observing their growth on YEPD agar (yeast extract 1%, peptone 2%, dextrose 2% and agar 2% w/v) with different percentages of NaCl i.e. 0%, 4%, 6%, 12%, and 16%. Inoculum from actively growing slants of yeasts were streaked on the plates and the plates were incubated at 26±1°C. Observations were made after 6 days of incubation. Growth was estimated by count of viable colony forming units (cfu) on the plates (Lars *et al.* 1988).

Cells were cultured in a defined liquid mineral salt medium (Alder & Gustafsson, 1980) with supplements as stated further. Starter culture was prepared by inoculating a loopful of actively growing yeast culture in 50 ml of the above medium supplemented with 1% w/v glucose in 250 ml Erlenmeyer flasks. The flasks were incubated at 26±1°C on rotary shaker (at 110 rpm) for 24 to 48 hours when the cell density reached  $2 \times 10^4$  cells/ml. These cultures (0.1 ml) were used as inoculum for 100 ml of the above medium in 250 ml Erlenmeyer flasks supplemented with different concentrations of stress solutes. Concentrations tested were NaCl : 0%, 4%, 6%, 12% and 16%; KCl and Na<sub>2</sub>SO<sub>4</sub> : 0.4%, 4%, and 8%. Tests were run in triplicate. The flasks were run on rotary shaker at 110 rpm and 26±1°C. After 24 hours incubation 0.05 ml culture was added to 50 ml of molten medium (having same composition with 1% w/v glucose and the same percentage of the stress solute plus 2% bactoagar) and poured into replicate plates. The cfu were counted after 6 days of incubation. For all the media pH was adjusted to 6, incubation temperature was 26±1°C and the plates were incubated enclosed in polythene bags to avoid desiccation.

## RESULTS AND DISCUSSION

Details of the results of screening 16 yeast isolates for their growth at different percentage of NaCl concentration is given in Table 1. Two species of *Debaryomyces*, *D. hansenii* and *D. marama* showed excellent growth from 0% to 16% NaCl concentrations, while *D. vanriji* did not grow at 16% although it grew well from 0% to 12% NaCl concentrations. *Rhodotorula graminis* was the most sensitive of all the *Rhodotorula* isolates tested, exhibiting poor growth at 0% and 12% onwards, its optimal



Table 1 — Growth of yeast isolates in different concentrations of sodium chloride

Yeast species	Concentration of NaCl				
	0%	4%	6%	12%	16%
<i>Candida</i> sp.	⊕⊕⊕	⊕⊕⊕⊕	⊕⊕⊕	⊕⊕	⊕⊕
<i>Candida albicans</i>	⊕⊕⊕	⊕⊕⊕⊕	⊕⊕	⊕	⊕
<i>Candida guilliermondii</i>	⊕⊕⊕	⊕⊕⊕⊕	⊕⊕⊕	⊕⊕	—
<i>Candida membranaefaciens</i>	⊕⊕⊕⊕	⊕⊕⊕⊕	⊕⊕⊕	⊕⊕	—
<i>Candida parapsilosis</i>	⊕⊕⊕	⊕⊕⊕⊕	⊕⊕⊕	⊕⊕	—
<i>Candida parapsilosis</i>	⊕⊕⊕	⊕⊕⊕⊕	⊕⊕⊕	⊕⊕	⊕
<i>Debaryomyces hansenii</i>	⊕⊕⊕⊕	⊕⊕⊕⊕	⊕⊕⊕⊕	⊕⊕⊕⊕	⊕⊕⊕
<i>Debaryomyces marama</i>	⊕⊕⊕	⊕⊕⊕⊕	⊕⊕⊕⊕	⊕⊕⊕	⊕⊕⊕
<i>Debaryomyces vanriji</i>	⊕⊕⊕	⊕⊕⊕⊕	⊕⊕⊕	⊕⊕⊕	—
<i>Saccharomyces kluyveri</i>	⊕⊕⊕⊕	⊕⊕⊕⊕	⊕⊕	⊕	—
<i>Saccharomyces cerevisiae</i>	⊕⊕⊕⊕	⊕⊕⊕⊕	⊕⊕⊕	⊕	—
<i>Rhodotorula</i> sp.	⊕⊕	⊕⊕⊕⊕	⊕⊕⊕	⊕⊕	⊕
<i>Rhodotorula glutinis</i>	⊕⊕⊕	⊕⊕⊕⊕	⊕⊕⊕	⊕⊕	⊕
<i>Rhodotorula minuta</i>	⊕⊕⊕	⊕⊕⊕⊕	⊕⊕⊕	⊕⊕	⊕
<i>Rhodotorula graminis</i>	⊕	⊕⊕⊕⊕	⊕⊕⊕	⊕	—
<i>Rhodotorula rubra</i>	⊕⊕	⊕⊕⊕⊕	⊕⊕⊕	⊕⊕	⊕

⊕⊕⊕⊕ (250 - 150 cfu) Excellent growth, ⊕⊕⊕ (150 - 50 cfu) good growth,  
 ⊕⊕ (50 - 10 cfu) moderate growth, + (10 - 1 cfu) poor growth,  
 — no growth.

growth was at 4% NaCl concentration while *R. rubra* proved most tolerant with optimal growth at 4% NaCl concentration. Most of the species of red yeast *Rhodotorula* lost their pigmentation from NaCl concentration of 6% onwards but *R. rubra* maintained light pigmentation even at 16% NaCl concentration. All the species of *Candida* exhibited wide range of flexibility except for *C. albicans* which grew well up to 4% NaCl concentration. *Candida* sp. was most versatile exhibiting excellent growth at 4% and it grew moderately at 12% and 16% NaCl concentrations. Most of the other yeast isolates tested showed excellent growth up to 4% and good growth up to 6% but grew poorly above 12% concentration.

Details of the results of testing 6 yeast isolates for their growth on different concentrations of stress solutes are given in Table 2. *Debaryomyces hansenii* exhibited equally good growth from 0% to 16% NaCl concentrations with 206 cfu at 0%, 260 cfu at 4%, 220 cfu at 12%, and even 184 cfu at 16% NaCl concentration

Table 2 — Growth of six yeast isolates in different concentrations of stress solutes: colony forming units (cfu)/plate

Yeast species	NaCl					KCl			Na <sub>2</sub> SO <sub>4</sub>		
	0%	4%	6%	12%	16%	0.4%	4%	8%	0.4%	4%	8%
<i>Debaryomyces hansenii</i>	206	260	248	220	184	210	210	204	220	208	220
<i>Debaryomyces marama</i>	188	260	240	180	174	188	84	25	182	174	-
<i>Debaryomyces vanriji</i>	160	240	180	174	-	180	32	30	178	180	184
<i>Rhodotorula glutinis</i>	170	220	160	20	5	6	4	-	10	20	10
<i>Saccharomyces cerevisiae</i>	200	208	180	5	-	2	5	-	8	28	22
<i>Saccharomyces kluyveri</i>	204	200	25	2	-	88	28	-	160	26	20

*D. marama* could also grow in wide range of NaCl concentrations, optimal viable cfu 260 at 4%, 188 cfu at 0%, and 174 cfu at 16%. *Debaryomyces vanriji* too had good growth from 0% to 12% but failed at 16% NaCl concentration. *Saccharomyces cerevisiae* had good growth with 180 cfu at 8% but poor at 12% NaCl concentration. *S. kluyveri* showed good growth with 200 cfu at 4%, but at 6% growth became poor. Both the *Saccharomyces* sp. could not grow at 16% NaCl concentration. *Rhodotorula glutinis* had good growth with 229 cfu till 8% but had only a few cfu (5) at 16% NaCl concentration.

In KCl and Na<sub>2</sub>SO<sub>4</sub> test concentration (Table 2) *D. hansenii* exhibited steady growth from 0% to 8% concentrations, whereas *D. vanriji* and *D. marama* could grow up to 8% of KCl and not in Na<sub>2</sub>SO<sub>4</sub>. *Rhodotorula glutinis* had poor growth of 4 cfu at 8% KCl and Na<sub>2</sub>SO<sub>4</sub>, while nil at 8% KCl and 10 cfu at 8% Na<sub>2</sub>SO<sub>4</sub> respectively.

All the three species of *Debaryomyces* exhibited very good growth in a wide range of salt concentrations (stress solutes) of NaCl, KCl, Na<sub>2</sub>SO<sub>4</sub>. *Debaryomyces hansenii* was the most versatile species.

This study proves that a number of species of *Candida* and *Rhodotorula* which regularly occur in the marine environment are also highly versatile in their salt tolerance and can stay viable and grow in high concentration of stress solutes as well as in very low concentrations. This establishes them to be of euryhaline nature. Further work is in progress.

#### ACKNOWLEDGEMENT

The author gratefully acknowledges the encouragement from Dr. B. N. Desai, former director and Dr. V. N. Sankaranarayanan, SIC, NIO, Cochin.

## REFERENCES

- Alder, L., Blomberg, A. & Nilsson, A. 1985. Glycerol metabolism and osmoregulation in the salt tolerant *Debaryomyces hansenii*, *J. Bacteriol.* 162 : 300-306.
- Alder, L. & Gustafsson, L. 1980. Polyhydric alcohol production and intracellular amino acid pool in relation to halotolerance of the yeast *Debaryomyces hansenii*, *Arch. Microbiol.* 124 : 123-130.
- Brown, A. D. 1976. Microbial water stress, *Bacteriol. Rev.*, 40: 803-846.
- Gould, G. W. & Measures, J. C. 1977. Water relations in single cell. *Philosophical Trans. Royal Soc.* 278: 151-166.
- Gupta, R. & Prabhakaran N. 1990. Fungi isolated from the EEZ of Indian coast, In: *Proc. First Workshop Scient. Resul. FORV Sagar Sampada*, edited by K. J. Mathew, (CMFRI, Cochin) pp. 37-46.
- Holmes, P. K., Dundas, I. E. D. & Halvorson, H. O. 1965. Halophilic enzymes in cell free extracts of *Halobacterium salinarum*, *J. Bacteriol.* 90: 1159-1160.
- Ito, N. & Takada, H. 1978. The relationship between salt tolerance and RNA synthesis in a marine yeast *Rhodotorula glutinis* Var. *Salinarum*. *Trans. Mycol. Soc. Jap.* 19: 419-423.
- Lan, G. 1990. Preliminary study on the relation of the growth and reproduction of two species of marine yeast with salinity effects. *Mar. Sci. Haiyang Kexue.* 2: 18-21.
- Lars, A. Nilsson, A. & Alder L. 1988. Role of glycerol in osmotolerance of yeast *Debaryomyces hansenii*. *J. Gen. Microbiol.* 134: 669-677.
- Naganuma, T. & Horikoshi, K. 1993. Extremely halotolerant *Halomonas* sp. isolated from a tar ball and its cellular fatty acid composition. *J. Mar. Biotechnol.* 1: 151-157.
- Yancey, P. H., Clark, M. E., Hand, S.C., Bowlus, R.D. & Somero, G. N. 1982. Living with the water stress: evolution of osmolyte systems. *Science* 217: 1214-1222.

\* \* \*

## Distribution of heterotrophic bacteria around Laccadive Islands

V. Chandrika

Central Marine Fisheries Research Institute  
Dr.Salim Ali Road, P.B.No.1603  
Cochin-682 014

### ABSTRACT

Distribution of heterotrophic bacteria in water samples collected from surface and 50 m depth in 26 stations around Laccadives in EEZ between 08°50' and 12° and 71° and 74° E onboard *FORV Sagar Sampada* was studied. The size of colonies isolated from surface water were very small when compared to colonies from 50 m depth. Green fluorescent *Pseudomonas* was predominant in some stations. Counts ranged from  $0.81 \times 10^8$ /ml to  $2.66 \times 10^8$ /ml in surface waters and  $0.9 \times 10^8$ /ml to  $2.20 \times 10^8$ /ml in 50 m depth. Night samples harboured less counts when compared to daytime samples. Out of 23 cultures studied *Vibrio*, *Alcaligenes*, green fluorescent *Pseudomonas* formed the main flora and members of Enterobacteriaceae were absent. Both gram-positive and gram-negative bacteria were isolated of which 94.6% were gram-negative rods. Their correlation with environmental parameters are discussed.

### INTRODUCTION

Information on the ecophysiology and activity of microbial population from the Indian Ocean around Laccadives is very much limited (Nair, 1979; Loka Bharati & Chandramohan, 1990). Very recently Moriarty (1979) and Moriarty *et al.* (1985) published a comprehensive review on the productivity and trophic role of bacteria on coral reefs. Chandramohan & Ramaiah (1987) found that nearly 50 to 80% of assimilated carbon was respired by heterotrophic activity indicating a very high rate of mineralization. However, very little is known about quantitative and qualitative abundance and the pattern of vertical distribution of bacteria from the Indian Ocean around Laccadives in EEZ between 08°50' and 12°00'N and 71°00'E. In this communication the results of the standing crop of heterotrophic bacteria of water samples

from 0 to 50 m in the Lakshadweep Archipelago and nearby oceanic waters is reported (Fig.1). No station was closer to the land.

## MATERIALS AND METHODS

The area surveyed (Fig.1) was lying within 8°- 12°N and 71°- 74°E (around Laccadives) at a depth range of 150- 4000 m. A total of 26 multidisciplinary stations were covered in cruise No.82 between 7th December to 20th December, 1990.

Water samples were collected from the surface and 50 m with the help of Rosette sampler and stored in sterilised screw cap tubes. The samples were analysed immediately onboard using selective mediums Zo Bell 2216 Marine Agar and glucose asparagin agar (GAA) by spread plate technique. Sample (0.5 ml) was pipetted on to the surface of each of three plates and at once spread widely with a fine wire-loop. Plates were incubated for three days and total viable bacterial colonies were counted in a colony counter. The viable count was calculated from the average colony count per plate and the bacterial count is expressed as numbers per ml. For the determination of predominant generic composition, colonies were selected randomly and identified up to generic level by subjecting them to various diagnostic tests. The purified cultures were identified according to a scheme of Simidu & Aiso (1962) and in accordance with Bergy's manual (Buchanan & Gibbons, 1974).

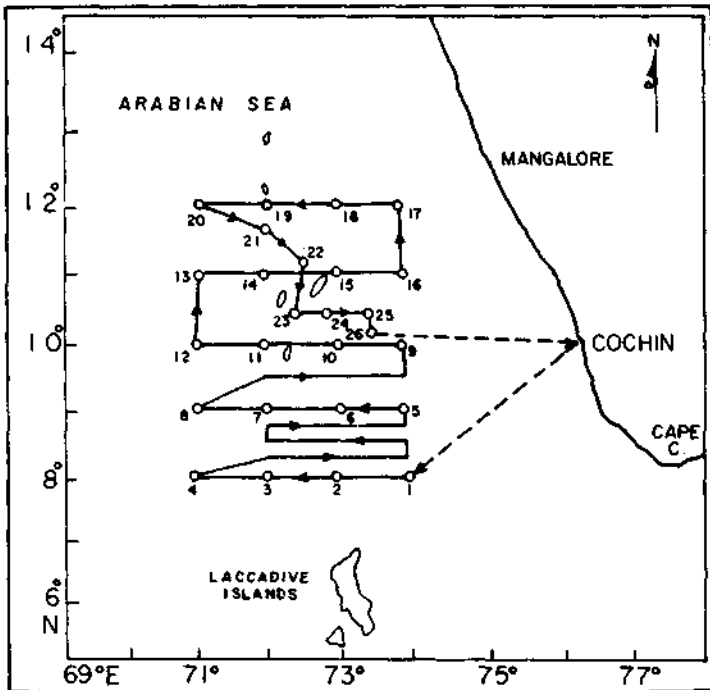

Fig. 1 - Station locations

## RESULTS AND DISCUSSION

The morphological, physiological and biochemical properties of heterotrophic bacteria isolated from surface water and 50 m depths are shown in Table 1. Of the identified isolates 94.6% were gram-negative short-rods and 23.8% were chromogenic and formed asporogenous rods. In general most of the cultures were highly pleomorphic. The number declined with increasing water depth. The temperature range at the surface was about 25°- 28°C. Station 13 recorded the lowest surface temperature of 18.5°C. Although, the surface of the open ocean is subject to seasonal changes a marked uniformity of temperature was recorded in the surface waters in many stations. In fact the variation was not more than 0.2°-0.3°C in data already available (Austin, 1988). In the present observation the sampling was always in the photic zone and the variation recorded was 2° to 3°C. Oxygen was in the range 1.4 to 3.8 ml/l. Kriss (1959, 1976) and his colleagues in their extensive study of the heterotrophic bacteria in the world oceans reported that marine heterotrophic bacteria will reflect hydrological structure of the oceans. The high counts obtained in the present study reflected the fertility and hydrological structure of the area.

The different genera of bacteria formed were *Alcaligenes* (42.3%), *Vibrio* (34.6%), *Pseudomonas* (20%) and *Flavobacterium* (3.8%). *Alcaligenes* occurred in large numbers in 50 m depth compared to other genera in this region of the Arabian Sea although *Pseudomonas* was the predominant genus occurring in marine environment (Zo Bell, 1946). Simidu *et al.* (1982) reported the predominance of Vibrionaceae among the heterotrophic bacteria in seawater and on the plankton from the terrigenous influenced coastal areas of Japan and in East China Sea as well as in stations remote from the land. In the present study *Alcaligenes*, *Vibrio* and green fluorescent *Pseudomonas* were found predominant in open sea surface waters apparently playing an important role in the biodegradation process of organic matter.

In the present study, the number of sampling layers was only two (0 and 50 m) to draw a conclusion on the detailed hydrological structure of the water column although irregularity in the vertical distribution of the bacterial number was clear. Quantitatively, the counts ranged from  $0.8 \times 10^8$  /ml to  $2.66 \times 10^8$  /ml in surface waters (Table 1) and  $0.9 \times 10^8$  to  $2.20 \times 10^8$  /ml in 50 m depth. Night samples harboured less counts when compared to daytime samples. In surface waters counts were more but size of the colony was punctiform even at higher dilutions whereas in 50 m samples size of the colony was bigger but number of colony was found less.

Comparison of bacterial population among the total stations (26) indicated that station 5 recorded highest count of  $1220 \times 10^8$  /ml in surface water. The high counts at station 5 may be attributed to larger quantities of organic matter from the remains of dead organisms or to upwelling which brings nutrient-rich water to the surface (Gundersen, 1976). The 50 m depth layer always recorded low counts as compared to surface water (Table 1). The counts were comparatively low in stations 1, 2, 6, 8, 12, 16, 19, 20, 21 in surface waters. The various bacterial intensity indicated the existence

Table 1 - Microbiological and chemical parameters

St. no.	Temp (°C)	D.O <sub>2</sub> (ml/l)	Bacteria (x 10 <sup>8</sup> /ml)
<i>Surface seawater</i>			
1	29.00	3.30	1.28
2	27.90	2.30	1.96
3	28.50	3.30	18.20
4	26.70	3.00	60.00
5	28.60	3.40	1220.00
6	28.70	3.40	2.09
7	28.90	3.50	336.00
8	28.80	3.40	0.94
9	28.70	3.60	7.90
10	28.50	3.50	14.00
11	27.40	2.50	80.00
12	28.50	3.60	1.06
13	18.50	3.60	20.90
14	28.90	3.60	2.09
15	27.00	2.20	2.30
16	28.00	3.60	0.90
17	27.20	3.40	2.14
18	27.20	3.40	2.14
19	29.00	3.60	1.13
20	25.40	3.30	0.98
21	26.80	1.40	0.01
22	27.00	3.30	16.00
23	27.80	3.60	62.00
24	27.90	3.70	114.00
25	27.00	3.00	106.00
26	25.50	3.00	186.00
<i>50 m depth</i>			
1	28.50	3.60	196.00
2	28.40	3.20	2.09
3	28.20	3.20	2.09

(Contd ....)

Table 1 — *Contd.....*

St. no.	Temp (°C)	D.O <sub>2</sub> (ml/l)	Bacteria (x 10 <sup>8</sup> /ml)
4	28.00	3.30	302.00
5	29.00	3.40	1060.00
6	27.50	3.60	92.00
7	29.20	3.50	115.00
8	29.00	3.40	0.28
9	29.00	3.50	1.48
10	29.00	3.60	2.42
11	29.50	3.70	104.00
12	29.00	3.50	9.80
13	29.00	2.70	108.00
14	29.40	3.60	2.18
15	29.50	2.20	106.00
16	28.50	3.60	232.00
17	29.00	3.70	3.00
18	29.50	3.60	306.00
19	29.50	3.60	2.06
20	28.20	3.50	290.00
21	29.80	3.40	182.00
22	29.00	3.70	2.50
23	28.50	3.70	102.00
24	28.00	3.60	1.28
25	29.00	3.80	238.00
26	29.00	3.70	90.00

of bacteria in localised pockets of life commensurate with available sources of nutrient (Zo Bell, 1946).

The data obtained on bacterial count and environmental parameters at 0 and 50 m in the 26 stations were treated statistically, and observed that there was no significant relation between the bacterial count and other environmental parameters.

One of the critical factors in the study of bacterial flora from the natural environment is the composition of the media used (Buck, 1974). The present study was carried out on Zo Bell's 2216 and glucose asparagine agar. Simidu *et al.* (1982) reported that in PPES-II medium gave more viable counts and colony forming units than Zo Bell



2216 medium. Both the media gave maximum viable counts and with these media the number of pigmented bacteria are especially underestimated. But in the present study it was observed that green fluorescent pigmented bacteria were predominant in many surface water samples collected during daytime. If these results are also valid for open seawater bacteria the study should be evaluated as a survey of only fast growing organisms. All these zymogenous bacterial flora play a crucial role in the circulation of carbon in the sea quickly degrading various organic compound produced in the marine environment. For more comprehensive understanding of the bacterial processes in the open sea ecosystem, extensive analysis of bacteria is necessary including oligotrophic bacterial flora in the water columns.

### ACKNOWLEDGEMENT

The author gratefully acknowledges the assistance of Chief Scientist, Captain and crew of cruise No.82 of the *FORV Sagar Sampada*.

### REFERENCES

- Austin, B. 1988. *Marine microbiology*, (Cambridge University Press, New York) pp. 222.
- Buck, J.D. 1974. Effects of medium composition on the recovery of bacteria from sea water, *J. Exp. Mar. Biol.Ecol.* 15:25-34.
- Buchanan, R.E. & Gibbons, N.E. (eds.). 1974. *Bergey's manual of determinative bacteriology* (The Williams and Wilkins Co., Baltimore) pp. 1246.
- Chandramohan, D & Ramaiah, N. 1987. Heterotrophic activity and bacterial biomass in coral atolls of Lakshadweep archipelago. In: *Contribution in marine science*, edited by T.S.S. Rao *et al.* (Dr. S.Z. Qasim, Sastyabtapurti Felicitation Committee, NIO, Goa) pp. 117-130.
- Gundersen, K. 1976. Cultivation of microorganisms, In: *Marine ecology: A comprehensive integrated treatise on Life in oceans and coastal waters*, Vol. III, Part 1, edited by O. Kinne, (John Wiley, London).
- Kriss, A.E. 1959. *Marine microbiology*, (USSR Academy Sciences, Moscow) pp. 455 (in Russian).
- Kriss, A.E. 1976. *Microbiological oceanography*, (Nauka, Moscow) pp. 269 (in Russian).
- Loka Bharathi, P.A. & Chandramohan, D. 1990. Sulfate reducing bacteria from the Arabian Sea—their distribution in relation to thiosulfate—oxidising and heterotrophic bacteria, *Bull. Mar. Sci.* 47: 622-630.
- Moriarty, D.J.W. 1979. Biomass of suspended bacteria over coral rocks. *Mar. Biol.* 53:193-200.
- Moriarty, D.J.W, Pollard, P.C. & Hont, W.G. 1985. Temporal and spatial variation in bacterial production in the water column over a coral reef, *Mar. Biol.* 85: 285-292.
- Nair, S. 1979. Microbial characteristics of the Laccadive sea (Lakshadweep), *Indian J. Mar. Sci.* 8: 227-231.
- Simidu, U. & Aiso, K. 1962. Occurrence and distribution of heterotrophic bacteria in sea water from the Kamogawa Bay, *Bull. Jap. Soc. Sci. Fish.* 28: 1133-1141.
- Simidu, U., Kurniko, T. & Yoshiharu, A. 1982. Heterotrophic bacterial population in South China Sea, *Bull. Japan Soc. Sci. Fish.* 48: 425-431.
- Zo Bell, C.E. 1946, *Marine microbiology*, (Chronica Botanica, Waltham Mass, USA) pp. 240.

## **Some observations on primary production and plankton biomass along the continental shelf and slope off the northeast coast of India during January 1989**

G.S.D. Selvaraj

Central Marine Fisheries Research Institute, P.B.No-1603, Cochin - 682 014

and

V. Srinivasan

Botany Department, University of Madras, Madras - 600 005

### **ABSTRACT**

The present study deals with the quantitative aspects of chlorophyll pigments, primary productivity and plankton biomass from the continental shelf and slope off the northeast coast of India between 16° and 20°N latitudes towards the end of northeast monsoon season. In surface waters, the mean values of chl-*a*, -*b*, and -*c* were 0.249, 0.275 and 0.837 mg/m<sup>3</sup> along the shelf and 0.246, 0.260 and 0.805 mg/m<sup>3</sup> in the slope respectively while the net primary productivity values were 0.074 and 0.081 g C/m<sup>3</sup>/d for the shelf and slope waters respectively. Column productivity in the upper 0-50 m water in the shelf and slope regions were 2.9 and 3.25 g C/m<sup>2</sup>/d with an average production of 3.08 g C/m<sup>2</sup>/d. Higher rate of production was observed around 18° and 20°N latitudes. Zooplankton biomass exhibited progressive increase in volume from 16° to 20°N. The estimated mean zooplankton biomass volume of the study area was 28.83 ml/m<sup>2</sup>. The mean transfer coefficient from primary to secondary production was found to be 14% when 50% of the zooplankton biomass was considered as the daily rate of production. From the mean primary and secondary productivity values, potential tertiary production of pelagic fishery resources in the upper 0-50 m water column of the study area for the month was assessed. The factors that are likely to cause error in the estimation of secondary production are discussed.

### **INTRODUCTION**

It is well-known that plankton plays a vital role in the distribution and abundance of marine living resources. A perusal of literature reveals that studies on the hydro-

logical features and plankton productivity from the offshore waters of the east coast of India are limited since 1975 (Radhakrishna, 1978; Radhakrishna *et al.* 1978; Achuthankutty *et al.* 1980; Sreekumaran Nair *et al.* 1981; Kaladharan *et al.* 1989; Mathew *et al.* 1989; Prakash & Raman, 1989; Selvaraj *et al.* 1989; Krishnakumari & Goswami, 1993) as compared to the studies from offshore waters of the west coast of India. The present study provides some information on the hydrological features and primary and secondary productivity of the continental shelf and adjacent slope waters off the northeast coast of India between lat. 16°N and 20°N towards the end of the northeast monsoon (January) season.

## MATERIALS AND METHODS

The study is based on the hydrographic and plankton data collected on board *FORV Sagar Sampada* (cruise No. 57) from 14 stations along the continental shelf and the adjacent slope off the northeast coast of India (Fig.1) during January 1989. Water samples were collected at the stations onboard using Rossette water sampler from 1, 25, 50, 100 and 200 m depths. Water temperature, salinity, dissolved oxygen and chlorophyll pigments (chl-*a*, -*b*, -*c*) were determined adopting standard methods (Strickland & Parsons, 1968). Phytoplankton pigments were measured for the surface samples only using Perkin-Elmer UV/VIS spectrophotometer onboard. Primary productivity experiments were conducted for the water samples collected from 1, 25, 50

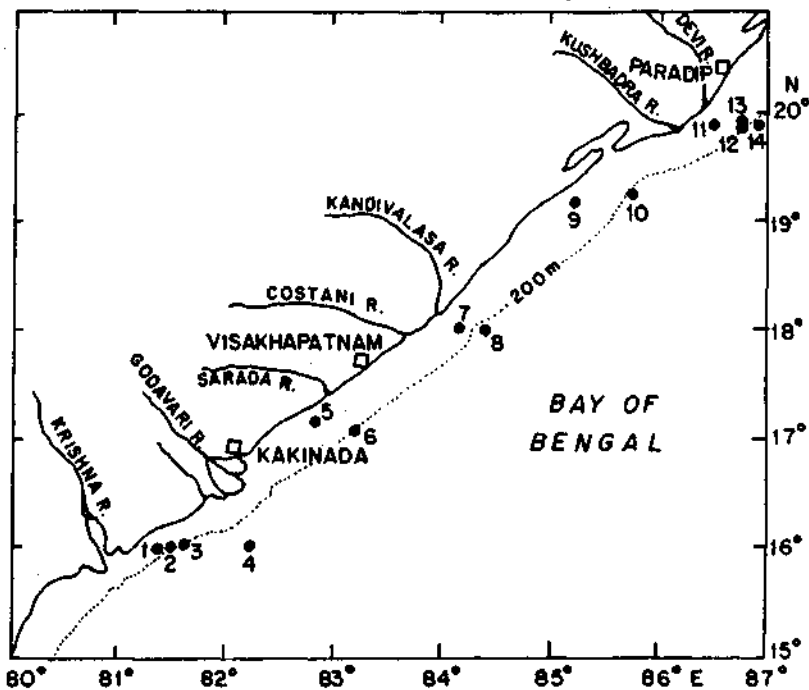

Fig. 1 - Map of northeast coast of India showing stations

and 100 m column depths adopting L and D bottle oxygen technique under simulated light incubation for 3 hours. The productivity values thus derived were extrapolated for 12 hours of the day.

Oblique sampling of zooplankton was made by Bongo-60 net at desired warp length, by releasing the warp to a maximum of 200 m in the oceanic stations and withdrawing the net immediately at the vessel speed of one nautical mile per hour. Wet displacement volume of the zooplankton was determined onboard for each sample within 12-24 hours of preservation in 5% formalin and then after a month of preservation to determine the percentage of shrinkage due to preservation. The wet volume of each sample was quantified in ml per 100 m<sup>3</sup> water. To convert the zooplankton biomass volume into organic carbon, the ratio (1 ml wet volume = 78.5 mg dry weight; 38% of dry weight = mg organic carbon) standardised by Dalal & Parulekar (1986) for the Indian Seas was adopted; and to convert the biomass volume into daily rate of secondary production, 50% of the biomass (used by Qasim & Ansari, 1981) was tested.

## RESULTS

*Water temperature* — The daily average sea surface temperature in different latitudes ranged from 24.1°C at 20°N to 26.4°C at 16°N showing a decreasing trend towards north in January. The column average values in the upper 0-50 m also indicated almost the same trend (Fig.2). At 50 m depth zone, it was higher (26.9°C) around 17°N and low (24.8°C) around 20°N. At 100 m and 200 m depths, higher values of 25.5°C and 26.3°C respectively were observed at 18°N while low values of 19.8° and 19.9°C were recorded at 100 m around 20° and 16°N and 12.6° and 12.8°C at 200 m around 19° and 20°N respectively. In general, low temperature was recorded around 20°N at surface and deeper waters during January.

*Salinity* — The daily average salinity values at different latitudes between 16°-20°N varied from 29.3 to 33.7x10<sup>-3</sup> at surface, 33.7-35.7x10<sup>-3</sup> at 50 m, 34.9-36.9x10<sup>-3</sup> at 100 m and 34.3-36.9x10<sup>-3</sup> at 200 m depth zones. In general, the salinity values were less in the upper 0-50 m around 16°N and 20°N in the shelf and slope waters (Fig.2). Below 50 m, the daily average varied between 34.3 and 36.9x10<sup>-3</sup> among the different latitudes. Relatively low salinity was recorded at surface around 20°N and in the deeper waters (50-200 m) around 16°N.

*Dissolved oxygen* — The daily average dissolved oxygen values at surface varied from 3.75 ml/l at 16°N to 5.59 ml/l at 20°N showing an increasing trend towards north (Fig.2) while this trend was not clear in the column waters. Below 50 m, the values were 2.5 ml/l (except at 18°N). At 100 m, the mean dissolved oxygen values at each latitude (16°-20°N) were 0.64, 1.20, 3.46, 1.92 and 1.82 ml/l, while the values at 200 m depth were 0.61, 0.66, 2.01, 1.47 and 1.12 ml/l respectively. The ranges and mean for the surface and the upper 0-50 column waters of the shelf and slope are given in Table 1.

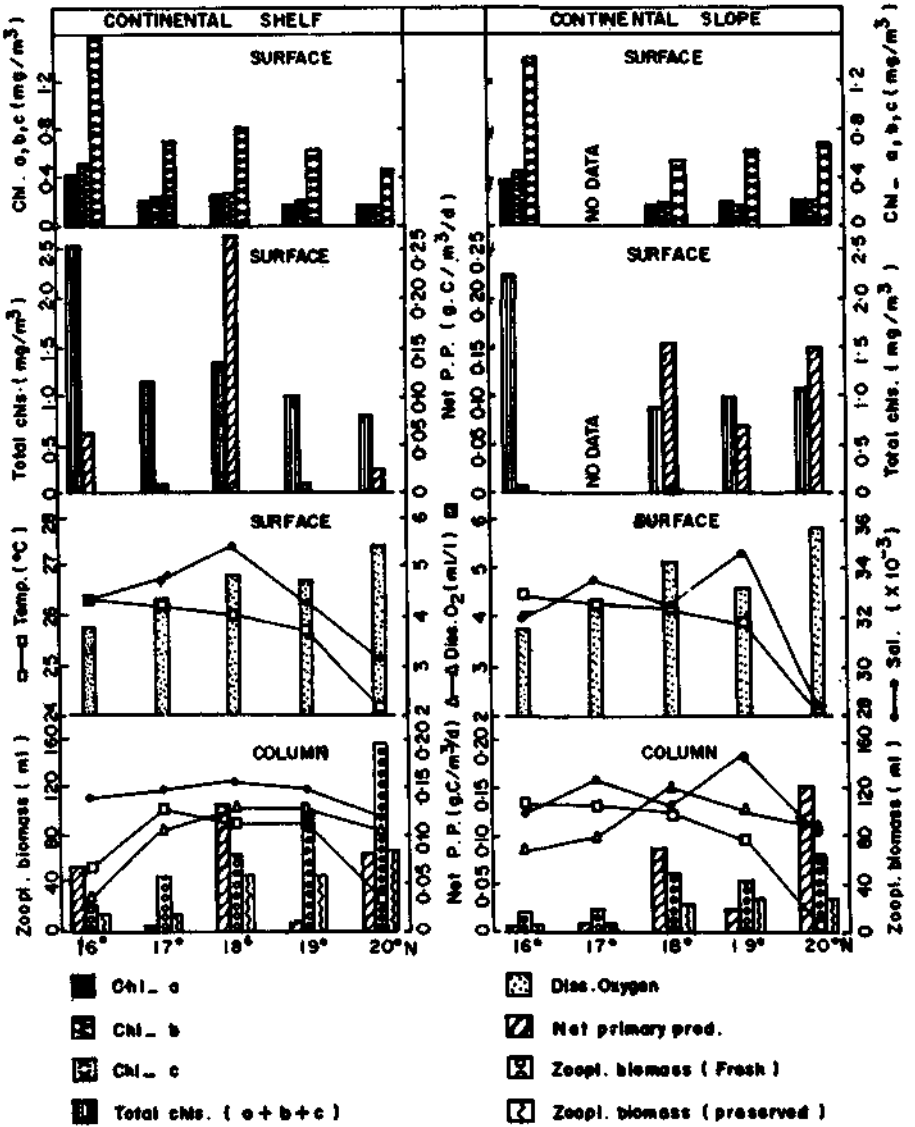

Fig. 2 - Hydrography, phytoplankton pigments, primary production and zooplankton biomass of the shelf and slope waters during January 1989

*Phytoplankton* — Phytoplankton was constituted by multispecies population, dominated by species of *Rhizosolenia*, *Ceratium*, *Chaetoceros* and *Amphisolenia* in the order of abundance. Other groups encountered were *Biddulphia*, *Coscinodiscus*, *Thalassiothrix*, *Peridinium*, *Hemidiscus*, *Skeletonema* and *Planktoniella*. Among them, *Rhizosolenia* and *Biddulphia* were more along the shelf edge and adjacent slope region.

*Chlorophyll concentration* — In the shelf region, the concentration of chl-*a* in the surface water ranged from 0.169 to 0.424 mg/m<sup>3</sup>, chl-*b* 0.164-0.514 mg/m<sup>3</sup>, and chl-*c* 0.461-1.592 mg/m<sup>3</sup> with their mean values recorded as 0.249, 0.275 and 0.837 mg/m<sup>3</sup> respectively (Table 2). In the slope waters, the concentration of chl-*a* at surface ranged from 0.178 to 0.390 mg/m<sup>3</sup>, chl-*b* 0.181-0.456 mg/m<sup>3</sup> and chl-*c* 0.539-1.391 mg/m<sup>3</sup> with their mean values recorded as 0.246, 0.260 and 0.805 mg/m<sup>3</sup> respectively. In general, the chl-*c* concentration was more at all the latitudes in the shelf and slope region during January (Fig.2). The mean total chlorophyll concentration (chl-*a* + *b* + *c*) for the shelf and slope waters were 1.361 and 1.311 mg/m<sup>3</sup> respectively.

*Primary production* — The average net productivity values along the shelf and slope were 0.074 and 0.081 g C/m<sup>3</sup>/d at surface, 0.042 and 0.048 g C/m<sup>3</sup>/d at 50 m and 0.026 and 0.040 g C/m<sup>3</sup>/d at 100 m depth. Out of the 10 stations where experiments were conducted at 100 m depth, 8 stations showed no values, while at 50 m depth, 8 out of the 14 stations showed productivity values. Hence, the production values in the upper 0-50 m water column alone were considered in the present study. The net

Table 1 - Distribution of temperature, salinity and dissolved oxygen in the continental shelf and slope waters

Parameters	Shelf		Slope	
	Range	Mean	Range	Mean
	<i>Surface</i>			
Temp. (°C)	24.10-26.30	25.70	24.10-26.45	25.80
Sal. (x10 <sup>-3</sup> )	30.30-34.80	32.70	28.35-34.75	32.20
Diss. O <sub>2</sub> (ml/l)	3.75-5.35	4.59	3.74-5.83	4.71
	<i>Column (upper 0-50 m)</i>			
Temp. (°C)	24.65-26.50	25.80	24.20-26.70	26.00
Sal. (x10 <sup>-3</sup> )	32.80-34.20	33.65	32.15-35.45	33.70
Diss.O <sub>2</sub> (ml/l)	2.67-4.56	4.00	3.70-5.03	4.30

production values of the shelf and slope in the surface and upper 0-50 m water column are depicted in Fig.2. In general, the productivity values were higher around 18° and 20°N and the values in the slope waters were higher than in the shelf region with the productivity values recorded up to 100 m depth (2 stations) at 19° and 20°N. The mean net primary productivity values in the upper 0-50 m water column of the shelf and slope were 2.90 and 3.25 g C/m<sup>2</sup>/d respectively and the overall average for the shelf and slope together was 3.08 g C/m<sup>2</sup>/d (Table 3).

*Zooplankton* — Biomass was constituted by copepods, chaetognaths, siphonophores, appendicularians, ostracods, mysids, lucifers, salps, doliolids, medusae,

Table 2 - Phytoplankton pigments and primary productivity in the surface waters of continental shelf and slope

Parameters	Shelf		Slope	
	Range	Mean	Range	Mean
Chl-a (mg/m <sup>3</sup> )	0.169-0.424	0.249	0.178-0.390	0.246
Chl-b (mg/m <sup>3</sup> )	0.164-0.514	0.275	0.181-0.456	0.260
Chl-c (mg/m <sup>3</sup> )	0.461-1.592	0.837	0.539-1.391	0.805
Total chlorophyll (a + b + c) (mg/m <sup>3</sup> )	0.794-2.530	1.361	0.902-2.237	1.311
Net prod. (mg. C/m <sup>3</sup> /d)	0.007-0.264	0.074	0.007-0.154	0.081

Table 3 - Estimated mean primary and secondary production in the upper 0-50 m water column (shelf and slope station values are pooled together to get the mean)

Lat. (°N)	N.P.P. (g C/m <sup>2</sup> /d) (T C/km <sup>2</sup> /d)	Zoopl. biomass fresh volume (ml/m <sup>2</sup> )	Rate of zoopl. prod. (50% of biomass)		Transfer coefficient (P.P. to sec. prod.) (%)
			(ml/m <sup>2</sup> /d)	(g C/m <sup>2</sup> /d) (T C/km <sup>2</sup> /d)	
16	1.800	09.15	4.575	0.136	7.58
17	0.550	15.97	7.985	0.238	43.31
18	5.350	28.42	14.210	0.424	7.92
19	0.950	35.50	17.750	0.529	55.73
20	6.750	55.13	27.565	0.822	12.18
Average	3.080	28.83	14.415	0.430	13.96

pteropods, heteropods, other gastropods, decapod larvae, euphausiids, polychaetes, fish eggs and larvae. Gelatinous planktonic groups such as salps, doliolids, medusae and siphonophores contributed more by volume around 20°N sector in the continental shelf.

*Secondary production* — Displacement volumes (soon after preservation) of the biomass showed the lowest value of 20.66 ml/100 m<sup>3</sup> water at 16°N and the highest of 157.8 ml/100 m<sup>3</sup> at 20°N along the shelf indicating a progressive increasing trend towards north while the respective values in the slope were 15.95 and 62.73 ml/100 m<sup>3</sup> (Fig.2). The averages for the shelf and slope were 76.7 and 38.64 ml/100 m<sup>3</sup> water respectively. The overall mean biomass volume between 16° and 20°N along the shelf and adjacent slope waters was 28.83 ml/m<sup>2</sup> (Table 3). When 50% of the zooplankton biomass was considered as the daily rate of production (Qasim & Ansari, 1981), the overall average value of the secondary production was 0.430 g C/m<sup>2</sup>/d (Table 3).

## DISCUSSION

The hydrographic features at surface indicated that the ranges in temperature, salinity and dissolved oxygen were higher in the slope than in the shelf region while in the column waters, the dissolved oxygen values showed wide fluctuation in the shelf region (Table 1). Wide fluctuation in dissolved oxygen is due to the low value (1.59 ml/l) recorded at 50 m around 16°N, which indicates low biological productivity in this region. The fall in salinity noticed especially around 16° and 20°N (Fig.2) might be attributed to the influence of the northeast monsoon and the subsequent fresh water discharge through large rivers.

The chlorophyll concentration and primary productivity values recorded in January during the present survey are higher than those values recorded by Kaladharan *et al.* (1989) in the shelf and slope waters of this region in October 1988 and by Prakash & Raman (1989) in December 1986. Qasim (1977) has stated that the surface primary production per unit area in the Bay of Bengal is higher than that of the Arabian Sea while the column production is much higher in the Arabian Sea. While the earlier studies have recorded primary productivity range of 0.1-0.5 g C/m<sup>2</sup>/d in the northern Bay of Bengal, the average value of 3.08 g C/m<sup>2</sup>/d recorded during January 1989 between 16°N and 20°N along the shelf and slope suggests that this area, in general, is fertile towards the-end of the northeast monsoon season.

The mean displacement volume of the zooplankton biomass (soon after preservation) showed high values of 76.7 and 38.64 ml/100 m<sup>3</sup> water in the shelf and slope respectively indicating that the shelf region had a double fold of production as compared to the slope waters. Highest volume of 157.8 ml/100 m<sup>3</sup> recorded in the shelf region at 20°N was chiefly contributed by the gelatinous groups like salps, doliolids and medusae. Higher concentrations to the extent of 90 ml/100 m<sup>3</sup> and a mean volume of 33.2 ml/100 m<sup>3</sup> water have been recorded earlier from the shelf region between Madras and Visakhapatnam during June 1978 (Sreekumaran Nair *et al.*



1981). The overall average production rate of zooplankton in the study area estimated is  $0.430 \text{ g C/m}^2/\text{d}$ , while Qasim & Ansari (1981) have estimated the production rate for Andaman Sea as  $0.144 \text{ g C/m}^2/\text{d}$  in the 0-200 m water column. This also indicates that the study area is relatively fertile during January.

The data also indicated a progressive increasing trend in dissolved oxygen content and zooplankton abundance towards northern latitudes along the shelf and slope (Fig.2). The availability of higher level of dissolved oxygen (above 4 ml/l) in the upper 0-50 m water column with plankton biomass abundance towards north reveals that the shelf and the adjacent slope waters between  $18^\circ$  and  $20^\circ\text{N}$  latitudes are highly productive zones especially towards the end of the northeast monsoon season. The very low dissolved oxygen level ( $< 2 \text{ ml/l}$ ) recorded at 100 m and 200 m between  $16^\circ$  and  $20^\circ\text{N}$  (except around  $18^\circ\text{N}$ ) indicates that the deeper waters are neither productive nor suitable for fishery resources during this period. The variation observed in plankton abundance among the different latitudes and between the shelf and slope might be due to the changes in water quality as evidenced from place to place.

In the present study, the chlorophyll concentrations do not indicate any direct relationship with primary productivity values. However, while the concentration of chlorophyll pigments helps as an index to indicate the abundance of phytoplankton in water, it is clear that the primary productivity values, in relation to chlorophyll concentration, determine the nature and physiological state of the phytoplankton cells.

In the present survey, the phytoplankton production and zooplankton biomass volume indicated, in general, an inverse relationship especially towards north in the shelf region (Fig.2). This inverse relationship indicates that the turnover from primary to secondary production level is very high. The transfer coefficient from primary production to secondary production ranged from 7.58% to 55.73% (Table 3) showing an average of 14% when 50% of the zooplankton biomass (Qasim & Ansari, 1981) was considered as the daily rate of secondary production. The range in the transfer coefficient observed in the present study falls within the range (0.3-56.2%) recorded by Cushing (1973) for the day and night samples collected from 0-200 m depth with the mean turnover of 3.3%. According to Qasim & Ansari (1981), the mean turnover from primary to secondary production is 10%. As compared to these mean values, the transfer coefficient value of 14% obtained in the present investigation indicates that the turnover from primary to secondary level of production is high in the upper 0-50 m water column towards the end of the northeast monsoon season. If the transfer coefficient value in the present study is considered as 10%, the daily rate of secondary production would come to about 35% of the zooplankton biomass (mean  $0.301 \text{ g C/m}^2/\text{d}$ ) which would appear to be a more realistic figure since the zooplankton biomass volume was significantly contributed by the gelatinous groups like salps and doliolids in January.

According to Qasim & Ansari (1981), the potential tertiary production is 0.1% of primary production and 1% of secondary production in terms of organic carbon which, when multiplied by the factor 10, gives the live weight of tertiary production.

Accordingly, the mean primary productivity of  $3.08 \text{ g.C/m}^2/\text{d}$  ( $3.08 \text{ tonnes C/km}^2/\text{d}$ ) amounts to  $95.48 \text{ tonnes C/km}^2/\text{month}$  along the shelf and slope between  $16^\circ$  and  $20^\circ\text{N}$  which would be  $0.955 \text{ tonne live weight}$  of tertiary production of pelagic resources per  $\text{km}^2$  for January. When 50% of the zooplankton biomass is considered as the daily rate of production, the mean secondary production of  $0.430 \text{ g C/m}^2/\text{d}$  ( $0.430 \text{ tonne C/km}^2/\text{d}$ ) would be  $13.33 \text{ tonnes C/km}^2/\text{month}$  leading to  $1.333 \text{ tonnes live weight}$  of tertiary production/ $\text{km}^2/\text{month}$ ; and if 35% of the zooplankton biomass is considered as the daily rate of production, then the mean secondary production of  $0.301 \text{ g C/m}^2/\text{d}$  ( $0.301 \text{ tonne C/km}^2/\text{d}$ ) would give rise to  $0.933 \text{ tonne live weight}$  of tertiary production of fishery resources/ $\text{km}^2/\text{month}$  during January.

In the case of zooplankton sampling for quantitative assessment of the biomass, when the flow meter is not available onboard or if it goes out of order during the cruise, the biomass displacement volumes obtained from the shallow and deeper stations at varying warp length do not, as such, give the correct picture of their relative abundance; and this may at times mislead to wrong conclusions. The error that is likely to occur in the case of the actual biomass volume and relative abundance of the samples is indicated in Table 4. In such cases, when the warp length (WL) varies from sample to sample, the biomass volumes obtained could be converted into volume per 100 m WL as a standard to compare the data within the cruise (Table 4). However, this data cannot be compared with the other published data. Instead, the biomass displacement volume (ml) may be converted into volume per  $100 \text{ m}^3$  of water filtered adopting the formula at  $1 \text{ m WL} = 1.26 \text{ m}^3$  water filtered when the twin Bongo-60 net is used at the vessel speed of 1 nautical mile per hour while withdrawing the net. (The mean value of  $200 \text{ m WL} = 252 \text{ m}^3$  water filtered was derived from several such sampling using the flow meter onboard *FORV Sagar Sampada* cruises).

Another serious error normally occurring in the volumetric estimation of the plankton biomass is due to the shrinkage of plankton in preservation, especially when the duration of cruise is one month or more, or when the unloading of plankton

Table 4 - Quantitative estimation of plankton biomass

Lat. ( $^\circ\text{N}$ )	Warp length (m)	Actual volume obtained (ml)	Estimated volume (ml/100m WL)	Estimated volume (ml/100m <sup>3</sup> )
16	70	19.6	28.00	22.27
16	100	24.0	24.00	19.05
16	200	50.4	25.20	20.00
16	200	30.0	15.00	11.90
17	30	16.8	56.00	44.21
17	100	24.8	24.80	19.68

Table 5 - Shrinkage of plankton biomass due to preservation

Lat.(°N)	Shelf			Slope		
	Fresh (ml/100m <sup>3</sup> )	Preserved (ml/100m <sup>3</sup> )	Shrinkage (%)	Fresh (ml/100m <sup>3</sup> )	Preserved (ml/100m <sup>3</sup> )	Shrinkage (%)
16	20.66	13.85	32.96	15.95	8.29	48.02
17	44.21	14.21	67.86	19.68	8.57	56.45
18	63.05	45.03	28.58	50.63	25.08	50.46
19	97.78	46.35	52.60	44.23	28.99	34.46
20	157.80	67.11	57.47	62.73	27.10	56.80
Average	76.70	37.31	51.36	38.64	19.61	49.25

samples from the ship is delayed. This may cause error in the quantitative assessment, especially in the computation of plankton biomass data to assess the potential fishery resources. Keeping this in view, the percentage of shrinkage of zooplankton volume after one month was determined in the present study (Table 5). The mean displacement volume of zooplankton biomass (soon after preservation) indicated high values of 76.7 and 38.64 ml/100 m<sup>3</sup> in the shelf and slope waters respectively while their volumes reduced to 37.31 and 19.61 ml/100 m<sup>3</sup> respectively due to shrinkage after a month of preservation in 5% formalin. This shrinkage varied from sample to sample. The fluctuation in the shrinkage is due to the changes in the percentage composition of zooplankton groups which varied from about 30% to 70%. The percentage increased where the gelatinous groups of plankton were more in the samples. On average, the shrinkage of 50% in one month could be considered to get a more realistic picture. However, more work on these aspects would be desirable.

### ACKNOWLEDGEMENT

Authors are grateful to Dr. P.S.B.R. James, former Director, CMFRI, Cochin for the facilities provided to carry out this work. Thanks are also due to (late) Mr. I. David Raj of CMFRI, and Mr Supriya Pal, Research Scholar, Berhampur University for rendering their co-operation onboard in the collection of zooplankton samples.

### REFERENCES

- Achuthankutty, C.T., Madhupratap, M., Nair, V.R., Sreekumaran Nair, S.R. & Rao, T.S. S. 1980. Zooplankton biomass and composition in the western Bay of Bengal during late S.W. monsoon, *Indian J. Mar. Sci.* 9: 201-206.
- Cushing, D.H. 1973. Production in the Indian Ocean and the transfer from primary to the secondary level, in: *The biology of the Indian Ocean*, edited by B. Zeitzschel (Springer Verlag, Berlin) 475-486.

- Dalal, S.G. & Parulekar, A.H. 1986. Validity of zooplankton biomass estimates and energy equivalent in the Indian Ocean, *Indian J. Mar. Sci.* 15: 264-266.
- Kaladharan, P., Alavandi, S.V. & Pillai, V.K. 1989. Dissolved Mercury levels and chlorophyll concentrations in the offshore waters of the northeast coast of India. In: *Proc. First Workshop Scient. Resul. FORV Sagar Sampada*, edited by K.J. Mathew, (CMFRI, Cochin) 25-27.
- Krishna Kumari, L. & Goswami, S.C. 1993. Biomass and biochemical composition of zooplankton from northwest Bay of Bengal during January 1990. *Indian J. Mar. Sci.* 22: 143-145.
- Mathew, K.J., Naomi, T.S., Geetha A. Vincent, D., Anilkumar, R. & Solomon, K. 1989. Studies on zooplankton biomass and secondary and tertiary production of the EEZ of India, In: *Proc. First Workshop Scient. Resul. FORV. Sagar Sampada*, edited by K.J. Mathew, (CMFRI, Cochin) 59-69.
- Prakash, K.P. & Raman, A.V. 1989. Primary productivity and phytoplankton pigments in the southwest Bay of Bengal during December, 1986. In: *Proc. First Workshop Scient. Resul. FORV Sagar Sampada*, edited by K.J. Mathew, (CMFRI, Cochin) 55-58.
- Qasim, S.Z. 1977. Biological productivity of the Indian Ocean, *Indian J. Mar. Sci.* 6: 122-137.
- Qasim, S.Z. & Ansari, Z.A. 1981. Food components of the Andaman Sea, *Indian J. Mar. Sci.* 10: 276-279.
- Radhakrishna, K. 1978. Primary productivity of the Bay of Bengal during March-April 1975, *Indian J. Mar. Sci.* 7: 58-60.
- Radhakrishna, K., Bhattathiri, P.M.A. & Devassy, V.P. 1978. Primary productivity of the Bay of Bengal during August-September 1976, *Indian J. Mar. Sci.* 7: 94-98.
- Selvaraj, G.S.D, Paulpandian, A L. & Purushothaman, A. 1989. Primary productivity and plankton abundance along the shelf and oceanic waters off southeast coast of India during August. 1987, In: *Proc. First Workshop Scient. Resul. FORV Sagar Sampada*, edited by K.J. Mathew., (CMFRI, Cochin) 47-53.
- Sreekumaran Nair, S.R., Nair, V.R., Achuthankutty, C.T. & Madhupratap M. 1981. Zooplankton composition and diversity in western Bay of Bengal, *J. Plankton Res.* 3: 493-508.
- Strickland, J.D.H. & Parsons, T.R. 1968. *A practical handbook of seawater analysis*, Bull. No. 167. (Fish. Res. Bd. Canada, Ottawa) pp. 311.

\* \* \*

## **Diurnal variations in the vertical distribution and abundance of zooplankton in the continental shelf waters off Cochin during April 1991**

G.S.D. Selvaraj, K.J. Mathew & Molly Varghese

Central Marine Fisheries Research Institute, P.B. No - 1603 Cochin-682014

### **ABSTRACT**

The present study is based on zooplankton samples collected by vertical hauls from 0-30, 30-60 and 60-90 m depths from a 100 m depth station in the continental shelf (09° 44' N, 75° 42' E) off Cochin for two days at three hourly interval. The mean displacement volume of zooplankton biomass at these depth zones were 6.24, 6.70 and 6.07 ml/100 m<sup>3</sup> water while their numerical counts were 14490, 13355 and 11290 no/100 m<sup>3</sup> respectively. The overall mean volume (ml) and number per 100 m<sup>3</sup> in the entire water column (0-90 m) were 6.34 and 13045 respectively and were distributed as 5.89 ml and 11715 no/100 m<sup>3</sup> in the daytime and 6.79 ml and 14376 no/100 m<sup>3</sup> during night hours respectively. The biomass was dominated by copepods (75.6%), decapod larvae (12.2%), chaetognaths (6.5%) and appendicularians (2.4%) in April. In general, copepods, decapod larvae and appendicularians showed increasing trend in number from the bottom (60-90 m) to the surface layer (0-30 m); chaetognaths, medusae, pteropods, heteropods, salps and doliolids were distributed more in the middle zone (30-60 m); while ostracods and planktonic polychaetes were more in the bottom zone (60-90 m). Distribution of amphipods and ostracods indicated significant diurnal vertical migration. The phenomenon of mid- night sinking was noticed in the case of copepods, chaetognaths, appendicularians, medusae, siphonophores, salps and doliolids.

### **INTRODUCTION**

Although considerable studies on the diurnal vertical migration of zooplankton in the ocean have been made in several parts of the world (Sverdrup *et al.* 1942), similar studies are not available to any significant level from the Indian seas. Majority of the zooplankton groups, which form food of several crustaceans, molluscs, fishes and marine mammals, are known to make extensive diurnal vertical migration in response to light and other physico-chemical characteristics of the environment (Daniel, 1977; Nair, 1977; Peter & Nair, 1978; Madhupratap *et al.* 1981; Gajbhiye *et al.* 1984). In

view of their importance in the marine food-chain and as a fishery associated factor, the present investigation was carried out at a 100 m depth station during April 1991 to study their vertical distribution and diurnal variation in the stable premonsoon season.

## MATERIALS AND METHODS

Hydrographic data and zooplankton samples were collected at three hourly interval for two days during 11-13 April 1991 from a 100 m depth station in the continental shelf off Cochin (09° 44' N; 75° 42'E). Seawater temperature, salinity and depth were recorded by the micro-computer (MICOM STD Profile) instrument from surface to bottom and the range and mean values of temperature and salinity for 0-30, 30-60 and 60-90 m depth zones were determined. Zooplankton samples were collected by vertical hauls from these three depth zones using a closing type net having a mouth diameter of 110 cm and mesh size of 0.3 mm. The plankton samples thus collected from each 30 m vertical column were preserved separately in 5% formalin; and displacement volumes of the zooplankton and numerical counts of the different zooplankton groups in each sample were estimated. From the diurnal data for two days at three hourly interval, mean values for the respective hours were calculated for the three depth zones. The data for 0600, 0900, 1200 and 1500 hrs were treated for the day and 1800, 2100, 2400 and 0300 hrs for the nighttime. High and low tide phases of the day were determined based on the diurnal fall and rise in water temperature observed in the bottom layer at 90 m depth.

## RESULTS

### Hydrography

The ranges in seawater temperature at 0-30, 30-60 and 60-90 m depth zones were 29° - 31.25°, 28.15° - 30.3° and 22.65° - 28.75 °C showing the variation of 2.25°, 2.15° and 6.1°C respectively while the variation at 0 - 60 m depth was 3.1°C only indicating that the thermocline was prevailing around 60 m depth in April. The ranges in salinity at the three depth zones were 34.6 - 34.8, 34.7-35.3 and 35-35.65  $\times 10^{-3}$  with the variation of 0.2, 0.6 and 0.65  $\times 10^{-3}$  respectively; while the variation at 0-60 m water column was 0.7  $\times 10^{-3}$  which indicated the stability of the marine environment during premonsoon season. The water temperature below 60 m depth showed wide diurnal variation with rhythmic rise and fall in values. At 90 m depth, very low values were recorded between 0900 and 1200 hrs and high values between 1500 and 1800 hrs of the day (Fig. 1) indicating high and low tide phases of the day respectively in the shelf waters.

### Zooplankton biomass

The displacement volumes of zooplankton biomass in the 30 m vertical haul varied from 3.86 to 8.59 ml/100 m<sup>3</sup> at 0-30 m, 5.08 to 8.06 ml/100 m<sup>3</sup> at 30-60 m and 5.08

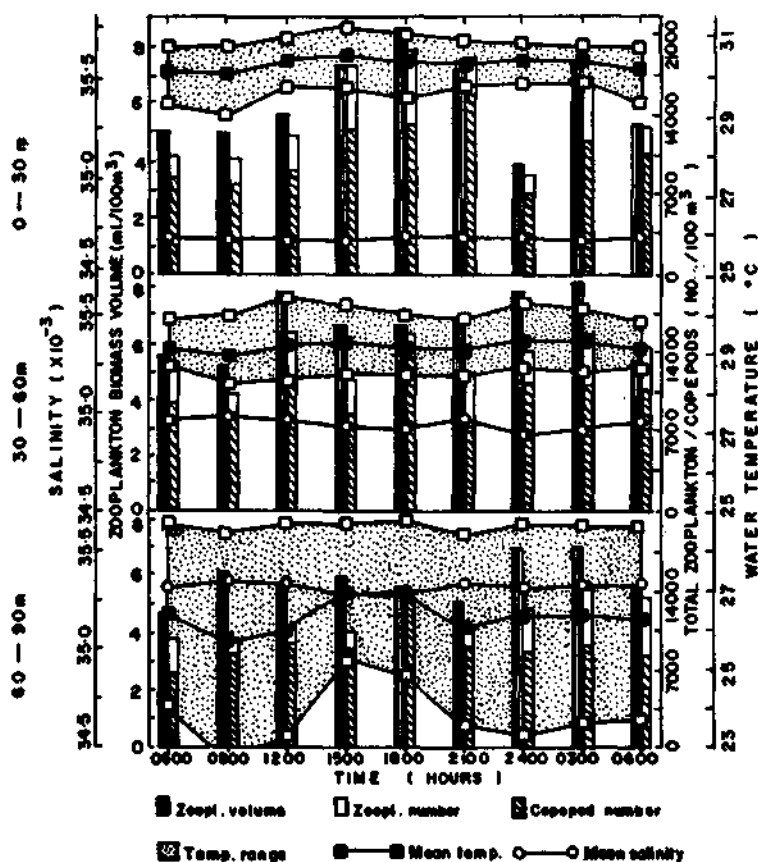

Fig. 1 - Diurnal variation in temperature, salinity and zooplankton biomass dominated by copepods at 0-30, 30-60 and 60-90 m depth zones during April 1991

-  $7.01 \text{ ml}/100 \text{ m}^3$  at 60-90 m depth zones; and their mean values were 6.24, 6.70 and  $6.07 \text{ ml}/100 \text{ m}^3$  water respectively. The numerical counts of total zooplankton varied from 8780-19292, 10259-15726 and 9414-14158  $\text{no}/100 \text{ m}^3$  respectively (Table 1) and their averages were 14490, 13355 and 11290  $\text{no}/100 \text{ m}^3$  at the respective depth zones. The overall mean volume and numerical count in the entire 0-90 m vertical column of water were 6.34 ml and 13045  $\text{no}/100 \text{ m}^3$  respectively. The volume and number in the three depth zones showed that the density of zooplankton was relatively less in the bottom layer below 60 m (Fig.1).

### Relative abundance

The zooplankton biomass was constituted by copepods (75.6%), decapod larvae (12.2%), chaetognaths (6.5%), appendicularians (2.4%), planktonic molluscs comprising of pteropods, heteropods, other gastropods and bivalves (0.7%), amphipods (0.55%), ostracods (0.45%) and medusae (0.4%). The other groups which contributed

Table 1 - Diurnal variation in zooplankton counts (no/100m<sup>3</sup>) at 0-30, 30-60 and 60-90 m depth zones

Time (hrs.)	0-30m	30-60m	60-90m	0-90m
0600	10529	11872	9414	10605
0900	10242	10259	9537	10013
1200	12181	15726	10659	12855
1500	18464	11497	10200	13387
1800	19292	15578	14158	16343
2100	19148	12170	10263	13860
2400	8780	14141	12184	11702
0300	17297	15600	13906	15601
Day average	12854	12339	9952	11715
Night average	16129	14372	12628	14376

individually to less than 0.4% were salps, doliolids, siphonophores, planktonic polychaetes, mysids, lucifers and fish larvae (totalling 1.2%).

### Vertical distribution

The diurnal variations in the vertical distribution and abundance of different zooplankton groups at 0-30, 30-60 and 60-90 m depth zones are depicted in Fig.2. The mean numerical counts of the different groups at the three depth zones indicated the abundance of copepods, decapod larvae, appendicularians, amphipods, mysids and lucifers in the upper zone (0-30 m); chaetognaths, medusae, salps, doliolids, pteropods, heteropods and euphausiids in the middle zone (30-60 m); and ostracods, planktonic polychaetes, planktonic gastropods (other than pteropods and heteropods) and bivalves in the bottom zone (60-90 m). Their percentages of abundance in the respective zones are given in Table 2. The data further revealed that majority of the groups were abundant in the water column above the thermocline depth (60 m). The mean numerical counts of the zooplankton groups which showed their abundance above and below thermocline depth are given in Table 3.

### Day and night variations

In general, night collections were rich in zooplankton at the three depth zones with their abundance in the upper 0-30 m zone (Table 1); and the increase was contributed chiefly by copepods, decapod larvae, amphipods, planktonic molluscs and fish larvae (Table 4). Chaetognaths were relatively more at night in the upper zone (0-30 m) as compared to the daytime abundance while ostracods and planktonic polychaetes showed their abundance at night in the middle zone (30-60m). Medusae, salps and



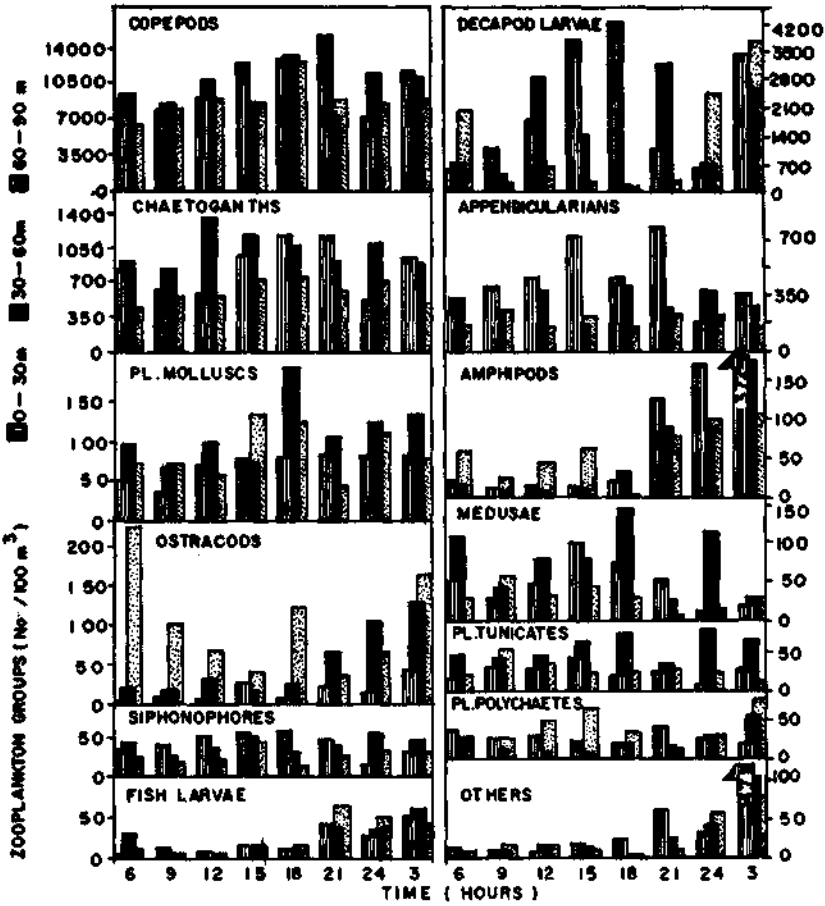

Fig.2 - Dial variation in the distribution of zooplankton groups at 0-30, 30-60 and 60-90 m depth zones

doliolids were relatively more in the upper zone (0-30 m) during the day-time than at night indicating their preference to day light. Among the major groups, appendicularians and siphonophores did not show any remarkable difference between day and night hours.

**Diurnal migration and mid-night sinking**

During diurnal observation, most of the dominant zooplankton groups indicated their abundance in the upper 0-30 m water column during night. Among them,

Table 2 - Relative abundance (%) of zooplankton groups at 0-30, 30-60 and 60-90 m depths (Day and night values are pooled together)

Zoopl. groups	0-30m (%)	30-60m (%)	60-90m (%)
Copepods	36.26	33.88	29.86
Decapod larvae	42.97	31.75	25.28
Appendicularians	47.43	32.32	20.25
Amphipods	44.39	26.17	29.44
Mysids	45.16	32.26	22.58
Lucifers	50.00	25.00	25.00
Siphonophores	37.50	37.50	25.00
Chaetognaths	34.32	41.34	24.34
Medusae	31.21	49.04	19.75
Salps	22.58	45.16	32.26
Doliolids	23.86	52.28	23.86
Pteropods	24.07	47.53	28.40
Heteropods	29.17	41.66	29.17
Euphausiids	29.41	41.18	29.41
Fish larvae	32.18	32.18	35.64
Ostracods	10.12	29.17	60.71
Pl. polychaetes	31.96	24.74	43.30
Other pl. gastropods	31.82	31.82	36.36
Pl. bivalves	29.41	29.41	41.18

copepods, chaetognaths, appendicularians, medusae, salps, doliolids and siphonophores exhibited a sharp decline in their number at mid-night (2400 hrs) in the upper zone with considerable increase in the middle zone (30-60 m) indicating the phenomenon of mid-night sinking. It was followed by their abundance again in the upper zone (0-30 m) at 0300 hrs with considerable reduction in the middle zone (Fig.3). The amphipods, which were abundant at 60-90 m in the daytime, exhibited their abundance in the upper and middle zones during night hours, while the ostracods, which were distributed more in the bottom zone (60-90 m) during day time, showed their abundance in the middle zone (30-60 m) at night. Further, the amphipods and ostracods indicated their downward movement to the bottom zone in the early morning hours (Fig.3). Decapod larvae did not show any definite trend of dispersal in the present study. Of all the zooplankton groups, amphipods and ostracods exhibited very significant diurnal vertical migration.

## DISCUSSION

The distribution of temperature and salinity at different depths in the diurnal study indicated the existence of thermocline around 60 m depth at this station during April (Fig.4). The temperature showed wide variation than salinity. The variation (differ-

Table 3 - Density (no/100m<sup>3</sup>) of major zooplankton groups in the water column above and below thermocline (60m) (Day and night values are pooled together)

Zoopl. groups	0-60m (no/100m <sup>3</sup> )	60-90m (no/100m <sup>3</sup> )
Copepods	10372	8832
Decapod larvae	1799	1217
Chaetognaths	959	617
Appendicularians	380	193
Medusae	63	31
Siphonophores	42	28
Salps	10	10
Doliolids	33	21
Pl. molluscs	98	46
Amphipods	75	63
Mysids	12	7
Lucifers	10	7
Euphausiids	12	10
Ostracods	33	102
Pl. polychaetes	28	42
Fish larvae	28	31

Table 4 - Day and night variations in the numerical counts of major zooplankton groups (mean values in no./100 m<sup>3</sup>) at different depth zones

Zooplankton groups	0-30m		30-60m		60-90m	
	Day	Night	Day	Night	Day	Night
Total zooplankton	12854	16129	12339	14372	9954	12630
Copepods	9572	11872	9295	10743	7991	9674
Decapod larvae	1799	2339	1353	1665	775	1655
Chaetognaths	757	978	1080	1017	575	659
Appendicularians	459	442	280	303	200	186
Medusae	56	42	77	77	39	21
Siphonophores	42	39	39	42	28	24
Salps & doliolids	32	17	49	46	24	24
Pl. Molluscs	60	84	88	140	70	91
Amphipods	14	172	14	98	49	74
Ostracods	14	21	21	81	109	98
Pl. Polychaetes	32	28	14	32	46	39
Fish larvae	14	39	17	39	10	49

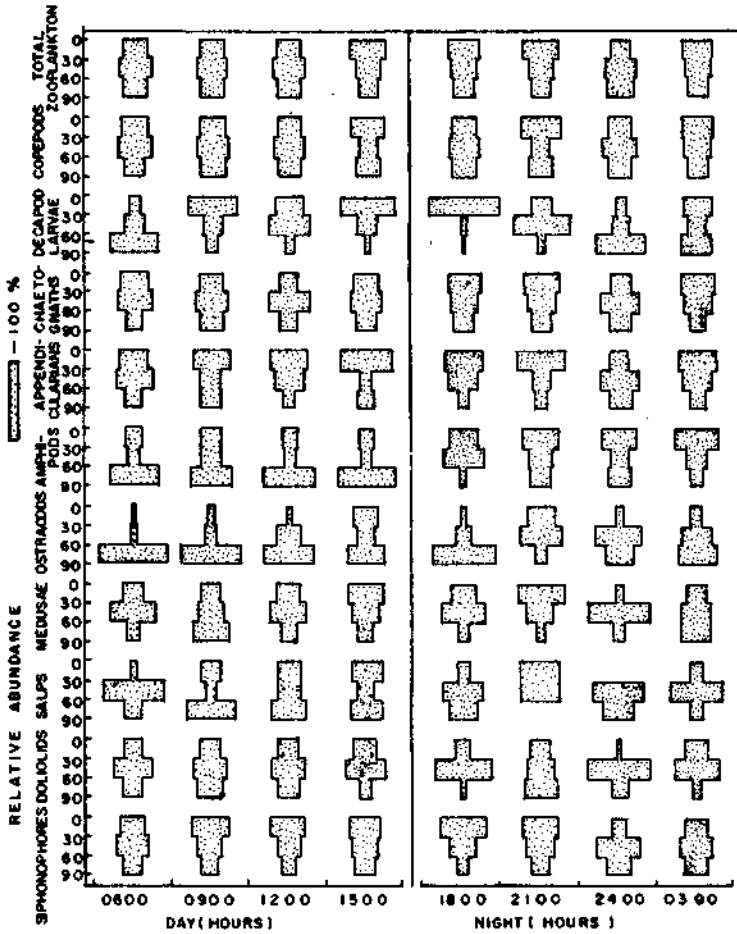

Fig.3 - Relative abundance of zooplankton groups during day and night hours showing diurnal vertical migration and mid-night sinking

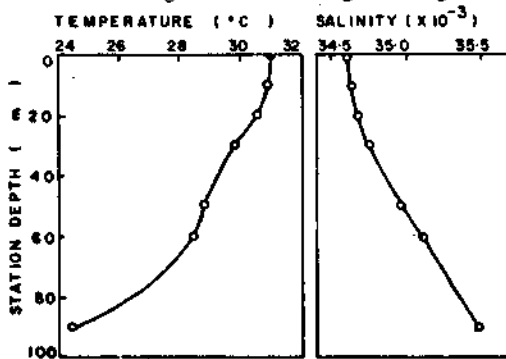

Fig.4 - Vertical profiles of temperature and salinity in the shelf waters off Cochin during April

ence between minimum and maximum values) in temperature above and below thermocline was 3.1° and 6.1°C respectively while that of salinity was 0.7 and 0.65 x 10<sup>-3</sup> respectively. Hence, salinity does not seem to be a limiting factor for the distribution, abundance and vertical migration of zooplankton groups in April. The relatively low density of zooplankton recorded below 60 m depth (thermocline) might be attributed to the wide (diurnal) variation in temperature (6.1°C) observed between 60 and 90 m water column (Fig.1). Compared to this variation, the variation of 3.1°C observed in the 0-60 m water column is less which seems to favour the distribution and abundance of zooplankton groups in the water column above the thermocline as evidenced from the results of the present study (Tables 2, 3). Peter & Nair (1978) reported higher concentration of zooplankton biomass in the water column above thermocline dominated by copepods, chaetognaths and decapod larvae along the southwest coast of India during December 1976. Madhupratap *et al.* (1981) also recorded highest zooplankton biomass value for the water column above thermocline in the Andaman Sea during February 1979, and according to them, chaetognaths, appendicularians, decapods and euphausiids were dominant above the thermocline. However, in the present investigation, euphausiids were numerically less, in general, and were relatively more in the middle zone (Table 2).

As observed in the present study, Madhupratap *et al.* (1981) also reported the abundance of ostracods below the thermocline. However, in the present investigation, the amphipods and ostracods distributed more below thermocline (60-90 m) in daytime (Fig.3) showed their remarkable abundance in the surface layer (0-30 m) and middle layer (30-60 m) respectively during night hours indicating their upward migration above thermocline. To those planktonic groups showing diurnal vertical migration from the bottom zone (60-90 m) such as ostracods, amphipods and planktonic molluscs (other than pteropods and heteropods) and to those groups evenly distributed above and below 60 m depth such as salps and fish larvae, thermocline does not appear to be a limiting factor. However, the numerical counts of these groups are insufficient to draw at any definite conclusion. George *et al.* (1975) stated that thermocline seems to act as a barrier in the vertical movement of some species of ostracods; Nair (1977) on some species of chaetognaths; Daniel (1977) on some species of siphonophores; and Peter & Nair (1978) concluded that thermocline influences the distribution of zooplankton significantly. However, the results in the present investigation indicated that some of the species of these zooplankton groups are not influenced by the thermocline in the shelf waters.

The zooplankton abundance in relation to high tide and low tide phases revealed that majority of the zooplankton groups were abundant at this station during low tide period only (Table 5). The abundance of copepods, chaetognaths, decapod larvae, appendicularians, medusae, siphonophores, amphipods, planktonic molluscs, salps, lucifers, euphausiids and fish larvae during the low tide phase than at high tide phase indicated that these zooplankton groups were abundant in the inshore shelf waters than in the offshore oceanic realm at the respective depths. Those groups which were more

Table 5 - Zooplankton abundance (no/100 m<sup>3</sup>) at 0-90 m in relation to tides

Zooplankton groups	High tide influence			Low tide influence		
	0900 hrs	1200 hrs	Average	1500 hrs	1800 hrs	Average
Copepods	8197	9622	8909	9856	13089	11472
Chaetognaths	669	852	760	968	1009	988
Decapod larvae	568	1737	1152	1815	1510	1662
Appendicularians	305	332	318	363	333	348
Madusae	42	51	46	72	81	76
Siphonophores	27	35	31	48	32	40
Amphipods	15	23	19	29	19	24
Pl. polychaetes	23	29	26	32	26	29
Ostracods	43	36	39	29	41	35
Pl. molluscs	60	77	68	98	134	116
Salps	9	8	8.5	6	19	12.5
Doliolids	33	28	30.5	37	19	28
Fish larvae	9	8	8.5	17	14	15.5
Lucifers	3	3	3	5	6	5.5

during high tide phase than at low tide phase such as ostracods and doliolids indicated their relative abundance in the offshore oceanic waters at the respective depths (Table 5).

The results revealed that most of the zooplankton groups exhibited the phenomenon of mid-night sinking by their reduction in number in the surface layer at 2400 hrs and their retrieval back to surface water column within the next two or three hours. This phenomenon might be related to the influence of light (Sverdrup *et al.* 1942). It is presumed that the exclusive disappearance of the light in the mid-night hour might cause confusion in their movement and lead to their dispersion downward for a while till the desired intensity of light penetrates the surface of the sea; and then they might move upward according to the desired light as preferred by the different groups of zooplankton in the species level.

In general, the mean zooplankton number indicated an increasing trend during the day as well as night and the number in the night collections were more as compared to that of day hours at the three depth zones. Gajbhiye *et al.* (1984) also reported higher zooplankton population during night than day collection in the inshore waters off Versova (Bombay). Such increase in the zooplankton number might be attributed to the spawning activities of the respective dominant groups with intensive spawning at night; and their considerable reduction in number noticed in the early morning hours

might be due to subsequent grazing by the higher organisms of the sea. The results indicated that the proportionate increase noticed at three hourly interval was, in general, more in the upper euphotic water column (0-30m) during the day hours whereas the relative increase observed at the bottom zone (60-90m) below the thermocline was more in the night hours. The increase in the upper euphotic layer might be attributed to the congenial environment present there with less variability in water quality influencing rapid productivity of copepods and other dominant groups. The increase observed at the bottom zone might be attributed to the reproductive cycle of demersal species of zooplankton groups and the influence of tidal flow in the bottom layer (below thermocline) providing more plankton from the neighbouring inshore/offshore waters. The increasing trend in zooplankton number observed, in general, at the three depth zones and the average zooplankton density of 6.34 ml/100 m<sup>3</sup> recorded in the 0-90 m water column in April, as compared to the average zooplankton volume (4.71 ml/100m<sup>3</sup>) recorded in the inshore waters off Versova (Bombay) during a diurnal study in February (Gajbhiye *et al.* 1984), proves that the environment prevailing along the continental shelf off Cochin during April is very favourable for zooplankton production.

### ACKNOWLEDGEMENT

Authors are grateful to Dr. P.S.B.R. James, former Director for providing facilities. Thanks are also due to Mr. R. Anilkumar for the help rendered on board in the collection of the zooplankton samples.

### REFERENCES

- Daniel, R. 1977. Vertical distribution of siphonophora in relation to thermocline in Arabian Sea and Southwest Indian Ocean, In: *Proc. Symp. Warm Water Zooplankton*, (UNESCO/NIO, Goa) 124-127.
- Cajbhiye, S.N., Nair, V.R. & Desai, B.N. 1984. Diurnal variation of zooplankton off Versova (Bombay), *Mahasagar - Bull. Natn. Inst. Oceanogr.* 17: 203-210.
- George, M.J., Purushan, K.S. & Madhupratap, M. 1975. Distribution of planktonic ostracods along the southwest coast of India, *Indian J. Mar. Sci.* 4: 201-202.
- Madhupratap, M., Nair, V.R., Nair, S.R.S. & Achuthankutty, C.T. 1981. Thermocline and zooplankton distribution, *Indian J. Mar. Sci.* 10: 262-265.
- Nair, V.R. 1977. Zonation of chaetognath species along the southwest coast of India, *Indian J. Mar. Sci.* 6: 142-146.
- Peter, G. & Nair, V.R. 1978. Vertical distribution of zooplankton in relation to thermocline, *Mahasagar - Bull. Natn. Inst. Oceanogr.* 11: 169-175.
- Sverdrup, H.U., Johnson M.W. & Fleming, R.H. 1942. *The oceans, their physics, chemistry and general biology*, (Prentice Hall, Englewood Cliffs, N.J.) pp. 1087.

\* \* \*

## Zooplankton standing stock, community structure and diversity in the northern Arabian Sea

S.C. Goswami & Y. Shrivastava

National Institute of Oceanography, Dona Paula, Goa-403004

### ABSTRACT

The effects of large scale oil spill, which occurred during the Gulf War in 1991 on zooplankton standing stock, community structure and diversity in the northern Arabian Sea were studied. Surface (1-0m) and vertical zooplankton hauls (200-0m, 250-0m and 500-0m) were taken during *FORV Sagor Sampada* cruise 94 (12-23 September 1991). The shelf region was rich in zooplankton standing stock than the oceanic waters. Highest standing value (581 ml/100m<sup>3</sup>) was obtained at a coastal station (lat. 22° 07' N and long. 67° 03' E) and was due to swarm of gammarid amphipods and shoal of sergestid shrimp *Acetes johnei*. Herbivores dominated the zooplankton community and copepods were most abundant (36.9 to 71.7%). The other important taxa were siphonophores, euphausiids, chaetognaths and decapod larvae. Copepod population showed distinct coastal and oceanic communities. Niche partitioning among congeners particularly the members of genus *Pleuromamma* was discernible. Species diversity was higher in the oceanic waters and an inverse relationship between standing stock and species diversity was the general trend. High standing stock, faunal and species diversity values indicated no apparent impact of oil spill on plankton population in the studied area.

### INTRODUCTION

Zooplankton investigations in the Indian Ocean pertain mostly to taxonomy, zoogeography and ecology. Information on zooplankton standing stock (biomass), community structure and diversity with particular reference to oil spill is scarce. The Gulf War during January and February 1991 resulted in a massive oil spill of 6 to 8 million barrels into the sea. There were apprehensions that this oil might reach the Indian coast due to wind and surface currents and influence marine resources. To monitor the effects of this oil spill on marine biota, zooplankton studies were carried out in the northern Arabian Sea and results are presented in the paper.



## MATERIALS AND METHODS

The present study is based on 74 samples collected during *FORV Sagar Sampada* cruise 94 (12 to 23 September 1991). Sampling was done at 44 stations located in the northern Arabian Sea between lat. 16° and 23°N and long. 62° and 73°E (Fig. 1). Surface zooplankton samples were taken at all stations (44 samples) while vertical hauls were made to the surface from 200 m (15 samples), 250 m (10 samples) and 500 m (5 samples). All the samples were collected using a Bongo net fitted with a precalibrated digital flowmeter. The net was towed at 2 knot speed for 10 minutes and the samples were preserved in 5% formaldehyde. Zooplankton standing stock was determined as displacement volume. An aliquot of 6.25 to 10% of the sample was examined for numerical abundance. To evaluate spatial variability, a one-way analysis of variance (ANOVA) test was done and a probability of  $\leq 0.05$  was taken to indicate significant differences. Species diversity 'D' indice was calculated after transforming the zooplankton counts to their numbers per cubicmeter (Margalef, 1968). Environmental parameters such as water temperature, salinity and dissolved oxygen were determined using standard procedures (Strickland & Parsons, 1972). For study of diel variability in plankton population, the zooplankton samples collected between 0600 to 1800 hrs and 1800 to 0600 hrs were considered arbitrarily as day and night samples respectively.

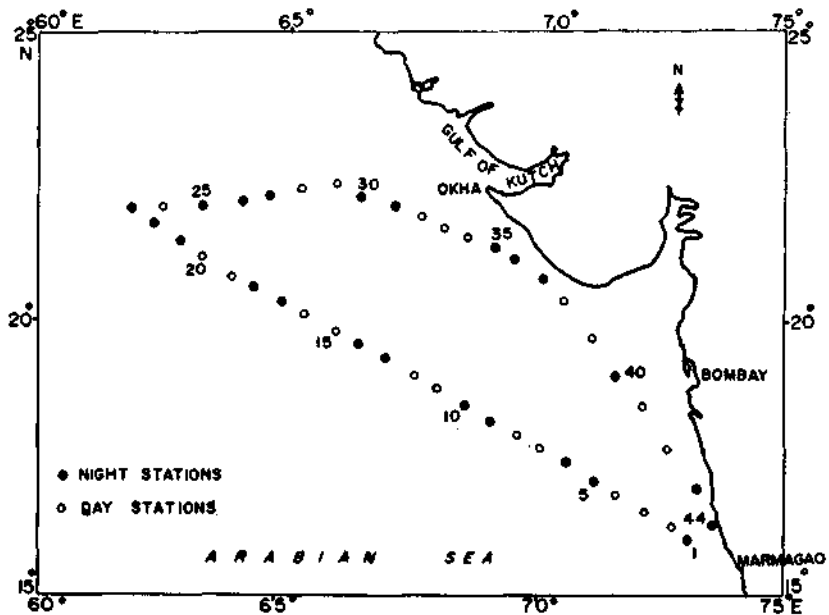

Fig. 1- Station positions

## RESULTS AND DISCUSSION

The northern Arabian Sea is closed by landmass on its northern boundary. There is semi annual reversal of surface currents. The flow pattern consists of several eddies and meanders (Qasim, 1982). These factors seem to influence the biological, physical and chemical characteristics of the region. The water temperature, salinity and dissolved oxygen values at surface ranged from 26.9° to 28.7° C, 35.05 to 36.93  $\times 10^{-3}$  and 400 to 475  $\mu\text{mol/l}$  respectively. In general, the temperature and dissolved oxygen increased from north to south while salinity showed the reverse trend. High salinity in the northern region was reported probably due to excess evaporation over precipitation and to high salinity water coming from the Persian Gulf (Qasim, 1982). The dissolved oxygen values were low at depths between 200 to 500 m. Naqvi (1987) reported occurrence of oxygen deficient conditions at depth between 150 to 1000 m in the Arabian Sea.

### Zooplankton standing stock and composition

The standing stock values (Figs 2,3) ranged from 3 to 581  $\text{ml}/100\text{m}^3$  (av. = 78  $\text{ml}/100^3$ , n = 74). Diel variations were discernible with higher values at night (av. = 137  $\text{ml}/100\text{m}^3$ ) as compared to those of day (av. = 54  $\text{ml}/100\text{m}^3$ ). The average values obtained from the zooplankton samples from the surface, 200 to 0m, 250 to 0m and 500 to 0m depths at day were 28, 54, 65 and 84  $\text{ml}/100\text{m}^3$  while the corresponding values at night were 137, 57, 85 and 53  $\text{ml}/100\text{m}^3$  respectively. The lowest value of 3  $\text{ml}/100\text{m}^3$  was recorded from the surface layer during the day. High visibility and the typical escapist behaviour of zooplankton to avoid predators were the possible reasons given for the poor occurrence of zooplankton in the surface layers (Achuthankutty *et al.* 1992). Higher average values at night could be due to vertical migration of zooplankton. In general, the standing stock values were more in the north and northeastern region. The highest value (581  $\text{ml}/100\text{m}^3$ ) obtained was at st. 31 (lat. 22° 0'N and long. 67° 3'E). The value is higher than the record value (280  $\text{ml}/100\text{m}^3$ ) reported earlier from the north and the northeastern Arabian Sea (lat. 22° 4' N and long. 67° 3' E) during March (Paulinose & Arvindakshan, 1977) but lower than recently reported value (1200  $\text{ml}/100\text{m}^3$ ) from the same area in the months of March and November (Goswami *et al.* 1992). Price *et al.* (1993) gave mean zooplankton standing stock value of 103  $\text{ml}/100\text{m}^3$  in the western Gulf based on postwar data of 1992.

Twenty six taxa were present in the collections from different sampling strata. The distribution of 19 common taxa at 4 depths during day and night is given in Tables 1,2. The remaining 7 groups included foraminiferans, ctenophores, cladocerans, mysids, cumaceans, isopods and echinoderm larvae. These groups occurred sporadically and in small numbers (%) and were considered together as others. Based on overall mean number the percentage occurrence of various groups in order of abundance was copepods (56.95), siphonophores (10.54), euphausiids (7.15), chaetognaths (6.53), decapod larvae (4.97), amphipods (3.86), hydromedusae (2.08), appendiculari-

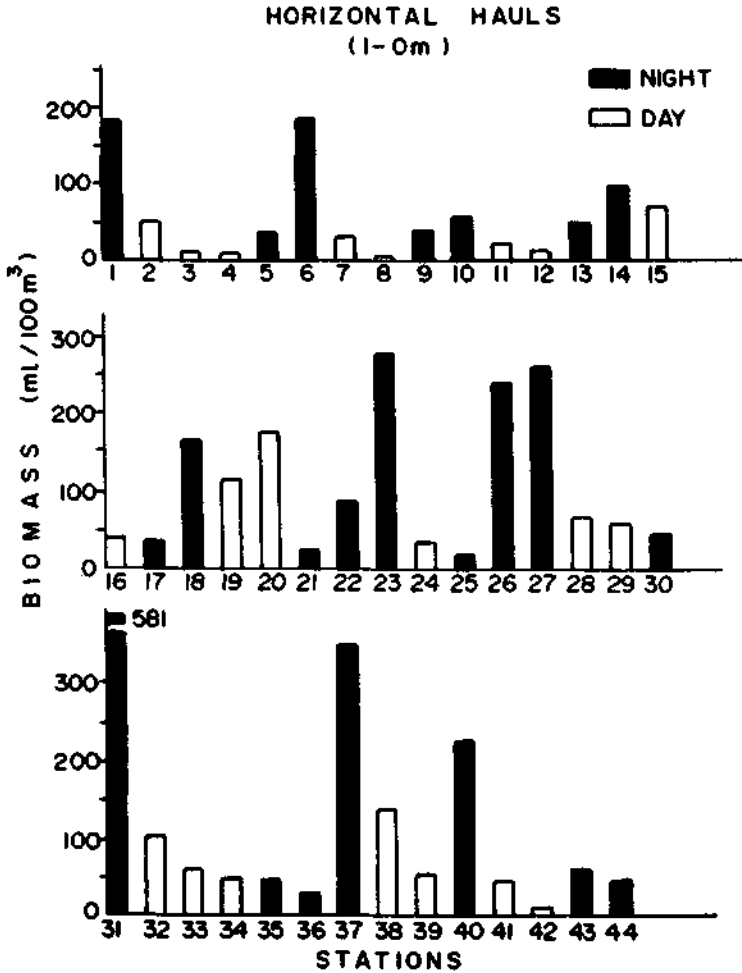

Fig.2- Zooplankton biomass distribution in surface layer

ans (1.63), salps and doliolids (1.13), fish eggs (1.1), mysids (0.94), polychaete larvae (0.9), ostracods (0.53), crustacean eggs (0.49), heteropods (0.38), pteropods (0.24), fish larvae (0.08) and others (0.5). Copepods were most common both in the surface and the water column (36.95 to 71.72%, overall mean 35315 individuals/100m<sup>3</sup>). Their minimum and maximum percentages were obtained in the zooplankton samples collected from surface and 250-0m depth (Table 1). No single group dominated the zooplankton population. The dominance of the copepods was overshadowed at a coastal station where shoal of sergestid shrimp (*Acetes johni*) in association with swarm of adult gammarid amphipods was observed at night. Diel variations in numerical abundance of zooplankton were also noticed in other areas. There was more

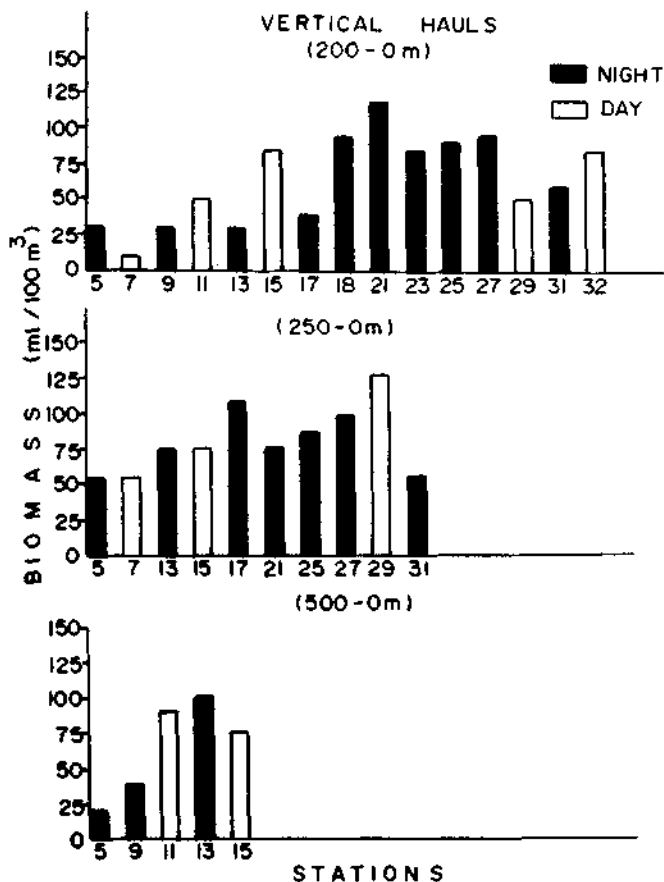

Fig.3- Zooplankton biomass distribution in the water column

than two-fold increase in counts in night samples (av. = 51278 organisms/100m<sup>3</sup>) as compared to the day samples (av. = 24461 organisms/100m<sup>3</sup>). Majority of the groups occurred abundantly in the night samples except halobates, polychaete larvae, crustacean eggs, fish eggs and fish larvae. Maximum number of fish eggs (629/100m<sup>3</sup>) and fish larvae (156/100m<sup>3</sup>) were recorded in the samples from surface and 500 to 0m depth respectively. Myctophidae formed the main component of ichthyoplankton. The zooplankton communities varied in the coastal and oceanic waters. Herbivores dominated the coastal waters. Copepods, cladocerans, ostracods, pteropods, sergestids and tunicates were common there. Carnivores such as siphonophores, hydromedusae, chaetognaths and poecilostomatid copepods occurred more in the oceanic waters.

### Species distribution

Copepods, siphonophores, euphuasiids, chaetognaths and decapod larvae were important taxa and constituted the major component of zooplankton population. An account of distribution of various taxa and their common species in the coastal and oceanic waters has been given below:

Table 1 - Percentage occurrence of common zooplankton groups at four sampling depths in day and night samples (values in parentheses are night samples)

Groups	1-0m	200-0m	250-0m	500-0m	Average number (no./100m <sup>3</sup> )
Copepods	9.85 (27.10)	23.68 (36.04)	29.38 (42.34)	24.02 (31.97)	35315
Siphonophores	3.32 (13.68)	3.80 (6.35)	2.83 (0.51)	9.02 (4.05)	6656
Euphausiids	0.98 (10.12)	1.75 (3.58)	1.26 (3.48)	3.46 (3.55)	4513
Chaetognaths	1.94 (3.04)	3.96 (3.79)	2.97 (3.16)	3.86 (3.17)	4120
Decapod larvae	1.33 (9.26)	1.92 (1.24)	1.41 (1.41)	1.87 (0.84)	3137
Amphipods	0.67 (4.64)	1.22 (1.10)	0.68 (1.81)	3.77 (1.14)	2435
Hydromedusae	0.32 (3.03)	0.59 (0.96)	0.10 (1.72)	0.46 (0.71)	1315
Appendicularians	0.27 (1.98)	1.26 (1.81)	0.11 (0.80)	0.39 (0.49)	1032
Salps & doliolids	0.73 (1.44)	0.37 (0.85)	0.10 (0.80)	0.39 (0.29)	828
Fish eggs	0.96 (0.57)	0.82 (0.41)	0.20 (0.62)	0.60 (0.27)	693
Mysids	0.31 (1.50)	0.17 (0.13)	0.12 (0.39)	0.84 (0.13)	596
Polychaete larvae	0.02 (0.11)	0.59 (0.34)	1.19 (0.39)	0.18 (0.31)	563
Ostracods	0.02 (0.06)	0.42 (0.41)	0.19 (0.31)	0.43 (0.46)	352
Gastropod larvae	0.03 (0.56)	0.12 (0.20)	0.10 (0.03)	0.28 (0.73)	331
Crustacean eggs	0.19 (0.12)	0.20 (0.26)	0.30 (0.15)	0.51 (0.33)	306
Heteropods	0.21 (0.23)	0.25 (0.27)	0.15 (0.17)	0.15 (0.11)	240
Pteropods	0.11 (0.25)	0.09 (0.06)	0.04 (0.05)	0.12 (0.17)	158
Fish larvae	0.06 (0.05)	0.22 (0.10)	0.13 (0.13)	0.25 (0.26)	156
Halobates	0.10 (0.02)	0.00 (0.00)	0.00 (0.22)	0.00 (0.03)	56
Others	0.51 (0.30)	0.26 (0.40)	0.04 (0.21)	0.20 (0.18)	319

*Copepods* — A total of 86 species of pelagic copepod belonging to 21 families were identified. Percentage occurrence of copepods belonging to different families at 4 sampling strata was tabulated (Table 3). Species of family Paracalanidae (*Paracalanus parvus*, *P. aculeatus*, *Acrocalanus gracilis*, *A. gibber* and *Acrocalanus* spp); Eucalanidae (*Eucalanus subcrassus*, *E. crassus*, *E. attenuatus* and *E. monachus*); Temoridae (*Temora turbinata* and *T. discaudata*); Acartiidae (*Acartia spinicauda*, *A. erythraea* and *A. negligens*); Centropagidae (*Centropages furcatus*, *C. tenuiremis*, *C. orsinni*, *C. trispinosus*, *C. dorsipinatus* and *C. alcockii*); Clausocalanidae (*Clausocalanus arcuicornis*); Pontellidae (*Labidocera pectinata*, *L. acuta*, *L. minuta*, *Calanopia minor*, *C. elliptica*, *Pontella danae*, *P. securifer*,

Table 2- Percentage occurrence of individuals of common zooplankton groups at four sampling depths (values in the parentheses are night samples)

Groups	1-0m	200-0m	250-0m	500-0m
Copepods	4.58 (12.59)	7.13 (10.84)	19.41 (21.72)	10.18 (13.55)
Siphonophores	8.17 (33.99)	6.59 (10.15)	9.93 (1.79)	20.27 (9.11)
Euphausiids	3.56 (36.81)	4.12 (8.43)	6.50 (18.00)	11.41 (11.17)
Chaetognaths	7.72 (12.11)	10.22 (9.78)	16.81 (17.88)	13.96 (11.52)
Decapod larvae	6.96 (48.43)	6.52 (4.20)	10.42 (10.53)	8.94 (4.00)
Amphipods	4.54 (31.27)	5.35 (4.79)	6.53 (17.36)	23.12 (7.04)
Hydromedusae	3.97 (37.79)	4.75 (7.79)	1.98 (30.41)	5.19 (8.12)
Appendicularians	4.19 (31.54)	12.32 (18.66)	2.38 (18.18)	5.59 (7.14)
Salps & doliolids	14.58 (28.52)	4.77 (10.99)	12.23 (13.25)	10.74 (4.92)
Fish eggs	22.72 (13.42)	12.55 (6.27)	6.67 (20.81)	10.42 (7.14)
Mysids	8.69 (41.29)	3.15 (2.31)	4.62 (15.48)	21.06 (3.40)
Polychaete larvae	0.66 (3.28)	11.19 (6.35)	49.29 (16.09)	4.97 (8.17)
Ostracods	0.92 (3.05)	12.83 (12.33)	12.69 (20.48)	18.35 (19.35)
Gastropod larvae	1.36 (27.75)	3.62 (6.41)	3.02 (5.96)	50.60 (1.28)
Crustacean eggs	10.46 (6.30)	6.94 (9.15)	22.21 (11.44)	19.12 (14.38)
Heteropods	14.06 (16.06)	11.04 (11.56)	14.37 (16.56)	9.27 (7.08)
Pteropods	11.22 (25.91)	6.00 (4.26)	5.37 (8.06)	26.86 (12.32)
Fish larvae	6.46 (4.45)	0.00 (0.00)	20.30 (19.23)	23.56 (25.00)
Halobates	6.64 (3.10)	0.00 (0.00)	0.00 (90.26)	0.00 (0.00)
Others	26.30 (15.49)	8.76 (13.22)	2.19 (15.81)	10.38 (7.90)

*P. spinipes*, *Pontellopsis scotti*, *P. regalis*, *P. herdmani* and *Pontellopsis* spp.); Oithonidae (*Oithona rigida*, *O. brevicornis*, *O. plumifera* and *O. nana*); Macrosetellidae (*Miracia efferata* and *Macrosetella gracilis*) and Ectinosomidae (*Microsetella rosea*) were common in the zooplankton samples from the coastal regions. Species of the genera *Paracalanus*, *Acrocalanus*, *Centropages* and *Temora* were ubiquitous and distributed over larger areas. Numerous specimens of *T. turbinata* (5271 individuals/100m<sup>3</sup>) were obtained at st. 42 during day. This species was reported to be an opportunistic, positively related to the abundance of phytoplankton and other particulate matter (Paffenhoffer *et al.* 1988). Swarming of *T. turbinata* was observed from the west coast associated with monsoon (Stephen & Iyer, 1979).

The copepod community in the oceanic waters was constituted mainly by omnivore and carnivore forms. Species of families Calanidae (*Canthocalanus pauper*,; *Undinula vulgaris*, *U. darwini* and *Mesocalanus tenuicornis*); Candaci-

Table 3- Percentage occurrence of individuals belonging to common copepod family from four depths in day and night collections (Values in the parentheses are of night samples)

Families	1-0 m	200-0 m	250-0 m	500-0 m
Calanidae	0.35 (0.11)	6.76 (1.73)	3.26 (2.33)	2.72 (2.60)
Eucalanidae	1.40 (2.31)	13.44 (6.13)	10.14 (8.89)	4.33 (2.08)
Paracalanidae	10.27 (13.56)	3.13 (4.16)	0.60 (1.54)	0.51 (1.64)
Clausocalanidae	0.68 (0.60)	2.96 (1.06)	0.36 (0.45)	0.57 (0.80)
Acertiidae	0.31 (0.33)	0.89 (0.49)	0.13 (0.11)	0.19 (0.21)
Centropagidae	4.02 (2.91)	0.86 (1.00)	0.19 (0.78)	0.29 (0.33)
Temoridae	4.33 (3.96)	4.49 (1.63)	0.85 (0.67)	0.63 (0.91)
Scolecithricidae	0.18 (0.12)	0.22 (0.29)	0.36 (0.29)	0.58 (0.64)
Candacidae	0.12 (0.06)	0.86 (1.00)	2.40 (2.41)	2.67 (3.58)
Pontellidae	29.67 (19.44)	4.14 (2.32)	3.26 (0.61)	1.47 (0.79)
Metridiidae	0.00 (0.03)	0.76 (5.61)	0.78 (2.58)	3.73 (12.68)
Lucicutidae	0.00 (0.04)	3.59 (5.99)	3.68 (5.11)	2.42 (3.56)
Augaptilidae	0.00 (0.00)	0.42 (1.12)	3.53 (3.44)	3.59 (3.38)
Aetideidae	0.00 (0.00)	0.67 (1.64)	3.98 (4.22)	3.79 (4.46)
Heterorhabdidae	0.00 (0.00)	0.57 (0.83)	2.26 (2.95)	3.62 (4.77)
Eucaetidae	0.06 (0.16)	0.34 (3.81)	3.26 (3.45)	4.21 (3.80)
Oncaeidae	0.16 (0.41)	4.78 (2.29)	3.17 (3.01)	4.59 (5.09)
Corycaeidae	0.70 (1.24)	3.10 (1.82)	3.64 (3.64)	2.87 (2.96)
Oithonidae	0.66 (1.42)	0.39 (0.84)	2.22 (1.64)	0.58 (0.63)
Sapphirinidae	0.00 (0.02)	0.67 (0.15)	1.39 (1.85)	0.25 (0.81)
Harpacticoidae	0.14 (0.21)	0.20 (0.08)	0.19 (0.16)	0.01 (0.06)

idae (*Candacia bradyi*, *C. pachydactyla*, *C. discaudata*, *C. aethiopica* and *Candacia* spp); Eucaetidae (*Euchaeta rimana*, *E. concinna*, *E. wolfendeni* and *Euchaeta* spp); Scolecithricidae (*Scolecithrix danae* and *S. bradyi*); Lucicutiidae (*Lucicutia flavicornis*, *L. ovalis* and *Lucicutia* spp); Metritiidae (*Gaussia princeps*, *Gaussis* spp, *Pleuromamma gracilis* and *P. indica*); Aetideidae (*Aetideus giesbrechtii*); Augaptilidae (*Haloptilus longicornis* and *Haloptilus* spp); Heterorhabdidae (*Heterorhabdus papilliger*); Oncaeidae (*Oncea venusta* and *O. conifera*); Corycaeidae (*Corycaeus gibbulus*, *C. caeus*, *C. speciosus* and *Corycaeus* spp) and Sapphirinidae (*Sapphirina opalina*, *S. metallina*, *Copilia mirabilis* and *C. vitrea*) were abundant in collections from the oceanic realm. Certain species viz. *Cosmocalanus darwini*, *Scolecithrix danae*, *Lucicutia flavicornis*, *Candacia bradyi*,

*Oncaea venusta* and *Corycaeus gibbulus* were common in samples from the coastal waters. These species could be termed as intermediate. Their common occurrence in both habitats might be due to surface circulation and mixing of neritic and oceanic waters. Based on the spatial extent of distribution of different species, 3 groups of pelagic copepods such as oceanic, neritic and intermediate were identified (Pillai, 1974). The bathymetric distribution of copepod species showed 3 categories — i) species which occurred more in the epipelagic layer (200-0m); ii) forms recorded below 200 m and iii) species which were present throughout the sampling depth. Majority of the species belonged to the first category. Species such as *Paracalanus parvus*, *P. aculeatus*, *Acrocalanus gracilis*, *Eucalanus monachus*, *Centropages tenuiremis*, *C. furcatus*, *Candacia bradyi*, *Labidocera pectinata*, *Temora turbinata*, *Scolecithrix danae*, *Pontella securifer*, *Pontellopsis scotii* and *Pleuromamma gracilis* were common and invariably present in the epipelagic layer. *Eucalanus attenuatus*, *Lucicutia flavicornis*, *Euchaeta concinna*, *Aetideus giesbrechtii*, *Haloptilus longicornis*, *Heterorhabdus papilliger* and *Sapphirina opalina* occurred more in depth between 200 to 500m. The remaining species did not evince any definite distributional pattern and belonging to the third category. Members of families Paracalanidae and Pontellidae were observed during the day. The number of species belonging to different families increased at night. Niche partitioning on vertical ranges among congeneric species of genus *Pleuromamma* was observed. *P. gracilis* was recorded in upper layers in areas with dissolved oxygen content exceeding 45  $\mu\text{mol/l}$  where as *P. indica* was numerous at 500 m depth contour tolerating oxygen deficient waters. The variations could be assigned to resource partitioning or different migratory habits of the species (Roe, 1974).

*Siphonophores* — Siphonophores were next abundant group, occurring commonly in the coastal waters. *Lensia* spp and *Diphyes* spp represented siphonophore population.

*Euphausiids* — These were sparsely distributed in the coastal region but were abundant in the oceanic area. Species belonging to 4 genera viz. *Euphausia*, *Stylochreiron*, *Nematoscelis* and *Thysanopoda* were recorded. *E. diomediae* was the dominant species.

*Chaetognaths* — The population density of chaetognaths ranged from 24 to 2858/100m<sup>3</sup>. Their occurrence was more in samples taken between 15° and 18°N lat. Higher counts were obtained in the coastal region particularly at night. Twelve species belonging to 3 genera - *Sagitta*, *Pterosagitta* and *Krohnitta* were identified. The species in order of abundance were *Sagitta enflata*, *S. bedoti*, *S. neglecta*, *S. pacifica*, *S. robusta*, *S. pulchra*, *S. regularis*, *S. ferox*, *Pterosagitta draco*, *S. hexaptera*, *Krohnitta pacifica* and *S. lyra*. The first three species occurred more in coastal waters while the remaining in the oceanic area. Single specimen of *S. lyra* was obtained from a sample taken from 500 to 0m depth. This species was reported to be mesoplanktonic occurring in abundance below 700 m depth (Silas & Srinivasan, 1969).



*Decapod larvae* — Sergestids were most commonly (18.1 to 23.7) represented by species of genus *Lucifer* (*L. hanseni*, *L. typus* and *Lucifer* spp), *L. hanseni* being the most common. The other decapod groups comprised mainly of Penaeidea, Caridea, Stenopidea, Anomura and Brachyura. Penaeidea and brachyuran larvae were abundant in the coastal belt. The penaeid prawn larvae were represented by species of genera *Penaeus*, *Metapenaeus* and *Parapeneopsis*. Larvae of *M. dobsoni* were most abundant. The zoea and megalopa larvae of edible crabs represented the brachyuran population.

Hydromedusae were more in samples from the coastal area. The amphipods of the suborder Gammaridea and Hyperidea were common particularly between 22° and 24°N lat. The polychaetes were represented mainly by *Pelagobia* spp. The cladocerans were most abundant in the coastal waters, their population density decreased in the offshore region. *Evadne tergestina* and *Penilia avirostris* were the two species, former was dominant (62.8%). Tunicates were common in oceanic samples. *Oikopleura* spp were the representative of appendicularians. *Thalia democratica* and *Dolioletta* were common forms of salps and doliolids respectively.

### Species diversity

The species diversity (D) values in the oceanic realm ranged between 6.4 and 9.2 (av. = 7.4) and in the coastal waters between 2.8 and 7.6 (av. = 5.5). Higher diversity values in the former habitat was due to stable environmental conditions prevailing there, which permitted the planktonic communities to diversify. The coastal belt of the Arabian Sea is enriched with nutrients during the southwest monsoon (June to September) resulting in phytoplankton abundance. High concentration of primary food generally results in swarming of few herbivores/omnivores such as copepods (*Temora turbinata*), gammarid amphipods (*Atylus* spp) and sergestid shrimps (*Acetes johni*). The swarming of zooplankters in the coastal waters resulted in low diversity but high biomass community. The increasing gradient in species diversity from estuaries to nearshore and coastal waters and oceanic areas was reported (Madhupratap, 1983).

Based on present data, zooplankton standing stock and species diversity, it can be concluded that there was no apparent effect of Gulf oil spill on plankton population in the western Exclusive Economic Zone (EEZ) of India. This corroborates the earlier observation on post spill zooplankton distribution in the NW Gulf (Al-Yamini *et al.* 1993).

### ACKNOWLEDGEMENT

Authors are grateful to the Director for facilities. Thanks are due to Dr. Z.A. Ansari for help rendered in collection of samples.

### REFERENCES

- Achuthankuty C.T., Nair S.R.S., Nair V.R., Padmavati G. & Madhupratap, M. 1992. Microdistribution of zooplankton in the neustonic realm of the eastern Arabian Sea during southwest monsoon,

- In: *Oceanography of the Indian Ocean*, edited by B.N. Desai, (Oxford and IBH Publ. Co., New Delhi) 177-190.
- Al-Yamini F.Y., Al-Rifaie K. & Ismail W. 1993. Post-spill zooplankton distribution in the NW Gulf, *Mar Poll Bull.* 27: 239-244.
- Goswami S.C., Sarupria J.S. & Bhargava R.M.S. 1992. Zooplankton standing stock assessment and fishery resources in the Indian seas, In: *Oceanography of the Indian Ocean*, edited by B.N. Desai, (Oxford & IBH Publ. Co., New Delhi), 217-226.
- Madhupratap M. 1983. Zooplankton standing stock and diversity along an oceanic track in the western Indian Ocean, *Mahasagar - Bull. Natn. Inst. Oceanogr.* 16: 463-467.
- Margalef R. 1968. *Perspectives in ecological theory*, (University of Chicago Press, Chicago), pp. 111.
- Naqvi S.W.A. 1987. Some aspects of the oxygen deficient conditions and denitrification in the Arabian Sea, *J. Mar. Res.* 45: 1049-1072.
- Paffenhoffer G. A., Sherman B.K. & Lee T.N. 1988. Summer upwelling on the southeastern continental shelf of the USA 1981: Distribution, abundance and patch formation of zooplankton, *Prog. Oceanogr.* 19: 403-436.
- Paulinose V.T. & Arvindakshan P.N. 1977. Zooplankton biomass, abundance and distribution in the North and Northeastern Arabian Sea, In: *Proc. Symp. Warm. Water Zoopl.* (UNESCO/NIO, Goa), 132-136.
- Pillai P.P. 1974. *Studies on pelagic copepods of Indian Seas*, Ph.D. thesis, University of Kerala, Trivandrum, pp.446.
- Price A.R.G., Mathews C.P., Ingle R.W. & Al-Rasheed K. 1993. Abundance of zooplankton and penaeid shrimp larvae in the western Gulf: Analysis of pre-war (1991) and post-war data, *Mar. Poll. Bull.* 27: 273-278.
- Qasim S.Z. 1982. Oceanography of the northern Arabian Sea, *Deep-Sea Res.* 29: 1041-1068.
- Roe H.S.J. 1974. Observations on diurnal vertical migrations of an oceanic animal community, *Mar. Biol.* 28: 99-113.
- Silas E.G. & Srinivasan M. 1969. A new species of *Eukrohnia* from the Indian seas with notes on three other species of chaetognatha, *J. Mar. Biol. Ass. India.* 10: 1- 33.
- Stephen R. & Iyer H.K. 1979. Species composition and coexistence of calanoid copepods in the shelf waters of Cochin, *Mahasagar - Bull. Natn. Inst. Oceanogr.* 12: 227-238.
- Strickland J.D.H. & Parsons T.R. 1972. *A practical handbook of seawater analysis*, Bull. No. 167, (Fish.Res. Bd. Canada, Ottawa), pp.310.

## Spatial and temporal distribution of chaetognatha from the eastern Arabian Sea

M. Srinivasan

Marine Biological Station, Zoological Survey of India, 100, Santhome High Road, Madras - 600 028

### ABSTRACT

The distribution and abundance of epipelagic chaetognaths from the zooplankton samples collected during the first 10 cruises of FORV SAGAR SAMPADA in 1985 at 258 stations located in the eastern Arabian Sea were studied. 13 species belonging to the three genera *Krohnitta*, *Pterosagitta* and *Sagitta* were found in the samples. The presence of the mesopelagic species *Sagitta decipiens* Fowler in the samples collected from the upper 150m indicates upwelling, a process characteristic of the west coast of India.

### INTRODUCTION

Chaetognaths from the Arabian Sea along the west coast of India are wellknown. The distribution of chaetognaths along the west coast of India (George, 1952; Nair & Rao, 1973; Silas & Srinivasan, 1968, 1969, 1970; Srinivasan, 1972, 1976, 1979, 1987, 1988, 1990) and from the northern Arabian Sea bordering the Arabian countries, Pakistan and India, were reported (Nair, 1967, 1977, 1978; Pierrot-Bults & Nair, 1991). As limited information is available on the fluctuations of chaetognaths from the Arabian Sea during the premonsoon, monsoon and postmonsoon seasons, this study will contribute to further knowledge on the distribution of chaetognatha.

### MATERIALS AND METHODS

The material for this study was obtained from the zooplankton samples collected in 1985, during the first 10 cruises of FORV SAGAR SAMPADA from 258 stations located in the Exclusive Economic Zones of the eastern Arabian Sea along the west coast of India, between 4° and 24°N and 64° and 79°E. The samples were collected with Bongo-60 net (mesh size 0.33 mm) from 150 m to surface oblique haul, when the ship was in motion at 2 knot speed. The quantity of water filtered was determined with

the flow meter. The samples were preserved in 5% neutralized formaldehyde solution. The displacement volume of the samples was determined in the laboratory. The chaetognaths from the whole sample were sorted out when the volume was <5 ml and when the volume was more than 5 ml, aliquot samples not <5 ml was taken, chaetognaths were sorted, counted and the total numbers for the whole sample were calculated. Then the number of specimens in the quantity of water filtered were standardized for 1000 m<sup>3</sup> of water filtered for all the samples.

As all the 258 stations were occupied within 4° and 24°N and 64° and 79°E, to get a clear picture of distribution, the total area of operation during the first 10 cruises of FORV *Sagar Sampada* were divided into 36 grids of 2° squares. The latitudes between 4° and 24°N were divided into 10 grids of 2° squares as 'A' to 'J' and the longitudes 64° to 79°E were divided into 8 grids of 2° squares as 1 to 8. The total numbers of chaetognaths from all samples of the stations located in each 2° square grids were totalled and the average was taken to represent the 2° square grids for the purpose of chaetognath distribution.

For seasonal distribution studies, samples (64) collected from February to May were grouped under premonsoon season, from June to September (70 samples) under monsoon season and the remaining 124 samples collected from October to January were grouped under postmonsoon season.

## RESULTS AND DISCUSSION

This study has revealed the presence of 13 species of Chaetognatha (Table 1) belonging to the genera *Sagitta* Quoy & Gaimard, *Pterosagitta* Costa and *Krohniitta* Ritter-Zahony.

### Spatial distribution

The average number of chaetognaths per station from the eastern Arabian Sea along the west coast of India was 14188/1000 m<sup>3</sup> (range : 1078-153138/m<sup>3</sup>). When the chaetognath population is taken as such, the maximum density was found in the shelf regions of Cochin and Mangalore (Fig. 1), as in the case of distribution of euphausiids (Mathew *et al.* 1990). Further it was observed that the density of chaetognath population below Ratnagiri coast (17°N) decreases from the shelf to offshore areas.

As in the case of total chaetognath population, the abundance of *Sagitta enflata* (Fig.2 A) was noticed in the shelf areas of Cochin, Mangalore and south of Marmagoa. More than 10000 individuals / 1000 m<sup>3</sup> were found at a station in these areas. Further off Bombay, Kandla and Veraval coasts also this was found in more numbers, whereas, in the offshore waters below Ratnagiri, *S.enflata* was found less than 5000/1000 m<sup>3</sup>. This species was recorded in all the samples. Among the 13 species, *S.enflata* was the most abundant species and it formed 75% of the total chaetognaths.

Table 1 - Abundance of chaetognatha species

Sl.no.	Species	Abundance (%)
1.	<i>Sagitta enflata</i> Grassi	74.5
2.	<i>Sagitta bedoti</i> Beraneck	8.5
3.	<i>Sagitta pacifica</i> Tokioka	7.5
4.	<i>Pterosagitta draco</i> (Krohn)	2.5
5.	<i>Sagitta neglecta</i> Aida	1.7
6.	<i>Sagitta robusta</i> Doncaster	1.4
7.	<i>Sagitta ferox</i> Doncaster	1.2
8.	<i>Sagitta decipiens</i> Fowler	1.0
9.	<i>Krohnitta pacifica</i> (Aida)	1.0
10.	<i>Sagitta hexaptera</i> d'Orbigny	0.2
11.	<i>Sagitta pulchra</i> Doncaster	0.2
12.	<i>Sagitta regularis</i> Aida	0.2
13.	<i>Kronhitta subtilis</i> (Grassi)	0.1

*Sagitta bedoti* occupied the second place in the order of abundance and it formed 8.5% of the total chaetognaths. It was present in 34 of the 36 grids (2° squares). The density of *S.bedoti* was more along the shelf regions of Cochin, Mangalore, Margao, Bombay and Veraval than in the offshore regions (Fig.2 B).

*Sagitta pacifica* formed 7.5% of the total chaetognaths. This was found in abundance in the offshore regions (except near Ratnagiri) of the sampled areas (Fig.2 C) than in the shelf regions. As this is an oceanic form, this was found in greater numbers in the offshore waters than in the neritic waters, whereas *S.bedoti* was found in more numbers in the neritic waters, as this is a neritic species (Srinivasan, 1976). This was found in all the 36 grids.

*Pterosagitta draco* formed 2.5% of the total chaetognaths. This was present in all the samples from 35 of the 36 grids. The distribution of *P.draco* shows that the density was more in the southeastern region of the Arabian Sea (below 13°N) along the west coast of India than in the northeastern region (Fig.2 D). Above 13°N the population decreased in number from the shelf to oceanic region.

Among the remaining 9 species of chaetognaths, the distribution of the 8 epipelagic species (*Sagitta neglecta*, *S. robusta*, *S. ferox*, *S. hexaptera*, *S.pulchra*, *S. regularis*, *Krohnitta pacifica* and *K. subtilis*) were not individually dealt with as they formed <7% of the total chaetognaths.

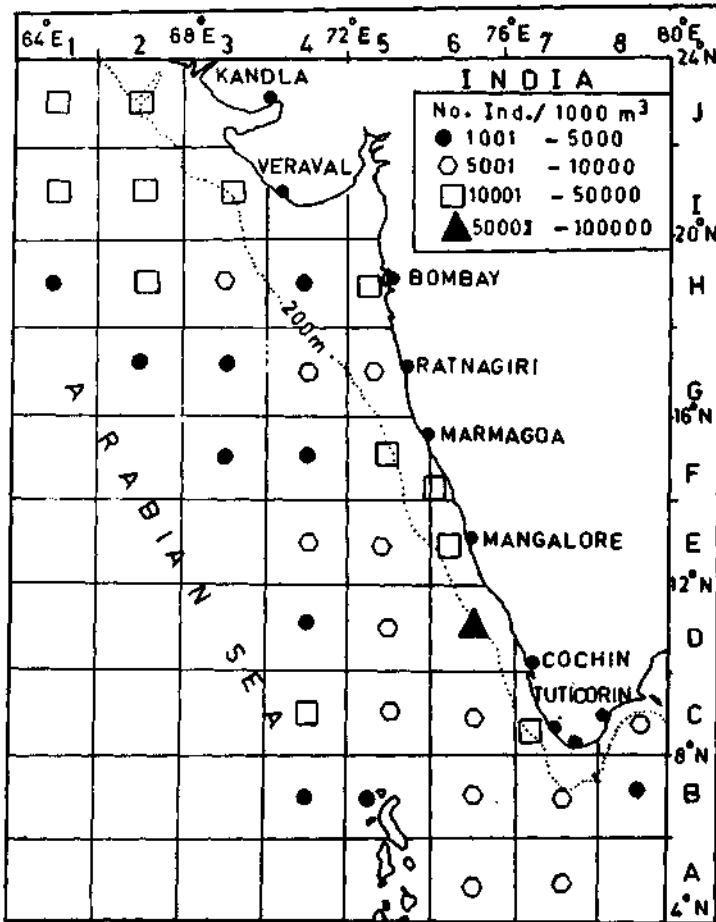

Fig. 1 — Distribution of chaetognaths along the west coast of India, during 1985

### Seasonal distribution

The distribution of chaetognaths during the premonsoon, monsoon and postmonsoon seasons revealed that 18.5% of the total chaetognaths were from the samples of the premonsoon season, 52.5% from the monsoon and the remaining 29% were from the postmonsoon season. As in the case of copepods (Pillai, 1990) and euphausiids (Mathew *et al.* 1990), chaetognaths were also found in more numbers during the monsoon season (19563/1000 m<sup>3</sup> were found during the monsoon while the numbers were 6882/1000 m<sup>3</sup> during the premonsoon season and 10842/1000 m<sup>3</sup> during the postmonsoon season).

During the premonsoon season, the chaetognath density was less at areas below 14°N (Fig.3 A) and maximum density was noticed off Kandla, Veraval, Bombay and

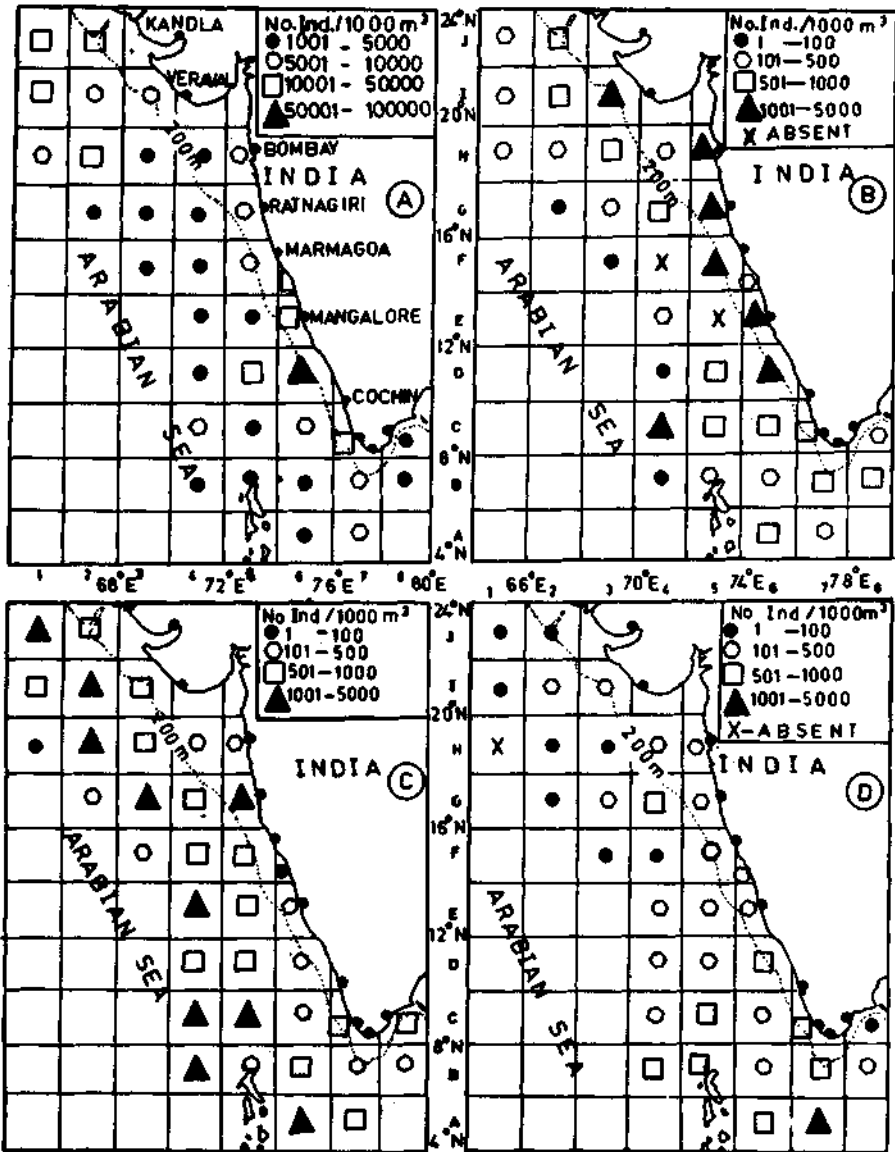

Fig. 2 — Distribution of : A) *Sagitta enflata*, B) *Sagitta bedoti* C) *Sagitta pacifica* and D) *Pterosagitta draco* along the west coast of India during 1985

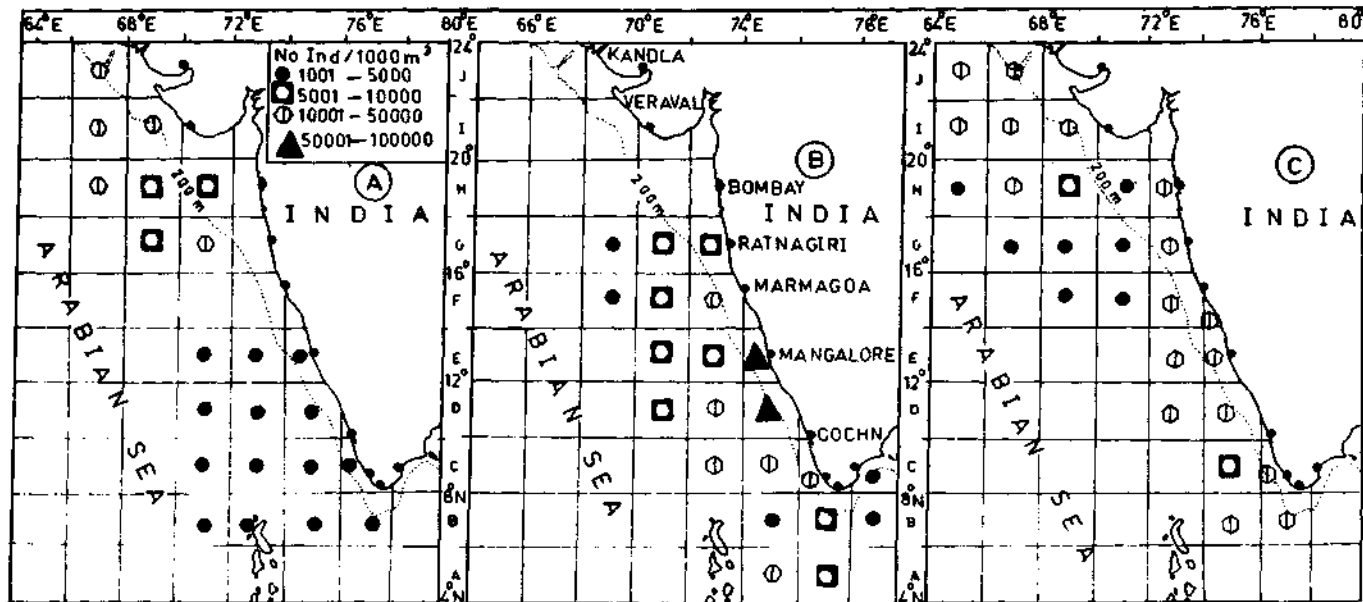

Fig. 3 — Distribution of chaetognatha along the west coast of India during : A) premonsoon, B) monsoon and C) postmonsoon seasons of 1985



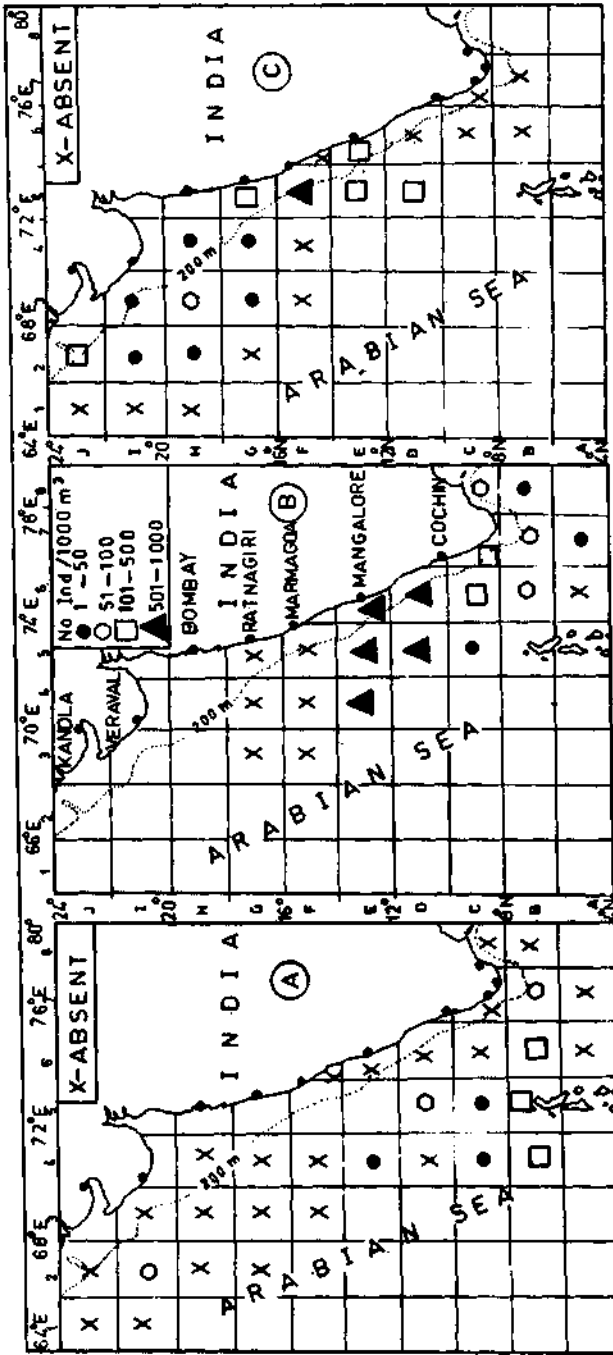

Fig. 4 — Distribution of *Sagitta decipiens* along the west coast of India during : A) premonsoon, B) monsoon, and C) postmonsoon seasons of 1985

Ratnagiri coasts. The same trend was reported in the case of copepods distribution during the premonsoon period (Pillai, 1990). Whereas, during the monsoon season, the chaetognath concentration was more at areas below 14°N than above 14°N (Fig.3 B). During the postmonsoon period, the density of the chaetognath population was more along the shelf regions of the entire coast (Fig.3 C).

### ***Sagitta decipiens* as indicator of upwelling**

The distribution of *S. decipiens* from the eastern Arabian Sea along the west coast of India, shows that this species was not found in the samples collected from the shelf areas during the premonsoon period (Fig.4 A). It was found in less numbers at few oceanic stations below Mangalore. Whereas during the monsoon period, it was found in large numbers in the shelf and oceanic waters below Mangalore (Fig.4 B). During the postmonsoon period, (Fig.4 C) it was found in the shelf and oceanic regions above the Mangalore coast. *S. decipiens* is a mesopelagic oceanic species, cosmopolitan in temperate and warm oceanic region (Alvarino, 1965). As it is an inhabitant of the waters of low temperature, low oxygen and high salinity, it could be made use of to identify the movement of deep waters (Sund, 1961). Further, as it is always associated with colder waters with low temperature and dissolved oxygen, its influx over the shelf areas should have been along with the intruding cold waters into the continental shelf (Srinivasan, 1976).

It is a known fact that, the upwelling off southwest coast of India, starts with the onset of southwest monsoon in June and lasts throughout the monsoon and the cold water retreats only in the latter half of October (Banse, 1968; Ramamirtham & Jayaraman, 1961). Already published reports are available about the possible use of *S. decipiens* as indicator of upwelling along the California coast (Alvarino, 1964, 1967), southwest coast of India (Srinivasan, 1976) and along the Costa Rica (Segura *et al.* 1992). Alvarino (1964, 1967) stated that the occurrence of *S. decipiens* in the upper 100 m of California indicates the process of upwelling. Srinivasan (1976) reported that this species could be used as an indicator of upwelling along the southwest coast of India, as this was found in large numbers in the samples collected from 90 m in the shelf region. Further Segura *et al.* (1992) pointed out the presence of *S. decipiens*, a mesopelagic species in the epipelagic waters, indicating upwelling along the Costa Rica in the Pacific Ocean.

In conclusion, it may be stated that the density of the chaetognath population is very rich between Cochin and Marmagoa coasts and of Gujarat coast during the monsoon season and the presence of *S. decipiens* in the shelf and oceanic waters (in 150 m to surface oblique hauls) during the monsoon and postmonsoon seasons is significant because it is an oceanic mesopelagic species associated with colder waters with low temperature and dissolved oxygen. Hence this species could be used as an indicator of upwelling along the southwest coast of India.

## ACKNOWLEDGEMENT

Author thanks Dr A.K.Ghosh, Director, Zoological Survey of India, Calcutta and Dr P.Dhandapani, Deputy Director, Marine Biological Station, Madras for the facilities provided and to the Directors, Department of Ocean Development, New Delhi and Central Marine Fisheries Research Institute, Cochin for providing the samples.

## REFERENCES

- Alvarino, A. 1964. Bathymetric distribution of chaetognaths, *Pacif. Sci.* 8: 64-82.
- Alvarino, A. 1965. Chaetognaths, *Oceanogr. Ann. Rev.* 3: 115-194.
- Alvarino, A. 1967. Bathymetric distribution of Chaetognatha, Siphonophora, Medusae and Ctenophora off San Diego, California, *Pacif. Sci.* 21: 474-485.
- Banse, K. 1968. Hydrography of the Arabian Sea shelf of India and Pakistan and effects on demersal fishes, *Deep-Sea Res.* 15: 45-79.
- George, P.C. 1952. A systematic account of chaetognaths of the Indian coastal waters with observations on their seasonal fluctuations along the Malabar coast, *Proc. Nat. Inst. Sci. India*, 18: 657-689.
- Mathew, K.J., Naomi, T.S., Antony, G. & Scariah, K.S. 1990. Distribution of Euphausiacea in space and time in the Indian EEZ and contiguous seas, In: *Proc. First Workshop Scient. Result. FORV. Sagar Sampada*, edited by K.J.Mathew, (CMFRI, Cochin) 121- 127.
- Nair, R.V. 1967. A preliminary report on the biomass of chaetognaths in the Indian Ocean comparing the Southwest and northeast monsoon periods, *Bull. Natl. Inst. Sci. India*, 38: 747- 752.
- Nair, R.V. 1977. Chaetognaths of the Indian Ocean, In: *Proc. Symp. Warm Water Zooplankton*, (UNESCO/NIO, Goa), 168-195.
- Nair, R.V. 1978. Bathymetric distribution of chaetognaths in the Indian Ocean, *Indian J. Mar. Sci.* 7: 276-282.
- Nair, R.V. & Rao, T.S.S. 1973. The Chaetognatha of the Arabian Sea. In: *The biology of the Indian Ocean*, Vol. 3 edited by B. Zeitschel, (Springer Verlag, Berlin) 293-317.
- Pierrot-Bults, A.C. & Nair, V.R. 1991. Distribution patterns in Chaetognatha, In: *The Biology of chaetognaths*, edited by Q.Bone, H.Kapp & A.C. Pierrot-Bults (Oxford University Press, London) 87- 116.
- Pillai, P.P. 1990. Heterogeneity in the distribution pattern of pelagic copepods collected onboard *FORV Sagar Sampada* in EEZ, In: *Proc. First Workshop Scient. Result. FORV Sagar Sampada*, edited by K.J. Mathew, (CMFRI, Cochin) 95-108.
- Ramamirtham, C.P. & Jayaraman, R. 1961. The hydrological features of the continental shelf waters off Cochin during three years 1958 and 1959, *J. Mar. Biol. Ass. India*, 2: 199-207.
- Segura, L., Hernandez, R.M. & Morones, L.M. 1992. Distribution Y abundancia de los quetognatos (Chaetognatha) en la region del Dorno de Costa Rica, *Riv. Biol Trop.* 40: 35-42.
- Silas, E.G. & Srinivasan, M. 1968. On the little known Chaetognatha *Sagitta bombayensis* Lele & Gae, 1936 from Indian waters, *J. Mar. Biol. Ass. India*, 9: 84-95.
- Silas, E.G. & Srinivasan, M. 1969. A new species of *Eukrohnia* from the Indian seas, with notes on three other species of Chaetognatha, *J. Mar. Biol. Ass. India*, 10: 1-33.
- Silas, E.G. & Srinivasan, M. 1970. Chaetognaths of the Indian Ocean with a key for their identification, *Proc. Indian Acad. Sci.* 71: 177-192.
- Srinivasan, M. 1972. Two new records of meso and bathyplanktonic chaetognaths from the Indian seas, *J. Mar. Biol. Ass. India*, 13: 130-133.
- Srinivasan, M. 1976. Distribution of Chaetognatha, with special reference to *Sagitta decipiens* as an indicator of upwelling along the west coast of India, *J. Mar. Biol. Ass. India*, 16: 127-142.

- Srinivasan, M. 1979. Taxonomy and ecology of Chaetognatha in relation to their role as indicator organisms of watermasses, *Zool. Surv. India, Techn. Monogr.* 3: 1-47.
- Srinivasan, M. 1987. Chaetognatha from the northern Arabian sea collected during the cruises of INS DARSHAK, *J. Mar. Biol. Ass. India*, 23: 151-160.
- Srinivasan, M. 1988. *Pterokrohnia arabica* a new genus and new species of Chaetognatha from the Arabian Sea, *J. Mar. Biol. Ass. India*, 28: 199-201.
- Srinivasan, 1990. Studies on the Quantitative distribution of Chaetognatha from the Indian seas, collected during the cruises 1-44 of FORV Sagar Sampada, In: *Proc. First Workshop Scient. Result. FORV Sagar Sampada*, edited by K.J. Mathew, (CMFRI, Cochin) 81-84.
- Sund, P.N. 1961. Some features of the autoecology and distribution of Chaetognatha in the eastern Tropical Pacific, *Inter-Amer. Trop. Tuna Comm. Bull.* 5: 307-331.

\* \* \*

## Distribution and abundance of cladocerans in the eastern Arabian Sea

T. S. Naomi, K. J. Mathew, Geetha Antony, T. V. Sathianandan & P. P. Pavithran  
Central Marine Fisheries Research Institute, P. B. No. 1603, Cochin-682014

### ABSTRACT

Of the two species, *Penilia avirostris* Dana and *Evadne tergestina* Claus encountered, 86% of the population of the former occurred within the 50 m depth zone and 75% of the total population of the latter in the 50 m-100 m depth zone. Striking day-night variations in the population densities of *Penilia* and *Evadne* were observed. The samples collected at night contained 99.7% and 88% of the populations of the former and latter species respectively. Swarming of *Evadne* and *Penilia* is a regular phenomenon during the southwest monsoon season. The highest concentration of the former species was observed in August and that of the latter in September. High concentrations of *Penilia* and *Evadne* were observed in the 30 m depth zone off Cochin and in the 40 m depth zone off Karwar. The abundance of *Penilia* observed in the 30 m depth zone of Wadge Bank off Cape Comorin coincided with its maximum recorded in August off Cochin. The length frequency studies on *Penilia* and *Evadne* showed that different size classes dominated in the different regions from 07°N to 19°N and that an increase in size of the individuals was evident from south to north in both *Penilia* and *Evadne*. Fecundity of *Penilia* was the highest in the southernmost region between 07°00'N and 09°00'N while that of *Evadne* was in the northern region, 15°N- 19°N. Gamogenetic females of both *Penilia* and *Evadne* were very few in number. Occurrence of large numbers of parthenogenetic females of *Penilia* and *Evadne* with well developed advanced embryos in their brood pouches in the night samples probably suggest nocturnal brood maturation.

### INTRODUCTION

Marine cladocerans are a group of unique planktonic crustaceans that exhibit parthenogenesis and swarming during certain seasons of the year. They are an ideal prey of the planktivorous fishes and play an important role in the marine food web and as feed in piscicultural practices.

Preliminary observations in the distribution, abundance and seasonal variations of cladocera as a group from the shelf and oceanic waters of the seas around India were

reported earlier (Naomi *et al.* 1989). The specieswise abundance, length frequency distribution, fecundity, seasonal and diurnal variations of the cladocerans occurring in the samples collected by *FORV Sagar Sampada* during 1985-1987 from the shelf and oceanic waters of the eastern Arabian Sea are presented in this report.

## MATERIALS AND METHODS

Out of the 592 samples collected by oblique hauls from an average depth of 150 m to the surface using a twin Bongo 60 net of mesh aperture 0.33 mm fitted with a calibrated flowmeter, 62 samples contained cladocera. Of which 32 were collected during nighttime and the rest during daytime.

The average number of *Penilia avirostris* and *Evadne tergestina* present in half a degree square area was estimated per 1000 m<sup>3</sup>. Since the depth at the stations sampled varied from 27 m to 4060 m the area of the Arabian Sea between 07°N — 23°N lat. and 68° 25'E — 77°30'E long. was divided into five depth zones for comparing the specieswise abundance. And also into 8 regions from south to north for the purpose of regionwise abundance. Day- night variations and fluctuations in the premonsoon (February- May), monsoon (June-September) and postmonsoon (October-January) seasons were also noted.

The number of individuals examined was 789 of which 587 were *Evadne* and the rest 202 were *Penilia*. The number measured for determining the gross and standard length was 50 when the sample contained large numbers, otherwise all the specimens were measured. The gross length (GL) of *Evadne* was taken as the total length of the carapace including head (Mullin & Onbe, 1992) and the standard length (SL) as the distance from the cervical part to the tip of the caudal furcae. The GL of *Penilia* was taken as the distance from the anterior tip of the head to the base of the caudal setae (Della Croce, 1965). The GL of each embryo per parthenogenetic female was measured and the fecundity, i.e. the number of eggs or embryos per batch was counted. Variations in the mean fecundity and length frequency distributions in different latitudes and seasons were studied. Correlation between hydrography and the abundance of cladocerans is attempted for a few stations sampled where the concentration of *Penilia* and *Evadne* were high.

## RESULTS AND DISCUSSION

Studies on the distribution of cladocerans in the eastern Arabian Sea during 1985-1987 revealed that the abundance of *Evadne tergestina* and *Penilia avirostris* in the coastal waters of Cochin (10°N-76°E) and Karwar (14°51'N-73°37'E) was quite high. The trends in seasonal upwelling and the high overall biological productivity of the region off Cochin and Karwar have been well documented as both are well-known for the production of major pelagic fishes along the west coast of India (Johannessen *et al.* 1981; Naomi 1986; Rao, *et al.* 1992). The hydrophysical conditions defined by the temperature of 24.55°C, salinity of  $26.20 \times 10^{-3}$  and the dissolved

oxygen content of 2.47-1.25 ml/l during August (Table 1) appeared to have favoured the proliferation of these planktonic crustaceans in the coastal waters off Cochin in the 30 m depth zone, where the abundance of *Penilia* far exceeded that of *Evadne*. The other regions of high abundance of *Penilia* are in the Wadge Bank (Table 1) off Cape Comorin (07°10'N-77°10'E) as well as in the northeastern part (23°N- 67°E) of the Arabian Sea known for the high productivity as reported by Warren *et al.* (1966) and Rao *et al.* (1979). During August *Penilia* alone constituted the high concentration of cladocera in the 30 m depth zone around the Wadge Bank when the temperature was as low as 23.5°C but the salinity  $34.58 \times 10^{-3}$  and oxygen values 4.5 ml/l recorded were higher. On the other hand, in the region off Karwar in the 40 m depth zone the density of *Penilia* (25989) and *Evadne* (47813) was higher in September. While in the northeastern part of the Arabian Sea in the 50 m depth zone the concentration of *Penilia* (2244) observed during October was moderate. These observations concur with the views of Pillai & Pillai (1975) and Mukundan (1971) that the abundance and disappearance of cladocera are abrupt and there is a south to north movement in their occurrence along the west coast of India between July and December.

The distribution of *Evadne* was such that 75% occurred in the 50- 100 m depth zone though the sampling depth varied from 27 m to 4060 m while 86% of *Penilia* was present in the region up to a depth of 50 m and beyond that it occurred in isolated pockets (Fig.1). More than 85% of *Penilia* occurred in the second region between 09°01'N and 11°00'N lat. (Fig.2) while dense populations of *Evadne* were observed between 13°01'N-15°00'N lat. near the coast where upwelling was reported by Panikkar & Jayaraman (1966) during the southwest and early postmonsoon seasons. The increase in the population of cladocera following upwelling has been reported by others (Naomi *et al.* 1989; Longhurst and Bainbridge, 1964). It was observed that the concentration of *Penilia* was higher in the monsoon season contributing to 99.7% of the total. The abundance of *Evadne* constituting 83% also occurred in the monsoon

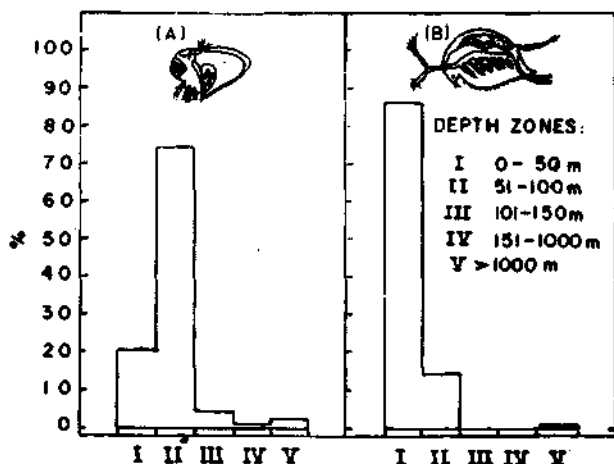

Fig.1 — Variation in the abundance of *Evadne* (A) and *Penilia* (B) in different depth zones

Table 1 — Hydrographic parameters of some selected stations along with the cladoceran abundance in the eastern Arabian Sea

Date	Time (hrs)	Position		Depth (m)	No./1000 m <sup>3</sup>		Temp. (°C)	Salinity (×10 <sup>-3</sup> )	Diss. oxy- gen (ml/l)	Depth of haul (m)
		Lat. °N	Long. °E		<i>Penilia</i>	<i>Evadne</i>				
26.6.86	1745	07°20'	77°26'	126	0	2,676	26.2	33.2	4.41	0
							-	33.2	4.28	10
							-	33.2	3.79	20
							-	32.5	3.57	30
27.6.86	0036	07°49'	77°06'	59	0	773	25.0	32.5	4.41	0
							-	32.2	4.28	10
							-	32.2	2.05	20
							-	31.8	1.07	30
27.6.86	1110	08°14'	77°08'	38	63	159	23.8	32.5	4.19	0
							-	32.2	1.96	10
							23.0	33.2	1.43	20
							-	32.5	1.33	30
2.7.86	0518	10°28'	75°55'	27	547	894	25.5	34.3	2.45	0
							23.8	34.6	0.86	10
							23.5	35.0	0.49	20

Contd.



Table 1 — *Contd....*

Date	Time (hrs)	Position		Depth (m)	No./1000 m <sup>3</sup>		Temp. (°C)	Salinity (×10 <sup>-3</sup> )	Diss. oxy- gen (ml/l)	Depth of haul (m)
		Lat. °N	Long. °E		<i>Penilia</i>	<i>Evadne</i>				
2.7.86	0846	10°00'	76°04'	28	0	318	27.0	35.0	3.66	0
							24.0	33.2	1.02	10
19.8.86	1822	10°00'	76°00'	34	7,24,545	8,182	24.6	26.1	2.47	0
							-	26.2	1.72	10
							-	26.3	1.00	20
							-	26.2	1.25	30,
25.8.86	2124	07°55'	77°10'	55	89,460	0	23.5	34.6	4.5	0
							-	35.1	5.2	10
							-	34.7	4.7	20
							-	34.3	4.7	30
21.9.86	1930	16°52'	72°26'	90	0	282	27.0	34.3	4.0	0
							26.8	34.8	4.0	10
							26.6	35.1	3.8	20
							26.7	35.4	3.5	30

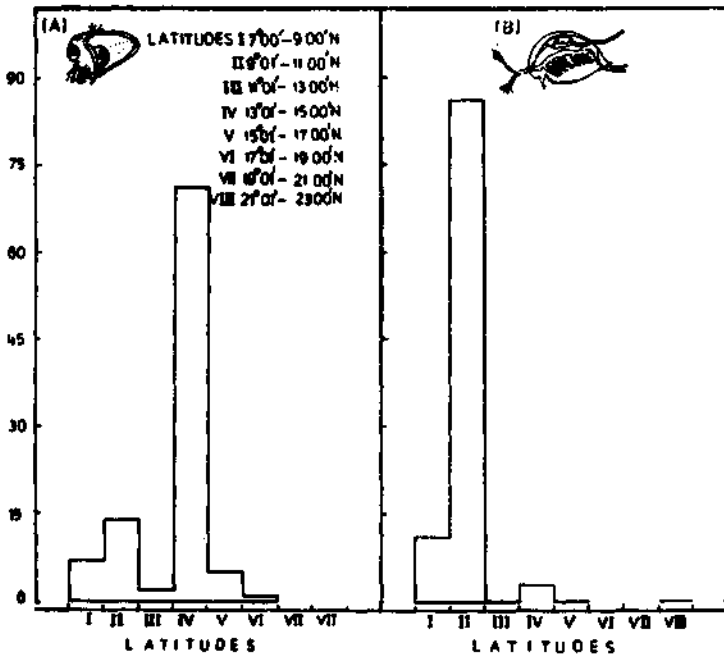

Fig.2 — Variation in the abundance of *Evadne* (A) and *Penilia* (B) in different latitudes

and the concentration observed per month was found to be highest in September followed by August. The density of one species was more than the other in the coastal waters off Cochin during August and Karwar during September as reported earlier by Naomi (1986) and Rajagopalan *et al.* (1992).

The study of seasonal variations in the density of cladocerans in the day and night time collections revealed the occurrence of *Penilia* limited to the collections made during nighttime in the monsoon season (99.7%) with only a few specimens occurring in the day time samples. However, they were present comparatively in large numbers during the postmonsoon season in the day collections. Figure 3 shows greater concentration of *Evadne* in the night collections made during the premonsoon and monsoon seasons when compared to those of day collections. However, *Evadne* was more or less equal during day and night in the postmonsoon season. The depth of the stations except in one (1402 m) from where the cladocerans obtained varied from 27 to 92 m indicating that these organisms remained in the column during night. Onbe (1977) suggests that cladocerans are known to perform reverse diurnal migrations and according to Mullin & Onbe (1992) diurnal vertical migrations are not undertaken by *Penilia* but *Evadne* migrates to deeper waters at night in the Inland sea of Japan.

The length frequency studies (Fig.4) revealed that the gross length (GL) of the parthenogenetic females of *Evadne* ranged from 375 to 1175  $\mu\text{m}$  and the standard

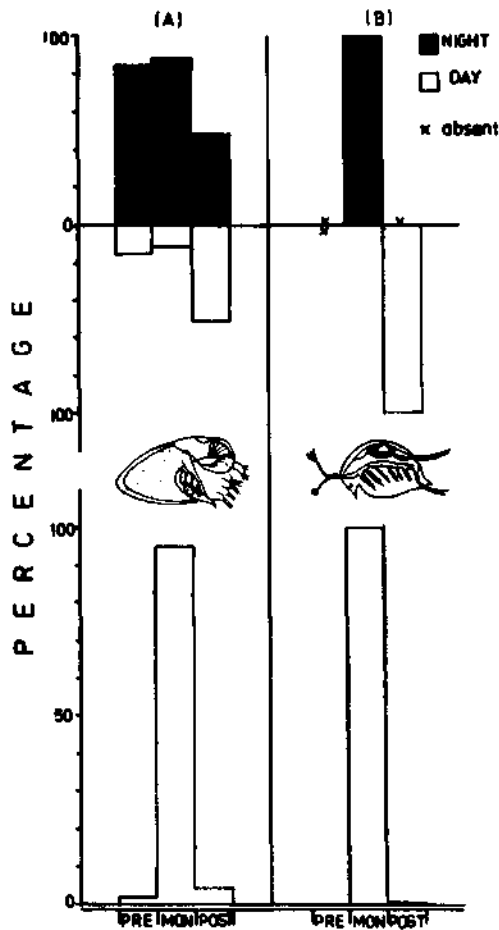

Fig.3 — Seasonal variation of *Evadne* (A) and *Penilia* (B) during day and night

length (SL) from 275 to 700  $\mu\text{m}$ . Females of *Evadne* of size class 375-400  $\mu\text{m}$  were without embryos except in one specimen carrying four embryos and the SL of this particular individual was the lowest (275) observed among the 586 females examined. *Evadne* of the size class 801-900  $\mu\text{m}$  GL and those of 501 to 550  $\mu\text{m}$  SL dominated the collections. There was positive correlation ( $r=0.912$ ) between the gross length and standard length of these organisms and it was higher ( $r=0.915$ ) in the night samples (Table 2).

The GL of *Penilia* varied from 400 to 900  $\mu\text{m}$  and the females of 701 to 750  $\mu\text{m}$  GL constituted the dominant size class in the collections. The variations in the size composition of the individuals collected during day and nighttime samples were more pronounced in both the species. While bigger parthenogenetic females of *Evadne* of

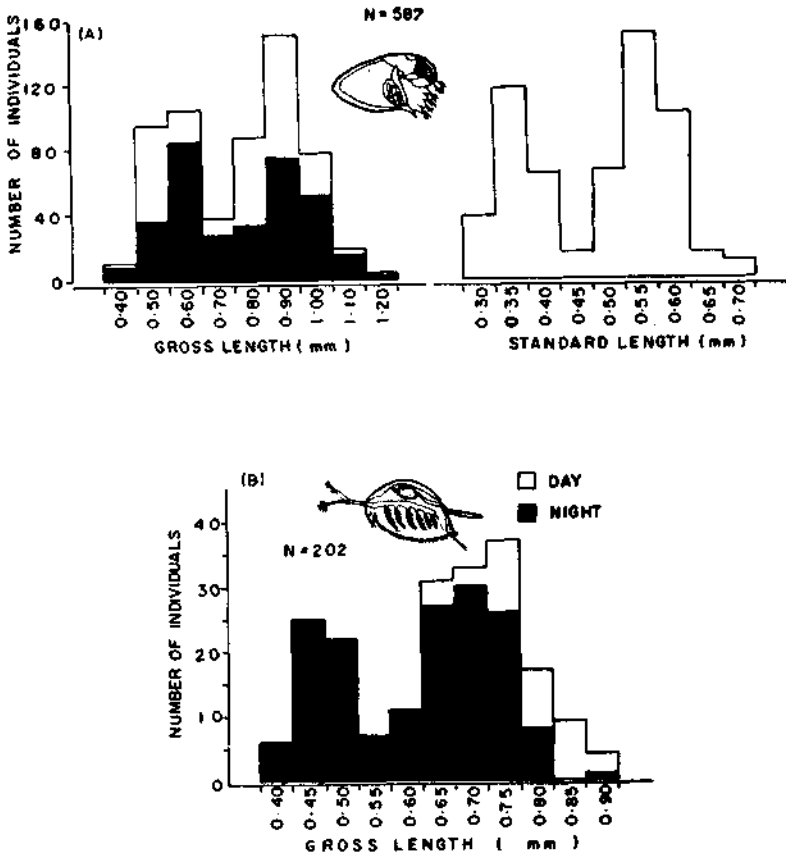

Fig.4 — Length frequency distribution of *Evadne* (A) and *Penilia* (B)

900  $\mu\text{m}$  and more in GL dominated the night collections, smaller females of 400-600  $\mu\text{m}$  GL constituted the night samples in the case of *Penilia*. Larger females of *Penilia* of size 800-900  $\mu\text{m}$  GL were observed in the day collections (Fig.4). In the night samples *Evadne* of size 776-1175  $\mu\text{m}$  GL carried 1-12 embryos of 150-600  $\mu\text{m}$  GL in their brood pouches and the individuals containing advanced embryos with well developed eyes were found only in the night collections. However, *Evadne* of the day collections of 750-775  $\mu\text{m}$  in size were found to have the same number of embryos but smaller in the size range of 73-325  $\mu\text{m}$  GL. There was no significant correlation between the size of the parent and the number of embryos per batch.

The difference recorded in the length of embryos contained in the brood pouches of *Evadne* was well marked with early stage (75-275  $\mu\text{m}$  GL), advanced (175-600  $\mu\text{m}$  GL) and paedogenetic (225-425  $\mu\text{m}$  GL). There was no clear demarcation in the growth and development of these three different embryos of *Evadne* in the brood

Table 2 — *Evadne tergestina* Claus: Relationship between mean GL, SL, embryo number and embryo length [\* Day and night. (n: 586); \*\* Night. (n: 333)]

Sl no	Mean of the measurement ( $\mu\text{m}$ )	Students' t value	Probability	Correlation
1.	* GL: 735.39 * SL: 471.04	53.620	0.000	0.912
2.	* GL: 735.39 * Emb. leng.121.64	17.070	0.000	0.577
3.	* SL: 471.04 * Emb. leng.121.64	12.438	0.000	0.457
4.	** GL: 733.18 ** SL: 458.63	41.156	0.000	0.915
5.	** GL: 733.18 ** Emb. leng.140.32	13.304	0.000	0.590
6.	** SL: 458.63 ** Emb. leng.140.32	10.509	0.000	0.500

pouches. The size of the smallest individual in the plankton was 375  $\mu\text{m}$  GL. Positive correlation was observed between the mean embryo length and GL ( $r=0.577$ ) and SL (0.457) for the total number of individuals ( $n=587$ ) and the same recorded exclusively for the night samples ( $n=333$ ) was higher for GL ( $r=0.590$ ) and SL ( $r=0.500$ ) as shown in Table 2. This indicates the predominance of advanced stages at night when the developing embryos cause increase in GL and expansion of the brood pouch while the increase in SL is marginal. According to Mullin & Onbe (1992), the broods mature at night and the young ones are released towards dawn and the nocturnal maturation and release of broods reduce visual predation of gravid females of *Evadne*.

Whereas, the parthenogenetic females of *Penilia* of 578-800  $\mu\text{m}$  GL in size present in the night samples were having 1-10 well developed embryos of 250-325  $\mu\text{m}$  GL in their brood pouches and still larger females of 625-875  $\mu\text{m}$  GL occurring in the day collections were with 1-9 embryos of 125-250  $\mu\text{m}$  GL. Prevalence of smaller individuals and the presence of well developed embryos in the night samples suggested brood maturation of *Penilia* in the night. Mullin & Onbe (1992) concluded that *Penilia* could contain mature embryos at anytime but more likely at night.

Seasonal fluctuations in the different size groups of both the species and their fecundity (Fig.5) showed that *Evadne* of 501 to 550  $\mu\text{m}$  SL increased during the premonsoon and monsoon seasons and their fecundity was maximum in the monsoon months. Almost all the size groups of *Penilia* occurred in moderate abundance during

the monsoon months. Larger *Evadne* (551-600  $\mu\text{m}$  SL) and *Penilia* (750-850  $\mu\text{m}$  GL) were preponderant in the postmonsoon period and their percentage frequency of fecundity recorded highest values during the period. Maximum number of eggs or embryos up to 12 per brood was registered during July-September and October in *Evadne* and up to 10 per brood in *Penilia* in August. Gamogenetic *Evadne* encountered were two in October and three in November. The only one gamogenetic *Penilia* observed was in August. At no time the male of either species was observed in the collections. Paedogenesis in *Evadne* was encountered in February and June. Della Croce & Venugopal (1972) reported a maximum of 6 embryos per brood in *Penilia* and 7-10 embryos in *Evadne* from the Indian Ocean. However, remarkable variations occur in the reproductive potential of parthenogenetic females of the different regions (Raymont, 1983) and in the same region from time to time to maintain or accelerate the rapid production of parthenogenetic populations.

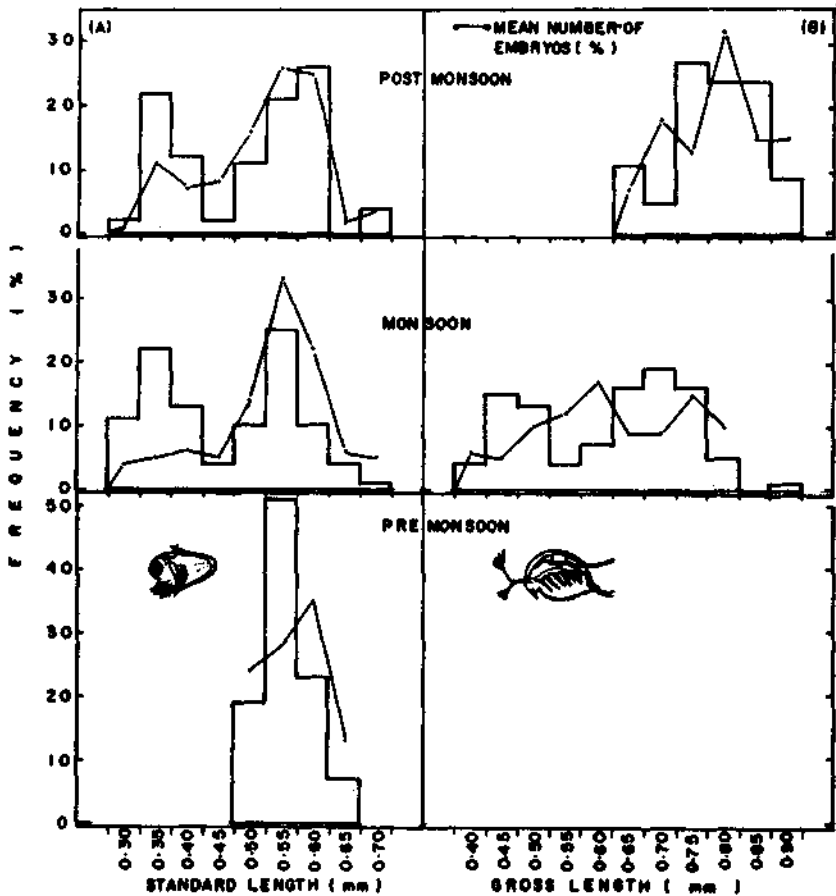

Fig.5 — Mean fecundity and size frequency distribution of *Evadne* (A) and *Penilia* (B) in different seasons

It was observed that there was variation in the occurrence of the frequency of the different size groups of both *Evadne* and *Penilia* in the different latitudinal sectors (Figs.6,7). *Evadne* of 350- 400  $\mu$ m SL dominated in the southern sectors (09°01'N-15°00'N lat.) while still bigger individuals of 551-600  $\mu$ m SL in the northern sectors (15°01'N-19°00'N lat.). Though the frequency percentage of fecundity was higher in the size class 501-550  $\mu$ m SL in the southern region (07°00'N-13°00'N lat.) the highest (39%) was observed in the size group 551-600  $\mu$ m SL in the northern region (13°00'N-19°00'N lat.). Larger *Evadne* of 651-700  $\mu$ m SL were confined to the northernmost region (17°01'N- 19°00'N lat.) as shown in Fig.6. A distinct increase in the abundance of the size groups of *Penilia* from south to north was indicated with the exception of the region 13°01'N-15°00'N lat. where moderate fecundity was observed

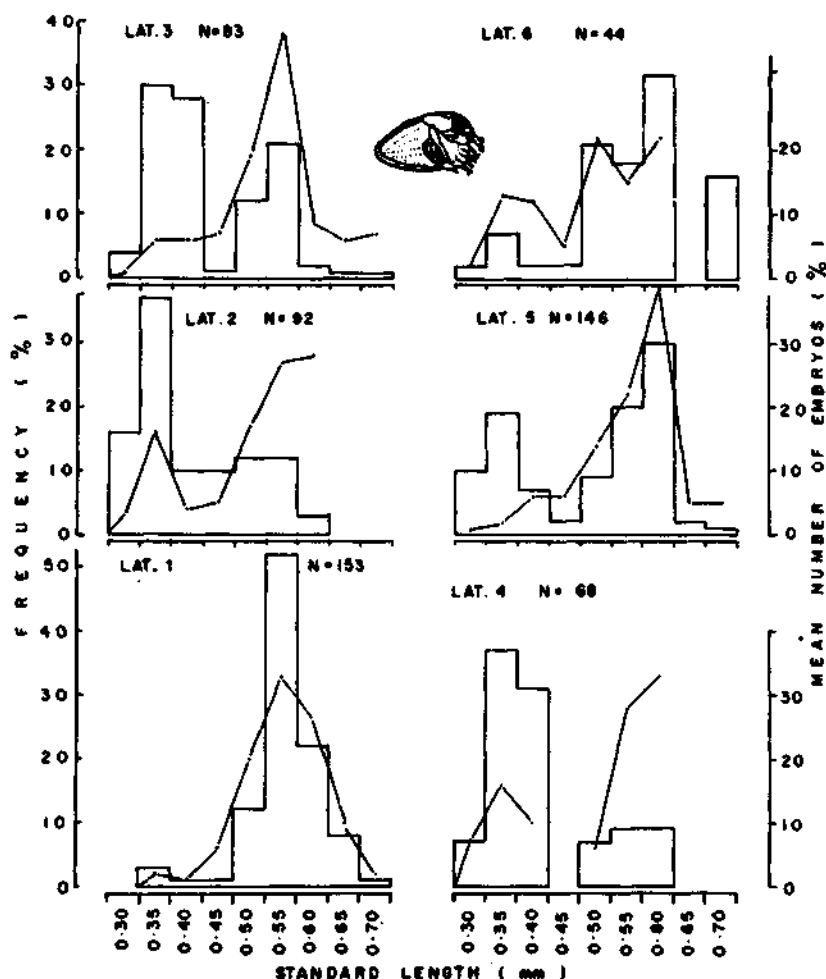

Fig.6 — Mean fecundity and size frequency distribution of *Evadne* in different latitudes

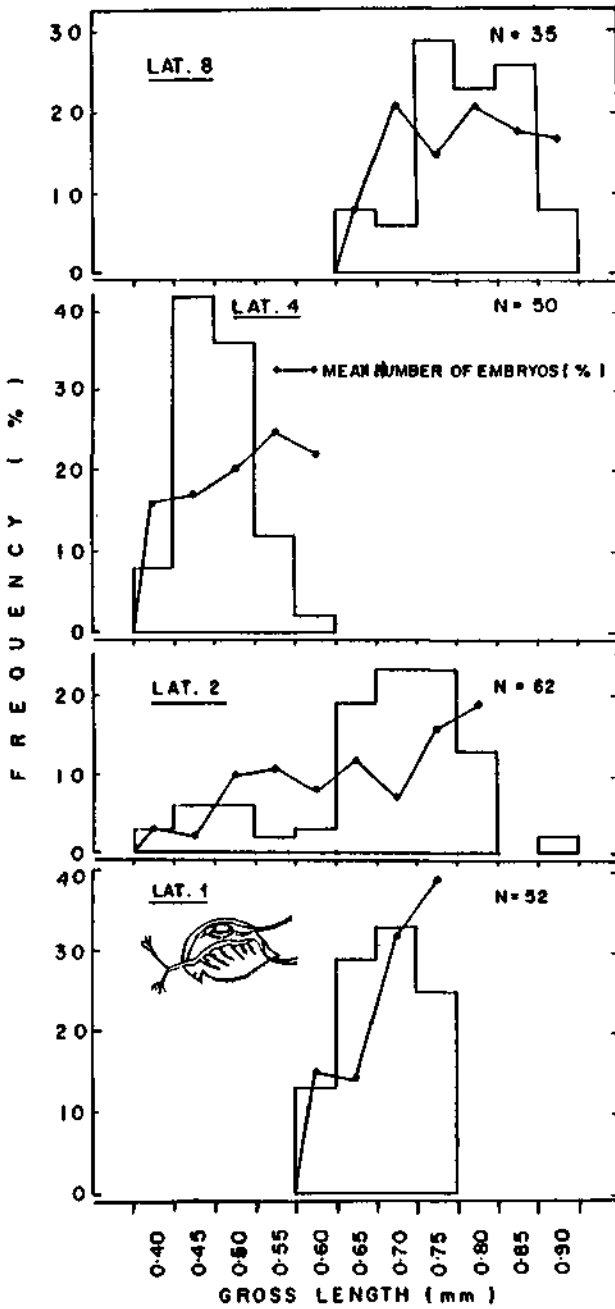

Fig.7 — Mean fecundity and size frequency distribution of *Penilia* in different latitudes



in the size class 501-550  $\mu\text{m}$  GL. Fecundity was usually high in the larger sized *Penilia* of 701-800  $\mu\text{m}$  GL and the maximum was encountered in the southernmost region between 07°00'N- 09°00'N lat. Similar observations on the geographic variations of size and fecundity of *Podon schmackeri* in the northwestern Pacific were reported by Kim & Onbe (1989).

### ACKNOWLEDGEMENT

The authors are grateful to Dr. P.S.B.R.James, former Director and Dr. P.V.Rao, Director for their encouragement and guidance. They are extremely thankful to Mr.K. Balan, for the facilities to analyse the data. They are indebted to Mr. R. Anilkumar for the timely help.

### REFERENCES

- Della Croce, N. 1965. Observations on the marine cladoceran *Penilia avirostris* in the northwestern Atlantic waters, *Technical papers of the Bureau of Sport Fisheries and Wildlife, United States Department of the Interior Fish and Wildlife Service*. pp 13.
- Della Croce, N. & Venugopal, P. 1972. Distribution of marine cladocerans in the Indian Ocean, *Mar.Biol.* 15(2): 132-136.
- Johannessen, O.M., Subbaraju, G. & Blindheim, J. 1981. Seasonal variations of the oceanographic conditions off the southwest coast of India during 1971-1975, *Fisk.Dir.Skr.Ser.Hav Unders.* 18: 247-261.
- Kim, S.W. & Onbe, T. 1989. Distribution and zoogeography of the marine cladoceran *Podon schmackeri* in the northwestern Pacific, *Mar.Biol.* 102: 203-210.
- Longhurst, A.R. & Bainbridge, V. 1964. *Bull.Inst.Fr.Afr.Moires. Ser.A* 26: (2): 337-402.
- Mullin, M. M. & Onbe, T. 1992. Diel reproduction and vertical distributions of the marine cladocerans, *Evadne tergestina* and *Penilia avirostris* in contrasting coastal environments, *J.Plankton Res.* 14 (1): 41-59.
- Mukundan, C. 1971. Plankton of the Calicut inshore waters and its relationship with coastal pelagic fisheries, *Indian J.Fish.* 14: 271-292.
- Naomi, T.S. 1986. On the zooplankton of the inshore waters of Karwar during 1980-81, *Indian J.Fish.* 33(3): 336-346.
- Naomi, T.S., Antony, G & Mathew, K.J. 1990. Studies on the distribution of cladocera in the eastern Arabian Sea and the Bay of Bengal, In: *Proc. First Workshop Scient.Resul. FORV Sagar Sampada*, edited by K.J. Mathew, (CMFRI, Cochin) 85-93.
- Onbe, T. 1977. The biology of marine cladocerans in a warm temperate water, In: *Proceedings of the Symp.on Warm Water Zooplankton*, (NIO/UNESCO), 383-393.
- Panikkar, N.K. & Jayaraman, R. 1966. Biological and oceanographic differences between the Arabian Sea and the Bay of Bengal as observed from the Indian region, *Proc.Indian Acad.Sci.* 64 B 5: 231-240.
- Pillai, P.P. & Pillai, M.A. 1975. Ecology of the cladocerans of the plankton community in the Cochin backwater, *Bull.Dept.Mar.Sci.Univ.Cochin.* 7(1): 127-136.
- Rajagopalan, M.S., Thomas, P.A., Mathew, K.J., Daniel, Selvaraj, G.S.D., George, R.A., Mathew, C.V., Naomi, T.S., Kaladharan, P., Balachandran, V.K. & Antony, G. 1992. Productivity of the Arabian Sea along the southwest coast of India, *Bull.Cent.Mar.Fish.Res.Inst.* 45: 9-37.

- Rao, D.S., Ramamirtham, C.P. & Kunhikrishnan, N.P. 1979. Hydrography of the waters along the Gujarat coast during the summer period of the year 1963, *J.Mar.Biol.Ass.India.* 21 (1&2): 133-142.
- Rao, D.S., Ramamirtham, C.P., Murthy, A.V.S., Muthusamy, S., Kunhikrishnan, N.P. & Khambadkar, L.R. 1992. Oceanography of the Arabian Sea with particular reference to the southwest monsoon. *Bull.Cent.Mar.Fish.Res.Inst.* 45: 4-8.
- Raymont, J.E.G. 1983. *Plankton and productivity in the oceans*, Vol.2 (Pergamon Press) pp. 819.
- Warren, B., Stommel, H. & Swallow, J.C. 1966. Water masses and patterns of flow in the Somali basin during the southwest monsoon of 1964. *Deep-Sea Res.* 13: 825-860.

\* \* \*

## Studies of planktonic ostracoda collected from Arabian Sea and Bay of Bengal

K.J. Mathew, M.Vijayan, M.S. Rajagopalan & P.P. Pavithran

Central Marine Fisheries Research Institute, P.B. No. 1603, Cochin - 682 014

### ABSTRACT

General distribution and numerical abundance of planktonic ostracods, as a whole, in the Exclusive Economic Zone of India and nearby seas based on 1086 collections (1985-'88) are discussed. The average density of ostracods in the area investigated was estimated to be 17395/1000 m<sup>3</sup>. The ostracods occurred far more abundantly in the shelf waters than in the oceanic areas. Samples collected indicated that 95% of the ostracod population occurred off the west coast of India round the year. They were found remarkably high (61168/1000 m<sup>3</sup>, 63.3%) between 10°N and 15°N off the west coast, while their abundance between 10°N and 15°N off the east coast of India was the lowest (624/1000 m<sup>3</sup>, 0.65%). The abundance of ostracods was always associated with monsoon when the maximum of 31920/1000 m<sup>3</sup> was obtained and this was mainly due to the swarming nature of these organisms. The minimum was observed during the premonsoon period when an average of 1508/1000 m<sup>3</sup> ostracods occurred. Comparison of ostracod distribution in the EEZ of India between day and night yielded values of 30.95 and 69.05% respectively, which showed that they are more abundant during night, thereby illustrating pronounced diurnal vertical migration.

### INTRODUCTION

Planktonic ostracods contribute significantly to the biomass of marine zooplankton especially of tropical and subtropical oceans. Deevey (1968) found that off Bermuda, they ranked third in abundance after copepods and tunicates with numbers ranging to a maximum of 36/m<sup>3</sup> to 11-15/m<sup>3</sup>, apart from protozoa. In IIOE collections also, ostracods formed a major portion of the zooplankton with maximum occurrence of 12500 specimens per haul (Nair *et. el.*, 1973). Probably the first study on planktonic ostracods from Indian Ocean was based on the *Valdivia* expedition material (Müller, 1906). Later Cannon (1940) gave a list of planktonic ostracods collected during *John Murray* expedition. *Dana* expedition materials were studied by Poulsen (1962, 1965, 1969).

However, until recently a little effort was made to study the ostracods for their quantitative distribution over space and time. It was during the IIOE that such a study was attempted for ostracods in general and for some of the major species. These included the works of George *et. al.* (1975), George & Nair (1980), Nair & Madhupratap (1984). The present study concerns mainly with the general distribution and abundance of planktonic ostracods in the EEZ and contiguous seas of India based on the *FORV Sagar Sampada* collections.

## MATERIALS AND METHODS

The material which formed the basis of the study was collected onboard *FORV Sagar Sampada* from the Indian EEZ and contiguous seas (Fig.1) during the period 1985-'88. The gear used was Bongo-60 net of mesh size of 0.33 mm. Hauls were made from 150 m to surface in oblique manner with the ship in motion at 2 knots speed. A precalibrated flow meter was used in most cases. The plankton was preserved in 5% formaldehyde solution. In the laboratory the total volume was determined by displacement method. After removing the macroplankton, a minimum of 5 ml of zooplankton was sorted out into different groups and enumerated. The biomass as well as individual groups were estimated for 1000 m<sup>3</sup> of water.

For the purpose of comparisons, the study area was divided into four latitudinal regions namely, region-1: 04°30'N to 10°N; region-2: 10°N to 15°N; region-3: 15°N to 20°N and region-4: 20°N to 23°N. The area west of 77°30'E was considered as eastern Arabian Sea and that east of it as Bay of Bengal. The shelf area mentioned in the paper is the area within the continental shelf and that beyond it is called as oceanic area. The three seasons recognized in the paper are premonsoon (February to May), monsoon (June to September) and postmonsoon (October to January). The samples collected between 0600 and 1800 hrs have been considered as day samples and those collected between 1800 and 0600 hrs as night samples. A total of 1086 zooplankton samples collected during cruises 1-44 have been analysed for the present study.

## RESULTS

### Quantitative abundance

The general observations made on the occurrence and abundance of the ostracods showed that numerically, they formed one of the major components of the zooplankton. Their average numerical density (no/1000 m<sup>3</sup>) in the EEZ and the contiguous seas which are under the present investigation has been 17395. While the average density for the eastern Arabian Sea alone was 24144, the average for the Bay of Bengal was 1369 which were equal to 95.36% and 4.64% respectively. When a comparison for the numerical abundance was made between the continental shelf and oceanic waters of the two sea areas separately it was found that though there was vast difference in number of ostracods between the two sea areas, the percentage of abundance in the shelf and oceanic waters was proportionately equal, being around 7:3.

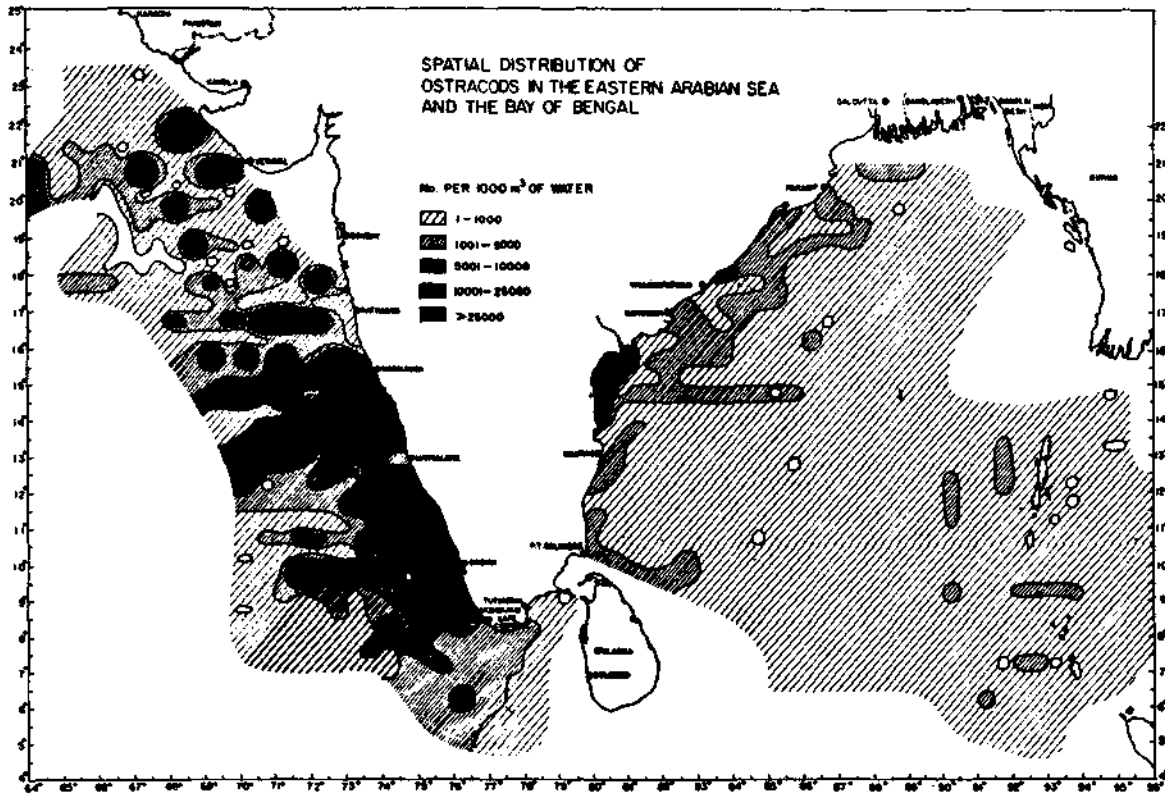

Fig.1- Spatial distribution of pelagic ostracods in the EEZ and contiguous seas of India

### **Spatial distribution**

Considerable variations in the distribution and abundance of ostracods were seen spatially. Figure 1 illustrates the pattern of distribution in the eastern Arabian Sea and the Bay of Bengal. Although ostracods tended to be patchy in distribution in both the sea areas, they were in high densities along the southwest coast of India especially within the shelf area. Such high densities were noticed between Trivandrum and Quilon, Alleppey and Kasaragod and between north of Malpe and Goa. Other areas were not so rich except for small isolated areas off Ratnagiri, Tharapur, Veralval and Dwaraka.

Bay of Bengal was found to be less favourable for the development of ostracod population when compared to the eastern Arabian Sea. With a few exceptions, the abundance was very low and of uniform nature. Moderately high density in the shelf area especially off Krishnapattinam, Machilipatnam and off Kalingapatnam was noticed. The ostracod representation was found to be poor in the Andaman Sea.

### **Distribution in the shelf and oceanic areas**

The ostracods were fairly very abundant in the shelf waters where the occurrence was 35526 which accounted for 79% of the total, whereas the occurrence in the oceanic area was 9446 only, the percentage equivalent of it being 21. Thus in general, a more than three-fold increase was seen in the shelf, which signifies the neritic nature of the ostracods.

There was vast difference in the rate of ostracod abundance in the shelf and oceanic areas of the west and the east coasts. When the shelf waters of the west coast contained ostracods 53059 similar area of the east coast had a population density of 2611 and indicating a 20 times increase for the west coast. Similarly a 17 times increase in the population density was experienced in the oceanic waters of the west coast in comparison to that of the same area in the east coast. The numerical density in the oceanic waters of the west coast was 15749 and for the east coast 924.

### **Monthly and seasonal variations in numerical abundance**

The monthly variations in ostracod abundance worked out for the entire area of investigation (Arabian Sea and Bay of Bengal together) showed that September, with an average number of 61639/1000 m<sup>3</sup> of water, accounted for the maximum. Generally speaking the period from June to December yielded the maximum when the number ranged from more than 10000 to around 62000 (Fig.2). The abundance between January and March was rather moderate with the population swinging between 2000 and 3000 individuals.

A monthwise projection of the data obtained separately for the eastern Arabian Sea and the Bay of Bengal is presented in Fig.3. Highest abundance was during September for both the seas, though there was no comparability in density of ostracods between the two (74254 in the Arabian Sea and 6486 in the Bay of Bengal). In general the months of June to December were the best for the ostracods of the eastern Arabian

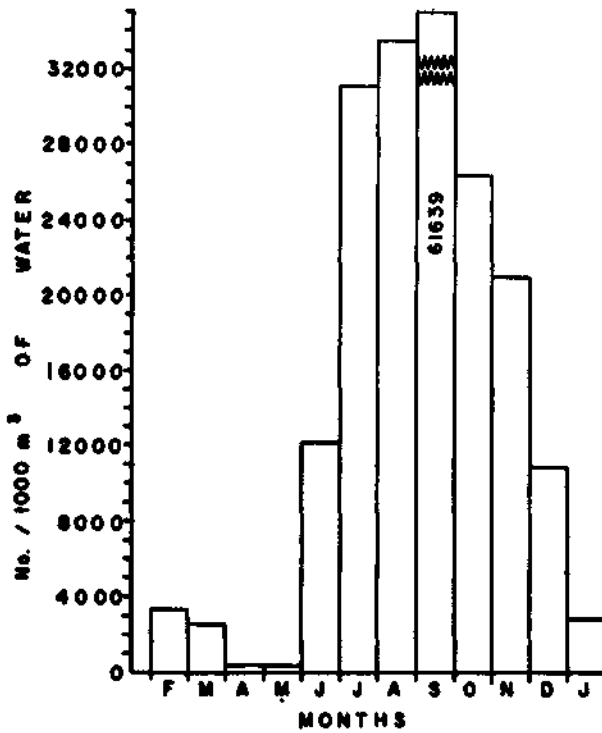

Fig.2 - Monthly variations in the abundance of pelagic ostracods

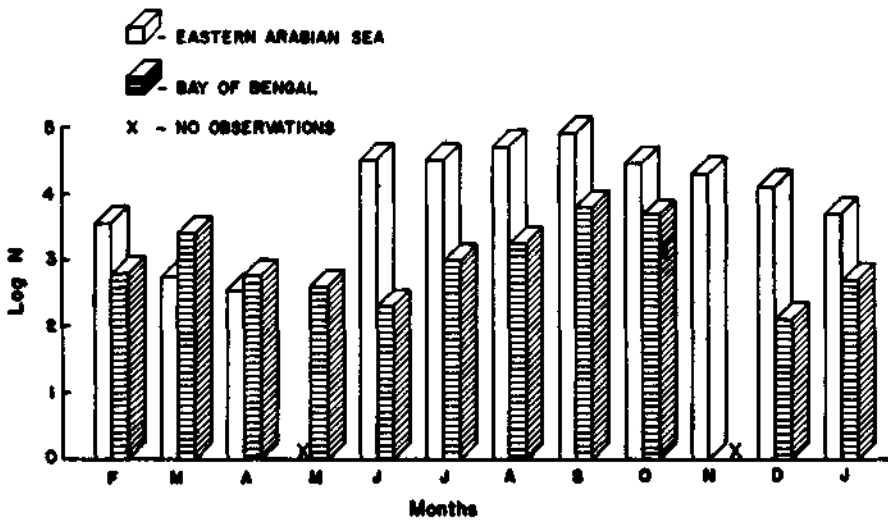

Fig.3 - Monthly coastwise variations in the abundance of pelagic ostracods

Sea whereas March, September and October were the favourable months in the Bay of Bengal. The least abundance off the west coast was during March and April (577 and 345 respectively) while it was during June and December in the Bay of Bengal.

When the 12 months were categorised into 3 seasons it was possible to get the seasonal variations in ostracod abundance. Of all the 3 seasons, the monsoon season with an average number of 33801/1000 m<sup>3</sup> ostracods (68.14%) peaked followed by the postmonsoon season with an average of 14320 (28.87%). The least abundance was registered during the premonsoon when only 1482 (2.99%) ostracods were present. The monsoon abundance of ostracods in the Arabian Sea was phenomenal, the mean number being 48466. Relatively this season was the most favourable of the 3 seasons for these planktonic animals, for 73.25% of the total of 3 seasons was represented in this season.

The trend of seasonal variation in the Bay of Bengal was the same as that in the Arabian Sea but for the drastic reduction in the average seasonal values. The highest, of course, was registered during the monsoon period but the number was a mere 2385 (148.50%). The postmonsoon accounted 1956 which was equal to 29.87% of the total. The premonsoon yielded 1059 ostracods which was 21.57% of the total of 3 seasons. On the whole the southwest monsoon period was the best season for ostracods in the Bay of Bengal also. The premonsoon average number for both the sea areas was almost equal though there was marked variations in the percentage of abundance.

In the shelf waters the ostracods in comparison to that of the oceanic waters (Fig.4) during the 3 seasons were 62.58% during the premonsoon, 72.4% during the monsoon and 79% during the postmonsoon. Similarly in the oceanic waters a proportionate decrease in relation to the shelf waters was noticed, the values being 37.42%, 27.6%

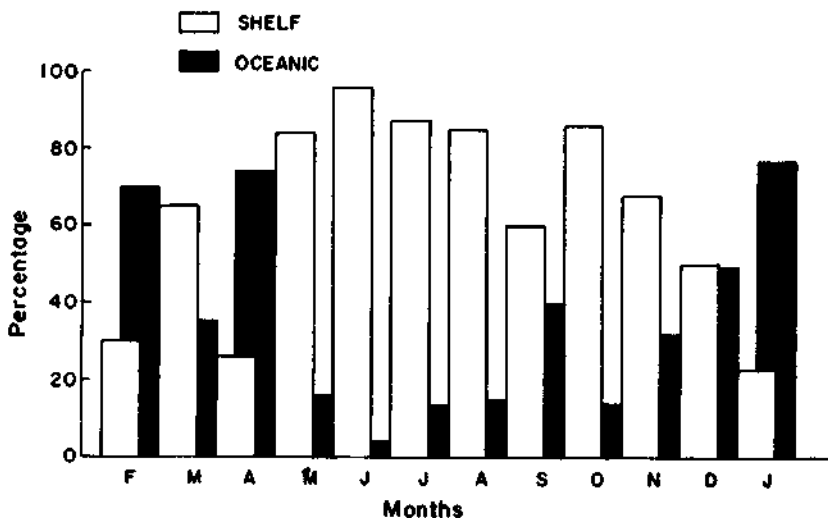

Fig.4 - Shelf and oceanic variations in the abundance of pelagic ostracods



and 21% during the respective seasons. The variations within the shelf during the 3 seasons were also worked out, the values being 2.68% during the premonsoon, 64.63% during the monsoon and 32.69% during the postmonsoon periods. In the oceanic area, the variations among the 3 respective seasons were of the magnitude of 4.48%, 68.78% and 26.75%.

### Latitudinal distribution

Along the west coast it was found that the region between  $10^{\circ}$  and  $15^{\circ}$ N (Fig.5) was the most productive for the ostracods which had a population density of  $61168/1000\text{ m}^3$  and this was 67% of the total ostracods present in the 4 latitudinal regions. The density of population in the other 3 regions was around 1000 with the minimum in region-1. Along the east coast the latitudinal region between  $15^{\circ}$  and  $20^{\circ}$ N with a population density of  $2449/1000\text{ m}^3$  was the richest and this was equal to 46.13% of the total. The least abundance of 624 was in the second region.

A comparison between the two sea areas showed that the richest latitudinal region in the entire area was between  $10^{\circ}$  and  $15^{\circ}$ N in the Arabian Sea which accounted for 63.38% of the total population and that all the latitudinal regions of the Arabian Sea put together claimed 94.48% against the 5.02% in the Bay of Bengal.

### Coastwise and regionwise seasonal distribution

To examine which of the 3 seasons contributed the maximum ostracods in the respective sea areas, the ostracod populations in each latitudinal region was further divided into 3 seasons. The results (Fig.6) showed that it was the southwest monsoon

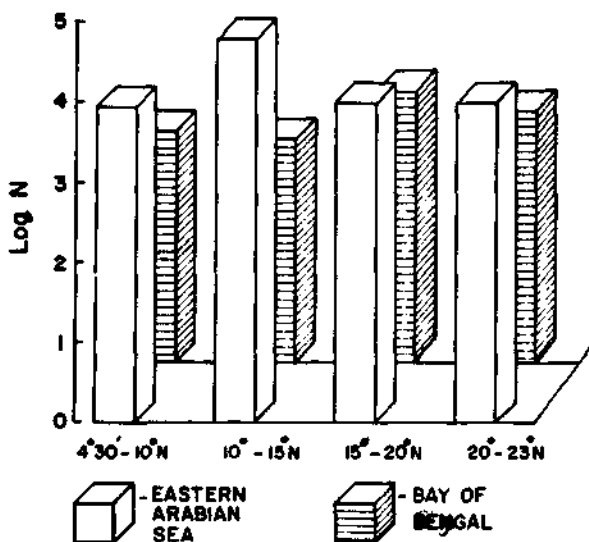

Fig.5 - Coastwise latitudinal variations in the abundance of pelagic ostracods

period which maximised the population density in all the latitudinal regions in both the sea areas except the region between 20° and 23°N. The density in the latitudinal region between 10° and 15°N during the monsoon season was 111564/1000 m<sup>3</sup> which was the maximum of all the regions. On the other hand the monsoon maximum in the latitudinal region between 15° and 20°N in the Bay of Bengal was of the order of 7252/1000 m<sup>3</sup>.

An attempt was also made to understand the exact month in which a particular latitudinal sector contained the maximum number of ostracods. Thus it was found that

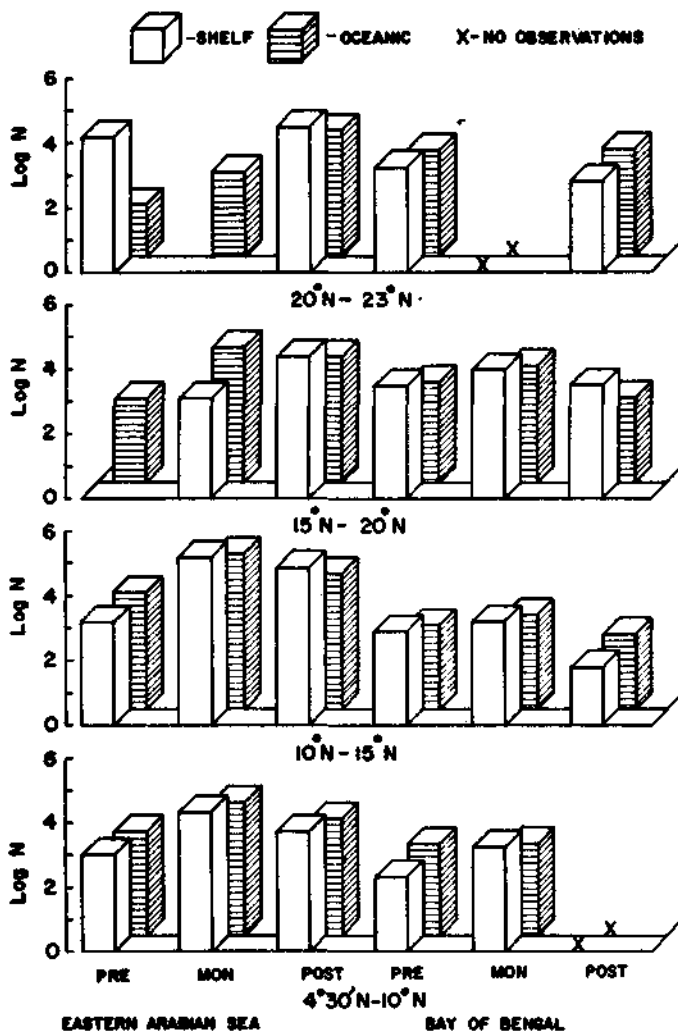

Fig.6 - Coastwise, latitudinal, seasonwise variations of pelagic ostracods in the shelf and oceanic waters

the month of September which is considered here as part of the southwest monsoon season (to say exactly the last month of this season) produced the maximum number, in the 2nd latitudinal region of the eastern Arabian Sea and the occurrence was 217739/1000 m<sup>3</sup>.

### Day-night abundance

In view of the large number of samples during both day (654 samples) and night (427 samples) a comparison between the two for the ostracod abundance became possible for the entire area of investigation and in different situations. While 69.05% of the total ostracods collected was taken during night, the day samples took a share of only 30.95% thereby showing more than double the number of ostracods in the night samples. The result shows that the ostracods exhibit strong diurnal vertical migration in this tropical waters.

A further study of the day-night variations during the different months was carried out (Fig.7). In all the months except August, there was a nighttime abundance. In August 51% of ostracods were present in a day samples maximum nighttime increase by 89.8% was observed during September.

Seasonwise analysis of the day-night variations showed that while 67.1% of ostracods was present in the night samples during the premonsoon, 74.2% was present in the night samples of the monsoon season. However, such a drastic difference between the day and night samples was not observed during the postmonsoon season when the nighttime increase was by 60.1% over the day samples. The trend of nighttime increase was more or less the same in the shelf and oceanic areas, the increase being around 70%. A seasonwise analysis of the day-night variations showed

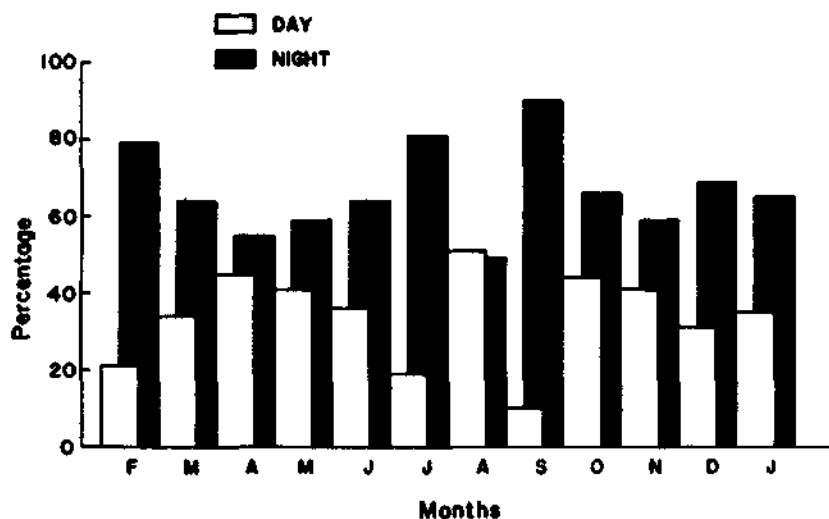

Fig.7 - Monthly day-night variations in the abundance of pelagic ostracods

a nighttime abundance by 67% over the day during the premonsoon season. During the monsoon season there was a 74% increase in the night samples. The night samples of the postmonsoon season contained only 60% of the total ostracods.

The diurnal variations in the 4 latitudinal regions were studied separately for the Arabian Sea and the Bay of Bengal. The most pronounced nighttime increase was noticed in the eastern Arabian Sea in the southernmost latitudinal region where 85% of ostracods was noticed during the night. In the 2nd latitudinal region between 10°-15°N, 65% of the ostracods was in the night samples. In the next northern latitude between 15°-20°N the nighttime increase was only by 57% and in the northernmost latitudes. The day samples contained more ostracods and the increase was by 59%.

Thus a gradual decrease of the nighttime abundance was noticed from south to north culminating in a daytime increase in the northernmost latitude. In the Bay of Bengal, on the other hand a daytime abundance was observed in the 1st, 2nd and the 3rd latitudinal regions. However, 78% of ostracods was present in the night samples in the northernmost latitudinal region.

## DISCUSSION

The striking feature noticed during the present study was the uniformly high density of ostracods in all the areas of the eastern Arabian Sea than in the Bay of Bengal. The Arabian Sea accounted for 95% of the total ostracods. This kind of high density in the Arabian Sea, though not to the extent of ostracods, has been established in varying degrees for the zooplankton biomass (Mathew *et al.* 1990a) and for some of the major groups of zooplankters namely mysids, euphausiids, heteropods, pteropods (Mathew *et al.* 1990b,c,d), foraminifers, cladocerans (Naomi *et al.* 1990a,b), chaetognaths (Srinivasan, 1990), amphipods (Revikala *et al.* 1990), lucifer and larval gastropods (Geetha *et al.* 1990a,b). The congenial environmental factors for a high primary production has been attributed to this part of the Arabian Sea. In this sea area, the southwest coast between lat. 10° and 15°N is the richest being influenced by upwelling which is a contributing factor for the very high production at all the levels of the food web.

The swarming nature of ostracods was revealed on many occasions during the present study. Unusually high abundance to the level of a population explosion was noticed especially during September and October at several localities mainly in the shelf waters off the west coast such as between Trivandrum and Quilon, Alleppey and Kasaragod and between north of Malpe and Goa. Such population explosions were not observed in the Bay of Bengal. Similar population explosion of ostracods has been reported by Nair *et al.* (1973) from several localities in the Arabian Sea namely Karachi, Gujarat and Kerala where the numerical density of population exceeded 62500/1000 m<sup>3</sup>. According to them the number in the Bay of Bengal never exceeded 2500/1000 m<sup>3</sup>.

A study of the day-night variations in abundance revealed a pronounced vertical migration with these animals, being more in the night samples with a few exceptions in certain localities. Angel & Fasham (1975) who studied the distribution of ostracods of the northeast Atlantic found a slight daytime increase for these plankters. The reason for this could be attributed to the large vertical coverage of the sampling depth which reached up to 2000 m and this might have nullified the effect of the vertical migration which was performed well within the sampling depth and hence a day-night difference was not discernible. However, Louis *et al.* (1976) found that only 67% of the samples collected during the day-night hours contained ostracods compared to 91% during the night and they concluded that the depths sampled recruited more ostracods from greater depths during the night. Nair *et al.* (1973) though observed a nighttime abundance of ostracods in the Indian Ocean in general, a day-night variation in occurrence was not established in the Arabian Sea. However, no mention is made of the number of samples available for the study of diurnal variations in those areas where diurnal variation was not observed.

The month of September contributed the maximum number of ostracods. A significant day-night variation in abundance was noticed, being more in the night samples which once again confirmed the strong vertical up and down movement in the 0-150 m depth zone. More studies are to be made by correlating the ostracod abundance with the hydrographic parameters which could not be made during the present studies for want of data.

### ACKNOWLEDGEMENT

Authors are thankful to Dr. P.S.B.R. James, former Director for his interest in this work. Thanks are also due to Dr.K.S. Scariah, for the help rendered in the analysis of the data.

### REFERENCES

- Angel, M.V. & Fasham, M.J.R. 1975. Analysis of the vertical and geographic distribution of the abundant species of planktonic ostracods in the northeast Atlantic *J. Mar. Biol. Ass. U.K.* 55: 709-737.
- Cannon, H.G. 1940. *Ostracoda. Scientific Report of the John Murray Expedition*, 6: 319-320.
- Deevey, G.B. 1968. Pelagic ostracods of the Sargasso Sea off Bermuda: Description of species, seasonal and vertical distribution *Peabody Museum of Natural History (Yale University)*, 26: pp.125.
- Geetha, A., Mathew, K.J. & Naomi, T.S. 1990 a. Studies on the distribution and abundance of the genus *Lucifer* collected during the cruises of FORV *Sagar Sampada* In: *Proceedings of the First Workshop on Scientific Results of FORV Sagar Sampada*, edited by K.J. Mathew, (CMFRI, Cochin) 129-136.
- Geetha, A., Naomi, T.S. & Mathew, K.J. 1990 b. Studies on the occurrence and abundance of planktonic gastropods other than pteropods and heteropods from the EEZ of India and adjoining seas In: *Proceedings of the First Workshop on Scientific Results of FORV Sagar Sampada*, edited by K.J. Mathew, (CMFRI, Cochin) 165- 178.

- George, J., Purushan, K.S. & Madhupratap, M. 1975. Distribution of planktonic ostracods along the southwest coast of India, *Indian J. Mar. Sci.* 4: 201-202.
- George, J. & Nair, V.R. 1980. Planktonic ostracods of the northern Indian Ocean. *Mahasagar - Bull. Natn. Inst. Oceanogr.* 13(1): 29-44.
- Louis, S.K., Wirsing, S & McManus, M. 1976. Biological studies of the Bermuda Ocean Acre: Planktonic Ostracoda. *Smithsonian Contributions to Zoology*, No. 223: pp.34.
- Mathew, K.J., Naomi, T.S., Geetha, A., Vincent, D., Anilkumar, R. & Solomon, K. 1990a. Studies on zooplankton biomass and secondary and tertiary production of the EEZ of India In: *Proceedings of the First Workshop on Scientific Results of FORV Sagar Sampada*, edited by K.J. Mathew, (CMFRI, Cochin) 59-70.
- Mathew, K.J., Geetha, A., Naomi, T.S. & Solomon, K. 1990 b. On the quantitative abundance of Mysidacea collected from the eastern Arabian Sea and the Bay of Bengal In: *Proceedings of the First Workshop on Scientific Results of FORV Sagar Sampada*, edited by K.J. Mathew, (CMFRI, Cochin) 109-114.
- Mathew, K.J., Naomi, T.S., Geetha, A & Scariah, K.S. 1990 c. Distribution of Euphausiacea in space and time in the Indian EEZ and contiguous seas In: *Proceedings of the First Workshop on Scientific Results of FORV Sagar Sampada*, edited by K.J. Mathew, (CMFRI, Cochin) 121-128.
- Mathew, K.J., Naomi, T.S., Geetha, A & Solomon, K. 1990 d. Distribution and abundance of pteropod and heteropod molluscs in the EEZ and adjoining waters of India In: *Proceedings of the First Workshop on Scientific Results of FORV Sagar Sampada*, edited by K.J. Mathew (CMFRI, Cochin), 155-164.
- Müller, G.W. 1906. Ostracoda, *Wissenschaftliche Ergebnisse Deutschen Tiefsee Expedition auf dem Dampfer Valdivia*, 8:29-154.
- Nair, K.K.C., George, J. & Rao, T.S.S. 1973. Distribution of certain planktonic crustaceans and insect halobates in the Indian Ocean *Indian J. Mar. Sci.* 2: 116-121.
- Nair, R.V. & Madhupratap, M. 1984. Latitudinal range of epiplanktonic Chaetognatha and Ostracoda in the western tropical Indian Ocean, *Hydrobiologia*, 112: 209-216.
- Naomi, T.S., Mathew, K.J. & Geetha, A. 1990a. Studies on the distribution of recent planktonic Foraminifera in the Arabian Sea and Bay of Bengal In: *Proceedings of the First Workshop on Scientific Results of FORV Sagar Sampada*, edited by K.J. Mathew (CMFRI, Cochin) 71-80.
- Naomi, T.S., Geetha, A. & Mathew, K.J. 1990b. Studies on the distribution of Cladocera in the eastern Arabian Sea and the Bay of Bengal In: *Proceedings of the First Workshop on Scientific Results of FORV Sagar Sampada*, edited by K.J. Mathew, (CMFRI, Cochin) 85-94.
- Poulsen, E.M. 1962. Ostracoda - Myodocopa. Part I. Cypridiniformes - Cypridinidae *Dana Report*, 57: 1-414.
- Poulsen, E.M. 1965. Ostracoda - Myodocopa. Part II. Cypridiniformes - Rutidermatidae, Sarriellidae and Asteropidae *Dana Report*, 65: 1-484.
- Poulsen, E.M. 1969. Ostracoda - Myodocopa. Part IIIA. Halocypriformes - Thanmatocypridae and Halocypridae *Dana Report*, 84:1-224.
- Revikala, S., Mathew, K.J. & Scariah, K.S. 1990. Preliminary studies on planktonic amphipods collected by FORV Sagar Sampada In: *Proceedings of the First Workshop on Scientific Results of FORV Sagar Sampada*, edited by K.J. Mathew, (CMFRI, Cochin) 115- 120.
- Srinivasan, M. 1990. Studies on the quantitative distribution of Chaetognatha in the Indian Seas collected during the cruises 1-44 of FORV Sagar Sampada In: *Proceedings of the First Workshop on Scientific Results of FORV Sagar Sampada*, edited by K.J. Mathew, (CMFRI, Cochin) 81-84.

## **Distribution and abundance of zooplankton in the northern Arabian Sea with reference to oil spill in the Gulf waters**

K.J. Mathew & K. Solomon

Central Marine Fisheries Research Institute, P.B. No.1603, Cochin - 682 014

### **ABSTRACT**

Zooplankton of the northern Arabian Sea between lat. 16° and 23°N and long. 62° and 73°E was studied in March, 1991 for understanding the impact on zooplankton, of the large scale oil slick occurred in the Gulf waters during the Gulf War in January-February, 1991. On the whole the zooplankton biomass was very rich in the area and there was no evidence to show that the zooplankton community, up to a depth of 200 m was adversely affected by the oil slick. On the other hand serious depletion in the populations of zooplankton was noticed in the Bombay High area (stn.2241) where the oil drilling operations are on and tar balls of different sizes were collected in the plankton net operated at these stations. An increase from west to east was noticed in general with regard to several groups of zooplankton. However, the total biomass showed an increase from east to west. This increase was mainly due to the populations of large sized salps, west of long 68°E which also excluded other plankters from this area. The high quantities of salps with fair abundance of other plankters yielded biomass values as high as 70724 ml/1000 m<sup>3</sup> which is the highest value ever recorded from the Indian Ocean.

### **INTRODUCTION**

The zooplankton, like phytoplankton, is an indicator of the general fertility and water quality of a sea area. An imbalance in its population structure could bring about far reaching effects on the dependent fishery resources. The imbalance could be brought about by natural as well as man-made reasons. Fluctuations in the environmental conditions resulting in poor upwelling, rise in sea surface temperature, underwater disturbances, altered monsoons and water currents from natural causes while pollution, especially due to oil spills, represents one of the major man-made causes.

The northern Arabian Sea is highly prone to the pollution due to oil because of the oil drilling operations in the Gulf waters and the Bombay High. In addition, oil tankers

ply regularly in several routes across the Arabian Sea. All these could cause oil spills which could be deleterious to the living organisms especially to the millions of microscopic plankters which sustain the food supply in the sea.

In January-February, 1991, the Arabian Gulf area was under the grip of a major oil pollution which occurred during the Gulf War. It was feared that the major part of the northwestern Arabian Sea would be affected on account of oil pollution. It was also feared that the spilled oil might reach the Indian coast due to the prevailing winds and currents.

Shortly after the oil slick in the Gulf waters, it was decided to investigate into the consequences of the oil pollution, and how it would affect the Indian Exclusive Economic Zone. The *FORV Sagar Sampada* was deployed for the investigation and the vessel undertook a special cruise in the northern Arabian Sea from 16-20 March, 1991. As part of the programme, studies were made on the zooplankton also and the results are presented in this paper.

## MATERIALS AND METHODS

Forty-four sampling stations were occupied in the northern Arabian Sea between lat. 16°- 23°N; long. 62°- 73°E (Fig.1). Zooplankton samples were collected using a Bongo-60 net of 0.4 mm mesh size fitted with a precalibrated digital 'Hydrobios' flow meter. Surface hauls were made at almost all the stations while vertical hauls from a depth of 200 m to surface were made at alternate stations. After determining the

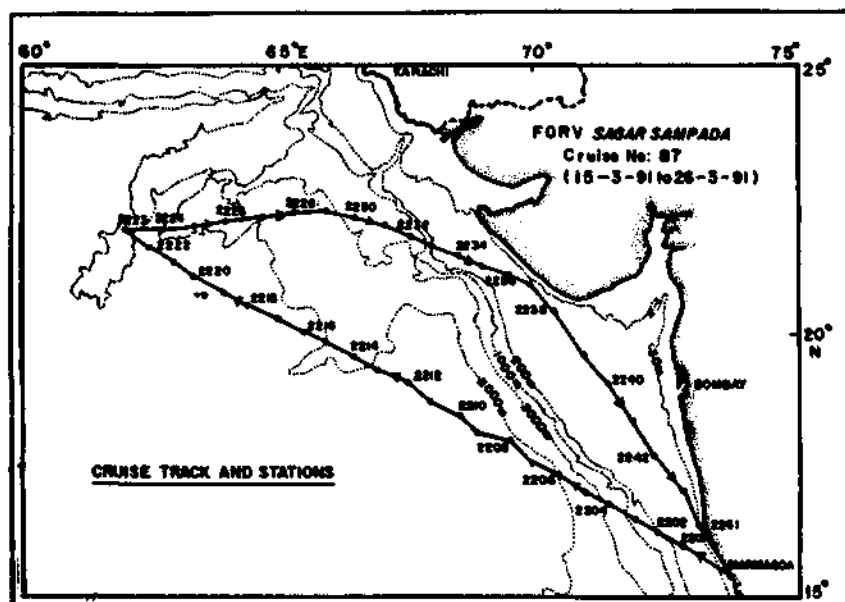

Fig. 1 - Location of sampling stations



volume by displacement method, zooplankton were sorted out into different groups and noted their numerical counts.

### RESULTS

In general, the zooplankton biomass was very rich in the area investigated except in the region of Bombay High. Tar balls of varying sizes were collected in the plankton net operated in the surface as well as column waters. The total plankton was rich in the oceanic region towards the Gulf waters.

The average biomass of zooplankton in the surface waters was 5537 ml/1000 m<sup>3</sup> (range 3.77 to 70724 ml). The minimum values were obtained from the Bombay High between Stations 2240 and 2242. Very high values were due to the preponderance of salps of which large sized were present towards the Gulf area especially between stations 2215 and 2228. The highest biomass value of 70224 ml/1000 m<sup>3</sup> was obtained from station 2209. Out of the six samples which showed high abundance of zooplankton, five were collected during night.

The average biomass of zooplankton in the column waters was estimated to be 5666 ml/1000 m<sup>3</sup>. This value was almost similar to that of surface waters. As in the case of surface zooplankton, the total biomass in the column waters was also more towards the Gulf region (Fig.2). In the column plankton also the salps contributed the maximum. The highest value of 24000 ml was from station 2225 and the least value of 62.5 ml in the column waters was, again, from the Bombay High area. Out of the 13 stations with high volumes of zooplankton, six were sampled in the day while

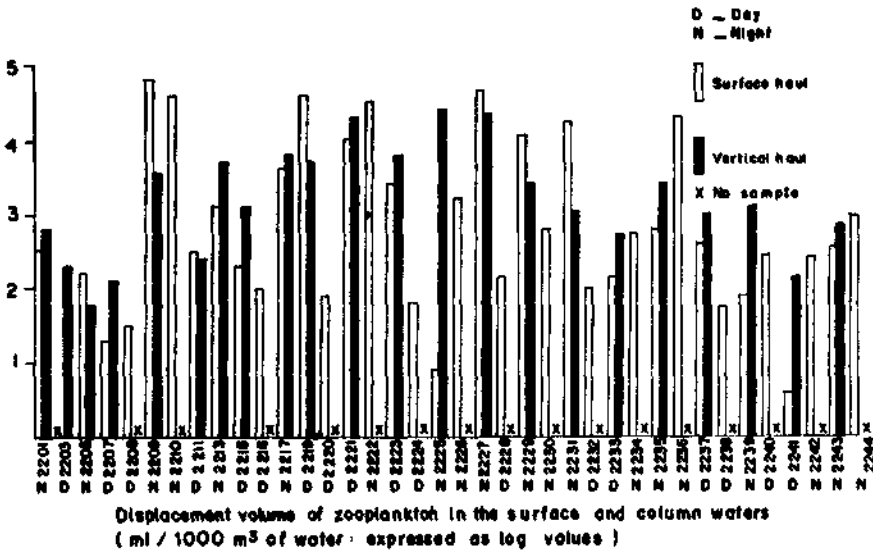

Fig. 2 - Zooplankton biomass collected from surface and column waters arranged stationwise (ml/1000 m<sup>3</sup> of water expressed as log values)

seven were sampled in the night thereby indicating almost equal abundance of zooplankters during day and night in the column waters.

It was found that majority of the groups had a tendency to increase numerically towards the eastern part of the study area (Figs.3,4), the groups being decapods, euphausiids, amphipods, polychaetes, siphonophores, medusae, gastropods, heteropods, *Lucifer*, foraminifers, fish eggs and fish larvae. In the column waters also all the above groups with addition of appendicularians, mysids, chaetognaths and doliolids showed a numerical abundance towards the east. Copepoda was one group which was almost uniformly represented throughout the area sampled.

Copepods were numerically the second abundant group. Their range in the surface waters was between 4955 and 125340 and in the column waters their range varied from 22316 (between 67° and 68°E) to 255507 (between 68° and 69°E) (Fig.3). A flourishing copepod population was noticed towards the Gulf waters. Three stations, say, 2200, 2213 and 2217 had unusual numbers of ostracods at 626819, 510993 and 3784800 respectively. The ostracods being a surface swarming group showed considerable variations in their abundance. They showed a gradual increase towards west. The appendicularians were numerically more in the column waters (range 1185, between 63° and 64°E to 48301, between 68° and 69°E). This group was almost uniformly present in the study area. The decapods were less represented in the western part and the increase from west to east was evident.

Euphausiids showed a marked increase from west to east. The maximum number of 35096 was noticed in the Indian shelf waters and the increase was mostly due to the surface swarming species of *Euphausia sibogae* and *E. diomedae*. In the column waters the maximum number of euphausiids was collected between 68° and 69°E. The amphipods were numerically well represented, their abundance being towards the east. Their number was more in the surface waters the maximum being 31007 between 64° and 65°E. Closer to the Gulf region (64° and 65°E) mysids at the rate of 80911 were recorded. These were also sparsely distributed in the column waters. A definite eastward increase was noticed with planktonic polychaetes. More of them were found in the column waters maximum being 2023 between 70° and 71°E.

The siphonophores were more abundant towards the coastal zone. A strong east-west difference in abundance was noticed, the trend of abundance being more towards the east. In the surface waters, from a mere 132 at the westernmost station, their number rose to 48277 in the Indian shelf waters. The medusae which has a patchy distribution was more towards the east. They were more abundant in the column waters. However, whatever present showed a increase towards the east. In the surface waters their number ranged from 14 to 7825 while in the column waters the range was between 86 and 32955. The chaetognaths formed an abundant group in the surface as well as column waters the minimum and maximum number in the respective water bodies being 935-36647 and 4929-94166. The planktonic molluscs were represented by pteropods, heteropods and few other gastropods. They were seen in large numbers

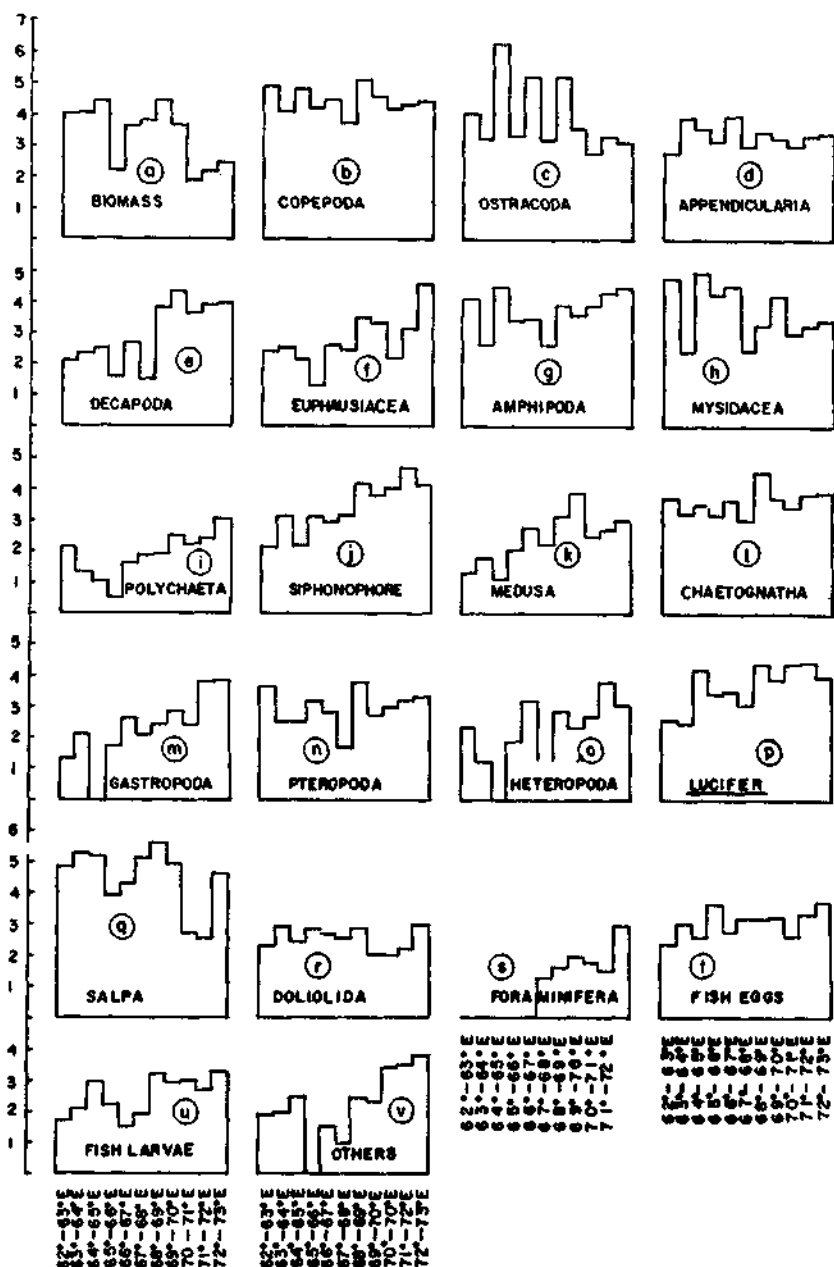

Fig. 3 - Quantitative abundance (no/1000 m<sup>3</sup> of water expressed as log values) of major zooplankters in the surface waters (average values for each longitudinal sector arranged from west to east)

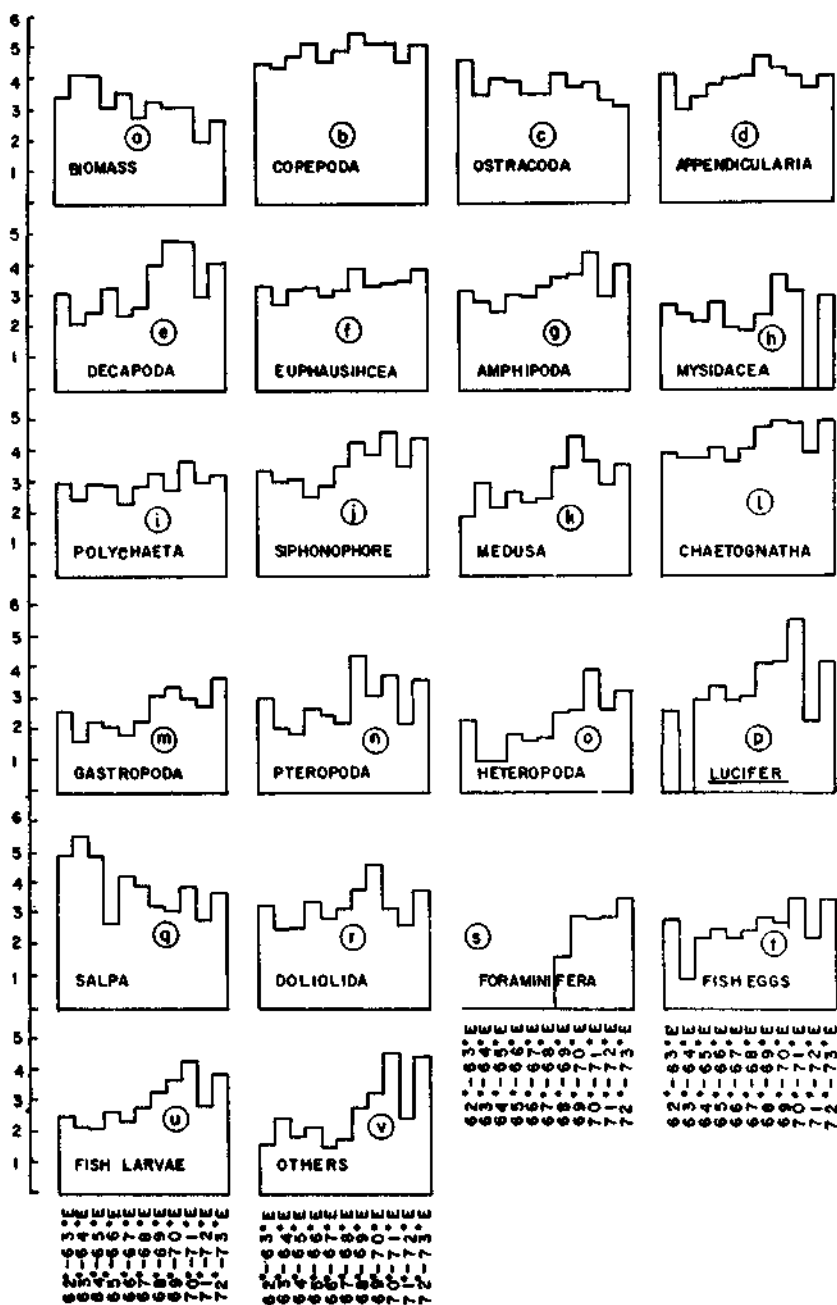

Fig. 4 - Quantitative abundance (no/1000 m<sup>3</sup> of water expressed as log values) of major zooplankters in the column waters up to 200 m depth (average values for each longitudinal sector arranged from west to east)

in the Indian shelf waters. The *Lucifer*, a neritic group was more in the Indian coastal waters.

The salps occurred in abundant numbers in the surface and column waters. Younger forms were more in the nearshore and shelf areas while larger specimens were the rule in the oceanic waters. Their quantity was such that about 70 ml/m<sup>3</sup> of water was present at station 2210. Their beast population was noticed in the Bombay High area. The maximum number of salps per 1000 m<sup>3</sup> of water was 829888 in the surface and 585869 in the column waters. The doliolids though widely present were always moderate in number. A striking feature observed with foraminifers was that they were absent west of 67°35'E. They were mostly inshore in habit.

The fish eggs and larvae registered an increase towards the east and were particularly abundant over the continental shelf with the maximum nearer to the coast. While the eggs were comparatively more in the surface, the larvae were more in the column waters.

## DISCUSSION

The northern Arabian Sea supports a very rich population of zooplankton. Haq *et al.* (1973) who studied the plankton of the Arabian Sea near to the Pakistan coast have recorded the biomass values as high as 2080 ml/1000 m<sup>3</sup> which they considered as the highest value ever recorded from the Indian Ocean. However, Paulinose & Aravindakshan (1977) obtained values as high as 2800 ml/1000 m<sup>3</sup> during December 1973 and May 1974 from the Arabian Sea and the high values were due to the abundance of ostracods, which very often surpassed the biomass of the copepods. During the present investigation, the presence of large sized salps especially towards the Gulf area resulted in very high biomass values than ever. The highest value noted for the surface waters was 70724 ml/1000 m<sup>3</sup> at station 2208 and in terms of number it was 829888/1000 m<sup>3</sup>. The ostracods were also numerous at this station being 626819. In the column waters the highest biomass value noted for salps was 24000 ml/1000 m<sup>3</sup>, its number being 139394.

Prasad (1969) observed that the zooplankton values were high in the Arabian Sea between 10° and 25°N and between 50° and 65°E. The average biomass was of the order of 274 ml/1000 m<sup>3</sup>. Earlier Bogorov & Vinogradov (1961) obtained an average value of 100 ml from the northern Arabian Sea in March. The average biomass value obtained during the present studies were 5537 ml for surface and 5665 ml for the column waters which are far higher than that recorded at any time in the Indian Ocean. The fact that these higher values have been obtained during March, when the phytoplankton populations are at a minimum due to nutrient restrictions, especially in the oceanic waters is interesting. However, the most dominant plankter, the salps, being a carnivore feeding upon other zooplankters might not have had any influence from the least production at the primary level.

In the Bombay High area between 70° and 72°E there was marked decrease in the overall quantity of zooplankton and the various groups. The least represented groups were polychaetes, medusae, salps, doliolids in the column waters. At stations 2241 and 2242, the water was highly impoverished of zooplankton. Several common groups namely ostracods, decapods, euphausiids, amphipods, mysids, polychaetes, medusae, chaetognaths, gastropods, pteropods, doliolids and fish eggs which were abundant in the nearby areas were totally absent in the column waters in these stations. In the surface waters at these stations six groups namely euphausiids, mysids, polychaetes, pteropods, salps and doliolids were absent. The plankton samples collected from the surface as well as column waters at the above two stations contained of tar balls of different sizes.

With regard to the eastwest abundance of zooplankton groups, it was seen that majority of them had minimum abundance in the western part of the area studied from where their number gradually increased to the eastern part which is towards India. However, volumetrically the increase was westward and this was due to the very high abundance of large sized salps there.

Copepods, ostracods, appendicularians, decapods, euphausiids, amphipods, mysids, polychaetes, siphonophores, chaetognaths, pteropods, heteropods, *Lucifer*, doliolids, fish eggs and fish larvae had an abundance in the column waters of the westernmost zone (long. 62°-63°E) than the immediate eastern sector (63°- 64°E). However, the number of salps was 82675/1000 m<sup>3</sup> in the western most sector which was not in anyway a low number. In the surface waters, closer to the Gulf countries, abundance of zooplankton was exhibited by majority of the groups except appendicularians, euphausiids, siphonophores, medusae, gastropods, salps, doliolids, fish eggs and fish larvae. However, the observed reduction in number of these groups was not significant except in the case of appendicularians, siphonophores and salps.

From the foregoing account it could be seen that the zooplankton populations in the area investigated were rich except in the Bombay High area. The observed eastwest increase or decrease in the case of certain groups was only relative, in the sense that a group was considered less abundant because of the very high abundance of certain other group or groups in the same area, which shadowed all others. Thus the observed relatively low numbers of various zooplankters, other than salps towards the Gulf area, was more due to the extraordinary high number of salps, and the total biomass was more towards the Gulf area. Thus it could be concluded that the Gulf waters were congenial for the occurrence and abundance of zooplankton at the time of observations and the large oil spill had either no influence on them or the effect, if at all there had been any, did not exist at the time of investigation.

#### ACKNOWLEDGEMENT

Authors are thankful to Dr P.S.B.R. James, former Director for his keen interest in this work and to Dr R. Sen Gupta, National Institute of Oceanography, Goa for the help and guidance.

## REFERENCES

- Bogorov, V.G. & Vinogradov, M.E. 1961. Some features of plankton biomass distribution in the surface water in the Indian Ocean during the winter of 1959-60, *Okeanol, Issled.* 4: 72- 75.
- Haq, S.M., Ali Khan, J. & Chugatai, S. 1973. The distribution and abundance of zooplankton along the coast of Pakistan during postmonsoon and premonsoon period, In: *The biology of the Indian Ocean*, edited by B. Zeitzchel, (Springer-Verlag, Berlin) 257-272.
- Paulinose, V.T. & Aravindakshan, P.N. 1977. Zooplankton biomass, abundance and distribution in the north and northeastern Arabian Sea, In: *Proceedings of the symposium on warm water zooplankton*, (UNESCO/NIO, Goa) 132-136.
- Prasad, R.R. 1969. Zooplankton biomass in the Arabian Sea and the Bay of Bengal with a discussion on the fisheries of the region. *Proc. Nat. Inst. Sci. India*, 35: 399-437.

\* \* \*

## **Planktonic amphipod distribution in the deep scattering layer of the Exclusive Economic Zone of India**

S. Revikala\*

Central Marine Fisheries Research Institute,

P.B. No. 1603, Cochin - 682 014

### **ABSTRACT**

The amphipods collected from the deep scattering layer (DSL) of Arabian Sea and Bay of Bengal belonged to 13 families viz. Cystisomatidae, Oxycephalidae, Pronoidae, Anapronoidae, Vibiliidae, Lycaeidae, Lycaeopsidae, Phronimidae, Platyscelidae, Phrosinidae, Scinidae, Lancecolidae and Hyperitidae. The amphipod abundance showed wide fluctuations. Oxycephalidae, Phronimidae and platyscelidae were widely distributed in both the shelf and oceanic regions of the west coast. In the east coast Phronimidae and Phrosinidae were widely distributed in the shelf and these two families together with Vibiliidae and Platyscelidae were widely distributed in the oceanic regions. In this investigation only Phronimidae was found to have wide distribution in the shelf and oceanic regions of both the Arabian Sea and Bay of Bengal. Vibiliidae and Phrosinidae showed aggregation in the oceanic region and these two together with Lycaeidae showed such a trend in the shelf of the west coast. Similarly in the east coast while Lycaeidae and Pronoidae showed aggregation in the shelf, only the former showed that trend in the oceanic region. While Cystisomatidae had a moderate distribution in the shelf of both the coasts and in the oceanic region of the west coast, it had a poor distribution in the oceanic region of the east coast. Vibiliidae and Oxycephalidae were moderately distributed in both the shelf and oceanic regions of the east coast. All other families of amphipods had a poor distribution.

### **INTRODUCTION**

The deep scattering layer (DSL) which exhibits widespread occurrence in the world oceans supports zooplankton and nekton and hence forms a notable source of forag

---

\* Present address : Chetna, 39/1847, Warriam Road, Cochin - 682 016



for pelagic fishes (Sitas, 1972). Earlier Kinzer (1969) noted the occurrence of DSL in the western Arabian Sea and found that the oxygen deficiency was not a limiting factor for plankton concentration. The findings on DSL biomass by Menon & Prabha Devi (1990) stressed the importance of this layer along the Exclusive Economic Zone (EEZ) of India.

The significance of hyperiid amphipods as a planktonic group has been highlighted by Bowman & Gruner (1973) and their role in the food chain of mackerels and herrings (Bowsfield, 1951); tunas (Tsuruta, 1963) and seals (Dunbar, 1946) has been reported. Ecological studies on hyperiid amphipods of waters around Indian sub-continent include those of Nair (1972, 1977), Revikala *et al.* (1990) and Molly Varghese *et al.* (1994). Yet another study showed the distribution and abundance of oxycephalid amphipods (Nair, 1986) collected by International Indian Ocean Expedition (IIOE 1960-1965) which explored only the surface and subsurface waters down to 200 m.

This paper on the amphipods of the DSL up to 540 m is intended as part of an attempt to throw more light into the eco-behavioural peculiarities of this group. Quantitative approach in terms of relative abundance and frequencies of occurrence are presented here. Though the amphipods were identified to species the present analysis has been restricted to the family level distribution which appeared significant by virtue of their eco-behavioural pattern and spatio-temporal distribution.

## MATERIALS AND METHODS

The amphipods of the DSL of the Bay of Bengal and Arabian Sea were sampled during the cruises of *FORV Sagar Sampada* during February 1985 - May 1986 with a 2.5 m Issac-Kidd mid water trawl (IKMT). The samples were collected from appropriate depths of DSL recorded by echosounders at a frequency of 38 and 120 kHz. During the operations, the IKMT was fitted with a net sonde to monitor the position of the gear relative to the concentration of the DSL. The net was dragged at a speed of 3 knots for 30 minutes horizontally along the DSL and then hauled. The amphipods were preserved in 5% formaldehyde solution and identified. Relative abundance and frequency of occurrence of each family were calculated. The statistical analysis was done following Wallwork (1976) and Prabhoo (1986).

## RESULTS

While the DSL was diffuse in some observations, it was very prominent in other instances. Sometimes it was unilayered while at other times it was multilayered. The amphipod samples considered for the present study belonged to the principal layer of the DSL.

The monthly mean data on the DSL amphipods from the EEZ for day and night is given in Table 1. The abundance showed wide fluctuations. The density was fairly high during the night samplings of March '85 and January and April '86 and high during day samplings of April '85, December '85 and April '86. Low abundance

Table 1 - Monthly mean number of amphipods from the deep scattering layer of the EEZ of India

Period	Amphipods (no./haul)		
	Day	Night	Total
Feb. 1985	14.50	55.21	34.86
March	19.98	131.65	75.82
April	50.08	38.40	44.24
May	No collection		
June	28.22	41.39	34.81
July	26.50	26.99	26.75
Aug.	40.10	29.68	44.89
Sept.	21.65	18.70	20.18
Oct.	10.53	09.33	09.93
Nov.	19.47	42.80	31.24
Dec.	52.10	48.37	50.24
Jan. 1986	23.70	123.65	73.68
Feb.	40.81	70.85	55.83
March	37.36	48.98	43.17
April	90.41	105.95	98.18
May	09.77	18.07	13.92

values were recorded in the night during September '85, October '85 and May '86 and low during day samplings of February '85, October '85 and May '86.

The amphipods belonged to 13 families viz. Cystisomatidae, Oxycephalidae, Vibiliidae, Phronimidae, Platyscelidae, Phrosinidae, Lycaeidae, Pronoidae, Scinidae, Lanceolidae, Hyperiididae, Lycaeopsidae and Anapronoidae. Amphipods that belonged to Oxycephalidae, Phronimidae, Platyscelidae and Phrosinidae had higher relative abundance in the day and night samples of the shelf region of the west coast (Table 2). While the relative abundance of Vibiliidae was higher during day, it was very low during night. In the shelf region of the east coast, on the other hand, Phronimidae, Phrosinidae, and Pronoidae had higher relative abundance in the day and night samples (Table 3). Lycaeidae, however, had a very low relative abundance during day. It was noteworthy that while Oxycephalidae and Platyscelidae had a higher relative abundance in the shelf region of the west coast, they had a low relative abundance in the same region of the east coast. But Pronoidae was relatively more abundant in the east coast and less in the west coast.

Table 2- Relative abundance of Amphipod families in deep scattering layer in the shelf and oceanic waters of the west coast of India

Family	Shelf			Oceanic		
	Day	Night	Total	Day	Night	Total
Cystisomatidae	3.80	3.82	3.81	3.43	1.68	2.30
Oxycephalidae	16.30	22.29	19.06	21.28	10.65	14.39
Vibilliidae	19.84	2.55	11.88	6.50	16.32	12.85
Phronimidae	14.95	23.25	18.77	24.23	29.29	27.50
Platyscelidae	18.75	11.78	15.54	11.58	9.68	10.35
Phrosinidae	16.30	13.06	14.81	18.09	17.68	17.82
Lycaeidae	3.80	9.55	6.45	1.89	1.61	1.71
Pronoidae	0.54	0.32	0.44	0.24	0.32	0.29
Scinidae	0.27	0.64	0.44	0.35	1.35	1.00
Lanceolidae	0	0	0	0.47	0.19	0.29
Hyperiididae	0	0.32	0.15	0.12	0.26	0.21
Lycaeopsidae	0	0	0	0	0.06	0.04
Unidentified	5.44	12.42	8.65	11.82	10.90	11.23

The amphipod families were grouped into constancy classes based on their frequency of occurrence viz. accidental (1% - 25%), accessory (26% - 50%) constant (51% - 75%) and absolute (76% - 100%). In the day samples of the shelf region of the west coast Oxycephalidae, Phronimidae and Platyscelidae had moderate frequencies of occurrence and hence were classified as constant, Vibilliidae, Phrosinidae and Lycaeidae as accessory and Pronoidae, Cystisomatidae and Scinidae as accidental. None of the amphipods present in this region had the status of absolute class. In the night samples, on the other hand, Phronimidae and Oxycephalidae came under absolute class due to their very high frequencies of occurrence. Other amphipod families like Platyscelidae and Lycaeidae were categorised as constant, Phrosinidae and Vibilliidae as accessory and Cystisomatidae, Pronoidae, Scinidae and Hyperiididae as accidental.

In the day samples of the shelf region of the east coast Phronimidae had very high frequency of occurrence and was hence classified as absolute and families Cystisomatidae, Vibilliidae, Platyscelidae, Oxycephalidae, Phrosinidae, Lycaeidae, and Pronoidae as accessory owing to their lower frequencies of occurrence. In the night samples Phronimidae and Phrosinidae had moderately high frequencies of occurrence and were classified as constant and families Platyscelidae, Lycaeidae, Pronoidae and Anapronoidae as accessory.

Table 3 - Relative abundance of Amphipod families of the deep scattering layer in the shelf and oceanic waters of the east coast of India

Family	Shelf			Oceanic		
	Day	Night	Total	Day	Night	Total
Cystisomatidae	06.78	00.00	02.56	00.00	05.00	01.59
Oxycephalidae	05.08	00.00	01.92	02.33	10.00	04.76
Vibiliidae	06.78	00.00	02.56	20.93	20.00	20.63
Phronimidae	22.00	12.37	16.03	06.98	30.00	14.29
Platyscelidae	03.39	04.12	03.85	11.63	25.00	15.87
Phrosinidae	28.81	31.96	30.77	39.53	05.00	28.57
Lycaeidae	01.69	21.65	14.10	18.60	00.00	12.70
Pronoidae	25.42	28.87	27.56	00.00	00.00	00.00
Scinidae	00.00	00.00	00.00	00.00	05.00	01.59
Lanceolidae	00.00	00.00	00.00	00.00	00.00	00.00
Hyperiididae	00.00	00.00	00.00	00.00	00.00	00.00
Anapronoidae	00.00	01.03	00.64	00.00	00.00	00.00

In the oceanic region of the west coast *Oxycephalidae*, *Vibiliidae*, *Phronimidae*, *Platyscelidae* and *Phrosinidae* had higher relative abundance in the day and night samples (Table 2). In the east coast *Vibiliidae* *Phronimidae*, *Platyscelidae* and *Phrosinidae* had higher relative abundance in day and night samples (Table 3). *Lycaeidae* was present only in the day samples.

In the day samples of the oceanic region of the west coast only *Phronimidae* had very high frequency of occurrence and classified as absolute, *Oxycephalidae* as constant, *Lycaeidae*, *Phrosinidae*, *Vibiliidae* and *Platyscelidae* as accessory and *Cystisomatidae*, *Pronoidae*, *Scinidae*, *Lanceolidae* and *Hyperiididae* as accidental. In the night collections while *Phronimidae* was absolute, *Oxycephalidae*, *Vibiliidae* and *Platyscelidae* were constant, *Phrosinidae* was accessory and *Cystisomatidae*, *Pronoidae*, *Scinidae*, *Lanceolidae*, *Hyperiididae*, *Lycaeopsidae* and *Lycaeidae* were accidental.

In the day samples of the oceanic region of the east coast most of the families were classified as constant and *Oxycephalidae* and *Lycaeidae* which had lower frequencies of occurrence were classified as accessory. In the night samples *Phronimidae*, *Vibiliidae* and *Platyscelidae* were classified as constant and *Cystisomatidae*, *Oxycephalidae*, *Phrosinidae* and *Scinidae* as accessory. Thus none of the families had very high or very low frequencies of occurrence.

## DISCUSSION

The relative abundance of the various families together with their frequencies of occurrence provide a more realistic picture of the spatial distribution (Wallwork, 1976) of the amphipods in the DSL of the EEZ of India. Higher relative abundance and increased frequency of occurrence points to the rich distribution. Thus Oxycephalidae, Phronimidae and Platyscelidae showed wide distribution in the shelf and oceanic waters of the west coast. Bowman (1960) noted that pelagic amphipods were more abundant in high latitudes. Fage (1960) reported higher abundance of Oxycephalids in the Indian Ocean than in other oceans. Nair (1986) found Oxycephalids in 33.63% of the total samples up to a depth of 200 m collected by IIOE. The present investigation revealed that besides Oxycephalidae, Phronimidae and Platyscelidae also had the similar status as far as their distribution is concerned in the west coast. Phronimidae and Phrosinidae in the shelf waters and Vibiliidae and Platyscelidae together with the above two families showed wide distribution in the oceanic waters of the east coast. Thus Phronimidae has been found to be the only family with wide distribution in the shelf and oceanic waters of both the Arabian Sea and Bay of Bengal.

An increased relative abundance and lower frequency of occurrence is indicative of aggregation (Wallwork, 1976). While Vibiliidae, Phrosinidae and Lycaeidae had distribution with aggregation in the shelf waters of the west coast, the two former families showed this status in the oceanic waters. In the east coast shelf waters, on the other hand, while Lycaeidae and Pronoidae showed aggregation, only the former showed such a trend in the oceanic waters. Cystisomatidae showed a moderate distribution in the shelf waters of both the coasts and in the oceanic waters of west coast and a poor distribution in the oceanic waters of the east coast. Vibiliidae and Oxycephalidae also showed a moderate distribution pattern in the shelf and oceanic waters of the east coast. In the shelf waters of the west coast families like Pronoidae, Scinidae and Hyperiididae and in the oceanic waters of this coast besides these families Lycaeidae, Lanceolididae and Lycaeopsidae had a very poor distribution. The present finding as far as Hyperiididae is concerned is at variance with that of Nair (1986) who recorded this family to have the maximum abundance and wide distribution up to 200 m depth in the Indian Ocean. An explanation for this, perhaps, be the avoidance of the net by these along with others. Anapronoidae and Cystisomatidae together with Scinidae were poorly represented in the shelf and oceanic waters of the east coast.

The relative abundance variability of different families of amphipods during day and night samplings in the shelf and oceanic waters and scintillations in their frequency of occurrence could be due to their ecological and behavioural attributes. In this context it is noteworthy that several hyperiid amphipods exhibit commensalism and parasitism on other zooplankton (Bowman & Gruner, 1973). It is known that most hyperiids are associated with some species of gelatinous zooplankton, at least during some stage of their life history. For several phronimids the salps are both a source of food and protection. Other amphipod families like Lycaeopsidae, Pronoidae and Platyscelidae exhibit association with Siphonophores and Hyperiididae with medusae.

Oxycephalids are known to be associated with Ctenophores also though many are free living forms.

The amphipod density was fairly high during the night samplings of March 1985 and January and April 1986 which are the premonsoon months of both the years. Similar trend was observed during April 1985, December 1985 and April 1986 when the mean amphipod abundance maxima were recorded for the day samplings. Following the trends of amphipod abundance during day and night samplings, the aggregate mean values of abundance also showed the peaks for the months of March 1985, January 1986 and April 1986. Kathirvel (1990) recorded the peak occurrence of Phyllosoma larvae in the DSL of Indian EEZ during October-April period. Similarly Balasubramanian & Suseelan (1990) recorded the maximum average catch of the swarming crabs in the DSL of the west coast of India during the premonsoon period.

### ACKNOWLEDGEMENT

The author is thankful to Dr.K.J. Mathew for his guidance and to the Director for providing facilities to carry out this work. Sincere thanks are due to the DOD for financial assistance.

### REFERENCES

- Balasubramanian, C.P. & Suseelan, C. 1990. Preliminary observations on the distribution and abundance of the swarming crab *Charybdis (Goniohellenus)* Smithi Macleay in the deep scattering layers along the west coast of India. In: *Proc. First Workshop Scient. Resul. FORV Sagar Sampada*, edited by K.J. Mathew, (CMFRI, Cochin) 385 - 391.
- Bowman, T.E. 1960. The pelagic Amphipod genus *Parathemisto* (Hyperiidæ: Hyperiidæ) in the North Pacific and adjacent Arctic Ocean, *Proceedings of the United States National Museum*, 112 (3439): 343-392.
- Bowman, T.E. & Gruner, H.E. 1973. The families and genera of Hyperiidæ (Crustacea, Amphipoda), *Smith. Contr. Zool.* 146: 1-64.
- Bowfield, E.L. 1951. Pelagic amphipods of the Belle Island Strait region, *J. Fish. Bd. Canada*, 8 : 134-163.
- Dunbar, M.J. 1946. On *Themisto libellula* in Baffin Land coastal waters, *J. Fish. Res. Bd. Canada*, 6 (6) : 419-434.
- Fage, L. 1960. Oxycephalidæ. Amphipods pelagiques, *Dana. Rept.* 9(52) : 1-145.
- Kathirvel, M. 1990. On the collections of Phyllosoma larvae by Issacs-Kidd mid water trawl from the west coast of India. In: *Proc. First Workshop Scient. Resul. FORV Sagar Sampada*, edited by K.J. Mathew, (CMFRI, Cochin) 141-146.
- Kinzer, J. 1969. On the quantitative distribution of zooplankton in deep scattering layers, *Deep-Sea Res.* 16 : 117-125.
- Menon, N.G. & Prabha Devi, L. 1990. Studies on the biomass in the deep scattering layers of the Indian EEZ. In: *Proc. First Workshop Scient. Resul. FORV Sagar Sampada*, edited by K.J. Mathew, (CMFRI, Cochin) 257-271.
- Molly Varghese, Mathew, K.J., Naomi, T.S., Geetha Antony & Solomon, K. 1994. On the quantitative abundance of amphipods around Andaman-Nicobar Islands, *Second Workshop on Scientific Results of FORV Sagar Sampada*. (Abstracts).

- Nair, K.K.C. 1972. A note on an amphipod swarm along the south-west coast of India, *Curr. Sci.* 41 (5) : 185-186.
- Nair, K.K.C. 1977. Distribution and relative abundance of Phronimidae (Hyperiidæ : Amphipoda) in the Indian Ocean, *Proc. Symp. warm water Zoopl.* (UNESCO/NIO, Goa) 155-167.
- Nair, K.K.C. 1986. *Studies on the Amphipods (Hyperiidæ : Oxycephalidæ) of the Indian Ocean*. Ph.D thesis. Univ. of Kerala, pp.364.
- Prabhoo, N.R. 1986. Collembolan community in a bamboo grove and grass plot, In: *Proc. 2nd Int. Nat. Seminar on Apterygota*, edited by R. Dallai, (University of Siena, Italy) 149-155.
- Revikala, S., Mathew, K.J. & Scariah, K.S. 1990. Preliminary studies on planktonic amphipods collected by FORV Sagar Sampada, In: *Proc. First Workshop Scient. Resul. FORV Sagar Sampada*, edited by K.J. Mathew, (CMFRI, Cochin) 115-117.
- Silas, E.G. 1972. Investigations on the deep scattering layers in the Laccadive Sea, *Proc. Symp. Corals and Coral reefs*, (Mar. Biol. Ass. India, Cochin) 257-274.
- Tsuruta, A. 1963. Distribution of plankton and its characteristics in the oceanic fishing grounds with special reference to their relation to fishery, *J. Shimonoseki, Coll. Fish.* 12 : 13-214.
- Wallwork, J.A. 1976. *The distribution and diversity of soil fauna*, (Academic Press, London) pp. 356.

\* \* \*

## Composition of heteropods in the Andaman Sea

P.N. Aravindakshan & Rosamma Stephen

National Institute of Oceanography, Regional Centre, P.B. No.1913  
Cochin - 682 018

### ABSTRACT

Distribution of species of Atlantidae, Carinariidae and Pterotracheidae in the Andaman Nicobar sea is discussed in this paper based on samples of *FORV Sagar Sampada*. *Oxygrus keraudreni* and *Protatlanta souleyeti* are reported for the first time from this area.

### INTRODUCTION

Heteropods and pteropods are the two pelagic molluscan groups that are highly adapted for planktonic life. Compared to pteropods, heteropods are very few in regular zooplankton collections. Studies on heteropods of the Indian Ocean are very few. Tesch (1949) gave the geographical range of selected species of these in the world oceans. Frontier (1963, 1968) and Richter (1974) studied the heteropods of the Meteor Expedition. Aravindakshan (1969, 1973, 1977) studied certain groups of heteropods collected during the International Indian Ocean Expedition. The numerical abundance of heteropods in the EEZ of India is given by Mathew *et al.* (1990a). This paper deals with the distribution of heteropods from the Andaman and Nicobar seas.

### MATERIALS AND METHODS

Heteropods were obtained from the zooplankton samples collected onboard *FORV Sagar Sampada* from the Andaman and Nicobar area during 1986 to 1990. The details of collection and the procedure adopted are given by Mathew *et al.* (1990b). The data are presented as number of individuals per 1000 m<sup>3</sup>.

### RESULTS AND DISCUSSION

The Heteropoda includes three families, namely Atlantidae, Carinariidae and Pterotracheidae. The genera encountered in the study are given below.



Family Atlantidae: *Oxygyrus*, *Oxygyrus*, *Protatlanta*, *Atlanta*

Family Carinariidae: *Carinaria*, *Pterosoma*, *Cardiapoda*

Family Pterotracheidae: *Pterotrachea*, *Firoloida*

Figure 1 shows the distribution of the heteropod groups identified from the Andaman Sea. In the family Atlantidae *Oxygyrus keraudreni* was observed from 14 stations mostly from oceanic waters and *Protatlanta souleyeti* only from two stations. These two species are recorded for the first time from Andaman Sea. The *Atlanta* was the most abundant genus in the family Atlantidae represented by *A. peroni*, *A. gaudichaudi*, *A. lessueuri* and *A. inclinata*. *A. inflata*, *A. helicoides*, *A. fusca* and *A. turriculata*. Of this *A. peroni*, *A. fusca* and *A. turriculata* were well represented in these samples. Highest density of 1640 specimens/1000 m<sup>3</sup> was recorded at a station located at 10.30°N and 89°57'E.

The family Carinariidae was represented by *Carinaria cithara*, *C. cristata*, *Cardiapoda placenta* and *Pterosoma planum*. *Carinaria cithara* was present in two stations in the northwestern side while *C. cristata* was present only in three stations in the southern region. *Pterosoma planum* was obtained from 5 stations south of 11°00'N. *Cardiapoda placenta* was encountered from as many as 17 stations distributed over the entire Andaman-Nicobar area.

The genus *Pterotrachea* is represented by *P. coronata* at three stations and *P. hippocampus* in a single station, the former was encountered between 10.5°N and 9.5°N and the latter at 7°N - 93°30'E near Nicobar. Under the genus *Firoloida*, *Firoloida desmaresti* is the only species. This is a very common species and is well distributed in the Andaman area. Highest density of 540 specimens/1000 m<sup>3</sup> of *Firoloida* was obtained from the same station from which highest density of *Atlanta* specimens were recorded.

Heteropods are widespread among the tropical seas. They are essentially surface dwellers confined to the upper 100 m. *Carinaria* and *Pterotrachea* move about freely after loosing proboscis, eyes and visceral nucleus. The material from *FORV Sagar Sampada* offered intact specimens of all families except those of Atlantidae. An overall picture of the distribution of the species of heteropods was given by Tesch (1949) from the material obtained from Carlsberg and Dana Expeditions. His study did not cover the northern part of the Indian Ocean. The analysis of the heteropods collected during IIOE by Aravindakshan (1969, 1973, 1978) cover the northern Indian Ocean and deals mainly with Carinariidae and Pterotracheidae. The present observation helps to provide an idea on the distribution of these species in the waters around Andaman and Nicobar islands.

Eventhough *Atlanta* spp are regular components of samples obtained from 100 m to surface, reports from Indian Ocean is limited (Tesch, 1910, 1949). This study indicates that species of *Atlanta* are well distributed in the Bay of Bengal also. *Oxygyrus keraudreni* was found scattered over the Andaman-Nicobar area. Tesch (1949) obtained this species from the Ceylon and Scyhellles. Tesch's account of

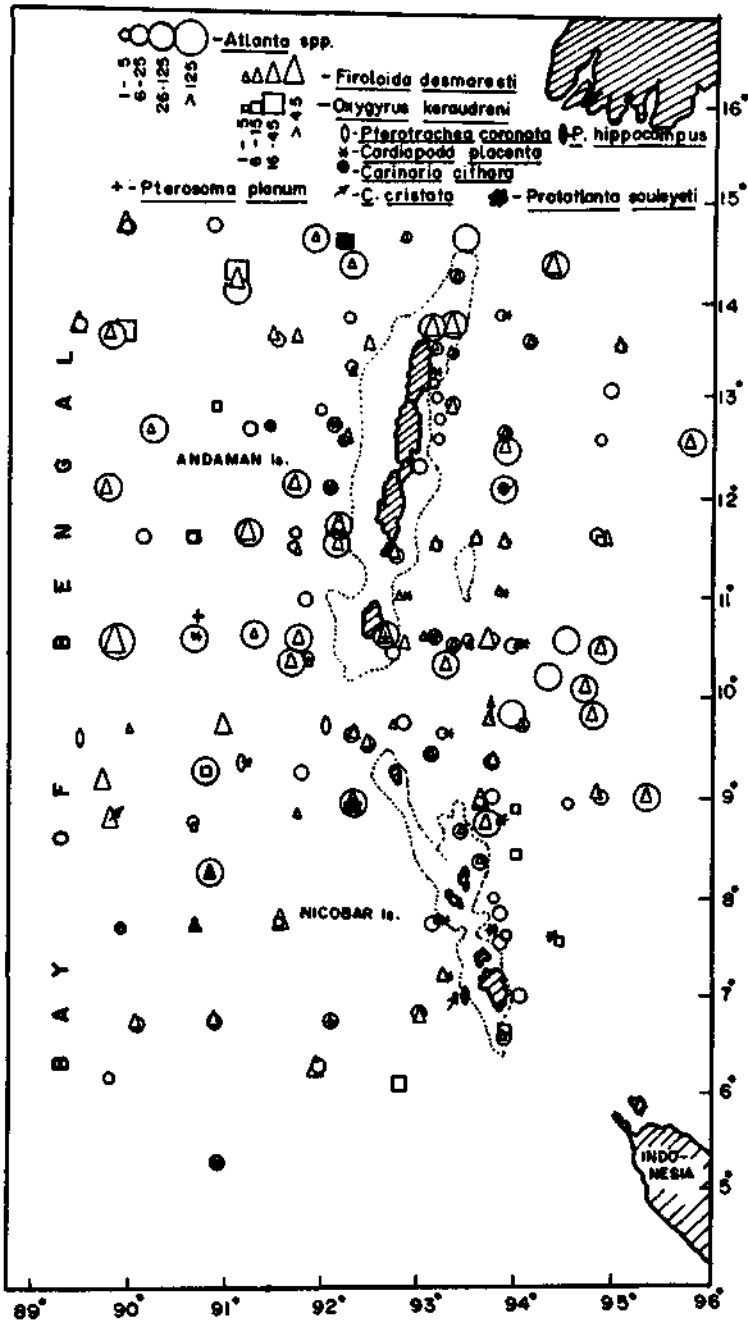

Fig.1 - Distribution of heteropods in the Andaman Sea (no./1000 m<sup>3</sup>)

*Protatlanta souleyeti* showed its distribution south of the equator and he specifically mentioned that the species was not obtained from the Indo-Malayan region, hence, this forms the first report of this species from the region. *Carinaria cithara* and *C. cristata* were recorded from the area south of 10°N (Tesch, 1949). But from the IIOE collections, Aravindakshan (1967) did not obtain species of *Carinaria* from the Bay of Bengal. This study shows that both *C. cithara* and *C. cristata* are present in Andaman and Nicobar seas. *Pterosoma planum* and *Cardiapoda placenta* were found to be well distributed in the Bay of Bengal, *Pterotrachea coronata* and *P. hippocampus* were also represented in the Bay of Bengal. *Firoloida desmaresti* was frequent in the collections of Andaman-Nicobar area, sometimes occurred in swarms. In general this study shows that heteropod genera are well distributed in the Andaman and Nicobar area.

### ACKNOWLEDGEMENT

The authors are grateful to the Director, CMFRI, Cochin for allotting the heteropods for specialised study. They are also thankful to the Scientist-in-Charge, R.C., Cochin and Director NIO, Goa for their interest in the work.

### REFERENCES

- Aravindakshan, P.N. 1969. Preliminary report on the geographical distribution of the species of Carinariidae and Pterotracheidae (Heteropoda, Mollusca), from the International Indian Ocean Expedition, *Bull. Natl. Inst. Sci. India*, 38: 575-585.
- Aravindakshan, P.N. 1973. Distribution and ecology of *Pterotrachea coronata* (Forsk.) In: *The biology of the Indian Ocean*, Vol.3, edited by B. Zeitzschel, (Springer - Verlag, Berlin) 399-400.
- Aravindakshan, P.N. 1977. Pterotracheidae (Heteropoda, Mollusca) of the Indian Ocean from the International Indian Ocean Expedition, *Proc. of the Symp. on Warm Water Zooplankton*, (UNESCO/NIO, Goa) 137-145.
- Frontier, S. 1963. Heteropodes et Pteropodes recoltés dans le plancton de Nosy Be' Cah. *ORSTOM (Oceanogr)*, 1: 213-227.
- Frontier, S. 1968. Heteropodes et Pteropodes. Donn'ees Sur la - fauna Pelagique. Gebon der Congo et de l' Angola Off Rech. Sci. Techn. Outre - Mer, *Océanographie* 417, 1-11.
- Mathew, K.J., Naomi, T.S., Antony, G., Vincent, D., Anilkumar, R. & Solomon, K. 1990b. Studies on zooplankton biomass and secondary and tertiary production of the EEZ of India, In: *Proceedings of the Workshop on Scientific results of the FORV Sagar Sampada*, edited by K.J. Mathew, (CMFRI, Cochin) 59-69.
- Mathew, K.J., Naomi, T.S., Antony, G. & Solomon, K. 1990a. Distribution and abundance of pteropod and heteropod molluscs in the EEZ and adjoining waters of India, In: *Proc. First Workshop Scient. Result. FORV Sagar Sampada*, edited by K.J. Mathew (CMFRI, Cochin) 155-163.
- Richter, G. 1974. Die Heteropoden der Meteor - Expedition in den Indischen Ozen 1964/65 Meteor Forsch Ergebnisse, Reihe D, 17: 55-78.
- Tesch, J.J. 1910. Pteropod and Heteropod Percy Sladen Trust Expedition to the Indian Ocean in 1905, *Trans. Linn. Soc. Lond.* 14: 170-189.
- Tesch, J.J. 1949. Heteropoda, *Dana Report*, 34: 1-53.

## Ostracods of Andaman Sea

Rosamma Stephen & P.P. Meenakshikunjamma

National Institute of Oceanography, Regional Centre, P.B. No. 1913.  
Cochin - 682 018

### ABSTRACT

Distribution of 12 species of ostracods was studied from the waters around Andaman-Nicobar area. *Euconchoecia aculeata* was the most abundant species occurring mostly as swarms with a maximum density of 9732 specimens/1000 m<sup>3</sup>. *Cypridina dentata* was represented only in 6 stations. High abundance for most of the species was observed during premonsoon period.

### INTRODUCTION

Ostracods are frequently found in zooplankton collections and sometimes they outnumber the copepods. Swarming of certain species of ostracods is reported to be a regular phenomenon in coastal waters (Tranter & George, 1972; Paulinose & Aravindakshan, 1977). Prior to 1969 only a very few reports are available on the Indian Ocean ostracods (Müller, 1906; Cannon, 1940). The most extensive work on this group is based on the material from the International Indian Ocean Expedition (1962-65) (George, 1969, 1976, 1977). Distribution of ostracods in the northern Indian Ocean is reported by George & Nair (1980) and along the southwest coast by George *et al.* (1975). During the IIOE emphasis was given to deal the vast extent of Indian Ocean and hence a systematic coverage of each section was not attempted.

Oceanographic studies of the Andaman Sea are very few. Desai *et al.* (1986) pointed out the discontinuity in the surveys conducted so far in the Andaman Sea. An account of ostracods from Andaman Sea is given in a study of crustacean groups of this sea (Madhupratap *et al.* 1981; Nair *et al.* 1981). The *FORV Sagar Sampada* had conducted cruises in the EEZ including the Andaman and Nicobar islands and provided zooplankton material that can be utilized for studies in space and time. This paper deals with the distribution, abundance and seasonal variations of some important genera of ostracods collected from this area during 1986-90.

## MATERIALS AND METHODS

The material for this study was sorted out from the zooplankton samples collected onboard *FORV Sagar Sampada* during her cruises 14, 29, 46, 48, 50, 52, 55, 56, 60 and 69 which cover most of the months. The area of investigation is between lat. 15° and 5° N; long. 89° to 96°E. Samples were collected with Bongo 60 net from 150 - 0m. Ostracod number from each sample was converted to no/1000 m<sup>3</sup> according to the procedure given by Mathew *et al.* (1990).

## RESULTS AND DISCUSSION

Figures 1 and 2 show the distribution of abundant and common ostracod species. Table 1 presents the average values for the three seasons, premonsoon (Feb.-May), monsoon (June- Sept.) and postmonsoon (Oct.-Jan.) .

Ten genera (*Cypridina*, *Halocypris*, *Euconchoecia*, *Metaconchoecia*, *Orthoconchoecia*, *Spinocoea*, *Paraconchoecia*, *Conchocoetta*, *Conchoecia*, *Conchoecilla*), were identified from the samples. Genus *Cypridina* was represented by *Cypridina dentata* which was present only at 6 stations on the western side of the north Andaman Sea (Fig. 1). Highest density of 5137 no/10000 m<sup>3</sup> was observed during day in May.

In the genus *Euconchoecia*, *E. chierchia* and *E. aculeata* were encountered in the Andaman area. *E. aculeata* was the most abundant species with an average density of 1006/1000 m<sup>3</sup>. Swarming was observed in many stations and maximum density of 9732 no/1000 m<sup>3</sup> was found near north Andaman island in May. Ostracods of more than 2500 no/1000 m<sup>3</sup> were found in patches especially between 13.5°N and 14.5°N and between 8°N and 10.5°N (Fig. 1). *Halocypris brevis* (Fig. 1) was also widespread in the Andaman Sea with high densities between 9° and 11°N.

*Paraconchoecia procera* and *P. elegans* were found scattered in the Andaman and Nicobar area (Fig.2) *Conchocoetta giesbrechti* was represented in appreciable numbers. High density was found in the central and southern parts of the area studied. *Orthoconchoecia striola* and *Metaconchoecia rotunda* (Fig.2) were observed in very few numbers, the former being mostly confined in the southern region and the latter towards northern and central regions.

*Spinocoea Porrecta* was fairly represented in the area studied (Fig. 2) whereas *Conchoecia magna* was sparsely encountered from few stations around Andaman islands. *Conchoecilla daphnoides* was recorded from only 3 stations from the northeastern side of Andaman islands during April.

George & Nair (1980) have discussed the distribution of ostracods in the northern Indian Ocean, based on IIOE samples collected during 1962 to 1965, which gave an overall picture of the ostracod species. Later Nair *et al.* (1981) studied the ostracods collected during January-February 1979. Periodic investigations on the biodiversity of any group is essential to assess any long-term changes in the species assemblage of

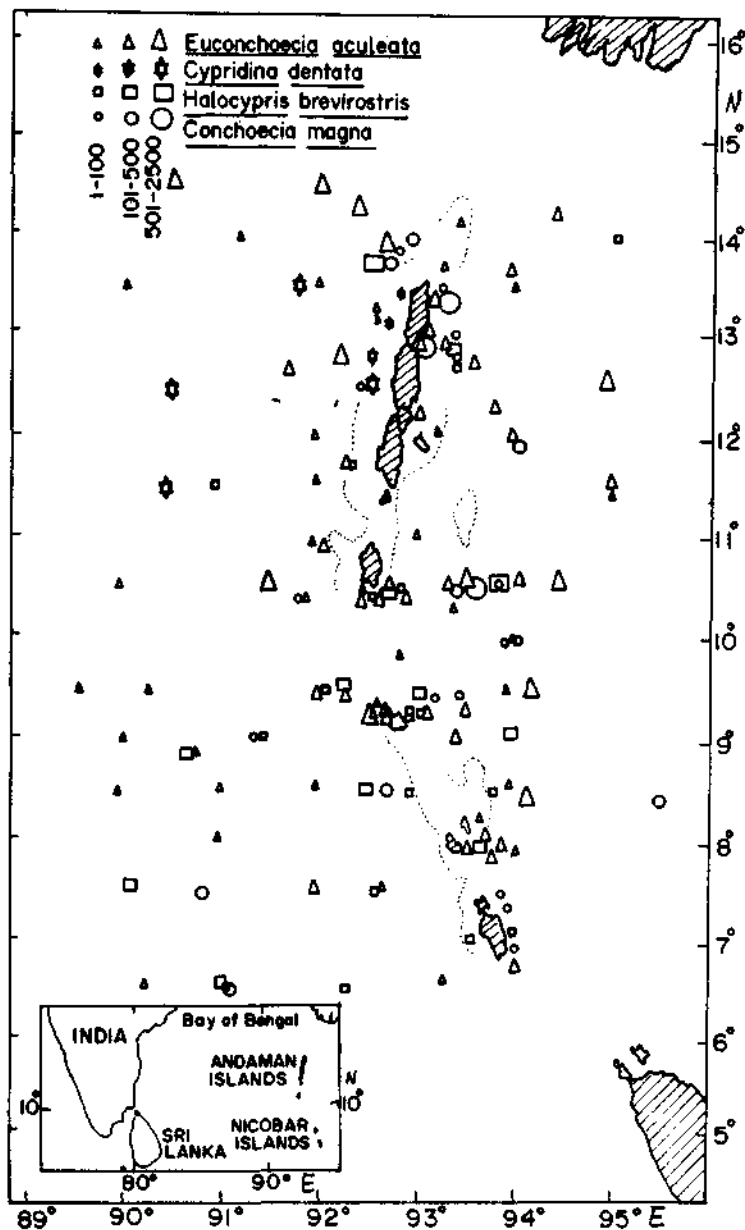

Fig. 1-Distribution and abundance of common species of ostracods in the Andaman Sea (no. per 1000 m<sup>3</sup> of water)

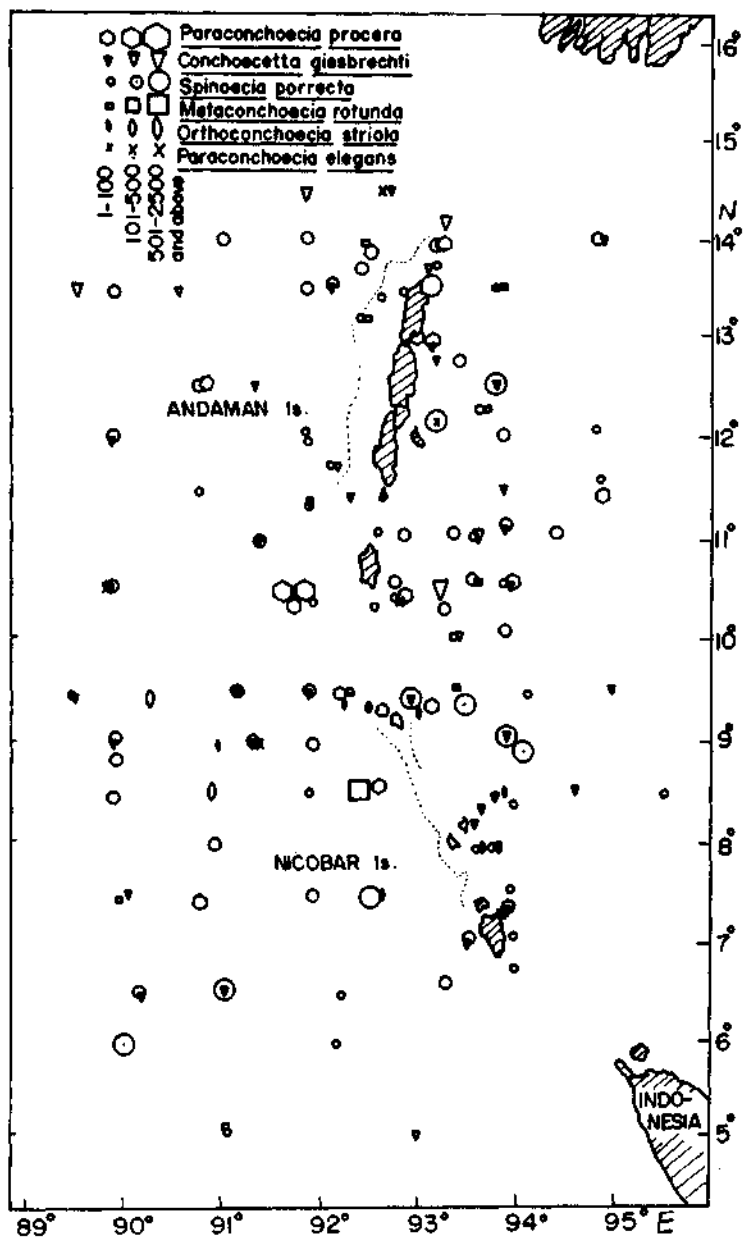

Fig. 2- Distribution and abundance of common species of ostracods in the Andaman Sea (no. per 1000 m<sup>3</sup> of water)

Table 1 - Seasonal variation in the common ostracod species in the Andaman Sea (average no. per 1000 m<sup>3</sup> of water)

Species	Season		
	Premonsoon	Monsoon	Postmonsoon
<i>Cypridina dentata</i>	65	0	4
<i>Halocypris brevirostris</i>	29	11	58
<i>Euconchoecia aculeata</i>	228	1657	1132
<i>Metaconchoecia rotunda</i>	24	0	36
<i>Orthoconchoecia striola</i>	9	0	0
<i>Spinocoea porrecta</i>	183	212	84
<i>Paraconchoecia procera</i>	192	0	47
<i>Conchocetta giesbrechti</i>	35	14	21
<i>Conchoecia magna</i>	132	0	90

a particular environment. The samples of *Sagar Sampada* form excellent material for making comparison.

*Cypridina dentata* the most abundant neritic species of the west and east coasts, occur only sporadically in the Andaman Sea. Nair *et al.* (1981) and Madhupratap *et al.* (1981) reported this species from the eastern Andaman Sea. In the present study swarms of the species were observed from few stations. The sudden swarming of this species may be associated with special ecological conditions of the environment probably due to rains and small-scale upwelling. Santhakumari & Saraswathy (1981) had also reported swarms of *C. dentata* from the east coast in November after the heavy rains of the northeast monsoon. *Conchoecia magna* and *Metaconchoecia rotunda* were well represented during January to April. *Conchoecilla daphnoides* is reported to be more common in Andaman and Indonesian region. (George & Nair 1980). The present data also showed its presence in the eastern side. The comparison of the earlier studies indicated that the composition of ostracods has not changed over the years. The main feature that controls the distribution of ostracod species is salinity. Surface salinity in the Andaman area is 32.8‰ (Babu & Sastry, 1976) during late winter. The salinity of the Bay of Bengal during the monsoon is very low and this can inhibit the dispersal of higher saline species.

Compared to the species in IIOE (George & Nair, 1980) few species are encountered in the *Sagar Sampada* collections. These samples represent the fauna in 150 to 0 m and hence the lesser number of species. However it is possible to trace the seasonal variation in species composition. Table 1 shows the average numerical abundance for the species. Most of the species showed high average values during the premonsoon period. *Euconchoecia aculeata* was abundant during the monsoon period with a moderately high value in the postmonsoon period. *Cypridina dentata*



was present only in May but with very high values. The sudden swarming of *C. dentata* may be associated with the frequent rains associated with the monsoons. George & Nair (1980) reported *E. aculeata* as the most abundant species in the Bay of Bengal. This study also revealed a regular swarming of the species. Further evidence on the preference of these two species to the waters of the Arabian Sea and Bay of Bengal can be brought to light by the analysis of ostracods collected by *FORV Sagar Sampada* in different seasons from the west and east coasts of India.

### ACKNOWLEDGEMENT

The authors are grateful to the Director, CMFRI, Cochin for allotting the material for this study and to Dr.K.J.Mathew of the Institute for providing the data. They are indebted to the Director, NIO, Goa and to the Scientist-in-Charge Regional Centre, NIO Cochin for their encouragement.

### REFERENCES

- Babu, R.V. & Sastry, J.S. 1976. Hydrography of the Andaman Sea during late winter. *Indian J. Mar. Sci.*, 5: 179.
- Canon, H.G., 1940. *Scientific Report of the John Murray Expedition*, 6: 319-320.
- Desai, B.N., Bhargava, R.M.S., Sarupria, J.S. & Pankajakshan, T. 1986. Oceanographic coverage of Andaman and Nicobar Seas. *Proc. Conf. on Sci., Tech. Inputs for Island Develop.* (DOD/Indian Ass Advancement Sci. New Delhi) 86-102.
- George, J. 1969. A preliminary report on the distribution and abundance of planktonic ostracods in the Indian Ocean, *Bull. Nat. Inst. Sci. India*, 38: 641-648.
- George, J., Purushan, K.S. & Madhupratp, M. 1975. Distribution of planktonic ostracods along southwest coast of India, *Indian J. Mar. Sci.*, 4: 201-202.
- George, J. 1976. Cypridid ostracods in Indian Ocean plankton, In: *Proc. Symposium on warm water zooplankton*, (UNESCO/NIO, Goa) Abstract No. 12.
- George, J. 1977. *Studies on planktonic ostracods of the northern Indian Ocean*, Ph.D. thesis, University of Cochin, Cochin.
- George, J. & Nair, V.R. 1980. Planktonic ostracods of the northern Indian Ocean. *Mahasagar-Bull. Nat. Inst. Oceanogr*, 13 (1): 29-44.
- Madhupratap, M., Nair, S.R., Achuthankutty C.T. & Nair, V.R. 1981. Major crustacean groups and zooplankton diversity around Andaman - Nicobar Islands, *Indian J. Mar. Sci.*, 10:266-269.
- Mathew, K.J., Naomi, T.S., Antony, G., Vincent, D., Anilkumar, R & Solomon, K 1990. Studies on zooplankton biomass and secondary and tertiary production of the EEZ of India. In: *Proceedings of the workshop on Scientific results of FORV Sagar Sampada*, edited by K.J. Mathew (CMFRI, Cochin) 59-69.
- Müller, G.W. 1906. *Ostracoda Wissenschaftliche Ergebnisse Deutsche Tiefsce Expedition auf dem Bampfer Valdivia*, 8: 29-154.
- Nair, S.R.S., Nair, V.R., Achuthankutty,C.T. & Madhupratap,M. 1981. Composition and diversity of plankton in western Bay of Bengal. *J. Plankton. Res.* 3 (4): 493-508.
- Paulinose, V.T. & Aravindakshan, P.N. 1977. Zooplankton biomass, abundance and distribution in the north and northeastern Arabian Sea. In: *Proceedings of the Symposium on Warm Water Zooplankton*,(UNESCO/NIO, Goa) 132-136.

- Santhakumari, V. & Saraswathy, M. 1981. Zooplankton production along Tamil Nadu coast, *Maharashtra-Bull. Natn. Inst. Oceanogr.* 14(4): 289-302.
- Tranter, D.J. & George, J. 1972. Zooplankton abundance at Kavarathi and Kalpeni atolls in the Laccadives, In: *Proceedings of the Symposium on Corals and Coral Reefs*. (Marine Biological Association of India) 239-256.

\* \* \*

## Zooplankton standing stock off south of Great Nicobar Island during an oil spill incident and after

T.C. Gopalakrishnan, K.K. Chandrasekharan Nair & V.N. Sankaranarayanan

National Institute of Oceanography, Regional Centre, P.B. No.1913

Cochin - 682 018

### ABSTRACT

An intensive sampling was carried out in the oil plume area between lat.5°56' to 6°42'N and long. 93°10' to 94°30'E. For a comparative study, samples were also collected along the international oil tanker route along the 5°45'N latitude from 82°E to 92°E longitude. The biomass values noted two weeks after the oil spill along the oil tanker route (negligible to 50 ml/100 m<sup>3</sup>) and in the vicinity of the island (2.45 to 70 ml/100 m<sup>3</sup>) suggested that the standing stock was not much affected as there was no trace of any oil in these areas after two weeks of the accident. This may be due to the natural dispersion and disintegration of oil, associated with the local winds and south-westerly currents. Zooplankton biomass was relatively high 8 months after the oil spill and it ranged from 5.62 to 72.3 ml/100 m<sup>3</sup> along the tanker route and 2.32 to 83.3 ml/100 m<sup>3</sup> at the oil spilled site. This may either be due to the full recovery of the environment or the normal seasonal variations. Later observations did not show any eventual damage to the fauna and flora as expected.

### INTRODUCTION

An estimated amount of 18000 tonne of crude oil was spilled in the sea at the western entry to the strait of Malacca due to the collision of a Danish oil tanker VLCC *Maersk Navigator*, carrying 300000 tonne of light crude oil, with another tanker *Sanko Honour* on 21st Jan. 1993. As reported by the coast guard, if an oil patch of 90 km<sup>2</sup>, just 16 nautical miles south of Indira Point (southern tip of the great Nicobar Island), detailed studies were carried out in the waters of the southern Nicobar area in the Bay of Bengal. The first phase of the study was conducted onboard *ORV Sagar Kanya* (cruise 81) during January/February 1993, to assess the immediate environmental impact of the oil spill and its consequent effect on the biota. The second phase was carried out during September/October 1993 onboard *FORV Sagar Sampada* (cruise 113) to estimate the possible long-term effects if any. Observations were made on the

zooplankton, oil slicks, floating tar balls, dissolved/dispersed petroleum hydrocarbons, sinking oil globules/tar particles, bacteria, yeasts and fungi. This paper gives an account on the zooplankton standing stock along the international oil tanker route in the southern Bay of Bengal and the areas to the south of the great Nicobar from where the oil patch was reported.

## MATERIALS AND METHODS

During the first cruise, which was conducted two weeks after the oil spill (27-1-93 to 11-2-93), zooplankton samples were collected from 22 stations (Fig. 1) along the oil tanker route. The sampling was made from 82°00'E to 92°00'E longitude along 5°45'N latitude at 30 nautical miles intervals. These collections were made from the surface (0-15 cm) and subsurface (20-30 cm) layers using a Neuston net (300  $\mu$ ) (Hydrobios, Germany) having a mouth area of 30x15' cm. From the area where the oil plume was noticed (between 93°10' to 94°30'E longitude and 5°56' to 6°42'N latitude), 17 samples were collected as cited above, at 15 nautical miles intervals. During the second cruise, 8 months after the oil spill (21-9-93 to 10-10-93), the same area was surveyed and sampling of subsurface (20-30 cm) zooplankton was carried out using Bongo net 300  $\mu$  (30 cm diameter). For comparative studies of the samples collected during the two cruises, subsurface samples from the Neuston net alone were considered. Neuston net could not be used for the second cruise due to operational difficulties. Though the gears used differ in design, the stratum sampled and the mesh size of the net used remained same and the values expressed are in terms of unit

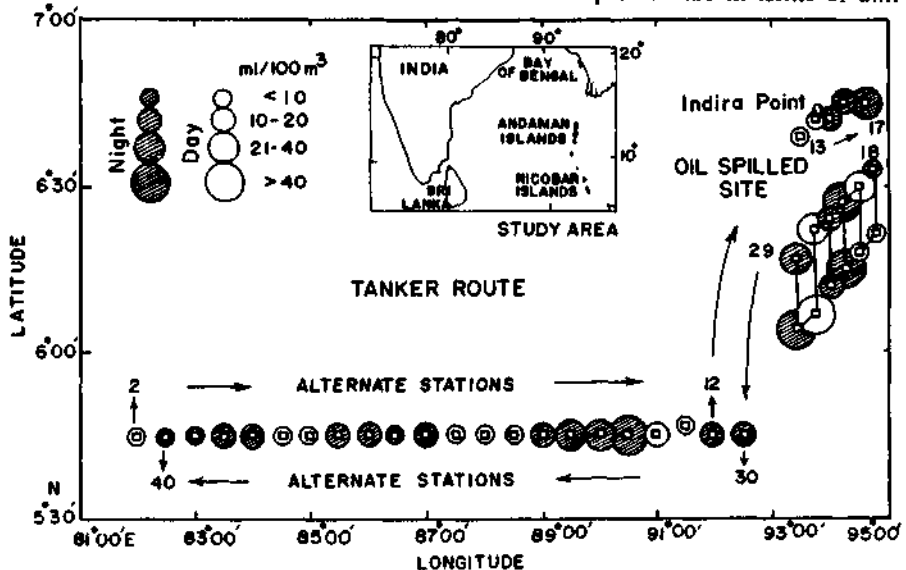

Fig. 1 - Density distribution of zooplankton biomass along the oil tanker route and oil spilled site, two weeks after the incident. (Sagar Kanya Cruise no.81)

volume of water filtered. Eleven samples were collected along the oil tanker route at  $1^\circ$  intervals (Fig.2 A) and from the oil plume area 14 samples were collected (Fig.2 B). Observations were also made on the shoreline, up to 15 km south of Campbell Bay, to assess the impact of the oil spill on the biota inhabiting the intertidal zone.

## RESULTS AND DISCUSSION

All along the oil tanker route, the zooplankton biomass was relatively low ( $<10$  to  $20 \text{ ml}/100 \text{ m}^3$ ) except in the case of collections made closer to the great Nicobar area which had medium ( $21 - 40 \text{ ml}/100 \text{ m}^3$ ) to high ( $>40 \text{ ml}/100 \text{ m}^3$ ) biomass; whereas around 50% of the collections made from the oil plume area, in the vicinity of the island, revealed medium to high biomass (Fig.1, Table 1). Corresponding observations made 8 months after the accident showed comparatively higher values ( $>40 \text{ ml}/100 \text{ m}^3$ ) of biomass both along the tanker route and the oil spilled site (Fig.2, Table 2). Likewise, the numerical abundance of most of the taxa also showed considerable increase in their dominance in both the areas investigated (Figs. 3, 4 and Table 3). Numerical abundance of major taxa showed the following order of dominance. viz.

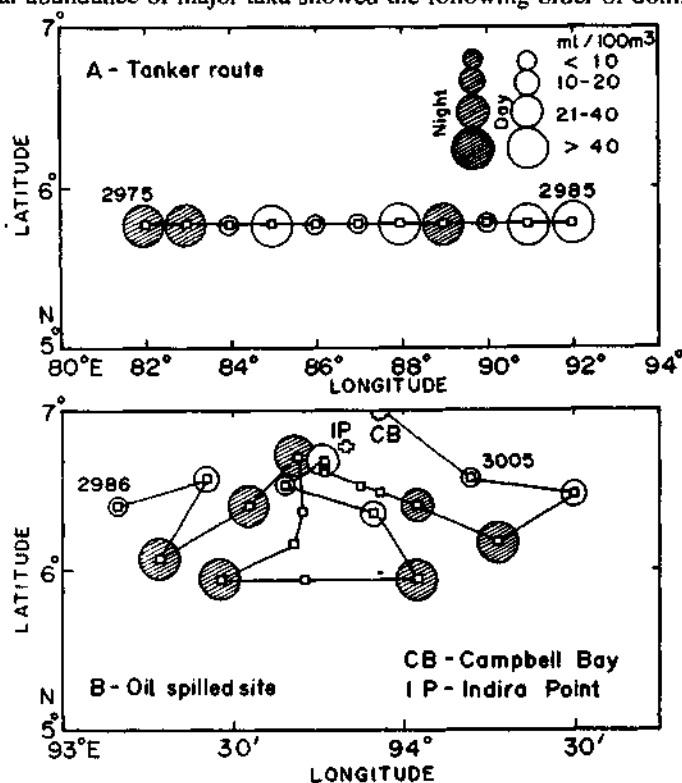

Fig.2 - Density distribution of zooplankton biomass along the oil tanker route and oil spilled site, eight months after the incident. (Sagar Sampada Cruise no.113)

Table 1 — Station locations and zooplankton biomass *ORV Sagar Kanya*  
(Cruise - No.81)

St. no.	Date	Time (hrs)	Lat. (N)	Long. (E)	Biomass (ml/100 m <sup>3</sup> )
<i>Tanker route</i>					
2	30-1-93	1100	05°45'	82°00'	5.00
3	30-1-93	1905	05°45'	82°59'	6.25
4	31-1-93	0300	05°45'	84°00'	10.00
5	31-1-93	1045	05°45'	85°00'	5.00
6	31-1-93	1850	05°45'	85°58'	10.00
7	1-2-93	0255	05°45'	86°59'	10.00
8	1-2-93	1105	05°45'	87°59'	5.00
9	1-2-93	1940	05°43'	88°59'	12.50
10	2-2-93	0415	05°45'	90°00'	25.00
11	2-2-93	1200	05°45'	91°00'	10.00
12	2-2-93	2030	05°45'	92°00'	20.00
30	6-2-93	0615	05°45'	92°30'	17.50
31	6-2-93	1255	05°47'	91°30'	3.75
32	6-2-93	2020	05°45'	90°30'	50.00
33	7-2-93	0307	05°45'	89°30'	27.50
34	7-2-93	0954	05°45'	88°30'	5.00
35	7-2-93	1650	05°45'	87°30'	4.37
36	7-2-93	2326	05°44'	86°30'	7.50
37	8-2-93	0620	05°45'	85°30'	17.50
38	8-2-93	1248	05°45'	84°30'	Neg.
39	8-2-93	1930	05°45'	83°30'	10.00
40	9-2-93	0155	05°45'	82°30'	7.50
<i>Oil spilled site</i>					
13	3-2-93	1100	06°40'	93°29'	7.50
14	3-2-93	1415	06°42'	93°46'	7.50
15	3-2-93	1900	06°43'	94°02'	20.00
16	3-2-93	2240	06°44'	94°16'	20.00

*Contd....*

Table 1 — *Contd.*....

17	4-2-93	0230	06°44'	94°36'	25.00
18	4-2-93	0600	06°34'	94°44'	7.50
19	4-2-93	1100	06°23'	94°52'	5.00
20	4-2-93	1420	06°17'	94°35'	2.45
21	4-2-93	1655	06°30'	94°29'	25.00
22	4-2-93	2000	06°28'	94°12'	50.00
23	4-2-93	2300	06°15'	94°17'	50.00
24	5-2-93	0130	16°12'	04°04'	16.25
25	5-2-93	0345	06°24'	93°57'	10.00
26	5-2-93	1430	06°22'	93°41'	22.50
27	5-2-93	1730	06°07'	93°46'	60.00
28	5-2-93	2035	06°05'	93°30'	70.00
29	5-2-93	2310	06°17'	93°24'	37.50

Copepoda, Chaetognatha, Appendicularia, Euphausiacea, Siphonophora and Thaliacea etc. and the least being Sipunculida (Table 3). Among the tertiary producers, the fish larvae on an average were found to the tune of 0.04 to 0.42% and 0.09 to 0.20% along the tanker route and oil spilled site after 2 weeks and 8 months respectively, after the accident. Gonostomatid and Myetophid fish larvae constituted 90% of the fish larval population. At the same time catches from midwater trawling showed the successive dominance of fishes such as *Gymnocranius grandoculic*, *Lethrinus microdon*, *L. conchyliatus*, *Pseudobalistes flavimarginatus* and *Ostracion meleagris*. Corresponding values for fish eggs from the above cited areas and periods were 0.49 to 1.09% and 0.27 to 0.64% respectively. Contrary to the above, decapod larvae showed their dominance after the oil spill in both the areas compared to values after 8 months (Table 3). Among decapods, sergestids dominated, followed by brachyurans, carideans, penaeids and others. Tertiary production which is assumed as 10% of the secondary standing stock suggested a production of 0.44 to 5.00 g/m<sup>3</sup> and 0.56 to 7.23 g/m<sup>3</sup> during the two successive cruises along the tanker route and 0.25 to 7.00 g/m<sup>3</sup> and 0.23 to 8.33 g/m<sup>3</sup> in the oil spilled site respectively. It was interesting to note that the marine insect *Halobates* was found in good numbers all-over the area, more so along the tanker route.

The general trend noticed in the study was that the open ocean (tanker route) was relatively poor in zooplankton standing stock compared to the waters south of the great Nicobar Island. Fairly high production was noticed (>10ml/100 m<sup>3</sup>) from waters surrounding Sri Lanka, Andaman Sea and Bay of Bengal (Prasad, 1969; Panikkar & Rao, 1973). Areas near to the equator mostly showed poor production (<5ml/100 m<sup>3</sup>).

Table 2 — Station positions and zooplankton biomass *FORV Sagar Sampada* (Cruise - No. 113).

St. no.	Date	Time (hrs)	Lat. (N)	Long. (E)	Biomass (ml/100 m <sup>3</sup> )
<i>Tanker route</i>					
2975	24-9-93	2030	05°46'	82°09'	72.30
2976	25-9-93	0245	05°45'	83°00'	52.30
2977	25-9-93	1000	05°45'	84°00'	19.70
2978	25-9-83	1730	05°45'	85°00'	51.80
2979	26-9-93	0135	05°45'	86°00'	11.70
2980	26-9-93	0915	05°45'	87°00'	11.50
2981	26-9-93	1615	05°45'	88°00'	49.50
2982	26-9-93	2338	05°45'	89°00'	54.80
2983	27-9-93	0700	05°45'	90°00'	5.60
2984	27-9-93	1545	05°45'	91°00'	68.70
2985	27-9-93	2324	05°45'	92°00'	63.70
<i>Oil spilled site</i>					
2986	28-9-93	1017	06°24'	93°00'	7.50
2987	28-9-93	1420	06°34'	93°26'	15.60
2988	28-9-93	2123	06°05'	93°18'	75.30
2989	29-9-93	0215	06°24'	93°34'	73.00
2990	29-9-93	0640	06°42'	93°42'	47.80
2993	29-9-93	2104	06°22'	93°43'	83.30
2995	30-9-93	0355	06°09'	93°41'	16.80
2996	30-9-93	0724	05°56'	93°88'	2.30
2997	30-9-93	1152	05°56'	94°03'	36.60
2998	30-9-93	1600	06°21'	93°55'	10.60
3002	1-10-93	0000	06°24'	94°03'	25.50
3003	1-10-93	0353	16°10'	94°17'	77.60
3004	1-10-93	0820	06°28'	94°30'	11.90
3005	1-10-93	1205	06°34'	94°12'	8.60



Table 3 — Numerical abundance (NA) (no/100 m<sup>3</sup>) and relative percentage (RP) of different zooplankton group along the oil tanker route and oil spilled site after the incident

Group	Tanker route				Oil spilled site			
	After 2 weeks		After 8 months		After 2 weeks		After 8 months	
	NA	RP	NA	RP	NA	RP	NA	RP
1. Foraminifera	155	1.20	250	1.02	136	0.43	104	0.28
2. Hydromedusae	21	0.16	159	0.65	91	0.29	26	0.07
3. Siphonophora	114	0.85	60	0.24	567	1.79	230	0.61
4. Polycheata	3	0.02	6	0.02	215	0.68	450	1.20
5. Cladocera	66	0.49	170	0.69	555	1.75	1250	3.32
6. Ostracoda	5	0.04	12	0.05	61	0.19	150	0.40
7. Amphipoda	146	1.09	440	1.80	287	0.91	325	0.86
8. Copepoda	10062	75.30	14726	60.11	21777	68.84	28240	75.10
9. Sergestidae	53	0.40	992	4.05	73	0.23	244	0.65
10. Euphausiacea	129	0.97	1367	5.58	233	0.74	247	0.66
11. Mysidacea	107	0.80	36	0.15	174	0.55	350	0.93
12. Gastropoda	97	0.73	194	0.79	290	0.92	600	1.60
13. Heteropoda	43	0.32	489	1.99	121	0.38	344	0.91
14. Pteropoda	61	0.46	120	0.49	132	0.42	158	0.42
15. Cephalopoda	-	-	-	-	7	0.02	-	-
16. Chaetognatha	917	6.86	3284	13.41	2758	8.72	1458	3.88
17. Salps and doliolids	293	2.19	16	0.07	1572	4.97	30	0.08
18. Appendicularia	706	5.28	1500	6.12	1119	3.54	2250	5.98
19. Fish eggs	65	0.49	268	1.09	81	0.27	242	0.64
20. Fish larvae	5	0.04	108	0.42	29	0.09	76	0.20
21. Zoea larvae	58	0.43	52	0.21	120	0.38	75	0.20
22. Decapod larvae	199	1.49	126	0.51	1011	3.19	384	1.02
23. Echinoderm larvae	20	0.15	36	0.15	86	0.27	180	0.48
24. Polychaete larvae	2	0.01	5	0.02	15	0.05	40	0.11
25. Alima larvae	18	0.13	5	0.02	25	0.08	1	0.003
26. Megalopa larvae	13	0.10	19	0.08	69	0.22	140	0.37

Contd....

Table 3 — *Contd....*

27.	Lamellibranch larvae	-	-	-	-	3	0.01	-	-
28.	Brachiopod larvae	-	-	-	-	9	0.03	-	-
29.	Cirriped larvae	-	-	-	-	4	0.01	-	-
30.	Sipunculida	3	0.02	-	-	10	0.03	-	-
31.	Halobates	1	0.01	57	0.23	3	0.01	11	0.03
	Total	13362		24497		31633		37605	

It was observed that when Arabian Sea on an average had a biomass of 28.5 ml/100 m<sup>3</sup>, the zooplankton standing stock in the eastern region of the Indian Ocean and Java Sea ranged between 7.7 to 18 ml/100 m<sup>3</sup> (Prasad, 1969). General trend noticed was that, the eastern portion of the Indian Ocean becomes highly productive during northeast monsoon (December - February) (Panikkar & Rao, 1973). High biomass values overlapped areas of shallow surface layer in regions of upwelling. Bay of Bengal has been noticed for its high abundance of fish eggs and larvae and their present abundance towards the coastal areas suggest the possibility of their breeding grounds (Panikkar & Rao, 1973). Maximum zooplankton production reported in Andaman Sea was 100 - 150 ml/100 m<sup>3</sup> (Anon, 1988; Desai & Kesavadas 1988). Biomass of 164.04 ml/1000 m<sup>3</sup> have been noted for the shelf area (EEZ) of both east and west coasts of India and Andaman and Nicobar Islands together (Mathew *et al.* 1990). Oceanic areas of the Bay of Bengal, on an average had a biomass of only 36.65 ml/1000 m<sup>3</sup>, which was almost half when compared to corresponding areas in the Arabian Sea (Mathew *et al.* 1990). Earlier works from the Andaman Nicobar areas have reported an average biomass of 5.6 ml/100 m<sup>3</sup> (1.8 to 14.4 ml/100 m<sup>3</sup>) (Madhupratap *et al.* 1981 a, b) which is very poor when compared to later reports. Unlike the present finding, the above workers noted crustacea as the bulk constituent of the zooplankton. In their collections ostracods were present in 97% of the samples, whereas in the present collections they were totally absent. Of the estimated 7.9 million tonnes of fish production from the EEZ of India, Andaman and Nicobar waters had a share of 1.39 million tonne, though the present catch from the latter area is only 1500 tonne. A comparison of the zooplankton biomass data of the present observations in the oil spilled site with that of the earlier reports from the same area showed that the impact of the oil spill, either short-term or long-term, is not pronounced.

Arabian Sea and Bay of Bengal are important sea routes for most of the oil moving from the Gulf to the Far East and thus vulnerable to oil discharge either accidentally or on account of routine shipping activities (Desai & Kesavadas, 1988). Arabian Sea is the world's busiest tanker route with maximum oil slick (Sengupta & Qasim, 1982).

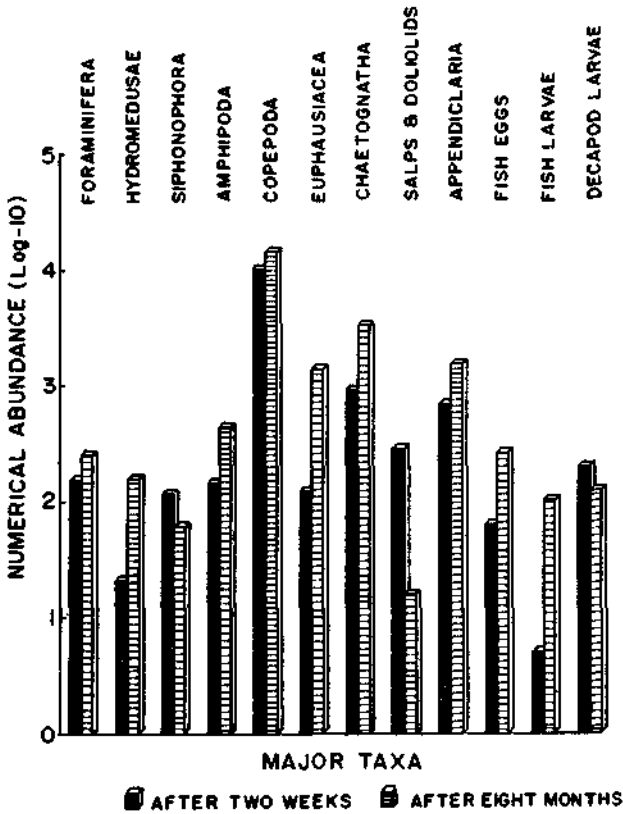

Fig.3 - Numerical abundance of major zooplankton groups-oil tanker route

Compared to Arabian Sea, Bay of Bengal is less polluted in terms of oil slicks and related floating tar balls as evidenced by the present and earlier studies.

The various physico-chemical changes that take place when crude oil is spilled at the sea and its effect on marine biota are explained by various workers (Bonsdorff, 1981; Gerlach, 1981). Andaman waters are not influenced by oil tanker traffic or significant oil pollutants from sewage or land run off (Topgi *et al.* 1981). Data based on the above 1979 observations in this area, showed that the dissolved petroleum hydrocarbon concentrations ranged between 28 and 83  $\mu\text{g/l}$  at 0-10 m and the average being  $51 \pm 1$  and  $55 \pm 1.2 \mu\text{g/l}$  respectively. In another observation the authors have reported  $73 \pm 1.3$  and  $61 \pm 1.4 \mu\text{g/l}$  at the surface and 10 m respectively from the oil tanker route across the Bay of Bengal which are higher compared to Goan waters (Fondekar *et al.* 1980). The global range estimated is 0-100  $\mu\text{g/l}$  (Farrington & Mayer, 1975). The range of floating tar balls in the oil tanker route in the Bay of Bengal was 0-69.75  $\text{mg/m}^2$  and the mean concentration of dissolved and dispersed hydrocarbons

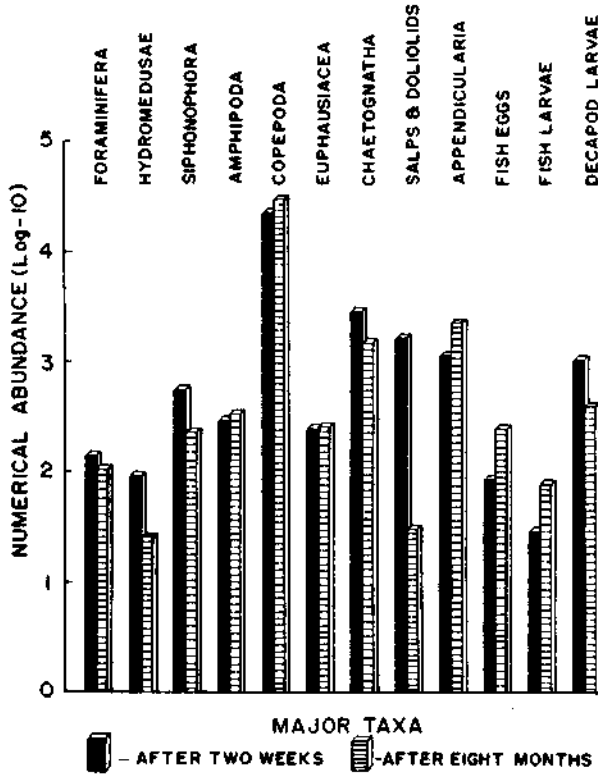

Fig.4 - Numerical abundance of major zooplankton groups - oil spilled site

for 0-20 m was  $24.1 \mu\text{g/l}$  (Sengupta & Kureishy, 1981). North of this route, Bay of Bengal was relatively free from floating tar balls. The dissolved petroleum hydrocarbons along the oil tanker route in the southern Bay of Bengal at 0, 10 and 20 m was  $19.95 \pm 3.38$ ,  $16.78 \pm 2.53$  and  $13.45 \pm 2.17 \mu\text{g/l}$  respectively (Topgi *et al.* 1982). In any case, the oil tanker route in the Bay of Bengal is far less contaminated as compared to many oil tanker routes in various geographical areas.

The present study in the Nicobar area conducted after the oil spill showed that the dissolved petroleum hydrocarbons got reduced remarkably from a maximum of  $5.4 \text{ mg/l}$  to  $0.31 \mu\text{l}$  over a span of 8 days and in the tanker route, it reduced from  $15.4$  to  $0.31 \mu\text{g/l}$  (Anon, 1993). Tar balls were absent in all the stations of the spill area and it was present in a few stations in the tanker route. Zooplankton samples collected during the second cruise from the spilled site showed double concentration of aliphatic hydrocarbon (0.60% of dry weight) when compared to samples from tanker route. Coral debris collected 15 km south of Campbell Bay also showed traces of aliphatic hydrocarbons (0.003% of dry weight) (Anon, 1993). Aromatic hydrocarbons

did not show much variations in zooplankton from the oil spilled site (0.16% of dry weight) and the tanker route (0.098% of dry weight).

Immediately after an oil spill zooplankton will ingest oil, but this phenomena is short lived. Traces of aliphatic and aromatic hydrocarbons noticed in the mixed zooplankton collected from areas south of great Nicobar did not show any pronounced effect on the zooplankton standing stock as evidenced by their dense concentrations. The regular wash and spill from the oil tankers along the tanker route might get accumulated in these areas during this time of the season (September-November) which is a transitional period for both prevailing winds and currents (Wyrski, 1973) thereby allowing more residence time for the petroleum products to disperse and disintegrate.

From the studies made, one can confidently conclude that the oil spill in the Nicobar waters might not have inflicted any serious lethal effect on the biota or any ecological distortions whether short or long-term. The oil patch traced to the south of great Nicobar was broken into patches by winds, currents and waves and it got drifted towards the west-south westerly direction with decreasing concentrations away from the accident site towards the open ocean.

### ACKNOWLEDGEMENT

Authors are thankful to Dr. E. Desa, Director, NIO, Goa for providing facilities to carry out this work, and Dr.R. Sengupta, Emeritus Scientist, NIO, Goa for his active and dynamic guidance. Thanks are also due to the captains and crew of *ORV Sagar Kanya* cruise 81 and *FORV Sagar Sampada* cruise 113 for their help and co-operation throughout the survey.

### REFERENCES

- Anon. 1988. *Oceanographic atlas of the EEZ of India*, Vol. 1, (NIO, Goa).
- Anon. 1993. *Maersk Navigator oil spill in the great channel (Andaman Sea)*, Technical Report 1 & 2 (NIO, Goa), No. 1:1-19 & No.2:1-20.
- Bonsdorff, E. 1981. Antonio Gramsci oil spill, *Mar. Poll. Bull.*, 12(9): 301-305.
- Desai, B.N. & Kesavadas, V. 1988. Oceanography of the EEZ of India. In: *40 years of research - A CSIR overview*, edited by N.R. Rajagopal, (CSIR, New Delhi) 23-52.
- Farrington, J.W. & Mayer, P.A. 1975. In: *Environmental chemistry*, Vol.1, edited by G. Eglinton; (The Chemical Society, UK) 1-109.
- Fondekar, S.P., Topgi, R.S. & Noronha, R.J. 1980. Distribution of petroleum hydrocarbons in the Goa coastal waters. *Indian J. Mar. Sci.* 9: 286-288.
- Gerlach, S.A. 1981. Oil pollution, In: *Marine pollution diagnosis and therapy*, (Springer - Verlag, Berlin) 71-96.
- Madhupratap, M., Achuthankutty, C.T., Sreekumaran Nair, S.R. & Nair, V.R. 1981 a. Zooplankton abundance of the Andaman Sea, *Indian J. Mar. Sci.* 10(3):258-261.
- Madhupratap, M., Sreekumaran Nair, S.R., Achuthankutty, C.T. & Nair, V.R. 1981 b. Major crustacean groups and zooplankton diversity around Andaman - Nicobar Islands. *Indian J. Mar. Sci.* 10(3): 266-269.

- Mathew, K.J., Naomi, T.S., Geetha Antony, Vincient, D., Anilkumar, R. & Solomon, K. 1990. Studies on zooplankton biomass and secondary and tertiary production of the EEZ of India, In: *Proc. First Workshop Scient. Resul. FORV Sagar Sampada*, edited by K.J. Mathew, (CMFRI, Cochin) 59-96.
- Panikkar, N.K. & Rao, T.S.S. 1973. Zooplankton investigation in Indian waters and the role of the Indian Ocean Biological Centre. *Handbook to the International Zooplankton Collections*, (Indian Ocean Biological Centre, NIO, CSIR, Cochin) 5: 11-162.
- Prasad, R.R. 1969. Zooplankton biomass in the Arabian Sea and the Bay of Bengal with a discussion on the fisheries of the region, *Proc. Nat. Inst. Sci. India*, 35(5): 399-437.
- Sengupta, R. & Kureishy, T.W. 1981. Present state of oil pollution in the northern Indian Ocean, *Mar. Poll. Bull.* 12(9): 295-301.
- Sengupta, R. & Qasim, S.Z. 1982. Oil pollution studies in northern Indian Ocean, *Petroleum Asia Journal*, Dec-Feb, 1982: 34- 37.
- Topgi, R.S., Noronha, R.J. & Fondekar, S.P. 1981. Dissolved petroleum hydrocarbons in the Andaman Sea. *Indian J. Mar. Sci.* 10: 241-242.
- Topgi, R.S., Noronha, R.J., Fondekar, S.P. & Sengupta, R. 1982. Dissolved petroleum hydrocarbons along the oil tanker route in the southern Bay of Bengal, *Indian J. Mar. Sci.* 11: 175-176.
- Wyrki, K. 1973. Physical oceanography of the Indian Ocean, In: *Biology of the Indian Ocean*, edited by B. Zeitzschel, (Springer - Verlag) 18-36.

\* \* \*

## **Pelagic tunicata from the seas around Andaman & Nicobar group of islands**

P.Dhandapani

Marine Biological Station, Zoological Survey of India, 100 Santhome High Road,  
Madras - 600 028

### **ABSTRACT**

Plankton samples from 20 stations were collected from the seas around Andaman & Nicobar Islands revealed the presence of 13 species of salps 5 species of doliolids, 1 species of pyrosome and 21 species of Larvacea of which many proved to be new distributional records.

### **INTRODUCTION**

The pelagic tunicates comprise of two classes, i.e. Thaliacea (salps, doliolids and pyrosomes) and Larvacea (appendicularians), form the second level feeders, but not secondary producers, in the marine pelagic foodchain. Also, in the pelagic ecosystem, they play an active role as a safety valve to maintain a balance in the phyto-zooplankton proportion in the sea (Dhandapani, 1981). All the pelagic tunicates are so sensitive to environmental parameters that they form isolated communities of a specific water-mass, thus indirectly act as indicator of watermasses (Tokiooka, 1940; Thompson, 1942, 1948; Fraser, 1949; Ganapathi & Bhavanarayana, 1958). Therefore, the present account which is the study of samples collected from the waters close to Andaman & Nicobar Islands covering the area from 6.3° to 15° N lat., 91° to 95° E long. and should be significantly different from other collections made at scattered stations from the Bay of Bengal by other workers (Tokiooka, 1955; Ganapathy & Bhavanarayana, 1958; Fenaux, 1969; Dhandapani, 1977 a,b).

### **MATERIALS AND METHODS**

Twenty plankton samples were collected from the seas around Andaman & Nicobar Islands (Fig.1) during cruise 46 of *FORV Sagar Sampada* (26 April to 19 May 1988), from 200 m to surface at stations where the depth prevailed. At stations where

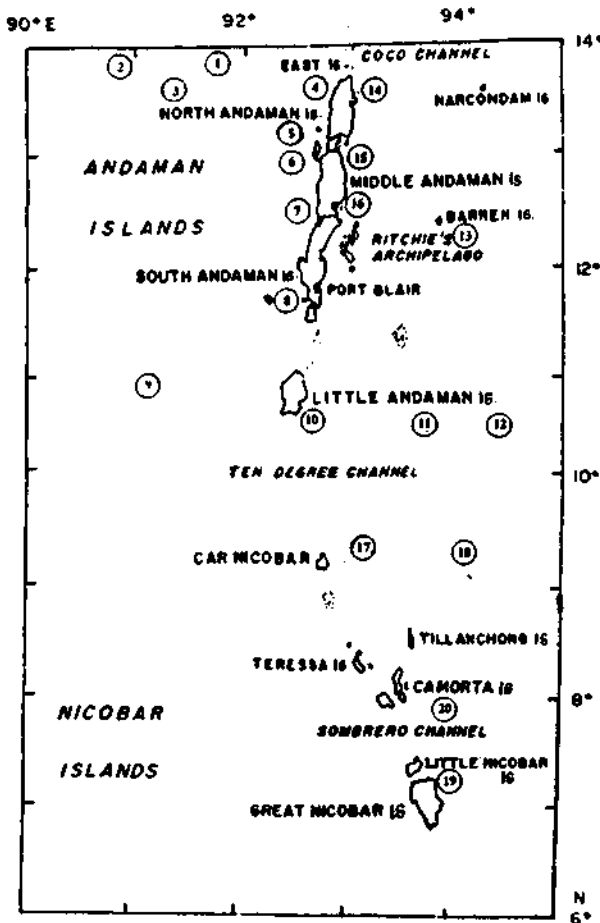

Fig.1 — Map showing sampling stations in A&N Islands

depth was below 200 m, approximately a 10 m clearance was given from sea bottom to avoid the net from touching the bottom before drawing the net to surface. The samples were sorted out for salps, doliolids, pyrosomes and appendicularians. The samples were stained in 1% Rose Bengal solution for identification.

## RESULTS AND DISCUSSION

As it is a study to estimate the quality and distributional pattern of pelagic tunicates, an attempt is made only to list (Table 1) the species with relevant remarks as and when needed as follows :



- Class : Thaliacea  
 Order : Salpida  
 Family : Salpidae  
 Subfamily : Cyclosalpinae  
 Genus : *Cyclosalpa* de Blainville, 1827  
*Cyclosalpa sewelli* Metcalf, 1927

It is a credit to Andaman & Nicobar seas to contribute the type species from the Nan Cowri Harbour of Nicobar group of islands. This species is well distributed in the tropical belt of both Indian and Pacific Ocean but absent in Atlantic Oceans. Presently the species is collected from sts. 1, 14 and 16 but not from the type locality.

*Cyclosalpa floridana* (Apstein, 1894)

The type locality is from Western North Atlantic. Although this species is recorded from all the three oceans, the concentration seem to be more in the Indo-Pacific region. Sewell (1926) has recorded this species from the Nicobar region but the present study specimen is from st. 12 which lies more towards Mergui Archipelago.

- Subfamily : Salpinae  
 Genus : *Thalia* Blumenbach, 1798  
*Thalia democratica* (Forskal, 1775)

The type locality is near Molloraca, Western Mediterranean; and the world distribution is from lat. 45° S to 50° N lat. all around the globe (Van Soest, 1973). Presently, it is recorded from sts. 3,6,7,10-16 which are located north of 10° lat. channel of Andaman & Nicobar waters.

*Thalia rhomboides* (Quoy & Gaimard, 1824)

The type locality is between Re'union and Australia. The world distribution is limited to certain pockets like Malay Archipelago, Red Sea, Capetown and Polynesian islands and to tropical belt. The present record is at sts. 1,6 and 18 which are above 10° lat. channel; and this is the first record of occurrence in Andaman & Nicobar seas.

*Thalia longicauda* (Quoy & Gaimard, 1824)

The type locality is near Port Jackson, E. Australia; and the world distribution is known from eastern coast of S. America and both in the Atlantic and Indian Ocean parts of Africa. Presently it is recorded from st. 12 which is more toward Mergui Archipelago. This is the first record for this part of Indian Ocean.

*Thalia orientalis* Tokioka, 1937

The type locality is at Misaki, central east coast of Japan. But the world distribution indicates a major concentration in Atlantic. For the first time this is recorded from Indian Ocean in Andaman Sea at sts. 3 and 4 which are between 13° and 14° N lat.

Table 1 — Qualitative distribution in each station

S.no.	Species	Stations																			
		1	2	3	4	5	6	7	8	9	10	11	12	13	14	15	16	17	18	19	20
1.	<i>Cyclosalpa sewelli</i>	+												+		+					
2.	<i>Cyclosalpa floridana</i>											+									
3.	<i>Thalia democratica</i>			+			+	+			+	+	+	+	+	+	+				
4.	<i>Thalia rhomboides</i> *	+					+										+			+	
5.	<i>Thalia longicauda</i> *											+									
6.	<i>Thalia orientalis</i> *			+	+																
7.	<i>Thalia cicar</i> *									+											
8.	<i>Thalia sibogae</i> *		+	+						+											
9.	<i>Rittriella amboinensis</i>								+		+										
10.	<i>Ritteriella picteti</i>						+														
11.	<i>Ritteriella retracta</i> *						+					+									+
12.	<i>Brooksia rostrata</i>						+		+							+					
13.	<i>Wheelia clyndrica</i>										+		+			+	+				
14.	<i>Doliolum denticulatum</i>	+	+	+	+	+				+						+	+				
15.	<i>Doliolum nationalis</i> *																	+			+

Contd....

Table 1 - Contd...

S.no.	Species	Stations																			
		1	2	3	4	5	6	7	8	9	10	11	12	13	14	15	16	17	18	19	20
16.	<i>Doliolum ehrenbergi</i>						+	+	+	+	+			+	+						
17.	<i>Doliolina mulleri</i>	+	+	+						+		+	+								
18.	<i>Dolioletta genenbauri</i>			+						+			+								
19.	<i>Doliopsis rubescence*</i>									+											
20.	<i>Pyrosoma atlanticum*</i>	+		+						+			+							+	+
21.	<i>Oikopleura albicans*</i>	+		+			+								+						
22.	<i>Oikopleura cophocerca</i>			+							+		+	+							
23.	<i>Oikopleura dioica*</i>	+							+		+		+		+			+		+	+
24.	<i>Oikopleura fusiformis</i>				+					+										+	
25.	<i>Oikopleura cornutogastra*</i>		+		+			+		+			+								+
26.	<i>Oikopleura intermedia*</i>			+		+	+			+	+		+					+			
27.	<i>Oikopleura longicauda</i>		+	+	+		+			+	+	+		+	+			+	+		+
28.	<i>Oikopleura parva</i>		+																		
29.	<i>Oikopleura refescence</i>	+	+	+	+										+	+			+	+	
30.	<i>Stegosoma magnum*</i>			+								+	+							+	+

Contd....

Table 1 – Contd...

S.no.	Species	Stations																			
		1	2	3	4	5	6	7	8	9	10	11	12	13	14	15	16	17	18	19	20
31.	<i>Stegosoma indica</i> *								+	+	+		+				+			+	
32.	<i>Megalocercus huxleyi</i>	+	+		+	+	+	+			+	+	+		+	+	+	+			+
33.	<i>Althufia sp.</i> *				+																
34.	<i>Pelagopleura sp.</i>	+																			
35.	<i>Fritillaria borealis</i>	+	+	+	+	+							+				+		+	+	+
36.	<i>Fritillaria formica f. digitata</i>				+				+					+	+				+		
37.	<i>Fritillaria fraudax</i> *				+																
38.	<i>Fritillaria haplostoma</i> *				+								+	+			+	+			+
39.	<i>Fritillaria pellucida</i>		+	+		+	+	+		+			+			+					
40.	<i>Fritillaria bicornis</i> *				+																
41.	<i>Tectillaria fertilis</i>		+	+																	
	Total	11	11	21	8	5	11	7	4	13	9	6	17	5	9	7	9	6	6	9	7

\*Indicate new records.

*Thalia cicar* Van Soest, 1973

The type locality is north of Curaco along the northern coast of South America. It is further recorded from Red Sea and Timor Sea. Present record is the first for Andaman Sea at st. 9 only, which is situated east of Little Andamans.

*Thalia sibogae* Van Soest, 1973

The type locality is from Japanese waters in Sulu-Archipelago. The present recording in Andaman Sea (at sts. 2,3 and 8) is a new record to Indian Ocean and the second record after the type description.

Genus : *Ritteriella* Metcalf, 1919

*Ritteriella amboinensis* (Apstein, 1904)

The type locality of the species is from near the Island of Ambon (Indonesia). This species is well represented in the Indian and Pacific Ocean but rare in Atlantic Ocean. Sewell (1926) has recorded this species from Andaman Sea and the present recording is from sts. 7 and 9 only.

*Ritteriella picteti* (Apstein 1904)

The type locality is from near the Island of Ambon (Indonesia) and this species is distributed in the tropical region of Indian and Pacific Oceans. Sewell (1926) has recorded this species from the Andaman Sea. Present study records this species from st. 6 only.

*Ritteriella retracta* (Ritter, 1906)

The type locality of this species is from near Japan and this species is distributed from 40°S to 50°N in all the three oceans. This is a new distributional record for the Andaman Sea and has been collected from sts. 6, 11 and 18.

*Brooksia rostrata* (Transtedt, 1893)

The type locality of the species is from Atlantic Ocean. This species is well represented in the tropical belt of all the three oceans. Sewell (1926) recorded this species only from Nicobar area. Present record from sts. 6, 8 and 15 indicates its popular occurrence around Andaman Islands also.

Genus : *Wheelia* Yount, 1954

This genus is represented by a single species, *Wheelia cylyndrica* which was formerly placed under genus *Salpa*.

*Wheelia cylyndrica* (Cuvier, 1804)

The type species is from Mediterranean. Although very common in Bay of Bengal, during the present study this species was collected only at sts. 10, 12, 15 and 16.

Order : Doliolida

Family : Doliolidae

Genus : *Doliolum* Quoy & Gaimard, 1835

*Doliolum denticulatum* Quoy & Gaimard, 1835

The type locality of this species is from Pacific Ocean near New Zealand. The global distribution of this species is so wide that it is found both in tropical and temperate waters. The specimen of the present study was collected from sts. 1-5, 9, 13, 15 and 16 showing a wider distribution all around Andaman group of islands.

*Doliolum nationalis* Borgert, 1893

The type locality of this species is from Atlantic Ocean. This species is distributed in all the three oceans both in temperate and tropical waters. Presently *D.nationalis* is recorded from sts. 18 and 19 which fall under Nicobar group of islands and is the first record for this area.

*Doliolum ehrenbergi* Krohn, 1852

The type locality of this species is Mediterranean Sea. Although considered as a variety of *D.denticulatum*, this species shows distinct morphological characters to be recognised as a species. Being cosmopolitan, this species has been recorded both in temperate and tropical waters. In the present collection it may be noted that it occupies an equal status with *D.denticulatum* by being present at sts. 6-10, 12-14. Earlier, this species was recorded off Great Nicobar Island (Dhandapani, 1977).

Genus : *Doliolina* Borgert (1894)

*Doliolina mulleri* (Krohn, 1852)

The type locality is the Mediterranean Sea; but is distributed both in temperate and tropical waters. This has been recorded previously from Great Nicobar Island (Dhandapani, 1977). During the present study it has been collected from sts.1-3, 9,11,12,18 and 19 thus covering the entire study area.

Genus : *Dolioletta* Borgert (1894)

*Dolioletta genenbauri* (Uljannin, 1884)

The type locality of this species is Mediterranean Sea. This species reproduces so prolifically that under suitable conditions it forms a swarm to cover many square kilometres. Strangely this species was collected only st. 3.

Genus : *Doliopsis* Vogt, 1854

*Doliopsis rubescence* Vogt, 1854

This is a rare group of doliolid with five body muscles and the type species is from the Mediterranean Sea. This species was earlier recorded in the Malacca Strait (Dhandapani, 1977) and the present collection at st. 9 which lies east of Little Andaman, is a new record for this area.

Order : Pyrosomida

Family : Pyrosomatidae

Genus : *Pyrosoma* Peron, 1804

*Pyrosoma atlanticum* Peron, 1804

The type species is from Atlantic Ocean. This species has world- wide distribution and therefore the present record, although indicates a new distributional pattern, cannot be considered as significant. Colonies of about 15 to 20 cms were collected at sts. 1 and 3 in the trawl net, though not in plankton nets. The tetrazoids were present in the plankton collection of sts. 9,12,19 and 20.

Class : Larvacea

Family : Oikopleuridae

Sub family : Oikopleurinae Lohman,1933

Genus : *Oikopleura* Mertens, 1831

*Oikopleura albicans* (Leuckart, 1854)

Samples were collected from sts. 1, 6 and 14 and is the first record of the species from Andaman & Nicobar seas.

*Oikopleura cophocerca* (Gegenbaur, 1855)

Previously recorded by Fenaux (1969), this species was collected from sts. 3, 10 and 12.

*Oikopleura dioica* Fol, 1812

This is the first record for Andaman Sea and has been collected from sts. 1, 10, 12, 14, 17, 19 and 20.

*Oikopleura fusiformis* Fol, 1872

This species has been recorded by Fenaux (1969) in many stations around Andaman Sea. The present collections represent sts. 4, 7, 9 and 19, thus showing extensive distribution.

*Oikopleura cornutogastra* (Aida, 1907)

This is a new distributional record from Andaman & Nicobar seas. Present study reveals its distribution in larger area but in few collections made at sts. 2, 4, 7, 9 and 20.

*Oikopleura intermedia* Lohmann, 1896

This species was previously recorded by Fenaux (1969) off 95° long. The present record indicates its presence from sts. 3, 5, 6, 9, 10, 12 and 17, thus showing a new pattern of distribution in the Andaman & Nicobar Islands.

*Oikopleura longicauda* (Vogt, 1854)

This is another common species found extensively distributed in this sea and was recorded at sts. 2-4 & 9-10, 13, 14, 17, 18 and 20.

*Oikopleura parva* Lohmann 1896

This was previously recorded from close to Great Nicobar Island (Fenaux, 1969; Dhandapani 1977 a,b). Present record at sts. 2 and 12 extends its distribution to seas around northern groups Islands also.

*Oikopleura rufescence* Fol, 1872

This species was well represented in the Andaman & Nicobar seas in IIOE collection (Fenaux, 1969). Similarly, the present record shows an extensive distribution around the entire group of islands as represented at sts. 1-4, 14, 15, 18 and 19.

Genus : *Stegosoma* Chun, 1888

*Stegosoma magnum* (Langerhans, 1880)

It is a new distributional record for this area. The presence of this species at sts. 3, 11, 12, 19 and 20 indicates its rarity of occurrence.

*Stegosoma indica* Dhandapani, 1977

The paratypes of this species were collected at the entrance of Malacca Strait (Dhandapani, 1977 b). The present recording at sts. 8-10, 16 and 19 extends its distribution all around Andaman & Nicobar Islands.

Genus : *Megalocercus* Chun 1888

*Megalocercus huxleyi* Chun, 1888

This is a highly cosmopolitan species found in all seas of the world preferably limited to the tropical belt. Previously recorded by Fenaux (1969), the present recording at sts. 1,2,4-7,10-12,14-17 and 20 obviously indicates its extensive distribution in this area.

Genus : *Althufia* Lohmann 1896

*Althufia* sp.

Only one slightly mutilated sample was recorded at st.3 and despite the fact that only one species (*A.tumida*) is known in this genus, this sample needs further study for confirmation. This is the first record of this genus in Bay of Bengal.

Genus : *Palagopleura* Lohmann, 1926

*Pelagopleura* sp.

Only one sample of doubtful identification of this genus was handled at st.3. Similar doubtful occurrence was reported previously by Fenaux (1969) in the central Bay of Bengal area and also close to Visakhapatnam coast, along the east coast of India.

Family : Fritillariidae Seeliger, 1895

Genus : *Fritillaria* Quoy & Gaimard, 1833

*Fritillaria borealis* Lohmann, 1905

This has been previously recorded by Fenaux (1969) and the present collection at sts. 1-5,12,16,18-20 indicates its extensive distribution in this part of Indian Ocean.

*Fritillaria formica f. digitata* Lohmann & Buckman, 1926

It is surprising that this form of species *F.formica* is not yet being recognised as a distinct species; and a confirmation may be made only after analysing its global distributional pattern. Presently this form was collected at sts. 3, 7, 13, 14 and 18.

*Fritillaria fraudax* Lohmann, 1896

This is the first record of this species in this part of the Indian Ocean, and only one specimen was collected from st.3.

*Fritillaria haplostoma* Fol, 1872

This is the first record of this species from the Andaman & Nicobar seas. Present record of this species from sts. 3, 12, 16, 17 and 19 indicates its extensive distribution in this area.

*Fritillaria pellucida* (Busch, 1851)

Fenaux (1969) recorded this species off Nicobar group of islands. Dhandapani (1977 b) recorded *F. Omani*; but the collection of *E.pellucida* at sts. 2, 3, 5, 6, 7, 9, 12 and 15 reveals its extensive occurrence in this part of Indian Ocean.

*Fritillaria bicornis* Lohmann, 1896

This is the first record of this species from Bay of Bengal and has been collected from st. 3 only which indicates its rarity.



Genus : *Tectillaria* Lohmann, 1926  
*Tectillaria fertilis* (Lohmann, 1896)

Previously recorded by Fenaux (1969), this species was recorded from sts. 2 and 3 which lies at 91° latitude.

The productivity of an ecosystem, particularly of the marine environment, can be assessed only on the basis of the quality and quantity of the primary producers and the resultant grazers. Being suspension feeders, with an increasing rate of feeding in proportion to the availability of primary producers, the quality of pelagic tunicates present is indicative of productivity of the sea. The occurrence of 41 different species of pelagic tunicates collected within a period of 15 days in Andaman & Nicobar seas is an evidence of its high productivity. Work on the pelagic ecosystem of this area is desired to follow the food chain to estimate fish production of this marine ecosystem.

### ACKNOWLEDGEMENT

The author is thankful to Capt. Ramaswamy, Chief Officer; Chief Scientist K.G. Girijavallabhan and all other colleagues of various institutions for their co-operation.

### REFERENCES

- Dhandapani, P. 1977 a. On doliiodids collected from the Bay of Bengal. (*Proc. Symp. Warm Water Zoopl.*) (UNESCO/NIO, Goa) pp.13- 17.
- Dhandapani, P. 1977 b. Descriptions of two new species of Larvacea with a list of other species collected from the Bay of Bengal. (*Proc. Symp. Warm Water Zoopl.*) (UNESCO/NIO, Goa) pp.60- 64.
- Dhandapani, P. 1981. The role of Thaliacea in marine plankton ecosystem. (*Proc. Symp. Ecol. Amin. Popul.*) Part I, (Zool. Surv. India, Calcutta) pp 51-71.
- Fenaux, R. 1969, Les Appendicularies du Golfe du Bengale. (*Mar. Biol.*) 2(3): 252-263.
- Franser, J.H. 1949. The Distribution of Thaliacea in Scottish waters. (*Scientific Investigation No.1*), Scottish Home Dept. pp. 1-44.
- Ganapati, P.N. & Bhavanarayana, P.V. 1958. Pelagic tunicates as indicators of water movements off Waltair coast. (*Curr. Sci.*) 27 : 57-58.
- Sewell, R.B.S. 1926. The salps of the Indian Seas. (*Rec. Indian Mus.*) 28 : 65-126.
- Thompson, H. 1942. Pelagic tunicates in the plankton of South- eastern Australian waters, and its place in oceanographic studies. (*CCSIR, Australia, Bull.*) No.153.
- Thompson, H. 1948. Pelagic tunicates of Australia. (*CCSIR, Australia*), pp.196, pl.75.
- Tokioka, H. 1940. Some additional notes on Japanese appendicularian fauna. (*Rec. Oceanogr. Works Japan*), 11(1): 1-26.
- Tokioka, T. 1955. A small collection of chaetognaths and pelagic tunicates from the north-eastern part of the Indian Ocean. (*Publ. Seto Mar. Biol. Lab.*) 5(1): 74-78.
- Van Soest, R.N.M. 1973. The genus (*Thalia*) Blumenbach, 1798 (Tunicata : Thaliacea), with descriptions of two new species. (*Beaufortia*) (No.271), 20: 193-212.

## **Quantitative abundance of amphipods around Andaman-Nicobar Islands**

Molly Varghese, K. J. Mathew, T. S. Naomi, Geetha Antony & K. Solomon  
Central Marine Fisheries Research Institute, PB No 1603, Cochin- 682 014

### **ABSTRACT**

The present study deals with the quantitative distribution and abundance of amphipods of the Andaman Sea in time and space, based on the zooplankton samples collected during the cruises 46- 73 of *FORV Sagar Sampada* during 1988-1990. Mean number of amphipods (no/1000 m<sup>3</sup>) reached the maximum of 1763 in January and the minimum of 315 in July. The seasonal density was maximum during the northeast monsoon and minimum for the southwest monsoon and their mean numbers were estimated as 812 and 463/1000 m<sup>3</sup> respectively. In general, they were abundant in the region where the station depths ranged between 50 and 100 m with the mean estimated as 800/1000 m<sup>3</sup> of water. Analysis of day and night samples did not show any remarkable variation. The distribution and abundance of amphipods in relation to time and space are discussed in the paper.

### **INTRODUCTION**

The amphipods enjoy a worldwide distribution and they form an important food item for fishes (Nair, 1972). Nair *et al.* (1973) while studying the Amphipoda in the Indian Ocean, have mentioned very little about the abundance of this group in the Andaman Sea. Revikala *et al.* (1990) have made a general study of the amphipods of the Indian EEZ based on random sampling and indicated higher density of amphipods in Andaman Sea also. However, the information about the quantitative abundance of this important group of crustaceans in space and time in the Andaman Sea is less investigated. Hence, an attempt was made to study the distribution and quantitative abundance of amphipods in space and time, around Andaman-Nicobar Islands, making use of the samples collected over a period of two years on board *FORV Sagar Sampada* during cruises 46-73 during 1988-90.

## MATERIALS AND METHODS

The material for the study was obtained from the zooplankton collections of *FORV Sagar Sampada* (12 cruises) to the seas around Andaman-Nicobar groups of islands during April 1988 - May 1990. The zooplankton was collected by oblique hauls from an average depth of 150 m to the surface using a Bongo 60 net (mesh aperture 0.50 mm) fitted with a calibrated flow meter. Aliquots of minimum 5 ml of zooplankton were analysed whenever the biomass determined by displacement volume exceeded this quantity. Out of this the average number of amphipods present in  $1000\text{ m}^3$  of water per half a degree square area was estimated.

Studies on latitudewise, depthwise, seasonal, monthly and day and night variations were made. For the requirement of the study, the total area was conveniently divided into 4 latitudes such as: 1)  $6^{\circ}30'N - 8^{\circ}30'N$ , 2)  $8^{\circ}30'N - 10^{\circ}30'N$ , 3)  $10^{\circ}30'N - 12^{\circ}30'N$  and 4)  $12^{\circ}30'N - 14^{\circ}30'N$ , and the number of specimens obtained in each zone was compared. Studies pertaining to the quantitative distribution of amphipods were done for the depth zones such as  $< 50\text{m}$ ;  $51-100\text{m}$ ;  $101-200\text{m}$  and  $>200\text{m}$ . The period of study was divided into 3 seasons such as - premonsoon (February-May), southwest monsoon (June-September) and northeast monsoon (October-January) and the numerical abundance during each season was also studied.

## RESULTS AND DISCUSSION

*Frequency of sampling and geographical distribution* - Out of the 249 stations covered, 101 stations were located in the west and 148 in the east of Andaman-Nicobar islands. The frequency of sampling in each half degree square is shown in Fig.1. Of the 249 zooplankton samples, 248 contained amphipod population. The mean number of amphipods for the entire area estimated as 629 per  $1000\text{ m}^3$  of water, which is only 0.70% of the total zooplankton. Jossi (1972) also stated that percentage contribution by numbers of the amphipods to the total zooplankton averaged less than 1% while studying amphipods in the Arabian Sea, Java Sea, and the Indian Ocean. The distribution pattern of amphipods around the island is depicted in Fig.1. Higher concentration was noticed in the northwestern part of north Andaman, near Port Blair, southern and eastern parts of Car Nicobar and southwestern portion of Great Nicobar, where, the population density was between 1001 and 5000 numbers per  $1000\text{ m}^3$  of water. Areas of poor concentration were observed between Little Andamans and Car Nicobar, and between Little Andamans and the main groups of Andaman islands slightly towards the west, where, the density was  $<100/1000\text{ m}^3$ .

*Variations in shelf and oceanic regions* - Since the continental shelf area is very narrow, only 55 samples were collected from there and the rest 194 were from the adjacent oceanic region and the average numbers present in the 2 regions were 672 and 622 respectively, showing a slightly higher density in the shelf area (52%) than in oceanic waters (48%). Similar observation was made by Revikala et al. (1990) in the EEZ of India and adjoining seas.

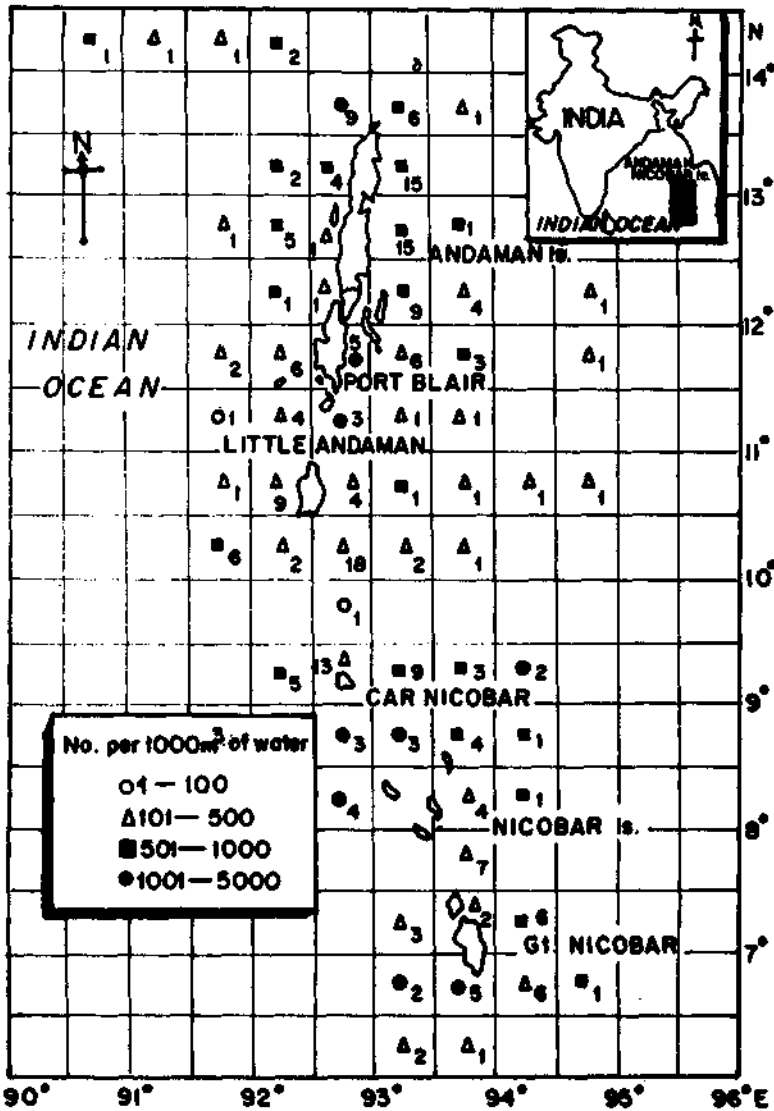

Fig.1 - Sampling frequency (in each half degree square) and geographical distribution of amphipods (no/1000 m<sup>3</sup>) around Andaman-Nicobar islands

*Latitudewise distribution* - There was a gradual increase in the density of amphipod population from south to north i.e. from 6°30'N to 14°30'N except the region between 10°30'N and 12°30'N, where the least concentration was observed(Fig.2). However, the entire area was rich in amphipod population with more than 500 specimens present in each region, with a minimum of 513 in the 3rd region and maximum of 732 in the 4th region. The maximum density of amphipods recorded in

the 4th region i.e. between  $12^{\circ}30'N$  and  $14^{\circ}30'N$  can be due to a low saline cold water condition prevailed in these latitudes (Mathew et al. 1994).

*Seasonal distribution in different latitudinal sectors* - The distribution in different latitudinal regions became more clear from the seasonal study in these 4 areas (Fig.3). Compared to other two seasons, the mean numbers were low during the

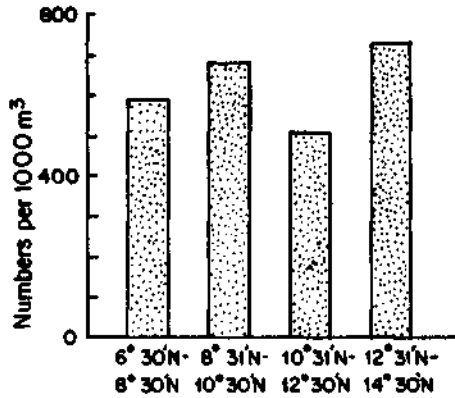

Fig.2 - Regionwise variation in the abundance of amphipods

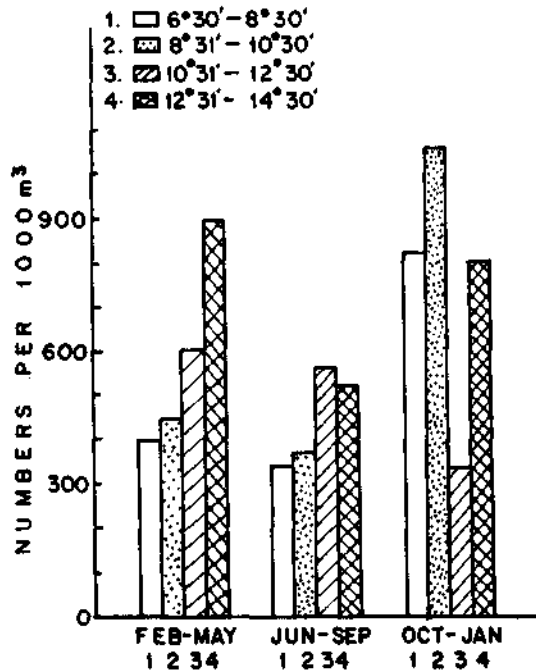

Fig.3 - Seasonal variations in the abundance of amphipods in different latitudinal regions

southwest monsoon season in the 1st, 2nd and 4th latitudinal regions, and the density steadily increased from 1st to 4th region, during premonsoon period. The low value in the 3rd region was distinct during the northeast monsoon season and the concentration was found to decrease gradually from February-May to October-January period in this region. Monthwise studies (Fig.4) revealed that the density was at its peak during January in the region between 6°30'N and 10°30'N while, the peak in the region between 10°30'N and 12°30'N was in November and in the 4th region between latitudes 12°30'N and 14°30'N the maximum concentration was noticed in February. The population density was minimum in the regions 6°30'N-8°30'N and 8°30'N-10°30'N in November and July respectively while during October the numbers were least in the region between 10°30'N and 14°30'N.

*Depthwise distribution* - The depth at different stations ranged from 40 to 3538 m and to understand the longitudinal distribution of amphipods from the shore the area has been divided into different depth zones and the concentration of amphipods in these zones were studied. They were found to prefer the area having a depth ranged between 51 and 100 m, where the maximum of 800 numbers per 1000 m<sup>3</sup> (35%) of the total population was observed(Fig.5). The least 15% (339 specimens) was noticed

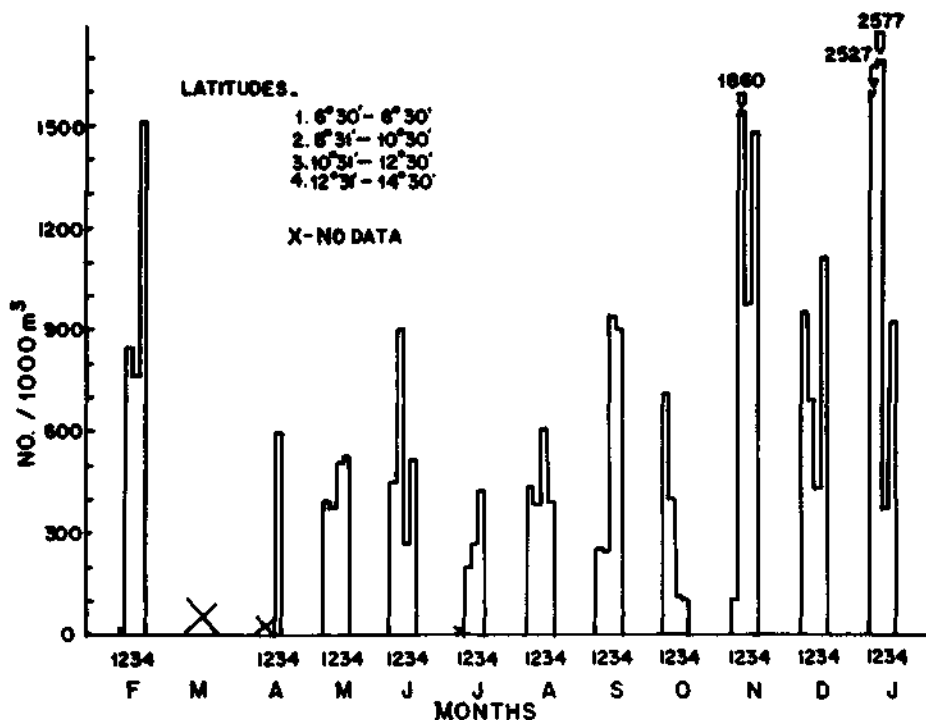

Fig.4 - The monthly variations in the distribution of amphipods in different latitudinal regions

in areas having less than 50 m depth. The density of the population was moderate in areas having more than 100 m depth. Depthwise study will be more meaningful when it is related to different seasons(Fig.6). At the second depth region where the overall maximum density was observed, the highest mean number of 1063 was observed

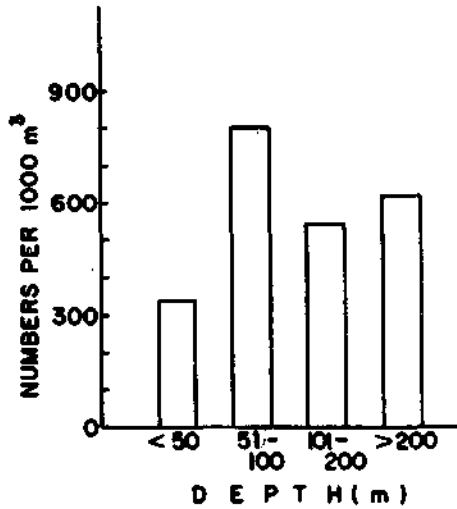

Fig.5 - Distribution of amphipods in areas having different depths

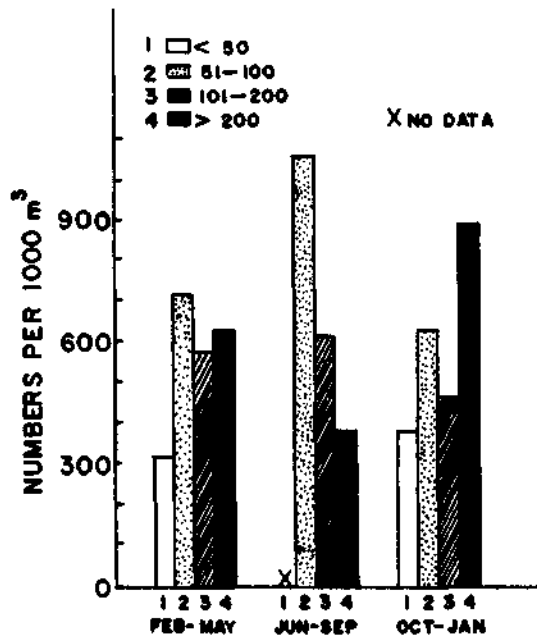

Fig.6 - Seasonwise abundance of amphipods in different depth areas

during the southwest monsoon season and the average numbers decreased as the depth at stations increased in the same season. In the premonsoon period also, the highest concentration was recorded at the 2nd depth region; while during the northeast monsoon, even though the mean number was higher at the 2nd depth area, the highest was observed in areas having more than 200 m depth.

*Monthly and seasonal variations* - Irrespective of depths or latitudes when the monthly variations were worked out it was found that higher concentrations were in February, November, December, and January (Fig. 7). Similar to this, Nair *et al.* (1973) recorded high concentration in the Andaman Sea during the period October 16 to April 15. They also noticed a higher abundance of amphipods in areas of upwelling and or land drainage. Again, according to Bhattathiri & Devassy (1981) the primary productivity is at a higher level during January when compared to that of February in Andaman Sea. In the present study also, the highest of amphipods density was recorded during the northeast monsoon season (43%) with the maximum of 1763 numbers in January. Minimum concentration was observed during the southwest monsoon period (24%) with least abundance of 315 numbers in July. In view of the above findings, similar to other reports, combined with the observations during the

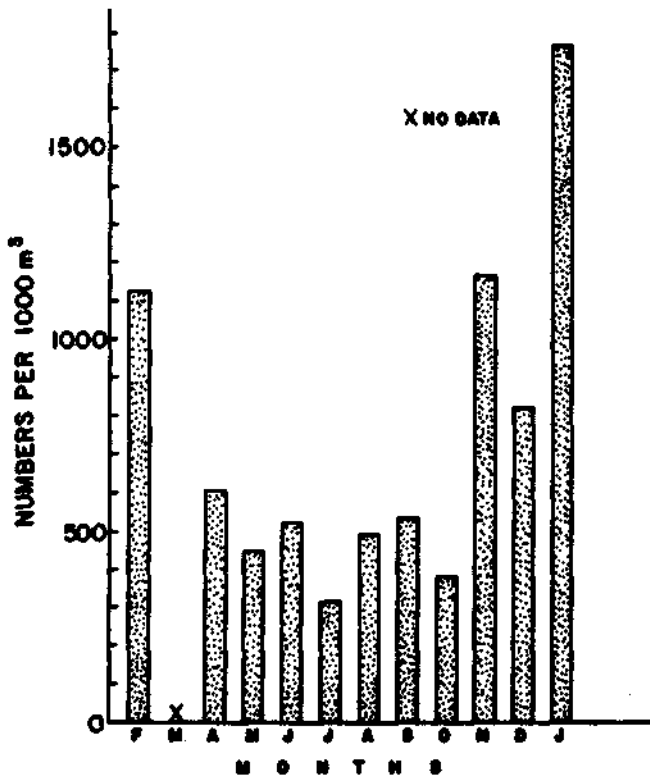

Fig.7 - Monthly abundance of amphipods



present study it may be concluded that there exists a positive relation between abundance of amphipods, and upwelling and primary productivity.

**Day and night variations** - During the study period, 180 samples collected were during daytime and the rest 69 at night; and their mean numbers were estimated as 640 and 615 respectively indicating slight daytime abundance. Monthly variations in day and night samples is shown in Fig.8. The higher mean numbers at daytime was due to the effect of one day collection which contained very high number of amphipods to the tune of 12276/1000 m<sup>3</sup> in January whereas all other values were below 3500. When a day/night estimate was made excluding this single high value of January, the average number for the day and at night were 575 and 615 respectively showing slightly higher concentration during nighttime. According to Revikala *et al.*(1990) there was not much variation in the concentrations of amphipods collected during day and at nighttime, in the Indian EEZ and adjoining seas. Nair (1977) noticed that one of the amphipods, *Paraphronima crassipes* dominated in the day collections in the Bay of Bengal during northeast monsoon. The day and night variations were found to be associated with months and seasons. It was interesting to note that the occurrence of amphipods remained the same in different months pertaining to the same season but the only exception was in November. The night collections represented more of amphipods during the southwest monsoon, while the reverse was true for the premonsoon and northeast monsoon seasons.

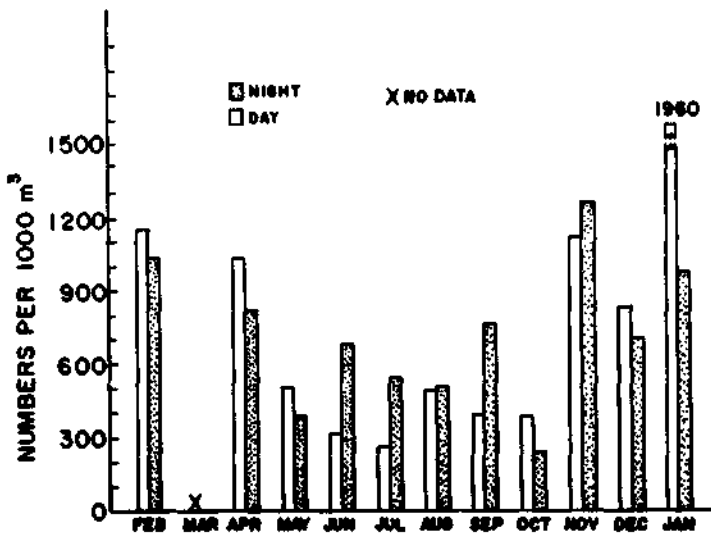

Fig.8 - Monthly day-night variations in the abundance of amphipods

## ACKNOWLEDGEMENT

Authors are thankful to Dr.P.Vedavyasa Rao, Director and Dr.P.S.B.R.James, Ex-Director, for their keen interest in this work.

## REFERENCES

- Bhattathiri, P.M.A. & Devassy, V.P. 1981. Primary productivity of the Andaman Sea, *Indian J. Mar. Sci.* 10: 243-247.
- Jossi, J.W. 1972. Distribution and abundance of pelagic amphipods in the Arabian Sea, Java Sea and Indian Ocean with notes on their contribution to the total zooplankton, *J.Mar.Biol.Ass.India*, 14: 115-138.
- Mathew, K.J., Kurup,K.N., Naomi,T.S., Antony, G. & Solomon, K. 1994. *Second Workshop Scient. Resul. FORV Sagar Sampada*, Abstr. No. 53.
- Nair, K.K.C. 1972. A note on an amphipod swarm along the southwest coast of India, *Curr. Sci.* 41: 185-186.
- Nair, K.K.C. 1977. Distribution and relative abundance of paraphronimidae (Hyperiididae, Amphipoda) in the Indian Ocean, In: *Proc. Symp. Warm Water Zoopl.*, (UNESCO/NIO, Goa) 155-167.
- Nair, K.K.C., Jacob, P.G. & Kumaran, S. 1973. Distribution and abundance of planktonic amphipods in the Indian Ocean, In: *The biology of Indian Ocean, Ecological studies 3*, edited by B.Zeitzechel, (Springer -Verlag, New York) pp.349-356 and 521- 544.
- Revikala, S., Mathew, K.J. & Scariah, K.S. 1990. Preliminary studies on planktonic amphipods collected by *FORV Sagar Sampada*, In: *Proc.First Workshop Scient. Resul. FORV Sagar Sampada*, edited by K.J.Mathew,(CMFRI, Cochin) 115-119.

\* \* \*

## **Ichthyoplankton from Andaman and Nicobar seas**

C.B. Lalithambika Devi, Rosamma Stephen, P.N. Aravindakshan  
& P.P. Meenakshikunjamma

National Institute of Oceanography, Regional Centre,  
P.B. No. 1913, Cochin - 682 018

### **ABSTRACT**

Ichthyoplankton of the Andaman and Nicobar seas were studied for their spatial, seasonal and day and night variations from 357 zooplankton samples collected during 1986 to 1990. High density of fish larvae was encountered in the shelf waters. Maximum number of 4938 larvae/1000 m<sup>3</sup> was obtained from an offshore station north of Andaman Island (lat. 13°57'N and long. 92°38'E). Fish eggs and larvae were represented in all months. Fish eggs were found throughout the year with higher concentrations during day but the maximum density was found in night collections during December. However there was no definite pattern of distribution of larvae during day or night. The maximum number was in November. Latitudinally fish larvae were definitely higher towards northern latitudes with the maximum number of larvae between 13° and 15°N. Eggs were abundant in the postmonsoon period. Myctophidae, Gonostomidae, Gobiidae, Bregmacerotidae and Serranidae were the dominant groups.

### **INTRODUCTION**

The first major account of the quantitative distribution of fish eggs and larvae of the Indian Ocean was given in the plankton atlas (IOBC, 1970) based on the zooplankton collections of the International Indian Ocean Expedition (1962-65). Peter (1969, 1982) and Lalithambika Devi (1977, 1986) discussed some aspects of the ichthyoplankton of Indian Ocean. The UNDP/FAO Pelagic Fisheries Project had surveyed the shelf region of south India for ichthyoplankton (Anon, 1976); George (1979) dealt with some aspects of fish larvae of southwest coast of India. A more systematic sampling of the EEZ and adjacent waters of India was done onboard *FORV Sagar Sampada* during 1986 to 1990. These samples provide a better representation of ichthyoplankton of EEZ and adjacent waters. Manickasundaram & Ramaiyan (1990) have reported on the fish eggs and larvae of Andaman and Nicobar area, based on collections taken during June and July 1988. This paper deals with spatial, seasonal

and day and night variation of fish eggs and larvae of the Andaman and Nicobar region collected during cruises of *Sagar Sampada*.

## MATERIALS AND METHODS

Fish eggs and larvae contained in the 355 oblique hauls from 150 m to surface using Bongo-60 net of 0.33 mm mesh size, collected onboard *FORV Sagar Sampada* between 15° to 5°N latitude and 89° to 96°E longitude were studied. Samples were available in all the months of the year except March. The details of methodology and the procedure for the analysis and interpretation are given by Mathew *et al.* (1990).

## RESULTS

Out of the 355 samples examined, fish larvae were found in almost all collections except in 3 day-samples while eggs were absent in 7 day and 6 night collections. However, macro fish larvae occurred only in 12 samples, 11 of which were taken during night. Fish eggs were more in the shelf waters than in oceanic region. High density areas where fish eggs exceeded 1250/1000 m<sup>3</sup> were found north of Andaman Islands. The shelf waters of Andaman and Nicobar Islands (Fig. 1) also sustained high number of eggs. The highest number 5990 eggs/1000 m<sup>3</sup> was collected from a station situated at lat. 10°20' N and long. 92°40'E. Fish larvae were also more in the shelf waters between 92° and 94°E longitudes (Fig. 2). However, highest density of 4938 larvae/1000 m<sup>3</sup> was recorded from a station north of Andaman Islands (lat. 13°57' N, long. 92°38'E).

*Monthly variation*— Considering the average number of fish eggs and larvae for different months (1986-90), the highest number of fish eggs of 897 eggs/1000 m<sup>3</sup> in December and the lowest density 126 eggs/1000 m<sup>3</sup> in June were recorded. The period between April to October was found to be less productive (Table 1). Fish larvae were also available throughout the year with highest number of 1153 larvae/1000 m<sup>3</sup> in November and the lowest in June (174 larvae/1000 m<sup>3</sup>). They were less dense in May and October.

*Seasonal variation*— Abundance of fish eggs and larvae were considered on the basis of three seasons viz. premonsoon (Feb. - May), monsoon (June - Sept.) and postmonsoon (Oct. - Jan.) (Table 2). Highest density of fish eggs and larvae was found during postmonsoon season having 463 eggs/1000 m<sup>3</sup> and 384 larvae/1000 m<sup>3</sup>. The lowest density of eggs was noticed during monsoon period, whereas larvae showed decrease in premonsoon period.

*Latitudinal abundance*— With regard to the seasonal variation of fish eggs and larvae in the different latitudes, it was found that eggs were abundant during the postmonsoon season in the southern latitudes (5°-7°, 7°-9° and 9°- 11°) whereas towards the northern latitudes the variation between the seasons decreased with slight dominance during premonsoon season (Fig. 3A). Latitudinally although mixed distribution pattern was observed in the case of larvae in 7°-9° and 9°- 11° latitudes, a

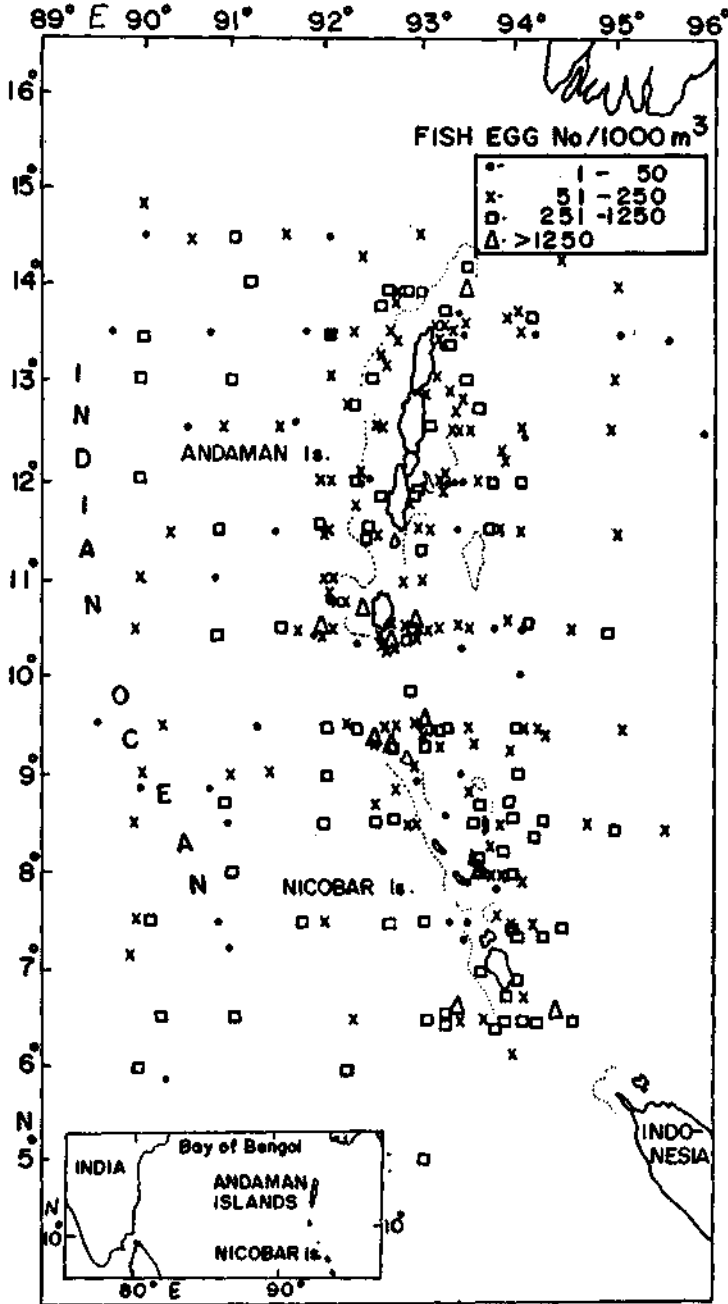

Fig. 1 - Distribution and abundance of fish eggs in the Andaman and Nicobar Seas

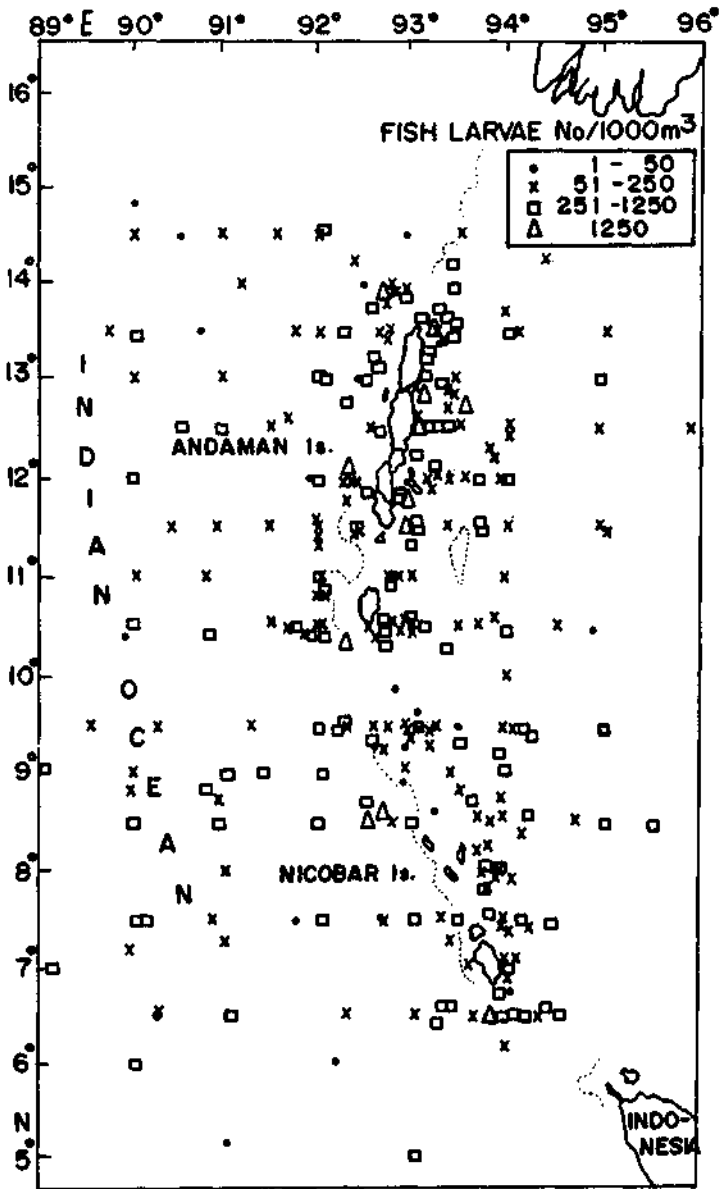

Fig. 2 - Distribution and abundance of fish larvae in the Andaman and Nicobar Seas

definite increase in their abundance from premonsoon to postmonsoon season in the latitudes 11°-13° and 13°- 15° was evident. In the 5°- 7° latitudes also larval abundance was noted during postmonsoon season (Fig. 3B). Latitudinally distribution pattern observed was of mixed type in the case of eggs, with a maximum of 425 eggs/1000 m<sup>3</sup> at the southern latitudes (5°-7°) and minimum towards northern lati-

Table 1 — Average number (no/1000 m<sup>3</sup>) of fish eggs and larvae in different months (1986-90)

Month	Eggs	Larvae
February	567	656
March	-	-
April	140	276
May	191	187
June	126	174
July	237	307
August	236	392
September	126	443
October	200	187
November	452	1153
December	897	287
January	394	553

Table 2 — Average number (no/1000 m<sup>3</sup>) fish eggs and larvae showing seasonal variation.

Season	Eggs		Larvae		Total	
	Day	Night	Day	Night	Egg	Larvae
Premonsoon (Feb.-May)	213	181	231	301	199	263
Monsoon (June-Sept.)	222	106	301	392	181	334
Postmonsoon (Oct.-Jan.)	424	620	389	363	463	384

tudes (Table 3). A reversing trend was found for the fish larvae with higher density towards northern latitudes with a maximum of 406 larvae/1000 m<sup>3</sup> at 13°-15°N.

*Day and night variation*— In general, day and night variation was not pronounced. Slight dominance of eggs were noticed during day in all months except December when 2997 eggs/1000 m<sup>3</sup> were found during night (Fig. 4A). A slight dominance was noticed during night in April also. Generally larvae were more during night except in January, May and October (Fig. 4B). Eggs were dominant at night (620 eggs/1000 m<sup>3</sup>) during postmonsoon season whereas they were dominant during day with other two seasons. This was just reversed in the case of larvae which showed dominance during day in the postmonsoon season (389 larvae/1000 m<sup>3</sup>) but in other two seasons they were abundant at night (Table 2). Eggs were more during daytime in the different latitudes except 13°-15°N. In contrast to this; larvae were abundant during night in all latitudes except 5°-7°N (Fig. 3).

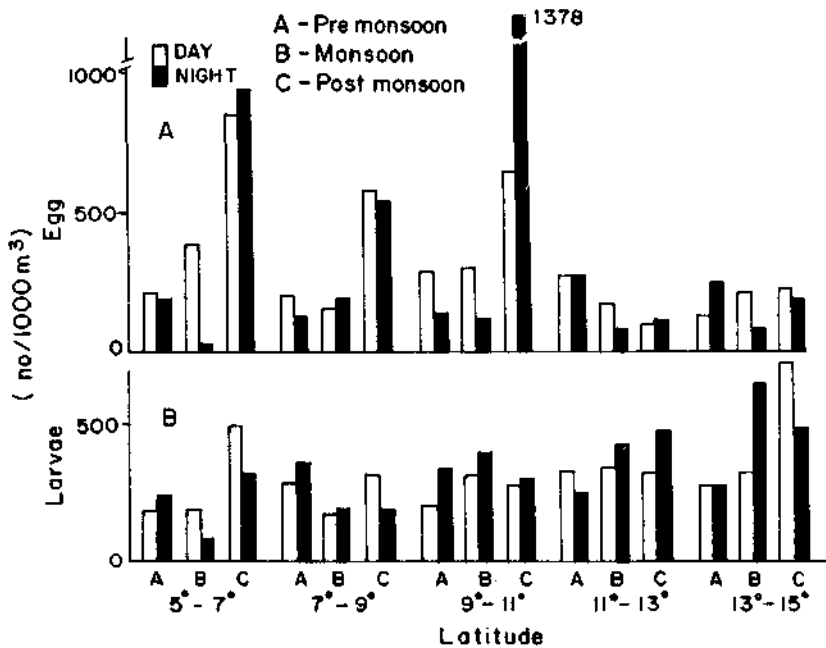

Fig. 3 - Latitudinal abundance of fish eggs (A) and larvae (B) with seasonal and day - night variation

Table 3 — Average number (no/1000 m<sup>3</sup>) of fish eggs and larvae in different latitudes showing day and night variation.

Latitude (°N)	Eggs		Larvae		Total	
	Day	Night	Day	Night	Eggs	Larvae
5° - 7°	502	244	317	211	425	286
7° - 9°	224	200	271	272	215	271
9° - 11°	434	321	270	342	394	295
11° - 13°	186	160	330	371	175	347
13° - 15°	176	185	400	419	179	406

*Larval abundance in relation to zooplankton biomass*— No direct relationship was discerned between the volume of zooplankton and the number of fish larvae (Fig. 5). The maximum number of 4938/1000 m<sup>3</sup> was recorded not from the sample of highest volume of zooplankton but from 183.6 ml/1000 m<sup>3</sup>. The minimum number of 5 larvae/1000 m<sup>3</sup> was from a sample of 18.31 ml/1000 m<sup>3</sup>. However, higher density of larvae (above 1800/1000 m<sup>3</sup>) was found in samples of the quantity of 110 to 230 ml/1000 m<sup>3</sup>. In fish larvae encountered Myctophidae, Gonostomidae, Gobiidae, Bregmacerotidae and Serranidae were the dominant families.



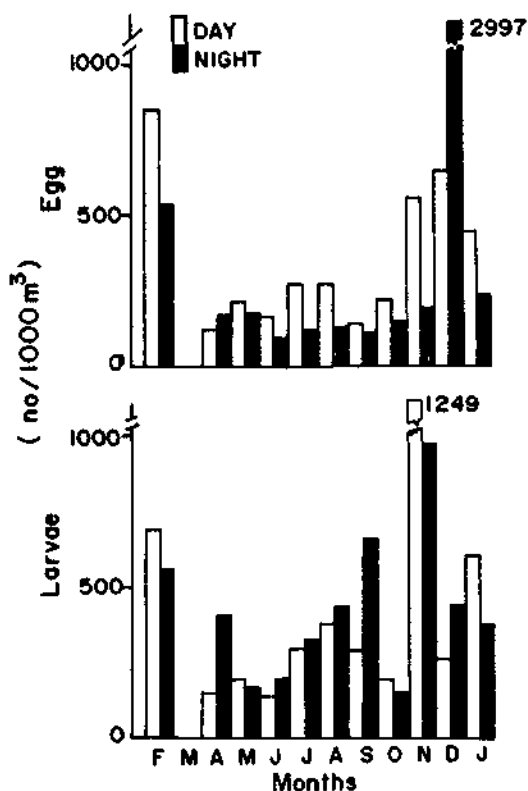

Fig. 4 - Monthly day - night variations in the abundance of fish eggs (A) and larvae (B)

## DISCUSSION

In general the Islands of this archipelago have steep slopes and hence oceanic conditions prevail even in the near shore areas. The surface salinity values varying from 33.22 to  $34.58 \times 10^{-3}$  showed an increasing trend from south to north on the western side as well as the eastern side. The Andaman Sea receives varying quantities of fresh water and is connected to the South China Sea through Strait of Malacca. The surface water temperature varied from 26° to 28°C. Temperature showed a northward decreasing trend. (Laly Mathew & Pillai, 1990).

Bay of Bengal is regarded as a cradle for young fishes as eggs and larvae are abundant as compared to other regions of Indian Ocean (Peter, 1969, 1982; Lalithambika Devi, 1977, 1986). Information on fish eggs and larvae of Andaman and Nicobar islands is meagre. Madhupratap *et al.* (1980) reported that fish larvae were better represented around Andaman Islands based on the samples collected during February. Manickasundaram & Ramaiyan (1990) have reported relative abundance of larvae over that of eggs invariably at all stations based on the samples taken during June and

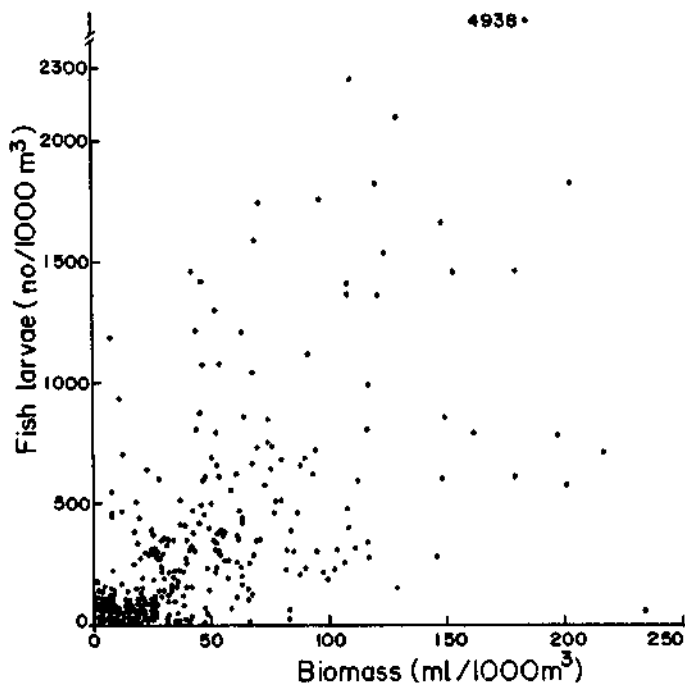

Fig. 5 - Relationship between abundance of zooplankton biomass and the number of fish larvae

July. In the present study also larvae were dominant over eggs in the premonsoon and monsoon seasons but the trend was reversed during postmonsoon season. Eggs and larvae obtained during plankton collections provide a direct measure of the spawning areas and seasons. The abundance of eggs towards southern latitudes and larvae towards northern latitudes may be due to the prevailing current pattern. Balachandran (1980) indicated that the major factor controlling vertical migration of fish larvae is light rather than temperature. In the present study the day and night variation was not pronounced. Studies on different species of larvae of Bothid flat fishes showed that some species prefer day rather than night (Lalithambika Devi, 1986).

Variation in the number of fish larvae in some of the collections might be due to the patchiness or predation or both. The uneven distribution of larvae could also be due to the tendency of adult fishes to release clumps of eggs as well as to choice of food. Cushing (1966, 1967) stated that coincidence of food supply with larval distribution was important and probably critical for their survival. The role of hydrographic parameters in the distribution of fish larvae cannot be ignored. The annual variation in the concentration of larvae in the Bay of Bengal changed directly with

southerly (cyclonic) and northerly (counter cyclonic) circulation of water during changing monsoon. The distribution of larvae in the equatorial area is governed by the eastward drift and westward flow. According to Peter (1982) during the southwest monsoon period high concentration of fish larvae was seen as patches along the coastal areas and were maximum during NE monsoon period in Bay of Bengal.

Although the maximum plankton biomass always coincided with the peak period of upwelling followed by larval abundance brought about by the prevailing upwelled water from the mesopelagic region to the surface. The number of larvae has no direct relation with the biomass. Peter (1969) indicated that when the plankton volumes were high, the number of larvae were not proportionately higher or *vice-versa*. Peter (1982) and Lalithambika Devi (1986) observed that the maximum number of larvae was not found in samples of larger biomass but from samples which were neither high nor low. This is true in the present study also. However, George (1979) has reported a positive correlation from coastal waters of southwest coast of India. Nakamura & Matsumoto (1966) have stated that large number of fish larvae was contained in low or moderate volume of zooplankton.

The presence of predators like medusae, ctenophores, ostracods, chaetognaths and others may affect the number of fish larvae in the plankton. The inconsistent and irregular relationship between the number and the biomass could also be due to the type of gear used, region, time and duration of sampling.

Biogeographical distribution of zooplankton - fish larvae - depends on specific environmental factors such as light, temperature, salinity and dissolved oxygen. Lalithambika Devi (1977) reported that highly significant negative correlation existed between number of flat fish larvae and salinity as well as dissolved oxygen. In the present study fish eggs were found more towards the southern latitudes where the salinity is comparatively low and temperature high and larvae were found more towards northern latitudes where the salinity is comparatively high and temperature low.

### ACKNOWLEDGEMENT

The first author wishes to express her deep sense of gratitude to Dr. P.S.B.R. James, former Director and to Dr. K.J. Mathew CMFRI, Cochin for providing study material with relevant data. The authors also wish to express their sincere thanks to Dr. E. Desa, Director and to Dr. V.N. Sankaranarayanan, Scientist-in-Charge, N.I.O. for the encouragement and necessary facilities to undertake the study.

### REFERENCES

- Anon. 1976. *Oil sardine larvae*, UNDP/FAO Pelagic Fishery Project, IND 69/593, Progress Report No.15, 18 - 99.
- Balachandran, T. 1980. *Studies on meroplankton*. Ph.D. thesis, University of Cochin, Cochin, pp.319.
- Cushing, D.H. 1966. Biological and hydrographical changes in British Seas during the last thirty years, *Biol. Rev.* 41: 211-258.

- Cushing, D.H. 1967. The grouping of marine population, *J. Mar. Biol. Ass. U.K.* 47: 193-208.
- George, K.C. 1979. *Studies on the distribution on abundance of fish eggs and larvae of the southwest coast of India with special reference to scombroids*. Ph.D. thesis, University of Cochin, Cochin, pp.197.
- IOBC. 1970. Distribution of fish eggs and larvae in the Indian Ocean, *Plankton Atlas*, II (2) [NIO, (CSIR), Goa].
- Lalithambika Devi, C.B. 1977. Distribution of larvae of the flat fishes (*Heterosomata*) in the Indian Ocean. In: *Proc. Symp Warm Water Zoopl.* (UNESCO/NIO, Goa) 18-20.
- Lalithambika Devi, C.B. 1986. *Studies on the flat fish (Heterosomata) larvae of the Indian Ocean*. Ph.D. thesis, University of Kerala, Trivandrum, pp. 480.
- Laly Mathew & Narayana Pillai, V. 1990. Chemical characteristics of the waters around Andamans during late winter. In: *Proc. First Workshop Scient. Resul. FORV Sagar Sampada*, edited by K.J. Mathew, (CMFRI, Cochin) 15-18.
- Madhupratap, M., Achuthankutty, C.T., Nair, S.R.S & Nair, V.R. 1980. Zooplankton abundance in the Andaman Sea, *The Andaman Sea*, Technical Report 02/80/(NIO, Goa) 128-133.
- Manickasundaram, M. & Ramaiyan, V. 1990. On some fish eggs and larvae from the Andaman and Nicobar Seas, In: *Proc. First Workshop Scient. Resul. FORV Sagar Sampada*, edited by K.J. Mathew (CMFRI, Cochin) 193-199.
- Mathew, K.J., Naomi, T.S., Geetha Antony, Vincent, D., Anilkumar, R. & Soloman, K. 1990. Studies on zooplankton biomass and secondary and tertiary production of the EEZ of India. In: *Proc. First Workshop Scient. Resul. FORV Sagar Sampada*, edited by K.J. Mathew, (CMFRI, Cochin) 59-69.
- Nakamura, E.L. & Matsumoto, W.M. 1966. Distribution of larval tuna in Marquesan waters, *U.S. Fish Bull.* 66(1):1-22.
- Peter, K.J. 1969. Preliminary report on the density of fish eggs and larvae in the Indian Ocean, *Bull. Nat. Inst. Sci. India*, 38 (2): 854-863.
- Peter, K.J. 1982. *Studies on some fish larvae of the Arabian Sea and Bay of Bengal* Ph.D. thesis, University of Cochin, Cochin, pp. 349.

\* \* \*

## Medusae from the sea around Laccadive group of islands (7°-18°N/69° - 76°E)

V. Santhakumari

National Institute of Oceanography, Regional Centre,  
P.B.No.1913, Cochin - 682 018.

### ABSTRACT

Forty-four species of hydromedusae belonging to 20 families were obtained from the samples collected during the period 1985-1987. Studies on abundance, diurnal variation and distribution are investigated. High densities were observed from samples collected at night. The dominant species of this area were *Solmundella bitentaculata*, *Liriope tetraphylla*, *Aglaura hemistoma*, *Rhopalonema velatum* and *Cytaeis tetrastyla*.

### INTRODUCTION

Laccadive group includes 21 coral islands and banks in the southeastern Arabian Sea, about 100 to 250 km away from the southwest coast of India. Information on the medusae of this region is scanty (Vannucci & Santhakumari, 1969, Vannucci *et al.* 1970). Distribution of hydromedusae from Indian Ocean was studied by Vannucci & Navas (1973). The present investigation enhances the knowledge on the occurrence, abundance, variation and distribution of hydromedusae from this area.

### MATERIALS AND METHODS

Collections were made onboard *FORV Sagar Sampada* (3 cruises) during 1985-1987. The studies were based on 116 samples collected from the area, around the Laccadive groups of islands, by oblique tows from 150 m depth to surface using a Bongo - 60 net (mesh aperture 0.33 mm) equipped with a calibrated flow meter. The samples were preserved in 5% formaldehyde. Hydromedusae were identified up to species level. The estimated abundance is expressed as no./1000 m<sup>3</sup>.

## RESULTS AND DISCUSSION

Forty-four species belonging to 20 families were obtained from these samples. The list of species are given below:

### Order: Anthomedusae

#### Family: Tubulariidae

- Euphysa aurata* Forbes, 1848  
*Ectopleura sacculifera* Kramp, 1957

#### Family: Corymorphidae

- Cnidocodon leopoldi* Bouillon, 1978

#### Family: Cladonimatidae

- Cladonema* sp.

#### Family: Cytaeidae

- Cytaeis tetrastyla* Eschscholtz. 1829  
*Cytaeis vulgaris* Agassiz & Mayer, 1899

#### Family: Hydractiniidae

- Podocoryne apicata* Kramp, 1959

#### Family: Bougainvillidae

- Bougainvillia fulva* Agassiz & Mayer, 1899  
*Kollikerina octonemalis* Maas, 1905

#### Family: Pandaeida

- Merga tergestina* (Neppi & Stiasny, 1912)  
*Leukartiara octona* Fleming, 1823  
*Pandea conica* Quoy & Gaimard, 1827

#### Family: Calycopsidae

- Heterotiara minor* Vanhoffen, 1911

### Order: Leptomedusae

#### Family: Companulariidae

- Phialidium hemisphaericum* Leuckart, 1856  
*Phialidium simplex* Browne, 1902

#### Family: Lovenellidae

- Eucheilota menoi* Kramp, 1959

#### Family: Phialuciidae

- Phialucium condensum* Kramp, 1953  
*Octophialucium indicum* Kramp, 1958  
*Octophialucium begelowi* Kramp, 1955

#### Family: Eirenidae

- Eirene elliceana* (Agassiz & Mayer, 1902)  
*Helgicirrho malayensis* (Stiasny, 1928)

## Family: Eutimidae

*Eutima curva* Browne, 1905*Eutima commensalis* Santhakumari, 1970

## Family: Aequoreidae

*Aequorea aequorea* (Forskal, 1775)*Aequorea conica* Browne, 1905*Aequorea parva* Browne, 1905

## Order: Limnomedusae

## Family: Proboscidae

*Proboscidaea ornata*

## Order: Trachymedusae

## Family: Rhopalonematidae

*Rhopalonema velatum* Gegenbaur, 1856*Rhopalonema funerarium* (Vanhoffen, 1902)*Pantachogon scotti* Browne, 1910*Amphagone apicata* Kramp, 1957*Amphagone apsteini* (Vanhoffen, 1902)*Crossota alba* Begelow, 1913*Aglaurea hemistoma* Peron & Lessuer, 1809*Aglantha digitata* Müller, 1775*Aglantha elata* (Haeckel, 1879)*Aglantha intermedia* Begelow, 1909

## Family: Geryonidae

*Geryonia proboscidaea* (Forskal, 1775)*Liriope tetraphylla* Chamisso & Eysenhardt, 1821

## Order: Narcomedusae

## Family: Aeginidae

*Aegina citrea* Eschscholtz, 1829*Solmundella bitentaculata* Quoy & Gaimard, 1833

## Family: Solmariidae

*Pegantha clara* Begelow, 1909

## Family: Cuninidae

*Cunina octonaria* Mc Crady, 1857*Cunia tenella* Begelow, 1909

The data from all the samples of 3 cruises are pooled together and presented in Fig. 1. The maximum density of medusae 3882/1000 m<sup>3</sup> was observed from Ratnagiri coast. This peak was chiefly contributed by the dense swarms of the Trachymedusan species *Liriope tetraphylla*. It is a warm water, holoplanktonic, euryhaline, eurythermal cosmopolitan species. The range 500 and above are seen more in areas in between Mangalore and south of Cochin. *Solmundella bitentaculata* and *Aglaurea hemistoma*

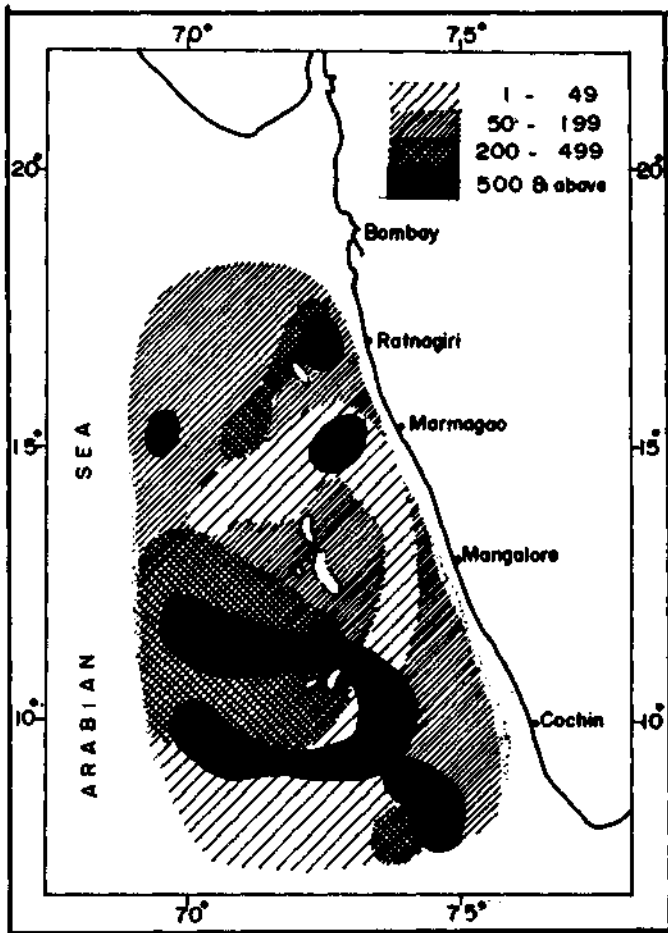

Fig. 1— Distribution of medusae during 1985, 1986 and 1987 from Laccadive Sea

occurred in large numbers and supported for the high densities. The next values, ranging from 200-499, were observed in places near to the higher values and were closer to the coasts. *Rhopalonema velatum* was the next abundant species and found more in the southwest areas. It is also euryhaline, eurythermic species and found to be widely distributed in almost all watermasses. *Cytaeis tetrastyla* multiplies through intensive vegetative reproduction and thus contributed for the high numbers in the coastal areas. Species next in order of abundance were *Amphagon apicata*, *Aglantha elata*, *Cnidocodon leopoldi*, *Bougainvillia fulva*, *Phialidium hemisphaericum*, *Crossota alba*, *Cytaeis vulgaris*, *Octophialucium indicum*, *O. begelowi*, *Eirene elliceana*, *Cunina tenella*, *C. octonaria*, *Eucheitota menoni*, *Aequorea acquorea* and *A. conica*. Rest of the species were rarely seen from very few stations. *Eutima commensalis* is reported as an endemic species of Cochin estuary and its occurrence



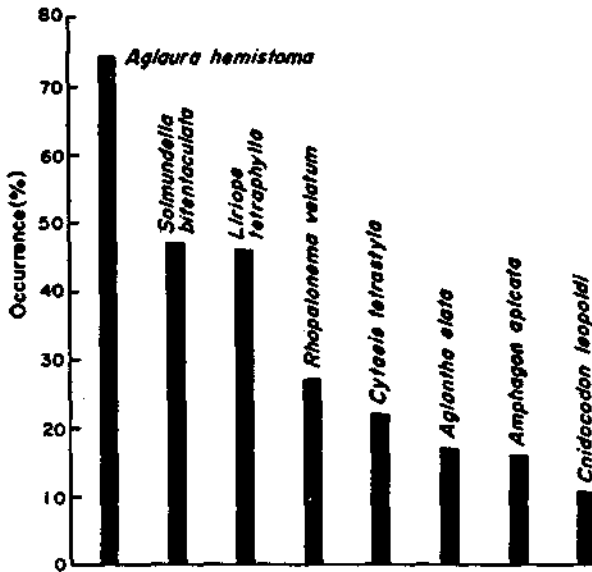

Fig. 2— Percentage composition of abundantly occurring species of this area

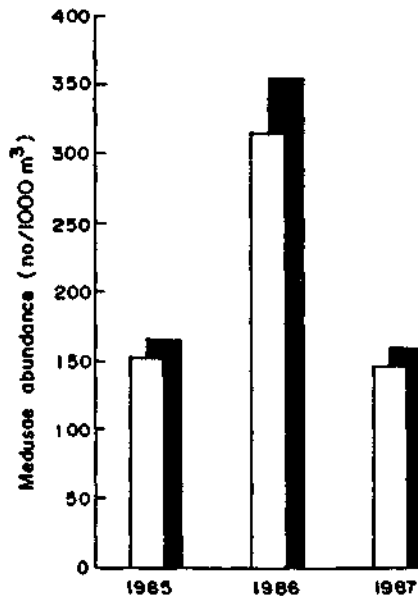

Fig. 3— Day and night variation of the medusae. White column represents day and black column represents night

from off shore area might be quite accidental. The hydroid of this species lives as endocommenal inside the mantle cavity of the shipworms (Santhakumari, 1970). Some species like *Ectopleura succilifera* was found only once. Vannucci & Navas (1973b) recorded it from the upwelling areas of Indian Ocean. Goswami (1979) reported *Eirene ceylonensis*, *Eirene* sp. and *Obelia* spp as common forms from Laccadive sea. But these species were not found from the present samples. *Obelia* spp might have escaped the net because of the large mesh size (0.33 mm).

The percentage composition of the dominant and commonly occurring species are shown in Fig. 2. Of all the 44 species *A. hemistoma* is the most commonly found species with 74% of occurrence. The dominant species were distributed throughout this area. In the population, juveniles and immature specimens were more than the adult ones. Occurrence of juveniles in most of the collections suggesting continuous breeding.

All the samples considered for the study were put under day and night categories and the results obtained are presented in Fig.3. Increase in values were noticed from night collections. Santhakumari (1991) reported diel variation of medusae from west coast of India.

The probable existence of stable eddy systems above 100 m depth and close to the islands might be one of the factors leading to the abundance of decapod larvae (Sen Gupta *et al.* 1979). This view augments the present findings of the abundance of medusae near to the coasts. Here in the present study more than half of the species are meroplanktonic forms. It is clear from the present study that Anthomedusae and Leptomedusae contribute much to species diversity while Trachymedusae and Narcomedusae are responsible for the density of the population. Thus an assemblage of meroplanktonic and holoplanktonic species are discernible in this region.

### ACKNOWLEDGEMENT

Author expresses her gratitude to the Director, C.M.F.R.I, Cochin, for providing the hydromedusae samples for the study.

### REFERENCES

- Briggs, J.C. 1974. *Marine zoology*, (Mc Graw - Hill, New York) pp. 475.
- Goswami, S.C. 1979. Diel variations of zooplankton community at Kavaratti atoll (Lakshadweep), *Tech. Rep.* 01/79, (NIO, Goa). 145- 157.
- Sen Gupta, R., Moraes, C., Kureishy, T.W., Sankaranarayanan, V.N., Jana, T.K., Naqvi, S.W.A. & Rajagopal, M.D. 1979. *Chemical oceanography of the Arabian Sea. Part 4 - Laccadive Sea*, *Tech. Rep.* 01/79 (NIO, Goa) pp. 25-43.
- Santhakumari, V. 1970. The life cycle of *Eutima commensalis* sp. nov. (Eutimidae, Hydromedusae), *Mar. Biol.* 5 (2): 113-118.
- Santhakumari, V. 1991. Ecology, distribution and diel variation of medusae from west coast of India. *Proc. Kerala Sci. Congs*, 35- 36.

- Vannucci, M. & Santhakumari, V. 1969. New records of Hydromedusae from the shelf area off Kerala coast. *J. Mar. Biol. Ass. India*, 11: 40-43.
- Vannucci, M., Santhakumari, V. & Dos Santos, E.P. 1970. The ecology of hydromedusae from the Cochin area., *Mar. Biol.* 7 (1): 49-58.
- Vannucci, M. & Navas, D. 1973 a. On the ecology of Indian Ocean hydromedusae, *IOBC Handbook*, 5: 1-54.
- Vannucci, M. & Navas, D. 1973 b. Patterns of distribution of Arabian Sea Hydromedusae. *Spl. Publ. Mar. Biol. Ass. India*. 110- 121.
- Vannucci, M. & Navas, D. 1973 c. Distribution of hydromedusae in the Indian Ocean. In: *The biology of the Indian Ocean*, edited by B. Zeitzschel, (Springer - Verlag, Berlin) pp. 272-281.

\* \* \*

## Zooplankton abundance in the continental shelf waters of the northeast coast of India

K.J. Mathew, K.N. Kurup, T.S. Naomi, Geetha Antony & K. Solomon

Central Marine Fisheries Research Institute, P.B. No. 1603, Cochin-682 014

### ABSTRACT

Higher concentrations of zooplankton standing stock and population occurred in the region off Chilka lake and Paradip ( $19^{\circ} 10' N$ - $19^{\circ} 55' N$  and  $85^{\circ} 09' E$ - $86^{\circ} 50' E$ ) during January and off Visakhapatnam ( $17^{\circ} 30' N$ -  $18^{\circ} 28' N$  and  $83^{\circ} 14' E$ -  $84^{\circ} 29' E$ ) during November and April. The most productive period along the northwestern part of the Bay of Bengal was the northeast monsoon season (October-January) followed by the premonsoon season (February-May). High abundance of copepods, chaetognaths, siphonophores, cladocerans, fish larvae, planktonic molluscs, amphipods, foraminifers and larval polychaetes constituted the northeast monsoon maximum. Very low biomass values were recorded during the southwest monsoon season (June-September). The neretic zone up to 50 m depth was rich in zooplankton population during northeast monsoon and further to a lesser extent up to 100 m during the premonsoon season. However, a steady decline was evident with increasing depth zones. The less saline northern part exhibited remarkable differences in the abundance of the population and standing stock in such a way that 63% of the total was confined to the northern region. Fish eggs were predominant during February-May and larvae in July and January-February. The peak period of the zooplankton population coincided with the maximum landings of the pelagic and demersal fishery resources of the northwestern coast of the Bay of Bengal.

### INTRODUCTION

After the IOE, investigations on the coastal zooplankton standing stock and population in relation to hydrographical parameters of the northwestern part of the Bay of Bengal were a few and far between. Nair *et al.* (1977,1981) and Achuthankutty *et al.* (1980) studied the zooplankton of the area during the southwest monsoon. Further, Pati (1980) and Vijayakumar & Sarma (1988) made observations for a period of one year. Recently the wealth of data collected by FORV Sagar Sampada during her random surveys in the EEZ and the contiguous seas of India from 1985 to 1988 yielded valuable information on plankton abundance, production, and the potentials of

different fishery resources (CMFRI, 1990). However, in subsequent years special emphasis was laid to study the importance of specific regions in the Bay of Bengal based on their overall productivity and estimates of fish catch. The northwestern shelf region of the Bay of Bengal ( $16^{\circ}$ - $20^{\circ}$  N) is well-known for the rich harvest of demersal fishery resources like croakers, perches, catfish, elasmobranchs, prawns, etc. (Krishnamurthy, 1976) and recently of the pelagic resources like mackerels and sardines (CMFRI, 1995). Therefore, exclusive surveys were undertaken along the continental shelf of the northeast coast of India between April 1988 and February 1989 and the present paper incorporates the observations made on the pattern of abundance and seasonal fluctuations of zooplankton at different depth zones together with hydrography and appraises the abundance of the fishery of the region during the peak period of the secondary producers.

## MATERIALS AND METHODS

Monthly samples of zooplankton were taken from a total of 99 stations covering an area of about  $65000 \text{ km}^2$  along the northeast coast of India (Fig. 1). Zooplankton samples by oblique hauls were collected from an average depth of 200 m to the surface using Bongo 60 net (mesh aperture 0.33 mm) fitted with a calibrated flowmeter "Hydrobios". The biomass values by displacement volume and the numerical abundance of constituent groups and larval forms were estimated per  $1000 \text{ m}^3$  of water filtered. The more saline southern part ( $16^{\circ}$ -  $18^{\circ}$ N) of the study area is differentiated from the less saline northern part ( $18^{\circ}$ -  $20^{\circ}$ N) as lat.1 and lat.2 respectively. The entire area from which the collections taken was divided into four depth zones (stations with less than 50 m as 1, 50 to 100 m as 2, 100 to 200 m as 3 and more than 200 as 4) for the purpose of comparison of the neretic from the deeper areas. 'Two-way ANOVA' was attempted to ascertain the significance of the difference of mean values of standing stock over seasons, latitudes and different depth zones. Contour map of biomass was produced by kriging (SURFER version 4.14, Golden Software Inc.).

## RESULTS AND DISCUSSION

### Biomass

Isopleths of biomass (Fig.2) show that there were regions of higher concentration in the northwestern part of the Bay of Bengal in the area off Chilika lake and Paradip ( $19^{\circ}10'N$ - $19^{\circ}55'N$  and  $85^{\circ}09'E$ - $86^{\circ}50'E$ ) and off Visakhapatnam ( $17^{\circ}30'N$ - $18^{\circ}28'N$  and  $83^{\circ}14'E$ - $84^{\circ}29'E$ ). The biomass value registered off Paradip in January was the highest (757.0 ml) while that occurred off Visakhapatnam during November and April was moderate (316-352 ml). In general, the observed mean value (105.5 ml) for the whole study area was higher than that of the earlier observation (Mathew *et al.* 1990a) for the same region.

The variations of mean biomass shown against season, latitude and depth zones (Fig.3) reveal that the most productive period is the northeast monsoon season

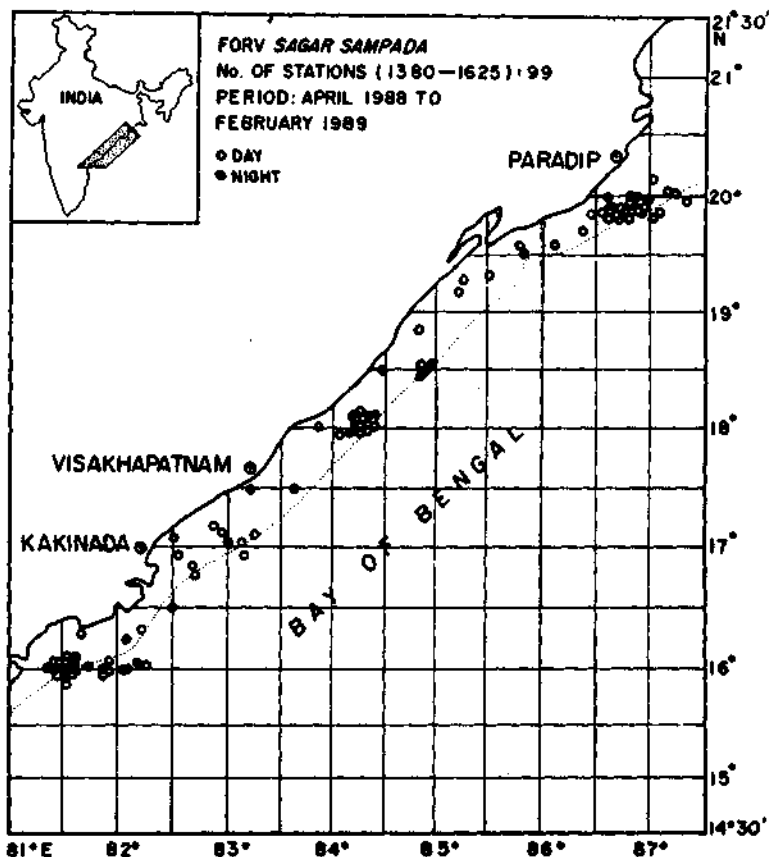

Fig. 1— Map showing the location of sampling stations

followed by the premonsoon. The neretic zone up to 50 m depth was rich in zooplankton population and thereafter a steady decline was observed with the increasing depth. The more saline southern part (lat.1) and the less saline northern part (lat.2) exhibited remarkable differences in abundance of the population and standing stock in such a way that 63% of the total was confined to the northernmost region. The statistical analyses (Table 1) show that there is significant interaction between the season and depth ( $F=0.001$ ) and that the mean values differ significantly in different depth zones over seasons ( $F=0.000$ ). Similarly there is indication that significant variation of biomass occur in latitudes over the seasons ( $F=0.001$ ).

It is generally acknowledged that high abundance of zooplankton population occur in the northwest coastal belt of the Bay of Bengal during the southwest monsoon and that there is comparatively low production in the following northeast monsoon. There are reports of coastal upwelling in the region off Waltair (Murty & Varadachari, 1968) and off Visakhapatnam (Rao, *et al.* 1986) during premonsoon and southwest monsoon, and a 40 km wide band of upwelling driven by local wind along the western

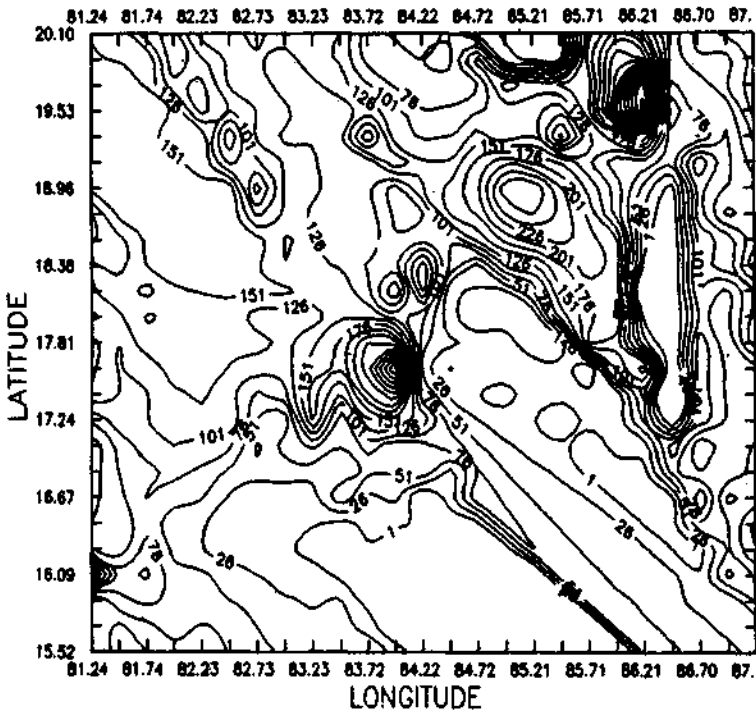

Fig. 2— Isopleths of biomass ( $\text{ml}/1000 \text{ m}^3$ )

boundary of Bay of Bengal during July-August (Shetye *et al.* 1991). According to Sankaranarayanan & Reddy (1968) there is evidence of coastal upwelling in the northwestern Bay in January and all these point towards nutrient enrichment of the surface layers and the subsequent enhancement of phytoplankton production followed by zooplankton abundance. The average temperature and salinity of the water column recorded for the season were the lowest ( $27.20^\circ\text{C}$  and  $29.09 \times 10^{-3}$ ) during the northeast monsoon when the highest mean ( $144.39 \text{ ml}$ ) biomass was observed. The freshwater influx and the high nutrient load towards the head of the Bay (Qasim, 1977) coupled with the southwesterly current and the prevailing wind pattern along with the effect of upwelling would have caused the gradual piling up of the standing crop in the coastal waters especially between the regions  $18^\circ\text{N}$  and  $20^\circ\text{N}$ . It may be noted that the biomass registered higher values towards the end of November and throughout January and the nutritional status of the predominant zooplankters encountered were either herbivores or filter feeders, though there were other carnivores and omnivores. The percentage contribution of the biomass during the premonsoon was 37.86 and that of the southwest monsoon 13.67. Vijayakumar & Sarma (1988) observed the peak in zooplankton biomass along the northwest coast during the northeast monsoon and low values in the southwest monsoon and attributed it to the

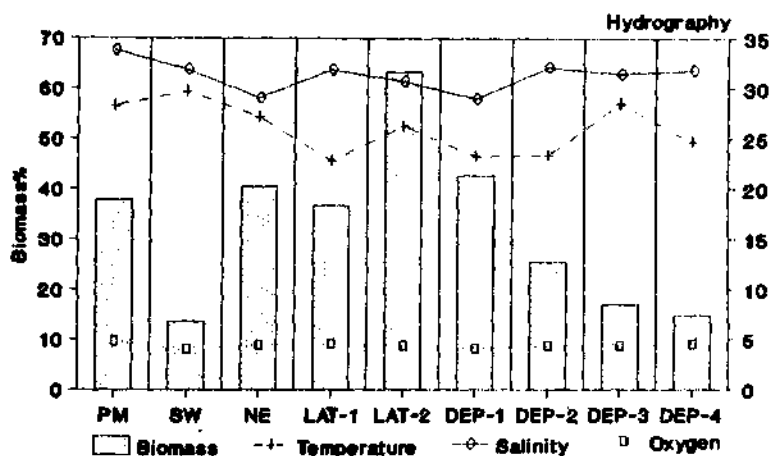

Fig. 3— Variations in biomass against season, latitude and depth

Table I— Analysis of variance

Source of variation	Sum of squares	DF	Mean square	F	Significance of F
<i>Biomass of season and depth</i>					
Main effects	344375.223	5	68875.045	5.330	0.000
Season	179361.503	2	89680.751	6.941	0.002
Depth	163037.001	3	54345.667	4.206	0.008
2-way interactions	334568.649	6	55761.442	4.316	0.001
Season depth	334568.649	6	55761.442	4.316	0.001
Explained	678943.872	11	61722.170	4.777	0.000
Residual	1124134.298	87	12921.084		
Total	1803078.170	98	18398.757		
<i>Biomass by latitude and season</i>					
Main effects	279770.624	3	93256.875	5.883	0.001
Latitude	98432.402	1	98432.402	6.210	0.014
Season	200414.747	2	100207.373	6.322	0.003
2-way interactions	49197.414	2	24598.707	1.552	0.217
Lat. season	49197.414	2	24598.707	1.552	0.217
Explained	328968.038	5	65793.608	4.151	0.002
Residual	1474110.132	93	15850.647		
Total	1803078.170	98	18398.757		



mixing of low saline surface waters with that of the high saline nutrient rich bottom water during upwelling or turbulence caused by other factors leading to proliferation of zooplankters as suggested by Ganapati (1973).

It deserves special mention here that along with the peak in abundance of the secondary producers the commercially important fishes caught from the northwestern region during this particular season also showed maximum. Scariah *et al.* (1987) while giving the average annual catch for the ten year period, up to 1984, records the highest landings in the last quarter followed by the first quarter for the Orissa coast where the planktivorous fishes such as sardines, pomfrets etc. constituted more than 33%. But in later years the percentage contribution of the pelagic fishes in terms of mackerels, carangids, ribbon fishes and pomfrets varied from 31% in 1988 to 45% in 1989 (CMFRI, 1995). Along the Andhra coast landings of the pelagic fishes which were more than 53% up to 1984 (Alagaraja *et al.* 1987) further increased to 62% in 1988 and 63% in 1989 (CMFRI, 1995) and the estimated catch was the highest during the first or last quarter of the year. The abundance observed in oil sardine, pomfrets, tuna and tuna like fishes was conspicuously more during 1988 and 1989 (CMFRI, 1995) along the northwestern coast. Therefore, it is logical to conclude that the spurt observed in the proliferation of the zooplankton population in the northeast monsoon might bear a close trophic link to that of the fishery resources harvested from the northwestern part of the Bay of Bengal. It may be that the plankton production funnelled either by pelagic or demersal route into the fish production (Sheldon *et al.* 1975).

### Monthly variations

The monthly mean biomass value of 285.42 ml was the maximum in January and the hydrographic parameters registered were 23.98°C,  $29.85 \times 10^{-3}$  and 4.34 ml. Almost all the major groups and larval forms exhibited increased abundance during January. There was sizable reduction in the constituent groups in February (Fig.4). Many groups dwindled except euphausiids, fish eggs and larvae and their combined association was very prominent in February. Euphausiids were poorly represented during May-June and their relative abundance was never more than 5% at any time. Fish eggs were predominant during February-May and larvae in July and January-February. Pelagic fish in spent or partially spent condition were commonly found in the area off Visakhapatnam during January-May (Luther, 1995).

Copepods formed the most abundant group constituting more than 54% of the total population except in July. Though the percentage contribution was as high as 76% in June it came down to 48%, the lowest, encountered in July when siphonophores, chaetognaths, pelagic tunicates especially the appendicularians and salps, lucifers, planktonic molluscs, euphausiids, larval decapods and fish larvae occurred in appreciable numbers. The density of copepods was the highest in January.

Greater concentration of pelagic tunicates was found in January when aggregates of thaliaceans and appendicularians appeared in the collections. The salps were

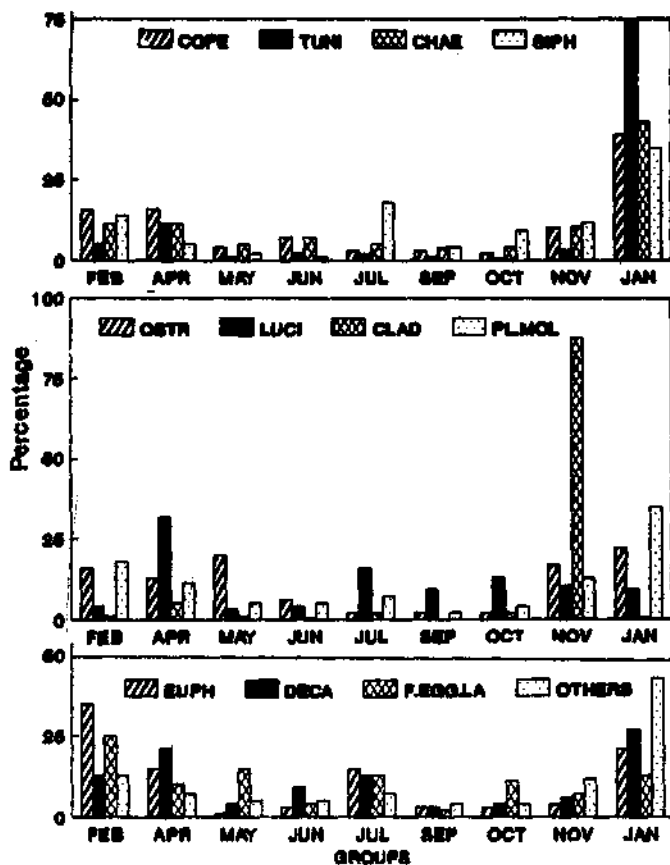

Fig. 4— Monthly variations of different groups

always more in number than the doliolids except in April. Appendicularians were also present in large numbers during April. The zooids of *Pyrosoma* were very common in February.

Chaetognaths were most abundant in January and to a lesser extent in February and July though they were present throughout the period of observation and contributed 5 to 9% of the total population. The highest density of siphonophores was observed in January, and their relative abundance was 15 and 12% respectively during July and October.

Ostracods were moderately abundant throughout but the peak was noticed in January. After reaching the maximum in April, lucifers recorded the lowest number in May but formed 7% of the total in October. The population of the cladocerans exhibited wide fluctuations in their abundance throughout the period of study but appeared in swarms during November. The density of larval decapods was the highest

in January. They were well represented in the coastal waters during February and April.

The planktonic molluscs included larval lamellibranchs, gastropods, heteropods and pteropods and occurred in considerable numbers during January. A few phyllosoma appeared in the samples taken from the second and fourth depth zones during January and April respectively. Planktonic foraminifers were present throughout the period of observation and were remarkably high in January. Amphipods as a group was quite significant among the planktonic crustaceans and were found to form an important component of the population during January-February. Larval polychaetes were present in large numbers during January and April. Stomatopod larvae in January and mysids in February appeared in appreciable numbers. Hydromedusae were abundant in the neretic waters during January-February. Juveniles of cephalopods and *Amphioxus* occurred occasionally in significant numbers, the former in June and the latter in November and January. A few isopods were also encountered in the collections.

### Seasonal abundance

The zooplankton standing stock and the many groups like copepods, chaetognaths, siphonophores, fish larvae, planktonic molluscs, cladocerans, amphipods, larval stomatopods, polychaetes, hydromedusae, ctenophores and foraminifers were at the peak of their abundance during the northeast monsoon season (Fig.5) when the mean temperature and salinity observed were low. On the other hand, pelagic tunicates, ostracods, lucifers, euphausiids, larval decapods and fish eggs showed greater affinity to high temperature ( $28.32^{\circ}\text{C}$ ), salinity ( $33.82 \times 10^{-3}$ ) and dissolved oxygen (4.85 ml/l) and their maximum abundance was observed in the premonsoon. The distribution pattern exhibited by copepods, cladocerans and euphausiids agree with the findings of earlier workers (Pillai 1990; Naomi et al. 1990; Mathew et al. 1990b). The abundance of zooplankton was very low during the southwest monsoon when the average temperature ( $29.70^{\circ}\text{C}$ ), salinity ( $31.89 \times 10^{-3}$ ) and oxygen (3.98 ml/l) recorded were moderate. It may be noted that the earlier works on the northwestern coast

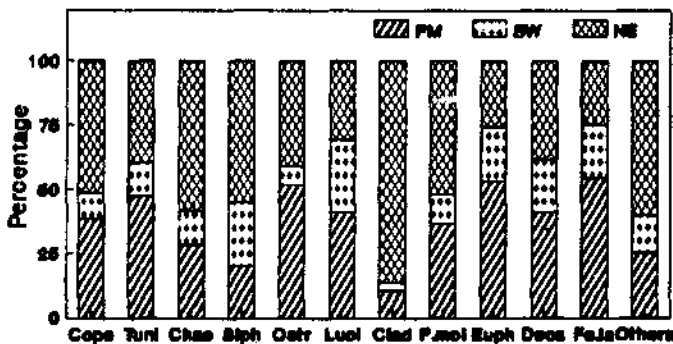

Fig. 5— Seasonal variations of different groups

(Nair *et al.* 1977; Achuthankuty *et al.* 1980; Nair *et al.* 1981) were confined to either 1 or 2 months during the southwest monsoon period. It is probable that the large inflow of fresh water entering the marine environment at several points might have helped in strengthening the stratification particularly in the northern part due to incomplete mixing and reduced wind forcing at times (Suryanarayana *et al.* 1992). The prevailing characteristics of the Bay waters at the time of sampling would not have been favourable for the continued development and proliferation of zooplankters. The number of stations covered in the present study during the premonsoon, southwest monsoon and northeast monsoon were 30, 28 and 41 respectively. Continuous observations of longer duration would throw more light on the pattern of zooplankton abundance and distribution along the northwestern region of the Bay of Bengal.

### Latitudinal abundance

There were wide variations in the biomass and numerical abundance of the groups collected from the southern (lat.1) and northern (lat.2) sectors. Out of the 99 stations sampled, 52 were from lat.1 and the rest from lat.2. An increasing trend in abundance towards north was evident in the majority of the groups. When the mean biomass recorded from north was 135.36 ml it was only 78.51 ml from the south. Almost all the groups except euphausiids showed a northward shift in numerical abundance (Fig.6). The prime components among them were cladocerans followed by pelagic tunicates. The average temperature and salinity observed for the northern and southern latitudes were 26.30°C and  $30.69 \times 10^{-3}$  and 22.83°C and  $31.88 \times 10^{-3}$  respectively. The pattern of distribution over seasons in both the sectors (Fig.7) reveal that more than 50% of copepods, pelagic tunicates, ostracods, euphausiids, fish eggs and larvae occurred in the premonsoon and the rest in the northeast monsoon in the southern latitude. In the northern latitude the trend was completely different in that all the major groups except lucifers, larval decapods and fish eggs displayed maximum abundance in the northeast monsoon season. No groups attained peak in the southwest monsoon season in both the sectors.

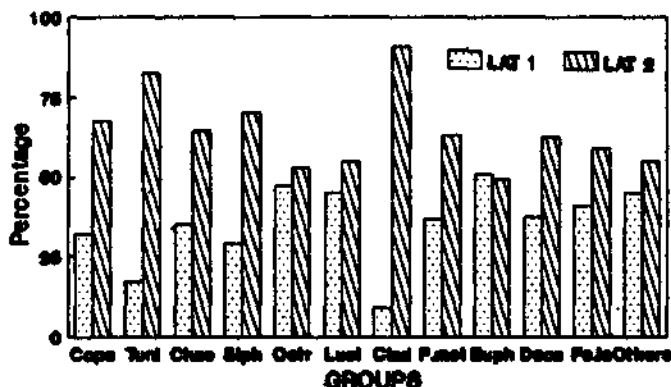

Fig. 6— Latitudinal variations of different groups

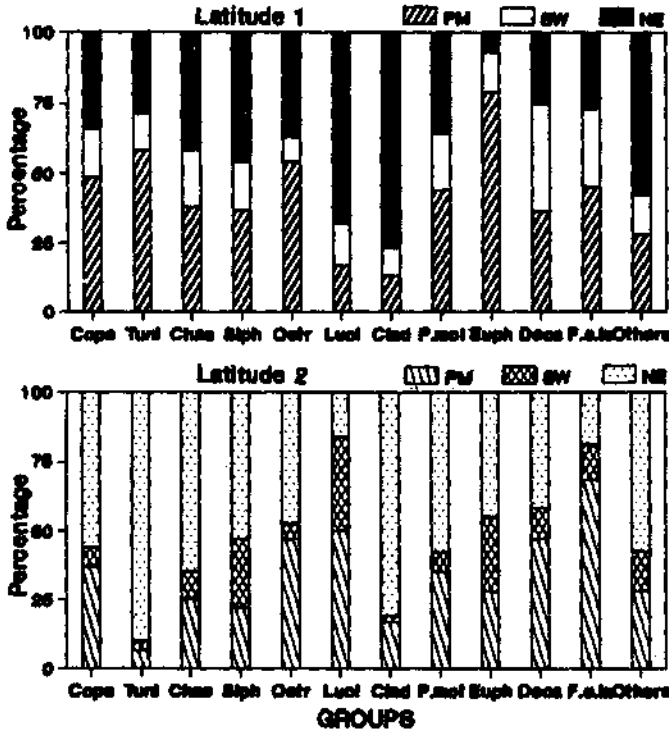

Fig. 7— Seasonal variations in lat.1 and lat.2

### Depthwise distribution

Though the fish larvae (3999) were present in large numbers in the first depth zone, the highest number of fish eggs (7322) were collected from the third depth zone, euphausiids from the second zone and ostracods from the fourth zone respectively (Fig. 8). The rest of the zooplankton population resided mainly in the neretic region up to 50 m depth zone of the northwestern Bay. The average salinity of the different depth zones fluctuated from  $28.99$  to  $32.14 \times 10^{-3}$ . During the northeast monsoon the salinity registered  $22.43 \times 10^{-3}$  and oxygen  $2.89$  ml/l in the first depth zone when it supported more than 58% of the total population.

The day-night variations (Fig.9) show that the ostracods, lucifers and planktonic molluscs occurred more in the nighttime collections and that there was no difference in the distribution of larval decapods during day or night.

### Secondary production

The secondary production was estimated following the method suggested by Dalal & Parulekar (1986). The average production of the area,  $4.91$   $\text{gC/m}^2/\text{y}$  was relatively higher than that of an earlier observation which was less than  $3$   $\text{gC/m}^2/\text{y}$  (Mathew et

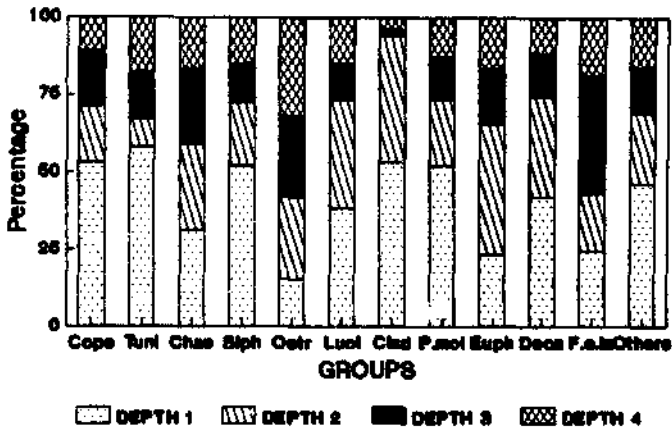

Fig. 8— Variations in different depths

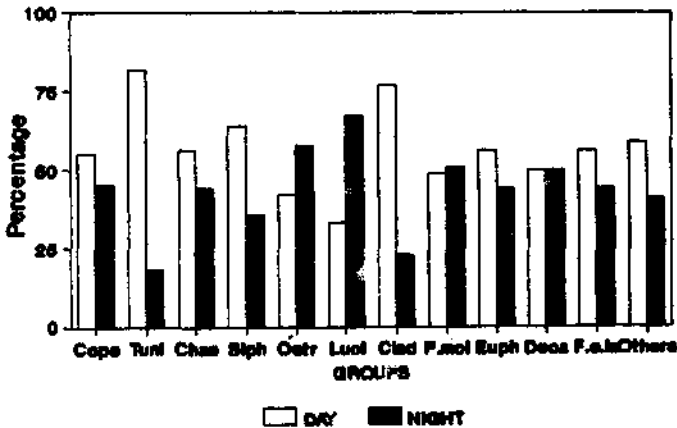

Fig. 9— Day-night variations of different groups

al. 1990a). The production estimated per degree square area showed the highest value off Chilka lake ( $9.07 \text{ gC/m}^2/\text{y}$ ) followed by that off Paradip ( $7.47 \text{ gC/m}^2/\text{y}$ ) and Visakhapatnam ( $7.9 \text{ gC/m}^2/\text{y}$ ).

Fluctuations in the community structure and zooplankton standing stock have frequently been referred to biological interactions including selective predation. Further investigations of longer duration covering the three seasons of the area are necessary to understand and assess the trophodynamics of the coastal waters of the northwestern Bay of Bengal.

### ACKNOWLEDGEMENT

The authors wish to express their sincere gratitude to Dr.P.S.B.R.James, former Director, CMFRI, Cochin for his keen interest in this work. They are indebted to Mr T.V.Sathianadan and Mr M.B.Seynuddin for their help in computer processing of the

data. They are also grateful to M/s Saji K. David and K.M. Santhosh, Project Scientists of NRSA for their timely help. They are thankful to M/s R. Vasanthakumar, K. Vijayakumar, P. Krishnakumar, V.V. Singh, P. Kaladharan and Daniel Selvaraj for collecting the zooplankton samples onboard *Sagar Sampada*.

## REFERENCES

- Achuthankutty, C.T., Madhuratap, M., Nair, V.R., Nair, S.R.S. & Rao, T.S.S. 1980. Zooplankton biomass and composition in the western Bay of Bengal during late southwest monsoon. *Indian J. Mar. Sci.* 9: 201-206.
- Alagaraja, K., Yohannan, K.C., Ammini, P.L. & Pavithran, P.P. 1987. An appraisal of the marine fisheries of Andhra Pradesh, *Spl. Publ. CMFRI*, 33: 1-53.
- CMFRI. 1990. *Proceedings of the first workshop on scientific results of FORV Sagar Sampada*, 5-7 June, Cochin. (Ed.) K.J. Mathew, (CMFRI, Cochin-14), 1-465.
- CMFRI. 1995. Marine fish landings in India during 1985-1993 *Mar. Fish. Infor. Serv. T & E Ser.* 136: 1-30.
- Dalal, S. G. & Parulekar, A. H. 1986. Validity of zooplankton biomass and energy equivalent in the Indian Ocean, *Indian J. Mar. Sci.*, 15: 264-266.
- Ganapati, P. N. 1973. Biological oceanography of the Bay of Bengal. *Mahasagar-Bull. Natn. Inst. Oceanogr.* 6 (2): 84-94.
- Krishnamurthy, B. 1976. An assessment of the demersal fishery resources off the Andhra-Orissa coast based on exploratory trawling. *Indian J. Fish.* 21 (2): 557-565.
- Luther, G. 1995. Fishery and resource characteristics of mackerel of Visakhapatnam coast, *Mar. Fish. Infor. Serv. T & E Ser.* 138: 1-5.
- Mathew, K. J., Naomi, T. S., Antony, G., Vincent, D., Anilkumar, R. & Solomon, K. 1990a. Studies on zooplankton biomass and secondary and tertiary production of the EEZ of India In: *Proc. First Workshop Scient. Resul. FORV Sagar Sampada*, edited by K. J. Mathew, (CMFRI, Cochin) pp. 59-69.
- Mathew, K. J., Naomi, T. S., Antony, G. & Scariah, K. S. 1990b. Distribution of euphausiacea in space and time in the Indian EEZ and contiguous seas, In : *Proc. First Workshop Scient. Resul. FORV Sagar Sampada*, edited by K.J. Mathew, (CMFRI, Cochin) pp. 121-127.
- Murty, C.S. & Varadachari, V. V. R. 1968. Upwelling along the east coast of India, *Proc. Symp. Indian Ocean, Bull Natn Inst. Sci. India*, 38: 80-86.
- Nair, V. R., Peter, G. & Paulinose, V. T. 1977. Zooplankton studies in the Indian Ocean. I. From Bay of Bengal during southwest monsoon period, *Mahasagar—Bull. Natn. Inst. Oceanogr* 10 (1&2): 45-54.
- Nair, S.R. S., Nair, V. R., Achuthankutty, C. T. & Madhuratap, M. 1981. Zooplankton composition and diversity in the western Bay of Bengal, *J. Plankton Res.* 3(4): 493-508.
- Naomi, T. S., Antony, G. & Mathew, K. J. 1990. Studies on the distribution of cladocera in the eastern Arabian Sea and the Bay of Bengal. In: *Proc. First Workshop Scient. Resul. FORV Sagar Sampada*, edited by K. J. Mathew, (CMFRI, Cochin) pp. 85-93.
- Pati, S. 1980. Observations on the hydrography and inshore plankton of the Bay of Bengal off Balasore, *Hydrobiologia*, 70: 123-132.
- Pillai, P. P. 1990. Heterogeneity in the distribution pattern of pelagic copepods collected onboard *FORV Sagar Sampada* in the Indian EEZ, In: *Proc. First Workshop Scient. Resul. FORV Sagar Sampada*, edited by K. J. Mathew (CMFRI, Cochin) pp. 95-108.
- Qasim, S. Z. 1977. Biological productivity of the Indian Ocean, *Indian J. Mar. Sci.* 6(2): 122-137.
- Rao, T. V. N., Rao, D. P., Rao, B. P. & Ramaraju, V. S. 1986. Upwelling and sinking along Visakhapatnam coast, *Indian J. Mar. Sci.* 15 (2): 84-90.

- Sankaranarayanan, V. N. & Reddy, C. V. G. 1968. Nutrients of the northwestern Bay of Bengal, *Proc.Symp. Indian Ocean., Bull. Natn. Inst. Sci. India.* 38: 148-163.
- Scariah, K. S., Philipose, V., Dan, S. S., Nair, P. K. & Subbaraman, G. 1987. An appraisal of the marine fisheries in Orissa, *Spl. Publ. CMFRI*, 32: 1-37.
- Sheldon, R. W., Sutcliffe Jr. W. H. & Paranjape, M. A. 1975. Structure of pelagic food chain and relationship between plankton and fish production, *J. Fish. Res. Board Can.* 34: 2344-2353.
- Shetye, S. R., Shenoi, S. S. C., Gouveia, A. D., Michael, G. S., Sundar, D & Nampoothiri, G. 1991. Wind driven coastal upwelling along the western boundary of the Bay of Bengal during southwest monsoon, *Continental Shelf Research.* 11 (11): 1397-1408.
- Suryanarayana, A., Murty, C. S. & Rao, D. P. 1992. Characteristics of coastal waters of the western Bay of Bengal during different monsoon seasons, *Aust. J. Mar. Freshwater Res.* 43: 1517-1533.
- Vijayakumar, R. & Sarma, V. V. 1988. Zooplankton studies in Visakhapatnam harbour and nearshore waters of east coast of India, *Indian J. Mar. Sci.* 17: 75-77.

\* \* \*



**Distribution and abundance of the genus  
*Vinciguerria* (Gonostomatidae) in the DSL of Indian  
EEZ with a note on the biology of  
*Vinciguerria nimbaria***

N.G. Menon, N.G.K. Pillai, R. Reghu & K. Balachandran  
Central Marine Fisheries Research Institute, P.B. No. 1603,  
Cochin-682014

**ABSTRACT**

In the DSL fish biomass one of the dominant genus was *Vinciguerria*, represented by three species such as *V. nimbaria*, *V. attenuata* and *V. poweriae*. The occurrence of *Vinciguerria* was frequent in northwest and southwest area of EEZ at varying depths. The average number per haul in Isaac Kidd mid water trawl (IKMT) was 149 in day and 191 in night collection. *Vinciguerria nimbaria* has accounted for more than 95% of the total catch of the genus. Its total length varied from 10-56 mm. The length weight relationship is  $\log W = -5.5691 + 3.1676 \log L$ . Invariably the species fed on copepods, ostracods, cladocerans, appendicularians euphausiids, chaetognaths, fish larvae etc. with variations in feeding intensity during day and night. About 92 % of the catch belonged to mature fishes. The species spawns only once in a year and the fecundity ranged from 140 to 770 ova in fishes of 34 - 55 mm total length.

**INTRODUCTION**

The bioacoustic scattering layer occurring widely in world oceans is an important ecosystem which supports a wide assemblage of meso-zooplankton, micro- and macro- nekton. The availability, abundance and vertical migrations of many epi- and meso-pelagic fishes are influenced or controlled by the diurnal and seasonal occurrence and intensity of the preferred food organisms, macro- zooplankton, in the deep scattering layer (DSL). Although considerable efforts have gone into the study of the biocomposition, their intensity, diurnal movements, speed and magnitude of migrations, predator- prey relationship and its energetics within this ecosystem of DSL organisms from different parts of world oceans (Tucker, 1951; Alverson, 1961; King & Iverson, 1962; Pearcy, 1965; Bary, 1966; Pearcy & Laurs 1966; Taylor, 1968;

Kinzer, 1969), studies from India on the subject are limited to the works of Silas & George (1969), Silas (1972), George (1989), Menon & Prabha Devi (1990), Menon (1990), Mathew & Natarajan (1990), Kathirvel (1990), Balasubramanian & Suseelan (1990), Suseelan & Nair (1990), Mini Raman & James (1990), James & Prabha Devi (1990) Meiyappan & Nair (1990), and Pon Siraimettan (1990). The importance of epi- and meso-pelagic fishes, preferably from the oceanic realm, is gaining importance in the light of present stagnating or declining coastal fish production. Many groups of micro-nektonic meso-pelagic resources form prey organisms to shoaling pelagics like tuna, shark etc. and as such their distribution and abundance in the oceanic waters give vital clue to the availability of the latter groups of exploitable resources. Of the several groups of fishes occurred in the DSL, the genus *Vinciguerria* is an important genera, often appears in large concentrations. Therefore, this group was selected for a detailed investigation on their distribution, abundance and biology.

## MATERIALS AND METHODS

The DSL of Indian EEZ was sampled by using an Isaacs Kidd mid water trawl (IKMT) net (2.5 m) during the first 15 cruises of *FORV Sagar Sampada* in February 1985 - May 1986. The samples were collected from appropriate depths (invariably the principle layer) of DSL recorded by echo sounders. Out of 563 stations covered during the 15 cruises the net was operated from 445 stations at 3 knot speed. Among these 364 stations yielded DSL biomass at the rate of 0.1 to 38.1 ml/1000 m<sup>3</sup> from depths ranging from 20-540 m depending on day or night operations. The samples were sorted into different groups and the fish biomass was subjected for detailed study on species composition. One of the dominant species, *Vinciguerria nimbaria* was separated for biological studies like length composition, length weight relationship, food and feeding habits, maturity conditions, ova diameter frequency and fecundity. The stomach content of *V. nimbaria* collected from the DSL during 1985 - 86 were analysed for the qualitative and quantitative composition, the intensity of feeding in relation to day and night, season; qualitative and quantitative composition of diet in different seasons, day and night, relation between meso-zooplankton stock in the DSL and the feeding preference using standard methods (Hynes, 1950; Pillai, 1952; and Natarajan & Jhingran, 1961). Altogether 500 fishes of both sexes within the size range of 12-56 mm were utilised for the stomach content analysis. The degree of fullness of the stomach was noted as gorged; full, 3/4, 1/2, 1/4; trace and empty. Fishes with gorged, 3/4, and 1/2 stomachs were treated as 'actively fed' and fishes with stomach 1/4, trace and empty as 'poorly fed'. The samples were pooled for 2 hourly interval for diurnal feeding intensity studies. The food organisms were identified to groups/generic level, wherever possible. The ova diameter frequency of the species at different maturity stages was worked out by using the methods of Clark (1934), Prabhu (1956).

## RESULTS

In the total DSL biomass, finfishes occurred in 82% of IKMT stations and accounted for 5.4% and their abundance ranged from 0.01 to 45.5 g/1000 m<sup>3</sup>. The genus *Vinciguerria* occurred in 90 stations, (51 night and 39 day) out of which 73 stations were in west coast and 17 in the east coast (Fig.1). Along the west coast the catch (number) per haul ranged from 1 to 2931 in night hauls and 2 to 1254 in day hauls. From the east coast its abundance varied from 1 to 7 number per haul in day and 1 to 530 in night operations.

*Vinciguerria* was dominant in the DSL of south west coast especially at 07°15' N, 77°50'E (2931 no/haul); 12°00' N, 75°04'E (1254 no/haul) and 07°10'N, 76° 06'E (1110 no/haul). The average number per haul was 149 in day and 191 in night collections.

Latitude wise number per haul of *Vinciguerria* in the west coast (Table 1) has ranged from 20 to 904 in 06°N and 07° N respectively. In the day collections high catches were recorded in 12°N (1254 no) and 17°N (614 no); whereas it was found to be abundant in 07°N (1126 no) and 20°N (815 no) in night hauls. In the east coast invariably better catches were recorded in night collections at 15°N and 19°N (269 and 283 no respectively).

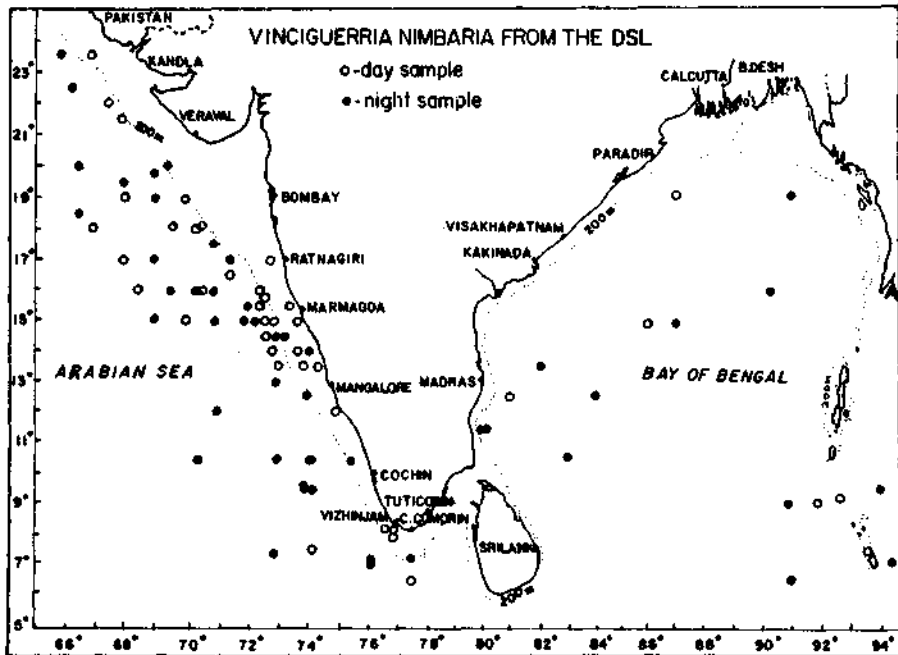

Fig. 1 - Geographical distribution of *Vinciguerria* in the DSL during day and night hauls

Table 1 - Latitude wise IKMT catch (no/haul) of *Vinciguerria nimbaria* during day and night

Latitude ( $^{\circ}$ N)	Catch (no/haul)		
	Day	Night	Mean
		West coast	
23	91	308	200
22	7	274	141
21	243	-	243
20	-	815	815
19	60	60	60
18	108	4	22
17	614	137	257
16	26	51	39
15	17	20	19
14	4	51	20
13	455	65	195
12	1254	60	458
10	17	25	23
09	28	86	63
08	113	-	113
07	15	1126	904
06	20	-	20
		East coast	
06	-	10	10
07	-	189	189
09	6	3	5
10	-	91	91
11	-	60	60
12	3	-	3
13	-	14	14
15	2	269	135
19	1	283	189

Table 2 - Seasonal IKMT catch (no/haul) of *Vinciguerria nimbaria* during day and night

Months	Day	Night	Mean
		West coast	
January	-	111	111
February	-	-	-
March	-	21	21
April	22	120	81
May	-	-	-
June	-	-	-
July	128	-	128
August	26	28	27
September	75	26	56
October	97	143	120
November	1254	2931	2092
December	169	200	189
		East coast	
March	1	-	1
April	6	51	42
June	3	74	57
July	7	1	4

*Vinciguerria* occurred throughout the year in the west coast with particular abundance in November (2092 no) followed by December (189 no). In November the night catch was 2931 while day yielded only 12543 (Table 2).

It occurred from shallow grounds of 33 m depth to deep oceanic areas of 3878 m depth along the west coast and from 46 m to 3759 m in the east coast. Generally in occurred in the DSL from surface to 80 m depth during night and in higher depths (100 - 320 m) during day (Fig.2). Sizable stocks reside the meso-pelagic habitat of the EEZ and migrate vertically.

In the total catch of *Vinciguerria*, *V. nimbaria* was accounted for 95 % followed by *V. attenuata* and *V. poweriae*.

#### Biology of *V. nimbaria*

*Size frequency* — In the north west region from 16° - 23° N the total length of *V. nimbaria* (Fig.3) ranged from 12 - 56 mm with major modes at 32 mm (August), 16,

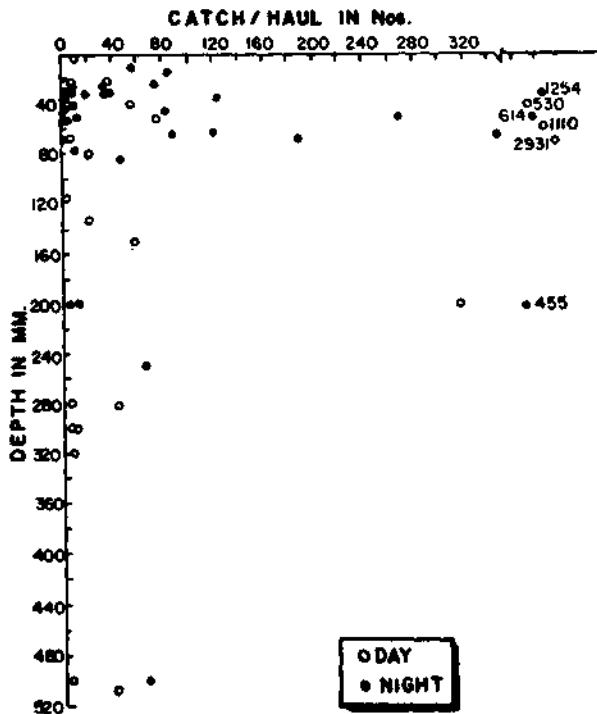

Fig. 2 - Bathymetric catch per haul of *V. nimbaria* in the DSL

20, 28, 32 and 40 mm (October) and 20, 28, 40, 44 and 48 mm (December). The length frequency in the south west region from  $06^{\circ}$  -  $15^{\circ}$  N showed a size range of 12-52 mm with several modes at 32, 40 mm (April), 32 mm (October), 36 mm (November) and 20, 24, 28 and 44 mm (December). Its size frequency from  $06^{\circ}$ N along east coast ranged from 12-36 mm in the month of April and the modes were at 16 and 28 mm. From the available data, it is possible to presume that the life span of the species is only one year.

**Length-weight relationship** — The length weight relationship of *V. nimbaria* (Fig.4) was established based on 300 individuals of total length 12-56 mm and weight range of 6 - 760 mg. The relationship was found to be:  $\log W = - 5.5691 + 3.1676 \log L$ . ( $r = 0.9830$ ).

**Food and feeding habits** — The feeding intensity was generally poor during nighttime (Fig.5). In the north west region about 75% of the night catches were poorly fed, while in day catches 46% were actively fed. Along the south west region the feeding intensity was generally low compared to north west region. In this region 69% in the night catches and 78% in day catches were poorly fed. During the premonsoon the feeding intensity was found to be active (90% in day and 55% in night). In

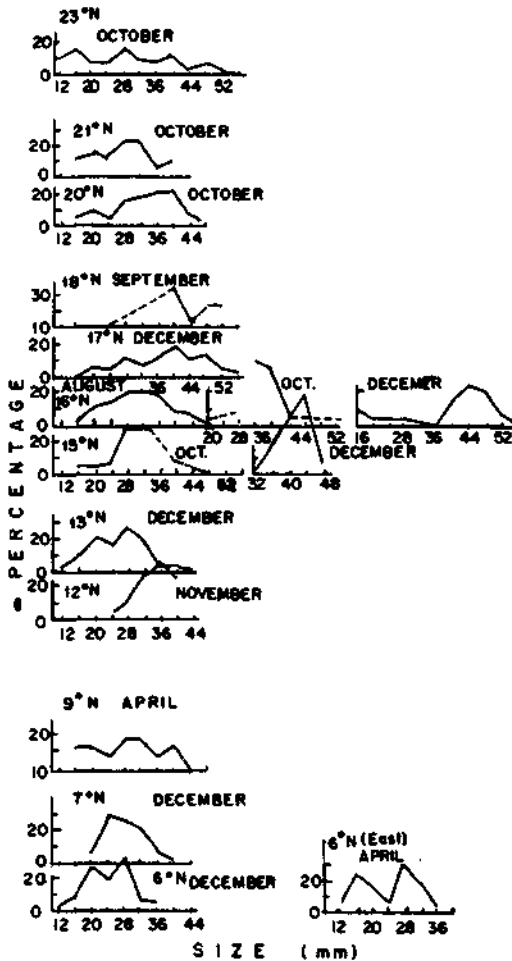

Fig. 3 - Length frequency of *V. nimbaria* in each latitude

monsoon season 90% was poorly fed during day and 20% in night- time. During postmonsoon months the feeding intensity was poor at night (96%) and active in day (36%).

During day hours the feeding intensity was high with gorged or full stomach in 0600 - 1200 hrs and 1600 - 1800 hrs. A wide variety of planktonic organisms like copepods, ostracods, fishes, chaetognaths, mysids amphipods formed the food. In night hours the feeding intensity was generally poor. During 0600 - 0800 hrs, however, 95% of the fishes were with full stomach. Invariably there was no feeding activity from 0000 - 0600 hrs although the DSL was at the surface 50m. During 0000 - 0600 hrs it fed on a narrow spectrum of planktonic organisms like copepods, ostracods, and fishes. Copepods were common in the diet at 1800 - 2200 hrs. Fishes were frequently

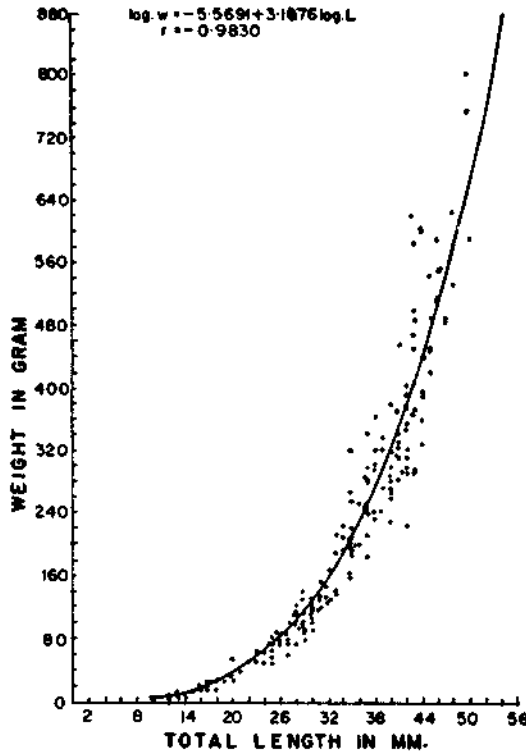

Fig. 4 - Length-weight relationship of *V. nimbaria*

preyed upon by *V. nimbaria* during 1800 - 2400 hrs. Ostracods were yet another common item encountered throughout the night (Fig.6).

*Vinciguerria numbaria* fed on meso-zooplanktonic organisms from DSL intensively during early and late hours of day. The major organisms on which it preyed upon were copepods, ostracods, fishes, crustacean larvae, chaetognaths, euphausiids, amphipods, mysids, appendicularians and others. *V. nimbaria* might be in middle of a fairly short food chain: phytoplankton → microzooplankton → copepods → ostracods → *V. nimbaria* → larger pelagic predator fishes and cephalopods. The feeding activity was invariably slow in late night and minimal at depth in daytime. The seasonal feeding pattern of *V. nimbaria* showed that copepods (45.2%), digested matter (19%), ostracods (14.6%) and fishes (6.2%) were common in premonsoon months (Table 3). Similarly in postmonsoon, copepods (26.8%), digested matter (22%), ostracods (19.3%) and fishes (9.1%) were abundant food organisms. In monsoon months the most preferred food items were ostracods (22.8%), copepods (99.4%), digested crustaceans (16.7%) and fishes (14.2%).

*Vinciguerria nimbaria* ascend the water column along with the vertically moving meso-zooplankton during evening and descend down by morning. The abundance of the fish and their migrations might be influenced by the availability of the prey organisms. The feeding activity was generally high in the surface layers and minimal



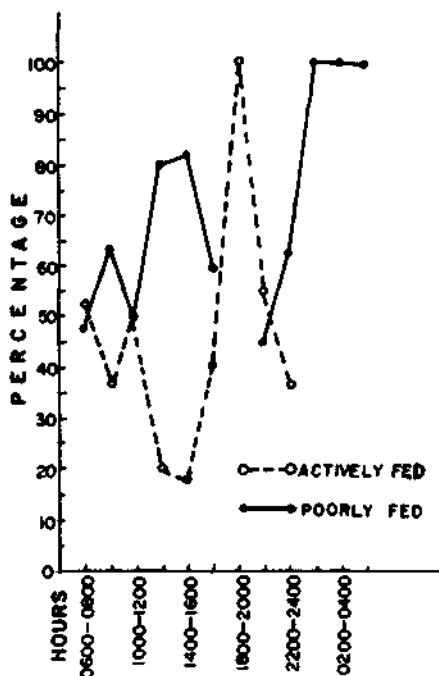

Fig.5 - Diurnal variations in the feeding intensity of *V. nimbaria*

at depth. The meso-zooplankton of the DSL was supported chiefly by euphausiids, decapods, fish eggs/ larvae, copepods, chaetognaths, pteropods, heteropods, crustacean larvae, ostracods, mysids and others. The diurnal percentage composition of various meso-zooplanktons in the DSL are shown in Fig.6. The planktonic component showed marked variations between day and night catches. The dominant meso-zooplankton in day hauls were euphausiids, decapods, fishes, chaetognaths and larval crustaceans; while the night catches were predominated by copepods, euphausiids, decapods, pteropods and heteropods, larval crustaceans and fishes. *V. nimbaria* fed selectively on copepods, ostracods, fish larvae etc. although they formed only a small fraction in the DSL zooplankton.

**Reproduction** — The ova diameter frequency of *V. nimbaria* showed that the species spawns only once in the spawning season, as it has only a single modal size (0.7 mm) in the most mature group of ova in stages v and vi (Fig.7). Ripe females were recorded during August - December and spent fishes in October - December (Table 4). Ripe and spent males were noticed in the catches during August - October. The fecundity of *V. nimbaria* has ranged from 140 - 770 mm in fishes of 34 - 55 mm total length and the mean fecundity is estimated at 400 ova. The ripe ova were in the size range of 0.5 - 1 mm diameter with the dominant mode at 0.7 mm. The size at first maturity of this species is at 30 mm total length.

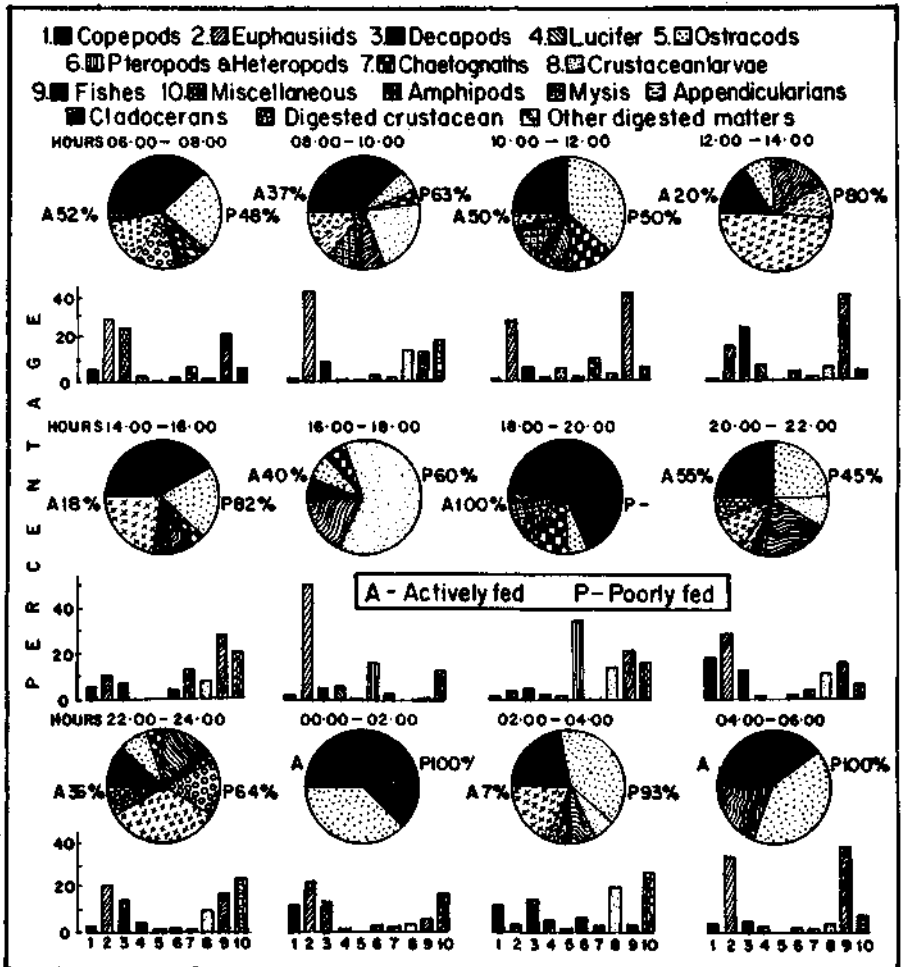

Fig. 6 - Dial variations of meso-zooplankton (percentage composition), food composition of *V. nimbaria* and its feeding intensity during day and night

### DISCUSSION

In order to understand the food relationship and the rate of metabolism from the lower to higher levels in the food web of the DSL ecosystem, a study on the larger nekton, their extent and periodicity of vertical ascends and descends, bathymetric and seasonal abundance and the degree to which these organisms are predator or prey of other trophic levels is pertinent. In addition to meso-zooplankton, the DSL biocomponents include a wide assemblage of young or adults of epi- and meso- pelagic fishes and they too vertically migrate along the macro-zooplankton. Menon (1990) analysed the IKMT samples from DSL, collected during *FORV Sagar Sampada* cruises, for the biocomposition and reported the wide occurrence of *Vinciguerria* (25.7% of total

Table 3 - Diurnal and seasonal food preference of *Vinciguerria nimbaria* from the DSL

Food items	Percentage composition				
	Day	Night	Post- monsoon	Monsoon	Premonsoon
Copepods	29.5	30.7	45.2	19.4	26.8
Ostracods	15.5	23.4	14.6	22.8	19.3
Cheateognaths	3.6	2.7	3.2	6.5	2.6
Amphipods	2.7	1.0	1.5	4.7	1.9
Mysis	2.5	1.2	2.2	1.3	2.0
Euphausiids	-	2.2	-	6.7	-
Appendicularians	2.0	1.0	-	1.5	1.4
Cladocerans	-	1.3	-	-	1.3
Decapods	-	-	-	-	3.1
Crustacean larvae	8.9	2.4	1.7	-	7.7
Fishes	8.7	11.5	5.2	14.2	9.1
Digested crustaceans	3.1	5.9	4.7	16.7	2.5
Other digested matter	22.2	15.7	19.0	4.1	22.0
Miscellaneous	1.3	1.0	2.7	2.1	0.3

fish biomass) with particular dominance in night hauls. Workers like Aron (1962), King & Iverson (1962), and Percy & Laurs (1966) attributed this diurnal differential abundance as due to visual avoidance of the gear, differential speed of ascend and descend in night and day respectively, the former being slower than the latter and also better escapement and greater scatter during day.

The results of the present study indicated higher abundance of *Vinciguerria* in October - December, which agrees with the earlier findings by Silas & George (1969). They found that it occurs more in oceanic than neritic waters with high abundance during post and premonsoon months. *V. nimbaria* has higher abundance in 7, 12/13, 17 and 20 N along the Arabian Sea. This finding is consistent with the observation of George (1989) based on ichthyoplankton surveys in southwest coast of India.

The biology of *V. nimbaria* was worked out based on DSL samples and the life-span of the species is estimated to be less than one year. It feeds on meso-zooplankton and migrate concurrently with them. The importance of epi- and meso-pelagic fishes from the DSL in the food of oceanic large pelagics like skipjack and yellowfin tuna are stressed by Alverson (1961), Vinogradov & Voronina (1961) and Silas (1972). The interaction between the meso-zooplankton stocks and the vertically migrating *V. nimbaria* was studied for any possible correlation. *V. nimbaria* shows preferential feeding and the feeding activity was intense in day break and

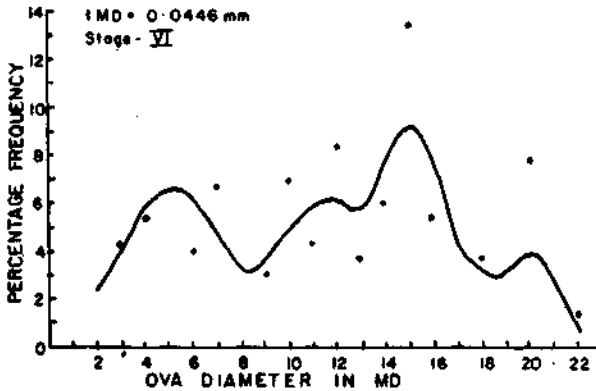
Fig. 7 - Ova diameter frequency of *V. nimbaria*Table 4 - Monthly maturity stages (Percentage) of *Vinciguerria nimbaria* along the west coast

	Maturity stages						
	I	II	III	IV	V	VI	VII
	<i>Females</i>						
February	-	-	25.0	-	75.0	-	-
April	-	23.0	30.8	30.8	15.4	-	-
August	-	13.3	46.7	11.7	26.7	2.2	-
September	-	15.8	57.9	26.3	-	-	-
October	-	6.7	31.1	31.1	18.9	6.7	5.5
November	-	-	-	76.9	23.1	-	-
December	3.0	24.2	21.2	19.8	25.8	4.5	1.5
	<i>Males</i>						
February	-	-	-	33.3	66.7	-	-
April	-	-	71.4	88.6	-	-	-
August	-	6.7	22.2	17.8	48.9	2.2	2.2
September	-	6.3	37.5	31.2	25.0	-	-
October	-	6.7	24.0	37.3	24.0	-	8.0
November	-	-	33.3	63.0	3.7	-	-
December	4.8	9.5	15.9	30.1	39.7	-	-

evenings, mostly at surface. The analysis of the present data indicates that the species is a visual feeder as evidenced by their intense feeding activity during day break and dusk hours, when the DSL moves in the column -descend in day break and ascend in dusk. The poor feeding in day time might be due to non-availability of the prey organism in the normal depth strata of *V. nimbaria*. During the day-light hours the DSL, preferably macro-zooplankton layer, descends far down to 400 - 500 m or more. Moreover at daytime the DSL forms several discrete layers and occupy different depths, below the predator species habitat.

### ACKNOWLEDGEMENT

The authors are thankful to Dr. P.S.B.R. James, former Director, and Dr. P. Bensam, Head, Demersal Fisheries Division for encouragement.

### REFERENCES

- Alverson, F.G. 1961. Day light surface occurrence of myctophid fishes off the coast of Central America, *Pacific Science*, 15 (3): 35 - 43.
- Aron, W. 1962. The distribution of animals in the eastern North Pacific and its relationship to physical and chemical conditions, *J. Fish. Res. Bd. Canada*, 19 (2): 271 - 314.
- Balasubramanian, C.P. & Suseelan, C. 1990. Preliminary observations on the distribution and abundance of the swarming crab, *Charybdis Goniobellenus smithii* Macleay in the Deep Scattering Layer along the west coast of India, In : *Proc. First Workshop Scient. Result FORV Sagor Sampada*, edited by K.J. Mathew, (CMFRI, Cochin) 385 - 391.
- Bary, B.Mc. 1966. Back scattering at 12 kc/c in relation to biomass and number of zooplanktonic organisms in Saanich Inlet, British Columbia, *Deep-Sea Res.* 13 (4): 655 - 656.
- Clark, F.N. 1934. Maturity of the California Sardine (*Sardina caerulea*), determined by ova diameter measurements, *Calif. Fish and Game. Fish. Bull.*, 42 : 1 - 49.
- George, K.C. 1989. Results of ichthyoplankton surveys along the southwest coast of India with special reference to pelagic fish resources, *J. Mar. Biol. Ass. India*, 31 (1 & 2): 172 - 179.
- Hynes, H.P.N. 1950. The food of freshwater sticklebacks (*Gasterosteus aculeatus* and *Pygosteus pungitius*) with a review of methods used in studies of food of fishes, *J. Anim. Ecol.* 19: 36 - 58.
- James, P.S.B.R. & Prabha Devi, L. 1990. Observation on the distribution of leptocephali of the EEZ of India, In: *Proc. First Workshop Scient. Result FORV Sagor Sampada*: edited by K.J. Mathew, (CMFRI, Cochin) 281 - 283.
- Kathirvel, M. 1990. On the collection of phyllosoma larvae by Isaacs Kidd midwater trawl from the west coast of India, In: *Proc. First Workshop Sci. Result FORV Sagor Sampada*, edited by K.J. Mathew (CMFRI, Cochin) 141 - 146.
- King, J.E. & Iverson, R.T.B. 1962. Midwater trawling for forage organisms in the Central Pacific 1951 - 1956, *Fishery Bull. Fish Wild. Ser. U.S.* 62 (210): 271-321.
- Kinzer, J. 1969. On the quantitative distribution of zooplankton in deep scattering layers, *Deep-Sea Res.* 16 : 117 - 125.
- Mathew, K.J. & Natarajan, S. 1990. Investigations on the DSL of the Indian EEZ with special reference to Euphausiids as a component, In: *Proc. First Workshop Scient. Result FORV Sagor Sampada*, edited by K.J. Mathew, (CMFRI, Cochin) 375 - 401.
- Meiyappan M. M. & Prabhakaran Nair, K. 1990. Preliminary studies on the cephalopods collected from the deep scattering layers of the EEZ and adjacent seas, In: *Proc. First Workshop Sci. Result FORV Sagor Sampada*, edited by K.J. Mathew, (CMFRI, Cochin) 397 - 401.

- Menon, N.G. 1990. Preliminary investigation on the fish biomass in the deep scattering layers of the EEZ of India. In: *Proc. First Workshop Sci. Result FORV Sagar Sampada*, edited by K.J. Mathew, (CMFRI, Cochin) 273-280.
- Menon, N.G. & Prabha Devi, L. 1990. Studies on the biomass in the deep scattering layer of the Indian EEZ. In: *Proc. First Workshop Sci. Result FORV Sagar Sampada*, edited by K.J. Mathew, (CMFRI, Cochin) 257 - 271.
- Mini Raman & James, P.S.B.R. 1990. Distribution and abundance of lantern fishes of the family Myctophidae in the EEZ of India. In: *Proc. First Workshop Sci. Result FORV Sagar Sampada*, edited by K.J. Mathew, (CMFRI, Cochin) 285 - 290.
- Natarajan A.V. & Jhingran, V.G. 1961. Index of preponderance - A method of grading the food elements in the stomach analyses of fishes, *Indian J. Fish.* 8(1): 54 - 59.
- Pearcy, W.G. 1965. Some distributional features of mesopelagic fishes off Oregon, *J. Mar. Res.* 22 : 83 - 102.
- Pearcy, W.G. & Laurs, R.M. 1966. Vertical migration and distribution of mesopelagic fishes off Oregon, *Deep - Sea Res.* 13 : 153 - 165.
- Pillai, T.V.R. 1952. A critique of methods of food of fishes, *J. Zool. Soc. India*, 4: 185 - 200.
- Pon Siraimetan. 1990. Bioproductivity studies in the southwest coast of India and Equatorial region. In: *Proc. First Workshop Scient. Result FORV Sagar Sampada*, edited by K.J. Mathew, (CMFRI, Cochin) 297 - 303.
- Prabhu, M.S. 1956. Maturation of intraovarian eggs and spawning periodicities in some fishes, *Indian J. Fish.* 3(1): 59 - 90.
- Silas, E.G. 1972. Investigations on the deep scattering layers in the Laccadive sea, In: *Proc. Symp. Corals and Coral Reefs, 1969*, (Mar. Biol. Ass. India, Cochin). 257 - 274.
- Silas, E.G. & George K.C. 1969. On the larval and postlarval development and distribution of the mesopelagic fish *Vinciguerria nimbaria* (Jordan and Williams) (Family Gonostomatidae) off the west coast of India and the Laccadive sea, *J. Mar. Biol. Ass. India*, 11 (1 & 2): 218 - 250.
- Suseelan, C. & Nair, K.R.M. 1990. Quantitative distribution of pelagic shrimps in the deep scattering layers of the Indian EEZ. In: *Proc. First Workshop Scient. Result FORV Sagar Sampada*, edited by K.J. Mathew, (CMFRI, Cochin) 361 - 370.
- Taylor, F.H.C. 1968. The relationship of mid water trawl catches to sound scattering layers off the coast off Northern British Columbia, *J. Fish Res. Bd. Canada*, 25(3): 457 - 672.
- Tucker, G.H. 1951. Relation of fishes and other organisms to the scattering off under water sound, *J. Mar. Res.* 10(2): 215 - 238.
- Vinogradov, M.E. & Voronina, N.M. 1961. Influence of oxygen deficit on the distribution of plankton in the Arabian Sea, *Okenologie*, 1 (4): 578 - 670.

\* \* \*

## Distribution and abundance of elasmobranchs in the Indian EEZ

Grace Mathew<sup>1</sup>, P. Devadoss<sup>2</sup>, E. Vivekanandan<sup>2</sup>, M. Feroz Khan<sup>3</sup> & P.U. Zacharia<sup>4</sup>

<sup>1</sup> Central Marine Fisheries Research Institute, P.B. No. 1603, Cochin - 682014

<sup>2</sup> Madras Research Centre of Central Marine Fisheries Research Institute, Egmore, Madras - 600006

<sup>3</sup> Calicut Research Centre of Central Marine Fisheries - Research Institute, West Hill, Calicut - 673005

<sup>4</sup> Mangalore Research Centre of C. M.F.R.I., Mangalore - 575001

### ABSTRACT

Elasmobranchs were present in 100 trawling stations of depth up to 170 m, along the Indian EEZ, where the *FORV Sagar Sampada* carried out fishing operations during her first hundred cruises. Abundance and distribution of sharks, skates and rays in the different latitudinal zones are discussed. The catchable potential of this resource up to the 50 m depth zone has been estimated as 64934 tonne. Elasmobranchs being on exploitable resource, the potential yield beyond 50 m in the EEZ is estimated as 88985 m tonne. Though the maximum catch was obtained from the southwest area, the maximum c.p.u of elasmobranchs was observed to be along the northwest region.

### INTRODUCTION

Elasmobranchs form one of the promising resource that could be exploited from the EEZ of India. The potential yield estimated for this resource, as per the latest revalidation is 65000 metric tonne within 50 m depth and 103000 metric tonne beyond 50 m. Sudarsan *et al.* (1988) based on exploratory surveys gave quantitative assessment of rays along the outer continental shelf and slope of the southwest coast. Ninal *et al.* (1992) gave an account of the elasmobranch resources in the southeast and south-west coasts and the Wadge Bank. An attempt was made to put together the information on the distribution and abundance of elasmobranchs from the trawling surveys by *FORV Sagar Sampada* in the EEZ of India.

## MATERIALS AND METHODS

Data on catch and effort were collected during the period 1985- 1991 in cruises 1-90, using various high speed trawl nets operated from *FORV Sagar Sampada*. Elasmobranchs that occurred in 100 trawling station were analysed for species composition, length frequency, sex, maturity etc. For the sake of analysis of the data, the entire area surveyed was divided into northwest, southwest, northeast, southeast and the Andaman regions. Depth- wise distribution and abundance of the resources were assessed by grouping into depth zones of 0-50 m, 51-100 m, 101-150 m and depth beyond 150 m. Standing stock was estimated using the "swept area" method of Gulland (1971).

## RESULTS

Sharks and rays contributed equally to the skates formed only a meagre percentage. Among sharks *Carcharinus* spp predominated *Amphitistius kuhli* and *Dasyatis* spp were the predominant species of rays. The potential yield for elasmobranchs, estimated in the present study was 65000 metric tonne, which agrees with the figures given by the latest revalidation committee though lower than those given by James *et al.* (1986).

### Geographical abundance

Geographical distribution and abundance of elasmobranchs are given in Tables 1-3. The highest catch rate of 2191 kg/hr was recorded off the coast of Kutch area, followed by 625 kg/hr of rays in the Wadge Bank region. Good concentration of rays were located off Cochin in the depth zone 51-100 m and also off Quilon. At depth of 48 m fairly rich grounds were located off Cape Comorin in the Wadge Bank region with catch rates varying from 120 kg to 145 kg/hr. Sharks were present in good concentration off Cape Comorin and off Mangalore in the depth zone 0-50 m and also at in the Quilon Bank region as well as the Wadge Bank region in the 51-100 m depth zone. Along the northwestern region of the EEZ, dense concentrations of rays were located off Bombay, Veraval coasts with catch rates varying from 100-150 m kg/hr. Rich ground for sharks were also noticed along the Ratnagiri coasts. On the northwest coast, off Kandla the entire trawl catch was constituted by rays; of Veraval 69% of the catch was shared by sharks and rays.

In the southeastern region and in the Gulf of Mannar (Table 2) elasmobranchs were abundant in the shallow regions. Off Manappad good concentrations of sharks were observed. High density pockets were reckoned off Madras and Cuddalore with catch rates 264 kg/hr and 130 kg/hr respectively. Fairly rich grounds for rays were located at 11°39'N, 79°54'E and 14°05'N, 80°23'E. Along the northeastern region, a higher concentration of sharks and rays were noticed in the shallow depths of up to 50 m than in the deeper realms. High catch rates ranging from 89 kg/hr to 123 kg/hr of sharks were obtained off Machilipatnam and Kakinada area and off Paradeep coasts. Rich



Table 1— Latitudewise abundance (in kg) of elasmobranchs in the western region of the EEZ of India at different depth zones

Latitude (°N)	Southwest coast				Latitude (°N)	Northwest coast			
	Sharks	Rays	Skates	Total		Sharks	Rays	Skates	Total
	<i>Depth 0-50 m</i>					<i>Depth 0-50 m</i>			
7°	134	130	-	264	15°	-	11	-	11
8°	39	35	-	74	17°	5	-	-	5
9°	2	150	-	153	21°	16	105	-	121
12°	-	15	1	15					
13°	300	-	-	300					
	<i>Depth 51-100 m</i>					<i>Depth 51-100 m</i>			
7°	84	750	10	844	18°	219	-	-	219
8°	178	327	53	558	20°	17	151	-	168
9°	250	-	-	250	22°	-	2119	-	2119
	<i>Depth 101-150 m</i>								
7°	-	48	-	48					
8°	-	85	9	94					
13°	-	6	-	6					
	<i>Depth 151 m and beyond</i>								
8°	-	-	68	68					

Table 2— Latitudewise abundance (in kg) in the eastern regions of the Indian EEZ in different depth zones

Southeast coast					Northeast coast				
Latitude (N)	Sharks	Rays	Skates	Total	Latitude (°N)	Sharks	Rays	Skates	Total
<i>Depth 0-50 m</i>					<i>Depth 0-50 m</i>				
8°	200	-	-	200	15°	94	3	-	97
11°	-	300	3	303	16°	104	150	-	254
12°	394	-	-	394	17°	-	3	-	3
14°	-	219	-	219	19°	128	144	-	272
<i>Depth 51-100 m</i>					<i>Depth 51-100 m</i>				
13°	-	40	-	40	15°	2	-	-	2
14°	11	-	-	11	16°	4	4	-	8
					17°	128	-	-	123
					18°	-	-	0.5	0.5
					19°	30	10	-	40
					20°	-	82	80	162
					<i>Depth 101-150 m</i>				
					16°	-	2	-	2

Table 3— Latitudewise abundance (in kg) of elasmobranchs in the Andaman-Nicobar regions of the Indian EEZ at different depth zones

Latitude	Sharks	Rays	Skates	Total
		<i>0-50 m</i>		
12°	-	40	93	133
14°	7	-	-	7
		<i>51-100 m</i>		
6°	22	220	-	242
8°	15	20	-	35
10°	215	787	-	1002
11°	10	-	-	10
12°	18	80	2	100
13°	178	-	80	258
		<i>101-150 m</i>		
12°	7	-	25	32

grounds for skates were located at 20°N, 87°E with catch rates ranging from 50 to 110 kg/hr.

High density pockets were located in the sea around Andaman -Nicobar area (Table 3). In the depth zone 51-100 m at 10° 43'N, 92°15.5' E, the catch was exclusively of rays. High production rate of rays were obtained from 06°42'N, 93°56'E and 10°27'N and 92°32'E, respectively. High catch rate of 151 kg/hr was obtained from 13°10'N, 92°37'E and 10°27'N, 92°31'E.

### Seasonal abundance

In the southwestern regions of the Indian EEZ (Table 4) sharks as well as rays were more abundant during January-March and October- December months. Along the northwest coast, good concentrations of sharks occurred during October-December and rays were abundant during July-September period.

In the southeastern regions (Table 5) abundance of sharks were noticed during April-September months, but rays were abundant during January-March and October-December period. In the seas around Andaman-Nicobar Islands, sharks showed a seasonal abundance during first and third quarters while rays occurred in good concentrations during January-June period (Table 6).

Table 4— Seasonal abundance (in kg) of elasmobranchs in the western region of Indian EEZ

Depth	Season	Southwest			Depth	Season	Northwest		
		Sharks	Rays	Skates			Sharks	Rays	Skates
0-50 m	Jan-Mar	300	150	1	0-50 m	Jan-Mar	-	-	-
	Apr-Jun	2	51	-		Apr-Jun	-	-	-
	Jul-Sep	173	79	-		Jul-Sep	5	-	-
	Oct-Dec	-	50	-		Oct-Dec	16	116	-
51-100 m	Jan-Mar	327	935	-	51-100 m	Jan-Mar	14	151	-
	Apr-June	-	-	3		Apr-Jun	-	-	-
	Jul-Sep	-	145	-		Jul-Sep	19	2191	-
	Oct-Dec	357	297	85		Oct-Dec	203	-	-
101-150 m	Jan-Mar	-	85	-					
	Apr-Jun	-	48	-					
	Jul-Sep	-	-	-					
	Oct-Dec	-	6	9					
150 m and above	Jan-Mar	-	-	-					
	Apr-Jun	-	-	-					
	Jul-Sep	-	-	-					
	Oct-Dec	-	-	68					

Table 5— Seasonal abundance (in kg) of elasmobranchs in the Eastern region of the Indian EEZ

Depth	Season	Sharks	Rays		Skates
			<i>Southeast</i>		
0-50 m	Jan-Mar	-	519	-	-
	Apr-Jun	394	-	-	-
	Jul-Sep	200	-	-	3
	Oct-Dec	-	-	-	-
51-100 m	Jan-Mar	11	-	-	-
	Apr-Jun	-	40	-	-
	Jul-Sep	-	-	-	-
	Oct-Dec	-	-	-	-
<i>Northeast</i>					
0-50 m	Jan-Mar	183	6	-	-
	Apr-Jun	-	-	-	110
	Jul-Sep	15	150	-	-
	Oct-Dec	140	194	-	50
51-100 m	Jan-Mar	128	2	-	-
	Apr-Jun	-	4	-	0.5
	Jul-Sep	36	10	-	-
	Oct-Dec	-	80	-	80

Table 6— Seasonal abundance (in kg) of elasmobranchs in the Andaman-Nicobar regions of the Indian EEZ

Depth	Season	Sharks	Rays	Skates
0-50 m	Jan-Mar	-	-	-
	Apr-Jun	7	40	-
	Jul-Sep	-	-	-
	Oct-Dec	-	-	-
51-100 m	Jan-Mar	56	807	-
	Apr-Jun	178	-	80
	Jul-Sep	114	80	2
	Oct-Dec	10	220	-

### Depthwise distribution and abundance

From the present study it could be discernible that along the western half of the Indian EEZ as well as in the seas around Andamans (Tables 1, 3), elasmobranchs are more abundant in the depth zone 51-100 m than in the shallower waters. On the contrary, in the eastern half of the EEZ of India (Table 2) 85% of the catch came from the shallower regions of depth less than 50 m.

Very high catch rates of 625 kg/hr were obtained from the 51-100 m depth zone on the southwest coast. (Table 1). The highest catch per hour available in the present study also came from the 51-100 m in the northwestern region. From the same depth strata, 600 kg/hr was obtained from the Andaman region (Table 3). From the eastern half, the highest catch rate of 300 kg/hr was obtained from the depth zone 0-50 m off Cuddalore. Hardly 2% of the catches were obtained beyond 100 m depth.

### DISCUSSION

Seasonal abundance in the present study shows a similar pattern as observed by Ninan *et al.* (1992) along the southwest coast, including the Wadge Bank with high catch rate during September- March months. Devadoss *et al.* (1989) also noticed a similar pattern of seasonal abundance and has correlated this with the availability of pelagic fish stock like sardines mackerels etc during this period. Along the southeast coast there is more concentration of elasmobranchs, especially of sharks in the shallower strata during April-October months. Devadoss *et al.* (1989) observing a similar pattern of abundance attributes this to the availability of food, especially the pelagic shoaling fishes during this period.

From the present study it could be concluded that highly productive grounds for elasmobranchs were available in many localised areas especially over the northwestern region and also along the Andaman-Nicobar regions which are practically unexploited, in addition to the already known grounds on the southwest and southeast regions. These grounds if exploited in a judicious manner, offer possibilities of developing into usable fisheries.

### ACKNOWLEDGEMENT

Authors are grateful to Dr. P.S.B.R. James, former Director, for his kind encouragement in the present study.

### REFERENCES

- Devadoss, P., Kuthalingam, M.D.K., & Thiagarajan, R. 1989. The present status and future prospects of elasmobranch fishery in India. *Bull. Cent. Mar. Fish. Res. Inst.* 44 (1): 188-199.
- Gulland, J.A. 1971. *The fish resources of oceans*, (Fishing News Books Ltd., London) pp. 255.
- James, P.S.B.R., Alagaraswamy, K., Narayana Rao, K.V., Muthu, M.S., Rajagopalan, M.S., Alagaraja, K., & Mukundan, C., 1986. Potential marine fishery resources of India, *Seminar on Potential Marine Fishery Resources: CMFRI Spl.Publ* 30: 44-74.

- Ninan, T.V., Sivaji, V., Jagannadh, N. & Ramalingam, L. 1992. Observations on demersal resources survey between lat 7°N and 11°N along southwest coast, Wadge Bank and Gulf of Mannar during 1988-1990, *Bull. Fish. Sur. India*, 24: 14-40.
- Sudarsan, D., Sivaprakasan, T.E., Somavanshi, V.S. John, M.E., Nair K.N.V., & Antony Joseph. 1988. An appraisal of the marine fishery resources of the Indian Exclusive Economic Zone, *Bull. Fish. Sur. India*, 18: 1-82.

\* \* \*

## Finfish resources in the north eastern region in the Indian EEZ

N.G. Menon, N.G.K. Pillai, S. Lazarus & P. Nammalwar

Central Marine Fisheries Research Institute, P.B. No— 1603, Cochin-682 014

### ABSTRACT

Bottom trawling conducted in 53 stations lat. 16°00'N -20°30'N; long. 81°30'E - 87°15'E revealed a production range of 3 - 15000 kg/haul with a mean of 581 kg/haul; the average catch in the region was 567.3 kg/hr. The dominant finfish in the surveyed area were Indian drift fish (36.4%), carangids (22.5%), catfishes (7.1%), bull's eye (6.9%), goat fishes (3.9%), nemipterids (3.3%) etc. The bathymetric zones above 200 m and 51-100 m were found to be highly productive with average catch rate of 1615 and 830 kg/hr respectively. In the surveyed region the highest production rate was at lat. 19°N (1384 kg/hr).

### INTRODUCTION

Northeastern region of Indian EEZ has an estimated fishery potential of 321000 tonne, out of which about 63% (204000 tonne) is presently exploited (Anon, 1991). The potential demersal fish resources in the area is 143000 tonne, whereas only 68% (97000 tonne) is currently exploited by the commercial fisheries. The fishery survey results of 1980-85 period in the Indian EEZ (Joseph & John, 1987) indicated catch rate of 228.5 kg/hr in the northeast coast with major composition as catfishes (40 kg/hr), mackerel (28.3 kg/hr), carangids (33.7 kg/hr), sciaenids (16.0 kg/hr), perches (11.5 kg/hr), nemipterids (10.9 kg/hr), elasmobranchs (19.7 kg/hr) etc. Similar survey conducted during 1980-'86 along the northeast coast (16°- 20°N) revealed promising catches of tunas, carangids, sharks, catfishes, silverbellies etc. in the coastal waters and bull's eye, Indian drift fish (*Psenes indicus*), *Centrolophus niger* etc. from deeper regions (Sudarsan & Somvanshi, 1988). Ruben *et al.* (1989) estimated the trawl fishery resource potential of continental shelf and adjacent areas along the northeast coast, based on exploratory fishery surveys as 151000 tonne. The earlier cruises (nos. 1-44) of FORV Sagar Sampada have conducted trawling all along the Indian EEZ during January 1985 to March 1988 and located fairly rich fishing grounds for mackerel, bull's eye, carangids, *Psenes indicus*, catfishes, barracudas etc. in the lat.



15°- 20°N along the northeast coast of India (James & Pillai, 1990; Sivakami, 1990; Bande et al. 1990). As those cruises were of general survey nature, full justice to estimates, could not be made on the bathymetric, geographical and seasonal abundance of several fish resources available in the northeastern region. In view to fill the above lacuna, concerted efforts were made to have more coverage in the area and all seasons of 1988 and 1989 so as to assess the resource potential in this area. Exclusive cruises on board *FORV Sagar Sampada* (such as nos. 45, 47, 49, 51, 53, 54, 57 and 58) were undertaken during April 1988- February 1989 in the northeastern region of the EEZ with an emphasis to cover repeatedly most of the geographical areas during different months in different depth zones.

## MATERIALS AND METHODS

During the 8 cruises, bottom trawls were operated from 53 stations, spread over a year, in order to locate the seasonal and bathymetric distribution and abundance of various fish resources. The area covered in the above 8 cruises extend from latitude 16°-20°30'N and long. 81°30' -87°15'E with a track distance of 22000 line km and an approximate area of 65000 km<sup>2</sup>. The depth of operation of bottom trawl ranged from 30-203 m with greater emphasis in 51-100 m depth zone. This survey is based on information drawn from the reports of 8 cruises of *FORV Sagar Sampada*, and an attempt is made to interpret the fish production and species-wise abundance of different resources in the latitude, seasons and bathymetric realms of 0-50, 51-100, 101- 150, 151-200 and above 200 m along the northeast coast. The standing stock in each area of 10' grids was estimated by the swept area method of Gulland (1965). The potential yield is reckoned as 60% of the standing stock. As trawling is mainly carried out in the depth belt 30-200 m, the estimates given pertain to that area.

## RESULTS

### Demersal resources

The finfish production by bottom trawling along the northeast coastal region as a whole ranged from 3-15,000 kg/ haul with a mean of 581 kg. The average catch was 567.3 kg/hr. Some of the high concentration fishing grounds along this region were: 17°26.5'N, 83°32.9'E (1700 kg/hr), 19° N, 85°05'E (1991 kg/hr), 19°19'N, 85° 15'E (15000 kg/hr), and 19°22'N, 85°19'E, (12000 kg/hr) in the depth zones 51-100 m and above 200 m. The finfish catch (Table 1) in this region consisted mainly of demersal and column fishes such as *Psenes indicus* (36.4%), carangids (22.50%), catfishes (7.1%), bull's eye (6.9%), nemipterids (3.3%), goat fishes (3.9%) etc. The depth-wise fish abundance data of the 8 cruises revealed that bathymetric zones above 200 m and 51-100 m are highly productive with catch rates of 1615 and 830 kg/hr respectively followed by 0-50 m depth zone (196 kg/hr), 101-150 m (127 kg/hr) and 151-200 m (29 kg/hr).

Table 1 - Production, rate of production and percentage in total catch of major finfishes in the north-eastern region of the EEZ

Fishes	Production (kg)	Rate of production (kg/hr)	Total catch (%)
<i>Psenes indicus</i>	10982	205.3	36.4
Carangids	6790	127.5	22.5
Catfishes	2138	40.0	7.1
<i>Priacanthus</i> spp	2985	39.2	6.9
Goat fishes	1181	22.2	3.9
Nemipterids	1007	18.9	3.3
Barracudas	333	6.3	1.1
<i>Epinephelus</i> spp	276	5.2	0.9
Elasmobranchs	130	2.4	0.4
<i>Lutianus</i> spp	99	1.9	0.3
Others	5154	96.3	17.2
Total	30175	564.0	

### Cruise wise resource abundance

Cruise-wise fish resource abundance, seasons and percentage composition of major groups are shown in Table 2. During the cruise no. 45 along lat. 16°00' - 20°30' N and long. 81°30' - 87°15' E in the month of April 1988, the bottom trawl produced a total catch of 1567 kg with an average catch rate of 145.8 kg/hr. The depth of operation ranged from 30 to 60 m. The catch composed chiefly of nemipterids (30.8%) and goat fishes (21%). During the cruise (no. 47) the vessel surveyed almost the same area (16°00' N-20°30' N and 81°30' E- 84°48' E) and trawled five stations along the depth region 89-203 m in May/June 1988. The total production was 2700 kg with a catch rate of 540 kg/hr. The highest catch of 1700 kg was recorded from the station, 17°26' N, 83°33' E at a depth of 203 m and composed chiefly of *Priacanthus* spp (80%). The cruise no. 49 was conducted during July 1988 and covered the same area within the depth zone 60-175 m. In the total production of this cruise, *Priacanthus* spp. (43%), catfishes (14.2%), *Psenes indicus* (13.9%) and carangids 12.9% were the dominant groups landed by bottom trawls. Bottom trawl operated from 6 stations (37-65 m depth) during cruise no. 51 in September with catches ranging from 40 to 374 kg/haul. Out of the 17 stations covered in cruise no. 53 bottom trawl operated only at 6 stations in the depth zone 55-170 m during October 1988. The catch per haul ranged from 32- 1009 kg with a mean of 316.4. The cruise no. 54 (November) yielded a total fish catch of 1565 kg from the depth belt 35-95 m at a mean catch rate of 208.7

Table 2 - Cruise-wise and seasonal production of major finfish (kg), their percentage composition (in parentheses) and total catch rate along the northeastern region of the EEZ

Cruise no.	Period	Trawling (hr)period	Catfishes	Elasmobranchs	Nemip-terids	Caran-gids	Lizard fish	Barra-cuda	<i>Pria-canthus</i> spp	<i>Epine-phelus</i> spp	<i>Lutjanus</i> spp.	<i>Psenes indicus</i>	Goat fish	Others	Total	Catch (kg/hr)
45	April	10.75	195.0 (12.4)	4.5 (0.3)	483.0 (3.8)	118.0 (7.5)	1	-	10.0 (0.6)	-	-	2.0 (0.1)	330.0 (21.0)	423.5 (27.3)	1567	145.8
47	May/ June	5.0	10.0 (0.4)	3.3 (0.1)	338.2 (12.5)	61.4 (0.3)	31.3 (0.2)	-	1525.2 (56.5)	-	-	32.0 (1.2)	50.3 (1.9)	648.3 (23.9)	2700	540.0
49	July	6.75	43.0 (14.2)	3.5 (1.2)	0.4	39.0 (12.9)	-	1.2 (0.7)	130.0 (42.9)	-	-	42.0 (13.9)	-	43.9 (14.2)	303	44.9
51	Sept.	6.00	39.0 (5.1)	40.0 (5.3)	3.0 (0.4)	128.0 (16.9)	26.0 (3.4)	-	3.5 (0.5)	-	-	2.0 (0.3)	128.0 (16.9)	386.5 (61.2)	756	126.0
53	Oct	5.5	21.0	-	1.0	73.0 (4.2)	2.4 (0.1)	16.3 (0.9)	81.0 (4.5)	215.0 (12.4)	425.0 (24.4)	-	14.0 (0.8)	891.3 (51.5)	1740	316.4
54	Nov.	7.5	165.0 (10.5)	40.5 (2.6)	36.0 (2.6)	616.0 (39.4)	30.0 (1.9)	2.5 (0.2)	128.8 (8.2)	10.0 (0.6)	18.0 (1.2)	19.0 (1.2)	95.3 (6.1)	403.9 (25.8)	1565	208.7
57	Jan.	5.0	38.0 (1.7)	5.5 (0.7)	47.0 (2.1)	83.5 (3.7)	-	221.0 (9.9)	17.0 (0.8)	3.8 (0.2)	87.0 (3.9)	1182.0 (52.8)	224.0 (10.0)	328.2 (14.7)	2237	447.4
58	Feb.	7.0	1647.0 (8.5)	3.9 (0.2)	97.0 (0.5)	5670.8 (29.3)	91.6 (0.5)	199.0 (1.0)	40.0 (0.2)	-	91.0 (0.5)	9703.0 (50.2)	336.0 (1.7)	1427.6 (7.4)	19306.9	2758.1

kg/hr and carangids (39.4%) were the most abundant item. The total production from cruise No. 57 (January) was 2237 kg with a catch rate of 447.4 kg/hr. *Psenes indicus* formed 57.3% of the total catch and covered 16 stations. Bottom trawling conducted in cruise No. 58 from seven stations along the depth zone 62-68 m produced a total catch of 19342 kg (ranging from 250- 15000 kg/haul) in February. A peak concentration of 15000 kg/hr was realised from the station 19°19' N, 85°15' E at a depth of 62 m and 50% of the catch consisted of *Psenes indicus*.

### Latitudewise yield and abundance

Finfish production and rates of yield in different latitudes of 15°-20°N and their major catch composition are given in Table 3. The production (23586 kg) as well as rate of production (1429 kg/hr) were the highest in 19°N latitude along the depth belt of 42-178 m. In 17°N latitude (48-203 depth) the total catch was 3091 kg with a mean catch rate of 263 kg/hr. The trend of total production in latitude 18°N and 20°N were 1915 kg and 1310 kg respectively with corresponding catch rate of 147 and 174 kg/hr. Indian drift fish (*Psenes indicus*), carangids and catfish were the dominant fishes in 19°N, whereas in 18°N, *Epinephelus* spp, *Lutjanus* spp., *Priacanthus* spp and carangids were the chief components. Fish like nemipterids, *Priacanthus* spp, elasmobranchs and carangids occurred in fair quantities in the lat. 16°, 17° and 20°N.

Table 3 - Latitude-wise fish production, rate of production and the major components in the northeastern region of the EEZ

Lat. (°N)	No. of stations	Total trawling hours	Total production (kg)	Catches (kg/hr)	Depth (m)	Major species
15°	1	0.75	5.1	6.8	100	-
16°	5	3.5	331.6	94.7	50-170	<i>Priacanthus</i> spp, elasmobranchs, carangids, catfishes
17°	10	11.75	3091.4	263.0	48-203	<i>Priacanthus</i> spp, nemipterids
18°	14	13.0	1915.1	147.3	45-160	<i>Epinephelus</i> spp, <i>Lutjanus</i> spp, <i>Priacanthus</i> spp, carangids
19°	16	17.0	23522.0	1383.6	42-178	<i>Psenes indicus</i> , carangids, catfishes
20°	6	7.5	1310.0	174.7	30-60	Nemipterids, carangids

### Depthwise yield and abundance

Percentage composition of various finfishes in the bathymetric zones of 0-50 m, 51-100 m, 101-150 m, 151-200 m and above 200 m are given in Table 4. In the depth zone below 50 m, the average catch rate was 196 kg/hr and the catch composed mostly of nemipterids, goat fishes, cat fishes and carangids. The depth zone 51-100 m yielded an average catch rate of 545 kg/hr with the major component fishes as *Psenes indicus* carangids and catfishes. A mean catch rate of 127.2 kg/hr was recorded from the depth zone, 101-150 m and the yield consisted mainly of nemipterids, carangids and lizard fishes. The rate of yield was the lowest (29.1 kg/hr) in the bathymetric realm, 150-200 m and the catch, composed of *Priacanthus* spp. (61.2%) and *Psenes indicus*. From above 200 m depth only one station was trawled with a catch rate of 1615 kg of finfishes/hour. *Priacanthus* spp (84.5%) and nemipterids were the chief component of the catch.

Table 4 - Depth-wise abundance (kg/hr) of major fishes in the northeastern region of the EEZ

Fish	Depth zones (m)				
	0-50	51-100	101-150	151-200	>200
Elasmobranchs	2.9	3.2	0.2	-	-
Nemipterids	40.8	5.8	45.1	0.1	124.1
Carangids	21.2	213.2	9.1	0.2	17.0
Lizard fish	2.0	1.6	4.3	-	-
Barracudas	0.4	10.9	0.1	-	-
<i>Priacanthus</i> spp	0.8	21.1	3.1	17.8	1360.0
<i>Epinephelus</i> spp	0.3	9.2	-	-	-
<i>Lutianus</i> spp	1.1	2.8	-	-	-
Other perches	0.2	23.0	-	-	-
<i>Psenes indicus</i>	0.3	362.0	-	1.1	28.4
Goatfish	34.1	25.5	-	-	-
Catfish	24.6	60.9	-	-	-
Others	67.2	90.8	65.2	9.9	85.0
Total	196.1	830.0	127.2	29.1	1615.0

### Abundance trends of specific fish resources

**Indian drift fish (*Psenes indicus*)-** Its catch rate fluctuated from 0.5 - 7500 kg/haul. The average catch per hour was 206.2 kg. The species was abundant in 19°00'N-85°05' E (1180 kg/hr) at 84 m depth; in 19° 19' N-85° 15' E (7500 kg/hr) at 62 m depth and in 19° 20' N- 85° 19' N (1800 kg/hr) at 65 m depth. The highest production was during February.

**Carangids-** The yield per haul ranged from 0.2 - 5250 kg with a mean of 127.5 kg/hr. High concentrations were located in stations, 19°26'N- 85°09' E (90 m depth) with a catch rate of 500 kg/hr; 19°19'N,85°15' E (62m) with a catch/hour of 5250 kg and 18°06'N,84°02'E (64 m) with a catch rate of 200 kg/hr. Production of carangids was high in February and November.

**Carfishes-** The catch per haul fluctuated from 0.3-1500 kg. High concentration of 1500 kg/hr was located at 19°19'N,85°15' E from a depth of 62 m in February.

**Bull's eye (*Priacanthus spp.*)-** The catch per haul ranged from 1- 1360 kg and the average catch rate was 39.2 kg/hr. High concentration (1360 kg/hr) of bull's eye was located at 17°26.5'N,83°32.9'E from a depth of 202 m during May. The catch per haul of goat fishes ranged from 0.3-300 kg. Good concentration of goat fishes were located at stations, 20°30'N,87°15'E (200 kg/hr from 30 m depth), 19°00'N,85°05'E (221 kg/hr from 84 m depth) and 19°19'N,85°15' E (300 kg/hr from 62 m depth) during January-April. The catch of nemipterids fluctuated from 0.8-300 kg/haul and better catches were obtained in April, May. The yield of barracuda *Sphyraena* spp ranged from 0.3 - 220 kg/haul at an average catch rate of 6.3 kg/hr. High density ground for barracudas was located at 19°00'N,85°05'E (220 kg/hr at 84 m depth) during January. The catch of *Epinephelus* spp varied from 38-210 kg/haul and the average catch rate was 5.2 kg/hr. Elasmobranchs were caught at an average catch rate of 2.4 kg/hr.

### Seasonal abundance

Seasonal abundance trend of bottom trawl catch in the northeast region showed comparatively high values almost throughout the year ranging from 45 kg/hr (July) to 2758 kg/hr. (February). The production rate was found to be higher in the months of October to February. The higher catch rates are invariably backed by rich availability of the Indian drift fish, *Psenes indicus* and perches. In the depth belt 50-100 m the monthly catch rate varied from 5-2758 kg/hr. Fairly high rate of production was recorded from above 100 m depth zone in May.

### Potential demersal yield

The estimated potential yield of ground fish resources in the northeast coast within the depth belt 30-200 m is 154000 tonne at the rate of 2.2 tonne/km<sup>2</sup>. The depth zone 51-100 m has an estimated potential of 89600 tonne forming 58% of the total potential yield. The rate of production from this depth zone is estimated at 5.2 tonne/km<sup>2</sup>. The

depth zone 100-200 m has a lower potential of about 17000 tonnes with a production potential rate of 1.2 tonne/km<sup>2</sup>. The shallow coastal waters upto a depth of 50 m has only a limited potential yield of 47500 tonne at a rate of 1.2 tonne/km<sup>2</sup>. This depth belt was only sparsely covered by *FORV Sagar Sampada* cruises and therefore the estimated potential might be an under estimate and needs further confirmation. The depth zones of 50 m are currently poorly exploited by the commercial fishing fleet. The potential yield is high in latitude 19°N (84900 tonne) followed by 17°N (17800 tonne) and 20°N (1700 tonne).

### Pelagic resources

The pelagic trawl was operated at 17 stations during 5 cruises and a total catch of 30 kg was landed with a catch rate of 1.76 kg/hr. Among the 17 stations surveyed by pelagic trawling, fish were caught only from three stations (18°N, 84°15'E; 19°28'N, 85°30'E and 18°16.3'N, 84°24'E) at 60, 58 and 78 m depth respectively. The pelagic trawls failed to land any resources from many of the stations whenever it was operated. The average catch consisted of a cow-nose ray (20 kg), seer fish, goat fish, wolf herring (*Chirocentrus* spp) and juveniles of sardines and mackerel.

## DISCUSSION

The results of the region-wise exclusive surveys indicated the spatial, seasonal and bathymetric abundance of varied types of finfish resources along the northeastern region of the EEZ. The rate of total fish production of 567 kg/hr achieved in the present cruises showed tremendous improvement over the value of 228kg/hr obtained by exploratory surveys from the same region during 1980- 85 (Joseph & John, 1987) and the production rate of 315 kg/hr reported by Sivakami (1990), based on the results of the first 44 cruises of *FORV Sagar Sampada* during 1985-88. Present yield rates obtained in respect of *Psenes indicus* (206 kg/hr), carangids (127 kg/hr), *Priacanthus* spp (39 kg/hr) and nemipterids (19 kg/hr) are far higher than earlier rates *Psenes indicus* 5.2 kg/hr, carangids, 33.8 kg/hr; *Priacanthus* spp 9.3 kg/hr and nemipterids (10.9 kg/hr) reported from the northeast coast of 16°-20°N (Joseph & John, 1987). Further, the production rates of various fish resources recorded by Sivakami (1990) from the east coast also showed lower values as compared to the present surveys. Abundance of some of the major resources in different depth zones is comparable with the earlier survey results from this region. Higher rates of production were recorded at different depth zones, for nemipterids (0-50 and 100-200 m), perches (50-100 m), carangids (50-100 m), catfishes (0-100 m), *Priacanthus* spp (50-100 m) and *Psenes indicus* (50-100 m) when compared to FSI results (Joseph & John, 1987). Latitude-wise fish production rates obtained in the present surveys are considerably higher than FSI's *Matsya Shikari* catch rates in 17° N and 19° N; whereas similar trends are noticed in 18° and 20°N latitudes (Sudarsan & Somavanshi, 1988).

The estimated potential of 154000 tonne in this region up to 200 m depth is very close to the estimated potential of 143000 tonne given by the working group on revalidation of potential marine fisheries resources of the EEZ for the north east coast (Anon, 1991) and the estimate of Ruben *et al.* (1989) at 151000 tonne. Since the survey coverage below 50 m depth is inadequate, the estimate from this depth zone might be an under estimate (47500 tonne). Similarly depths above 200 m are also not adequately covered and therefore, no attempt was made to estimate the potential from this depth zone. The present survey results clearly showed that the depth belt 50-100 m is highly productive with a potential of 5.2 tonne/km<sup>2</sup> and the major finfishes caught from this realm were Indian drift fish and carangids. Sudarsan *et al.* (1988) have reported high density finfish stock in this area throughout the year. Bottom trawling results from the mid shelf (51-100 m) areas have also indicated consistently high production rates throughout the year with peak in October- February months.

Present survey results from the northeastern region of the EEZ have shown that this region's share to marine fish production of the country could be substantially increased through intense bottom trawling in depths above 50 m for exploiting some of the conventional and non-conventional resources. This survey unfolds some of the concentration pockets for *Psenes indicus* along the region which could be exploited on a commercial scale.

### ACKNOWLEDGEMENT

Authors are thankful to Dr. P.S.B.R. James, former Director, for his keen interest shown in this work and to Dr. P.Bensam for encouragements.

### REFERENCES

- Anon 1991. Report of the working group on revalidation of the potential marine fisheries resources of the Exclusive Economic Zone (MPEDA, Cochin) pp.57.
- Bande, V.N., Menon, N.G. & Balachandran, K. 1990. Studies on the distribution and abundance of Bull's eye (*Priacanthus* spp) in the EEZ of India. In: *Proc. First Workshop Scient. Resul. FORV Sagar Sampada*, edited by K.J. Mathew, (CMFRI, Cochin) 233-238.
- Gulland, J.A. 1965. *Manual of methods for fish stock assessment, Part I -Fish Population analysis.* FAO Fish. Tech. Pap. 40: 1-68.
- James, P.S.B.R. & Narayana Pillai, V. 1990. Fishable concentration of fishes and crustaceans in the offshore and deep sea areas of the Indian Exclusive Economic Zone based on observations made on board *FORV Sagar Sampada*, In: *Proc. First Workshop Scient. Resul. FORV Sagar Sampada*, edited by K.J. Mathew (CMFRI, Cochin) 201-214.
- Joseph, K.M. & John M.E. 1987. Potential marine fishery resources. *CMFRI Special Publication No.* 30: 18-43.
- Ruben, S., Sudhakara Rao, G., Luther, G., Appa Rao, T., Radhakrishna, K., Appanna Sastry, Y., & Radhakrishnan, G. 1989. An assessment of the bottom trawl fishery resources of the north east coast of India. *CMFRI Bull. No. 44 (Part 1):* 59-77.
- Sivakami, S. 1990. Observations on the demersal fishery resources of the coastal and deep sea areas of the Exclusive Economic Zone of India. In: *Proc. First Workshop Scient. Resul. FORV Sagar Sampada*, edited by K.J. Mathew (CMFRI, Cochin) 215- 232.



Sudarsan, D. & Somavanshi, V.S. 1988. Fishery resources of the Indian Exclusive Economic Zone with special reference to upper east coast, *Bull. Fish. Surv. India*, 16: 1-26.

Sudarsan, D., Sivaprakasam, T.E., Somavanshi, V.S., John, M.E., Nair, K.N.V. & Joseph Antony. 1988. In appraisal of the marine fishery resources of the Indian Exclusive Economic Zone, *Bull. Fish. Surv. India*, 18: 1-35.

\* \* \*

## Catfish resource in the Indian shelf waters

N.G. Menon, K. Balachandran, S.G. Raje, P.U. Zachariah, M.Feroz Khan,  
Y. Appanna Sastry & P. Jayasankar

Central Marine Fisheries Research Institute, P.B.No.-1603,  
Cochin- 682014

### ABSTRACT

An attempt is made to analyse the bottom trawl fishing data collected by 91 cruises of *FORV Sagar Sampada* (1985 - '91). The vessel trawled in 544 stations spread over both the coasts up to a depth of 100 m and catfishes appeared in 54 stations with catch 3 -2401 kg/hr. The dominant species occurred beyond 50 m depth belt was invariably *Tachysurus thalassinus* whereas shoaling species like *T. tenuispinis* and *T.dussumieri* are reported from grounds less than 50 m. The resource has better abundance in 51 -100 m depth belt along northwest and northeast region.

### INTRODUCTION

The estimated potential marine catfish available for exploitation in the Indian EEZ is 123000 tonne out of which 60000 tonne is from depths below 50 m and 63000 tonne from above 50 m depth (Anon, 1991). The annual average production of catfishes during 1988 -1992 period was 44167 tonne showing a general declining trend. This production was achieved chiefly from coastal waters preferably below 50 m depth. The decline in the landing is more marked in the southwest region. In the maritime states of Kerala, Karnataka and Goa the catfish landings have declined drastically from 9960 tonne (1988) to 1029 tonne (1992); 8817 (1988) to 294 tonne (1992); and 3925 (1988) to 123 tonne (1992) respectively. Although the earlier exploratory surveys, acoustic surveys and experimental fishing surveys have located potentially rich catfish fishing grounds along the coasts, the present landings from the shallow grounds registered a continuously dwindling trend. Investigations conducted so far on this important group of demersal fish clearly reveal that the major reasons for the depletion of stocks are brooder/spawner destruction from spawning grounds during a restricted spawning season by a mass harvesting device, the purse seine and irrational removal of juveniles and destruction of their feeding grounds by incessant coastal bottom trawl operations (Silas *et al.* 1980; Anon, 1987; James *et al.* 1989; Bensam & Menon, 1994). Further the stock assessment studies conducted on this group also reveal that

most of the shoaling and migrating species are over exploited from the presently fished grounds of <50 m depth (Anon, 1987; Menon *et al.* 1994).

It is relevant to recall here the results of ground fish resource surveys of FSI, FAO/UNDP and *FORV Sagar Sampada*, all of which have located fairly high productive grounds for catfishes in depths above 50 m preferably along southwest during monsoon season (Rao *et al.* 1977; Philip, 1986; Joseph & John 1987; Sudarsan *et al.* 1988; James & Pillai, 1990; Vijayakumar & Naik, 1991). In order to sort out this anomaly between the high potentials and low production, the results of the experimental fishing surveys (bottom trawl) conducted on board *FORV Sagar Sampada* during cruises 1-91 (1985 - 1991) are analysed critically to evaluate the present trend of catfish potential in different geographic and bathymetric realm of the shelf waters, preferably within 50 - 100 m depth belt, where the maximum trawling was undertaken. Short biological account of major species caught in the bottom trawl is also included in this report.

## MATERIALS AND METHODS

Catch particulars of bottom trawl nets (Chalut, Star model, Granton, Kalute, HSDT I, II, III) operated from *FORV Sagar Sampada* during cruises 1 -91 along the EEZ during February 1985 - June 1991 are utilised for this study. The data were analysed for different regions, northwest, southwest, southeast and northeast. The data were also pooled for different bathymetric zones, 0-50m 51-100m and above 100m to estimate the bathymetric abundance in the above 4 regions. The species composition was estimated for each region and the samples were analysed for the size composition and maturity conditions. The standing stocks and potential yields are estimated (Gulland, 1969) and 60% of the standing stock (B) is reckoned as the potential yield. The biomass was estimated for each 10 square grid (343 km<sup>2</sup>) by averaging the catch per hour of the different stations coming within the 10 grid and using the head rope length of the bottom trawl net operated and speed of tow in the respective stations.

## RESULTS

Since the potential yield of catfishes within below 50 m depth zone is well-known from the commercial trawl data records of earlier studies, the present attempt is mainly restricted to estimate the potential yield of catfishes within the depth zone of 51 - 100m. Out of 414 trawling stations covered catfishes were reported from 54 stations preferably in the depth belt 30 - 100 m. In the middle shelf waters (51-100m) the vessel trawled along 234 stations and catfish occurred in 34 stations.

### Experimental fishing

In order to estimate the relative availability and abundance of ground fish resources in different geographic and bathymetric areas of middle and outer shelf waters of the EEZ, bottom trawling was made in 414 stations within the depth belt 30-200 m and in

a few stations beyond 200 m also. The total catch (Table 1) from the surveyed areas in the EEZ was 262.6 tonne at a catch rate of 634 kg/haul and catfish formed only 2.2% of the total catch. The vessel occupied 234 stations within 51 - 100 m depth belt with an yield of 200.1 tonne (76% of total catch) and catfish has accounted for 1.2% of the total catch of this depth zone. In the total catfish landings the 51-100 m depth zone contributed only <40%.

Along the northwest region the vessel trawled in 55 stations, out of which 41 stations were within the depth belt 51-100 m and the average fish catch rate in this depth zone was 517 kg/hr. Catfish was caught in 7 stations within the depth belt 36-64 m with a production range of 10-597 kg/ haul. In this region catfish has accounted for 20% of the total positive trawl catch with a mean catch rate of 79.6 kg/hr. In the southwest region the vessel trawled at 198 stations, out of which 109 stations were within 51-100 m depth with a mean catch rate of 1094 kg/hr. Only 9 stations yielded catfish and the catch ranged from 5 to 2401 kg/haul. It formed 47.8% of the total positive trawl catch of this region. The mean catfish catch rate was 269.2 kg/hr. Along the west coast catfish has accounted for 37.8% of the total bottom trawl productions by the positive stations in the total 253 stations occupied by the vessel. The mean catch was 185 kg/hr in the west coast.

Although the vessel trawled in 57 stations along the southeast coast with a fish production of 338 kg/hr, catfish was never encountered from the trawl catch of this region in appreciable quantities either from shallow grounds or from deeper areas. During the cruises the vessel covered 104 stations for bottom trawling operations along the northeast region. The region yielded a catch rate of 389 kg/hr of fish. Catfish was recorded in 38 stations within the depth belt 33 - 100 m (Fig.1). The catch ranged from 3-1500 kg/haul and has accounted for 9.8% of the total trawl catch of 38 stations. The mean catfish catch from this region was 73.7 kg/hr.

Table 1 - Regionwise bottom trawling results of *FORV Sagar Samnada*

Region	Total stations trawled	No. of stations with catfish catch	Depth range (m)	Total catch (kg)	Catfish catch (kg)	Catfish in total catch (%)	Average total catch (kg/hr)	Average catfish catch (kg/hr)
Northwest	55	7	36-235	25573	597	2.3	465	11
Southwest	198	9	40-400	155287	2557	1.6	784	13
Northeast	104	38	33-263	48191	2725	5.7	463	26
Southeast	57	-	23-221	33595	-	-	589	-

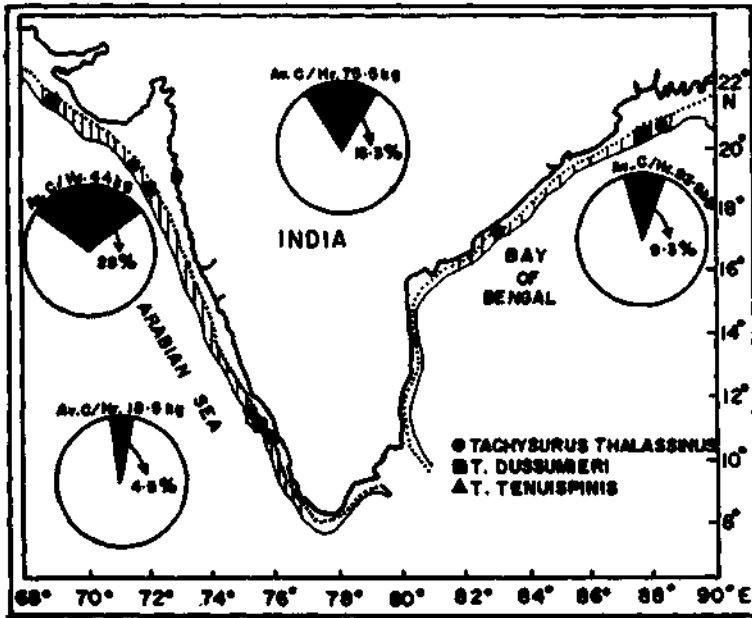

Fig. 1 - Regionwise average catfish catch (kg/hr) in 50-100 m depth zone

### Production from different latitudes

The rate of catfish production in the northwest region has varied from 20 kg/hr in  $16^{\circ}\text{N}$  to 195 kg/hr in  $18^{\circ}\text{N}$  latitude (Table 2). In the southwest region the catfish yield has ranged from 11 kg/hr in  $12^{\circ}\text{N}$  to 808 kg/hr in  $10^{\circ}\text{N}$  latitude. The latitude-wise production rate was within 4.5 kg/hr ( $16^{\circ}\text{N}$ ) and 35 kg/hr in  $20^{\circ}\text{N}$  in the northeast region.

### Bathymetric abundance

Latitude-wise catfish catch/hour from the two depth zones 0-50m and 51-100m is given in Table 2. The catfish catch by bottom trawl from depth below 50m was 120.3 kg/hr along the northwest region. Whereas the production rate was 44 kg in the depth zone 51-100 m. It has accounted for 17.8 % in shallow grounds of less than 50 m and 27.8% in middle shelf areas of 51- 100m. The shallow grounds of <50 m depth zone in the southwest zone landed catfishes at a catch rate of 613.8 kg/hr and it has accounted for about 80% of the trawl catch. In the depth belt 51-100m the catch rate was only 18.5 kg/hr and catfish formed 4.5% of the total catch. The catfish production rate from 0-50 m depth belt along the northeast region was 73.7 kg/hr and it formed 13.3% of the total yield of bottom trawl operations. Higher production rates of about 94 kg/hr was recorded from 51- 100m depth zone and catfish has accounted for 9.3%.

Table 2 - Latitudewise and depthwise catfish abundance

Latitude	Total catch (kg)	Catfish catch (kg)	Catfish (%)	Catfish catch (kg/hr)	0-50 m depth			51-100 m depth		
					Total catch (kg)	Catfish catch (kg)	Catfish (%)	Total catch (kg)	Catfish catch (kg)	Catfish (%)
West coast										
18°N	1772	195	11	194	1772	195	11	-	-	-
17°N	524	150	29	75	189	96	51	335	54	16
16°N	100	20	20	20	-	-	-	100	20	20
15°N	599	232	39	66	599	232	39	-	-	-
14°N	58	13	22	13	-	-	-	58	13	22
13°N	480	50	10	50	-	-	-	480	50	10
12°N	1710	27	2	11	1635	12	1	75	15	33
10°N	2456	2418	98	808	2434	2413	99	22	12	55
9°N	116	12	10	12	116	12	10	-	-	-
7°N	526	37	7	37	526	37	7	-	-	-
East coast										
20°N	3576	316	12	35	2495	300	12	81	13	16
19°N	23706	2297	10	119	1075	237	22	22631	2060	9
18°N	1174	90	8	17	288	16	6	886	74	8
17°N	291	16	6	11	-	-	-	291	16	6
16°N	97	9	9	5	49	4	8	48	5	10

### Potential yield

The potential yield of catfish for each 10' square grid for areas upto 100 m depth belt was estimated by utilising the catch per hour data derived from the bottom trawling results. Although the stations were few, the estimate for the northwest region (15° N-23° 30'N) shows a potential of 26500 tonne from 51-100 m depth belt. The estimated potential for the southwest region (7° 30'N -15°N) is only 3540 tonne from 51-100 m depth zone. The northeast region (15°N- 21° 45' N) within the depth belt 51-100 m has an estimated potential of 10100 tonne. The potential yield /km within 51-100 m has ranged from 0.12 tonne/km in the southwest coast, 0.27 tonne/ km in the northwest region to 0.58 tonne/km in the northeast region. The shallower grounds of 0-50 m depth has an estimated potential of 57000 tonne which is very close to the revalidated potential from this depth belt, in the northwest, southwest and northeast regions with the maximum contribution of 64% from the northeast region alone.

### Seasonal abundance

The monthly catfish catch rates from three regions, northwest, southwest and northeast is shown in Table 3. The coverage is not sufficient enough to give seasonal abundance of catfish in the surveyed areas. However from the available data it is found that the resource has better abundance during postmonsoon months of September - December with catch rate ranging from 46-195 kg/hr preferably in 51-100 m depth zone. This resource is abundant in depths below 50 m during monsoon season with

Table 3 - Seasonal abundance of catfishes

Months	Northwest catch (kg/hr)	Southwest catch (kg/hr)	Northeast catch (kg/hr)
January	-	12	15
February	-	-	-
March	-	-	18
April	-	-	49
May	-	-	140
June	-	495	-
July	20	50	26
August	-	-	-
September	96	-	55
October	195	-	29
November	46	-	46
December	92	12	-

monthly values of 50-496 kg/hr in July and June respectively. In the northeast region, with a better seasonal coverage, it is found that the average monthly catch rate varied from 15 kg/hr (January) to 140 kg/hr (May). No definite seasonal abundance of catfish is discernible in this region.

### Species composition

The species composition of catfish in the coastal commercial fisheries and their biology have been well presented (Anon, 1987; Dan, 1977, 1980; Menon, 1979, 1984 a,b ; Menon *et al.* 1992; Majumdar, 1971, 1977, 1978). Along the northwest coast species such as *Tachysurus dussumieri*, *T. caelatus*, *T. tenuispinis* and *O. militaris* dominated the coastal fishery although more than 8 species occurred in this region. On the contrary, the survey results showed that the most abundant component of catfish from 51-100 m depth is *T. thalassinus*. In the southwest region the nearshore commercial catch composed chiefly of *T. tenuispinis*, *T. thalassinus*, and *T. dussumieri* in their order of abundance. Several species appeared in the commercial catches of southeast coast with particular dominance of *T. thalassinus*, *T. dussumieri*, *T. caelatus* and *T. platystomus*. Although many species were caught from the shallow grounds of northeast coast. The experimental bottom trawling in 51-100 m depth netted only *T. thalassinus* and *T. dussumieri*.

### Biology

Biological investigations conducted based on data and samples derived from bottom trawl landings preferably from depths above 50 m on three species such as *T. thalassinus*, *T. tenuispinis* and *T. dussumieri* revealed that the entire exploited stocks belong to adult populations in the age classes II - V years. The length range of *T. thalassinus* was from 20-60 cm and the dominant size classes were within 35-50 cm. The size of *T. tenuispinis* varied from 30-50 cm and dominated by 45-50 cm fishes. The catch of *T. dussumieri* was low and represented by sizes 30-70 cm. Invariably females of *T. thalassinus* (F:M = 1:0.7) dominated the catch and belonged to maturity stages III - V in June, July months. It fed mainly on *Nemipterus* spp. *Squilla* spp and other ground fishes and prawns. *T. tenuispinis* catch was predominated by maturity stages II - IV and the sex ratio was F:M = 1:0.9.

## DISCUSSION

The revalidated catfish potential from the Indian EEZ is 123000 tonne, to be shared by 0-50 m depth and above 50 m depth at the rate of 60000 tonnes and 63000 tonnes respectively (Anon, 1991). The production from presently exploited grounds below 50 m depth showed a gradual decline from 54219 tonne (1988) to 34100 tonne (1991). In this catch the northwest region contributed 57% and the northeast region 23%, whereas the southwest and southeast regions together landed only 20% of the total yield. On the contrary during 1978 - '82 the average catfish catch was 51734 tonne



which is shared by northwest (37.6%), southwest (34.6%), southeast (9.8%) and northeast (18%). This drastic decline in production along the southwest and southeast regions especially in depths below 50 m is due to irrational destruction of spawners and brooders, juvenile overharvest by mechanised trawlers from coastal fishing ground and destruction of prey diversity from the feeding grounds (James *et al.* 1989; Lakshmi & Srinivasa Rao, 1992; Menon *et al.* 1992; Bensam *et al.* 1994). Further the stock assessment of catfishes from depths below 50 m also showed that the present fishing pressure has surpassed the optimum for a sustainable yield (Anon 1987 ; Menon *et al.* 1994). In this circumstance it is felt necessary to analyse the bottom trawl data collected by *FORV Sagar Sampada* especially from the middle shelf water (above 50 m) for a meaningful estimate of the catfish biomass and potential yield available in the middle shelf waters for exploitation, which could be of immense help for managing this resource.

The earlier resource surveys conducted by FSI showed the highest catch rate (40.2 kg/hr) for catfish from the northeast region forming 17.4% of the total catch. The survey also indicated that the depth zone 50-100 m is highly productive for catfish with 53.2 kg/hr, whereas fairly high catches (45.7 kg/hr) were recorded in depths below 50 m in the southwest coast (Joseph & John, 1987). Ruben *et al.* (1987) estimated the potential yield of catfishes in the northeast coast as 30000 tonne; whereas the present estimate from 51-100 m depth of above region is only 10000 tonne. James & Pillai (1990) also reported that higher concentration of catfish exist off southwest, centralwest and northeast coasts. Vijayakumaran & Naik (1991) also reported on the high abundance (55 kg/hr) of catfishes along the northeast coast within 51-100 m depth belt. The rate of production based on the present analysis from the same region shows still higher value (94 kg/hr) and catfish formed 9% of the total catch. From the stagnating or declining production in the coastal waters, it is evident that the resource within 50 m depth is being tapped either to the optimum level or beyond the sustainable yield. The commercial coastal fishery was mainly supported by juvenile or sub-adult stages (30-80% of catfish catch or trawl net) from the mechanised trawlers and spawner/brooder from the purse seine fishery (about 60% of the total catfish catch by the gear). Mass exploitation at both the stages are detrimental to sustainable yield. Therefore, efforts should be made to exploit the stocks available in the deeper waters of 51-100 m.

The results of the present investigation very clearly showed that the potential available in the deeper grounds belong to higher age classes and mature fishes, spawned atleast once, therefore, their exploitation does not pose recruitment overfishing.

## REFERENCES

- Anon. 1987. Marine catfish resources of India, *Bull. Cent. Mar. Fish. Res. Inst.* 40:1-94.  
Anon. 1991. *Report on working group on revalidation of the potential marine fisheries resources of the Exclusive Economic Zone*, (MPEDA, Cochin) pp.57.

- Bensam, P & Menon N.G. 1994. The endangered, vulnerable and rare demersal marine finfishes of India, In : *Threatened fishes of India*, (NATCON, Allahabad): pp.297-305.
- Bensam, P. Menon.N.G, Balachandran.K, Andrews, J. 1994. Need for protecting the non-edible benthic biota of the in-shore waters for the benefit of the coastal resources and the fishing industry. *Mar. Fish. Infor. Serv. T & E Serv.* No 128 : 1 - 5.
- Dan, S.S. 1977. Maturity, spawning and fecundity in the catfish, *Tachysurus tenuispinis* (Day), *Indian J. Fish.* 24: 96-106.
- Dan, S.S. 1980. Age and growth in the catfish, *Tachysurus tenuispinis* (Day), *Indian J. Fish.* 27 (1&2): 220-235.
- Gulland, J.A. 1969. Manual of methods for fish stock assessment, Part 1. Fishery population analysis. *FAO Mar. Fish. Sic. A*, pp.154.
- James, P.S.B.R., Bande, V.N., Menon.N.G., & Balachandran K. 1989. The catfish resources of southwest coast of India: Prospects and management problems, *Bull. Cent. Mar. Fish. Res. Inst.* 44 (1):78-94.
- James, P.S.B.R. & Pillai V.N. 1990. Fishable concentrations of fishes and crustaceans in the offshore and deep sea areas of the Indian Exclusive Economic Zone based on observations made on board *FORV Sagar Sampada*, In: *Proc. First Workshop Sci. Result FORV Sagar Sampada*, edited by K.J. Mathew, (CMFRI, Cochin) pp.201-213.
- Joseph, K.M. & John M.E. 1987. Potential marine fishery resources, *CMFRI Special Publication* No 30 : 18-43.
- Lakshmi, K. & Srinivasa Rao, K. 1992. Trends in catfish catches at Visakhapatnam showing disappearance of *Arius tenuispinis*. *J. Mar. Biol. Ass. India*, 34 (1 & 2): 26 -37.
- Menon, N.G. 1979. *Studies on the biology and fishery of the giant marine catfish, Tachysurus thalassinus (Ruppell)*, Ph.D. thesis, University of Cochin, Cochin.
- Menon, N.G. 1984 a. Observation on the intraovarian ova of a few tachysurids from Indian waters, *Indian J. Fish.* 31 (2):250-256.
- Menon, N.G. 1984 b. On the biology of the flat-mouthed catfish, *Tachysurus platystomus* (Day) from Mandapam *Indian J. Fish.* 31 (2): 293 -308.
- Menon, N.G. Bande, V.N. Muthiah, Raje, S.G. Zachariah, P.U. & Balachandran K. 1992. Present status of exploitation of fish and shellfish resources : Catfishes. *Bull. Cent. Mar. Fish. Res. Inst.* 45: 133-153.
- Menon, N.G., Srinath, M. Zachariah, P.U. Raje, S.G. & Appanna Sastry. Y. 1994. Stock assessment of catfishes of India, *Indian J. Fish.* 39 (1 & 2):65-84.
- Mojumder, P. 1971. Length-weight relationship in catfish *Tachysurus thalassinus* (Ruppell), *Indian J. Fish.* 18: 179-182.
- Mojumder, P. 1977. Length frequency studies in the catfish, *Tachysurus thalassinus* (Ruppell) at Waltair during the years 1964-65 to 1969-70, *Indian J. Fish.* 25 (1 & 2) : 109 - 121.
- Philip, K.P. 1986. Fishery resources off the offshore and deep sea waters of Karnataka and the fishing effort suggested for exploitation, In: *Proc. Sem. on problems and prospects of marine fishing and fish processing in Karnataka*, (Forum of Fishery Professionals, Mangalore) pp.28-35.
- Rao, K.V. N., Kumaran, M. & Sankara Subramanian J. 1977. Resources of ribbonfishes and catfishes of the southwest coast of India, *Seafood Export J.* 9 (1):9 -26.
- Reuben, S. Sudhakara Rao. G., Luther, G., Appa Rao, T., Radhakrishna, K., Appanna Sastry, Y. & Radhakrishnan, G. 1989. An assessment of the bottom trawl fishery resources of the northeast coast of India, *Bull. Cent. Mar. Fish. Res. Inst.* 44 (1):59-77.
- Silas, E.G., Parameshwaran Pillai, P., Dhulkhed M.H. Muthiah C. & Syda Rao, G. 1980. Purse seine fishery - Imperative need for regulations, *Mar. Fish. Infor. Serv. T & E Ser.* 24 : 1 -9.

- Sudarsan, D., Sivaprakasam, T.E., Somavanshi, V.S., John, M.E., Nair, K.N.V. & Joseph, A. 1988. An appraisal of the marine fishery resources of the Indian Exclusive Economic Zone, *Bull. Fish. Surv. India*. 18: pp.85.
- Vijayakumaran, K. & Naik, S.K. 1991. Demersal finfish resources of the inter-continental shelf of the EEZ, In: *Proc. Nat. Workshop Fish. Resour. Data Fish Indus*, (PSI, Bombay) pp. 71-79.

\* \* \*

## **Distribution of finfish resources along southeast coast of India in relation to certain environmental parameters**

S.Sivakami, P. Marichamy, P. Livingston, G. Gopakumar, R. Thiagarajan, E. Vivekanandan, Kuber Vidyasagar, G. S. Daniel Selvaraj. S, Muthusamy, N. G. K.Pillai & M. Zafar Khan

Central Marine Fisheries Research Institute, P.B. No.- 1603 Cochin - 682 014

### **ABSTRACT**

This paper embodies the distribution pattern of major finfish resources along the southeast coast of India as observed during the cruises operated by *FORV Sagar Sampada*. A total of 16 cruises (1985-90) operated along latitude 7°15' - 15°00' N and longitude 75°50' - 82°31' E hauled a total catch 37.5 tonnes with a catch rate of 537 kg/hr. The catch was constituted mainly by threadfin breams (43%), perches (14%), barracudas (9.72%), carangids (8.56%) and elasmobranchs (4.81%). Seasonally higher catch rates were obtained during July- September period. Depth range of 60 - 80 m had denser population of finfish resources. Water temperature and salinity appeared to influence the distribution of major finfishes more than dissolved oxygen. Groups such as threadfin breams were found preferring cooler waters of Wadge Bank area, while barracudas appear to occupy warmer waters of Gulf of Mannar.

### **INTRODUCTION**

Though it has been conventionally believed that the coastal waters along the east coast of India are less productive as compared to its counterpart along the west coast, there has been a growing awareness during the recent past to acknowledge a change in the scene. Evaluating the fishery potential of the east coast, Sudarsan & Joseph (1978) opine that the difference in the potential yield between the two coasts is very less being only 16.26 %.

Southeast coast of India, with its narrow shelf region being influenced by the riverine discharge and with one of the productive waters along the Palk Bay and Gulf of Mannar, tend to have a dynamic ecosystem influencing the distribution of its fishery resources. Unlike along the west coast of India, the distribution of various fish groups along the southeast coast in relation to prevailing environmental characters is

not much understood except for the general studies made by Misra & Menon (1955), Virabhadra Rao (1973), Subrahmanyam (1973), and Murthy *et al.* (1990). The present paper is an attempt to evaluate the distribution and abundance of major finfish resources in relation to certain hydrographical parameters based on the reports of the cruises undertaken by *FORV Sagar Sampada*.

## MATERIALS AND METHODS

Reports of 16 cruises ( Table 1) operated by *FORV Sagar Sampada* during 1985 to 1990 along the southeast coast of India ( within the area of lat.  $7^{\circ}15' - 15^{\circ}00'N$  and long.  $75^{\circ} 50' - 82^{\circ} 31' E$ ) were analysed for their station wise catch particulars qualitatively and quantitatively. Fish caught in bottom trawl alone were considered for this study. Catch per effort was worked out based on the effort input in terms of hours/minutes.

With a view to obtaining the seasonal pattern of the catch, cruises operated during the months of June to September were considered for the premonsoon season, those operated during October to January for monsoon season ( northeast monsoon) and those during February to May for postmonsoon season.

Gear depth in each station was noted and stations operated in depth ranges 0 -20 m, 20-40 m, 40-60 m, 60-80 m, 80-100 m and 100-150 m and above 150 m were grouped together and average catch per hour worked out in reckoning the depthwise catch data. Likewise, catch rates for different areas of fishing operations were also noted.

Data pertaining to the water temperature, salinity and dissolved oxygen from the nearest depth to that of the fishing depth were noted and averages worked out for comparison with the catch rates in various depth ranges in different fishing areas.

## RESULTS

### Exploitation

Catch details of various cruises are presented in Table 1. A total of 37499 kg of fish, crustacean and cephalopod resources were obtained, with a catch rate of 537 kg/hr. A comparative assessment of cruise-wise catches showed that cruise no.33 (  $07^{\circ}31' - 9^{\circ}00' N$ ,  $76^{\circ}22' - 77^{\circ}32' E$ ) hauled the maximum catch of 25864 kg with a catch rate of 2874 kg/hr during July 1987. The lowest catch rate of 1.64 kg/hr was from  $11^{\circ} 10' - 13^{\circ}37' N$  and  $79^{\circ} 57' - 80^{\circ} 28' E$  during December 1989.

### Species composition

Details regarding the percentage contribution of different fish groups are given in Table 2. It may be noticed that the catch was dominated by *Nemipterus* spp (43%) followed by barracudas (*Sphyraena* spp) (9.72% ), carangids (8.56% ) and elasmobranchs (4.81% ). Perches were represented by species such as *Epinephelus* spp.

Table 1 - Particulars of fish catch in cruises operated along the southeast coast of India during 1985-90

Cr.no.	St. no.	Period of operm.	Depth range(m)	Position		Total catch (kg)	Catch rate (kg/hr)
				Latitude	Longitude		
3	4	June 1985	45-631	10° 29'- 13° 30'	08° 13'-08° 30'	409	109
5	2	July 85	42-221	07° 50'- 10° 00'	75° 50'-77° 51'	2051	1025
13	6	Feb. 86	23-68	10° 30'- 15° 00'	80° 00'-81° 26'	980	42.15
13	6	March 86	40-86	11° 30'- 14° 13'	79° 54'-80° 29'	1881	26871
25	5	Dec. 86	39-75	10° 30'- 13° 00'	90° 10'-80° 28'	488	89.6
26	1	Jan. 87	38	14° 31'	82° 31'	220	220
30	0	May 87	No fishing				
33	11	July 87	30-83	07° 31'- 09° 00'	76° 77'-77° 32'	25864	2873.78
34	5	Aug. 87	22-91	11° 00'- 14° 12'	79° 53'-80° 58'	3316	72.98
35	2	Sept. 87	84-168	14° 12'- 14° 59'	80° 18'-80° 23'	1575	787.5
59	4	June 89	52-82	10° 30'- 14° 11'	80° 09'-80° 23'	640	213.33
61	2	Aug. 89	79-85	11° 00'- 13° 58'	79° 00'-81° 25'	2300	1533.33
63	1	Sept. 89	85	13° 25'	80° 28'	40	120
67	3	Dec. 89	50-60	11° 10'- 13° 37'	79° 57'-80° 28'	5	1.64
70	2	Feb. 90	48-60	11° 23'- 14° 05'	80° 23'-80° 27'	574	287
72	4	April 90	48-78	10° 30'- 15° 00'	80° 14'-80° 30'	197	69.35
Total stns=58						37499	537

Table 2 - Seasonal abundance (kg/hr) of various groups of fishes along the southeast coast of India

Groups/Species	Premonsoon				Monsoon		Postmonsoon			Total	
	June	July	August	Sept.	Dec.	Jan.	Febr.	March	April	[kg/hr]	[%]
Elasmobranchs	1.93	96.54	0	0	0	92	7.17	44.43	53	25.9	4.81
Carangids	5.33	110.64	180.7	0	6.67	80	12.81	66.14	0.71	45.97	8.56
Nemipterids	0	1437.73	14.61	0	0	1	2.85	18	4.59	230.7	42.96
<i>Epinephelus</i> spp	2.52	79.55	1.04	0	3.64	0	1	19.86	0	15.6	2.91
<i>Lethrinus</i> spp	19.26	23.64	0	0	14.58	0	0	50	0	12.21	2.27
<i>Lutjanus</i> spp	0	2.27	23.83	0	10.14	0	0	14.86	0	4.94	0.92
<i>Lutianus</i> spp	19.26	19.09	0	0	0	0	0	0	1.06	4.91	0.91
<i>Pomadasys</i> spp	22.22	0	0	0	0	0	0	0	0	2.15	0.4
<i>Diagramma</i> spp	0	21.82	0	0	6.97	0	0	0	0	65.78	1.07
<i>Pentaprion</i> spp	42.96	0	2.08	0	0	40	1.7	0	0	5.51	1.02
Other perches	3.7	2.82	43.48	2	0	0	1.66	0	0	5.05	0.94
Cat fishes	0	5.82	0	0	0	3	0	0	0	0.95	0.17
Sciaenids	0	0	0	0	0	0	8.52	0	0	3.07	0.57
Lizard fishes	0	28.09	10.26	0	0	0	0	2.86	1.06	4.68	0.87

Contd...

Table 2 — Contd...

Groups/Species	Premonsoon			Monsoon			Postmonsoon			Total [kg/hr]	Total [%]
	June	July	August	Sept.	Dec.	Jan.	Febr.	March	April		
Goat fishes	0	8.64	0.35	0	0	0	6.88	2.14	0	4.09	0.76
<i>Leiognathus</i> spp	4	3.64	5.21	0	2.32	0	5.39	0	0	3.59	0.67
<i>Sphryaena</i> spp	0	322	0	0	0	0	3.33	2.28	0	52.16	9.72
Seer fish	0	4.54	0	0	1.32	0	0	0	1.77	0.97	0.18
Mackerel	0	0	86.96	0	0	0	0	0	0	7.16	1.33
<i>Dussummeria</i> spp	0	0	0	0	0.09	0	0	0	0	0.34	0.06
<i>Psenes indicus</i>	0	59	0	0	0	0	0	0	0	9.29	1.73
<i>Psenoposis cyanea</i>	0	0	0	100	0	0	0	0	0	3.58	0.66
<i>Priacanthus</i> spp	0	8.64	0	500	0	0	0	0.74	0	19.33	3.66
Balistids	0	30.72	0	0	0	0	0	0	0	4.84	0.9
Miscell.fishes	20.44	229.21	52.52	24	7.87	4	6.91	47.43	5.48	51.68	9.63
Jelly fish	4	0	0	0	0	0	0	0	0	0.38	0.07
Crustaceans & cephalopods	9.78	39.11	33.91	20	1.74	0	3.2	0	1.77	12.04	2.24
Total catch (kg/hr)	155.4	2537.7	454.96	646	58.39	220	61.57	268.71	69.43	537	



(3.9%), *Lethrinus* spp (2.27%), *Diagramma* spp (1.07%), *Lutjanus* spp (0.92%), *Lutianus* spp (0.91%) and *Pomadasys* spp (0.40%). Other demersal fish represented were lizard fish (0.87%), goat fish (0.76%), *Leiognathus* spp (0.67%) and Sciaenids (0.57%). Pelagic groups such as seer fish (0.18%), mackerel (1.33%) and *Dussumieria* spp (0.06%) were also represented in the catches. Mesopelagic fish like *Priacanthus* spp (3.60%), *Psenus indicus* (1.73%), *Psenopsis cyaena* (0.66%) and balistids (0.9%) were also caught occasionally. Apart from finfish, crustaceans and cephalopods constituted 2.24% of the total catches.

### Seasonal abundance

Catch rate (kg/hr) of various groups of fish caught during different months/seasons of the year is given in Table 2. The catch rate was more during the premonsoon months of June to September with the maximum catch rate of 2537 kg/hr recorded during July followed by September (646 kg/hr). During the northeast monsoon season, the catch was generally less, with no cruises undertaken during October-November months. However, cruises operated during December and January brought catch rates of 58.4 kg/hr and 220 kg/hr respectively. Postmonsoon (February to May) brought a higher catch rate ranging from 61.57 to 268.71 kg/hr during February and March respectively.

Qualitatively, nemipterids were the maximum, with a catch rate of 1437 kg/hr followed by *Sphyraena* spp (322 kg/hr), carangids (100 kg/hr) and lizard fish (28 kg/hr) during July. Perches like *Epinephelus* spp (79.55 kg/hr) and *Diagramma* spp (31.82 kg/hr) were represented during the premonsoon month of July, while *Priacanthus* spp (500 kg/hr) was caught during September.

### Bathymetric distribution

Depthwise catch details are presented in Table 3. It is discernible that the maximum catch rate of 1500 kg/hr was obtained from 60-80 m depth range. The next abundant catch rate of 535 kg/hr was recorded from deeper waters of >150 m depth. Deeper waters of 80-100 m range and shallow waters of 20-40 m, range brought almost similar catch rate of 423.45 kg and 410 kg respectively. The next catch rate in abundance was obtained from 40-60 m depth range (29.85 kg/hr) while there was no catch recorded from 100-150 m depth range.

Specieswise, 60-80 m depth range had *Nemipterus* spp (1171.45 kg/hr) followed by carangids (98.90 kg/hr), mackerel (45.45 kg/hr), and *Epinephelus* spp (167.56 kg/hr) as the dominant form while surprisingly at the depth range of 20-40 m, other forms such as *Sphyraena* spp (196.35 kg/hr), elasmobranchs (64.61 kg/hr), carangids (24.5 kg/hr) and *Lethrinus* spp (28.04 kg/hr) were the dominant forms. It may be pointed out that forms such as *Psenes indicus*, *Psenopsis cyaena*, *Priacanthus* spp. and balistids were dominant in deeper waters above 80 m in depth.

Table 3 - Bathymetric distribution and abundance (kg/hr) of various fishery resources along the southeast coast of India

Groups/species	Depth, range[m]				
	20-40	40-60	60-80	80-100	>150
Elasmobranchs	64.61	16.71	8.63	0	0
Carangids	24.5	55	98.9	4.46	0
Nemipterids	0.61	63.4	1171.45	167.56	0
<i>Epinephelus</i> spp	11.44	19.93	26.18	0	0
<i>Lethrinus</i> spp	28.04	11.43	0.9	0	0
<i>Lutjanus</i> spp	6.5	2.56	10.9	4.08	0
<i>Lutianus</i> spp	0	11.16	0.27	0.63	0
<i>Pomadasys</i> spp	0	5	0	0	0
<i>Diagramma</i> spp	10.09	7.46	0	0	0
<i>Pentaprion</i> spp	2.91	10.26	2.27	0	0
Other perches	1	1.23	24.36	3.83	0
Cat fishes	1.57	1.3	0	0	0
Sciaenids	8.16	6.9	0	0	0
Lizard fishes	0	4.43	13.9	5.72	0
Goat fishes	53.45	7.03	1.72	0.25	0
<i>Leiognathus</i> spp	11.06	1.7	0.27	0	0
<i>Sphryaena</i> spp	196.35	3.83	2.45	0	0
Seer fish	3.25	0.33	0	0	0
Mackerel	0	0	45.45	0	0
<i>Dussumieria</i> spp	1.34	0	0	0	0
<i>Psenes indicus</i>	0	2.51	20.45	12.77	83
<i>Psenopsis cyaena</i>	0	0	0	31.92	0
<i>Priacanthus</i> spp	0	0.83	4.54	156.44	16.16
Balistids	0	11.26	0	0	0
Miscell. fishes	37.46	2.83	46.81	21.07	425.33
Jelly fish	0	0.9	0	0	0
Crustaceans & cephalopods	5.83	11.76	21.27	15.32	10
Total(kg/hr)	410.1	291.85	1500.6	423.45	535

### Areawise distribution

Details regarding the distribution and abundance of different groups of fish occurring in different areas are given in Table 4. It is evident that area 7°-77° (Wadge Bank) brought a catch rate of 2456 kg/hr contributed mainly by nemipterids (1807 kg/hr). Area 8°-78° (Gulf of Mannar) also indicated an abundant distribution with a catch rate of 4032 kg/hr, contributed mainly by pelagic groups such as *Sphyræna* spp (2801 kg/hr) followed by elasmobranchs (561.6 kg/hr) and carangids (161 kg/hr). Areas 11°-79° (Pondicherry) and 14°-80° (Krishnapatnam) with catch rate of 465.83 kg/hr and 266.31 kg/hr respectively had carangids as the main component. It is interesting to note that deep water forms such as *Psenopsis cyæna* and *Priacanthus* spp were caught mainly from 14°-80° area.

### Distribution in relation to hydrographical parameters

Particulars on the distribution of dominant finfish resources in relation to hydrological parameters such as water temperature, salinity and dissolved oxygen are presented in Figs. 1 and 2. Maximum catch rate of nemipterids was obtained from 60-80 m depth range (1171 kg/hr) of area 7°-77° (Wadge Bank), where water temperature was low being 24.37°C while salinity was moderate ( $35.33 \times 10^{-3}$ ). It may also be pointed out that at a particular station from where a catch rate of 9375 kg/hr of nemipterids was obtained, the water temperature and salinity were 22.10°C and  $33.9 \times 10^{-3}$  respectively. It is also evident that in other areas such as 11°-79°, 11°-80°, 12°-80°, 13°-80° and 14°-80° of high water temperature regime and low salinity, low catch of nemipterids was obtained. Dissolved oxygen, however with a narrow range of 3.46 - 5.37 ml/l does not appear to have any influence on the distribution of nemipterids.

Other perches represented by species like *Epinephelus* spp, *Lethrinus* spp, *Lutjanus* spp, *Lutjanus* spp, *Pomadasys* spp, distributed mainly in 7°-77°, 7°-78°, 10°-80° and 11°-79° areas were found concentrated in 20-60 m depth range where generally low temperature (24.35°C - 25.21°C) and moderate salinity ( $35.78 \times 10^{-3}$ ) prevailed. Dissolved oxygen was in a range of 3.45 - 4.2 ml/l in different areas.

Barracudas and elasmobranchs were caught mainly from 20-40 m depth range of area 8°-78° (Gulf of Mannar) where the average water temperature was warmer (24.9°C) with moderate salinity ( $35.6 \times 10^{-3}$ ) and high dissolved oxygen content (4.2 ml/l). It may also be noticed that in the depth range of 40 - 60 m in the Gulf of Mannar area, where the temperature was very high being 27.5°C with higher salinity range of  $35.9 \times 10^{-3}$  catch was negligible in spite of high dissolved oxygen content (4.3 ml/l). Carangids were found distributed more in 60-80 m depth in 11°-79° area and 40-60 m depth range of 7°-78° and 14°-80° area, where salinity was moderate within the range of  $28.9 - 29.5 \times 10^{-3}$ . It may be noticed that temperature was low (24.35°C) in 7°-78° area, but was moderate or high in other areas of their

Table 4 - Areawise distribution (kg/hr) of various fishery resources along the southeast coast of India during 1985-90

Groups	Areas								
	7°-77°	7°-78°	8°- 77°	8°-78°	10°-80°	11°- 79°	12°-80°	13°-80°	14°-80°
Elasmobranchs	34.27	0	120	561.6	0	39.42	13.2	2.86	20.86
Carangids	77.87	600	70	161	6.62	141.98	2.49	6.22	58.85
Nemipterids	1807	0	0	0	0	1.57	10.15	9.53	0.32
<i>Epinephelus</i> spp	85.71	0	250	0	7.43	5.25	0.36	6.22	8.44
<i>Lethrinus</i> spp	12	6	200	6.43	10.05	45.99	0	0.56	11.89
<i>Lutjanus</i> spp	0	0	0	6.43	5.48	22.33	0	0.23	2.21
<i>Lutianus</i> spp	14.85	160	0	0	0	0	0.92	0.16	9.83
<i>Pomadasys</i> spp	0	0	0	0	17.14	0	0	0	0
<i>Diagramma</i> spp	0	400	0	120	2.74	0	0	0	2.45
<i>Pentaprion</i> spp	0	0	0	0	1.37	0	0.02	18.67	3.27
Other perches	3.54	0	0	0	2.05	32.85	0.55	1.26	0
Cat fishes	4.11	0	0	22.4	0	0	0	0	0.24
Sciaenids	0	0	0	0	0	1.07	0	11.67	0
Lizard fishes	28	0	0	0	0	7	1.84	0.39	0.08
Goat fishes	9.71	20	0	0	2.45	2.89	0	3.76	6.55

Contd...

Table 4 — Contd...

Groups	Areas									
	7°-77°	7°-78°	8°-77°	8°-78°	10°-80°	11°-79°	12°-80°	13°-80°	14°-80°	
<i>Leiognathus</i> spp	0	50	0	12	11.22	7.75	0	3.02	0	
<i>Sphryaena</i> spp	4.8	0	0	2801	0	0	2.86	3.51	3.44	
Seer fish	0	0	0	40	0	0	0.46	0.28	0.24	
Mackerel	0	0	0	0	0	65.7	0	0	0	
<i>Dussumieria</i> spp	0	0	0	0	0	0	0	1.34	0	
<i>Peenes indicus</i>	71.31	50	0	0	0	0	0	0	0	
<i>Psenopsis cyanea</i>	0	0	0	0	0	0	0	0	20.49	
<i>Priacanthus</i> spp	10.85	0	0	0	0	0	0.46	0	102.45	
Balistids	37.48	120	0	0	0.59	0	0	0	0	
Miscell. fishes	221.51	590	40	214.4	15.7	72.46	5.52	10.82	11.47	
Jelly fish	0	0	0	0	0	0	0	1.51	0	
Crustaceans and cephalopods	32.6	120	20	60	6.97	20.76	6.04	7.85	3.21	
Total catch	2456.06	2000	770	4032	89.71	465.83	38.96	85.86	266.31	

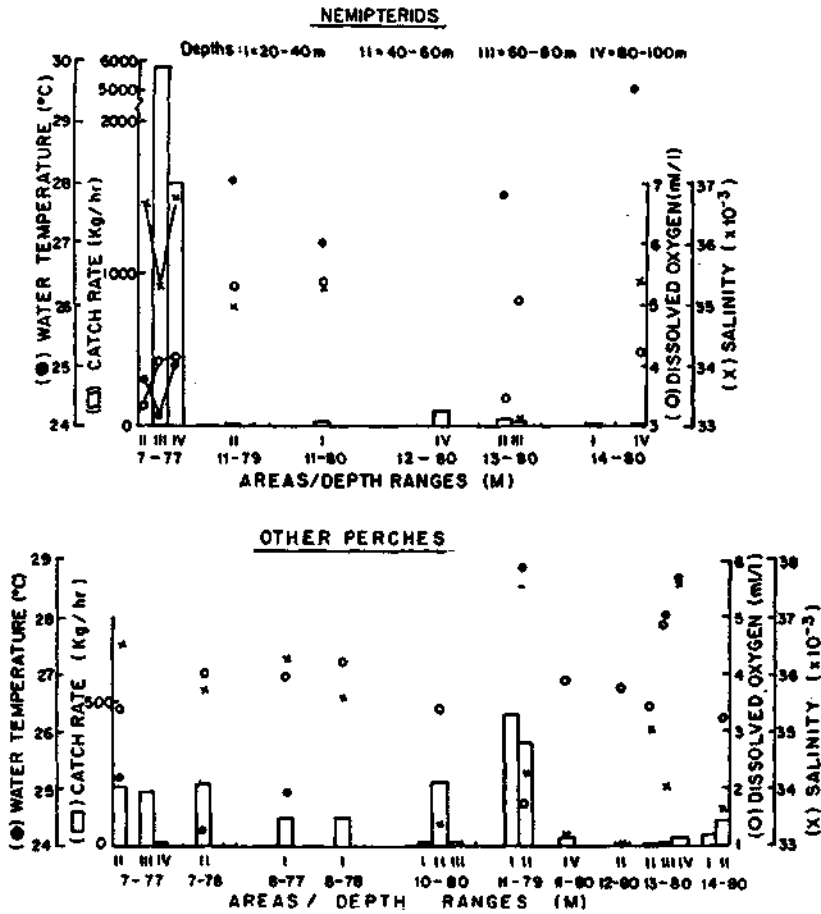

Fig. 1 — Catch rate (kg/hr) of Nemipterids and other perches caught in relation to water temperature, salinity and dissolved oxygen of the nearest fishing depth from the southeast coast of India

occurrence. Dissolved oxygen was fairly high within the range of 3.45 - 5.27 ml/l, except in 11° - 79° area where it was only 1.81 ml/l.

### DISCUSSION

The higher catch rates obtained during the premonsoon season (June-September) in the present study may be attributed to the higher phytoplankton production which is accounted to be 2 to 2.5 times more than that of northeast monsoon period along the southern part of Bay of Bengal (Sukhanova, 1964). This view is supported by the fact that along Palk Bay region, very high values of organic production to the tune of 435 mg C/m / day to 2340 mg C/m /day was reported during June to July months, and also because of the time lag involved in the drifting nature of plankton blooms, a slightly extended periodicity up to September can be justified in yielding good catches.

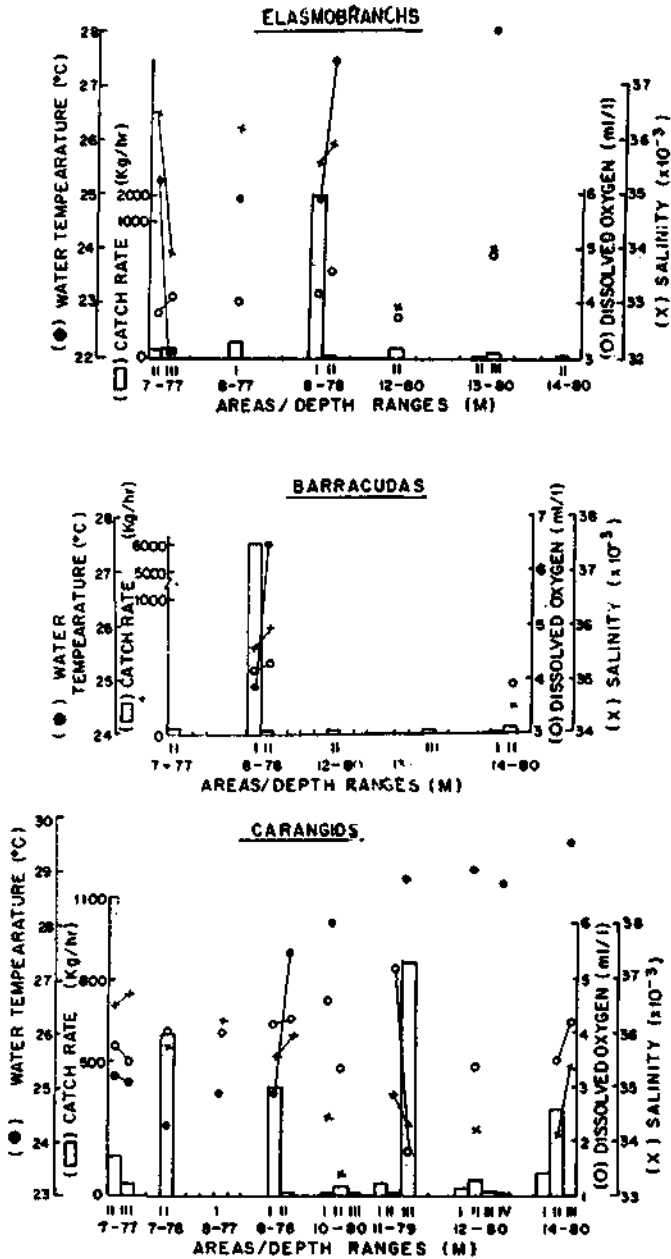

Fig. 2 — Catch rate (kg/hr) of elasmobranchs, barracudas and carangids caught in relation to water temperature, salinity and dissolved oxygen of the nearest fishing depth from the southeast coast of India

It may also be noticed that the catch rate is minimum during the northeast season (October-January). While the lesser coverage during the monsoon season cannot be ruled out, it may be pointed out that the standing crop of phytoplankton during the northeast monsoon season is several times less than that of southwest monsoon season (Subrahmanyam, 1973). Further it is reported that in region between 8° and 12° N, the waters were barren during the transition period of October-December period between the monsoons (Zernova & Ivanov, 1964). And the increase in catch rate observed during the postmonsoon period may be due to the reported upwelling occurring in the Bay of Bengal from January to June at different centres along the east coast (Varadachari & Sharma, 1967). It may therefore be surmised that fish production in Bay of Bengal is highly influenced by monsoon shifts as is also suggested by Steemann-Nielson & Jensen (1957) and an extensive investigation during different season is necessary in order to give a true picture.

Bathymetric distribution (Table 3) of major finfish resources as observed in the present study shows that maximum concentration is recorded in 60-80 m depth range, with other depth ranges moderately populated. It is generally observed that productivity is more towards the shore decreasing seaward (Nair *et al.* 1973). But according to Radhakrishna *et al.* (1972), the shelf and slope waters are equally productive with less intensity in the offshore areas. However, being influenced by the various eco-biological factors such as temperature, light, availability of food etc., fish tend to move to and from the shallow and deeper waters and the behavioural pattern of fish may account for making both shelf and slope waters more or less equally distributed with fish.

A scrutiny of the catch particulars in the present study indicates that nemipterids and barracudas (*Sphyræna* spp) the most dominant groups caught were obtained from the Wadge Bank and Gulf of Mannar area respectively during July, the former being caught from 60-80 m depth range and the latter from shallow waters of 20 - 40 m depth range. It may also be noticed from the present results that deeper areas of Wadge Bank had cooler waters of high salinity, while Gulf of Mannar area had warmer waters of moderate salinity. Upwelling has been reported to be pronounced during July-September period along the southwest coast, which extends up to the Wadge Bank area off Cape Comorin (Banse, 1959, 1968). The upwelled waters are rich in nutrients, with low temperature and dissolved oxygen and high salinity brought from the deeper areas. The hydrological variations in the waters of Wadge Bank and Gulf of Mannar may be due to the difference in the extent of upwelling in these areas and also due to the influence of fresh water discharge into the Bay of Bengal. The abundance of nemipterids in the Wadge Bank area may be due to their preference for cooler upwelled waters rich in nutrients. Further postulating a theory of correlation of nemipterid fishery with the hydrological conditions of the adjacent waters, Krishnamoorthy (1973) reported that the hydrological changes may have some effect too close to be casual on the benthic organisms on which nemipterids feed. It is also possible that the distribution of nemipterids may have some relation with their breeding grounds for these fishes are reported to breed in trawling grounds beyond 50 m depth (Murthy, 1984). Therefore there is scope to believe that food and spawning



exert some influence on the abundance of nemipterids in the trawling grounds (Appa Rao, 1989) which in turn are influenced by hydrological factors, for water temperature alone or in conjunction with salinity, regulates maturation of ova, buoyancy of eggs, larval development and abundance of preferred food.

Likewise, barracudas which abound the shallow inshore waters were found to prefer warmer low saline waters of Gulf of Mannar. Here, it may be surmised that barracudas prefer the waters of Gulf of Mannar, since in the Bay of Bengal, the shelf waters are nearly isothermal without much fluctuation (Subrahmanyam, 1973).

James (1973) has observed the Gulf of Mannar area to be one of the rich grounds for elasmobranchs with skates and rays confined mostly to 15-37 m depth range. Moreover, the appearance of sharks along the east coast is very often noticed in association with the abundance of their food-fish such as sardines and mackerels (Devadoss *et al.* 1989), whose distribution in turn is influenced by fluctuations in hydrological factors such as water temperature and salinity within 20 m depth range (Ramana *et al.* 1991). Therefore, it may be concluded that the distribution of elasmobranchs in the Gulf of Mannar area may have some relation with the availability of their food fishes, whose distribution in turn is controlled by the prevailing hydrological characters.

Wadge Bank area was reported to be one of the richest perch (Kalava) grounds (Silas, 1969) with species like snappers (*Lutjanus* spp.) preferring high saline waters. These fishes are known to inhabit the crevices of rocky beds of varying depths, coming out occasionally in shoals for food from the nutrient rich upwelled waters (Menon *et al.* 1977). The distribution of species like *Epinephelus* spp, *Lethrinus* spp, *Lutjanus* spp etc. in the Wadge Bank area may probably be related to their preference for suitable substratum and optimum hydrological conditions.

Carangids in the adult stage are reported to be piscivorous preferring *Stolephorus* spp (Sreenivasan, 1978; Sivakami, 1993). According to Narayana Pillai (1991) *Stolephorus* spp, avoiding unfavourable temperature in the Ratnagiri - Karwar region and further south, tend to migrate to the southeast coast between Cape Comorin and Tuticorin in dense congregations during June to October period. Nursery grounds of carangids are also being located in the central and southern shelf including Wadge Bank area (Rao *et al.* 1977). The distribution of carangids in the 7°-78°, 8°- 78° and 11°-79° areas, as observed in the present study may therefore be attributed to their feeding and breeding requirements.

The effect of low oxygen content in the upwelled water is a matter of concern. According to Banse (1959, 1968), the low oxygen content which goes even below 0.15 ml/l can adversely affect the distribution of demersal fishes. However according to Murthy (1992), the dwindling of fish catches may be caused by the toxic effect of bacterial load in the upwelled water. Narayana Pillai (1991) states that the upwelled water gets oxygenated within a short time due to contact with atmosphere and also due to wind action. In the present study, dissolved oxygen content in different depth ranges was generally within a range of 3.45 - 5.27 ml/l and did not exhibit any adverse

influence on the distribution of fish fauna. And the higher oxygen content of the waters of the Bay of Bengal may be due to lesser organic content (Subrahmanyam, 1973).

Movements of fish tend to be influenced by water movements and plankton bloom, with the water movement dependent on temperature, salinity gradient and wind action, and plankton production on the nutrient in the water (Subrahmanyam, 1973). While pelagic fishes such as sardine and mackerel, subsist on plankton, with the predators like elasmobranchs around, bottom feeding fishes thrive on benthic organisms which in turn subsist on the plankton—dead or alive, sinking to the bottom. Thus the distribution of pelagic and demersal fish is to a great extent influenced by the dynamic interactions of different trophic levels. In the present case, it is found that when the nutrient rich warmer upwelled waters of high salinity in the Wadge Bank harbours fish like nemipterids and other perches, pelagic forms such as *Sphyraena* spp, elasmobranchs and carangids form congregations in the Gulf of Mannar area, where their smaller food fishes like sardine, mackerel and whitebaits thrive favoured by the optimum water temperature and salinity conditions. It is therefore felt that for a thorough understanding of the distribution of different groups of fishes in time and space, it is imperative that the interaction of different trophic levels with the prevailing hydrological and meteorological conditions need be examined which can help a long way in locating and forecasting the fishing grounds and thus enhancing the fish production.

### ACKNOWLEDGEMENT

Authors thank Dr.P.S.B.R. James, former Director, for the encouragement during the preparation of this paper. Thanks are also due to the Officer-in-Charge, Sagar Sampada Cell, for providing the cruise data.

### REFERENCES

- Appa Rao, T. 1989. Fishery of threadfin bream at Waltair with notes on some aspects of biology of *Nemipterus mesoprion* (Bleeker), *J. Mar. Biol. Ass. India*. 31 (1&2): 103 - 109.
- Banse, K. 1959. On upwelling and bottom trawling off the south- west coast of India, *J. Mar. Biol. Ass. India*. 1 (1) : 33-48.
- Banse, K. 1968. Hydrography of the Arabian Sea shelf of India and Pakistan and effects demersal fishes, *Deep-Sea Res.* 15: 45-79.
- Devadoss, P., Kuthalingam, M.D.K. & Thiagarajan, R. 1989. The present status and future project of elasmobranch fishery in India, In: *Nat. Symp. On R & D in Marine Fisheries*, Part I : CMFRI, Bull. 44:188-198.
- James, P.S.B.R. 1973. Sharks, rays and skates as a potential fishery resources off the east coast of India, In: *Proc. Symp. Mar. Liv. Res. Seas India*. Spl. Pubn. (CMFRI, Cochin) 483 - 494.
- Krishnamoorthy, B. 1973. An assessment of nemipterus fishery off Andhra-Orissa coasts based on exploratory fishing, In: *Proc. Symp. Liv. Res. Seas India*: Spl. Pubn. (CMFRI, Cochin) 495 - 516.
- Menon, M.D., Varghese C.P. & Haridas, C., 1977. Development of Trap fishing for rock cod off southwest coast of India, *Seafood Export J.* 9 (1): 5-14.

- Misra, K.S. & Menon, M.A.S. 1955. On the distribution of the elasmobranchs and cheimaeras of the Indian region in relation to the mean annual isotherms, *Rec. Indian Mus.* 53 : 73-86.
- Murthy, V.S.R. 1984. Observations on the fishery of threadfin breams (Nemipteridae) and on the biology of *Nemipterus japonicus* (Bloch) from Kakinada, *Indian J. Fish.* 31 : 1-18.
- Murthy, A.V.S., Gopalakrishna Pillai, N. Zafar Khan, M. Sunil Kumar, K.U. & Alavandi, S.V. 1990. Variation in fish catches from the continental shelf between Quilon and Gulf of Mannar and its relation to oceanographic conditions during the southwest monsoon period, In : *Proc. 1st Workshop FORV Sagar Sampada*, edited by K. J. Mathew, (CMFRI, Cochin) 291 - 294.
- Murthy, A.V.S. 1992. A critical study on the bad effects of upwelled waters on fisheries as exemplified by the situation of the Kerala-Karnataka region of the west coast of India, *J. Mar. Biol. Ass. India*, 34 ( 1 & 2): 246-252.
- Nair, P. V. R. Samuel, S., Joseph, K.J. & Balachandran, V.K. 1973. Primary production and potential fishery resources in the seas around India, In: *Proc. Symp. Liv. Res. Seas India*, Spl. Pubn. (CMFRI, Cochin) 184-198.
- Narayana Pillai, V. 1991. Salinity and thermal characteristics of the coastal waters off southwest coast of India and their relation to major pelagic fisheries of the region. *J. Mar. Biol. Ass. India*, 33 (1&2) : 115-133.
- Radhakrishna, K., Bhattathiri, P.M.A. & Devassy, V.P. 1978. Primary productivity of the Bay of Bengal during August - September period, *Indian J. Mar. Sci.* 7: 94-98.
- Ramana, T.V., Nathaniel D.E. & Reddy, M.P.M. 1991. Distribution of some oceanographic factors in the Arabian Sea off Manjeswar and their possible effect on oil sardine and mackerel fisheries in the area, *J. Mar. Biol. Ass. India*, 33 : 9-18.
- Rao, K.V.N., Kumaran, M. & Sankarasubramanian, J. 1977. Resources of horse mackerel off the southwest coast of India, *Seafood Export J.* 9 : 9-27.
- Silas, E.G. 1990. Exploratory fishing by *R.V. Varuna*, *Bull. Cent. Mar. Fish. Res. Inst.* 12: pp. 86.
- Sivakami, M.S. 1993. On the food habits of the fishes of the family Carangidae ( Unpublished).
- Sreenivasan, P.V. 1978. Observations on the fishery and biology of *Megalaspis cordyla* at Vizhinjam, *Indian J. Fish.* 25 ( 1&2) : 122-140.
- Steeman-Nielsen, E. & Jensen, E.A. 1957. Primary oceanic production. The autotrophic production of organic matter in the oceans, *Galathia Repts.* Copenhagen, I, 4: 49-136.
- Subrahmanyam, R. 1973. Hydrology and plankton as indicators of marine resources, In : *Proc. Symp. Liv. Res. Seas India. Spl. Pubn.* (CMFRI, Cochin) 199-228.
- Sukhanova, I.N. 1964. The phytoplankton of the northeastern Part of the Indian Ocean in the season of the southwest monsoon, *Trud. Inst. Okeanol. Akad. Nauk. SSSR.* 65 : 24-31.
- Varadachari, V.V.R. & Sharma, G.S. 1967. Circulation of the waters in the north Indian Ocean, *J. Indian Geoph. Uni.* 4 (2) : 61-63.
- Virabhadra Rao, K. 1973. Distribution pattern of the major exploited marine fishery resources of India, In: *Proc. Symp. Liv. Res. Seas India* Spl. Pubn. (CMFRI, Cochin) 18 - 101.
- Zernova, V.V. & Ivanov, A. 1964. On the distribution of phytoplankton as depending from hydrological conditions in the northern part of the Indian Ocean, *Trud. Inst. Okeanol. Akad. Nauk. SSSR.* 64: 257 - 264.

## Catch, abundance and some aspects of biology of deep sea fish in the southeastern Arabian Sea

M. Feroz Khan, P.U. Zacharia, K. Nandakumaran, S. Mohan,  
M. R. Arputharaj, D. Nagaraja & P. Ramakrishnan

Central Marine Fisheries Research Institute, P. O. Box- 1603,  
Cochin-682 014

### ABSTRACT

The bottom trawls operated by *FORV Sagar Sampada* in the southeastern Arabian Sea revealed the existence of grounds with potentially rich unexploited deep sea finfish resources. *Chlorophthalmus* sp. formed the most dominant species with catch rates of 4.6 tonne/hr at lat. 8°56' N long. 73° 35' E and 4.2 tonne/hr at lat. 8°55' N, long. 73°35'E. *Cubiceps natalensis* with catch rates of 2.8 t forms the next important species. Maximum catch rate of deep sea fish was observed at depths ranging from 300 to 350 m. The other major exploitable species include *Neopinnula orientalis*, *Pseneopsis cyanea*, *Chascanopsetta lugubris*, *Priacanthus hamrur* and *Chlorophthalmus bicornis*. Information on some aspects of biology of fishes landed in fairly good quantity are also dealt with. Concentrations of deep sea fish resources are found in comparatively shallower depths in the northern latitudes whereas a wider distribution is seen in the southern latitudes.

### INTRODUCTION

Deep sea fishes are rapidly gaining importance as a potential fishery resource, as the inshore fishery alone can no longer satisfy the growing demand for fish. In India exploratory fishery surveys conducted in deeper waters of the Exclusive Economic Zone have indicated the presence of unexploited deep sea fish resources in the peripheral shelf area and continental slope which have great scope for commercial exploitation. Joseph & John (1986) have stated that the deep sea resources in the outer shelf and continental slope comprised of a few non-conventional species like "big eye", "green eye", "black ruff", *Cubiceps* etc. in contrast to the multiplicity of species in coastal region.

Though the investigations made by Gravelly (1929), Silas (1969), Joseph *et al.* (1976), Philip *et al.* (1984), Joseph (1986), Nair & Joseph (1986), Sivaprakasam

(1986), James & Pillai (1990) and Gopalakrishnan *et al.* (1988) have reported on the availability and relative abundance of these deep sea fish resources, there is very little knowledge on the resource characteristics and biology of these deep sea fish resources. The present paper deals with the geographical and the bathymetrical distribution of deep sea fishes in the southeastern Arabian Sea based on data collected during the cruises of *FORV Sagar Sampada* along with information on some aspects of biology of important species. An attempt is also made for estimating the biomass of deep sea fish in this area.

## MATERIALS AND METHODS

The material for the present study was collected onboard *FORV Sagar Sampada* during cruise no. 40 and 96 at southeastern Arabian Sea (Fig. 1). During cruise no. 40 (1.1.1988 to 11.1.1988) High Speed Demersal Trawl (HSDT - III) and in cruise no. 96 (18.11.1991 to 18.12.1991). Bottom Lobster trawl (BTR-L) was used. The catch details of stations covered between lat.  $8^{\circ}35'$  to  $12^{\circ}55'$  N and long.  $73^{\circ}56'$  to  $76^{\circ}28'E$  were analysed. A total of 20 trawling operations were carried out during cruise No.40 between 130 and 777 m depth (Fig. 1 A ) High Speed Demersal Trawl (HSDT - III) designed by CIFT, Cochin with a codend mesh size of 22 mm stretched knot to knot was used. In cruise no.96, 30 hauls were taken at an area between lat.  $08^{\circ}38'N$  to  $12^{\circ}55'N$  and long.  $73^{\circ}56'E$  to  $76^{\circ}28'E$  (Fig.1 B ). The depth of operation varied from 185 to 450 m .The catch was grouped into deep sea fish, other fish (which include resources like threadfin breams which are presently under commercial exploitation) and crustaceans and cephalopods. Latitudinal and depth-wise distribution and abundance of deep sea finfish resources were assessed after grouping the stations covered in each cruise into 4 depth zones of 101-200 m (Zone I), 201-300 m (Zone II), 301-400

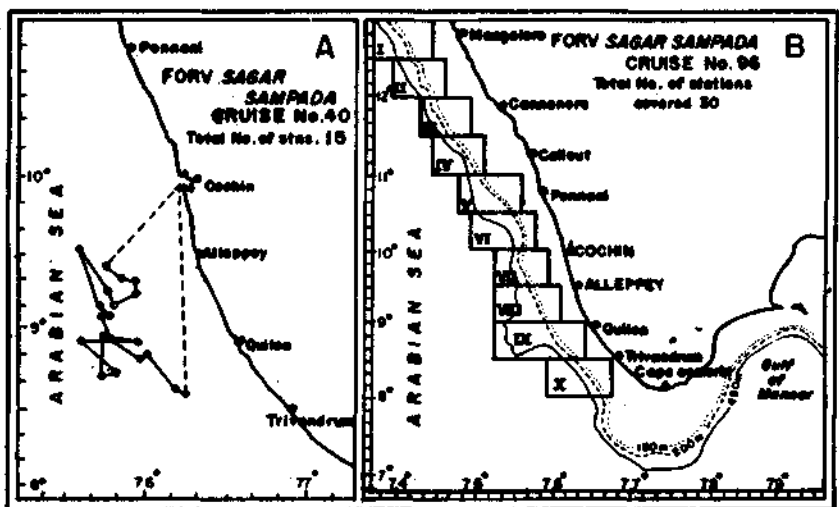

Fig. 1- Map showing the study area: A) cruise no.40, B) cruise no.96

m (Zone-III) and above 401 m to the maximum depth operated (Zone IV). Catch per unit effort was estimated against the total number of hours in each cruise. Samples were collected from each haul for biological investigations on length frequency, length-weight relationship, sex ratio and size at first maturity of important fish resources such as *Chlorophthalmus agassizi*, *Neopinnula orientalis*, *Pseneopsis cyanea*, *Cubiceps natalensis* and *Priacanthus hamrur*. Size frequency and percentage maturity of these species in different depth zones were categorised separately.

Latitudinal and depth-wise biomass of deep sea fish were estimated using "swept area" method (Sparre & Venema, 1992). The average biomass per unit area was estimated using the equation:

$$B = \frac{(Cw/a)*A}{X_1}$$

where Cw = catch in weight of a haul, a = the area swept by the gear during one unit of effort computed from the equation  $a = t * v * h * x_2$ ; where t = time spent for trawling, v = velocity of trawling (3.5 knots), h = average head rope length of HSDT - III and BTR - L (34.6 m),  $X_2$  = the effective net opening which was taken as 0.5 as suggested by Pauly (1983), A = total area swept and  $X_1$  = the portion of biomass actually retained by the gear (taken as 0.5 here).

## RESULTS

Details of trawling and fish catch are shown in Table 1 and haul-wise catch data is shown in Table 2. Among the total catch of 16 tonne obtained from all stations together, deep sea fish were most dominant forming 12.89 tonne (79.86%) followed by other fish - 1.59 tonne (9.8%) and crustaceans and cephalopods - 1.7 tonne (10.3%). During cruise no. 40 the maximum catch of 5.6 tonne of deep sea fish was recorded in haul no. 8 with a catch rate of 7.04 tonne/hr of trawling closely followed by 4.95 tonne of catch recorded in haul no. 10 with a catch rate of 4.95/hr of trawling. The total catch in cruise no. 96 was 26.13 tonne of which deep sea fish accounted 20 tonne (76.55%) followed by other fish - 2.2 tonne (8.4%) and crustaceans and cephalopods 3.9 tonne (14.9%). Maximum catch of 2.97 tonne with the same catch rate was obtained in haul no. 25 closely followed by 2.78 tonne in haul no. 28 with maximum catch rate of 3.6 tonne.

### Depth-wise abundance

The area between lat.8°N to 09°N was most productive with average catch rates of 915 kg/hr of deep sea fish closely followed by lat.09° to 10° N with catch rate of 754 kg/hr. Comparatively the least productive area was between lat. 12° to 13°N with a catch rate of 419 kg/hr. The deep sea fish was available at all depth zones (Table 3) between 08° to 09° N whereas this resource was not found above 400 m depth in lat.10° to 11° N. Between 10° to 13° N the bottom trawling did not yield any deep sea fish beyond 300 m depth. In the southeastern Arabian Sea the most productive depth

Table 1 - Haul-wise catch(C) and catch rate(CR) of deep sea fish, other fish, crustaceans and cephalopods in cruise no.40 (C=kg, CR=kg/hr)

Haul no.	Position		Depth (m)	Deep sea fishes		Other fishes		Cephalopods & crustaceans		Total catch C
	lat. (N)	long. (E)		C	CR	C	CR	C	CR	
1	08°35'	76°15'	235-307	106	159	94	141	270	405	470
2	08°38'	76°11'	273-293	21	55	452	1179	39	102	512
3	08°50'	76°00'	130-156	120	240	350	700	-	-	470
4	08°48'	75°45'	322	225	245	-	-	125	137	350
5	08°56'	75°45'	328-334	4948	4948	-	-	52	52	5000
6	08°42'	75°41'	312-314	89	119	18	24	48	64	155
7	08°43'	75°49'	398-421	29	70	12	29	49	118	90
8	08°55'	75°35'	304-307	5634	7043	336	420	30	37	6000
9	08°55'	75°55'	348-350	1200	2057	23	39	27	46	1250
10	08°55'	75°45'	344-358	71	144	-	-	89	180	160
11	09°04'	75°40'	246-260	25	50	13	26	22	44	60
12	09°04'	75°45'	299	55	97	99	175	146	257	300
13	09°08'	75°40'	341	53	106	7	14	50	100	110
14	09°32'	75°33'	731-777	0.6	2	0.4	1	-	-	1
15	09°12'	75°44'	361-382	83	151	6	11	21	39	110

range for deep sea fish was between 301 - 400 m with an average catch rate of 1478 kg/hr. Between 201 - 300 m moderately good catch of deep sea resource was obtained with a catch rate of 594 kg/hr. The average catch rate declined considerably in the deeper waters beyond 400 m depth with an average of 56 kg/hr.

A total of 34 deep sea finfish species were recorded during both cruises, of which 14 were considered important and their depth-wise abundance is shown in Fig. 2. *Chlorophthalmus agassizi* dominated the catch constituting 36.2% of deep sea fish catch followed by *Cubiceps natalensis* (19.2%), *Pseneopsis cyanea* (7.9%), *Neopinnula orientalis* (3.3%), *Peristedion pothumalava* (4.4%), *Chlorophthalmus bicornis* (3%), *Lampadena luminosa* (0.8%) and *Priacanthus hamrur* (0.7%). The depth-wise distribution of catch revealed that about 75% of important deep sea fish was concentrated between depth zone II and III. Only *Gymnoscopelus* sp. showed maximum abundance beyond 400 m depth. *Chlorophthalmus agassizi*, *Cubiceps natalensis* and *Neopinnula orientalis* were recorded from all depth zones indicating their wide distribution over space and time. *Acropoma* sp. *Priacanthus hamrur*,

Table 2 - Haul-wise catch(C) and catch rate(CR) of deep sea fish, other fish, crustaceans and cephalopods in cruise no.96 (C=kg, CR=kg/hr)

Haul no.	Position		Depth (m)	Deep sea fishes		Other fishes		Cephalopods & crustaceans		Total catch C
	lat. (N)	long. (E)		C	CR	C	CR	C	CR	
1	09°02'	75°56'	185	283	283	29	29	517	517	829
2	08°54'	75°59'	270	53	71	23	31	374	499	450
3	08°53'	75°44'	340	1482	1482	3	3	15	15	1500
4	08°43'	75°54'	450	745	74	-	-	51	51	125
5	09°10'	75°42'	400	28	42	2	3	25	38	55
6	12°36'	74°12'	185	528	704	161	215	511	681	1200
7	12°55'	73°56'	265	740	740	-	-	60	60	800
8	12°17'	74°20'	265	94	94	24	24	182	182	300
9	12°09'	74°21'	235	106	141	1	1.4	13	41	120
10	11°44'	74°35'	190	36	54	4	6	51	77	91
11	11°50'	74°28'	285	115	173	-	-	10	15	125
12	11°35'	74°58'	170	161	161	110	110	48	48	319
13	10°41'	75°22'	175	-	-	-	-	-	-	-
14	10°31'	75°27'	340	3.2	32	-	-	4.3	43	7.5
15	10°35'	75°15'	375	-	-	-	-	-	-	-
16	09°11'	75°51'	260	915	523	1084	619	51	29	2050
17	09°05'	75°35'	235	1063	1276	108	130	129	155	1300
18	09°00'	75°48'	330	1367	1367	82	82	51	51	1500
19	08°58'	75°58'	190	26	26	55	55	19	19	100
20	08°52'	75°58'	320	210	133	-	-	50	32	260
21	09°00'	75°45'	351	40	96	8	19	2	5	50
22	08°52'	75°55'	315	1691	1691	29	29	80	80	1800
23	09°15'	75°53'	225	27	27	69	69	1104	1104	1200
24	08°56'	75°48'	335	2357	2357	-	-	113	113	2500
25	08°41'	75°37'	335	2969	2969	-	-	31	31	3000
26	08°19'	76°28'	245	1145	1145	-	-	55	55	1200
27	08°38'	76°10'	280	98	90	-	-	52	48	150
28	10°56'	75°08'	260	2778	3623	-	-	22	29	2800
29	09°48'	75°36'	195	223	268	344	413	233	280	800
30	09°36'	75°39'	255	1391	959	25	17	84	58	1500



Table 3 - Depth-wise distribution and abundance [C = catch / (kg), CR = catch rate / (kg/hr), DSFB = deep sea fish biomass ( tonnes/nm<sup>2</sup>)]

Latitude range (°N)	Depth range														
	100 - 200 m			201 - 300 m			301 - 400 m			400 and above			Total		
	C	CR	DSFB	C	CR	DSFB	C	CR	DSFB	C	CR	DSFB	C	CR	DSFB
8 - 9	754	197	3.01	4916	466	7.13	22559	1581	24.18	131.6	60	0.92	28360.6	915	14.0
10 - 11	197	118	1.80	2893	2018	30.87	3.2	3.2	0.05	-	-	-	3093.2	754	11.5
12 - 13	528	704	10.77	940	342	5.23	-	-	-	-	-	-	1468	419	6.4
Total	1479	237	3.62	8749	594	9.10	22562.2	1478	22.60	131.6	56	0.90	32922.0	853	13.1

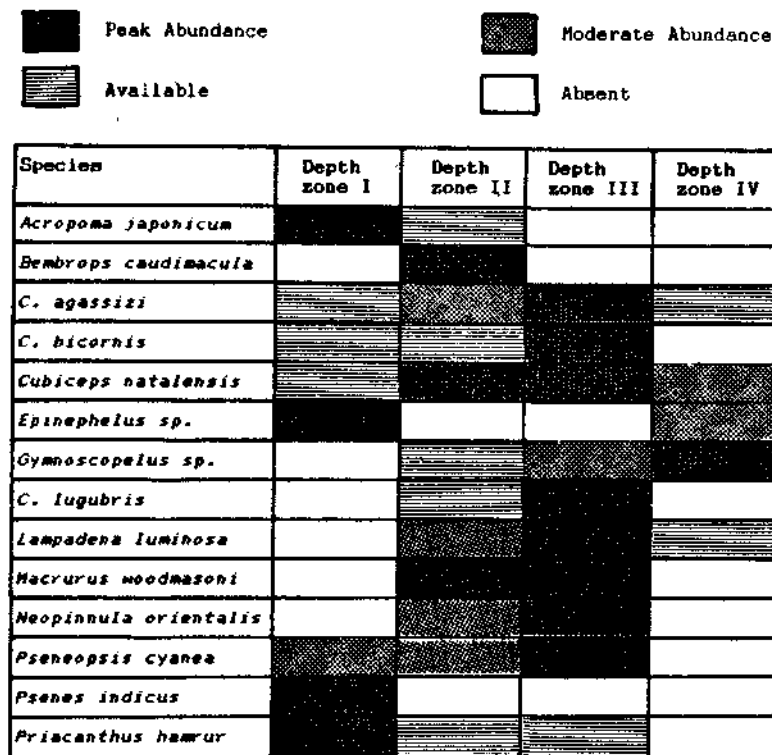

Fig. 2- Depthwise distribution and abundance of deep sea fish in the southeastern Arabian Sea (depth zone I = 100-200 m, depth zone II = 201-300m, depth zone III = 301-400m, depth zone - IV = above 400 m)

*Peristedion pothumalava*, *Psenes indicus* and *Epinephelus sp.* were found in abundance at relatively shallower areas.

A record catch of 13.3 tonne of *Chlorophthalmus agassizi* with catch rate of 1.7 tonne/hr was obtained at depth zone III. The maximum catch of 4.6 tonne of *Cubiceps natalensis* was recorded at 201 to 300 m depth with a catch rate of 0.4 tonne/hr of trawling.

### Biomass

The biomass estimated by 'swept area,' method showed that lat. 08° - 09° was most productive with 14.0 tonne/nm<sup>2</sup> of fish followed by lat. 10° - 11° having 11.5 tonne/nm<sup>2</sup> of deep sea fish. Depth zone III proved to be the most productive area with regard to deep sea fishes in the southeastern Arabian Sea with biomass of 9.1 and 3.6 tonne/nm<sup>2</sup> respectively. The area beyond 400 m depth was least productive with only 0.9 tonne/nm<sup>2</sup>. The average biomass of deep sea fishes in all depth zones was 13.1 tonne/nm<sup>2</sup>. The most productive area for deep sea fishes during this investigation was located between lat. 10°-11° at depths ranging from 201 - 300 m with a record biomass

of 30.87 tonne/nm<sup>2</sup> closely followed by lat. 08°-09° N at a depth ranging from 301-400 m with 24.18 tonne/nm<sup>2</sup>.

### Biology

*Chlorophthalmus agassizi* - Maximum abundance of this species was found in depth zone III (Fig.2). The length range, mean length and mean weight of male and female fishes are furnished in Table 4. Males were dominant in catch. The size at first maturity was estimated as 185 mm for males and females. The length-weight relationship found separately for both the sexes ( Table 5) show that the growth in length and weight of this species is allometric. *C. agassizi* was not represented in depth zone I. The length frequency and percentage of mature fishes in different depth zones are depicted in Fig.3. Fish of comparatively smaller size were abundant in depth zone II and bigger sized fish were more abundant in depth zone IV. In zone III the entire catch of *C. agassizi* consisted of males only.

*Cubiceps natalensis* - This species is highly abundant in depth zones II and III indicating its distribution mainly concentrated between 201 to 400 m depth even-though this species was found in all the depth zones (Fig.2). The length ranged between 115 to 205 mm for males and 145 to 205 mm for females (Table 4). Males outnumbered females in all depths. The percentage of mature fishes and size frequency in different depths are shown in Fig. 4. Among males 34% of the fish were mature. Depth-wise distribution shows that 52%, 21% and 90% of female fish caught from depth zones I, II and IV were mature. Female fish in depth zone IV were mature

Table 4 - Important biological characteristics of dominant deep sea fish

Species		Length range (mm)	Mean length (mm)	Mean weight (gm)	Sex ratio (%)	Size at first maturity (mm)
<i>Chlorophthalmus agassizi</i>	F	110-299	183.1	45.7	31.9	185
	M	100-299	161.9	31.2	68.1	185
<i>Neopinnula orientalis</i>	F	130-269	203.9	63.8	30.4	185
	M	130-299	181.7	37.2	69.6	185
<i>Cubiceps natalensis</i>	F	140-209	162.9	40.6	38.5	165
	M	110-209	155.8	40.6	61.5	165
<i>Pseneopsis cyanea</i>	F	100-189	147.3	39.5	43.6	165
	M	100-189	147.1	39.3	56.4	155
<i>Lampadena luminosa</i>	F	100-189	154.7	43.4	49	145
	M	50-199	145.8	35.1	51	155
<i>Priacanthus hamrur</i>	F	160-339	212.7	130.3	31.5	205
	M	160-269	206.9	113.0	68.5	195

M = Male

F = Female

Table 5 - Length-weight relationships of some important deep sea fish

Species		n	r	a	b
<i>Chlorophthalmus agassizi</i>	F	194	0.76	-3.46817	2.24766
	M	91	0.76	-3.37611	2.19234
<i>Neopinnula orientalis</i>	F	44	0.90	-5.03623	2.94444
	M	78	0.68	-3.44258	2.21046
<i>Pseneopsis cyanea</i>	F	80	0.86	-6.5890	3.76054
	M	108	0.80	-5.74284	3.37546
<i>Cubiceps natalensis</i>	F	94	0.75	-3.58508	2.34119
	M	161	0.50	-1.80714	1.55052
<i>Lampadena luminosa</i>	F	24	0.90	-3.43910	2.31116
	M	21	0.82	-4.89820	2.96750
<i>Priacanthus hamrur</i>	F	47	0.97	-3.99873	2.60965
	M	78	0.61	-3.18588	2.26980

n = No. of observations, r = correlation coefficient

a = Y - axis intercept, b = increment curvature

F = Female, M = Male

and of larger size indicating that the larger sized females concentrate in deeper waters. The size at first maturity estimated from the pooled data was 165 mm for both males and females. Results of length-weight relationship analysis (Table 5) indicate that there is a differential growth pattern in length and weight of females and males, the curvature value (b) being 1.5505 and 2.3411 respectively.

*Pseneopsis cyanea* - This species shows peak abundance in depth zone III and moderate abundance in zones I and II. The length ranged between 100 to 189 mm for males and 110 to 189 mm for females. The size at first maturity was 155 mm and 165 mm for males and females respectively. The important biological informations are furnished in Table 4. Male fish caught from comparatively shallow depths were all immature whereas in depth zones II and III immature fishes constituted 41% and 53% of males caught (Fig. 5). In case of females 34% of fish caught altogether were mature and 43%, 61% and 23% of female fish caught from depth zones I, II and III respectively were mature. Length-weight relationship shows that females are a little heavier than males with curvature values (b) of 3.76 and 3.37 for females and males respectively (Table 5).

*Priacanthus hamrur* - This fish was located in heavy concentrations at depth zone I though they were common in depth zone II and III (Fig. 2). *P. hamrur* was not available beyond 400 m. The percentage of maturity and size frequency are plotted in Fig. 6. The size of males ranged between 160 to 269 mm whereas females were much larger sized with sizes ranging from 160 to 339 mm. The males mature when they attain a length of 195 mm, a little earlier than the females (205 mm). Table 4 provides important biological information on *P. hamrur*. The males were dominant at all depth

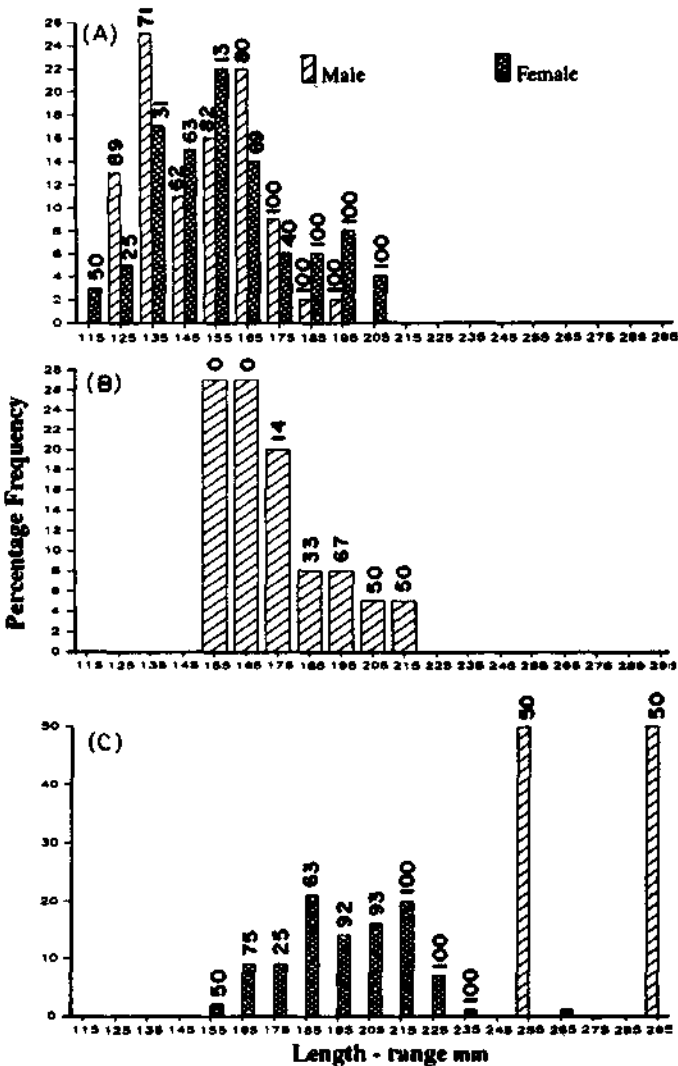

Fig. 3- Length frequency and percentage mature (values) of *Chlorophthalmus agassizi* at depths : A) 201-300 m, B) 301-400 m C) >400 m

zones. In the pooled data 71% of male fish caught were mature. Between 101-200 m, 60% of males were mature whereas at 201-300 m 96% of males were in mature state. Only 25% of females caught from the depth zone I were mature while higher concentration of mature female fish (96%) were captured from depth zone II. The length-weight relationship shows allometric growth with curvature value (b) of 2.3 and 2.6 for males and females respectively (Table 5).

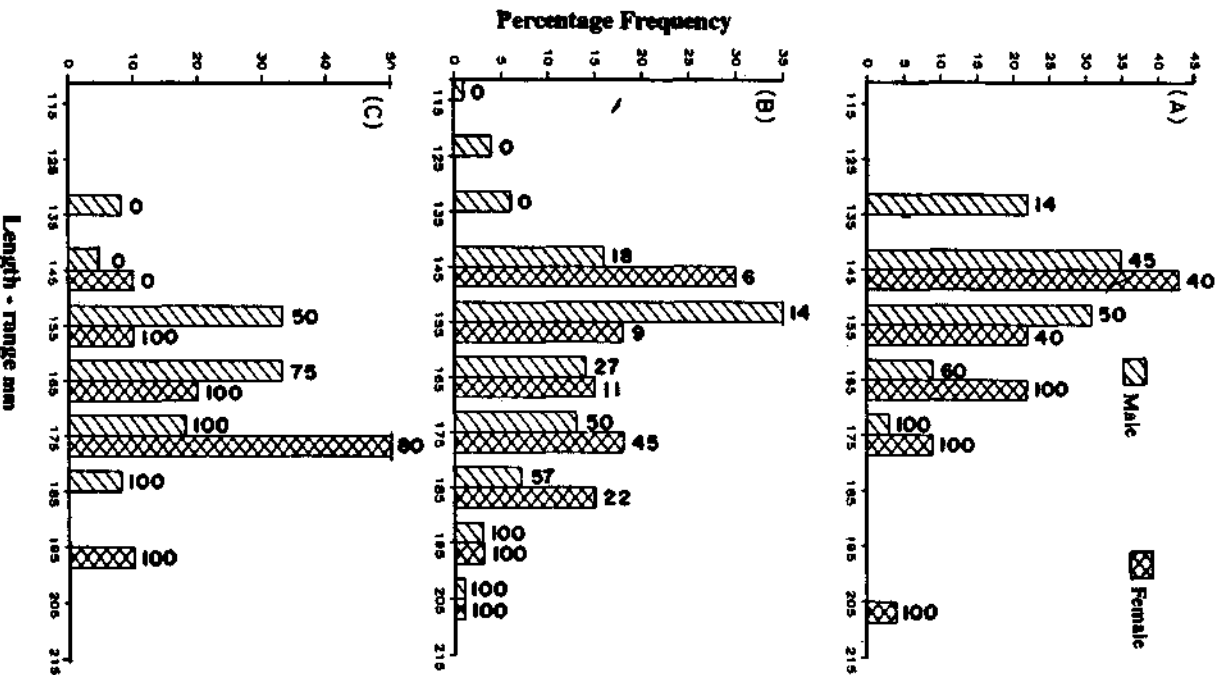

Fig. 4- Length frequency and percentage mature (values) of *Cubiceps natalensis* at depths: A) 100-200 m, B) 201 - 300m, C) > 400 m

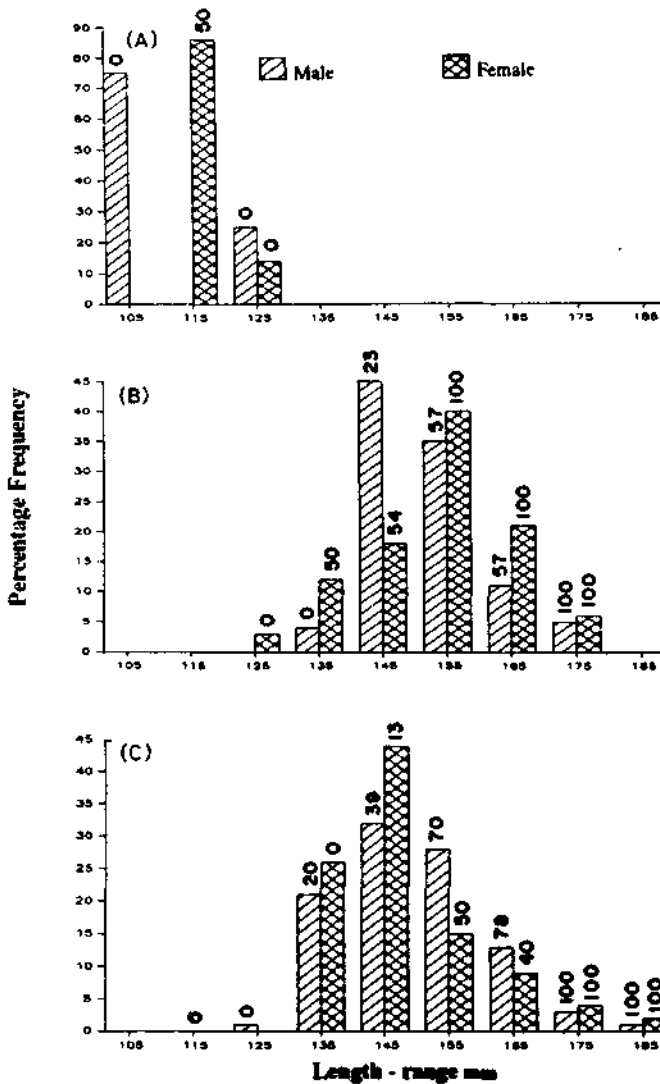

Fig. 5- Length frequency and percentage mature (values) of *Pseneopsis cyanea* at depths: A) 100-200 m, B) 201 - 300m, C) 301-400 m

*Neopinnula orientalis* - This species commonly known as 'sack fish' is highly abundant in depth zone III. The length range varied from 130 to 229 mm for males and 130 to 269 mm for females (Table 4). Males outnumbered females in total catch. 'Sack fish' is confined to depth zones II and III with maximum concentrations at latter depth. Larger sizes of mature females were caught from depth zone III. About 50% of the female fish occurring in depth zones I and II were in mature condition whereas majority (90%) were mature in depth zone III (Fig.7). About 50% of males caught

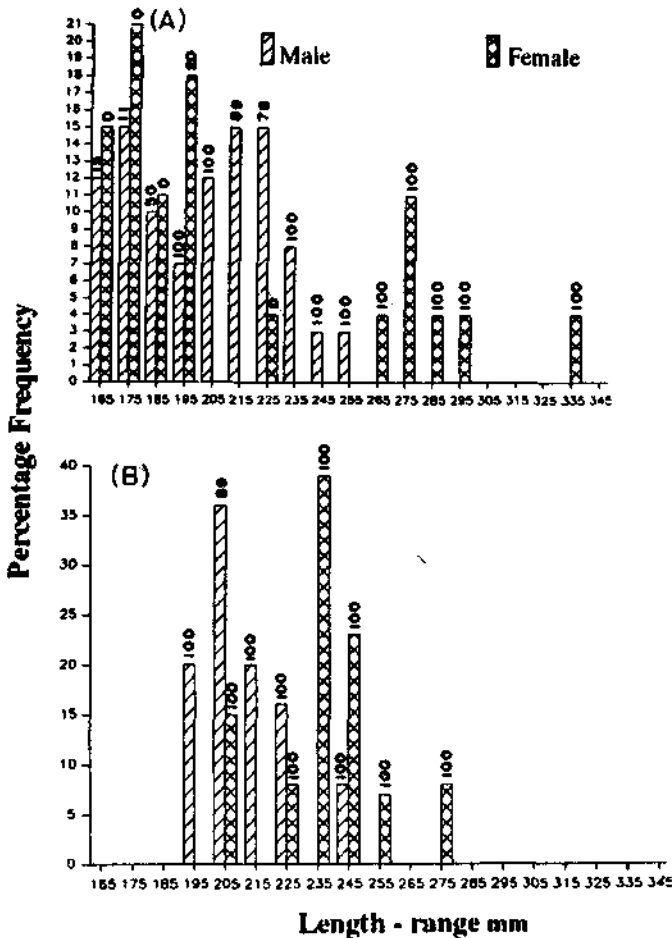

Fig. 6- Length frequency and percentage mature (values) of *Priacanthus hamrur* at depths: A)100-200 m, B) 201 - 300 m

from zone II and III were in mature condition. Both sexes attained maturity at 185 mm length. The length-weight relationship analysis showed an isometric growth for females with curvature value (b) of 2.9 (Table 5).

### DISCUSSION

Present study indicates the presence of significant concentrations of exploitable deep sea fish biomass in southeastern Arabian Sea. Studies by Prasad & Nair (1973) have shown high abundance of deep sea species like *Chlorophthalmus agassizi*, *Neopinnula orientalis*, *Pseneopsis cyanea*, *Cubiceps natalensis* etc in the upper continental slope (180-450 m depth zone) of Indian EEZ. According to Sivaprakasam (1986) *Chlorophthalmus agassizi* is available in plenty in the deeper waters between



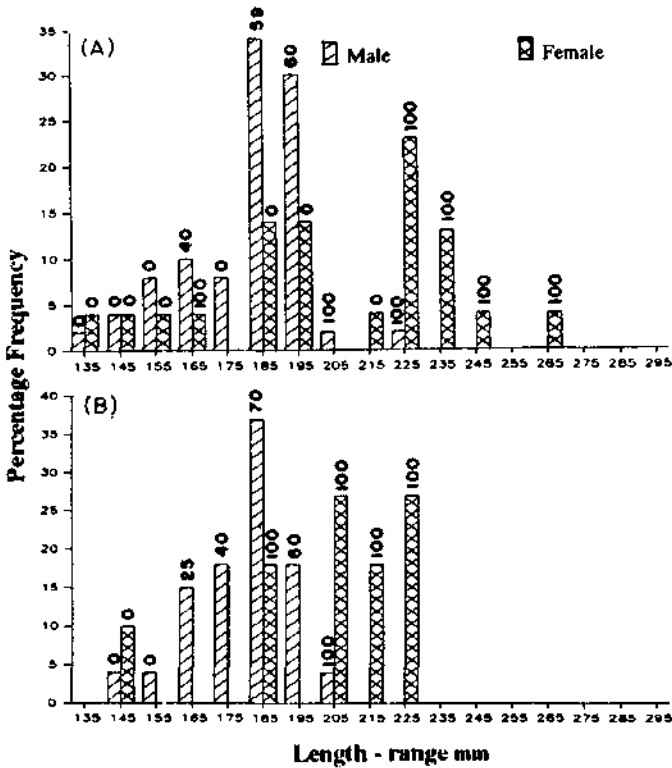

Fig.7- Length frequency and percentage mature (values) of *Neopinnula orientalis* at depths: A) 201-300 m, B) 301 - 400 m

200 to 600 m depth. Bande *et al.* (1990) have reported that *Priacanthus* spp forms a potential deep water resource at lat.07°-15° but beyond 200 m depth the availability decreases. According to Sivakami (1990) the neritic waters in the depth range of 151-398 m have promising potential for deep sea fishes like *Pseneopsis* spp, *Chlorophthalmus* spp, *Priacanthus* spp, *Cubiceps* spp and *Trichiurus auriga*. These fishes formed 43% of the total fish caught from this area. In the present study deep sea fish formed as high as 73% of the total catch.

Studies of Sudarshan *et al.* (1988) have shown that the most productive depth belt in southwest coast for demersal fish is 150-200 m depth with catch rate of 9.36 tonne/nm<sup>2</sup>. In the present study comparable biomass was obtained in 101-200 m depth at lat. 12°-13° N. However, maximum biomass of 22.6 tonne/nm<sup>2</sup> was obtained in 301-400 m depth zone. It is significant to note that an average catch rate of 815 kg/hr was recorded in the present study for deep sea fish alone which is very high compared to the catch rate obtained in the exploratory surveys (FSI, 1991). The present investigation shows that deep sea finfish resources are concentrated in comparatively

shallower depths in the northern latitudes whereas wider distribution is seen in the southern latitudes.

Though there are studies on the distribution and abundance of deep sea fishes, investigations on the biology of deep sea fishes are scanty. An analysis of biological data of dominant species mainly *Chlorophthalmus agassizi*, *Neopinnula orientalis*, *Cubiceps natalensis*, *Pseneopsis cyanea* and *Priacanthus hamrur* have provided new information on length-weight relationship, sex ratio, size at first maturity etc of the above species. High concentrations of mature and spawning females of *C. agassizi* at 301 to 400 m depth indicates that this zone may be the spawning grounds for this species. In the case of *Neopinnula orientalis* a clear distinction in the sex ratio in larger groups with mature females dominating in length above 200 mm was observed. It appears that *N. orientalis* spawns beyond 400 m depth as 90% among the females caught from this zone consisted of spawning females. Mature females of *Priacanthus hamrur* dominated above 200 m. Comparison of the length frequency of fishes available at 101 to 200 m depth and 201 to 300 m depths shows that larger sized fishes are available in the latter depths and the fish caught were fully mature indicating that this species may possibly spawn in deeper waters. In the case of *Cubiceps natalensis* the occurrence of mature females in abundance at depth zone III shows that spawners are concentrated in this zone.

Studies of Philip *et al.* (1984) reveals that deep sea fishes are comparable in nutritive values to the commonly available food fishes. The proximate composition indicated that all these species are protein rich, the value ranging from 14.4 to 17.5%. The experiments conducted (CIFT, 1990) have indicated that deep sea finfish resources could be utilised for a variety of fishery products. Therefore exploitation of more or less virgin deep sea finfish resources on larger scale from the Exclusive Economic Zone can significantly change the scenario of Indian fishery sector.

### ACKNOWLEDGEMENT

Authors are grateful to Dr.P.S.B.R. James, former Director and to Dr.P. Bensam, Head, Demersal Fisheries Division for their keen interest and encouragement. Thanks are also due to Dr.V. Narayana Pillai, Dr.K. Sunil Mohamed and Mr.M. Kathirvel for their valuable help and suggestions for improvement. Authors are also thankful to Mr.A. Nandakumar and Mr.H.S. Mahadevaswamy for rendering technical assistance.

### REFERENCES

- Bande, V. N., Menon, N. G & Balachandran, K. 1990. Studies on the distribution and abundance of bull's eye (*Priacanthus* spp) in the EEZ of India, In: *Proc. First Workshop Scient. Resul. FORV Sagar Sampada*, edited by K. J. Mathew, (CMFRI, Cochin) 233-238.
- CIFT. 1990. Studies on processing of deep sea fish caught onboard *FORV Sagar Sampada*, In: *Proc. First Workshop Scient. Resul. FORV Sagar Sampada*, edited by K. J. Mathew, (CMFRI, Cochin) 457-465.
- FSI. 1991. Annual Report 1990-'91, (Fishery Survey of India, Bombay) pp. 51.

- Gopalakrishnan, K., Varghese, B. C., Ali, D. M. & Pandian, P. 1988. Deep sea finfish resources of Indian Exclusive Economic Zone (beyond 150 m depth). In: *Proc. Nat. Workshop Fish. Resour. Data Fish. Indust*(Oct. 1988).
- Gravely, F. M. 1992. Report on a systematic survey of deep-sea fishing grounds by S.T."Lady Goshen" for 1927-'28, *Bull. Madras Fish. Dept.* 23 (1) : 153 - 187.
- James, P. S. B. R & Pillai, V. N. 1990. Fishable concentration of fishes and crustaceans in the offshore and deep sea areas of Indian Exclusive Economic Zone based on observations made onboard *FORV Sagar Sampada*, In: *Proc. First Workshop Scient. Resul. FORV Sagar Sampada*, edited by K. J. Mathew, (CMFRI, Cochin) 201-213.
- Joseph, K. M., Radhakrishnan, N. & Philip, K. P. 1976. Results of demersal fisheries survey along the east coast of India, *Bull. Expl. Fish. Proj. Vol.* 5: pp. 53.
- Joseph, K. M. 1986. Some observations on the potential marine fishery resources from the EEZ, *Bull. Fish. Surv. India*, 14: 1- 20.
- Nair, K. N. V. & Joseph, K. M. 1984. Important observations on deep sea resources made during 1983-'84, *Bull. Fish. Surv. India*, 13: pp 1-11.
- Pauly, D. 1983. Some simple methods for assessment for tropical fish stock, *FAO Fish. Tech. Pap.* 234: pp.52.
- Philip, K. M., Premchand, B, Auhad, G. K & Joseph, P. J. 1984. Note on the deep sea demersal resources of Karnataka-north Kerala coast, *Bull. Fish. Surv. India*, 14: pp 84.
- Prasad, R. R. & Nair, P. V. R. 1973. India and Indian Ocean Fisheries, *J. Mar. Biol. Ass. India.* 15 (1): 1-19.
- Silas, E. G. 1969. Exploratory fishing by *R V Varuna*, *CMFRI Bull.* 12: pp 86.
- Sivakami, S. 1990. Observations on the demersal fishery resources of the coastal and deep sea areas of the Exclusive Economic Zone. In: *Proc. First Workshop Scient. Resul. FORV Sagar Sampada*, edited by K. J. Mathew, (CMFRI, Cochin) 215-231.
- Sivaprakasam, T. E. 1986. In: *Occasional papers of FSI No.4 (Fishery Survey of India, Bombay)* p.13.
- Sparre, P. & Venema, S.C. 1992. *Introduction to tropical fish stock assessment*, *FAO Tech. Pap.* 306/1: pp. 655.
- Sudarshan, D., Sivaprakasam, T. E., Somavanshi, V. S., John, M. E., Nair, K. N. V. & Joseph, A. 1988. An appraisal of the marine fishery resources of Indian Exclusive Economic Zone, *Bull. Fish. Surv. India*, 18: pp. 81.

\* \* \*

## Distribution and abundance of carangids along the EEZ India

S. Sivakami, P.N. Radhakrishnan Nair, A.A.Jayaprakash, Mohammed Kasim, T.M. Yohannan, M. Sivadas, K.P. Said Koya & P.K. Seetha  
Central Marine Fisheries Research Institute, P.B.No. 1603,  
Cochin-682 014

### ABSTRACT

Distribution and abundance of carangid groups of fish along the EEZ of India based on the data collected during 80 cruises undertaken by *FORV Sagar Sampada* is presented here. East coast of India showed maximum concentration of carangids with a catch rate of 64 kg/hr along the northeast coast. The least distribution was noticed along the northwest coast ( 5 kg/hr). Carangids formed up to a maximum of 19 % of the total bottom trawl catch along the northwest coast. With more than 20 species of carangids reported to be caught in various cruises, *Decapterus* spp formed the most dominant group, followed by species like *Atule mate*, *Selar crumenophthalmus*, *Carangoides malabaricus* etc. Depthwise distribution showed higher density in the 60-80 m range all along the coast excepting the Andaman-Nicobar archipelago. Areawise, higher densities of carangids were noticed at latitude-longitude 7°N - 77°E, 11°N - 75°E, 11°N - 79°E, 14°N - 80°E, 18°N - 72°E, 19°N -85°E and 19°N -86°E. Seasonally, carangids were represented in the catch more during the monsoon especially along the northeast and southwest coasts. Potential yield of carangids along the EEZ of India is estimated to be 94971 tonne.

### INTRODUCTION

The marine fishery potential of the EEZ of India has been estimated to be 4.5 x 10 tonne, of which only 1.6 x 10 tonne is currently exploited mainly from the coastal waters up to 50 m depth (James *et al.* 1989). In order to obtain the target production, it is essential that the distribution and abundance of various underexploited resources from both inshore and offshore areas are properly understood. The carangid groups of fishes with a contribution of 2 to 4% of the total marine landings in India, is one such resource whose distribution pattern beyond 50 m depth range is totally obscure except for some fractional information available on their distribution in certain sectors of the EEZ of India (Kuthalingam, *et al.* 1973; Rao *et al.* 1977; Sekharan *et al.* 1973; Bapat

et al. 1982; Reuben et al. 1989; Sudarsan et al. 1991; Sudarsan, 1993). An evaluation of the distribution pattern of the carangid fishery resource is therefore found imperative for the proper and timely exploitation of this smaller pelagic group of fishes. The present work deals with the distribution and abundance of various carangid fishes in time and space along the EEZ of India.

## MATERIALS AND METHODS

Reports on the bottom trawl operations in about 80 cruises undertaken by *FORV Sagar Sampada* during 1985-90 were taken as the basis for the study. The EEZ of India is categorised into 5 zones namely the southwest ( $7^{\circ}$ - $15^{\circ}$  N,  $71^{\circ}$  20' -  $77^{\circ}$  30' E); northwest ( $15^{\circ}$ - $23^{\circ}$  30' N,  $67^{\circ}$  06' -  $74^{\circ}$  30' E); southeast ( $7^{\circ}$  06' -  $15^{\circ}$  N,  $77^{\circ}$  30' -  $80^{\circ}$  40' E); northeast ( $15^{\circ}$ - $20^{\circ}$  50' N,  $80^{\circ}$  20' -  $88^{\circ}$  E) and Andaman- Nicobar area ( $06^{\circ}$ - $14^{\circ}$  N,  $92^{\circ}$ - $94^{\circ}$  E). High speed demersal trawl (HSDT) and Granten Bobbin trawl were the gears used in the present study.

Catch particulars of carangids along with the total fish catch in each station were examined and the cruises operated in different months of the years under study were grouped together and average catch and catch rates reckoned in obtaining the seasonal pattern of distribution. With a view to examine the bathymetric distribution, stations operated at different depths were assorted into depth ranges of 0-20 m, 20-40 m, 40-60 m, 60- 80 m, 80 - 100 m, 100 - 150 m and above 150 m in different zones examined. Catch rate was worked out based on the total number of hours of fishing operations. Standing stock was estimated by the swept area method (Gulland, 1965). The values of standing stock thus obtained for each  $10' \times 10'$  square grid surveyed in each  $1^{\circ} \times 1^{\circ}$  grid area have been added up. The total value of standing stock for each zone was obtained by adding the values calculated for different  $1^{\circ} \times 1^{\circ}$  grid area trawled during the period of study. Potential yield is reckoned as 60% of the standing stock.

## RESULTS

### Exploitation

Particulars regarding the exploitation of carangids from different zones of the EEZ of India during 1985-90 are given in Table 1. Northeast coast indicated the maximum concentration of carangids with a total catch of 9162 kg. With a catch rate of 64.831 kg/hr, the group formed 19.12 % of the zone's total fish catch. Along the southeast coast, the total carangid catch of 3212 kg (45.563 kg/hr) contributed to 8.56 % of the total trawl catch. Southwest coast, despite a maximum effort input of 221/30 hrs/min brought a total carangid catch of only 4751.2 kg ( 21.450 kg/hr) constituting 2.85 % of total bottom trawl catch while northwest coast of India indicated the least concentration of carangids (310.6 kg; 5.13 kg/hr). Between the two coasts, east coast had denser population of carangids (58 kg/hr; 14.48%) against that of the west coast (18

Table 1 - Catch particulars of carangids from different regions along the EEZ of India

Region	No. of cruises	No. of Stn	Total carangid catch(kg)	Catch rate (kg/hr)	Regions total catch(kg)	Carangids in tot. catch (%)
Southwest	28	238	4751	21	166885	2.85
Northwest	13	61	310	5	26017	1.19
West coast tot.	41	299	50618	17	192902	2.62
Southeast	15	58	3212	45	37499	8.56
Northeast	13	105	9162	64	47921	19.12
East coast tot.	28	163	12374	58	85420	14.48
Andaman & Nicobar	11	45	1139	30	6139	18.56

kg/hr; 2.62%). Andaman & Nicobar archipelago also indicated good concentration with a catch rate of 1139.56 kg/hr (18.56%).

## Distribution

*Seasonal* - Catch rate of carangids caught during different months of the year along the zones under study is presented in Table 2. It may be noticed that along the southwest coast, good concentration of carangids coincided with the southwest monsoon months (May to August), with the maximum catch rate of 133 kg/hr obtained during August. While northwest coast did not indicate any seasonal pattern of distribution, east coast as a whole indicated good catches of carangids during the northeast monsoon months (October-January). Catch rates as high as 66 kg/hr and 80 kg/hr were obtained during March and January respectively along the southeast coast. However during August, a higher catch rate of 99 kg/hr was recorded along the southeast coast. This may probably be due to their migration for breeding purpose, for medium to high concentration of carangids are reported from the southern shelf including the Wadge Bank area during July/August period onwards (Rao *et al.* 1977). Along the northeast coast, a catch rate of 945 kg/hr and 142 kg/hr were recorded during February and November respectively. Along Andaman-Nicobar area also, good catches of carangids were noticed during the northeast monsoon season, with a maximum catch rate of 117 kg/hr obtained during November.

*Depthwise* - Particulars regarding the catch rate of carangids in different depth ranges in various zones is depicted in Fig. 1. It is noticeable that, depth range of 60-80 m indicated denser population of carangids all along the EEZ of India except along the Andaman-Nicobar area, where denser concentrations were noticed in the 80-100 m depth range. In the 60 - 80 m depth range, the maximum catch rate of 364 kg/hr was recorded from the northeast coast. Depth range of 40-60 m showed the next abundant

Table 2 - Seasonal variation of carangids(kg/hr) along the EEZ of India during 1985-90

Month	Monsoon seasons	Catch rate (kg/hr)				
		S.west	N.west	S.east	N.east	And. & Nic.
Jan.	N.east	13.00	N.op	80.00	16.80	5.10
Feb.		4.30	0.60	11.90	945.10	2.10
Mar.		20.50	N.ca.	66.10	2.90	N.op.
Apr.		14.40	N.op.	N.ca.	N.ca.	3.70
May		50.00	N.op.	N.op.	N.op.	69.50
June		69.60	N.ca.	5.90	N.op.	N.op.
July	S.west	25.60	2.50	9.30	N.op.	N.op.
Aug.		133.20	N.ca.	99.50	N.op.	N.op.
Sept.		N. ca.	1.50	N.ca.	13.80	29.00
Oct.		N.ca.	14.30	N.op.	90.40	22.40
Nov.	N. east	10.40	2.0	N.op.	142.40	117.30
Dec.		8.50	14.60	9.60	N.op.	3.00

N.ca. = No catch, N.op.= No operation

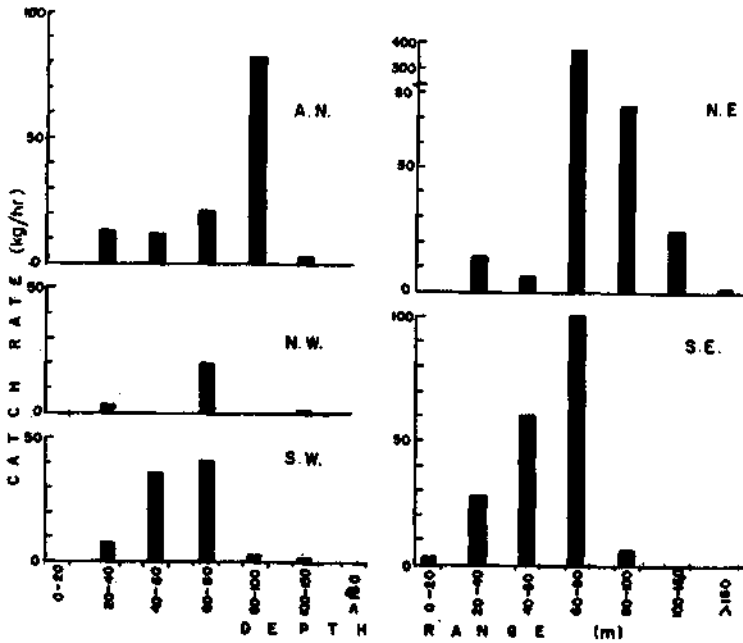

Fig. 1 - Catch rate (kg/hr) of carangids in different depth ranges in the various zones of the EEZ of India

distribution particularly along the southwest coast (36 kg/hr), southeast coast ( 59 kg/hr) and Andaman-Nicobar area (11 kg/hr). Concentration of carangids in the shallow waters of 20-40 m depth range was more only along the east coast including the Andaman-Nicobar area. It is interesting to note that depth range of 100 - 150 m showed distribution of carangids mainly along the northeast coast with a catch rate of 24 kg/hr. Along the Andaman-Nicobar area, 80-100 m depth range had the maximum concentration of 82.88 kg/hr of carangids.

### Productive areas

Average catch rate (kg/hr) in each square grid /sub area was compared in determining the productive areas for carangids along the EEZ of India (Fig.2, Table 3). Orissa coast (19°-85°/2B: above 2000 kg/hr, 19-86°/5D : 1000 - 2000 kg/hr, 19 - 85°/3D: 200-500 kg/hr) indicated having denser population of carangids along the northeast coast. Southeast coast, though with lesser number of stations, had the Wadge Bank area ( 7°- 77°/5D and 11° - 79°/1A : 500-1000 kg/hr) ( 7°- 78°/6A , 11°- 79°/1D, 14°- 80°/2B: 200-500 kg/hr) and (7°- 77°/4°E, 8°- 76° / 1°E and 14°-80°/4B, and 1C : 100-200 kg/hr) as productive areas for carangids. In the southwest coast, Wadge Bank (7°-77°/5B : 500 - 1000 kg/hr) Cannannore (11°-75°/3B : 200-500 kg/hr), Trivandrum ( 8°- 76° /5C) and Mangalore ( 13°- 74°/3B), and (14°-73°/2F ; 100-200 kg/hr) were found productive for carangids. Northwest coast indicated sparse distribution with a concentration of 100-200 kg/hr along Bombay coast (18°-72°/6A). Along Andaman- Nicobar archipelago, sub area 11°- 92°/5E ( 200-500 kg/hr) was found productive for carangids.

### Species composition

*Zonewise*- Percentage composition of different species of carangids along with the total carangid catch in different zones is presented in Table 4. It may be noticed that scads represented by *Decapterus russelli*, *Decapterus kurroides*, *D. macrosoma*, *D. lajang*, *D. macerullus* and *Decapterus* spp formed the most dominant group in all the sectors except along the northwest coast, where *Caranx* spp was the common group encountered. Scads enjoying a wider distribution all along the coast, constituted up to 90% and 88% of the total carangid catch from the northeast and southwest coasts respectively. Along Andaman-Nicobar area, *Decapterus kurroides* formed 46% of the total carangid catch. Other species of carangids represented were *Seriolina nigrofasciata* ( 2.21 %) along the southwest coast, *Selar mate* ( 17.92 %), *Carangoides malabaricus* ( 4.08 % ) and *Caranx* spp. along the southeast coast, *Selar crumenophthalmus* ( 2.44 % ) along the northeast coast, *Carangoides chrysophrys* ( 14.65 % ), *Megalaspis cordyla* ( 2.98 % ) and *S. crumenophthalmus* ( 11.41 % ) along the Andaman-Nicobar area.

*Areawise* - Catch rate of different species of carangids caught from different areas in various zones is presented in (Fig. 3). It is discernible that, of the scads, *Decapterus*



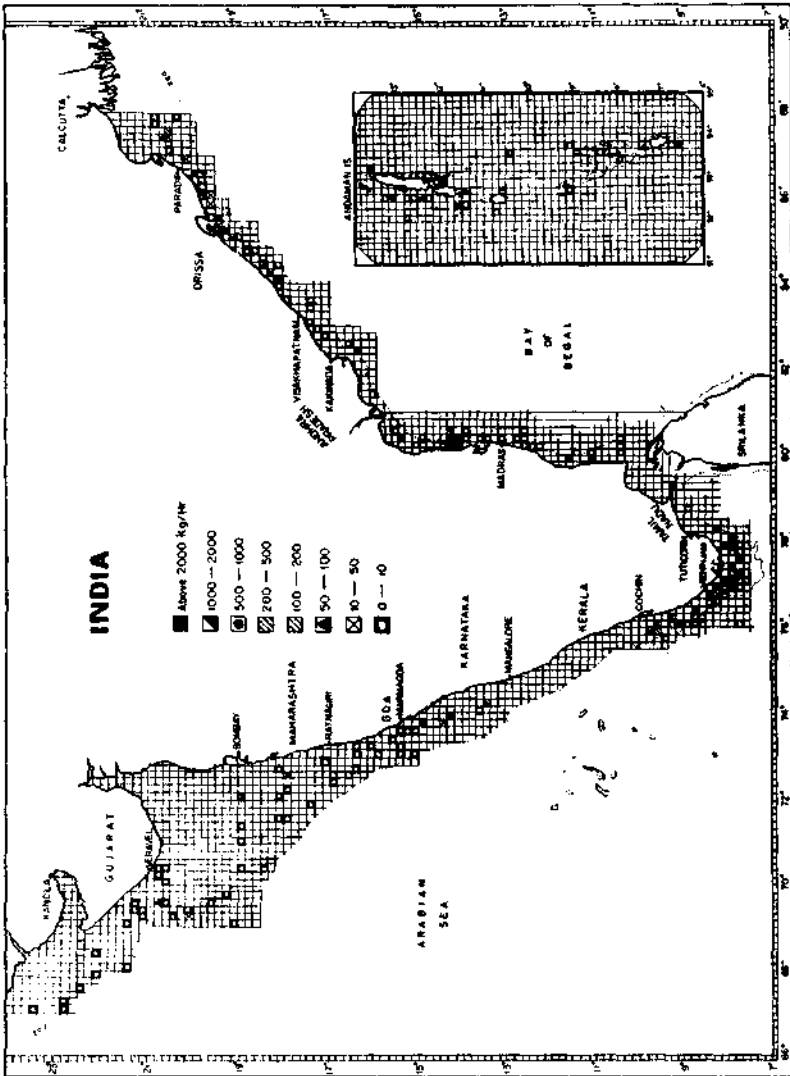

Fig. 2 - Productive areas for carangids along the EEZ of India

Table 3 - Major productive areas for carangid fishes along the EEZ of India as observed by *FORV Sagar Sampada* cruises during 1985-90

Sl.no.	Areas	Catch rate (kg/hr)	Sl.no.	Areas	Catch rate (kg/hr)
<i>1. Northeast</i>			3.	11 42 N - 92 25 E	50
1.	18 01 N - 84 07 E	79	4.	12 23 N - 92 34 E	120
2.	18 29 N - 84 23 E	200	<i>4. Southwest</i>		
3.	19 50 N - 86 31 E	1496	1.	07 56 N - 76 55 E	40
4.	19 26 N - 85 32 E	500	2.	07 48.5 N - 77 13.2 E	1340
5.	19 19 N - 85 15 E	5250	3.	07 43 N - 77 18 E	130
6.	20 30 N - 87 36 E	277	4.	08 10 N - 76 55 E	75
7.	20 31 N - 87 22 E	94	5.	08 21.4 N - 76 45.8 E	140
<i>2. Southeast</i>			6.	08 42 N - 76 27 E	120
1.	07 48 N - 77 34 E	540	7.	09 42 N - 75 53 E	140
2.	07 32 N - 77 44 E	75	8.	09 30 N - 75 53 E	195
3.	07 53 N - 78 08 E	300	9.	10 58 N - 75 31 E	131
4.	08 15 N - 78 18.6 E	200	10.	11 00 N - 75 22 E	336
5.	08 01 N - 77 58 E	145	11.	11 43 N - 74 59 E	175
6.	08 21.4 N - 76 45.8 E	140	12.	11 30 N - 75 16 E	840
7.	08 10 N - 76 55 E	75	13.	11 22 N - 75 17 E	16
8.	11 00 N - 79 00 E	1000	14.	13 30 N - 74 16 E	170
9.	11 08 N - 79 52 E	250	15.	14 12 N - 73 56 E	190
10.	14 05 N - 80 23 E	150	<i>5. Northwest</i>		
11.	14 13 N - 80 12 E	381	1.	18 58 N - 72 00 E	175
<i>3. Andaman-Nicobar</i>			2.	20 00 N - 70 56 E	25
1.	11 51 N - 92 53 E	55	3.	21 00 N - 69 20 E	30
2.	11 44 N - 92 49 E	528			

*russelli* was caught mainly from 7° N-77°E and 7°N - 78° E ( Wadge Bank ) areas along the southeast coast with a catch rate of 55 kg/hr and 600 kg/hr respectively. Along the northeast coast, *D.russelli* was obtained from 19° N - 85° E (Orissa ) area, the catch rate amounting to 227 kg/hr. *D. macrosoma* was the major component in 7° N - 77° E area ( 101 kg/hr ) along the southwest coast. *D.lajang* formed the dominant species in 11° N-79° E (250 kg/hr) area of the southeast coast. Along Andaman-

Table 4 - Species composition (%) of major species of carangids caught from different zones of the EEZ of India

Species/groups	S.west	N.west	S.east	N.east	Andm.& Nic.
<i>D.russelli</i>	17.69	0	31.6	72.86	8.81
<i>D.macerullus</i>	0	0	0	0	3.07
<i>D.kurroides</i>	0	0	0	0	46.5
<i>D.macrosoma</i>	28.44	0	0.62	0	0
<i>D.lajang</i>	0	0	31.44	0	0
<i>Decapterus</i> spp	42.13	2.96	1.1	16.35	2.5
<i>M.cordyla</i>	0.65	0	0.75	3.37	2.98
<i>Alepes djedaba</i>	0.18	0	0	0	0
<i>Alepes kalla</i>	0	0	0	0.03	0.35
<i>Atule mate</i>	0	0	17.92	0.03	0
<i>C.chrysofrys</i>	0	0	0	0.04	14.65
<i>C.malabaricus</i>	0.61	0	4.08	2.6	1.4
<i>C.armatus</i>	0	0	0	0	0.88
<i>C.oblongus</i>	0	0	0	0	0.43
<i>C.ferdau</i>	0	0	0.66	0	0.08
<i>Carangoides</i> spp	0	0	0.47	0	0
<i>Caranx ignobilis</i>	0.26	0	0	0.34	0
<i>Caranx tille</i>	0	0	0	0	0.61
<i>Caranx</i> spp	2.1	87.3	7.55	3.09	5.39
<i>S.crumenophthalmus</i>	0.42	0	0.62	2.44	11.41
<i>Selar</i> sp.	0	0	2.26	0	0
<i>S*.nigrofasciata</i>	2.21	0	0.62	0	0
Other carangids	5.24	9.45	0.25	0.84	0.08
Total carangid catch (kg)	4751.2	310.6	3212.24	9162.7	1139.56
Catch rate [kg/hr]	21.45	5.13	45.563	64.831	30.147
<i>C</i> = <i>Carangoides</i>		<i>D</i> = <i>Decapterus</i>			
<i>S</i> = <i>Selar</i>		<i>M</i> = <i>Megalaspis</i>			
<i>S*</i> = <i>Seriolina</i>					

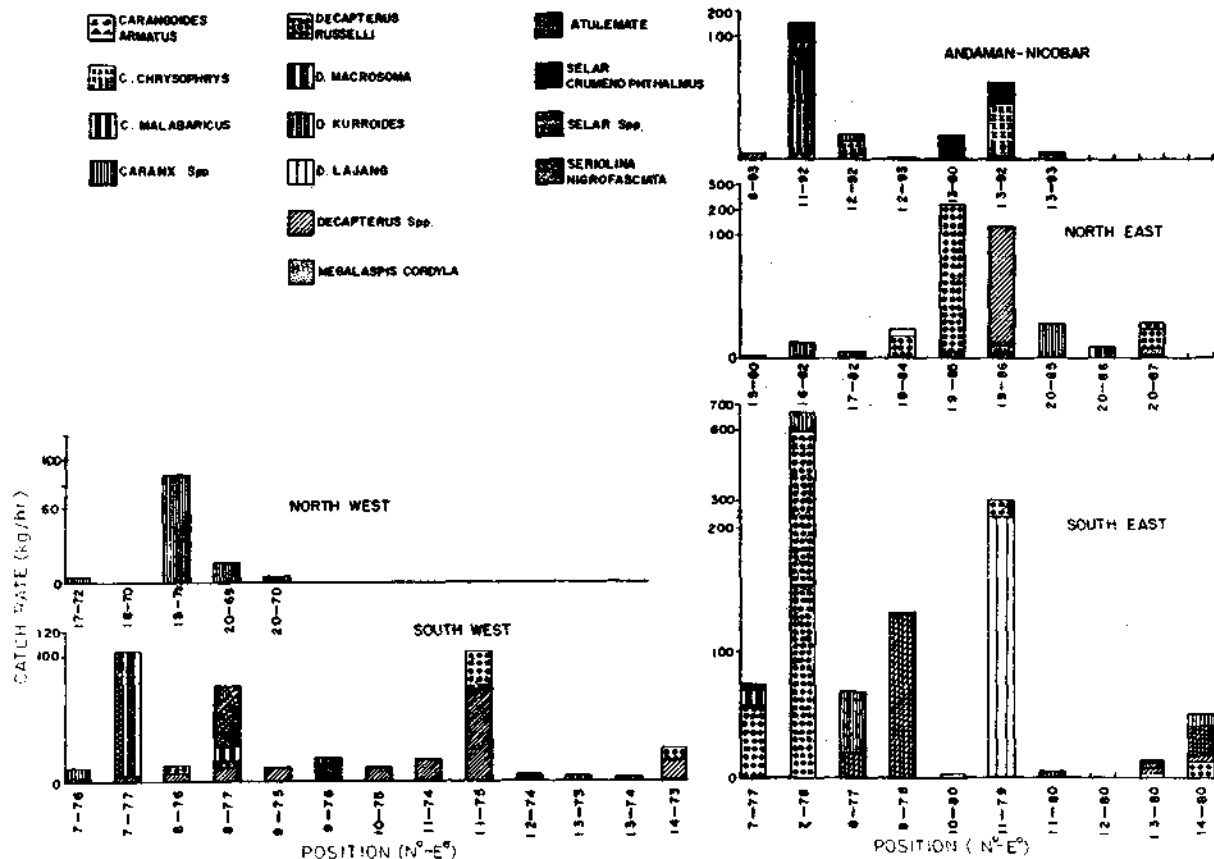

Fig. 3 - Species composition of carangids from different areas in various zones along the EEZ of India

Nicobar area *D. kurroides* formed denser concentration in the 11°- 92° area, with a catch rate of 86.67 kg/hr. Besides scads, species such as *C. chrysephrys* also formed an important component in the 13° N - 92° E area ( 41.75 kg/hr ) in the archipelago, while along the northwest coast, *Caranx* spp. was caught from 18° N - 72° E area with a catch rate of 87.5 kg/hr.

### Diurnal variation in the abundance of Scads

Catch rate of *Decapterus* spp caught from different stations of various zones is correlated with the time of trawling. The details are given in Fig. 4. It is evident that *Decapterus* spp were caught mainly during the daytime between 0600 - 1900 hrs in the evening with the maximum catch ( 5250 kg/hr ) obtained during 1420 hrs. It may be noticed that no catch of scads was observed during night hours.

### Potential yield

Particulars regarding the estimated potential yield of carangids in different depth ranges up to 150 m in various zones are given in Table 5. It may be noticed that carangids have a potential yield of 94970 tonne along the EEZ of India in a total survey area of 105640 km<sup>2</sup>. Among the various zones examined, northeast coast indicated a maximum of 47095 tonne followed by southeast coast with a potential yield of 27248 tonne. The least concentration of carangids was noticeable along the northwest coast with a potential yield of 1266 tonne. However, the density of carangids per km<sup>2</sup> indicated maximum concentration of 1.760 tonne along the northeast coast, 0.786 tonne in the southeast coast and 0.588 tonne in the southwest coast, with the least distribution of 0.186 tonne along the northwest coast. Along the Andaman-Nicobar

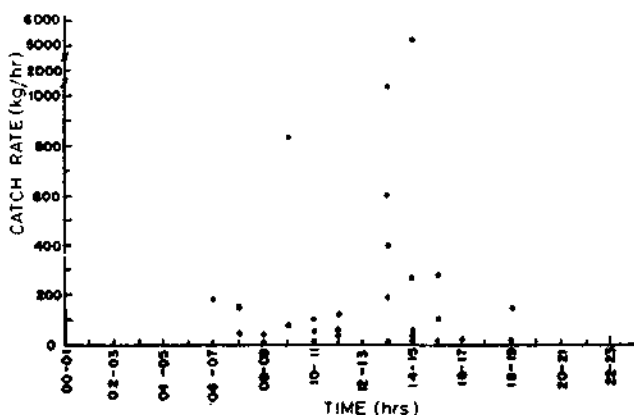

Fig. 4 - Diurnal variations in the abundance of scads caught from the EEZ of India [Multiple bars indicate different catch rates]

Table 5- Potential yield (tonne) of carangids from different depth ranges of various zones of the EEZ of India  
(Values in parentheses are potential yield/km<sup>2</sup>)

Depth range(m)	Southwest (Tot.P.Y*)	Northwest (Tot.P.Y)	Southeast (Tot.P.Y)	Northeast (Tot.P.Y)	Andaman & Nicobar (Tot.P.Y)	Total P.Y.	Total area (km <sup>2</sup> )
20-40	585.685 [0.240]	100.262 [0.097]	1039.54 [0.276]	2729.486 [0.362]	21.107 [0.062]	4476.081 [0.295]	15131
40-60	15709.68 [0.750]	26.385 [0.009]	7142.43 [0.991]	1720.574 [0.152]	397.351 [0.145]	24996.42 [0.556]	44890
60-80	10132.957 [0.777]	1134.537 [0.551]	4812.21 [1.754]	39543.607 [0.205]	29.127 [0.014]	55652.438 [2.192]	25382
80-100	622.677 [0.129]	5.277 [0.005]	216.34 [0.070]	3038.609 [1.771]	5464.251 [1.593]	9347.154 [0.665]	14063
100-150	197.883 [0.380]			63.323 [0.092]	237.46 [0.090]	498.666 [0.081]	6174
Total	27248.882 [0.588]	1266.461 [0.186]	13210.52 [0.786]	47095.59 [1.760]	6149.296 [0.689]	94970.758 [0.899]	
Tot.area [km <sup>2</sup> ]	46344	6817	16807	26754	8918		105640

\*Tot.P.Y= Total potential yield (tonne)

area, the estimated potential of carangids amounted to 6149 tonne with a density of  $0.689 \text{ km}^2$ . An average density of  $0.899 \text{ tonne/km}^2$  of carangids is discernible from all- over the coast. Depthwise, maximum potential yield was noticed in 60-80 m range (55652 tonne) which forms about 59% of the total potential yield.

## DISCUSSION

From the foregoing account, it is discernible that carangids with a concentration of 14.40 % of the total marine catch constitutes a denser population along the east coast, when compared to their contribution of 2.16 % along the west coast. It is a known fact that water mass of Bay of Bengal is warmer with pronounced estuarine influence on account of large inflow of fresh water through the major rivers. Primary productivity studies carried out along the Bay of Bengal indicate that its primary productivity though of a lesser magnitude, has certain areas like the Gulf of Mannar and Palk Bay with high rates of productivity of  $2 \text{ mgC/m}^3/\text{day}$  in the nearshore waters, (Nair *et al.* 1973). It has also been shown that east coast with a comparatively less organic matter content has higher dissolved oxygen content with simultaneous abundance of phyto and zooplankton (Subrahmanyam, 1973 ; Selvaraj *et al.* 1990) indicating higher productive zones for potential fishery resources. Nevertheless, the general tendency is for a lesser rate of exploitation along the east coast, probably because of the slower rate of motorisation of boats (Balan *et al.* 1993). It is high time to realise that east coast has great potential for fish like carangids as has also been reported earlier (Virabhadra Rao, 1973; George *et al.* 1977).

The trend in marine fish production and the share of northeast coast in total India's landings during 1956-85 has revealed that there has been perceptible increase in contribution from the northeast coast over the years from 7% in 1960 to 13% in 1984-85 (George *et al.* 1977). These surveys have also indicated that purse seining and mid water trawling could be effectively employed for exploiting the surface shoaling and transitory fish species such as decapterids, horse mackerel and other carangids. In the present study also, of all the sectors of EEZ of India examined, northeast coast contributes to maximum ( 19.12 % ) of carangids ( 64.83 kg/hr ). This may be due to the availability of fairly wider continental shelf area of trawlable muddy/sandy bottom, along the northeast coast, with the coast off Orissa characterised by several estuarine systems of higher productivity.

A depthwise evaluation of the distribution of carangids shows that they are more concentrated in the depth range of 60 - 80 m all along the coast except along the Andaman - Nicobar area. Since it has been found that the current production within 50 m depth range forms about 87% of the estimated potential yield, (Banerji, 1973), there is limited scope for further exploitation from the inshore waters. According to Sudarsan (1993) the offshore waters of EEZ of India can sustain a potential yield of 198000 tonne of carangids which is about 85.6% of their total potential yield. Moreover, pelagic fishes are subjected to frequent migration, in response to ecological and biological factors, with the younger age group entering the coastal waters and the

older ones remaining offshore. Attempts should be made to exploit this potential pelagic stock after estimating their magnitude and abundance through acoustic surveys and test fishing.

A sharp coincidence of the seasonal abundance of carangids in different sectors with the respective monsoon season is evident in the present study. It has already been established that monsoon has a bearing on enhancing productivity, for phytoplankton thrive well in waters of low salinity. Monsoon also influences the abundance of fishery resources through upwelling, though pronounced along the southwest coast of India is also reported to occur along the east coast (Subrahmanyam, 1973).

It may be noticed that carangids catch was dominated by *Decapterus* spp in almost all the sectors of EEZ especially from waters of 60 - 80 m depth range. The trawling experiments conducted in the sea off Kakinada have shown that *Decapterus* spp are abundant beyond 50 m depth (Murthy, 1991). Good concentration of *Decapterus* spp with a potential yield of about 1000 tonne along the Wadge Bank area is reported by Sudarsan (1993). At Cochin in the carangids caught in trawl from 30 - 150 m depth range, *Decapterus* spp are reported to constitute up to 78% in the trawl catches (Sivakami, 1995). According to Rao *et al* (1997), *Decapterus* spp enjoy a wider distribution extending from 7° N - 17°E along the southwest coast of India, mainly from 20 - 80 m depth range. While the phenomenon of upwelling may have a profound influence on the abundance of scads (Muthu *et al.* 1977), the habit of these neritic species to form congregation in the bottom during day and migrating upwards to feed at night may also influence their abundance in the catches. In the present case also an evaluation of the diel variation in their catch indicates that scads were caught in trawls mainly during the daytime.

It is also noticeable from the present observations that carangids catch was poor along the northwest coast with a corresponding low catch of *Decapterus* spp. Northwest coast of India with extensive trawling grounds proved has to be the best of all the region for the demersal fishes, with pelagic fishes forming only 19.08% (George *et al.* 1977). Eventhough Arabian Sea is rich in productivity, probably influenced by the upwelling, has its effect more on the southern region, the northern shelf with comparatively high saline waters with associated low productivity may not favour pelagic fishery. Nevertheless, the earlier reports on the availability of carangids like *M.cordyla* along the Porbander and Dwaraka areas may be due to their distribution in deeper waters, for *M.cordyla* is known to be more oceanic in distribution than either scads or trevallies (Rao *et al.* 1977).

The present study indicates a wider distribution of carangids extending between 20 m and 100 m along the Andaman-Nicobar area. The distribution of carangids in the shallow waters of 20-40 m may be attributed to the productivity of these waters which range from 0.2-0.5 gC/m<sup>3</sup>/day, where the high values were recorded over the shallow waters (Kumaran, 1973). Carangids also form denser concentrations in the deeper waters of 80 - 100 m, which are beyond the reach of indigeneous crafts currently operating in this area.



Banerji (1973) has estimated an optimum annual yield of 25000 tonne of carangids from the inshore waters of Indian seas of which 21760 tonne is already exploited. Sudarsan (1993) has worked out a potential yield of 231000 tonne of carangids along the EEZ of India from the waters up to 200 m depth range. Along the northwest coast of India, this group is reported to have potential yield of 15085 tonne from waters up to 180 m depth of which about 5413 tonne is currently exploited (Reuben *et al.* 1989). Likewise, along the southwest coast of India, in a survey area extending from Gulf of Mannar to Ratnagiri, the standing stock of carangids was estimated to be 141000 tonne (Rao *et al.* 1977). Along the northwest coast of India, the biomass of *M.cordyla*, an offshore species of carangids itself amounts to 40500 tonne (Joseph & Somvanshi, 1988). In the present study, an estimated potential yield of 94970 tonne of carangids was obtained from waters up to a depth range of 150 m of the EEZ with about 59% of the potential yield obtained from 60-80 m depth range. However a comparison of the estimates by various authors may not yield a reliable picture, since the estimations are based on the gears used, depth of the area exploited, catchability coefficient adopted in the estimation and time and season of surveys conducted. Nevertheless, according to Srinath (1989), the annual yield of carangids caught within 50 m depth during 1961-85 ranged between 20000 tonne in 1968 to 59000 tonne in 1984 (excluding the island waters) thereby indicating a wide gap from the estimated potential yield, and offering further scope for exploitation of this smaller pelagic resource especially from waters beyond 50 m depth as has also been opined by Reuben *et al.* (1989) and Sudarsan (1993).

### ACKNOWLEDGEMENT

Authors wish to express their deep sense of gratitude to Dr.P.S.B.R.James, former Director, for the constant encouragement.

### REFERENCES

- Balan, K., Narayana Kurup, K., Andrews, J. & Alagaraja, K. 1993. Emerging pattern of exploitation of the marine fishery resources of the inshore waters of India with particular reference to low energy fishing. In: *Proc. Nat. Workshop on Low Energy Fishing* (Soc. Fish. Techn., Cochin): 12-18.
- Banerji, S.K. 1973. An assessment of the exploited pelagic fisheries of the Indian seas. In: *Proc. Symp. Liv. Res. Seas India*. Spl. Pubn. (CMFRI, Cochin) 114-136.
- Bapat, S.V., Deshmukh, V.M., Krishnamurthi, B., Muthiah, C., Kagwade, P.V., Ramamritham, C.P., Mathew, K.J., Krishnapillai, S. & Mukundan, C. 1982. Fishery resources of the Exclusive Economic Zone of the northwest coast of India. *CMFRI Bull.* 33 : 1-86.
- George, P.C., Antony Raja, B.T., & George, K.C. 1977. Fishery resources of the Indian Economic Zone, *Souv., Integrated Fisheries Project*: 79-114.
- Gulland, J.A. 1965. Manual of method for fish stock assessment part of fish population analysis, *FAO Fish Tech. Pap.* 40 : 1-68.
- James, P.S.B.R., Jacob, T., George, K.C., Narayana Pillai, V. Mathew, K. J., & Rajagopalan, M. S. 1989. National strategy for exploitation and utilisation of the potential marine fishery resources of India. A projection. In: *Nat. Symp. R & D. in Marine Fisheries, CMFRI Bull.* 44 (1): 111 - 136.

- Joseph, A. & Somvanshi, V.S. 1988. Application of swept volume method in pelagic stocks assessment of *Megalaspis cordyla* (Linnaeus) along northwest coast of India. In: *Fish stock assessment in Indian waters*, (F S I, Bombay) 136 - 148.
- Kumaran, M. 1973. The fishery potential of Andaman and Nicobar islands. In: *Proc. Symp. Liv. Res. Seas India Spl. Pubn.* (CMFRI, Cochin) 387 - 389.
- Kuthalingam, M.D.K., Mazumdar, D. & Chatterjee, A.K. 1973. Offshore fishery resources of the Bay of Bengal from sand heads to Gopalpur. In: *Proc. Symp. Liv. Res. Seas India. Spl. Pubn.* (CMFRI, Cochin) 338 - 364.
- Murthy, V.S.R. 1991. Observations on some aspect of biology and population dynamics of the scad *Decapterus russelli* (Ruppell) (Carangidae) in the trawling grounds off Kakinada. *J. Mar. Biol. Ass. India*, 33 ( 1-2) : 396 - 408.
- Muthu, M. S., Narasimham, K.A. Sudhakara Rao, G. Appanna Sastry, Y. & Ramalingam, P. 1977. On the commercial trawl fisheries off Kakinada during 1967-70. *Indian J. Fish.* 22: 171-186.
- Nair, P.V.R., Samuel S., Joseph, K.J. & Balachandran, V.K. 1973. Primary production and potential fishery resources in the seas around India. In: *Proc. Symp. Liv. Res. Seas India Spl. Pubn.* (CMFRI, Cochin) 184 - 198.
- Rao, K.V.N., Kumaran, M. & Sankarasubramanian, J. 1977. Resources of horse mackerel off the southwest coast of India. *Seafood Export J.* 9 : 1- 16.
- Reuben, S., Sudhara Rao, G., Luther, G., Appa Rao, T., Radhakrishna, K., Appanna Sastry, Y. & Radhakrishnan, G. 1989. An assessment of the bottom trawl fishery resources of the northeast coast of India. In: *Nat. Symp. on R & D in Marine Fisheries. CMFRI Bull.* 44 (1) : 59 - 77.
- Sekharan, K.V., Muthu, M.S., Venkatasubba Rao, Ramamohana Rao, V., Muzumdar, P., & Rueben, S. 1973. Exploratory trawling on the continental shelf along the northwestern part of the Bay of Bengal. In : *Proc. Symp. Liv. Res. Seas India. Spl. Pubn.* (CMFRI, Cochin) 280 -337.
- Selvaraj, G. S.D., Paulpandian, A.L., & Purushothaman, A., 1990. Primary productivity and plankton abundance along the shelf and oceanic waters off southeast coast of India during August 1987. In : *Proc. First Workshop. Scient. Result. FORV Sagar Sampada*, edited by K.J. Mathew, (CMFRI, Cochin) 47 - 53.
- Sivakami, S. 1995. On the carangid fishery off Cochin with a note on the biology of *Decapterus russelli* (Ruppell) (Unpublished).
- Srinath, M. 1989. Trend of the major exploited marine fishery resources of India during 1961 - 85. In : *Nat. Symp. on R & D in Marine Fisheries. CMFRI Bull.* 44 (1) : 272 - 283.
- Subrahmanyam, R. 1973. Hydrography and plankton as indicators of marine resources. In : *Proc. Symp. Liv. Res. Seas India : Spl. Pubn.* (CMFRI, Cochin) 199 - 228.
- Sudarsan, D., Somavanshi, V.S., Gopalakrishnan, K. & Reddy, K.S.N. 1991. Prospects of increasing pelagic fish production from the continental shelf along the north- eastern maritime states of India. *J. Mar. Biol. Ass. India.*, 33 ( 1 & 2) : 198 - 206.
- Sudarsan, D. 1993. Marine fishery resources in the Exclusive Economic Zone of India In: *Proc. Nat. Workshop on Low Energy Fishing* (Soc. Fish. Techn., Cochin) 3 - 11.
- Virabhadra Rao, K. 1973. Distribution pattern of the major exploited marine fishery resources of India. In: *Proc. Symp. Liv. Res. Seas India. Spl. Pubn.* (CMFRI, Cochin) 18-101.

## Threadfin breams and lizard fish resources in the shelf waters of the Indian EEZ

K.V.S. Nair, R. Reghu, K. Balachandran, N. Gopinatha Menon, S.K. Chakraborty, P.U. Zacharia, E. Vivekanandan, G. Mohanraj, V.S. Rengaswamy & S.G. Rajee  
Central Marine Fisheries Research Institute, P.B.No. 1603, Cochin - 682 014

### ABSTRACT

The regional and seasonal distribution and abundance of threadfin breams and lizard fish are presented as revealed by the bottom trawling operations of *FORV Sagar Sampada* during cruises 56-91 (1989 and 1992). The threadfin breams occurred in 49 and lizard fish in 25% of the total number of bottom trawling stations surveyed. The most productive grounds for threadfin breams were located in the southwest coast between 8° and 15° N latitudinal zones, with the area 11°/75° yielding the highest average catch rate of 1794 kg/hr. Very high congregation and concentration of threadfin breams, composed mainly of *Nemipterus mesoprion* and *N. japonicus*, was observed in the southwest in 41- 80 m depth zones during southwest monsoon period. Lizard fish resources, composed mainly of *Saurida tumbil* and *S. undosquamis* were also relatively more dominant in the southwest coast than along the east coast and in the EEZ of Andaman-Nicobar islands. The size distribution of *N. japonicus* and *N. mesoprion* showed that smaller modal groups were dominant in shallower depth zones. The potential yield of threadfin breams in the southwest zone was estimated to be  $2.05 \times 10^5$ .

### INTRODUCTION

The threadfin breams constituted mainly by *Nemipterus mesoprion* and *N. japonicus* form an important constituent of the exploited demersal fishery resources of India. The estimated annual production of this resource is only 67000 tonne (average for 1988-90), which is caught mainly by small mechanised shrimp trawlers from the coastal waters of the shelf within 50 m depth. The exploratory survey conducted by the larger vessels have indicated very rich fishing grounds for threadfin breams in relatively deeper depth zones of the shelf above 50 m depth (Silas, 1969; Sudarsan *et al.* 1988, 1989). James *et al.* (1987) have identified threadfin breams as one of the most promising resources existing along both the coasts having good potential for increased exploitation. The lizard fish, comprising mainly of *Saurida tumbil* and *S. undosquamis*,

is another important component of the demersal resources along the coasts of India. Against an estimated potential of 48000 tonne, the average annual landing of the resource is only about 24000 tonne. James & Pillai (1989) have listed threadfin breams and lizard fish as two major exploited resources offering scope for increased production from depths beyond 50 m. Nair & Reghu (1989), and Sivakami (1989) also indicated these resources to be more abundant in 50-100 m depth zones along both the coasts. The present paper deals with the areawise, bathymetric and seasonal distribution and abundance of threadfin breams and lizard fish on the shelf mainly beyond 50 m depth, in the EEZ of India.

## MATERIALS AND METHODS

The catch and effort data collected by the bottom trawling operations of *FORV Sagar Sampada* during cruise no. 56-91 conducted between 1989 and 1992 were utilised for the study. The trawling was conducted usually for one hour at each of the bottom trawling stations. After recording the total catch, species composition etc. random samples were collected from each haul for biological investigations. For analysis of the data the area surveyed was divided into southwest, southeast, northeast and Andaman & Nicobar Island regions. The region was further divided into 1° fishing grids each representing an area of about 12372 km<sup>2</sup>. The stock size by depth was computed at 20 m depth interval for each latitude zone. The depthwise species composition and size distribution of the dominant species were determined for each latitude zone. Standing stock for the 50-100 m depth zone was estimated using the swept area method (Gulland, 1971).

## RESULTS

### Threadfin breams

*Geographical abundance* - The most productive area for threadfin breams was the 50-100 m depth zone of the southwest region which gave an average catch rate of 698 kg/hr (Table 1). It accounts for about 66% of the total fish catch. The southeast region showed a catch rate of about 54 kg/hr, which formed 12% of the total trawl catch. The northeast zone realised a catch rate of 19 kg/hr, while the least productive zone was found to be the EEZ of Andaman and Nicobar islands. In the southeast zone the threadfin bream catch rates were relatively poor ranging from 0.5 to 2.3 kg/hr. In the northeast the potential yield was slightly higher compared to the southeast region. The fishing grid 19°N/85°E registered a catch rate of over 35 kg/hr. In the Andaman-Nicobar waters the resource was recorded mainly in the northern latitudes, the catch rates ranging from 0.3 to 1.5 kg/hr. It may be mentioned that comparatively lesser fishing effort only could be expended in the Andaman & Nicobar area due to the untrawlable nature of the sea bottom.

The areawise distribution and abundance of threadfin breams for each 1° grid within 100 m depth line of the Indian EEZ is given in Table 1. In the southwest zone

Table 1 - Area-wise abundance of threadfin breams in the Exclusive Economic Zone of India

Area (N°/E°)	Catch rate (kg/hr)	Area (N°/E°)	Catch rate (kg/hr)
Southwest		Southeast	
8°/76°	706	10°/80°	0
8°/77°	30	11°/70°	-
9°/75°	261	12°/80°	0
9°/76°	1390	13°/80°	2
10°/75°	1037	14°/80°	1
11°/74°	100	15°/80°	267
11°/75°	1793	Average	54
12°/74°	185	Northeast	
13°/74°	235	16°/81°	0
14°/73°	60	17°/82°	0
14°/74°	5	18°/84°	0
15°/73°	500	19°/85°	35
Average	698	19°/86°	0
Andaman & Nicobar islands		Average	
10°/92°	0		19
11°/92°	1		
12°/92°	0		
12°/93°	0		
13°/92°	0		
Average	0		

the fishing sector 11°N/75°E yielded the highest average catch rate of 1793 kg/hr. The area 9°N/76°E and 10°/75°E also recorded catch rates of above 1000 kg/hr. Comparatively rich grounds yielding catch rates of over 500 kg/hr were observed in 8°N/76°E and 10°N/78°E. The fishing sector 8°N/77°E, 11°N/74°E, 14°N/73°E and 14°N/74°E indicated relatively low yield for this resource. During the course of the survey very high concentration of threadfin breams was noticed in the 50-100 m depth zone of the southwest region particularly during the southwest monsoon period. Some of the bottom trawling stations which recorded such very high catch rates were 11°75'N/23°04' E (14 tonne), 8°54'N/19°06' E (5.6 tonne/hr), 9°19'N/76°02' E (10 tonne/hr), 9°N/76°04' E (4.9 tonne/hr), 9°52'N/75°53' E (1.8 tonne), 10°30'/75°40' (7.0 tonne/hr), 11° N/75°24' E (2.4 tonne/hr), 11°28'N/75°07' E (2.3 tonne/hr) and 15°N/73°38' E (1.5 tonne/hr).

*Bathymetric distribution and abundance* - The depth-wise abundance showed that for the southwest region as a whole the depth zone 61-80 m was the most productive with a mean catch rate of 2175 kg/hr (Table 2). The depth zone 41-60 m at an average catch rate of 510.8 kg/hr, was also comparatively rich. The depth-wise abundance along different latitudinal zones indicated the threadfin breams to be more abundant at 60-80 m depth range between 9° and 11°N latitudes. In the southeast region the maximum abundance of threadfin breams was seen in 80-100 m depth zones. In 15°N zone the highest catch rate was recorded at 80-100 m depth range, while in southern latitudes the peak catch rates occurred at 60-80 m depths. In the northeast the bathymetric zone 80-100 m was the most productive, with catch rate of 46 kg/hr. In both southeast and northeast regions the catch rates of threadfin breams showed a decreasing trend with decreasing depth. In the EEZ of Andaman and Nicobar islands also the catch rates were relatively higher in deeper grounds.

*Seasonal abundance* - The seasonal distribution of the resource in the southwest region indicated that threadfin breams generally migrate and concentrate in the 40-80 m depth zones during the southwest monsoon season especially during July-August (Table 3). This congregation of the resource is more pronounced between 8° and 11°N latitudinal zones, where it supports a lucrative monsoon fishery. The season-wise coverage in the EEZ of southeast, northeast and Andaman-Nicobar waters is not sufficient to arrive at a conclusion on the seasonality of the distribution, availability and abundance of the resource.

*Species composition* - In the southwest region the threadfin breams in the shallower depth zones up to 60 m depths is composed almost equally of *Nemipterus japonicus* and *N. mesoprion* along with small quantities of *N. tolu*. Along 9° and 10°N latitudes *N. japonicus* predominated in the inner shelf (Table 4). In the deeper zones, *N. mesoprion* was the predominant species constituting about 80% of the catch. Along with *N. japonicus* and *N. mesoprion* in the southeast region *N. metopias* and *N. bleekeri* also formed a significant portion of the catch. In the northeast zone *N. mesoprion* formed the major species in 60-80 m depth strata while in 80-100 m depth

Table 2 - Depthwise abundance of threadfin breams along different latitudes in the Exclusive Economic Zone of India (kg/hr)

Lat. (°N)	Depth range			Average
	40-60 m	60-80 m	90-100 m	
<i>Southwest</i>				
8°	806	-	6	406
9°	995	1755	-	943
10°	67	3507	0	1191
11°	494	5597	200	2097
12°	470	15	-	242
13°	470	-	-	470
14°	32	-	-	32
15°	750	0	-	375
Average	510	2175	68	698
<i>Southeast</i>				
10°	-	1	0	0
11°	-	-	-	-
12°	0	-	-	0
13°	0	7	0	2
14°	1	-	-	1
15°	-	3	532	267
Average	0	3	177	54
<i>Northeast</i>				
16°	0	-	-	0
17°	0	-	-	0
18°	-	0	-	0
19°	1	16	46	21
Average	0	8	46	19
<i>Andaman &amp; Nicobar islands</i>				
6°	0	-	-	0
8°	0	-	-	0
10°	-	10	0	0
11°	-	0	3	1
12°	-	0	0	0
13°	0	1	-	-
Average	0	10	1	1

Table 3 - Seasonal abundance of threadfin breams (kg/hr) along different latitudes in the Exclusive Economic Zone of India

Lat. (°N)	Premonsoon	Monsoon	Postmonsoon
7°	-	-	-
8°	30	1397	2
9°	0	1351	14
10°	-	2333	123
11°	10	2687	107
12°	437	201	2
13°	470	-	-
14°	15	-	37
15°	1500	-	-
Average	308	1594	48

*N. japonicus* and *N. bleekeri* also formed a significant constituent of the resource. In the Andaman and Nicobar area the threadfin bream resource is composed of *N. japonicus*, *N. luteus* and *N. tolu*.

*Size distribution and maturity condition of dominant species*- The depth-wise size distribution of *N. mesoprion* showed that in most of the latitudinal zones the dominant modes occur at relatively smaller size groups in shallower depth zones. In *N. japonicus* also relatively smaller size groups were seen in shallower grounds. In both *N. mesoprion* and *N. japonicus* the percentage of gravid, spent and spent resting fish was found to be comparatively higher in deeper depth zones than in shallower depth strata.

### Lizard fish

*Geographical abundance* - The survey showed that the southwest region yielding an average catch rate of 25 kg/hr was the most productive area for the lizard fish (Table 5). It formed about 2.5% of the total demersal resources in the 50-100 m depth realm. The production of lizard fish in the outer shelf of the southeast zone was relatively poor at an average catch rate of 1.8 kg/hr. It formed only about 1% of the total demersal catch of the area. In the northeast and Andaman-Nicobar area also the potential yield was comparatively poor. The areawise abundance of lizard fish for each 1° grids/sectors is given in Table 5. The area 14°N/74°E yielded the highest average catch rate of 150 kg/hr which was followed by 15°N/73°E. The lizard fish abundance in the fishing grids/sectors along most of the southern latitudes was relatively poor. The average



Table 4 - Depthwise species composition (%) of threadfin breams at different latitudinal zones in the EEZ of India

	Depth range (m)											
	41-60 m				60-90 m			81-100 m				
	N.j	N.m	N.t	N.b	N.j	N.m	N.t	N.j	N.m	N.t	N.me	N.l
<i>Southwest</i>												
8°N	0	98	2	-	-	-	-	-	-	-	-	-
9°N	99	0	-	-	48	51	-	-	-	-	-	-
10°N	90	9	-	-	21	79	-	-	-	-	-	-
11°N	34	66	-	-	5	95	-	23	76	-	-	-
12°N	7	93	-	-	-	100	-	-	-	-	-	-
13°N	-	100	-	-	-	-	-	-	-	-	-	-
14°N	26	74	-	-	-	-	-	-	-	-	-	-
15°N	-	100	-	-	-	-	-	-	-	-	-	-
Average	47	51	-	-	18	82	-	23	76	-	-	-
<i>Southeast</i>												
10°N	-	-	-	-	100	-	-	-	-	-	-	-
13°N	-	-	-	-	-	-	100	-	-	-	-	-
14°N	-	-	-	100	-	-	-	-	-	-	-	-
15°N	-	-	-	-	-	100	-	-	-	-	100	-
Average	-	-	-	100	6	6	86	-	-	-	-	-
<i>Northeast</i>												
16°N	-	-	-	-	-	-	-	-	-	-	-	-
18°N	-	-	-	-	-	-	-	-	-	100	-	-
19°N	-	-	-	-	1	98	-	100	-	-	-	-
Average	-	-	-	-	1	98	-	25	-	75	-	-
<i>Andaman &amp; Nicobar Islands</i>												
11°N	-	-	-	-	-	-	-	11	-	1	-	87
12°N	-	-	-	-	-	-	-	-	100	-	-	-
Average	-	-	-	-	-	-	-	10	10	1	-	79

N.j = *Nemipterus japonicus*, N.m = *Nemipterus mesoprion*, N.t = *Nemipterus tolu*, N.b = *Nemipterus bleekeri*, N.me = *Nemipterus metopias*, N.l = *Nemipterus luteus*.

**Table 5 - Areawise abundance of lizard fishes in the Exclusive Economic Zone of India**

Area (°N/°E)	Catch rate (kg/hr)	Area (°N/°E)	Catch rate (kg/hr)
<b>Southwest</b>		<b>Southeast</b>	
8°/76°	3	10°/80°	0
8°/77°	3	11°/70°	-
9°/75°	7	12°/80°	0
9°/76°	11	13°/80°	0
10°/75°	0	14°/80°	-
11°/74°	0	15°/80°	4
11°/75°	9	Average	1
12°/74°	22	<b>Northeast</b>	
13°/74°	0	16°/81°	0
14°/73°	0	17°/82°	3
14°/74°	150	18°/84°	0
15°/73°	50	19°/85°	0
Average	25	19°/86°	0
<b>Andaman &amp; Nicobar islands</b>		<b>Average</b>	
10°/92°	0		1
11°/92°	1		
12°/92°	0		
12°/93°	0		
13°/92°	0		
Average	0		

catch rate in the southeast region was only 1.8 kg/hr, with the highest abundance being noticed at 15°N/80°E. In the northeast and Andaman-Nicobar region also the lizard fish production was very poor. In the southwest region high catch rates of over 100 kg/hr were recorded at some of the bottom trawling stations like 12°35'N/74°40'E, 14°N/74°40'E and 15°N/73°38'E.

**Bathymetric distribution and abundance** - The depthwise abundance showed that generally in the EEZ of the southwest region the lizard fish resource was relatively more abundant at 41-60 m depth zones (Table 6). The depthwise abundance along different latitudes also showed that in 11° and 12°N and 14° - 15°N latitudinal zones the catch rates were comparatively higher in the shallower areas of the shelf. In southern latitudes higher concentration of the resource was noticed in 60-100 m depth strata. In the southeast coast the lizard fish resource was poor, the highest catch rate recorded being 7 kg/hr in the 80-100 m depth range followed by 60-80 m depths.

**Seasonal distribution, abundance and species composition** — The seasonal distribution of lizard fish showed that in the southwest region the resource abundance in the shallower depth zones was the maximum during premonsoon months. During monsoon and postmonsoon period the catch rates were comparatively poor (Table 7). *Saurida undosquamis* formed the major component during premonsoon season, whereas *S. tumbil* was the predominant species during monsoon and postmonsoon periods. The size distribution of *S. tumbil* showed the occurrence of relatively larger size groups in 40-60 and 60-80 m depth strata in 9° - 11°N zones in the southwest coast, while smaller size groups predominated in 40-60 m depth zones in the southeast region.

**Potential yield** - The standing stock and potential yield of threadfin breams for the depth zone 60-100 m have been worked out for the major fishing zones. For the southwest the potential yield of threadfin breams was estimated at  $2.05 \times 10^5$  tonne. The potential yield was estimated to be 2700 tonne and 2100 tonne respectively for the southeast and northeast zones respectively. The potential yield of lizard fish for the southwest region in the 50-100 m depth zone was estimated to be 5500 tonne. The estimates for the southeast and northeast zones were only 205 and 75 tonne respectively.

## DISCUSSION

The intensive bottom trawling operations conducted by *FORV Sagar Sampada* during the second phase of the operation of the vessel have further confirmed the existence of rich and fishable concentrations of threadfin breams and lizard fish beyond 50 m in EEZ of India. During the course of the survey very high density pockets of threadfin breams were noticed in 50-100 m depth zones between 8° and 15°N latitudes during the monsoon months of July and August, often the entire catch being composed of threadfin breams. A catch rate of up to 14 tonne/hr has been realised during some of the cruises of this period. Sudarsan *et al.* (1988) also reported that threadfin breams form the most dominant component of the demersal finfish resource in 50-100 and 100-200 m depth strata between 8° and 11°N latitudes along the southwest coast. Sudarsan *et al.* (1989) estimated the potential yield for threadfin breams as 26600 tonne for depth strata below 50 m; 15200 tonne for 50-100 m and 10600 tonne for 100-200 m depth zones. The maximum sustainable yield of threadfin breams along the southwest coast of India was estimated to be 5800 tonne by Joseph

Table 6 - Depthwise abundance of lizard fishes (kg/hr) along different latitudes in the Exclusive Economic Zone of India

Lat. (°N)	Depth range			Average
	40-60 m	60-80 m	80-100 m	
<i>Southwest</i>				
8°	3	-	10	6
9°	0	34	-	16
10°	-	-	-	-
11°	16	10	10	12
12°	36	30	-	23
13°	-	-	-	-
14°	90	-	-	-
15°	75	-	-	75
Average	27	24	10	25
<i>Southeast</i>				
10°	-	-	-	-
11°	-	-	-	-
12°	-	-	-	-
13°	-	1	-	0
14°	-	-	-	-
15°	-	2	7	4
Average	-	1	2	1
<i>Northeast</i>				
16°	-	-	-	-
17°	2	-	-	2
18°	-	-	-	-
19°	-	-	-	-
Average	1	-	-	1
<i>Andaman &amp; Nicobar island</i>				
6°	-	-	-	-
8°	-	-	-	-
10°	-	-	-	-
11°	-	-	3	0
12°	-	-	-	-
13°	-	-	-	-
Average	-	-	1	1

Table 7 - Seasonal abundance of lizard fishes (Catch/hr) along different latitudes in the Exclusive Economic Zone of India

Lat. (°N)	Premonsoon	Monsoon	Postmonsoon
<i>Southwest</i>			
8°	11	-	0
9°	16	8	0
10°	-	-	-
11°	-	10	5
12°	50	3	40
14°	75	-	15
Average	37	3	6

(1987) and 52400 tonne by Sudarsan *et al.* (1987). The MSY estimate by John (1987) for the Kerala coast is only 27000 tonne. The relatively high potential yield estimate obtained during the present study is probably due to the extremely high catch rates obtained for this resource during the high speed demersal trawling operations of the vessel. The potential yield for perches consisting predominantly of threadfin breams estimated is only 125000 tonne in depths beyond 50 m (Anon, 1991).

The resource appraisal surveys of the demersal resources off Kerala showed that between December and April most of the nemipterid stocks occur in 100-200 m depth zone, while between July and October the major part was found at depths below 100 m (John, 1987). The threadfin breams which are more abundant in relatively deeper waters are known to move into shallower areas during monsoon period resulting in high catch and catch rates along Kerala coast (Nair & Jayaprakash, 1986). In the trawling grounds off Sakthikulangara and Cochin very high catches were obtained by small mechanised shrimp trawlers during the monsoon months of June-August, the catches during this period accounting for over 80% by weight of the total annual threadfin bream landings at these centres (Murty *et al.* 1992). Nair & Reghu (1989) also have shown that along the southwest coast the threadfin breams migrate and concentrate in 41-80 m depth strata during June-September.

James (1989) has pointed out that the bottom trawling operations of the exploratory survey vessels have clearly indicated that the commercially exploitable demersal resources including threadfin breams and lizard fish are confined mainly to the continental shelf region within a depth of 100 m which is well within the range of operation of medium trawlers of 17 m and that in most of the regions the 100-200 m depth zone forms only a minor percentage of our EEZ. So for exploitation of the threadfin bream resources of the deeper waters a redeployment of some of the medium trawlers operating along Indian coast may be attempted.

Recently to simulate interest in deep sea fishing the Govt. of India has given licenses for about 144 vessels belonging to 40 foreign companies. Some of the foreign vessels have already started trawling operations in Indian waters and a directed fishery for threadfin breams by 'Surimi' factor trawlers is emerging (Bhoopendranath & George, 1994). However, while permitting large scale targetted exploitation of this

resource by factory trawlers extreme care has to be taken to see that such joint venture projects would not lead to any harmful depletion of this important demersal resource.

### ACKNOWLEDGEMENT

Authors are grateful to Dr. P.S.B.R. James, former Director and Dr. P. Bensam, Head, Demersal Fisheries Division for their guidance and constant encouragement.

### REFERENCES

- Anon, 1991. Report of the working group on revalidation of the potential marine fishery resources of the Exclusive Economic Zone of India. (MPEDA, Cochin).
- Bhoopendranath, M.R. & George, V.C. 1994. Commercial application of the results of deep sea fishing investigations of CIFT onboard *FORV Sagar Sampada*, *Second Workshop on Scientific Results of FORV Sagar Sampada*, (15-17 February 1994), Abstract 69.
- Gulland, J.A. 1971. *The fish resources of the oceans* [Fishing News (Books) Ltd, London] pp. 255.
- James, P.S.B.R. 1989. Growth profile of marine fisheries in India, *Bull. Cent. Mar. Fish. Res. Inst.* 44 (1): 261-272.
- James, P.S.B.R., Alagarwamy, K., Narayana Rao, K.V., Muthu, M.S., Rajagopalan, M.S., Alagaraja, K. & Mukundan, C. 1987. Potential marine fishery resources of India *CMFRI. Sp. Publication* 30 : 44-74.
- James, P.S.B.R. & Narayana Pillai, V. 1989. Fishable concentration of fishes and crustaceans in the offshore and deep sea areas of the India Exclusive Economic Zone based on observations onboard *FORV Sagar Sampada*, In : *Proc. First Workshop. Scient. Resul. FORV Sagar Sampada*, edited by K.J. Mathew, (CMFRI, Cochin) 201-213.
- John, M.E. 1987. Population dynamics and stock estimates of the threadfin bream (*Nemipterus japonicus*) off Kerala, India, In: *Contributions to tropical fish stock assessment in India*, 45-62.
- Joseph, K.M. 1987. The fish resources of Indian Exclusive Economic Zone, Paper presented at the *National Seminar on Planning Expert Strategy for Indian Marine Fisheries.*, New Delhi.
- Murty, V.S., Nair, K.V.S., Thomas, P.A., Lazarus, S., Chakraborty, S.K., Raje, S.G., Gopal, C., Zacharia, P.U. & Velayudhan, A.N. 1992. Present status of exploitation of fish and shell fish resources: Threadfin breams, *Bull. Cent. Mar. Fish. Res. Inst.* 45 : 154-168.
- Nair, K.V.S. & Jayaprakash A.A. 1986. A note on the monsoon fishery for threadfin breams off Cochin, *Indian J. Fish.* 33 : 106-112.
- Nair, K.V.S. & Reghu, R. 1989. Studies on the threadfin bream and lizard fish resources in the Exclusive Economic Zone of India based on the demersal trawling operations of *FORV Sagar Sampada*, In : *Proc. First Workshop. Scient. Resul. FORV Sagar Sampada*, edited by K.J. Mathew (CMFRI, Cochin) 239-255.
- Silas, E.G. 1969. Exploratory fishing by *R.V. Varuna*, *Bull. Cent. Mar. Fish. Res. Inst.* 12: 1-86.
- Sivakami, S. 1989. Observations on the demersal fishery resources of the coastal and deep sea areas of the Exclusive Economic Zone of India. In: *Proc. First Workshop Scient. Resul. FORV Sagar Sampada* edited by K.J. Mathew, (CMFRI, Cochin) 215- 231.
- Sudarsan, D., Sivaprakasam, T.E., Somavanshi, V.S., John, M.E., Nair, K.N.V. & Joseph, A. 1988. An appraisal of the marine fishery resources of the Indian Exclusive Economic Zone, *Bull. Fish. Survey India*. 18: 1-85.
- Sudarsan, D., John, M.E. & Joseph A, 1989. An assessment of demersal stocks in the southwest coast of India with particular reference to the exploitable resources in the outer continental shelf and slope. *Bull. Cent. Mar. Fish. Res. Inst.* 44 (1) : 261- 272.

## **Demersal finfish resources in certain areas of the EEZ of southwest and southeast coast of India**

P. Bensam, V.N. Bande, S. Sivakami, K.V. Somasekharan Nair, N. Gopinatha Menon, Grace Mathew, P. Devadoss, P. Nammalwar, P.U. Zacharia, M. Feroz Khan, P. Jayasankar, G. Mohanraj, P. Livingston, V. Gandhi, A. Raju, S. Srinivasarangan, V. Rengaswami & S.G. Raju

Central Marine Fisheries Research Institute, P.B. No - 1603, Cochin - 682 014

### **ABSTRACT**

Bottom trawling data from the cruises of the *FORV Sagar Sampada* undertaken during 1989-91 in the middle and outer shelf waters of the southern EEZ, at 97 stations within a depth zone of 30 to 130 m, showed catch rates of 3 to 14000 kg/hr. The highest rate of 14 t/hr was recorded at lat. 11°N/75° 23. 4' E, followed by 5.5t/hr at 8°54'N N/76° 19.6' E off the southwest coast, whereas the abundance was comparatively less off the southeast coast. The average catch rate per hour off the southwest was 724 kg and off the southeast it was 405 kg. The important demersal finfishes available were: threadfin breams (72%), major perches (5%), rays, carangids and goatfish (4% each) off the southwest; and carangids (29%), major perches (23%), rays (19%), threadfin breams (10%) and goatfish (5%) off the southeast. The depth belt of 41-80 m off both the coasts was found to be more productive than deeper regions. The results indicate that the potential yield from the depth zone of 50-100 m off the southwest coast is  $2.6 \times 10^5$  tonne, which is much higher than the previous estimates of up to  $1.5 \times 10^5$  tonne. The single largest group (80%) in this zone is threadfin breams, followed by bull's eye, lizard fishes and flatheads.

### **INTRODUCTION**

Marine fish production from the southern coastal fishing grounds of India within about 50 m depth contour has been stagnating around  $1 \times 10^6$  tonne, which is almost close to the estimated potential of  $1.3 \times 10^6$  tonne. This production trend from the coastal zone, which is subjected to very intensive exploitation with some demersal stocks already indicating signs of overexploitation or near it, provides little opportunity for further enhancing the yield. However, beyond 50 m depth, an-estimated  $5 \times 10^5$  tonne are available (Anon, 1991). Some of the earlier investigations on the occurrence,

availability and abundance of major demersal and pelagic fishery resources in the nonconventional fishing grounds in the EEZ of southern India are by Silas (1969), Oommen (1974, 1980), James *et al.*, (1987), Sudarsan *et al.*, (1988) and James & Pillai (1989). The present paper deals with the geographical, bathymetric and seasonal availability and abundance of important demersal finfish resources in the middle and outer shelf waters of the southern EEZ, based on the trawling data from the cruises of the *FORV Sagar Sampada* during 1989-92.

## MATERIALS AND METHODS

The study is based on the bottom trawling operations of the *FORV Sagar Sampada* in cruise nos: 56 through 91. The area covered ranged from lat. 7° to 15°N and long. 73° to 82°E, (Fig.1). The vessel has occupied 295 stations, of which bottom trawling was possible only in 97 stations in depths varying from 3 to 130 m. Usually trawling was undertaken for about one hour in each station. The catch was sorted out and analysed in the laboratory of the vessel for total biomass and species composition. Random samples were used from each station for length measurements of various species and other biological needs.

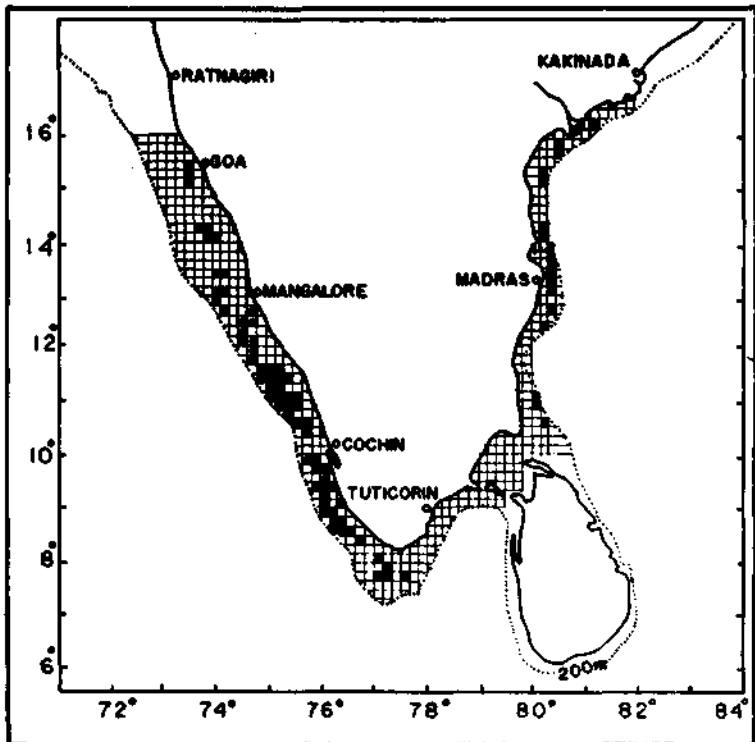

Fig.1 - Map showing the various stations (295 in number) occupied by *FORV Sagar Sampada* during 1989-92, out of which bottom trawling was undertaken in 97 stations



For analysing and processing the data, the area was demarketed into fishing grids of 1° latitude x longitude squares, each representing an area of 12373 km<sup>2</sup>. For studying the bathymetric distribution and abundance of the stock biomass, the data were analysed for depth ranges (i) up to 50 m depth and (ii) 50-100 m depth, for each latitudinal zone. Due to the profound influence of southwest monsoon on the distribution and abundance of most of the major fishery resources in Indian waters, the calendar year has been classified into premonsoon (February to May months), monsoon (June to August) and postmonsoon (September to January), in order to understand the seasonal abundance of the resources.

## RESULTS

### Geographical abundance

The areawise availability and abundance of demersal finfish resources in each 1° lat x long fishing grid are presented in Tables 1 and 2. The results have indicated that the southwest coast has an average catch rate of 72 kg/hr while the southeast has a rate of 405 kg/hr, the former showing about 78% more production potential than the latter. The important groups of fishes obtained in the bottom trawl catches were: threadfin breams (72%) off the southwest coast and carangids (29%) and major perches (23%) off the southeast.

Off the southwest coast, dense grounds of demersal finfishes located in the areas, in lat. °N/long °E (in kg/hr in parentheses) are: 11°/75° (2165), 9°/76° (1609) and 11°/75° (1124), composed mostly of threadfin breams (*Nemipterus japonicus*, *N. mesoprion*), bull's eye (*Priacanthus hamrur*, *P. tayena*, *P. macrocanthus*) and goat fishes. The areas 7°/77°, 8°/76° and 11°/76° have shown abundance of more than 500 kg/hr. In the area 7°/77° which is a part of the Wadge Bank, the resources were composed mainly of major perches and percoid fishes (*Plectorhynchus crassipinna*, *P. lineatus*, *Epinephelus tauvina*, *Pristipomoides*). Some higher levels of abundance in certain specific stations occupied are: 14 t/hr in 11°N/75° 23.4'E, 10 t/hr in 9°19'N/76°02'E, 7t/hr in 10°30'N/75°40.5'E, 5.5t/hr in 8°54'N/76° 19.60'E and 5 t/hr in 9° 0.4' N/76° 0.4'E. Off the southeast, the fishing area 10°N/80°E has recorded the highest catch of 1,033 kg/hr, with major perches (*Pristipomoides typus*, *Epinephelus*, *Lutjanus*) forming the bulk. The areas 14°N/80°E and 15°N/80°E have yielded catch rates of 650 and 465 kg/hr respectively with goatfishes, carangids and rays forming the bulk in the former and threadfin breams and bull's eye in the latter.

### Bathymetric/seasonal availability and abundance

The bathymetric availability and average abundance of demersal finfish resources as well as the major component species are presented in Tables 3 and 4. Analyses of the above data have indicated that for the southwest zone as a whole, the depth range of 50 to 100 m is more productive, with an average catch rate of 1390 kg/hr than the range up to 50 m depth which has yielded about 580 kg/hr. Threadfin breams have

Table 1 - Areawise average abundance of demersal finfish resources (kg/hr) in the southwest sector of the E E Z of India

Major groups/ species	Area in lat. °N/long. °E.													Gross Average
	7°17'	8°16'	8°17'	9°15'	9°16'	10°15'	11°14'	11°15'	12°14'	13°14'	14°13'	14°14'	15°13'	
Sharks	-	-	-	-	-	-	-	2	-	-	-	-	-	-
Skates	50	-	1	-	-	-	-	-	-	-	-	-	-	4
Rays	310	-	-	-	14	-	-	-	-	-	-	-	-	25
Carangids	-	22	10	18	15	20	-	8	-	5	190	-	18	24
<i>Rastrelliger kanagurta</i>	-	-	-	-	-	-	-	-	-	-	-	-	-	-
Silver bellies	-	-	-	-	-	-	-	-	-	-	-	-	-	-
Threadfin breams	-	707	30	261	1391	1037	100	1794	185	235	60	5	500	485
Lizard fishes	-	4	3	7	12	-	-	9	23	-	-	150	50	20
<i>Upeneus</i> spp	-	1	-	42	-	1	-	255	23	-	30	-	-	27
<i>Sphyræna</i> spp	-	-	-	-	1	1	-	4	-	-	-	-	-	-
<i>Priacanthus</i> spp	-	-	-	-	1	21	13	231	145	25	70	5	83	30
Perches	384	6	-	7	1	-	-	25	5	-	-	-	-	33
<i>Platycephalus</i> spp	-	-	-	-	1	1	-	1	184	-	-	-	-	14
Flat fishes	-	-	4	-	1	-	-	1	-	-	-	-	-	-
<i>Trichiurus</i> spp	-	-	-	-	-	-	-	-	21	-	-	-	10	1
Cat fishes	-	-	-	-	-	-	-	-	1	-	-	-	31	2
Other finfish	9	9	-	23	1	1	98	3	1	-	-	5	7	13
Miscellaneous	52	12	2	2	171	41	23	40	62	30	62	35	60	46
Total	805	761	50	260	1611	1123	234	2373	650	295	412	200	759	724

Table 2 - Areawise average abundance of demersal finfish resources (kg/hr) in the southeast sector of the E E Z of India

Major groups/ species	Area in lat.° N/long.° E						Gross average
	10°/80°	11°/80°	12°/80°	13°/80°	14°/80°	15°/80°	
Sharks	-	-	-	-	-	-	-
Skates	-	-	-	-	-	-	-
Rays	-	-	156	7	187	2	58
Carangids	457	-	3	3	306	-	128
<i>Rastrelliger kanagurta</i>	227	-	-	-	-	-	38
Silver bellies	-	-	-	-	-	-	-
Threadfin breams	1	-	-	2	1	268	45
Lizard fishes	1	-	-	1	-	5	1
<i>Upeneus</i> spp	-	-	-	1	107	8	19
<i>Sphyraena</i> spp	-	-	-	-	33	-	-
<i>Priacanthus</i> spp	-	-	-	-	-	75	6
Perches	303	25	-	15	-	-	12
<i>Platycephalus</i> spp	-	-	-	-	-	-	57
Flat fishes	-	-	2	1	-	19	4
<i>Trichiurus</i> spp	-	-	-	-	-	8	1
Cat fishes	-	-	-	-	-	-	-
Other finfishes	5	-	16	-	-	-	5
Miscellaneous	41	5	1	38	16	86	31
Total	1035	30	178	68	650	471	405

formed the most important single component in this depth zone followed by bull's eye, lizard fishes, flatheads, major perches and goatfishes. The study has also shown that the abundance is higher in deeper grounds along almost all the latitudinal zones, except lat, 7° and 12° N.

The seasonal availability and abundance of the major resources off the southwest zone are given in Table 5. It may be seen from the same that maximum abundance was during the monsoon season, with the average catch rate ranging between 1443 kg/hr along lat. 8°N and 2824 kg/hr along lat. 11°N. This is mainly due to the concentration

Table 3 - Bathymetric availability and average abundance of demersal finfish resources (kg/hr) along different latitudinal zones ( $^{\circ}$ N) in the southwest sector of the E E Z of India, and at depths <50 m and 51-100 m.

Major groups/ species	Latitudes ( $^{\circ}$ N)/Depth(m)																Gross average			
	7 $^{\circ}$		8 $^{\circ}$		9 $^{\circ}$		10 $^{\circ}$		11 $^{\circ}$		12 $^{\circ}$		13 $^{\circ}$		14 $^{\circ}$		15 $^{\circ}$		<50	51-100
	<50	51-100	<50	51-100	<50	51-100	<50	51-100	<50	51-100	<50	51-100	<50	51-100	<50	51-100	<50	51-100		
Sharks	-	-	-	-	-	-	-	-	6	-	-	-	-	-	-	-	-	-	1	-
Skates	-	75	-	1	-	-	-	-	-	-	-	-	-	-	-	-	-	-	-	10
Rays	-	464	-	-	-	10	-	-	-	-	-	-	-	-	-	-	-	-	-	68
Carangids	-	-	-	21	9	18	44	5	2	8	-	2	10	-	95	-	92	50	20	15
<i>Rastrelliger kanagurta</i>	-	-	-	21	-	-	-	-	-	-	-	-	-	-	-	-	-	-	-	-
Silver bellies	-	-	-	-	-	-	-	-	-	-	-	-	-	-	-	-	-	-	-	-
Threadfin breams	-	-	-	630	40	1721	82	1760	6	1992	900	98	470	-	33	-	-	1500	179	1100
Lizard fishes	-	-	-	5	5	11	-	-	833	18	100	23	-	-	90	-	-	150	25	30
<i>Upeneus</i> spp	-	-	-	1	-	20	-	46	-	-	-	27	-	-	15	-	-	-	106	14
<i>Sphyaena</i> spp	-	-	-	-	-	-	2	-	-	6	-	-	-	-	-	-	-	-	-	1
<i>Priacanthus</i> spp	-	-	-	-	2	-	5	8	59	30	300	123	-	-	38	-	25	250	59	59
Perches	1000	134	-	6	90	3	1	1	-	29	-	5	-	-	-	-	-	-	136	25
<i>Platycephalus</i> spp	-	-	-	-	1	-	-	-	-	1	-	210	-	-	-	-	-	-	1	30
Flat fishes	-	-	-	1	1	-	-	-	-	1	-	-	-	-	-	-	-	-	1	-
<i>Trichiurus</i> spp	-	-	-	-	-	-	-	-	-	-	-	-	-	-	-	-	-	10	-	2
Catfishes	-	-	-	-	-	-	-	-	-	-	-	1	-	-	-	-	42	-	6	-
Other finfishes	-	14	-	-	1	-	-	1	-	-	-	-	-	-	3	-	-	-	-	2
Miscellaneous	-	21	-	16	36	42	5	14	169	54	50	52	20	-	34	-	65	40	48	36
Total	1000	708	-	682	185	1825	139	1835	1075	2139	1350	542	500	-	308	-	224	2000	582	1392

Table 4 - Bathymetric availability and average abundance of demersal finfish resources (kg/hr) along different latitudinal zones ( $^{\circ}$ N) in the southeast sector of the E E Z of India, and at depth <50 m and 51-100 m

Major groups/ species	Latitudes ( $^{\circ}$ N)/Depth(m)										Gross average			
	10 $^{\circ}$		11 $^{\circ}$		12 $^{\circ}$		13 $^{\circ}$		14 $^{\circ}$		15 $^{\circ}$		<50	51-100
	<50 (*)	51-100	<50 (*)	51-100	<50 (*)	51-100	<50	51-100	<50 (*)	51-100 (*)	<50	51-100		
Sharks	-	-	-	-	-	-	-	-	-	-	3	-	1	
Skates	-	-	-	-	-	-	-	-	-	-	-	-	-	
Rays	-	-	-	155	-	10	187	-	-	-	-	114	3	
Carangids	455	-	3	-	3	5	306	-	-	-	-	104	115	
<i>R. kanagurta</i>	227	-	-	-	-	-	-	-	-	-	-	-	-	
Silver bellies	-	-	-	-	-	-	-	-	-	-	-	-	-	
Threadfin breams	-	-	-	-	-	4	1	-	-	-	267	-	68	
Lizard fishes	-	-	-	-	-	1	-	-	-	-	3	-	1	
<i>Upeneus</i> spp	-	-	-	-	2	1	107	-	-	-	8	37	2	
<i>Sphyræna</i> spp	-	-	-	-	-	-	33	-	-	-	-	11	-	
<i>Priacanthus</i> spp	-	-	-	-	-	-	-	-	-	-	-	-	-	
Perches	347	-	25	-	-	1	23	-	-	-	78	-	118	
<i>Platycephalus</i> spp	-	-	-	-	-	-	-	-	-	-	-	-	-	
Flat fishes	-	-	-	2	-	1	-	-	-	-	5	1	1	
<i>Trichiurus</i> spp	-	-	-	-	-	-	-	-	-	-	8	-	2	
Cat fishes	-	-	-	-	-	-	-	-	-	-	-	-	-	
Other finfishes	-	-	-	-	-	-	-	-	-	-	-	-	-	
Miscellaneous	5	-	5	20	-	66	32	16	-	-	93	33	34	
Total	1034	-	30	178	-	71	77	650	-	-	467	300	345	

(\*) Not operated

Table 5 - Seasonal average abundance of demersal finfish resources along different latitudinal zones in the southwest sector of the E E Z of India (A = Premonsoon, B = Monsoon, C = Postmonsoon)

Major groups/species	Latitudes in °N														
	7°			8°			9°			10°			11°		
	A	B	C	A	B	C	A	B	C	A	B	C	A	B	C
Sharks	-	(*)	-	-	-	-	-	-	-	(*)	-	-	18	3	-
Skates	-	-	150	3	-	-	-	-	-	-	-	-	-	-	-
Rays	227	-	475	-	-	5	-	-	-	-	-	-	-	-	-
Carangids	-	-	-	3	44	-	13	7	49	-	-	66	-	7	8
<i>R. kanagurta</i>	-	-	-	-	-	-	5	-	-	-	-	-	-	-	-
Silver bellies	-	-	-	-	-	-	1	-	-	-	-	-	-	-	-
Threadfin breams	-	-	-	30	1397	2	1	1351	15	-	2333	123	10	2687	107
Lizard fishes	-	-	-	11	-	1	17	8	1	-	-	-	-	10	5
<i>Upeneus</i> spp	-	-	-	3	-	-	-	-	67	-	-	-	2800	-	1
<i>Sphyræna</i> spp	-	-	-	-	-	1	-	-	-	-	-	3	-	9	-
<i>Priacanthus</i> spp	-	-	-	-	-	-	-	2	-	-	5	64	176	39	2
Perches	582	-	4	16	-	-	-	2	3	-	-	1	-	40	-
<i>Platycephalus</i> spp	-	-	-	-	-	-	-	-	-	-	-	-	-	1	-
Flat fishes	-	-	-	1	-	-	3	-	-	-	-	2	-	2	-
<i>Trichiurus</i> spp	-	-	-	-	-	-	-	-	-	-	-	-	-	-	-
Cat fishes	-	-	-	-	-	-	-	-	-	-	-	-	-	-	-
Other finfishes	13	-	2	21	-	9	6	3	2	-	-	5	-	-	10
Miscellaneous	56	-	27	212	1	9	28	46	44	-	-	20	196	27	111
Total	875	-	658	300	1442	26	74	1419	141	-	2338	282	3200	2824	241

(\*) Not operated

Contd....

Table 5 — *Contd...*

Major groups/ species	Latitudes in °N														
	12°			13°			14°			15°			Average		
	A	B	C	A	B (*)	C	A	B (*)	C	A	B (*)	C	A	B	C
Sharks	-	-	1	-	-	-	-	-	-	-	-	-	2	1	-
Skates	-	-	-	-	-	-	-	-	-	-	-	-	-	-	18
Rays	-	-	-	-	-	-	-	-	-	-	-	-	28	-	53
Carangids	2	3	2	10	-	-	5	-	99	50	-	3	10	10	25
<i>R. kanagurta</i>	-	-	-	-	-	-	-	-	-	-	-	-	-	-	-
Silver bellies	-	-	-	-	-	-	-	-	-	-	-	-	-	-	-
Threadfin breams	488	202	3	470	-	-	15	-	38	1500	-	-	308	1328	32
Lizard fishes	50	8	40	-	-	-	75	-	15	150	-	-	38	2	7
<i>Upeneus</i> spp	2	2	34	-	-	-	88	-	5	-	-	-	362	-	12
<i>Priacanthus</i> spp	150	1	-	-	-	50	15	-	35	250	-	-	70	8	12
Perches	-	-	9	-	-	-	3	-	-	-	-	-	15	7	2
<i>Platycephalus</i> spp	-	245	-	-	-	-	-	-	-	-	-	-	-	-	-
Flat fishes	-	-	-	-	-	-	-	-	-	-	-	-	-	41	-
<i>Trichiurus</i> spp	-	-	-	-	-	-	-	-	-	-	-	-	1	-	-
Cat fishes	-	2	2	-	-	-	-	-	-	-	-	47	-	-	5
Other finfishes	3	-	-	-	-	-	-	-	1	-	-	25	6	1	6
Miscellaneous	32	244	290	20	-	40	25	-	33	-	-	64	82	55	66
Total	728	707	381	500	-	90	226	-	226	2000	-	139	922	1442	261
(*) Not operated															

of threadfin breams composed of *Nemipterus mesoprion* and *N. japonicus* along the said latitudes. The highest catch rate of 3200 kg/hr along lat. 11°N was recorded during premonsoon, brought about mostly by concentration of goatfishes and bull's eye. But, along lat. 7°N and 13 to 15°N, the abundance was better during premonsoon than during postmonsoon, there being little coverage during the monsoon. Along lat. 7°N, perches and percoid fishes composed of *Plectorhynchus crassipinna*, *P. lineatus*, *Lutjanus lineolatus*, *Epinephelus tauvina* and *Lethrinus nebulosus* as well as rays (*Dasyatis kuhli*) have dominated the catches during premonsoon. The important groups in the catches in the latitude during postmonsoon were skates and rays.

### Estimation of potential yield

Since the vessel has conducted trawling mostly above 50 m depth zone, the potential yield has been estimated for the 50-100 m depth ranges of the southwest coast from lat. 7° to 15°N and of the southeast coast from lat. 10° to 14°N. Off the southwest coast, the potential in the above zone is estimated to be about  $0.26 \times 10^6$  tonne. Of this, threadfin breams (*N. mesoprion* and *N. japonicus*) has been the single largest group with an estimated harvestable yield of  $2.1 \times 10^5$  tonne, amounting to about 79% of the total demersal finfishes. Elasmobranchs composed mostly of skates and rays is estimated to be about 14000 t. The bull's eye contributed by *Priacanthus hamrur*, *P. tayena* and *P. macrocanthus* has a potential yield of 11000 t. The other demersal finfishes for which the sustainable potential has been estimated are in tonnes: flatheads, 56000; lizard fishes, 5500; major perches, 4700; goatfishes, 2500 tonne.

Off the southeast coast the potential trawlable yield from the 50 - 100 m depth is estimated to be only about 16000 t. Major perches formed the single largest component, with a potential of 4800 t. The important species/genera are: *Pristipomoides typus*, *Epinephelus*, *Lutjanus* and *Siganus*. This is followed by carangids, 4000 t; threadfin breams, 2782 t and mackerel 2520 t.

## DISCUSSION

The total exploitable resources estimated by George *et al.* (1977) for the 50 - 200 m depth zone off Kerala, Karnataka and Goa is  $3.25 \times 10^5$  tonne. According to Sudarsan *et al.* (1988), a potential of  $1.41 \times 10^5$  t is obtainable from the 50 - 100 m depth zone between lat. 8° and 15° N off the southwest coast. The potential for the shelf and slope beyond 50 m depth estimated by the Working Group on revalidation (Anon, 1991) is 112300 t for the southwest and 39000 t for the southeast. Of this, the component for the 50 - 100 m depth range is calculated to be only 63000 and 13400 t only respectively. But, the present estimates of  $2.6 \times 10^5$  tonnes, based on larger fishing coverages is significantly higher than those of Sudarsan *et al.* (1988) and Anon (1991).

As may be seen from the results presented, this higher estimate of the potential is mostly due to dense concentrations of threadfin breams in the 50 - 100 m depth realm



along certain latitudinal zones of the southwest coast (about 80%). Earlier, James & Pillai (1989) have reported high concentrations of this resource off the southwest coast during June - August period. The resource estimates for bull's eye, lizard fishes, flatheads, etc are more or less comparable to those of Sudarsan *et al.* (1988) and Anon (1991).

In spite of the recent fishing efforts by some mechanised trawlers beyond 50 m and up to about 70 m depth during certain seasons of the year, the outer shelf beyond 50 m along both the coasts still remains almost unexploited. The present studies have indicated larger concentrations of demersal finfish resources such as threadfin breams, bull's eye, lizard fishes, etc, forming rich harvestable grounds in the 50 - 100 m depth belt off both the southwest and southeast coasts.

### REFERENCES

- Anon. 1991. Report of the working group on revalidation of the potential marine fisheries resources of the Exclusive Economic Zone of India, (MPEDA, Cochin) pp. 57.
- George, P.C., Antony Raja, B.T. & George, K.C. 1977. *Fishery resources of the Indian Economic Zone*, (Marine Products Export Development Authority, Cochin).
- James, P.S.B.R. Alagaraswamy, K., Rao, K.V.N., Muthu, M.S., Rajagopalan, M.S., Alagaraja K. & Mukundan, C. 1987. Potential Marine fishery resources of India, *CMFRI Sp. Pub.* 30 : 44- 74.
- James, P.S.B.R. & Pillai, V.N. 1989. Fishable concentrations of fishes and crustaceans in the offshore and deep sea areas of the Indian Exclusive Economic Zone based on observations made onboard *FORV Sagar Sampada*, In: *Proc. First Workshop Scient. Result. FORV Sagar Sampada*, edited by K.J. Mathew, (CMFRI, Cochin) 201-213.
- Joseph, K.M. & John, M.E. 1987. Potential marine fishery resources. *CMFRI Sp. Pub.* 30: 18-43.
- Oommen, V.P. 1974. A brief account of the topography and fishery potential of the south west coast of India, *Mahasagar - Bull. Natn. Inst. Oceanogr.* 7 (1 & 2): 33 - 39.
- Oommen, V.P. 1989. Results of the exploratory fishing in Quilon Bank and Gulf of Mannar, *Bull. No.4*. (Integrated Fishery Project, Cochin) pp. 49.
- Silas, E.G. 1969. Exploratory fishing by *R.V. Varuna*, *CMFRI Bull.* 12: 1-86.
- Sudarsan, D., Sivaprakasam, T.E., Somavanshi, V.S., John, M.E., Nair, K.N.V. & Antony Joseph, 1988. An appraisal of the marine fishery resources of the Indian Exclusive Economic Zone, *Bull. Fish. Surv. India*, 18: 1-85.

\* \* \*

## **Perch resources of the shelf waters in the EEZ of India**

Grace Mathew<sup>1</sup>, G. Gopakumar<sup>2</sup>, S.Lazarus<sup>2</sup>, S.K.Chakraborty<sup>3</sup>, P.Kaladharan<sup>1</sup>,  
M.Firoz Khan<sup>4</sup>, P. Jayasankar<sup>5</sup>, K.M. Venugopal<sup>1</sup>

1. Central Marine Fisheries Research Institute, P.B. No. 1603, Cochin - 682 014
2. Vizhinjam Research Centre of CMFRI, Vizhinjam, Trivandrum - 695 521
3. Bombay Research Centre of CMFRI, Bombay - 400 023
4. Calicut Research Centre of CMFRI, West Hill P.O., Calicut -673 005
5. Mandapam Regional Centre of CMFRI, Mandapam Camp - 623 520

### **ABSTRACT**

The present paper deals with the distribution and abundance of perch resources in the Indian EEZ, based on trawling operations by *FORV Sagar Sampada* during cruises 1-90. Perches are available at depths 23-250 m; including the 27 stations along the Andaman Sea these were present in 151 stations. Trawling at depths within 100 m was more productive than beyond 100 m. The species composition also showed different pattern from within 100 m and beyond 100 m depth. The total yield of perches from the bottom trawling operations was 12 tonne with an average catch of 86.67 kg/hr. Though west coast registered a higher catch than the east coast, the catch rate was found to be better from the east coast. Good perch grounds were located between 18° to 20°N and 84° to 87° E at 60-70 m depth off the northeast coast.

### **INTRODUCTION**

Despite the innumerable innovations that have taken place, production from the marine sector is below the estimated assessments of potential yield. In the Exclusive Economic Zone of  $2.02 \times 10^6$  km<sup>2</sup>, concerted efforts are being made for a better and rational exploitation of the less exploited areas. The present surveys conducted by *FORV Sagar Sampada* are aimed at unravelling the unexploited and underexploited regions of the Indian EEZ. Perches, constituting one of the important components of the demersal resources, offer immense scope for exploitation along the coasts. The present paper deals with the distribution and abundance of perches in the EEZ of India, based on the data collected during cruises 1-90 of *FORV Sagar Sampada*.

## MATERIALS AND METHODS

The material for the study was collected by chalute bottom trawl, star model bobbin trawl, large granton trawl and also the CIFT designed High Speed Demersal Trawl (HSDT I-III). Perches were caught from 151 trawling stations in the depth range 23 to 130 m. Total catch, species composition etc, were recorded at each trawling station. The area surveyed was divided into northwest, southwest, northeast, southeast and Andaman and Nicobar regions. Depthwise distribution and abundance was studied by grouping the stations covered under different depth zones of 0-50, 51-100 and 101-150 m. Standing stock was estimated using the swept area method of Gulland (1971).

## RESULTS

### Distribution of perches in the Indian EEZ

Perches form one of the underexploited demersal finfish resources distributed widely along the shelf and upper slope regions of the EEZ. The average catch rate of perches in the present study was 121.02 kg/hr (Table 1). Fairly high catch rates of 143.51 kg/hr was noticed from the Andaman Sea. The average catch rate from the southwest region was 193.04 kg/hr. The southeast including the Gulf of Mannar yielded a good catch rate of 130 kg/hr; from the northeast coast also fairly good catch rate of 124 kg/hr was obtained. The northwest region was found to be the least productive, with average catch per hour of 39.24 kg.

### Geographical abundance

Very high production rate of the order of 900 kg/hr was obtained at depth less than 50 m in the area 7° 49'N and 77°3' off Cape Comorin. Again off Cape Comorin at 07°49'N, 77°10'E, high catch rates of 830 kg/hr were yielded. The highest production rates of 1486 kg/hr and 1640 kg/hr were obtained from 11°44'N, 92°39'E and 19°54'N, 86°46'E respectively. In the shallower depths of up to 50 m, high density pockets were located at stations 11°39'N, 79°54'E, 12°41'N, 80°23'E and

Table 1— Regionwise catch and catch per unit effort (in kg) of perches in the Indian EEZ

Region	Total catch (in kg)	Catch per unit in kg effort
Southwest	6801	193.04
Northwest	961	39.24
Northeast	2511	124.0
Southeast	2340	130.05
Andamans	1839.7	69.2

07°48'N, 77°34'E where the catch rates were 460, 288 and 264 kg/hr respectively. Productive areas were noticed in many stations along the southwestern regions (Table 2) in latitudes 7°, and 8°, where the catch ranged from 300 to 858 kg/hr. At many stations on the Wadge Bank and off Quilon the entire catch was constituted by perches. Off Marmagoa and at 15°N a few stations in the 101-150 m, depth zone 70% of the catch was constituted by perches. Along Ratnagiri coast at few stations 80% of the catch realised was shared by perches. In the Andaman Sea also high density pockets were located at 10°45'N, 92°19'E, 06°42'N, 93°56'E and 11°44'N, 92°46'E where the catch ranged between 300 and 1496 kg/hr. Along the northeast region (Table 3) in the depth zone 51-100 m highly productive areas were located at 18°49'N, 84°47'E, 18°02'N, 84°14'E, 16°04'N, 81°31'E, where the catch per hour ranged between 200 and 310 kg/hr forming 76-78% of the entire catch. In the southeastern region, in the Gulf of Mannar, off Madras and Cuddalore, good perch grounds were located mostly in the 51-100 m depth zone where the catch constituted exclusively of perches. At 14°11'N, 80°22'E the catch per hour obtained was 402 kg/hr and at 12°41'N, 80°23'E, it was 288 kg/hr and at 12°41'N, 80°23'E, it was 288 kg/hr, also at 10°30'N and 80°14'E the catch rate recorded was 256 kg/hr. Off Paradeep in the depth zone 51-100 m, 76-78% of the trawl net catch was shared by this resource. In the Andaman Sea at 10°45'N, 92°19'E (Table 4) 98% of the catch was constituted by perches.

### Depthwise distribution and abundance

From the present study, it could be discernible that 99.5% of the perch resources were obtained from 0-100 m depth strata. To be more precise, it was observed that catch was higher from the 51-100 m zone, than from the 0-50 m zone.

Along the southwest coast (Table 2) which includes the Wadge Bank and the Quilon Bank, 29.8% of the perch production was from the shallow regions of up to 50 m, 64.8% came from 51-100 m depth range and 6.2% from the deeper parts of the continental shelf. The highest catch rate of 900 kg/hr in the 0-50 m depth was obtained from the Wadge Bank; catch rates varying from 200 to 265 kg/hr were also obtained from depths 35 m and 45 m along the shallower parts of Quilon Bank and Wadge Bank. Yield was found to be better in the 51-100 m zone on the southwest coast (Table 2). The maximum catch rate of 850 kg/hr was observed in this depth zone on the Wadge Bank, from the Quilon Bank and from the rocky patches off Ponnani catch rates up to 420 kg/hr and 248 kg/hr respectively were obtained at the same depth zone. Off Karnataka, fairly dense concentrations of 300 kg/hr were noticed from depth up to 100 m.

On the northwest coast almost the entire catch came from the 51-100 m depth zone. The southeast zone showed fairly good catch (34.74%) from the shallower coastal waters up to 0-50 m. (Table 3) 64.8% was from 51-100 m beyond this depth the perch grounds were located in the shallow coastal waters up to 50 m depth off Cuddalore,

Table 2—Latitudewise abundance (in kg) of perches of the western half of Indian EEZ at different depth zones

Latitude	<i>Lutjanus</i> spp	<i>Lethrinus</i>	Serranids	<i>Plectorhynchus</i>	Other perches	Total
<i>Southwest coast</i>						
<i>Depth 0-50 m</i>						
7°	147	201	468	750	-	1566
8°	41	141	135	-	-	317
9°	41	-	-	2	-	2
13°	30	-	35	150	-	225
<i>Depth 51-100 m</i>						
7°	835	632	433	329	-	2229
8°	126	472	587	169	-	1354
9°	5	-	47	-	-	52
11°	-	-	300	-	-	300
12°	-	-	39	-	-	39
13°	25	-	35	-	-	60
14°	-	-	500	-	-	500
<i>Depth 101-150 m</i>						
8°	-	-	9	17	-	26
13°	18	-	6	-	-	24
15°	-	-	398	-	-	389
<i>Northwest coast</i>						
<i>Depth 0-50 m</i>						
18°	-	-	-	19	-	19
<i>Depth 51-100 m</i>						
15°	4	-	-	1	-	4
16°	-	-	254	1	-	255
17°	25	-	88	-	-	113
18°	-	-	241	-	-	241
19°	-	-	35	-	-	35
20°	-	-	-	-	47	47
21°	-	-	-	-	21	21
22°	-	-	60	-	-	60
23°	-	-	6	-	-	6
<i>Depth 101-150 m</i>						
16°	-	-	23	-	-	23

Table 3— Latitudewise abundance (in kg) of perches on the Eastern side of Indian EEZ at different depth zones

Latitude	<i>Lutjanus</i>	<i>Lethrinus</i>	Serranids	<i>Plectorhynchus</i>	Other perches	Total
<i>Southeast coast</i>						
<i>Depth 0-50 m</i>						
8°	18	10	46	1	-	74
10°	3	-	29	-	18	50
11°	70	350	40	-	-	460
12°	204	-	-	-	90	294
13°	16	25	1	30	-	72
14°	-	-	-	-	-	-
<i>Depth 51-100 m</i>						
7°	-	-	-	200	-	200
10°	93	193	17	264	270	837
11°	-	-	-	-	50	50
13°	106	18	4	-	18	146
14°	251	102	96	-	60	509
15°	-	32	-	-	-	32
<i>Depth 101-150 m</i>						
10°	14	-	-	-	-	14
<i>Northeast coast</i>						
<i>Depth 0-50 m</i>						
15°	2	3	-	-	-	5
16°	40	-	-	12	3	55
17°	-	-	-	-	17	17
18°	-	-	-	-	4	4
19°	120	-	-	72	-	192
20°	-	-	-	38	-	38
<i>Depth 51-100 m</i>						
16°	91	15	38	113	5	262
17°	16	-	-	102	-	118
18°	158	70	322	110	8	668
19°	1640	372	10	60	25	2107

Table 4— Latitudewise abundance (in kg) of perches in the Andaman-Nicobar region at different depth zones

Latitude	<i>Lujanus</i>	<i>Lethrinus</i>	Serranids	<i>Plectorhynchus</i>	Other perches	Total
<i>Depth 0-50 m</i>						
12°	-	11	-	6	-	17
13°	9	24	38	1	0.5	72.5
<i>Depth 51-100 m</i>						
6°	7	271	-	48	3	329
8°	87	7	10	-	-	104
10°	242.5	427	-	22	6	697.5
11°	1480	24	-	5	80	1589
12°	115	-	168	-	27	310
13°	91	335	96	227	-	749
<i>Depth 101-150 m</i>						
12°	-	-	7	-	-	7

Pondicherry with catch varying from 250 to 460 kg/hr. Catch rates up to 350-400 kg/hr were obtained in 51-100 m depths off Point Calimer and off Madras.

From the northeastern region 91% of the total perches caught were from the 51-100 m. Stations with dense populations of perches were located in the depth zone 51-100 m off Gopalpur and Paradeep coasts. The maximum catch rate of 1640 kg/hr was located in this depth belt.

Along the Andaman-Nicobar Sea, dense populations of perches abounded in the deeper waters. A total perch production of 3.87 tonne was obtained from this region, of which 97.5% came from the 51-100 m depth zone. A very high catch rate of 1496 kg/hr was obtained from the 51-100 m zone off south Andamans. Dense perch populations abounded off Little Andamans, south Andamans and north Andamans.

### Seasonwise abundance

The seasonwise distribution shows that (Table 5) along the southwest coast in the shallower depth of up to 50 m, perches were abundant during January to March and also during July to September. Dense populations occurred in the deeper waters of 51-100 m zone from July to December period. In the depth zone 101-150 m also this resource was present in fairly good quantity during October-December months. Along the northwestern region fairly good catches were recorded only from July up to December, in the 51-100 m depth zone.

On the southeastern parts of the Indian EEZ (Table 6) the distribution showed a different seasonal pattern. The resource was fairly abundant in the shallower waters

Table 5— Seasonal abundance (in kg) of perches along the western half of the Indian EEZ

	Southwest coast					Northwest coast						
	<i>Lut-janus</i> spp	<i>Lethrinus</i> spp	<i>Serranus</i> spp	<i>Plecto-rhynchus</i>	Other perches	Total	<i>Lut-janus</i> spp	<i>Lethrinus</i> spp	<i>Serranus</i> spp	<i>Plecto-rhynchus</i>	Other perches	Total
	0-50 m						0-50 m					
Jan-Mar	60	100	15	900	-	1075	-	-	-	-	-	-
Apr-Jun	-	-	-	2	-	2	-	-	-	-	-	-
Jul-Sep	117	201	621	-	-	939	-	-	-	-	-	-
Oct-Dec	41	41	12	-	-	94	-	-	-	19	-	19
	51-100 m						51-100 m					
Jan-Mar	5	10	467	-	-	575	4	-	1	-	-	5
Apr-Jun	33	-	84	35	-	152	-	1	-	-	-	-
Jul-Sep	45	35	1016	-	-	1096	25	-	484	1	-	510
Oct-Dec	908	1059	374	463	-	3900	-	-	199	-	68	267
	101-150 m						101-150 m					
Jan-Mar	18	-	9	-	-	27	-	-	-	-	-	-
Apr-Jun	-	-	-	-	-	-	-	-	-	-	-	-
Jul-Sep	-	-	20	-	-	20	-	-	-	-	-	-
Oct-Dec	-	-	375	17	-	392	-	-	-	-	-	-
	150 and above						150 and above					
Jan-Mar	3	-	-	-	-	3	-	-	23	-	-	23
Apr-Jun	-	-	-	-	-	-	-	-	-	-	-	-
Jul-Sep	-	-	-	-	-	-	-	-	-	-	-	-
Oct-Dec	-	-	-	-	-	-	-	-	-	-	-	-



Table 6— Seasonable abundance (in kg) of perches in the eastern Gulf of the Indian EEZ

	Southeast coast					Northeast coast						
	<i>Lutjanus</i> spp	<i>Lethrinus</i> spp	<i>Serranus</i> spp	<i>Plecto- rhyneus</i>	Other perches	Total	<i>Lutjanus</i> spp	<i>Lethrinus</i> spp	<i>Serranus</i> spp	<i>Plecto- rhyneus</i>	Other perches	Total
	Depth 0-50 m					Depth 0-50 m						
Jan-Mar	70	350	65	-	24	587	-	-	-	38	23	61
Apr-Jun	204	-	-	-	84	288	42	3	12	-	1	57
Jul-Sep	21	10	50	-	-	81	120	-	-	72	-	192
Oct-Dec	16	25	1	-	30	72	Depth 51-100 m					
	Depth 51-100 m					Depth 51-100 m						
Jan-Mar	37	-	100	-	18	155	126	387	49	281	33	376
Apr-Jun	240	150	17	240	110	757	-	-	35	40	-	75
Jul-Sep	110	105	-	200	201	616	1779	70	286	64	-	2199
Oct-Dec	63	90	-	24	69	246	Depth 101-150 m					
	Depth 101-150 m					Depth 101-150 m						
Jan-Mar	-	-	-	-	-	-	-	-	-	-	-	-
Apr-Jun	-	-	-	-	-	-	-	-	-	-	-	-
Jul-Sep	-	-	-	-	-	-	-	-	-	-	-	-
Oct-Dec	-	-	-	-	14	14	-	-	-	-	-	-

Table 7— Seasonal abundance (in kg) of perches on the Andaman-Nicobar area

Months	<i>Lutjanus</i> spp	<i>Lethrinus</i> spp	<i>Serranus</i> spp	<i>Plectorhynchus</i> spp	Other perches	Total
0-50 m						
Jan-Mar	-	-	-	-	-	-
Apr-Jun	9	35	38	7	0.5	88.5
Jul-Sep	-	-	-	-	-	-
Oct-Dec	-	-	-	-	-	-
51-100 m						
Jan-Mar	174	46	10	4	78	312
Apr-Jun	93.5	342	96	232	6	769.5
Jul-Sep	211	-	-	22	-	233
Oct-Dec	1544	676	168	44	44	2464
101-150 m						
Jan-Mar	-	-	-	-	-	-
Apr-Jun	-	-	-	-	-	-
Jul-Sep	-	-	-	-	-	-
Oct-Dec	-	-	7	-	-	7

of up to 50 m during the first half of the year. Fairly dense populations of perches were available during April-September period in the 51-100 m depth zone. In the north-eastern region resource abundance was noticed in January-March and October-December months. The same trend in seasonal abundance was observed in the Andaman region also (Table 7). In the depth zone 51-100 m fairly high density of population of perches was observed in the months January-March and October-December.

### Species composition

The major species of perches in the present study included *Lutjanus johri*, *L. guikheri*, *L. rivulatus*, *L. lineolatus*, *Lutjanus* sp. *Lethrinus nebulosus*, *Lethrinus* spp, *Pristipomoides types*, *P. multidens*, *P. filamentosus*, *Epinephelus diacanthus*, *E. tauvina*, *E. chlorostigma*, *Epinephelus* sp. *Argyrops spinifer*, *Plectorhynchus lineatus*, *P. diagramme*, *P. cressipinna*, *Diagramma pictum* etc. In the southwestern region in the depth zone 0-50 m, *Plectorhynchus* spp were abundant during January-March, which migrated to the deeper realms of 51-100 m during October-December. In the depth zone 0-50 m *Lutjanus* spp, *Lethrinus* spp and

*Serranus* spp though present in good quantity during July-September, these occurred in fairly dense proportions in the deeper zone of 51-100 m during the October-December.

Along the southeast coast, perches of family Serranidae were comparatively less. *Lethrinus* spp and *Lutjanus* spp were abundant in the shallower depths of 0-50 m during January-March and April-June, whereas fairly good quantities were obtained during April-June and July-September in the 51-100 m depth zone. Along the north-east coast *Lutjanus* spp occurred in the 0-50 m depth zone during October-December. In the Andaman Sea, 51-100 m depth zone had good concentrations of *Lutjanus* spp during October-December.

### Standing stock

Standing stock of perches estimated by the swept area method for the entire EEZ was 6870 tonne/km<sup>2</sup> in the present study. It was 2090 tonne/km<sup>2</sup> in the 0-50 m depth zone, 4400 tonne/km<sup>2</sup> in 51-100 m-depth whereas this was only 330 tonne/km<sup>2</sup> in depths beyond 100 m. West coast had the maximum standing stock of perches compared to the other four regions in the entire EEZ.

## DISCUSSION

Exploratory surveys conducted earlier have indicated the existence of underexploited resources of perches in the middle and outer shelf along both Arabian Sea and Bay of Bengal (Silas, 1969; Menon & Joseph, 1969; Joseph et al. 1987; Sudarsan et al. 1989). As observed by Joseph & John (1986) and James et al. (1986) perches offer immense scope for increased exploitation along both east and west coasts.

An evaluation of the relative abundance of perches in the different depth zones indicate the availability of this resource in fairly dense quantities in the 51-100 m depth zone in the EEZ of India. The same pattern was observed by Sudarsan et al. (1989) and Ninan et al. (1992) during the survey conducted by the Fisheries Survey of India vessels in the EEZ up to a depth of 300 m. The present study shows that along the southeastern parts of the Indian EEZ the resource was abundant in the shallower waters up to 50 m during January-June months. They seem to migrate into deeper waters of 51-100 m during April-September months. As observed by Joseph & John (1986) in the present study also it was observed that dense populations of perches occurred in the 51-100 m depth zone along the southwestern region during July-December months. Along the Andaman region the resource was abundant during January-March and October-December period. Similar pattern of abundance was noticed along the northeastern parts also. Very high density pockets were located along the northeastern parts and in the Andaman area during the present study. In many of these areas, the catch constituted exclusively of perches. This resource with judicious management policies offer very good scope for exploitation.

## ACKNOWLEDGEMENT

Authors are grateful to Dr. P.S.B.R. James former Director, and Dr. P.Bensam, Head, Demersal Fisheries Division for their kind encouragements in this study.

## REFERENCES

- Gulland, J.A. 1971. *The fish resources of the oceans*, (Fishing News Books Ltd., London) pp. 255.
- James, P.S.B.R., Alagarwami, K., Narayana Rao, K.V., Mathu, M.S. Rajagopalan, M.S., Alagaraja, K & Mukundan, C. 1986. Potential marine, fishery resources of India, Proceedings of the seminar on Potential Marine Fishery Resources, *CMFRI Spl. Pubn.*30: 44-74.
- Joseph, K.M. & John, M.E. 1986. Potential marine fishery resources, Proceedings of the seminar on Potential Marine Fishery Resources, *CMFRI, Spl. Pubn.* 18-43.
- Joseph, K.M., Sulochanan, P., Hohn, M.E., Somavanshi, V.S., Nair, K.N.V. & Antony Joseph. 1987. Demersal fishery resources of the Wadge Bank, *Bull. Fish. Sur. India*12: 1-52.
- Menon, M.D. & Joseph, K.M. 1969. Development of Kalava (rock cod) fishery of southwest coast of India—Prospects, *Sea food Export J.*1(2): 7-28.
- Ninan, T.V., Sivaji, V., Jagannadh, N., & Ramalingam, L. 1992. Observations on demersal resources survey between lat., 7°N and 11°N along southwest coast, Wadge Bank and Gulf of Mannar during 1989-90, *Bull. Fish. Sur. India*, 24: 14-32.
- Silas, E.G. 1969. Exploratory fishing from R.V. *Varuna*, *Bull. Cent. Mar. Fish. Res. Inst.*12: 86.
- Sudarsan, D., Sivaprakasan, T.E., Somavanshi, V.S., John, M.E., Nair, K.N.V. & Antony Joseph, 1988. An appraisal of the marine fishery resources of the Indian Exclusive Economic Zone, *Bull. Fish. Sur. India*, 18: 1-82.
- Sudarsan, D., John, M.E. & Antony Joseph. 1989. An assessment of demersal stocks in the southwest coast of India with particular reference to the exploitable resources in the outer continental shelf and slope, *Bull. Cent. Mar. Fish. Res. Inst.* 44(1): 266-272.

\* \* \*

## Finfish resources around Andaman and Nicobar islands

N.G.K. Pillai, N.G. Menon, R. Thiagarajan & A. Raju

Central Marine Fisheries Research Institute, P.B.No.1603, Cochin-682 014

### ABSTRACT

The average catch rate of finfishes obtained by *FORV Sagar Sampada* from the survey area in the Andaman Sea was 259 kg/hr and the yield ranged from 8.6 to 1260 kg/hr. Silver bellies was the most abundant component (37.5%) with a catch rate of 96.9 kg/hr. Carangids, elasmobranchs and perches accounted for 20.3%, 11.9% and 8.0% of the total catch and the corresponding catch rates were 52.5, 31.1 and 20.8 kg/hr respectively. The highest catch rate of 1260 kg/hr was recorded from 13°10'N - 92°37'E at a depth of 65m. The catch rate indicated that the depth zone 51-100 m is productive and yielded 84.7% of the total catch at a catch rate of 501.4 kg/hr. Although the pelagic trawl was operated at 38 stations, the catch realised was negligible (0.83 kg/hr).

### INTRODUCTION

The Andaman and Nicobar waters (596554 km<sup>2</sup>) forms about 29.6% of the total area of Indian EEZ, which is considered as one of the dominant upwelling areas of Indian Ocean and hence very productive for several fish resources. The earlier limited surveys indicated that the area is rich in tuna and tuna like fish, sharks, cephalopods and pelagic shoaling fish (Sudarsan, 1978; Sudarsan & Somvanshi, 1988, Sudarsan *et al.* 1988). Though the present fish production from this region is only 22339 tonne, the estimated potential yield is 139000 tonne which gives ample scope for intense exploitation (Anon, 1991). This vast potential demands extensive surveys in this region to locate and estimate various finfish resources in different zones, seasons and depths. Earlier surveys conducted by *FORV Sagar Sampada* during 1985-'88 period located high fishable concentration of threadfin breams, bull's eye, lizard fish etc. in the Andaman and Nicobar islands waters (James & Pillai, 1990). Bande *et al.* (1990) estimated regionwise and bathymetric abundance of bull's eye and its potential yield based on the 1985-88 survey data of *FORV Sagar Sampada*. Similarly, the abundance of the threadfin breams and lizard fish along the Andaman and Nicobar region was estimated by Nair & Reghu (1990). With an objective to confirm the results

obtained by earlier surveys as well as to get a more accurate picture on the finfish availability and abundance in the sea around Andaman and Nicobar islands the present study was carried out.

## MATERIALS AND METHODS

*FORV Sagar Sampada* carried out six exclusive cruises (April 1988 to January 1989) in the area lat.  $07^{\circ}53'$  -  $14^{\circ}30'N$ ; long.  $90^{\circ}30'$  -  $94^{\circ}54'E$ . The location of twelve stations from where the finfish were caught by bottom trawls is marked in Fig.1. Due to uneven rocky/coral grounds, bottom trawling could be carried out only from about 10% of the total stations sampled. However, all the pertinent data on the rate of yield, species composition and bathymetric abundance of various fishes are analysed and results presented in this account.

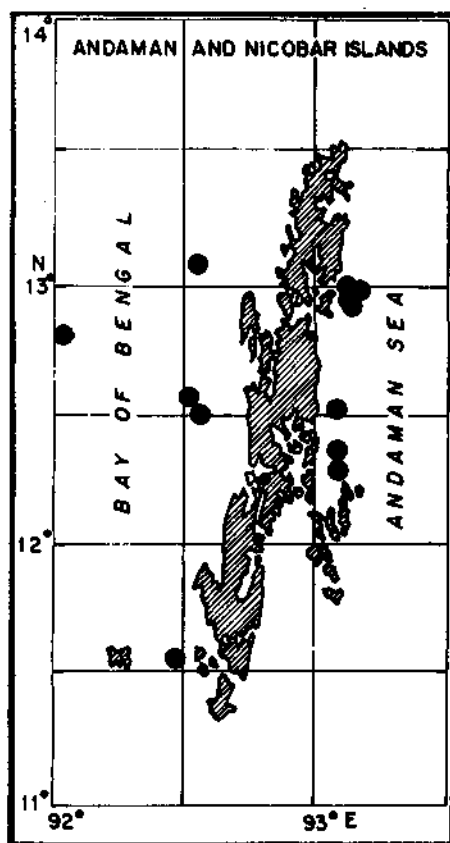

Fig.1 - Stations indicating the positions where the bottom trawling was conducted

## RESULTS

## Demersal resources

Bottom trawling operations in this region produced a total catch of 270 kg fish with an average catch rate of 259.3 kg/hr. In all the six cruises, bottom trawl could be operated only at 12 stations and yield ranged from 8.6 to 1260 kg/hr (Fig. 1). The groupwise catch rate and their percentage composition in the island waters is given in Table 1. In this region silver bellies formed the major catch (98.9 kg/hr) accounting for 37.5% of the total fish production. Carangids were the next important item (52.5 kg/hr) forming 20.3% followed by elasmobranchs (31.1 kg/hr and 11.9%), perches (*Epinephelus* spp, *Lutjanus* spp, *Lethrinus* spp) with a catch rate of 20.8 kg/hr (8.0%) and *Arioma indica* (11.3 kg/hr and 4.3% of total catch). Generally the catches were low in most of the stations. The highest catch of 1260 kg/hr was recorded from 13°10'N, 92°37'E at a depth of 65m and composed mostly of silver bellies (51.1%) and carangids (17.1%).

Table 1 - Fish production, abundance and percentage composition of major groups in the Andaman and Nicobar region

Groups	Production (kg)	Abundance (kg/hr)	Catch (%)
Silver bellies	775	96.9	37.5
Carangids	420	52.5	20.3
Miscellaneous fish	265	32.8	12.8
Elasmobranchs	247	31.1	11.9
<i>Arioma indica</i>	90	11.3	4.3
<i>Lethrinus</i> spp	79	9.9	3.8
<i>Epinephelus</i> spp	55	6.9	2.7
Lizard fish	32	4.0	1.5
<i>Lutjanus</i> spp	32	4.0	1.5
Ribbon fish	30	3.8	1.4
Barracudas	20	2.5	1.0
Other perches	15	1.9	0.7
Nemipterids	11	1.4	0.5
Bull's eye	3	0.4	0.1
Total	2074	259.4	

The total fish yield, catch rate and percentage composition of dominant fish in the depth zones 0-50, 51-100 and 101-150 m are presented in Table 2. In coastal waters of 50 m depth the catch rate was 204.8 kg/hr, which accounted for 7.4% of the total production. The main groups of fish caught were *Epinephelus* spp (950.5 kg/hr) and *Lethrinus* spp (47.9 kg/hr) forming 24.7% and 23.4% respectively of the total yield from 0-50 m depth zone. The highest catch rate of 501.4 kg/hr was recorded from 51-100 m depth zone forming 84.7% of the total fish production. Silver bellies (44%), carangids (22.1%), elasmobranchs (9.8%) and *A.indica* (5.1%) were the main fishes landed from this depth belt. Only 7.9% of the total catch was realised from the depth zone 101-150 m with a low rate of production of 59.6 kg/hr. The catch from this depth strata composed chiefly of elasmobranchs (25.1%), carangids (8.5%) and *Epinephelus* spp (7.9%). In general <100 m depths yielded high catch rates of silver bellies (261.5 kg/hr), carangids (155.4 kg/hr), perches (92.9 kg/hr) and elasmobranchs (87.2 kg/hr); whereas the area >100 m depth yielded low catch rates of elasmobranchs (26.9 kg/hr), carangids (5.1 kg/hr) and *Epinephelus* spp (4.7 kg/hr).

Out of 12 stations trawled elasmobranchs were recorded from 5 stations with catch rate of 8 to 163.5 kg/hr. The highest catch was from 12°18'N, 93°09'E at a depth of 65 m. The nemipterid landing was very low (0.5 to 5 kg/hr) in this region. The rate of production of carangids fluctuated from 1.3 to 480 kg/hr in the 8 positive (successful hauls) stations and the peak catch was from 12°30'N, 92°32'E at a depth of 90 m. The production of lizard fish and "bull's eye" were low with catch rate ranging from 0.4 to 12 kg/hr and 0.4 to 2 kg/hr respectively. Though *A.indica* was caught only from one station (12°30'N, 93°05'E) the rate of production was fairly high (360 kg/hr) from the depth of 90 m. The yield of perches ranged from 5 to 165.8 kg/hr and that of silver bellies from 0.1 to 770 kg/hr.

Table 2 - Depthwise fish resource abundance in the Andaman and Nicobar region

Depth (m)	Total catch (kg)	Catch (%)	Catch rate (kg/hr)	Major groups (kg/hr)
0 - 50	154	7.4	204.8	<i>Epinephelus</i> spp (50.5kg) - 24.7% in total catch of the depth zone <i>Lethrinus</i> spp (47.9kg) - 23.4% Carangids (26.6kg) - 13.0%
51 - 100	1755	84.7	501.4	Silver bellies (220.6 kg) - 44% Carangids (110.6kg) - 22.1% Elasmobranchs (49.1kg)- 9.8% <i>Arioma indica</i> (25.7kg)- 5.1%
101 - 150	165	7.9	59.6	Elasmobranchs (26.9kg)- 25.1% Carangids (5.1kg) - 8.5% <i>Epinephelus</i> spp (4.7kg)- 7.9%



## Pelagic resources

Pelagic trawl was operated at 38 stations during 5 cruises to assess the pelagic resources. The total yield was only 32.5 kg with a catch rate of 0.83 kg/hr. The catch comprised mainly of *Decapterus* spp, *Caranx* spp, *Diaphus* spp, juveniles of *Lethrinus* spp, *Caesio* spp and *Lutjanus* spp. In general the catch obtained by pelagic trawling was negligible. The major catch was *Decapterus* spp, *Diaphus* spp and *Caranx* spp weighing about 28.5 kg caught at 4 stations. The rest of the 13 positive trawling operations yielded only 4 kg of fish mainly constituted by juvenile fishes. No catch was obtained at 21 stations.

## DISCUSSION

Although *FORV Sagar Sampada* surveyed the Andaman and Nicobar waters during April 1988 to January 1989 and covered 124 stations, in six cruises, the bottom trawl was operated only from 12 stations by expending 8 hours effort, chiefly due to the uneven non-trawlable grounds in most of the stations. Further, the mean catch rate of 259.3 kg/hr is slightly higher than what was reported (247.1 kg/hr) by Sivakami (1990) from the same region in 1985-88 period. Fishes such as silver bellies (30%), carangids (17.2%), elasmobranchs (11.7%) and perches (10.3%) were the major groups available in this region (Sivakami, 1990). This observation is in perfect agreement with the current data of 1988-89 from Andaman and Nicobar waters. As regards the depthwise abundance of fishes, the highest catch rate of 230.9 kg/hr was recorded from 0-50 m and 27.8 kg/hr and 17.9 kg/hr from 51-100 and 101-150 m depth respectively by Sivakami (1990). On the other hand the present survey data indicates that the peak catch rate of 501.4 kg/hr was from 51-100 m depth belt. As most of the shelf area of this region is unsuitable for demersal trawling, in future surveys, intense efforts need be expended to long-lining, gillnetting, purse-seining and pelagic trawling in order to chart the areas of concentration of different finfishes.

## ACKNOWLEDGEMENT

Authors are thankful to Dr.P.S.B.R.James, former Director and Dr.P.P.Pillai for their keen interest and encouragement. Thanks are also due to Mr.M.N.K.Elayathu for the technical assistance.

## REFERENCES

- Anon. 1991. Report of the working group on revalidation of the potential marine fisheries resources of the EEZ of India, February 1991, pp. 57.
- Bande, V.N., Menon, N.G. & Balachandran, K. 1990. Studies on the distribution and abundance of Bull's eye (*Priacanthus* spp) in the EEZ of India. In: *Proc. First Workshop Scient. Resul. FORV Sagar Sampada*, edited by K.J.Mathew, (CMFRI, Cochin) 233-238.
- James, P.S.B.R. & Pillai, V.N. 1990. Fishable concentrations of fishes and crustaceans in the offshore and deep sea areas of the Indian Exclusive Economic Zone based on observations made on board

- FORV Sagar Sampada*, In: *Proc. First Workshop Scient. Resul. FORV Sagar Sampada*, edited by K.J.Mathew, (CMFRI, Cochin) 201- 213.
- Nair,K.V.S. & Reghu,R. 1990. Treadfin breem and lizard fish resources in the Exclusive Economic Zone of India based on demersal trawling operations of *FORV Sagar Sampada*, In: *Proc. First Workshop Scient. Resul. FORV Sagar Sampada*, edited by K.J.Mathew, (CMFRI, Cochin) 239-255.
- Sivakami,S. 1990. Observations on the demersal fishery resources of the coastal and deep-sea areas of the Exclusive Economic Zone of India, In: *Proc. First Workshop Scient. Resul. FORV Sagar Sampada*, edited by K.J.Mathew, (CMFRI, Cochin) 215-232.
- Sudarsan, D. 1978. Results of exploratory survey around the Andaman Islands, *Bull. Expl. Fish. Proj.* 7: pp.45.
- Sudarsan, D & Somvanshi, V.S. 1988. Fishery resources of the Indian Exclusive Economic Zone with special reference to upper east coast, *Bull. Fish. Surv. India.* 16: 1-26.
- Sudarsan,D., Sivaprakasam,T.E, Somvanshi,V.S., John,M.E., Nair,K.N.V. & Joseph,A. 1988. An appraisal of the marine fishery resources of the Indian Exclusive Economic Zone, *Bull. Fish. Surv. India*, 18: pp.85.

\* \* \*

## Mesopelagic fishes from equatorial waters contiguous to Indian EEZ

A.A. Jayaprakash

Central Marine Fisheries Research Institute, P.B. No. 1603, Cochin-682014

### ABSTRACT

Observations on the mesopelagic fishes taken by mid water trawl in the equatorial region (lat. 03°S- 03°N to long. 76°- 86°E) are presented. The trawling operations were carried out at 12 stations at a depth range of 40-200 m where the station depth varied from 2760-3600 m. The total catch from these stations was 156.6 kg at a catch per hour of 13.1 kg. The average catch per hour was 6.5 kg from the northern side of the equator compared to a higher value of 15.7 kg recorded from the southern side of the equator. Out of a variety of mesopelagic fishes caught, the myctophids constituted 61.3 per cent and the most dominant species were *Diaphus effulgens*, *Triphoturus nigrescens*, *Symbolophorus evermanni* and *Lampanyctus pusillus*. Among the rest of the mesopelagic fishes *Cubiceps natalensis* was the dominant species. The species and size composition of the major constituents are given. The need for target oriented fishing for the economic utilisation also is discussed.

### INTRODUCTION

There are a number of mesopelagic and bathypelagic fishes occurring in the EEZ of India and the contiguous seas. These resources, especially the myctophids have assumed importance in recent years in view of their potential for exploitation, human consumption, for production of fish meal/oil and as a source of animal protein. Recently the US GLOBEC (1993) studies have indicated that the Arabian Sea is dominated by myctophids and *Benthosema pterotum* is the largest single species population in the world with a stock estimate amounting to 100 million tons. The mesopelagic fishes are part of the deep scattering layer and are represented either in the juvenile or adult stage. They are opportunistic feeders on zooplankton, prawns and fishes. As part of the food web they are predators or prey at various trophic levels. They exhibit diurnal migration between surface and 200 m at night, and during day time remain at depths between 800 to 1000 m. During the vertical migration they

provide forage for commercial fishes and serve as a vital link between zooplankton community and larger predatory fishes.

Some of the studies on the mesopelagic resources such as the myctophids are on their taxonomy and distribution (Nafpaktitis & Nafpaktitis, 1969; Kotthaus, 1972) and on the ecology of the mesopelagic fauna in the eastern Indian Ocean (Legend, 1967). Studies on the myctophid fauna of the western and northern Arabian Sea were carried out by R/V Dr. Fridtjof Nansen during 1975-76. Information on the myctophid larvae is limited (Bekker, 1964; Ahlstrom, 1968; Valsa, 1979; and Peter, 1982; Mini Raman & James, 1990; Menon, 1990). The biochemical and nutritional aspects have been studied by Gopakumar *et al.* (1983) and Nair *et al.* (1983). The present paper gives a preliminary account on the qualitative abundance and size composition of mesopelagic fishes caught in the midwater trawl from the equatorial waters contiguous to the Indian EEZ.

## MATERIALS AND METHODS

The material for the study was collected from the mid water trawl catch onboard *FORV Sagar Sampada* cruise 12 in the equatorial waters contiguous to the Indian EEZ during 21 January to 18 February 1986. The area covered ranged from lat. 03°N to 03°S and long. 76°E to 86°E. German type rectangular mid water trawl was operated during day and night time at 12 stations (Fig.1) at depths varying from 40-200 m. The station depth varied from 2760-3600 m. The trawling time was maintained at

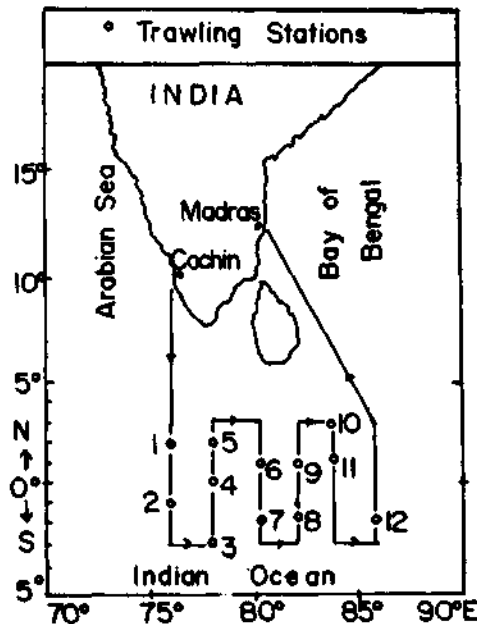

Fig.1 - Areas covered and pelagic trawling stations

30 minutes and the catch in each haul was computed to get the catch per unit effort in hour. Six hauls were made in the north side of the equator, one in the equator and five hauls in the southern side of the equator. The total catch, species and size composition was recorded onboard itself.

## RESULTS

The total catch from the 12 stations was 156.6 kg at a catch per hour of 13.1 kg. The catch was nil at stations 4 and 9. From the north side of the equator (stations 1,5,6,9,10 and 11) the total catch realised was 78 kg at a catch per hour of 6.5 kg. The total catch from the five stations (2,3,7,8 and 12) on the southern side amounted to 78.6 kg at a catch per hour of 15.7 kg. Taking the overall catch of mesopelagic fishes, the myctophids formed 61.3% , and regionwise they contributed to 59.8% on the northern side and 62.7% on the southern side of the equator. The important species of myctophids encountered were *Diaphus effulgens*, *Triphoturus nigrescens*, *Symbolophorus rufinus*, *Lampanyctus pusillus* and *Bolinichthys photothorax*. The size of these species ranged from 25-130 mm (Table 1). Among other mesopelagic fishes *Cubeiceps natalensis* constituted 5%. In addition a number other species were encountered and the details are given in Table 1.

## DISCUSSION

Though the mid water trawling operations in the equatorial region were not successful, the study has indicated the qualitative abundance of various mesopelagic species. The low catch and catch per hour appeared to be due to the poor performance of the gear, mostly due to non-target fishing. Various other reasons and setbacks have been attributed to it (Kuttappan *et al.* 1990). During the present cruise the position of the deep scattering layer (DSL) varied between 20- 400 m (Pon Siraimetan, 1990). Menon (1990) opined that in the equatorial Indian Ocean the Deep Scattering Layer was found in one to several layers. A thick but diffuse layer was recorded at 900-1000 m depth in station 01°N 80°E - 3500 m, 02°N 84°E - 3231 m and 00°N 86°E - 3325 during daytime. However, the principal layer was found at 250-400 m in most of the oceanic stations during January and February 1986. Based on the Issacs- Kid Mid Water Trawl collections Pon Siraimetan (1990) recorded the average fish biomass (vol in ml per 30 minutes haul) as 51.4 ml, 68.1 ml and 70.3 ml in the areas north of equator, equator and south of equator respectively. Here only two species of myctophids such as *Myctophum effulgens* and *M. evermanni* and among other fishes *Polyipnus spinosus*, *Nemichthys scolopaceus*, *Vinciguerria lucetia* were encountered compared to a variety of fishes noticed in the midwater trawl while only the juveniles of *M. effulgens* (5-40 mm) and *M. evermanni* (15-40) were noticed in the IKMT, larger and adult specimens occurred in the midwater trawl, indicating their concentration in the deeper layers of the deep scattering layer. The concentration of

Table 1 - Total catch and percentage contribution of mesopelagic fishes from the equatorial waters of the Indian sub-continent

Species	Contribution (%)			
	North of Equator	Equator	South of Equator	Size range (mm)
<b>Myctophids</b>				
<i>Diaphus effulgens</i>	8.7	-	26.1	40-130
<i>D. perspicillatus</i>	8.5	-	-	30-60
<i>D. splendidus</i>	7.0	-	-	25-65
<i>Symbolophorus evermanni</i>	-	-	1.9	30-85
<i>S. rufinus</i>	11.2	-	3.7	30-95
<i>Myctophum spinosum</i>	3.6	-	0.4	55-85
<i>M. phengodes</i>	5.0	-	-	40-65
<i>Lampanyctus pusillus</i>	2.8	-	10.3	30-85
<i>Lobianchia gemellarii</i>	2.8	-	1.0	35-80
<i>Triphoturus nigrescens</i>	9.5	-	6.0	40-85
<i>Bolinichthys photothorax</i>	-	-	10.6	40-90
<i>Ceratoscopelus warmingii</i>	0.8	-	2.8	30-75
<b>Other fishes</b>				
<i>Cubiceps natalensis</i>	4.7	-	5.3	15-120
<i>Diplophos taenia</i>	2.3	-	-	70-145
<i>Vinciguerria lucetia</i>	0.6	-	0.3	35-60
<i>Idiacanthus atlanticus</i>	0.8	-	0.6	140-240
<i>Stomias boa</i>	1.2	-	1.7	140-240
<i>Chauliodus sloani</i>	0.4	-	1.3	85-130
<i>Astronesthes niger</i>	1.7	-	0.5	
Miscellaneous fishes	4.9	-	8.9	
Prawns & squids	23.5	-	18.6	
Station Nos.	1,5,6,9,10 & 11	4	2,3,7,8,12	
<b>Total catch (kg)</b>	<b>78</b>	<b>nil</b>	<b>78.6</b>	

these fishes was comparatively higher before mid night compared to daytime and early hours.

Recent studies by the U.S. GLOBEC (1993) have indicated good potential of the myctophid fishes to the tune of 100 million tonnes in the world oceans. *Benthosema pterotum*, reported to be the most dominant species in the northern Arabian Sea was absent in the collections of IKMT and mid water trawl from the equator. The biochemical and nutritional aspects of myctophids and the immense possibilities for their utilisation have been indicated by Gopakumar *et al.* (1983) and Nair *et al.* (1983). Large quantities of myctophids such as *Diaphus* spp. are consumed by fishermen of Suruga Bay, but they sort out and discard *B. pterotum* as inedible (Kubota, 1982).

In view of the importance of the mesopelagic fishes, the need is to make target oriented surveys in the EEZ to study these resources in detail about their availability in space and time, and it is essential to investigate various aspects of the biology and fishery potential so that ways of economic exploitation can be worked out.

## REFERENCES

- Ahlstrom, E.H. 1968. Appraisal of the IIOE larval fish collection of IOBC Cochin, India. UNESCO/NS/IOC/INF Report No. 137: 1-10.
- Bekker, V.E. 1964. Slendertailed luminescent anchovies genera *Loweina*, *Tarletonbiana*, *Gonichthys* and *Centrobranchus* of the Pacific and Indian oceans. Systematics and distribution, *Trudy Instituta Okeanologii*, 73:79-97 (Engl. transl. U.S. Dept. Comm., 65-50120).
- Gopakumar, K., Nair, K.G.R., Nair, P.G.V., Nair, A.L., Radhakrishnan, A.G. & Nair, P.R. 1983. Studies on the lanternfish (*Benthosema pterotum*) 1. Biochemical and microbiological investigations, *Fish Technol. Soc., Cochin*. 20 (1): 17-19.
- Kotthaus, A. 1972. Fische des Indischen Ozeans "Meteor". *Forsche-Ergebnisse Reihe D*. a 12:12-35.
- Kubota, T. 1982. Food of lanternfishes in Suruga Bay, Central Japan, In: *North Pacific Aquaculture Symp.*, edited by B.R. Melteff & R.A. Neve. (University of Alaska) 275-283.
- Kuttappan, A.C., George, V.C., Varghese, M.D. & Vijayan, V. 1990. Development of mid water trawls. In: *Proc. First Workshop Scient. Result. FORV Sagar Sampada*, edited by K.J. Mathew, (CMFRI, Cochin) 435-439.
- Legend, M. 1967. Cycles biologiques des poissons mesopelagiques dans l'est de l'Océan Indien. Première note. *Scopelopsis multipunctatus*, *Gonostoma* sp., *Notolychnus valdiviae*, *Cah. ORSTOM, Oceanogr.* 5:73-98.
- Menon, N.G. 1990. Preliminary investigation on the fish biomass in the deep scattering layers of the EEZ of India. In: *Proc. First Workshop Scient. Result. FORV. Sagar Sampada*, edited by K.J. Mathew. (CMFRI, Cochin) 273-280.
- Mini Raman & James, P.S.B.R. 1990. Distribution and abundance of lanternfishes of the family Myctophidae in the EEZ of India, In: *Proc. First Workshop Scient. Result. FORV Sagar Sampada*, edited by K.J. Mathew, (CMFRI, Cochin) 285-290.
- Nafpaktitis, B.G. & Nafpaktitis, M. 1969. Lanternfishes (Family Myctophidae) collected during cruises 3 and 6 of the *R.V. Anton Brunn* in the Indian ocean, *Bull. Los Angeles Country Mus. Nat. Hist. Sci.* 5:1-79.
- Nair, V.R., James, M.A., Mathew, P.T. & Gopakumar, K. 1983. Studies on the lanternfish (*Benthosema pterotum*) 2. Nutritional evaluation. *Fish Technol. Soc. Cochin*. 20 (1): 20-23.
- Peter, K.J. 1982. Myctophid resources of Arabian Sea and Bay of Bengal. *Proc. Symp. Post Harvest Technology* (Fish Technol. Soc. Cochin) 83-84.

- Pon Siraimetan. 1990. Bioproductivity studies in the south west coast of India and equatorial region. In: *Proc. First Workshop Scient. Resul. FORV Sagar Sampada*, edited by K.J. Mathew, (CMFRI, Cochin) 297-303.
- U.S. GLOBEC. 1993. *Implementation plan and workshop report for US Globec studies in the Arabian Sea*. Report No. 9 ( U.S. Global Ocean Ecosystem Dynamics). pp. 105.
- Valsa, J.P. 1979. Larval development of the lanternfish *Diogenichthys panurgus*. *Bull. Dep. Mar. Sci., Univ. Cochin*. 10:1-18.



## Distribution, abundance and biology of unicorn cod, *Bregmaceros mccllelandi* in the deep scattering layers of Indian Exclusive Economic Zone

R. Reghu, K. Balachandran, N.G. Menon, E. Vivekanandan, S.K. Chakraborty  
& P. Devadoss

Central Marine Fisheries Research Institute, Cochin-682014

### ABSTRACT

In the deep scattering layer (DSL) the fishes have accounted for 5.4 % of the total (numerical) biomass. Juvenile fish belonging to different families were the most abundant component followed by Vinciguerria, myctophids, leptocephali, stomi-forms, and unicorn cod. The "unicorn cod is represented by a single species, *Bregmaceros mccllelandi* (2.4%) in the total fish biomass. It occurred in 52 stations out of 445 IKMT stations. During day time the average number per haul was 21 where as in night hauls it was 29. The resource was fairly abundant along the northwest coast within the depth belt of 200 m. Biological studies on the size composition, feeding habits, and reproductive biology of the species were also carried out. The length ranged from 10-65 mm. The major diet consists of copepods, euphausiids, cheatognaths, ostracods and decapod larvae. Invariably the feeding intensity was low. The catch was composed of mostly females in maturity stages IV-V. The species spawns only once in a year. The fecundity ranged from 530 - 980 in fishes of 42 - 50 mm in total length.

### INTRODUCTION

*Bregmaceros mccllelandi* (Thompson), unicorn cod or the spotted codlet, belongs to the family Bregmacerotidae and is a small fish, distributed along the Indian waters extending to China and Philippines; entering estuaries. It forms a coastal fishery along the coasts of Maharashtra and Gujarat. In dol net fishery the landings are the highest in the October - December period and the lowest in months of June to September. The fishery starts from October after the southwest monsoon with peak landings, which dwindles by March. Along the other coastal regions of India it occurs only in stray catches (Rao, 1973). Menon (1990) reported that Bregmacerotidae formed about 2.4% in the total fish biomass (numerical) from the Isacc Kidd Mid Water Trawl (IKMT)

hauls of deep scattering layer (DSL). The biocomposition of the DSL of Indian EEZ has been described by Silas (1972), Menon (1990), Menon & Prabha Devi (1990) and Mathew & Natarajan (1990). In the total biocomposition meso zooplankton occupied an important component (94.6 %) and finfishes formed 5.4 %. Juvenile fishes belonging to different families were the most abundant component followed by Vinciguerra, myctophids, leptocephali, stomiforms and unicorn cod. They form important prey organisms for many surface shoaling fishes. The unicorn cod is represented by a single species, *Bregmaceros mccllelandi*.

The distribution of the unicorn cod in the deeper waters is not clearly studied so far. Information on the biology is also of vital importance in view of its role in the food chain of the major oceanic pelagic resources. In spite of this, very little attention has been paid towards a detailed study of this fish. Hence an attempt is made to study the distribution, abundance and biology of *Bregmaceros mccllelandi* collected by IKMT from the DSL of Indian EEZ by FORV SAGAR SAMPADA.

## MATERIALS AND METHODS

The material for this study was collected from the *FORV Sagar Sampada* cruises made during February 1985 - May 1986. The samples were collected from appropriate depths (invariably the principle layers) of DSL recorded by echo-sounder. The Isaac Kidd Mid Water Trawl (IKMT) was operated from 445 stations at a 3 knot speed of

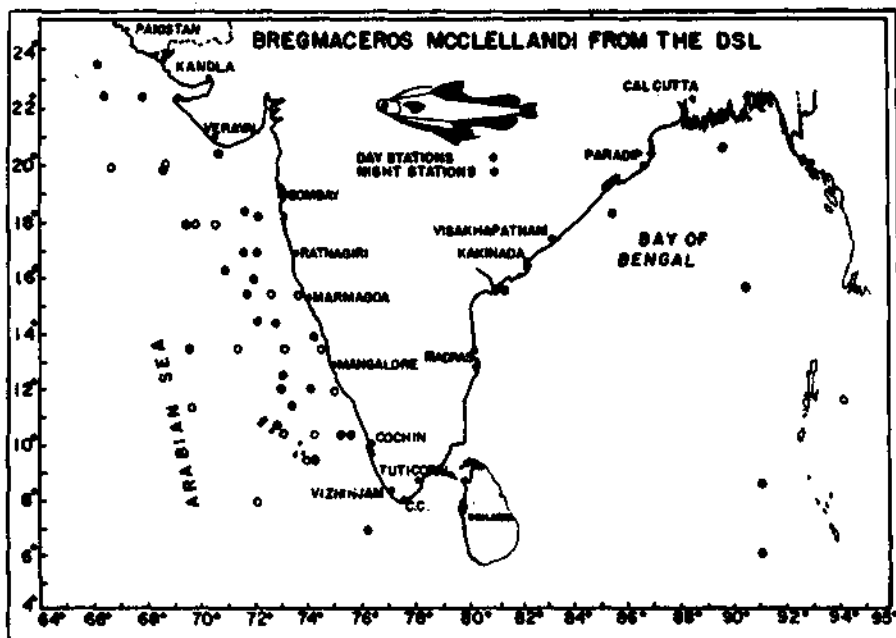

Fig. 1 - Station locations and general distribution of *B. mccllelandi*

which 364 stations yielded DSL biomass. *Bregmaceros maclellandi* occurred in 52 stations. The area (Fig.1) covered, the description of the gear and operational details are reported earlier Menon (1990), Menon & Prabha Devi (1990) and Mini Raman & James (1990). The species was separated for biological studies like length composition, food and feeding habits, maturity conditions, ova diameter frequency and fecundity by using standard techniques.

## RESULTS

The results of this investigation provide a preliminary knowledge of the horizontal and, depthwise distribution, food and feeding habits and its fecundity. Menon (1990) reported that fish abundance in DSL ranged from 0.01 to 45 g/1000 m in the total DSL fish biomass. Fish were recorded in 82 % of the total IKMT stations. Fishes of the family Bregmacerotidae formed about 2.4 % (numerical) of DSL; during day time it was 2 % and in the nighttime it was 2.7 %. It was reported from 52 stations. During daytime hauls the average catch was 21 number per haul and in night the IKMT brought 29 numbers per haul.

*Horizontal distribution* — The DSL, IKMT day and night stations where *B. maclellandi* reported during February 1985 to May 1986 are shown in Fig.1. The unicorn cod is fairly well represented in the northwest coast especially along 15° - 19° N latitude; whereas its occurrence was moderate along southwest coast and Andaman and Nicobar waters. The species was recorded in 22 stations in northwest and 20 stations in the southwest coast of Indian EEZ. The important areas of abundance in all the regions where the catch per haul was more than 10 numbers are given in Table 1.

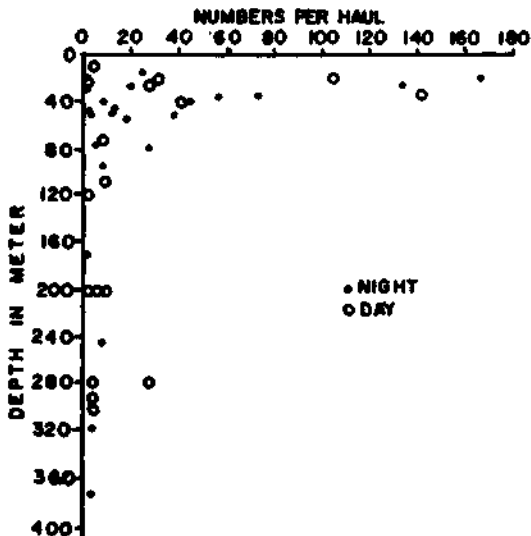

Fig. 2 - Depthwise distribution of *B. maclellandi*

Table 1 - Major area of abundance of *Bregmaceros maclellandi* in the DSL of Indian EEZ

Region	Position		Time	Catch (No/haul)
	Lat. (N)	Long (E)		
Northwest	16°25'	70°54'	N	70
	19°59'	68°30'	D	27
	20°30'	69°30'	N	57
	23°30'	66°00'	N	43
	22°30'	66°21'	N	14
	18°30'	71°30'	N	19
	15°30'	73°20'	D	105
	18°20'	72°02'	N	166
	19°40'	70°40'	D	141
Southwest	13°30'	71°24'	N	51
	10°29'	75°30'	N	74
	15°00'	73°00'	D	44
	14°00'	74°10'	N	25
	12°00'	72°59'	N	21
	08°00'	71°58'	D	29
Northeast	18°33'	85°28'	N	27
	20°57'	89°31'	N	32
A & N Islands	09°00'	91°01'	N	12
	14°50'	92°00'	N	42
	15°00'	87°18'	N	37
	15°00'	90°31'	N	133

*Depthwise abundance* — It is clear that the fish were common in DSL depth range with in 200 m. Fairly high catch was recorded during nighttime in the surface layers upto about 80 m (Fig.2).

*Size frequency distribution* — The distribution of the size composition is based on the study of 400 fishes. The total length ranged from 10 - 65 mm with one or two modes in each months. The monthwise, latitudewise length frequency distribution is given in Fig.3. From the size group studies it is evident that in the DSL the unicorn cod is composed of the size groups 10 - 65 mm.

*Food and feeding habits* — One of the most important problems of fishery research is the investigation of the nutrition of fish in order to understand the qualitative and quantitative connection between them and their food organisms. This

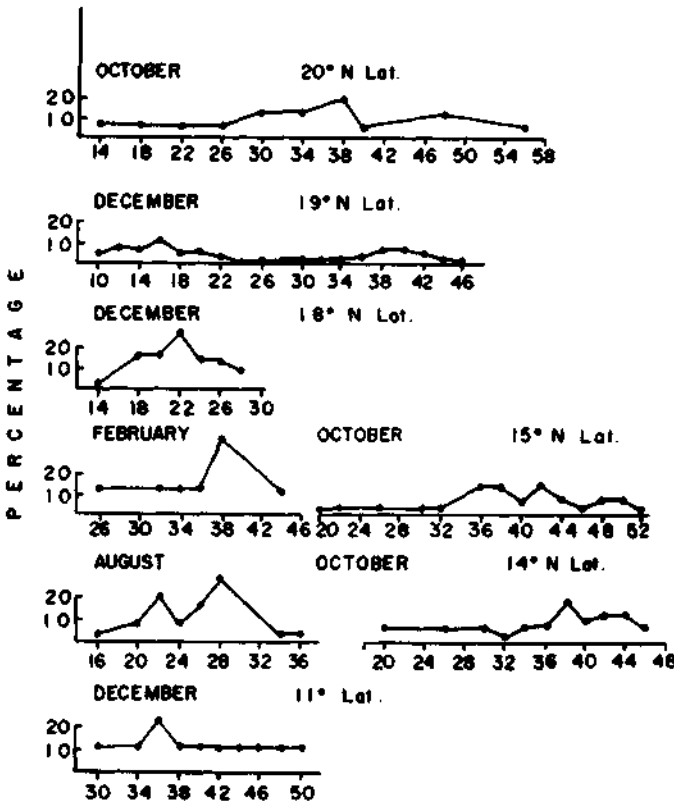

Fig. 3 - Monthwise and latitudewise size distribution of *B. mccllellandi*

provides valuable data not only for the determination of the food chains, but also about the shoaling and migratory habits of the fishes. *B. mccllellandi* forms a major food item of many scieanids, polynemids and other fishes. In the DSL unicorn cod was caught along with many mesozooplankton and it feeds on these organisms.

A total of 300 fishes collected from the DSL, in the size range of 20 - 52 mm of both the sexes were utilised for the study. Generally the feeding intensity was found to be very low. Greater feeding activity was observed in the samples collected during early morning hours of 0400 - 0600 hrs. The feeding intensity was relatively less during day time. In the night samples the fish showed a complete cessation of feeding as evidenced by 100 % empty stomachs. *B. mccllellandi* feeds mainly on the DSL components by selecting a few smaller organisms. The main food was found to be copepods (35.7%), smaller crustaceans (10.7 %), ostracods (9.5 %), cladocerans (4.1%), and small fishes (3.6%). Infrequent items were euphausiids and chaetognaths. The digested matter constituted a good portion (16.7%) and it is mainly of smaller crustaceans (Fig.4). *B. mccllellandi* caught from the DSL showed a preference for smaller planktonic organisms like copepods, ostracods and crustacean larvae, may be

due to the small mouth opening. The feeding generally takes place in the surface layers during early morning hours.

**Maturity conditions** — Pre-adults were observed during October - February. The fishes were found to be in maturing conditions throughout the period. The matured and the gravid (ripe) gonads were observed during October - December. The ratio between male and female is M: F = 1 : 1.8.

**Ova diameter study** — Gonads of mature fish of *B. mccllellandi* were examined for ova diameter studies and the frequency distribution (Fig.5) showed a bimodal distribution with a single group of most mature ova, the size ranging from 0.446 - 3.568 mm. This is a clear indication that *B. mccllellandi* spawns only once in a season.

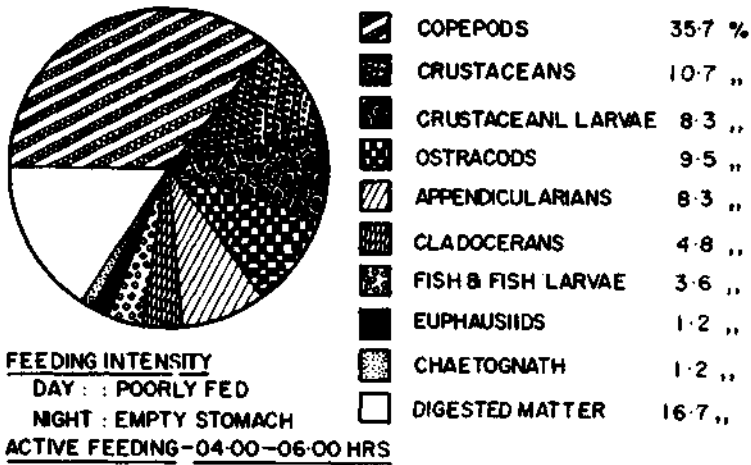

Fig. 4 - Food and feeding habits of *B. mccllellandi*

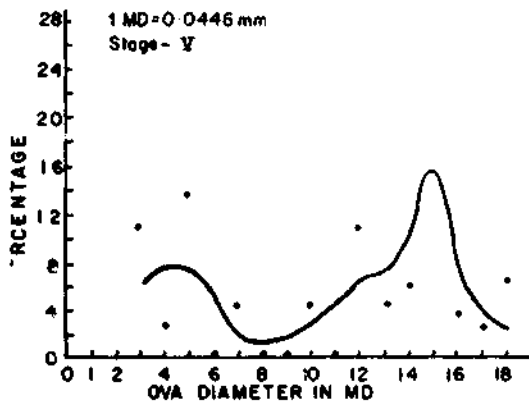

Fig. 5 - Ova diameter polygon on *B. mccllellandi*

**Fecundity** — The fecundity of *B. mccllellandi* was estimated from 15 fishes of the maturity stage V in the size group 40 - 50 mm. The number of most mature ova ranged from 530 - 980 with a mean of 730 ova.

## DISCUSSION

The distribution of *B. mccllellandi* from the DSL showed a good concentration along the coasts off Bombay and Ratnagiri. Another area of good concentration were observed at 10° 29' N - 75° 30' E near the southwest and at a pocket in Andaman waters. It is well-known that good *B. mccllellandi* fishery exist at Bombay by dol nets. Banerji (1973) opined that with slight decrease in fishing effort, it is possible to gain an increase of about 10 % in the yield. Except Maharashtra and Gujarat, nowhere does a commercial fishery exist for this fish. Since the availability of this resource in the DSL shows the possibility of a future fishery in the oceanic waters, attempts may be made to develop a fishing programme for the species considering the market value of this fish due to its palatability. The sporadic availability of juveniles of *Bregmaceros* spp in the southwest coast was earlier pointed that among the fish larvae, *Bregmaceros* composed 4 % (Anon, 1975, 1976). Jones & Pantulu (1958) reported the larvae and juveniles of *B. mccllellandi* in Bengal and Orissa coast. Eventhough the availability of larvae and juveniles occurred in southwest coast and northeast coast there is no commercial fishery for the unicorn cod in these areas; may be due to the larger mesh size of the commercial fishing net used in these areas. In the east coast it is evident that *B. mccllellandi* available in the area forms a food component of *Saurida tumbil*, *Apogon septenstriatus*, *A. nigripinnis*, *Chorinemus lysan*, *Johnius anaeus*, *Upeneus sulphureus*, *Trichiurus haumela*, *Pseudorhombus triocellatus* and *Uranoscopus lebech* (Rao, 1964) and the catfish, *Tachysurus thalassinus* (Mojumder, 1969).

In the coastal waters off Waltair, crustaceans constituted the food of *B. atripinnis* (*B. mccllellandi*) of which prawns were very important (Rao, 1994). The food chain in the DSL is not clearly studied so far and no relationship can be attempted now. But, by and large, *B. mccllellandi* is found to feed on copepods, ostracods and other smaller planktonic organisms from the DSL and the larger pelagic organisms may consume a considerable amount of *B. mccllellandi*. Bapat & Bal (1952) stated that *Otolithus argenteus*, *Sciaena glacuc*, *S. miles*, *S. semiluctosa* and *Apogon bandanesis* were all feeding the *B. mccllellandi*, Suseelan & Nair (1969) found the *B. mccllellandi* in stomachs of *Otolithus ruber*, *Johnis dussumieri*, *Pomadayas hasta* and *Polynemus heptadactylus*. Kagwade (1970) found *B. mccllellandi* in the stomachs of *Polynemus indicus*, *P. heptadactylus* and *P. plebeius*. Bapat (1970) reported that Bombay duck feeds on *B. mccllellandi*. The Koth, *Otolithoides brunneus* fed on *B. mccllellandi* (Jayaprakash, 1971). So this unicorn cod is evidently an important link in the food chain of many commercially important species.

## ACKNOWLEDGEMENT

Authors are grateful to Dr. P.S.B.R. James, former Director for his keen interest in this study and to Dr. P. Bensam, Head, Demersal Fisheries Division for his encouragements.

## REFERENCES

- Anon. 1975, Young fish studies, *UNDP/FAO Pelagic Fishery Project. Progress Report No. 10*: pp.14.
- Anon. 1976, Plankton, Fish eggs and larva studies, *UNDP/FAO Pelagic Fishery Project. Progress Report No. 17*: pp. 27.
- Banerji, S.K. 1973. An assessment of the exploited pelagic fisheries of Indian seas, In: *Proc. Symp. Living Resources of the Seas around India*, (CMFRI, Cochin) 115-136.
- Bapat, S.V. 1970. The Bombay duck, *Harpodon nehereus* (Ham), *Bull. Cent. Mar. Fish. Res. Inst.* 21: 1-66.
- Bapat, S.V. & Bal, D.V. 1952. The food of some young fishes from Bombay, *Proc. Indian Acad. Sci.* 35 B : 78-92.
- Jayaprakash, A.A. 1971. Food and feeding habits of juvenile 'Koth'. *Otolithoides brunneus* (Day) in Bombay waters, *Indian J. Fish.* 21 (1): 127-140.
- Jones, S. & Pantulu, V.R. 1958. On some larval and juvenile fishes from the Bengal and Orissa coasts, *Indian J. Fish.* 5 (1): 118-143.
- Kagwade, P.V. 1970. The polynemid fishes of India, *Bull. Cent. Mar. Fish. Res. Inst.* 18: 1-69.
- Mathew, K.J. & Natarajan, S. 1990. Investigations on the DSL of the Indian EEZ with special reference to Euphausiids as a component, In: *Proc. First Workshop Scient. Resul. FORV Sagar Sampada*, edited by K.J. Mathew, (CMFRI, Cochin) 375-383.
- Menon, N.G. 1990. Preliminary investigation on the fish biomass in the Deep Scattering Layers of the EEZ of India, In: *Proc. First Workshop Scient. Resul. FORV Sagar Sampada*, edited by K.J. Mathew, (CMFRI, Cochin) 273-280.
- Menon, N.G. & Prabha Devi, L. 1990. Studies on the biomass in the deep scattering layer of the Indian EEZ, in : *Proc. First Workshop Scient. Resul. FORV Sagar Sampada* , edited by K.J. Mathew, (CMFRI, Cochin) 257-271.
- Mini Raman & James, P.S.B.R. 1990. Distribution and abundance of lantern fishes of the family Myctophidae in the EEZ of India, In: *Proc. First Workshop Scient. Resul. FORV Sagar Sampada*, edited by K.J. Mathew, (CMFRI, Cochin) 285 - 290.
- Mojumder, P. 1969. Food of catfish *Tachysurus thalassinus* (Ruppell), *Indian J. Fish.* 16 (1&2): 161 - 169.
- Rao, K.S. 1964. Food and feeding habits of fishes from trawl catches in the Bay of Bengal with observations on diurnal variation in the nature of food, *Indian J. Fish.* 11 (1): 277 - 314.
- Rao, K.V. 1973. Distribution pattern of the major exploited marine fishery resources of India, In : *Proc. Symp. Living Resources of the Seas around India*, (CMFRI, Cochin) 18 - 101.
- Silas, E.G. 1972. Investigations on the deep scattering layers in the Laccadiv sea, In : *Proc. Symp. Corals and Coral Reefs* (Mar. Biol. Ass. India, Cochin) 257 - 274.
- Suseelan, C. & Nair, K.V.S. 1969. Food and feeding habits of the demersal fishes off Bombay, *Indian J. Fish.* 16 (1 & 2) : 56 - 74.

\*\*\*



## **Hydrographic features off northeast coast and Andaman - Nicobar Islands in relation to demersal finfish resources**

P. Bensam, K.V. Somasekharan Nair, A. Nandakumar, M.S. Rajagopalan  
& J. Narayanaswamy

Central Marine Fisheries Research Institute, P.B. No. 1603, Cochin - 682014

### **ABSTRACT**

Temperature varied from 17.6 to 28.5°C, salinity values from 32.12 to 35.21  $\times 10^{-3}$  and dissolved oxygen from 0.8 to 4.41 ml/l. No identifiable relationship could be established between these three parameters and the total fish abundance, probably because the catch was made up of many species having different requirements. Higher abundance of trawl catches was from January to May when bottom water temperature was relatively low. The highest level of abundance of 2764 kg/hr in February 1989 was recorded when the parameters were 26°C, 33.6  $\times 10^{-3}$  and 2.71 ml/l; and the lowest level of 43.2 kg/hr in July 1988 was when the parameters were 25.3°C, 34.48  $\times 10^{-3}$  and 1.6 ml/l.

### **INTRODUCTION**

Information available on the areawise, depthwise and seasonwise abundance of fish resources in the Exclusive Economic Zone of the northeast coast and Andaman - Nicobar islands is rather little (Sudarsan *et al.*, 1988). Also, very few attempts have been made to correlate such abundance with the prevailing environmental conditions in the area except the preliminary ones by Krishnamoorthi (1973), Sekharan *et al.* (1973) and Sudarsan (1977). The present paper attempts to correlate the spatial and seasonal fluctuations in the abundance of finfish resources with the hydrological conditions of the fishing area in the EEZ of the northeast coast and Andaman-Nicobar waters based on the data obtained during the cruises 45-58 of *FORV Sagar Sampada* (April 1988 - February 1989).

### **MATERIALS AND METHODS**

Water samples were collected from standard hydrographic depths (0-500 m) using reversing Nansen bottles. Temperature was measured by reversing thermometers.

Salinity and dissolved oxygen were found out using standard analytical methods (Strickland & Parsons, 1968). Bottom trawling operations were undertaken using High Speed Demersal Trawls designed and fabricated by Central Institute of Fisheries Technology. Normally the gear was operated for a minimum one hour duration. The details with regard to shooting duration of fishing, hauling, quantity and quality of the catch were recorded. The specieswise and total catch rates during different months were analysed with respect to seawater temperature, salinity and dissolved oxygen.

## RESULTS

### Physico-chemical parameters off northeast coast

*Temperature* - The temperature distribution pattern given in Fig.1 shows high values over the continental shelf and adjoining offshore areas in May and June 1988 with surface temperatures ranging from 28° to 32°C. The surface temperature decreased to 28.3° to 29.5°C in September 1988. A secondary maximum in surface

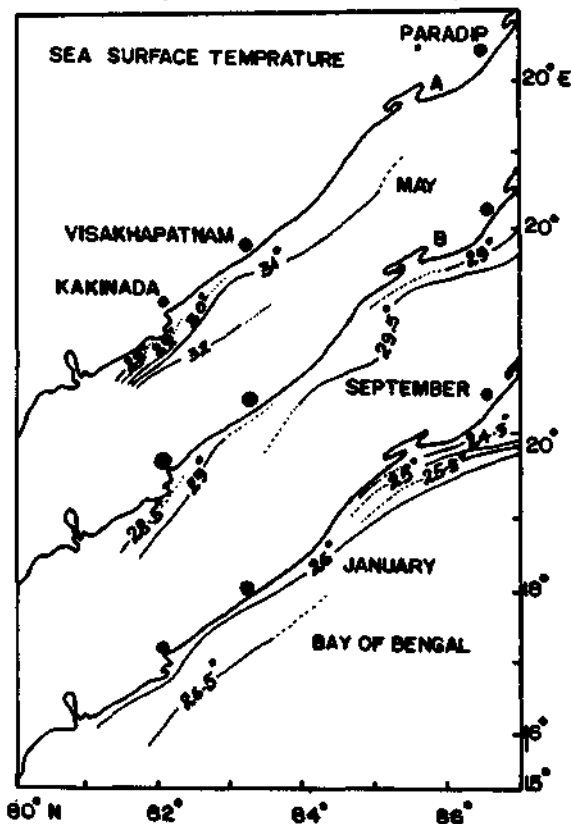

Fig. 1 - Seasonal distribution of sea surface temperature (°C) in the EEZ of the northeast coast of India

temperature occurred between 29° and 31°C in October. The lowest surface temperature was observed in January 1989 with values ranging between 24.1° and 26.5°C. The vertical profile of temperature distribution along lat. 16°, 18° and 20° N zones for different months is presented in Fig.2. The stations in lat. 16°N sector recorded low values ranging from 15.4° to 28°C in the upper 250 m depth column in May 1988. The mixed layer observed up to 50 to 75 m depth zone during July at lat. 16° and 18° N was confined up to 20 m depth in September. The stations at lat. 20°N sector recorded a shallow thermocline and low subsurface layers in July. The mixed layer was found to extend below 50 m depth during October. From October to November the temperature pattern showed a decreasing trend ranging from 24.9° to 29.3°C at 50 m and from 22.3° to 27.3°C at 100 m. During January 1989 the subsurface layers recorded low temperatures of 15.6° and 17.3°C at 100 m depth in the transects at lat. 16° and 20°N respectively.

**Salinity** — The seasonal distribution of sea surface salinity is given in Fig.3. The surface salinity values were generally high in April 1988 ranging between 34.83 and 35.17 x 10<sup>-3</sup>. During May and June 1988 the pattern showed a reduction and the values ranged from 31.95 to 33.62 x 10<sup>-3</sup>. By July the salinity values showed another peak with values ranging between 33.21 and 34.64 x 10<sup>-3</sup>. Salinity decreased to values between 20.05 and 24.20 x 10<sup>-3</sup> during October. In January 1989 the surface values varied between 27.91 and 34.81 x 10<sup>-3</sup>. The salinity values of the subsurface waters which were high in April 1988 showed a reduction during May and June 1988 with a

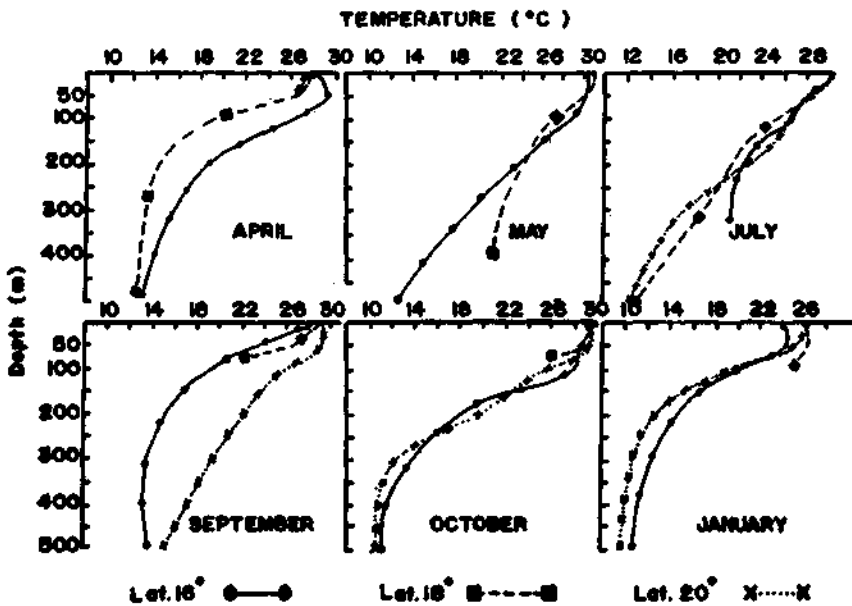

Fig.2 - Vertical profile of temperature distribution along lat. 16°, 18° and 20°N during different months in the EEZ of the northeast coast of India

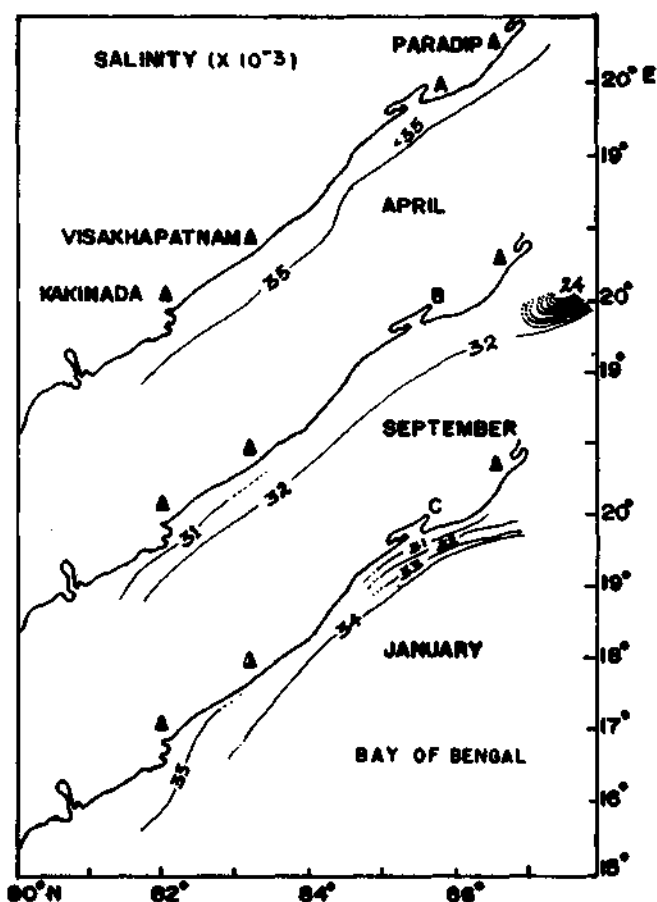

Fig. 3 - Seasonal distribution of sea surface salinity ( $\times 10^{-3}$ ) in the EEZ of the northeast coast of India

minimum of  $31.61 \times 10^{-3}$  at 20 m depth and a maximum of  $34.80 \times 10^{-3}$  at 450 m depth (Fig.4). Relatively lower values prevailed at lat.  $16^{\circ}$ - $17^{\circ}$ N sector than at lat.  $20^{\circ}$ N. Salinity decreased during September with values between  $31.54$  and  $34.47 \times 10^{-3}$  at 50 m and between  $32.30$  and  $34.73 \times 10^{-3}$  at 400 m depth. In general salinity values during October 1988 were low from the surface to 30 m depth, while below there was an increase compared to the previous month. In January 1989 salinity has marginally increased up to 200 m depth.

*Dissolved oxygen* — Generally high values ranging from 4.98 to 5.17 ml/l were recorded at the surface over the entire shelf region in April 1988. During May and June the values were high at lat.  $16^{\circ}$ N while it was relatively low at lat.  $17^{\circ}$ - $18^{\circ}$ N sector. There was a decrease in surface values during July. Surface values were lower in September 1988 ranging from 2.43 to 3.90 ml/l at lat.  $16^{\circ}$ N when compared to

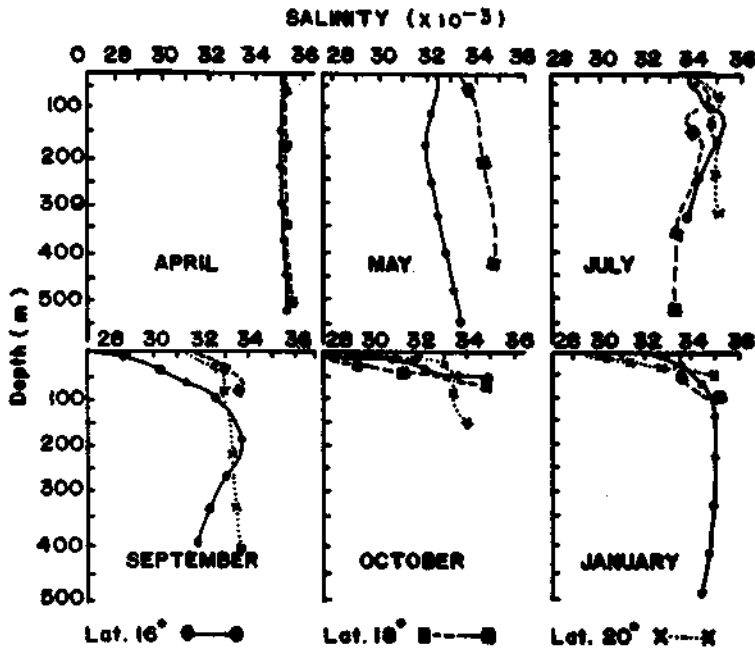

Fig. 4 - Vertical profile of salinity ( $\times 10^{-3}$ ) along lat.  $16^{\circ}$ ,  $18^{\circ}$  and  $20^{\circ}$ N for different months in the EEZ of the northeast coast of India.

northern areas where high values of 3.90 to 4.80 ml/l prevailed. In October 1988 and January 1989 the surface values were relatively higher. The vertical profile of dissolved oxygen (Fig.5) showed that in shallow stations the 1 ml/l oxygen layer which is usually found at deeper areas occurred at depths between 30 and 50 m at lat.  $16^{\circ}$ N and between 50 and 75 m at lat.  $18^{\circ}$ N during September 1988. In October this layer was found at depths below 100 m in the  $18.20^{\circ}$ N sector. During November low oxygen content was recorded at depth below 100 m in the shelf and 1 ml/l layer occurred below 150 m depth at lat.  $20^{\circ}$ N sector.

### Physico-chemical features of the Andaman-Nicobar islands

**Temperature** — The sea surface temperature varied between  $29.8$  and  $30.5^{\circ}\text{C}$  in April 1988. During June the temperature values ranged between  $28.4^{\circ}$  and  $29.2^{\circ}\text{C}$ , which declined to between  $27.1$  and  $28^{\circ}\text{C}$  during November–December 1988. During April 1988 a thermocline occurred at depths of more than 50 m in the northern latitudes; during June the thermocline was observed between 75 and 100 m depth. During November and December the thermocline was found to occur below 100 m in the southern regions while in the northern areas it was observed below 50 m depth.

**Salinity** — During April 1988 surface salinity varied between  $30.58$  and  $34.65 \times 10^{-3}$  with comparatively higher values towards southern latitudes. In June salinity

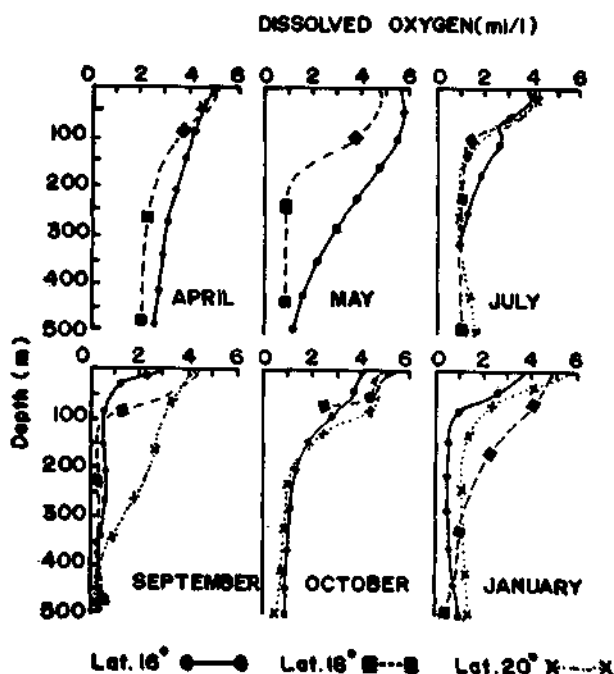

Fig. 5 - Vertical profile of dissolved oxygen along lat. 16°, 18° and 20°N during different months in the EEZ of the northeast coast of India

varied between  $31.78$  and  $35 \times 10^{-3}$ , without much regional variation. During November and December the values were between  $32.04$  and  $33.67 \times 10^{-3}$ . A salinity maximum of  $35 \times 10^{-3}$  was found at 200 m with slightly lower values in surface areas in April 1988. During August the maximum values of salinity occurred between 300 and 500 m depth in the areas north of lat.  $12^{\circ}30'N$  and between 200 and 500 m in the area south of it.

**Dissolved oxygen** — In April 1988 the dissolved oxygen values were below 4 ml/l in the upper 100 m column. During June the surface waters were well oxygenated with 5 ml/l. In November and December 1988 the values were more or less uniform from surface to 50 m depth. In April 1988 dissolved oxygen values below 1 ml/l were observed at 200 m depth in the northern sector between lat.  $10^{\circ}30'$  and  $14^{\circ}30'N$ . During June values of 1 ml/l were found at 500 m. In August low values of 1 ml/l occurred at depths between 150 and 200 m at lat.  $11^{\circ}30'N$  and between 200 and 400 m between lat.  $7^{\circ}$  and  $8^{\circ}N$ .

### Species abundance

The abundance of major categories of finfish obtained in demersal trawling in relation to hydrographic conditions of the bottom waters is given in Table I. In the northeast coast the peak month of finfish abundance in the shallower areas of the shelf

Table 1 - Abundance of demersal finfish in the bottom trawl catches during April 1988 - February 1989 in relation to hydrographic conditions

Months	Hydrographic parameters			Name of species/groups* (catch rate in kg/hr)								Total catch rate (kg/hr)
	Temp. (°C)	Sal. ( $\times 10^{-3}$ )	Diss. O <sub>2</sub> (ml/l)	1	2	3	4	5	6	7	8	
<i>Northeast coast of India</i>												
April '88	26.1	35.21	4.41	60.1	0.1	1.6	41.3	21.9	0.2	-	32.0	157.2
May	17.6	32.12	0.8	169.0	10.5	683.5	-	-	14.2	-	122.3	999.5
June	27.3	33.95	1.65	0.7	52.8	16.8	3.4	5.0	1.2	-	114.1	194.0
July	25.3	34.48	1.60	0.1	0.1	17.2	0.1	6.2	6.0	-	13.5	43.2
Sept	27.9	33.40	3.10	0.5	4.4	0.6	21.3	6.9	0.3	-	115.0	149.0
Oct	28.5	34.39	2.79	0.2	0.4	13.5	2.3	3.5	-	203.7	24.0	247.6
Nov	28.2	34.75	2.89	7.1	14.2	16.4	12.3	20.5	2.7	9.1	141.2	223.5
Jan '89	24.8	33.90	3.70	9.5	-	3.5	44.7	7.6	236.5	26.9	118.9	447.6
Feb	26.0	33.60	2.71	13.6	0.7	58.0	48.0	235.0	1186.1	13.0	1209.6	2764.0
<i>Andaman-Nicobar Islands</i>												
April - May '88	28.4	32.93	2.44	1.0	5.0	-	-	-	12.9	39.0	241.6	299.0
June	17.8	34.73	2.50	2.5	-	2.0	-	-	-	-	13.5	18.0
Aug	-	33.23	3.78	0.2	0.3	-	-	-	-	-	0.5	1.0
Sept	-	-	-	-	-	-	-	-	-	-	-	-
Dec	24.2	33.89	-	-	-	0.4	-	-	-	12.8	136.8	150.0
Jan '89	25.9	34.47	-	0.6	0.7	0.1	-	-	-	27.0	15.6	44.0

\*Species/groups: 1) *Nemipterus* spp, 2) *Saurida* spp, 3) *Priacanthus* spp, 4) *Upeneus* spp, 5) Catfish, 6) *Psenes indicus*, 7) Perches, 8) Others

were April, November 1988 and January-February 1989 when the bottom water temperature was relatively low at the respective trawling depths. The peak abundance of threadfin bream *Nemipterus* in the inner continental shelf of up to 80 m was in April 1988, January and February 1989, when the bottom waters were characterised by lower temperature. The outer continental shelf recorded the maximum catch rate in May. The catch rate of goat fishes *Upeneus* also showed an almost identical pattern in abundance. The peak abundance of *Priacanthus* was in May 1988 in 150 - 200 m depth when the bottom waters were characterised by high salinity, low temperature and low oxygen. In the shallow shelf the maximum catch rates of *Psenes indicus* were in January and February. In the Andaman-Nicobar seas the highest catch rate of 299 kg/hr was noticed in May 1988 when the bottom water temperature was relatively higher, the catch consisting mainly of elasmobranchs, silver bellies and perches.

## DISCUSSION

The studies undertaken by Sekharan *et al.* (1973) on the exploratory trawling of the continental shelf along the north-western part of the Bay of Bengal have revealed no indication of a drift in the abundance of the demersal fishes to offshore grounds in February - April, probably because the upwelling observed in this area was too weak to exert any influence on a wide scale (Jayaraman, 1965). The best catch rates of all categories of fish in the offshore grounds were observed during July - September in all zones, probably due to the effect of a shallow thermocline in the western side of the Bay of Bengal (Prasad, 1952), suggesting that there may be upwelling in the Bay during July - August. Sekharan *et al.* (1973) however noticed demersal fish abundance along lat. 17°N zone to be the highest during April - June and suggested a time lag of 1 - 2 months between the period of maximum plankton production (March - April) and the highest abundance of demersal fishes, provided the two are related. Krishnamoorthi (1973) has observed that off Andhra-Orissa coasts the peak period of abundance of *N. japonicus* was from January to April coinciding with the northern current system. In the present investigation this group has maximum catch rates during April-May.

Nishida & Sivasubramaniam (1986) observed that temperature and salinity do not vary much during a year in deeper waters and opined that deepsea demersals do not move or migrate extensively but probably remain in areas where environmental conditions are constant. They have also stated that lizard fishes generally inhabit shallow waters of 100-150 m and prefer relatively high temperatures of 19° - 27°C with optimum of 20°-22°C and salinity of  $34-34.4 \times 10^{-3}$  with optimum of  $34.2 - 34.4 \times 10^{-3}$ . The minimum, maximum and optimum dissolved oxygen ranges reported were 0.2, 2.5 and 0.5 - 1.0 ml/l respectively. *Priacanthus* occurs in low and high temperature ranges of 14- 27°C with optimum of 14°- 22°C, high salinity ranges of  $34 - 35.8 \times 10^{-3}$  with optimum of  $34.2 - 34.6 \times 10^{-3}$  and low dissolved oxygen range of 0.2 - 2.5 ml/l with optimum of 1.0 - 1.5 ml/l. In the present studies, the peak abundance of *Priacanthus* was seen in relatively deeper waters of 150 - 200 m, low temperature of 17.6°C and dissolved oxygen of 0.8 ml/l values. The catch rates of lizard fish *Saurida*



were relatively higher in comparatively shallow waters of up to 150 m characterised by a temperature of 27.3°C and dissolved oxygen of 1.65 ml/l.

### REFERENCES

- Jayaraman, R. 1965. Upwelling off the east coast of India, *Curr. Sci.* 34 (4): 121-122.
- Krishnamoorthi, B. 1973, An assessment of *Nemipterus* fishery off Andhra - Orissa coasts based on exploratory fishing, In: *Proc. Symp. on Living Resources of the Seas Around India*, (CMFRI, Cochin) 495-516.
- Nishida, T. & Sivasubramaniam, K. 1986. Atlas of deep water demersal fishery resources in the Bay of Bengal BOBP/Working paper/53 (Marine Fishery Resources Management in the Bay of Bengal, Colombo) pp.49.
- Prasad, R.R. 1952. Preliminary observations on the temperature gradients and light penetrations in the upper 200 feet of water in the Bay of Bengal, *Proc. Indian. Acad. Sci.*, 36: 61-69.
- Sekharan, K.V., Muthu, M.S. Rao, K.V.S., Ramamohana Rao, V., Mojunder, P. & Reuben, S. 1973. Exploratory trawling on the continental shelf along the north western part of the Bay of Bengal, In: *Proc. Symp. on Living Resources of the Seas Around India*, (CMFRI, Cochin) 280 - 337.
- Strickland, J.D.H & Parsons, T.R. 1968. *A Practical handbook of sea water analysis*. *Bull. Fish. Res. Bd. Canada*. 167: pp. 311.
- Sudarsan, D. 1977. Fish trawl catches of Shoal Bay, Port Blair, (Andaman) in relation to hydrography and zooplankton, *Matsya*, 3: 83-86.
- Sudarsan, D., Sivaprakasam, T.E., Somavanshi, V.S., John, M.E., Nair, K.V. & Joseph, A. 1988. An appraisal of the marine fishery resources of the Indian Exclusive Economic Zone, *Bull. Fish. Surv. India*. 18: pp. 85.

\* \* \*

## Occurrence of ribbonfish in the Indian EEZ

P N Radhakrishnan Nair, Alexander Kurian, C. Muthiah, S. Lazarus,  
R. Thiagarajan, M. Zaffar Khan & Prathibha Rohit

Central Marine Fisheries Research Institute, PB No.1603,  
Cochin-682 014

### ABSTRACT

The survey conducted by *FORV Sagar Sampada* during 1985-91 (90 cruises) revealed the occurrence of ribbonfish in 56 stations out of 904 stations where fishing was conducted. It was reported from 41 stations along the west coast and 14 stations along the east coast. About 14 tonne of ribbonfish was caught in these operations which formed 4.8% of the total fish catch. West coast was more productive and contributed 93.6% of the catch, while the east coast only 6.4%. It abundantly occurred in the southwest, centralwest, northwest and northeast coasts. Depth-wise study revealed that major portion of the catch was obtained from within the 100 m depth zone. The dominant species reported was *Trichiurus lepturus*.

### INTRODUCTION

The exploratory surveys conducted by *FORV Sagar Sampada* in the Indian EEZ during 1985-91 were mainly aimed at charting out the exploited, underexploited and unexploited regions and to locate virgin fishing grounds. These fishing surveys had been successful in locating some areas of ribbonfish concentrations along the Indian coasts, especially on the west coast. Ribbonfish is one of the major pelagic fish resources and the average estimated catch in the commercial production during 1985-89 was 94555 tonne forming 5.3% of the all India marine fish landing. In 1992 this has reached an all time high of 111000 tonne forming 4.8% of the total catch and 9.4% of the pelagic groups. The present study is aimed to bring out the findings of *FORV Sagar Sampada* (1985-91) on the distribution and abundance of ribbonfish in Indian EEZ.

### MATERIALS AND METHODS

During February 1985 to June 1991 *FORV Sagar Sampada* conducted 90 cruises covering 2234 stations in the seas along the west and east coasts of India and also

Lakshadweep and Andaman & Nicobar Islands. The number of cruises and stations covered in these cruises along the Arabian Sea and the Bay of Bengal were almost equal with 1129 stations in 46 cruises in the former and 1105 stations in 44 cruises in the latter. Fishing was conducted in 904 stations which formed 40.5% of the total number of stations. Out of this pelagic trawling was carried out in 370 stations (40.9%) and bottom trawling in 534 (59.1%) stations. Trawling stations were selected at random on the basis of echosounder/fish finder recordings, indicating the bathymetric profile, types of sea bottom and also the availability of fishable concentrations of all fishes and other marine resources. Depth of operation of the gear was decided on the basis of the above observations. The types of trawl nets operated in these cruises were mainly Chalute Bottom Trawl, High Speed Demersal Trawls (I, II, & III), Granton Bobbin Trawl and High Life Queen's Trawl. The fishing particulars and the quantity as well as quality of the catch (species-wise) were recorded in the fishing log maintained by every cruise. Since the ribbonfish catch in the pelagic trawling was nearly scanty the data collected from the bottom trawling was utilised in the present study. The hauls which contained the ribbonfish were considered as the effective hauls and further analysis of the data for the estimation of abundance was based on these effective hauls. The areas surveyed were divided into 1 degree square grids and the average ribbonfish catch (kg/hr) in each grid was estimated by dividing the total catch in each square by the number of effective hauls in that grid. The abundance was studied in different depth zones: 0-50 m, 50-100 m, 100-200 m and beyond 200 m.

## RESULTS

The total catch realised in all these operations (Table 1) were 293 tonne, out of which 99.4% was obtained from bottom trawling. The catches of the pelagic trawling were totally poor, and the total catch realised was only 1.8 tonne forming 0.6% of the total fish catch and the ribbonfish catch was also negligible. The occurrence of

Table 1— A comparison of operational and catch particulars of fishing by *Sagar Sampada* between west and east coasts of India

Particulars	West coast	East coast	Total
Total number of fishing stations	496	408	904
Pelagic trawl stations	176	194	370
Bottom trawl stations	320	214	534
Total fish catch (tonne)	242.4	50.8	293.2
Catch in pelagic trawl (tonne)	1.6	0.2	1.8
Catch in bottom trawl (tonne)	240.9	50.5	291.4
No. of hauls with ribbonfish	41	15	56
Total ribbonfish catch (tonne)	13.1	0.9	14.0

ribbonfish was noticed in 56 stations covering 6.2% of the total fishing stations. Altogether 14 tonne of ribbonfish was landed in these hauls forming 4.8% of the total catch. The catch rate was estimated to 249 kg/hr of effective trawling and 26 kg/hr of total bottom trawling.

### Abundance

**West coast** - Ribbonfish was widely distributed on the west coast than on the east coast. About 13.1 tonne of the total catch came from the west coast. It was collected from 41 stations, spread over 20 grids, between Longitude 68°- 70°E and Latitude 8°- 22°N (Fig.1). The frequency of occurrence was maximum on the Gujarat coast and also along the south Kerala and the central Maharashtra coasts. The minimum and maximum catches were 0.1 kg/hr in sts.743 and 737 (lat. 19°N- long. 60°30'E and lat.17°N-long. 70°30'E) and 3000 kg/hr at st. 1244 respectively (Table 2).

**East coast** - Compared to the west coast the ribbonfish catch in the east coast was much less and its distribution and abundance was limited to the northern sector, beyond 15 °N. The catch was reported from 14 stations spread over 9 grids and from one station at 13°10'N - 92°37'E in the seas around Andaman and Nicobar Islands (Fig.1). Its distribution in the east coast was mainly off Orissa and north Andhra coasts. The total catch realised in 15 effective hauls, was 0.9 tonne forming 6.4% of the total ribbonfish catch on both the coasts, and 1.8% of the total fish catch in the east coast. The minimum and maximum abundance noticed were 0.1 kg/hr at st.1426 (16°15'N - 82°03'E, off central Andhra coast) and 492.8 kg/hr at st.1625 (off south

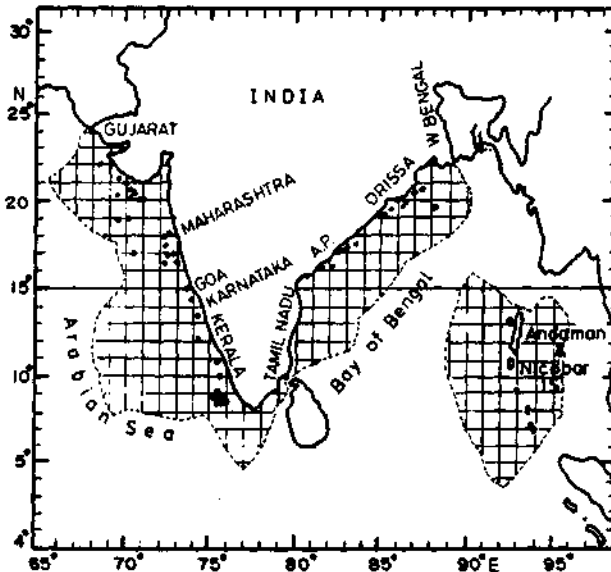

Fig.1— Areas of ribbonfish occurrence in the Indian EEZ recorded during FORV Sagar Sampada cruises

Table 2 - Station-wise abundance of ribbonfish in west and east coasts  
(catch 30 kg/hr and above)

Cruise no.	St. (no.)	Lat. (N)	Long. (E)	Depth (m)	Catch (kg/hr)
<i>West coast</i>					
2	45	20°25'	69°38'	92	57.6
8	213	22°00'	68°30'	68	900.6
10	314	77°58'	72°14'	81	204.4
18	631	13°31'	74°16'	40	600.0
20	694	08°30'	76°00'	365	30.0
22	781	20°00'	70°56'	65	34.7
37	1213	18°02'	72°42'	36	1506.2
37	1217	20°00'	71°00'	74	350.4
37	1219	21°00'	70°00'	35	49.6
37	1220	21°15'	69°30'	46	96.6
38	1242	20°33'	70°23'	56	400.0
38	1243	20°31'	72°28'	56	150.0
38	1244	20°36'	70°19'	57	3000.0
39	1277	08°30'	76°00'	365	30.0
42	1309	08°40'	75°48'	340	1858.5
42	1313	08°57'	75°42'	335	280.0
42	1314	08°46'	75°43'	337	250.0
42	1319	08°44'	75°32'	315	2988.0
42	1320	08°46'	75°39'	305	40.6
87	2237	20°59'	70°00'	39	34.0
87	2238	20°27'	70°25'	65	70.0
<i>East coast</i>					
13	454	19°00'	84°50'	54	70.4
26	913	17°30'	83°38'	65	57.8
36	1206	20°38'	87°22'	35	60.0
57	1609	19°05'	85°09'	84	109.6
58	* 1625	19°47'	86°25'	68	492.8

Orissa coast) respectively (Table 2). The average catch rate in the effective hauls was estimated as 58.3 kg/hr. Though several cruises were conducted in the seas around Andaman and Nicobar Islands, ribbonfish was reported from only one station on the northwest coast of Andaman island with a catch rate of 25.2 kg/hr. The average catch per grid was maximum at 19°-20°N and 86°-87°E and minimum in 16°-17°N and 82°-83°E squares.

### Depth-wise distribution

The ribbonfish was generally abundant within 100 m depth zone but good catches were observed in deeper waters also (Table 3). On the west coast, the average catch rate was 111 kg/hr in 0-50 m depth, 209 kg/hr in 50-100 m, 7.3 kg/hr in 100-200 m and 149 kg/hr beyond 200 m depth zones. This shows that 50-100 m depth zone contributed the maximum (43.9%) while 31.1% of the catch came from beyond 200 m depth. The least catch (1.5%) was noticed in 100-200 m depth zone. In the southwest region the ribbonfish concentrations were noticed in deeper waters while in the central-west coast they were in the coastal areas. Further north, off Veraval, they were abundant up to 100 m depth. The maximum catch rate of 3000 kg/hr was reported from 57 m depth. On the east coast, almost entire catch was from the coastal waters within 100 m depth. The average catch rates were 36.3 kg/hr in 0-50 m and 39.2 kg/hr in 50-100 m depths. Beyond 100 m depth it formed only 1 kg/hr (Table 3). Along the east coast the 50-100 m depth zone, which contributed 51.2% of the ribbonfish was found to be slightly more productive than the inshore area within 50 m depth, from where 47.5% of the catch was obtained. The maximum catch rate (493 kg/hr) was recorded from 68 m depth, off Chilka lake area. In Andaman and Nicobar area the reported catch of 25 kg/hr came from 65 m depth.

### Species composition

*Trichiurus lepturus*, *T. auriga* and *Lepturocanthus savala* were the most common species in the catch. On the west coast *T. lepturus* formed 79.3% and the rest by *T. auriga* while on the east coast *L. savala* dominated forming 72.8% and the rest by *T. lepturus*.

## DISCUSSION

The potential yield for ribbonfish up to 200 m depth zone of Indian EEZ, as estimated by the revalidation committee (Anon.1991) for the period 1985-89, is 311000 tonne which is 8% of the total potential yield of 3900000 tonne and the catchable potential yield is 30.4% at up to 50 m depth zone. The average exploited catch during 1985-89 was only 78384 tonne which clearly shows ample scope for increasing the catch. According to James & Pillai (1990) the present rate of exploitation of ribbonfish is much less than the potential yield. According to Rao *et al.*(1977) the standing stock of ribbonfish between the Gulf of Mannar and Ratnagiri was about 4 times of the then landings and suggested that its catch could be doubled without

Table 3 - Depth-wise distribution of ribbonfish (kg/hr) along the latitudes

Latitudes	Depth range (m)			
	0-50	50-100	100-200	Above 200
	<i>West coast</i>			
8° -9°N	—	—	—	592.7
9° -10°N	—	2.0	9.8	—
10° -11°N	24.3	—	—	—
11° -12°N	—	—	—	—
12° -13°N	—	—	—	0.5
13° -14°N	600.0	—	—	—
14° -15°N	5.0	—	—	—
15° -16°N	—	10.0	—	—
16° -17°N	—	3.0	4.8	—
17° -18°N	2.3	115.0	—	0.1
18° -19°N	36.0	13.1	—	0.1
19° -20°N	—	2.1	—	—
20° -21°N	39.0	419.2	—	—
21° -22°N	73.1	—	—	—
22° -23°N	—	900.6	—	—
Average	111.4	209.3	7.3	148.4
Percentage	23.4	43.9	1.5	31.1
	<i>East coast</i>			
13° -14°N	—	0.5	—	—
14° -15°N	—	—	—	—
15° -16°N	7.6	—	—	—
16° -17°N	—	2.8	1.0	—
17° -18°N	—	21.9	—	—
18° -19°N	—	—	—	—
19° -20°N	—	169.6	—	—
20° -21°N	65.0	1.0	—	—
Average	36.3	39.2	1	—
Percentage	47.5	51.2	1.3	—

adversely affecting the stock. Sivakami (1990) noticed abundant resource of *Trichiurus* spp in <50 m and 51-100 m depth range. Rao *et al.* (1977), based on the acoustic surveys and experimental fishing along the Kerala coast, located large concentrations of young *T.lepturus* (200-250 mm) at 250 m depth along the southern Wadge Bank area which, according to them, might be an important nursery ground for the species. Significant resource of ribbonfish along the northwest coast has been indicated during the exploratory surveys (Bapat *et al.*1982). Along the centralwest coast Chakraborty (1990) has observed that the stock of *T.lepturus* in Bombay waters is very sound and is not under threat of depletion. James & Pillai (1990) noticed good concentrations of the resource along the northwest, centralwest, southwest and northeast coasts.

According to Rao *et al.* (1977) good concentrations of ribbonfish occur up to 80 m depth along the Kerala coast from April to September with the maximum intensity between May and July. This has been endorsed (Lazarus *et al.* 1992), that in Kerala the peak period is during monsoon months while it is the pre- and the postmonsoon periods in other areas along the west coast. Rao *et al.* (1977) also observed that concentrations of ribbonfish shift northward from 8° to 16°N during November/December and thereafter a southward movement commences by about April/May and a good portion of biomass was found between 8° to 11°N from July to September when low salinity and temperature prevails due to southwest monsoon in this region.

All these earlier observations confirm that ribbonfish forms a major fishery along the west coast and is concentrated along the southwest, central, centralwest, northwest and northeast zones within 100 m depth area. As suggested by James *et al.* (1978, 1986) it has emerged as an important commercial fishery resource in the landings along the coasts of India especially in the southern and northern parts of the west coast. It may be concluded that, in the light of recent trends in the commercial ribbonfish fishery, the results obtained from the experimental fishing conducted by *FORV Sagar Sampada* on the distribution and abundance of ribbonfish along the Indian EEZ is a true indication of the fishery characteristics of the natural stock.

## ACKNOWLEDGEMENT

Authors wish to express their sincere thanks to Dr.P.Vedavyasa Rao and Dr. P.S.B.R. James, the ex-Directors of CMFRI Cochin, for their encouragement and also to Dr. P.Parameswaran Pillai for his valuable suggestions and guidance.

## REFERENCES

- Anon. 1991. *Report of the working group on the revalidation of the potential yield of fishery resources in the Indian EEZ* (Ministry of Agriculture Government of India, New Delhi) pp. 57.
- Bapat, S. V. Deshmukh V. M., Krishnamurthi, B., Muthiah, C., Kagwade, P. V., Ramamirtham, C. P., Mathew, K. J., Krishna Pillai, S. & Mukundan, C. 1982. Fishery resources of the Exclusive Economic Zone of the northwest coast of India. *Bull. Central Mar. Fish. Res. Inst.*, 33: 1-81.
- Chakraborty, S. K. 1990. Fishery, age, growth and mortality estimates of *Trichiurus lepturus* Linnaeus from Bombay waters, *Indian J. Fish.*, 37 (1): 1-7.



- James, P.S.B. R, Gupta T.R.C & Shanbhogue, S. L., 1978. Some aspects of the biology of ribbonfish *Trichiurus lepturus* Linnaeus. *J. Mar. Biol. Ass. India*, 20 (1&2): 120-137.
- James, P.S.B.R, Alagarwami, K., Narayana Rao, K.V., Muthu, M.S., Rajagopalan, M. S., Alagaraja, K. & Mukundan, C. 1986. Potential marine fishery resources of India, *J. Mar. Biol. Ass. India* 30: 44-74.
- James, P.S.B.R. & Pillai, V.N. 1990. Fishable concentrations of fishes and crustaceans in the offshore and deep sea of the Indian Exclusive Economic Zone based on observations made onboard *FORV Sagar Sampada*. In: *Proceedings of the First Workshop on Scientific Results of FORV Sagar Sampada*, edited by K.J. Mathew, (CMFRI, Cochin) 201-213.
- Lazarus, S., Scariah, K.S., Khan, M .Z. & Velayudhan, A. K. 1992. Present status of exploitation of fish and shellfish resources: Ribbonfishes. *Bull. Cent. Mar. Fish. Res. Inst.*, 45: 121-132.
- Rao, K.V.N, Kumaran, N. & Sankaranarayanan, J. 1977. Resources of ribbonfish and catfish off the southwest coast of India, *Seafood Export J.*, 9(1): 9-25.
- Sivakami, S., 1990. Observations on the demersal fishery resources of the coastal and deep sea areas of the Exclusive Economic Zone of India, In: *Proceedings of the first workshop on Scientific Results of FORV Sagar Sampada*, edited by K.J. Mathew (Central Marine Fisheries Research Institute, Cochin) 215-231.

\* \* \*

## Oceanic squids - their distribution, abundance and potential in the EEZ of India and contiguous seas

K. Prabhakaran Nair, M.M.Meiyappan, R. Sarvesan, Kuber Vidyasagar, G. Syda Rao,  
K. Sunilkumar Mohamed, P.K.Asokan, A.P. Lipton, K.Ramadoss,  
V.G. Surendranathan, D.Nagaraja & K. Jayabalan

Central Marine Fisheries Research Institute, P.B. No. 1603, Cochin - 682 014

### ABSTRACT

*FORV Sagar Sampada* collected a good number of oceanic squids belonging to several families from the Indian EEZ and contiguous seas. Of these, the most important species was the purpleback flying squid *Symplectoteuthis oualaniensis* which forms a potential oceanic squid resource. This species was caught in pelagic trawl at depths up to 200-250 m from surface in the oceanic areas. Though the squid is known to be distributed throughout India's oceanic waters, it frequently occurred in comparatively more abundance, up to 318 squids per haul, in the northeastern Arabian Sea. There was wide variation in the size of this squid (from 20 mm to 472 mm), the largest individual weighing 4.5 kg. The diamondback squid *Thysanoteuthis rhombus*, the largest specimen of which measured 585 mm in length and 5.3 kg in weight, was also caught from a few stations. Besides these large species, several others belonging to families such as Onychoteuthidae, Histioteuthidae, Enopteuthidae and Cranchiidae are also distributed in the EEZ. A large number of oceanic squids were collected at night, which is indicative of their diel vertical migration towards surface layers during night hours.

### INTRODUCTION

The importance of oceanic squids as a potential resource in the Indian waters has been well recognised. The occurrence and distribution of different species of oceanic squids have been recorded by many workers since late 60's (Filippova, 1968; Silas, 1968, 1969; Okutani, 1973; Yamanaka *et al.* 1976, 1977; Roper *et al.* 1984). Some of these authors indicated that a few species, especially the purpleback flying squid *Symplectoteuthis oualaniensis*, are potential resources which offer vast scope for exploitation. Initial studies by *Sagar Sampada* since 1985 provided additional information on the distribution, behaviour and biology of this squid, and on the distribution of other oceanic squids and mesopelagic cephalopods (Meiyappan & Nair, 1990; Meiyappan

et al. 1990; Nair et al. 1990; Sarvesan & Meiyappan, 1990; Sreenivasan & Sarvesan, 1990). Nair et al. (1992) gave an account of the experimental squid jigging operations on the west coast of India, in which the purpleback flying squid was one of the components of the catch. Nair et al. (1992) provided some information on the biology of this squid based on the samples collected in the same experimental fishing. One of the objectives of the cruises of *FORV Sagar Sampada* was to locate and identify the stocks of exploitable resource of oceanic squids (as well as other resources) in the EEZ.

## MATERIALS AND METHODS

The oceanic squids collected in pelagic trawl operations onboard *FORV Sagar Sampada* in the Exclusive Economic Zone and its contiguous seas during 1985-1992 formed the data base for this study. Pelagic trawl was used in 40 cruises, mostly in oceanic waters beyond the continental shelf but occasionally in shallow waters of <100 m depth. The gears used were the German-type rectangular midwater trawls of CIFT design. These nets were operated for about 30-60 minutes duration for each haul in depths up to 420 m. The cephalopods collected in each haul were sorted for qualitative studies with regard to temporal distribution of different species of oceanic squids. Whenever direct observations onboard were not possible, log data of the cruise reports were consulted and preserved samples were studied. The length of squid always refers to the dorsal mantle length (DML). Since the catches of oceanic squids taken in each haul were very poor or insignificant, often a few grams in weight, quantitative estimation was not possible. Therefore the present study is limited to the distribution of component species and their relative abundance in different regions of the EEZ. In the absence of sufficient data, the earlier estimates of potential oceanic squid resources have been discussed in the light of the new information gathered by *Sagar Sampada* cruises.

## RESULTS

Sufficiently wide coverage was given to different regions on the east and the west coasts, including the Andaman-Nicobar waters, Lakshadweep waters and the central equatorial waters. The geographic regions, number of positive stations for oceanic squids in each of the regions, bottom depths and depths of operation of gear are given in Table 1. The maximum coverage was on the west coast, of which the centralwest region had the highest number of stations positive for cephalopods, followed by the southwest region, including the Lakshadweep waters. On the east coast, the southeast region and the centraleast region had almost equal number of cephalopod stations. The Andaman-Nicobar waters were rich in oceanic squids, with as many as 31 positive stations. In the central equatorial region 6 stations were positive for oceanic squids. In all, there were 169 positive stations.

Table 1— Number of stations positive for oceanic squids by region, based on pelagic trawl operation by *FORV Sagar Sampada*

Region	Latitude	No. of squid stations	Bottom depth (m)	Depth of gear operation (m)
Southwest	6° - 12°N	35	145-4500	20-400
Centralwest	12° - 18°N	42	62-4150	25-225
Northwest	18° to North	14	87-3444	40-1590
Southeast	6° - 12°N	18	244-3816	20-380
Centraleast	12° - 18°N	19	2578-3452	25-350
Northeast	18° to North	4	250-2100	70-100
Andaman-Nicobar	4° -15°N, 89° -95°E	31	447-4057	18-350

Most of these stations, situated within the EEZ and slightly beyond, were in the oceanic areas with depths up to 4500 m but some stations, especially on the west coast, had shallower depths up to 62 m. The gear was operated mostly within 100 m from sea surface but occasionally at deeper depths up to 420 m; at one station (21°N, 67°15'E) in the northwest region the gear was operated at a depth of 1590 m.

The geographic positions of stations from where oceanic squids were obtained are shown in Fig.1. The centralwest region and the southwest region including the Lakshadweep waters abound in oceanic squids as judged from the frequency of their occurrence. In the northwest region they are also obtained from contiguous areas beyond the EEZ. The coverage in the northeast region was poor, since there were only 16 stations where pelagic trawl was operated, out of which four were positive for oceanic squids. In the centraleast region and the southeast region there was fairly good distribution of oceanic squids, but in the Andaman-Nicobar waters their occurrence was much more frequent. In the central equatorial region, out of 12 pelagic trawl stations six were positive for oceanic squids. In general, oceanic squids are distributed in the entire EEZ and its contiguous waters, with more concentration in some areas like the northeastern Arabian Sea, southeastern Arabian Sea, Lakshadweep waters, southwestern and centralwestern Bay of Bengal and the Andaman-Nicobar waters.

Quantitywise, the catches of oceanic squids obtained in pelagic trawl from almost all stations were very poor or negligible, often 1 kg and very rarely 10 kg. In most hauls the squids occurred in very few numbers and weighed a few grams only.

A number of species of oceanic squids belonging to several oegopsid families occur but at present most of them are not used for human consumption due to their small size, unfavourable body consistency and insufficient quantity, eventhough they con-

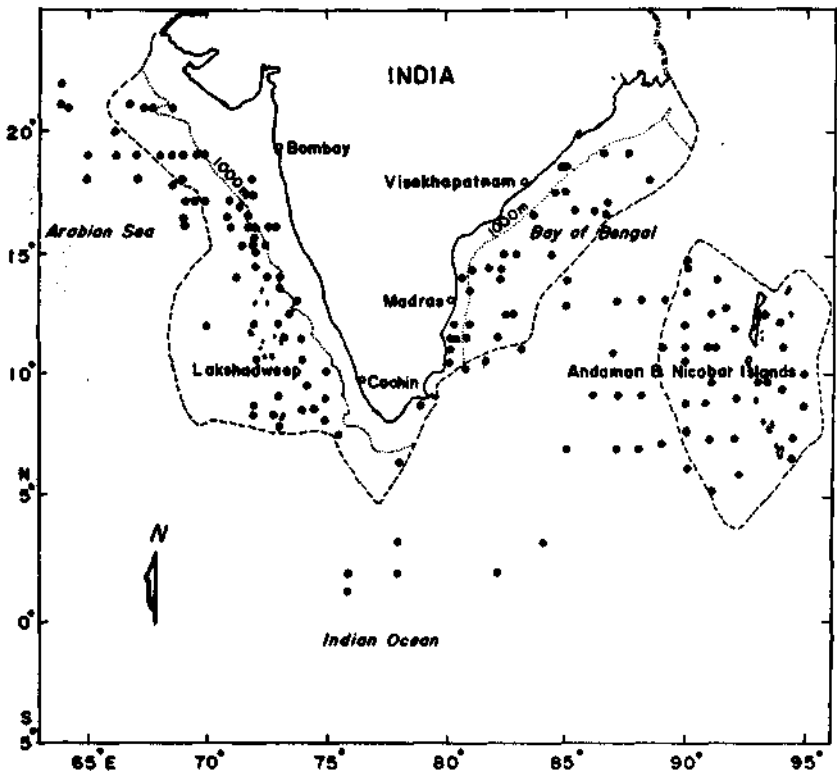

Fig. 1- Distribution of oceanic squids (dots) in the EEZ of India and contiguous areas, based on pelagic trawling by *FORV Sagar Sampada* (broken line is the outer boundary of EEZ)

stitute an important forage item to many fishes in the oceanic areas. The most important among the oceanic squids is the purpleback flying squid *Symplectoteuthis oualaniensis* which belongs to the commercially significant oceanic squid family of the world, Ommastrephidae. It is a large-sized squid occurring in commercial quantities in the Gulf of Aden, northern Arabian Sea, Japan, Taiwan and Hawaiian Islands where it is collected in moderate to heavy quantities by jigging and dipnet fishing. Earlier surveys indicated the occurrence of this squid in many parts of the Indian waters with concentration in some areas, especially in the northern Arabian Sea. The cruises of *Sagar Sampada* further confirmed this and provided additional information on the distribution of this in many other areas.

The pelagic trawl operations did not reveal any fishable concentration of medium and large-sized *S. oualaniensis* at most of the stations, as the maximum number obtained from a single station was only 318 squids of <200 mm length with 115 mm modal size, weighing 20 kg; the next highest number from another station was 74 with the same modal size. In all other stations the squids collected were few in number and smaller in size, with some exceptions. From station 517, situated northeast of Car-

Nicobar Island, 3537 juvenile squids of 13-26 mm were obtained in one hour of pelagic trawling. The largest squid, measuring 472 mm in length and 4.7 kg in weight, was collected from station 774 in the northwest region. Five more squids measured >400 mm from the same station, all caught at depths of 110-250 m. A large squid of 425 mm weighing 4.5 kg was obtained from station 1225 in the northwest region.

Another large species of oceanic squid rarely obtained in *Sagar Sampada* cruises is the diamondback squid *Thysanoteuthis rhombus* of the family Thysanoteuthidae. Most of the specimens of this species collected were small in size and stray in occurrence and on no occasion any fishable concentration of this squid was observed. The largest squid obtained was a female measuring 585 mm in length and weighing 5.3 kg, caught from Andaman-Nicobar waters. All other specimens collected from different parts of the EEZ were small in size, measuring 40-105 mm in length.

Most other oceanic squids collected by *Sagar Sampada* were small species, except for some species such as the common clubhook squid *Onychoteuthis banksii*. Small and medium-sized squids of this species measuring 28-100 mm length occurred at some stations on the west coast, while in the Bay of Bengal its occurrence was sparse. In the Andaman-Nicobar waters its distribution was more frequent and as many as 82 squids of 32-195 mm length were taken in pelagic trawl from 9 stations in a single cruise. Young squids (85-100 mm) of another large species, *Ancistrocheirus lesueri*, were collected in stray numbers from the west coast and from Andaman-Nicobar waters.

Smaller species recorded were *Abralia andamanica*, *Abraliopsis gilchristii*, *Cranchia* spp, *Liocranchia* spp, *Leachia* spp, *Enoploteuthis* sp., *Chiroteuthis* sp., *Octopoteuthis* sp., *Histioteuthis* sp, *Ctenopteryx* sp., and *Japatella* sp. Among squids *Abralia*, *Abraliopsis* and *Cranchia* occurred more frequently in maximum number of stations. Apart from squids, some octopods (*Octopus* spp and *Argonauta* sp.) were also obtained.

The number of squids obtained during night were much higher than during day, and about 65% of the oceanic squids were collected at night, indicative of their diel vertical migration towards surface layers during night hours.

## DISCUSSION

The pelagic trawling operations conducted by *Sagar Sampada* in the Indian EEZ and in some areas contiguous to it have corroborated earlier observations on the distribution of oceanic squids in general, and the purpleback flying squid *Symplectoteuthis oualaniensis* in particular (Filippova, 1968; Silas, 1968; Zuev, 1971; Okutani, 1973; Yamanaka *et al.* 1976, 1977). Dense concentrations were observed in exploratory surveys in the north Arabian Sea, and medium and large-sized squids up to a size of 500 mm were caught in jigging operations. Though a few large-sized squids were taken in pelagic trawl by *Sagar Sampada*, the occurrence of such large squids was extremely rare. Even the smaller squids were few in number except the

instance of over 3500 juveniles caught at a station in Andaman-Nicobar waters. In the exploratory squid jigging operations with light-attraction system off the southwest and centralwest coasts, purpleback flying squid was observed at a rate of 33 kg (576 squids) per night (Nair *et al.* 1992); the highest areawise catch recorded was 1438 squids (75 kg) per night. This shows that squids are present in Indian waters and can be fished by jigging. Jigging was not possible from *Sagar Sampada*, and the only one available was pelagic trawling, the performance of which was very poor throughout the cruises. Therefore, pelagic trawling operations did not give much information about the stock position or potential of not only oceanic squids but also any other pelagic fishery resources.

Though the picture of the extent of the oceanic squid resource and its potential has not emerged, the cruises provided new information on the distribution of *Symplectoteuthis oualaniensis* in Indian waters. Earlier studies have indicated the occurrence in some areas, especially in the northern Arabian Sea (Yamanaka *et al.* 1976, 1977) and off the southwest coast of India (Silas, 1968). The occurrence of juveniles in the pelagic trawl collections, the observation on many occasions of shoals of medium and large-sized squids aggregating near the ship attracted by its light, and the exploratory squid jigging operations on the southwest coast of India (Nair *et al.* 1992) have further confirmed this. The *Sagar Sampada* cruises have revealed the distribution of this squid in the Bay of Bengal, especially off the southeast coast and the centraleast coast. The occurrence of juvenile squids, particularly that of over 3500 numbers at a single station in the Andaman-Nicobar waters (Sreenivasan & Saevesan, 1990) indicates that this region is rich in oceanic squid resource, and that this may be one of its breeding and nursery grounds.

All these point towards the importance of the purpleback flying squid as a potential resource in the Indian waters, and there is need for exploiting the resource in the light of the high unit price of squids in the export trade. Chikuni (1983) indicated the possibility of commercial fishery for this squid in the eastern Arabian Sea. Realising the scope for exploitation of this squid, Silas (1986) gave the projection that about 2500 t could be harvested by 1990, and somewhere between 25000 t and 50000 t would be the exploitation by the year AD 2000. However, there is still no fishery for this squid in India, nor there is any information on the fishery in Indian waters by other countries under any charter agreement. The main reason for this is probably the lack of suitable catching technique to fish in distant waters away from the conventional neritic region. Pelagic trawling has proved ineffective, but jigging seems to be the ideal method in the absence of any other suitable technique. Jigging takes advantage of the squid behaviour of getting attracted towards artificial light. Another advantage of jigging is that only the medium and large-sized squids are jigged, and the juvenile population is not affected. However, the economics of jigging operations in Indian waters is yet to be proved.

## ACKNOWLEDGEMENT

The authors are thankful to Dr. P.S.B.R. James, former Director, for approving this topic for presentation at the workshop, and to all those connected with the management and operation of *FORV Sagar Sampada* for providing all facilities onboard.

## REFERENCES

- Chikuni, S. 1983. Cephalopod resources in the Indo-Pacific region, *Advances in assessment of world cephalopod resources, FAO Fish. Tech. Pap.* 231: 264-304.
- Fillippova, J.A. 1968. *New data on the cephalopoda of the Indian Ocean*, In: *Proc. Symp. Mollusca*, Pt. 1, (Marine Biological Association of India, Cochin) 257-264.
- Meiyappan, M.M. & Prabhakaran Nair, K. 1990. Preliminary studies on the cephalopods collected from the Deep Scattering Layers of the Indian Exclusive Economic Zone and adjacent seas, In: *Proceedings of the First Workshop on Scientific Results of FORV Sagar Sampada*, edited by K.J. Mathew, (CMFRI, Cochin) 397-401.
- Meiyappan, M.M., Sarvesan, R. & Prabhakaran Nair, K. 1990. Preliminary studies on the distribution and abundance of planktonic cephalopods in the Indian Exclusive Economic Zone and adjacent seas, In: *Proceedings of the First Workshop on Scientific Results of FORV Sagar Sampada*, edited by K.J. Mathew, (CMFRI, Cochin) 185-190.
- Nair, K.N.V. Ninan, T.V., Joseph, P.J. & Jagannadh, N. 1992. An account of exploratory squid jigging off west coast of India, *Bull. Fish. Surv. India*, 23: 1-26.
- Nair, K.P., Meiyappan, M.M., Kuriakose, P.S., Sarvesan, R., Lipton, A.P., Sunilkumar Mohamed, K., Asokan, P.K., Mathew Joseph & Nagaraja, D. 1992. Biology of squids, *Bull. Fish. Surv. India*, 23: 27-42.
- Nair, K.P., Satyanarayana Rao, K., Sarvesan, R., Meiyappan, M.M., Syda Rao, G., Mathew Joseph & Nagaraja, D. 1990. Oceanic squid resources of the EEZ of India, In: *Proceedings of the First Workshop on Scientific Results of FORV Sagar Sampada*, edited by K.J. Mathew, (CMFRI, Cochin) 403-407.
- Okutani, T. 1973. Preliminary note on planktonic oegopsid cephalopod larvae obtained by the International Indian Ocean Expedition, *J. Mar. Biol. Ass. India*, 15 (1): 213-217.
- Roper, C.F.E., Sweeney, M.J. & Nauem C.E. 1984. *FAO species catalogue*, Vol. 3, *Cephalopods of the world. An annotated and illustrated catalogue of species of interest to fisheries*, *FAO Fish. Synop.* 125 (3) : pp. 277.
- Sarvesan, R. & Meiyappan, M.M. 1990. Qualitative and quantitative distribution of planktonic cephalopods in the Exclusive Economic Zone of India, In: *Proceedings of the First Workshop on Scientific Results of FORV Sagar Sampada*, edited by K.J. Mathew, (CMFRI, Cochin), 179-184.
- Silas, E.G. 1968. Cephalopoda of the west coast of India collected during the cruises of the *Research Vessel Varuna*. with a catalogue of the species known from the Indian Ocean, In: *Proceedings of the Symposium on Mollusca*, Pt. 1, (Mar. Biol. Ass. India, Cochin) 277-359.
- Silas, E.G. 1969. Exploratory fishing by *R.V. Varuna*, *Bull. Cent. Mar. Fish. Res. Inst.* 12: 1-86.
- Silas, E.G. 1986. Cephalopod resources: perspectives, priorities and targets for 2000 A.D., In: *Cephalopod bionomics, fisheries and resources of the exclusive economic zone of India*, *Bull. Cent. Mar. Fish. Res. Inst.* 37: 172-183.
- Sreenivasan, P.V. & Sarvesan, R. 1990. On the cephalopods collected during the exploratory survey by *FORV Sagar Sampada* in the Andaman-Nicobar Seas, In: *Proceedings of the First Workshop on Scientific Results of FORV Sagar Sampada*, edited by K.J. Mathew, (CMFRI, Cochin) 409-414.
- Yamanaka, H., Nishigawa, Y. & Morita, J. 1976. Summary report on cruises of the *R.V. Shoyo Maru* in the North Arabian Sea., 2 October 1975 to 14 January 1976, *FAO Tech. Rep.* 11: 1-47.



Yamanaka, H., M. & Nakamura, I. 1977. Summary Report on cruises of the *R.V. Shoyo Maru* in the North Arabian Sea, 2 October 1976 to 13 January 1977, *FAO Tech. Rep.* 14: 1-82.

Zuev, G.V. 1971. *Cephalopods from the northwestern part of the Indian Ocean*, (Pishchevaya Promyshlennost Press, Moscow), pp. 223.

\* \* \*

## Cephalopod resources in southeast and northeast coasts of India and Andaman - Nicobar waters

V. Kripa, K. P. Nair, Kuber Vidyasagar, G. Syda Rao, A.P. Lipton, K.K. Appukuttan, P.V. Srinivasan, M.E. Rajapandian, P. Natarajan, K. Ramadoss, N. Burayya, K.T. Thomas, P. Achayya, M.M. Bhaskaran & Mathew Joseph

Central Marine Fisheries Research Institute, Post Box No. 1603, Cochin - 682 014

### ABSTRACT

During 1988-'90, *FORV Sagar Sampada* has made 28 exclusive cruises to three regions in the Bay of Bengal covering different seasons of the year. Cephalopods formed one of the components of the demersal fishery resources of these regions, with the pelagic resources remaining insignificant. The commercially important neritic species of squids (*Loligo duvauceli*, *Doryteuthis sibogae* and *Doryteuthis singhalensis*), and cuttlefish (*Sepia aculeata*) were comparatively more in number and quantity than the species of oceanic squid *Symplectoteuthis oualaniensis* and other less important oceanic squids. The former groups of cephalopods were taken in demersal trawl and the latter in pelagic trawl. The distribution and relative abundance of various neritic and oceanic group of cephalopods by area and depth is given in the paper.

### INTRODUCTION

Cephalopods form an important marine resource, the exploitation of which has recorded a phenomenal increase in the recent years. The major fishing areas for this resource are the traditional fishing grounds, close to the shore. Information on the resource potential of cephalopods in the EEZ is available from the works of Joseph (1966); Silas (1986); Silas *et al.* (1986); Sudarsan *et al.* (1988, 1990); Philip & Somvanshi (1991). However, only very limited information is available on the cephalopod resources of the Andaman and Nicobar area (Sreenivasan & Sarvesan, 1990). In the present study the cephalopod resource in the waters off the northeast and southeast coasts of India and Andaman and Nicobar area as revealed by surveys made by *FORV Sagar Sampada* during 1988-90 is presented.

## MATERIALS AND METHODS

During the period 1988-90 *FORV Sagar Sampada* has made exclusive cruises to the three regions in the Bay of Bengal covering the areas in the southeast region lat. 10°40'-15°06'N and long 79°57'-81°25'E, northeast region lat. 15°-20°10'N and long. 81°22'-87°25'E and in the waters around Andaman and Nicobar islands lat. 6°30'-14°30'N and long 91°35'-94°55'E. The data presented in the paper pertain to the catch obtained in the pelagic and demersal trawls operated in these areas. Details of the cruises including the number of stations where cephalopods contributed to the catch is given in Tables 1,2. The catch data from all the cruises is pooled and analysed for the distribution and relative abundance of various neritic and oceanic groups of cephalopods by area and depth.

## RESULTS

### Northeast region

In the northeast region nine cruises (Tables 1, 2) were performed. The total cephalopod catch was only 315 kg, accounting for about 1% of the total catch of 31 tonne obtained from this region. Almost the entire catch was by bottom trawl. The pelagic trawl was operated within 40-120m depth from the surface in the oceanic waters where the bottom depth ranged between 250 to 3100 m. Bottom trawl was operated within 30-146 m depth. The catch per hour of trawling in NE region was very low, less than 5 kg in pelagic trawl operation. (Fig. 1) Cephalopods were trawled from six depth ranges within 20-40 m to 140-160 m. The catch rates obtained from these depth ranges are shown in Fig. 2. The highest catch of 203 kg which formed 42% of the total catch was obtained from 89 m depth, off Kakinada.

The entire catch of cephalopods taken in pelagic trawl was made up of the purple back flying squid *Symplectoteuthis oualaniensis* (Ommastrephidae). This is a widely distributed Indo-Pacific species, but in the Indian Ocean it is restricted to the northern and central parts. At present this species is not exploited from Indian water because of its restricted distribution in the oceanic regions far away from the coasts. In the cephalopod catch obtained from bottom trawl operation 47% (146 kg) was of squids and 53% (164 kg) cuttlefish. *Loligo duvacoelii* was the single squid species while *Sepia pharaonis* and *S. aculeata* were the main cuttlefish components.

### Southeast region

In the southeast coast seven cruises (Tables 1, 2) were performed during the period from June 1989 to April 1990. The total cephalopod catch was 141 kg accounting for 3.2% of the total catch of 5.4 tonne. Almost the entire catch was taken in the bottom trawl, while the share of pelagic trawl was insignificantly small in terms of quantity (1.4%). Pelagic trawling was done in the oceanic region and the depth of operation of the gear was 150 m from the surface, while bottom trawling was carried out within 48-101 m depth from the coastline. The duration of operation of the trawl varied from

Table 1 — Details of stations positive for cephalopod occurrence based on bottom trawl operations in the northeast, southeast and Andaman & Nicobar regions of Bay of Bengal

Cruise no.	Month/year	Position	Depth (m)	No. of stations	Cephalopod catch (kg)
<i>Northeast coast of India</i>					
44	March '88	19°40'-86°12'E	44	5	39
45	April '88	16°04' - 20°00'N;81°32' - 86°35'E;	40-60	5	6
47	May-June '88	16°14' - 17°05'N;82°01' - 83°02'E;	89-146	3	231
49	July '88	15°58' - 20°00'N;81°30' - 84°12'E;	75-87	2	2
51	Sept. '88	18°03' - 20°10'N;84°12' - 87°00'E;	46-65	4	13
53	Oct. '88	18°02' - 18°53'N;84°14' - 84°49'E;	64-120	3	3
54	Nov. '88	16°00' - 19°43'N;81°22' - 86°20'E;	52-100	4	12
57	Jan. '89	17°12' - 19°55'N;82°50' - 86°31'E;	30-35	2	2
58	Feb. '89	19°30'N; 85°39'E	65	1	2.5
<i>Southeast coast of India</i>					
59	June '89	10°30' - 14°11'N;80°09' - 80°22'E;	55-101	3	52
61	Aug. '89	10°45';80°12'E	80	1	52
63	Sept. '89	13°25' - 15°33'N;80°28' - 80°44'E;	65-80	1	24
67	Dec. '89	11°18' - 12°50'N;79°57' - 80°28'E;	50-85	2	4
70	Feb. '90	14°05'N;80°23'E	48	1	4
72	April '90	10°30' - 15°00'N;80°14' - 80°30'E;	48-98	4	5
<i>Andaman &amp; Nicobar region</i>					
46	May '88	12°18' - 13°26'N;92°43' - 93°09'E;	65-73	2	3
48	June '88	12°55' - 93°03'E	142	1	1
56	Jan. '89	12°32' - 12°42'N;92°05' - 93°05'E;	78-107	2	5
62	Aug. '89 Sept.	10°37' - 11°51'N;92°15' - 92°54'E;	90-92	2	1
66	Nov. '89	10°49'N;92°16'E	70	1	1
69	Feb. '90	11°45' - 12°49'N;92°35' - 92°47'E;	73-83	2	5
73	May '90	13°22'N;92°43'E	76	1	5

Table 2 — Details of stations positive for cephalopod occurrence based on pelagic trawl operations in the northeast, southeast and Andaman & Nicobar regions of Bay of Bengal

Cruise no.	Month/year	Position	Depth (m)	No. of stations	Cephalopod catch (kg)
<i>Northeast coast of India</i>					
44	March '88	15°00' - 19°00'N; 82°40' - 87°25'E;	50-120	6	4.5
<i>Southeast coast of India</i>					
67	Dec. '89	12°00' - 15°06'N; 80°24' - 81°15'E;	150	2	2
<i>Andaman &amp; Nicobar region</i>					
48	June '89	12°40'N; 91°45'E	65	1	1
50	Aug. '89	7°59' - 12°40'N; 91°45' - 93°45'E;	65-100	4	1
60	July '89	10°30'N; 92°45'E	65	1	1
64	Oct. '89	10°30' - 13° 13' N; 92° 45' - 93°20'E;	100	2	1

20 minutes to 75 minutes. The maximum catch rate of 75 kg/hr was recorded at lat. 13°25'N, long. 80°28'E.

The cephalopod catch in the pelagic trawl composed of only squids while in the bottom trawl catch 53% (74 kg) was squids and 47% (65 kg) cuttlefish. The squid catch composed of mainly of *Loligo duvaucelii*. Other squids observed were *Doryteuthis sibogae* and *Doryteuthis singhalensis*. Among cuttlefish the dominant species was *Sepia pharaonis*. Besides, this, *Sepia aculeata* was also obtained in few numbers.

### Andaman & Nicobar region

The total cephalopods catch from the twelve cruise (Tables 1, 2) in the Andaman-Nicobar waters was just 25 kg in the total catch of 4939 kg. The pelagic trawl was operated at a depth of 65-100 mm depth from the surface where the bottom depth was within 210- 3000 mm. Bottom trawl was also operated off Andaman- Nicobar islands where the bottom depth ranged from 70 m to 92 m. The catch per hour was less than 1 kg in most of the stations with a maximum of 8 kg at lat. 10°37'N; long. 92°15'E. The maximum catch was only 4 kg taken at lat. 13°22'N, long 92°15'E. The maximum catch was only 4 kg taken at lat 13°22'N, long 92°43'E from a depth of 76 m. Cephalopods were obtained mostly at two depth zones 60-80 m and 80-100 m. The

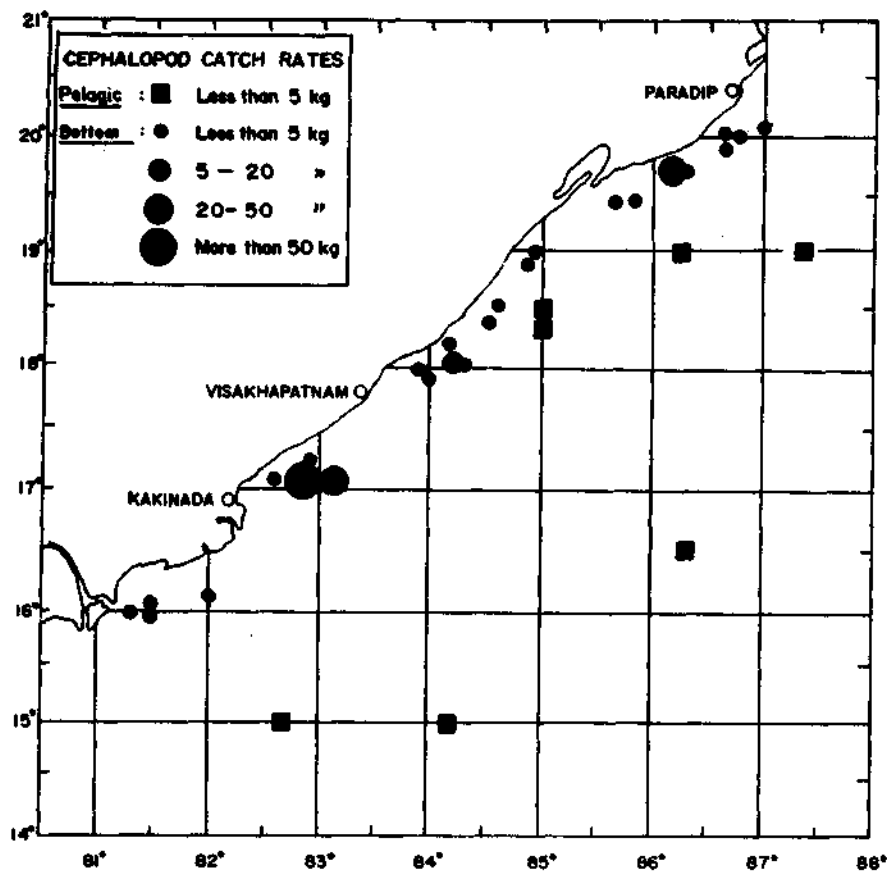

Fig. 1 — Catch per hour (kg) of cephalopods taken in the pelagic and bottom trawl operated off the northeast coast of India

depth zone 80-100 m gave slightly better catch rate of 3.4 kg/hr, than the 60-80 m zone giving 2.2 kg/hr.

The most important component of the cephalopod catch was the purple black flying squid *Symplectoteuthis oualaniensis* in the size range of 14-132 mm. All squids were juveniles with the modal sizes of 25 mm and 65 mm. Apart from this squid, a few numbers of the small-sized oceanic squid *Abralia andamanica* were also obtained from stations at lat.  $9^{\circ}21'N$ , long.  $93^{\circ}03'E$  and lat.  $7^{\circ}59'N$ ; long.  $93^{\circ}45'E$ .

## DISCUSSION

The cephalopod resource as revealed by the catches, obtained by *Sagar Sampada* cruises is very low in the three regions surveyed. This does not mean that resources do not exist but evidently the catching technique is imperfect. Instead of using the pelagic

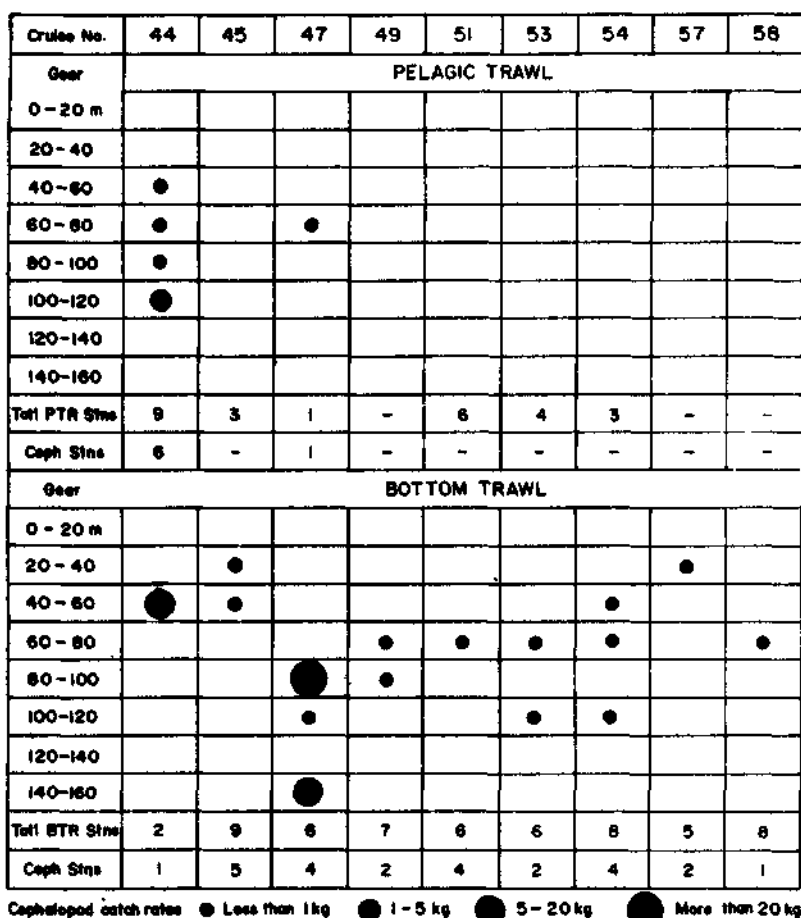

Fig.2 — Catch per hour (kg) of cephalopods taken from different depth ranges during different cruises of *FORV Sagar Sampada* off the northeast coast of India

and demersal trawls meant for finfishes and shrimps, the squid jigging method meant exclusively for squids must be tried. The data is quite insufficient to give any indication of the resources position of cephalopods in the area except providing some information on the qualitative distribution of different species of squids and cuttlefish by area and depth. In the Andaman-Nicobar waters the grounds were quite unsuitable for bottom trawling and this may be a reason for the negligible quantity of cephalopods obtained rather than their absence in the area.

The importance of the oceanic species as a resource in the Arabian Sea and Bay of Bengal has been highlighted by Nair *et al.* (1990). The surveys carried out by *FORV Sagar Sampada* during 1988-90, add more information on the distributional range of this species off the east coast. This squid is known for its positive phototactic behaviour

(Chikuni, 1983). In the recent surveys it was noted that more number of squids were collected at night than during day which supports the earlier finding that this species exhibits vertical migration towards surface at night.

Earlier reports on the results of the exploratory surveys in the Andaman-Nicobar waters, by Sreenivasan & Sarvesan (1990) indicate the occurrence of 26 species belonging to 22 genera. Based on the occurrence of 3537 numbers juveniles of *Symplectoteuthis oualaniensis* in catch, it was suggested that this area may be nursery ground for *Symplectoteuthis oualaniensis*. Presence of juveniles of this species in the pelagic trawl in the recent survey substantiates this view.

The data on cephalopods collected by *FORV Sagar Sampada* during the course of three years add more information to the temporal and spatial distribution of oceanic cephalopods.

### REFERENCES

- Chikuni, S. 1983. Cephalopod resources in the Indo-Pacific region, In: *Advances in assessment of world cephalopod resources*, edited by J.E. Caddy, *FAO Fish. Tech. Pap.* 231: 264-305.
- Joseph, K.M. 1966. Some observations on potential fishery resources from the Indian EEZ, *Bull. Fish. Surv. India*, 14: 1-20.
- Nair, K.P. Satyanarayana Rao, K., Sarvesan, R., Meiyappan, M.M., Syda Rao, G., Mathew J & Nagaraja, D. 1990. Oceanic squid resources of the EEZ of India, In: *Proc. First Workshop Scient. Resul. FORV Sagar Sampada*, edited by K.J. Mathew, (CMFRI, Cochin) 403-407.
- Philip, K.P. & Somavanshi, V.S. 1991. Squid and cuttlefish resources of the Indian Continental shelf and slope; *Proc. Nat. Workshop. Fish. Resour. Data. Fish. Industr.* 88-97.
- Silas, E.G. 1986. Cephalopod resources: Perspective priorities and targets for 2000 A.D., *Bull. Cent. Mar. Fish. Res. Inst.* 37: 172-183.
- Silas, E.G., Kuber Vidyasagar, Nair, K.P. & Narayana Rao. 1986. Cephalopod resources revealed by exploratory surveys in Indian seas, *Bull. Cent. Mar. Fish. Res. Inst.* 37: 129-136.
- Sreenivasan, P.V. & Sarvesan, R. 1990. On the cephalopods collected during the exploratory survey by *FORV Sagar Sampada* in the Andaman-Nicobar seas, In: *Proc. First Workshop Scient. Resul. FORV Sagar Sampada*, edited by K.J. Mathew, (CMFRI, Cochin): 409- 413.
- Sudarsan, D., Sivaprakasam, T.E., Somavanshi, V.S., John, M.E., Nair, K.N.V. & Antony Joseph. 1988. An appraisal of the marine resources of the Indian EEZ *Bull. Fish. Surv. India*, 18: pp. 85.
- Sudarsan, D., John, M.E. & Somavanshi, V.S. 1990. Marine Fishery Resources Potential of the Indian Exclusive Economic Zone - an update, *Bull. Fish. Surv. India*, 20: pp. 27.

\* \* \*



## Demersal resources off northwest coast of India

A. Anrose, L. Ramalingam, A.K. Bhargava, G. Nagarajan, V.V. Naik,  
Vajjayanti Rane & M.A. Prabhu Arachi

Fishery Survey of India, Madras Zonal Base Fishing Harbour,  
Royapuram, Madras-600 013

### ABSTRACT

The paper presents the results of demersal resources survey done by *FORV Sagar Sampada* between the depth 50 m and 300 m along the continental shelf and slope of Indian EEZ of northwest coast of India during the cruises 103 and 105 A (August - September and November 1992) between the lat. 15°N and 23°N. Among the depth strata surveyed, the highest catch rate of 740.4 kg/hr was recorded in the depth range 50-100 m and the areas surveyed, the lat. 20°N yielded the highest catch rate of 831.7 kg/hr. Analysis of depthwise distribution revealed that nemipterids constituted 37.8%, ribbon fish 12.3%, sciaenids 10.4% etc., in 50-100 m even in the 100-200 m depth zone also nemipterids constituted the maximum of 47.3% followed by sciaenids (12.2%). Significant quantities of nemipterids, lizard fishes and bull's eye were recorded in all the latitudes.

### INTRODUCTION

Northwest coast of India extending from lat. 15°N to 23°N is traditionally known for rich fishery resources. Wide continental shelf, extending as far as 150 miles and abundant discharge by rivers from Gulf of Cambay and the Gulf of Kutch could be considered as the factors favourable for the availability of rich resources in the area. Information is available on the demersal and columnar resources of the region based on the results of exploratory fishing (Jayaraman *et al.* 1959, Sivaprakasam, 1965; Dwivedi *et al.* 1977 a,b,c; Swaminath *et al.* 1977 a,b). The findings of the vessels of Fishery Survey of India, *Matsya Nireekshani*, *Matsya Varshini* and other vessels are also available as periodic reports of FSI (Joseph, 1974, 1980; Sudarshan *et al.* 1988, 1990). *Matsya Mohini* of FSI has been conducting demersal surveys along the northwest coast since 1986. However, these studies have by and large been restricted up to a depth of about 150 m for various reasons. Therefore, it was proposed to undertake a deep water survey by *FORV Sagar Sampada* from 100 to 1000 m depth

as this vessel has the requisite machinery and equipments onboard. Cruise no.103 and 105 A were undertaken during August-September 1992 and November 1992 respectively. The results of demersal trawl survey done during these cruises are presented in this paper.

## MATERIALS AND METHODS

Demersal resources survey was carried out along the northwest coast between lat. 15°N and 23°N in the depth range of 50 to 299 m. The area under survey was demarcated as different depth zones viz, 50-100 m, 100-200 m and beyond 200 m. Echo surveys were carried out in the depth beyond 200 m of which beyond 300 m depth shows the sudden depth fluctuations and highly uneven terrain which may however needs revision and hence fishing was not done beyond 300 m depth. The hauls were distributed randomly and altogether 67 hauls were made by four different types of trawl gears. The total catch, fishing effort, species composition etc., were recorded for each haul. The catch per unit effort and percentage of species composition were worked out for different latitudes and depths. The catch netted by the different gears in both the cruises are pooled together for the present study.

## RESULTS AND DISCUSSION

The areawise and depthwise catch per unit effort obtained during the period under study are shown in Table 1. Among all the areas surveyed, the lat.20°N registered the highest catch rate of 831.7 kg/hr followed by the lat.22°, 21° and 19°N by yielding cph of 800.7 kg, 572.6 kg and 412.8 kg respectively. The lowest cph of 102 kg and 231.3 kg were recorded from the lat.17° and 16°N respectively. The abundance of resources is comparatively more in the northern areas than the southern areas. Among the different depth zones, 50-100 m zone yielded the maximum cph of 740.4 kg followed by the 100-200 m zone (477.8 kg) and deeper waters beyond 200 m contributed very low cph of 14.3 kg.

The catch per unit effort recorded from the depth zone of 50-100 m of lat.16°, 20°, 21°, 22°N and the 100-200 m depth zone of 15°, 17°, 18°, 19°N were better than that of the other areas and depth zones. Good catches of nemipterids, lizard fish and priacanthids were recorded from all the depth zones of all areas whereas low catch rate of cephalopods and rock cods were recorded from the areas below 200 m depth. Elasmobranchs, upenids, carangids and Indian drift fish were also recorded with low catch rates.

The latitudewise percentage composition of various species recorded in detail is given in Table 2. In lat.15°N, a total of 2.75 hr of actual fishing effort was expended in 100-200 m depth strata. The catch was predominated by nemipterids (90.7%) followed by cephalopods (3.5%). In lat. 16°N *Priacanthus* sp. formed 45.4% followed by nemipterids (25.8%) and *Epinephalus* spp (25.3%) of the catch for 3.42

Table 1 - Areawise, depthwise and specieswise CPH recorded in demersal resources survey

Species/group	Depth 50-100 m						Depth 100-200 m									Depth 200-300 m		
	16°	17°	20°	21°	22°	Total	15°	16°	17°	18°	19°	20°	21°	22°	Total	19°	20°	Total
Elasmobranchs	-	-	7.5	0.8	-	3.4	-	-	-	-	5.0	1.1	1.3	1.3	3.7	-	1.3	0.3
<i>Epinephalus</i> sp.	63.4	78.2	1.1	1.2	-	17.1	8.0	30.0	-	-	-	6.4	15.5	70.7	22.3	-	-	-
Polynemids	-	-	7.8	12.5	-	6.5	-	-	-	-	-	-	-	-	-	-	-	-
Sciaenids	-	-	51.4	0.3	650.0	75.0	-	-	-	-	-	31.6	83.7	134.2	58.3	-	-	-
Carangids	0.7	0.4	34.0	65.4	50.0	35.8	-	-	-	0.1	-	0.9	1.7	135.1	31.0	-	-	-
<i>Schyaena</i> sp.	-	-	3.1	15.9	-	5.5	-	-	-	-	-	0.2	6.7	6.5	3.0	5.2	1.3	4.3
Upenids	-	-	28.2	74.1	39.5	30.5	-	-	-	-	-	-	-	0.3	0.1	-	-	-
<i>Arius</i> sp.	-	-	4.6	2.3	-	2.6	-	-	-	-	-	-	0.2	-	0.1	-	-	-
Nemipterids	69.2	7.3	314.5	411.2	400.0	281.4	233.9	4.0	200.0	91.9	8.5	526.4	305.5	137.3	226.1	-	-	-
<i>Saurida</i> sp.	0.7	-	86.5	42.1	-	48.0	2.5	-	8.0	26.2	190.0	101.1	55.5	21.3	52.2	-	-	-
<i>Priacanthus</i> sp.	121.4	4.4	0.9	1.9	-	15.8	3.6	8.0	-	195.9	15.0	14.9	3.2	9.4	41.3	8.6	12.1	9.4
<i>Trichiurus</i> sp.	-	0.4	86.3	39.0	550.0	90.0	-	-	-	-	-	0.8	4.0	4.5	1.3	-	-	-
Clupeids	-	-	4.3	0.3	-	1.9	-	-	-	-	-	-	-	-	-	-	-	-
<i>Ariomma indica</i>	-	-	0.3	-	-	0.1	-	-	-	-	225.0	0.2	0.8	0.6	14.3	-	-	-

Contd. . . .

Table 1—Contd. . . .

Species/group	Depth 50-100 m						Depth 100-200 m								Depth 200-300 m			
	16°	17°	20°	21°	22°	Total	15°	16°	17°	18°	19°	20°	21°	22°	Total	19°	20°	Total
Flat fish	-	-	0.7	-	-	0.3	-	-	-	-	-	-	-	-	-	-	-	-
Mackerel	-	-	17.6	-	-	7.5	-	-	-	-	-	-	-	-	-	-	-	-
<i>Apogon quadrifasciatus</i>	-	-	28.6	-	-	12.2	-	-	-	-	-	-	-	-	-	-	-	-
<i>Centropomus aureus</i>	-	-	47.6	-	-	20.3	-	-	-	-	-	-	-	-	-	-	-	-
Cephalopods	2.1	0.6	11.5	11.4	15.5	9.5	9.1	36.0	12.0	6.3	85.0	11.3	5.6	4.9	11.1	-	-	-
Prawns	-	-	0.4	-	-	0.1	-	-	-	-	-	-	-	-	-	-	-	-
Lobsters	-	-	0.3	-	-	0.1	-	-	-	-	-	-	-	-	-	-	-	-
Crabs	-	-	0.4	-	1.5	0.3	-	-	-	0.1	-	-	-	1.9	0.4	-	-	-
Other Fishes	-	-	152.6	21.8	70.0	76.5	-	-	-	-	-	0.2	5.8	46.7	12.2	-	-	-
Catch per hour	257.5	91.3	890.2	700.2	1776.5	740.4	257.1	78.0	220.0	320.3	528.5	695.1	489.5	574.7	477.6	13.8	14.0	14.0

Table 2 - Latitudewise percentage composition of species recorded

Species/group	lat. 15°N	16°N	17°N	18°N	19°N	20°N	21°N	22°N
Elasmobranchs	-	-	-	-	0.9	0.7	0.2	0.1
<i>Epinephalus</i> sp.	3.4	25.3	70.3	-	-	0.3	1.7	6.8
Polynemids	-	-	-	-	-	0.6	-	-
Sciaenids	-	-	-	-	-	5.5	9.8	29.2
Carangids	-	0.3	0.3	0.1	-	2.9	4.7	14.3
<i>Sphyraena</i> sp.	-	-	-	-	0.3	0.3	1.8	0.6
Upenids	-	-	-	-	-	2.2	5.1	1.0
<i>Arius</i> sp.	-	-	-	-	-	0.4	0.2	-
Nemipterids	90.7	25.8	22.9	28.6	1.6	45.5	60.4	23.3
<i>Saurida</i> sp.	1.0	0.2	0.6	8.2	35.7	10.5	8.8	2.1
<i>Priacanthus</i> sp.	1.4	45.4	3.9	61.0	3.3	0.7	0.5	0.9
<i>Trichiurus</i> sp.	-	-	0.4	-	-	7.4	3.1	14.2
Clupeids	-	-	-	-	-	0.4	0.1	-
<i>Ariomma indica</i>	-	-	-	-	42.3	0.1	0.1	0.1
Flat fishes	-	-	-	-	-	0.1	-	-
Mackerel	-	-	-	-	-	1.5	-	-
<i>Apogon quadrifasciatus</i>	-	-	-	-	-	2.4	-	-
<i>Centropomus aureus</i>	-	-	-	0.1	-	4.0	-	-
Cephalopods	3.5	3.0	1.6	1.9	15.9	1.4	1.4	0.9
Prawns	-	-	-	-	-	0.1	-	-
Lobster	-	-	-	-	-	0.1	-	-
Crabs	-	-	-	0.1	-	0.1	-	0.2
Other fishes	-	-	-	-	-	12.8	2.1	6.3

Table 3 - Depthwise percentage composition of species recorded

Species/group	Depth range (m)		
	50-100	100-200	200-300
Elasmobranchs	0.5	0.2	5.3
<i>Epinephalus</i> sp.	2.3	4.7	-
Polynemids	0.4	-	-
Sciaenids	10.4	12.2	-
Carangids	4.8	6.5	-
<i>Sphyraena</i> sp.	0.7	0.5	21.1
Upenids	4.5	0.2	-
<i>Arius</i> sp.	0.3	0.1	-
Nemipterids	37.8	47.3	-
<i>Saurida</i> sp.	6.4	10.8	-
<i>Priacanthus</i> sp.	2.1	9.4	73.6
<i>Trichiurus</i> sp.	12.3	0.4	-
Clupeids	0.3	-	-
<i>Ariomma indica</i>	0.1	2.8	-
Flat fish	0.1	-	-
Mackerel	1.0	-	-
<i>Apogon quadrifasciatus</i>	1.6	-	-
<i>Centropomus aureus</i>	2.7	-	-
Cephalopods	1.2	2.4	-
Prawns	0.1	-	-
Lobsters	0.1	-	-
Crabs	0.1	-	-
Other fishes	10.2	2.5	-

hours fishing effort. In lat. 17°N *Epinephalus* sp. was most abundant (70.3%) followed by nemipterids (22.9%). In lat. 18°N, *Priacanthus* sp. formed 61% followed by nemipterids (28.6%). In lat. 19°N *Ariomma indica* formed 42.3% followed by *Saurida* sp. (35.7%). In 20° N almost all the species listed in the table were netted of which nemipterids formed the dominant group. Similarly in lat. 21° N nemipterids formed the bulk (60.4%) followed by sciaenids (9.8%). In lat. 22° N, sciaenids formed 22.2% followed by nemipterids (23.3%). In general, significant quantities of nemipterids, *Saurida* sp. and *Priacanthus* sp. were recorded in all the latitudes.

The results of analysis of depthwise distribution of species are furnished in Table 3. Nemipterids, ribbon fish and sciaenids contributed 37.8%, 12.3% and 10.4%

respectively in the depth stratum 50-100 m. The catch recorded from the depth zone of 100- 200 m was dominated by the nemipterids (47.3%) followed by sciaenids (12.2%), lizard fishes (10.8%) and priacanthids (9.4%). The results obtained in the present study is in agreement with the earlier reports. Vijayakumaran & Naik (1991) reported that the nemipterids formed about 48% of the catch from depth zone 100-200 m; James & Pillai (1990) reported that fishable concentration of nemipterids are available along the west coast; Sivakami (1990) reported that 61% of the catch of the centralwest zone was formed by the nemipterids. The major share of the catch registered from the deeper water was contributed by the priacanthids (73.6%) followed by *Sphyræna* sp. (21.1%) and elasmobranchs (5.3%). Joseph (1984, 1986) recorded bulls eye along north.Kerala and Karnataka coasts with peak occurrence in 100-150 m during April-June forming 11.3% in the total fish yield; Bande *et al.* (1990) reported the distribution of bull's eye along the shelf of 20-262 m depth. Stray catches of cephalopods were also recorded from the waters up to 200 m.

### ACKNOWLEDGEMENT

Authors are grateful to Dr.D. Sudarsan, Director General, Fishery Survey of India, Bombay and Mr. T.E. Sivaprakasam, Zonal Director, FSI, Bombay, the Project Co-ordinator for their guidance and constant encouragement. Thanks are also due to Director, DOD, New Delhi and Officer-in-Charge of *FORV Sagar Sampada* Cell, Cochin for providing facilities and to CIFT scientists for their co-operation in carrying out the survey.

### REFERENCES

- Bande, V.N., Gopinatha Menon, N. & Balachandran, K. 1990. Studies on the distribution and abundance of bull's eye (*Priacanthus* spp) in the EEZ of India, In: *Proc. First Workshop Scient. Resuli FORV Sagar Sampada*, edited by K.J. Mathew, (CMFRI, Cochin) 233-238.
- Dwivedi, S.N., Radhakrishnan, N. & Philip, K.P. 1977 a. Indo-Polish industrial fisheries survey along the northwest coast of India. Preliminary report of the first cruise of *M.T. Murena* (8th Jan. to 10th Feb. 1977) and supporting vessels, *Expl. Fish. Proj. Report* No. 1: pp.31.
- Dwivedi, S.N., Radhakrishnan, N., Vijayakumaran, K. & Nair, M.K.R. 1977 b. Indo-Polish industrial survey along the northwest coast of India. Preliminary report of second cruise of *M.T. Murena* and supporting vessels for the period from 19th February to 12th April 1977, *Expl. Fish. Proj. Report* No.2: pp.49.
- Dwivedi, S.N., Radhakrishnan, N., Sulochanan, P., Nair, K.K.R. & Joseph, A. 1977 c. Indo-Polish industrial fisheries survey along northwest coast of India; Part. I, Preliminary report of the third cruise of *M.T. Murena* and supporting vessels for the period from 21st April to 21st May, 1977, *Expl. Fish. Proj. Report* No.3: pp.43.
- Jayaraman, Sehappa, R.G. Mohamed, K.H. & Bapat, S.V. 1959. Observations on the trawl fisheries of the Bombay and Saurashtra waters 1949-50 to 1954, *Indian J. Fish.* Vol. 6, No.1.
- Joseph, K.M. 1974. Demersal fisheries resources off the northwest coast of India, *Bull. Expl. Fish. Proj.* No.1: pp.45.
- Joseph, K.M. 1980. Comparative study of the demersal fishery resources of the Indian waters as assessed by 17.5 m trawlers, *Bull. Expl. Fish. Proj.* No.10: pp.40.

- Joseph, K.M. 1984. Salient observations on the results of fishery resources survey during 1983-84, *Bull. Fish. Surv. India*, Vol.No.13/84: 1-11.
- Joseph, K.M. 1986. Some observations on potential fishery resources from the Indian EEZ, *Bull.Fish.Surv.India*, No.14: 1-20.
- James, P.S.B.R. & Pillai, V.N. 1990. Fishable concentration of fishes and crustaceans in the offshore and deep sea areas of the Indian Exclusive Economic Zone based on observations made on-board *FORV Sagar Sampada*, In: *Proc. First Workshop Scient. Result. FORV Sagar Sampada*, edited by K.J. Mathew. (CMFRI, Cochin) 201-213.
- Sivakami, S. 1990. Observations on the demersal fishery resources of the coastal and deep sea areas of the Exclusive Economic Zone of India, In: *Proc.First Workshop Scient. Result FORV Sagar Sampada*, edited by K.J. Mathew, (CMFRI, Cochin) 215-231.
- Sivaprakasam T.E. 1965. Survey of the demersal fisheries of the Saurashtra waters, *Science and Culture*, 31: 589-591.
- Sudarsan, D., Sivaprakasam, T.E., Somvanshi, V.S., John, M.E., Nair, K.N.V. & Joseph, A. 1988. An appraisal of the marine fishery resources of the Indian Exclusive Economic Zone, *Bull. Fish. Surv. India*, 18: pp.70.
- Sudarsan, D., John, M.E. & Somvanshi, V.S. 1990. Marine fishery resources potential in the Indian Exclusive Economic Zone. An update, *Bull. Fish. Surv. India*, 20: pp.27.
- Swaminath, M., Radhakrishna, N., Nair, M.K.R. & Joseph, A. 1977a. Indo-Polish industrial fisheries survey along the northwest coast of India. Preliminary report of the fourth cruise of *M. T. Murena* for the period from 15.6.77 to 22.8.77. *Expl. Fish. Proj. Report*. No.4: pp.24.
- Swaminath, M., Radhakrishnan, N., Akhtar, M.R., Nair, M.K.R. & Joseph, A. 1977b. Indo-Polish industrial fisheries survey along the northwest coast of India. - Preliminary report of the fifth cruise of *M.T. Murena* and supporting vessels for the period from 7th Sept. to 14th October 1977, *Expl. Fish. Proj. Report* No.5: pp.39.
- Vijayakumar, K. & Naik, S.K. 1991. Demersal finfish resources of the inner continental shelf of the EEZ, In: *Proc. Nat. Workshop. Fish. Resour. Data. Industry*: edited by D.Sudarsan & V.S. Somvanshi (FSI, Bombay) 71-79.

\* \* \*



## **Fish biomass estimation by calibrating the echointegrator deflection against catch data**

S. Natarajan, K.G. Girijavallabhan & A. Nandakumar  
Central Marine Fisheries Research Institute, Tatapuram P.O. , P.B.No. 1603, Cochin-682 014  
and

R.E. Benjamin  
Department of Economics, Madurai Kamaraj University, Madurai -625 021

### **ABSTRACT**

Acoustic survey for fish resources was conducted using echosounder (EK-400) with echointegrator (QD). The echointegrator coupled with echosounder sums-up the echo signal received. The sum of the echo signal received per nautical mile covered is an index of the quantum of fish recorded and therefore a measure of the relative density of fish in surveyed area. It is converted into absolute biomass using the calibration constant obtained by correlating the trawl catch data against the echointegrator reading corresponding to the opening of the net. The calibration constant thus arrived at was  $1327 \text{ kg/n.mile}^2$  corresponding to 1 mm integrator deflection per nautical mile covered.

### **INTRODUCTION**

The living resources of the sea though renewable are subject to depletion due to continuous and over exploitation. Therefore the knowledge of stocks, their distribution in space and time, migration, fluctuations in their abundance, and annual recruitment levels and optimum level of harvesting of resources is absolutely essential for proper planning and management. In recent days hydro-acoustic instruments such as echosounder, sonar, echointegrator and trawl sonde are used to collect the required data in a systematic manner and for analysis of the same to provide reliable information on various aspects mentioned above for the effective management.

Fish resources survey using the acoustic equipments is generally termed as "acoustic survey" which is considered to be far superior to the conventional "spot fishing survey" technique for the following reasons.

- This methodology is infinitely faster, since survey is done at a normal speed of the vessel and or large area can be covered and sampled quickly.

- Acoustic surveying is carried out to probe the entire column all along the track wherever the vessel moves, whereas a trawl survey is restricted only to trawlable ground corresponding to the depth interval swept by the gear.
- Wear and tear of the gear and fishing time is reduced, as fishing is done occasionally for identification purpose only.

Considering its proven advantages as mentioned above the use of acoustic technology in modern fisheries research is becoming more relevant and important. In India erstwhile UNDP/FAO/Pelagic Fisheries Project carried out extensive acoustic surveys from 1971 to 1978 for the important fish resources of the southwest coast of India and estimated their biomass. Major fish resources responding to acoustic surveys by echosounder and echointegrator in Indian waters are the column fish such as white-baits, catfish, ribbonfish and horse-mackerel etc, (Natarajan *et al.* 1980). In the case of surface schooling fish such as oil sardine and Indian mackerel, sonar survey has found to be more suitable acoustic technique for location and quantification. Acoustic surveys for fish resources are being conducted in Indian waters by *FORV Sagor Sampada* since 1985. Also using the same acoustic equipments investigations on the deep scattering layer (DSL) of the Indian EEZ was carried out, with special reference to euphausiids as a component (Mathew *et al.* 1990). The systematic collection of acoustic survey data during the cruises nos. 19, 20, 86, 116 of *FORV Sagor Sampada* were critically analysed and presented in this paper.

## MATERIALS AND METHODS

Most modern acoustic equipments such as scientific echosounder (Simrad EK-400), echointegrator (Simrad QD), sonar (Simrad SM- 600), trawl eye (FR-500), hydrography echosounders (Simrad EA- 200), speed and distance log (Simrad NL) with electronic data processing facilities available on board *FORV Sagor Sampada* were used to locate fish schools quantitatively and qualitatively, plankton distribution in the deep scattering layer (DSL) and aimed trawling in the Exclusive Economic Zone (EEZ) of India.

The vessel, fitted with survey equipment is sailed on a predetermined parallel track keeping the instruments on. Setting of the instruments are power-high, beam wide-wide, pulse width 3 m sec., band width-3 kHz, PD-5 (normalised to 1 n.mile) resetting - log '0', attenuation '0' dB, SL-137.6dB. VR-0, and TVG-20 log R. The integrator deflection for everyone nautical miles was noted. At the end of the cruise, the values obtained (mm per nautical mile) were plotted along the track on the chart and zero density line drawn, which forms fish special distribution chart (Figures 1-4) giving the synoptic picture of fish concentration with in the surveyed area. With the help of planimeter the area of concentration of fish ('A' in square nautical mile) was obtained. The average density in tonne/n mile<sup>2</sup> was obtained using the following relations (Forbes & Nakken, 1972,)  $d=cxM$  where  $M$  = average echointegrator output signal per elementary distance sampling unit (EDSU) referred to the distance unit being sailed (mm per n.mile), 'C' = proportionality coefficient, system constant or calibration constant which is the function of equipment parameters and the reflective

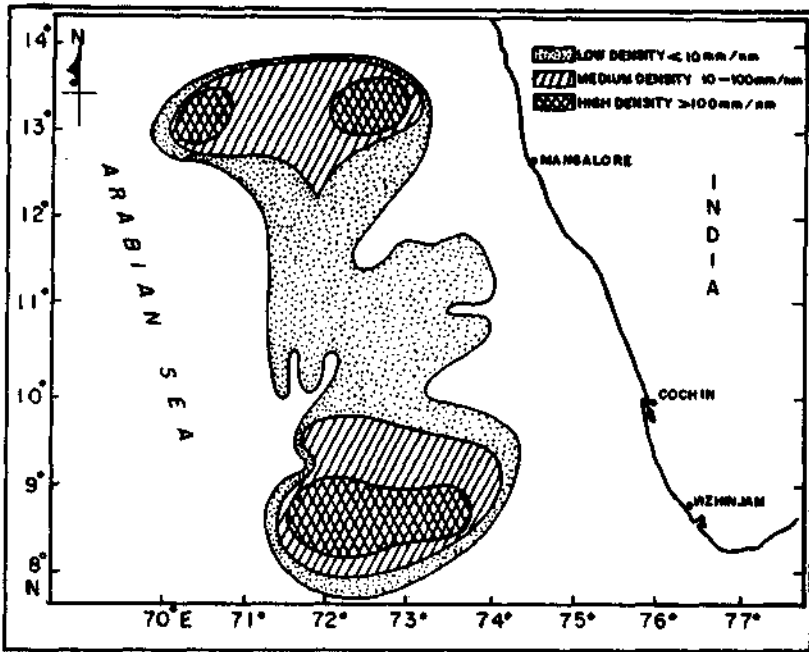

Fig.1 - Fish distribution chart (SS 19/86 23 July - 6 August 1986)

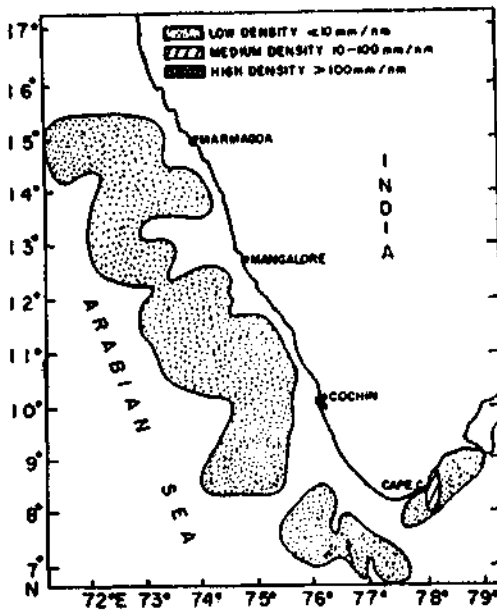

Fig.2 - Fish distribution chart (SS 20/86 19 August - 8 September 1986)

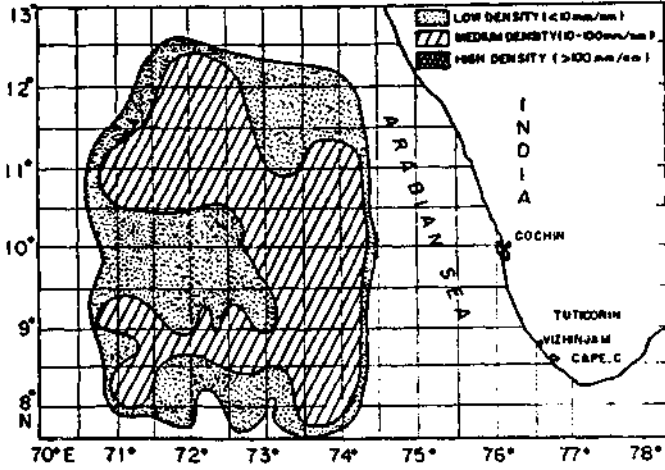

Fig.3 - Fish distribution chart (SS 86/91 2-9 March 1991)

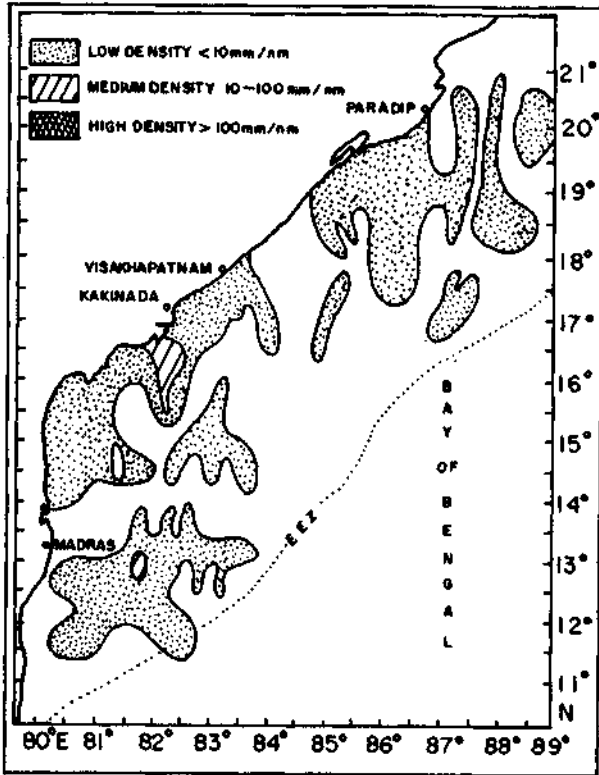

Fig.4 - Fish distribution chart (SS 116/93 22 December 93 - 1 January 1994)

properties of fish. (This assumes that the fish in the area are of the same species or of species with same acoustic properties). The total biomass  $W$  (in tonne) was arrived at by multiplying area and density, ( $W = A \times \bar{d}$ ). Bottom trawling was carried out by *FORV Sagar Sampada* at lat.  $09^{\circ}41'N$ , long.  $76^{\circ}03' E$  in 45 m depth. Trawl sonde was used to find out the opening of the net. By calibrating the integrator reading corresponding to the opening of the trawl net against the fish catch (Anon, 1973) considering the volume of the water fished by the trawl and the volume sampled by the echosounder beam, assuming the catching coefficient is one i.e., that all fish in front of the trawl mouth are subsequently being caught, the average calibration constant value  $C$  was calculated as 1327 kg or 1.327 tonne/n. mile<sup>2</sup> corresponding to 1 mm integrator deflection per nautical mile covered. The basis for arriving at the calculated figure of  $C$  as 1.327 tonne/n. mile<sup>2</sup>/mm deflection is elucidated below:

Length of head rope + foot rope, $L_r$	= 67.4 m
Vertical opening, $H_v$	= 2.5 m
Fish catch when dragged for 1 nmi, $w$	= 0.33 tonne
Deflection of echointegrator corresponding to opening of the net when covered for 1 nmi, $d_n$	= 5.48 m.m
Deflection of echointegrator corresponding to sea surface (transducer level) to bottom at 40 m depth when covered 1 nmi, $d_t$	= 18 m.m
The volume of the net swept along 1 nmi, $v_n$ (assuming the cross-section of the net as circular with circumference equal to the length of foot rope + head rope)	= 668890.76 m <sup>3</sup>
Volume of the net insonified by the beam corresponding to the opening of the net considering the beam angle and depth of operation, $V_{nb}$	= 25048.3 m <sup>3</sup>
Total volume of the beam considering 40 m depth, 8° beam angle and conical shape of the beam (circular transducer), $V_{tb}$	= 206683.2 m <sup>3</sup>
Fish catch reduced to the corresponding volume of net insonified by beam, $w_b$	= $\frac{w \times V_{nb}}{V_n}$ = $0.33 \times \frac{25048.3}{668890.76}$ = 0.012 tonne
Fish catch reduced to 1 mm deflection corresponding to the volume of net insonified by the beam, $w/mm$	= $\frac{w_b}{mm_n} = \frac{0.012}{5.48} = 0.002$
Fish catch raised to 1n. mile <sup>2</sup> considering the total volume of the beam ( $V_{tb}$ ) and volume of water of 1n. mile <sup>2</sup> at 40 m depth, ( $V_{1n.mile^2}$ ), $C$	= $w_b \times V \frac{1n.mile^2}{V_{tb}}$ = $0.002 \times \frac{137196160}{206683.2}$ = 1.327 tonne/n.mile <sup>2</sup> /mm
Packing density in the area of calibration, $d$	= $C \times mm_t = 1.327 \times 18$ = 23.88 tonne/n.mile <sup>2</sup>

## RESULTS AND DISCUSSION

The average packing densities of fish and total fish biomass estimation for the four cruises are given in Table 1. The packing density was maximum in the cruise no.86 comparing the other 3 cruises. This difference could be related to the time period of survey. Cruise nos. 19 and 116 were conducted during monsoon along the west coast and east coast of India respectively. Cruise no.20 corresponds to the transition period from monsoon to post-monsoon. Even then the packing density was less 2.59 tonne/n.mile<sup>2</sup>. This may be due to the following reasons. Pelagic fish (sardine and mackerel) coming to the surface during post-monsoon period which has been confirmed earlier (Anon, 1974). The fish available up to 10 m from the surface is not covered by the integrator survey since the transducer is fixed at the hull about 5 m below the surface. The time varied gain (TVG) will not be effective in the beginning for 5 m from the surface of the transducers. Hence sonar survey was carried out for estimating fish biomass within 10 m from the surface (Krishna Rao *et al.* 1980). However, sonar survey could not be carried out on board *FORV Sagar Sampada* because of technical failure.

The estimation by this method will not be accurate and it is supposed to be less (Anon, 1973), since it is assumed that the fishing efficiency is 100% i.e. all the fish recorded in front of the trawl is being caught. But there will definitely be some small sized fish which escape from the net depending upon mesh size of the net. Secondly the efficiency of the fishing master also plays a role in the accuracy of the estimated calibration constant value, in turn the biomass estimation because the echosounder records the fish available just below the vessel. Whereas, the net is few hundred meters away from the vessel depending upon the depth of operation. It is presumed that the net is dragged exactly on line with path of the vessel and the fish as recorded in the echosounder is caught. But the position of the net may be deviated from the centre of the path of the vessel either port or star board side due to water current, wind velocity, etc. for which the fishing master must correct the course of the vessel accordingly, considering the hydrodynamics and gear behaviour. If the judgement by fishing master is wrong in manoeuvring the vessel while trawling, it may lead to under-estimation of fish biomass. Though the present estimated value of calibration constant is comparable with the findings of Pelagic Fisheries Project (Olsen *et al.* 1977), it need be confirmed by comparing with estimation arrived through other methods also in order to establish percentage of error or deviation. And also the live fish calibration for the commercially important species need by carried out as was done in the Pelagic Fisheries Project to overcome the inaccuracy in estimation caused by the erratic fishing, by considering the integrator deflection for the insonified fish of the known species and quantities (Vitullo *et al.* 1980).

The spatial distribution charts (Figs 1 - 4) give the area of concentration of fish with different density strata along the area of survey. This helps in locating the fishing ground easily. However, to understand the migratory pattern of the resources, regular survey with the definite short period interval is a must. Also the spatial distribution

Table 1 - Estimated fish biomass by acoustic surveys  
(Calibration constant C in tonne/n.mile<sup>2</sup>/mm is 1.327 tonne for all the cruises)

Cruise no.	Period	Survey area	Aver. packing densities (tonne/n.mile <sup>2</sup> /mm) $\bar{d}$	Estimated biomass (tonne/n.mile <sup>2</sup> ) $W = \bar{d} \times A$	Major resources
19	22-27 July 86	8°30'N to 13°30'N 70°00'E to 74°00'E	8.04	434160 T	<i>Cubiceps natelemis</i> <i>Gempylus Serpens</i> <i>Kyphosis</i> sp.
20	19 Aug. - 9 Sept. 1986	6°30'N to 15°30'N 70°00'E to 79°00'E	2.73	172218 T	<i>Priacanthus</i> sp. <i>Nemipterus</i> sp. <i>Epinnala</i> sp.
86	28 Feb. - 10 March 1991	8°00'N to 12°00'N 71°00'E to 74°00'E	15.99	863460 T	Deep sea fishes, prawns and cephalopods
116	22 Dec. '93 - 10 January 94.	11°00'N to 21°00'N 80°00'E to 89°00'E	2.59	132867 T	Perches, microphils deep sea prawns

$\bar{d}$  = Average packing density in tonne/n.mile<sup>2</sup>; W = total fish biomass in tonne; A = area of fish concentration in n.mile<sup>2</sup>  
(obtained from Figs 1 - 4, fish distribution chart using planimeter)

maps could be drawn and the fish biomass could be estimated for the different species which will help in selective fishing.

Suitable computer software technology is needed so that spatial distribution chart could be drawn by the automatic plotter coupled with the computer. The biomass can be calculated with the help of the computer to provide the required information immediately after the survey is over. On the whole the systematic acoustic survey technique and technology has become a dependable tool to cover large part of commercial fish resources of Indian EEZ. Indigenous production of simple and cheap echosounders will go a long way in their increased use in efficient exploitation of fishery resources if encouraged.

### ACKNOWLEDGEMENT

Authors are thankful to the Captain of *FORV Sagar Sampada*, fishing masters and the service engineers of M/s Norinco for the help rendered in fishing operations and to Dr. K. Rangarajan for offering valuable suggestions.

### REFERENCES

- Anon, 1973. Answers to questionnaire. *Financing Agriculture* 5 (2 & 3) : July-October 1973.
- Anon, 1974. Survey results, 1972/73, *UNDP/FAO Pelagic Fisheries Project (IND.69/593)*, *Progress Report*. 6. Cochin Bergen, pp.141.
- Forbes, S. & Nakken, O. 1972. Manual of methods for fisheries resources services and appraisal, Part-2. *FAO Manual in Fishery Science* No.5: pp.138.
- Krishna Rao K, Natarajan S. & Daniel G.P.E. 1980. Estimation of fishery resources using sonar, *Fish. Technol.* 17: 12-13.
- Mathew, K.J. & Natarajan, S. 1990. Investigation on the DSL of the Indian EEZ with special reference to euphausiids as a component, In: *Proc. First Workshop Scient. Resul. FORV Sagar Sampada*, edited by K.J. Mathew, (CMFRI, Cochin) 355-375.
- Natarajan, S., George, K.C. & Bande, V.N. 1980. Echo location of fish, *Mar. Fish. Info. Serv. T&E Set* 7: 1-12.
- Olsen, S. Tveite, S. & Cnakraborty, D 1977. Acoustic surveying in tropical waters, *P.v.R. eun. con. Inst. Explor. Mar.*, 170: 248-252.
- Vitullo, A.N., Natarajan, S. & Daniel, E. 1980. Live fish calibration of hydro-acoustic equipments on board *R. V. Rastrelliger*. FI:DP/ IND/75/038 Field document Vol.7, (FAO, Rome) pp.87.

\* \* \*



## Evaluation of sampling gear for demersal resource surveys

M.R.Boopendranath<sup>1</sup>, P.A.Panicker<sup>1</sup>, V.S.Kakati<sup>2</sup>, S.G.Raje<sup>2</sup>, G.K.Avhad<sup>3</sup>,  
Paul Pandian<sup>3</sup>, P.Sulaiman<sup>4</sup> & V.C.George<sup>1</sup>

- 1 Central Institute of Fisheries Technology, P.O.Matsyapuri, Cochin - 682 029
- 2 Central Marine Fisheries Research Institute P.B. No. 1603, Cochin - 682 014
- 3 Fishery Survey of India, Botwala Chambers, Sir P.M. Road, Bombay - 400 001
- 4 Integrated Fisheries Project, P.B. No. 1801, Foreshore Road, Cochin - 682 016

### ABSTRACT

The three demersal trawls evaluated were 38 m HSDT-II, indigenously developed by CIFT for deep sea fishing in Indian EEZ; and two imported designs, viz., 45.6 m Expo model demersal trawl and 50 m fish trawl operated from vessels of FSI and IFP, respectively. Vertical opening at trawl mouth was highest for 50 m fish trawl (3.2 m), followed by Expo model demersal trawl (2.5 m) and 38 m HSDT-II (2.2 m), due to differences in overall dimensions and design features. Estimate of horizontal opening between otter boards was highest for 38 m HSDT-II probably due to low drag of the gear, followed by 45.6 m and 50 m trawls. Lowest catch per unit effort obtained by 38 m HSDT-II is presumably due to smaller dimensions of the gear, larger codend mesh size and difference in ground rig, in addition to chance factors. However, 38 m HSDT-II scores on several features desirable in demersal sampling gear such as simplicity in design and construction, ease of operation; lower twine surface area and drag; and ground rig suitable for wider range of bottom conditions. Modifications to make it more effective while sampling for crustaceans and small-sized finfish components are described.

### INTRODUCTION

Scientific trawl surveys are widely used for monitoring demersal stocks and estimating population parameters for calibration of stock assessment models (Sparre *et al.* 1986). Diversity in gears and sampling procedures have often limited the quality of stock assessment results (Jhingran, 1982). The implication of variability in trawl selectivity on stock assessment and management have been discussed by Gulland (1969), Pope *et al.* (1975) and Sparre *et al.* (1969). Adoption and consistent use of

standard sampling gear and standard sampling procedures would minimise the effect of gear-dependent variation in selectivity and abundance estimates. Further, knowledge of size selection attributes of such sampling trawl could be used for getting unbiased estimates of age composition of the population.

The main objective of cruise no. 109 (5-19 May 1993) of *FORV Sagar Sampada* (71.5 m LOA; 2285 hp) was determination of design, rigging and operational parameters of different designs of trawl nets available with user agencies such as Central Institute of Fisheries Technology (CIFT), Fishery Survey of India (FSI) and Integrated Fishery Project (IFP). These parameters were evaluated against features adjudged desirable in a demersal sampling gear.

### MATERIALS AND METHODS

The three trawls operated were: i) 38 m HSDT-II (G1), indigenously developed by CIFT for high speed demersal trawling in Indian EEZ and successfully field-tested from *FORV Sagar Sampada* (Panicker, 1990; Panicker, et al. 1993); ii) 45.6 m Expo model trawl (G2), an imported design operated from FSI vessels and iii) 50 m fish trawl (G3), a Norwegian design operated from IFP vessel. Salient features of the trawl nets are given in Table I and their comparative sizes are represented in Fig. 1. All the three gears are proven designs and have been extensively operated earlier, under the range of fishing conditions appropriate for each gear. *Perfect* (Denmark) economy model V-shaped otter boards of 285 x 126 cm, approximately 2800 kg weight per set

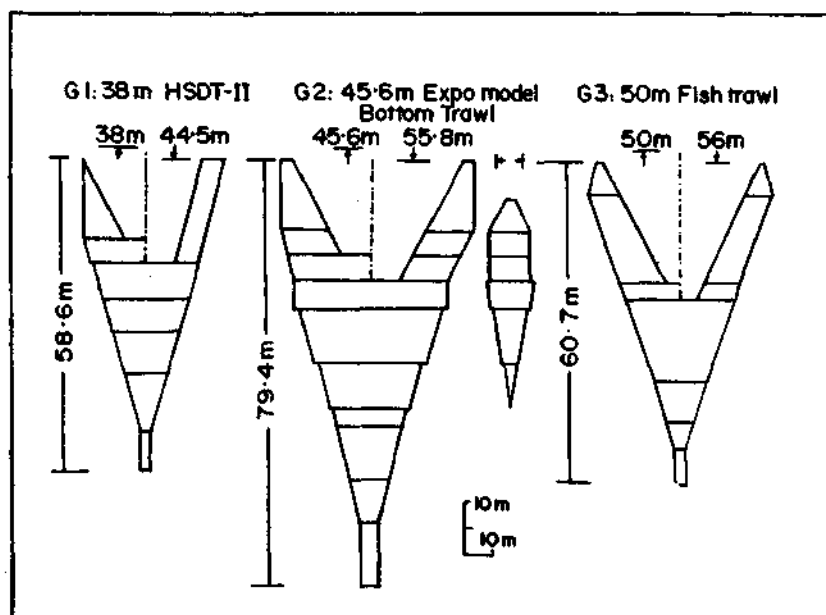

Fig. 1—Comparative sizes of trawls

with through flow and square keel and weathering surface, were used for the operations.

Gear parameters such as vertical opening at trawl mouth and horizontal opening between otter boards were measured at 118-126 m depth off Karwar, keeping vessel speed (3.5 kn), tow direction and fishing area unchanged. Towing speed was measured by ship's doppler speed log. Vertical opening at trawl mouth was measured using SIMRAD FR 500 Trawl Eye System connected to SIMRAD CF 100 Colour Display at 10 m expansion mode. In the absence of acoustic sensors for measuring horizontal opening between otter boards, its relative measure was estimated by multiplying the measured divergence of main warps for 1 m distance from the towing points with the

Table 1 — Salient features of trawl nets operated

	G1	G2	G3
	38 m HSDT-II	45.6 m Expo model trawl	50 m fish trawl
Head rope (m)	38.0	45.6	50.0
Foot rope(m)	44.5	55.8	56.0
Construction:			
Panels (no.)	2	4	2
Panel sections(no.)	15	37	19
Mesh sizes (stretched mm):			
Wings	150	400	140
Square batings and belly	150-50	400-40	120-80
Codend	50	30	45
Bridles (no.)	2	3	2
Bridle length (m)	50	50	50
Floats	200	270	200
	mm diam.	mm diam.	mm diam.
	45 nos	17 nos	17 nos
Ground rig	Rubline with 200-100 mm diam. discs; ca. 750 kg in air; tied to foot rope with 10 cm gap	Link chain 150 kg in air; closely tied to foot rope	Link chain and SWR seized with sisal; 140 kg in air; closely tied to foot rope

number of metres of warp paid out and adding this to the distance between towing points. Total twine surface area of the nets were estimated using the method suggested by FAO (1974). An estimate of the net drag at 3.5 kn was obtained using the formula developed by MacLennan (1981) which is based on twine surface area.

Comparative fishing operations were conducted in the waters off Karwar, Kottekunnu and Quilon at depths ranging from 120 to 350 m. The bottom trawls G1, G2 and G3 were operated in rotation, keeping operational parameters such as towing speed, tow direction, depth zone and fishing grounds unchanged for each set of comparative fishing operations and data on total catch and catch composition were collected. Twelve comparative operations were conducted in 4 cycles using the three gears.

## RESULTS AND DISCUSSION

Gear parameters and catch details are summarised in Table 2. Higher vertical opening was realised by G3 (3.2 m), followed by G2 (2.5 m) and G1 (2.2 m). The difference in vertical opening is attributed to variation in overall dimensions of the gears; and particular design features such as a deep V-cut in the wings of G3; four panel construction and multi-bridles in G2.

Vertical opening of the trawl ideally should match the vertical distribution characteristics of the target species for optimisation of fishing efficiency. Experience during fishing investigations onboard *FORV Sagar Sampada* (cruise nos. 97, 99, 109; unpublished data) has shown that 87 % of the shoal pattern of demersal fishery resources representing *Nemipterus* spp., *Decapterus* spp., *Priacanthus* spp., *Centrolophus* spp., elasmobranchs, *Trichiurus auriga*, deep sea prawns, deep sea lobster, *Sphyræna* sp., cephalopods, perches, *Neopinnula* sp., catfish and miscellaneous fish are generally restricted to less than 2 m height. Demersal echo traces during cruise nos 109, rarely exceeded 2 m height and were generally within 0.5 m.

Horizontal opening between otter doors is an important gear parameter as it influences the effective sweep area by virtue of herding effect of sweeps, otter boards and sand-mud clouds generated by the doors, on many finfish components (Main & Sangster, 1981). Horizontal opening is primarily determined by sheer force of otter boards, towing speed and drag of the gear. Horizontal opening index was maximum for G1, probably due to low drag of the gear, followed by G2 and G3.

Twine surface area of G1, G2 and G3 were calculated as 136, 166 and 161 m<sup>2</sup>. As the twine surface area is proportional to the net drag, formula developed by MacLennan (1981), was used to get an approximate estimate of total net drag. At the towing speed (3.5 kn) used, net drag worked to be 70230, 85720 and 83140 N, respectively for G1, G2 and G3. The low drag of the gear make it suitable for operation from a wide range of vessel classes.

Mean haul-wise CPUE obtained by G1, G2 and G3 was respectively, 134, 589 and 405 kg/h. Percentage composition of the catches obtained by the three trawls, during

Table 2— Gear parameters and results of comparative fishing operations

	G1	G2	G3
	38 m HSDT-II	45.6 m Expo model trawl	50 m fish trawl
<b>Gear parameters</b>			
Vertical opening at trawl mouth(m)	2.2	2.5	3.2
Horizontal opening between otter boards (m)	90	76	70
Twine surface area (m <sup>2</sup> )	136	166	161
Net drag at 3.5 kn (N)	70230	85720	83140
<b>Fishing results</b>			
No. of hauls	4	4	4
Total towing duration (min)	240	240	285
Towing speed (kn)	3.5	3.5	3.5
Mean haul-wise CPUE (kg/hr)	134	589	405
<b>Catch composition (%)</b>			
<i>Decapterus</i> sp.	37.0	0.8	10.4
<i>Nemipterus</i> spp	23.4	35.2	44.8
<i>Centrolophus</i> spp	5.4	10.0	22.4
<i>Priacanthus</i> sp.	3.7	1.8	3.0
<i>Cubiceps</i> sp.	3.4	19.4	2.7
<i>Chlorophthalmus</i> sp.	1.9	0.9	0.7
<i>Saurida</i> sp.	1.5	0.3	0.9
Elasmobranchs	0.4	2.8	2.4
Deep sea prawns	3.2	1.4	1.4
Deep sea lobster	5.8	1.1	5.3
Cephalopods	1.3	1.5	1.3
Others	13.0	24.7	4.9

comparative operations is given in Table 2. The data set is insufficient for evaluation of fishing performance through statistical inference of the catch (Nair, 1982). The variation in catch rates among the trawls could have been caused by: i) difference in overall dimensions of the gear - head rope of G3, G2 and G1 was respectively 50, 45.6 and 38 m (Fig. 1) ; ii) difference in codend mesh size and consequent difference in size selectivity - G2 had the smallest codend mesh size (30 mm ), followed by G3 (45 mm) and G1 (50 mm); iii) difference in ground rig and consequently operating height of fishing line - G1 was rigged for operations in smooth to moderately uneven ground conditions using rubline with a bosom disc diam. of 200 mm, loosely hung (10 cm) to the foot rope; G2 was rigged with iron link chain and G3 with pieces of link chain and SWR seized with sisal, closely tied to the foot rope for smooth bottom operations; and iv) chance occurrence of shoals in the fishing ground which was supported by echogramme readings during comparative fishing operations.

Sampling gear for survey of demersal resources, ideally should have features such as carefully selected wing, body and codend mesh sizes to retain representative size range of fishable stock; low overall dimensions and drag to permit its operations from a wide range of vessel classes; optimum net mouth configuration to suit the vertical distribution characteristics of fish shoal; simplicity of construction and operation; inter-changeable net panels to facilitate easy repairs and replacement onboard; and design and rigging features to facilitate its operation in a wide range of bottom conditions.

Among the three bottom trawls evaluated , 38 m HSDT-II could prove to be more advantageous as a sampling gear, considering the following:

i) Lower CPUE obtained by HSDT-II during the limited number of comparative operations, could be attributed to smaller overall dimensions, larger codend mesh size, and difference in ground rig, in addition to chance factors. Cumulative data from cruises 97, 99 and 109 of *FORV Sagar Sampada*, for HSDT-II has given an average CPUE of 1.27 t/hr and maximum of 12 t/hr (no. of operations :19; total towing duration: 18 hr 25 min) with representation of all expected demersal components of the fishing area, which indicate the overall fishing efficiency of the gear in demersal operations (*FORV Sagar Sampada* cruise reports: 97, 99 and 109).

ii) Vertical opening at trawl mouth of 2.2 m realised by HSDT- II though less than the other two gears seems to be adequate for demersal trawl surveys particularly when accompanied by acoustic observations, as vertical distribution of fish close to bottom is most often within 2 m.

iii) Horizontal opening between wing-ends as proportion of headline length could be expected to be better in HSDT-II as reflected in the indices of horizontal opening between otter boards.

iv) Having rigged with rubline of 200-100 mm diam. discs HSDT-II would be workable over a wider range of ground conditions.

v) Having got a lower twine surface area ( $136 \text{ m}^2$ ) and consequently lower net drag (70230 N), HSDT-II would be operable from a wide range of vessel classes.

vi) From the point of view of ease of fabrication and ease of operation, HSDT-II scores over the other two gears due to lower number of panel sections in its make-up, two-bridle system and smaller overall dimensions.

As most of the intrinsic gear selection occurs in the codend of a trawl (Clark, 1963; Ellis, 1963) in order to make HSDT-II less size-selective, it would be advisable to reduce the codend mesh size to 30 mm for demersal finfish surveys. Further, as crustaceans are generally not amenable to herding leading to their escape through large meshes in the front trawl sections, it would be advisable to modify the gear using a mesh size sequence of 80, 60, 50 and 40 mm for wing, square, batings and belly and codend mesh size of <30 mm.

Knowledge of gear efficiency in terms of escapement of fish through codend, front trawl sections (Ellis, 1963) and underneath the foot rope (Godo & Walsh, 1992) and resultant size selection with respect to particular species is essential to get unbiased estimates of age composition of the population for biological investigations and absolute abundance estimates. Such details for the adopted sampling gear need to be determined through specially designed gear selection experiments.

### ACKNOWLEDGEMENT

Authors are thankful to the Officer-in-Charge, Sagar Sampada Cell of DOD, for the facilities provided; the Master, officers and crew of *FORV Sagar Sampada*; cruise participants from FSI, IFP, DOD and CIFT; service engineers from M/s. NORINCO, Cochin for their co-operation during the investigations. Authors from CIFT are thankful to the Director, CIFT, Cochin for permission to publish this paper. They are grateful to Mr. H.Krishna Iyer, EIS Divn. for valuable advice during the evaluation of the results.

### REFERENCES

- Clark, J.C. 1963. Size selection of fish by otter trawls: Results of recent experiments in the northwest Atlantic, *ICNAF Spec. Publ.* 5: 24-96.
- Ellis, R.W. 1963. Experiments to investigate the escape of fishes through meshes of different parts of the trawl, *ICNAF Spec. Publ.* 5: 97-101.
- FAO 1974. *Otter board design and performance*, FAO Fishing Manual. (FAO, Rome) pp. 82.
- Godo, O.R. & Walsh, S.J. 1992. Escapement of fish during bottom trawl sampling - implications for resources assessments, *Fish. Res.* 13: 281-292.
- Gulland, J.A. 1969. *Manual of methods for fish stock assessment*, Part I: Fish population analysis, *FAO Man. Fish. Sci.* 4: pp.154.
- Jhigran, V.G. 1982. *Fish and fisheries of India*, (Hindustan Publishing Corporation, New Delhi) pp. 666.
- MacLennan, D.N. 1981. The drag of four panel demersal trawls, *Fish. Res.* 1: 23-33.
- Main, J. & Sangster, G.I. 1981. A study of the fish capture process in a bottom trawl by direct observations from a towed underwater vehicle, *Scott. Fish. Res. Rep.* 23: pp. 23.
- Nair, A.K.K. 1982. Investigations on the number of trials required for statistical comparison of fishing gears, *Fish. Technol.* 19: 49-53.

- Panicker, P.A. 1990 *FORV Sagar Sampada* and development of demersal trawls for Indian EEZ - A status paper on prospects and constraints, In: *Proc. First Workshop Scient. Resl. FORV Sagar Sampada*, edited by K.J. Mathew, (CMFRI, Cochin) 427- 434.
- Panicker, P.A., Boopendranath, M.R. & Syed Abbas, M. 1993. Observations on deep sea demersal resources in the exclusive economic zone of southwest coast of India, *Fish. Technol.* 30: 102- 108.
- Pope, J.A., Margetts, A.R., Hamley, J.M. & Akyuz, E.F. 1975. Manual of methods for fish stock assessment. Part 3: Selectivity of fishing gear, *FAO Fish. Tech. Pap.* 41: pp. 46.
- Sparre, P. Ursin, E. & Venema, S.C. 1989. Introduction to tropical fish stock assessment, *FAO Fish. Tech. Pap.* 306: pp. 337.

\* \* \*



## Development and performance of a large mesh semipelagic trawl for offshore waters

P.George Mathai, V. Vijayan, M.D. Varghese & V.C. George

Central Institute of Fisheries Technology  
P.O.Matsyapuri, Cochin - 682 029

### ABSTRACT

A large mesh trawl of 33.7 m head rope length was developed and tested from *FORV Sagar Sampada*. The design aspects, rigging details and operational features are discussed in this paper. The performance of the gear system was monitored with the aid of acoustic and electro-mechanical equipments. The percentage composition of different species caught in different hauls were worked out and it was observed that semipelagic fishes like *Upeneus* sp., *Decapterus* sp., *Trichiurus* sp. and *Dussumeria hasselti*, formed more than 60% of the catch. The average catch per unit effort exceeded 1 tonne with a maximum of 3 tonne. The net attained a vertical spread of 13-18% and horizontal spread of 55 - 62% of head rope length.

### INTRODUCTION

Semipelagic trawling as a fishing method fills the gap between the working range of conventional midwater and bottom fishing gear opening up avenue for exploiting untapped resources. The rich semipelagic resources of northwest coast were not exploited fully with either midwater or bottom trawls and hence this attempt to harvest these resources with large mesh semipelagic trawls. Dickson (1971) reported the effect on net drag while using large mesh on the fore part of the trawls. Kunjipalu *et al.* (1979) and Vijayan *et al.* (1992) have commented on the advantage of large meshes in bottom and midwater trawls, respectively.

Semipelagic trawl, a modified version of midwater trawl was developed and used for catching fish occurring just above sea bottom (Anon, 1987). There is a precise difference between high opening trawls and semipelagic trawls, as the former is designed for ground contact, whereas the latter is so rigged as to fish a metre or so above sea bottom (Garner, 1978). The semipelagic trawl incorporates certain characteristics of midwater trawl. The side panels are more than just half the width of top and bottom panels and webbings have large meshes of thinner twines. The mouth of

the net is kept open with sinkers and front weight at foot rope and more floats at the head rope. These trawls could be towed just above sea bottom by adjusting the sweep and speed of tow. The behaviour of the net, while under tow, is monitored by necessary adjustments made in the mode of operation. The versatility of V-form otter boards provides scope for using these boards efficiently for semipelagic fishing (Garner, 1978).

In the present communication, the design details, rigging and functional characteristics of 33.7 m large mesh semipelagic trawl are furnished, based on field investigations undertaken from *FORV Sagar Sampada*.

### MATERIALS AND METHODS

A 33.7 m large mesh semipelagic trawl with side panels 60% width of the upper and lower panels was used for studying its performance. The design details and rigging pattern are shown in Figs 1 and 2. The net was rigged with 13 deep sea plastic floats of 300 mm diam. and 60 kg of GI link chain of 8 mm diam. along head rope and foot rope, respectively. A front weight/depressor weighing 36 kg (link chain) was attached to the distal end of each leg of 8 m long provided at the extreme ends of foot rope. These legs join with the sweep lines (50 m) connected to the backstrops.

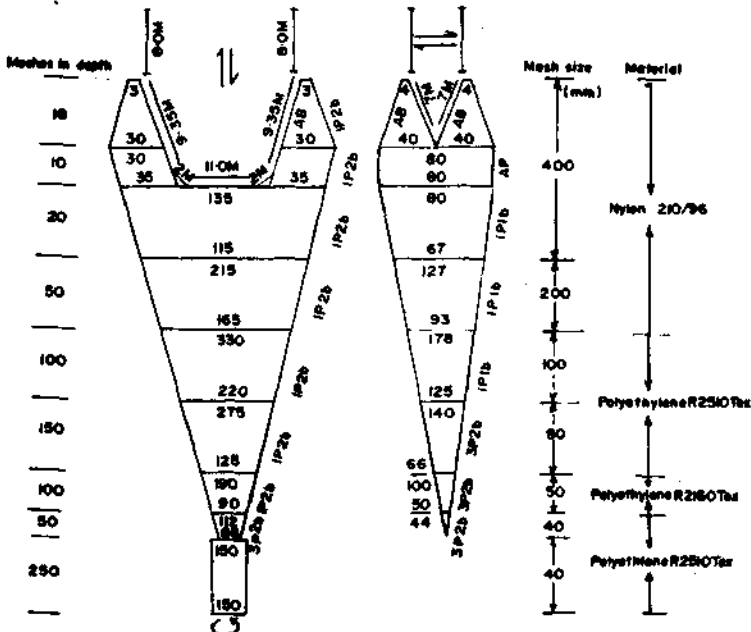

Fig. 1.— The 33.7 m RMT-6EL semipelagic gear (Head rope and foot rope: 18 mm diam. combination rope; side rope: 25 mm diam. PE)

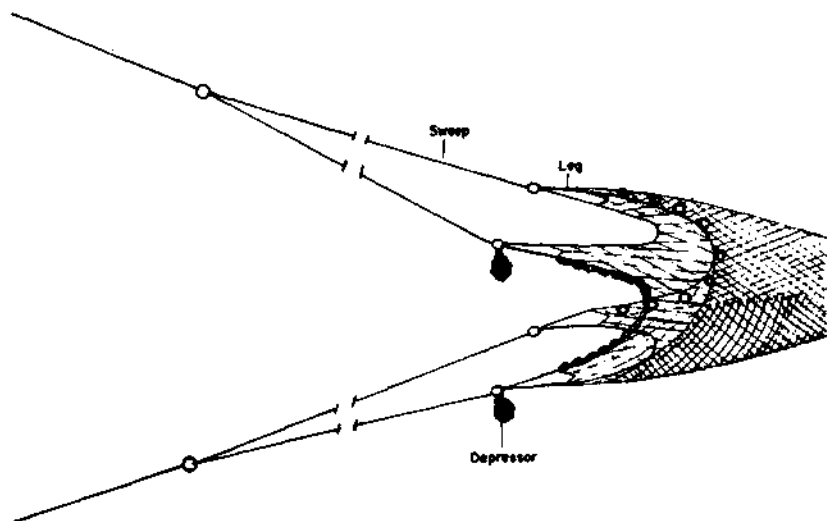

Fig. 2— The 33.7 m RMT-6EL semipelagic trawl: rigging details

The net was operated in combination with *Perfect V*-form otter boards of 2850 x 1800 mm, weighing 1.4 tonne. Vertical spread of the net was measured with a trawl eye, FR500 (SIMRAD). The distance between otter boards was calculated by the method described by Benyami (1956). The position of the otter boards with reference to the vessel was recorded with sonar, and the speed of tow was measured with doppler speed log. The field tests were conducted from *FORV Sagar Sampada* (71.5 m LOA, 2285 hp), during 1991-93, cruises 97, 103, 111, 112 and 115, of which the data from northwest were considered for this study.

## RESULTS AND DISCUSSION

The field tests were carried out along the northwest, 20°13'N -21°12' N lat. and 69°29'E-70°38'E long. The details of different hauls are given in Table 1. During the course of the cruise altogether 20 hauls were made fetching 20.3 tonne of fish and the catch per unit effort was estimated as 1041.4 kg/hr. Analysis of data on the species composition showed that 61% of the catch was formed by semipelagic fishes, viz., *Decapterus* sp., *Upeneus* sp., *Dussumeria hasselti*, squids and catfish (Table 2). The catch included commercially important pelagic fishes like seerfish, barracuda and carangids.

Table 1—Operational details and catch data

Sl. no.	Lat.	Long.	Depth (m)	Warp (m)	Speed (kn)	Duration (min)	Catch (kg)
1	20°47'N	69°44'E	70	150	4.0	60	600
2	20°47'N	69°47'E	66	150	4.5	60	2500
3	20°57'N	69°33'E	64	150	4.5	60	2000
4	21°02'N	69°26'E	67	150	4.5	60	1400
5	21°08'N	69°21'E	68	150	4.5	45	650
6	21°04'N	69°22'E	70	150	4.0	60	750
7	20°54'N	69°38'E	67	150	4.5	45	400
8	20°56'N	69°31'E	70	150	4.5	60	115
9	20°21'N	70°31'E	75	250	4.0	60	500
10	20°24'N	70°38'E	59	150	4.0	60	208
11	20°25'N	70°38'E	57	100	4.0	60	250
12	20°35'N	70°04'E	68	150	4.0	30	183
13	20°42'N	70°05'E	60	150	4.0	60	1005
14	20°40'N	69°56'E	59	150	4.0	60	520
15	20°46'N	69°59'E	59	150	4.0	60	830
16	20°42'N	70°04'E	58	150	4.0	60	520
17	20°48'N	69°45'E	67	150	4.0	60	965
18	20°53'N	69°37'E	66	180	4.0	90	4500
19	20°54'N	69°35'E	67	200	4.0	60	1255
20	20°12'N	69°40'E	42	150	4.0	60	1157

The behaviour of the gear was monitored with trawl eye and sonar. The gear attained a vertical height of 4-6 m at a speed of 4-4.5 knots. The horizontal spread was measured as 62% of head rope length. The boards were located at distance of 245 m from the vessel at a depth of 52 m, while releasing 150 m warp at a speed of 4 knots.

Though the average catch /hr recorded was more than one tonne, a maximum catch of 4.5 tonne was obtained while towing for 90 min. This indicates that the net is quite effective in catching semipelagic fishes provided the operational conditions and fish concentration are favourable. The rich resource of semipelagic fishes available in the northwest coast could be effectively exploited by this gear to augment fish production.

The large mesh and lighter twine in the fore part could reduce the drag considerably which in turn will be helpful to curtail fuel consumption (Nayak & Seshapa,

Table 2— Catch composition

Species	Percentage
<i>Decapterus</i> sp.	21.81
<i>Upeneus</i> sp.	12.25
<i>Dussumeria hasseti</i>	10.04
<i>Trichiurus</i> sp.	10.03
<i>Rastrelliger</i> sp.	4.38
<i>Nemipterus</i> sp.	4.08
Squid	4.01
Perches	3.47
<i>Saurida</i> sp.	3.25
<i>Arius</i> sp.	3.06
Horse mackerel	1.67
<i>Caranx</i> sp.	1.28
Barracuda	0.24
Shark	0.24
<i>Chorinemus</i> sp.	0.14
Seerfish	0.07
Other fishes	19.98

1983; Dickson, 1971). The use of thinner twines also enables to reduce the cost of the gear.

The behaviour of the gear with respect to vertical and horizontal opening is comparable to high opening trawl used for harvesting off-bottom fishes. Kuttappan *et al.* (1990) observed a vertical opening of 18% for midwater trawls having side panel 80% of the width of upper and lower panels. The gear used for the present study has 60% side panels which is in line with design proposed by Wileman *et al.* (1988). Since the net could be dragged at higher speed than bottom trawls it could catch more of fast swimming fishes.

### ACKNOWLEDGEMENT

Authors are indebted to Director for his kind permission to present this communication. Thanks are also to Mr. M.V. Baiju, for his active participation in the cruise programmes. They wish to express their gratitude to Department of Ocean Development, for providing onboard facilities and also to the officers and crew of the vessel for their co-operation in the field tests.

## REFERENCES

- Anon. 1987. *Fishing techniques*, (Japanese International Co-operation Agency, Tokyo) pp. 187.
- Benyami, M. 1956. In: *Modern fishing gear of the world*, edited by H. Kristjonnsson, (Fishing News Books Ltd., London) pp. 213.
- Dickson, W. 1971. Trawl gear selection, design and construction in relation to fish behaviour, vessel power and fishing conditions, In: *Modern fishing gear of the world*, edited by H. Kristjonnsson, (Fishing News Books Ltd., London) pp. 336.
- Garner, J. 1978. In: *Pelagic and semipelagic trawling gear*, (Fishing News Books Ltd., Farnham) pp. 59.
- Kunjipalu, K.K., Kuttappan, A.C. & George Mathai, P. 1979. A new large mesh trawl for demersal fishery. *Fish. Technol.* 16: 19-27.
- Kuttappan, A.C., George, V.C., Varghese, M.D. & Vijayan, V. 1990. Development of midwater trawls. In: *Proc. First Workshop Scient. Resul. FORV Sagar Sampada*, edited by K.J. Mathew (CMFRI, Cochin) 435-439.
- Nayak, K.B. & Seshappa, D.S. 1993. Effect of large meshes on the body of trawl nets in energy conservation. *Fish. Technol.* 30: 1-5.
- Vijayan, V., Joseph Mathai, T., Mhalathkar, H.N. & Syed Abbas, M. 1992. Advantage of large meshes in midwater trawl. *Fish. Technol.* 29: 1-8.
- Wileman, D., Yngvesson, S.R. & Hansen, K. 1988. In: *Proc. world symp. on fishing gear and fishing vessel design*, (Marine Institute, St. Johns, Canada) pp. 66 (abstracts).

\* \* \*

## **Advantages of square mesh codend on the conservation of demersal fisheries in Indian EEZ**

N. Subramonia Pillai, M.D. Varghese, M. Syed Abbas & H. Krishna Iyer

Central Institute of Fisheries Technology  
P.O. Matsyapuri, Cochin - 682 029

### **ABSTRACT**

Square mesh in the codend play an important role on the selectivity of trawl gear and the conservation of resources. Comparative fishing trials between the square mesh and diamond mesh codends were carried out in deeper waters from *FORV Sagar Sampada*. The length frequency measurements of the important species of fish caught in both the codends showed the supremacy of square mesh by retaining more bigger fish and eliminating under sized and juvenile fishes, than the diamond mesh.

### **INTRODUCTION**

The size and shape of codend mesh play a prominent role on the selectivity of gear and conservation of fishery resources. Any fishing gear which aims to conserve the fish stock should effectively catch only the target species of high quality and legally accepted size, using minimum quantity of fuel. The profit from trawling will be less, if large quantity of under sized fish are caught. So the mesh size for the codend, is to be regulated by which the escapement of fishes smaller than the minimum permitted size is facilitated in order to conserve the resources. According to Robertson (1986) limiting the destruction of juvenile fish is one way of conserving the stock of important demersal species. Earlier studies suggested increase of mesh size for better selectivity.

Panicker & Sivan (1965) recommended increase of codend mesh size to 40 mm stretched for shrimp fishing. The capacity of codend to allow the under sized fish to escape depends on the size, shape and unobstructed opening of the mesh. The conventional diamond mesh tends to close during the drag when the codend fills up and the tension on the mesh bar increases (Fonteyne & M'Rabet, 1992). Unlike the diamond mesh a square mesh is not distorted by water pressure, the netting retains its original shape and the mesh is kept open fully (Stewart & Robertson, 1985). The use

of square mesh also enables better filtering capacity thereby reducing drag. Selectivity experiments with square mesh codend have shown that the square mesh are more effective for round fish, than diamond mesh (Robertson, 1983; Robertson & Stewart, 1986). But the square mesh has not much influence on selectivity in the case of flat fish (Fonteyne & M'Rabet, 1992). Investigations to study the effect of square mesh codend on selectivity revealed that square mesh codend of 30 mm mesh size is more selective in eliminating under sized fishes when compared to the diamond mesh codend. The present communication deals with investigations on square mesh and diamond mesh (40 and 50 mm mesh size) to study the selectivity on demersal fishes in deeper waters.

## MATERIALS AND METHODS

Codends with square mesh and diamond mesh of 40 and 50 mm mesh size (Fig. 1) were fabricated with 2.5 mm diam. polyethylene twine as described by Robertson (1986). The 40 mm square and diamond mesh codends were attached to a 38 m hybrid trawl and 50 mm square mesh and diamond mesh codends to 50 m high speed demersal trawl (Panicker, 1990; Panicker *et al.* 1993). Both diamond and square mesh codends were attached together as twin codend for simultaneous observation. Fishing trials were carried out from *FORV Sagar Sampada* during cruise nos 99 and 105, in the depth range of 50 to 200 m, along the west coast. Length frequency measurements of the samples of important species such *Nemipterus* sp., *Decapterus* sp., *Priacanthus* sp., *Saurida* sp. and squids from square mesh and diamond mesh were recorded.

## RESULTS AND DISCUSSION

Percentage composition of length group of important species caught in the square mesh and diamond mesh codends of 40 mm and 50 mm mesh size are given in Table 1. It is evident from the data that smaller size group of fishes of all species are more in diamond mesh codend than in square mesh codend, the latter retained larger size

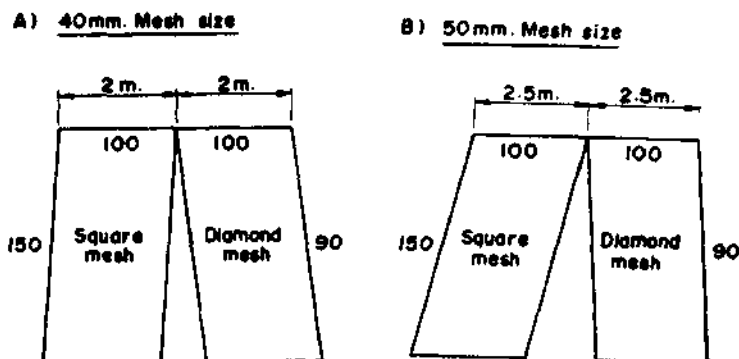

Fig. 1— Design details of square mesh and diamond mesh codends



Table 1—Percentage composition of length group of important species caught by square mesh and diamond mesh codends of 40 mm and 50 mm mesh size

Length group (mm)	40 mm mesh size		50 mm mesh size	
	Square mesh	Diamond mesh	Square mesh	Diamond mesh
<i>Nemipterus</i> sp.				
81-100	Nil	10.7	Nil	0.3
101-120	0.7	9.3	Nil	10.2
121-140	43.3	28.0	20.1	30.0
141-160	28.6	33.3	42.2	31.3
161-180	18.0	13.4	26.9	20.4
181-200	5.3	1.3	7.4	6.5
201-220	1.9	4.0	2.8	0.3
221-240	2.0	Nil	0.3	0.3
>241	Nil	Nil	0.3	Nil
<i>Priacanthus</i> sp.				
101-120	12.0	24.8	1.0	12.3
121-140	32.8	36.0	27.5	38.2
141-160	35.2	24.0	60.9	44.7
161-180	18.4	13.6	6.0	2.4
181-200	0.8	0.8	2.4	1.6
201-220	0.8	0.8	1.6	0.8
<i>Decapterus</i> sp.				
121-140	Nil	23.0	Nil	Nil
141-160	67.0	66.0	Nil	16.6
161-180	23.1	9.1	19.1	27.5
181-200	10.0	2.0	62.6	50.9
201-220	Nil	Nil	18.3	5.0
<i>Saurida</i> sp.				
101-120	42.0	44.0	10.4	30.8
121-140	24.0	28.0	32.0	35.4
141-160	25.0	22.0	38.4	25.6
161-180	9.0	6.0	14.4	6.4
181-200	Nil	Nil	4.6	1.8

Contd....

Table 1 — Contd...

Length group (mm)	40 mm mesh size		50 mm mesh size	
	Square mesh	Diamond mesh	Square mesh	Diamond mesh
<i>Sciaenids</i>				
161-180	-	-	5.0	18.0
181-200	-	-	26.0	35.0
201-220	-	-	41.0	27.0
221-240	-	-	24.0	18.0
>241	-	-	4.0	2.0
<i>Squids</i>				
101-120	12.3	33.0	20.5	49.4
121-140	26.7	10.6	45.3	29.2
141-160	13.2	13.2	16.4	13.4
161-180	26.6	24.6	12.6	6.2
181-200	21.2	18.6	5.2	1.8

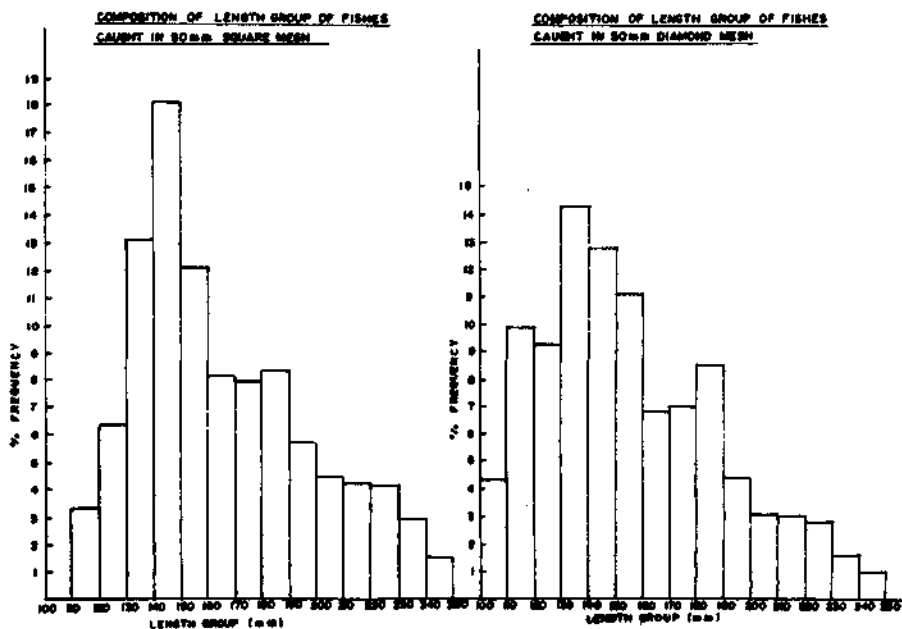

Fig. 2—Composition of length groups of fishes caught in 50 mm square and diamond mesh codend

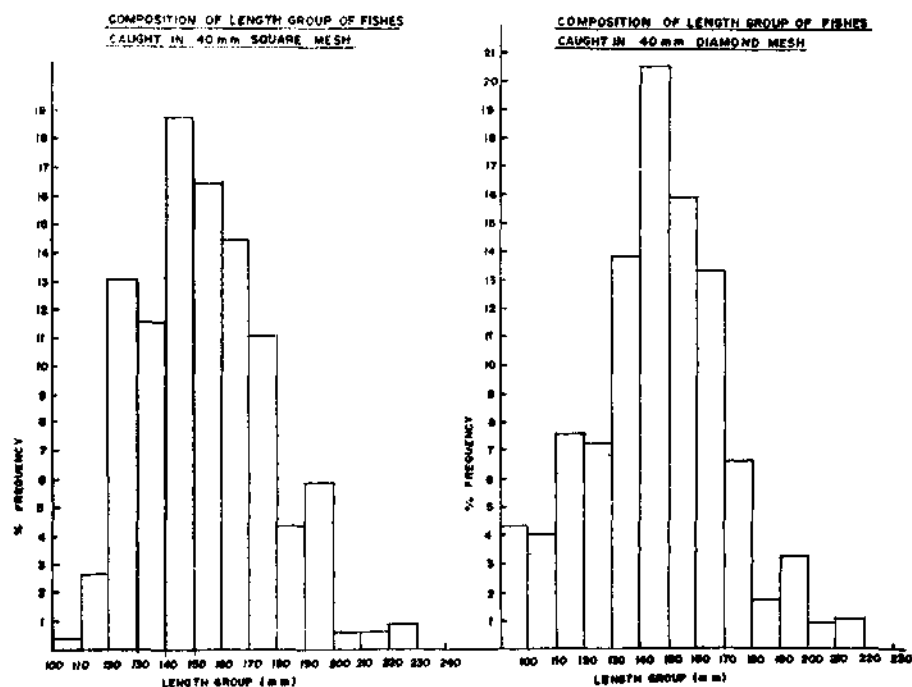

Fig. 3—Composition of length group of fishes caught in 40 mm square and diamond mesh codends

Table 2— Analysis of the data on square mesh and diamond mesh codend of 40 mm mesh size

Species	Mean		Std.devn.		CV.		SK	
	SM	DM	SM	DM	SM	DM	SM	DM
<i>Nemipterus</i> sp.	140.8	145.9	23.4	28.1	16.6	19.3	0.18	0.004
<i>Decapterus</i> sp.	214.8	209.9	52.3	20.6	24.4	9.8	0.38	0.01
<i>Priacanthus</i> sp.	179.0	179.0	7.5	7.8	4.2	4.3	0.15	0.19
Squids	163.8	145.7	25.1	28.4	15.3	19.5	-0.20	-0.21
	Q1		Q2		Q3			
	SM	DM	SM	DM	SM	DM	SM	DM
<i>Nemipterus</i> sp.	140.8	134.7	153.7	147.1	172.3	159.6		
<i>Decapterus</i> sp.	201.3	189.1	210.0	208.1	229.3	227.2		
<i>Priacanthus</i> sp.	173.5	173.5	176.9	177.7	181.5	183.9		
Squids	130.0	121.4	163.7	160.0	186.4	185.0		

SM: square mesh; DM: diamond mesh; CV: coefficient of variation;  
SK: Bowley's coefficient of skewness; Q1, Q2 & Q3: quartiles

Table 3— Analysis of the data on square mesh and diamond mesh codends of 50 mm mesh size

Species	Mean		Std.devn.		CV.		SK.	
	SM	DM	SM	DM	SM	DM	SM	DM
<i>Nemipterus</i> sp.	156.1	151.6	19.2	22.8	12.3	15.0	0.41	0.09
<i>Decapterus</i> sp.	195.7	196.4	12.0	15.6	6.1	8.5	0.02	-0.23
<i>Priacanthus</i> sp.	151.2	143.5	15.2	17.0	10.0	11.8	0.12	-0.11
<i>Saurida</i> sp.	147.7	135.4	17.0	16.7	11.5	12.3	-0.004	0.13
Sciaenids	220.8	208.8	13.5	17.9	6.1	8.6	0.02	-0.02
Squids	138.8	132.6	23.1	20.8	16.6	15.7	0.30	0.31
	Q1		Q2		Q3			
	SM	DM	SM	DM	SM	DM		
<i>Nemipterus</i> sp.	148.9	134.0	161.1	149.1	173.1	167.0		
<i>Decapterus</i> sp.	209.5	192.3	219.5	208.2	230.0	223.4		
<i>Priacanthus</i> sp.	142.3	134.4	148.5	144.4	156.4	152.5		
<i>Saurida</i> sp.	135.4	123.1	146.7	133.6	157.9	147.3		
Sciaenids	209.5	192.3	219.5	208.5	220.0	223.4		
Squids	125.9	16.5	137.9	125.7	160.4	143.2		

SM: square mesh; DM: diamond mesh; CV: coefficient of variation; SK: Bowley's coefficient of skewness; Q1, Q2 & Q3: quartiles

groups of all important species. The percentage composition of different size groups of all varieties of fish caught in the square mesh and diamond mesh codend of 40 and 50 mm mesh size are given in Figs. 2,3. The length of different varieties of fishes varied from 90 to 250 mm. In the first 25% length point up to 130 mm, the 50 mm square mesh accounted only 9.6% and 40 mm square mesh 15.6%, whereas 50 mm diamond mesh landed 23.6% and 40 mm diamond mesh 23.1% establishing supremacy of square mesh in eliminating under sized fish. In the case of bigger size groups of fish also the percentage is more in square mesh compared to diamond mesh.

The data was statistically analysed with a view to assess the efficiency of the square mesh netting as a conservation measure over the diamond mesh. Length frequency data of the representative samples of catch from square and diamond mesh codends were made separately for all important species mentioned earlier. Estimate of mean and standard deviation; coefficient of variation; first, second and third quartiles and Bowley's coefficient of skewness were calculated from the length frequency distribution of each variety of the fish caught in the square and diamond mesh codends of 40 and 50 mm mesh size and are presented in Tables 2,3, respectively. The coefficient of variation gives an idea as to in which net the catch composition is more uniform; the first, second and third quartiles give the 25%, 50% and 75% length points of the frequency distribution and Bowley's coefficient of skewness gives whether the fre-

quency distribution is skewed to the left, right or symmetrical. The results of the analysis of the data clearly indicate the supremacy of square mesh in the conservation of most varieties of fish except in the case of squids, where both square and diamond mesh codends are equally efficient in retaining similar size group.

Between the two mesh sizes of square mesh, the data indicate that 50 mm square mesh codend allowed more under sized fish to escape, when compared to the 40 mm mesh size, thereby providing better efficiency in selectivity and conservation.

### ACKNOWLEDGEMENT

Authors are grateful to Dr. K. Gopakumar, Director for granting permission to publish this paper and also to the Master and Officers of *FORV Sagar Sampada* for the assistance during the fishing trials.

### REFERENCES

- Fonteyne, R. & M'Rabet, R. 1992. Selectivity experiments with diamond mesh and square mesh codends in the Belgium coastal beam trawl fishing, *Fish. Res.* 13: 221-227.
- Panicker, P.A. 1990. Development of demersal trawls for Indian EEZ: A status paper on prospects and constraints. In: *Proc. First Workshop on Scient. Resul. FORV Sagar Sampada*, edited by K.J. Mathew, (CMFRI, Cochin) 427-434.
- Panicker, P.A., Boopendranath, M.R. & Syed Abbas, M. 1993. Observations on deep sea demersal resources in the exclusive economic zone off southwest coast of India, *Fish. Technol.* 30: 102-108.
- Panicker, P.A. & Sivan, T.M. 1965. On the selective action of the codend meshes of shrimp trawl, *Fish. Technol.* 2: 220-228.
- Robertson, J.H.B. 1983. Square mesh codend selectivity experiments on Whiting and Haddock, *International Council for Exploration of the Sea CM 1983/B: 25*, pp. 4.
- Robertson, J.H.B. 1986. Design and construction of square mesh codends, *Scottish Fisheries Information Pamphlet* No. 12, pp.10.
- Robertson, J.H.B. & Stewart, P.A.M. 1986. Analysis of length selection data from comparative fishing experiments with square and diamond mesh codends on Haddock and Whiting, *Scottish Fisheries Working Paper* No. 9, pp.8.
- Stewart, P.A.M. & Robertson, J.H.B. 1985. Small mesh codend covers, *Scottish Fishery Research Report* No. 32, pp.11.

## Development and performance of 50 m high opening trawl

K.K. Kunjipalu, M.R.Boopendranath, P. George Mathai, M.D. Varghese,  
M. Syed Abbas, N. Subramonia Pillai & V.C. George

Central Institute of Fisheries Technology, P.O. Matsyapuri,  
Cochin - 682 029

### ABSTRACT

Performance of a 50 m six-panelled high opening trawl, developed for harvesting bottom and off-bottom resources of Indian EEZ, is presented in this paper. The gear developed an average vertical opening of 6.1 m at trawl mouth, and an estimated spread of 55.5 m between otter boards during operations within 60-150 m depth, at a trawling speed of 4 kn and scope ratio of ca. 1:3. Wing-end spread was calculated to be approximately 64% of the headline length. A total of 67 t of fish and shellfish was landed using two variants of the gear, during 82 hauls. Overall CPUE realised was 923 kg/hr. Significant catch rates of some non-traditional trawl resources such as *Atroubucca marleyi* (Sciaenidae) and trigger fishes (Balistidae) were obtained during operations off northwest coast and Wadge Bank, respectively.

### INTRODUCTION

High opening trawls are useful when the vertical distribution of the target species is beyond the range of conventional low-rise two-panel or four-panel bottom trawls (Garner, 1967, 1978). Relatively high vertical opening at trawl mouth in high opening trawl is generally obtained by additional side panels and redistribution of towing forces along headline by means of riblines (Nakamura, 1971; Kodera, 1971). High opening trawl with 6 or 8 panels have been developed for inshore trawling in India (Deshpande *et al.* 1970; Kunjipalu *et al.* 1984; 1990). In this paper, operational performance of a 50 m high opening trawl developed for harvesting bottom and off-bottom resources of Indian EEZ, is presented, based on full scale field trials from *FORV Sagar Sampada*.

## MATERIALS AND METHODS

High opening trawl (HOT) of 50 m headline length used for the operations (Fig. 1) is based on the design of 25 m six-panelled high opening trawl developed by Kunjipalu et al. (1990). Two variants of the gear (HOT I & II) differing slightly in jib dimensions on the bottom panel, other dimensions being equal, were used for the experiments. HOT I and II have foot ropes of 61 and 57 m, respectively. The trawls were rigged with 200 mm diam. floats and iron link chain (@ 3.3 kg/m) or rubline (cut tyre discs @ 10 kg/m).

*Perfect* (Denmark), economy model, V-shaped otter boards (2850 x 1800 mm; ca. 2800 kg per set) were used for operations with 50 or 60 m sweeps. Fishing operations were conducted from *FORV Sagar Sampada* (71.5 m LOA; 2285 hp) in the EEZ of west coast within 50-340 m depth during cruises 97A, 103, 105A and 110 (1991-93).

Vertical opening at trawl mouth was measured using SIMRAD FR500 Trawl Eye System. Horizontal opening between otter boards was estimated from measured divergence of main warps for 1 m distance from the towing points and mean values were used for calculating approximate spread at wing-ends (Koyama, 1974). Measurements were made using HOT-I in depth range of 60-150 m, at a towing speed of 4 kn and scope ratio of ca. 1:3. Tension on the warps was measured using tension meter and speed from ship's doppler speed log.

## RESULTS AND DISCUSSION

Mean vertical opening at trawl mouth obtained was 6.1 m (SD: 0.6; n:2) and horizontal opening between otter boards was estimated as 52 m (SD:16.85; n:6), wing-end spread roughly calculated from mean horizontal spread at otter board was 32 m i.e., 64% of headline length. Average tension on the warps was 3.7 tonne (SD:0.56; n:14).

Nearly 67 tonne of fish and shellfish was landed during 82 fishing operations (total towing duration: 72 hr 30 min). Overall catch per unit effort (CPUE) realised was 923 kg/hr contributed by trigger fishes 20.3%, *Nemipterus* spp 18.4%, *Decapterus* spp 11.8%, *Upeneus* spp 6.5%, ribbon fishes 6.5%, sciaenids 5.9%, perches 5.5%, *Saurida* spp 3.5%, carangids 2.2%, *Megalaspis* spp 1.9%, high value shellfish (cephalopods, prawns and lobsters) 1.7% and miscellaneous fish. Operational details and particulars of catch obtained during different cruises are given in Tables 1-3.

HOT-I obtained a mean haul-wise CPUE of 1301 kg/hr within a depth range of 65-70 m, between 20°13' - 21°N during cruise no.97A (Dec.91 - Jan'92). Main catch constituents were *Decapterus* spp 34.5%, *Upeneus* spp 14%, ribbon fish 11.2%, *Megalaspis* spp 6.5%, carangids 4.6%, perches 4.6%, catfish 2.7%, cephalopods 2.5%, sciaenids 2.1%, *Nemipterus* spp 2.1%, *Protonibea* spp 1.8%, elasmobranchs 1.3%, mackerel 1.16%, *Saurida* spp 1.2% and other fishes (Table 2). The same gear obtained a mean CPUE of 804 kg/hr during cruise No.103 (Aug.-Sept. 1992) in the fishing area between 51-130 m depth, 18°13' - 23°02'N, mainly constituted by

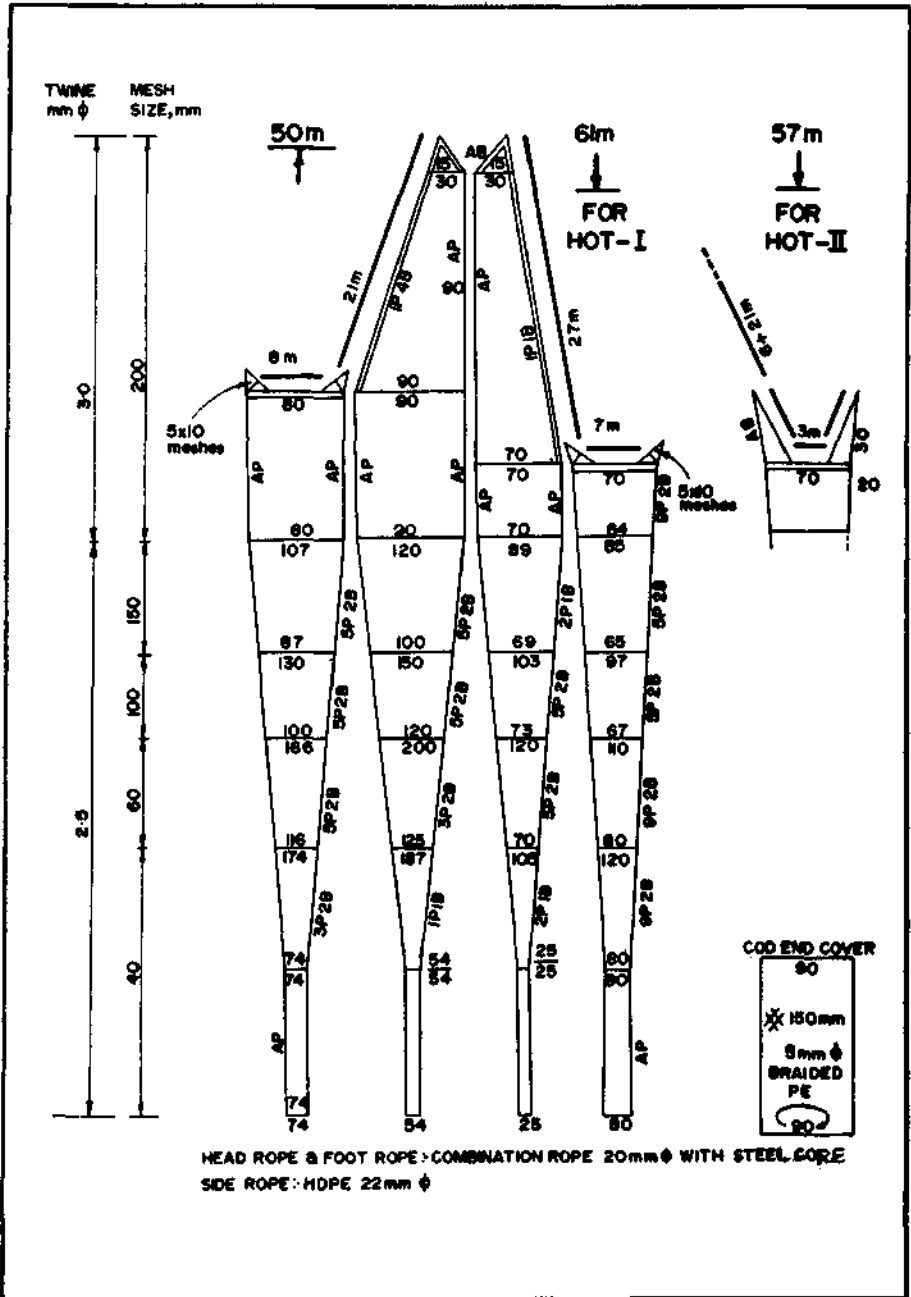

Fig. 1— Design of 50 m high opening trawl I and II



Table 1— Particulars of fishing operations using high opening trawls during cruises 97A, 103, 105A and 110 of *FORV Sagar Sampada*

Cruise no. & period	Depth range (m)	Fishing area	No. of hauls	Fishing effort (hr:min)	Total catch (kg)	Mean CPUE (kg/hr)
<i>50 m high opening trawl - I</i>						
97A 26-12-91- 1-1-92	64-70	20°13' - 21°00'N 69°28' - 70°52'E	16	14:50	19300	1301.1
103 31-8-92- 20-9-92	51-130	18°13' - 23°02'N 67°06' - 70°52'E	32	27:35	22180	804.1
110 10-7-93- 19-7-93	55-250	07°06' - 07°44'N 76°54' - 77°58'E	17	17:00	19235	1131.5
		Sub-total	65	59:25	60715	1021.9
<i>50 m high opening trawl - II</i>						
105A 9-11-92- 20-11-92	112-323	15°10' - 22°26'N 67°24' - 72°56'E	13	10:10	4190	412.1
110 18-7-93- 21-7-93	52-340	07°42' - 08°55'N 75°51' - 77°56'E	4	02:55	2025	694.3
		Sub-total	17	13:05	6215	475.0
		Total	82	72:30	66930	923.2

Table 2- Catch rates of 50 m high opening trawl - I during cruises 97A, 103 and 110 of FORV Sagar Sampada

Species/groups	Cruise 97A		Cruise 103		Cruise 110	
	Catch (kg)	CPUE (kg/hr)	Catch (kg)	CPUE (kg/hr)	Catch (kg)	CPUE (kg/hr)
Trigger fishes	-	-	-	-	12085	710.9
<i>Decapterus</i> sp.	6650	448.5	201	7.3	-	-
<i>Nemipterus</i>	405	27.3	9423	341.6	2300	135.3
<i>Upeneus</i> spp	2705	182.4	265	9.6	1374	80.8
Ribbon fishes	2160	145.6	2090	75.8	-	-
Perches	895	60.3	387	14.0	1972	116.0
<i>Atrobucca marleyi</i>	-	-	2885	104.6	-	-
<i>Megalaspis</i> sp.	1260	84.9	-	-	-	-
<i>Saurida</i> sp.	225	15.6	1935	70.2	-	-
Carangids	965	65.1	-	-	529	31.1
Catfishes	525	35.4	31	1.1	-	-
Cephalopods	480	32.4	190	6.9	312	18.4
Sciaenids	410	27.6	520	18.9	-	-
<i>Protonibea</i> sp.	343	23.1	-	-	-	-
Elasmobranchs	335	22.6	99	3.6	-	-
Mackerel	307	20.7	35	1.1	-	-
<i>Parascloopsis</i> sp.	-	-	538	19.5	-	-
<i>Centropomus</i> sp.	-	-	500	18.1	-	-
<i>Apogon</i> sp.	-	-	300	10.9	-	-
<i>Sphyraena</i> sp.	145	9.8	60	2.2	-	-
Seerfish	131	8.8	-	-	-	-
<i>Chorinemus</i> sp.	125	8.4	-	-	-	-
<i>Priacanthus</i> sp.	-	-	-	-	-	-
Slip mouths	50	3.4	-	-	-	-
<i>Polynemus</i> sp.	-	-	80	2.9	-	-
Flatfishes	25	1.7	-	-	-	-
<i>Ariomma</i> sp.	-	-	35	1.3	-	-
Prawns & lobsters	10.5	0.7	14.5	0.5	-	-
Other fishes	1148.5	77.4	2419.5	87.7	663	39.0
Total	19300.0	1301.1	22180	804.1	19235	1131.5

Table 3 — Catch rates of 50 m high opening trawl - II during cruises 105A and 110 of FORV Sagar Sampada

Species/groups	Cruise 105A		Cruise 110	
	Catch(kg)	CPUE(kg/hr)	Catch(kg)	CPUE (kg/hr)
Trigger fishes	-	-	1525	522.9
<i>Priacanthus</i> sp.	1368	134.6	-	-
<i>Decapterus</i> sp.	1061	104.4	-	-
<i>Cubiceps</i> sp.	-	-	170	58.3
<i>Ariomma</i> sp.	461	45.3	-	-
Perches	364	35.8	42	14.4
<i>Centrolophus</i> sp.	-	-	85	29.1
Cephalopods	223	21.9	5	1.7
<i>Saurida</i> sp.	207	20.4	-	-
Sciaenids	121	11.9	-	-
<i>Nemipterus</i> spp	118	11.6	50	17.1
Deep sea prawns	-	-	30	10.3
<i>Chlorophthalmus</i> sp.	-	-	25	8.6
<i>Epinnula</i> sp.	-	-	10	3.4
Ribbon fishes	78	7.7	-	-
<i>Sphyraena</i> sp.	32	3.1	-	-
Elasmobranchs	9	0.9	-	-
Other fishes	148	14.6	83	28.5
<b>Total</b>	<b>4190</b>	<b>412.1</b>	<b>2025</b>	<b>694.3</b>

*Nemipterus* spp 42.5%, sciaenids 15.3%, ribbon fish 9.4%, *Saurida* sp. 8.7%, *Parascolopsis* spp 2.4%, *Centropomus* sp. 2.3%, perches 1.7%, *Apogon* sp. 1.4%, *Upeneus* spp 1.2% and others. Black mouth croaker (*Atroubucca marleyi*), a new sciaenid resource was caught at catch rates ranging from 50 to 1000 kg/hr between 56 and 128 m depth contributing 13% of the total landings (Table 2). Operations during cruise No.110 (July 1993) off southwest coast, between 07°06' - 07°44'N, 55-250 m obtained a mean CPUE of 1131 kg/hr. Trigger fishes (Family: Balistidae) formed a significant constituent of the landings (62.8%) followed by *Nemipterus* sp. 11.9%, perches 10.3%, *Upeneus* spp 7.1%, carangids 2.8%, cephalopods 1.6% and other fishes (Table 2).

HOT-II obtained a mean haul-wise CPUE of 412 kg/hr during cruise No.105A (Nov. 1992) between 15°10' - 22°26'N, 110-325 m depth (Table 1). Landings consisted of *Priacanthus* sp. 32.7%, *Decapterus* sp. 25.3%, *Ariomma* sp. 11%, perches 8.7%, cephalopods 5.3%, *Saurida* spp. 4.9%, sciaenids 2.9%, *Nemipterus* spp. 2.8%, ribbon fish 1.7% and other fishes (Table 3). The same gear during cruise No.110 (July 1993) obtained a mean CPUE of 694 kg/hr between 07°42' - 08°50'N, 58-340 m depth constituted by trigger fishes 75.3%, *Cubiceps* sp. 8.4% *Centrolophus* sp. 4.2%, *Nemipterus* spp. 2.5%, perches 2.1%, deep sea prawns 1.5%, *Chlorophthalmus* sp. 1.2% and others (Table 3).

High opening trawls are designed to attain high vertical opening while still firmly in contact with the seabed. In this respect, it differs from semi-pelagic trawls in which the otter boards are in contact with the seabed while the trawl net is so rigged as to fish a certain distance above seabed (Garner, 1978). Operational parameters and catch rates obtained at different fishing grounds indicate efficient performance of the new high opening trawl and its suitability for harvesting bottom and off-bottom resources vertically distributed within about 6 m from the seabed.

### ACKNOWLEDGEMENT

Authors are thankful to Dr. K. Gopakumar, Director for permission to publish the paper, and Mr. P.A. Panicker, for support and encouragement. They are also thankful to DOD, New Delhi for facilities provided; service engineers from M/s.NORINCO, Cochin for their co-operation during cruises.

### REFERENCES

- Deshpande, S.D., Rama Rao, S.V.S & Vijayan, V. 1970. Results of preliminary fishing trials with 15.8 m six-seam otter trawl, *Fish. Technol.* 7:186-189.
- Garner, J. 1967. *Modern deep sea trawling gear* (Fishing News Books Ltd., London) pp 83.
- Garner, J. 1978. *Pelagic and semi-pelagic trawling gear*, (Fishing News Books Ltd., Farnham) pp 59.
- Kodera, K. 1971 Aimed bottom and midwater trawling techniques of Japanese factory stern trawlers, In: *Modern fishing gear of the world*, edited by H. Kristjonsson, (Fishing News Books Ltd., London) 411-420.
- Koyama, T. 1974 Study on the stern trawl, *Bull. Tokai. Reg. Fish. Res. Lab.* No.77: 171-247.
- Kunjipalu, K.K., Boopendranath, M.R., Gopalakrishnan, K. & Kuttappan, A.C. 1984. A new high trawl for Veraval waters, *Fish. Technol.* 21:86-90.
- Kunjipalu, K.K., Subramonia Pillai, N. & Boopendranath, M.R. 1990. Performance of high opening trawls off Veraval, northwest coast of India, *Fish. Technol.* 27: 1-4.
- Nakamura, M. 1971. Trawling gear in Japan, In: *Modern fishing gear of the world*, Vol. 3, edited by H. Kristjonsson, (Fishing News Books Ltd., London) 456-462.

\* \* \*

## **Calibrations of hydro-acoustic instruments onboard *FORV Sagar Sampada***

S. Natarajan, Mohamed Kasim, G. Gopakumar

Central Marine Fisheries Research Institute, Post Box No.1603, Tatapuram. P.O.  
Cochin-682 014

V. Ravindranathan

Department of Ocean Development, Foreshore Avenue, Cochin-682 016

&

A. Ramakrishnan

Central Institute of Fisheries Technology, Matsyapuri-P.O. Cochin-682 029

### **ABSTRACT**

Calibration is carried out to keep up the precision of the instruments by determining their calibre. Calibration of hydro acoustic equipments onboard *FORV Sagar Sampada* was carried out periodically and the performance records were maintained. Deviation and the deficiencies were noted down for applying the correction while interpreting the output of the instruments.

### **INTRODUCTION**

*FORV Sagar Sampada* is engaged in fishery research work since 1985 in Exclusive Economic Zone (EEZ) of India. The vessel is equipped with most modern hydro acoustic instruments used for acoustic survey in the assessment of fish resources. Fish resources assessment is vital for fishery management in planning for harvesting, processing, marketing and setting up of fish based industries. Acoustic survey is considered to be more reliable and advantageous among many other methods available for fish resources estimation, since it gives the results quickly, covers larger area without destruction or damage to the resources during the survey and expenditure is comparatively less.

The major equipments used onboard *FORV Sagar Sampada* for resources estimation are the scientific echosounder EK-400 operating on 38 and 120 kHz and echointegrator Simrad QD coupled with data printer TI 703. The accuracy of the

resources estimation depends on the performance of these instruments. Therefore, the calibration of these instruments are vital for maintaining the high standard of accuracy of the research findings.

Calibration in general means the process of determining the calibre of instruments. It involves: i) the measurement of the equipment parameters (transmitter power output, frequency, band-width, beam-width, pulse-width etc) to confirm that they are within the specified limit, ii) the measurement of absolute value of noise level which is one of the limiting factors in the use of hydro acoustic equipments and iii) the measurement of received echo level to determine the back-scattering strength of the reflecting object, the target. The calibration was carried out on the acoustic survey equipments onboard *FORV Sagar Sampada* and the results, since 1985, are described below.

## MATERIALS AND METHODS

Cruises were arranged exclusively for the purpose of calibration during the calm weather season, along west coast, mostly off Trivandrum. Acoustic equipments were switched on continuously for 12 hours and ensured stable operations before commencing any measurements. Other heavy electrical equipments such as winches were switched off to minimise external noises. The equipment parameters like transmitter output power, frequency, band-width, pulse-width, TVG attenuation etc were measured and corrected to the specified level by adjusting the pre-set controls. The test equipments used were oscilloscope, digital voltmeter, signal generator; function generator, frequency counter, attenuator, AC voltmeter and test hydrophone. The performance of the echo-integrator was tested selecting test transducer and confirmed that it was functioning to the specified level.

The vessel was anchored at 40 m depth. The 60 mm copper sphere of -33.6 dB target strength was placed below the transducer along the axis of the beam. The amplitude of the echo signal was measured on the oscilloscope and the SL+VR was calculated using the formula of (Foote *et al.* 1983).

$$SL+VR = EL-TS+20 \log R+2\alpha r - G+40 \log R$$

where SL is source level, VR is voltage response. VL is echo level, TS is target strength, R is range of the target, r is effective range of TVG,  $\alpha$  is absorption co-efficient and G is gain or attenuator settings.

The rigging arrangement to position the standard target (copper sphere) is shown in Fig. 1. In order to bring the copper sphere to the centre of the beam around 20 m below the vessel's hull, 3 electrically operated winches were used. The winches were locally fabricated using a 12 V DC motor (whiper motor) with a small cable drum fixed to the shaft of the motor. The cable drum was wound with 0.60 mm diameter steel wire used to suspend the copper sphere. The winches were fixed on to the pre-fabricated triangular aluminium frame with a small pulley at one end. Two frames were fixed on the star board side of the gun-wale (raised edge of the deck of the ship)

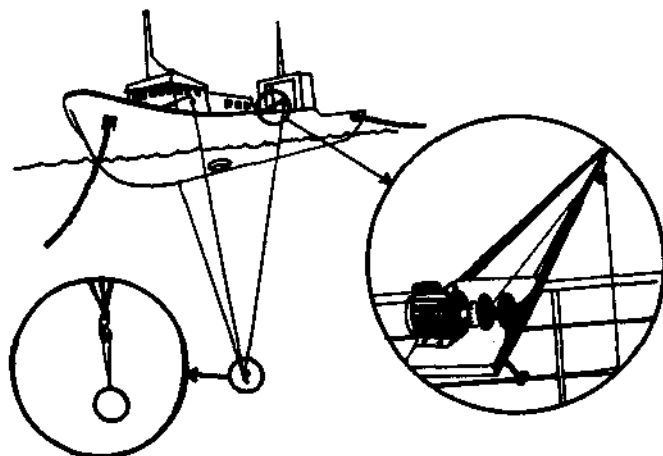

Fig.1 - Rigging of a research vessel for calibration using copper sphere as target

and one in the port side. The suspension lines from the winch drum were passed through the respective pulley and fastened to the copper sphere with affixed loop. The supply for the winch motor was connected through a double pole, double throw spring loaded switch which can change the polarity of the supply to the motor in turn the direction of the rotation of the cable drum. The winch control system was located in acoustic room. By observing the oscilloscope for the maximum echo signal level and the echo mark of the copper sphere on the echo-gram of the echosounder. Three suspension lines were either released or heaved to position the copper sphere to the centre of the beam.

## RESULTS AND DISCUSSION

Values of the SL+VR obtained are given in Table 1. The value obtained during the year 1993 is considerably less. As the performance and other measurements on equipment parameters were satisfactory, the low value could be attributed to the non-alignment of the standard target with the axis of the beam due to underwater current. The calibration is carried out annually and or whenever some vital parts of the equipments such as transducer, transmitter-receiver printed circuit board etc are changed. The values of the SL + VR are documented so as to effect the correction in the estimation as and when required while carrying out acoustic survey for resources estimation and for the future reference.

### Calibration using standard target

The voltage amplitude of the signal appearing at the output terminal of the receiver of an echo ranging system depends on the reflecting properties of the target, receiving sensitivity and transmitting power. When characteristics of the transmitter and the

Table 1 - Source level + voltage response value obtained during different calibrations onboard *FORV Sagār Sampada* using copper sphere as standard target (Diameter = 60 mm, TS = 33.6 dB)

Echosounder - EX 400

Transducer No. 1

Date	Power	Attenuation setting (dB)			
		0dB	10dB	20dB	30dB
15.10.1984	High	137.6	128.1	118.1	108.1
	Low	129.3	119.3	109.6	097.7
07.09.1985	High	137.5	128.1	118.1	108.1
	Low	129.1	119.3	109.6	077.9
12.04.1990 to 14.04.1990	High	124.1	124.1	114.1	104.2
	Low	-	-	-	-
16.05.1992 to 20.5.1992	High	136.9	126.9	116.9	106.9
	Low	130.1	120.1	110.1	100.1
07.01.1993 to 09.01.1993	High	111.5	101.5	091.5	081.5
	Low	-	-	-	-

receiver are known, the properties of the target could be judged from the amplitude and the shape of the echo signal received (Forbes & Nakken, 1972). For the measurement of the parameters of the transmitting and the receiving system, hydrophone is used. Hydrophone is very sensitive to external temperature. As the measurements are undertaken in the ambient condition, maintaining the constant temperature is not practicable. Hence, the precision in the measurement becomes poor. The method of measuring SL + VR using standard target do not involve the use of hydrophone and the inaccuracy caused by the instability of the hydrophone is avoided resulting improved precision in the measurement.

### Live fish calibration

An echointegrator connected to the echosounder sums up the echo signals received. The output of the echointegrator per nautical mile covered is an index of the amount of fish recorded, and therefore a measure of relative density of fish in the area. The magnitude of the output of the integrator depends on the equipment parameters and the acoustic characteristic of the fish parameters, called calibration constant. This is established through live fish calibration by considering the integrator deflection for the insonified fish of the known species and quantities (Johannesson & Losse, 1977) and used for converting the relative biomass into absolute biomass.



Live fish calibration experiment was carried out onboard *R V Rastrelliger* and calibration constant was obtained for mackerel and sardine (Vittulo *et al.* 1980). As the type of instruments used onboard *R V Rastrelliger* are different from *FORV Sagar Sampada*, these constants cannot be used. Therefore to have the absolute biomass estimate of fishery resources, live fish calibration need be carried out onboard *FORV Sagar Sampada* in future for the commercially important species, following the methods of Vittulo *et al.* (1980).

### Calibrating integrator using trawl catch data

Another method of establishing calibration constant, 'C' used in fish resources estimation is by calibrating the integrators reading against the corresponding trawl catch (Anon. 1973). The calibration constant established onboard *FORV Sagar Sampada* based on above method was  $1327 \text{ kg/n.mile}^2/\text{mm}$ , which means if the vessel has sailed one nautical mile distance and integrator deflection is 1 mm then the fish biomass will be 1327 kg in that one square nautical mile area. However, this method may lead to under estimation of resources as it is assumed that the fishing efficiency is 100% which is not practicable.

### Target strength measurement

The target strength (TS) of the underwater object is defined as ratio of the reflected sound intensity to the incident sound intensity at 1 m from the object expressed in decibels. The magnitude of TS of fish relates to fish size, morphology, physiology and orientation (Johannesson, 1983). Target strength of 100% reflecting sphere (diameter 12 cm) is -30dB (Bodholt, 1970).

The TS measured for the catfish (Anon. 1974) is as follows:

Mean length (cm)	Mean TS(dB)	Fish (no/kg)
23	-40	11
33	-33.5	3.7

The TS informations help the fishery scientists to know the size of the fish while carrying out the survey and to preserve fish stock for optimum exploitation. Also the knowledge of the target strength of the fish concerned provides another independent means of estimating absolute biomass by the volume back-scattering method (Anon, 1973).

This study could be carried out onboard *FORV Sagar Sampada* for all other commercially valued species utilising the existing equipments in future. Ofcourse with the additions of the latest generation of scientific echosounder ES 400 with the colour printer will give colour hard copy of echogram and size distribution diagram.

The distribution diagram will show number of fish/weight of fish in percentage on Y-axis and fish length or TS values on the X- axis. To sum up the conclusion the calibration need be carried out regularly once in a year or whenever any major part of the equipment are changed during the fair weather season and documented. Live fish

calibration and target strength measurement for the commercially important species need be attempted.

### ACKNOWLEDGEMENT

Authors are thankful to the Director, CMFRI for the permission to present the paper. They are also grateful to Mr. Toorshwal, Simrad expert, Mr. Bo Lundgren and Mr. Morgen Sorensen, Danida experts and Dr. Srinivasan for their guidance and also for the master, *FORV Sagar Sampada*, fishing masters, Mr. Dinesh Babu, Norinco Service engineer and other scientific staff for rendering help during the different calibration cruises.

### REFERENCES

- Anon. 1973. Answers to questionnaire, *Financing agriculture* Vol.V. No.2-3, July-October 1973.
- Anon. 1974. Survey results, 1972/73. UNDP/FAO Pelagic Fisheries Project (IND 69/593). Progress report No.6. Cochin Burgen.pp. 141.
- Bodholt, H. 1970. Measuring target strength and back-scattering strength *SIMRAD Bulletin* Nos. 5.
- Foote, K.G., Knudsen, H.P. & Vestnes, G. 1983. Standard calibration of echosounders and integrators with optimal copper sphere, *Fisk Dr. Skr.Scr.Hav. Unders.*, 17: 335-346.
- Forbes, S.T. & Nakken, O. 1972. *Manual of methods for fisheries research survey and appraisal*, Part 2 - *The use of acoustic instruments for fish detection and abundance estimation*. FAO. *Man. Fish Sci.* No. FIRM/MS: pp. 139.
- Johannesson, K.A. 1983. *Fisheries acoustic. A practical manual for aquatic biomass estimation*. FAO. *Fish. Tech. Pap* No 240: pp. 249.
- Johannesson, K.A. & Losse, G.P. 1977. Methodology of acoustic estimation of fish abundance in some UNDP/FAO resource survey project. *Rep.P.v.Reun.CIEM*, 170: 296-318.
- Vitullo, A.N., Natarajan, S. & Daniel, E., 1980. Live fish calibration of hydro-acoustic equipments onboard *R. V. Rastrelliger*, FI: DP/IND/75/038 Field document Volume. 7 (FAO, Rome), pp.87.

\* \* \*

## Underwater acoustic instrumentation for investigating deep scattering layer

S. Natarajan, K.G. Girijavallabhan & M.S. Rajagopalan

Central Marine Fisheries Research Institute P. B. No 1603, Cochin-682014

### ABSTRACT

The instruments used for the DSL studies were scientific echo-sounder for detection, Isacc's Kid Midwater trawl for sampling mesopelagics and the trawl sonde to lower the IKMT to the exact depth at which the DSL appeared. Opening of the IKMT and the temperature of the seawater at which the DSL appeared was also recorded on the trawl sonde system. The echoscope connected to the echosounder showed the DSL in different colours depending upon its density. The continuous monitoring on echogram revealed that the DSL observed at surface during night and at 600 m depth during day.

### INTRODUCTION

Developments in hydro acoustic instruments for fish detection locating fishing grounds and fish resources estimation have been taken place during the last four decades. Starting from simple echosounders and sonars, the present day equipments, help in qualitative and quantitative assessment with better resolution and precision. In India, the era of application of acoustics in fisheries investigations began in the late fifties with the import of few vessels from Norway for fisheries research and surveys along the west-coast of India. The arrivals among them were *R.V.M.O. Christensen*, *R.V. Kalava*, and *R.V. Varuna* (Silas, 1969). They were fitted with echosounders and simple sonar. *R.V. Conch* of the University of Kerala fitted with echosounder (Simrad, Norway) was also available for fishery research. In the beginning these instruments were used in general for quantitative studies of the fishery resources, plankton distribution, deep scattering layer (DSL) and in limited way for gross quantification of certain demersal fish resources. The UNDP/FAO Pelagic Fishery Project (1971-1979), Cochin, for the first time used the full range of acoustic instruments for the pelagic fish resources survey of southwest coast of India. The instruments consisted of Simrad (Norway) series of equipments namely Scientific Echosounder EK-120, the external dry paper recorder EX-70, Survey Sonar SU/SR2,

Trawl sonde and Echo integrator QM installed on two vessels. They were *R.V. Rastrelliger*, a 152' steel stern ramp trawler cum Purse-Seiner and *R.V. Sardinalla*, a 54' fibre glass vessel of similar operational capabilities. Some important observations were made by making use of the above acoustic instruments and the results were published elsewhere. In due course, the instruments were replaced by next generation type of EKS system of echosounders with EQ/EK recorders (Vitullo *et al.* 1980). In 1982 *R.V. Skipjack*, a 107' steel stern ramp trawler fitted with Simrad EQ/EX echosounders and SU Sonar was acquired by CMFRI, Cochin for fishery research. In the absence of the echo-integrator it was possible to use the instruments only for echo location and sonar survey for the surface schools.

Since 1984, *FORV Sagar Sampada* (LOA-71.5 m) is engaging for fishery and oceanographic research in Indian waters. Most modern and sophisticated acoustic equipments such as scientific echo-sounder (Simrad EK-400), echo-integrator (Simrad QD), sonar (Simrad SM-600), trawl eye (FR-500), hydrography echosounders (Simrad EA-200), speed log (Simrad-NL) with electronic data processing facilities are available onboard the vessel which can be used for location of fish schools, quantitative and qualitative studies of the fishery resources, plankton distribution in the DSL and aimed trawling in the Exclusive Economic Zone (EEZ) of India. Connected instrumentations, their specifications, optimum settings of the equipment parameters for the DSL studies and the interpretation of the echogram on DSL are discussed in this paper.

## MATERIALS AND METHODS

The acoustic survey equipment system onboard *FORV Sagar Sampada* used for DSL studies consist of scientific echosounder EK-400 for detecting fish schools, DSL and finding their depth, echo-integrator for quantifying the biomass, trawl sonde for lowering the net to the desired depth, distance speed log for providing log mark for everyone nautical mile while sailing and data terminal TI-703 for providing the integrator output as a print-out. The salient feature of these equipments are described below.

*Scientific echosounder (Simrad-EK-400)* – This is designed to meet the scientific demands for an echosounder that can do more than just present a fish or bottom echo on an echogram paper. The most modern technology is used in designing this equipment. Introduction of micro-processor technique has also made it possible to eliminate the use of number of switches and potentiometer controls in the front of the control panel. Yet so many parameters are possible to select through the 4x4 position key board. Simple and straightforward menu, together with an unambiguous interactive display are mounted on the front of the separate control unit. The main units of this are recorder units, control units, transceiver unit and either for single beam or two dual beam transducers. Any other auxiliary equipments with parallel B, C, D, ten digits sources can be connected to this echosounder and the respective data will be printed out on the top of the echogram. Also this could be equipped with supplement-

tary equipments like slave recorder, tape recorder, Simrad QX integrator processor, Simrad QD echo-integrator etc. It can operate on either 38 kHz or 120 kHz. Other technical specifications are as follows (Anon, 1980a):

<i>Parameters</i>	38 kHz	120 kHz
Power supply	250 V 50Hz±5%	250 V 50Hz±5%
Power consumption	435 W	435 W
Receiver gain	85 dB	85 dB
Attenuation	010 and 20dB	010 and 20dB
Noise level	+ 15 dB IV RMS	+15 dB IV RMS
Output impedance	50 ohms	50 ohms
Pulse width	0.3, 1.3 & 10 MS	0.1, 0.3, 1 & 3 MS
Power output	2500 W	1000 W
TVG	20/40 Log R	20/40 Log R
Beam width		
Narrow	8°	4° (circular)
Wide	22°	4°
Main Range	0-1000 M	0-1000 M
Mode of operation	Normal, dynaline and contour line	Normal, dynaline, and contour line

*Trawl sonde (Simrad-FR-500)* – It gives the information on the opening of the net and also the position of the net with respect to the surface of the water and the sea bottom. After observing the depth of the fish shoal by the echosounder the net could be positioned in the right depth to trap the fish shoal with the help of trawl sonde. Also a temperature sensor placed in the transducer, which is tied on to the head rope of the trawl net, gives the temperature prevailing along the path of the net to establish the relations between the fish biomass and the temperature of the seawater.

*Echo-integrator (Simrad QD)* – Generally an echo-integrator in conjunction with scientific echosounders provides numerical estimate of the echo abundance. It measures the combined strength and number of echoes received from a selected volume of a seawater. The integrated values are displayed as a raising line across the echogram alongwith fish and bottom echoes, particularly the echo-integrator (Simrad QD), interfaced to scientific echosounder EK-400. This system consists of Simrad QX integrator preprocessor and two micro computers that are programmed to measure, present and log the mean volume backscattering strength ( $S_V$ ) and mm deflection (Anon, 1980b).

*Data terminal No. TI 703* – It is the primary means of data input to the computer and data output from the computer. The system parameters and the integration layer selection is fed through this terminal. The integrator output is available as printout in

A4 format at the rate of 10.2 characters per inch (CPI)/80 characters per line in its standard printing configuration. In its compressed configuration the terminal prints 17 CPI (132 characters per line) (Anon, 1988).

*Simrad NL Doppler speed log* – This provides analog speed indication of the vessel and digital distance read out. Working frequency is 1 MHz. It has two speed ranges of 0-10 and 0-20 knot. The accuracy of the speed is better than 2 percent. The output signal of the log is fed to the echosounder EK-400 and echo integrator QD for providing mile marker and resetting the integration respectively for each nautical mile distance sailed by the vessel (Anon, 1979).

*Isacc's Kid Midwater trawl* – It was a gear, onboard *FORV Sagar Sampada*, used to collect the mesopelagic samples on observation of DSL recording in the echosounder. This was made of nylon webbing with four sections of different mesh sizes of 25 mm, 16 mm, 11 mm and 5 mm and length of 500 mm, 500 mm, 8250 mm and 1750 mm respectively, totalling 11 m. The width was tapered from 2500 mm at the mouth opening to 750 mm at the codend. A specially designed 2.5 m length, aluminium depressor weighing 25 kg was attached to the gear in order to maintain the proper opening of the net to the maximum of 4 m. A 5 litre capacity bucket was attached to the codend where the samples of DSL components get collected.

The towing speed was 3 knots. The fishing warp was paid out at the rate of 25 meters per minute and retrieved at 12½ meters per minute. The vessel was sailed along the predetermined track having all the instruments preset for the required programme as given below:

Frequency	:	38 kHz for deep water, 120 kHz for shallow water
Pulse length	:	Narrow (0.3 MS for 38 kHz and 1 MS for 120 kHz)
Receiver band width	:	Wide
Beam width	:	Wide
Power output	:	High for deep water and low for shallow water
Attenuation	:	'0' dB
Time varied gain (TVG)	:	20 Log R
Main range (depth)	:	As required

The echosounder was run continuously day and night. Log marker was set to mark every nautical mile sailed. Latitude and longitude against time and date were recorded on the echogram for every two hours in order to refer back and locate geographically. The echo mark of the DSL was observed constantly. They appeared like a smoky layer with small grains (Natarajan et al. 1980) which could be easily distinguished from fish echo by experience. The depth range at which the DSL appeared was determined by observing the echogram. When significant DSL appeared, the Isacc's Kid Midwater trawl was lowered with trawl sonde, transducer

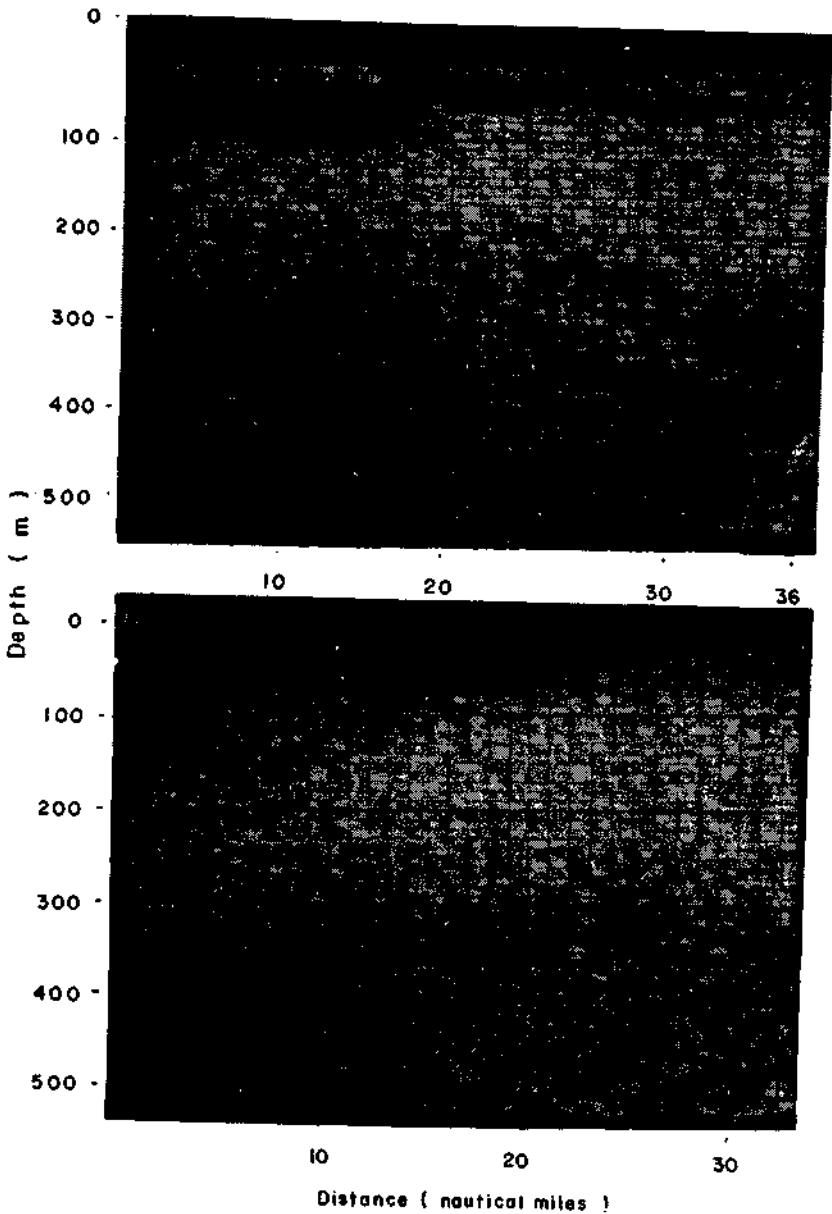

Fig.1 — Echogram of DSL recorded in the early morningtime (A), lat.  $12^{\circ} 11' N$ , long.  $81^{\circ} 47' E$  range 500 m., time 0600 hrs. and noontime (B), lat.  $13^{\circ} 29' N$ , long.  $80^{\circ} 50' E$  range 500 m., time 1200 hrs

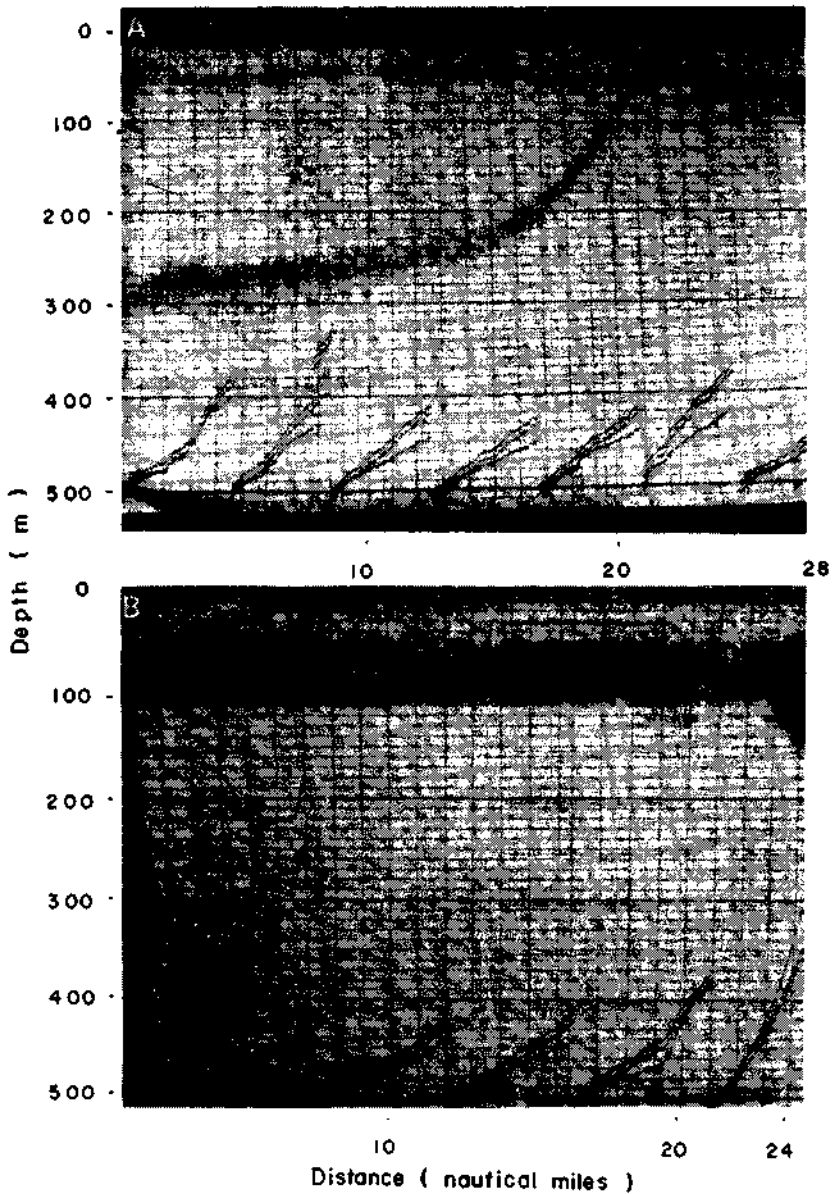

Fig.2 — Echogram of DSL recorded in the eveningtime (sunset time) (A) lat.  $12^{\circ} 30' N$ , long.  $81^{\circ} 42' E$ ., range 500 m. time 1630 hrs and night-time (B), lat.  $14^{\circ} 06' N$ , long.  $80^{\circ} 29' E$ ., range 500 m., time 2400 hrs.



fixed on to the head-rope. The IKMT was lowered to the depth at which the DSL appeared by observing the trawl sonde recorder. It recorded the vertical opening of the net and also the temperature of the seawater all along the path of the net. The vessel speed and warp length of the net were manoeuvred in such a way that net followed the DSL and trapped them. After dragging the net for a specified time, it was hauled. The sample was preserved and analysed by conventional methods. The echo-scope with colour display was used to discriminate the size and density of the organism based on the colour which was the function of echo energy level.

## RESULTS AND DISCUSSION

The continuous monitoring on the behaviour of DSL carried out (cruise No. SS/116A for 24 hours) from the echogram along the east coast, revealed that DSL oscillated between surface and 450 meter depth. It was found that the first symptom of descending of DSL started as early as 0600 hrs and it formed into three distinguished layer by 0800 hrs, the first one being between 300 m and 360 m. The second layer was formed between 390 m and 410 m. The third layer was between 420 m to 450 m (Fig. 1A). Thereafter, around 1200 hrs, all the three layers merged into one covering 300 m to 400 m (Fig. 1B). By about 1600 hrs the DSL started ascending and reached the surface by about 1800 hrs (Fig. 2A). During night, the layer remained between 40 m and 100 m (Fig. 2B). It was also confirmed that on sunny day the DSL penetrates up to 600 m depth. The time and rate of ascending and descending of DSL

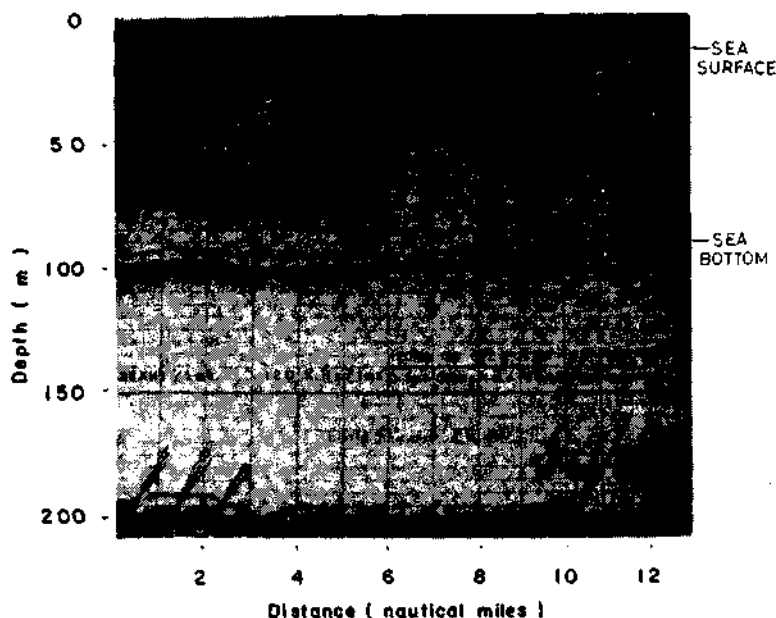

Fig. 3— Echogram of DSL recorded for different frequencies and pulse length

also depend upon the sunlight (Mathew & Natarajan, 1990). Figure 3 shows the effect of frequency and pulse length on the echogram. It was found that 0.3 mS pulse length for 38 kHz frequency and 1mS pulse length for 120 kHz were more suitable. Also, special station was conducted by lowering the CTD and found (by observing the graph of light transmission in %) that the light attenuation was more at the depth corresponding to the DSL observed in the echogram. Hence it is possible to identify the existence of the DSL and to know the depth by observing the % of light transmission by casting the CTD.

The DSL studies using the echosounder, have brought to the light the existence of two vast resources viz. the mesopelagic resources composed of smaller fishes, other crustaceans and invertebrates (Mathew & Natarajan, 1990). It is possible to make use of the echo-integrator for the quantification of the DSL also. It is suggested to attempt by conducting acoustic survey and allotting the mm deflection value of echo-integrator corresponding to DSL and compare with estimation by other conventional method in the future.

### ACKNOWLEDGEMENT

Authors are thankful to the Director for the kind co-operation and permission for presenting the paper. Thanks are also due to the Captain of *FORV Sagar Sampada*, the fishing masters and the participating scientific staff of the cruise No. SS/116A for their co-operation in the successful conduct of the cruise.

### REFERENCES

- Anon. 1979. *Simrad NL Doppler speed log instruction manual*, (P1110E) (Simrad Subseas A/S Horten, Norway).
- Anon. 1980a. *Simrad EK-400 scientific echosounder instruction manual*, (P 1308E) (Simrad Subseas A/S Horten, Norway).
- Anon. 1980b. *Simrad QD echo-integrator instruction manual*, (Simrad Subseas A/S Horten, Norway).
- Anon. 1983. *Instruction manual, Silent 700 Model 703*, (Data Terminal Texas Instruments, Houston, USA).
- Mathew, K. J. & Natarajan, S. 1990. Investigation on the DSL of the Indian EEZ with special reference to euphausiids as a component, In: *Proceedings of First Scientific results FORV Sagar Sampada*, edited by K.J. Mathew, (CMFRI, Cochin), 355-375.
- Natarajan, S., George, K.C., & Bande, V.N. 1980. Echo location of fish, *Mar. Fish. Infor. Serv. T&E Ser.* 7: 1-12.
- Silas, E.G. 1969. Exploratory fishing by *R.V. Varuna*, *Bull. Cent. Mar. Fish Res. Inst.* 12: 1-86.
- Vitullo, A.N., Natarajan, S. & Daniel, E. 1980. Live fish calibration of hydro-acoustic equipment onboard *R.V. Rastrelliger*, FI:DP/IND/75/038 Field document Vol. 7, (FAO, Rome) pp. 87.

## Modified atmosphere storage of fillets from sea bream *Argyrozona argyrozona*

T.K. Srinivasa Gopal, V.N. Nambiar, K.V. Lalitha, Jose Joseph & P.V. Prabhu

Central Institute of Fisheries Technology Matsyapuri P.O., Cochin-682029

### ABSTRACT

Sea bream (*Argyrozona argyrozona*) was filleted and cut into pieces (125 to 140 g). Three pieces were sealed in each 12 micron polyester laminated with 230 gauge low density polythene pouches containing 80% CO<sub>2</sub> and 20% air (MAP) and air (control) and stored in ice (0° to 4°C). The MAP samples could be organoleptically accepted till 40 days, whereas the control samples was acceptable for 22 days. The storage studies indicated that the total volatile base nitrogen changed from 6.37 to 17.29 mg/100g in case of control samples and 6.37 to 24.57 mg/100g in case of MAP samples at the time of rejection. Total bacterial count in case of control samples increased from  $4.85 \times 10^4$ /g to  $4.08 \times 10^7$ /g within 22 days and similar increase was noticed in the case of MAP samples when stored till the 40th day. The counts of *Lactobacilli* did not show much increase during storage in both the samples. Plenty of yeast cells were observed in all the samples. Anaerobic *Clostridium botulinum* type D was present in the samples stored under MAP, indicating that the oxygen tension in the MAP was not sufficient to inhibit the growth of anaerobes.

### INTRODUCTION

Coyne (1932, 1933) was one of the first investigators to use modified atmosphere systems to fishery products. Recent studies by Banks *et al.* (1980) and Brown *et al.* (1980) have shown that while carbon dioxide is effective in inhibiting the growth of gram negative bacteria such as *Pseudomonas* growth of gram positive bacteria such as *Lactobacillus* is stimulated. Most of such work are related to fishes from cold waters. Parkin *et al.* (1981) reported that shelf life of fresh rock cod fillets (*Sebastes*) could be extended very effectively in modified atmosphere containing 80% CO<sub>2</sub> and 20% air. Recent work by Srinivasa Gopal *et al.* (1990) proved that a mixture of 80% CO<sub>2</sub> and 20% O<sub>2</sub> was more beneficial in extending the shelf life of *Catla catla* fillets when stored at 0°-4°C. The shelf life was limited to 28 days using 80% CO<sub>2</sub> and 20% O<sub>2</sub>, 20 days in gas mixtures of 50% CO<sub>2</sub> and 50% O<sub>2</sub> compared to 12 days in air. Since

it is more economical to use CO<sub>2</sub> and air than CO<sub>2</sub> and O<sub>2</sub>, the present investigation was taken up to determine the effect of 80% CO<sub>2</sub> and 20% air concentration on the microflora and shelf life of sea bream fillets, stored at chill storage temperature (0°-4°C).

## MATERIALS AND METHODS

Sea bream (*Argyrozona argyrozona*) caught at Angria Bank onboard *FORV Sagar Sampada* cruise 97B at a depth of 25- 28m, weighing 6.7 kg, was filleted and cut into pieces of 125 to 140 g. Three fillets were sealed in each 12 micron plain polyester laminated with 230 gauge low density polythene pouches containing 80% CO<sub>2</sub> and 20% air (Modified atmosphere packaging), and air (control) and stored in ice (0°- 4°C). At intervals during storage, samples were drawn for chemical, microbiological and sensory evaluation. Total volatile nitrogen (TVN) was determined by the microdiffusion method of Conway (1947) from the trichloroacetic acid extract of the muscle. Total plate count (TPC) was determined using tryptone glucose extract agar (TGA:Oxoid) with normal saline (0.85% NaCl) as the diluent. The plates were incubated at room temperature (28°±1°C) and counts were taken after 48 hours. Coliforms were enumerated using violet red bile agar (VRB: Oxoid) and *E. coli*, *Faecal streptococci* and *Coagulase positive Staphylococci* were enumerated as per IS: 2237 (1971). *Lactobacillus* counts were taken using MRS agar (MRS:Oxoid). The samples stored under 80% CO<sub>2</sub> and 20% air was tested for the presence of *Clostridium botulinum* toxin after 43 days of storage by the method of Hobbs *et al.* (1982). The sample (100 g) was homogenised with 300 ml of gelatin phosphate buffer (pH 6.5) and centrifuged at 3000 g for 15 min. The supernatant fluid was removed and used for toxin assay. The preliminary toxicity test and conformation of the positive sample by a toxin neutralisation test was done in white mice (18-20 g) (Kautter *et al.* 1984). The microbial flora of the fish fillets were determined initially and after storage in air and MAP samples at frequent intervals (Surendran & Gopakumar, 1981). The organoleptic qualities of the products were evaluated on a 10 point hedonic scale, 5 being the acceptability limit by a taste panel consisting of 10 members. Water vapour transmission rates (WVTR) of the packaging films were determined as per IS: 1060 (1960) Part II. Oxygen transmission rate (OTR) was determined as per ASTM D 1434 (1975). Tensile strength and elongation at break in machine and cross directions were determined as per IS: 2508 (1984) by taking 5 x 1.5 cm piece of specimen. Moisture was determined by keeping 5g of the fish sample in a weighed petridish and dried at 102°- 105°C until constant weight. Drip percentage was calculated based on the volume of the drip collected and expressed as percentage of the muscle. For the determination of pH, 5-10g of the fish sample was homogenised with same quantity of distilled water using a homogeniser. pH of the slurry thus obtained was measured using a pH meter.

## RESULTS AND DISCUSSION

The packaging material used for the study has low WVTR ( $5.74\text{g/m}^2/37^\circ\text{C}/24\text{ h}$ , 90% RH) and OTR ( $85\text{ ml/m}^2/24\text{ h/atmosphere}, 20^\circ\text{C}$ ). It has a tensile strength of  $48\text{ kN/mm}^2$  in the machine direction and  $32\text{ kN/mm}^2$  in cross direction. The elongation at break is 112% in machine direction and 129% in cross direction. Hence the gas concentration can be maintained for a reasonable period in the pouch.

Figure 1 shows the variation in moisture content, drip volume, TVN and pH respectively of the fish fillets stored in MAP and control. The amount of TVN production (Fig. 1c) was less in MAP samples compared to that in control samples. Drip volume(%) was more in MAP samples compared to that in control. This is perhaps due to tissue softening which will be induced in fillets held at higher carbon dioxide concentrations (Parkin & Brown, 1981).

Changes in pH have also been suggested as a mechanism of inhibition of microbial activity (Sander & Soo, 1978). The change in pH may be due to the absorption of  $\text{CO}_2$  on the food surface and a subsequent ionization of the carbonic acid. pH of the modified atmosphere samples dropped considerably from 6.06 to 5.76, whereas in case of control sample the pH increased from 6.06 to 6.13 during 15 days storage and remained constant till the spoilage occurred. Drop in pH is one of the significant factor in increasing the shelf life of fish fillets.

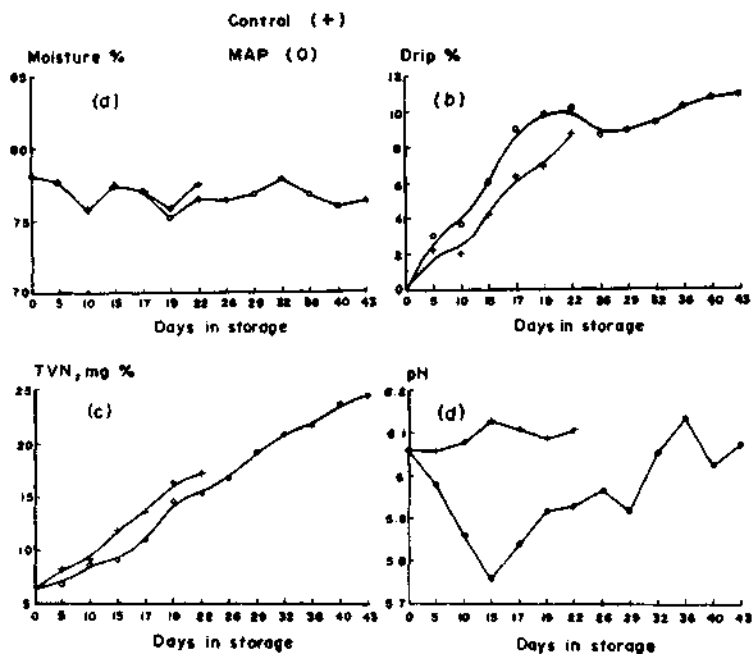

Fig. 1 - Changes in moisture, drip, total volatile nitrogen and pH of fish fillets stored at  $0^\circ\text{-}4^\circ\text{C}$  in MAP and control

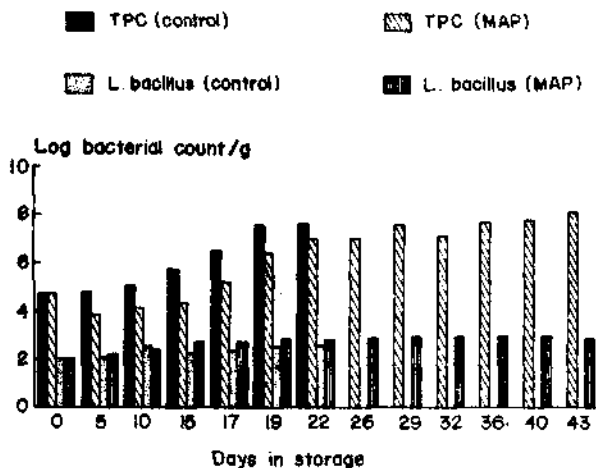

Fig.2 - Total plate counts and *Lactobacillus* counts in MAP and control

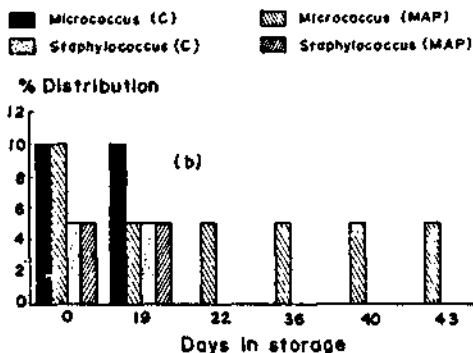
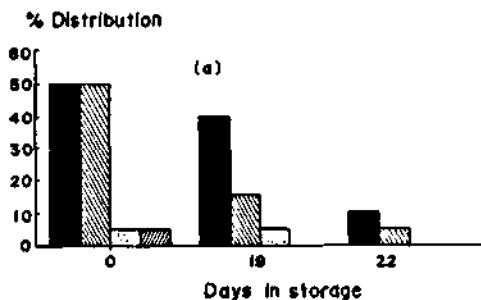

Fig.3 - Changes in the distribution of (a) *Micrococcus* and *Staphylococcus* (b) *Pseudomonas* and *Aeromonas* bacteria in fish fillets stored at 0°- 4°C in MAP and control

Organoleptic characteristics of samples were better in MAP samples compared to control samples initially and also during storage. The samples could be organoleptically accepted till 40 days in ice if packed in MAP, whereas the storage life for the control samples was 22 days in ice. In the present study the shelf life was found to be extended by a factor of 1.8.

The total bacterial count and the count of *Lactobacillus* are shown in Fig.2. *E. coli*, coliforms and faecal streptococci were not detected in any of the samples. The total bacterial count (log count/g) increased from 4.68 to 7.61 in the case of control within 22 days and to 8.10 in the case of samples stored under MAP within 43 days. The mechanism for the inhibition or delay of outgrowth of microorganisms in CO<sub>2</sub> enriched atmospheres has been discussed by a number of investigators. Coyne (1932) first postulated that certain groups of organisms could be inhibited by CO<sub>2</sub>, while other groups would not be affected. He further stated that CO<sub>2</sub> interfere with enzyme

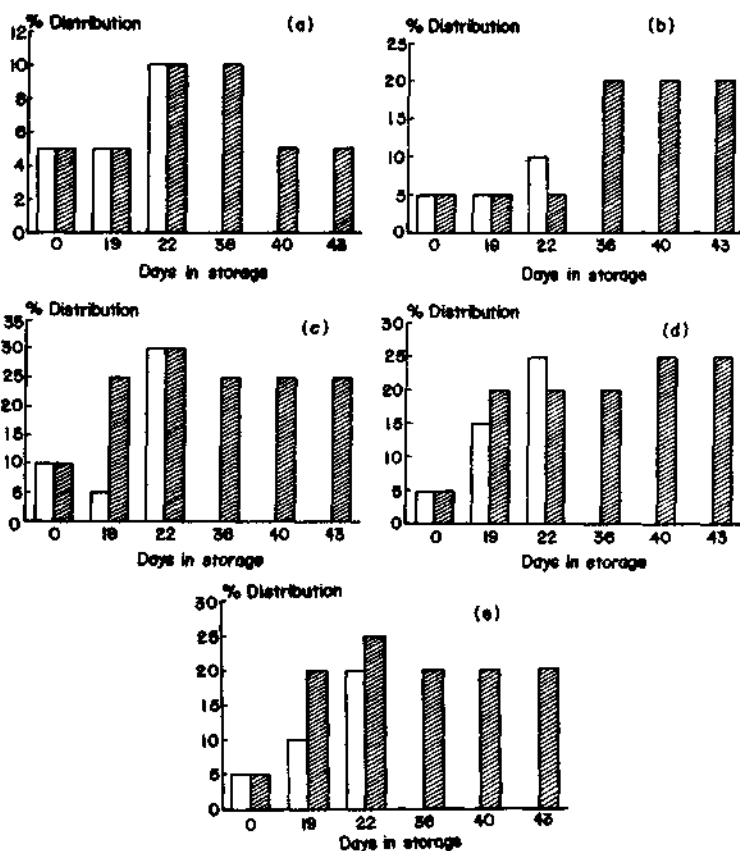

Fig.4 - Changes in the distribution of (a) Enterobacteriaceae (b) *Bacillus* (c) corynebacterium (d) yeast and (e) *Lactobacillus* in fish fillets stored at 0°-4°C in control (unfilled bars) and modified atmosphere packaging (filled bars)

systems attached to the cell. Haines (1933) suggested that CO<sub>2</sub> could interfere with the dehydrogenating enzymes of the cell. King & Nagel (1975) further elaborated that CO<sub>2</sub> enters into the mass action equilibration for enzymatic decarboxylation and concluded that a high concentration of CO<sub>2</sub> would inhibit the metabolic activity of the microflora. The *Lactobacillus* count did not show significant increase both in MAP and control during cold storage (Fig.2). Figure 3 shows the changes in *Micrococcus* and *Staphylococcus*, *Bacillus*, *Enterobacteriaceae*, *Pseudomonas* and *Aeromonas*, *Corynebacterium*, *Lactobacillus* and yeast during storage of MAP and control samples in chilled condition. The initial microflora was mainly constituted by *Micrococcus* which gradually disappear during storage (Fig. 3a). The percentage of *Bacillus*, *Corynebacterium*, *Lactobacillus* and yeast showed gradual increase during storage (Fig. 4) *Clostridium botulinum* D type was detected in MAP after 43 days storage as confirmed by neutralisation test with type specific antitoxins.

Modified atmosphere storage using 80% CO<sub>2</sub> and 20% air in conjunction with refrigeration (0°- 4°C) has been shown to significantly increase the shelf life of deep sea bream fillets. Storage of fish fillets stored under MAP shows the symptoms of toxin production at the above concentration of carbon dioxide and air. The development of more yeast cells has been observed to favour the growth of *Clostridium botulinum* apparently through the oxidation of acid with a resulting increase in pH. The development of toxin may be due to reduction in oxygen tension by other competing organisms. In order to effectively utilize the extended shelf life aspect of MAP, study is needed to ensure the minimum CO<sub>2</sub> and O<sub>2</sub> concentration so as to avoid the toxin production.

### ACKNOWLEDGEMENT

The authors are grateful to Dr. K. Gopakumar, Director, for his kind permission to publish this paper and to Mr. Thomas J. Mammoottil and Mr. G. Omanakuttan Nair for their technical assistance.

### REFERENCES

- ASTM D 1434, 1987. Standard test methods for gas transmission rate of plastic film sheeting, (American Society for Testing and Materials, Philadelphia) p. 611-626.
- Banks, H., Nickelson, R. & Finne, G. 1980. Shelf life studies on carbon dioxide packaged finfish from the Gulf of Mexico, *J. Food Sci.* 45: 157-162.
- Brown, W.D., Albright, D.A., Watts, B., Heyer, B., Spruce, B. & Price, R.J. 1980. Modified atmosphere storage on rock fish and Silver salmon, *J. Food Sci.* 45: 93-96.
- Conway, E.J. 1947. Microdiffusion analysis and volumetric error, (Crossby Lockwood and Sons, London) 1947, pp. 199.
- Coyne, F.P. 1932. The effect of carbon dioxide on bacterial growth with special reference to the preservation of fish Part I, *J. Soc. Chem. Ind. (Lond)* 51: 119-121.
- Coyne, F.P. 1933. The effect of carbon dioxide on bacterial growth with special reference to the preservation of fish, Part 2. Gas storage of fresh fish, *J. Soc. Chem. Ind. (London)*, 52: 19T-24T.



- Haines, R.B. 1933. The influence of carbon dioxide on the rate of multiplication of certain bacteria, as judged by viable counts. *J. Soc. Ind. Chem.* 52: 13T-17T.
- Hobbs, G., Crowther, J.S., Neaves, P., Gibbs, P.A. & Jarvis, B. 1982. Detection and isolation of *Clostridium botulinum*, In: *Isolation and identification methods for food poisoning organisms*, edited by E. L., Janent, Corny, Diane, Roberts & F.A. Skinner, SAB Technical series No. 17. (Academic Press, London) 151-164.
- IS: 2237. 1971. *Specification for frozen prawns (Shrimp)*, First edn. (Indian Standards Institution, New Delhi).
- IS: 1060. 1960. Part II. *Methods of sampling paper and allied products*. (Indian Standards Institution, New Delhi).
- IS: 2508. 1984. *Specification for low density polythene film*, (Indian Standards Institution, New Delhi).
- Kautter, D.A., Lynt, R.K. & Solomon, H.M. 1984. *Clostridium botulinum* In *FDA bacteriological manual*, (Association of Official Analytical Chemists, Arlington), p. 18.01.
- King, A.D. & Nagel, C.W. 1975. Influence of carbon dioxide upon the metabolism of *Pseudomonas aeruginosa*, *J. Food Sci.* 40: 362-366.
- Parkin, K.L., Wells, M.J. & Brown, W.D. 1981. Modified atmosphere storage of rockfish fillets, *J. Food Sci.* 48: 370-374.
- Sander, E.H. & Soo, H.M. 1978. Increasing shelf life by carbon dioxide treatment and low temperature storage of bulk fresh chickens packaged in nylon/surlyn film, *J. Food Sci.* 43: 1519.
- Surendran, P.K. & Gopakumar, K. 1981. Selection of bacterial flora in the chlorotetracycline treated oil sardines (*Sardinella longiceps*), Indian mackerel (*Rastrelliger kanagurta*) and prawn (*Metapenaeus dobsoni*) during ice storage, *Fish. Technol.* 18: p.133.
- Srinivasa Gopal, T.K., Nambiar, V.N., Bhattacharya, S.K., Jose Joseph & Prabhu, P.V. 1990. Modified atmosphere storage of fresh water fish fillets (*Catla catla*). In: *Proceedings of the Symposium on Chilling and freezing of new fish products*, (International Institute of Réfrigération, London) p. 141-146.

\* \* \*

## **Formation of histamine in Indian mackerel, *Rastrelliger kanagurta* and mackerel tuna, *Euthynnus affinis* at ambient temperature $10^{\circ} \pm 1^{\circ}\text{C}$ and in ice**

P.K. Vijayan & K K. Balachandran

Central Institute of Fisheries Technology, Willingdon Island, Matsyapuri P.O.  
Cochin-682 029

### **ABSTRACT**

In mackerel, the formation of histamine was not significant up to a period of 10 hr at ambient temperature ( $26^{\circ}\text{C}$ ) reaching an average value of only 7.51 mg/100g fish and increased significantly thereafter. In iced mackerel the production of histamine was not significant throughout the storage period of 5 days, whereas at  $10^{\circ}\text{C}$  significant levels of histamine were recorded beyond 56 hr of storage. The pattern of histamine formation in mackerel tuna followed a similar trend. Significant levels of histamine were formed in fish stored beyond 14 hr at  $28^{\circ}\text{C}$ ; while no significant levels of histamine were formed in samples stored at  $10^{\circ}\text{C}$  and in ice for 5 and 7 days respectively. Since histamine production is practically insignificant in ice stored fish, proper icing is the best and efficient method for preventing histamine in fish.

### **INTRODUCTION**

Fish belonging to the Scombroid group are known for their susceptibility to accumulate histamine, a biogenic toxin produced in the fish muscle during bacterial spoilage. Toxic levels of histamine in fish and fish products lead to severe health hazards in human beings. In the earlier outbreaks of histamine poisoning, fish of the Scombroid group were frequently encountered and hence the poisoning came to be known as "Scombroid fish poisoning" (Arnold & Brown, 1978).

Study on histamine in Indian fishes, especially Scombroid fish is very scanty. Kalyani & Bai (1965) studied histamine formation during storage and spoilage in some teleosts. Incidence of histidine decarboxylase bacteria in fish and fish environs and the level of histamine in two Scombroid fish *Scomberomorus guttatus* and *Rastrelliger kanagurta* was reported by Subburaj *et al.* (1984). Ames *et al.* (1987)

studied histamine formation in Indian oil sardine at 31°, 23° and 10°C and in ice. Vijayan *et al.* (1989) studied the histamine content in fish sold in the retail markets in relation to their content of histidine decarboxylase bacteria. Chakraborti (1991) reported significant levels of histamine in some dried fishes available at Kakinada coast. Apart from these reports no other information is available on histamine formation in tuna and tuna like fish in India. In the present study, histamine formation in two Scombroid fish: mackerel tuna, *Euthynnus affinis* and Indian mackerel, *Rastrelliger kanagurta* at ambient temperature, 10°C and in ice is reported.

## MATERIALS AND METHODS

The Indian mackerel was collected off Kakinada coast during the *FORV Sagar Sampada* cruise no. 26, conducted in the month of January 1987. The mackerel tuna was collected off Quilon coast at cruise no. 79 conducted in the month of October 1990. Immediately on collecting, the fish was thoroughly washed and stored in three lot as:

- A - Kept mixed with an equal quantity of flake ice and stored in an ice box, replacing the ice every 24 hr.
- B - Kept stored in a refrigerator maintained at  $10^{\circ} \pm 1^{\circ}\text{C}$ .
- C - Kept stored in an open tray and left on the deck of the ship under shade at ambient temperature.  $26^{\circ} \pm 1^{\circ}\text{C}$  in the case of Indian mackerel. The ambient temperature of storage in the case of mackerel tuna was  $28^{\circ} \pm 1^{\circ}\text{C}$ .

Samples for estimation of histamine were drawn from the stored lots everyday for 5 days in the case of mackerel stored in ice. Mackerel stored at 10°C was sampled every 8 hr for 72 hours. Fish stored at ambient temperature (26°C) were sampled at every 2 hr for 12 hr and thereafter every 4 hr for the remaining 20 hr by which time, the fish became putrid and smelling foul. Overall quality of the fish was recorded and the samples were stored in the freezer storage of the ship maintained at -20°C.

Samples of mackerel tuna stored in ice and 10°C were drawn daily for 7 days and 5 days respectively. Samples from ambient temperature (28°C) stored fish were drawn every 2 hr beginning from the 6th hour of storage and continued for 22 hr. The samples kept in the cold storage (-20°C) were taken to the laboratory where the assay for histamine was carried out as per the method suggested by Hardy & Smith (1976).

## RESULTS AND DISCUSSION

The quality of fish stored in ice, at 10°C and ambient temperature and histamine formed under these conditions are presented in Tables 1-3.

At ice storage, no significant levels of histamine were formed in Indian mackerel throughout the storage period of 5 days. In the case of mackerel tuna very small amounts of histamine were formed though quite insignificant.

Table 1 - Histamine in Indian mackerel *Rastrelliger kanagurta* and mackerel tuna *Euthynnus affinis* stored in ice

Storage period (days)	Overall quality	Histamine (mg/100g)	Mean (mg/100g)
<i>Rastrelliger kanagurta</i>			
1	Good	0.57 - 1.62	0.60
2	Good	0.29 - 1.44	0.83
3	Fair	0 - 0.74	0.41
4	Poor	0 - 1.70	1.23
5	Poor	0 - 1.27	1.27
<i>Euthynnus affinis</i>			
1	Excellent	0.73 - 1.703	1.089
2	Good	0.89 - 3.930	2.358
3	Good	1.28 - 3.630	2.313
4	Fair	0.746 - 3.740	2.086
5	Fair	0.624 - 4.140	2.340
6	Fair	3.390 - 8.674	6.546
7	Fair	2.210 - 3.452	2.650

In Indian mackerel stored at 10°C, there was a slow increase in histamine production as the storage period increased and some samples stored for 64 hr contained 64.71 mg/100g histamine. Another sample stored for 72 hr contained 29.25 mg/100g of histamine. There was no significant increase in the level of histamine at 10°C in mackerel tuna.

At ambient temperature the histamine production was rapid in both Indian mackerel and mackerel tuna. In Indian mackerel, the histamine content increased slowly in the beginning up to 10 hr and beyond 10 hr the histamine production was quite rapid. Samples stored for 12 hr contained histamine 42.74 mg/100g and by 24 hr it increased to 261.47 mg/100g. Similarly the histamine production was slow up to 14 hr in mackerel tuna stored at ambient temperature (28°C) and increased in samples stored beyond 14 hr. By 22 hr 211.21 mg histamine/100g fish was recorded.

Many have reported that, in fresh mackerel and mackerel stored at temperatures 2°-10°C, the histamine production is negligible or practically nil (Hardy & Smith, 1976; Salguero & Mackie, 1979; Edmunds & Eitenmiller, 1975; Pan & Orejana, 1985; Ames *et al.* 1987; Ames *et al.* 1987) observed that no significant amount of histamine

Table 2 - Histamine in Indian mackerel *Rastrelliger kanagurta* and mackerel tuna *Euthynnus affinis* stored at 10°C

Storage period hr/day	Overall quality	Histamine (mg/100g)	Mean (mg/100g)
<i>Rastrelliger kanagurta</i>			
8	Excellent	0 - 0.34	0.20
16	Good	0 - 1.29	0.65
24	Good	0.68 - 1.24	0.94
32	Fair	1.28 - 2.09	1.71
40	Fair	1.66 - 3.01	2.14
48	Fair	2.82 - 4.60	3.40
56	Poor	4.22 - 8.72	6.15
64	Poor	4.62 - 64.71	21.15
72	Poor	4.82 - 29.25	13.41
<i>Euthynnus affinis</i>			
1 d	Excellent	2.68 - 3.44	3.06
2 d	Good	1.48 - 2.63	2.05
3 d	Good	2.40 - 3.36	2.80
4 d	Fair	3.92 - 4.60	4.20
5 d	Fair	4.82 - 5.62	5.14

was formed in Indian oil sardine stored in ice for 11 days with histamine averaging only 1 mg/100g fish. In the present study, Indian mackerel (*R. kanagurta*) and mackerel tuna (*E. affinis*) stored in ice did not show any significant levels of histamine formation for 5 and 7 days respectively.

It has also been reported that small amounts of histamine were formed when the fish was stored at temperature 2°-10°C, depending on the humidity of the environment and that no histamine was formed at -20°C even in two months time (Dabrowski *et al.* 1968; Cattaneo & Cantoni, 1978; Baldrati *et al.* 1980; Ota & Kaneko, 1958; Edmunds & Eitenmiller, 1975; Ames *et al.* 1987). Ames *et al.* (1989) observed no significant level of histamine at 10°C for 6 days with an average of 1.5 mg/100g fish. In the present study also, no significant level of histamine was formed in mackerel tuna for 5 days. But Indian mackerel developed significant level of histamine at 10°C after an induction period of 56 hr. This shows that bacterial activity leading to production of

Table 3 - Histamine in Indian mackerel *Rastrelliger kanagurta* and mackerel tuna *Euthynnus affinis* stored at ambient temperature

Storage period (hr)	Overall quality	Histamine(mg/100g)	Mean(mg/100g)
<i>Rastrelliger kanagurta</i> (26°C)			
4	Excellent	Nil	Nil
6	Good	0.18 - 0.20	0.19
8	Fair	0.48 - 0.67	0.58
10	Poor	0.77 - 11.31	7.51
12	Poor	5.59 - 42.74	30.00
16	Bad	86.14 - 103.32	92.25
20	Bad	151.15 - 194.82	180.00
24	Bad	211.41 - 261.47	234.00
28	Bad	267.20 - 287.36	274.00
32	Bad	242.82 - 272.18	260.00
<i>Euthynnus affinis</i> (28°C)			
0	Excellent	Nil	Nil
6	Excellent	1.83 - 2.61	2.30
8	Good	4.20 - 5.01	4.60
10	Good	9.90 - 11.22	10.71
12	Fair	11.82 - 14.64	13.40
14	Fair	14.14 - 18.20	16.17
16	Poor	24.41 - 46.83	35.62
20	Poor	86.83 - 96.16	91.05
22	Poor	172.65 - 211.21	189.84

toxic levels of histamine can occur in Indian mackerel at low temperatures such as 10°C.

Large amount of histamine was formed at high storage temperatures, 17°-25°C (Kimata & Kawai; 1953a; Baldrati *et al.* 1980; Frante *et al.* 1981). Kimata & Kawai (1953a) observed 826 mg histamine/100g in Pacific mackerel stored for 46 hr at 23°C. In a similar study Kimata & Kawai, (1953b) observed 354 mg of histamine/100g in

mackerel fillets stored for 75 hr at 17°C. Baldrati *et al.* (1980) observed a histamine level of 67 mg/100g in mackerel stored at 18°C for 3 days. Investigations seem to pinpoint that temperatures in the range of 20°- 25°C as optimal for histamine production in fish. Salguero & Mackie (1979) suggest that at high storage temperatures, conditions exist for the growth of bacteria capable of producing relatively large amounts of histamine. The present observation of high levels of histamine, 287.36 mg/100g fish in Indian mackerel stored for 28 hr at 26°C and 211.21 mg/100g fish in mackerel tuna stored for 22 hr at 28°C are in agreement with the above observations. It is also important to note that significant levels of histamine are formed at a relatively short period of 12 hr in Indian mackerel and 16 hr in mackerel tuna at ambient temperatures.

The results show that fresh Indian mackerel and mackerel tuna do not contain histamine and that stored in ice (0°C) do not develop significant levels of histamine for an appreciable period, say 5 and 7 days respectively. Significant levels of histamine may be formed in Indian mackerel at 10°C when kept for beyond 56 hr. Higher levels of histamine may be formed after an induction period of 10 hr in Indian mackerel and 14 hr in mackerel tuna at ambient temperatures. Since histamine production is practically insignificant in ice and frozen stored fish, proper icing or frozen storage may be employed for preventing histamine formation in fish.

### ACKNOWLEDGEMENT

Authors are grateful to Dr. K. Gopakumar, Director for his kind permission to publish this paper and to Mr. A. Kassim Kunju and Mr. Padmarajan for their technical assistance onboard *FORV Sagar Sampada*.

### REFERENCES

- Ames, G.R., Gopakumar, K. & Vijayan, P.K. 1987. Histamine formation in the Indian oil sardine, *Sardinella longiceps*, *INFOFISH Marketing Digest* No. 2/87: p. 41.
- Arnold, S.H. & Brown, W.D. 1978. Histamine toxicity from fish products, *Advances in Food Research*, 24:113-54.
- Baldrati, G., Fornari, M.B., Spotti, E. & Incerti, I. 1980. Effect of temperature on histamine formation in fish rich in free histidine, *Ind. Conserv.* 55: 114.
- Cattaneo, P. & Canthoni, C. 1978. Identification and rapid determination of histamine in fish samples, *Ind. Aliment.* 17: 303-307.
- Chakraborti, R. 1991. Histamine content in dried fish products from Kakinada coast, *Fish Technol.* 28:59-62.
- Dabrowski, T., Kolakowski, E. & Markiewicz, K. 1968. Histamine as an indicator of freshness of fish. 1. Change of imidazole compounds in flesh of Baltic herring stored at 0°-2°C. *Nahrung*, 12: 631- 637.
- Edmunds, W.J. & Eitenmiller, R.R. 1975. Effect of storage time and temperature on histamine content and histidine decarboxylase activity of aquatic species, *J. Food, Sci.* 40:516-519.

- Frank, H.A., Yoshinaga, D.H. & Nip, W.K. 1981. Histamine formation and honey-combing during decomposition of skipjack tuna (*Katsuwonus pelamis*) at elevated temperatures, *Marine Fish. Rev.* 43(10): 9-14.
- Hardy, R. & Smith, J.G.M. 1976. The storage of mackerel (*Scomber scombrus*). Development of histamine and rancidity, *J. Sci. Food. Agric.* 27:595-599.
- Kalyani, M. & Bai, P. 1965. Histamine formation during spoilage and storage in some teleosts, *J. Annamalai Uni.* 26:149-153.
- Kimata, M. & Kawai, A. 1953a. The freshness of fish and the amount of histamine present in the meat. 1. *Mem. Res. Inst. Food. Sci., Kyoto Uni.* 5:25-54.
- Kimata, M. & Kawai, A. 1953b. A new species of bacterium which produces a large amount of histamine on fish meats found in spoiled fresh fish, *Mem. Res. Inst. Food. Sci. Kyoto Univ.* 6:1-2.
- Ota, F. & Kaneko, K. 1958. On the formation of amine in fish muscle. VII. Effect of freezing on the histamine formation in the thawed fish muscle, *Nippon Suisan Gakkaishi*, 24:140-143.
- Pan, B.S., & Orejana, F.M. 1985. Histamine in marine products. Production by bacteria measurement and prediction of formation, *FAO. Fish. Tech. Pap.* 253: 34-35.
- Subburaj, M., Karunasagar, I. & Karunasagar, I. 1984. Histidine decarboxylating bacteria in fish and fish environs, *Food. Microbiol.* 1:263-267.
- Salguero, J.F. & Mackie, I.M. 1979. Histidine metabolism in mackerel (*Scomber scombrus*). Studies on histidine decarboxylase activity and histamine formation during storage of flesh and liver under sterile and non-sterile conditions, *J. Fd. technol.* 14:131-139.
- Vijayan, P.K., Surendran, P.K. & Balachandran, K.K. 1989. Incidence of histamine in marine fishes sold in retail markets in relation to their content of histidine decarboxylating bacteria, *J. Mar. Biol. Ass. India.* 31(1&2): 202-204.

\* \* \*



## Preservation of fish in ice and ice-seawater slurry

Francis Thomas, T.S.G. Iyer & K.K. Balachandran

Central Institute of Fisheries Technology, Matsyapuri P.O., Cochin-682 029

### ABSTRACT

The rates of cooling of sea fresh fish on board in ice and, ice - (sea) water slurry were studied. Cooling is faster in ice-water slurry and the fish attains a minimum temperature in the range  $-0.3^{\circ}$  to  $-0.8^{\circ}\text{C}$ . The minimum temperature attained by fish in ice is only  $0.3^{\circ}$  to  $1.4^{\circ}\text{C}$ . The rate of chilling is influenced by the weight and shape of the fish. Rate of chilling decreases with increase in the weight and girth of the fish. Species do not considerably influence the rate of cooling.

### INTRODUCTION

Scientific handling and preservation on board contribute very much to the quality and shelf life of fish. Icing or storage in refrigerated/chilled seawater are the main preprocess practices recommended for onboard preservation, depending on the vessel size and facilities available onboard. The rapidity with which fish is initially cooled and maintenance of that cold temperature is a decisive factor in its shelf life. It has been reported that when prechilled in ice-water and then iced, *Labeo rohita* showed a shelf life of 9 days compared to 7 days when iced directly (Durairaj & Krishnamurthi, 1986). Chapman (1990) reported that a slurry of ice in seawater is the most effective medium for chilling finfish at sea to maintain its quality. Experiments were conducted on board *FORV Sagar Sampada* to study the rates of cooling of various species and sizes of fish when chilled in ice alone and in ice-seawater slurry. The results are presented in this paper.

### MATERIALS AND METHODS

The studies were conducted in two different periods, viz., November-December, 1992 and July 1993 during the cruises of *FORV Sagar Sampada*. Thirteen offshore and deep sea fish were collected from the trawl catches. The species studied were *Sufflamen fraenatus*, *Odonus niger*, *Upeneus vittatus*, *Priacanthus hamrur*, *Nemipterus mesoprion*, *Acanthurus* sp., *Lethrinus* sp., *Nemipterus japonicus*,

*Psenes indicus*, *Saurida tumbil*, *Caranx* sp., *Seriola* sp., and *Rastrelliger kanagurta*. Immediately after unloading, the catch was washed well and sorted species-wise and size-wise. About 4 kg each of different species of fish of uniform weight range was iced in the ratio 1:2 (fish to ice) in ice box. Flake ice of uniform size was used for icing. An ice-seawater slurry was made by mixing flake ice and clean seawater at ambient temperature in the ratio 3:1 (Chapman, 1990). Similarly, 4 kg fish was immersed in the ice-seawater slurry in an ice box similar to one used for icing fish. The ratio of fish to ice-seawater slurry was 3:8. The core temperature of the fish was measured at definite intervals in both cases using a freezer temperature monitor (Ramakrishnan et al. 1982) till it became constant.

Generally it is recommended to ice the fish in 1:1 ratio. In these the ratio of fish to ice was 1:2. Higher quantity of ice-seawater slurry was taken because of the following reasons - i) in order to dip the fish completely in ice slurry even at the time of rolling and pitching of the vessel especially during the monsoon, ii) to carry out the dipping process instantaneously.

## RESULTS AND DISCUSSION

As seen from Table 1, the lowest temperature attained in ice is always  $> 0^{\circ}\text{C}$  while in case of ice-seawater slurry, it is  $< 0^{\circ}\text{C}$  irrespective of species and size of fish. Theoretically it is impossible to attain  $0^{\circ}\text{C}$  or lesser temperature (negative) using fresh water ice. In case of ice-seawater slurry, ice melts at temperature lower than  $0^{\circ}\text{C}$  due to the presence of salts in seawater (lowering of melting point). The lowest tempera-

Table 1 - Chilling of fish in ice and in ice-seawater slurry

Species	Weight (g)	Lowest temperature reached		Time (min.) required to reach		
		Ice	Ice-seawater slurry	Lowest temperature		$0^{\circ}\text{C}$ in ice-seawater slurry
				Ice	Ice-seawater slurry	
<i>Sufflamen fraenatus</i>	65	0.3	-0.8	50	19	9
<i>Odonus niger</i>	100	0.4	-0.8	67	18	10
<i>Upeneus vittatus</i>	105	0.5	-0.8	69	31	15
<i>Priacanthus hamrur</i>	200	0.3	-0.7	87	34	19
<i>Nemipterus mesoprion</i>	250	0.8	-0.7	96	47	29
<i>Acanthurus</i> sp. (Surgeon fish)	510	1.4	-0.4	105	69	52
<i>Lethrinus</i> sp. (Pigface-bream)	610	1.0	-0.5	136	80	60

ture attained also depends on the size of the fish except in case of *Acanthurus* sp. (510g) which attained the temperature of 1.4°C and -0.4°C compared with *Lethrinus* sp. (610 g) which attained the temperature of 1°C and -0.5°C respectively. Also *Priacanthus hamrur* attained a temperature of 0.3°C compared with other fish having less weight (*Odonus niger* and *Upeneus vittatus*).

The time taken to reach the lowest temperature is always less in ice - seawater slurry compared with only ice. As seen from Fig.1, the cooling is faster in ice - seawater slurry compared with ice for same species (*Lethrinus* sp.). This is an important factor from the point of view of spoilage of fish during further storage. Even the biggest fish used in the experiment (*Lethrinus* sp.) attained 0°C in just 60 min in the slurry while the smallest fish in ice (*Sufflamen fraenatus*) attained lowest temperature of 0.3°C in 50 min. The same species using the slurry attained 0°C in just 9 min. This clearly compares the cooling efficiency of both the systems used in the experiment.

*Nemipterus japonicus* and *Psenes indicus* of two size grades each were cooled in ice-seawater slurry and the rates of cooling were recorded (Fig.2). The rate of cooling can be influenced by the size, particularly the girth of the fish. The time taken for *N. japonicus* of average weight 80g was only 26 min to attain a core temperature of 0°C whereas fish of 120g average weight took 36 min to reach the same temperature. This was more evident in the case of *Psenes indicus* where a fish of 35 g attained a core temperature of 0°C in 10 min whereas fish of 100 g took 34 min to attain 0°C.

Rates of cooling of four species of fish viz., *Saurida tumbil*, *Caranx* sp., *Seriola* sp. and *Rastrelliger kanagurta* are presented in Fig.3. The results do not indicate any significant difference in the cooling rate between the species. However, whatever difference is there can be attributed to the shape, rather than the species. For example in the case of *S. tumbil* and *Caranx* sp. (75 g each) the latter is seen to cool more rapidly than the former because of its flat shape and consequent less girth compared to *S. tumbil*. In the case of *Seriola* sp. and *R. kanagurta* (190 g each) the difference is less significant, again because of the shapes only.

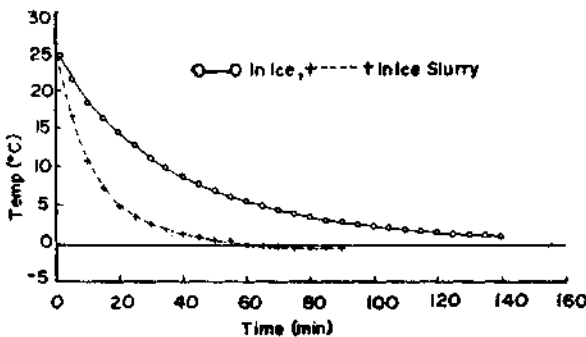

Fig.1 - Rate of cooling of *Lethrinus* sp. in ice and in ice - seawater slurry

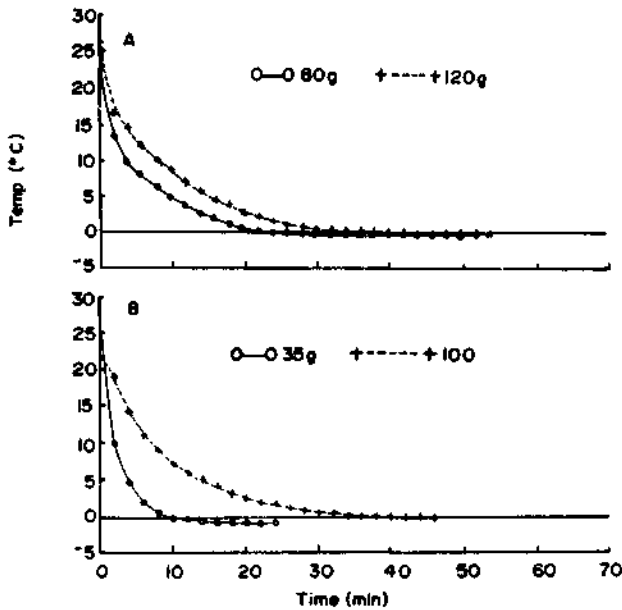

Fig. 2- Influence of size on rate of cooling of *Nemipterus japonicus* (A) and *Psenes indicus* (B)

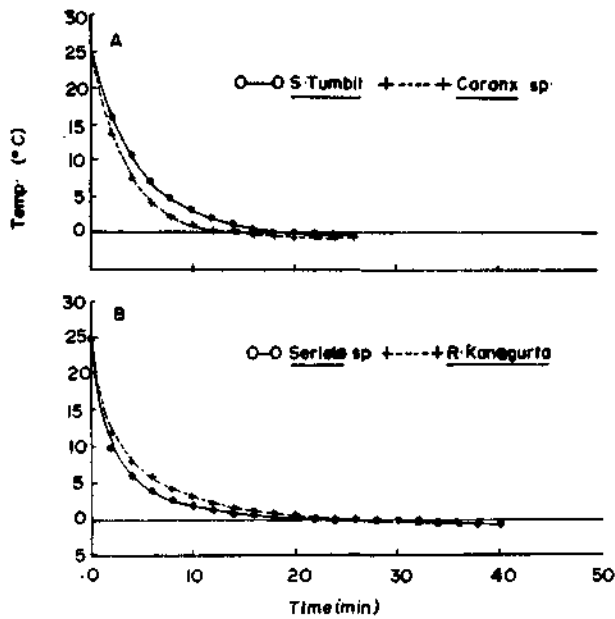

Fig. 3 - Influence of species on rate of cooling in ice-seawater slurry

In case of refrigerated seawater system, (RSS), the recommended ratio is 3:1 to 4:1 (fish to RSS). However, the rate of cooling is faster in ice or ice-seawater slurry than RSS due to melting of ice (latent heat of melting), even though RSS has better contact with fish than in other two systems. There is a problem of salt intake by fish in ice-seawater system. The salt content of seawater varies between 30 to 35 ppt. In the study the ratio of ice to seawater is 3:1, hence the salt content in the slurry would be <10 ppt. The ratio of fish to seawater is 3:2. Hence excessively long period of storage of fish in ice-seawater slurry may result in the absorption of salt by fish as in the case of RSS storage. The extent of salt content in fish tissue will affect processing and eating qualities. Therefore, once the fish is chilled to 0°C, it may immediately be removed from the cooling medium and stored as desired. In case sorting of fish onboard is likely to consume more time, thus affecting its quality, immediate chilling of the whole lot in ice-seawater system can be advantageously employed. When the fish is significantly cooled, it can be sorted and stored appropriately.

### ACKNOWLEDGEMENT

Authors are thankful to Dr. K. Gopakumar, Director for his kind permission to present this paper. Authors are grateful to Mr. P.A. Panicker, Mr. K.K. Kunjipalu and Dr. M.D. Varghese for the help rendered during the collection of samples, Mr. P.J. Joseph, FSI, Cochin for the identification of the samples, Dr. P.T. Mathew and Mr. P.D. Padmaraj for technical assistance.

### REFERENCES

- Chapman, L. 1990. Ice slurries get top marks for quality product, *Australian Fisheries*, 49 (7) : 16 - 19.
- Durairaj, S. & Krishnamurthi, S. 1986. The preservation of some Indian fresh water fish. *Fish. Technol.* 23: 115-119.
- Ramakrishnan, K. Vijayabharathi, K. & Sivadas, T.K. 1982. Freezer temperature monitor and alarm, *Fish. Technol.* 19:109-112.

\* \* \*

## Chemical and taste panel evaluation of the mechanically separated flesh of six species of fish

V. Muraleedharan, P.A. Perigreen & K. Gopakumar

Central Institute of Fisheries Technology Cochin - 682029, India

### ABSTRACT

The mechanically separated flesh of six species of fish, (*Tachysurus* sp., *Megalaspis cordyla*, *Upeneus vittatus*; *Johnius* sp., *Saurida tumbil* and *Trichiurus savala*), caught on board *FORV Sagar Sampada* from the northwest region of the Indian EEZ were examined chemically and by taste panel studies. *Saurida tumbil* gave maximum mince yield. Cooked mince of *Johnius* sp. scored maximum for overall acceptability.

### INTRODUCTION

The world demand for seafoods is on the increase. One way of meeting this demand is through the exploration and exploitation of unconventional resources. Another way is through more efficient means of utilising the available catch. One such method of increasing importance is the production of minced fish flesh products (Young, 1983; Regenstein, 1986; Gopakumar, 1987; Martin, 1988; Anon, 1989). Development of mince-based products should provide dual opportunities of utilisation of low value fish and also diversification of the industry for international trade in value added products. This calls for a general understanding about the yield of mince from various fish and on the quality and characteristics of the mechanically separated flesh. This paper reports the yield of mince from six species of fish caught on board *FORV Sagar Sampada* and discusses the physical and chemical quality and taste panel evaluation of the separated flesh.

### MATERIALS AND METHODS

Species of *Tachysurus* sp. (catfish), *Megalaspis cordyla* (horse mackerel), *Upeneus vittatus* (goatfish), *Johnius* sp. (jewfish), *Saurida tumbil* (lizard fish) and *Trichiurus savala* (ribbonfish), caught by high opening trawl onboard *FORV Sagar Sampada*, were used for the studies. Fish were washed in running water, arranged in

stainless steel trays in 10 kg lots and frozen in a contact plate freezer at  $-40^{\circ}\text{C}$ . The frozen materials were kept in the cold room ( $-20^{\circ}\text{C}$ ) of the vessel till it touched port (15 days). In the shore laboratory, the blocks were allowed to thaw at room temperature, eviscerated and washed free of any undesirable matter.

Except catfish, all fish were deboned in a Baader-694 machine equipped with 3 mm perforated drum. Catfish was filleted and the flesh separated manually and minced in a hand mincer. The yield of the minces based upon the whole fish weight was noted. Moisture, protein, extractable protein and ash were determined in whole fish and mince, according to AOAC (1990) methods. Lipids were estimated by extraction with petroleum ether in a soxtec system (Tecator 1040).

Mince lots of 50 g were sealed in high density polyethylene pouches and steamed for 30 min without pressure. After cooking, samples were served to an experienced panel of members to mark the samples for aroma, flavour, toughness and acceptability on a ten point scale; the higher the score, the greater the attribute except in the case of toughness where score 5 was designated as preferred texture.

## RESULTS AND DISCUSSION

The colour and appearance of the minces are given in Table 1. The minces were generally of light colour and pleasing appearance except those of catfish and horse mackerel which were unattractive with red-dark brown colour and oily appearance. The highest yield of mince was from lizard fish. Catfish recorded the lowest yield (27.42%) because of the high proportion of its head and viscera waste. The yield of mince from other fish was between 31% and 52% (Table 1).

The chemical composition of whole fish and the respective minces is given in Table 2. Moisture content of fish varied from 64.15% (goat fish) to 75.87% (lizard fish). Goat fish recorded the highest fat content and ribbon fish the lowest. This was true of the respective minces also. Dressing and mincing of the fish reduced the ash content which ranged from 1.01% (jewfish) to 1.79% (lizardfish). Protein values of the fish and minces did not record much variations but the extractability of protein was highest for jewfish mince. The bone content of the minces are uniformly low making them ideal for a variety of mince-based products which demand low levels of bone.

Taste panel evaluation of the cooked mince is given in Table 3. The results clearly differentiate catfish and horse mackerel mince with low scores for aroma and acceptability. The flesh of lizard fish was markedly tough and dry. This can be attributed to the presence of formaldehyde which caused rapid denaturation resulting in toughening of flesh. This agrees with the comparatively low value for protein extractability. Goatfish mince was rated soft but with less pleasing flavour because of the higher oil content. Jewfish scored high with aroma and flavour becoming the most acceptable mince of the lot. Ribbonfish had a relatively tough texture but the overall acceptability was high.

Table 1 - Details of fish processed and yield of mince

Species	Length (cm)	Weight (g)	Mince yield (%)	Mince appearance
<i>Tachysurus</i> sp.	45.75	1160.0	27.42	Dark reddish unattractive
<i>Megalaspis cordyla</i>	17.50	65.00	31.20	Slight dark brown
<i>Upeneus vittatus</i>	16.25	56.80	46.29	Pink-red
<i>Johnius</i> sp.	16.85	64.75	33.50	Off-white
<i>Saurida tumbil</i>	28.50	198.80	56.40	Off-white
<i>Trichiurus savala</i>	98.80	1082.00	52.50	Pink

Table 2 - Analytical characteristics of whole fish (A) and mince (B)

Species	Moisture (%)	Protein (N×6.25) (%)	Fat (%)	Ash (%)	Protein extractability (%)	Bone content (%)
<i>Tachysurus</i> sp.	A 69.84	17.06	7.52	4.78	-	-
	B 79.25	18.75	1.35	1.20	62.66	0.08
<i>Megalaspis cordyla</i> .	A 71.07	19.64	2.89	5.69	-	-
	B 76.82	20.63	1.40	1.38	51.86	0.10
<i>Upeneus vittatus</i>	A 64.15	18.01	12.58	4.98	-	-
	B 72.12	19.40	6.17	1.09	67.26	0.11
<i>Johnius</i> sp.	A 71.89	18.01	6.12	1.85	-	-
	B 77.99	18.23	1.74	1.01	75.15	0.08
<i>Saurida tumbil</i>	A 75.87	17.14	2.9	2.42	-	-
	B 76.68	19.85	1.75	1.79	51.46	0.12
<i>Trichiurus savala</i>	A 75.63	18.82	1.52	3.05	-	-
	B 77.83	18.36	1.32	1.14	55.01	0.07

Table 3 - Taste panel evaluation of cooked mince

Species	Aroma	Flavour	Toughness	Acceptability
<i>Tachysurus</i> sp.	4.2	4.4	4.5	4.8
<i>Megalaspis cordyla</i>	4.5	4.6	4.1	4.9
<i>Upeneus vittatus</i>	5.0	5.1	3.9	6.1
<i>Johnius</i> sp.	5.5	6.3	3.2	7.2
<i>Saurida tumbil</i>	5.3	5.8	7.2	6.3
<i>Trichiurus savala</i>	5.5	6.1	4.4	6.8



Most of the species of fish employed for the studies gave good yield of mince with desirable properties. But it may be borne in mind while formulating products that even in the case of mince with lower scores for acceptability, the properties are amenable to change with the addition of appropriate ingredients or by washing off of the unwanted fractions of flesh.

## REFERENCES

- Anon. 1990. Studies on processing of deep sea fish caught onboard *FORV Sagar Sampada*. In: *Proceedings of the First Workshop on Scientific Results of FORV Sagar Sampada*, edited by K.J. Mathew, (CMFRI, Cochin) 457-465.
- AOAC. 1990. *Official methods of analysis*, edited by K. Helrich, (Association of Official Analytical Chemists, Washington), 864-889.
- Gopakumar, K. 1987. Minced fish based products, In: *Proc. Symp. Diversification of Post-harvest Technology for Low cost fish*, edited by K.K. Balachandran, (Society of Fishery Technologists, Cochin) 139-148.
- Martin, R.E. 1988. Seafood products: Technology and research in the U.S. *Food Tech.* 42(3): 58-62.
- Regenstein, J.M. 1980. The Cornell experience with minced fish, In: *Advances in fish science and technology*, edited by J.J. Connell, (Blackwell Scientific Publ. Oxford) 192-197.
- Young, R.H. 1983. Best-sellers from shrimp by-catch. *Infofish Mark. Dig.* 5: 32-34.

\* \* \*

## Utilization of unconventional fish resources for surimi preparation

V. Muraleedharan, K.P. Antony, P.A. Perigreen & K. Gopakumar  
Central Institute of Fisheries Technology, Cochin - 682 029, India

### ABSTRACT

*Trichiurus lepturus*, *Epinephelus chlorostigma*, *Epinephelus diacanthus*, *Atrubucca marleyi*, *Nemipterus mesoprion* and *Priacanthus hamrur*, caught on board *FORV Sagar Sampada*, were used for the preparation of surimi. The minces of fish were generally light in colour with low fat content. The surimi prepared was white with good flavour and gel strength. The yield ranged from 23.5% (*P. hamrur*) - 32.8% (*T. lepturus*).

### INTRODUCTION

Surimi is washed, refined fish mince, prepared from low fatty white meat with good gel forming ability to have an elastic texture and other desirable characteristics like bland flavour, emulsifying capacity, tensile strength and elasticity. Surimi processing technology originally developed in Japan has now spread to many countries. Most surimi is prepared from Alaska pollack (*Theragra chalcogramma*), but the reduced availability of this species compelled the user countries to make use of the non-traditional fish species (Shimizu *et al.* 1981; Putro, 1989; Kano, 1992; Nishioka, 1993). An elaborate process of leaching of the mince is necessary to get the desired textural attributes. Recently Gopakumar *et al.*, (1992) have optimised the washing schedule to get desired properties from four species of under-utilised tropical fish. In the present work six species of unconventional fish were used for surimi preparation and the properties are reported.

### MATERIALS AND METHODS

The fish were collected from demersal trawl catches onboard *FORV Sagar Sampada* during cruise no. 105-A, using high opening trawl. Species selected for the study were *Trichiurus lepturus*, *Epinephelus chlorostigma*, *Epinephelus diacanthus*, *Atrubucca marleyi*, *Nemipterus mesoprion* and *Priacanthus hamrur*. The fish were

frozen immediately after capture and kept in the cold storage. Processing of the fish in laboratory was done according to the flow chart shown in Fig.1. Moisture and ash were determined according to AOAC (1990) methods. Lipids were extracted from the dried mince with petroleum ether using soxtec (Tecator, 1046) system. Total nitrogen was estimated by digesting a measured quantity and then distilling using Kjeltac auto analyser (Model 1030, Tecator).

Washed and dewatered mince sample of 50 g was homogenised with 2% sodium chloride (w/w) and stuffed in PVC casings (3 cm dia x 5 cm l). The samples were heated at 90°C for 30 min. The cooked samples were loaded in Universal Testing Machine (Zwick, 1484). Compression was done with a probe of 0.5 cm dia and cross

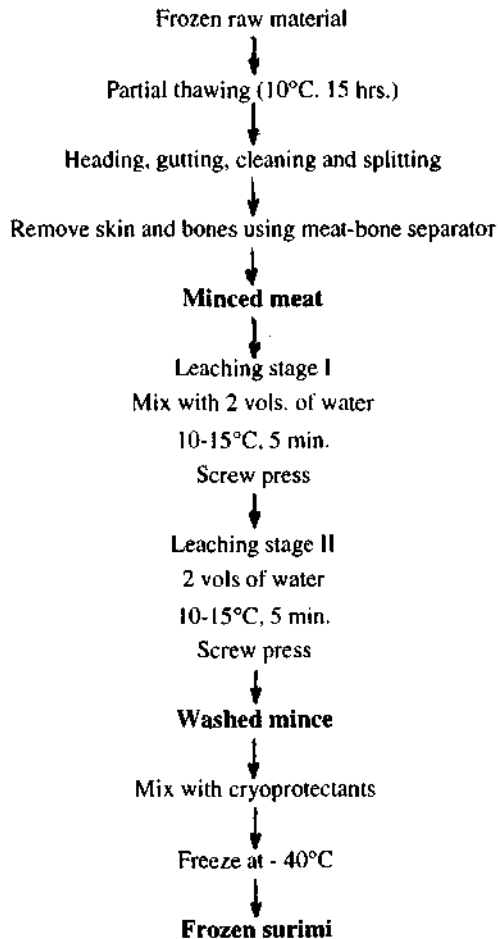

Fig. 1 - Method of surimi preparation

Table 1 - Proximate composition/characteristics of raw mince and surimi

Composition/ characteristics	<i>Epinephelus chlorostigma</i>	<i>Epinephelus diacanthus</i>	<i>Prichanthus hamrur</i>	<i>Nemipterus japonicus</i>	<i>Trichiurus lepturus</i>	<i>Atrubucca marleyi</i>
<b>Raw mince</b>						
Colour	Light pink	Light pink	Pink -brown	Light pink	Dull white	Dull white
Moisture(%)	77.31	80.14	77.01	79.89	77.49	78.60
Protein (%)	19.18	18.08	19.01	18.20	19.11	18.02
Fat (%)	1.41	1.01	2.01	1.18	1.12	1.05
Ash (%)	1.50	0.94	1.27	1.29	1.35	1.41
<b>Surimi</b>						
Yield (%) on whole fish weight	24.8	24.1	23.5	25.9	32.8	23.6
Colour	Dull white	Dull white	Light pink-white	White with pinkish tinge	Almost white	Almost white
Moisture (%)	72.3	76.7	75.02	77.9	76.12	77.09
Fat (%)	0.52	0.11	0.48	0.14	0.20	0.20
Gel strength (g. cm)	692	641	733	751	740	832
Texture	Soft, firm	Soft, smooth	Soft, firm	Soft, firm	Soft, firm	Firm, tough

head speed of 10 mm/min. The force at rupture (g) multiplied by deformation (cm) determined gel strength. The colour, flavour and texture of the steamed (30 min) samples were evaluated by a trained panel.

The washed and dewatered mince was homogenised in a silent cutter for 1 min at 10°-15°C. Sorbitol (4% w/w), sucrose (3% w/w), sodium tripoly phosphate (0.1% w/w) were added to the mince and again homogenised for 2 min. The material was frozen in trays at -40°C and stored at -23°C.

## RESULTS AND DISCUSSION

The composition/characteristics of raw mince and surimi are shown in Table 1. The fish used for processing were generally low - medium fatty with light flesh. The colour of mince did not improve much after the first washing but there was appreciable change after the second volume exchange as has been reported by Gopakumar *et al.* (1992). Out of the six species of fish, *T. lepturus* produced ideal product with maximum whiteness and best yield.

The lipid content of the fish was low. Therefore, even a low volume exchange could wash out the lipids to an appreciable extent, making the surimi ideal for the preparation of a variety of products.

Washing leads to leaching off of the sarcoplasmic protein of fish flesh thereby enriching the myofibrillar protein fraction. This facilitates unfolding and cross linking of actomyosin resulting in a gel network (Lee, 1984). This capacity for gelation of the protein structure is appreciable for all fishes used, which have recorded gel strength ranging from 641 - 832 g.cm. The gel strength could be increased with prolonged washings but for practical purposes and to limit the loss of protein (Lee, 1984), the leaching was done in two stages with low volume of water.

The quality of *kamaboko*, the traditional product of Japan, is mainly dependent upon the high gel strength and low fat content of surimi used for its preparation (Lee, 1986). For the preparation of fabricated foods and analogue products, the surimi has to be white in colour, devoid of fish odour and taste. Sensory evaluation shows that the products from the six species of fish satisfy these requirements.

The species of fish used here have successfully come through the preliminary trials of surimi processing. Recent raw material shortages in Japan and other countries and the resultant high surimi prices will definitely make these trials worth the effort.

## REFERENCES

- AOAC, 1990. *Official methods of analysis*, edited by K. Helrich, (Association of Official Analytical Chemists, Washington). 864-889.
- Gopakumar, K., Muraleedharan, V. & Bhattacharyya, S.K. 1992. Preparation and properties of surimi from tropical fish, *Food Control*, 13: 109-112.
- Kano, I. 1992. Tropical surimi. *Infofish International*, 1: 21-25.
- Lee, C.M. 1984. Surimi processing technology. *Fd Technol.* 38: 69-80.

- Lee, C.M. 1986. Surimi manufacturing and fabrication of surimi based products, *Fd Technol.* 40: 115-124.
- Nishioka, F. 1993. Frozen surimi from sardine, *Infofish International*, 1: 31-34.
- Putro, S. 1989. Surimi prospects in developing countries. *Infofish International*, 5: 29-32.
- Shimizu, V., Machida, R. & Takenami, S. 1981. Species variations in gel forming characteristics of fish meat paste, *Bull. Jap. Soc. Sci. Fish.* 47: 533-536.

\* \* \*

## Onboard salting of deep-sea fishes and quality of the cured products

K. George Joseph, P. Ravindranathan Nair, T.S. Unnikrishnan Nair & Cyriac Mathen\*  
Calicut Research Centre of Central Institute of Fisheries Technology,  
Calicut - 673 005

### ABSTRACT

Four species of deep-sea fishes caught during the 99<sup>th</sup> cruise of *FORV Sagar Sampada* along the southwest coast of India were subjected to salting onboard followed by further curing on shore. Of these, *Decapterus* sp., *Nemipterus* sp. and *Psenes* sp. yielded cured products of high quality, whereas, *Psettodes* sp. was not found suitable for curing.

### INTRODUCTION

A considerable amount of work has been carried out on processing technology as well as nutritional aspects of deep-sea fishes. Lekshmy Nair *et al.* (1988) evaluated the nutritional quality of texturised meat from *Nemipterus japonicus* Chakraborti *et al.* (1991) suggested a method of preparing salted and pressed *Psenes indicus*. Samuel *et al.* (1987) have reported on methods of processing *Priacanthus* spp. into frozen blocks, fillets, minced fish, canned fillets, salted and dried products and their marketability. *Sphyræna barracuda* has also been used for salting and drying (Anon, 1989). Eventhough all these samples were collected during cruises of *FORV Sagar Sampada*, processing them into different products was carried out in the laboratories after landing. But no information is available on the onboard salting and curing. Therefore, a scheme was drawn up to conduct the salting onboard the vessel and study the quality of the products.

### MATERIALS AND METHODS

Four species of fish were used for the experiments. These were caught during the 99<sup>th</sup> cruise of *FORV Sagar Sampada*, during March-April 1992, along the southwest

\*Present address: Central Institute of Fisheries Technology Cochin - 682 029

coast from Cochin to Goa and back. The species caught were : *Decapterus* sp. (off Mulki), *Nemipterus* sp. (off Karwar), *Psenes* sp. (off St. George, Goa) and *Psettodes* sp. (off Mangalore). The samples were collected from the deck and taken to the wet laboratory of the vessel; *Decapterus* sp. and *Nemipterus* sp. were eviscerated and washed, whereas *Psenes* sp. and *Psettodes* sp. were subjected to thorough washing only. Each sample was then salted in the ratio 1:4 and packed in plastic buckets. The buckets were closed with plastic lids and secured with a cover of polythene sheet, and taken to the shore laboratory after landing.

Salted samples (2kg) were dried in the sun for three consecutive days and stored in stoppered glass jars for observation. Two other sets (2 kg each) of samples consisting of *Decapterus* sp. and *Nemipterus* sp. were given dip treatment for ten minutes in saturated solution of calcium propionate (CaP) in saturated sodium chloride brine before drying. A time lapse of 15 to 20 days occurred between salting and drying since the cruise was for a period of 20 days. Apart from analyses for chemical and bacteriological characteristics, periodic visual observations were also made. Chemical characteristics like moisture, salt, fat and total volatile nitrogen (TVN) were estimated according to AOAC (1980) methods. Bacterial load was determined by pour plate technique using tryptone glucose yeast extract agar.

## RESULTS AND DISCUSSION

Tables 1-3 give the chemical, bacteriological and organoleptic characteristics of *Decapterus* sp., *Nemipterus* sp. and *Psenes* sp. respectively. Organoleptic assessment shows that the dried products prepared from the salted samples of *Decapterus* sp. and *Nemipterus* sp. remained in very good condition for 60 days after drying. These were found to be in a better condition than those of *Psenes* sp. The samples of *Nemipterus* sp. have been adjudged "acceptable" even after storage for a period of 90 days after drying although slight discolouration could be observed. Treatment with CaP gives protection against deterioration besides enhancement of organoleptic qualities. Moisture content in the case of *Nemipterus* sp. is slightly on the higher side. It is due to the thickness and bigger size of the samples. The TVN value for the pickled sample after 90 days is very much lower than those of the dry samples. Therefore, it is reasonable to infer that *Nemipterus* sp. can be salted and stored as pickle for up to 90 days and samples can be drawn for drying whenever the need arises.

Unlike *Decapterus* sp. and *Nemipterus* sp., *Psenes* sp. developed slight rancid odour after storage for 30 days after drying. The fat content was very high and consequently, drying in the sun had to be controlled to prevent the fat from oozing out. However, exudation of fat was observed during the storage of the dried product and this resulted in the decrease in fat content as shown in Table 3. As for the samples kept as pickle, it may be noted that the fat content after 90 days was recorded at a level lower than the fat content of the dried product after 30 days' storage. This is due to the loss of fat during the process of pickling wherein the fish are kept immersed in the self-brine by weighing down with sufficiently heavy substances. Such a sample, after



Table 1- Chemical, bacteriological and organoleptic/sensory characteristics of dried/pickled *Decapterus* sp.

Sample	Storage (days)	Moisture (%)	NaCl (% DWB)	Fat (%DWB)	Protein (%DWB)	TVN (mg/100 g)	Bact. load (cfus/g)	Organoleptic/sensory characteristics
Dried	30	47.63	38.69	8.40	49.00	84	11	Firm texture, good colour and appearance, natural fishy odour.
..	60	47.73	38.89	8.04	ND*	140	45	Firm texture, good colour and appearance, natural fishy odour.
..	90	ND	ND	ND	ND	166	68	Loss of natural appearance, slight yellowing, crumbling.
Dried CaP treated	30	46.63	36.05	6.74	54.25	56	29	Firm texture, very good appearance, silver grey colour with sheen, natural fishy odour.
..	60	41.67	34.75	6.17	ND	112	14	Firm texture, very good appearance, silver grey colour with sheen, natural fishy odour
..	90	ND	ND	ND	ND	144	58	Partial loss of silver grey colour and sheen, breaks of if pressed.
In pickle	30	49.32	38.84	7.02	45.37	88	15	Firm texture, natural colour, slightly wrinkled, natural fishy odour.
..	60	ND	ND	ND	ND	ND	ND	Firm texture, natural colour, slightly wrinkled, natural fishy odour.
..	90	56.93	39.12	6.50	42.00	140	28	Softening of flesh, loss of the natural fishy odour.

\* ND = Not determined

Table 2 - Chemical, bacteriological and organoleptic/sensory characteristics of dried/pickled *Nemipterus* sp.

Sample	Storage (days)	Moisture (%)	NaCl (% DWB)	Fat (%DWB)	Protein (%DWB)	TVN (mg/100 g)	Bact.load (cfus/g)	Organoleptic/sensory characteristics
Dried	30	51.07	51.29	5.31	42.00	138	19	Very good appearance, firm texture, natural fishy odour.
..	60	53.79	54.69	4.33	ND*	168	44	Very good appearance, firm texture, natural fishy odour.
..	90	ND	ND	ND	ND	188	97	Slight discoloration, firm texture, no off-odour, acceptable condition.
Dried CaP treated	30	49.32	47.44	5.13	42.87	104	16	Very good appearance, firm texture, natural fishy odour.
..	60	53.21	45.20	4.70	ND	146	28	Very good appearance, firm texture, natural fishy odour.
..	90	ND	ND	ND	ND	174	68	Slight loss of natural colour and appearance, firm texture, acceptable condition.
In pickle	30	53.56	50.78	5.94	38.33	67	12	Good colour and appearance, firm texture, natural fishy odour.
..	60	ND	ND	ND	ND	ND	ND	Good colour and appearance, firm texture.
..	90	61.48	53.53	5.71	29.75	70	28	Slight off-odour, softening of texture.

\*ND = Not determined

Table 3 - Chemical, bacteriological and organoleptic/sensory characteristics of dried/pickled *Psenes* sp.

Sample	Storage (days)	Moisture (%)	NaCl (%DWB)	Fat (%DWB)	Protein (%DWB)	TVN (mg/100 g)	Bact.load (cfus/g)	Organoleptic/sensory characteristics
Dried	30	44.01	35.00	15.36	42.00	126	19	Good colour and appearance, soft texture, oily odour.
..	60	46.55	38.25	9.73	ND*	226	55	Good appearance, slight rancid odour.
..	90	ND	ND	ND	ND	252	72	Texture soft, breakage when pressed, loss of the natural appearance, exudation of fat, rancid odour.
In pickle	30	48.72	42.46	10.21	36.52	42	21	Good colour and appearance, soft texture.
	60	ND	ND	ND	ND	ND	ND	Good colour and appearance, soft texture, oily odour.
..	90	56.46	50.11	9.42	32.29	56	61	Slight rancid and off- odour, soft texture, spoilage set in.

\* ND = Not determined

removal of part of the fat, will normally be better suited for drying. On the contrary, it was seen that keeping the fish under brine for more than 60 days was not at all advantageous since rancidity and spoilage set in afterwards. Similarly, in the case of dried samples, rancidity was noticed after storage for 60 days. As in the case of *Decapterus* sp. and *Nemipterus* sp., the TVN value for the pickled sample even after 90 days is very low compared to the values of the dried samples after storage for 30 and 60 days respectively. Chakraborti et al. (1991) found that salted and pressed *Psenes indicus* packed in nylon bag under vacuum had a storage life of 120 to 135 days while those packed without vacuum were acceptable for 45 to 60 days. In the present study, keeping *Psenes* sp. as pickle for a period of up to 60 days was advantageous since this species is fatty, and pickling gives it better protection than storage as dried product.

Crumbling of the dried product was observed together with yellowing in the case of *Decapterus* sp. when stored for 90 days.

Total bacterial load of all the samples was found to be very low, the range being 11 to 61 cfus/g during the storage period of 60 days. The reasons for such low levels of bacterial loads are, possibly, the freshness of the fish used for salting and the fish being processed within one or two hours after bringing the catch onboard.

George et al. (1992) have reported that the shelf life of commercial samples of dry fish, as available in the markets is usually a maximum of 10 to 15 days. Infestation by insects and fungi and presence of dirt and extraneous matter are some of the problems associated with the commercial products. These can be brought to the minimum if salting is done onboard the vessel.

*Psettodes* sp. caught off Mangalore was given thorough washing before being salted in the ratio 1:4 and packed in plastic buckets. On examination after bringing the sample to the laboratory, it was seen that the flesh had disintegrated, leaving only the bones intact, turning the self-brine into a black liquor. It is therefore inferred that this particular species of fish is not suitable for salt curing. Even though no elaborate studies were conducted to understand the mechanism of changes taking place during the pickled storage of the fish, it is assumed that specific proteolytic changes take place due to some particular enzymes or even the salt itself.

The present study shows that the three deep-sea fish resources (*Decapterus* sp., *Nemipterus* sp. and *Psenes* sp.) can be processed and salted onboard to prepare cured products of better quality and shelf-life than the commercial samples of salted fish currently available in the markets. Microbiological quality of the products also is very high.

#### ACKNOWLEDGEMENT

Authors are thankful to Dr.K. Gopakumar, Director, for permission to publish this paper. They thank Mr.P.A. Panicker, Chief Scientist, Mr. S.V.S.R.Rao, Dr.M.D.Varghese, Mr.N.Subramonia Pillai and Mr.K.A. Abbas for collection of samples. Thanks

are also due to Mr. T. John, Mr.P.T. Viswambharan, Mrs. Tara K and Mrs M. K. Sreelekha for technical assistance during processing and analyses of the samples.

### REFERENCES

- Anon. 1990. In: *Proc. First Workshop Scient. Resul. FORV Sugar Sampada*, edited by K.J. Mathew, (CMFRI, Cochin) 457-465.
- AOAC. 1980. *Official methods of analysis*,(Association of Official Analytical Chemists, Washington) pp. 1018.
- Chakraborti, R., Gupta, S.S. & Panduranga Rao, C.C. 1991, *Fish Technol.* 28(2): 137-141.
- George Joseph, K., Ravindranathan Nair, P.,Unnikrishnan Nair, T.S.& Cyriac Mathen. 1992. *Fishing Chimes*, July, 1992: 21-33.
- Lekshmy Nair, Jose Stephen,A.,Vasantha Shenoy,A. & Gopakumar. K. 1988. *Fish. Technol.* 25(2): 127-131.
- Samuel, G. E., Girija, S. & Jose, C.J. 1987. In: *Recent trends in processing low cost fish*,(Society of Fisheries Technologists, Cochin) 145-148.

\* \* \*

## RECOMMENDATIONS

The Second Workshop on Scientific Results of *FORV Sagar Sampada* was held at Cochin from 15-17 February 1994. The Workshop was attended by over 200 delegates representing various user organisations and the eminent experts in the field of oceanography, marine fisheries and instrumentation. A total of 97 papers were presented and discussed under 6 technical sessions. In the plenary session held on 17th February 1994, the overall strategy of optimum utilization of this national facility for extending the knowledge on different aspects of marine sciences, marine dynamics, assessment of resources and their utilization was discussed. On the basis of these deliberations the following recommendations were made and an action plan was formulated.

1. During the past 10 years *FORV Sagar Sampada* has collected a wealth of information on many oceanographic, meteorological, geological and productivity parameters and fishery resources. The Workshop felt that it is now an appropriate time to review the data/information so far collected and intergrate them with a view to suggest their commercial application for optimum exploitation of various resources. For this purpose, the Workshop recommends that a multi-disciplinary Committee may be constituted by the DOD to work on these aspects and prepare a comprehensive report.
2. *Sagar Sampada* has been provided with several sophisticated instruments and fishing aids onboard. However, it is observed that for operating them and interpreting the data it is essential that the participating scientists from different organisations are properly trained. The Workshop therefore recommends that a well-planned training programme be organised and implemented at regular intervals.
3. Considering the wealth of information generated through Remote Sensing satellite data on SST and other parameters and also the corresponding sea truth data collected during the cruises, it is recommended that an integrated study be undertaken by the NRSA, CMFRI, NIO and other collaborating Institutions to validate the SST data and PPZ data using acoustic equipment, trawler catch and related data. Such an exercise would also help in standardising methodologies and calibrating the various instruments.
4. Noting that, voluminous data have been collected by the Vessel on various aspects of fishery environment, the potential resources and technological

- aspects, there is need for collating the entire information and bring out comprehensive reports on different fishery resources and their abundance in relation to various environmental parameters.
5. At present the information on promising resources such as Bull's eyes, Indian drift fish, scads, deep sea prawn and cephalopods are only indicative and these have to be quantified by undertaking further exploratory and experimental fishing using acoustics, standardised gear and fishing technology.
  6. Directed studies have to be undertaken on the availability of non-conventional resources such as *Benthoosema* in the Arabian Sea whose abundance is estimated to be over 100 million tonnes. The exploitation and utilization of this resource for fish meal, fish feed and protein extracts are worth considering. The Workshop suggests that directed studies on this resources be undertaken through mission oriented cruises.
  7. The vessel has excellent facilities in the form of an aquarium with recirculating facility for investigations on the physiology, reproductive and nutritional aspects on live fish. The workshop suggests that this important area of research be encouraged. This will also be useful in studying planktonic eggs and larvae, their precise identification leading to recruitment and population studies.
  8. The First Workshop has stressed the urgent need for investigating the abundance and distribution of pelagic and columnar fishes and also the spawning populations and young fish abundance. The Workshop reiterates that this may be undertaken immediately through well planned and organised programmes.
  9. In the cruises so far conducted and in the ensuing cruises large numbers of samples relating to phytoplankters, zooplankters finfish and shell fishes have been accumulated will be collected. Sorting out these collections into different groups for further detailed studies is a major task. The present arrangement made in this connection was found to be inadequate and not successful due to the absence of an agency with required manpower and facilities. In order to study expeditiously the material collected, it is recommended that DOD may establish a laboratory/centre for this purpose and engage trained personnel/scholars on contract basis to sort out this material, and prepare monographs.
  10. Existing Institutes such as CMFRI, CIFT are facing acute shortage of young scientists in different disciplines to participate in the cruise programmes on a sustained basis. In this context it is recommended that DOD may create a nucleus of Project Scientists to go regularly onboard the vessel so that the cruise programmes are not effected. Similarly the fishing master, fishing hands and other staff are also properly trained for advanced methods of fishing such as long lining, squid jigging etc.
  11. Providing incentives to scientists in the form of honorarium or sea allowance is a long pending issue. It is recommended that the scientists be given adequate allowances for participation in the cruise.

**12. Priorities for future work**

- Acoustics to estimate biomass of fishery resources
- Bottom topography, trawlable from grounds and their extent
- Sonar surveys for surface and pelagic schools of fish
- Comprehensive work on DSL in entire EEZ
- Fish migration studies using ultrasonic tags to track the routes
- Continuous monitoring of pollution at various depths
- Fish behaviour studies using aquarium onboard
- Seasonal data on primary productivity
- Round the year data on primary productivity, secondary production, environmental data and fisheries resources at fixed stations on a regionwise basis
- Effective pelagic and midwater trawling
- Standardisation of fishing gears, pelagic midwater and bottom trawls
- Recruitment studies and spawning surveys
- Analyses of all existing data by a study group to intergrate resource and environmental information to bring out comprehensive reports for commercial utilisation
- Evolve a method of transfer of results to fishing industry for commercial exploitation of resources.

\* \* \*



## Subject Index

A & N Islands 445, 217, 229  
Acoustic instruments 505  
Acoustic methods 461  
Amphipods 185, 229  
Andaman Sea 193, 197, 85  
Andaman and Nicobar fish 399  
Andaman & Nicobar seas 239  
Arabian Gulf 175  
Arabian Sea (Northern) 127, 175  
*Argyrozona argyrozona* 513  
Atmospheric forcing 25  
*Arobucca marleyi* 539

Bay of Bengal 445  
Biomass estimation 461  
Biomass 271  
*Bregmaceros maclellandi* 411  
Brunt-Vaisala frequency 39

Calibration of instruments 499  
Carangid fishes 347  
Catfish 305  
Cephalopods 445  
Chaetognatha 139  
Circulation 47  
*Clostridium botulinum* 513  
Cochin 7, 19, 25, 65, 75, 115  
Cod 411  
Community structure 127  
Conservation 483  
Convective instability 65  
Cooling 7  
Current structure 19

Deep scattering layer 185, 271, 411  
505  
Deep sea fish 331, 545  
Deepening 25  
Demersal 445  
Demersal resources 375, 419  
Demersal fishes 483  
Dial variations 75  
Diamond mesh 483  
Dissolved oxygen 75  
Diurnal variation 115

EEZ 185, 387, 429, 437  
Effect of oil spill 85  
Elasmobranchs 285  
Environmental impact 1  
Environmental parameters 315  
*Epinephelus chlorostigma* 539  
*Epinephelus diacanthus* 539  
Equatorial waters 405  
*Euthynnus affinis* 521  
*Evadne tergestina* 149  
Ext. coefficient 19

Fecundity 149  
FFT analysis 47  
Finfish 295, 375  
Finfish bottom trawling 399  
Finfish resources 315  
Fish 347, 545  
Fish resources 405, 429  
Fish mince 539  
Fish preservation 529

Fish abundance 331, 461  
 Fish biology 331  
 Fish flesh 535  
 Fisheries finfish 419  
 Fishery resources 257  
 Fishing trials 483  
 Flesh evaluation 535  
 Forced waves 57

**G**ear selectivity 483

**H**armonics and coherence 47  
 Heat exchange 75  
 Heating regime 7  
 Heteropods 193  
 Heterotrophic bacteria 97  
 High opening trawl 491  
 Histamine 521  
 Hydroacoustic instruments 499  
 Hydrography 103, 419  
 Hydromedusae 249

**I**ce 529  
 Ice-seawater slurry 529  
 Ice storage 513, 521  
 Ichthyoplankton 239  
 Indian mackerel 521  
 Indicator species 139  
 Inertial frequency 39  
 Infra-gravity waves 57  
 Internal waves 39, 47, 65  
 Intradiurnal variability 25

*Johnius sp.* 535

Laccadive Islands 97  
*Lactobacilli* 513  
 Length frequency 483  
 Lizardfish resources 363

**M**ackerel tuna 521

Marine fisheries 1  
 Medusae 249  
*Megalaspis cordyla* 535  
 Mesopelagic fishes 405  
 Microbial population 85  
 Mixed layer depth 7  
 Mixed layer 25, 33  
 Mixing 65  
 Modelling 33  
 Modified atmosphere 513

**N**E coast 103, 295  
*Nemipterus mesoprion* 539  
 Neritic 445  
 Northeast coast 419  
 Northwest coast 453

**O**cean response 7  
 Oceanic squids 437  
 Oceanic 445  
 Off-shore flow 7  
 Oil plume 205  
 Oil spill 175  
 Onboard salting 545  
 Ostracoda 163, 197  
 Oxygen 19

**P**elagic tunicata 217  
*Penilia avirostris* 149  
 Perches 387  
 Plankton shrinkage 103  
 Planktonic ostracoda 163  
 Potential energy 65  
 Premonsoon 19, 33  
 Premonsoon warming 75  
 Preservation 529  
*Priacanthus hamrur* 539  
 Primary productivity 103  
 Product quality 545  
 Pycnocline 39

*Rastrelliger kanagurta* 521

Rate of chilling 529  
Resource surveys 469  
Ribbonfish 429

Salinity 7, 25, 75  
Sampling gear 469  
*Saurida tumbil* 535  
Sea bream 513  
Secondary productivity 103  
Semipelagic trawls 477  
Shear instability 65  
Shelf waters 7  
Shoaling 25  
Size classes 149  
Southeast coast 315  
Spectral density 39  
Square mesh 483  
Squids 437  
Standing stock 205, 257  
Stratified water column 39  
Stratified waters 47  
Surimi 539  
Survey 295

*Tachysurus* sp. 535  
Temperature 75  
Temperature gradient 7  
Tertiary production 103  
Thermocline 75  
Thermocline 115  
Thermohaline response 25  
Threadfin bream 363  
Tidal influence 25  
Tidal impulse 75  
Tides 115

Time series data 19  
Transfer coefficient 103  
Trawl catch 429  
Trawl resource 491  
Trawl performance 491  
Trawl efficiency 477  
Trawl survey 453, 469  
*Trichiurus lepturus* 539  
*Trichiurus savala* 535  
Tuna 521  
Tunicata 217  
Turbulent kinetic energy 65

Underexploited resource 387  
Underexploited resource EEZ 285  
Unicorn cod 411  
*Upeneus vittatus* 535  
Upwelling 139, 19

Vertical distribution 115  
Vertical gradients 75  
Vessel facilities 1  
*Vinciguerria* 271

Wave groups 57  
Wave dynamics 65  
Waves 39, 47  
Wind stress 7

Yeasts 91

Zooplankton 115, 175, 257, 205,  
127

## Author Index

- Abbas, M. Syed 483, 491  
Achayya, P. 445  
Ananth, P.N. 57  
Anilkumar, R. 75  
Anrose, A. 453  
Antony Geetha 149, 229, 257  
Antony, K.P. 539  
Antony Geetha 149, 229  
Appanna Sastry, Y. 305  
Appukuttan, K.K. 445  
Arachi, M.A.P. 453  
Aravindakshan, P.N. 193, 239  
Arputharaj, M.R. 331  
Asokan, P.K. 437  
Avhad, G.K. 469
- Balachandran, K. 271, 305, 363, 411, 521, 529  
Benjamin, R.E. 461  
Bensam, P. 375, 419  
Bhargava, A.K. 453  
Bhaskaran, M.M. 445  
Boopendranath, M.R. 469, 491  
Burayya, N. 445
- Chakraborty, S.K. 363, 387, 411  
Chandrika, V. 97
- Daniel Selvaraj, G.S. 315  
Devadoss, P. 285, 375, 411  
Dhandapani, P. 217
- Feroz Khan, M. 331, 375, 387
- Gandhi, V. 375  
George, V.C. 469, 491  
Girijavallabhan, K.G. 461, 505  
Gopakumar, G. 315, 387, 499, 535, 539  
Gopalakrishnan, T.C. 205  
Goswami, S.C. 127  
Gupta Ranu, 85, 91
- Hareesh Kumar, P.V. 19, 33, 65
- Iyer, H. Krishna 483  
Iyer, T.S.G. 529
- James, V.V. 7, 47  
Jayabalan, K. 437  
Jayaprakash, A.A. 347, 405  
Jayasankar, P. 305, 375, 387  
Joseph, Jose 513  
Joseph, K. George 545  
Joseph, M. 445  
Joseph, M.G. 7, 25
- Kakati, V.S. 469  
Kaladharan P. 387  
Kasim, Mohamed 347, 499  
Khan, M.F. 285, 305  
Kripa, V. 445  
Kunjipalu, K.K. 491  
Kurian, Alexander 429  
Kurup, K.N. 257
- Lalitha, K.V. 513

Lalithambika Devi, C.B. 239  
 Lazarus, S. 295, 387, 429  
 Lipton, A.P. 437, 445  
 Livingston, P. 315, 375

**M**  
 Madhusoodanan, P. 7, 25  
 Marichamy, P. 315  
 Mathai, P.George 477, 491  
 Mathen, Cyriac 545  
 Mathew, Grace 285, 375, 387  
 Mathew, K.J. 115, 149, 163, 175,  
 229, 257  
 Meenakshikunjamma, P.P. 197  
 Meiyappan, M.M. 437  
 Menon Gopinatha, N.363  
 Menon, N.G. 271, 295, 305, 375,  
 399, 411  
 Mohamed, K. Sunilkumar 437  
 Mohan Kumar, N. 19, 33, 39, 65  
 Mohan, S. 331  
 Mohanraj, G. 363, 375  
 Muraleedharan, V. 535, 539  
 Murthy, P.G.K. 39, 47  
 Murty, A.V.S. 1  
 Muthiah, C. 429  
 Muthusamy, S. 315

**N**  
 Nagaraja D. 331, 437  
 Nagarajan, G. 453  
 Naik, V.V. 453  
 Nair, K.K.C. 205  
 Nair, K.P. 445  
 Nair, K.V.S. 363, 375, 419  
 Nair, P.N.R. 347, 429  
 Nair, P.R. 545  
 Nair, T.S.U. 545  
 Nambiar, V.N. 513  
 Nammalwar, P. 295, 375  
 Nandakumar, A. 419, 461  
 Nandakumaran, K. 331  
 Naomi, T.S. 149, 229, 257  
 Narayanaswamy, J. 419  
 Natarajan, P. 445

Natarajan, S. 461, 499, 505

**P**  
 Panicker, P.A. 469  
 Paul, P. 469  
 Pavithran, P.P. 149, 163  
 Perigreen, P.A. 535, 539  
 Pillai, N.G.K. 271, 315, 399  
 Pillai, N. Subramonia 483, 491  
 Prabhu, P.V. 513  
 Prasada Rao, C.V.K. 57

**R**  
 Rajagopalan, M.S. 75, 163, 419, 505  
 Rajapandian, M.E. 445  
 Raje, S.G. 305, 363, 375, 469  
 Raju, A. 375, 399  
 Ramadoss, K. 437, 445  
 Ramakrishnan A. 499  
 Ramakrishnan, P. 331  
 Ramalingam, L. 453  
 Rane, Vijayanti 453  
 Rao, G. Syda 437, 445  
 Ravindranathan V. 499  
 Reghu, R. 271, 363, 411  
 Rengaswami V. 375  
 Rengaswamy, V.S. 363  
 Revikala, S. 185  
 Rohit, Prathibha 429

**S**  
 Said Koya, K.P. 347  
 Sankaranarayanan, V.N. 205  
 Santhakumari, V. 249  
 Sarvesan, R. 437  
 Seetha, P.K. 347  
 Selvaraj, G.S.D. 75, 103, 115  
 Shrivastava, Y. 127  
 Sivadas, M. 347  
 Sivakami, S. 315, 347, 375  
 Solomon, K. 175, 229, 257  
 Srinivasa Gopal, T.K. 513  
 Srinivasan, M. 139  
 Srinivasan, P.V. 445  
 Srinivasarangan, S. 375  
 Stephen, Rosamma 193, 197, 239

Sulaiman P. 469

Surendranathan, V.G. 437

**T**atavarti, Rao 57, 65

Thiagarajan, R. 315, 399, 429,

Thomas, Francis 529

Thomas, K.T. 445

**V**arghese, M.D. 477, 483, 491

Varghese, Molly 115, 229

Venugopal, K.M. 387

Vidyasagar, Kuber 315, 437, 445

Vijayan, M. 163

Vijayan, P.K. 521

Vijayan, V. 477

Vivekanandan, E. 285, 315, 363, 411

**Y**ohannan, T.M. 347

**Z**acharia, P.U. 285, 305, 331, 363,  
375

Zaffar Khan, M. 315, 429