

## Identifying Appliances using NIALM with Minimum Features

Sunil Semwal\*, R S Prasad\*\*

\* Departement of Instrumentation and Control Engineering, Graphic Era University Uttarakhand, India

\*\* Departement of Electrical and Electronics Engineering, Graphic Era University Uttarakhand, India

---

### Article Info

#### Article history:

Received Sep 19, 2014

Revised Oct 24, 2014

Accepted Nov 5, 2014

---

#### Keyword:

Load signature

NIALM

Smart grid

Smart meter

---

### ABSTRACT

Government of India has decided to install smart meters in fourteen states. Smart meters are required to identify home appliances to fulfill various tasks in the smart grid environment. Both intrusive and non-intrusive methods have been suggested for identification. However, intrusive method is not suitable for cost and privacy reasons. On the other hand, techniques using non-intrusive appliance load monitoring (NIALM) are yet to result in meaningful practical implementation. Two major challenges in NIALM research are the choice of features (load signatures of appliances), and the appropriate algorithm. Both have a direct impact on the cost of the smart meter. In this paper, we address the two issues and propose a procedure with only four features and a simple algorithm to identify appliances. Our experimental setup, on the recommended specifications of the internal electrical wiring in Indian residences, used common household appliances' load signatures of active and reactive powers, harmonic components and their magnitudes. We show that these four features are essential and sufficient for implementation of NIALM with a simple algorithm. We have introduced a new approach of 'multi point sensing' and 'group control' rather than the 'single point sensing' and 'individual control', used so far in NIALM techniques.

Copyright © 2014 Institute of Advanced Engineering and Science.  
All rights reserved.

---

### Corresponding Author:

Sunil Semwal,

Departement of Instrumentation and control enginreeing,

Graphic Era University,

566/6 Bell Road Clementown, Dehradun, Uttarakhand, India.

Email: sunil.111213@gmail.com

---

## 1. INTRODUCTION

A Non-intrusive Appliance Load Monitoring (NIALM) method is designed to monitor electrical and electronic appliances when they are in use. This is carried out by an analysis of the extracted features (load signatures) of the appliances. This analysis estimates nature of individual load signatures of the appliances forming the combination in switched ON states. In true NIALM operation, human intervention is not needed for identification of individual appliances at the circuit breaker level. Thus, it facilitates a very convenient method of collecting information about the use of appliances, viz, type of the appliances and their power and energy consumptions profile. This information provides data which are extremely valuable to all the players, viz., consumers, utilities, and appliance manufacturers for the purpose of upgrading the performance when and where needed. Using NIALM, a smart meter placed outside a home can determine how much energy goes into each appliance in the residence. The complexity of instrumentation in smart meter development increases with increase in the number of features which results in increase in the sensors for extracting load signatures. Also, design of the algorithm impacts complexity, as involving large number of features would not help in developing a simple algorithm. Both hardware requirement and features used in algorithm have an impact on the ultimate cost of a smart meter. From practical considerations, it is important and highly essential, particularly for majority of consumers in developing countries like India and Indian subcontinental

[1], to ensure that the cost of meter is within the financial capacity of such consumers. It is not surprising that in spite of several techniques proposed in [1]-[9], not even one has found its practical application since none meets the desired goals of the use of smart meters fully and so has not proved worthy of practical implementation. From consumers' point of view, smart meters of today have proven to be a bad deal [10-12]. Without exception, one of the major reasons which is responsible for complex hardware and complex software in implementing NIALM techniques, proposed till date, is the use of a single point current sensing at the incoming mains supply to the meter. The current sensor senses the waveform of a mixture of electrical and electronic residential appliances which generally operate on different principles [10]. For a middle class Indian family the number of such household appliances does hardly exceed thirty five, whereas in the United States the number may always be more than fifty. The current wave form (CW) signature of hybrid variety of appliances is bound to be more and more complex with increasing number of devices. As a consequence, it becomes essential to use analytical tools requiring a large number of features and rigorous mathematical algorithms to disaggregate the loads [2]. A major impediment to the growth of India's economy is the wide gap in the demand and supply of power [13]. According to a report [14], India's aggregate technical and commercial (AT & C) losses are among the highest in the world, averaging 28.44% (2008-09 data). The financial loss has been estimated at 1.5% of the national GDP, and is growing steadily. Faced with this situation, Government of India (GOI) set up a task force for implementation of smart meters installation pilot projects in Indian domestic and industrial houses in a phased manner, starting with selected areas in fourteen states of the union [15]. This decision of a power-deficient India has provided enough opportunity for nearly half a dozen multinational companies to set up their units in India for production of smart meters [16].

Table 1. Light load and power appliances

Sr.	Light Load Appliance	Sr.	Light Load Appliance	Sr.	Power Appliances
1	TL(40W)	7	Tube light (40W)	14	Air conditioner
2	IL (60W)	8	DSO	15	Induction Cooker
3	CFL	9	CPU	16	Micro-oven
4	Laptop	10	Function Generator	17	Room Heater
5	Monitor	11	Mobile charger (Nokia)	18	Electric Press
6	Fan	12	TV		-----
		13	Fridge		

### 1.1 Smart Meters from India's Perspectives

Considering the benefits of smart grid-smart meter technology, viz., reduction of AT & C losses and prevention of outages, apart from remote and transparent energy billing, the task force has identified the functionalities of smart meters in each of the selected areas in fourteen states as shown below:

AMIR-Advance Meter Infra Structure for Residential consumers, AMII-Advance Meter Infrastructure for Industrial consumers; OM-Outage Management; PLM-Peak Load Management; PQM-Power Quality Management; MG-Micro-grid Management; DG-Distributed Generation Management.

IEEE Standards Association, recognizing India as the third largest market for smart meter, has also pin-pointed four key challenges for smart grid adoption in India, viz., power theft, inadequate grid infrastructure, low metering efficiency, and lack of awareness among the consumers [17]. Smart meter being an integral component of a smart micro-grid (distribution network), India is expected to install 130 million smart meters by 2020 [18]. The task force committee has also stressed on the development of a low cost meter, without compromising on the assigned functions of the meters, so that these are easily affordable to the significantly large consumers in middle and lower income groups. According to a recent report [11], Germany has taken a decision to reject the recommendations of the European Union (EU) for installation of smart meters in 80% of homes by 2020 because it is likely to prove too costly for consumers. Recently [19], according to MOU signed between GOI and Germany, technical assistance from Germany will enable evacuation of nearly 30,000 MW of solar and wind power for integration into the national grid. GOI is also encouraging the consumers to use the roof-top solar cells, to meet their own demands during peak load situations. With this scenario in view, the objectives which have been set for smart meters in India are:

(i) monitoring appliances' load and energy profile, (ii) integrating intermittent and distributed sources of energy, (iii) monitoring health of appliances and equipments inside and outside (power quality) the premises, (iv) transparent and remote real time energy billing of consumers, and (v) enabling self-healing of grids to prevent/ reduce frequency of outages. A look at the desired objectives in (i), (iii), and (v) above, requires that consumers' loads must be identified. If some of the identified appliances are required to be switched OFF for

reasons including consumption of high power during critical peak load conditions, this operation has to be carried out remotely by the utility. Although, in literature, many NIALM techniques have been reported [1]-[9], there is no discussion regarding the method used for switching (OFF/ON) faulty and/or high power consuming appliance(s) in critical load conditions.

Since there has to be no use of sensors (NIALM) in the appliances' outlets, it would require consumer's assistance for switching operations. But there is no guarantee that the consumer would be present in his/her residence at the time of this switching operation. If the use of sensors in the outlets of potentially high power consuming appliances is considered unavoidable, this amounts to intrusive method. An example of intrusive method can be seen in the Florida state in USA where utilities have inserted sensors in some potentially high power consuming appliances. There is a prior written agreement with the consumers that, in case it is required, these 'harming' smart appliances will be switched OFF/ ON directly by the utility. This technique may be quite satisfactory for USA and other rich and developed countries, but may not be acceptable and practicable for the consumers in India because of cost involved in the use of sensors and privacy issues. This scenario brings us into the subject matter of our study in this paper. We address all these issues using NIALM with non intrusive feature extraction (NIFE) technique. Ming et al in their recent paper [8] have stressed that NIALM and NIFE are two very different but related techniques. The limitations of the existing NIALM techniques have been exposed in a review paper [10]. In the existing NIALM techniques, multiplicity of features and algorithms cause serious confusions for the smart meter developers. In this paper, we show that using only steady state values of active power  $P$ , reactive power  $Q$ , harmonic components  $h$ , and their magnitudes  $m_h$ , it is possible to identify the appliances correctly. In fact we have modified our study in this paper from the previously reported preliminary findings reported in [20] where thirteen appliances were used and load signatures were extracted using only a single current sensor placed at the incoming mains supply to the meter (same as in all NIALM techniques). Algorithm used [20] was based on templates matching with the unknown combination of appliances operating simultaneously. However, a serious limitation in our previous study was the requirement of large storage space in memory. For 13-appliances (single-point sensing), the number of templates for all possible appliance combinations was 8191. For the four features case, the templates would be as many times higher. This is not considered an efficient and practical approach despite giving accurate identification, also commented in [2]. Therefore, in the first part of the study, in this paper, we first examine whether the specifications of internal electrical wiring (IEW) of Central Public Works Department (CPWD), a GOI organization, can facilitate a 'natural' disaggregation of the loads in order to enable the procedure of templates matching practical for the Indian domestic residences. Since the specifications of IEW provides distribution of appliances in a group in several parallel circuits, we have used multi-point sensing of CW rather than the single point mode of sensing as applied in reported works on NIALM [1]-[9],[20]. We explain later (next section) the big advantages that accrue when multi point sensing is used, and we claim that this method is reported for the first time in this paper. In the second part of our study, we show that it is possible to successfully identify the appliances correctly, except that the control operation (ON/OFF) of appliances, on the direction of utility, will be performed by 'group control' rather than by 'individual control'. Our experiments, with twenty five 'light' load appliances, distributed in four parallel circuits, and five 'power' load appliances, connected in three parallel power circuits, exactly as per the IEW specifications, have been conducted in laboratory environment, with constant supply voltage ensured. For identification, we have followed the procedure of templates matching [7] despite the criticisms by some authors [2]. We show that their criticism of comparison method as an inefficient and impractical approach does not apply to the multiple point sensing. For example, in case of 25 appliances case, used in this paper, the total of all possible combinations works out to over 33.5 millions requiring as many templates, if only a single current sensor is used. Templates matching in this case are clearly meaningless. In our case, since all the appliances are distributed in a number of parallel circuits, and the current sensors used are the same in number as the circuits, one sensor for each circuit, the total of possible combinations drastically reduces to the sum of possible combinations in each circuit. Taking the same example of 25-appliances case, if we distribute them in four parallel circuits, say 6-appliances in three and seven appliances in one, then the total of all possible combinations works out to merely 316 which is an insignificant number in comparison, and so the templates matching is definitely a practical proposition, as in [7]. We have, therefore, considered this approach in our experiments. This paper is organized as follows: next section discusses the salient features of IEW specifications of CPWD; Section III briefly reviews the status of research using NIALM. Here, we also discuss our approach and the suitability of implementing NIALM on the hardware platform provided by the existing IEW specifications. Section IV describes the algorithm, while section V deals with the experimental procedures and some assumptions used in the experiments. In the next section we discuss the results of identification with some examples. Finally, we conclude giving our analysis of the experiments and results, and future work required for further improvements.

## 1.2 IEW Specifications of CPWD (INDIA)

Specific features of specifications of internal electrical wiring (IEW), which are relevant to the experiments conducted in this paper, are given below.

### *Capacity of circuits*

(i) each lighting circuit (appliance rating not exceeding 6 A) shall be loaded such that not more than ten such appliances or a maximum of 800 W, whichever is less, are connected; in case of CFL appliances, where load may be less, number of such appliances may be suitably increased without exceeding allowable wattage. (ii) each power circuit can feed the appliances at the power outlets such that (a) not more than two appliances of 16 A (1kW) ratings are connected to 16 A outlets, (c) in case of loads > 1 kW, these shall be controlled by suitably rated miniature circuit breaker (MCB)/ switch and cable size shall be decided as per calculations; Since each lighting circuit can have a maximum of 10 appliances, total power rating not exceeding 800 W, then, on the realistic assumption that a middle class residential house does not have more than thirty five 6 A appliances, these can be distributed in the following manner: We can distribute seven appliances in each of the five light circuits without loading fully, keeping one or two spare circuits for future needs; similarly for six power appliances (16 A) in a house, we can distribute them in three power circuits, two in each. This means we require five sensors for lighting circuits and three for power circuits. The conditioned outputs from these sensors are connected to the input port in the microcontroller unit (MCU), each pin in the input port has a unique address for a group of appliances connected in a circuit. Similarly, the sensors outputs in power circuits will also be connected to a port in MCU, providing unique address of each group of appliances in a power circuit. Therefore, for the purpose of NIALM, which is described next, we need an algorithm to monitor and identify a maximum of only ten appliances at a time irrespective of how many appliances are in use in a house. This provides the 'first level' of 'natural' load disaggregation, while the final level of disaggregation, where individual appliances are identified, will be carried out by the algorithm. Note that the task of developing the algorithm is rendered easy due to this natural first level disaggregation. A command would fetch on-line the aggregate signal of a group of appliances forming the combination or group in a circuit.

## 2. NIALM

The concept of NIALM has been fully explained in literature [1]-[10]. Several features from the basic voltage and current signals (both steady states and transients) such as active power (P), reactive power (Q), power factor (pf), harmonic components (h), magnitudes of h (mh), current waveform (CW), V-I trajectory load signatures, eigen values, switching transient waveform shape, instantaneous admittance waveform, energy usage pattern of the loads, etc., have been used in NIALM [2], [3]. The algorithms used vary from a 'single algorithm' to 'multiple algorithms', the latter used in 'Committee Decision Mechanism' (CDM) in which majority of 'votes' (i.e., agreement), 'cast' by each of the algorithms, decides the final result of identified appliances [2]. Some published reports [8], [10] highlight the shortcomings of most of the NIALM techniques with respect to feature extraction. Applications of neural networks using spectral features have also been tried to solve the problems of identification [7]. The authors [8] stress that at present in most of these techniques [21-25] load signatures are collected intrusively. They further emphasize that non-intrusive identification of load activities and non-intrusive extraction of load signatures are two related but different problems. Another serious omission in present-day NIALM techniques is the absence of discussion regarding the technique used to switch OFF a faulty and/or high power consuming device in case of critical power supply conditions such as peak loads [26]. This is an essential requirement in power management. Probably, the absence of discussion is on the assumption that consumers are supposed to be present at their premises who would switch off the identified appliances when intimated by the utility. However, there is no guarantee that the consumers shall be present when such operation is warranted. In such a case of emergency, the utility will have no other option but to switch OFF the supply to the entire house. This can raise serious rights and privacy issues of consumers, for some of their appliances may be supposed to be in ON state permanently, and/ or some appliance(s) may need to be kept ON when the occupants of the house have to go out. This problem arises because of single point sensing of current signal as the relay, on command from the utility, will cut-off the power supply at the single point of entry. In multi-point sensing there will be at least no blackout of the entire house; only partial appliances in a particular group would be affected. Again, a serious difficulty arises with regard to the choice of features and algorithms in the context of achieving a reasonably low cost of the meter, since more features require more sensors, and complex nature of load signatures require sophisticated data acquisition hardware, and complicated algorithms add to time complexity, culminating overall, in a very complex hardware and software, defeating the objective. Despite the ongoing research in identification techniques since over two decades, the unresolved problem till date is

to find an answer to the questions “what are the ‘optimal’ features of appliances to be considered essential and sufficient for identification?”; and “what is the ‘optimal’ algorithm to be used for identification?”. An essential requirement of optimality is the use of minimum sensors to reduce the hardware complexity and cost, and minimum time and space complexity for the algorithm to be simple. If one chooses to design and develop a smart meter following [2] and some other published reports [3]-[9] for practical use in billions of residential houses in countries like India, the cost would be so prohibitive that the consumers would likely reject them outright. The two unresolved issues, stated earlier, are precisely the reasons why NIALM presently is the most attractive issue for researchers in smart meter design.

### 3. ALGORITHM

Following assumptions are made for the implementation of the algorithm:

- (i) Only single phase appliances are used both in light and power circuits. Plug-in types of loads are not considered.
- (ii) The algorithm is based strictly on the specifications of IEW of CPWD, Govt of India.
- (iii) Steady state values of features P, Q, h, and mh for all possible appliance combinations (templates)  $\sum^l C_r$  and  $\sum^p C_r$ , where  $l \leq 10$ ,  $r = 1,2,\dots,l$  for light load appliances; and  $p \leq 2$ ,  $r=1,2$  for power load appliances, are stored in memory locations. For a maximum of 10 appliances in a light circuit, the total combinations would be 1023. However, in the experiments in the lab environment, a maximum of 7 appliances has been used in one circuit and 6 appliances in the remaining three light circuits. Similarly, for three power circuits, 2 power appliances, which are the maximum allowable, are connected in two power circuits and one in the third. The four features (in (iii) above) of all possible combinations of appliances in each of the light circuits, are stored in three matrices,  $M_1$ ,  $M_2$ , and  $M_3$ ; where the columns of  $M_1(s,5)$  contain normalized values of features P, Q, I, pf, VA although we use only features P and Q in the algorithm; the columns of  $M_2(s, 8)$  contain the first eight odd harmonics components of feature h, and the columns of  $M_3(s,8)$  contain the magnitudes of first eight odd harmonics components of features mh; where s is the total number of all possible combinations of appliances in each circuit. For the unknown combination, which is to be identified, the corresponding extracted features are stored in matrices  $M_4(1,5)$ ,  $M_5(1,8)$ , and  $M_6(1,8)$ . The essence of algorithm is explained as follows: storing all the features of individual appliances, as well as of all possible combinations of the appliances in matrices as stated above, and using a small threshold value ( $\pm 0.01$ ) for normalized measured values of P and Q to account for the possible variations in supply voltage, the algorithm compares on-line the signature of the unknown composite load (UCLF) of appliances (Appl) in switched ON position, first with the P values in the stored templates. Since the small threshold or tolerance value, chosen after some trials, is not optimal, it is quite likely that two or more templates may be indicated in this comparison. In the next step (second stage) another comparison is made with the Q values with the templates obtained after comparison. This, in all likelihood, will further reduce the number of templates. In the third stage of comparison with features h of the templates remaining as residue from the second stage, there will possibly be further reduction, leaving the residue, hopefully, as the single desired candidate. If not, the fourth stage of filtering through mh accomplishes this task of final identification. Note that the use of mh is based on the principle that if a waveform is resolved into a series of spectral components, superposition of power applies because of the orthogonality of spectral components of different frequencies.

Table 2. Appliances installed in the circuits

Sr.	Light load appliances connected in light circuits (LC1-LC4)			
	LC1	LC2	LC3	LC4
1	TL(40W)	CFL(8W)	CFL(8W)	Tube light (40W)
2	IL (60W)	CFL(15W)	Incand. Lamp (200 W)	Bulb (60W)
3	CFL	Tube light (40W)	Mobile charger (Nokia)	CFL (15W)
4	Laptop	DSO	Laptop	Laptop
5	Monitor	CPU	monitor	TV
6	Fan	Function Generator	Fan	Fridge
7	Washing machine	Washing machine	Room heater	Fan

Sr.	Power load appliances connected in power circuits (PC1-PC3)		
	PC 1	PC 2	PC 3
1	Electric Press	Air conditioner	Micro-oven
2	Ind Cooker	Induction Cooker	Room Heater

If there still remains a situation where the possible candidates in identification at the fourth stage of filtering are more than one, some other suggested features such as I, pf, and CW would be used to finally identify the

appliances in the unknown combination. Fortunately, however, in extensive experimentations with common domestic appliances and a few lab equipments (Table 1) we found that unique identification was always confined within the first four stages of filtering. The salient features of the algorithm are shown more explicitly by a flow chart in Figure 1. The appliance codes are entered in the appliance combinations database code matrix, CM; e.g., for a 6-appliances case the codes entered in CM = [1 1; 2 2; 3 3; 4 4; 5 5; 6 6; ..; 9 14; 10 15; ..; 39 346; 40 356; 41 456; ..; 63 123456]. At the time of data acquisition the appliances are coded in single digit numbers, 1,2,..,7.

**4. EXPERIMENTAL PROCEDURE**

Domestic appliances commonly used in Indian middle class families have been shown in Table 1. Table 2 shows the appliances connected in the four light circuits LC1 to LC4 and power circuit PC1 to PC3. Due to unavailability of a few domestic appliances for some circuits, these have been substituted by a few lab equipments, such as digital storage oscilloscope (DSO), function generator (FG), and monitor, which contribute a richer variety of attributes of features in h and mh. An experimental laboratory setup was created to represent an electrical installation strictly as per CPWD specifications on a fabricated wooden frame. There are some common appliances on the light load circuits, which are generally the case in houses, but power load appliances in power circuits are distinct. With six devices connected in each of the three light circuits, and seven in the fourth light circuit, the total number of possible combinations works out to 316, each representing different combinations of devices switched ON. For six power appliances, these were distributed equally in three circuits, the total number of different combinations being only three for each circuit.

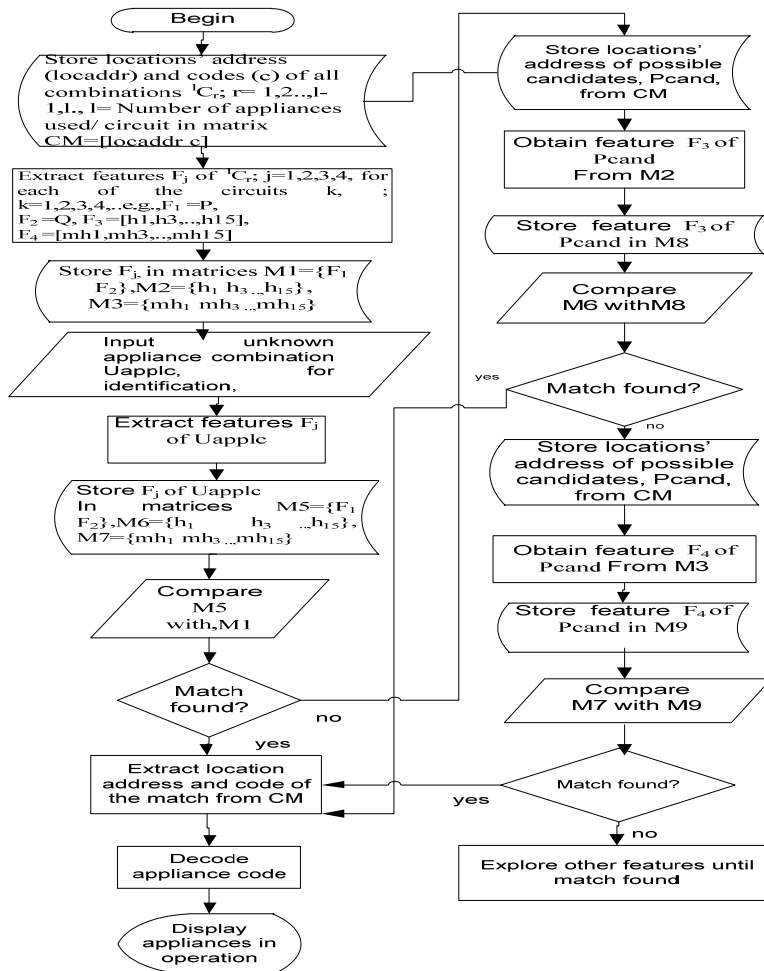

Figure 1. Flow chart of proposed algorithm

The data acquisition was in four steps: first step consists of extraction of basic features (P, Q, I, pf, VA) of individual appliances in each circuit, second step was extraction of load signature of these basic features of all possible combinations of the appliances in each circuit, third step was extraction of h components (fundamental, 3<sup>rd</sup>, 5<sup>th</sup>, 7<sup>th</sup>, 9<sup>th</sup>, 11<sup>th</sup>, 13<sup>th</sup>, and 15<sup>th</sup>) of individual and all possible combinations of appliances in each circuit, and the fourth step was for extraction of signature mh. Note that for spectral components, significance of contribution of harmonics for the first eight odd harmonics was determined by the ratio of  $((mh)_{\max}/10)$ . If any mh value is less than this ratio, it is ignored (assumed zero in value), and corresponding to these ignored mh values, the relevant harmonic components were also ignored. Only these modified values were then selected for the templates to be stored in memory. Thus, we have not normalized the modified mh values since their magnitudes were made comparable, unlike the P, Q, I, pf, and VA data. For each combination a total of six readings (each 10 seconds apart) in steady states were taken for each feature, out of which only those readings which showed no variation were used for storing templates in memory. Load signatures of individual as well combinations of appliances were extracted in two modes: off-line and on-line (real-time) described below.

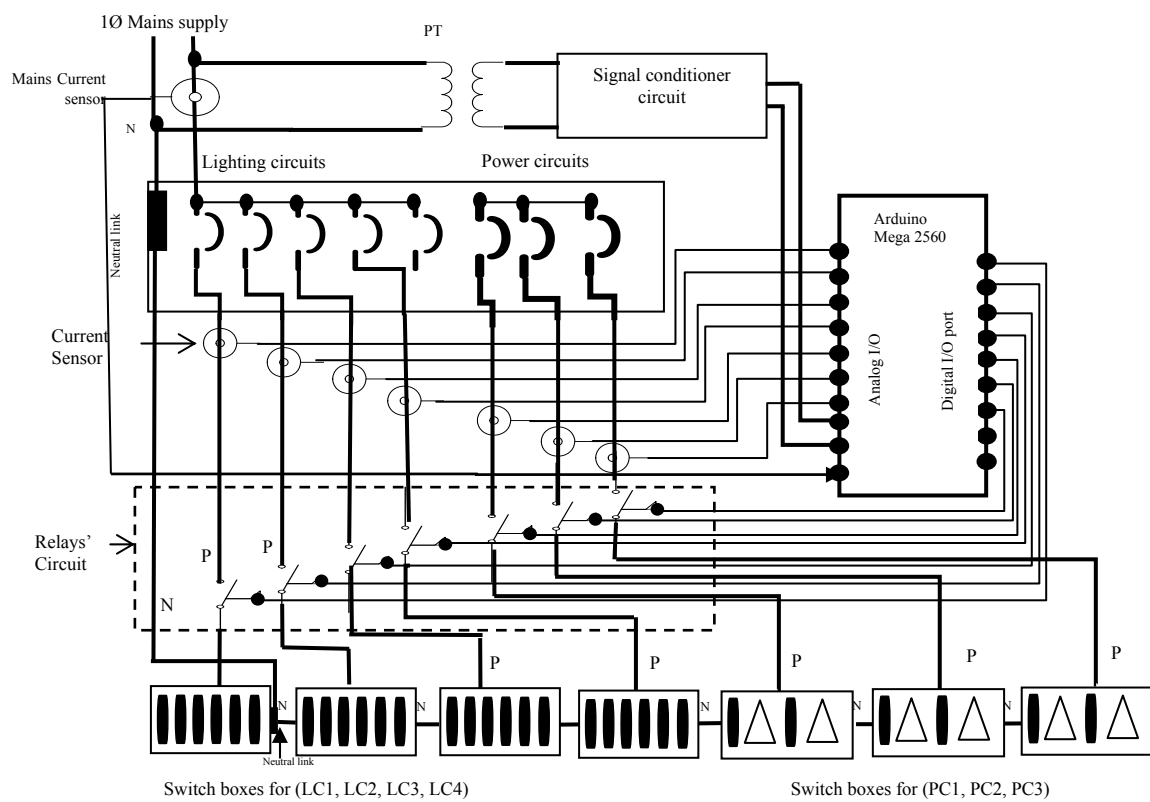

Figure 2(a). Schematic for experimental setup for data acquisition

#### 4.1. Off-Line Mode of Measurement

In the off-line mode, the experimental set up consisted of a recently marketed smart socket meter (manufacturers M/s Hama GmbH & Co KG, Germany) along with digital storage oscilloscope (DSO) with current sensors. Plug meter is an electrical energy meter which plugs in between any appliance and the AC outlet. It measures power consumption,  $I_{\text{rms}}$ ,  $V_{\text{rms}}$  with power factor ( $\cos\Phi$ ). The smart socket meter was used for direct measurement (steady states) of P, Q, I, pf, and VA. Only P and Q features were used. For extraction of spectral components h and mh, DSO was used. A single smart socket meter was used in turn for each of the light and power circuits.

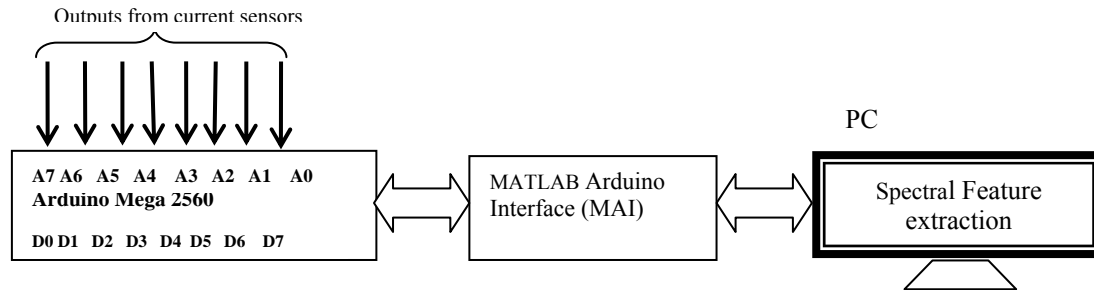

Figure 2(b). Schematic for experimental setup for spectral feature (h, mh) extraction

#### 4.2. On-Line (Real-Time) Mode of Measurement

In the on-line mode for P and Q measurement, Arduino microcontroller [23] was used. Arduino Mega 2560 development board receives current and voltage signature from respective sensors to compute the load profile (P, Q, I, V, pf) of connected appliances. As shown in Figure 2(a) the four current sensors in light circuits are placed at the exit of each circuit wire from the DB, and, similarly, three current sensors have been used at the exit point of each power circuit from the DB. Additionally, one current sensor is used right at the incoming mains to the DB. This sensor has been used for monitoring and recording of total current drawn from the supply so that this may be used in future work for on-line energy consumption data and its onward transmission to utility, and has not been used for identification of appliances. Figure 2(a) provides the hardware platform for all data acquisition requirement for the basic features (P, Q, I, pf, VA) while Figure 2(b) shows the schematic of spectral feature extractions; all eight current sensors are connected to the analog input port of microcontroller [23] which is interfaced with PC by using MATLAB Arduino interface package. MATLAB Support Package for Arduino enables communication with the microcontroller over a USB cable, so that the current signals from the sensors can be directly used in MATLAB environment for signal processing (FFT, Wavelet).

### 5. RESULTS AND DISCUSSIONS

A total of 316 ‘unknown’ combinations ( $3 \times 63 + 1 \times 127$ ), i.e., for all possible combinations of appliances in the four light circuits, were tested in off-line and on-line (real-time) mode for validation of the algorithm using computer program developed on the MATLAB platform. The ‘unknown’ off-line combinations were selected randomly from among the known combinations whose templates were stored in memory locations as stated earlier. The results of these tests were found correct for all these combinations. Next, validation of the procedure was also carried out in real time in respect of P and Q values by random switching of appliances in ON states in each of the four light circuits. For the on-line validation in respect of h and mh values, the experiments using Arduino microcontroller are still in progress, and so only off-line mode of these values were used in validation of the algorithm. The result of the test was found very satisfactory since, except for two unknown combinations in circuit LC2, all other test candidates were uniquely identified. Not a single ambiguity ever occurred. We now copy a few results of the program execution for some randomly switched on-line unknown combinations. In the examples, the format of the result displayed is: first number indicates the location in memory of the stored template for matching with the unknown combination, the second number indicates the code of the appliances, and the third number shows the stage of filtering at which the identification is completed. Figure given for each of the displayed results shows the number of possible candidates as residue at each stage of filtering until the final identification stage, and also shows the addresses of locations of stored candidates’ templates, which emerge as the residue, matching with the unknown combination under test. The decoding of the location code of the candidate, which is found to match exactly with the unknown combination, is done through program as explained below. It may be noted that the identification is never found to occur at the 1<sup>st</sup> stage, i.e. P. This is obvious because the tolerance level of 0.01 selected after a few trials includes values ( $P \pm 0.01P$ ) and ( $Q \pm 0.01Q$ ) of active and reactive powers and so includes more than one candidate in P always. We give only one example from each of the light circuits, and one example from power circuit, for want of space.

*Circuit LC1:* Ex                      41      456   4

For this example, Figure 3 displays the results of identification in respect of the number of possible candidates (residue) available in P, Q, h, and mh and their respective location address including the location address of the candidate which identifies the unknown combination of appliances. The decoding of location



address (41), shown as 456, is the identity of individual appliances in combination. We copy from the MATLAB the results of the executed program and explain the steps of execution.

```
>> loc = 13 22 24 29 30 32 34 35 37 39 41 43 48 50
>> locq = 8 11
>> filtq = 0.1275 0.1824 0.1318 0.1190 0.1358
           0.1196 0.1867 0.1318 0.1161 0.1322
>> loch = 1 2
>> filth = 1 0 5 0 9 0 13 0
           1 0 5 0 9 0 13 0
>> locmh = 41
>> filtmh = 4.9700 0 2.5500 0 1.8600 0 1.1100 0
```

We can see the effect of tolerance value resulting in selection of as many as fourteen possible P candidates whose addresses of storage are given in 'loc'. When filtered through the next stage Q, the number of possible candidates drastically reduces to two, whose storage addresses are indicated indirectly by linked numbers in 'locq', i.e., the number 8 in locq refers to location number 35 in loc, and 11 in locq refers to location number 41 in loc (which is actually the desired address of unknown combination). 'filtq' shows two possible candidates in Q, the columns 1-5 represent the normalized values of five features (P,Q,..,VA) of templates stored at loc 35 and 41. The third stage of filtering through h still yields two candidates shown in 'filth' given by linked numbers 1, 2 indicated by 'loch' which refers to the linked numbers in locq, i.e., 1 in loch refers to serial number 8 in locq which refers to location number 35 in loc, similarly 2 in loch refers to 11 in locq which refers to 41 in loc.

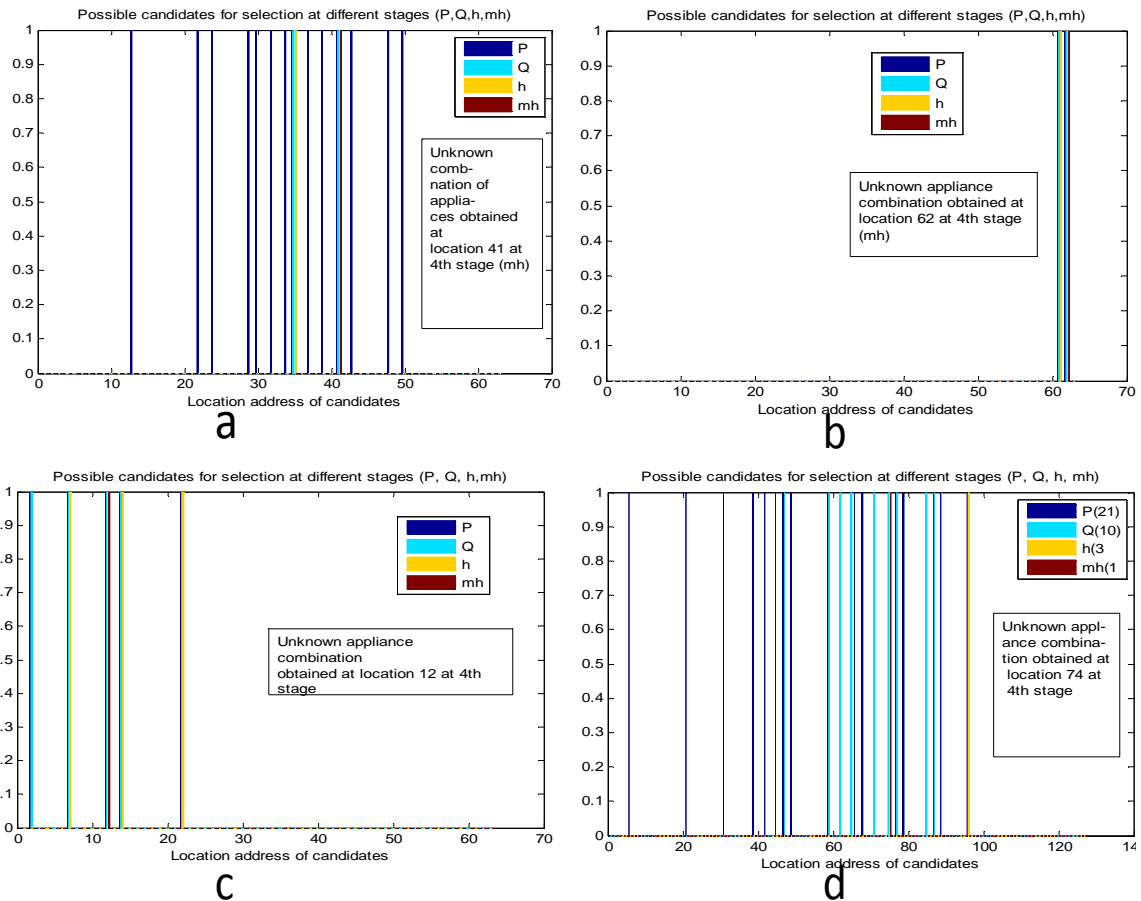

Figure 3. Identification of appliances (LC1, LC2, LC3, LC4)

Since, even at the 3<sup>rd</sup> stage (h) the candidates for identification are more than one, the 4<sup>th</sup> stage (mh) of filter action is gone through which now uniquely identifies directly the location number 41 in 'locmh' where the stored template of combination matches the unknown appliances combination, while the values of mh for this

unknown combination are shown in 'filtmh'. We can also see these location addresses of possible candidates P, Q, h, and the mh in Figure 3.

Circuit LC2 Ex 62 23456 3

Circuit LC3 Ex 12 23 4

Circuit LC4

As shown in Table 2, this circuit has seven appliances whose total number of possible combinations works out to 127. Note that this circuit contains TV and fridge among the appliances. We show three typical cases of identification with the same interpretations as given in the earlier examples. As an example, we copy from MATLAB the executed result.

Ex 74 1345 4

Current wave (cw) features:

Current waveform of appliances connected in circuits LC1, LC2, LC3, LC4 are shown in Figure 4.

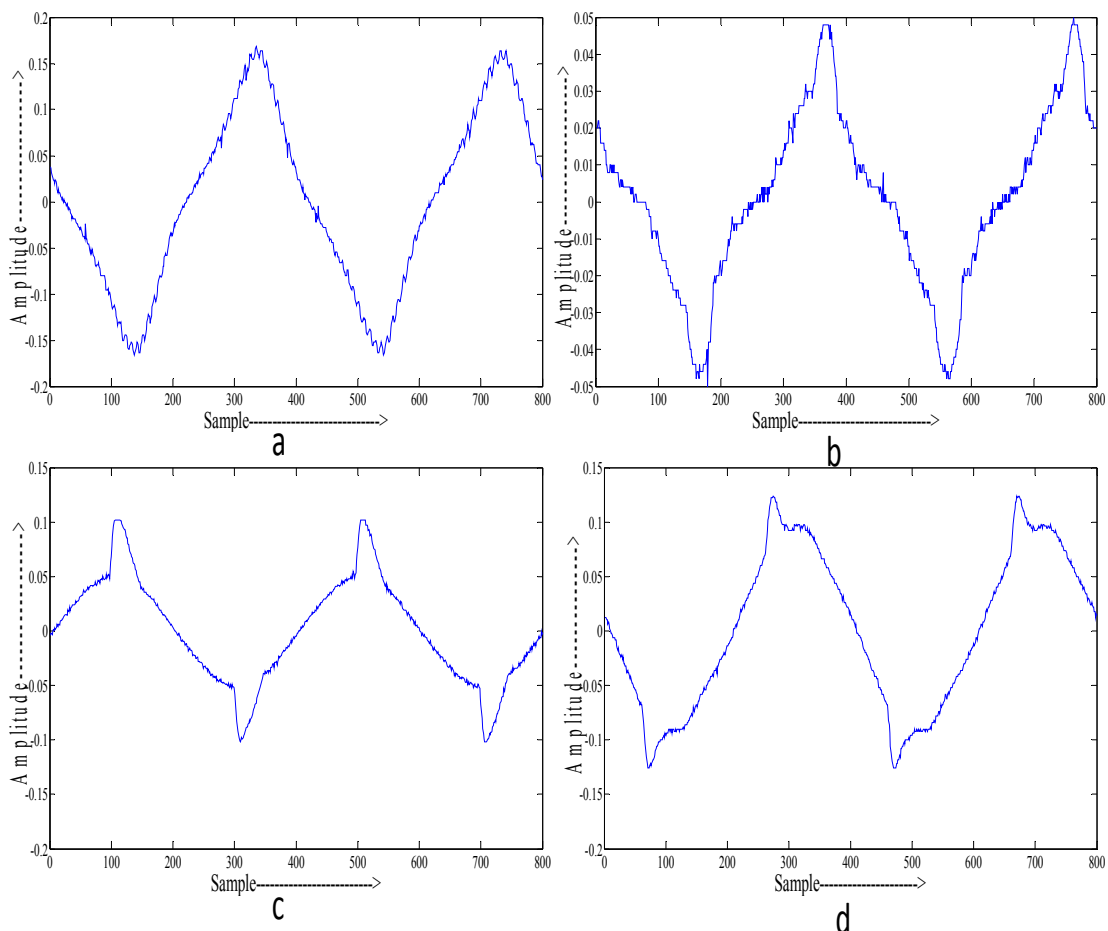

Figure 4. Current wave form of LC1, LC2, LC3, LC4

### 5.1. Summary of Light Circuits Identification

Table 3 shows identification frequency at different stages of filtering in the four light circuits, LC1, LC2, LC3, and LC4. Note that, here, the frequency of identification at mh stage is progressively increasing as we proceed from LC1 to LC4. This is because some of the appliances used in LC2, LC3, and LC4 are progressively richer in harmonics, and in their spectral magnitudes, mh. This behavior is supported by the CW signatures of appliances in Figure 4 for a case when all the installed appliances are simultaneously in ON states in the four circuits. As shown, CW for LC1 is nearly sinusoidal, while for the remaining three circuits, their CW signatures increasingly depart from sinusoidal nature. The P, Q, I, pf, VA and h, mh values of these circuits are shown in Figure 5.

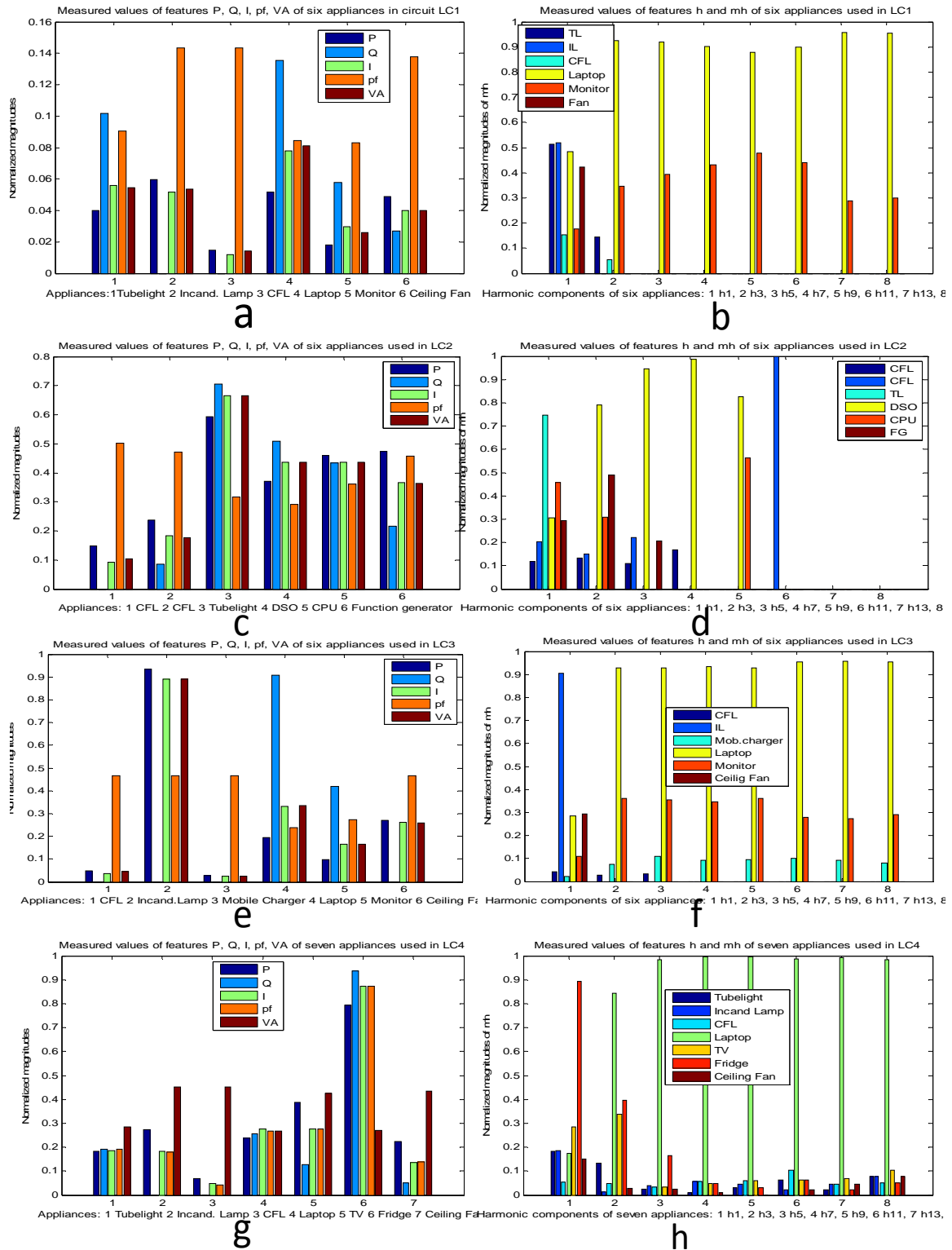

Figure 5. Feature P, Q, I, Pf, VA (a,c,e,g) and h, mh (b,d,f,h), LC1 (a, b) LC2 (c, d) LC3 (e, f) LC4 (g, h)

### 5.2. Importance of Spectral Components in Identification

The importance of spectral components as feature is reflected by the experiments conducted. Most of the identification problems resulting in poor and ambiguous identifications are, in our view, because of not considering the spectral magnitudes (mh) as an essential load signature of appliances. Further, we emphasize that only ‘significant’ contributors among the first eight odd harmonic components and their magnitudes

should be considered in identification. The criterion for judging the significance of contribution is already explained in section V.

**5.3. Identification in Power Circuits**

Since there cannot be more than two power appliances in one power circuit as per CPWD specifications, the identification was the easiest since their features were easily distinguishable. The details of the appliances used in three power circuits, PC1, PC2, and PC3 are shown in Table 2. The features CW, h, and mh of the two appliances, viz., induction cooker (IC) and air conditioner (AC), which are installed in circuit PC2, are shown in Figure 6 (a) and 6 (b) respectively. Simply because not more than two power appliances, which are generally attributed with high power consumptions and/or high harmonic contents, can be connected in one power circuit in accordance with the IEW specifications (CPWD), this facilitates a ‘natural’ disaggregation of complicated loads. Note that when these ‘complicated loads’ get mixed with the uncomplicated ones in a single point sensing approach, the procedure of identification is compelled to involve the use of several types of load signatures.

Table 3. Identification frequencies at different stages

Circuits /combinations	Light load appliances (6A Loads)			
	Identification at P, Q, h, and mh stages			
	P	Q	h	mh
LC1/(63)	Nil	38	20	05
LC2/(63)*	Nil	30	18	13
LC3/(63)	Nil	13	15	35
LC4/(127)	Nil	44	21	62

\*Only in this circuit two failures were found.

Therefore, in our suggested procedure, the natural load disaggregation provides an easy and unambiguous identification when compared with almost all other NIALM techniques in literature. Since it is very obvious that the cost involved in the use of several current sensors in our approach would be small compared to the cost involved in a multi feature approach, item wise detailed analysis is not considered necessary. This, in our view, is the one possible reason why none of the suggested NIALM approaches has made any significant headway in practical applicability and acceptability. Figure 7 show the features P, Q, I, pf, VA, and h, mh respectively, when both the power appliances (refer to example) are in use at the same time. The templates required to be stored in memory for power appliances identification are only three, and the identification procedure of templates matching in our experiments always concluded on 1<sup>st</sup> or 2<sup>nd</sup> stage.

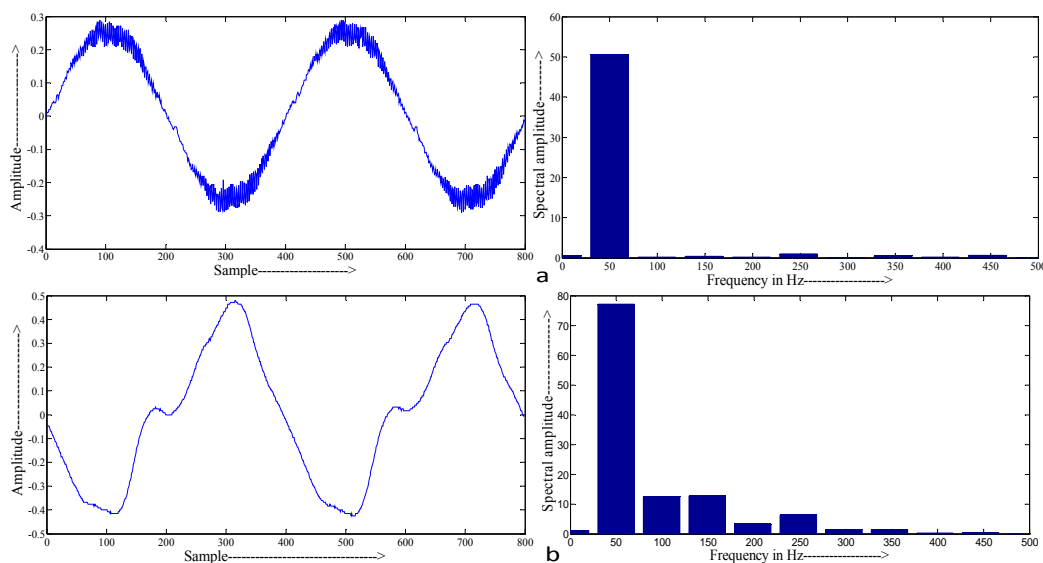

Figure 6. CW signature and h, mh feature of (a) IC, (b) AC

For a hypothetical case of two very similar power appliances with similar features, we also explored the use of the principles of Independent Component Analysis (ICA) as reported in [24]. However, in our experiments, we experienced no problems in identification with various combinations using the templates matching approach.

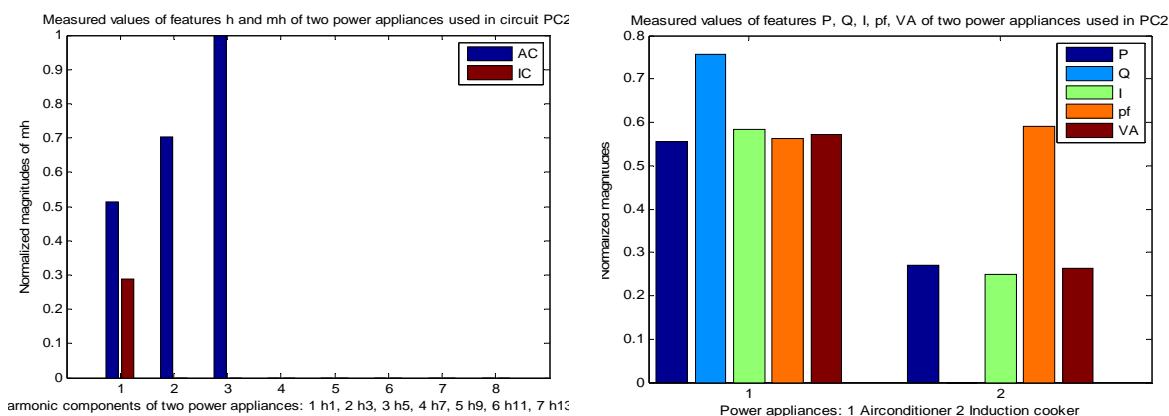

Figure 7. Profile (P,Q...,VA) and Profile h, mh in PC2

## 6. CONCLUSIONS

This paper presents a new approach to the identification of the electric appliances for Indian domestic consumers. It has been shown that the unresolved task of developing an easy and practical procedure for identifying domestic appliances is accomplished by a new procedure worthy of practical implementation in India and elsewhere subject to the internal electrical installations following specifications prescribed by CPWD. The identification procedure is based on a new approach of multi-point sensing rather than the single point sensing of CW suggested so far in NIALM research. The separation of power loads from light loads and multi-point sensing are the keys to the major simplification in the identification procedure. This new approach, based on templates matching, uses only four features: active and reactive power, harmonic components and their magnitudes. Since this procedure uses minimum number of features with a very simple algorithm, the cost of developing a smart meter for Indian domestic residences is bound to be very reasonable, not exceeding three thousand Indian rupees, equivalent of fifty dollars approximately. The next phase of research will include plug-in type loads.

## REFERENCES

- [1] G. W. Hart, "Non-intrusive appliance load monitoring", Proc. IEEE, vol. 80, no.12, Dec. 1992, pp. 1870-1891.
- [2] Jian Liang, Simon K. K. Ng, Gail Kendall, and John W. M. Cheng, "Load Signature Study—Part I: Basic Concept, Structure, and Methodology", *IEEE transactions on power Delivery*, Vol. 25, No. 2, April 2010, pp. 551-560.
- [3] Jian Liang, Simon K. K. Ng, Gail Kendall, and John W. M. Cheng, "Load Signature Study—Part II: Basic Concept, Structure, and Methodology", *IEEE transactions on power Delivery*, Vol. 25, No. 2, April 2010, pp. 561-569.
- [4] Zhenyu Wang and Guilin Zheng, "Residential Appliances Identification and Monitoring by a Nonintrusive Method", *IEEE transactions on Smart Grid*, Vol. 3, No. 1, March 2012, pp. 80-92.
- [5] Marisa Figueiredo, Anade Almeida and Bernardete Ribeiro, Home electrical signal disaggregation for non-intrusive load monitoring (NILM) systems, *Neurocomputing*, Vol. 96, pp. 66-73, Elsevier, September 2012.
- [6] Steven R Shaw, Steven B Leeb, Leslie K Norford, Robert W Cox, "Nonintrusive Load Monitoring and Diagnostics in Power Systems", *IEEE Trans on Instrumentation and Measurement*, Vol. 57, No 7, July 2008, pp 1445-1454.
- [7] D. Srinivasan, W. S. Ng, and A. C. Liew, "Neural-Network-Based Signature Recognition for Harmonic Source Identification", *IEEE Transactions on Power Delivery*, Vol. 21, No. 1, JANUARY 2006, pp.398-405.
- [8] Ming Dong, Paulo C M Meira, Wilsun Xu, C Y Chung, "Non-Intrusive Signature Extraction for Major Residential Loads", Digital object identifier 10.1109/TSG.2013.2245926, pp 1-9; (Accepted for publication in *IEEE Trans on Smart Grid*, 2013).
- [9] H Y Lam, G S K Fung, W K Lee, "A Novel Method to Construct Taxonomy of Electrical Appliances Based on Load Signatures", *IEEE Trans on Consumer Electronics*, Vol 53, No 2, May 2007, pp 65-660.
- [10] Michael Zeifman and Kurt Roth, Nonintrusive Appliance Load Monitoring: Review and Outlook, *IEEE Transactions on Consumer Electronics*, Vol. 57, No. 1, February 2011, pp. 76-84.
- [11] Online [http://www.smartgridnews.com/artman/publish/Technologies\\_Metering/Nein-German-ministry-rej](http://www.smartgridnews.com/artman/publish/Technologies_Metering/Nein-German-ministry-rej), "German ministry rejects smart meters". (News dated 8/18/2013).

- [12] Online [http://www.smartgridnews.com/artman/publish/Technologies\\_Metering/Nein-German-ministry-rej](http://www.smartgridnews.com/artman/publish/Technologies_Metering/Nein-German-ministry-rej) (News dated 8/18/2013); "Smart meters" (News dated 8/15/2013).
- [13] "Energy Statistics 2013", 20<sup>th</sup> issue, published by Central Statistics Office, Ministry of Statistics and Program Implementation, Govt of India, New Delhi.
- [14] Online <http://indianpowersector.com/home/about>. "Overview of Indian Power Sector"
- [15] Online <http://www.metering.com/node/2195914>, "Smart grid pilot project in India short listed"
- [16] Online <http://www.smartgrid-for-india.blogspot.in/p/companies.html>, "Smart Grid for India".
- [17] Online <http://www.smartgrid-for-india.blogspot.in>, "Smart Grid Interaction: IEEE SA pinpoints four key challenges for Smart Grid Implementation in India, October 24, 2012
- [18] Online [http://www.asian-power.com/sites/default/files/asianpower/.../AP\\_May\\_2013\\_Ir\\_12.pd](http://www.asian-power.com/sites/default/files/asianpower/.../AP_May_2013_Ir_12.pd), "metering india smartly-Asian Power".
- [19] Online <http://www.desismartgrid.com/2013/05/Indian-power-minister-leads>, "Indian Power Minister leads high-level delegation to Germany for Smart Grids".
- [20] R. S. Prasad, Sunil Semwal "A Simplified New Procedure for Identification of Appliances in Smart Meter Applications", *Proced. Of 7<sup>th</sup> IEEE International Systems Conference*, April 15-18, Orlando, Florida, USA, 2013 pp. 339-344.
- [21] M. Dong, P.C.M. Meira, W. Xu, and W. Freitas, "An event window based load monitoring technique for smart meters", *IEEE Trans Smart Grid*, vol 3, no 2, pp 551-560.
- [22] M. Berges, E. Goldman, H.S. Mathews, and L. Soibelman, "Learning systems for electric consumption of buildings", in *Proc ASCE Int Workshop on Computing in Civil Engineering*, Austin, TX, USA, pp1-10.
- [23] Online <http://arduino.cc/en/Main/ArduinoBoardMega2560>
- [24] Sunil Semwal, Deepak Joshi, R.S. Prasad, Dogga Raveendhra "The practicability of ICA in home appliances load profile separation using current signature: a preliminary study", *Conf. Proced. of IEEE international conference ICPEC'13, Dingdigul, Tamilnadu, India, Feb 6-8, 2013*, pp 756-759
- [25] Rao, Gummadi Srinivasa, and Y. P. Obulesh. "Voltage Profile Improvement of Distribution System using Distributed Generating Units", *International Journal of Electrical and Computer Engineering (IJECE)* 3.3 (2013): 337-343.
- [26] Zubair, Ahmed, Aman Abdulla Tanvir, and Md Mehedi Hasan. "Optimal planning of standalone solar-wind-diesel hybrid energy system for a coastal area of Bangladesh", *International Journal of Electrical and Computer Engineering (IJECE)* 2.6 (2012): 731-738.

## BIOGRAPHIES OF AUTHORS



**Sunil Semwal:** Pursuing Ph.D from Graphic Era University, he received his B.Tech degree in Instrumentation Engineering from University Science and Instrumentation Centre, Srinagar Garhwal, Uttrakhand, India and M.E. degree in Electronics from Punjab Engineering College, Chandigarh, Punjab, India. Currently he is working as Assistant Professor in Electrical and Electronics Engineering department at Graphic Era University Dehradun, Uttrakhand, India. His area of interest is smart metering, NIALM and artificial intelligence



**Dr. Rai Sachindra Prasad:** Received his Ph.D degree in electrical engineering from Indian Institute of Technology Kharagpur, India and PG Diploma in instrument technology from IISc Bangalore, India. Currently he is working as Professor in Electrical and Electronics Engineering department at Graphic Era University Dehradun, Uttrakhand, India. His area of interest is Smart Meter/ Smart Grid; Systems Engineering (Modeling Natural systems); Integration of Renewable Energy Sources in micro-grid; PC-based Instrumentation.