

On the Analogy of Non-Euclidean Geometry of Human Body With Electrical Networks

Alexander Penin*, Anatoli Sidorenko*, Ashok Vaseashta**

* D. Ghitu Institute of Electronic Engineering and Nanotechnologies, Chisinau, Moldova

** IASC/ICWI, NUARI, 13873 Park Center Rd. Ste 500, Herndon VA, USA

Article Info

Article history:

Received Jan 13, 2014

Revised Apr 20, 2014

Accepted May 8, 2014

Keyword:

Electrical network

Human body

Möbius equivalent

Non-Euclidean geometry

ABSTRACT

A review of application of non-Euclidean geometries for interpreting the process of the growth in the human body is presented and features employing non-Euclidean geometries in the electric circuit theory are modeled. Growth of the human body and changes of parameters of an operating regime of an electronic network correspond to projective and conformal transformations which possess an invariant being the cross-ratio of four points. The common mathematical apparatus represents interdisciplinary approach in view of analogy of processes of a different physical nature. The results obtained here demonstrate development of a methodology of application of non-Euclidean geometries and its biological correlation to the growth of human body.

Copyright © 2014 Institute of Advanced Engineering and Science.
All rights reserved.

Corresponding Author:

Ashok Vaseashta,

IASC/ICWI, NUARI,

13873 Park Center Rd. Suite 500

Herndon, VA USA

Email: prof.vaseashta@ieee.org

1. INTRODUCTION

The growth of the human body is essentially a nonlinear process for ordinary or Euclidean geometry. Analysis of the structure and growth reveals that separate body parts or all the three-component kinematics blocks (the phalanxes of fingers, the three-membered extremities and the three-membered body) change according to Möbius transformations which are characteristic for conformal and projective geometry. Such transformations possess an invariant or invariable value. Therefore, all the above mentioned three-component blocks are characterized by a constant value throughout the human life [1], [2]. From this point of view, Euclidean geometry appears as a possible analytical instrument. The advent of the special theory of relativity led to a new term, "geometrization of physics", which is a methodological doctrine and may be defined as the application of geometrical methods in physics, whenever possible. This is formally the theory of invariants of some group of transformations (Poincaré-Lorentz group), or space-time geometry. The basic principles of projective geometry which are reflected in methods of linear perspective. The geometrization of physics, biology, and neuroscience covered a multitude of fields and as a result of its biological application, there is an image of a subject in which both distances and corners change. It is important to note that these changes appear neither arbitrarily or randomly, but are invariant being the cross-ratio of four points on a straight line (a double proportion).

Geometry of the Euclidean space complemented by one infinitely remote point, is called the conformal geometry [3]. Projective interpretation in the form of a stereographic projection of points of the sphere to the plane gives an example of the conformal plane (as an example of such stereographic projection is cartography), when the value of the cross-ratio of four points remains constant [4]. Such plane projection is applied in physics for solving of electrostatic problem.

Möbius's certain subgroup of transformations corresponds to Lobachevski's geometry or hyperbolic geometry, the so-called Poincare's conformal interpretation [5]. It indicates that the space of visual perception is characterized by Lobachevski geometry. A number of publications show that in electric networks, the changes of operating regime parameters can be interpreted as projective and conformal transformations. In addition, the relationship of regime parameters at different parts of a network also is being described by projective transformations [6], [7], [8]. An interdisciplinary approach applies common mathematical apparatus in various areas of science and the similarity of processes of different physical nature. As the example of such interdisciplinary approach, we present a review of application of non-Euclidean geometries for interpretation of the human body growth process, and the features of use of non-Euclidean geometries in the electric circuit theory are shown.

2. ON THE FEATURES OF GEOMETRIC TRANSFORMATIONS

Projective transformations General case: Generally, the projective transformation of points of one straight line U_L into the points of the other line R_L is set of points with the projection center S or the three pairs of respective points (shown in Figure 1). The projective transformations preserve the cross ratio of four points,

$$m = (R_L^1 R_L^2 R_L^3 R_L^4) = \frac{R_L^2 - R_L^1}{R_L^2 - R_L^4} \div \frac{R_L^3 - R_L^1}{R_L^3 - R_L^4}$$

$$m = (U_L^1 U_L^2 U_L^3 U_L^4)$$

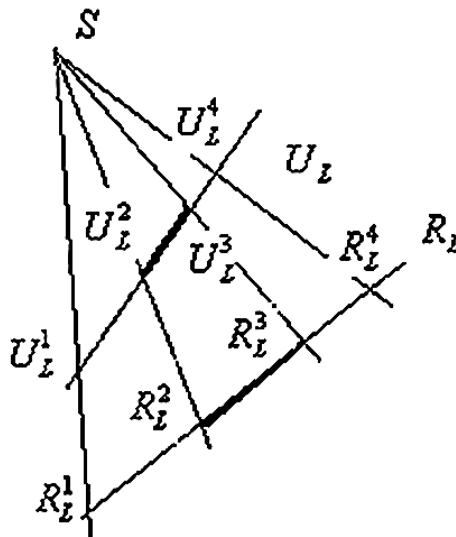

Figure 1. Projective transformation of straight lines points

Affine transformation: There is the projection center S , but the straight lines are U_L, R_L parallel. Therefore, the invariant of an affine transformation is the simple ratio or proportion of three points.

Euclidean transformation: If the projection $S \rightarrow \infty$ center and the straight lines U_L, R_L are parallel, the projection is carried out by parallel lines. This projection corresponds to the Euclidean transformation, which is parallel translation of a segment. The Euclidean transformation preserves the difference of points. The transformations of an initial rectangular coordinate grid, considered here are presented in Figure 2.

Stereographic projection: The projection of points of the sphere $U_i(U_1, U_2)$ from the top pole on the tangent plane n_1, n_2 placed at the bottom pole is presented in Figure 3. For the sake of simplicity, the coordinate axes U_1, U_2 and n_1, n_2 are coincident.

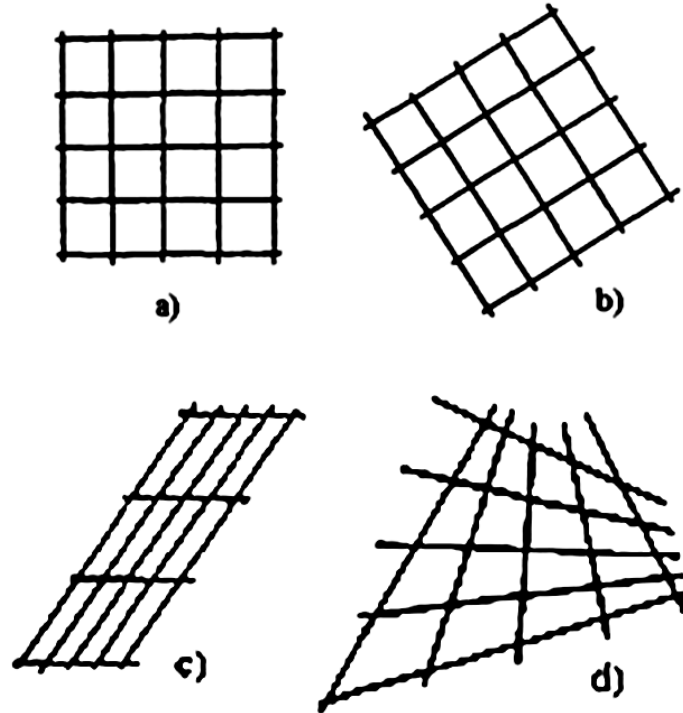

Figure 2. a): Characteristic transformation of the Cartesian grid by various group transformations, b): Euclidean, c): affine, and d): projective.

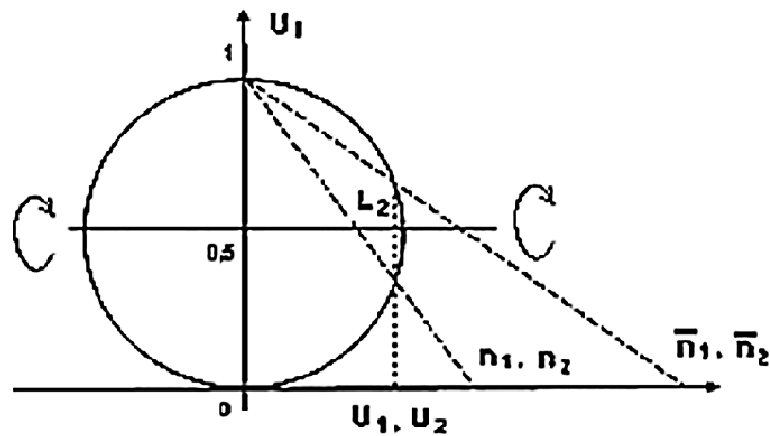

Figure 3. Stereographic projection of the sphere on the conformal plane n_1, n_2

The conformal plane differs from Euclidean by existence of one infinitely remote point corresponding to the top pole of the sphere.

Conformal transformations: The area of changes of the values U_1, U_2 corresponds to the sphere equator in Figure 4a.

Let the value U_1 to be, $U_1 = const$ (that is the line L_1). The circular section L_2 is on the sphere while the circle L_3 is on the plane n_1, n_2 . The similar family of circles is described by the rotation group of sphere, as it is shown by arrows in Figure 4. By definition, Möbius's group of transformations preserve the values of angles and transform spheres into spheres. In addition, Möbius's transformations are locally similar transformations, as shown in Figure 5.

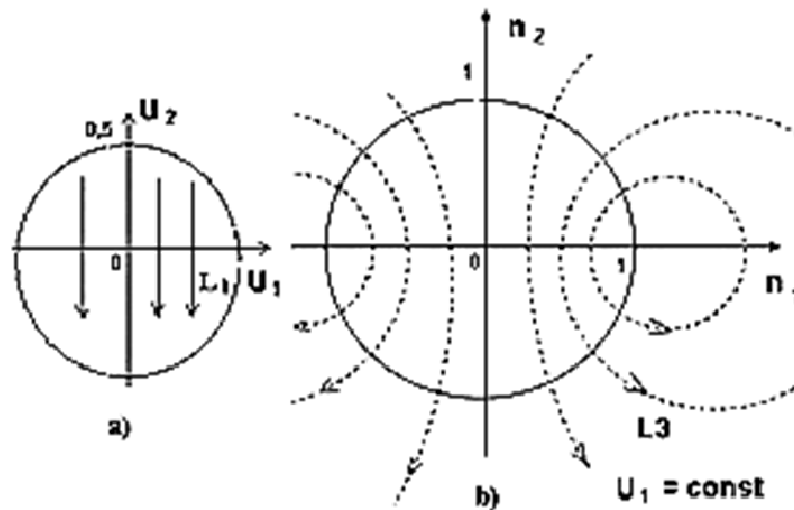

Figure 4. Correspondence of the plane U_1, U_2 , a): to conformal plane n_1, n_2 , b): for $U_1 = const$

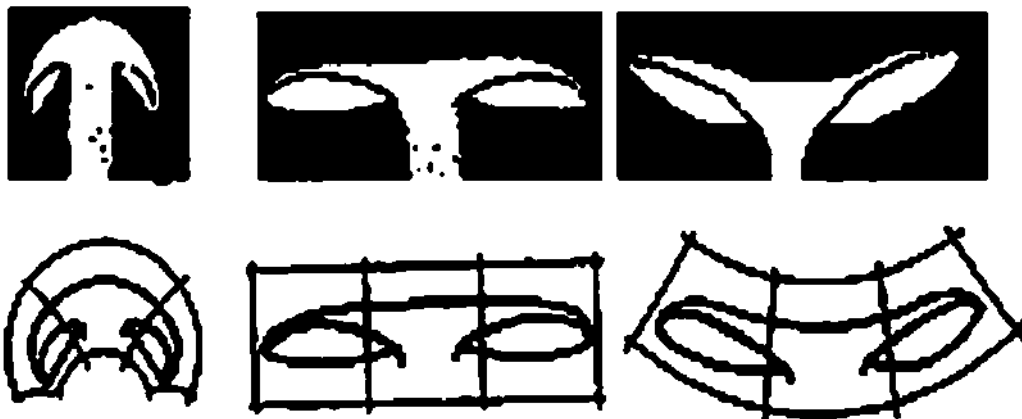

Figure 5. Growth transformations in cap of fungus and their modeling as Möbius's transformations.

3. GROWTH CHANGES OF VALUES OF THE HUMAN BODY AS NON- EUCLIDEAN TRANSFORMATIONS

Nonlinear transformations of human skull as a function of aging are described as Möbius's transformations in Figure 6.

Growth changes of three-component kinematic blocks (the phalanxes of fingers, the three-membered extremities and the three- membered body) are characterized by the constant value of the cross-ratio of four points. In particular, for the fingers the cross- ratio has is given by:

$$W = \frac{(C - A) \cdot (D - B)}{(C - B) \cdot (D - A)} = const$$

The expressions in parentheses are the lengths of segments between the end points of finger phalanxes. AB, BC, and CD are the lengths of basic phalanx, middle one and the end phalanxes. The values of the cross-ratio of all the blocks, at least during individual development, are grouping around the benchmark 1.31. Meanwhile, the growth of the human body is essentially nonlinear, as shown in Figure 7.

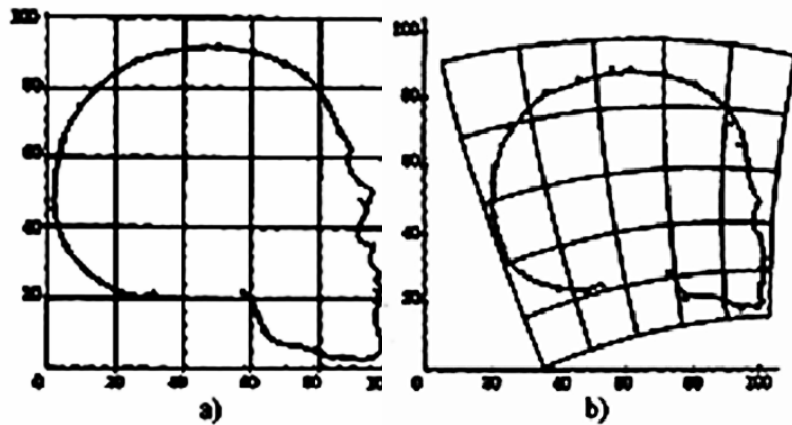

Figure 6. Möbius's transformations in the modelling of ontogenetic transformations of human skulls. Profiles of the skull of, a): an adult, and b): a 5-year old child.

Thus, all three-membered blocks of the human kinematics are Möbius equivalent and Möbius invariable during the human lifetime.

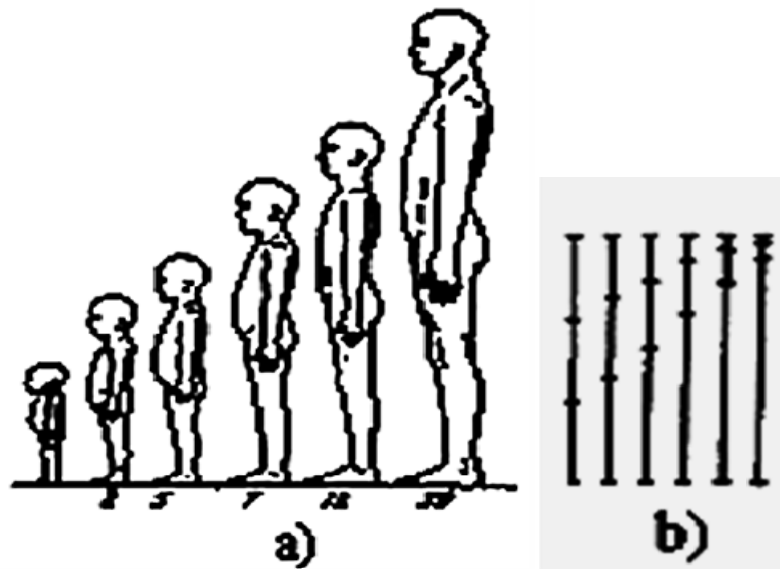

Figure 7. Changes of the growing human body with, a): aging, and b): three-stretch parts cross-ratios are equal to 1.31.

4. PROJECTIVE TRANSFORMATIONS OF ELECTRIC NETWORK - THE CROSS- RATIO VALUES

Let an electric circuit (an active two-pole circuit A), as shown in Figure 8 is considered. At change of load $R_L > 0$ from a regime of short circuit (SC) ($R_L = 0$) to the open circuit (OC) ($R_L = \infty$), the load straight line or I-V characteristic $I_L(U_L)$ is obtained. Further, it is possible to calibrate the I-V characteristic by the load resistance values variation.

The equation $V_L(R_L)$ has the characteristic linear-fractional view,

$$V_L = V_0 \frac{R_L}{R_i + R_L}$$

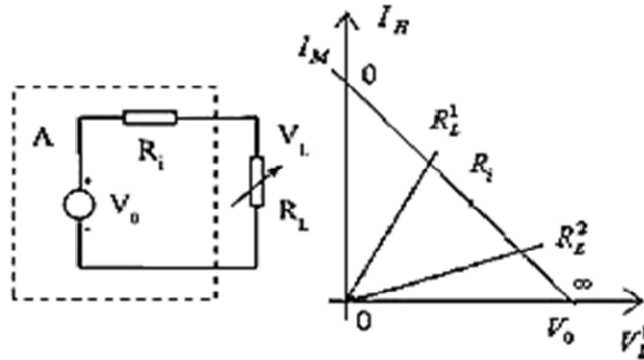

Figure 8. Electric circuit with variable load and its I-V characteristic

It gives a basis for consideration of the transformation of the straight line R_L into line V_L as projective one in Figure 9.

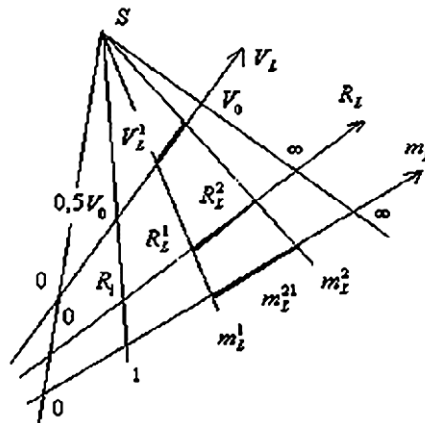

Figure 9. Projective transformation $R_L \rightarrow U_L$ and the cross ratio m_L

It is convenient to use the points of characteristic regimes, as the pairs of respective points, namely the short circuit, open circuit, and maximum load power. If the fourth point is the point of running regime, R_L^1, V_L^1, I_L^1 , then the cross ratio m_L has the form,

$$m_L^1 = (0 R_L^1 R_i \infty) = \frac{R_L^1 - 0}{R_L^1 - \infty} : \frac{R_i - 0}{R_i - \infty} = \frac{R_L^1}{R_i}$$

$$m_L^1 = (0 \ V_L^1 \ 0,5V_0 \ V_0) = \frac{V_L^1}{V_0 - V_L^1} \tag{1}$$

Thus, the coordinate of running regime point is a set of this values m_L , which is defined in the invariant manner through the various regime parameters, R_L, V_L . The regime change $R_L^1 \rightarrow R_L^2$ can be expressed similarly as,

$$m_L^{21} = (0 \ R_L^2 \ R_L^1 \ \infty) = \frac{R_L^2}{R_L^1} = \frac{V_L^2}{V_0 - V_L^2} : \frac{V_L^1}{V_0 - V_L^1} \tag{3}$$

Now, it should be made the identical changes of the regime for different initial regimes on the line V_L in Figure 10.

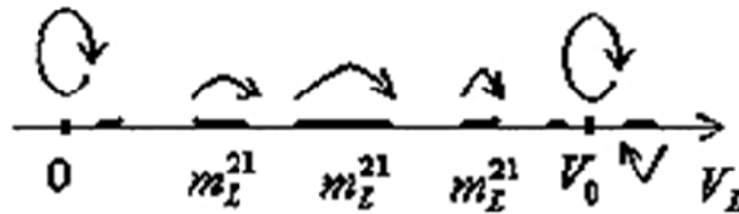

Figure 10. Identical changes of regime for different initial regimes

For this purpose, from the equation (2) we obtained an expression for $V_L^2 (V_L^1)$, eliminating R_i for two values R_L^2, R_L^1

$$\frac{V_L^2}{V_0} = \frac{m_L^{21} \cdot \frac{V_L^1}{V_0}}{(m_L^{21} - 1) \cdot \frac{V_L^1}{V_0} + 1} \tag{4}$$

The transformation obtained using the parameter m_L^{21} translates the point of initial regime V_L^1 into the point V_L^2 . Therefore, by keeping the parameter of this transformation invariable and by setting different values of initial regime V_{L1}^1, V_{L2}^1 , etc., we obtain the points of the subsequent regimes V_{L1}^2, V_{L2}^2 , etc., which form a segment of invariable length (in sense of projective geometry), that is considered as a segment movement in geometry. Here, the character of a change of Euclidean (usual) length of the segment is visible. Approaching to the base points, Euclidean length is decreasing to zero and then is increasing again at the moment of transition to the external area. Thus, regime changes are projectively similar for different initial regimes. The change of a segment with an invariable value of the cross-ratio is similar to that shown in Figure 7b).

In the theory of the projective transformations, the fixed points play an important role, which can be considered as the base points. For their finding, the equation (4) is solved for condition $V_L^1 = V_L^2$. It turns out the two real roots, $V_L = 0, V_L = V_0$ which define a hyperbolic transformation and hyperbolic (Lobachevski) geometry, respectively. If roots of the equation coincide, one fixed point defines a parabolic transformation and, respectively, parabolic (Euclidean) geometry. If roots are imaginary, geometry is elliptic (Riemannian). **Input- output projective conformity of network** - Let us consider a two-port circuit TP (Figure 11). It can be represented in an equation, such as,

$$\begin{pmatrix} V_0 \\ I_0 \cdot \rho \end{pmatrix} = \begin{pmatrix} ch \gamma & sh \gamma \\ sh \gamma & ch \gamma \end{pmatrix} \cdot \begin{pmatrix} V_1 \\ I_1 \cdot \rho \end{pmatrix}$$

where γ is an attenuation coefficient, ρ is characteristic or wave resistance. This transformation can be seen as a rotation of the radius-vector $0Y_L$ of constant length at the angle γ to the position $0Y_{IN}$ in the pseudo-Euclidean space I, V (Figure 11b). Then, we have also the following invariant

$$V_1^2 - I_1^2 \rho^2 = V_0^2 - I_0^2 \rho^2$$

as length of the vector $0Y_L$. This approach corresponds to Lorentz transformations in mechanics of the relative motion. The conductivities at the input and output of the two-port network are connected already by linear- fractional expression,

$$Y_{IN1} \rho = \frac{Y_{L1} \rho + th \gamma}{1 + Y_{L1} \rho \cdot th \gamma}$$

This expression corresponds to the rule of addition of relativistic velocities. Let us consider the points Y_{L1}, Y_{IN1} on superposed axis in Fig.11(c). This figure represents a point movement from the position Y_{L1} to the position Y_{IN1} (or the segment movement $Y_{L1} Y_{IN1}$) for different initial values Y_{L1} as shown by arrows. Then, the points ± 1 are fixed. The cross-ratio of the points Y_{L1}, Y_{IN1} , relatively fixed points, determines the “length” of segment $Y_{L1} Y_{IN1}$ or the maximum of efficiency K_{PM} of a two-port circuit:

$$m(Y_{L1} Y_{IN1}) = \frac{1 - th \gamma}{1 + th \gamma} = K_{PM}$$

Thus, one more founded invariant is equal to a concrete number. That invariant is similar to the cross-ratio of the human body equal to 1.31.

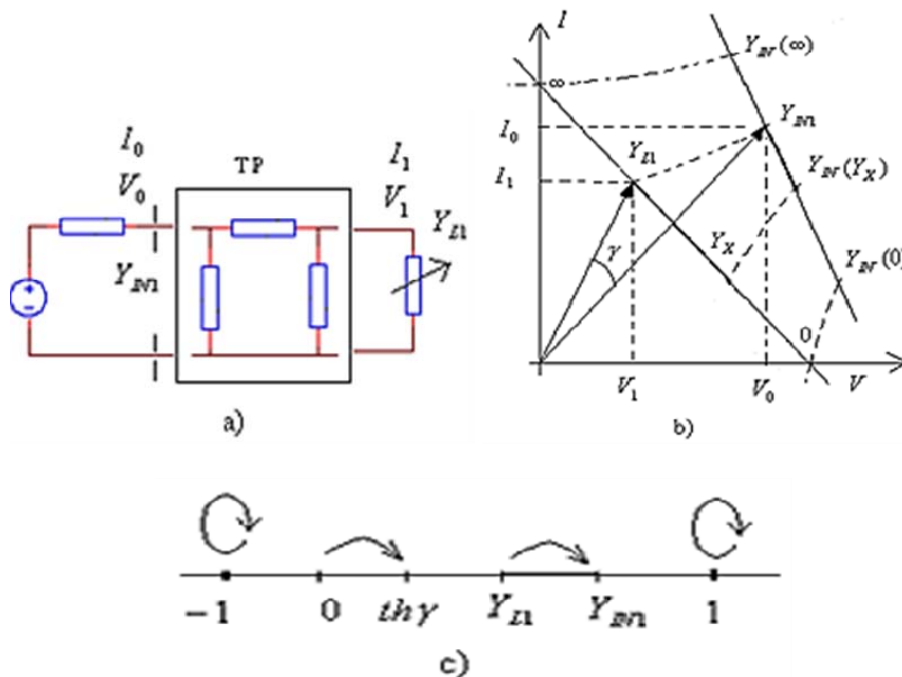

Figure 11. a): Two-port network ; b): input- output characteristic; and c): movement of the segment for different initial values .

Cascade connection of two-ports - Let us consider the cascaded two-ports TP1 and TP2 in Figure 12. The relationship of regime parameters at different parts of the network or “movement” on these parts also corresponds to projective transformations. The load change from the value Y_{L2}^1 to the value Y_{L2}^2 defines the correspond changes Y_{L1} , Y_{IN1} . The length of segments of all the load lines is different for the usually used Euclidean geometry.

If the mapping is viewed as the projective transformation, the invariant, which is the cross-ratio of four points, is performed and defines the same length of segments. Thus, networks of this kind are projectively – similar. Therefore, there is some kind of the electro - biological analogy: disproportionate change of segments of load line for different parts of a network corresponds to growth changes of parts of the human body.

Projective plane - If the network containing two changeable loads, projective geometry for the plane can be shown. In that case, the load straight lines form the coordinate triangles. Therefore, networks of this kind are also projectively - similar.

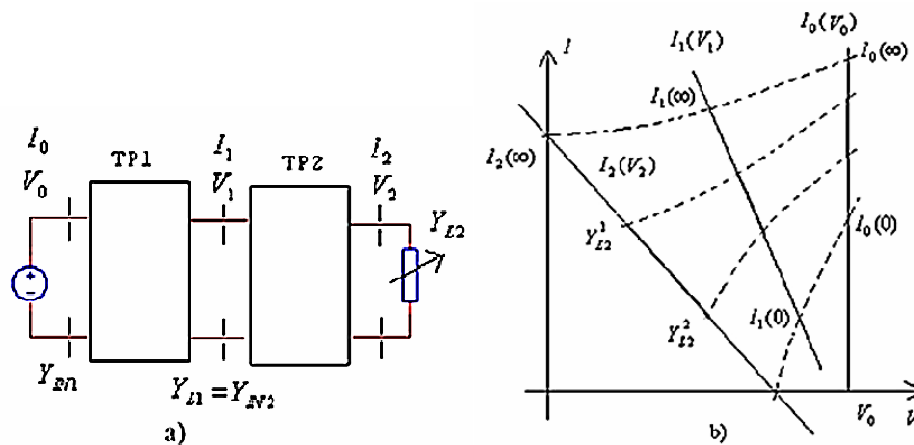

Figure 12. a): Cascade connection of two two-ports; b): Corresponding I-V characteristics.

5. CONFORMAL TRANSFORMATIONS OF ELECTRIC NETWORK

Let us consider a power supply system with two voltage regulators VR_1, VR_2 and loads R_1, R_2 shown in Figure 13. The regulators define voltage transmission coefficient or transformation ratio n_1, n_2 . The voltage regulators are connected to a limited capacity supply, voltage source U_0 . An interference of the regulators on regimes or load voltages U_1, U_2 is observed because of existence of an internal resistance R_i . Let us consider the case $R_i = R_1 = R_2$.

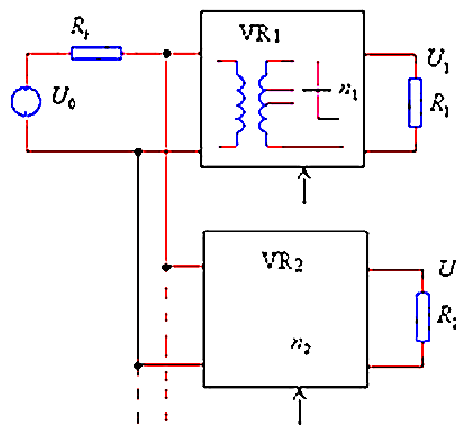

Figure 13. Power supply system with two voltage regulators

The network behavior or “kinematics” via variable parameters n_1, n_2 is described by a sphere in the coordinates U_1, U_2, U_i in Figures 3, 4. For regulation, it is better to use such groups of transformations or movements of points in the planes U_1, U_2 and n_1, n_2 , when it is impossible to deduce a working point over the circles, which correspond to the equator of sphere by a finite switching number.

In this sense, we derive a hyperbolic geometry. On the plane U_1, U_2 it is the Beltrami-Klein's model and on the plane n_1, n_2 it is the Poincare's model. The corresponding circle carries the name of the absolute and defines an infinitely remote border. Let us put the value $n_2 = 0$. Then, the regime change goes only on axes U_1 and n_1 . The conformity of the characteristic points and running point is shown in Figure 14.

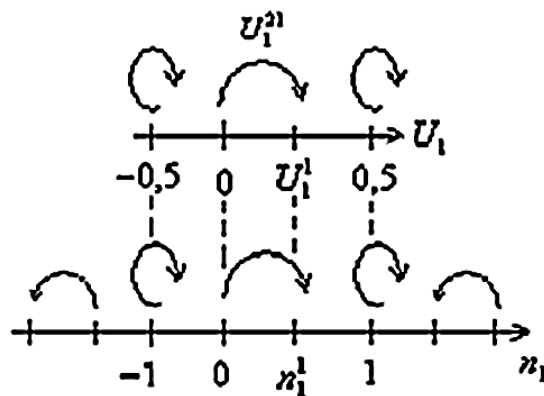

Figure 14. Conformity of the variables U_1, n_1 of the hyperbolic transformations

From the methodical point of view, it is useful to consider the hyperbolic transformation by the analogy, corresponding to the relativistic rule of speed composition in relative movement mechanics. If, for example $U_1^1 = 0.5$, then $U_1^2 = 0.5$ and it does not depend from the value U_1^{21} . In the case $R_i \neq R_1 \neq R_2$, the sphere will be transformed to an ellipsoid. Therefore, these network will be conformally or Möbius-similar for the plane n_1, n_2 . Therefore, there is some kind of the electro - biological analogy: the change of network parameters corresponds to growth changes of biological objects.

6. CONCLUSION

The analysis of human growth and analysis of operating regimes of electric networks shows an invariant of projective and conformal transformations. Different types of the cross-ratio take place for an electric network. The change of an operating regime of the given network or change of network parameters results to the projective or conformal similarity of networks. The established electro-biological analogy develops a methodological basis of application of non-Euclidean geometries for these areas.

REFERENCES

- [1] S.V. Petukhov, “Non-Euclidean geometries and algorithms of living bodies,” *Computers & Mathematics with Applications*, 17, no. 4-6, pp. 505-534, 1989. <http://www.sciencedirect.com/science/article/pii/0898122189902484>
- [2] T. Lundh, J. Udagawa, S. E. Hanel, and H. Otani, “Cross- and triple- ratios of human body parts during development,” *The Anatomical Record*, vol.294, no.8, pp.1360–1369, 2011.
- [3] Conformal geometry, Available: http://en.wikipedia.org/wiki/Conformal_geometry.
- [4] Stereographic projection, Available: http://en.wikipedia.org/wiki/Stereographic_projection.
- [5] Hyperbolic geometry, Available: http://en.wikipedia.org/wiki/Hyperbolic_geometry.
- [6] A. Penin, “The invariant properties of two-port circuits,” *International Journal of electrical and computer engineering*, vol.4, no.12, pp.740- 746, 2009.
- [7] A. Penin, “Invariant properties of cascaded six-pole networks,” *International Journal of circuits, systems and signal processing*, vol.6, no.5, pp.305-314, 2012.

- [8] A. Penin, A. Sidorenko, "Method for transmission of two signals through the three-wire direct current line" Patent MD 543, Int. Cl. H04B 3/32, H04B 3/54, G01R27/16, BOBI 8/2012, page 28.

BIOGRAPHIES OF AUTHORS



Dr Alexander Penin is senior research associate at the Institute of Electronic Engineering and Nanotechnologies, Academy of Sciences of Moldova, Kishinev Moldova. He obtained PhD in Engineering from the Polytechnic Institute of Odessa, Ukraine in 2011. He specializes in Electric circuit theory and has served as principal designer at the Academy of Sciences of Moldova for many projects.



Prof. Anatolie Sidorenko is Director of Institute of Electronic Engineering and Nanotechnologies, Academy of Sciences of Moldova. Prior to assuming this position in 2006, he served as the Head of the Cryogenic Laboratory. He obtained PhD in Solid State Physics at the Institute for Low Temperatures, Kharkov, Ukraine. In 1991, he obtained Habilitation in Physics of Superconductors and was nominated as Member-correspondent of the Academy of Sciences of Moldova in 2012 and was awarded the "Dmitrie Cantemir" Gold medal - the highest recognition of the Moldavian Academy of Sciences. He has served as visiting scientist in Institut für Physik, University of Augsburg, Germany and visiting scientist in University of Karlsruhe, University of Augsburg and Institute of Nanotechnology, KIT- Karlsruhe, Germany.

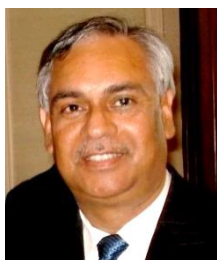

Prof. Ashok Vaseashta received a PhD from the Virginia Polytechnic Institute and State University, Blacksburg, VA in 1990. Before joining as the Director of Research at the Institute for Advanced Sciences Convergence (IASC) and International Clean Water Institute (ICWI), he served as a Professor of Physics and Physical Sciences and Director of Research at the Nanomaterials Processing and Characterization Laboratories, Graduate Program in Physical Sciences at Marshall University. Concurrently, he holds several visiting/distinguished/chaired Professorships in several international institutions. Since 2007, he served the U.S. Government in several positions supporting counter terrorism efforts. He is fellow of the American Physical Society, Institute of Nanotechnology, New York Academy of Sciences. He was awarded Gold medal by the State Engineering University of Armenia and several other national and international awards. He is an active member of several national and international professional organizations.