

Wind Generation Impact on Symmetrical Fault Level at Grid Buses

A. Hamzeh, Sadeq A. Hamed, Zakaria Al-Omari

Electrical Engineering Department, Faculty of Engineering, Al-Ahliyya Amman University, Jordan

Article Info

Article history:

Received Oct 9, 2017

Revised Mar 14, 2018

Accepted Aug 21, 2018

Keyword:

Evaluation criteria
Grid balanced faults
Impact on fault level
Wind generation

ABSTRACT

This paper mainly aims at evaluating quantitatively the impact of wind turbine generators (WTGs) on fault level (FL) in case of a balanced fault occurring in the host grid (HG). This impact is not generic but it depends on the grid configuration, operation mode, and load profile; the impact may be positive for a network while it is negative for another one. Therefore, the impact will be estimated for a specific distribution network (DN). The grid faults and wind generations (WGs) are simulated by the simulation tool Power Factory DigSilent 14.0.506. The paper addresses the influence on FL of grid buses in general and particularly on FL of the point of common coupling (PCC). The effect of both penetration and dispersion levels of embedded WTGs on fault response is also investigated. Moreover, the influence of WG type on FL is assessed. It is concluded, among other points, that the FL at PCC could rise by about 150% and 17% due to embedded WG of type 1 and type 2 respectively, what it leads to the recommendation to avoid installing type 1 wind systems for new wind farms.

Copyright © 2018 Institute of Advanced Engineering and Science.
All rights reserved.

Corresponding Author:

Zakaria Al-Omari,

Electrical Engineering Department, Faculty of Engineering, Al-Ahliyya Amman University,
Al-Ahliyya Amman University Post Office, Zip code 19328 (Amman Jordan).

Email: zomari@ammanu.edu.jo

1. INTRODUCTION

In recent years, as wind power (WP) is sustainable and green power, its penetration in power system has increased significantly and is expected to persist rising in the future [1]. The worldwide cumulative installed wind capacity was around 487 GW at end 2016 as seen from Figure 1. The Penetration of WP reached high levels in 2015 in some countries as Denmark (21%), Portugal (18%), Ireland (14%), and Germany (9%). It is worth noting that about 82 countries are exploiting WP on a commercial level [2, 3].

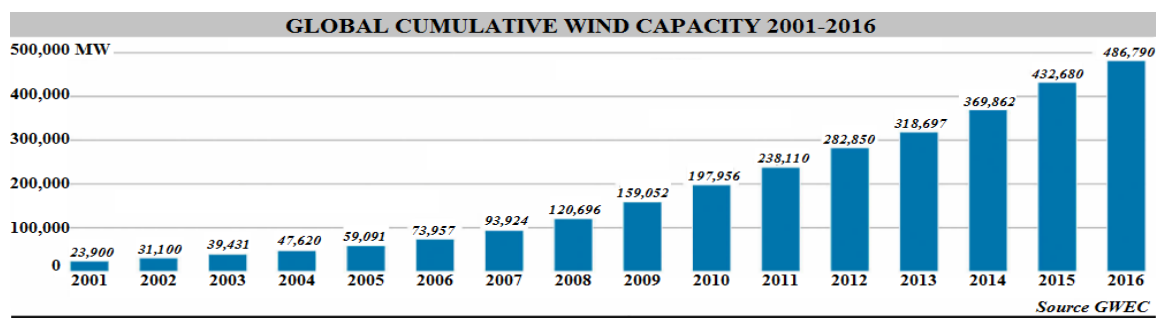

Figure 1. World wind power cumulative capacity 2001-2016[2]

The penetration of WP can be defined in terms of energy or power (capacity) as the WG production percentage of the total electric energy demand on one hand or as of WP capacity percentage of peak load [4]. The increase of integrated WG raised the interest in studying the influence of integrated wind units on the static and transient performance of the power system. This effect is not generic and can be positive or negative depending on the type of WG system, HG configuration and load profile. There are mainly four types of WG systems with different interface modes. Types 1 and 2 represent a fixed-speed asynchronous generator (AG) and variable-slip AG with variable rotor resistance respectively [5]. Both types are directly connected to the grid. Type 3 represents a variable-speed, doubly-fed AG with two-ways connection to the grid; namely rotor-side converter and direct stator connection.

Variable-speed generators with full converter grid interface belong to Type 4 systems. This paper focuses mainly on Type 4 wind system, where the interface between the variable-speed synchronous generator and the grid is an AC/AC converter including a DC link as shown in Figure 2 [6]. The HG is frequently subjected to different faults. Initially, when the installed WP capacity was not very high, wind generators are disconnected from the grid when a grid fault occurred. Recently, wind turbines (WTs) are required to remain connected during grid faults and, furthermore, to provide active support to the grid [7].

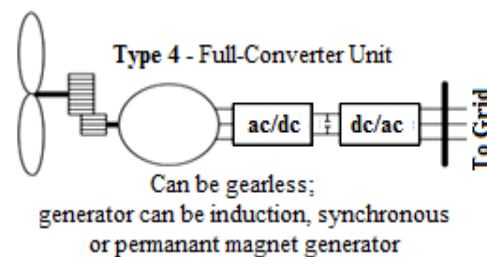

Figure 2. Wind turbine generator type 4 [8]

The reaction of wind generators to faults occurring on the HG is mainly determined by the generator type. Types 1 and 2 respond in a similar way as large induction machines used in industrial applications. The reaction of Types 3 and 4 to grid faults is determined by the control of the wind system [9]. Many researchers have studied the impact of distribution generation (DG) on the FL of hosting DN. Most studies conducted the research on case studies, because the DG impact is not generic as mentioned earlier in this paper [10]. Presents a study of effect of hybrid PV-WT on FL of a very simple network with one load bus using simple models for the studied system; the FL of the DN experienced 37% increase due to connected DG. The analysis of network strength at the point of WTGs connection (PCC) and a comparison of WTGs to support the AC network are discussed in [11]; the system modeling is very simple where the grid at PCC is represented as infinite bus. [12] provides an investigation of a case study network (small grid) concerning short circuit analysis among other processes with and without DGs using Matlab program; a maximum increase of 75.25% in FL has been recorded when DGs are placed in certain buses. In [13], the FL contributions of different WTGs for faults at the terminal of the generator were simulated using a simplified model to determine FL characteristics for symmetrical faults.

The main objective of this paper is using the German simulation program Power Factory DigSilent 14.0.506 to quantify the impact of integrating WG of Types 1 and 4 into the DN in case of balanced faults occurring in the hosting grid. The impact will be estimated for a typical weak DN. As the FL (MVA short circuit capacity) is an indicator for the "grid strength" on one hand and an important figure for circuit breaker (CB) selection on the other hand, this paper addresses the influence on the FL of grid buses, in general, and on the FL of the PCC, which is the grid point to which WT is connected in particular.

2. SIMPLE RULES FOR HOST CAPACITY OF WIND GENERATION

WG systems are connected to any voltage level of the distribution system. This voltage level is mainly determined by the connected WP (Host capacity). For a certain voltage level, it must be distinguished between PCC on the network and PCC on a bus. About five times wind capacity can be connected to a bus relative to that connected to network of the same voltage level. While small distributed WT systems up to 50 kVA are connected to low voltage network, wind units of 50-250 kVA capacity are connected to low voltage buses. The voltage levels used in distribution systems are: low voltage (LV<1kV), medium voltage (1 kV<MV<50 kV), and high voltage (50<HV<130). The exact values of voltage levels differ from country to

country [14]. Some recommended approximate rules are used in some countries for estimation of DG host capacity in terms of distribution system voltage levels. However, additional calculations should be performed to check the validity of these simple rules for the studied case. Table 1 shows some of the rules that are used.

Table 1. Design Rules for Host Capacity in Distribution Systems [9, 14]

Voltage Level	Host Capacity
LV network (400 V)	50 kVA
LV Bus (400 V)	200-250 kVA
MV network	2-5 MVA
MV Bus	10-40 MVA
HV	Up to 100 MVA

An alternative simple approach to deciding if a DG may be connected is to require that the three-phase short-circuit level (FL) at PCC is a minimum multiple of the DG rating, meaning $DG \text{ rating} = FL / \text{Multiple}$. Multiple as high as 20 or 25 has been required for WTs/wind farms in some countries, but again these simple approaches are very conservative. Some studies suggest a minimum multiple of ≥ 50 [15]. Maximizing of WG accommodation can be performed by means of mathematical programming techniques and genetic algorithms alongside fulfilling technical requirements as losses and FLs [16].

The interface inverters used in modern WT are pulse width modulated (PWM) converters using IGBTs or MOSFETs. These converters are able to control not only the active power but also the reactive power needed by the generator. To reduce the harmonics produced by such converters, filters should be used, which are not expensive due to the high frequency range (some kHz).

3. CONCEPT OF FAULT LEVEL

The balanced fault at a point of a network can be characterized in terms of the fault current if that would flow under fault conditions. This fault current must indeed be compared to the normal load current, which is inversely proportional to the nominal voltage. To compensate for the voltage level effect, the balanced fault at faulted bus is characterized in terms of the FL (short-circuit capacity SCC MVA) [17]. This quantity is usually expressed in MVA and is defined as

$$FL = \sqrt{3} V_{rated} \times I_f \quad [MVA] \quad (1)$$

Assuming that the base line voltage is equal to the nominal voltage, we find that the per unit value of the FL is equal to the per unit value of the fault current:

$$FL \text{ pu} = I_f \text{ pu} \quad (2)$$

Finally, if we assume that the voltage is equal to its nominal value prior to the fault, the per unit value of the FL is given by

$$FL \text{ pu} = \frac{1}{|Z_{th}|} \quad (3)$$

where Z_{th} is the Thevenin impedance, seen from the location of the fault looking back into the network.

The FL therefore is an indication of 'how close' a particular point is from the generation sources of a system. For example, FLs in an EHV transmission system can be three times in magnitude larger than in a LV distribution system. For strong grids, typical values of FL for voltages 0.4 kV, 10 kV, 15 kV, 30 kV, 70 kV, and 130 kV are 5 MVA, 400 MVA, 500 MVA, 1300 MVA, 2500 MVA, and 10 GVA respectively [18]. Rather than providing a detailed model of their network to the designers of WG scheme, distribution utilities usually give them the FL at the connection point and the ratio X/R of the source impedance. It is known that all types of distributed generators increase FLs to some extent. As the increased FL could exceed the design limit of the network, quantitative studies on DG impact on FL are required to avoid the possible negative effects on system operation and harm to personnel as well [19].

4. EVALUATION CRITERIA

For achieving a systematic methodology to quantify the impact of WT generation on the hosting grid, a set of evaluation criteria are defined and mathematically formulated [20,21].

- a. Penetration level (PL%): It is defined as the ratio of the total WG power to the peak load of the hosting grid:

$$PL\% = \frac{\sum P_{WT}}{\sum P_{load}} \times 100 \quad (4)$$

- b. Dispersion level (DL%): It is defined as the ratio of the number of WT buses to the number of load buses:

$$DL\% = \frac{\#WT\ Buses}{\#Load\ Buses} \times 100 \quad (5)$$

This criterion points out to the geographic dispersion of WTGs and not its capacity.

- c. Fault level rise index (FLRI%): FLRI% for a bus is the ratio of the difference between FL with WT generation and FL without WT generation, to the FL without WT generation:

$$FLRI\% = \frac{FL_{+WT} - FL_{-WT}}{FL_{-WT}} \times 100 \quad (6)$$

5. THE STUDIED NETWORK

A wide range of simulations have been carried out for a typical distribution grid 20/0.4 kV as shown in Figure 3 using the software Power Factory DigSilent 14.0.506 [22]. The grid is a modified version of an example network in the Power Factory.

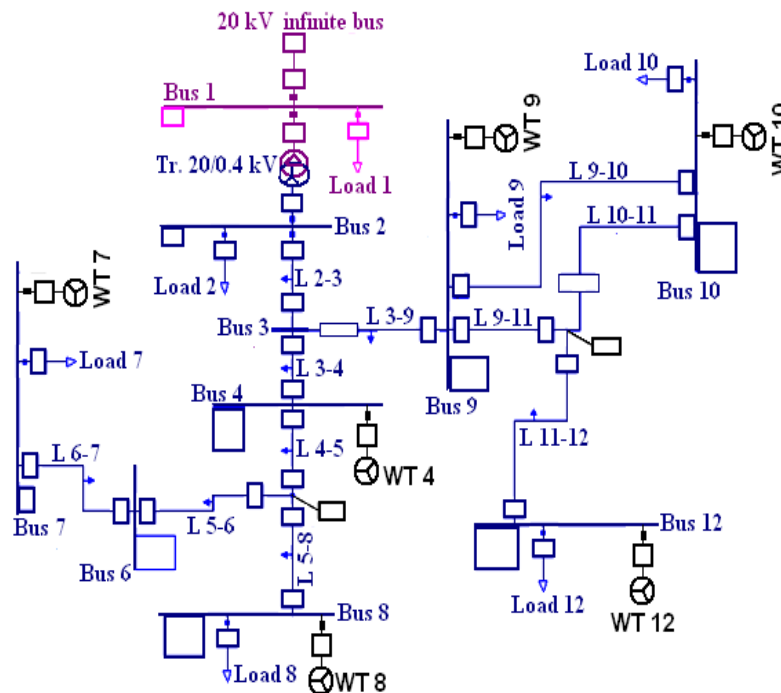

Figure 3. Test distribution grid with several WT generators [22, 23]

The network consists of 12 buses, 11 lines as shown in Table 2 and 7 concentrated loads as shown in Table 3. The load profile has been determined so that the grid (Base case) represents a weak network, as it is the real case for DNs in our region. Several WT units can be simulated as connected or disconnected to the grid through its corresponding CBs.

Table 2. Lines Data of Test Network

Name	Number of Custom	Max. Load kVA	Average Load kVA	Power Factor	Max. Loading %
L 10-11	0	0.	0.	1.	100.
L 11-12	26	86.26941	31.2	0.95	100.
L 2-3	6	33.65449	7.2	0.95	100.
L 3-4	20	72.29907	24.	0.95	100.
L 3-9	12	51.8123	14.4	0.95	100.
L 4-5	10	46.1526	12.	0.95	100.
L 5-6	6	33.65449	7.2	0.95	100.
L 5-8	15	59.82822	18.	0.95	100.
L 6-7	13	54.53995	15.6	0.95	100.
L 9-10	5	30.14953	6.	0.95	100.
L 9-11	0	0.	0.	1.	100.

Table 3. Concentrating Loads Data of Test Network

Name	Act. Pow. MW	React. Pow. MVAr	App. Pow. MW	I kA	Pow. Fact
Load 1	0.045	0.02179	0.05	0.00144	0.9
Load 10	0.045	0.02179	0.05	0.07216	0.9
Load 12	0.045	0.02179	0.05	0.07216	0.9
Load 2	0.045	0.02179	0.05	0.07216	0.9
Load 7	0.045	0.02179	0.05	0.07216	0.9
Load 8	0.045	0.02179	0.05	0.07216	0.9
Load 9	0.045	0.02179	0.05	0.07216	0.9

6. SIMULATIONS, RESULTS AND DISCUSSIONS

Different scenarios are simulated to evaluate the impact of WG on FLs at HG buses. The faults simulated by the program Power Factory DigSilent V14.0.506 are three-phase short circuits occurring at grid buses with zero impedance, 0.1 sec break time, and 1.0 sec fault clearing time. We assume that the embedded WT units will not be shut-down in case of faults occurring in the HG.

5.1. Case Study 1: Fault Levels for Base Case

First a load flow program for the base case (grid without WT) is performed using Newton-Raphson method. Then computation of balanced faults at all buses is carried out. The simulation results of FLs for all buses are shown in Figure 4. It is found that the maximum FL (6.17 MVA) is at bus 2 (the closest bus to supply point) and the minimum FL (1.24 MVA) is at bus 8 (the most far bus 8 from supply point).

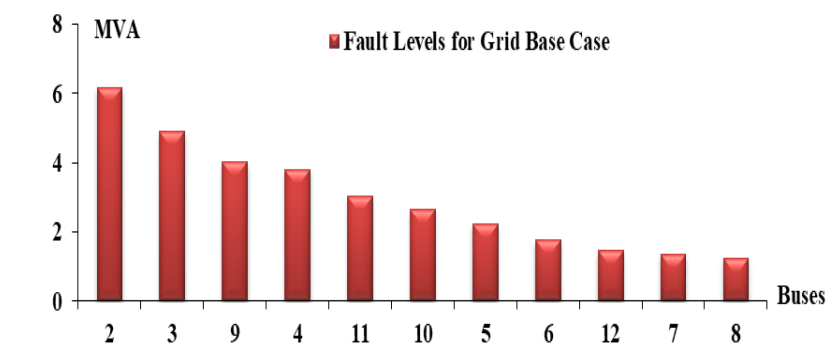

Figure 4. Fault levels for balanced fault at all buses of grid base case

5.2. Case Study 2: Embedding a Single WT at Bus 8

A 250 kVA WT unit, unity PF, is connected to bus 8. Simulation of 6.1 is repeated and the computer results are graphically shown in Figure 5. We calculate the FL rise index FLRI% for all buses and represent the results in Figure 6. The FLRI% values are found to be about 17% for WT-bus, 8-9% for adjacent buses of WT-bus (i.e. buses 5, 6, and 7), and 2-4% for buses that are in a moderate distance from WT-bus.

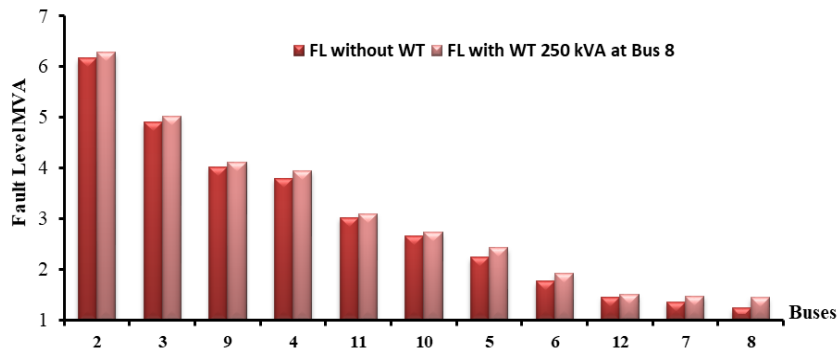

Figure 5. Fault levels without WT and with 250 kVA WT at bus 8

5.3. Case Study 3: Impact of WT Type on Fault Level

A WT Type 1 shown in Figure 7 is connected to Bus 8. This wind induction generator is connected directly to the grid.

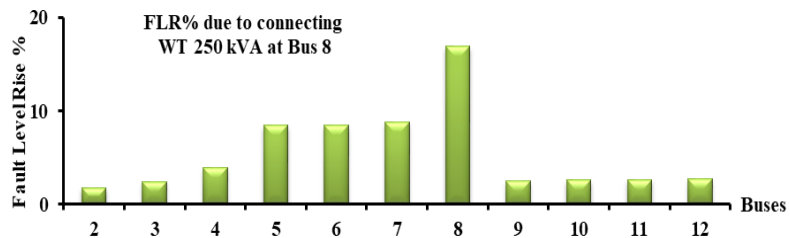

Figure 6. Fault level rise index FLR% with 250 kVA WT at bus 8

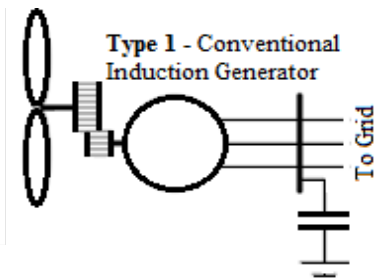

Figure 7. Typical Configuration of a Type 1 WTG [8]

The squirrel cage AG is selected from the Power Factory library. Double-cage, 250 kW/0.4 kV/2/EXPLOSION PROOF MULT with the following per unit parameters: $X_{rm}=0.01$, $R_s=0.0316$, $R_{rA2}=0.1$, $X_{rA2}=0.1$, Rated mechanical power=250 kW, Efficiency at nominal operation=95%, Rated PF=0.88. First, power flow is run where the PCC bus is simulated in the program as AS bus type which requires the input of WTG active power while its slip and reactive power are calculated by the program. Then the short circuit computation is activated to determine the FLs of all buses with the WT type 1 is connected. Figure 8 shows a comparison chart of FL rise % of all buses for the two cases, namely with WT Type 4 and WT Type 1 of the same capacity being connected at Bus 8. It is obvious from Figure 8 that a conventional WT Type 1 causes much more FL rise than a WT Type 4 (about 9 times the magnitude for PCC bus and 2-5 times for other busses of the grid). The reason behind this is that Type 1 generator is directly connected to the grid while the Type 4 generator is interfaced with the grid through a full-scale converter.

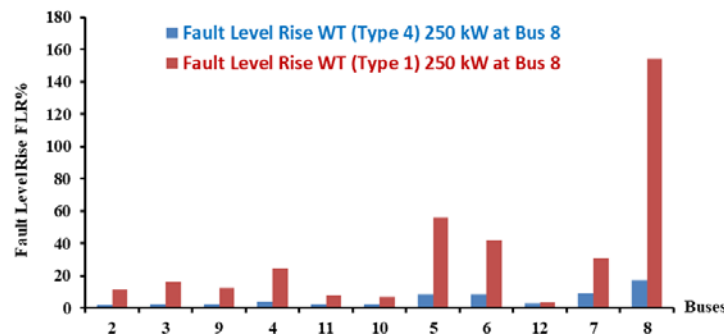

Figure 8. Comparison of FLR% of all buses for similar WT Type 4 and WT Type 1 connected to Bus 8

5.4. Case Study 4: Impact of Penetration Level on Fault Level

A wind generator type 4 with varying capacities (100, 150, 200, 250, 300 kVA) is connected to bus 10 and system simulation is carried out as in 6.1. The results show that FLR% increases with increasing capacity almost linear as Figure 9 shows for the 3 selected buses, namely WT-PCC (bus 10), adjacent bus (bus 9) and far bus (bus 2). It is clear from Figure 8 that the increase is approximately linear for each bus with different slope. The FL rise % for the two cases 300 kVA and 200 kVA WT unit connected to the bus 10, lies between 3% and 15% for 200 kVA WT and between 4% and 25% for 300 kVA WT. Therefore, the expected FL rise would limit the allowable power of WT unit to be connected to the grid.

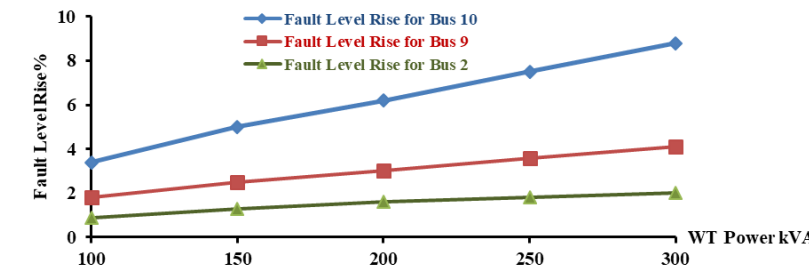

Figure 9. Variation of FLR% for 3 selected buses vs. WT power injected at bus 10

5.5. Case Study 5: Impact of PCC Location on Fault Quantities

A WT unit (200 kVA, pf=1) is connected at buses 3, 4, 7, and 10 respectively. A balanced fault simulation at bus 9 is carried out for each case. The fault current and FL for bus 9 are computed. The results are shown in Figure 10. It is obvious from Figure 9 that changing the location of PCC has a very little influence on both the FL and the fault current for the same WT capacity.

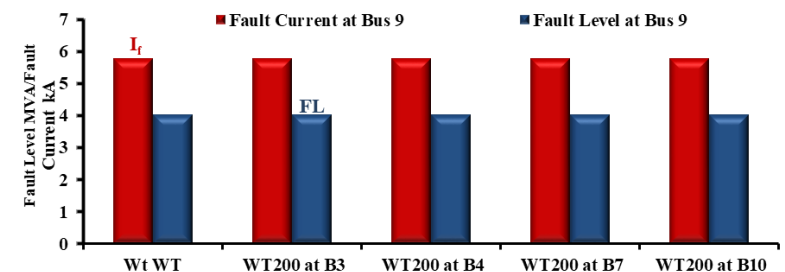

Figure 10. Impact of point of common coupling on FL and If

5.6. Case Study 6: Impact of Dispersion Level on Fault Level

A simulation of a fault at bus 9 is conducted in two different scenarios:

- a. Connecting a single 200 kVA-WT at bus 3
- b. Connecting 50 kVA-WT at each of buses 3, 4, 7, 10 at the same time (i.e. DI% is 4 times of Scenario a). Figure 11 shows the simulation results; it is noticed that the FL increases by about 17% with an increase in the dispersion by 4 times.

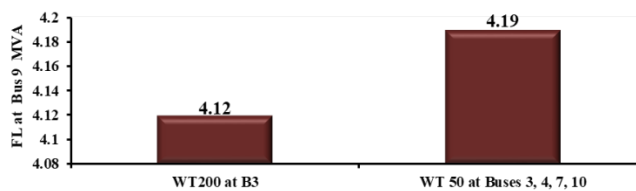

Figure 11. Impact of dispersion of WTs on fault level at bus 9

7. CONCLUSIONS

With an embedded WT type 4 into the grid, the fault currents and consequently the FLs are increased, especially when the fault is close to the wind generation PCC. The FL at PCC increases by 17% relative to FL without WT. The FL rises almost linearly with increasing WT penetration level, where the line slope decreases when the distance of the concerned bus from PCC is increased. The location of PCC has a very little influence on values of FL and fault current for the same WT capacity. The FL increases by about 17% with increasing dispersion level to about 4 times for the same total WT capacity. A conventional WT type 1 causes much more FL rise than a WT type 4 (about 9 times for PCC bus and 2-5 times for other buses of the grid). Therefore, it is recommended to use the WG system with full interface converter (Type 4) for the new installed wind farms. It is essential to check if the connection of WG to the DN could result in FLs exceeding the design limit of the network, particularly if it is already being operated close to its design limit. In this case, the CBs concerned should be replaced to avoid the risk of damage, and failure of the equipment with consequent risk of injury to personnel and interruption of supply under short circuit fault conditions. Although the obtained results are specific for the studied network, the conclusions are valid qualitatively for any network and the methodology forms a guide for identifying the violence of design limit of grid CBs.

REFERENCES

- [1] S. Siva Sakthi, R. K. Santhi, N. Murali Krishnan, S. Ganesan, S. Subramanian, "Wind Integrated Thermal Unit Commitment Solution using Grey Wolf Optimizer", International Journal of Electrical and Computer Engineering (IJECE) Vol. 7, No. 5, October 2017, pp. 2309~2320.
- [2] GWEC, "Global wind statistics 2016, 10.2.2017"
- [3] <http://www.iea.org/topics/renewables/subtopics/wind/> 2015
- [4] Holttinen, H., Meibom P, et al, "Impacts of large amounts of wind power on design and operation of power systems, results of IEA collaboration". 8th International Workshop on Large Scale Integration of Wind Power into Power Systems as well as on Transmission Networks of Offshore Wind Farms, 14-15 Oct. 2009 Bremen
- [5] M. Najafi Khoshrodi, Mohammad Jannati, Tole Sutikno, "A Review of Wind Speed Estimation for Wind Turbine Systems Based on Kalman Filter Technique", International Journal of Electrical and Computer Engineering (IJECE) Vol. 6, No. 4, August 2016, pp. 1406~1411
- [6] IEEE PES Wind Plant Collector System Design Working Group, 2009. "Characteristics of Wind Turbine Generators for Wind Power Plants" web.eecs.utk.edu/~tolbert/power_electronics/pubs/Fangxing_li_ieeepes2009_3.pdf
- [7] Iov, F., Cutululis, N. A., Hansen, A. D., & Sørensen, P. "Grid Faults Impact on the Mechanical Loads of Active Stall Wind Turbine". In Proceedings of The Second International Symposium on Electrical and Electronics Engineering, ISEEE08. ISEEE.2008
- [8] Pouyan Pourbeik, Proposed Changes to the WECC WT4 Generic Model for Type 4 Wind Turbine Generators, Copyright © 2013 Electric Power Research Institute, Inc.
- [9] Santjer F., Gerdes G. J., "Wind Turbine Grid Connection and Interaction", Deutsches Wind energy-Institute GmbH Germany, 2001.
- [10] Abdel-Salam M. et al: "Effect of Micro-Grid Renewable Micro-sources on Short Circuit Capacity of Hosting Distribution Networks", INTELEC(r) 2013 · 13. - 17. October 2013, Hamburg - © VDE VERLAG GMBH · Berlin · Offenbach.
- [11] Shaikh F.K et al. (Eds.): "Impact of Wind Integration on National Transmission Network" IMTIC 2013, CCIS 414, pp. 13-23, 2014. DOI: 10.1007/978-3-319-10987-9_2, © Springer International Publishing Switzerland 2014
- [12] Barsoum N. et al: "Power Analysis for a Limited Bus Grid System with Distribution Generators", Global Journal of Technology & Optimization Volume 8 • Issue 2, P 2-10, 2017
- [13] Muljadi E. and Gevorgian V. "Short-Circuit Modeling of a Wind Power Plant", The Power & Energy Society General Meeting, Detroit, Michigan, July 24-29, 2011
- [14] Jenkins N., R. Allan, et al. Embedded Generation. IEE Power and Energy Series 31,2000
- [15] Yunjun, "Einspeisung von DEA in Verteilungsnetz der Mittelspannungsebene", 2008, DA an der Lehrstuhl fuer Elektrische Versorgungsnetze, Erlanen-Nuernberg Universitaet
- [16] L. F. Ochoa, A. Padilha-Feltrin, et al, "Maximizing the accommodation of distributed wind power generation", C I R E D 19th International Conference on Electricity Distribution Vienna, 21-24 May 2007
- [17] Youssef Mobarak, Mahmoud Hussein, "Voltage Instability of Initiation Fault Duration as Influenced by Nodes Short Circuit Levels NSCL", International Journal of Electrical and Computer Engineering (IJECE) Vol. 6, No. 3, June 2016, pp. 1305 ~ 1318
- [18] Soens, J. Driesen, R. Belmans, "Interaction between Electrical Grid Phenomena and the Wind Turbine's Behavior", proceedings of ISMA2004.
- [19] KEMA Limited, "The Contribution to Distribution Network Fault Levels From the Connection of Distributed Generation", DG/CG/00027/00/00 URN, Crown Copyright 2005.
- [20] González-Longatt F. M., "Impact of Distributed Generation over Power Losses on Distribution System", Proceedings of 9th International Conference Electrical Power quality, Barcelona, 9-11 October 2007
- [21] Hamzeh A., Integration of Distribution Generation into Electrical Distribution Generation, © 2010-2011, Damascus University Publications

- [22] DIgSILENT GmbH, Germany, "Technical Documentation for Power Factory Simulation tool", Copyright 2011.
[23] Al-Omari Z., "Influence of Control Modes of Grid-Connected Solar Photovoltaic Generation on Grid Power Flow", Engineering 2014, 6, 914-922. <http://dx.doi.org/10.4236/eng>.

BIOGRAPHIES OF AUTHORS



Ali Hamzeh, Ph.D.El.Eng. was born in Syria. He received B.Sc degree in Mechanical & Electrical Engineering from Aleppo University, Syria and his Ph.D degree in Electrical Power Engineering, from University of Dresden, Germany. He is currently a Full Professor at Electrical Engineering Department at Faculty of Engineering, Al-Ahliyya Amman University in Amman, Jordan. His main research interests are Integration of Distributed Generations (wind and solar) into electric grid, Power system security, Power system stability, Smart grids, Design and operation of Solar PV and Wind Turbine systems, Energy Efficiency and Environmental Protection and Operation & Maintenance of conventional and renewable electric power systems. He has published over 120 technical papers in Journals and Conferences and authored 17 text books in areas of electrical power engineering and renewable energy systems

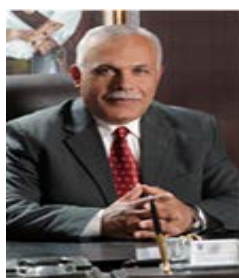

Sadeq Abdullah Hamed, he is the president of AAU since 2011, He received the B.Sc degree in Electrical Power Engineering from the Damascus University, M.Sc. in Power Electronics and Systems and Ph.D. in Power Electronics (AC Power Conditioning & Electrical Machines Control) from the UMIST, UK. Prof. Hamed has published more than 25 research papers in highly-ranked journals and conferences. In addition to his long experience in the field of education as a university professor, locally and internationally, he has supervised many M.Sc Theses. Prof. Sadeq Hamed was the Vice-President for Academic Affairs & Dean of the Faculty of Engineering at AAU, also as Dean of Faculty of Engineering Technology, Al-Balqa' Applied University, Vice Dean, of Faculty of Engineering and Technology and Chairman of the Department of Electrical Engineering, University of Jordan.



Zakaria Al-Omari, was born in Irbid Jordan on June 3, 1966. He received his MSc degree (1991), in Electrical Engineering/Power from the Faculty of Electrical Engineering, Vinnytsia State Polytechnic Institute, Ukraine and his PhD degree from the Faculty of Electrical Engineering, Vinnytsia National Technical University, Ukraine in 1998. Currently he is an Associate Professor at Electrical Engineering Department at Faculty of Engineering, Al-Ahliyya Amman University in Amman, Jordan. His main interests are minimizing of power system losses, renewable energy, load forecasting, reliability and efficiency. He has published 14 technical papers in Journals and international conferences.