

## Voltage profile enhancement in distribution network using static synchronous compensator STATCOM

Mohammed Y. Suliman

Department of Technical Power Engineering, Technical College, Northern Technical University, Iraq

---

### Article Info

#### Article history:

Received Mar 9, 2019

Revised Jan 23, 2020

Accepted Feb 1, 2020

---

#### Keywords:

D-q Theory

FACTS

Fuzzy logic

STATCOM

Vsc

---

### ABSTRACT

STATCOM is one of FACTS devices that used as regulator for transmission and distribution systems which works for reactive power compensation. STATCOM utilisation in distribution system mostly for enhancing the profile of voltage, where used for adjusting the disturbance voltage by injecting into the system a controllable voltage. This paper present a Fuzzy controller based on STATCOM to enhance the voltage profile in distribution network. The controller of STATCOM has simulated for different types of abnormal load conditions of balance and unbalance load. The results of simulation show ability of proposed design to enhance the load voltage which was 96% of the nominal value.

Copyright © 2020 Institute of Advanced Engineering and Science.  
All rights reserved.

---

### Corresponding Author:

Mohammed Y. Suliman,  
Department of Technical Power Engineering,  
Technical College, Northern Technical University,  
Mosul, Iraq.  
Email: mohammed.yahya@ntu.edu.iq

---

## 1. INTRODUCTION

STATCOM is one of the most important devices can be used in power flow control and power quality, which permit a utilise function in the prepared in the manner that without any loss the performance expectation. The equipments such as transformer, motor, computer, printer, equipment of communication and all types of house machines. These equipments mentioned were affect to the quality of power negatively [1]. When a large load in the network the reactive power unable to be transmitted even though with essential of buses voltage magnitude [2]. Voltage instability cause complete or partial discontinuation in the network. The STATCOM advantage is that can regulate efficiently the injected current in to the bus [3]. Also STATCOM has several applications in compensation of the conditions of sag/swell, the Suppressing in harmonics of line currents and improve the power factor in the load, and reactive power compensation in transmission line also in the load also STATCOM mitigate the fluctuations of the bus voltage [4, 5]. STATCOM with storage energy is advisable for controlling the injected voltage in its magnitude and also the angle by VSC "Voltage Source Converter" for controlling the powers "active and reactive" of STATCOM [6]. Many works have been suggested for the implementation of voltage profile enhancement in the literature. Improving Voltage Profile using PI Controller in [7]. Whereas [8] presents Optimal location of UPFC to enhance voltage profile. In [9] presents Enhancement of voltage profile using SVC. The use of PI controller in [7], has many drawbacks that needs tuning at each operating point, slow in response and less smoother. The use of UPFC in [8], needs settings and controllers for both STATCOM and also for SSSC. The use of SVC in [9], have passive parameters that affect to the tuning of the system and make some oscillation in response. The new porposed of STATCOM for voltage profile enhancement with Fuzzy logic control is a high-speed response and smoother than conventional controller also the proposed system use VSC instead of passive element in SVC. The use of d-q theory to calculate the reactive power and the bus voltage

for compensation added another feature of small-time calculation of about one cycle compared with previous works [7],[8] and[9] that takes more than one cycle for calculation the peak amplitude, and need more peripherals design.

**2. VOLTAGE REGULATION AND COMPENSATION**

The shunt device connections for regulation of bus voltage are shown in Figure 1. The model contains power transmission line, supply ( $V_s$ ), and load where the injection was in the middle of the line. Phasor diagram, shows that line current angle has relation with the load side, which means that the active component of current ( $I_c$ ) is injects to enhance the line current ( $I_{sc}$ ) and then the load voltage. The device of current source is used for compensating the load reactive component this done by inject or absorb current ( $I_c$ ) to or from the network. This lead to enhance regulation of voltage and also reduced reactive component of the source current. Figure 2 shows Q-V characteristics of STATCOM, where the inductive load requires enough reactive current for appropriate working so, the source should be feeding it; and this will increase the line current from the generating area. If the feeding of reactive power is near load area, the supply current may be reduced thus improving the voltage regulation (load side) [10]. Three methods can improve the regulation; first by using a bank of capacitor, by using VSI "voltage source inverter" or by using CSI "current source inverter" [11]. The STATCOM provide voltage for supporting the system under huge abnormal condition through that the bus voltage would be deviate from the compensator normal range [12]. The main advantage of the use of voltage source converter VSC that reactive power can be generate (instead of using capacitors) independent to the line current [13]. The three phase inverter used in inject the controllable voltage, many techniques of modulation wrer used to implement the VSC like SPWM (sine PWM) or SVPWM (Space Vector PWM) [14]. In distribution system the STATCOM connected before load as shown in Figure 3[15].

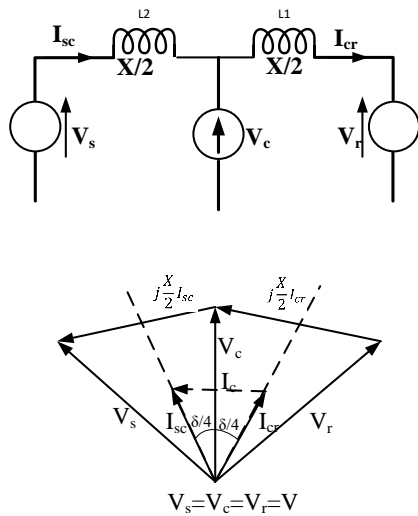

Figure 1. Principles of shunt compensation

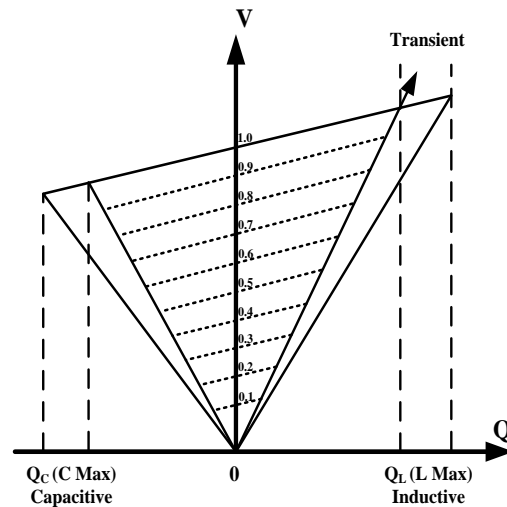

Figure 2. V-Q characteristics of STATCOM

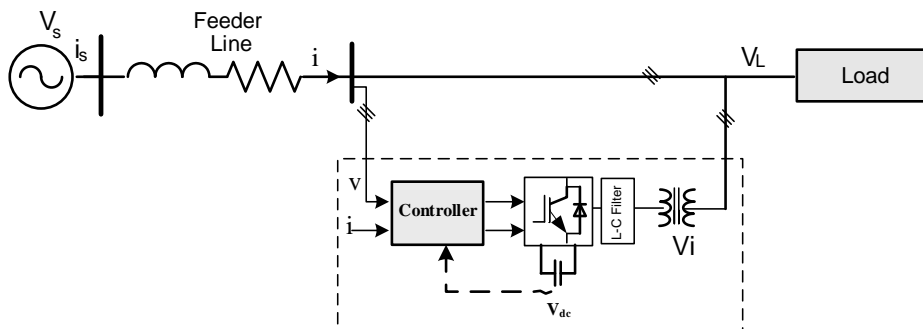

Figure 3. STATCOM connection

**3. MEASURING THE REACTIVE POWER AND LINE VOLTAGE**

For measuring reactive power and line voltage, d-q theory has been applied [16]. This theory valid for time-domain “operation in transient or steady state”, and can be applied for different current and voltage waveforms, this allowing to design controller in real time for reactive power [17]. Also the simple of transformation calculations, and easy to separate the alternated value and mean value respectively [18]. This theory performs by transformations known “park transformation” from a stationary to rotating coordinates “abc to dq” [19]. The applied of dq theory (i.e.  $v_a$ ,  $v_b$  and  $v_c$ ) is as follows:

$$\begin{bmatrix} v_d \\ v_q \\ v_0 \end{bmatrix} = \frac{2}{3} \begin{bmatrix} \cos(\varnothing) & \cos(\varnothing - \frac{2\pi}{3}) & \cos(\varnothing + \frac{2\pi}{3}) \\ -\sin(\varnothing) & -\sin(\varnothing - \frac{2\pi}{3}) & -\sin(\varnothing + \frac{2\pi}{3}) \\ \frac{1}{2} & \frac{1}{2} & \frac{1}{2} \end{bmatrix} \begin{bmatrix} v_a \\ v_b \\ v_c \end{bmatrix} \tag{1}$$

$$\begin{bmatrix} i_d \\ i_q \\ i_0 \end{bmatrix} = \frac{2}{3} \begin{bmatrix} \cos(\varnothing) & \cos(\varnothing - \frac{2\pi}{3}) & \cos(\varnothing + \frac{2\pi}{3}) \\ -\sin(\varnothing) & -\sin(\varnothing - \frac{2\pi}{3}) & -\sin(\varnothing + \frac{2\pi}{3}) \\ \frac{1}{2} & \frac{1}{2} & \frac{1}{2} \end{bmatrix} \begin{bmatrix} i_a \\ i_b \\ i_c \end{bmatrix} \tag{2}$$

$$\varnothing = (\omega t + \theta) \tag{3}$$

Where “ $\varnothing$ ” is phase angle between the fixed and rotating coordinates with respect to time and “ $\theta$ ” is angle between voltage and current. The compensated active and reactive power:

$$p = V_d I_d + V_q I_q \tag{4}$$

$$q = V_d I_q - V_q I_d \tag{5}$$

The accumulated voltage is:

$$v = \sqrt{v_d^2 + v_q^2} \tag{6}$$

**4. STATCOM CONTROL DESIGN**

Figure 4 shows the control system block diagram of the STATCOM. The phase voltages are measured and the signals enter low pass filter for eliminating high frequency component. The d-q components in (1) and (2) are calculated using “park transformation”. The aggregated voltage then calculated using (6) this voltage is a feedback to closed loop control system, where compared with the  $v_{ref}$  set point reference voltage of the busbar then error signals will generate  $v_{error}$ .

$$V_{error} = V + V_{ref} \tag{7}$$

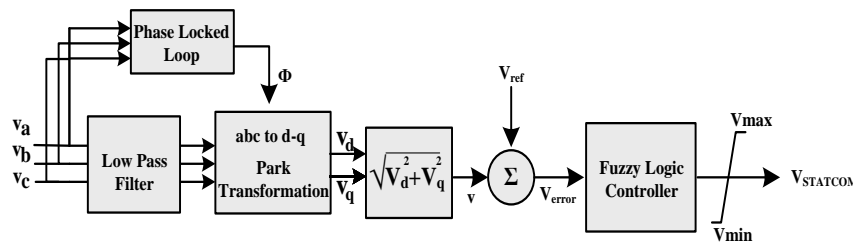
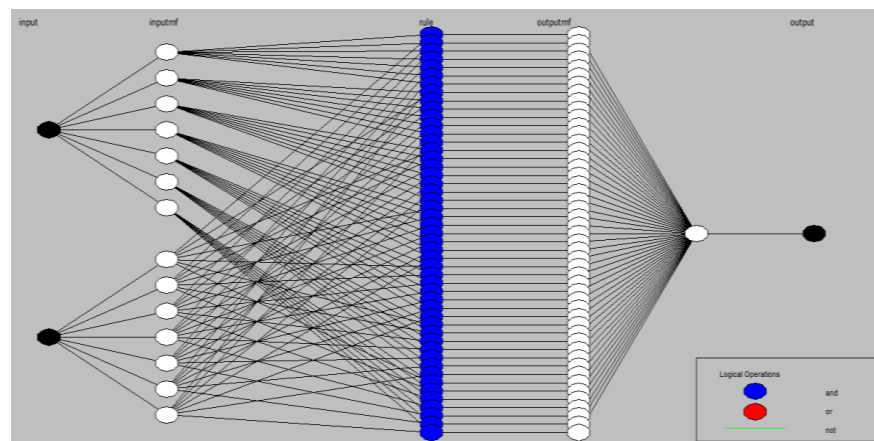

Figure 4. Block diagram of control system

**5. FUZZY LOGIC CONTROL SYSTEMS**

In this study FLC “Fuzzy logic controller” was used, FLC is adequate for systems that have mathematical model is not easy to derive [20]. Takagi-Sugeno inference mechanism systems is applied in this study [21]. Artificial Neural Network (ANN) is used for tuning the MFs “membership functions” of the Takagi-Sugeno [22]. The fuzzy logic control with capabilities of using the adaptive learning of ANN,

from this approach trained can be more easy also the rule base of Fuzzy is reduced [23]. The Fuzzy control system constructed of 5-layers, two types of parameters in each layer some of them needs tuning other not during step of training [24]. The details of emulating fuzzy logic control design steps for five layers output is given in reference [25]. The two inputs universe of discourse are divide into 7 triangle MFs and the overlap between them of 50%, the input to the controller is error and  $\Delta$ error, so that for 7 MFs, 49-control rules resultant of linear functions that required to determine as shown in Figure 5a and b. To tune these rules using ANN, 2-groups of data are used. Also 2- vectors of input:  $V_{error}$  and  $\Delta V_{error}$  the output is modulation index "m".



(a)

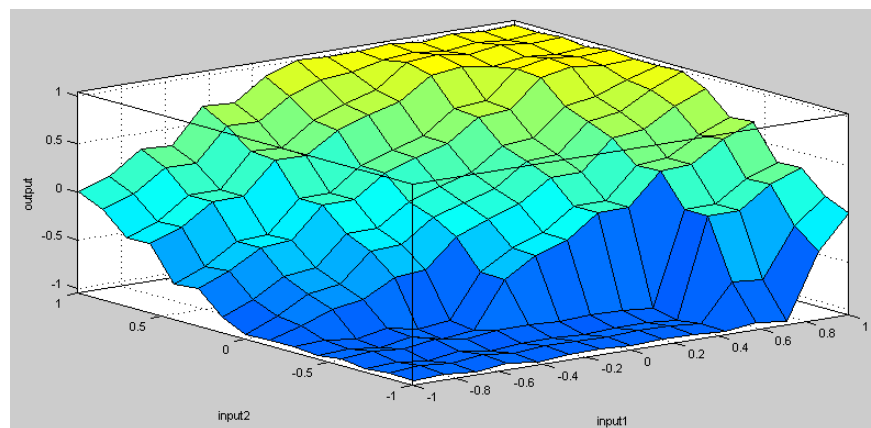

(b)

Figure 5. Fuzzy logic design (a) structure (b) the surface

## 6. SIMULATION STUDY

Study model contain feeder and changeable load of 2- load branches for balance condition and additional load for unbalance condition as shown in Figure 6. The STATCOM in load side for compensating the load voltage. Test the model start by load changing and continues measure the voltage at load bus the compensation done at  $t=0.65$  seconds for balance load as shown in Figure 7. The result shows the load voltage drop increased proportionally as load increase, drop was maximum (0.8 pu) occur between 0.33 and 0.65 sec respectively. Figure 8 shows the results for unbalance load action to compensate the load voltage for unbalance condition the STATCOM mitigate and restored the load voltage drop at 0.5 seconds. Figure 9 shows the load current before and after compensation, this compensation process done by injecting voltage  $V_{STATCOM}$  where phase voltage as a reference as shown in Figures 10 and 11 respectively. The FFT analysis of the voltage of bus BB3 is shown in Figure 12, the total harmonic distorsion THD was 0.22% after injects  $V_{STATCOM}$ . The power-voltage characteristic at load bus shown in Figure 13, from results can note that the load voltage enhanced the amplitude with STATCOM and also stability margin increased.

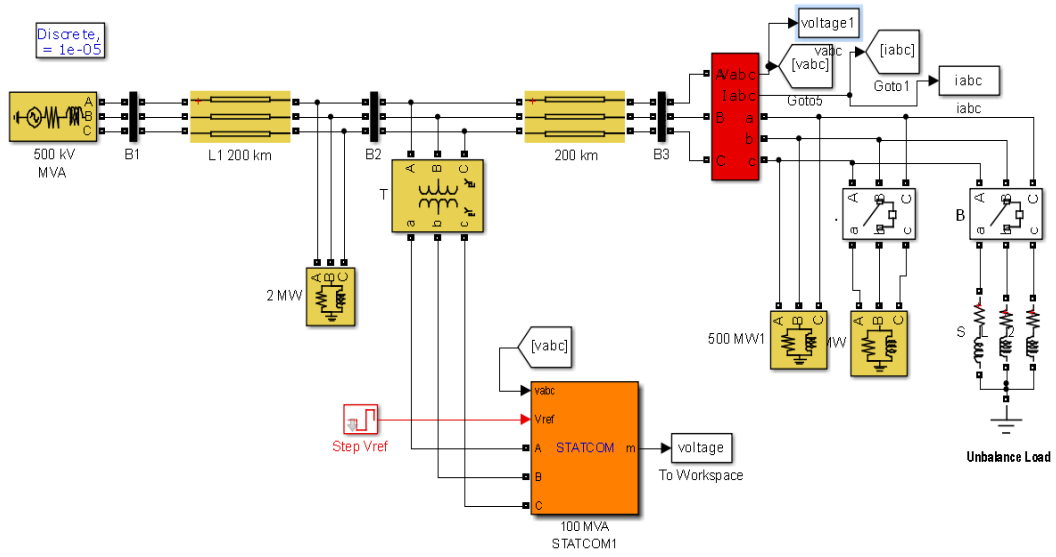

Figure 6. Proposed system model for simulation

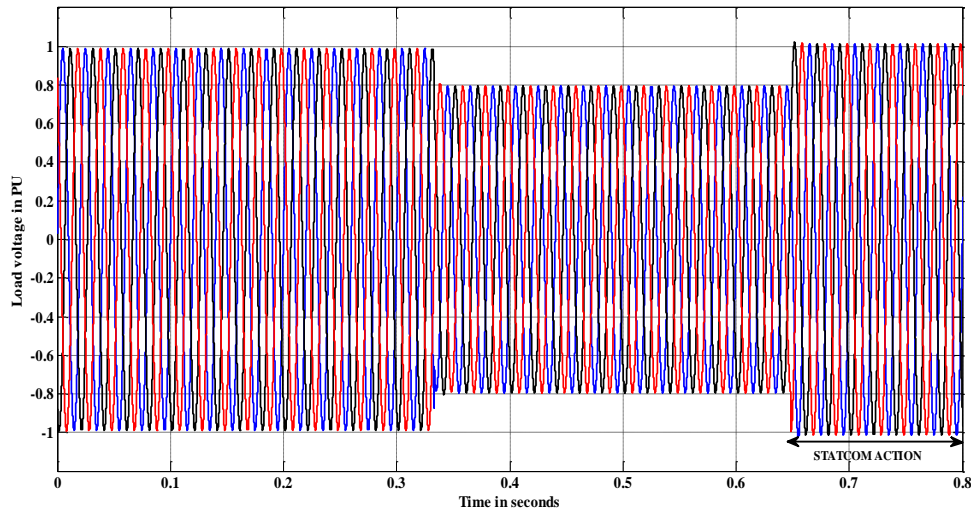

Figure 7. The 3-phase waveforms of voltage at balance load

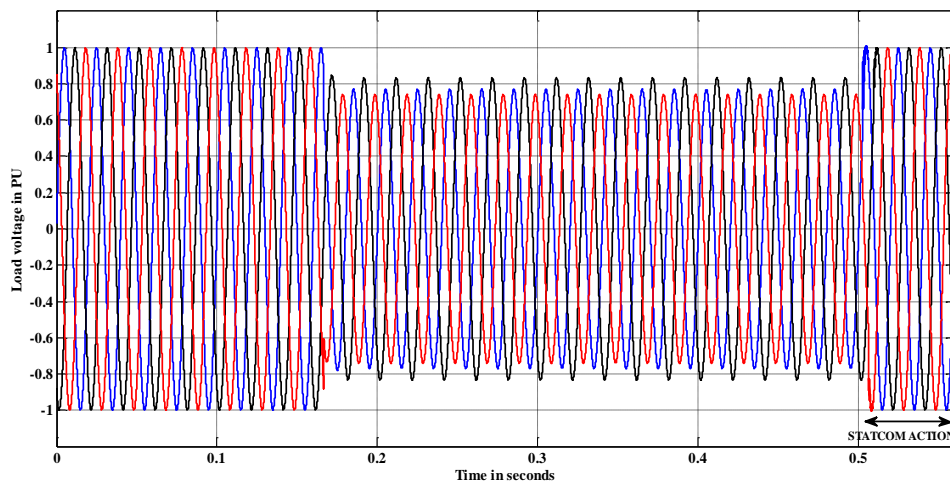

Figure 8. The 3-phase voltage at unbalance load

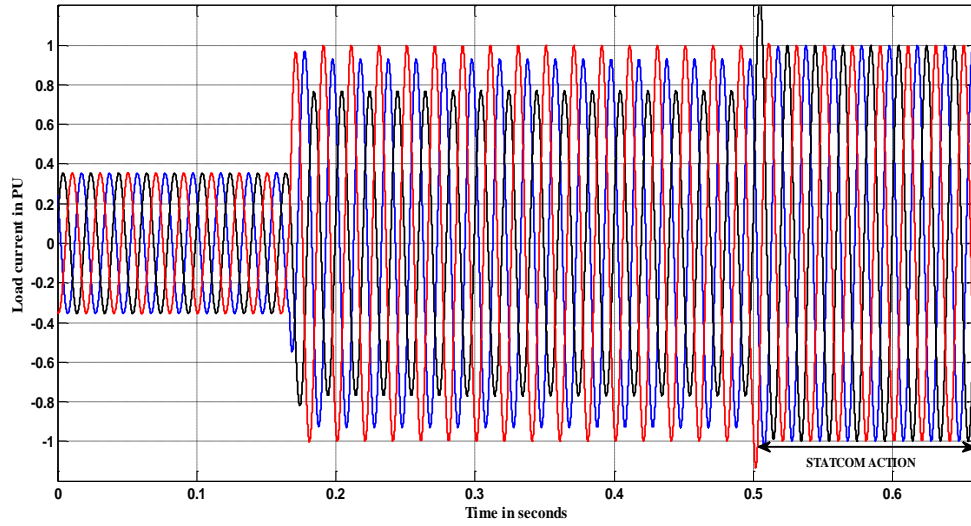

Figure 9. Load current

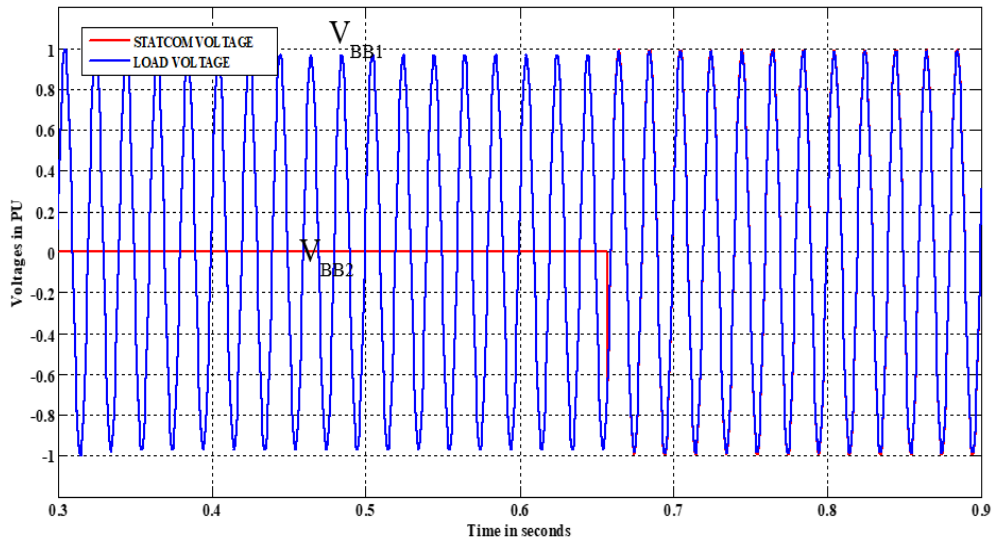

Figure 10. The STATCOM voltage and load voltage

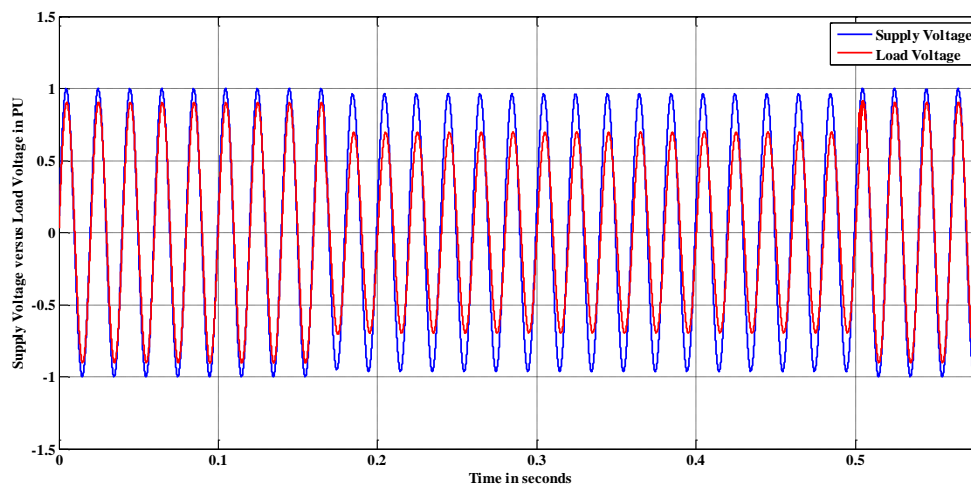

Figure 11. The BB2 voltage with compensation

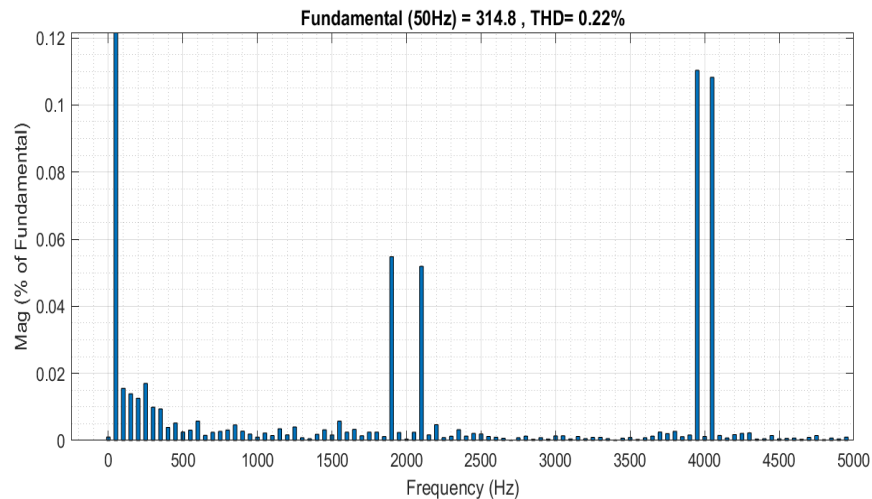

Figure 12. The FFT analysis of the voltage of BB3

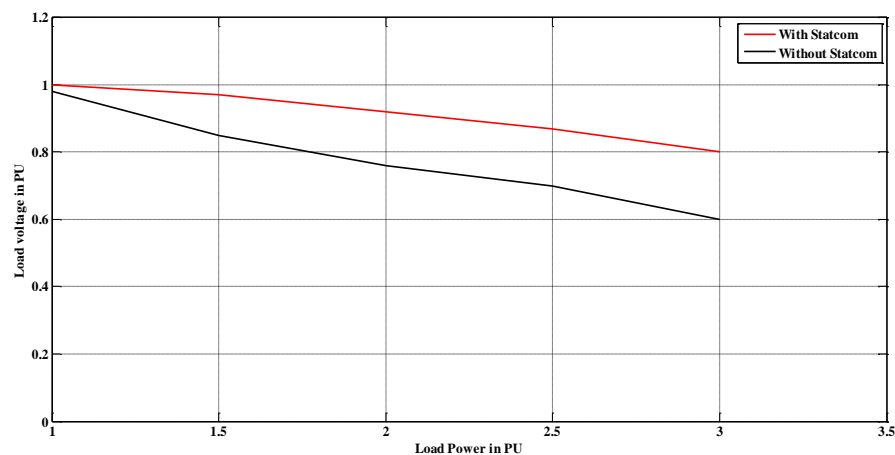

Figure 13. P-V curve

## 7. CONCLUSION

In this study, a STATCOM based Fuzzy logic control has been installed in load side, two cases of disturbance conditions have been studied using MATLAB simulation the increase in load in balance and unbalance. Results shown the compensation system with Fuzzy controller enhance the load voltage also increase the stability margin about 20%. The simulation compared before and after inject compensation voltage was studied for two types of load balance and unbalance condition. In two conditions the STATCOM ability to restore the voltage of the load to the nominal value (within 97%). The use of STATCOM in compensation more flexible and simple in design the controller and also not affect to the network parameters as in [7], [8] respectively. Also fast response of design compensation system due to small computation time compared with and [9], this important for implementation in real time.

## REFERENCES

- [1] E. Acha, C. Fuerte, H. Ambriz and C. Angeles-Camacho, "FACTS Modeling and Simulation in Power Networks", John Wiley & Sons Ltd, pp 21-23, 2004.
- [2] P. Kumar, "Enhancement of power quality by an application FACTS devices," *International Journal of Power Electronics and Drive Systems (IJPEDS)*, vol.6, no. 1, pp. 10-17, 2015.
- [3] A. Oukennou, et al., "Coordinated Placement and Setting of FACTS in Electrical Networks based on eqKalai-smorodinsky Bargaining Solution and Voltage Deviation Index," *International Journal of Electrical and Computer Engineering (IJECE)*, vol. 6, no. 6, pp 4079-4088, 2018.
- [4] R. Mathur and R. Varma, "Thyristor-based FACTS Controllers for Electrical Transmission Systems," Wiley-IEEE Press Power engineering, Piscataway, NJ, Mar, pp 34-36, 2002.

- [5] Hingorani and L. Gyugyi, "Understanding FACTS, Concepts and technology of flexible AC transmission systems," *IEEE Press*, pp 172-174, 2000.
- [6] B. Yang, G. Zeng, Y. Zhong and Z. Su, "Cascade STATCOM step wave optimization based on PSO," *IEEE International Power Electronics and Application Conference and Exposition*, pp1445-1450, shanghai, china, 2014.
- [7] S. H. Qazi and M. W. Mustafa, "Improving Voltage Profile of Islanded Microgrid using PI Controller," *International Journal of Electrical and Computer Engineering (IJECE)*, vol. 8, no. 3, pp 1383-1388, 2018.
- [8] S. Hocine and L. Djamel, "Optimal number and location of UPFC devices to enhance voltage profile and minimizing losses in electrical power systems", *International Journal of Electrical and Computer Engineering (IJECE)*, vol.9, no.5, pp 3981-3992, 2019.
- [9] B. Singh and G. Agrawal, "Enhancement of voltage profile by incorporation of SVC in power system networks by using optimal load flow method in MATLAB/Simulink environments", *Energy Reports, Elsevier*, vol 4, pp 528-535, 2018.
- [10] Anulal A.M, A. Mohan and Lathika B.S, "Reactive power compensation of wind-diesel hybrid system using STATCOM with Fuzzy tuned and ANFIS tuned PID controllers", *International Conference on Control Communication & Computing India (ICCC)*, pp. 325-330, Trivandrum, 2015.
- [11] Hailian Xie, Angquist Lennart, and Hans Peter Nee, "Investigation of Statcoms with Capacitive Energy Storage for Reduction of Voltage Phase Jumps in Weak Networks," *IEEE trans. on power systems*, Vol. 24, No. 1, FEB. 2009.
- [12] R. Vanitila and M. Sudhakaran, "Differential Evolution algorithm based Weighted Additive FGA approach for optimal power flow using multi-type FACTS devices", *Emerging Trends in Electrical Engineering and Energy Management Conference (ICETEEEM), Chennai*, pp. 198-204, 2012.
- [13] Liu Qing and Wang Zengzeng, "Coordinated design of multiple FACTS controllers based on fuzzy immune co-evolutionary Algorithm", *IEEE Power & Energy Society General Meeting, Calgary, AB*, pp. 1-6, 2009.
- [14] H. B. Tolabi, M. H. Ali, and M. Rizwan, "Simultaneous reconfiguration, optimal placement of DSTATCOM and photovoltaic array in distribution system based on fuzzy ACO approach," *IEEE Trans. Sustain. Energy*, vol. 6, no. 1, pp. 210-218, Jan. 2015.
- [15] C. Kumar and M. Mishra, "A Multifunctional DSTATCOM Operating Under Stiff Source," *IEEE Trans. Ind. Electron.*, vol. 61, no. 7, pp 3131-3136, 2014.
- [16] Ghias Farivar, Branislav Hredzak and Vassilios G. Agelidis, "Decoupled Control System for Cascaded H-Bridge Multilevel Converter Based STATCOM," *IEEE Transactions on Industrial Electronics*, vol. 63, no. 1, pp. 322-331, 2016.
- [17] S. Vashishtha and K. Rekha, "Space Vector PWM in Three-phase Voltage Source Inverter: A Survey," *International Journal of Electrical and Computer Engineering (IJECE)*, vol. 8, no. 1, 2017.
- [18] N. Cherkaoui et al, "A Comparison Study of Reactive Power Control Strategies in Wind Farms with SVC and STATCOM," *International Journal of Electrical and Computer Engineering (IJECE)*, vol. 8, no. 6, pp. 4836-4846, 2018.
- [19] V. Ponanathi and B. R. Kumar, "Three-phase statcom controller using D-Q frame theory for a three-phase SEIG feeding single phase loads," *2015 2nd International Conference on Electronics and Communication Systems (ICECS)*, pp. 926-931, Coimbatore, 2015.
- [20] M. Y. Suliman and S. S. Al-Juboori, "Design of Fast Real Time Controller for the Dynamic Voltage Restorer Based on Instantaneous Power Theory," *International Journal of Energy and Power Engineering*, vol. 5, no. 2-1, pp. 1-6, 2016.
- [21] M. M. Almelian et al, "Enhancing the performance of cascaded three-level VSC STATCOM by ANN controller with SVPWM integration," *International Journal of Electrical and Computer Engineering (IJECE)*, vol. 9, no.5, pp. 3880-3890, 2019.
- [22] M. Y. Suliman and R. K. Antar, "Power Flow Controller Based on A New Proposed STATCOM Controller", *International Journal of Applied Science and Engineering*, vol. 7, no. 4, 2018.
- [23] Ogunboyo P. Taiwo, Remy T and Innocent E. Davidson, "Voltage profile enhancement in low voltage 11/0.4 kV electric power distribution network using dynamic voltage restorer under three phase balance load," *IEEE AFRICON conference*, pp 991-996, 2017.
- [24] P. T Ogunboyo, R. Tiako, I. E. Davidson, "Application of Dynamic Voltage Restorer for Power Quality Improvement in Low Voltage Electrical Power Distribution Network," *An Overview, International Journal of Engineering Research in Africa*, vol. 28, pp.143-156, 2017.
- [25] M. Y. Suliman, M. E. Farrag and S. Bashi, "Design of Fast Real Time Controller for the SSSC Based on Takagi-Sugeno (TS) Adaptive Neuro-Fuzzy Control System," *International Conference on Renewable Energies and Power Quality (ICREPQ'14)*, vol. 1, no. 12, pp 1025-1030, 2014.

## BIOGRAPHY OF AUTHORS



**Mohammed Y. Suliman** received his BSc, M.Sc. and Ph. D. degrees from University of Mosul, Iraq in 1995, 1998 and 2014 respectively. Currently, he is an assistance professor, in the Technical College, Northern Technical University. His research interests include power system assessment, Power Electronics, FACTS, Renewable energy.