

Modeling of Dynamical System Piloted by Discrete Subsystem Based on Bond Graph Approach

Ben Salem J, Lakhoua M. N., El Amraoui L.

Mechatronic Systems and Signals, ENICarthage, University of Carthage, Tunisia

Article Info

Article history:

Received Apr 20, 2017

Revised Jun 5, 2017

Accepted Sep 11, 2017

Keywords:

ABS braking system

Mechatronic system

Modeling of a dynamic system

SADT bond graph

Systemic modeling

ABSTRACT

This paper is a contribution to the analysis and modeling of a mechatronic system with dynamic behavior that is controlled by a digital computer. In this paper, a bibliographic research on mechatronic systems is presented by specifying a case study of the Anti-lock Braking System (ABS). Then, a methodology of systemic modeling of the ABS system based on two methods Structured Analysis Design Technique (SADT) and bond graph (BG) is proposed. The model created is validated with three software programs: CarSim, 20 Sim and Simulink.

Copyright © 2017 Institute of Advanced Engineering and Science.
All rights reserved.

Corresponding Author:

Ben Salem J,

U.R: Mechatronic Systems and Signals, ENICarthage,

University of Carthage, Tunisia.

Email: bsj_jamel@yahoo.fr

1. INTRODUCTION

Modeling is one of the major activities of researchers. Conceptualizing physical phenomena through a model, makes it possible to understand the links between the physical quantities specific to the system and so to predict the role of a modification of the systems part. Modeling it also helps re-engineering of the system [1].

A dynamic system is a set of components in interaction, spread over several states and structured according to certain properties. Currently, dynamic systems are controlled by computers, which make it possible to obtain functions of use and to treat the functions of requirements of the systems. Among the dynamic systems controlled by digital computers, we found the mechatronic systems [2].

The first part of this paper presents the main characteristics of the mechatronic systems. Then, a case study of an ABS braking system is presented. The second part is interested in the analysis by systemic approach, in this part we proposed a methodology based on two tools of modeling.

The third part proposes a strategy for modeling and simulation of the hydraulic part piloted by a digital system using the bond graph approach.

2. CHARACTERICS OF A MECATRONIC SYSTEM

The term mechatronics was introduced in 1969 by an engineer from the Japanese company Yaskawa Electric Corporation to characterize a system integrating a mechanical part and an electronic part.

Several references define mechatronics as the integration of mechanical and electromechanical systems (mechanical elements, machines, precision mechanics) with electronic systems (microelectronics, power electronics, sensors, actuators) and information technology (systems theory, modeling, automation, software, artificial intelligence) [3].

More recently, the development of the microcontrollers with high integration and flash memories as well as the use of evolved programming languages, allowed designing systems very successful within very short time frames.

The appearance of mechatronic systems is a revolution for the industrial world. Indeed, the mechatronics system is very present in our everyday life as well as in the industrial middle. It affects many applications in various fields such as transport, the medical field, the space domain as well as it affects more and more the world of transport and in particular the automotive sector [4]. Indeed, in the current automobiles, we use processors to implement the various systems of control. The microcontroller integrates some embarked memory (EEPROM/EPROM), allowing a digital treatment of the analog inputs. The anti-lock braking system (ABS) was also introduced in cars in the 1970s. The ABS operates by detecting the wheel lock and then reduces or eliminates the blockage by modulating the hydraulic pressure.

In this paper, we take as example the ABS system to explain our contribution to the modeling of a dynamic system piloted by a digital computer.

3. PRESENTATION OF THE ABS SYSTEM

The ABS system allows relaxing the hydraulic pressure on the wheel when it detects a blocking on her. Then it increases it until the new blocking occurs, in which the cycle starts again [5]. The locking of a wheel is detected by a rotation sensor. The calculator compares the data with the stored braking curves and detects the braking anomalies. Physically, the master cylinder is replaced by solenoid valves that release the pressure to break the wheel whose system has detected the locking. The oil discharged during the release of the pressure is returned to the circuit by the pump common to the whole system.

The ABS system modulates the brake pressure by interposing between the master cylinder and the wheel disc. A solenoid valve is going either to maintain or to decrease the pressure in every pipe. These solenoid valves are commanded by a calculator from information given by four sensors, to the risk of blocking of wheels. Every sensor placed in front of a target detects the variation of the wheel speed.

The ABS system includes: a hydraulic unit; an electronic calculator; one speed sensor and one target per wheel and a dashboard indicator that represents a man-machine interface

Figure 1 represents the ABS braking system [6].

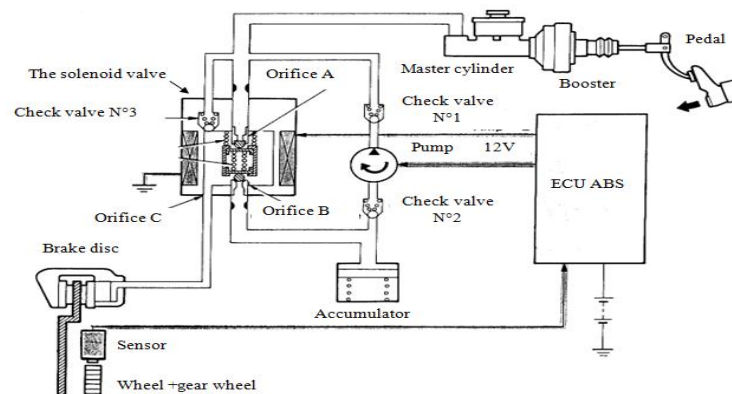

Figure 1. Elements of the ABS system

During the braking without trend to the blocking, both solenoid valves are at rest, the connection between master cylinder and caliper is open. The caliper receives all the pressure of the conventional braking circuit. If braking is intense and the wheel will lock, the pressure can be changed by excitation of the solenoid valves.

Several researchers interested in the modeling of the ABS braking system. The following paragraph cites some of these works:

Researchers Chun-Kuei Huang & al. (2010) [7], modeled the hydraulic part of the ABS braking system of a motorcycle and they simulated its functioning after estimating the slips and speed of the wheels.

Chankit Jain & al. (2014) [8], have explained the dynamic equations of the wheel during ABS braking, they used a Simulink model and the PI control strategy to maintain the slip then they simulated the speed and the braking distance of the vehicle.

Researchers Chun-Liang Lin & al. (2011) [9], have presented how the slip ratio control problem in ABS is nonlinear and complicated. They used a sliding mode controller to generate appropriate torque for the driving motor of two-wheel electric vehicles that ensures optimality of the slip ratio for efficient vehicle brake.

4. SYSTEMIC MODELING OF THE HYDRAULIC GROUP OF ABS

System modeling is a new discipline that brings together the theoretical, practical and methodological approaches, relating to the study of what is recognized as too complex, is a transversal scientific method that can be used on a large number of scientific objects [10]. Indeed, every system is seen for global way that can be analyzed as a form of an operating system and a control system whose structures and behaviors must be represented. Systemic analysis is based on several methodologies.

In this paper, we will use the Structured Analysis Design Technique (SADT) method [11] and the Bond Graph (BG) approach [12] to model the hydraulic part of the ABS braking system. In the following the both methods are presented.

In this paper, we propose a contribution based on two methodologies, SADT and bond graph to model a multidisciplinary dynamic system controlled by a digital computer, it is the ABS braking system. The calculator, depending on the behavior of the wheel and slip values can choose three phases represented by the following global function (Figure 2).

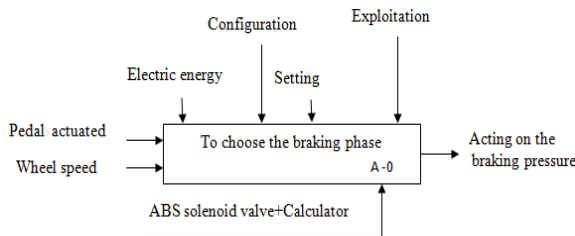

Figure 2. Overall function of the SADT model

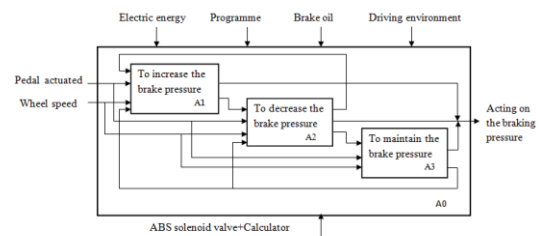

Figure 3. Node A0 of the SADT model

The node A-0 makes it possible to give a general graphical representation and to highlight all the information relating to this system. At this level the functioning is not yet clear. The presentation of the lowest node gives a more detailed idea on the system functioning. Figure 3 shows the A0 node of the SADT model.

The previous graphic representation highlights the internal organization of the system by showing three blocks that contain three phases of functioning detailed thereafter.

- **Increase the pressure:** The force exerted on the brake pedal generates a braking pressure, which is transmitted directly to the caliper. In this phase, there is a conventional braking circuit.
- **Maintain the pressure:** The risk of blockage is reached, at this time the exhaust solenoid valve remains at rest (closed). The hydraulic circuit between the solenoid valves and the caliper becomes isolated, after the calculator closes the inlet solenoid valve. The check valve 3 allows releasing the wheel quickly.
- **Decrease the pressure:** The risk of blocking the wheel persists; its slip threshold is exceeded. At this time, the calculator acts on the pump to reduce the brake pressure on the caliper by returning the liquid to the master cylinder. The deceleration of the wheel decreases and the inlet solenoid valve remains pressurized. In this case, the calculator opens the exhaust solenoid valve.

5. FUNCTIONING OF THE DIGITAL PART SYSTEM

Taking into account the signals measured by the speed sensors, the calculator commands the electric excitement of solenoid valves following a well-defined strategy. Indeed, the signals of the sensors allow the calculator to determine the speeds, the accelerations, and the sliding of the wheels. The calculator takes in precaution the errors of measures; it is based on a calculated reference speed, which corresponds to a maximum slip. The reference speed is determined from two wheel speeds taken diagonally.

Figure 4 shows the control strategy of the Bosch digital calculator of the selected system.

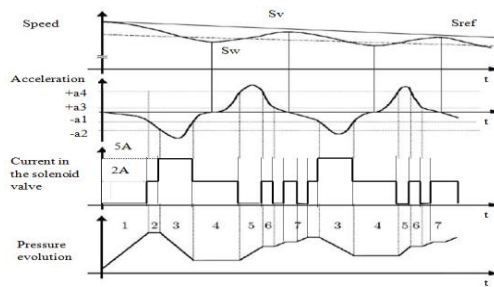

Figure 4. Operating strategy of the ABS calculator

Legend:

- S_{ref} : The calculated reference speed
- S_w : The linear wheel speed
- S_v : The speed of the vehicle
- a_4 : maximum acceleration after automatic brake release
- a_3 : minimum vehicle acceleration after pressure reduction
- a_1 : acceptable deceleration for normal braking
- a_2 : maximum deceleration accepted for normal braking

Initially the wheel speed and the reference speed are identical. As the pressure grows, the circumferential deceleration of the wheel increases. At the end of phase 1, the deceleration exceeds the predetermined fixed threshold ($-a_1$), which commands the transition from the solenoid valve to the holding position. The deceleration increases until the curve leaves the stable zone, at the end of phase 2. The wheel speed drops below the reference speed and deceleration becomes large (greater than a_2). The solenoid valve is supplied with a current (5 A) to reduce the braking pressure until the acceleration exceeds the threshold ($-a_1$). At this time the calculator produces a current of 2 A to return to the pressure holding phase. The acceleration increases and exceeds the threshold (a_3), at this instant, the calculator opens the circuit. The pressure in the wheel cylinder increases, then a holding sequence. Phase 7 is the under braking phase, in which the speed varies between a minimal acceleration and a minimal deceleration. The calculator triggers a series of pressure surges in steps, with holding ranges until a new blocking trend.

In order to determine the operating principle of the ABS braking system, we used CarSim and Matlab software programs. Infact, CarSim software is a commercial software package that predicts the performance of vehicles in response to driver controls in a given environment [12]. The Simulink software is a platform for modeling and simulation of dynamic multi-domain systems. The model of the braking system based on the two software programs is represented by the Figure 5, the brake set point on the master cylinder is represented by the Figure 6.

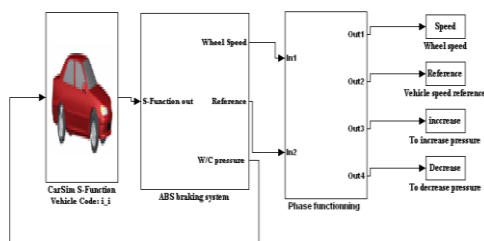

Figure 5. Simulink-CarSim model of the ABS system

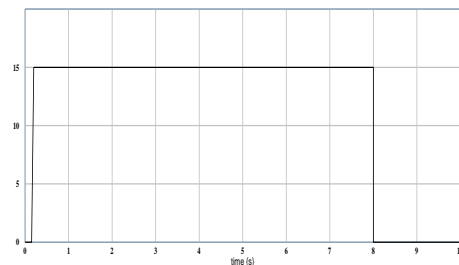

Figure 6. Brake set point on the master cylinder

The model consists of three blocks: The CarSim S-Function block is the model of a vehicle, programmed by the developer of this software. The second block represents the ABS braking system of the

vehicle with a simplified environment (flat road and friction forces are negligible). On the other hand, the third block represents a part of the treatment of the signals to determine the operating cycles of the calculator.

The following curves represent: the speed evolution of the forward left wheel, the reference speed of the vehicle, so the pressure and slip coefficient evolution during braking.

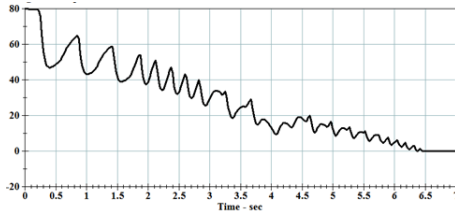

Figure 7. The speed evolution of the forward left wheel (Km/h)

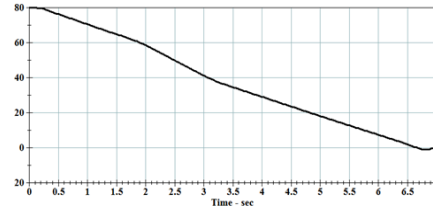

Figure 8. The reference speed of the vehicle (Km/h)

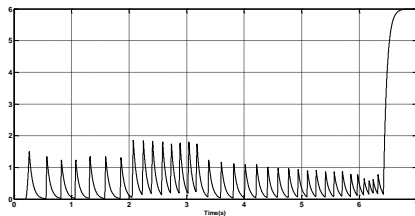

Figure 9. Pressure evolution applied to the brake disc during the braking operation

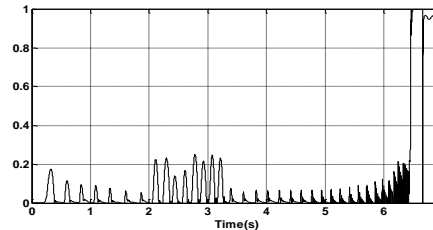

Figure 10. Slip coefficient evolution during braking

The speeds of the wheel represented by the figure 7 is undulated, it increases when the wheel meets a blocking and decreased when the blocking is avoided.

The simulation of the brake pressure is shown in the figure 9. After the stop of the vehicle, the applied pressure is of value 6 MPa. In this figure the rise of the pressure is of infinite slope, but its decrease varies exponentially. Figure 10 represent the evolution of the sliding corresponding to the velocity profile presented previously.

The determination of the operating phase depends on the slip coefficient defined by the following equation [18].

$$\lambda = \frac{Sv - R.\omega}{Sv} \quad (1)$$

where:

λ : the Slip ratio

Sv : the linear speed of the vehicle

$R.\omega$: the lineaire speed of the wheel

6. BOND GRAPH MODEL OF THE SYSTEM

The system treated by this paper is a hydraulic system, Nonlinear and controlled by a digital calculator. In the following we will propose a methodology of modeling by bond graph of a system composed of both subsystems: a digital subsystem operating in On/Off mode, this is the calculator and another nonlinear subsystem represents the solenoid valves and the check valves.

6.1. Elements of the Model

In the model appears the symbol of a diode. Several studies have used the model of the diode to achieve an electronic system model. Researchers [19] have modeled the diode as being a junction «0» with

Vd value and a dissipative element to design the model of a photovoltaic cell it has two different approaches: one called fixed topology and the other is the variable topology.

- *The variable topology of a diode*

In models with variable topology, semiconductors are always modeled by an open circuit, but in the off state they are generally modeled by a short circuit.

- *The fixed topology of a diode*

The model conventionally used for the representation of a semiconductor is considered as a binary resistor. The semiconductor is modeled according to its state of conduction: by high resistance “Roff” in its off state and a low resistance “Ron” while driving.

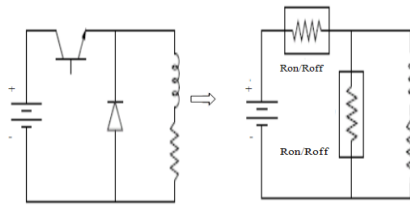

Figure 11. Fixed topology of a diode

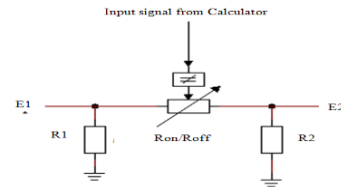

Figure 12. Equivalent circuit of an On/Off switch

The operation of the brake fluid requires that it can be considered as being incompressible, so that it transmits all the force applied to the brake pedal.

According to [6], the accumulator has the following characteristic: the Empty volume is 1.8 Cm³; the maximal volume is 2.3 cm³; the maximum pressure is 11 bars. In permanent regime the pressure is defined by:

$$P = \rho \cdot g \cdot h \quad (2)$$

The capacity of the tank is:

$$C = \frac{S}{\rho g} \quad (3)$$

where:

S: tank section

ρ : the density of brake oil is 1.06Kg/1

g: the value of gravity acceleration is 9.81

These informations allows to determine the value of the capacitive element which representing the accumulator. The switch is represented by the electrical circuit in figure 12.

The sequences of operation of the On/Off switch are as follows. If input signal from calculator =1, then Ron, else Roff. The two resistors R1 and R2 allow to switch E1 efforts variables and E2. Indeed, Ron if E2=E1 else Roff if E2=0. The other elements of the model are mentioned in the Table 1.

Table1. Elements of the Model

Elements	Subsystems
Pressure	Pressure produced by the master cylinder
Se	Power source
Chekvalve1	Oil check valve 1
Chekvalve2	Oil check valve 2
Chekvalve3	Oil check valve 3
Decrease	ECU signal to decrease the pressure
Increase	ECU signal to increase the pressure
GY motor	The drive motor of the discharge pump
Ipipe	The inductance of the pipe connecting the hydraulic unit to the oil tank
IIpipe	The inductance of the pipe connecting the master cylinder to the hydraulic unit
Inertia	The inertia of the motor shaft
Imotor	The excitation inductance of the motor
Orifice A	Upper orifice of the solenoid valve (Controlled by 2A)
Orifice B	Intermediate orifice of the solenoid valve (Controlled by 5A)
Orifice C	Lower orifice of the solenoid valve
Rfriction	The viscous friction of the motor shaft
Rloss	Pressure loss in the pipe
Rmotor	Wire resistance in the motor
Switch1	On / off resistance
Switch2	On / off resistance
Tank	Accumulator

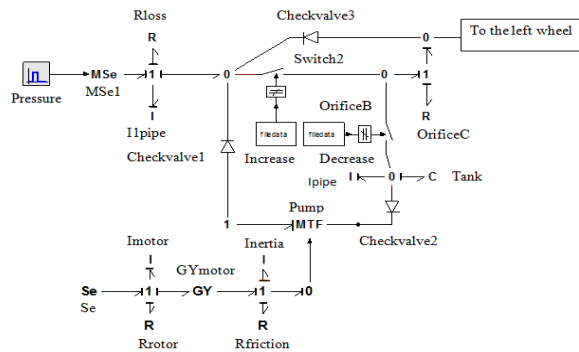

Figure 13. The bond graph model of the hydraulic system controlled by a calculator

The simulation of the previous model using the software 20 Sim shows that it is very slow. Indeed, in this model there are 47 variables, 53 equations, 4 state variables and 2 algebraic loops. This forces us to simplify this model, after neglecting the effects of some elements in the model.

Assuming that the losses in the pipes are negligible, this hypothesis makes it possible to neglect the resistance R_{loss} . Of more the length of the pipe is 1.2 meters, That is to say the inductance is 1.2 Henry, what minimizes the constant of time (L/R) . In this case it is possible to neglect the effects of the inductance I_{IIpipe} .

Knowing that Se is a DC voltage of 12 V. Consider the case where the DC motor operates in permanent regime. In this case the torque is constant; this makes the pump which transforms the torque in pressure by means of an eccentricity. And which is represented by the MTF element, can be represented by an element TF with constant transformation factor. This factor is determined according to the motor characteristic and the discharge pressure value.

6.2. Simulation of the Model

After simplifications previously indicated, the model simulation with the software 20 Sim gives the following results.

Figure 14 shows the control signals generated by the calculator, after taking into account the slip variation and the signals from the speed sensors. These two signals are called "to increase the pressure" during which, the calculator generates an intensity of 2A and the other signal has the name "to decrease the pressure" during which the calculator generates an intensity of 5A. During phase "maintain pressure" the calculator does not intervene because, it does not produce intensity.

Figure 15 represents the evolution of the pressure according to the evolution of the speed of the left wheel. This is a two-level signal, of which the pressure in the pipe which is to be applied to the wheel

assumes a value of 6 MPa, if the calculator has not detected a wheel lock. On the other hand the value is of the order of 2MPa if the calculator detects a blocking. The comparison between the pressure evolution in continuous control represented by figure 9, simulated by the two software CarSim and Simulink, and the curve on to Figure 15 simulated by the software 20 Sim, makes it possible to mention the remarks below.

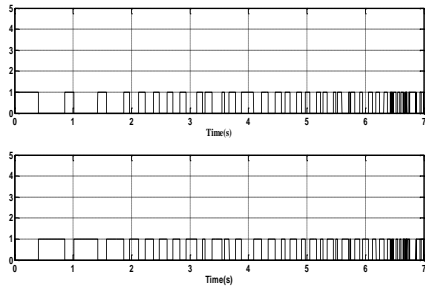

Figure 14. Calculator control signals during braking

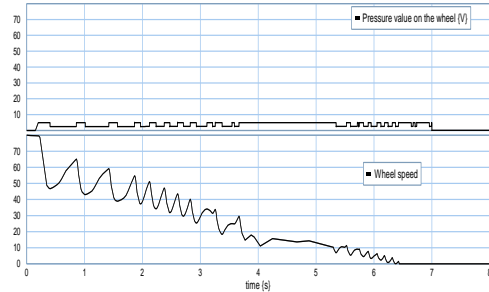

Figure 15. Pressure variation as a function of the speed of the left wheel

At the beginning when the speed varies between (80 and 60 km/h) the sliding represented by the figure 10 shows that the values are not critical. The behavior of two models is identical (low operating frequency), etc.

During the critical phase that is between 2 and 3.2 seconds, where the speed varies between 60 and 38 km/h, the slip ratio overtakes 2 %. The first model reacts by increasing the pressure value on the other hand the second reacts by increasing the switching frequency. During the time interval between 3.2 and 5 seconds, where the slip is low and the speed varies between 38 and 19 Km/h. The first model is reacted in the same manner as during the first phase where the speed is high. On the other hand, the second model works with the total pressure, it is reasonable because the sliding is unimportant. At the stop, between 6 and 7s, the pedal is still pressed; the first model is slower to reach its final value (6 MPa). However, the second model responds instantaneously and reaches the same final pressure value.

6.3. Functioning of the Model

During braking, the force (pressure) on the cathode of the check valve N ° 3 is greater than the force on the anode, and then this diode is blocked until the driver releases the pedal at time 8s. The variation of the flow variable (the oil flow) which passes through this diode is represented by figure 17.

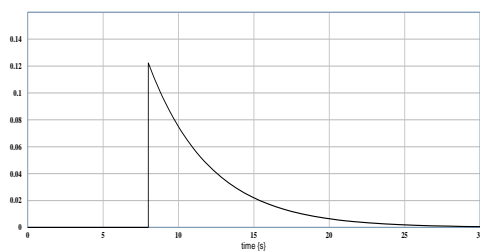

Figure 16. Oil flow rate, check valve 3

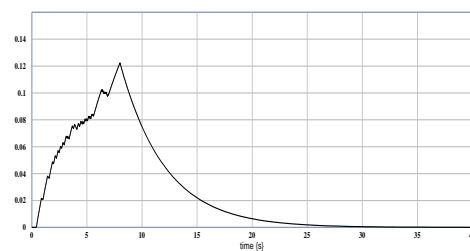

Figure 17. Flow variation in the pipeline

During the phase of increase of braking pressure, the valve N ° 1 is closed (diode blocked) and the connection with the valve N ° 2 is turned off. The anode of diode N ° 2 is subjected to the same force as the reservoir, but the diode is blocked (the circuit is open).

During the pressure holding phase, the states of diodes do not change. Having the calculator commands the On/Off resistance. The orifice C opens and the volume of the reservoir increases.

During the pressure reduction phase, the calculator opens the orifice B represented by a controlled switch. The flow (flow rate of oil) passes from the reservoir to the master cylinder under the action of the pump to accelerate the discharge this pump is schematized by a flow transformer. In this phase the two

diodes 1 and 2 conduct. The variation of the oil flow from the master cylinder to the brake disc is represented by the Figure 17.

7. CONCLUSION

This paper is a contribution to the field of modeling, wherein a methodology based on two tools has been proposed. The first tool is concerned with functional analysis to extract user functions and constraint parameters from the system, this is the SADT method. The system chosen to explain our contribution is the ABS braking system which is a dynamic system. For that reason, we used the bond graph method to study this behavior. The bond graph is an effective tool for monitoring internal and external system parameters. Indeed, any change in these parameters can be simulated after modifying the values of the passive elements that constitute the model. Thus, it shows its effect on the evolution of the outputs.

In this paper, we have used software of great aptitude for the modeling of multidisciplinary systems to explain the operation of the ABS braking system on the one hand, and to validate our contribution on the other. The results obtained by this approach make it possible to think about improving hydraulic or pneumatic systems in the industrial world, which minimizes the use of regulators.

REFERENCES

- [1] M. Vergé and D. Jaume, "Modélisation structurée des systèmes avec les bond Graphs," Edition TECHNIP, 2003.
- [2] Z. Khaouch, M. Zekraoui, J. Bengourram, N. Kouider and M. Mabrouki, "Mechatronic Modeling of a 750kW fixed-Speed Wind Energy Conversion System Using the Bond Graph Approach," ISA Transactions, 2017.
- [3] F. A. Salem and A. A. Mahfouz, "Mechatronics Subsystems, Classification, Role, Selection Criteria and Synergistic Integration in Overall System Design," American Journal of Educational Science, Vol. 2, No. 3, pp. 16-28, 2016.
- [4] M.B Barron and W.F Powers, "The Role of Electronic Controls for Future Automotive Mechatronic Systems", IEEE/ASMA Transactions on mechatronics, 1996.
- [5] L. Liang Xujian, L. Xiangyu Wang, Y. Liu, J. Song and X. Ran," Transient Switching Control Strategy from Regenerative Braking to anti-lock Braking with a Semi-brake-by-wire System," International Journal of Vehicle Mechanics and Mobility, Vol 54,No 2, pp 231-257, 2016.
- [6] J. Ben Salem, M. N. Lakhoua and L. El Amraoui, "System Approach Based on the Bond Graph Applied to Anti-lock Braking System," Journal Automation & Systems Engineering, vol 11, no 1, pp 1-10, 2017.
- [7] K. Chun Huang and S. Ming-Chang, "Design of a Hydraulic Anti-lock Braking System (ABS) for a Motorcycle," Journal of Mechanical Science and Technology, Vol 24, No 5, pp 1141–1149,2010
- [8] J. Chankit, R. Abhishek, D. Abhishek, "Linear Control Technique for Anti-Lock Braking System," Journal of Engineering Research and Applications, Vol. 4, No 8, pp 104-108, 2014.
- [9] L. Chun-Liang and Y. Meng-Yao, "Design of Anti-lock Braking System for Electric Vehicles via Short-circuit Braking," Second International Conference on Mechanic Automation and Control Engineering (MACE), 2011.
- [10] P. Jaulent, "Génie logiciel les méthodes : SADT, SA, E-A, SA-RT, SYS-P-O, OOD, HOOD," Armand Colin, 1992.
- [11] A. Mughal, "Elements of BG Real Time Modeling, Simulation and Control of Dynamical Systems," Springer, 2016.
- [12] L.Cheng, Z.Ye, Z.Eong, "BG Modeling and Simulation Analysis of Direct Drive Volume Control Electro-hydraulic Servo System With Long Pipeline," International Conference on Aircraft Utility Systems (AUS), IEEE/CSAA ,2016