

Internet of Things: Low Cost and Wearable SpO₂ Device for Health Monitoring

R. R. Adiputra, S. Hadiyoso, Y. Sun Hariyani

Telkom Applied Science School, Telkom University, Indonesia

Article Info

Article history:

Received Sep 9, 2017

Revised Dec 27, 2017

Accepted Jan 13, 2018

Keyword:

Heart rate

Internet of things

Oxygen saturation

Real time

Website

ABSTRACT

This paper discusses a device for measuring oxygen saturation (SpO₂) and heart rate as parameters of the representations of heart conditions. SpO₂ device that have been made has a small dimension, wearable and high mobility with battery as the main power source. The device connects to a node MCU as a data processor and an internet network gateway to support internet of things applications. Data sent to the Internet cloud can be accessed online and real time via website for further analysis. The error rate at heart rate measurement is ± 2.8 BPM and for oxygen saturation (SpO₂) is $\pm 1.5\%$. Testing data transmission delay until it can be displayed on website is 3 second that depends on internet traffic conditions.

Copyright © 2018 Institute of Advanced Engineering and Science.
All rights reserved.

Corresponding Author:

S. Hadiyoso,

Telkom Applied Science School,

Telkom University,

Telekomunikasi Rd. Terusan Buah Batu, Bandung 40257, Indonesia.

Email: sugondo@telkomuniversity.ac.id

1. INTRODUCTION

The development of information technology, encouraging innovation and change involving experiments in health. Utilization of information technology in this field is the process of recording, examination, diagnosis, treatment, intensive care, monitoring, medical rehabilitation and others. It aims to improve the service and ease of access by the people. Furthermore, penetration of internet users continues to increase, followed by an increase in service quality. This is one of the opportunities in developing internet-based applications called internet of things (IoT). IoT development in health services for example real time monitoring application facilitates easy access, flexible, fast access and medical record.

One of health organ parameter which is of serious concern is the heart organ. The simplest of heart health representation can be represented by oxygen saturation (SpO₂) and heart rate. Measurement of SpO₂ used for early detection of hypoxemia [1]. Continuous monitoring of SpO₂ is also required for physiological trauma management [1]. In some conditions (eg patients with chronic disease or elderly people) monitoring can be done remotely called home care/health monitoring [2-4] based on IoT concept. The wireless pulse oximeter product on [5] is equipped with intelligent monitoring system, suitable for home care monitoring.

The development of pulse oximeter technology is very significant with the trend of high mobility, low power, wireless and low price. Some research on the realization of low cost pulse oximeter have been performed on [6-8]. But not yet support remote monitoring application, the measurement result can only be seen on display device. Other studies [9-12], realized the health monitoring device with wireless transmission but access to local area only. In fact in many conditions, between patients with medical expert are located in a remote location but needed monitoring in real time and continuous. Related research on Photoplethysmogram to measure pulse rate at [13], [14] but the device has not been used to measure SpO₂.

Therefore, it needs a digital pulse oximeter that is wearable, high mobility and can be used for continuous monitoring through the global internet network. In this paper we discussed an IoT application for monitoring pulse oximeter include SpO2 and heart rate device. With this device, patients and medical experts can monitor these parameters at any time and anywhere. The contribution of this research is to develop a health device that uses local components and also embedded system applications based on IoT to improve health services. Oxygen saturation meter has high accuracy comparable to standard medical devices and can be used for remote monitoring application.

2. METHODOLOGY

The implemented system, shown in Figure 1, consists of the hardware part of the finger sensor, the oximeter module which will calculate the heart rate and oxygen saturation (SpO2) as well as the MCU node that will serve as the gateway to the internet. In this work, the data will be sent via the internet so that the measurements can be seen on the patient's side and the doctor / hospital in realtime in the form of display on the website. Data is also stored in the database so it can be displayed again to see the progress of patient health. The analog front end design of the oximeter module is shown in Figure 2.

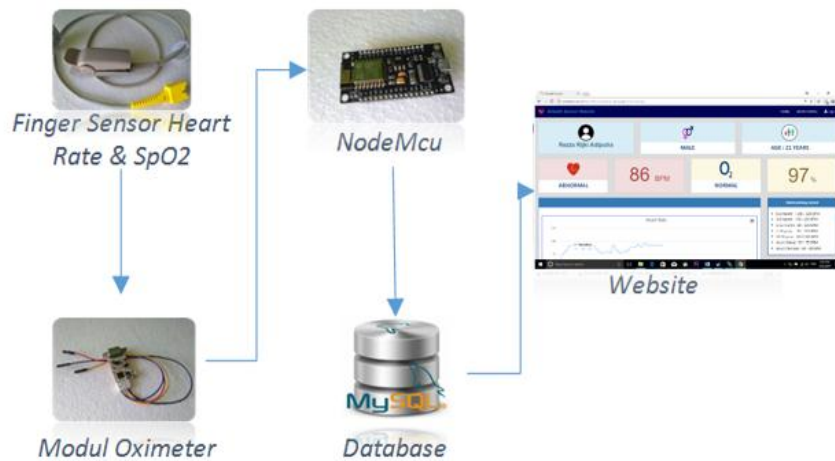

Figure 1. Implemented System

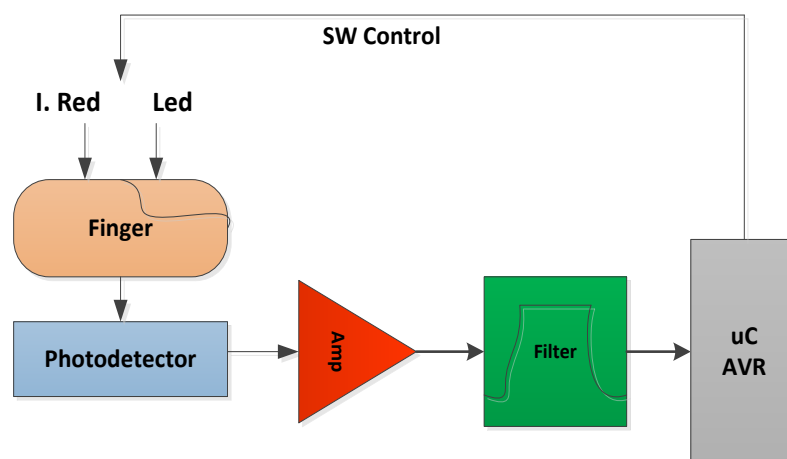

Figure 2. Analog Front End of Pulse Oximeter

The oxygen saturation measurement is compared the light absorption in the photodetector of the two different light waves, the equation is [15].

Figure 3 shows the illustration to obtain HR.

$$R = \frac{AC_{red} / DC_{red}}{AC_{ired} / DC_{ired}} \tag{1}$$

and the equation to obtain heart rate (HR) is

$$HR = \frac{60}{(T_{peak N+1} - T_{peak N}) \text{ second}} \tag{2}$$

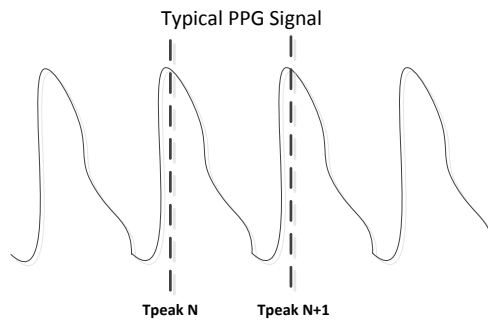

Figure 3. Illustration to obtain HR

The flow diagram of device usage can be seen in Figure 5. Patients must input name and age on the website interface and put on finger sensor probe. On the probe there is a light source and a light detector. The light source located on one side of the probe will result in red and infrared light to be emitted through the fingertips, light traveling through the fingers will then be detected by the photodiode. From the measured light intensity changes, SpO2 and heart rate values are obtained. The digital value of the readout results then sent to the database cloud via NodeMCU as the gateway.

The website will retrieve data from the database cloud and display the results of heart rate and oxygen saturation both of values and graphs form in real time as shown in Figure 4. In addition to displaying measurement data, the website also displays the condition of patients with Normal and Abnormal based on heart rate, SpO2, sex and age of patient.

On the other side, hospital admins can see the patient's measurements record for ease in performing the right treatment to the patient, as shown in Figure 6.

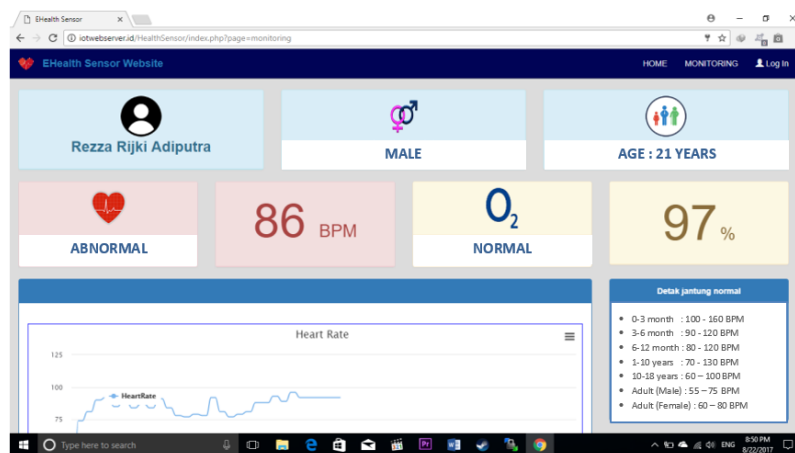

Figure 4. Website Display: sample measurement results

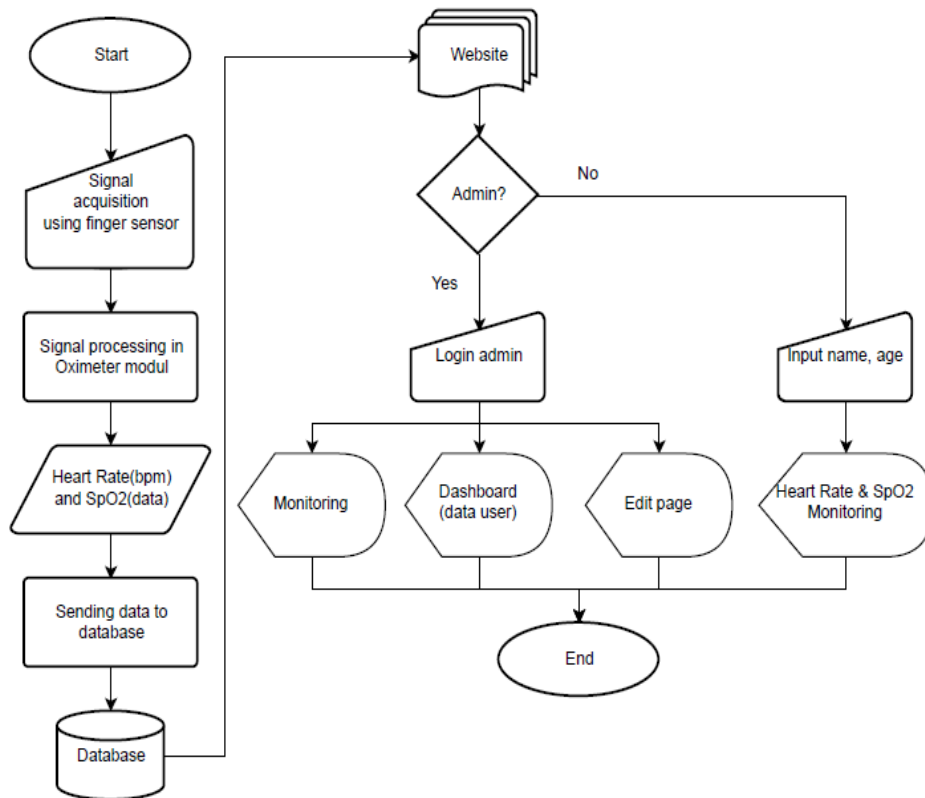

Figure 5. Work Flow Diagram of System

NO	Name	Age	Sex	Record	Date	Time	HR	SpO2
1	Ahmad Mudhofar	21	M	Check up	22/08/17	09:34:28	84	97
2	Ahmad Mudhofar	21	M	Check up	22/08/17	09:34:25	84	97
3	Ahmad Mudhofar	21	M	Check up	22/08/17	09:34:12	88	98
4	Ahmad Mudhofar	21	M	Check up	22/08/17	09:34:10	88	98
5	Ahmad Mudhofar	21	M	Check up	22/08/17	09:34:03	90	96
6	Ahmad Mudhofar	21	M	Check up	22/08/17	09:34:01	90	96
7	Ahmad Mudhofar	21	M	Check up	22/08/17	09:33:53	88	97
8	Ahmad Mudhofar	21	M	Check up	22/08/17	09:33:50	88	97
9	Ahmad Mudhofar	21	M	Check up	22/08/17	09:33:42	91	97
10	Ahmad Mudhofar	21	M	Check up	22/08/17	09:33:40	91	97
11	Ahmad Mudhofar	21	M	Check up	22/08/17	09:33:32	88	97
12	Ahmad Mudhofar	21	M	Check up	22/08/17	09:33:30	88	97
13	Ahmad Mudhofar	21	M	Check up	22/08/17	09:33:22	95	96
14	Ahmad Mudhofar	21	M	Check up	22/08/17	09:33:20	95	96

Figure 6. Recorded Data

3 RESULT AND DISCUSSION

Verification of measurement results is done by comparing the measurement of the proposed device with the standard clinical instrument (Mindray patient monitor). Sample of measurements result is taken every 10 seconds either on the proposed device or Mindray. Table 1 shows an example of measurement results on the first 5 data for male patients with 20 years old.

Comparison of measured heart rate and SpO2 data can be seen in Figure 7. Measurement results from 15 sample shown on Figure 8 and Figure 9, the average difference of heart rate reading is ± 2.8 bpm and the average difference of SpO2 reading is $\pm 1.5\%$.

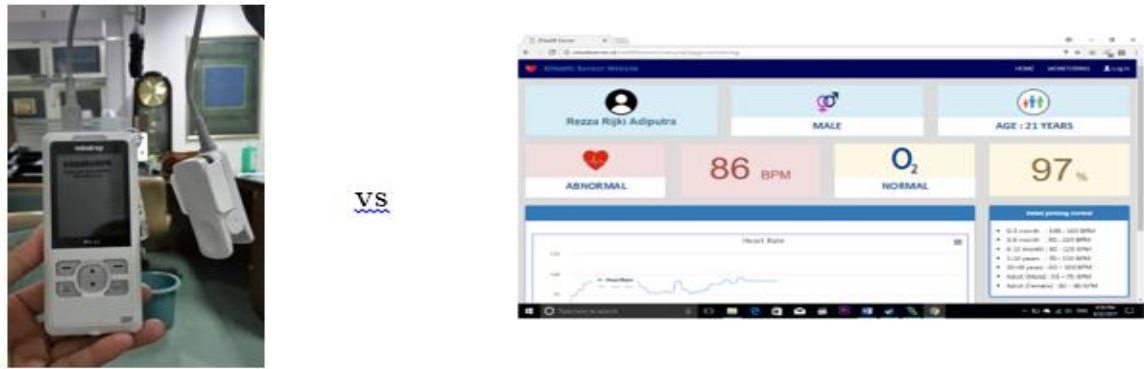

Figure 7. Comparison of measured heart-rate and SpO2

Table 1. Comparison of test results

NO	Mindray		Proposed Device		Note
	Heart Rate(bpm)	SpO ₂ (%)	Heart Rate (bpm)	SpO ₂ (%)	
1	84	99	83	97	Male 20 Years old
2	77	98	81	97	
3	85	98	84	97	
4	79	98	79	96	
5	82	98	81	97	

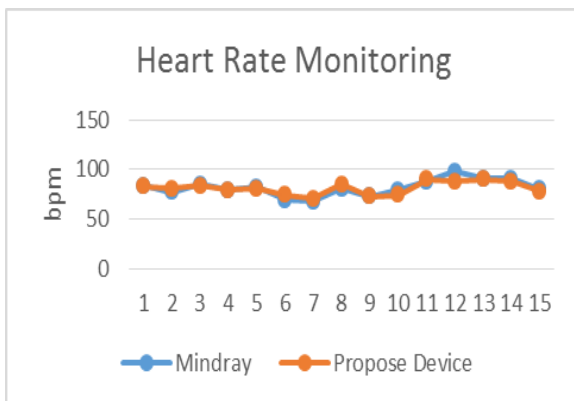

Figure 8. Measured HR(bpm) using mindray and proposed device

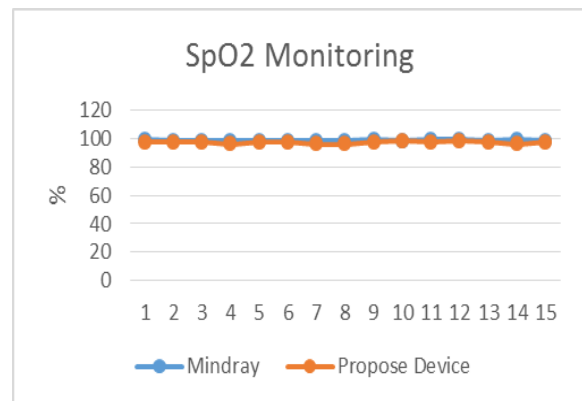

Figure 9. Measured SpO2(%) using mindray and proposed device

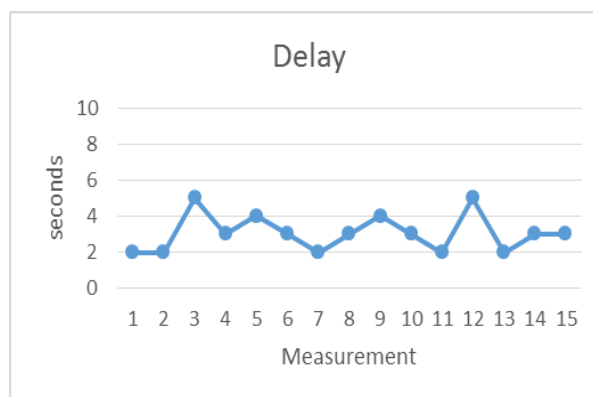

Figure 9. Delay testing result

To perform QoS on realtime service, also conducted the delay test which is done to know how long the process of sending the required data from oximeter module to be displayed in the website by looking at the time since the data sent by oximeter module until displayed on the website. Testing is done using Wifi connection with Bandwidth 10Mbps. The measurement results can be seen in Figure 10, with an average delay of 3 seconds.

4 CONCLUSION

We have successfully realized device to measure oxygen saturation and pulse rate for IoT application. Both data are successfully sent to the cloud and are widely accessible through web pages. From the result of the accuracy test, it is found that the difference of reading with mindray device is ± 2.8 bpm for heart rate and $\pm 1.5\%$ for oxygen saturation (SpO₂). From the result of delay measurement by doing 15 times of data transmission test got result of delay equal to 3 second.

ACKNOWLEDGEMENT

This research is funded by The Government of the Republic of Indonesia, through "Penelitian Produk Terapan" scheme in year 2017. We would like to thank the Government for financial support of the research and School of Applied Science which provides laboratory and testing tools for the prototype implementation.

REFERENCES

- [1] F. Adochiei, C. Rotariu, R. Ciobotariu and H. Costin, "A Wireless Low-Power Pulse Oximetry System for Patient Telemonitoring," in *Advanced Topic in Electrical Engineering*, Bucharest, 2011.
- [2] H. Costin, C. Rotariu et al., "TELEMON – Complex System for Real Time Medical Telemonitoring of Vital Signs", in *Advancements of Medical Bioengineering and Informatics*, ISSN: 2066-7590, pp. 17-23, 2009.
- [3] Y. Jingjing, H. Shangfu, Z. Xiao, G. Benzhen, L. Yu, D. Beibei and L Yun, "Family Health Monitoring System Based on the Four Sessions Internet of Things", *TELKOMNIKA (Telecommunication Computing Electronics and Control)*, Vol.13, No.1, March 2015, pp. 314-320.
- [4] H. S. Kim, J. S. Seo and J. Seo, "A Daily Activity Monitoring System for Internet of Things Assisted Living in Home Area Networks", *International Journal of Electrical and Computer Engineering (IJECE)*, Vol. 6, No. 1, February 2016, pp. 399-405.
- [5] A.H. Kendrick, "Pulse Oximetry" in Buyers' Guide to Respiratory Care Products, online available at http://dev.ersnet.org/uploads/Document/0b/WEB_CHEMIN_2568_1194523770.pdf.
- [6] R. Yanuardhi, D. Soegiarto, A. Sularsa. "Rancang Bangun Pulse Oximetry Digital Berbasis Mikrokontroler Atmega 16", *e-Proceeding of Applied Science*, ISSN: 2442-5826, Vol.2, No.1 April 2016, pp. 332-338.
- [7] D. P. P. Indriani, Yudianingsih, E. L. Utari, "Perancangan Pulse Oximetry Dengan Sistem Alarm Prioritas Sebagai Vital Monitoring Terhadap Pasien", *Jurnal Teknologi Informasi*, Vol . IX Nomor 27 Nopember 2014, pp. 93-107
- [8] A.A. Putra , Kemalasari, P. Susetyo, "Rancang Bangun Pulse Oximetry Digital Berbasis Mikrokontroler", Publikasi ilmiah
- [9] A.S. Ekhare, U. M. Chaskar, "Design and Development of Low Unit Cost and Longer Battery Life Wireless Pulse Oximetry System", in International Conference on Advances in Computing and Communications, DOI 10.1109/ICACC.2014.73, pp. 278-285, 2014.
- [10] K. AlSharqi, A. Abdelbari, A. Abou-Elnour, and M. Tarique, "Zigbee Based Wearable Remote Healthcare Monitoring System for Elderly Patients", *International Journal of Wireless & Mobile Network*, Vol. 6, No. 3, June 2014
- [11] Y. Dai, J. Luo, "Design of Noninvasive Pulse Oximeter Based on Bluetooth 4.0 BLE", in International Symposium on Computational Intelligence and Design, DOI 10.1109/ISCID.2014.45, pp. 100-103, 2014.
- [12] E. Riyanto, H. Supriyono, U. Fadhillah, "Perancangan Pengukur Detak Jantung dan Suhu Tubuh Berbasis Arduino serta Smartphone Android", Publikasi Ilmiah, Universitas Muhammadiyah Surakarta , 2016.
- [13] E. C. Hai Yin and V. Muthukumar, "Intelligent Pillow for Heart Rate Monitor", *International Journal of Electrical and Computer Engineering (IJECE)*, Vol. 3, No. 6, December 2013, pp. 791-796
- [14] A. Rizal, et al., "Development of Wireless Patient's Vital Sign Monitor Using Wireless LAN (IEEE.802.11.b/g) Protocol", *International Journal of Electrical and Computer Engineering (IJECE)*, Vol. 4, No. 6, December 2014, pp. 893-901.
- [15] S. Lopez, "Pulse Oximeter Fundamentals and Design" Freescale Semiconductor Application Note, Document Number: AN4327, 2012.

BIOGRAPHIES OF AUTHORS

Rezza Rijki Adiputra received the Diploma of Telecommunication Engineering from Telkom University, Bandung, Indonesia in August 2017. His final project is “Monitoring of Oxygen Saturation (SpO₂) and Heart Rate Based on Website”.



Sugondo Hadiyoso received the Master.in Electrical-Telecommunication Engineering from Telkom University, Bandung, Indonesia in March 2012. He joined as a Lecturer in the department of Electronics and Communication Engineering of Telkom University, in 2010. where he is currently members of Biomedical Instrumentation Research Group in Telkom Univesity. His research interests are wireless sensor network, embedded system, logic design on FPGA and biomedical engineering.



Yuli Sun Hariyani received the Master.in Electrical-Telecommunication Engineering from Telkom University, Bandung, Indonesia. She joined as a Lecturer of Telkom University, in 2010. Her research interests are compressive sampling, Image Processing and Biomedical Engineering.